

VAULT WEST WALL ELEVATION

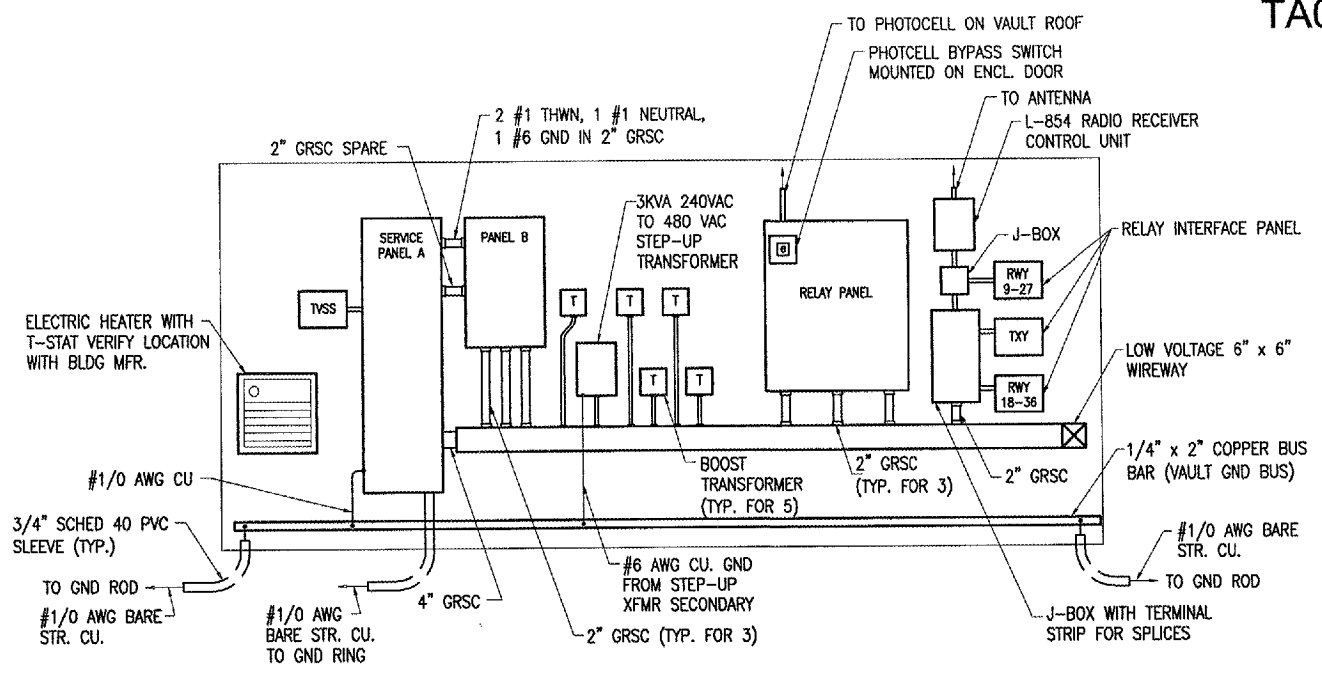

VAULT EAST WALL ELEVATION

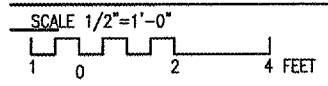
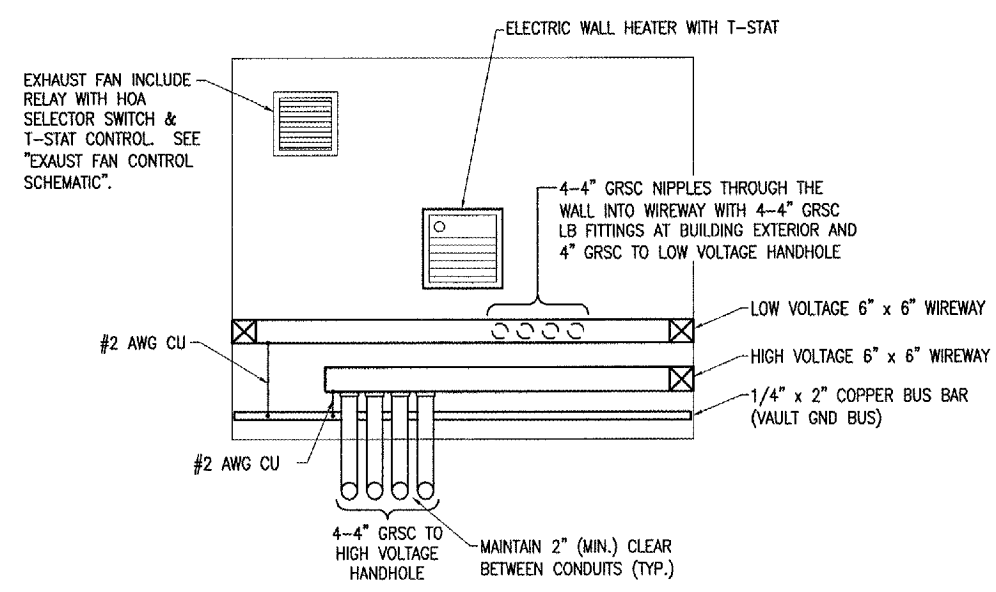
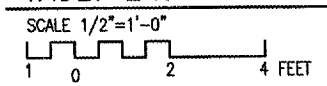

VAULT SOUTH WALL ELEVATION

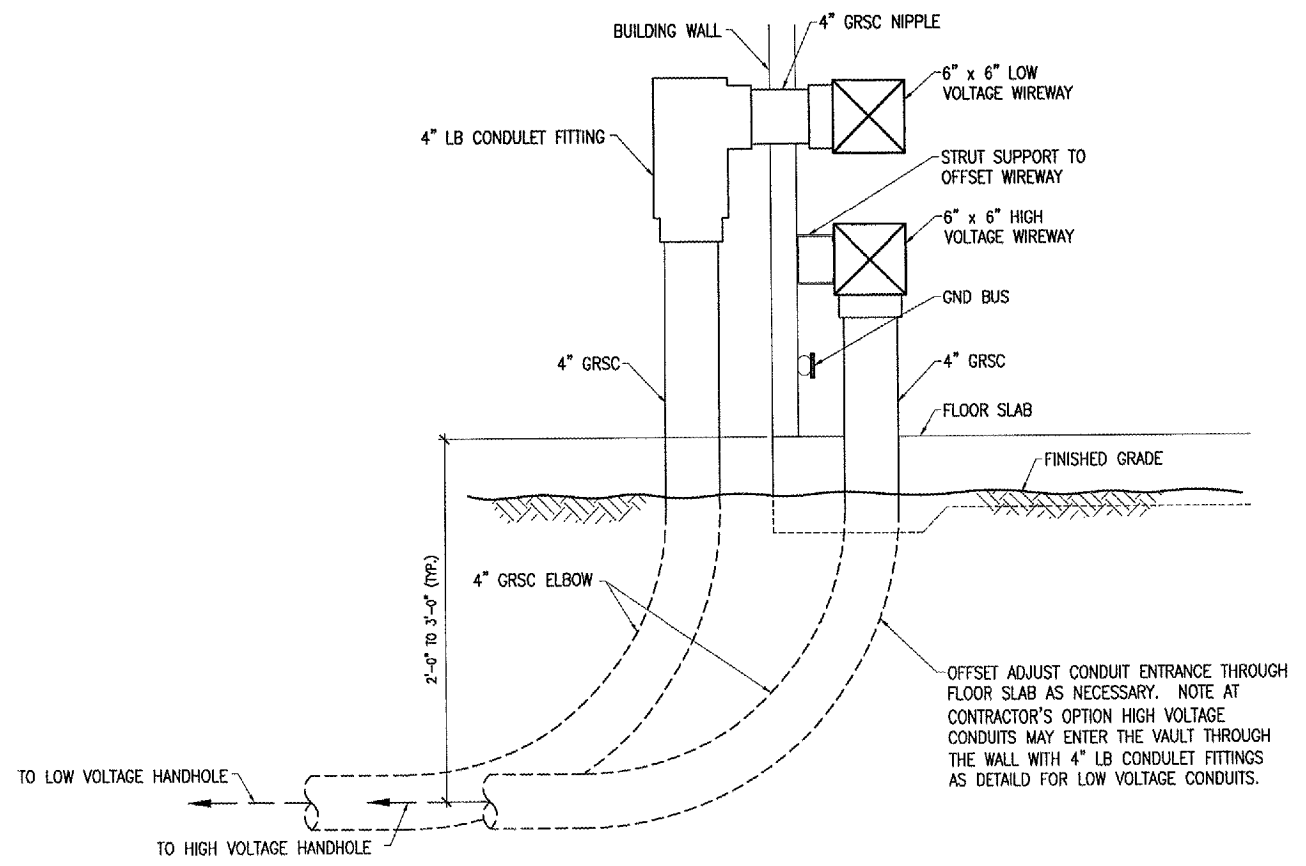
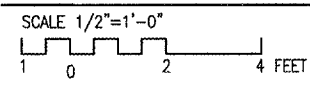

CONDUIT ENTRANCE DETAIL

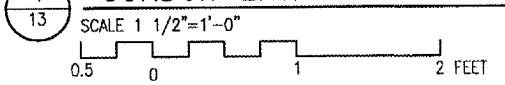

BY	
REVISION	
DATE	

TAYLORVILLE MUNICIPAL AIRPORT  
 TAYLORVILLE, ILLINOIS

IL PROJ.: TAZ-3166 A.I.P. PROJ.: 3-17-0100-B7

Proj. No. 828-03RWYGD_0800	02/22/05
Figure E-201.DWG	02/22/05
Scale 1/2"=1'-0"	02/22/05
Date 04/22/05	03/28/05
LAYOUT KNL	CAH
DRAWN MAE	
REVIEWED CAH	



CONSTRUCT  
 RUNWAY 9-27  
 PROPOSED  
 AIRPORT ELECTRICAL VAULT  
 WALL ELEVATIONS

APR 07, 2005 11:17 PM RAW I:\AIRPORTS\TAYLORVILLE\828-03RWYGD\AIRPORT\SHEETS\E-201.DWG - E-7