

F.A.U. RTE.	SECTION	COUNTY	TOTAL SHEETS	SHEET NO.
5012	02-00098-00-FP	BOONE	30	24
STA. 1+00 TO 7+50				

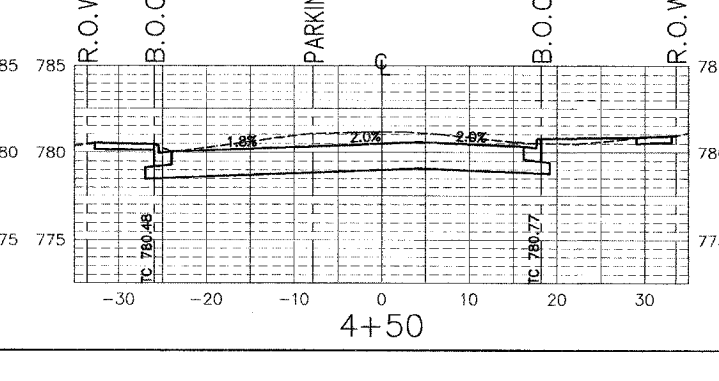
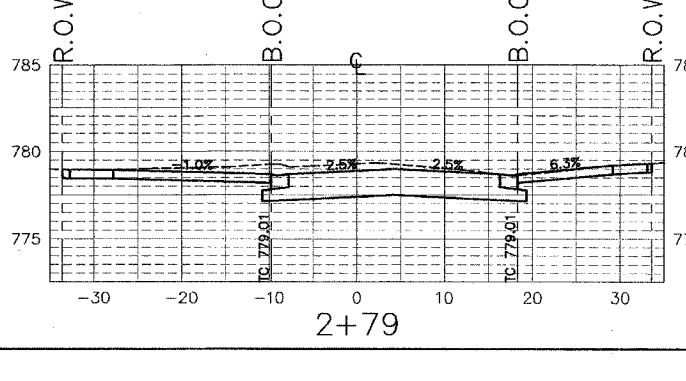
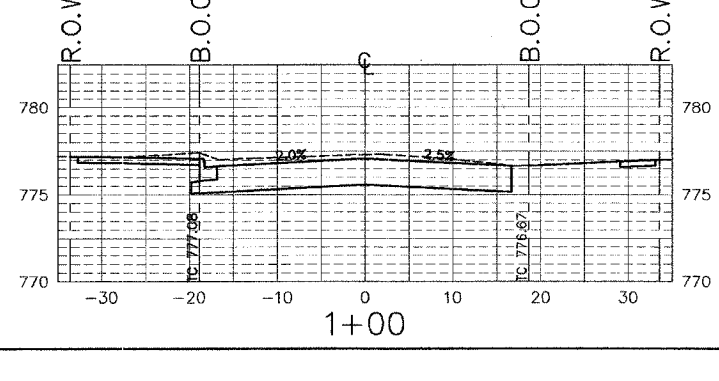
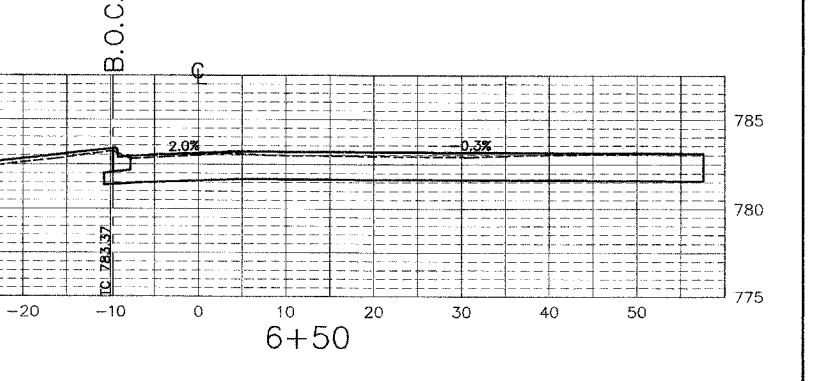
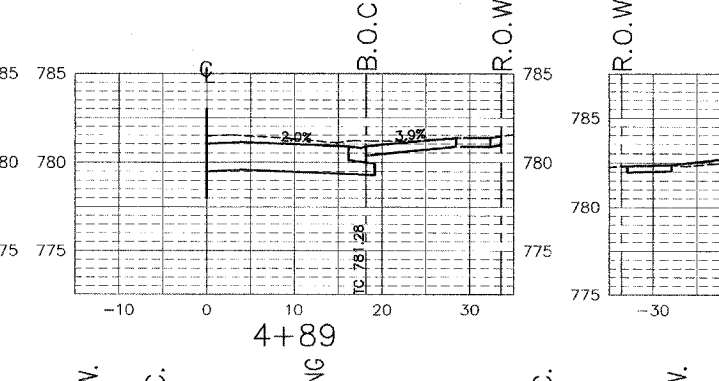
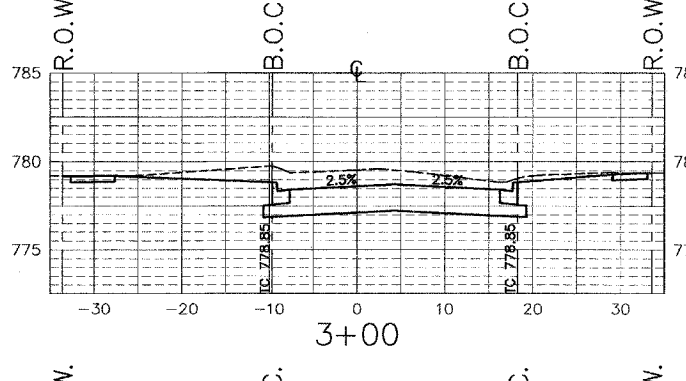
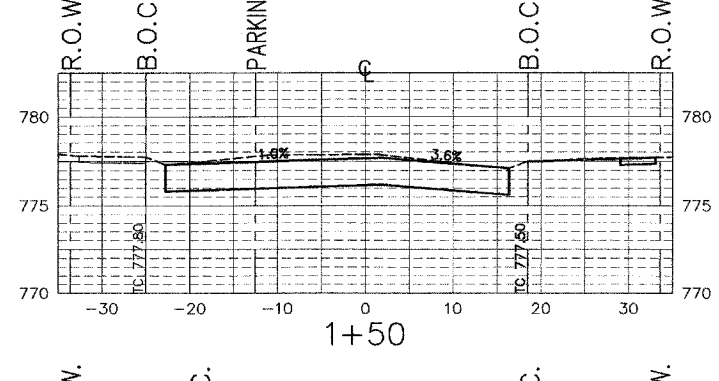
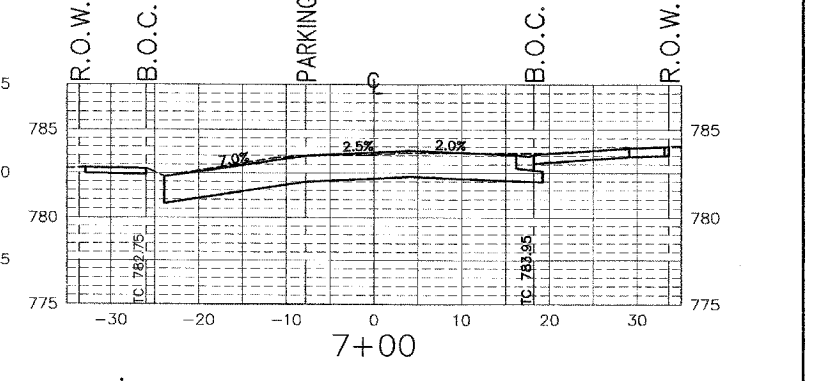
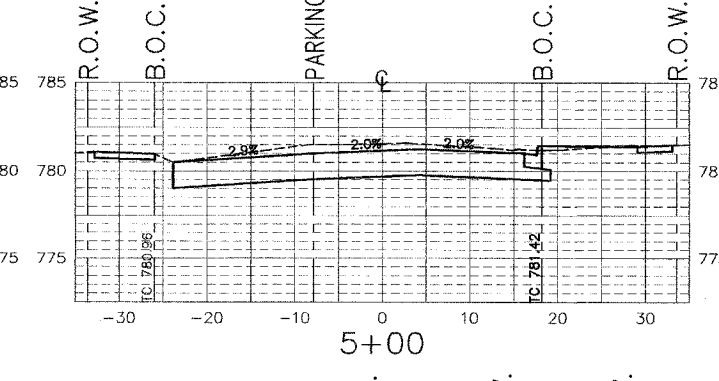
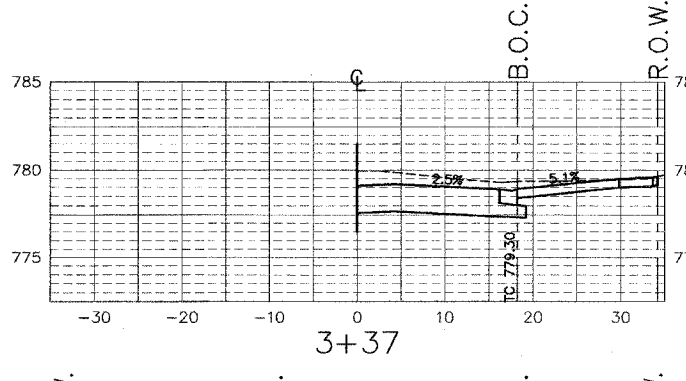
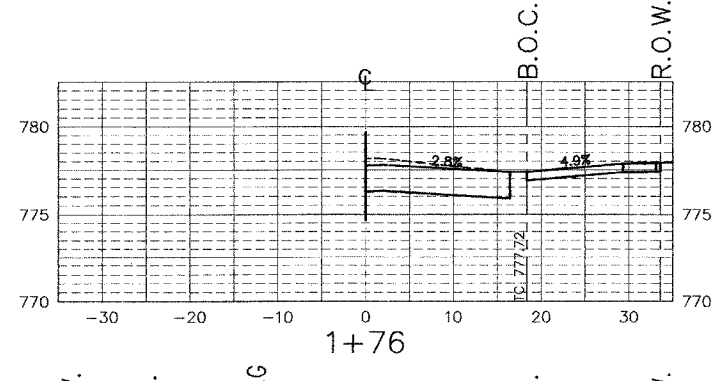
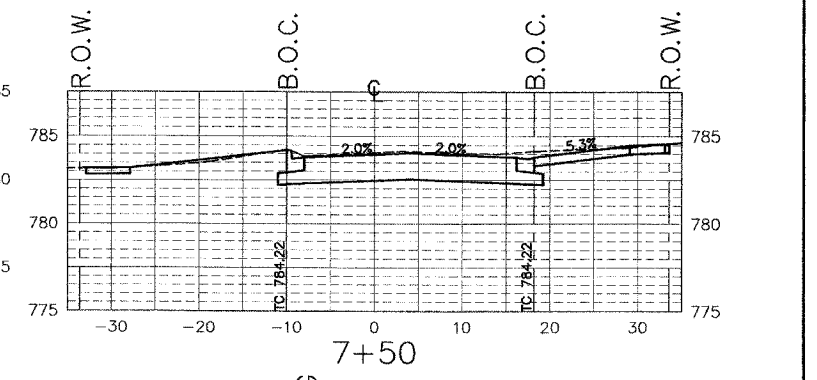
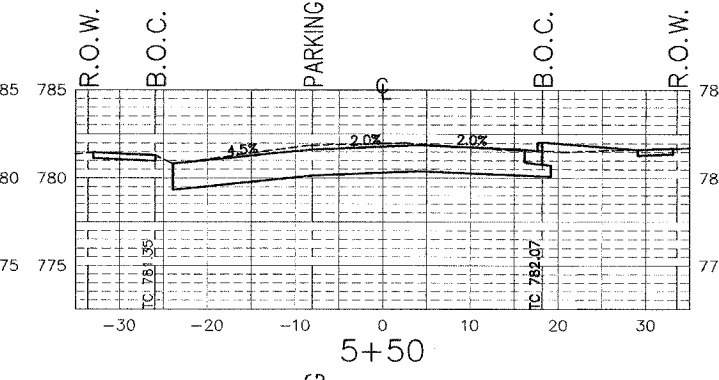
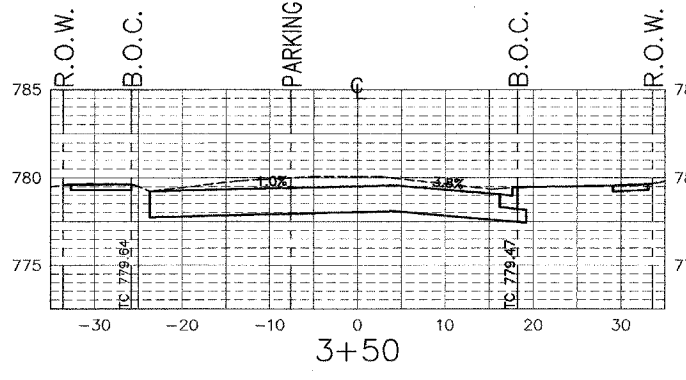
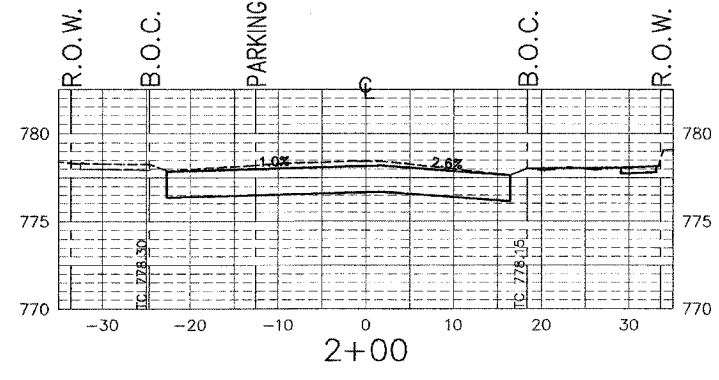
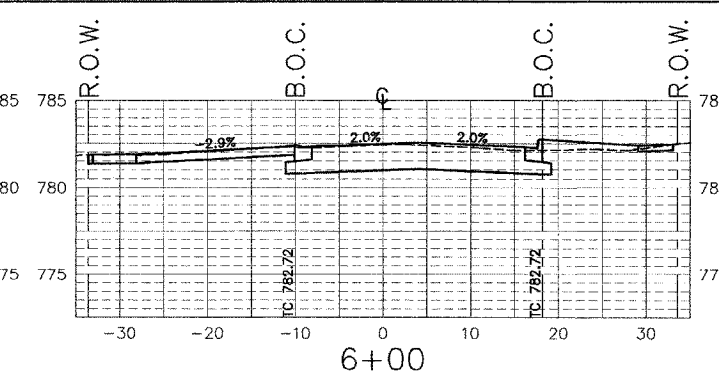
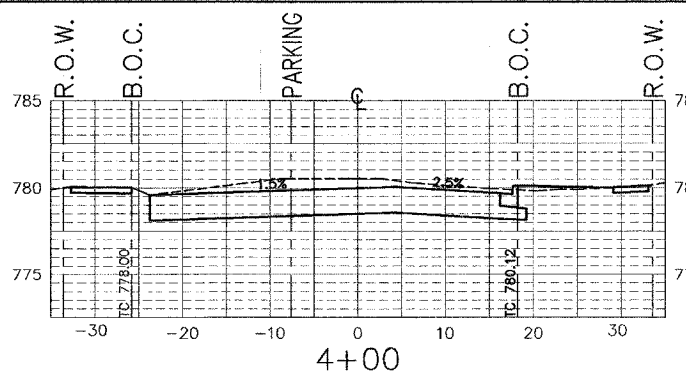
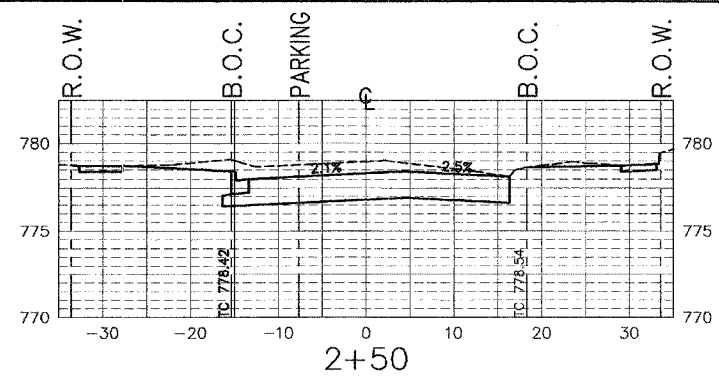

SCALES  
 HORIZ.: 1" = 10'  
 VERT.: 1" = 5'