

If you plan to submit a bid directly to the Department of Transportation

PREQUALIFICATION

Any contractor who desires to become pre-qualified to bid on work advertised by IDOT must submit the properly completed pre-qualification forms to the Bureau of Construction no later than 4:30 p.m. prevailing time twenty-one days prior to the letting of interest. This pre-qualification requirement applies to first time contractors, contractors renewing expired ratings, contractors maintaining continuous pre-qualification or contractors requesting revised ratings. To be eligible to bid, existing pre-qualification ratings must be effective through the date of letting.

REQUESTS FOR AUTHORIZATION TO BID

Contractors downloading and/or ordering CD-ROM's and are wanting to bid on items included in a particular letting must submit the properly completed "Request for Authorization to Bid/or Not For Bid Status" (BDE 124INT) and the ORIGINAL, signed and notarized, "Affidavit of Availability" (BC 57) to the proper office no later than 4:30 p.m. prevailing time, three (3) days prior to the letting date.

WHO CAN BID ?

Bids will be accepted from only those companies that request and receive written **Authorization to Bid** from IDOT's Central Bureau of Construction.

WHAT CONSTITUTES WRITTEN AUTHORIZATION TO BID? When a prospective prime bidder submits a "Request for Authorization to Bid/or Not For Bid Status" (BDE 124INT) he/she must indicate at that time which items are being requested For Bidding purposes. Only those items requested For Bidding will be analyzed. After the request has been analyzed, the bidder will be issued a **Proposal Denial and/or Authorization Form**, approved by the Central Bureau of Construction, that indicates which items have been approved For Bidding. If **Authorization to Bid** cannot be approved, the **Proposal Denial and/or Authorization Form** will indicate the reason for denial.

ABOUT AUTHORIZATION TO BID: Firms that have not received an authorization form within a reasonable time of complete and correct original document submittal should contact the department as to status. This is critical in the week before the letting. These documents must be received three days before the letting date. Firms unsure as to authorization status should call the Prequalification Section of the Bureau of Construction at the number listed at the end of these instructions.

ADDENDA AND REVISIONS: It is the contractor's responsibility to determine which, if any, addenda or revisions pertain to any project they may be bidding. Failure to incorporate all relevant addenda or revisions may cause the bid to be declared unacceptable.

Each addendum will be placed with the contract number. Addenda and revisions will also be placed on the Addendum/Revision Checklist and each subscription service subscriber will be notified by e-mail of each addendum and revision issued.

The Internet is the Department's primary way of doing business. The subscription server e-mails are an added courtesy the Department provides. It is suggested that bidder check IDOT's website <http://www.dot.il.gov/desenv/delett.html> before submitting final bid information.

IDOT is not responsible for any e-mail related failures.

Addenda Questions may be directed to the Contracts Office at (217)782-7806 or D&Econtracts@dot.il.gov

Technical Questions about downloading these files may be directed to Tim Garman (217)524-1642 or garmantr@dot.il.gov.

WHAT MUST BE INCLUDED WHEN BIDS ARE SUBMITTED?: Bidders need not return the entire proposal when bids are submitted. That portion of the proposal that must be returned includes the following:

1. All documents from the Proposal Cover Sheet through the Proposal Bid Bond
2. Other special documentation and/or information that may be required by the contract special provisions

All proposal documents, including Proposal Guaranty Checks or Proposal Bid Bonds, should be stapled together to prevent loss when bids are processed by IDOT personnel.

ABOUT SUBMITTING BIDS: It is recommended that bidders deliver bids in person to insure they arrive at the proper location prior to the time specified for the receipt of bids. Any bid received at the place of letting after the time specified will not be accepted.

WHO SHOULD BE CALLED IF ASSISTANCE IS NEEDED?

Questions Regarding	Call
Prequalification and/or Authorization to Bid	(217)782-3413
Preparation and submittal of bids	(217)782-7806
Mailing of plans and proposals	(217)782-7806
Electronic plans and proposals	(217)524-1642

ADDENDUMS AND REVISIONS TO THE PROPOSAL FORMS

Planholders should verify that they have received and incorporated the addendum and/or revision prior to submitting their bid. Failure by the bidder to include an addendum could result in a bid being rejected as irregular.

141

RETURN WITH BID

Proposal Submitted By
Name
Address
City

Letting June 17, 2005

BIDDERS NEED NOT RETURN THE ENTIRE PROPOSAL
(See instructions inside front cover)

NOTICE TO PROSPECTIVE BIDDERS

This proposal can be used for bidding purposes by only those companies that request and receive written AUTHORIZATION TO BID from IDOT's Central Bureau of Construction.
(SEE INSTRUCTIONS ON THE INSIDE OF COVER)

Notice To Bidders, Specifications, Proposal, Contract and Contract Bond



**Illinois Department
of Transportation**

Springfield, Illinois 62764

Contract No. 64A65
ROCK ISLAND County
Section D2 PATCHING 2005-4
District 2 Construction Funds
Route FAI 74

PLEASE MARK THE APPROPRIATE BOX BELOW:

- A Bid Bond is included.
- A Cashier's Check or a Certified Check is included.

Plans Included
Herein

Prepared by

S

Checked by

(Printed by authority of the State of Illinois)

INSTRUCTIONS

ABOUT IDOT PROPOSALS: All proposals issued by IDOT are potential bidding proposals. Each proposal contains all Certifications and Affidavits, a Proposal Signature Sheet and a Proposal Bid Bond required for Prime Contractors to submit a bid after written **Authorization to Bid** has been issued by IDOT's Central Bureau of Construction.

WHO CAN BID?: Bids will be accepted from only those companies that request and receive written **Authorization to Bid** from IDOT's Central Bureau of Construction. To request authorization, a potential bidder must complete and submit Part B of the Request for Authorization to Bid/or Not For Bid Status form (BDE 124 INT) and submit an original Affidavit of Availability (BC 57).

WHAT CONSTITUTES WRITTEN AUTHORIZATION TO BID?: When a prospective prime bidder submits a "Request for Proposal Forms and Plans" he/she must indicate at that time which items are being requested For Bidding purposes. Only those items requested For Bidding will be analyzed. After the request has been analyzed, the bidder will be issued a **Proposal Denial and/or Authorization Form**, approved by the Central Bureau of Construction, that indicates which items have been approved For Bidding. If **Authorization to Bid** cannot be approved, the **Proposal Denial and/or Authorization Form** will indicate the reason for denial. If a contractor has requested to bid but has not received a **Proposal Denial and/or Authorization Form**, they should contact the Central Bureau of Construction in advance of the letting date.

WHAT MUST BE INCLUDED WHEN BIDS ARE SUBMITTED?: Bidders need not return the entire proposal when bids are submitted. That portion of the proposal that must be returned includes the following:

1. All documents from the Proposal Cover Sheet through the Proposal Bid Bond
2. Other special documentation and/or information that may be required by the contract special provisions

All proposal documents, including Proposal Guaranty Checks or Proposal Bid Bonds, should be stapled together to prevent loss when bids are processed by IDOT personnel.

ABOUT SUBMITTING BIDS: It is recommended that bidders deliver bids in person to insure they arrive at the proper location prior to the time specified for the receipt of bids. Any bid received at the place of letting after the time specified will not be accepted.

WHO SHOULD BE CALLED IF ASSISTANCE IS NEEDED?

Questions Regarding	Call
Prequalification and/or Authorization to Bid	217/782-3413
Preparation and submittal of bids	217/782-7806
Mailing of CD-ROMS	217/782-7806

RETURN WITH BID



PROPOSAL

TO THE DEPARTMENT OF TRANSPORTATION

1. Proposal of _____

for the improvement identified and advertised for bids in the Invitation for Bids as:

**Contract No. 64A65
ROCK ISLAND County
Section D2 PATCHING 2005-4
Route FAI 74
District 2 Construction Funds**

This project consists of 0.91 mile of pavement patching on the Interstate 74 ramps at Avenue of the Cities (former 23rd Avenue) between the Mississippi River and IL Route 5 in Moline.

2. The undersigned bidder will furnish all labor, material and equipment to complete the above described project in a good and workmanlike manner as provided in the contract documents provided by the Department of Transportation. This proposal will become part of the contract and the terms and conditions contained in the contract documents shall govern performance and payments.

RETURN WITH BID

3. **ASSURANCE OF EXAMINATION AND INSPECTION/WAIVER.** The undersigned further declares that he/she has carefully examined the proposal, plans, specifications, form of contract and contract bond, and special provisions, and that he/she has inspected in detail the site of the proposed work, and that he/she has familiarized themselves with all of the local conditions affecting the contract and the detailed requirements of construction, and understands that in making this proposal he/she waives all right to plead any misunderstanding regarding the same.

4. **EXECUTION OF CONTRACT AND CONTRACT BOND.** The undersigned further agrees to execute a contract for this work and present the same to the department within fifteen (15) days after the contract has been mailed to him/her. The undersigned further agrees that he/she and his/her surety will execute and present within fifteen (15) days after the contract has been mailed to him/her contract bond satisfactory to and in the form prescribed by the Department of Transportation, in the penal sum of the full amount of the contract, guaranteeing the faithful performance of the work in accordance with the terms of the contract.

5. **PROPOSAL GUARANTY.** Accompanying this proposal is either a bid bond on the department form, executed by a corporate surety company satisfactory to the department, or a proposal guaranty check consisting of a bank cashier's check or a properly certified check for not less than 5 per cent of the amount bid or for the amount specified in the following schedule:

<u>Amount of Bid</u>	<u>Proposal Guaranty</u>	<u>Amount of Bid</u>	<u>Proposal Guaranty</u>
Up to \$5,000	to \$5,000 \$150	\$2,000,000	to \$3,000,000 \$100,000
\$5,000 to \$10,000	to \$10,000 \$300	\$3,000,000	to \$5,000,000 \$150,000
\$10,000 to \$50,000	to \$50,000 \$1,000	\$5,000,000	to \$7,500,000 \$250,000
\$50,000 to \$100,000	to \$100,000 \$3,000	\$7,500,000	to \$10,000,000 \$400,000
\$100,000 to \$150,000	to \$150,000 \$5,000	\$10,000,000	to \$15,000,000 \$500,000
\$150,000 to \$250,000	to \$250,000 \$7,500	\$15,000,000	to \$20,000,000 \$600,000
\$250,000 to \$500,000	to \$500,000 \$12,500	\$20,000,000	to \$25,000,000 \$700,000
\$500,000 to \$1,000,000	to \$1,000,000 \$25,000	\$25,000,000	to \$30,000,000 \$800,000
\$1,000,000 to \$1,500,000	to \$1,500,000 \$50,000	\$30,000,000	to \$35,000,000 \$900,000
\$1,500,000 to \$2,000,000	to \$2,000,000 \$75,000	over \$35,000,000	to \$35,000,000 \$1,000,000

Bank cashier's checks or properly certified checks accompanying proposals shall be made payable to the Treasurer, State of Illinois, when the state is awarding authority; the county treasurer, when a county is the awarding authority; or the city, village, or town treasurer, when a city, village, or town is the awarding authority.

If a combination bid is submitted, the proposal guaranties which accompany the individual proposals making up the combination will be considered as also covering the combination bid.

The amount of the proposal guaranty check is _____ \$(_____). If this proposal is accepted and the undersigned shall fail to execute a contract bond as required herein, it is hereby agreed that the amount of the proposal guaranty shall become the property of the State of Illinois, and shall be considered as payment of damages due to delay and other causes suffered by the State because of the failure to execute said contract and contract bond; otherwise, the bid bond shall become void or the proposal guaranty check shall be returned to the undersigned.

Attach Cashier's Check or Certified Check Here

In the event that one proposal guaranty check is intended to cover two or more proposals, the amount must be equal to the sum of the proposal guaranties which would be required for each individual proposal. If the guaranty check is placed in another proposal, state below where it may be found.

The proposal guaranty check will be found in the proposal for:

Item _____

Section No. _____

County _____

Mark the proposal cover sheet as to the type of proposal guaranty submitted.

RETURN WITH BID

6. **COMBINATION BIDS.** The undersigned further agrees that if awarded the contract for the sections contained in the following combination, he/she will perform the work in accordance with the requirements of each individual proposal comprising the combination bid specified in the schedule below, and that the combination bid shall be prorated against each section in proportion to the bid submitted for the same. If an error is found to exist in the gross sum bid for one or more of the individual sections included in a combination, the combination bid shall be corrected as provided in the specifications.

When a combination bid is submitted, the schedule below must be completed in each proposal comprising the combination.

If alternate bids are submitted for one or more of the sections comprising the combination, a combination bid must be submitted for each alternate.

Schedule of Combination Bids

Combination No.	Sections Included in Combination	Combination Bid	
		Dollars	Cents

7. **SCHEDULE OF PRICES.** The undersigned bidder submits herewith, in accordance with the rules and instructions, a schedule of prices for the items of work for which bids are sought. The unit prices bid are in U.S. dollars and cents, and all extensions and summations have been made. The bidder understands that the quantities appearing in the bid schedule are approximate and are provided for the purpose of obtaining a gross sum for the comparison of bids. If there is an error in the extension of the unit prices, the unit prices shall govern. Payment to the contractor awarded the contract will be made only for actual quantities of work performed and accepted or materials furnished according to the contract. The scheduled quantities of work to be done and materials to be furnished may be increased, decreased or omitted as provided elsewhere in the contract.

8. **CERTIFICATE OF AUTHORITY.** The undersigned bidder, if a business organized under the laws of another State, assures the Department that it will furnish a copy of its certificate of authority to do business in the State of Illinois with the return of the executed contract and bond. Failure to furnish the certificate within the time provided for execution of an awarded contract may be cause for cancellation of the award and forfeiture of the proposal guaranty to the State.

ILLINOIS DEPARTMENT OF TRANSPORTATION
 SCHEDULE OF PRICES
 CONTRACT
 NUMBER - 64A65

State Job # - C-92-015-05
 PPS NBR - 0-00845-2003
 County Name - ROCK ISLAND- -
 Code - 161 - -
 District - 2 - -
 Section Number - D2 PATCHING 2005-4

Project Number

Route
 FAI 74

Item Number	Pay Item Description	Unit of Measure	Quantity	x	Unit Price	=	Total Price
X3120600	STAB SUB-BASE REPL 4	SQ YD	150.000				
Z0075300	TIE BARS	EACH	289.000				
44200513	CL A PATCH T1 7	SQ YD	4.000				
44200517	CL A PATCH T2 7	SQ YD	159.000				
44200521	CL A PATCH T3 7	SQ YD	76.000				
44200523	CL A PATCH T4 7	SQ YD	1,106.000				
44213000	PATCH REINFORCEMENT	SQ YD	1,344.000				
44213200	SAW CUTS	FOOT	2,332.000				
67100100	MOBILIZATION	L SUM	1.000				
70101800	TRAF CONT & PROT SPL	L SUM	1.000				
78001110	PAINT PVT MK LINE 4	FOOT	6,418.000				

CONTRACT NUMBER **64A65**

THIS IS THE TOTAL BID **\$ _____**

NOTES:

1. Each PAY ITEM should have a UNIT PRICE and a TOTAL PRICE.
2. The UNIT PRICE shall govern if no TOTAL PRICE is shown or if there is a discrepancy between the product of the UNIT PRICE multiplied by the QUANTITY.
3. If a UNIT PRICE is omitted, the TOTAL PRICE will be divided by the QUANTITY in order to establish a UNIT PRICE.
4. A bid may be declared UNACCEPTABLE if neither a unit price nor a total price is shown.

RETURN WITH BID

STATE REQUIRED ETHICAL STANDARDS GOVERNING CONTRACT PROCUREMENT: ASSURANCES, CERTIFICATIONS AND DISCLOSURES

I. GENERAL

A. Article 50 of the Illinois Procurement Code establishes the duty of all State chief procurement officers, State purchasing officers, and their designees to maximize the value of the expenditure of public moneys in procuring goods, services, and contracts for the State of Illinois and to act in a manner that maintains the integrity and public trust of State government. In discharging this duty, they are charged by law to use all available information, reasonable efforts, and reasonable actions to protect, safeguard, and maintain the procurement process of the State of Illinois.

B. In order to comply with the provisions of Article 50 and to carry out the duty established therein, all bidders are to adhere to ethical standards established for the procurement process, and to make such assurances, disclosures and certifications required by law. By execution of the Proposal Signature Sheet, the bidder indicates that each of the mandated assurances has been read and understood, that each certification is made and understood, and that each disclosure requirement has been understood and completed.

C. In addition to all other remedies provided by law, failure to comply with any assurance, failure to make any disclosure or the making of a false certification shall be grounds for termination of the contract and the suspension or debarment of the bidder.

II. ASSURANCES

A. The assurances hereinafter made by the bidder are each a material representation of fact upon which reliance is placed should the Department enter into the contract with the bidder. The Department may terminate the contract if it is later determined that the bidder rendered a false or erroneous assurance, and the surety providing the performance bond shall be responsible for the completion of the contract.

B. Felons

1. The Illinois Procurement Code provides:

Section 50-10. Felons. Unless otherwise provided, no person or business convicted of a felony shall do business with the State of Illinois or any state agency from the date of conviction until 5 years after the date of completion of the sentence for that felony, unless no person held responsible by a prosecutorial office for the facts upon which the conviction was based continues to have any involvement with the business.

2. The bidder assures the Department that the award and execution of the contract would not cause a violation of Section 50-10.

C. Conflicts of Interest

1. The Illinois Procurement Code provides in pertinent part:

Section 50-13. Conflicts of Interest.

(a) Prohibition. It is unlawful for any person holding an elective office in this State, holding a seat in the General Assembly, or appointed to or employed in any of the offices or agencies of state government and who receives compensation for such employment in excess of 60% of the salary of the Governor of the State of Illinois, or who is an officer or employee of the Capital Development Board or the Illinois Toll Highway Authority, or who is the spouse or minor child of any such person to have or acquire any contract, or any direct pecuniary interest in any contract therein, whether for stationery, printing, paper, or any services, materials, or supplies, that will be wholly or partially satisfied by the payment of funds appropriated by the General Assembly of the State of Illinois or in any contract of the Capital Development Board or the Illinois Toll Highway authority.

(b) Interests. It is unlawful for any firm, partnership, association or corporation, in which any person listed in subsection (a) is entitled to receive (i) more than 7 1/2% of the total distributable income or (ii) an amount in excess of the salary of the Governor, to have or acquire any such contract or direct pecuniary interest therein.

(c) Combined interests. It is unlawful for any firm, partnership, association, or corporation, in which any person listed in subsection (a) together with his or her spouse or minor children is entitled to receive (i) more than 15%, in the aggregate, of the total distributable income or (ii) an amount in excess of 2 times the salary of the Governor, to have or acquire any such contract or direct pecuniary interest therein.

(d) Securities. Nothing in this Section invalidates the provisions of any bond or other security previously offered or to be offered for sale or sold by or for the State of Illinois.

(e) Prior interests. This Section does not affect the validity of any contract made between the State and an officer or employee of the State or member of the General Assembly, his or her spouse, minor child or any combination of those persons if that contract was in existence before his or her election or employment as an officer, member, or employee. The contract is voidable, however, if it cannot be completed within 365 days after the officer, member, or employee takes office or is employed.

The current salary of the Governor is \$150,700.00. Sixty percent of the salary is \$90,420.00.

RETURN WITH BID

2. The bidder assures the Department that the award and execution of the contract would not cause a violation of Section 50-13, or that an effective exemption has been issued by the Board of Ethics to any individual subject to the Section 50-13 prohibitions pursuant to the provisions of Section 50-20 of the Code and Executive Order Number 3 (1998). Information concerning the exemption process is available from the Department upon request.

D. Negotiations

1. The Illinois Procurement Code provides in pertinent part:

Section 50-15. Negotiations.

(a) It is unlawful for any person employed in or on a continual contractual relationship with any of the offices or agencies of State government to participate in contract negotiations on behalf of that office or agency with any firm, partnership, association, or corporation with whom that person has a contract for future employment or is negotiating concerning possible future employment.

2. The bidder assures the Department that the award and execution of the contract would not cause a violation of Section 50-15, and that the bidder has no knowledge of any facts relevant to the kinds of acts prohibited therein.

E. Inducements

1. The Illinois Procurement Code provides:

Section 50-25. Inducement. Any person who offers or pays any money or other valuable thing to any person to induce him or her not to bid for a State contract or as recompense for not having bid on a State contract is guilty of a Class 4 felony. Any person who accepts any money or other valuable thing for not bidding for a State contract or who withholds a bid in consideration of the promise for the payment of money or other valuable thing is guilty of a Class 4 felony.

2. The bidder assures the Department that the award and execution of the contract would not cause a violation of Section 50-25, and that the bidder has no knowledge of any facts relevant to the kinds of acts prohibited therein.

F. Revolving Door Prohibition

1. The Illinois Procurement Code provides:

Section 50-30. Revolving door prohibition. Chief procurement officers, associate procurement officers, State purchasing officers, their designees whose principal duties are directly related to State procurement, and executive officers confirmed by the Senate are expressly prohibited for a period of 2 years after terminating an affected position from engaging in any procurement activity relating to the State agency most recently employing them in an affected position for a period of at least 6 months. The prohibition includes, but is not limited to: lobbying the procurement process; specifying; bidding; proposing bid, proposal, or contract documents; on their own behalf or on behalf of any firm, partnership, association, or corporation. This Section applies only to persons who terminate an affected position on or after January 15, 1999.

2. The bidder assures the Department that the award and execution of the contract would not cause a violation of Section 50-30, and that the bidder has no knowledge of any facts relevant to the kinds of acts prohibited therein.

G. Reporting Anticompetitive Practices

1. The Illinois Procurement Code provides:

Section 50-40. Reporting anticompetitive practices. When, for any reason, any vendor, bidder, contractor, chief procurement officer, State purchasing officer, designee, elected official, or State employee suspects collusion or other anticompetitive practice among any bidders, offerors, contractors, proposers, or employees of the State, a notice of the relevant facts shall be transmitted to the Attorney General and the chief procurement officer.

2. The bidder assures the Department that it has not failed to report any relevant facts concerning the practices addressed in Section 50-40 which may involve the contract for which the bid is submitted.

H. Confidentiality

1. The Illinois Procurement Code provides:

Section 50-45. Confidentiality. Any chief procurement officer, State purchasing officer, designee, or executive officer who willfully uses or allows the use of specifications, competitive bid documents, proprietary competitive information, proposals, contracts, or selection information to compromise the fairness or integrity of the procurement, bidding, or contract process shall be subject to immediate dismissal, regardless of the Personnel code, any contract, or any collective bargaining agreement, and may in addition be subject to criminal prosecution.

2. The bidder assures the Department that it has no knowledge of any fact relevant to the practices addressed in Section 50-45 which may involve the contract for which the bid is submitted.

RETURN WITH BID

I. Insider Information

1. The Illinois Procurement Act provides:

Section 50-50. Insider information. It is unlawful for any current or former elected or appointed State official or State employee to knowingly use confidential information available only by virtue of that office or employment for actual or anticipated gain for themselves or another person.

2. The bidder assures the Department that it has no knowledge of any facts relevant to the practices addressed in Section 50-50 which may involve the contract for which the bid is submitted.

III. CERTIFICATIONS

A. The certifications hereinafter made by the bidder are each a material representation of fact upon which reliance is placed should the Department enter into the contract with the bidder. The Department may terminate the contract if it is later determined that the bidder rendered a false or erroneous certification, and the surety providing the performance bond shall be responsible for completion of the contract.

B. Bribery

1. The Illinois Procurement Code provides:

Section 50-5. Bribery.

(a) Prohibition. No person or business shall be awarded a contract or subcontract under this Code who:

(1) has been convicted under the laws of Illinois or any other state of bribery or attempting to bribe an officer or employee of the State of Illinois or any other state in that officer's or employee's official capacity; or

(2) has made an admission of guilt of that conduct that is a matter of record but has not been prosecuted for that conduct.

(b) Businesses. No business shall be barred from contracting with any unit of State or local government as a result of a conviction under this Section of any employee or agent of the business if the employee or agent is no longer employed by the business and:

(1) the business has been finally adjudicated not guilty; or

(2) the business demonstrates to the governmental entity with which it seeks to contract, and that entity finds that the commission of the offense was not authorized, requested, commanded, or performed by a director, officer, or high managerial agent on behalf of the business as provided in paragraph (2) of subsection (a) of Section 5-4 of the Criminal Code of 1961.

(c) Conduct on behalf of business. For purposes of this Section, when an official, agent, or employee of a business committed the bribery or attempted bribery on behalf of the business and in accordance with the direction or authorization of a responsible official of the business, the business shall be chargeable with the conduct.

(d) Certification. Every bid submitted to and contract executed by the State shall contain a certification by the contractor that the contractor is not barred from being awarded a contract or subcontract under this Section. A contractor who makes a false statement, material to the certification, commits a Class 3 felony.

2. The bidder certifies that it is not barred from being awarded a contract under Section 50.5.

C. Educational Loan

1. Section 3 of the Educational Loan Default Act provides:

§ 3. No State agency shall contract with an individual for goods or services if that individual is in default, as defined in Section 2 of this Act, on an educational loan. Any contract used by any State agency shall include a statement certifying that the individual is not in default on an educational loan as provided in this Section.

2. The bidder, if an individual as opposed to a corporation, partnership or other form of business organization, certifies that the bidder is not in default on an educational loan as provided in Section 3 of the Act.

D. Bid-Rigging/Bid Rotating

1. Section 33E-11 of the Criminal Code of 1961 provides:

§ 33E-11. (a) Every bid submitted to and public contract executed pursuant to such bid by the State or a unit of local government shall contain a certification by the prime contractor that the prime contractor is not barred from contracting with any unit of State or local government as a result of a violation of either Section 33E-3 or 33E-4 of this Article. The State and units of local government shall provide the appropriate forms for such certification.

RETURN WITH BID

(b) A contractor who makes a false statement, material to the certification, commits a Class 3 felony.

A violation of Section 33E-3 would be represented by a conviction of the crime of bid-rigging which, in addition to Class 3 felony sentencing, provides that any person convicted of this offense or any similar offense of any state or the United States which contains the same elements as this offense shall be barred for 5 years from the date of conviction from contracting with any unit of State or local government. No corporation shall be barred from contracting with any unit of State or local government as a result of a conviction under this Section of any employee or agent of such corporation if the employee so convicted is no longer employed by the corporation and: (1) it has been finally adjudicated not guilty or (2) if it demonstrates to the governmental entity with which it seeks to contract and that entity finds that the commission of the offense was neither authorized, requested, commanded, nor performed by a director, officer or a high managerial agent in behalf of the corporation.

A violation of Section 33E-4 would be represented by a conviction of the crime of bid-rotating which, in addition to Class 2 felony sentencing, provides that any person convicted of this offense or any similar offense of any state or the United States which contains the same elements as this offense shall be permanently barred from contracting with any unit of State or local government. No corporation shall be barred from contracting with any unit of State or local government as a result of a conviction under this Section of any employee or agent of such corporation if the employee so convicted is no longer employed by the corporation and: (1) it has been finally adjudicated not guilty or (2) if it demonstrates to the governmental entity with which it seeks to contract and that entity finds that the commission of the offense was neither authorized, requested, commanded, nor performed by a director, officer or a high managerial agent in behalf of the corporation.

2. The bidder certifies that it is not barred from contracting with the Department by reason of a violation of either Section 33E-3 or Section 33E-4.

E. International Anti-Boycott

1. Section 5 of the International Anti-Boycott Certification Act provides:

§ 5. State contracts. Every contract entered into by the State of Illinois for the manufacture, furnishing, or purchasing of supplies, material, or equipment or for the furnishing of work, labor, or services, in an amount exceeding the threshold for small purchases according to the purchasing laws of this State or \$10,000.00, whichever is less, shall contain certification, as a material condition of the contract, by which the contractor agrees that neither the contractor nor any substantially-owned affiliated company is participating or shall participate in an international boycott in violation of the provisions of the U.S. Export Administration Act of 1979 or the regulations of the U.S. Department of Commerce promulgated under that Act.

2. The bidder makes the certification set forth in Section 5 of the Act.

F. Drug Free Workplace

1. The Illinois "Drug Free Workplace Act" applies to this contract and it is necessary to comply with the provisions of the "Act" if the contractor is a corporation, partnership, or other entity (including a sole proprietorship) which has 25 or more employees.

2. The bidder certifies that if awarded a contract in excess of \$5,000 it will provide a drug free workplace by:

(a) Publishing a statement notifying employees that the unlawful manufacture, distribution, dispensation, possession or use of a controlled substance, including cannabis, is prohibited in the contractor's workplace; specifying the actions that will be taken against employees for violations of such prohibition; and notifying the employee that, as a condition of employment on such contract, the employee shall abide by the terms of the statement, and notify the employer of any criminal drug statute conviction for a violation occurring in the workplace no later than five (5) days after such conviction.

(b) Establishing a drug free awareness program to inform employees about the dangers of drug abuse in the workplace; the contractor's policy of maintaining a drug free workplace; any available drug counseling, rehabilitation, and employee assistance programs; and the penalties that may be imposed upon employees for drug violations.

(c) Providing a copy of the statement required by subparagraph (1) to each employee engaged in the performance of the contract and to post the statement in a prominent place in the workplace.

(d) Notifying the Department within ten (10) days after receiving notice from an employee or otherwise receiving actual notice of the conviction of an employee for a violation of any criminal drug statute occurring in the workplace.

(e) Imposing or requiring, within 30 days after receiving notice from an employee of a conviction or actual notice of such a conviction, an appropriate personnel action, up to and including termination, or the satisfactory participation in a drug abuse assistance or rehabilitation program approved by a federal, state or local health, law enforcement or other appropriate agency.

(f) Assisting employees in selecting a course of action in the event drug counseling, treatment, and rehabilitation is required and indicating that a trained referral team is in place.

(g) Making a good faith effort to continue to maintain a drug free workplace through implementation of the actions and efforts stated in this certification.

G. Debt Delinquency

1. The Illinois Procurement Code provides:

Section 50-11 and 50-12. Debt Delinquency.

The contractor or bidder certifies that it, or any affiliate, is not barred from being awarded a contract under 30 ILCS 500. Section 50-11 prohibits a person from entering into a contract with a State agency if it knows or should know that it, or any affiliate, is delinquent in the payment of any debt to the State as defined by the Debt Collection Board. Section 50-12 prohibits a person from entering into a contract with a State agency if it, or any affiliate, has failed to collect and remit Illinois Use Tax on all sales of tangible personal property into the State of Illinois in accordance with the provisions of the Illinois Use Tax Act. The contractor further acknowledges that the contracting State agency may declare the contract void if this certification is false or if the contractor, or any affiliate, is determined to be delinquent in the payment of any debt to the State during the term of the contract.

H. Sarbanes-Oxley Act of 2002

1. The Illinois Procurement Code provides:

Section 50-60(c).

The contractor certifies in accordance with 30 ILCS 500/50-10.5 that no officer, director, partner or other managerial agent of the contracting business has been convicted of a felony under the Sarbanes-Oxley Act of 2002 or a Class 3 or Class 2 felony under the Illinois Securities Law of 1953 for a period of five years prior to the date of the bid or contract. The contractor acknowledges that the contracting agency shall declare the contract void if this certification is false.

I. ADDENDA

The contractor or bidder certifies that all relevant addenda have been incorporated in to this contract. Failure to do so may cause the bid to be declared unacceptable.

J. Section 42 of the Environmental Protection Act

The contractor certifies in accordance with 30 ILCS 500/50-12 that the bidder or contractor is not barred from being awarded a contract under this Section which prohibits the bidding on or entering into contracts with the State of Illinois or a State agency by a person or business found by a court or the Pollution Control Board to have committed a willful or knowing violation of Section 42 of the Environmental Protection Act for a period of five years from the date of the order. The contractor acknowledges that the contracting agency may declare the contract void if this certification is false.

K. Apprenticeship and Training Certification (Does not apply to federal aid projects)

In accordance with the provisions of Section 30-22 (6) of the Illinois Procurement Code, the bidder certifies that it is a participant, either as an individual or as part of a group program, in the approved apprenticeship and training programs applicable to each type of work or craft that the bidder will perform with its own forces. The bidder further certifies for work that will be performed by subcontract that each of its subcontractors submitted for approval either (a) is, at the time of such bid, participating in an approved, applicable apprenticeship and training program; or (b) will, prior to commencement of performance of work pursuant to this contract, begin participation in an approved apprenticeship and training program applicable to the work of the subcontract. The Department, at any time before or after award, may require the production of a copy of each applicable Certificate of Registration issued by the United States Department of Labor evidencing such participation by the contractor and any or all of its subcontractors. Applicable apprenticeship and training programs are those that have been approved and registered with the United States Department of Labor. The bidder shall list in the space below, the official name of the program sponsor holding the Certificate of Registration for all of the types of work or crafts in which the bidder is a participant and that will be performed with the bidder's forces. Types of work or craft work that will be subcontracted shall be included and listed as subcontract work. The list shall also indicate any type of work or craft job category that does not have an applicable apprenticeship or training program. **The bidder is responsible for making a complete report and shall make certain that each type of work or craft job category that will be utilized on the project as reported on the Construction Employee Workforce Projection (Form BC-1256) and returned with the bid is accounted for and listed.**

The requirements of this certification and disclosure are a material part of the contract, and the contractor shall require this certification provision to be included in all approved subcontracts. In order to fulfill this requirement, it shall not be necessary that an applicable program sponsor be currently taking or that it will take applications for apprenticeship, training or employment during the performance of the work of this contract.

TO BE RETURNED WITH BID

IV. DISCLOSURES

A. The disclosures hereinafter made by the bidder are each a material representation of fact upon which reliance is placed should the Department enter into the contract with the bidder. The Department may terminate the contract if it is later determined that the bidder rendered a false or erroneous disclosure, and the surety providing the performance bond shall be responsible for completion of the contract.

B. Financial Interests and Conflicts of Interest

1. Section 50-35 of the Illinois Procurement Code provides that all bids of more than \$10,000 shall be accompanied by disclosure of the financial interests of the bidder. This disclosed information for the successful bidder, will be maintained as public information subject to release by request pursuant to the Freedom of Information Act.

The financial interests to be disclosed shall include ownership or distributive income share that is in excess of 5%, or an amount greater than 60% of the annual salary of the Governor, of the bidding entity or its parent entity, whichever is less, unless the contractor or bidder is a publicly traded entity subject to Federal 10K reporting, in which case it may submit its 10K disclosure in place of the prescribed disclosure. If a bidder is a privately held entity that is exempt from Federal 10K reporting, but has more than 400 shareholders, it may submit the information that Federal 10K companies are required to report, and list the names of any person or entity holding any ownership share that is in excess of 5%. The disclosure shall include the names, addresses, and dollar or proportionate share of ownership of each person making the disclosure, their instrument of ownership or beneficial relationship, and notice of any potential conflict of interest resulting from the current ownership or beneficial interest of each person making the disclosure having any of the relationships identified in Section 50-35 and on the disclosure form.

In addition, all disclosures shall indicate any other current or pending contracts, proposals, leases, or other ongoing procurement relationships the bidding entity has with any other unit of state government and shall clearly identify the unit and the contract, proposal, lease, or other relationship.

2. Disclosure Forms. Disclosure Form A is attached for use concerning the individuals meeting the above ownership or distributive share requirements. Subject individuals should be covered each by one form. In addition, a second form (Disclosure Form B) provides for the disclosure of current or pending procurement relationships with other (non-IDOT) state agencies. **The forms must be included with each bid or incorporated by reference.**

C. Disclosure Form Instructions

Form A: For bidders that have previously submitted the information requested in Form A

The Department has retained the Form A disclosures submitted by all bidders responding to these requirements for the April 24, 1998 or any subsequent letting conducted by the Department. The bidder has the option of submitting the information again or the bidder may sign the following certification statement indicating that the information previously submitted by the bidder is, as of the date of signature, current and accurate. The Certification must be signed and dated by a person who is authorized to execute contracts for the bidding company. Before signing this certification, the bidder should carefully review its prior submissions to ensure the Certification is correct. If the Bidder signs the Certification, the Bidder should proceed to Form B instructions.

CERTIFICATION STATEMENT

I have determined that the Form A disclosure information previously submitted is current and accurate, and all forms are hereby incorporated by reference in this bid. Any necessary additional forms or amendments to previously submitted forms are attached to this bid.

(Bidding Company)

Name of Authorized Representative (type or print)

Title of Authorized Representative (type or print)

Signature of Authorized Representative

Date

Form A: For bidders who have NOT previously submitted the information requested in Form A

If the bidder is a publicly traded entity subject to Federal 10K reporting, the 10K Report may be submitted to meet the requirements of Form A. If a bidder is a privately held entity that is exempt from Federal 10K reporting, but has more than 400 shareholders, it may submit the information that Federal 10K companies are required to report, and list the names of any person or entity holding any ownership share that is in excess of 5%. If a bidder is not subject to Federal 10K reporting, the bidder must determine if any individuals are required by law to complete a financial disclosure form. To do this, the bidder should answer each of the following questions. A "YES" answer indicates Form A must be completed. If the answer to each of the following questions is "NO", then the NOT APPLICABLE STATEMENT on the second page of Form A must be signed and dated by a person that is authorized to execute contracts for the bidding company. Note: These questions are for assistance only and are not required to be completed.

1. Does anyone in your organization have a direct or beneficial ownership share of greater than 5% of the bidding entity or parent entity? YES ___ NO ___
2. Does anyone in your organization have a direct or beneficial ownership share of less than 5%, but which has a value greater than \$90,420.00? YES ___ NO ___
3. Does anyone in your organization receive more than \$90,420.00 of the bidding entity's or parent entity's distributive income? (Note: Distributive income is, for these purposes, any type of distribution of profits. An annual salary is not distributive income.) YES ___ NO ___
4. Does anyone in your organization receive greater than 5% of the bidding entity's or parent entity's total distributive income, but which is less than \$90,420.00? YES ___ NO ___

(Note: Only one set of forms needs to be completed per person per bid even if a specific individual would require a yes answer to more than one question.)

A "YES" answer to any of these questions requires the completion of Form A. The bidder must determine each individual in the bidding entity or the bidding entity's parent company that would cause the questions to be answered "Yes". Each form must be signed and dated by a person that is authorized to execute contracts for your organization. **Photocopied or stamped signatures are not acceptable.** The person signing can be, but does not have to be, the person for which the form is being completed. The bidder is responsible for the accuracy of any information provided.

If the answer to each of the above questions is "NO", then the NOT APPLICABLE STATEMENT on page 2 of Form A must be signed and dated by a person that is authorized to execute contracts for your company.

Form B: Identifying Other Contracts & Procurement Related Information Disclosure Form B must be completed for each bid submitted by the bidding entity. It must be signed by an individual who is authorized to execute contracts for the bidding entity. *Note: Signing the NOT APPLICABLE STATEMENT on Form A does not allow the bidder to ignore Form B. Form B must be completed, signed and dated or the bidder may be considered nonresponsive and the bid will not be accepted.*

The Bidder shall identify, by checking Yes or No on Form B, whether it has any pending contracts (including leases), bids, proposals, or other ongoing procurement relationship with any other (non-IDOT) State of Illinois agency. If "No" is checked, the bidder only needs to complete the signature box on the bottom of Form B. If "Yes" is checked, the bidder must do one of the following:

Option I: If the bidder did not submit an Affidavit of Availability to obtain authorization to bid, the bidder must list all non-IDOT State of Illinois agency pending contracts, leases, bids, proposals, and other ongoing procurement relationships. These items may be listed on Form B or on an attached sheet(s). Do not include IDOT contracts. Contracts with cities, counties, villages, etc. are not considered State of Illinois agency contracts and are not to be included. Contracts with other State of Illinois agencies such as the Department of Natural Resources or the Capital Development Board must be included. Bidders who submit Affidavits of Availability are suggested to use Option II.

Option II: If the bidder is required and has submitted an Affidavit of Availability in order to obtain authorization to bid, the bidder may write or type "See Affidavit of Availability" which indicates that the Affidavit of Availability is incorporated by reference and includes all non-IDOT State of Illinois agency pending contracts, leases, bids, proposals, and other ongoing procurement relationships. For any contracts that are not covered by the Affidavit of Availability, the bidder must identify them on Form B or on an attached sheet(s). These might be such things as leases.

D. Bidders Submitting More Than One Bid

Bidders submitting multiple bids may submit one set of forms consisting of all required Form A disclosures and one Form B for use with all bids. Please indicate in the space provided below the bid item that contains the original disclosure forms and the bid items which incorporate the forms by reference.

- The bid submitted for letting item _____ contains the Form A disclosures or Certification Statement and the Form B disclosures. The following letting items incorporate the said forms by reference:

**ILLINOIS DEPARTMENT
OF TRANSPORTATION**

**Form A
Financial Information &
Potential Conflicts of Interest
Disclosure**

Contractor Name		
Legal Address		
City, State, Zip		
Telephone Number	Email Address	Fax Number (if available)

Disclosure of the information contained in this Form is required by the Section 50-35 of the Illinois Procurement Code (30 ILCS 500). Vendors desiring to enter into a contract with the State of Illinois must disclose the financial information and potential conflict of interest information as specified in this Disclosure Form. This information shall become part of the publicly available contract file. This Form A must be completed for bids in excess of \$10,000, and for all open-ended contracts. **A publicly traded company may submit a 10K disclosure (or equivalent if applicable) in satisfaction of the requirements set forth in Form A. See Disclosure Form Instructions.**

DISCLOSURE OF FINANCIAL INFORMATION

1. Disclosure of Financial Information. The individual named below has an interest in the BIDDER (or its parent) in terms of ownership or distributive income share in excess of 5%, or an interest which has a value of more than \$90,420.00 (60% of the Governor's salary as of 7/1/01). **(Make copies of this form as necessary and attach a separate Disclosure Form A for each individual meeting these requirements)**

FOR INDIVIDUAL (type or print information)

NAME: _____

ADDRESS _____

Type of ownership/distributable income share:

stock _____ sole proprietorship _____ Partnership _____ other: (explain on separate sheet):
% or \$ value of ownership/distributable income share: _____

2. Disclosure of Potential Conflicts of Interest. Check "Yes" or "No" to indicate which, if any, of the following potential conflict of interest relationships apply. If the answer to any question is "Yes", please attach additional pages and describe.

(a) State employment, currently or in the previous 3 years, including contractual employment of services. Yes ___ No ___

If your answer is yes, please answer each of the following questions.

1. Are you currently an officer or employee of either the Capitol Development Board or the Illinois Toll Highway Authority? Yes ___ No ___

2. Are you currently appointed to or employed by any agency of the State of Illinois? If you are currently appointed to or employed by any agency of the State of Illinois, and your annual salary exceeds \$90,420.00, (60% of the Governor's salary as of 7/1/01) provide the name the State agency for which you are employed and your annual salary. _____

RETURN WITH BID/OFFER

- 3. If you are currently appointed to or employed by any agency of the State of Illinois, and your annual salary exceeds \$90,420.00, (60% of the Governor's salary as of 7/1/01) are you entitled to receive (i) more than 7 1/2% of the total distributable income of your firm, partnership, association or corporation, or (ii) an amount in excess of the salary of the Governor? Yes ___ No ___
- 4. If you are currently appointed to or employed by any agency of the State of Illinois, and your annual salary exceeds \$90,420.00, (60% of the Governor's salary as of 7/1/01) are you and your spouse or minor children entitled to receive (i) more than 15 % in the aggregate of the total distributable income of your firm, partnership, association or corporation, or (ii) an amount in excess of 2 times the salary of the Governor? Yes ___ No ___

(b) State employment of spouse, father, mother, son, or daughter, including contractual employment services in the previous 2 years.

Yes ___ No ___

If your answer is yes, please answer each of the following questions.

- 1. Is your spouse or any minor children currently an officer or employee of the Capitol Development Board or the Illinois Toll Highway Authority? Yes ___ No ___
- 2. Is your spouse or any minor children currently appointed to or employed by any agency of the State of Illinois? If your spouse or minor children is/are currently appointed to or employed by any agency of the State of Illinois, and his/her annual salary exceeds \$90,420.00, (60 % of the Governor's salary as of 7/1/01) provide the name of your spouse and/or minor children, the name of the State agency for which he/she is employed and his/her annual salary. _____

- 3. If your spouse or any minor children is/are currently appointed to or employed by any agency of the State of Illinois, and his/her annual salary exceeds \$90,420.00, (60% of the salary of the Governor as of 7/1/01) are you entitled to receive (i) more then 71/2% of the total distributable income of your firm, partnership, association or corporation, or (ii) an amount in excess of the salary of the Governor? Yes ___ No ___
- 4. If your spouse or any minor children are currently appointed to or employed by any agency of the State of Illinois, and his/her annual salary exceeds \$90,420.00, (60% of the Governor's salary as of 7/1/01) are you and your spouse or minor children entitled to receive (i) more than 15 % in the aggregate of the total distributable income of your firm, partnership, association or corporation, or (ii) an amount in excess of 2 times the salary of the Governor? Yes ___ No ___

(c) Elective status; the holding of elective office of the State of Illinois, the government of the United States, any unit of local government authorized by the Constitution of the State of Illinois or the statutes of the State of Illinois currently or in the previous 3 years.

Yes ___ No ___

(d) Relationship to anyone holding elective office currently or in the previous 2 years; spouse, father, mother, son, or daughter.

Yes ___ No ___

(e) Appointive office; the holding of any appointive government office of the State of Illinois, the United States of America, or any unit of local government authorized by the Constitution of the State of Illinois or the statutes of the State of Illinois, which office entitles the holder to compensation in excess of the expenses incurred in the discharge of that office currently or in the previous 3 years.

Yes ___ No ___

(f) Relationship to anyone holding appointive office currently or in the previous 2 years; spouse, father, mother, son, or daughter.

Yes ___ No ___

(g) Employment, currently or in the previous 3 years, as or by any registered lobbyist of the State government.

Yes ___ No ___

RETURN WITH BID/OFFER

(h) Relationship to anyone who is or was a registered lobbyist in the previous 2 years; spouse, father, mother, son, or daughter. Yes ___ No ___

(i) Compensated employment, currently or in the previous 3 years, by any registered election or reelection committee registered with the Secretary of State or any county clerk of the State of Illinois, or any political action committee registered with either the Secretary of State or the Federal Board of Elections. Yes ___ No ___

(j) Relationship to anyone; spouse, father, mother, son, or daughter; who was a compensated employee in the last 2 years by any registered election or re-election committee registered with the Secretary of State or any county clerk of the State of Illinois, or any political action committee registered with either the Secretary of State or the Federal Board of Elections. Yes ___ No ___

APPLICABLE STATEMENT

This Disclosure Form A is submitted on behalf of the INDIVIDUAL named on previous page.

Completed by: _____
Name of Authorized Representative (type or print)

Completed by: _____
Title of Authorized Representative (type or print)

Completed by: _____ Date _____
Signature of Individual or Authorized Representative

NOT APPLICABLE STATEMENT

I have determined that no individuals associated with this organization meet the criteria that would require the completion of this Form A.

This Disclosure Form A is submitted on behalf of the CONTRACTOR listed on the previous page.

Name of Authorized Representative (type or print)

Title of Authorized Representative (type or print)

Signature of Authorized Representative Date _____

RETURN WITH BID/OFFER

ILLINOIS DEPARTMENT
OF TRANSPORTATION

Form B
Other Contracts &
Procurement Related Information
Disclosure

Contractor Name		
Legal Address		
City, State, Zip		
Telephone Number	Email Address	Fax Number (if available)

Disclosure of the information contained in this Form is required by the Section 50-35 of the Illinois Procurement Act (30 ILCS 500). This information shall become part of the publicly available contract file. This Form B must be completed for bids in excess of \$10,000, and for all open-ended contracts.

DISCLOSURE OF OTHER CONTRACTS AND PROCUREMENT RELATED INFORMATION

1. Identifying Other Contracts & Procurement Related Information. The BIDDER shall identify whether it has any pending contracts (including leases), bids, proposals, or other ongoing procurement relationship with any other State of Illinois agency: Yes ___ No ___

If **“No” is checked**, the bidder only needs to complete the signature box on the bottom of this page.

2. If “Yes” is checked. Identify each such relationship by showing State of Illinois agency name and other descriptive information such as bid or project number (attach additional pages as necessary). SEE DISCLOSURE FORM INSTRUCTIONS:

THE FOLLOWING STATEMENT MUST BE SIGNED

Name of Authorized Representative (type or print)	

Title of Authorized Representative (type or print)	
_____	_____
Signature of Authorized Representative	Date

RETURN WITH BID

SPECIAL NOTICE TO CONTRACTORS

The following requirements of the Illinois Department of Human Rights' Rules and Regulations are applicable to bidders on all construction contracts advertised by the Illinois Department of Transportation:

CONSTRUCTION EMPLOYEE UTILIZATION PROJECTION

- (a) All bidders on construction contracts shall complete and submit, along with and as part of their bids, a Bidder's Employee Utilization Form (Form BC-1256) setting forth a projection and breakdown of the total workforce intended to be hired and/or allocated to such contract work by the bidder including a projection of minority and female employee utilization in all job classifications on the contract project.
- (b) The Department of Transportation shall review the Employee Utilization Form, and workforce projections contained therein, of the contract awardee to determine if such projections reflect an underutilization of minority persons and/or women in any job classification in accordance with the Equal Employment Opportunity Clause and Section 7.2 of the Illinois Department of Human Rights' Rules and Regulations for Public Contracts adopted as amended on September 17, 1980. If it is determined that the contract awardee's projections reflect an underutilization of minority persons and/or women in any job classification, it shall be advised in writing of the manner in which it is underutilizing and such awardee shall be considered to be in breach of the contract unless, prior to commencement of work on the contract project, it submits revised satisfactory projections or an acceptable written affirmative action plan to correct such underutilization including a specific timetable geared to the completion stages of the contract.
- (c) The Department of Transportation shall provide to the Department of Human Rights a copy of the contract awardee's Employee Utilization Form, a copy of any required written affirmative action plan, and any written correspondence related thereto. The Department of Human Rights may review and revise any action taken by the Department of Transportation with respect to these requirements.

RETURN WITH BID



**Contract No. 64A65
ROCK ISLAND County
Section D2 PATCHING 2005-4
Route FAI 74
District 2 Construction Funds**

PART I. IDENTIFICATION

Dept. Human Rights # _____ Duration of Project: _____

Name of Bidder: _____

PART II. WORKFORCE PROJECTION

A. The undersigned bidder has analyzed minority group and female populations, unemployment rates and availability of workers for the location in which this contract work is to be performed, and for the locations from which the bidder recruits employees, and hereby submits the following workforce projection including a projection for minority and female employee utilization in all job categories in the workforce to be allocated to this contract:

TABLE A

TOTAL Workforce Projection for Contract														
JOB CATEGORIES	TOTAL EMPLOYEES		MINORITY EMPLOYEES				*OTHER MINOR.				APPREN-TICES		ON THE JOB TRAINEES	
	M	F	M	F	M	F	M	F	M	F	M	F		
OFFICIALS (MANAGERS)														
SUPERVISORS														
FOREMEN														
CLERICAL														
EQUIPMENT OPERATORS														
MECHANICS														
TRUCK DRIVERS														
IRONWORKERS														
CARPENTERS														
CEMENT MASONS														
ELECTRICIANS														
PIPEFITTERS, PLUMBERS														
PAINTERS														
LABORERS, SEMI-SKILLED														
LABORERS, UNSKILLED														
TOTAL														

TABLE B

CURRENT EMPLOYEES TO BE ASSIGNED TO CONTRACT			
TOTAL EMPLOYEES		MINORITY EMPLOYEES	
M	F	M	F

TABLE C

TOTAL Training Projection for Contract								
EMPLOYEES IN TRAINING	TOTAL EMPLOYEES		BLACK		HISPANIC		*OTHER MINOR.	
	M	F	M	F	M	F	M	F
APPRENTICES								
ON THE JOB TRAINEES								

*Other minorities are defined as Asians (A) or Native Americans (N).

Please specify race of each employee shown in Other Minorities column.

Note: See instructions on the next page

FOR DEPARTMENT USE ONLY

RETURN WITH BID

**Contract No. 64A65
ROCK ISLAND County
Section D2 PATCHING 2005-4
Route FAI 74
District 2 Construction Funds**

PART II. WORKFORCE PROJECTION - continued

B. Included in "Total Employees" under Table A is the total number of **new hires** that would be employed in the event the undersigned bidder is awarded this contract.

The undersigned bidder projects that: (number) _____ new hires would be recruited from the area in which the contract project is located; and/or (number) _____ new hires would be recruited from the area in which the bidder's principal office or base of operation is located.

C. Included in "Total Employees" under Table A is a projection of numbers of persons to be employed directly by the undersigned bidder as well as a projection of numbers of persons to be employed by subcontractors.

The undersigned bidder estimates that (number) _____ persons will be directly employed by the prime contractor and that (number) _____ persons will be employed by subcontractors.

PART III. AFFIRMATIVE ACTION PLAN

A. The undersigned bidder understands and agrees that in the event the foregoing minority and female employee utilization projection included under **PART II** is determined to be an underutilization of minority persons or women in any job category, and in the event that the undersigned bidder is awarded this contract, he/she will, prior to commencement of work, develop and submit a written Affirmative Action Plan including a specific timetable (geared to the completion stages of the contract) whereby deficiencies in minority and/or female employee utilization are corrected. Such Affirmative Action Plan will be subject to approval by the contracting agency and the **Department of Human Rights**.

B. The undersigned bidder understands and agrees that the minority and female employee utilization projection submitted herein, and the goals and timetable included under an Affirmative Action Plan if required, are deemed to be part of the contract specifications.

Company _____ Telephone Number _____

Address _____

NOTICE REGARDING SIGNATURE

The Bidder's signature on the Proposal Signature Sheet will constitute the signing of this form. The following signature block needs to be completed only if revisions are required.

Signature: _____ Title: _____ Date: _____

Instructions: All tables must include subcontractor personnel in addition to prime contractor personnel.

Table A - Include both the number of employees that would be hired to perform the contract work and the total number currently employed (Table B) that will be allocated to contract work, and include all apprentices and on-the-job trainees. The "Total Employees" column should include all employees including all minorities, apprentices and on-the-job trainees to be employed on the contract work.

Table B - Include all employees currently employed that will be allocated to the contract work including any apprentices and on-the-job trainees currently employed.

Table C - Indicate the racial breakdown of the total apprentices and on-the-job trainees shown in Table A.

RETURN WITH BID

**Contract No. 64A65
ROCK ISLAND County
Section D2 PATCHING 2005-4
Route FAI 74
District 2 Construction Funds**

PROPOSAL SIGNATURE SHEET

The undersigned bidder hereby makes and submits this bid on the subject Proposal, thereby assuring the Department that all requirements of the Invitation for Bids and rules of the Department have been met, that there is no misunderstanding of the requirements of paragraph 3 of this Proposal, and that the contract will be executed in accordance with the rules of the Department if an award is made on this bid.

(IF AN INDIVIDUAL) Firm Name _____
Signature of Owner _____
Business Address _____

(IF A CO-PARTNERSHIP) Firm Name _____
By _____
Business Address _____
Name and Address of All Members of the Firm:

(IF A CORPORATION)
(IF A JOINT VENTURE, USE THIS SECTION FOR THE MANAGING PARTY AND THE SECOND PARTY SHOULD SIGN BELOW)
Corporate Name _____
By _____
Signature of Authorized Representative _____
Typed or printed name and title of Authorized Representative _____
Attest _____
Signature _____
Business Address _____

(IF A JOINT VENTURE)
Corporate Name _____
By _____
Signature of Authorized Representative _____
Typed or printed name and title of Authorized Representative _____
Attest _____
Signature _____
Business Address _____

If more than two parties are in the joint venture, please attach an additional signature sheet.



RETURN WITH BID

Division of Highways
Proposal Bid Bond
(Effective November 1, 1992)

Item No.
Letting Date

KNOW ALL MEN BY THESE PRESENTS, That We
as PRINCIPAL, and

held jointly, severally and firmly bound unto the STATE OF ILLINOIS in the penal sum of 5 percent of the total bid price, or for the amount specified in Article 102.09 of the "Standard Specifications for Road and Bridge Construction" in effect on the date of invitation for bids, whichever is the lesser sum, well and truly to be paid unto said STATE OF ILLINOIS, for the payment of which we bind ourselves, our heirs, executors, administrators, successors and assigns.

THE CONDITION OF THE FOREGOING OBLIGATION IS SUCH, That Whereas, the PRINCIPAL has submitted a bid proposal to the STATE OF ILLINOIS, acting through the Department of Transportation, for the improvement designated by the Transportation Bulletin Item Number and Letting Date indicated above.

NOW, THEREFORE, if the Department shall accept the bid proposal of the PRINCIPAL; and if the PRINCIPAL shall, within the time and as specified in the bidding and contract documents, submit a DBE Utilization Plan that is accepted and approved by the Department; and if, after award by the Department, the PRINCIPAL shall enter into a contract in accordance with the terms of the bidding and contract documents including evidence of the required insurance coverages and providing such bond as specified with good and sufficient surety for the faithful performance of such contract and for the prompt payment of labor and material furnished in the prosecution thereof; or if, in the event of the failure of the PRINCIPAL to make the required DBE submission or to enter into such contract and to give the specified bond, the PRINCIPAL pays to the Department the difference not to exceed the penalty hereof between the amount specified in the bid proposal and such larger amount for which the Department may contract with another party to perform the work covered by said bid proposal, then this obligation shall be null and void, otherwise, it shall remain in full force and effect.

IN THE EVENT the Department determines the PRINCIPAL has failed to comply with any requirement as set forth in the preceding paragraph, then Surety shall pay the penal sum to the Department within fifteen (15) days of written demand therefor. If Surety does not make full payment within such period of time, the Department may bring an action to collect the amount owed. Surety is liable to the Department for all its expenses, including attorney's fees, incurred in any litigation in which it prevails either in whole or in part.

In TESTIMONY WHEREOF, the said PRINCIPAL and the said SURETY have caused this instrument to be signed by their respective officers this day of A.D.,

PRINCIPAL SURETY
(Company Name) (Company Name)
By: (Signature & Title) By: (Signature of Attorney-in-Fact)

Notary Certification for Principal and Surety

STATE OF ILLINOIS,
COUNTY OF

I, a Notary Public in and for said County, do hereby certify that
and

(Insert names of individuals signing on behalf of PRINCIPAL & SURETY)

who are each personally known to me to be the same persons whose names are subscribed to the foregoing instrument on behalf of PRINCIPAL and SURETY, appeared before me this day in person and acknowledged respectively, that they signed and delivered said instrument as their free and voluntary act for the uses and purposes therein set forth.

Given under my hand and notarial seal this day of A.D.

My commission expires Notary Public

In lieu of completing the above section of the Proposal Bid Form, the Principal may file an Electronic Bid Bond. By signing below the Principal is ensuring the identified electronic bid bond has been executed and the Principal and Surety are firmly bound unto the State of Illinois under the conditions of the bid bond as shown above.

Electronic Bid Bond ID# Company/Bidder Name Signature and Title

PROPOSAL ENVELOPE



PROPOSALS

for construction work advertised for bids by the
Illinois Department of Transportation

Item No.	Item No.	Item No.

Submitted By:

Name:
Address:
Phone No.

Bidders should use an IDOT proposal envelope or affix this form to the front of a 10" x 13" envelope for the submittal of bids. If proposals are mailed, they should be enclosed in a second or outer envelope addressed to:

Engineer of Design and Environment - Room 326
Illinois Department of Transportation
2300 South Dirksen Parkway
Springfield, Illinois 62764

NOTICE

Individual bids, including Bid Bond and/or supplemental information if required, should be securely stapled.

CONTRACTOR OFFICE COPY OF CONTRACT SPECIFICATIONS

NOTICE

None of the following material needs to be returned with the bid package unless the special provisions require documentation and/or other information to be submitted.

**Contract No. 64A65
ROCK ISLAND County
Section D2 PATCHING 2005-4
Route FAI 74
District 2 Construction Funds**



Illinois Department of Transportation



NOTICE TO BIDDERS

1. TIME AND PLACE OF OPENING BIDS. Sealed proposals for the improvement described herein will be received by the Department of Transportation at the Harry R. Hanley Building, 2300 South Dirksen Parkway, in Springfield, Illinois until 10:00 o'clock a.m., June 17, 2005. All bids will be gathered, sorted, publicly opened and read in the auditorium at the Department of Transportation's Harry R. Hanley Building shortly after the 10:00 a.m. cut off time.

2. DESCRIPTION OF WORK. The proposed improvement is identified and advertised for bids in the Invitation for Bids as:

**Contract No. 64A65
ROCK ISLAND County
Section D2 PATCHING 2005-4
Route FAI 74
District 2 Construction Funds**

This project consists of 0.91 mile of pavement patching on the Interstate 74 ramps at Avenue of the Cities (former 23rd Avenue) between the Mississippi River and IL Route 5 in Moline.

3. INSTRUCTIONS TO BIDDERS. (a) This Notice, the invitation for bids, proposal and letter of award shall, together with all other documents in accordance with Article 101.09 of the Standard Specifications for Road and Bridge Construction, become part of the contract. Bidders are cautioned to read and examine carefully all documents, to make all required inspections, and to inquire or seek explanation of the same prior to submission of a bid.

(b) State law, and, if the work is to be paid wholly or in part with Federal-aid funds, Federal law requires the bidder to make various certifications as a part of the proposal and contract. By execution and submission of the proposal, the bidder makes the certification contained therein. A false or fraudulent certification shall, in addition to all other remedies provided by law, be a breach of contract and may result in termination of the contract.

4. AWARD CRITERIA AND REJECTION OF BIDS. This contract will be awarded to the lowest responsive and responsible bidder considering conformity with the terms and conditions established by the Department in the rules, Invitation for Bids and contract documents. The issuance of plans and proposal forms for bidding based upon a prequalification rating shall not be the sole determinant of responsibility. The Department reserves the right to determine responsibility at the time of award, to reject any or all proposals, to readvertise the proposed improvement, and to waive technicalities.

By Order of the
Illinois Department of Transportation

Timothy W. Martin, Secretary

BD 351 (Rev. 01/2003)

INDEX
FOR
SUPPLEMENTAL SPECIFICATIONS AND RECURRING SPECIAL PROVISIONS
Adopted March 1, 2005

This index contains a listing of SUPPLEMENTAL SPECIFICATIONS and frequently used RECURRING SPECIAL PROVISIONS.

ERRATA Standard Specifications for Road and Bridge Construction (Adopted 1-1-02) (Revised 3-1-05)

SUPPLEMENTAL SPECIFICATIONS

<u>Std. Spec. Sec.</u>	<u>Page No.</u>
101 Definition of Terms	1
105 Control of Work	2
205 Embankment	3
251 Mulch	4
281 Riprap.....	5
282 Filter Fabric for Use With Riprap	8
285 Concrete Revetment Mats.....	10
311 Granular Subbase	14
351 Aggregate Base Course.....	15
440 Removal of Existing Pavement and Appurtenances	16
442 Pavement Patching	17
449 Removal and Replacement of Preformed Elastomeric Compression Joint Seal	18
481 Aggregate Shoulders	19
501 Removal of Existing Structures	20
503 Concrete Structures	21
505 Steel Structures	22
506 Cleaning and Painting Metal Structures	25
508 Reinforcement Bars	26
512 Piling	27
540 Box Culverts.....	28
589 Elastic Joint Sealer	30
602 Catch Basin, Manhole, Inlet, Drainage Structures and Valve Vault Construction, Adjustment and Reconstruction	31
603 Adjusting Frames and Grates of Drainage and Utility Structures	32
610 Shoulder Inlets with Curb	33
665 Woven Wire Fence	34
669 Removal and Disposal of Regulated Substances	35
671 Mobilization	36
702 Work Zone Traffic Control Devices	37
1003 Fine Aggregates	38
1004 Coarse Aggregate	39
1005 Stone, Concrete Blocks and Broken Concrete for Erosion Protection, Sediment Control and Rockfill	42
1006 Metals	46
1007 Timber and Preservative Treatment	49
1012 Hydrated Lime	50
1020 Portland Cement Concrete	51
1021 Concrete Admixtures	58
1022 Concrete Curing Materials	59
1024 Nonshrink Grout	61
1041 Brick	63
1043 Precast Reinforced Concrete Manhole Sections and Adjusting Rings.....	64
1056 Preformed Flexible Gaskets and Mastic Joint Sealer for Sewer and Culvert Pipe	66
1059 Elastic Joint Sealers	67
1060 Waterproofing Materials	68
1069 Pole and Tower	69
1070 Foundation and Breakaway Devices	70
1077 Post and Foundation	72
1080 Fabric Materials	73
1081 Materials For Planting	76
1083 Elastomeric Bearings	77
1094 Overhead Sign Structures	78
1103 Portland Cement Concrete Equipment	79

RECURRING SPECIAL PROVISIONS

The following RECURRING SPECIAL PROVISIONS indicated by an "X" are applicable to this contract and are included by reference:

<u>CHECK SHEET #</u>	<u>PAGE NO.</u>
1 State Required Contract Provisions All Federal-aid Construction Contracts (Eff. 2-1-69) (Rev. 10-1-83)	80
2 Subletting of Contracts (Federal-aid Contracts) (Eff. 1-1-88) (Rev. 5-1-93).....	82
3 X EEO (Eff. 7-21-78) (Rev. 11-18-80)	83
4 X Specific Equal Employment Opportunity Responsibilities NonFederal-aid Contracts (Eff. 3-20-69) (Rev. 1-1-94)	94
5 X Required Provisions - State Contracts (Eff. 4-1-65) (Rev. 4-1-93).....	100
6 Reserved	105
7 Asphalt Quantities and Cost Reviews (Eff. 7-1-88).....	106
8 National Pollutant Discharge Elimination System Permit (Eff. 7-1-94) (Rev. 1-1-03).....	107
9 Haul Road Stream Crossings, Other Temporary Stream Crossings and In-Stream Work Pads (Eff. 1-2-92) (Rev. 1-1-98)	108
10 Construction Layout Stakes Except for Bridges (Eff. 1-1-99) (Rev. 1-1-02).....	109
11 Construction Layout Stakes (Eff. 5-1-93) (Rev. 1-1-02).....	112
12 Use of Geotextile Fabric for Railroad Crossing (Eff. 1-1-95) (Rev. 1-1-97).....	115
13 Asphaltic Emulsion Slurry Seal and Fibrated Asphaltic Emulsion Slurry Seal (Eff. 8-1-89) (Rev. 2-1-97)	117
14 Bituminous Surface Treatments Half-Smart (Eff. 7-1-93) (Rev. 1-1-97)	123
15 Quality Control/Quality Assurance of Bituminous Concrete Mixtures (Eff. 1-1-00) (Rev. 3-1-05)	129
16 Subsealing of Concrete Pavements (Eff. 11-1-84) (Rev. 2-1-95).....	148
17 Bituminous Surface Removal (Cold Milling) (Eff. 11-1-87) (Rev. 10-15-97).....	152
18 Resurfacing of Milled Surfaces (Eff. 10-1-95)	154
19 PCC Partial Depth Bituminous Patching (Eff. 1-1-98).....	155
20 Patching with Bituminous Overlay Removal (Eff. 10-1-95) (Rev. 7-1-99)	157
21 Reserved	159
22 Protective Shield System (Eff. 4-1-95) (Rev. 1-1-03).....	160
23 Polymer Concrete (Eff. 8-1-95) (Rev. 3-1-05).....	162
24 Controlled Low-Strength Material (CLSM) (Eff. 1-1-90) (Rev. 3-1-05)	164
25 Pipe Underdrains (Eff. 9-9-87) (Rev. 1-1-98).....	169
26 Guardrail and Barrier Wall Delineation (Eff. 12-15-93) (Rev. 1-1-97)	170
27 Bicycle Racks (Eff. 4-1-94) (Rev. 1-1-97)	175
28 Reserved	177
29 Reserved	178
30 Reserved	179
31 Night Time Inspection of Roadway Lighting (Eff. 5-1-96).....	180
32 Reserved	181
33 English Substitution of Metric Bolts (Eff. 7-1-96).....	182
34 English Substitution of Metric Reinforcement Bars (Eff. 4-1-96) (Rev. 1-1-03)	183
35 Polymer Modified Emulsified Asphalt (Eff. 5-15-89) (Rev. 1-1-04).....	185
36 Corrosion Inhibitor (Eff. 3-1-80) (Rev. 7-1-99)	187
37 Quality Control of Concrete Mixtures at the Plant-Single A (Eff. 8-1-00) (Rev. 1-1-04)	188
38 Quality Control of Concrete Mixtures at the Plant-Double A (Eff. 8-1-00) (Rev. 1-1-04)	194
39 Quality Control/Quality Assurance of Concrete Mixtures (Eff. 4-1-92) (Rev. 3-1-05)	202
40 Traffic Barrier Terminal Type 1, Special (Eff. 8-1-94) (Rev. 1-1-03)	215
41 Reserved	216
42 Segregation Control of Bituminous Concrete (Eff. 7-15-97).....	217
43 Reserved	220

TABLE OF CONTENTS

LOCATION OF PROJECT	1
DESCRIPTION OF PROJECT	1
TRAFFIC CONTROL PLAN	1
TRAFFIC CONTROL AND PROTECTION (SPECIAL)	2
MAINTENANCE OF TRAFFIC	2
STABILIZED SUB-BASE REPLACEMENT, 4 INCH	2
CHAIR SUPPORTS (BDE).....	3
CONCRETE ADMIXTURES (BDE).....	3
CURING AND PROTECTION OF CONCRETE CONSTRUCTION (BDE).....	7
FLAGGER VESTS (BDE).....	14
HAND VIBRATOR (BDE)	14
MINIMUM LANE WIDTH WITH LANE CLOSURE (BDE).....	14
MULTILANE PAVEMENT PATCHING (BDE)	15
PARTIAL PAYMENTS (BDE).....	15
PAYMENTS TO SUBCONTRACTORS (BDE).....	16
PERSONAL PROTECTIVE EQUIPMENT (BDE).....	17
PORTLAND CEMENT (BDE).....	17
PORTLAND CEMENT CONCRETE (BDE).....	17
PORTLAND CEMENT CONCRETE PATCHING (BDE)	18
TRAFFIC CONTROL DEFICIENCY DEDUCTION (BDE)	21
WORKING DAYS (BDE)	21
SUBCONTRACTOR MOBILIZATION PAYMENTS (BDE)	21
STEEL COST ADJUSTMENT (BDE)	22
ADDITIONAL AWARD CRITERIA (BDE).....	26

STATE OF ILLINOIS

SPECIAL PROVISIONS

The following Special Provisions supplement the "Standard Specifications for Road and Bridge Construction," adopted January 1, 2002, the latest edition of the "Manual on Uniform Traffic Control Devices for Streets and Highways," and the "Manual of Test Procedures for Materials" in effect on the date of invitation for bids, and the Supplemental Specifications and Recurring Special Provisions indicated on the Check Sheet included herein which apply to and govern the construction of FAI Route 74, Section D2 Patching 2005-4, Rock Island County, Contract 64A65, and in case of conflict with any part or parts of said Specifications, the said Special Provisions shall take precedence and shall govern.

LOCATION OF PROJECT

This project is along Interstate 74 at the interchange with the Avenue of the Cities (formerly 23rd Avenue).

DESCRIPTION OF PROJECT

Work will include full depth concrete pavement patching on the ramps at the interchange of I-74 and Avenue of the Cities.

TRAFFIC CONTROL PLAN

Effective January 14, 1999

Traffic Control shall be according to the applicable sections of the Standard Specifications for Road and Bridge Construction, the applicable guidelines contained in the National Manual on Uniform Traffic Control Devices for Streets and Highways, Illinois Supplement to the National Manual on Uniform Traffic Control Devices, these special provisions, and any special details and Highway Standards contained herein and in the plans.

Special attention is called to Articles 107.09 and 107.14 of the Standard Specifications for Road and Bridge Construction and the following Highway Standards relating to traffic control.

Standards:

701426

702001

Details:

District Standard 95.2 (Traffic Control and Protection for Ramps)
Traffic Control and Protection (Special) Details

TRAFFIC CONTROL AND PROTECTION (SPECIAL)

This work shall be completed in accordance with the applicable portions of Section 700 of the Standard Specifications for Road and Bridge Construction, as stated herein, and as directed by the Engineer.

Traffic Control and Protection (Special) shall be used when patching in the three (3) lane portion of Ramp N-23. This is the area where two lanes from the 19th Street Frontage Road merge with the I-74 southbound off traffic to Avenue of the Cities.

Two flaggers will be required as shown in the plans at the area of this merge, one on the 19th Street Frontage Road and one on the ramp. They are to work together to coordinate the merging of these two different traffic flows.

This work will be paid for at the contract unit price per Lump Sum for TRAFFIC CONTROL AND PROTECTION (SPECIAL).

Equipment Illumination: The Contractor shall equip all machinery and vehicles with revolving amber lights, installed so the illumination is visible from all directions.

Median Crossover: The median crossover will generally not be available for Contractor use. It may be used only when both lanes adjacent to the median are closed. Under no condition shall left turn lanes be made to cross the median from lanes open to traffic.

Vehicle Parking: Parking of personal vehicles within the interstate right of way will be strictly prohibited. Parking of construction equipment within the right of way will be permitted only at locations approved by the Engineer.

MAINTENANCE OF TRAFFIC

The pavement patching operations shall be completed using District Standard 95.2 (Traffic Control and Protection for Ramps) and Traffic Control and Protection (Special) on the I-74 southbound off ramp to Avenue of the Cities where the ramp merges with the through traffic lanes with the 19th Street service road.

When placing pavement marking lines along the ramps, Traffic Control and Protection Standard 701426 is also to be used.

STABILIZED SUB-BASE REPLACEMENT, 4 INCH

This work shall be done in accordance with the applicable portions of Section 312 of the Standard Specifications.

This work shall consist of the removal of the disturbed or unsuitable sub-base material under areas of pavement patching. The sub-base replacement material shall meet the requirements in Section 442, Article 442.02, Note 1, and be used to restore the sub-base to the existing line and grade.

The placement of the material for the patch shall be placed upon the newly replaced sub-base upon the approval of the Engineer.

Quantities for this work have been estimated at 10% of the pavement removal and replacement and the final quantities shall be determined in the field by the Engineer.

This work will be measured and paid for at the contract unit price per Square Yard for STABILIZED SUB-BASE REPLACEMENT, 4 INCH.

CHAIR SUPPORTS (BDE)

Effective: November 1, 2002

Revised: November 2, 2002

Revise the fourth and fifth paragraphs of Article 421.06(a) to read:

“Pavement reinforcement shall be supported on steel chair supports at the depth below the pavement surface as indicated on the plans. The Contractor shall submit prints of shop drawings showing details of chair supports and their spacing to the Engineer and obtain the Engineer’s approval before any fabrication is begun.

The chair supports shall possess the necessary rigidity and be spaced at intervals close enough to hold the reinforcement at the proper depth and position. However, the spacing of the chair supports shall not exceed 900 mm (3 ft) transversely or 1.2 m (4 ft) longitudinally. The chair supports shall be fabricated with sand plates.”

CONCRETE ADMIXTURES (BDE)

Effective: January 1, 2003

Revised: July 1, 2004

Revise Article 1020.05(b) of the Standard Specifications to read:

“(b) Admixtures. Except as specified, the use of admixtures to increase the workability or to accelerate the hardening of the concrete will be permitted only when approved in writing by the Engineer. The Department will maintain an Approved List of Concrete Admixtures. When the Department permits the use of a calcium chloride accelerator, it shall be according to Article 442.02, Note 5.

When the atmosphere or concrete temperature is 18 °C (65 °F) or higher, a retarding admixture meeting the requirements of Article 1021.03 shall be used in the Class BD Concrete and portland cement concrete bridge deck overlays. The amount of retarding admixture to be used will be determined by the Engineer. The proportions of the ingredients of the concrete shall be the same as without the retarding admixture except that the amount of mixing water shall be reduced, as may be necessary, in order to maintain the consistency of the concrete as required. In addition, a high range water-reducing admixture shall be used in Class BD Concrete. The amount of high range water-reducing admixture will be determined by the Engineer. At the option of the Contractor, a water-reducing admixture may be used. Type I cement shall be used.

For Class PC and PS Concrete, a retarding admixture may be added to the concrete mixture when the concrete temperature is 18 °C (65 °F) or higher. Other admixtures may be used when approved by the Engineer, or if specified by the contract. If an accelerating admixture is permitted by the Engineer, it shall be the non-chloride type.

At the Contractor's option, admixtures in addition to an air-entraining admixture may be used for Class PP-1 concrete. The accelerator shall be the non-chloride type. If a water-reducing or retarding admixture is used, the cement factor may be reduced a maximum 18 kg/cu m (0.30 hundredweight/cu yd). If a high range water-reducing admixture is used, the cement factor may be reduced a maximum 36 kg/cu m (0.60 hundredweight/cu yd). Cement factor reductions shall not be cumulative when using multiple admixtures. An accelerator shall always be added prior to a high range water-reducing admixture, if both are used.

If Class C fly ash or ground granulated blast-furnace slag is used in Class PP-1 concrete, a water-reducing or high range water-reducing admixture shall be used. However, the cement factor shall not be reduced if a water-reducing, retarding, or high range water-reducing admixture is used. In addition, an accelerator shall not be used.

For Class PP-2 or PP-3 concrete, a non-chloride accelerator followed by a high range water-reducing admixture shall be used, in addition to the air-entraining admixture. For Class PP-3 concrete, the non-chloride accelerator shall be calcium nitrite.

For Class PP-2 or PP-3 concrete, the Contractor has the option to use a water-reducing admixture. A retarding admixture shall not be used unless approved by the Engineer. A water-reducing, retarding, or high range water-reducing admixture shall not be used to reduce the cement factor.

When the air temperature is less than 13 °C (55 °F) for Class PP-1 or PP-2 concrete, the non-chloride accelerator shall be calcium nitrite.

For Class PP-4 concrete, a high range water-reducing admixture shall be used in addition to the air-entraining admixture. The Contractor has the option to use a water-reducing admixture. An accelerator shall not be used. For stationary or truck mixed concrete, a retarding admixture shall be used to allow for haul time. The Contractor has the option to use a mobile portland cement concrete plant according to Article 1103.04, but a retarding admixture shall not be used unless approved by the Engineer. A water-reducing, retarding, or high range water-reducing admixture shall not be used to reduce the cement factor.

If the Department specifies a calcium chloride accelerator for Class PP-1 concrete, the maximum chloride dosage shall be 1.0 L (1.0 quart) of solution per 45 kg (100 lb) of cement. The dosage may be increased to a maximum 2.0 L (2.0 quarts) per 45 kg (100 lb) of cement if approved by the Engineer. If the Department specifies a calcium chloride accelerator for Class PP-2 concrete, the maximum chloride dosage shall be 1.3 L (1.3 quarts) of solution per 45 kg (100 lb) of cement. The dosage may be increased to a maximum 2.6 L (2.6 quarts) per 45 kg (100 lb) of cement if approved by the Engineer.

For Class PV, MS, SI, RR, SC and SH concrete, at the option of the Contractor, or when specified by the Engineer, a water-reducing admixture or a retarding admixture may be used. The amount of water-reducing admixture or retarding admixture permitted will be determined by the Engineer. The air-entraining admixture and other admixtures shall be added to the concrete separately, and shall be permitted to intermingle only after they have separately entered the concrete batch. The sequence, method and equipment for adding the admixtures shall be approved by the Engineer. The water-reducing admixture shall not delay the initial set of the concrete by more than one hour. Type I cement shall be used.

When a water-reducing admixture is added, a cement factor reduction of up to 18 kg/cu m (0.30 hundredweight/cu yd), from the concrete designed for a specific slump without the admixture, will be permitted for Class PV, MS, SI, RR, SC and SH concrete. When an approved high range water-reducing admixture is used, a cement factor reduction of up to 36 kg/cu m (0.60 hundredweight/cu yd), from a specific water cement/ratio without the admixture, will be permitted based on a 14 percent minimum water reduction. This is applicable to Class PV, MS, SI, RR, SC and SH concrete. A cement factor below 320 kg/cu m (5.35 hundredweight/cu yd) will not be permitted for Class PV, MS, SI, RR, SC and SH concrete. A cement factor reduction will not be allowed for concrete placed underwater. Cement factor reductions shall not be cumulative when using multiple admixtures.

For use of admixtures to control concrete temperature, refer to Articles 1020.14(a) and 1020.14(b).

The maximum slumps given in Table 1 may be increased to 175 mm (7 in.) when a high range water-reducing admixture is used for all classes of concrete except Class PV and PP.”

Revise Section 1021 of the Standard Specifications to read:

“SECTION 1021. CONCRETE ADMIXTURES”

1021.01 General. Admixtures shall be furnished in liquid form ready for use. The admixtures may be delivered in the manufacturer's original containers, bulk tank trucks or such containers or tanks as are acceptable to the Engineer. Delivery shall be accompanied by a ticket which clearly identifies the manufacturer and trade name of the material. Containers shall be readily identifiable to the satisfaction of the Engineer as to manufacturer and trade name of the material they contain.

Prior to inclusion of a product on the Department's Approved List of Concrete Admixtures, the manufacturer shall submit a report prepared by an independent laboratory accredited by the AASHTO Accreditation Program. The report shall show the results of physical tests conducted no more than five years prior to the time of submittal, according to applicable specifications.

Tests shall be conducted using materials and methods specified on a "test" concrete and a "reference" concrete, together with a certification that no changes have been made in the formulation of the material since the performance of the tests. Per the manufacturer's option, the cement content for all required tests shall either be according to applicable specifications or

335 kg/cu m (5.65 cwt/cu yd). Compressive strength test results for six months and one year will not be required.

In addition to the report, the manufacturer shall submit AASHTO T 197 water content and set time test results on the standard cement used by the Department. The test and reference concrete mixture shall contain a cement content of 335 kg/cu m (5.65 cwt/cu yd). The manufacturer may select their lab or an independent lab to perform this testing. The laboratory is not required to be accredited by the AASHTO Accreditation Program.

Prior to the approval of an admixture, the Engineer may conduct all or part of the applicable tests on a sample that is representative of the material to be furnished. The test and reference concrete mixtures tested by the Engineer will contain a cement content of 335 kg/cu m (5.65 cwt/cu yd). For freeze-thaw testing, the Department will perform the test according to Illinois Modified AASHTO T 161, Procedure B.

The manufacturer shall include in the submittal the following information according to ASTM C 494; the average and manufacturing range of specific gravity, the average and manufacturing range of solids in the solution, and the average and manufacturing range of pH. The submittal shall also include an infrared spectrophotometer trace no more than five years old.

When test results are more than seven years old, the manufacturer shall re-submit the infrared spectrophotometer trace and the report prepared by an independent laboratory accredited by the AASHTO Accreditation Program.

All admixtures, except chloride-based accelerators, shall contain no more than 0.3 percent chloride by mass (weight).

1021.02 Air-Entraining Admixtures. Air-entraining admixtures shall conform to the requirements of AASHTO M 154.

If the manufacturer certifies that the air-entraining admixture is an aqueous solution of Vinsol resin that has been neutralized with sodium hydroxide (caustic soda), testing for compliance with the requirements may be waived by the Engineer. In the certification, the manufacturer shall show complete information with respect to the formulation of the solution, including the number of parts of Vinsol resin to each part of sodium hydroxide. Before the approval of its use is granted, the Engineer will test the solution for its air-entraining quality in comparison with a solution prepared and kept for that purpose.

1021.03 Retarding and Water-Reducing Admixtures. The admixture shall comply with the following requirements:

- (a) The retarding admixture shall comply with the requirements of AASHTO M 194, Type B (retarding) or Type D (water-reducing and retarding).
- (b) The water-reducing admixture shall comply with the requirements of AASHTO M 194, Type A.

- (c) The high range water-reducing admixture shall comply with the requirements of AASHTO M 194, Type F (high range water-reducing) or Type G (high range water-reducing and retarding).

When a Type F or Type G high range water-reducing admixture is used, water-cement ratios shall be a minimum of 0.32.

Type F or Type G admixtures may be used, subject to the following restrictions:

For Class MS, SI, RR, SC and SH concrete, the water-cement ratio shall be a maximum of 0.44.

The Type F or Type G admixture shall be added at the jobsite unless otherwise directed by the Engineer. The initial slump shall be a minimum of 40 mm (1 1/2 in.) prior to addition of the Type F or Type G admixture, except as approved by the Engineer.

When a Type F or Type G admixture is used, retempering with water or with a Type G admixture will not be allowed. An additional dosage of a Type F admixture, not to exceed 40 percent of the original dosage, may be used to retemper concrete once, provided set time is not unduly affected. A second retempering with a Type F admixture may be used for all classes of concrete except Class PP and SC, provided that the dosage does not exceed the dosage used for the first retempering, and provided that the set time is not unduly affected. No further retempering will be allowed.

Air tests shall be performed after the addition of the Type F or Type G admixture.

1021.04 Set Accelerating Admixtures. The admixture shall comply with the requirements of AASHTO M 194, Type C (accelerating) or Type E (water reducing and accelerating)”

CURING AND PROTECTION OF CONCRETE CONSTRUCTION (BDE)

Effective: January 1, 2004

Revise the second and third sentences of the eleventh paragraph of Article 503.06 of the Standard Specifications to read:

“Forms on substructure units shall remain in place at least 24 hours. The method of form removal shall not result in damage to the concrete.”

Delete the twentieth paragraph of Article 503.22 of the Standard Specifications.

Revise the “Unit Price Adjustments” table of Article 503.22 of the Standard Specifications to read:

"UNIT PRICE ADJUSTMENTS	
Type of Construction	Percent Adjustment in Unit Price
For concrete in substructures, culverts (having a waterway opening of more than 1 sq m (10 sq ft)), pump houses, and retaining walls (except concrete pilings, footings and foundation seals): When protected by: Protection Method II Protection Method I	 115% 110%
For concrete in superstructures: When protected by: Protection Method II Protection Method I	 123% 115%
For concrete in footings: When protected by: Protection Method I, II or III	 107%
For concrete in slope walls: When protected by: Protection Method I	 107%"

Delete the fourth paragraph of Article 504.05(a) of the Standard Specifications.

Revise the second and third sentences of the fifth paragraph of Article 504.05(a) of the Standard Specifications to read:

"All test specimens shall be cured with the units according to Article 1020.13."

Revise the first paragraph of Article 504.06(c)(6) of the Standard Specifications to read:

"Curing and Low Air Temperature Protection. The curing and protection for precast, prestressed concrete members shall be according to Article 1020.13 and this Article."

Revise the first sentence of the second paragraph of Article 504.06(c)(6) of the Standard Specifications to read:

"For curing, air vents shall be in place, and shall be so arranged that no water can enter the void tubes during the curing of the members."

Revise the first sentence of the third paragraph of Article 504.06(c)(6) of the Standard Specifications to read:

"As soon as each member is finished, the concrete shall be covered with curing material according to Article 1020.13."

Revise the eighth paragraph of Article 504.06(c)(6) of the Standard Specifications to read:

"The prestressing force shall not be transferred to any member before the concrete has attained the compressive strength of 28,000 kPa (4000 psi) or other higher compressive release strength specified on the plans, as determined from tests of

150 mm (6 in.) by 300 mm (12 in.) cylinders cured with the member according to Article 1020.13. Members shall not be shipped until 28-day strengths have been attained and members have a yard age of at least 4 days.”

Delete the third paragraph of Article 512.03(a) of the Standard Specifications.

Delete the last sentence of the second paragraph of Article 512.04(d) of the Standard Specifications.

Revise the “Index Table of Curing and Protection of Concrete Construction” table of Article 1020.13 of the Standard Specifications to read:

“INDEX TABLE OF CURING AND PROTECTION OF CONCRETE CONSTRUCTION			
TYPE OF CONSTRUCTION	CURING METHODS	CURING PERIOD DAYS	LOW AIR TEMPERATURE PROTECTION METHODS
Cast-in-Place Concrete: ^{11/}			
Pavement			
Shoulder	1020.13(a)(1)(2)(3)(4)(5) ^{3/ 5/}	3	1020.13(c)
Base Course			
Base Course Widening	1020.13(a)(1)(2)(3)(4)(5) ^{1/ 2/}	3	1020.13(c)
Driveway			
Median			
Curb			
Gutter	1020.13(a)(1)(2)(3)(4)(5) ^{4/ 5/}	3	1020.13(c) ^{16/}
Curb and Gutter			
Sidewalk			
Slope Wall			
Paved Ditch			
Catch Basin			
Manhole	1020.13(a)(1)(2)(3)(4)(5) ^{4/}	3	1020.13(c)
Inlet			
Valve Vault			
Pavement Patching	1020.13(a)(1)(2)(3)(4)(5) ^{2/}	3 ^{12/}	1020.13(c)
Pavement Replacement	1020.13(a)(1)(2)(3)(4)(5) ^{1/ 2/}	3	442.06(h) and 1020.13(c)
Railroad Crossing	1020.13(a)(3)(5)	1	1020.13(c)
Piles	1020.13(a)(3)(5)	7	1020.13(e)(1)(2)(3)
Footings			
Foundation Seals	1020.13(a)(1)(2)(3)(4)(5) ^{4/ 6/}	7	1020.13(e)(1)(2)(3)
Substructure	1020.13(a)(1)(2)(3)(4)(5) ^{1/ 7/}	7	1020.13(e)(1)(2)(3)
Superstructure (except deck)	1020.13(a)(1)(2)(3)(5) ^{8/}	7	1020.13(e)(1)(2)
Deck	1020.13(a)(5)	7	1020.13(e)(1)(2) ^{17/}
Retaining Walls	1020.13(a)(1)(2)(3)(4)(5) ^{1/ 7/}	7	1020.13(e)(1)(2)
Pump Houses	1020.13(a)(1)(2)(3)(4)(5) ^{1/}	7	1020.13(e)(1)(2)
Culverts	1020.13(a)(1)(2)(3)(4)(5) ^{4/ 6/}	7	1020.13(e)(1)(2) ^{18/}
Other Incidental Concrete	1020.13(a)(1)(2)(3)(5)	3	1020.13(c)
Precast Concrete: ^{11/}			
Bridge Beams			
Piles			
Bridge Slabs	1020.13(a)(3)(5) ^{9/ 10/}	As required. ^{13/}	504.06(c)(6), 1020.13(e)(2) ^{19/}
Nelson Type Structural Member			
All Other Precast Items	1020.13(a)(3)(4)(5) ^{2/ 9/ 10/}	As required. ^{14/}	504.06(c)(6), 1020.13(e)(2) ^{19/}

Precast, Prestressed Concrete: ^{11/}		
All Items	1020.13(a)(3)(5) ^{9/10/}	Until strand tensioning is released. ^{15/} 504.06(c)(6), 1020.13(e)(2) ^{19/}

Notes-General:

- 1/ Type I, membrane curing only
- 2/ Type II, membrane curing only
- 3/ Type III, membrane curing only
- 4/ Type I, II and III membrane curing
- 5/ Membrane curing will not be permitted between November 1 and April 15.
- 6/ The use of water to inundate footings, foundation seals or the bottom slab of culverts is permissible when approved by the Engineer, provided the water temperature can be maintained at 7 °C (45 °F) or higher.
- 7/ Asphalt Emulsion for Waterproofing may be used in lieu of other curing methods when specified and permitted according to Article 503.18.
- 8/ On non-traffic surfaces which receive protective coat according to Article 503.19, a linseed oil emulsion curing compound may be used as a substitute for protective coat and other curing methods. The linseed emulsion curing compound will be permitted between April 16 and October 31 of the same year, provided it is applied with a mechanical sprayer according to Article 1101.09 (b), and meets the material requirements of Article 1022.07.
- 9/ Steam curing (heat and moisture) is acceptable and shall be accomplished by the method specified in Article 504.06(c)(6).
- 10/ A moist room according to AASHTO M 201 is acceptable for curing.
- 11/ If curing is required and interrupted because of form removal for cast-in-place concrete items, precast concrete products, or precast prestressed concrete products, the curing shall be resumed within two hours from the start of the form removal.
- 12/ Curing maintained only until opening strength is attained, with a maximum curing period of three days.
- 13/ The curing period shall end when the concrete has attained the mix design strength. The producer has the option to discontinue curing when the concrete has attained 80 percent of the mix design strength or after seven days. All strength test specimens shall remain with the units and shall be subjected to the same curing method and environmental condition as the units, until the time of testing.
- 14/ The producer shall determine the curing period or may elect to not cure the product. All strength test specimens shall remain with the units and shall be subjected to the same curing method and environmental condition as the units, until the time of testing.
- 15/ The producer has the option to continue curing after strand release.
- 16/ When structural steel or structural concrete is in place above slope wall, Article 1020.13(c) shall not apply. The protection method shall be according to Article 1020.13(e)(1).
- 17/ When Article 1020.13(e)(2) is used to protect the deck, the housing may enclose only the bottom and sides. The top surface shall be protected according to Article 1020.13(e)(1).
- 18/ For culverts having a waterway opening of 1 sq m (10 sq ft) or less, the culverts may be protected according to Article 1020.13(e)(3).

- 19/ The seven day protection period in the first paragraph of Article 1020.13(e)(2) shall not apply. The protection period shall end when curing is finished. For the third paragraph of Article 1020.13(e)(2), the decrease in temperature shall be according to Article 504.06(c)(6)."

Add the following to Article 1020.13(a) of the Standard Specifications:

"(5) Wetted Cotton Mat Method. After the surface of concrete has been textured or finished, it shall be covered immediately with dry cotton mats. The cotton mats shall be placed in a manner which will not mar the concrete surface. A texture resulting from the cotton mat material is acceptable. The cotton mats shall then be wetted immediately and thoroughly soaked with a gentle spray of water. For bridge decks, a foot bridge shall be used to place and wet the cotton mats.

The cotton mats shall be maintained in a wetted condition until the concrete has hardened sufficiently to place soaker hoses without marring the concrete surface. The soaker hoses shall be placed on top of the cotton mats at a maximum 1.2 m (4 ft) spacing. The cotton mats shall be kept wet with a continuous supply of water for the remainder of the curing period. Other continuous wetting systems may be used if approved by the Engineer.

After placement of the soaker hoses, the cotton mats shall be covered with white polyethylene sheeting or burlap-polyethylene blankets.

For construction items other than bridge decks, soaker hoses or a continuous wetting system will not be required if the alternative method keeps the cotton mats wet. Periodic wetting of the cotton mats is acceptable.

For areas inaccessible to the cotton mats on bridge decks, curing shall be according to Article 1020.13(a)(3)."

Revise the first paragraph of Article 1020.13(c) of the Standard Specifications to read:

"Protection of Portland Cement Concrete, Other Than Structures, From Low Air Temperatures. When the official National Weather Service forecast for the construction area predicts a low of 0 °C (32 °F), or lower, or if the actual temperature drops to 0 °C (32 °F), or lower, concrete less than 72 hours old shall be provided at least the following protection:"

Delete Article 1020.13(d) and Articles 1020.13(d)(1),(2),(3),(4) of the Standard Specifications.

Revise the first five paragraphs of Article 1020.13(e) of the Standard Specifications to read:

"Protection of Portland Cement Concrete Structures From Low Air Temperatures. When the official National Weather Service Forecast for the construction area predicts a low below 7 °C (45 °F), or if the actual temperature drops below 7 °C (45 °F), concrete less than 72 hours old shall be provided protection. Concrete shall also be provided protection when placed during the winter period of December 1 through March 15. Concrete shall not be placed until the materials, facilities and equipment for protection are approved by the Engineer.

When directed by the Engineer, the Contractor may be required to place concrete during the winter period. If winter construction is specified, the Contractor shall proceed with the construction, including concrete, excavation, pile driving, steel erection and all appurtenant work required for the complete construction of the item, except at times when weather conditions make such operations impracticable.

Regardless of the precautions taken, the Contractor shall be responsible for protection of the concrete placed and any concrete damaged by cold temperatures shall be removed and replaced by the Contractor at his/her own expense.”

Add the following at the end of the third paragraph of Article 1020.13(e)(1) of the Standard Specifications:

“The Contractor shall provide means for checking the temperature of the surface of the concrete during the protection period.”

Revise the second sentence of the first paragraph of Article 1020.13(e)(2) of the Standard Specifications to read:

“The Contractor shall provide means for checking the temperature of the surface of the concrete or air temperature within the housing during the protection period.”

Delete the last sentence of the first paragraph of Article 1020.13(e)(3) of the Standard Specifications.

Add the following Article to Section 1022 of the Standard Specifications:

“1022.06 Cotton Mats. Cotton mats shall consist of a cotton fill material, minimum 400 g/sq m (11.8 oz/sq yd), covered with unsized cloth or burlap, minimum 200 g/sq m (5.9 oz/sq yd), and be tufted or stitched to maintain stability.

Cotton mats shall be in a condition satisfactory to the Engineer. Any tears or holes in the mats shall be repaired.

Add the following Article to Section 1022 of the Standard Specifications:

“1022.07 Linseed Oil Emulsion Curing Compound. Linseed oil emulsion curing compound shall be composed of a blend of boiled linseed oil and high viscosity, heavy bodied linseed oil emulsified in a water solution. The curing compound shall meet the requirements of a Type I, II, or III according to Article 1022.01, except the drying time requirement will be waived. The oil phase shall be 50 ± 4 percent by volume. The oil phase shall consist of 80 percent by mass (weight) boiled linseed oil and 20 percent by mass (weight) Z-8 viscosity linseed oil. The water phase shall be 50 ± 4 percent by volume.”

Revise Article 1020.14 of the Standard Specifications to read:

“1020.14 Temperature Control for Placement. Temperature control for concrete placement shall conform to the following requirements:

- (a) Temperature Control other than Structures. The temperature of concrete immediately before placing, shall be not less than 10 °C (50 °F) nor more than 32 °C (90 °F). Aggregates and/or water shall be heated or cooled as necessary to produce concrete within these temperature limits.

When the temperature of the plastic concrete reaches 30 °C (85 °F), an approved retarding admixture shall be used or the approved water reducing admixture in use shall have its dosage increased by 50 percent over the dosage recommended on the Department's Approved List of Concrete Admixtures for the temperature experienced. The amount of retarding admixture to be used will be determined by the Engineer. This requirement may be waived by the Engineer when fly ash compensated mixtures are used.

Plastic concrete temperatures up to 35 °C (96 °F), as placed, may be permitted provided job site conditions permit placement and finishing without excessive use of water on and/or overworking of the surface. The occurrence within 24 hours of unusual surface distress shall be cause to revert to a maximum 32 °C (90 °F) plastic concrete temperature.

Concrete shall not be placed when the air temperature is below 5 °C (40 °F) and falling or below 2 °C (35 °F), without permission of the Engineer. When placing of concrete is authorized during cold weather, the Engineer may require the water and/or the aggregates to be heated to not less than 20 °C (70 °F) nor more than 65 °C (150 °F). The aggregates may be heated by either steam or dry heat prior to being placed in the mixer. The apparatus used shall heat the mass uniformly and shall be so arranged as to preclude the possible occurrence of overheated areas which might damage the materials. No frozen aggregates shall be used in the concrete.

For pavement patching, refer to Article 442.06(e) for additional information on temperature control for placement.

- (b) Temperature Control for Structures. The temperature of concrete as placed in the forms shall be not less than 10 °C (50 °F) nor more than 32 °C (90 °F). Aggregates and/or water shall be heated or cooled as necessary to produce concrete within these temperature limits. When insulated forms are used, the temperature of the concrete mixture shall not exceed 25 °C (80 °F). If the Engineer determines that heat of hydration might cause excessive temperatures in the concrete, the concrete shall be placed at a temperature between 10 °C (50 °F) and 15 °C (60 °F), per the Engineer's instructions. When concrete is placed in contact with previously placed concrete, the temperature of the concrete may be increased as required to offset anticipated heat loss.

Concrete shall not be placed when the air temperature is below 7 °C (45 °F) and falling or below 4 °C (40 °F), without permission of the Engineer. When placing of concrete is authorized during cold weather, the Engineer may require the water and/or the aggregates to be heated to not less than 20 °C (70 °F) nor more than 65 °C (150 °F). The aggregates may be heated by either steam or dry heat prior to being placed in the mixer. The apparatus used shall heat the mass uniformly and shall be so arranged as to preclude the possible occurrence of overheated areas which might damage the materials. No frozen aggregates shall be used in the concrete.

When the temperature of the plastic concrete reaches 30 °C (85 °F), an approved retarding admixture shall be used or the approved water reducing admixture in use shall have its dosage increased by 50 percent over the dosage recommended on the Department's Approved List of Concrete Admixtures for the temperature experienced. The amount of retarding admixture to be used will be determined by the Engineer. This requirement may be waived by the Engineer when fly ash compensated mixtures are used.

- (c) Temperature. The concrete temperature shall be determined according to ASTM C 1064."

FLAGGER VESTS (BDE)

Effective: April 1, 2003

Revised: April 1, 2005

Revise the first sentence of Article 701.04(c)(1) of the Standard Specifications to read:

"The flagger shall be stationed to the satisfaction of the Engineer and be equipped with a fluorescent orange, fluorescent yellow/green or a combination of fluorescent orange and fluorescent yellow/green vest meeting the requirements of the American National Standards Institute specification ANSI/ISEA 107-1999 for Conspicuity Class 2 garments and approved flagger traffic control signs conforming to Standard 702001 and Article 702.05(e)."

Revise Article 701.04(c)(6) of the Standard Specifications to read:

"(6) Nighttime Flagging. The flagger station shall be lit by additional overhead lighting other than streetlights. The flagger shall be equipped with a fluorescent orange, fluorescent yellow/green, or a combination of fluorescent orange and fluorescent yellow/green garment meeting the requirements of the American National Standards Institute specification ANSI/ISEA 107-1999 for Conspicuity Class 3 garments."

HAND VIBRATOR (BDE)

Effective: November 1, 2003

Add the following paragraph to Article 1103.17(a) of the Standard Specifications:

"The vibrator shall have a non-metallic head for areas containing epoxy coated reinforcement. The head shall be coated by the manufacturer. The hardness of the non-metallic head shall be less than the epoxy coated reinforcement, resulting in no damage to the epoxy coating. Slip-on covers will not be allowed."

MINIMUM LANE WIDTH WITH LANE CLOSURE (BDE)

Effective: January 1, 2005

Add the following paragraph after the eighth paragraph of Article 701.04(a) of the Standard Specifications.

“The minimum lane width adjacent to a closed lane during paving, patching, and other moving operations on freeways and expressways shall be a minimum of 3 m (10 ft). The 3 m (10 ft) shall be clear, unobstructed, and free of channelizing devices or other obstacles.”

MULTILANE PAVEMENT PATCHING (BDE)

Effective: November 1, 2002

Pavement broken and holes opened for patching shall be completed prior to weekend or holiday periods. Should delays of any type or for any reason prevent the completion of the work, temporary patches shall be constructed. Material able to support the average daily traffic and meeting the approval of the Engineer shall be used for the temporary patches. The cost of furnishing, placing, maintaining, removing and disposing of the temporary work, including traffic control, shall be the responsibility of the Contractor.

PARTIAL PAYMENTS (BDE)

Effective: September 1, 2003

Revise Article 109.07 of the Standard Specifications to read:

“**109.07 Partial Payments.** Partial payments will be made as follows:

- (a) Progress Payments. At least once each month, the Engineer will make a written estimate of the amount of work performed in accordance with the contract, and the value thereof at the contract unit prices. The amount of the estimate approved as due for payment will be vouchered by the Department and presented to the State Comptroller for payment. No amount less than \$1000.00 will be approved for payment other than the final payment.

The failure to perform any requirement, obligation, or term of the contract by the Contractor shall be reason for withholding any progress payments until the Department determines that compliance has been achieved. Furthermore, progress payments may be reduced by liens filed pursuant to Section 23(c) of the Mechanics Lien Act, 770 ILCS 60/23(c).

- (b) Material Allowances. At the discretion of the Department, payment may be made for materials, prior to their use in the work, when satisfactory evidence is presented by the Contractor. Satisfactory evidence includes justification for the allowance (to expedite the work, meet project schedules, regional or national material shortages, etc.), documentation of material and transportation costs, and evidence that such material is properly stored on the project or at a secure location acceptable and accessible to the Department.

Material allowances will be considered only for nonperishable materials when the cost, including transportation, exceeds \$10,000 and such materials are not expected to be utilized within 60 days of the request for the allowance. For contracts valued under \$500,000, the minimum \$10,000 requirement may be met by combining the principal (material) product of no more than two contract items. An exception to this two item

limitation may be considered for any contract regardless of value for items in which material (products) are similar except for type and/or size.

Material allowances shall not exceed the value of the contract items in which used and shall not include the cost of installation or related markups. Amounts paid by the Department for material allowances will be deducted from estimates due the Contractor as the material is used. Two-sided copies of the Contractor's cancelled checks for materials and transportation must be furnished to the Department within 60 days of payment of the allowances or the amounts will be reclaimed by the Department."

PAYMENTS TO SUBCONTRACTORS (BDE)

Effective: June 1, 2000

Revised: September 1, 2003

Federal regulations found at 49 CFR §26.29 mandate the Department to establish a contract clause to require Contractors to pay subcontractors for satisfactory performance of their subcontracts no later than 30 days from the receipt of each payment made to the Contractor.

State law addresses the timing of payments to be made to subcontractors. Section 7 of the Prompt Payment Act, 30 ILCS 540/7, generally requires that when a Contractor receives any payment from the Department, the Contractor is required to make corresponding, proportional payments to each subcontractor performing work within 15 calendar days after receipt of the state payment. Section 7 of the State Prompt Payment Act further provides that interest in the amount of 2% per month, in addition to the payment due, shall be paid to any subcontractor by the Contractor if the payment required by the Act is withheld or delayed without reasonable cause. The Act also provides that the time for payment required and the calculation of any interest due applies to transactions between subcontractors and lower-tier subcontractors throughout the contracting chain.

This Special Provision establishes the required federal contract clause, and adopts the 15 calendar day requirement of the Act for purposes of compliance with the federal regulation regarding payments to subcontractors. This contract is subject to the following payment obligations.

As progress payments are made to the Contractor in accordance with Article 109.07 of the Standard Specifications for Road and Bridge Construction, the Contractor shall make a corresponding partial payment within 15 calendar days to each subcontractor in proportion to the work satisfactorily completed by each subcontractor. The proportionate amount of partial payment due to each subcontractor shall be determined by the quantities measured or otherwise determined as eligible for payment by the Department and included in the progress payment to the Contractor. Subcontractors shall be paid in full within 15 calendar days after the subcontractor's work has been satisfactorily completed. The Contractor shall hold no retainage from the subcontractors.

This Special Provision does not create any rights in favor of any subcontractor against the State of Illinois or authorize any cause of action against the State of Illinois on account of any payment, nonpayment, delayed payment or interest claimed by application of the State Prompt Payment Act. The Department will neither determine the reasonableness of any cause for delay of payment nor enforce any claim to payment, including interest. Moreover, the Department will not approve any delay or postponement of the 15 day requirement. State law creates remedies

available to any subcontractor or material supplier, regardless of tier, who has not been paid for work properly performed or material furnished. These remedies are a lien against public funds set forth in Section 23(c) of the Mechanics Lien Act, 770 ILCS 60/23(c), and a recovery on the Contractor's payment bond in accordance with the Public Construction Bond Act, 30 ILCS 550.

PERSONAL PROTECTIVE EQUIPMENT (BDE)

Effective: July 1, 2004

All personnel, excluding flaggers, working outside of a vehicle (car or truck) within 7.6 m (25 ft) of pavement open to traffic shall wear a fluorescent orange, fluorescent yellow/green or a combination of fluorescent orange and fluorescent yellow/green vest meeting the requirements of the American National Standards Institute specification ANSI/ISEA 107-1999 for Conspicuity Class 2 garments. Other types of garments may be substituted for the vest as long as the garments have manufacturers tags identifying them as meeting the ANSI Class 2 requirement.

PORTLAND CEMENT (BDE)

Effective: January 1, 2005

Replace the first sentence of the second paragraph of Article 1001.01 of the Standard Specifications with the following:

“For portland cement according to ASTM C 150, the addition of up to 5.0 percent limestone by mass (weight) to the cement will not be permitted. Also, the total of all organic processing additions shall not exceed 1.0 percent by mass (weight) of the cement and the total of all inorganic processing additions shall not exceed 4.0 percent by mass (weight) of the cement.”

PORTLAND CEMENT CONCRETE (BDE)

Effective: November 1, 2002

Add the following paragraph after the fourth paragraph of Article 1103.01(b) of the Standard Specifications:

“The truck mixer shall be approved before use according to the Bureau of Materials and Physical Research's Policy Memorandum, “Approval of Concrete Plants and Delivery Trucks”.”

Add the following paragraph after the first paragraph of Article 1103.01(c) of the Standard Specifications:

“The truck agitator shall be approved before use according to the Bureau of Materials and Physical Research's Policy Memorandum, “Approval of Concrete Plants and Delivery Trucks”.”

Add the following paragraph after the first paragraph of Article 1103.01(d) of the Standard Specifications:

“The nonagitator truck shall be approved before use according to the Bureau of Materials and Physical Research’s Policy Memorandum, “Approval of Concrete Plants and Delivery Trucks”.”

Revise the first sentence of the first paragraph of Article 1103.02 of the Standard Specifications to read:

“The plant shall be approved before production begins according to the Bureau of Materials and Physical Research’s Policy Memorandum, “Approval of Concrete Plants and Delivery Trucks”.”

PORTLAND CEMENT CONCRETE PATCHING (BDE)

Effective: January 1, 2001

Revised: January 1, 2004

Revise Note 1 of Article 442.02 of the Standard Specifications, to read:

"Note 1. When patching ramp pavements and two lane pavements with two way traffic, Class PP-2, PP-3, or PP-4 concrete shall be used for Class A, Class B and Class C patching. For all other pavements, Class PP-1, PP-2, PP-3, or PP-4 concrete shall be used, at the Contractor’s option, for Class A, Class B and Class C patching."

Delete Note 2 of Article 442.02 of the Standard Specifications.

Add the following to Article 442.02 of the Standard Specifications:

“(l) Calcium Chloride (Note 5)..... 1013.01

Note 5. The calcium chloride accelerator, when permitted by the Department, shall be Type L (Liquid) with a minimum of 32.0 percent by mass (weight) of calcium chloride.”

Revise the first paragraph of Article 442.06(e) of the Standard Specifications to read:

"(e) Concrete Placement. For Class A, Class B and Class C Patches, concrete shall be placed according to Article 420.07 and governed by the limitations set forth in Article 1020.14, except that the maximum temperature of the mixed concrete immediately before placing shall be 35 °C (96 °F), the required use of an approved retarding admixture when the plastic concrete reaches 30 °C (85 °F) shall not apply."

Revise the first paragraph of Article 442.06(h) of the Standard Specifications to read:

"(h) Curing and Protection. In addition to Article 1020.13, when the air temperature is less than 13 °C (55 °F), the Contractor shall cover the patch with minimum R12 insulation until opening strength is reached. Insulation is optional when the air temperature is 13 °C - 35 °C (55 °F - 96 °F). Insulation shall not be placed when the air temperature is greater than 35 °C (96 °F)."

Revise the second paragraph of Article 701.05(e)(1)d.1. of the Standard Specifications to read:

"No open holes, broken pavement, or partially filled holes shall remain overnight for bituminous patching or when the Department specifies only Class PP-2, PP-3, or PP-4 concrete be used. The only exception is conditions beyond the control of the Contractor."

Revise Article 701.05(e)(2)b. of the Standard Specifications to read:

- "b. Strength Tests. For patches constructed with Class PP-1, PP-2, PP-3, or PP-4 concrete, the pavement may be opened to traffic when test specimens cured with the patches have obtained a minimum flexural strength of 4150 kPa (600 psi) or a minimum compressive strength of 22,100 kPa (3200 psi) according to Article 1020.09.

For patches constructed with Class PP-2, PP-3, or PP-4 concrete which can obtain a minimum flexural strength of 4150 kPa (600 psi) or a minimum of compressive strength of 22,100 kPa (3200 psi) in 16 hours, the pavement may be opened to traffic at a lower opening strength. The specimens cured with the patches shall have obtained a minimum flexural strength of 2050 kPa (300 psi) or a minimum compressive strength of 11,000 kPa (1600 psi) according to Article 1020.09, to permit opening pavement to traffic.

With the approval of the Engineer, concrete strength may be determined according to AASHTO T 276. The strength-maturity relationship shall be developed from concrete which has an air content near the upper specification limit. The strength-maturity relationship shall be re-established if the mix design or materials are changed."

Revise Article 701.05(e)(2)c. of the Standard Specifications to read:

- "c. Construction Operations. For Class PP-2, PP-3, or PP-4 concrete used on ramp pavements and two lane pavements with two way traffic, or when the Department specifies only Class PP-2, PP-3, or PP-4 concrete be used for other pavements, Contractor construction operations shall be performed in a manner which allows the patches to be opened the same day and before nightfall. If patches are not opened before nightfall, the additional traffic control shall be at the Contractor's expense. Any time patches cannot be opened before nightfall, the Contractor shall change subsequent construction operations or the mix design. The changes shall be at no additional cost to the Department."

Revise Table 1 of Article 1020.04 of the Standard Specifications by replacing Class PP concrete with the following:

"TABLE 1. CLASSES OF PORTLAND CEMENT CONCRETE AND MIX DESIGN CRITERIA				
Class of Concrete	Use	Specification Section Reference	Cement Factor kg/cu m (cwt/cu yd)	Max. Water/Cement Ratio kg/kg (lb/lb)
PP-1	PCC Pavement Patching Bridge Deck Patching	442	Type I Cement 385 to 445 (6.50 to 7.50) Type III Cement 365 to 425 (6.20 to 7.20)	0.44

PP-2	PCC Pavement Patching Bridge Deck Patching	442	Type I Cement 435 (7.35)	0.38
PP-3	PCC Pavement Patching Bridge Deck Patching	442	Type III Cement 435 (7.35)	0.35
PP-4	PCC Pavement Patching Bridge Deck Patching	442	Rapid Hardening Cement 355 to 370 (6.00 to 6.25)	0.50

For PP-1, the Contractor has the option to replace the Type I Cement with Class C fly ash or ground granulated blast-furnace slag. The amount of cement replaced shall not exceed 15 percent by mass (weight), at a minimum replacement ratio of 1.5:1.

For PP-2, the Contractor has the option to replace the Type I cement with ground granulated blast-furnace slag. The amount of cement replaced shall not exceed 30 percent by mass (weight), at a minimum replacement ratio of 1:1.

For PP-3, in addition to the cement, 60 kg/cu m (100 lb/cu yd) of ground granulated blast-furnace slag and 30 kg/cu m (50 lb/cu yd) of microsilica are required. For an air temperature greater than 30 °C (85 °F), the Contractor has the option to replace the Type III cement with Type I cement.

For PP-4, the cement shall be from the Department's "Approved List of Packaged, Dry, Rapid Hardening Cementitious Materials for Concrete Repairs".

TABLE 1. (CONT'D) CLASSES OF PORTLAND CEMENT CONCRETE AND MIX DESIGN CRITERIA					
Class of Concrete	Slump, mm (in.)	Mix Design Compressive Strength, kPa (psi)	Mix Design Flexural Strength, kPa (psi)	Air Content, %	Coarse Aggregate Gradations Permitted
		Hours	Hours		
		48	48		
PP – 1	100 (4) Max	22,100 (3200)	4150 (600)	4.0 – 7.0	CA-7, CA-11, CA-13, CA14, or CA-16
PP – 2	150 (6) Max	22,100 (3200)	4150 (600)	4.0 – 6.0	CA-7, CA-11, CA-13, CA14, or CA-16
PP – 3	100 (4) Max	22,100 (3200)	4150 (600)	4.0 – 6.0	CA-7, CA-11, CA-13, CA14, or CA-16
PP – 4	150 (6) Max	22,100 (3200)	4150 (600)	4.0 – 6.0	CA-7, CA-11, CA-13, CA14, or CA-16

For PP-1, PP-2, PP-3 or PP-4; only CA-13, CA-14, or CA-16 may be used for bridge deck patching. In addition, the mix design strength at 48 hours shall be increased to 27,500 kPa (4,000 psi) compressive or 4,650 kPa (675 psi) flexural for bridge deck patching.

For PP-1, the slump may be increased to 150 mm (6 in.) Max if a high range water-reducing admixture is used.”

Delete Article 1020.05(g) of the Standard Specifications.

TRAFFIC CONTROL DEFICIENCY DEDUCTION (BDE)

Effective: April 1, 1992

Revised: January 1, 2005

To ensure a prompt response to incidents involving the integrity of work zone traffic control, the Contractor shall provide a telephone number where a responsible individual can be contacted 24 hours-a-day.

When the Engineer is notified, or determines a traffic control deficiency exists, he/she will notify and direct the Contractor to correct the deficiency within a specified time. The specified time, which begins upon notification to the Contractor, will be from 1/2 hour to 12 hours based upon the urgency of the situation and the nature of the deficiency. The Engineer shall be the sole judge.

A deficiency may be any lack of repair, maintenance, or non-compliance with the traffic control plan. A deficiency may also be applied to situations where corrective action is not an option such as the use of non-certified flaggers for short term operations; working with lane closures beyond the time allowed in the contract; or failure to perform required contract obligations such as traffic control surveillance.

If the Contractor fails to correct a deficiency within the specified time, a daily monetary deduction will be imposed for each calendar day or fraction thereof the deficiency exists. The calendar day(s) will begin with notification to the Contractor and end with the Engineer's acceptance of the correction. The daily monetary deduction will be either \$1,000 or 0.05 percent of the awarded contract value, whichever is greater. For those deficiencies where corrective action was not an option this monetary deduction will be immediate.

In addition, if the Contractor fails to respond, the Engineer may correct the deficiency and the cost thereof will be deducted from monies due or which may become due the Contractor. This corrective action will in no way relieve the Contractor of his/her contractual requirements or responsibilities.

WORKING DAYS (BDE)

Effective: January 1, 2002

The Contractor shall complete the work within 20 working days.

SUBCONTRACTOR MOBILIZATION PAYMENTS (BDE)

Effective: April 2, 2005

To account for the preparatory work and operations necessary for the movement of subcontractor personnel, equipment, supplies, and incidentals to the project site and for all other

work or operations that must be performed or costs incurred when beginning work approved for subcontracting in accordance with Article 108.01 of the Standard Specifications, the Contractor shall make a mobilization payment to each subcontractor.

This mobilization payment shall be made at least 14 days prior to the subcontractor starting work. The amount paid shall be equal to 3 percent of the amount of the subcontract reported on form BC 260A submitted for the approval of the subcontractor's work.

This provision shall be incorporated directly or by reference into each subcontract approved by the Department.

STEEL COST ADJUSTMENT (BDE)

Effective: April 2, 2004

Revised: July 1, 2004

Description. At the bidder's option, a steel cost adjustment will be made to provide additional compensation to the Contractor or a credit to the Department for fluctuations in steel prices. The bidder must indicate on the attached form whether or not steel cost adjustments will be part of this contract. This attached form shall be submitted with the bid. Failure to submit the form shall make this contract exempt of steel cost adjustments.

Types of Steel Products. An adjustment will be made for fluctuations in the cost of steel used in the manufacture of the following items:

- Metal Piling (excluding temporary sheet piling)
- Structural Steel
- Reinforcing Steel

Other steel materials such as dowel bars, tie bars, mesh reinforcement, guardrail, steel traffic signal and light poles, towers and mast arms, metal railings (excluding wire fence), frames and grates, and other miscellaneous items will be subject to a steel cost adjustment when the pay item they are used in has a contract value of \$10,000 or greater.

Documentation. Sufficient documentation shall be furnished to the Engineer to verify the following:

- (a) Evidence that increased or decreased steel costs have been passed on to the Contractor.
- (b) The dates and quantity of steel, in kg (lb), shipped from the mill to the fabricator.
- (c) The quantity of steel, in kg (lb), incorporated into the various items of work covered by this special provision. The Department reserves the right to verify submitted quantities.

Method of Adjustment. Steel cost adjustments will be computed as follows:

$$SCA = Q \times D$$

Where: SCA = steel cost adjustment, in dollars
Q = quantity of steel incorporated into the work, in kg (lb)
D = price factor, in dollars per kg (lb)

$$D = CBP_M - CBP_L$$

Where: CBP_M = The average of the Consumer Buying Price indices for Shredded Auto Scrap (Chicago) and No. 1 Heavy Melt (Chicago) as published by the American Metal Market (AMM) for the day the steel is shipped from the mill. The indices will be converted from dollars per ton to dollars per kg (lb).

CBP_L = The average of the Consumer Buying Price indices for Shredded Auto Scrap (Chicago) and No. 1 Heavy Melt (Chicago) as published by the AMM for the day the contract is let. The indices will be converted from dollars per ton to dollars per kg (lb).

The unit masses (weights) of steel that will be used to calculate the steel cost adjustment for the various items are shown in the attached table.

No steel cost adjustment will be made for any products manufactured from steel having a mill shipping date prior to the letting date.

If the Contractor fails to provide the required documentation, the method of adjustment will be calculated as described above; however, the CBP_M will be based on the date the steel arrives at the job site. In this case, an adjustment will only be made when there is a decrease in steel costs.

Basis of Payment. Steel cost adjustments may be positive or negative but will only be made when there is a difference between the CBP_L and CBP_M in excess of five percent, as calculated by:

$$\text{Percent Difference} = \{(CBP_L - CBP_M) \div CBP_L\} \times 100$$

Steel cost adjustments will be calculated by the Engineer and will be paid or deducted when all other contract requirements for the steel items are satisfied. Adjustments will only be made for fluctuations in the cost of the steel as described herein. No adjustment will be made for changes in the cost of manufacturing, fabrication, shipping, storage, etc.

Attachment

Item	Unit Mass (Weight)
Metal Piling (excluding temporary sheet piling)	
Furnishing Metal Pile Shells 305 mm (12 in.), 3.80 mm (0.179 in.) wall thickness)	34 kg/m (23 lb/ft)
Furnishing Metal Pile Shells 305 mm (12 in.), 6.35 mm (0.250 in.) wall thickness)	48 kg/m (32 lb/ft)
Furnishing Metal Pile Shells 356 mm (14 in.), 6.35 mm (0.250 in.) wall thickness)	55 kg/m (37 lb/ft)
Other piling	See plans
Structural Steel	See plans for weights
Reinforcing Steel	See plans for weights
Dowel Bars and Tie Bars	3 kg (6 lb) each
Mesh Reinforcement	310 kg/sq m (63 lb/100 sq ft)
Guardrail	
Steel Plate Beam Guardrail, Type A w/steel posts	30 kg/m (20 lb/ft)
Steel Plate Beam Guardrail, Type B w/steel posts	45 kg/m (30 lb/ft)
Steel Plate Beam Guardrail, Types A and B w/wood posts	12 kg/m (8 lb/ft)
Steel Plate Beam Guardrail, Type 2	140 kg (305 lb) each
Steel Plate Beam Guardrail, Type 6	570 kg (1260 lb) each
Traffic Barrier Terminal, Type 1 Special (Tangent)	330 kg (730 lb) each
Traffic Barrier Terminal, Type 1 Special (Flared)	185 kg (410 lb) each
Steel Traffic Signal and Light Poles, Towers and Mast Arms	
Traffic Signal Post	16 kg/m (11 lb/ft)
Light Pole, Tenon Mount and Twin Mount, 9 m – 12 m (30 - 40 ft)	21 kg/m (14 lb/ft)
Light Pole, Tenon Mount and Twin Mount, 13.5 m – 16.5 m (45 - 55 ft)	31 kg/m (21 lb/ft)
Light Pole w/Mast Arm, 9 m – 15.2 m (30 - 50 ft)	19 kg/m (13 lb/ft)
Light Pole w/Mast Arm, 16.5 m – 18 m (55 - 60 ft)	28 kg/m (19 lb/ft)
Light Tower w/Luminaire Mount, 24 m – 33.5 m (80 - 110 ft)	46 kg/m (31 lb/ft)
Light Tower w/Luminaire Mount, 36.5 m – 42.5 m (120 - 140 ft)	97 kg/m (65 lb/ft)
Light Tower w/Luminaire Mount, 45.5 m – 48.5 m (150 - 160 ft)	119 kg/m (80 lb/ft)
Metal Railings (excluding wire fence)	
Steel Railing, Type SM	95 kg/m (64 lb/ft)
Steel Railing, Type S-1	58 kg/m (39 lb/ft)
Steel Railing, Type T-1	79 kg/m (53 lb/ft)
Steel Bridge Rail	77 kg/m (52 lb/ft)
Frames and Grates	
Frame	115 kg (250 lb)
Lids and Grates	70 kg (150 lb)

RETURN WITH BID

**ILLINOIS DEPARTMENT
OF TRANSPORTATION**

**OPTION FOR
STEEL COST ADJUSTMENT**

The bidder shall submit this form with his/her bid. Failure to submit the form shall make this contract exempt of steel cost adjustments. After award, this form, when submitted shall become part of the contract.

Contract No.: _____

Company Name: _____

Contractor's Option:

Is your company opting to include this special provision as part of the contract plans?

Yes No

Signature: _____ **Date:** _____

ADDITIONAL AWARD CRITERIA (BDE)

Effective: June 1, 2004

It is essential to the needs of the Department that work is completed within the contract time allowed and that inconvenience to the traveling public is held to a minimum. It is also essential to the public safety needs of the Department that open patches be closed according to the time limits set out in the contract. Therefore, this special provision establishes additional award criteria in accordance with 44 Illinois Administrative Code 650.70 of the Rules for Prequalification of Contractors and Issuance of Plans and Proposals. In addition to the prequalification rating established by the rule, the other award criteria advertised in the Invitation for Bids and procurement rules of the Department, the criteria set forth herein shall govern the award of this contract.

Within seven (7) working days after the date of the letting, the as-read low bidder shall submit on the attached form, a work plan detailing the Contractor's preparedness and manner of scheduling the work in order to explain how the Contractor will be able to complete work ordered in keeping with the contract lane restrictions and within allowable contract time. As a part of the plan, the Contractor shall provide the names of key response personnel, the manner and means of establishing 24 hour contact with the key response personnel, and the identification of the source of supply and delivery for key materials.

This contract does not allow for extensions of time due to interruptions of work or delivery of materials due to labor actions except for strikes or walkouts extending in duration more than five calendar days. Therefore, the plan shall disclose whether the Contractor has been the subject of any labor action, including but not limited to the actions of informational pickets at or near its work locations in the past three years. A Contractor making such a disclosure, shall incorporate in the work plan a full and complete description of the control, supply, and delivery of key materials. Furthermore, in the case where key materials will be supplied to a Contractor making such a disclosure, by subcontractors or material suppliers not under the direct control of the Contractor, a written certification signed by the Contractor and supplier shall be provided guaranteeing the uninterrupted supply and delivery of said materials to the job-site regardless of the occurrence of any labor action for which an extension of time will not be allowed, including but not limited to informational pickets, and specifying the manner by which the key materials will be delivered. For purposes of this special provision, key materials shall be defined as portland cement concrete.

The plan will be judged based on completeness, thoroughness, and ability to meet the needs of the Department. The Department reserves the right to confirm information contained in the submitted work plan with the Contractor, subcontractors, or material suppliers before the award of this contract. After award, the work plan shall become part of the contract.

Failure to submit the work plan within seven (7) working days after the date of the letting shall be cause to declare the submitted bid not responsive. To meet the seven (7) day requirement, the bidder may send the work plan by certified mail or delivery service within the seven (7) working day period. If a question arises concerning the mailing date of a work plan, the mailing date will be established by the U.S. Postal Service postmark on the original certified mail receipt from the U.S. Postal Service or the receipt issued by a delivery service. It is the responsibility of the as-read low bidder to ensure that the postmark or receipt date is affixed within the seven (7) working days if the bidder intends to rely upon mailing or delivery to satisfy the submission day

requirement. The work plan is to be submitted to the Illinois Department of Transportation, Bureau of Design and Environment Room 323, 2300 South Dirksen Parkway, Springfield, Illinois 62764 (Telefax: 217-785-1141). It is the responsibility of the bidder to obtain confirmation of telefax delivery.

**ILLINOIS DEPARTMENT
OF TRANSPORTATION**

ADDITIONAL AWARD CRITERIA

The as-read low bidder shall submit this form within seven (7) working days after the date of the letting. Failure to do so shall be cause to declare the submitted bid not responsive. After award, this form shall become part of the contract.

Company Name: _____

Contractor's Key Response Personnel:

Name: _____ 24 Hour Contact #: _____

Name: _____ 24 Hour Contact #: _____

Source of Supply and Delivery for Portland Cement Concrete:

Name: _____ Phone: _____

Address: _____

Name: _____ Phone: _____

Address: _____

Name: _____ Phone: _____

Address: _____

Labor Action Disclosure:

Has your company been the subject of labor actions including, but not limited to the actions of informational pickets at or near its work locations in the past three years?

Yes No

If yes, a written certification signed by the Contractor and supplier shall be provided guaranteeing the uninterrupted supply and delivery of materials. Also, in the work plan below, include a complete description of the control, supply and delivery of key materials.

Work Plan. (Include work schedule to show how work ordered will fulfill contract lane restrictions within allowable contract time.) _____

STATE OF ILLINOIS

DEPARTMENT OF TRANSPORTATION
PLANS FOR PROPOSED ROADWORK

Sheet 1 of 20

INDEX OF SHEETS

- 1. Cover Sheet
- Index of Sheets
- 2. Summary of Quantities
- 3. General Notes
- 4-6 Typical Sections
- 7-11 Schedule of Work
- 12-15 Plan Sheets
- 16-18 Traffic Control &
 Protection (Special)
- 19. As Built Plans
- 20. District Standard 95.2

FAI 74 (I-74)

C-92-015-05

D2 Patching 2005-4

D-92-024-05

Rock Island County

R1W

STANDARDS

- 442001-02
- 701426-02
- 702001-05
- 780001-01

**NOTE: NO PATCHING IS ON THE MAINLINE.
ALL REQUIRED PATCHING
IS ON THE RAMPS.**

CONTRACT NUMBER 64A65
CALL J.U.L.I.E. BEFORE YOU DIG
800-892-0123

pp2005-4

SOUTH MOLINE TWP. - Sec. 4, 9
MOLINE TWP. - Sec 4

Length of Project = 4,830' = 0.915 Mile.

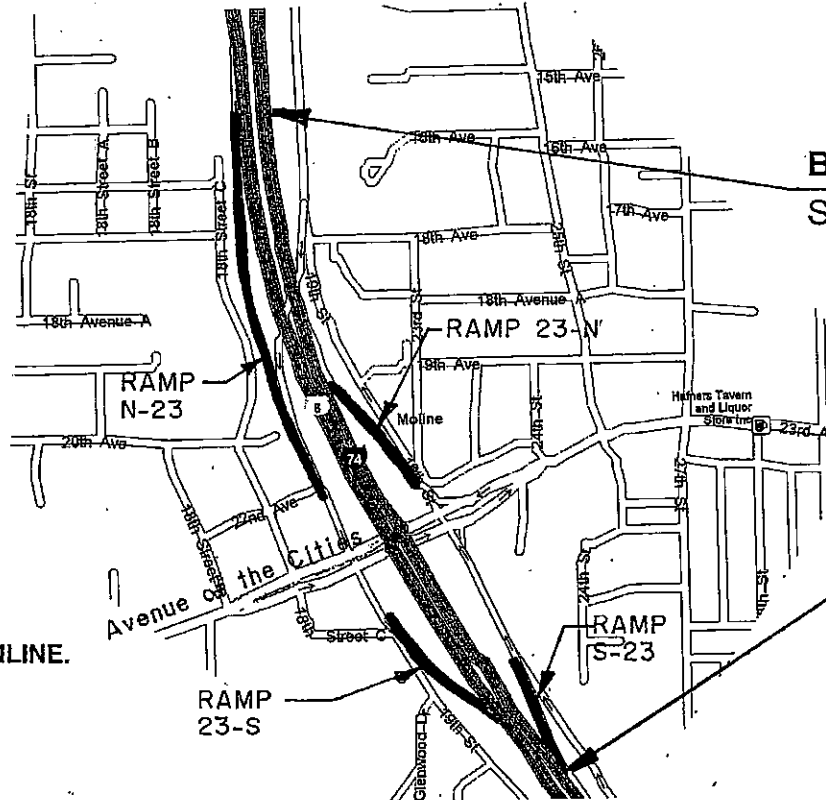

END WORK
Sta. 358+30

**DISTRICT 2
DIXON, ILLINOIS**

STATE OF ILLINOIS
DEPARTMENT OF TRANSPORTATION
DIVISION OF HIGHWAYS

SUBMITTED April 5, 2005

Gregory L. Mountain
DISTRICT ENGINEER

SUMMARY OF QUANTITIES
100% STATE

URBAN
J000

CODE NUMBER	ITEM	UNIT	QUANTITY
44200513	CLASS A PATCHES, TYPE I, 7 INCH	SQ. YD.	4
44200517	CLASS A PATCHES, TYPE II, 7 INCH	SQ. YD.	159
44200521	CLASS A PATCHES, TYPE III, 7 INCH	SQ. YD.	76
44200523	CLASS A PATCHES, TYPE IV, 7 INCH	SQ. YD.	1,106
44213000	PATCHING REINFORMCENT	SQ. YD.	1,344
44213200	SAW CUTS	FOOT	2,332
67100100	MOBILIZATION	L. SUM	1
70101800	TRAFFIC CONTROL AND PROTECTION (SPECIAL)	L. SUM	1
78001110	PAINT PAVEMENT MARKING - LINE 4 INCH	FOOT	6,418
X3120600	STABILIZED SUB-BASE REPLACEMENT, 4 INCH	SQ. YD.	150
Z0075300	TIE BARS	EACH	289

GENERAL NOTES

When laying out for patching, the minimum distance between new patches (saw cut to saw cut) shall be 15 feet. When patch spacing is less than 15 feet, the pavement between patches shall also be removed and replaced.

All mandatory joint sealing for Class A, Class B, and Class B (Hinge Jointed) patches as shown on the plans will not be measured for payment. Optional sawing of the joint for the sealant reservoir will not be measured for payment.

For all concrete patching that will not be resurfaced, the concrete shall be struck off flush with the existing pavement surface at each end of the patch.

The Engineer reserves the right to check all patches for smoothness by the use of a 10' rolling straight edge set to a 3/16" tolerance in the wheel paths. Any patch areas higher than 3/16" must be ground smooth with an approved grinding device consisting of multiple saws. The use of bushhammer or other impact devices will not be permitted. Any patch with depressions greater than 3/16" shall be repaired in a manner approved by the Engineer.

The mandatory saw cuts for pavement patching are:

Class A Patch: Cut two saw cuts at each end of the patch; one full depth and one partial depth. The longitudinal edges of the patch shall be cut full depth. When the patch is adjacent to a pcc shoulder, two saw cuts along the shoulder will be required.

Class B Patch: Cut two transverse saw cuts outlining the patch and one transverse pressure relief saw cut. The longitudinal edges of the patch shall be cut full depth. When the patch is adjacent to a pcc shoulder, two saw cuts along the shoulder will be required.

The mandatory saw cuts will be paid for at the contract unit price per Foot for SAW CUTS.

Tie bars shall be installed to tie PCC appurtenance to adjacent existing concrete pavement.

Tie the following
To the existing
Concrete Pavement

Length, size, and
Spacing of Tie Bars

Gutter or Curb & Gutter	(Standard 606001)	24" long No. 6 @ 24" centers
PCC Base Course	(Standard 353001)	24" long No. 6 @ 30" centers
PCC Pavement	(Standard 420101)	24" long No. 6 @ 30" centers

Tie bars to be installed in accordance with the applicable portions of Article 420.10(b) of the Standard Specifications. See Highway Standard 420001 for detail on longitudinal construction joint grouted-in-place tie bar. The tie bars will be paid for at the contract unit price Each for TIE BARS.

TYPICAL SECTIONS

RAMP PATCHING

FAI 74
D2 Patching 2005-4
Rock Island County
Sheet 4 of 20
Contract Number: 64A65

For RAMPS S-23, 23-S, & N-23

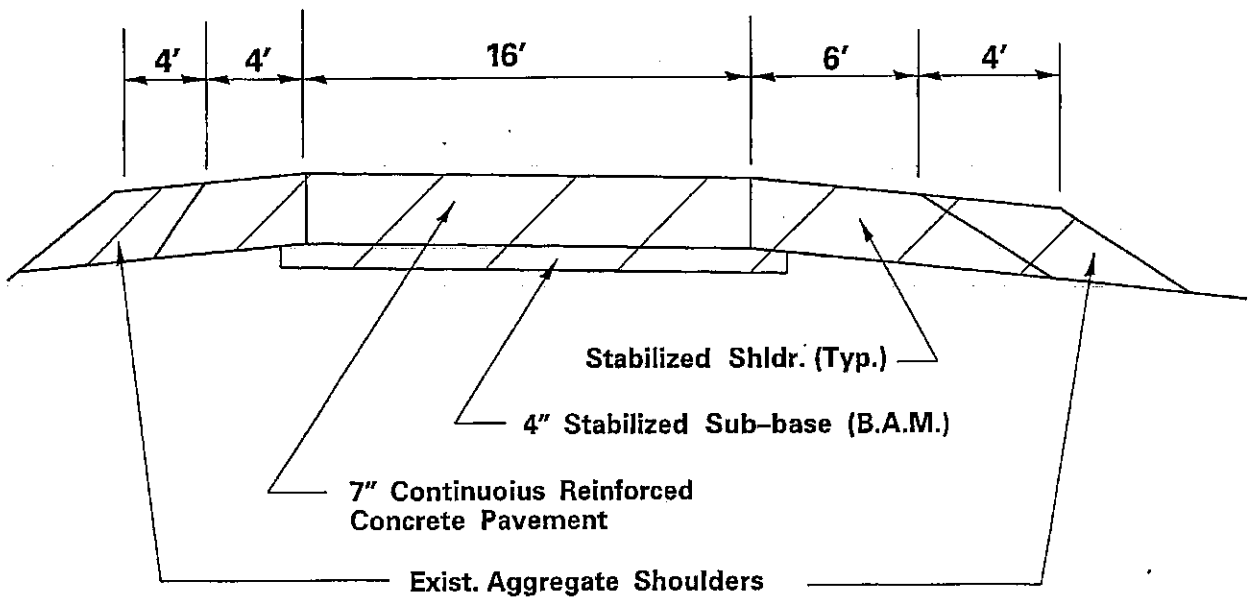
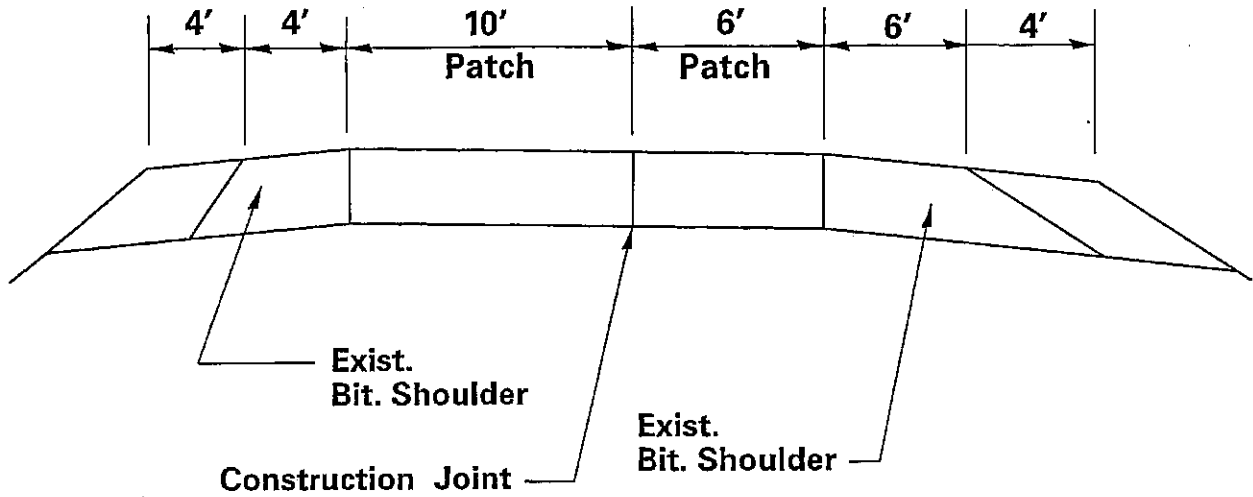

EXISTING RAMP

TYPICAL SECTIONS

FAI 74
D2 Patching 2005-4
Rock Island County
Sheet 5 of 20
Contract Number: 64A65

Ramp 23-N - On Ramp From Ave. of the Cities to I-74 NB

RAMP PATCHING

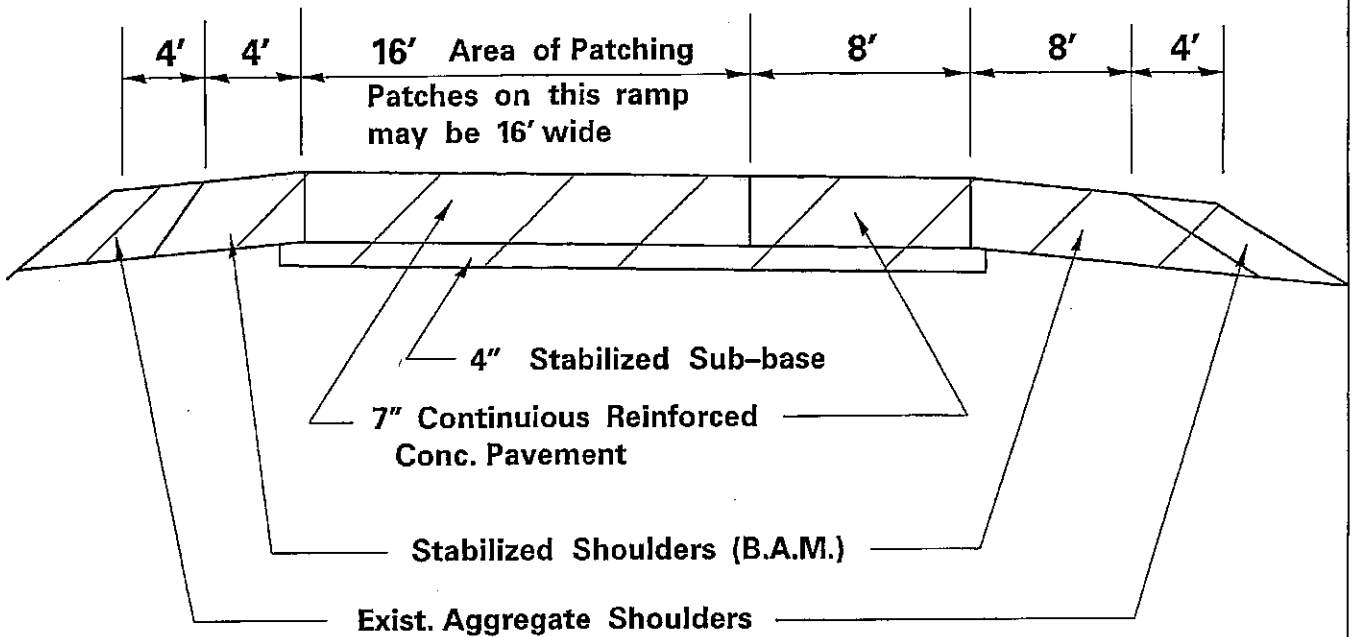

TYPICAL SECTIONS

RAMP PATCHING

For RAMP N-23 (Sta. 715+43 - 720+00)
I-74 SB Off Ramp to Ave. of the Cities

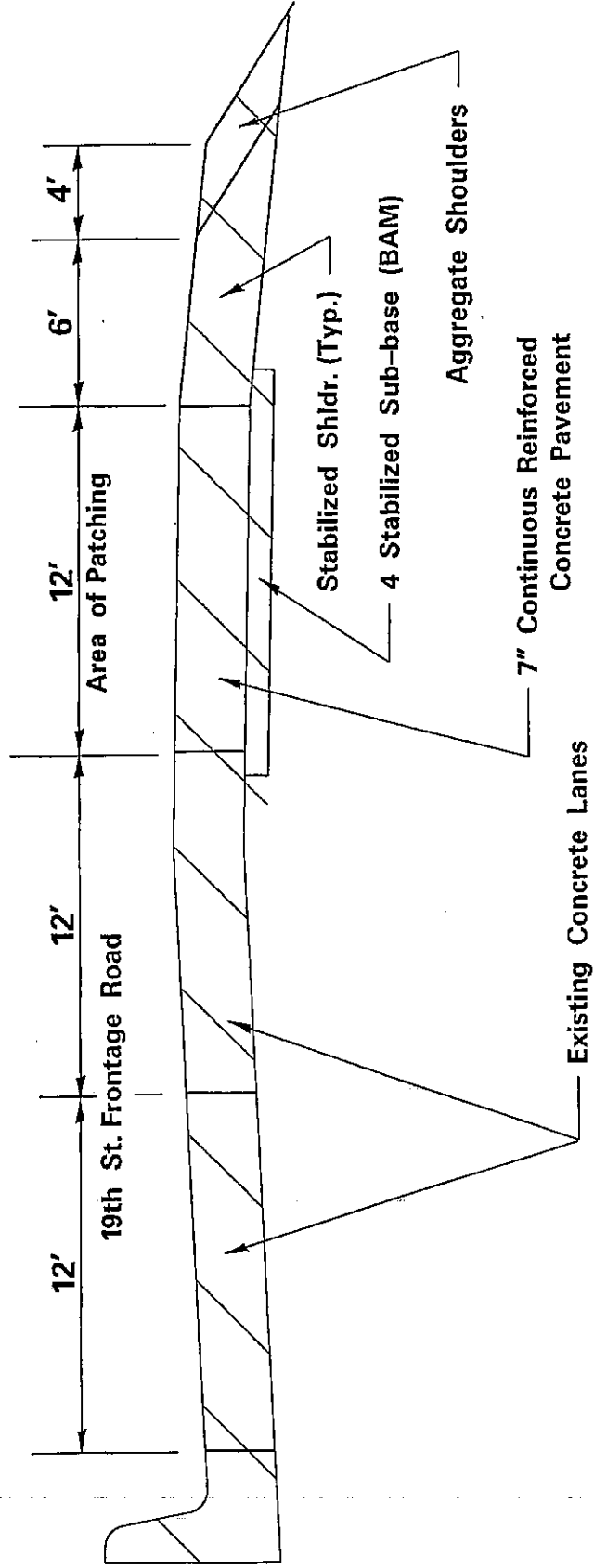

NOTE:
See Traffic Control & Protection (Special)
When Patching in this area

CLASS A PATCHES, 7 INCH

excel: patching74ramp23-N

STATION	REMARKS	LENGTH OF PATCH				AREA OF PATCHES								SAW CUTS (4W+L) (feet)	TIE BARS (each)	PATCHING REIN-FORCEMENT (yd ²)		
		LT LANE (feet)	RT LANE (feet)	LT LANE (yd ²)	RT LANE (yd ²)	TYPE 1		TYPE 2		TYPE 3		TYPE 4						
						LT LANE (yd ²)	RT LANE (yd ²)	LT LANE (yd ²)	RT LANE (yd ²)	LT LANE (yd ²)	RT LANE (yd ²)	LT LANE (yd ²)	RT LANE (yd ²)	LT LANE (yd ²)	RT LANE (yd ²)			
200' NORTH OF CTR. LINE OF AVE. OF THE CITIES IS 1' STUB FOR START OF RAMP = STA. 200+00																		
204 +45		16										28.4				80	5	28.4
204 +75		8														72		14.2
205 +50		40		14.2								71.1				104	19	71.1
206 +25		25										44.4				89	12	44.4
206 +75		20										35.6				84	9	35.6
207 +15		15										26.7				79	5	26.7
208 +00		20										35.6				84	9	35.6
+ 00																		
+ 00																		
+ 00																		
+ 00																		
+ 00																		
+ 00																		
+ 00																		
+ 00																		
+ 00																		
+ 00																		
+ 00																		
+ 00																		
+ 00																		
+ 00																		
+ 00																		
+ 00																		
+ 00																		
+ 00																		
+ 00																		
+ 00																		
+ 00																		
+ 00																		
+ 00																		
+ 00																		
+ 00																		
+ 00																		
+ 00																		
+ 00																		
+ 00																		
+ 00																		
+ 00																		
+ 00																		
Total This Sheet									14.2						241.8	592.0	59.0	256.0

Schedule of Work

<u>Paint Pavement Marking – Line 4 Inch</u> Location	Foot
Ramp S-23	
Lt. Sta. 106+40 – 111+65 (Solid Yellow)	525
Lt. Sta. 106+40 – 111+65 (Solid White)	525
Ramp 23-N	
Lt. Sta. 200+00 – 206+60 (Solid Yellow)	660
Lt. Sta. 206+60 – 207+22 (Solid White)	525
Rt. Sta. 201+65 – 207+22 (Solid White)	557
Ramp N-23	
Lt. Sta. 703+75 – 713+86 (Solid Yellow)	1,111
Rt. Sta. 703+75 – 713+86 (Solid White)	1,111
Ramp 23-S	
Lt. Sta. 800+00 – 807+45 (Solid Yellow)	745
Lt. Sta. 807+45 – 808+07 (Solid White)	62
Rt. Sta. 802+10 – 808+07 (Solid White)	<u>597</u>
Total	6,418

FAI 74
D2 Patching 2005-4
Rock Island County
Sheet 12 of 20
Contract Number 64A65

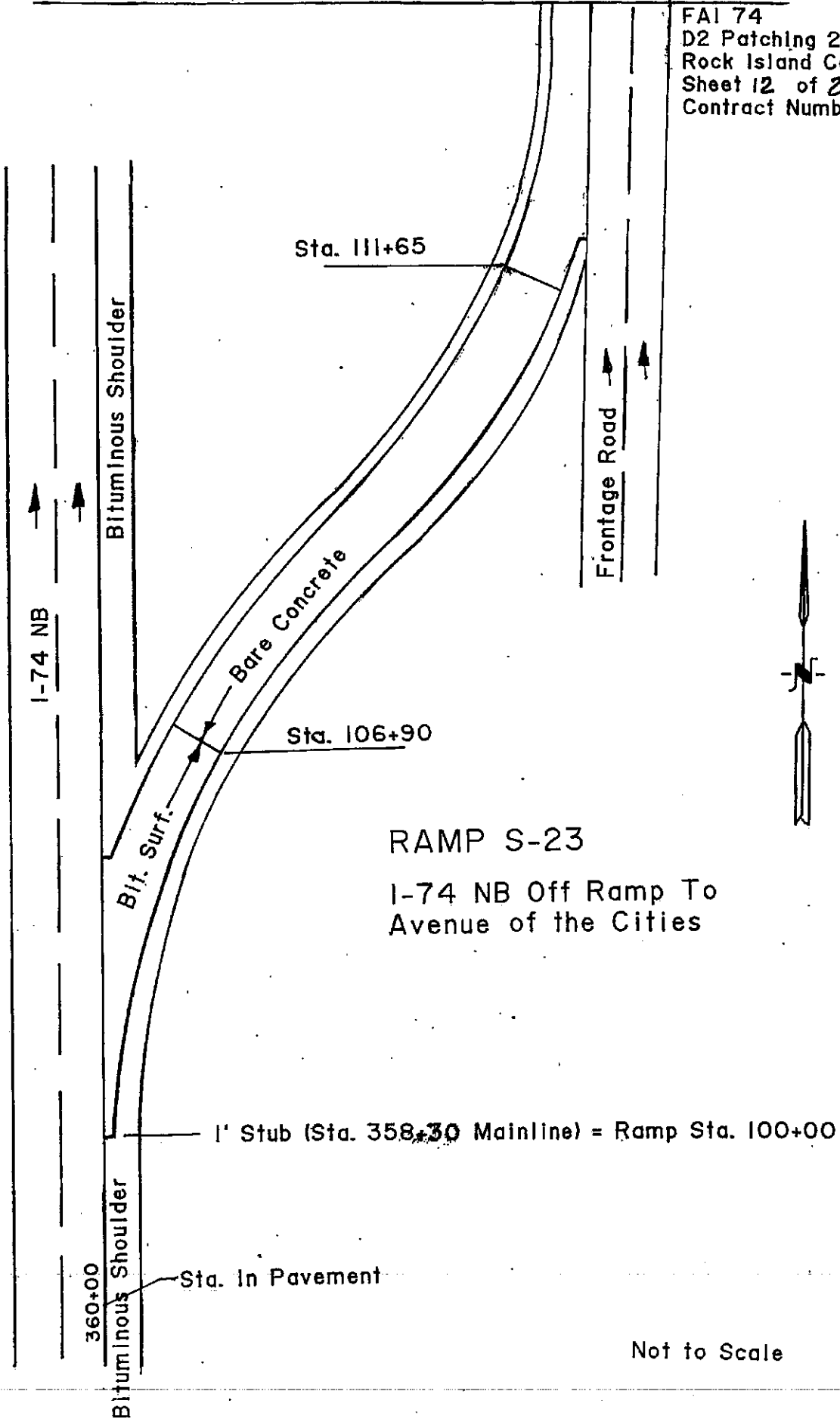

RAMP S-23

I-74 NB Off Ramp To
Avenue of the Cities

1' Stub (Sta. 358+30 Mainline) = Ramp Sta. 100+00

Sta. In Pavement

Not to Scale

FAI 74
D2 Patching 2005-4
Rock Island County
Sheet 13 of 20
Contract Number 64A65

RAMP 23-N

Avenue of the Cities
On Ramp to I-74 NB

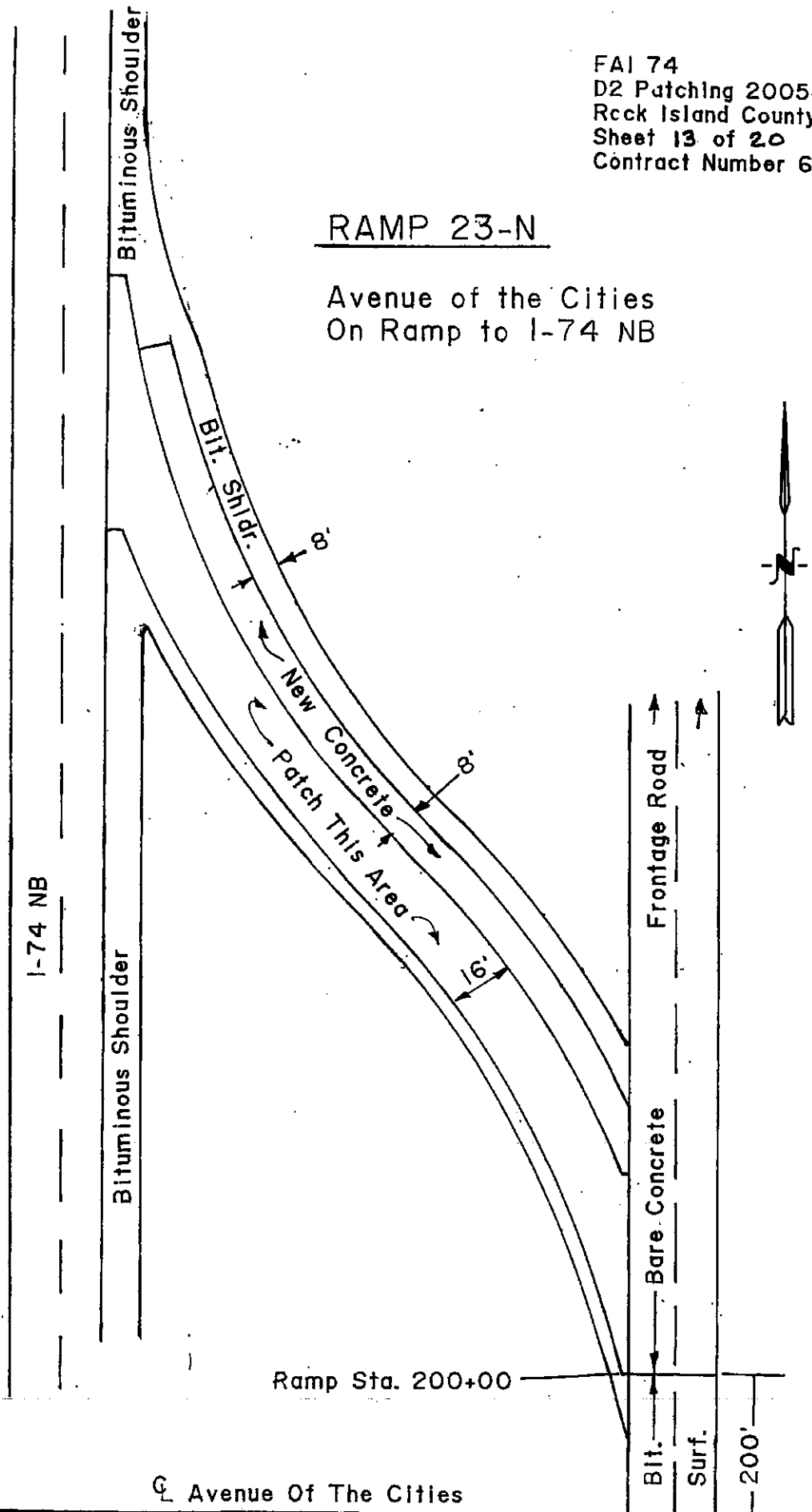

Q Avenue Of The Cities

(Over I-74)

Not to Scale

FAI 74
D2 Patching 2005-4
Rock Island County
Sheet 14 of 20
Contract Number 64A65

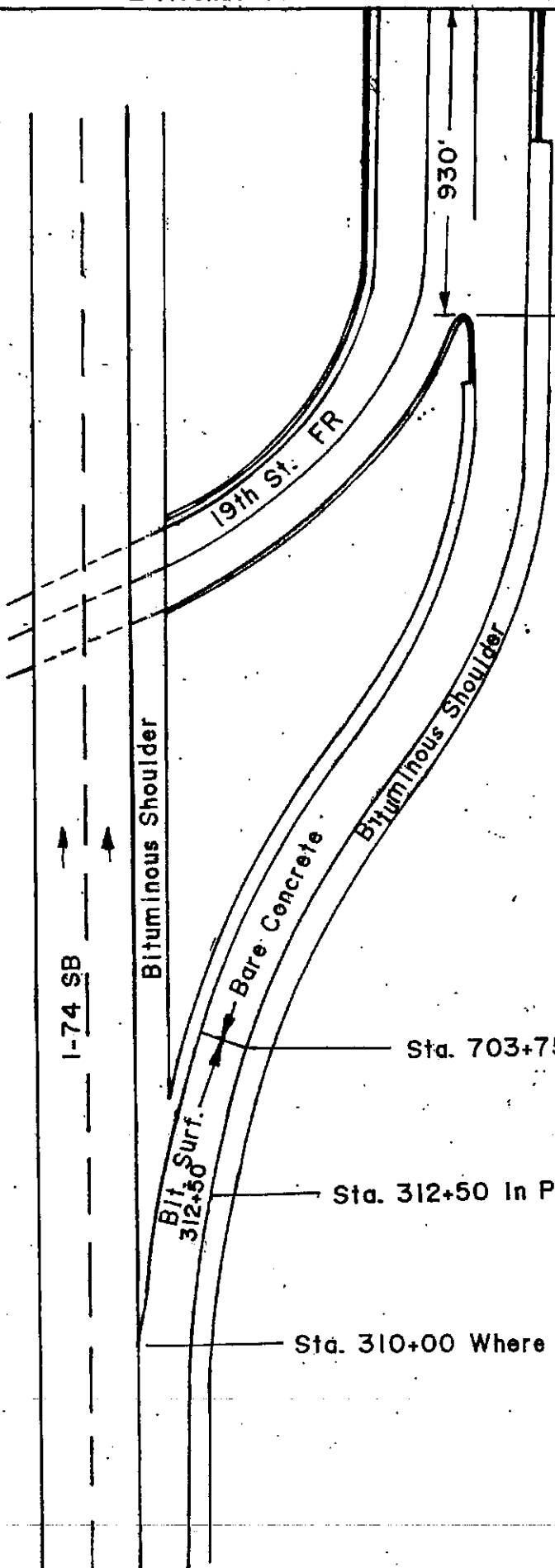

Sta. 715+43

RAMP N-23
I-74 SB Off Ramp To
Avenue of the Cities

Sta. 703+75

Sta. 312+50 In Pavt. = Ramp Sta. 700+00

Sta. 310+00 Where Edge Lines Separate

Not to Scale

FAI 74
D2 Patching 2005-4
Rock Island County
Sheet 15 of 20
Contract Number 64A65

RAMP 23-S
Avenue of the Cities
On Ramp to I-74 SB

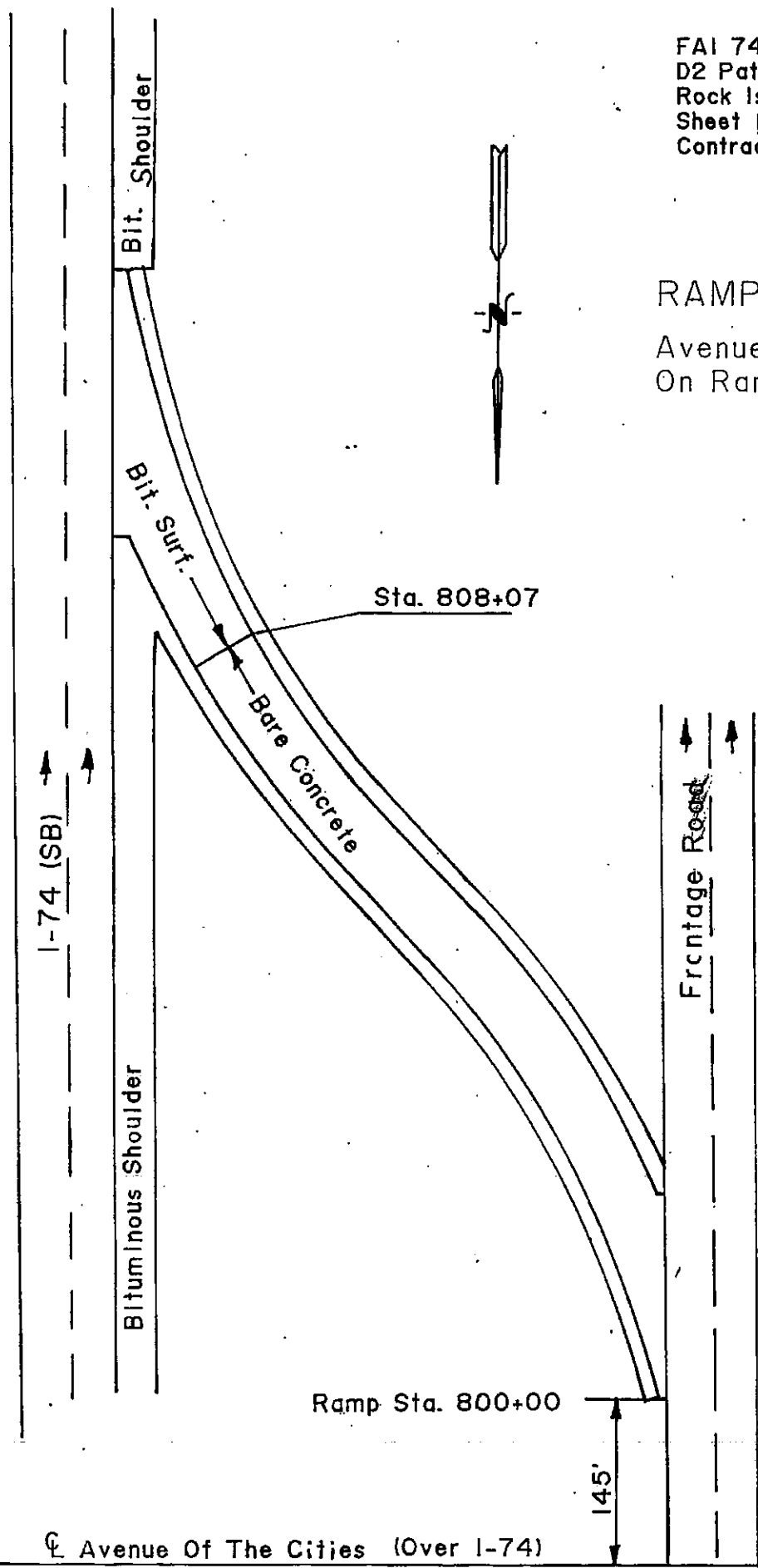

Not to Scale

FAI 74
D2 Patching 2005-4
Rock Island County
Sheet 16 of 20
Contract Number 64A65

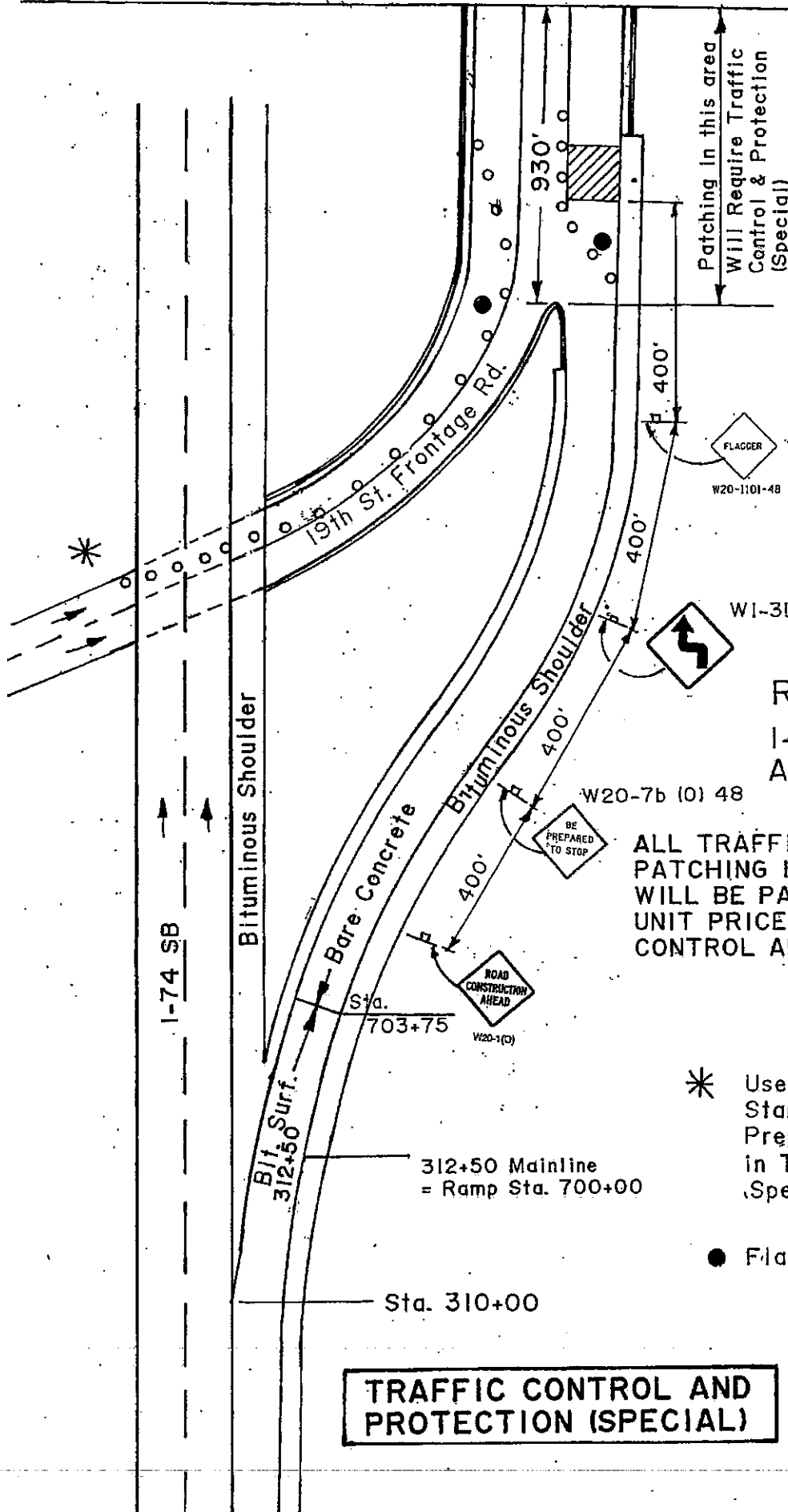

ALL TRAFFIC CONTROL REQUIRED WHEN
PATCHING IN THE 3 LANE SECTION
WILL BE PAID FOR AT THE CONTRACT
UNIT PRICE LUMP SUM FOR TRAFFIC
CONTROL AND PROTECTION (SPECIAL):

* Use traffic control & Protection
Standard 701601, but add "Be
Prepared To Stop" sign as shown
in Traffic Control & Protection
(Special)

● Flagger

**TRAFFIC CONTROL AND
PROTECTION (SPECIAL)**

Not to Scale

FAI 74
 D2 Patching 2005-4
 Rock Island County
 Sheet 17 of 20
 Contract Number: 64A65

NOTE: This set up is to be placed on the 19TH St. Frontage Road when pavement patching in the 3 lane section of Ramp N-23.

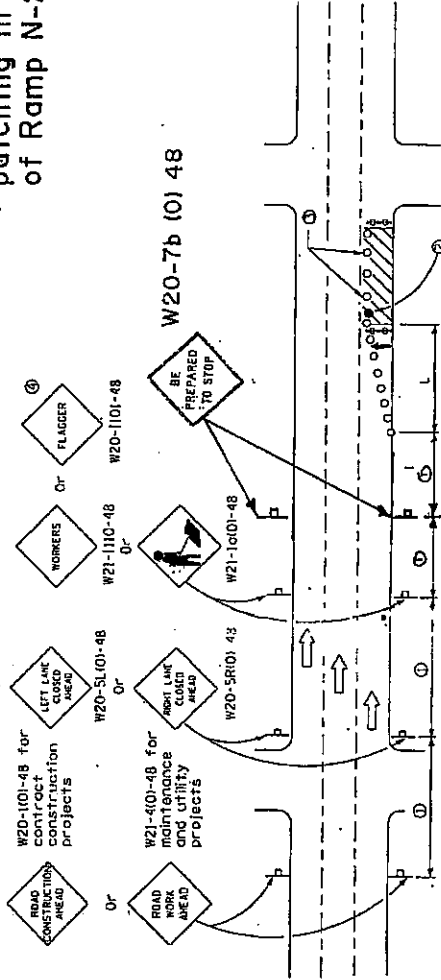

Posted Speed	Sign Spacing
55	164 m (500')
50-45	115 m (350')
<45	60 m (200')

SYMBOLS

- ↑ Arrow board
- Cone, drum or barricade
- ⊥ Sign on portable or permanent support
- ▨ Work area
- ⊕ Barricade or drum with flashing light
- ⊗ Type III bollards with flashing lights
- Flagger with traffic control sign.

① Refer to SIGN SPACING TABLE for distances.

② Required for speeds > 40 MPH

③ Cones at 8 m (25') centers for 75 m (250'). Additional cones may be placed at 15 m (50') centers. When drums or Type I or Type II barricades are used, the interval between devices may be doubled.

④ Use flagger sign only when flagger is present.

⑤ For approved sideroad closures.

GENERAL NOTES

This standard is used where, at any time, day or night, any vehicle, equipment, workers or their activities encroach on the pavement during shoulder operations or where construction requires lane closures in urban areas.

Calculate L as follows:

SPEED LIMIT	FORMULAS
70 km/h (40 mph) or less:	Metric: $L = \frac{WS^2}{150}$ English: $L = \frac{WS^2}{60}$
80 km/h (45 mph) or greater:	Metric: $L = 0.65(WWS)$ English: $L = (WWS)$

W = width of offset in meters (feet).

S = Normal posted speed km/h (mph).

All dimensions are in millimeters (inches) unless otherwise shown.

TRAFFIC CONTROL AND PROTECTION (SPECIAL)

DATE	REVISION
1-1-05	Added tangent to 2 lane urban

URBAN LANE CLOSURE,
 MULTILANE, 1W OR 2W WITH
 NONTRAVERSABLE MEDIUM

FAI 74
 D2 Patching 2005-4
 Rock Island County
 Sheet 18 of 20
 Contract Number: 64A65

NOTE: This set up is to be placed on the
 19TH St. Frontage Road when pavement
 patching in the 3 lane section
 of Ramp N-23.

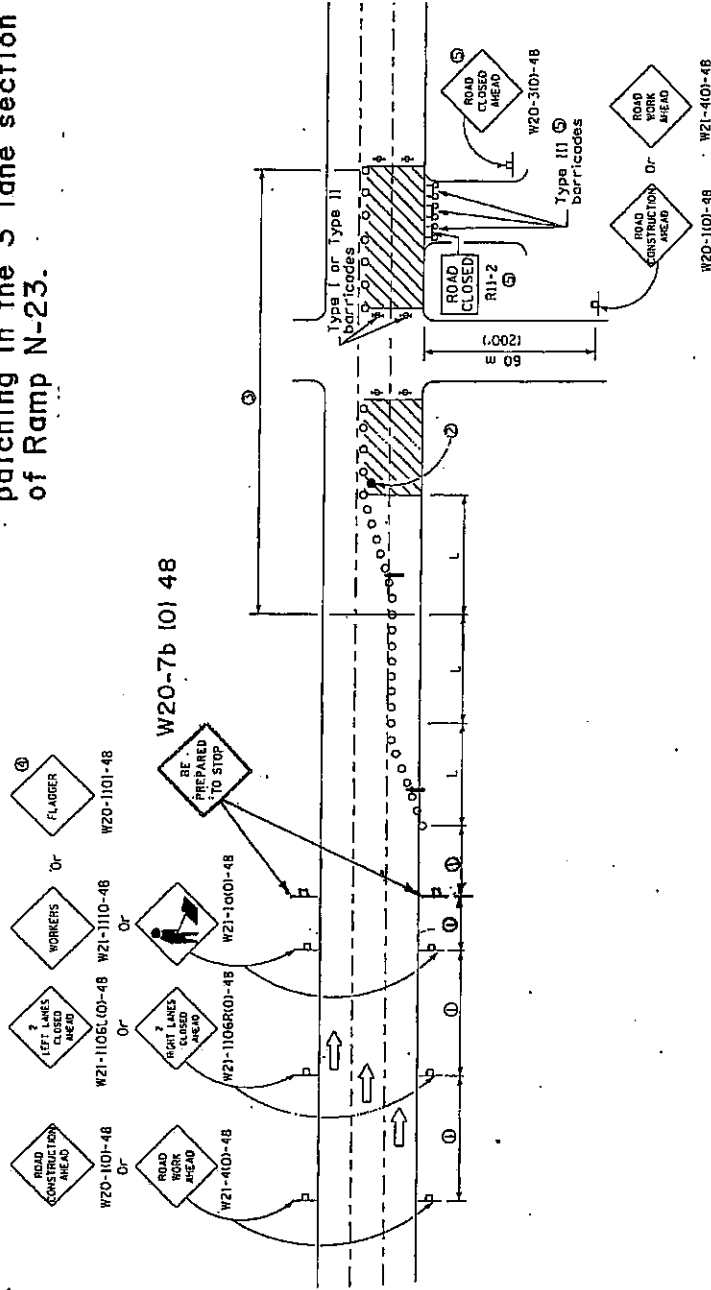

TRAFFIC CONTROL AND PROTECTION (SPECIAL)

All dimensions are in millimeters (inches) unless otherwise shown.

URBAN LANE CLOSURE,
 MULTILANE, 1W OR 2W WITH
 NONTRAVERSABLE MEDIAN

Illinois Department of Transportation	
DESIGNED BY	DATE
DRAWN BY	DATE
APPROVED BY	DATE
DATE	2005

FAI 74
 D2 Patching 2005-4
 Rock Island County
 Sheet 19 of 20
 Contract Number: 64A65

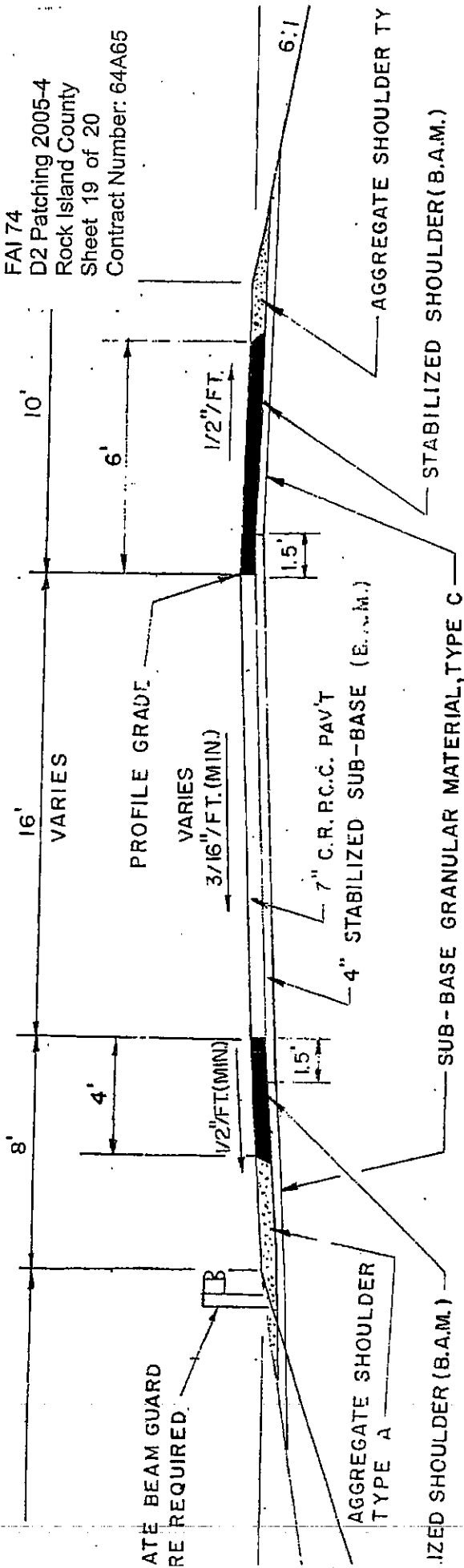

AS BUILT
 FOR INFORMATION ONLY

TYPICAL RAMP SECTION IN CUT
 (LOOKING IN DIRECTION OF TRAFFIC)

1.1 HT. OR WHERE
 INDICATED BY R.O.W.

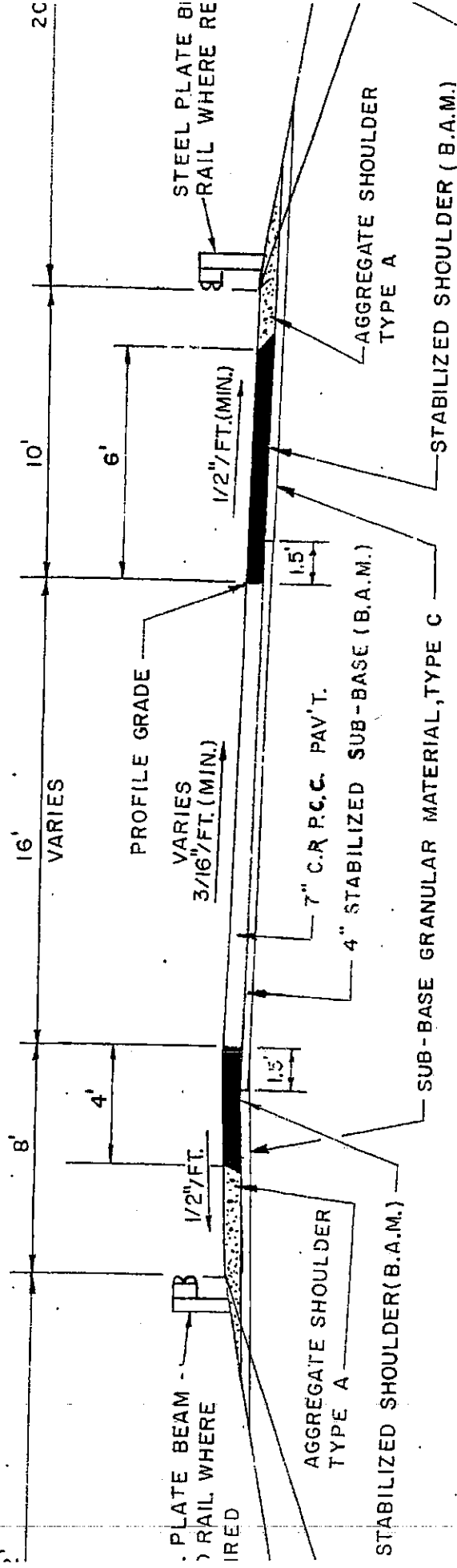

AGGREGATE SHOULDER (B.A.M.)

STABILIZED SHOULDER (B.A.M.)

AGGREGATE SHOULDER TYPE A

STABILIZED SHOULDER (B.A.M.)

TRAFFIC CONTROL AND PROTECTION FOR RAMPS

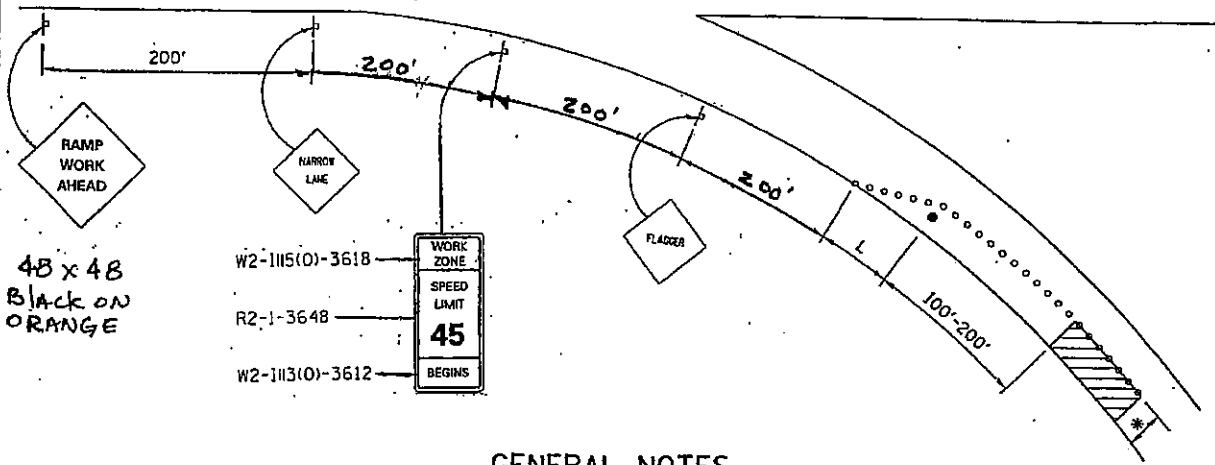

GENERAL NOTES

CONES AT 8 m (25') CENTERS FOR 105 m (350'). ADDITIONAL CONES MAY BE PLACED AT 15' m (50') CENTERS. WHEN DRUMS OR BARRICADES ARE USED, THE INTERVAL DEVICES MAY BE DOUBLED.

* WIDTH OF CLOSURE SHOWN ON RAMP PATCHING SCHEDULE OR AS DIRECTED BY ENGINEER.





L = CLOSURE WIDTH * TAPER RATIO IS SPEED LIMIT / 1 (POSTED OR ADVISORY)

ANY VISIBLE REPAIRS REQUIRED ON THE SHOULDER BECAUSE OF TRAFFIC SHALL BE PROVIDED AT THE CONTRACTORS EXPENSE. THE ENGINEER SHALL BE THE SOLE JUDGE FOR ANY SHOULDER REPAIRS.

THE RAMP SHALL BE COMPLETELY OPEN TO TRAFFIC BY NIGHTFALL.

TRAFFIC CONTROL AND PROTECTION FOR RAMPS SHALL BE INCLUDED IN THE COST OF STANDARD 701406 OR 701401

SYMBOLS

-  WORK AREA
-  SIGN
-  BARRICADE OR DRUM
-  CONE, DRUM OR BARRICADE
-  FLAGGER WITH TRAFFIC CONTROL SIGN

ALL DIMENSIONS ARE IN MILLIMETERS (INCHES) UNLESS OTHERWISE NOTED.

PLOT DATE: Wed Jan 26 10:30:08 2005
 FILE NAME: C:\Users\jstevens\Documents\64A65.dwg
 PLOT SCALE: 2.0000 / 1.0000
 REFERENCE: 64A65

ILLINOIS DEPARTMENT OF LABOR

PREVAILING WAGES FOR COUNTY EFFECTIVE JUNE 2005

The Prevailing rates of wages are included in the Contract proposals which are subject to Check Sheet #5 of the Supplemental Specifications and Recurring Special Provisions. The rates have been ascertained and certified by the Illinois Department of Labor for the locality in which the work is to be performed and for each craft or type of work or mechanic needed to execute the work of the Contract. As required by Prevailing Wage Act (820 ILCS 130/0.01, et seq.) and Check Sheet #5 of the Contract, not less than the rates of wages ascertained by the Illinois Department of Labor and as revised during the performance of a Contract shall be paid to all laborers, workers and mechanics performing work under the Contract. Post the scale of wages in a prominent and easily accessible place at the site of work.

If the Illinois Department of Labor revises the prevailing rates of wages to be paid as listed in the specification of rates, the contractor shall post the revised rates of wages and shall pay not less than the revised rates of wages. Current wage rate information shall be obtained by visiting the Illinois Department of Labor web site at <http://www.state.il.us/agency/idol/> or by calling 312-793-2814. It is the responsibility of the contractor to review the rates applicable to the work of the contract at regular intervals in order to insure the timely payment of current rates. Provision of this information to the contractor by means of the Illinois Department of Labor web site satisfies the notification of revisions by the Department to the contractor pursuant to the Act, and the contractor agrees that no additional notice is required. The contractor shall notify each of its subcontractors of the revised rates of wages.

Rock Island County Prevailing Wage for June 2005

Trade Name	RG	TYP	C	Base	FRMAN	*M-F>8	OSA	OSH	H/W	Pensn	Vac	Trng
=====	==	==	=	=====	=====	=====	==	==	=====	=====	=====	=====
ASBESTOS ABT-GEN		BLD		21.710	22.210	1.5	1.5	2.0	4.600	3.750	0.000	0.500
ASBESTOS ABT-GEN		HWY		22.210	23.210	1.5	1.5	2.0	5.280	3.670	0.000	0.600
ASBESTOS ABT-MEC		BLD		18.260	19.010	1.5	1.5	2.0	3.750	1.650	0.000	0.000
BOILERMAKER		BLD		28.970	31.970	2.0	2.0	2.0	7.020	6.600	0.000	0.210
BRICK MASON		BLD		23.060	24.310	1.5	1.5	2.0	6.500	4.000	0.000	0.310
CARPENTER		BLD		24.000	25.200	1.5	1.5	2.0	5.140	4.470	0.000	0.400
CARPENTER		HWY		24.920	26.670	1.5	1.5	2.0	5.600	4.510	0.000	0.400
CEMENT MASON		BLD		22.430	23.430	1.5	1.5	2.0	5.100	5.060	0.000	0.200
CEMENT MASON		HWY		22.110	23.110	1.5	1.5	2.0	5.100	5.000	0.000	0.350
CERAMIC TILE FNSHER		BLD		16.130	0.000	1.5	1.5	2.0	6.500	3.070	0.000	0.170
ELECTRIC PWR EQMT OP		ALL		22.510	0.000	1.5	1.5	2.0	4.500	6.080	0.000	0.110
ELECTRIC PWR GRNDMAN		ALL		18.810	0.000	1.5	1.5	2.0	4.500	5.070	0.000	0.090
ELECTRIC PWR LINEMAN		ALL		28.370	30.080	1.5	1.5	2.0	4.500	7.660	0.000	0.140
ELECTRICIAN		BLD		26.520	28.520	1.5	1.5	2.0	5.230	6.970	0.000	0.310
ELECTRONIC SYS TECH		BLD		19.800	21.150	1.5	1.5	2.0	5.230	3.780	0.000	0.310
ELEVATOR CONSTRUCTOR		BLD		30.090	33.850	2.0	2.0	2.0	7.275	3.420	1.810	0.000
GLAZIER		BLD		22.470	23.820	1.5	1.5	2.0	3.900	3.450	0.000	0.000
HT/FROST INSULATOR		BLD		25.860	27.060	1.5	1.5	2.0	4.300	6.850	0.000	0.300
IRON WORKER		ALL		22.380	24.170	1.5	1.5	2.0	7.690	7.990	0.000	0.360
LABORER		BLD 1		20.210	20.710	1.5	1.5	2.0	4.600	3.750	0.000	0.500
LABORER		BLD 2		21.710	22.210	1.5	1.5	2.0	4.600	3.750	0.000	0.500
LABORER		BLD 3		22.360	22.860	1.5	1.5	2.0	4.600	3.750	0.000	0.500
LABORER		HWY 1		21.710	22.710	1.5	1.5	2.0	5.280	3.670	0.000	0.600
LABORER		HWY 2		22.210	23.210	1.5	1.5	2.0	5.280	3.670	0.000	0.600
LABORER		HWY 3		22.840	23.840	1.5	1.5	2.0	5.280	3.670	0.000	0.600
LATHER		BLD		24.000	25.200	1.5	1.5	2.0	5.140	4.470	0.000	0.400
MACHINIST		BLD		34.540	36.290	2.0	2.0	2.0	3.200	4.100	2.380	0.000
MARBLE FINISHERS		BLD		16.130	0.000	1.5	1.5	2.0	6.500	3.070	0.000	0.170
MARBLE MASON		BLD		20.470	20.970	1.5	1.5	2.0	6.500	3.070	0.000	0.170
MILLWRIGHT	N	BLD		30.820	33.900	1.5	1.5	2.0	6.100	8.930	0.000	0.560
MILLWRIGHT	S	BLD		24.390	26.090	1.5	1.5	2.0	5.550	7.090	0.000	0.560
OPERATING ENGINEER		BLD 1		24.800	0.000	1.5	1.5	2.0	5.400	5.050	1.400	0.400
OPERATING ENGINEER		BLD 2		24.800	0.000	1.5	1.5	2.0	5.400	5.050	1.400	0.400
OPERATING ENGINEER		BLD 3		22.150	0.000	1.5	1.5	2.0	5.400	5.050	1.400	0.400
OPERATING ENGINEER		BLD 4		22.150	0.000	1.5	1.5	2.0	5.400	5.050	1.400	0.400
OPERATING ENGINEER		BLD 5		21.100	0.000	1.5	1.5	2.0	5.400	5.050	1.400	0.400
OPERATING ENGINEER		HWY 1		24.800	25.800	1.5	1.5	2.0	5.400	5.050	1.400	0.400
OPERATING ENGINEER		HWY 2		24.800	25.800	1.5	1.5	2.0	5.400	5.050	1.400	0.400
OPERATING ENGINEER		HWY 3		23.200	25.800	1.5	1.5	2.0	5.400	5.050	1.400	0.400
OPERATING ENGINEER		HWY 4		23.200	25.800	1.5	1.5	2.0	5.400	5.050	1.400	0.400
OPERATING ENGINEER		HWY 5		22.050	25.800	1.5	1.5	2.0	5.400	5.050	1.400	0.400
PAINTER		ALL		22.570	23.570	1.5	1.5	1.5	3.900	4.850	0.000	0.600
PAINTER OVER 30FT		ALL		23.820	24.820	1.5	1.5	1.5	3.900	4.850	0.000	0.600
PAINTER PWR EQMT		ALL		23.070	24.070	1.5	1.5	1.5	3.900	4.850	0.000	0.600
PILEDRIVER		BLD		24.000	25.200	1.5	1.5	2.0	5.140	4.470	0.000	0.400
PILEDRIVER		HWY		24.920	26.670	1.5	1.5	2.0	5.600	4.510	0.000	0.400
PIPEFITTER		ALL		29.720	32.690	1.5	1.5	2.0	4.450	6.780	0.000	0.490
PLASTERER		BLD		25.350	26.870	1.5	1.5	2.0	3.000	4.400	0.000	0.000
PLUMBER		ALL		29.720	32.690	1.5	1.5	2.0	4.450	6.780	0.000	0.490
ROOFER		BLD		22.000	23.250	1.5	1.5	2.0	4.890	4.820	0.000	0.190
SHEETMETAL WORKER		BLD		25.970	27.560	1.5	1.5	2.0	5.040	6.860	0.000	0.380
SPRINKLER FITTER		BLD		29.390	30.890	1.5	1.5	2.0	6.100	4.950	0.000	0.250

STONE MASON	BLD	23.060	24.310	1.5	1.5	2.0	6.500	4.000	0.000	0.310
TERRAZZO FINISHER	BLD	16.130	0.000	1.5	1.5	2.0	6.500	3.070	0.000	0.170
TERRAZZO MASON	BLD	20.470	20.970	1.5	1.5	2.0	6.500	3.070	0.000	0.170
TILE LAYER	BLD	24.000	25.200	1.5	1.5	2.0	5.140	4.470	0.000	0.400
TILE MASON	BLD	20.470	20.970	1.5	1.5	2.0	6.500	3.070	0.000	0.170
TRUCK DRIVER	ALL 1	24.090	0.000	1.5	1.5	2.0	7.000	3.200	0.000	0.000
TRUCK DRIVER	ALL 2	24.490	0.000	1.5	1.5	2.0	7.000	3.200	0.000	0.000
TRUCK DRIVER	ALL 3	24.690	0.000	1.5	1.5	2.0	7.000	3.200	0.000	0.000
TRUCK DRIVER	ALL 4	24.940	0.000	1.5	1.5	2.0	7.000	3.200	0.000	0.000
TRUCK DRIVER	ALL 5	25.690	0.000	1.5	1.5	2.0	7.000	3.200	0.000	0.000
TRUCK DRIVER	O&C 1	19.272	0.000	1.5	1.5	2.0	7.000	3.200	0.000	0.000
TRUCK DRIVER	O&C 2	19.592	0.000	1.5	1.5	2.0	7.000	3.200	0.000	0.000
TRUCK DRIVER	O&C 3	19.752	0.000	1.5	1.5	2.0	7.000	3.200	0.000	0.000
TRUCK DRIVER	O&C 4	19.952	0.000	1.5	1.5	2.0	7.000	3.200	0.000	0.000
TRUCK DRIVER	O&C 5	20.552	0.000	1.5	1.5	2.0	7.000	3.200	0.000	0.000
TUCKPOINTER	BLD	23.060	24.310	1.5	1.5	2.0	6.500	4.000	0.000	0.310

Legend:

M-F>8 (Overtime is required for any hour greater than 8 worked each day, Monday through Friday.)

OSA (Overtime is required for every hour worked on Saturday)

OSH (Overtime is required for every hour worked on Sunday and Holidays)

H/W (Health & Welfare Insurance)

Pensn (Pension)

Vac (Vacation)

Trng (Training)

Explanations

ROCK ISLAND COUNTY

MILLWRIGHT (SOUTH) - South of Interstate 80.

The following list is considered as those days for which holiday rates of wages for work performed apply: New Years Day, Memorial/Decoration Day, Fourth of July, Labor Day, Veterans Day, Thanksgiving Day, Christmas Day. Generally, any of these holidays which fall on a Sunday is celebrated on the following Monday. This then makes work performed on that Monday payable at the appropriate overtime rate for holiday pay. Common practice in a given local may alter certain days of celebration such as the day after Thanksgiving for Veterans Day. If in doubt, please check with IDOL.

Oil and chip resealing (O&C) means the application of road oils and liquid asphalt to coat an existing road surface, followed by application of aggregate chips or gravel to coated surface, and subsequent rolling of material to seal the surface.

EXPLANATION OF CLASSES

ASBESTOS - GENERAL - removal of asbestos material/mold and hazardous materials from any place in a building, including mechanical systems where those mechanical systems are to be removed. This includes the removal of asbestos materials/mold and hazardous materials from ductwork or pipes in a building when the building is to be demolished at the time or at some close future date.

ASBESTOS - MECHANICAL - removal of asbestos material from mechanical systems, such as pipes, ducts, and boilers, where the mechanical systems are to remain.

CERAMIC TILE FINISHER, MARBLE FINISHER, TERRAZZO FINISHER

Assisting, helping or supporting the tile, marble and terrazzo mechanic by performing their historic and traditional work assignments required to complete the proper installation of the work covered by said crafts. The term "Ceramic" is used for naming the classification only and is in no way a limitation of the product handled. Ceramic takes into consideration most hard tiles.

ELECTRONIC SYSTEMS TECHNICIAN

Installing, assembling and maintaining sound and intercom, protection alarm (security), master antenna television, closed circuit television, computer hardware and software programming and installation to the network's outlet and input (EXCLUDING all cabling, power and cable termination work historically performed by wiremen), door monitoring and control, nurse and emergency call programming and installation to the system's outlet and input (EXCLUDING all cabling, power and cable termination work historically performed by wiremen), clock and timing; and the installation and maintenance of transmit and receive antennas, transmitters, receivers, and associated apparatus which operates in conjunction with the above systems. All work associated with these system installations will be included EXCEPT (1) installation of protective metallic conduit, excluding less than ten-foot runs strictly for protection of cable, and (2) 120 volt AC (or higher) power wiring and associated hardware.

TRUCK DRIVER - BUILDING, HEAVY AND HIGHWAY CONSTRUCTION

Class 1. Drivers on 2 axle trucks hauling less than 9 ton. Air compressor and welding machines and brooms, including those pulled by separate units, truck driver helpers, warehouse employees, mechanic helpers, greasers and tiremen, pickup trucks when hauling materials, tools, or workers to and from and on-the-job site, and fork lifts up to 6,000 lb. capacity.

Class 2. Two or three axle trucks hauling more than 9 ton but hauling less than 16 ton. A-frame winch trucks, hydrolift trucks, vector trucks or similar equipment when used for transportation purposes. Fork lifts over 6,000 lb. capacity, winch trucks, four axle combination units, and ticket writers.

Class 3. Two, three or four axle trucks hauling 16 ton or more.

Drivers on water pulls, articulated dump trucks, mechanics and working forepersons, and dispatchers. Five axle or more combination units.

Class 4. Low Boy and Oil Distributors.

Class 5. Drivers who require special protective clothing while employed on hazardous waste work.

TRUCK DRIVER - OIL AND CHIP RESEALING ONLY.

This shall encompass laborers, workers and mechanics who drive contractor or subcontractor owned, leased, or hired pickup, dump, service, or oil distributor trucks. The work includes transporting materials and equipment (including but not limited to, oils, aggregate supplies, parts, machinery and tools) to or from the job site; distributing oil or liquid asphalt and aggregate; stock piling material when in connection with the actual oil and chip contract. The Truck Driver (Oil & Chip Resealing) wage classification does not include supplier delivered materials.

OPERATING ENGINEERS - BUILDING, HEAVY AND HIGHWAY CONSTRUCTION

Class 1. An engineer on Crane, Shovel, Clamshell, Dragline, Backhoe, Derrick, Tower Crane, Cable Way, Concrete Spreader (servicing two pavers), Asphalt Spreader, Asphalt Mixer, Plant Engineer, Dipper Dredge Operator, Dipper Dredge Craneman, Dual Purpose Truck (boom or winch), Leverman or Engineman (hydraulic dredge), Mechanic, Paving Mixer with tower attached, Pile Driver, Boom Tractor, Stationary, Portable or Floating Mixing Plant, Trenching Machine (over 40 H.P.), Building Hoist (two drums), Hot Paint Wrapping Machine, Cleaning and Priming Machine, Backfiller (throw bucket), Locomotive Engineer, Qualified Welder, Tow or Push Boat, Concrete Paver, Seaman Trav-L-Plant or similar machines, CMI Autograder or similar machines, Slip Form Paver, Caisson Augering Machine, Mucking Machine, Asphalt Heater-Planer Unit, Hydraulic Cranes, Mine Hoists.

Class 2. An engineer on Athey, Barber-Green, Euclid or Haiss Loader, Asphalt Pug Mill, Fireman and Drier, Concrete Pump, Concrete Spreader (servicing one paver) Bulldozer, Endloader, Log Chippers or similar machines, Elevating Grader, Group Equipment Greaser, LeTourneapul and similar machines, off-road haul units, DW-10 Hyster Winch and similar machines, Motor Patrol, Power Blade, Push Cat, Tractor Pulling elevating Grader or Power Blade, Tractor Operating Scoop or Scraper, Tractor with Power Attachment, Roller on Asphalt or Blacktop, Single Drum Hoist, Jaeger Mix and Place Machine, Pipe Bending Machine, Flexaplane or similar machines, Automatic Curbing Machines, Automatic Cement and Gravel Batch Plants (one stop set-up), Seaman Pulvi-Mixer or similar machines, Blastholer Self-propelled Rotary Drill or similar machines, Work Boat, Combination Concrete Finishing Machine and Float, Self-propelled Sheep Foot Roller or Compactor (used in conjunction with a Grading Spread), Asphalt Spreader Screed Operator, Apsco spreader or similar machine, Slusher, Forklift (over 6000 lb. cap. or working at heights above 28 ft.) Concrete Conveyors, Chip Spreader, Underground Boring Machine (BUILDING ONLY), Straddle Carrier, Hydro-Hammer (BUILDING ONLY), Hydraulic Pumps or Power Units Driven by any power source (except manually), used to hoist or lift machinery or material.

Class 3. An engineer on Asphalt Booster, Fireman and Pump Operator at Asphalt Plant, Mud Jack, Underground Boring Machine (HIGHWAY ONLY), Concrete Finishing Machine, Form Grader with Roller on Earth, Mixers (3 bag to 16E), Power Operated Bull Float, Tractor without Power attachment, Dope Pot (agitating motor), Dope Chop Machine, Distributor (back end), Straddle Carrier, Portable Machine Fireman, Hydro-Hammer (HIGHWAY ONLY), Power Winch on Paving Work, Self-propelled Roller or Compactor (other than provided for above), Pump Operator (more than one well-point pump), Portable Crusher Operator, Trench Machine (under 40 H.P.), Power Subgrader (on forms) or similar machines, Forklift (6000 or less cap.) Gypsum Pump, Conveyor over 20 H.P., Fuller Kenyon Cement Pump or similar machines.

Class 4. An engineer on Air Compressor (400 c.f.m. or over HIGHWAY ONLY), Light Plant, Mixers (1 or 2 bag), Power Batching Machine (Cement Auger or Conveyor), Boiler (Engineer or Fireman), Water Pumps (HIGHWAY ONLY), Mechanical Broom, Automatic Cement and Gravel Batch Plants (two or three stop set-up), Small Rubber-tired Tractors (not including backhoes or endloaders), Self-propelled Curing Machine, Brush Chipper, Driver on Truck Crane or similar machines.

Class 5. Oiler, Mechanic's Helper, Mechanical Heater (other than steam boiler), Belt Machine, Small Outboard Motor Boats (Safety Boat and Life Boat), Engine Driven Welding Machine, and Small Tractors (used to unroll or roll wire mesh), Water pumps (BUILDING ONLY), Air Compressors (BUILDING ONLY), Permanent Automatic Elevators.

LABORER - BUILDING

Class 1: General laborer, carpenter tender, tool cribman, salamander tender, flagman, form handler, floor sweeper, material handler, fencing laborer, cleaning lumber, landscaper, unloading explosives, laying of sod, planting/removal of trees, wrecking laborer, unloading of Re-Bars, scaffold worker, signal man on crane.

Class 2: Handling of materials treated with creosote, kettle men, prime mover or motorized unit used for wet concrete or handling of building materials, vibrator operator, mortar mixer, power tools used under the jurisdiction of laborers, sand points, gunnite nozzle men, welders, cutters, burners and torchmen, chain saw operator, jackhammer and drill operators, paving breakers, air tamping hammerman, concrete saw operator, concrete burning machine operator, coring machine operator - hod carrier and plasterer tender.

Class 3: Caisson worker after 6 foot depth, dynamite man, asbestos abatement worker, tunnel miners - mixerman (plaster only), pump man.

LABORER - HEAVY & HIGHWAY

Class 1: Rod or chain man, flagman, dumpman, spotter, broom man, landscaper, planting and removal of trees, fencing laborers, dispatcher, ticket writer, scaleman, cleaning of forms or lumber (in bone yard), laying of sod, moving and/or maintenance of flares and barricades.

Class 2: Operation of all hand, electric, air, hydraulic or mechanically powered tools under the jurisdiction of Laborers' including jackhammers, tempers, air spades, augers, concrete saws,

chain saws, utility saws, rock drills, vibrators, mortar mixer, power and hand saw (when clearing timber) general laborer (not elsewhere covered), craft-tender, material checker, material handler, form handler, concrete dumper, puddler, form setter helper, explosives handler, dynamite helper, center strip, reinforcing in concrete, wire mesh handler and installer, prime mover or any mechanical device taking the place of concrete buggy or wheelbarrow, sandpoint setter, asphalt kettleman. Sheeting hammer drivers, laying and jointing of telephone conduit, gas distribution men, pipe setter on laterals, drain tiles, culvert pipe, and storm sewer catch basin leads, catch basins, manholes, batch dumpers, tank cleaners, cofferdam workers, bankman on floating plant, jointman with pipelayers. Back-up man (corker, joint maker) with pipe setter on sewer and water mains, batterboard man or laser operator on sewer and water main, labor in ditch, or tunnel, on sewer or water mains and telephone conduit. Cutters, burners, torchman, gravel box man, asphalt plant laborers, concrete plant laborer, deck hand, unloading of steel and rebar, laser beam operator, wrecking laborers.

Class 3: Asphalt raker or luteman, head form setter, head dynamite man (powderman) head string or wireline man (on paving), pipe setter on sewer or water main, gunnite nozzle man, asphalt or concrete curb machine operator, head grade man, head tunnel miner, concrete burning machine operator, coring machine operator, welder.

Other Classifications of Work:

For definitions of classifications not otherwise set out, the Department generally has on file such definitions which are available. If a task to be performed is not subject to one of the classifications of pay set out, the Department will upon being contacted state which neighboring county has such a classification and provide such rate, such rate being deemed to exist by reference in this document. If no neighboring county rate applies to the task, the Department shall undertake a special determination, such special determination being then deemed to have existed under this determination. If a project requires these, or any classification not listed, please contact IDOL at 618/993-7271 for wage rates or clarifications.

LANDSCAPING

Landscaping work falls under the existing classifications for laborer, operating engineer and truck driver. The work performed by landscape plantsman and landscape laborer is covered by the existing classification of laborer. The work performed by landscape operators (regardless of equipment used or its size) is covered by the classifications of operating engineer. The work performed by landscape truck drivers (regardless of size of truck driven) is covered by the classifications of truck driver.