

If you plan to submit a bid directly to the Department of Transportation

PREQUALIFICATION

Any contractor who desires to become pre-qualified to bid on work advertised by IDOT must submit the properly completed pre-qualification forms to the Bureau of Construction no later than 4:30 p.m. prevailing time twenty-one days prior to the letting of interest. This pre-qualification requirement applies to first time contractors, contractors renewing expired ratings, contractors maintaining continuous pre-qualification or contractors requesting revised ratings. To be eligible to bid, existing pre-qualification ratings must be effective through the date of letting.

REQUESTS FOR AUTHORIZATION TO BID

Contractors downloading and/or ordering CD-ROM's and are wanting to bid on items included in a particular letting must submit the properly completed "Request for Authorization to Bid/or Not For Bid Status" (BDE 124INT) and the ORIGINAL, signed and notarized, "Affidavit of Availability" (BC 57) to the proper office no later than 4:30 p.m. prevailing time, three (3) days prior to the letting date.

WHO CAN BID ?

Bids will be accepted from only those companies that request and receive written **Authorization to Bid** from IDOT's Central Bureau of Construction.

WHAT CONSTITUTES WRITTEN AUTHORIZATION TO BID? When a prospective prime bidder submits a "Request for Authorization to Bid/or Not For Bid Status"(BDE 124INT) he/she must indicate at that time which items are being requested For Bidding purposes. Only those items requested For Bidding will be analyzed. After the request has been analyzed, the bidder will be issued a **Proposal Denial and/or Authorization Form**, approved by the Central Bureau of Construction, that indicates which items have been approved For Bidding. If **Authorization to Bid** cannot be approved, the **Proposal Denial and/or Authorization Form** will indicate the reason for denial.

ABOUT AUTHORIZATION TO BID: Firms that have not received an authorization form within a reasonable time of complete and correct original document submittal should contact the department as to status. This is critical in the week before the letting. These documents must be received three days before the letting date. Firms unsure as to authorization status should call the Prequalification Section of the Bureau of Construction at the number listed at the end of these instructions.

ADDENDA AND REVISIONS: It is the contractor's responsibility to determine which, if any, addenda or revisions pertain to any project they may be bidding. Failure to incorporate all relevant addenda or revisions may cause the bid to be declared unacceptable.

Each addendum will be placed with the contract number. Addenda and revisions will also be placed on the Addendum/Revision Checklist and each subscription service subscriber will be notified by e-mail of each addendum and revision issued.

The Internet is the Department's primary way of doing business. The subscription server e-mails are an added courtesy the Department provides. It is suggested that bidder check IDOT's website <http://www.dot.il.gov/desenv/delett.html> before submitting final bid information.

IDOT is not responsible for any e-mail related failures.

Addenda Questions may be directed to the Contracts Office at (217)782-7806 or D&Econtracts@dot.il.gov

Technical Questions about downloading these files may be directed to Tim Garman (217)524-1642 or Timothy.Garman@illinois.gov.

WHAT MUST BE INCLUDED WHEN BIDS ARE SUBMITTED?: Bidders need not return the entire proposal when bids are submitted. That portion of the proposal that must be returned includes the following:

1. All documents from the Proposal Cover Sheet through the Proposal Bid Bond
2. Other special documentation and/or information that may be required by the contract special provisions

All proposal documents, including Proposal Guaranty Checks or Proposal Bid Bonds, should be stapled together to prevent loss when bids are processed by IDOT personnel.

ABOUT SUBMITTING BIDS: It is recommended that bidders deliver bids in person to insure they arrive at the proper location prior to the time specified for the receipt of bids. Any bid received at the place of letting after the time specified will not be accepted.

WHO SHOULD BE CALLED IF ASSISTANCE IS NEEDED?

Questions Regarding	Call
Prequalification and/or Authorization to Bid	(217)782-3413
Preparation and submittal of bids	(217)782-7806
Mailing of plans and proposals	(217)782-7806
Electronic plans and proposals	(217)524-1642

ADDENDUMS AND REVISIONS TO THE PROPOSAL FORMS

Planholders should verify that they have received and incorporated the addendum and/or revision prior to submitting their bid. Failure by the bidder to include an addendum could result in a bid being rejected as irregular.

303

RETURN WITH BID

Proposal Submitted By
Name
Address
City

Letting June 13, 2008

BIDDERS NEED NOT RETURN THE ENTIRE PROPOSAL
(See instructions inside front cover)

NOTICE TO PROSPECTIVE BIDDERS

This proposal can be used for bidding purposes by only those companies that request and receive written AUTHORIZATION TO BID from IDOT's Central Bureau of Construction.

(SEE INSTRUCTIONS ON THE INSIDE OF COVER)

Notice To Bidders, Specifications, Proposal, Contract and Contract Bond



Illinois Department
of Transportation

Springfield, Illinois 62764

Contract No. 76B36
MARION County
Section (29Z-2,30-2)RS-3
Route FAP 322
Project ACNHF-0322(084)
District 8 Construction Funds

PLEASE MARK THE APPROPRIATE BOX BELOW:

- A Bid Bond is included.
- A Cashier's Check or a Certified Check is included

Plans Included
Herein

Prepared by

F

Checked by

(Printed by authority of the State of Illinois)

INSTRUCTIONS

ABOUT IDOT PROPOSALS: All proposals issued by IDOT are potential bidding proposals. Each proposal contains all Certifications and Affidavits, a Proposal Signature Sheet and a Proposal Bid Bond required for Prime Contractors to submit a bid after written **Authorization to Bid** has been issued by IDOT's Central Bureau of Construction.

WHO CAN BID?: Bids will be accepted from only those companies that request and receive written **Authorization to Bid** from IDOT's Central Bureau of Construction. To request authorization, a potential bidder must complete and submit Part B of the Request for Authorization to Bid/or Not For Bid Status form (BDE 124 INT) and submit an original Affidavit of Availability (BC 57).

WHAT CONSTITUTES WRITTEN AUTHORIZATION TO BID?: When a prospective prime bidder submits a "Request for Proposal Forms and Plans" he/she must indicate at that time which items are being requested For Bidding purposes. Only those items requested For Bidding will be analyzed. After the request has been analyzed, the bidder will be issued a **Proposal Denial and/or Authorization Form**, approved by the Central Bureau of Construction, that indicates which items have been approved For Bidding. If **Authorization to Bid** cannot be approved, the **Proposal Denial and/or Authorization Form** will indicate the reason for denial. If a contractor has requested to bid but has not received a **Proposal Denial and/or Authorization Form**, they should contact the Central Bureau of Construction in advance of the letting date.

WHAT MUST BE INCLUDED WHEN BIDS ARE SUBMITTED?: Bidders need not return the entire proposal when bids are submitted. That portion of the proposal that must be returned includes the following:

1. All documents from the Proposal Cover Sheet through the Proposal Bid Bond
2. Other special documentation and/or information that may be required by the contract special provisions

All proposal documents, including Proposal Guaranty Checks or Proposal Bid Bonds, should be stapled together to prevent loss when bids are processed by IDOT personnel.

ABOUT SUBMITTING BIDS: It is recommended that bidders deliver bids in person to insure they arrive at the proper location prior to the time specified for the receipt of bids. Any bid received at the place of letting after the time specified will not be accepted.

WHO SHOULD BE CALLED IF ASSISTANCE IS NEEDED?

Questions Regarding	Call
Prequalification and/or Authorization to Bid	217/782-3413
Preparation and submittal of bids	217/782-7806
Mailing of CD-ROMS	217/782-7806

RETURN WITH BID



PROPOSAL

TO THE DEPARTMENT OF TRANSPORTATION

1. Proposal of _____

Taxpayer Identification Number (Mandatory) _____

for the improvement identified and advertised for bids in the Invitation for Bids as:

**Contract No. 76B36
MARION County
Section (29Z-2,30-2)RS-3
Project ACNHF-0322(084)
Route FAP 322
District 8 Construction Funds**

3.47 miles of milling and HMA surface on U.S. Route 51 from Calumet Street to the Jefferson County line in Centralia.

2. The undersigned bidder will furnish all labor, material and equipment to complete the above described project in a good and workmanlike manner as provided in the contract documents provided by the Department of Transportation. This proposal will become part of the contract and the terms and conditions contained in the contract documents shall govern performance and payments.

RETURN WITH BID

3. **ASSURANCE OF EXAMINATION AND INSPECTION/WAIVER.** The undersigned further declares that he/she has carefully examined the proposal, plans, specifications, form of contract and contract bond, and special provisions, and that he/she has inspected in detail the site of the proposed work, and that he/she has familiarized themselves with all of the local conditions affecting the contract and the detailed requirements of construction, and understands that in making this proposal he/she waives all right to plead any misunderstanding regarding the same.

4. **EXECUTION OF CONTRACT AND CONTRACT BOND.** The undersigned further agrees to execute a contract for this work and present the same to the department within fifteen (15) days after the contract has been mailed to him/her. The undersigned further agrees that he/she and his/her surety will execute and present within fifteen (15) days after the contract has been mailed to him/her contract bond satisfactory to and in the form prescribed by the Department of Transportation, in the penal sum of the full amount of the contract, guaranteeing the faithful performance of the work in accordance with the terms of the contract.

5. **PROPOSAL GUARANTY.** Accompanying this proposal is either a bid bond on the department form, executed by a corporate surety company satisfactory to the department, or a proposal guaranty check consisting of a bank cashier's check or a properly certified check for not less than 5 per cent of the amount bid or for the amount specified in the following schedule:

<u>Amount of Bid</u>		<u>Proposal Guaranty</u>	<u>Amount of Bid</u>		<u>Proposal Guaranty</u>	
Up to	\$5,000	\$150	\$2,000,000	to	\$3,000,000	\$100,000
\$5,000	to \$10,000	\$300	\$3,000,000	to	\$5,000,000	\$150,000
\$10,000	to \$50,000	\$1,000	\$5,000,000	to	\$7,500,000	\$250,000
\$50,000	to \$100,000	\$3,000	\$7,500,000	to	\$10,000,000	\$400,000
\$100,000	to \$150,000	\$5,000	\$10,000,000	to	\$15,000,000	\$500,000
\$150,000	to \$250,000	\$7,500	\$15,000,000	to	\$20,000,000	\$600,000
\$250,000	to \$500,000	\$12,500	\$20,000,000	to	\$25,000,000	\$700,000
\$500,000	to \$1,000,000	\$25,000	\$25,000,000	to	\$30,000,000	\$800,000
\$1,000,000	to \$1,500,000	\$50,000	\$30,000,000	to	\$35,000,000	\$900,000
\$1,500,000	to \$2,000,000	\$75,000	over		\$35,000,000	\$1,000,000

Bank cashier's checks or properly certified checks accompanying proposals shall be made payable to the Treasurer, State of Illinois, when the state is awarding authority; the county treasurer, when a county is the awarding authority; or the city, village, or town treasurer, when a city, village, or town is the awarding authority.

If a combination bid is submitted, the proposal guaranties which accompany the individual proposals making up the combination will be considered as also covering the combination bid.

The amount of the proposal guaranty check is _____ \$(_____). If this proposal is accepted and the undersigned shall fail to execute a contract bond as required herein, it is hereby agreed that the amount of the proposal guaranty shall become the property of the State of Illinois, and shall be considered as payment of damages due to delay and other causes suffered by the State because of the failure to execute said contract and contract bond; otherwise, the bid bond shall become void or the proposal guaranty check shall be returned to the undersigned.

Attach Cashier's Check or Certified Check Here

In the event that one proposal guaranty check is intended to cover two or more proposals, the amount must be equal to the sum of the proposal guaranties which would be required for each individual proposal. If the guaranty check is placed in another proposal, state below where it may be found.

The proposal guaranty check will be found in the proposal for:

Item _____

Section No. _____

County _____

Mark the proposal cover sheet as to the type of proposal guaranty submitted.

RETURN WITH BID

6. **COMBINATION BIDS.** The undersigned further agrees that if awarded the contract for the sections contained in the following combination, he/she will perform the work in accordance with the requirements of each individual proposal comprising the combination bid specified in the schedule below, and that the combination bid shall be prorated against each section in proportion to the bid submitted for the same. If an error is found to exist in the gross sum bid for one or more of the individual sections included in a combination, the combination bid shall be corrected as provided in the specifications.

When a combination bid is submitted, the schedule below must be completed in each proposal comprising the combination.

If alternate bids are submitted for one or more of the sections comprising the combination, a combination bid must be submitted for each alternate.

Schedule of Combination Bids

Combination No.	Sections Included in Combination	Combination Bid	
		Dollars	Cents

7. **SCHEDULE OF PRICES.** The undersigned bidder submits herewith, in accordance with the rules and instructions, a schedule of prices for the items of work for which bids are sought. The unit prices bid are in U.S. dollars and cents, and all extensions and summations have been made. The bidder understands that the quantities appearing in the bid schedule are approximate and are provided for the purpose of obtaining a gross sum for the comparison of bids. If there is an error in the extension of the unit prices, the unit prices shall govern. Payment to the contractor awarded the contract will be made only for actual quantities of work performed and accepted or materials furnished according to the contract. The scheduled quantities of work to be done and materials to be furnished may be increased, decreased or omitted as provided elsewhere in the contract.
8. **CERTIFICATE OF AUTHORITY.** The undersigned bidder, if a business organized under the laws of another State, assures the Department that it will furnish a copy of its certificate of authority to do business in the State of Illinois with the return of the executed contract and bond. Failure to furnish the certificate within the time provided for execution of an awarded contract may be cause for cancellation of the award and forfeiture of the proposal guaranty to the State.

ILLINOIS DEPARTMENT OF TRANSPORTATION
 SCHEDULE OF PRICES
 CONTRACT
 NUMBER -

76B36

State Job # - C-98-006-08
 PPS NBR - 8-70056-0000
 County Name - MARION -
 Code - 121 - -
 District - 8 - -
 Section Number - (29Z-2,30-2)RS-3

Project Number
 ACNHF-0322/084/

Route
 FAP 322

Item Number	Pay Item Description	Unit of Measure	Quantity	x	Unit Price	=	Total Price
X4400100	PCC SURF REM VAR DP	SQ YD	545.000				
X6610100	BIT CURB REPAIR	FOOT	10.000				
Z0048665	RR PROT LIABILITY INS	L SUM	1.000				
Z0076600	TRAINEES	HOUR	1,000.000		0.800		800.000
40600200	BIT MATLS PR CT	TON	86.200				
40600300	AGG PR CT	TON	414.000				
40600635	LEV BIND MM N70	TON	4,279.000				
40600895	CONSTRUC TEST STRIP	EACH	1.000				
40600982	HMA SURF REM BUTT JT	SQ YD	1,779.000				
40600990	TEMPORARY RAMP	SQ YD	1,098.000				
40603540	P HMA SC "D" N70	TON	8,982.000				
40800050	INCIDENTAL HMA SURF	TON	58.000				
44000152	HMA SURF REM 3/4	SQ YD	118,755.000				
44000155	HMA SURF REM 1 1/2	SQ YD	7,212.000				
44000198	HMA SURF REM VAR DP	SQ YD	11,044.000				

ILLINOIS DEPARTMENT OF TRANSPORTATION
 SCHEDULE OF PRICES
 CONTRACT
 NUMBER - 76B36

State Job # - C-98-006-08
 PPS NBR - 8-70056-0000
 County Name - MARION - -
 Code - 121 - -
 District - 8 - -
 Section Number - (29Z-2,30-2)RS-3

Project Number
 ACNHF-0322/084/

Route
 FAP 322

Item Number	Pay Item Description	Unit of Measure	Quantity	x	Unit Price	=	Total Price
44000500	COMB CURB GUTTER REM	FOOT	25.000				
44200144	PAVT PATCH T2 12	SQ YD	397.000				
44200148	PAVT PATCH T3 12	SQ YD	43.000				
44200150	PAVT PATCH T4 12	SQ YD	58.000				
44300200	STRIP REF CR CON TR	FOOT	5,246.000				
48102100	AGG WEDGE SHLD TYPE B	TON	720.000				
48203100	HMA SHOULDERS	TON	3,895.000				
60300350	MAN FRAMES ADJUST	EACH	2.000				
60300405	VALVE BOX FRAMES ADJ	EACH	7.000				
60600505	CONC CURB SPL	FOOT	20.000				
60603900	COMB CC&G TB6.12 AEP	FOOT	25.000				
63100167	TR BAR TRM T1 SPL TAN	EACH	2.000				
63100169	TR BAR TRM T1 SPL FLR	EACH	1.000				
63304345	TERM SECT REM SIN RL	EACH	3.000				
67000400	ENGR FIELD OFFICE A	CAL MO	4.000				

ILLINOIS DEPARTMENT OF TRANSPORTATION
 SCHEDULE OF PRICES
 CONTRACT
 NUMBER -

76B36

State Job # - C-98-006-08
 PPS NBR - 8-70056-0000
 County Name - MARION - -
 Code - 121 - -
 District - 8 - -
 Section Number - (29Z-2,30-2)RS-3

Project Number
 ACNHF-0322/084/

Route
 FAP 322

Item Number	Pay Item Description	Unit of Measure	Quantity	x	Unit Price	=	Total Price
67100100	MOBILIZATION	L SUM	1.000				
70100310	TRAF CONT-PROT 701421	L SUM	1.000				
70100460	TRAF CONT-PROT 701306	L SUM	1.000				
70100600	TRAF CONT-PROT 701336	L SUM	1.000				
70102625	TR CONT & PROT 701606	L SUM	1.000				
70102630	TR CONT & PROT 701601	L SUM	1.000				
70102635	TR CONT & PROT 701701	L SUM	1.000				
70102640	TR CONT & PROT 701801	L SUM	1.000				
70300100	SHORT-TERM PAVT MKING	FOOT	12,719.000				
70300210	TEMP PVT MK LTR & SYM	SQ FT	638.000				
70300220	TEMP PVT MK LINE 4	FOOT	83,295.000				
70300250	TEMP PVT MK LINE 8	FOOT	653.000				
70300260	TEMP PVT MK LINE 12	FOOT	2,364.000				
70300280	TEMP PVT MK LINE 24	FOOT	453.000				
70301000	WORK ZONE PAVT MK REM	SQ FT	36,313.000				

CONTRACT NUMBER

76B36

THIS IS THE TOTAL BID

\$ _____

NOTES:

1. Each PAY ITEM should have a UNIT PRICE and a TOTAL PRICE.
2. The UNIT PRICE shall govern if no TOTAL PRICE is shown or if there is a discrepancy between the product of the UNIT PRICE multiplied by the QUANTITY.
3. If a UNIT PRICE is omitted, the TOTAL PRICE will be divided by the QUANTITY in order to establish a UNIT PRICE.
4. A bid may be declared UNACCEPTABLE if neither a unit price nor a total price is shown.

RETURN WITH BID

STATE REQUIRED ETHICAL STANDARDS GOVERNING CONTRACT PROCUREMENT: ASSURANCES, CERTIFICATIONS AND DISCLOSURES

I. GENERAL

A. Article 50 of the Illinois Procurement Code establishes the duty of all State chief procurement officers, State purchasing officers, and their designees to maximize the value of the expenditure of public moneys in procuring goods, services, and contracts for the State of Illinois and to act in a manner that maintains the integrity and public trust of State government. In discharging this duty, they are charged by law to use all available information, reasonable efforts, and reasonable actions to protect, safeguard, and maintain the procurement process of the State of Illinois.

B. In order to comply with the provisions of Article 50 and to carry out the duty established therein, all bidders are to adhere to ethical standards established for the procurement process, and to make such assurances, disclosures and certifications required by law. By execution of the Proposal Signature Sheet, the bidder indicates that each of the mandated assurances has been read and understood, that each certification is made and understood, and that each disclosure requirement has been understood and completed.

C. In addition to all other remedies provided by law, failure to comply with any assurance, failure to make any disclosure or the making of a false certification shall be grounds for termination of the contract and the suspension or debarment of the bidder.

II. ASSURANCES

A. The assurances hereinafter made by the bidder are each a material representation of fact upon which reliance is placed should the Department enter into the contract with the bidder. The Department may terminate the contract if it is later determined that the bidder rendered a false or erroneous assurance, and the surety providing the performance bond shall be responsible for the completion of the contract.

B. Felons

1. The Illinois Procurement Code provides:

Section 50-10. Felons. Unless otherwise provided, no person or business convicted of a felony shall do business with the State of Illinois or any state agency from the date of conviction until 5 years after the date of completion of the sentence for that felony, unless no person held responsible by a prosecutorial office for the facts upon which the conviction was based continues to have any involvement with the business.

2. The bidder assures the Department that the award and execution of the contract would not cause a violation of Section 50-10.

C. Conflicts of Interest

1. The Illinois Procurement Code provides in pertinent part:

Section 50-13. Conflicts of Interest.

(a) Prohibition. It is unlawful for any person holding an elective office in this State, holding a seat in the General Assembly, or appointed to or employed in any of the offices or agencies of state government and who receives compensation for such employment in excess of 60% of the salary of the Governor of the State of Illinois, or who is an officer or employee of the Capital Development Board or the Illinois Toll Highway Authority, or who is the spouse or minor child of any such person to have or acquire any contract, or any direct pecuniary interest in any contract therein, whether for stationery, printing, paper, or any services, materials, or supplies, that will be wholly or partially satisfied by the payment of funds appropriated by the General Assembly of the State of Illinois or in any contract of the Capital Development Board or the Illinois Toll Highway authority.

(b) Interests. It is unlawful for any firm, partnership, association or corporation, in which any person listed in subsection (a) is entitled to receive (i) more than 7 1/2% of the total distributable income or (ii) an amount in excess of the salary of the Governor, to have or acquire any such contract or direct pecuniary interest therein.

(c) Combined interests. It is unlawful for any firm, partnership, association, or corporation, in which any person listed in subsection (a) together with his or her spouse or minor children is entitled to receive (i) more than 15%, in the aggregate, of the total distributable income or (ii) an amount in excess of 2 times the salary of the Governor, to have or acquire any such contract or direct pecuniary interest therein.

(d) Securities. Nothing in this Section invalidates the provisions of any bond or other security previously offered or to be offered for sale or sold by or for the State of Illinois.

(e) Prior interests. This Section does not affect the validity of any contract made between the State and an officer or employee of the State or member of the General Assembly, his or her spouse, minor child or any combination of those persons if that contract was in existence before his or her election or employment as an officer, member, or employee. The contract is voidable, however, if it cannot be completed within 365 days after the officer, member, or employee takes office or is employed.

The current salary of the Governor is \$171,000.00. Sixty percent of the salary is \$102,600.00.

RETURN WITH BID

2. The bidder assures the Department that the award and execution of the contract would not cause a violation of Section 50-13, or that an effective exemption has been issued by the Board of Ethics to any individual subject to the Section 50-13 prohibitions pursuant to the provisions of Section 50-20 of the Code and Executive Order Number 3 (1998). Information concerning the exemption process is available from the Department upon request.

D. Negotiations

1. The Illinois Procurement Code provides in pertinent part:

Section 50-15. Negotiations.

(a) It is unlawful for any person employed in or on a continual contractual relationship with any of the offices or agencies of State government to participate in contract negotiations on behalf of that office or agency with any firm, partnership, association, or corporation with whom that person has a contract for future employment or is negotiating concerning possible future employment.

2. The bidder assures the Department that the award and execution of the contract would not cause a violation of Section 50-15, and that the bidder has no knowledge of any facts relevant to the kinds of acts prohibited therein.

E. Inducements

1. The Illinois Procurement Code provides:

Section 50-25. Inducement. Any person who offers or pays any money or other valuable thing to any person to induce him or her not to bid for a State contract or as recompense for not having bid on a State contract is guilty of a Class 4 felony. Any person who accepts any money or other valuable thing for not bidding for a State contract or who withholds a bid in consideration of the promise for the payment of money or other valuable thing is guilty of a Class 4 felony.

2. The bidder assures the Department that the award and execution of the contract would not cause a violation of Section 50-25, and that the bidder has no knowledge of any facts relevant to the kinds of acts prohibited therein.

F. Revolving Door Prohibition

1. The Illinois Procurement Code provides:

Section 50-30. Revolving door prohibition. Chief procurement officers, associate procurement officers, State purchasing officers, their designees whose principal duties are directly related to State procurement, and executive officers confirmed by the Senate are expressly prohibited for a period of 2 years after terminating an affected position from engaging in any procurement activity relating to the State agency most recently employing them in an affected position for a period of at least 6 months. The prohibition includes, but is not limited to: lobbying the procurement process; specifying; bidding; proposing bid, proposal, or contract documents; on their own behalf or on behalf of any firm, partnership, association, or corporation. This Section applies only to persons who terminate an affected position on or after January 15, 1999.

2. The bidder assures the Department that the award and execution of the contract would not cause a violation of Section 50-30, and that the bidder has no knowledge of any facts relevant to the kinds of acts prohibited therein.

G. Reporting Anticompetitive Practices

1. The Illinois Procurement Code provides:

Section 50-40. Reporting anticompetitive practices. When, for any reason, any vendor, bidder, contractor, chief procurement officer, State purchasing officer, designee, elected official, or State employee suspects collusion or other anticompetitive practice among any bidders, offerors, contractors, proposers, or employees of the State, a notice of the relevant facts shall be transmitted to the Attorney General and the chief procurement officer.

2. The bidder assures the Department that it has not failed to report any relevant facts concerning the practices addressed in Section 50-40 which may involve the contract for which the bid is submitted.

H. Confidentiality

1. The Illinois Procurement Code provides:

Section 50-45. Confidentiality. Any chief procurement officer, State purchasing officer, designee, or executive officer who willfully uses or allows the use of specifications, competitive bid documents, proprietary competitive information, proposals, contracts, or selection information to compromise the fairness or integrity of the procurement, bidding, or contract process shall be subject to immediate dismissal, regardless of the Personnel code, any contract, or any collective bargaining agreement, and may in addition be subject to criminal prosecution.

2. The bidder assures the Department that it has no knowledge of any fact relevant to the practices addressed in Section 50-45 which may involve the contract for which the bid is submitted.

RETURN WITH BID

I. Insider Information

1. The Illinois Procurement Act provides:

Section 50-50. Insider information. It is unlawful for any current or former elected or appointed State official or State employee to knowingly use confidential information available only by virtue of that office or employment for actual or anticipated gain for themselves or another person.

2. The bidder assures the Department that it has no knowledge of any facts relevant to the practices addressed in Section 50-50 which may involve the contract for which the bid is submitted.

III. CERTIFICATIONS

A. The certifications hereinafter made by the bidder are each a material representation of fact upon which reliance is placed should the Department enter into the contract with the bidder. The Department may terminate the contract if it is later determined that the bidder rendered a false or erroneous certification, and the surety providing the performance bond shall be responsible for completion of the contract.

B. Bribery

1. The Illinois Procurement Code provides:

Section 50-5. Bribery.

(a) Prohibition. No person or business shall be awarded a contract or subcontract under this Code who:

(1) has been convicted under the laws of Illinois or any other state of bribery or attempting to bribe an officer or employee of the State of Illinois or any other state in that officer's or employee's official capacity; or

(2) has made an admission of guilt of that conduct that is a matter of record but has not been prosecuted for that conduct.

(b) Businesses. No business shall be barred from contracting with any unit of State or local government as a result of a conviction under this Section of any employee or agent of the business if the employee or agent is no longer employed by the business and:

(1) the business has been finally adjudicated not guilty; or

(2) the business demonstrates to the governmental entity with which it seeks to contract, and that entity finds that the commission of the offense was not authorized, requested, commanded, or performed by a director, officer, or high managerial agent on behalf of the business as provided in paragraph (2) of subsection (a) of Section 5-4 of the Criminal Code of 1961.

(c) Conduct on behalf of business. For purposes of this Section, when an official, agent, or employee of a business committed the bribery or attempted bribery on behalf of the business and in accordance with the direction or authorization of a responsible official of the business, the business shall be chargeable with the conduct.

(d) Certification. Every bid submitted to and contract executed by the State shall contain a certification by the contractor that the contractor is not barred from being awarded a contract or subcontract under this Section. A contractor who makes a false statement, material to the certification, commits a Class 3 felony.

2. The bidder certifies that it is not barred from being awarded a contract under Section 50.5.

C. Educational Loan

1. Section 3 of the Educational Loan Default Act provides:

§ 3. No State agency shall contract with an individual for goods or services if that individual is in default, as defined in Section 2 of this Act, on an educational loan. Any contract used by any State agency shall include a statement certifying that the individual is not in default on an educational loan as provided in this Section.

2. The bidder, if an individual as opposed to a corporation, partnership or other form of business organization, certifies that the bidder is not in default on an educational loan as provided in Section 3 of the Act.

D. Bid-Rigging/Bid Rotating

1. Section 33E-11 of the Criminal Code of 1961 provides:

§ 33E-11. (a) Every bid submitted to and public contract executed pursuant to such bid by the State or a unit of local government shall contain a certification by the prime contractor that the prime contractor is not barred from contracting with any unit of State or local government as a result of a violation of either Section 33E-3 or 33E-4 of this Article. The State and units of local government shall provide the appropriate forms for such certification.

RETURN WITH BID

(b) A contractor who makes a false statement, material to the certification, commits a Class 3 felony.

A violation of Section 33E-3 would be represented by a conviction of the crime of bid-rigging which, in addition to Class 3 felony sentencing, provides that any person convicted of this offense or any similar offense of any state or the United States which contains the same elements as this offense shall be barred for 5 years from the date of conviction from contracting with any unit of State or local government. No corporation shall be barred from contracting with any unit of State or local government as a result of a conviction under this Section of any employee or agent of such corporation if the employee so convicted is no longer employed by the corporation and: (1) it has been finally adjudicated not guilty or (2) if it demonstrates to the governmental entity with which it seeks to contract and that entity finds that the commission of the offense was neither authorized, requested, commanded, nor performed by a director, officer or a high managerial agent in behalf of the corporation.

A violation of Section 33E-4 would be represented by a conviction of the crime of bid-rotating which, in addition to Class 2 felony sentencing, provides that any person convicted of this offense or any similar offense of any state or the United States which contains the same elements as this offense shall be permanently barred from contracting with any unit of State or local government. No corporation shall be barred from contracting with any unit of State or local government as a result of a conviction under this Section of any employee or agent of such corporation if the employee so convicted is no longer employed by the corporation and: (1) it has been finally adjudicated not guilty or (2) if it demonstrates to the governmental entity with which it seeks to contract and that entity finds that the commission of the offense was neither authorized, requested, commanded, nor performed by a director, officer or a high managerial agent in behalf of the corporation.

2. The bidder certifies that it is not barred from contracting with the Department by reason of a violation of either Section 33E-3 or Section 33E-4.

E. International Anti-Boycott

1. Section 5 of the International Anti-Boycott Certification Act provides:

§ 5. State contracts. Every contract entered into by the State of Illinois for the manufacture, furnishing, or purchasing of supplies, material, or equipment or for the furnishing of work, labor, or services, in an amount exceeding the threshold for small purchases according to the purchasing laws of this State or \$10,000.00, whichever is less, shall contain certification, as a material condition of the contract, by which the contractor agrees that neither the contractor nor any substantially-owned affiliated company is participating or shall participate in an international boycott in violation of the provisions of the U.S. Export Administration Act of 1979 or the regulations of the U.S. Department of Commerce promulgated under that Act.

2. The bidder makes the certification set forth in Section 5 of the Act.

F. Drug Free Workplace

1. The Illinois "Drug Free Workplace Act" applies to this contract and it is necessary to comply with the provisions of the "Act" if the contractor is a corporation, partnership, or other entity (including a sole proprietorship) which has 25 or more employees.

2. The bidder certifies that if awarded a contract in excess of \$5,000 it will provide a drug free workplace by:

(a) Publishing a statement notifying employees that the unlawful manufacture, distribution, dispensation, possession or use of a controlled substance, including cannabis, is prohibited in the contractor's workplace; specifying the actions that will be taken against employees for violations of such prohibition; and notifying the employee that, as a condition of employment on such contract, the employee shall abide by the terms of the statement, and notify the employer of any criminal drug statute conviction for a violation occurring in the workplace no later than five (5) days after such conviction.

(b) Establishing a drug free awareness program to inform employees about the dangers of drug abuse in the workplace; the contractor's policy of maintaining a drug free workplace; any available drug counseling, rehabilitation, and employee assistance programs; and the penalties that may be imposed upon employees for drug violations.

(c) Providing a copy of the statement required by subparagraph (1) to each employee engaged in the performance of the contract and to post the statement in a prominent place in the workplace.

(d) Notifying the Department within ten (10) days after receiving notice from an employee or otherwise receiving actual notice of the conviction of an employee for a violation of any criminal drug statute occurring in the workplace.

(e) Imposing or requiring, within 30 days after receiving notice from an employee of a conviction or actual notice of such a conviction, an appropriate personnel action, up to and including termination, or the satisfactory participation in a drug abuse assistance or rehabilitation program approved by a federal, state or local health, law enforcement or other appropriate agency.

(f) Assisting employees in selecting a course of action in the event drug counseling, treatment, and rehabilitation is required and indicating that a trained referral team is in place.

(g) Making a good faith effort to continue to maintain a drug free workplace through implementation of the actions and efforts stated in this certification.

G. Debt Delinquency

1. The Illinois Procurement Code provides:

Section 50-11 and 50-12. Debt Delinquency.

The contractor or bidder certifies that it, or any affiliate, is not barred from being awarded a contract under 30 ILCS 500. Section 50-11 prohibits a person from entering into a contract with a State agency if it knows or should know that it, or any affiliate, is delinquent in the payment of any debt to the State as defined by the Debt Collection Board. Section 50-12 prohibits a person from entering into a contract with a State agency if it, or any affiliate, has failed to collect and remit Illinois Use Tax on all sales of tangible personal property into the State of Illinois in accordance with the provisions of the Illinois Use Tax Act. The contractor further acknowledges that the contracting State agency may declare the contract void if this certification is false or if the contractor, or any affiliate, is determined to be delinquent in the payment of any debt to the State during the term of the contract.

H. Sarbanes-Oxley Act of 2002

1. The Illinois Procurement Code, Section 50-60(c), provides:

The contractor certifies in accordance with 30 ILCS 500/50-10.5 that no officer, director, partner or other managerial agent of the contracting business has been convicted of a felony under the Sarbanes-Oxley Act of 2002 or a Class 3 or Class 2 felony under the Illinois Securities Law of 1953 for a period of five years prior to the date of the bid or contract. The contractor acknowledges that the contracting agency shall declare the contract void if this certification is false.

I. Addenda

The contractor or bidder certifies that all relevant addenda have been incorporated in to this contract. Failure to do so may cause the bid to be declared unacceptable.

J. Section 42 of the Environmental Protection Act

The contractor certifies in accordance with 30 ILCS 500/50-12 that the bidder or contractor is not barred from being awarded a contract under this Section which prohibits the bidding on or entering into contracts with the State of Illinois or a State agency by a person or business found by a court or the Pollution Control Board to have committed a willful or knowing violation of Section 42 of the Environmental Protection Act for a period of five years from the date of the order. The contractor acknowledges that the contracting agency may declare the contract void if this certification is false.

K. Apprenticeship and Training Certification (Does not apply to federal aid projects)

In accordance with the provisions of Section 30-22 (6) of the Illinois Procurement Code, the bidder certifies that it is a participant, either as an individual or as part of a group program, in the approved apprenticeship and training programs applicable to each type of work or craft that the bidder will perform with its own forces. The bidder further certifies for work that will be performed by subcontract that each of its subcontractors submitted for approval either (a) is, at the time of such bid, participating in an approved, applicable apprenticeship and training program; or (b) will, prior to commencement of performance of work pursuant to this contract, begin participation in an approved apprenticeship and training program applicable to the work of the subcontract. The Department, at any time before or after award, may require the production of a copy of each applicable Certificate of Registration issued by the United States Department of Labor evidencing such participation by the contractor and any or all of its subcontractors. Applicable apprenticeship and training programs are those that have been approved and registered with the United States Department of Labor. The bidder shall list in the space below, the official name of the program sponsor holding the Certificate of Registration for all of the types of work or crafts in which the bidder is a participant and that will be performed with the bidder's forces. Types of work or craft work that will be subcontracted shall be included and listed as subcontract work. The list shall also indicate any type of work or craft job category that does not have an applicable apprenticeship or training program. **The bidder is responsible for making a complete report and shall make certain that each type of work or craft job category that will be utilized on the project as reported on the Construction Employee Workforce Projection (Form BC-1256) and returned with the bid is accounted for and listed.**

NA - FEDERAL

The requirements of this certification and disclosure are a material part of the contract, and the contractor shall require this certification provision to be included in all approved subcontracts. In order to fulfill this requirement, it shall not be necessary that an applicable program sponsor be currently taking or that it will take applications for apprenticeship, training or employment during the performance of the work of this contract.

L. Executive Order Number 1 (2007) Regarding Lobbying on Government Procurements

The bidder hereby warrants and certifies that they have complied and will comply with the requirements set forth in this Order. The requirements of this warrant and certification are a material part of the contract, and the contractor shall require this warrant and certification provision to be included in all approved subcontracts.

M. Disclosure of Business Operations in Iran

Public Act 95-0616 provides that each bid, offer, or proposal submitted for a State contract shall include a disclosure of whether or not the Company acting as the bidder, offer or, or proposing entity, or any of its corporate parents or subsidiaries, within the 24 months before submission of the bid, offer, or proposal had business operations that involved contracts with or provision of supplies or services to the Government of Iran, companies in which the Government of Iran has any direct or indirect equity share, consortiums or projects commissioned by the Government of Iran, or companies involved in consortiums or projects commissioned by the Government of Iran and either of the following conditions apply:

- (1) More than 10% of the Company's revenues produced in or assets located in Iran involve oil-related activities or mineral-extraction activities; less than 75% of the Company's revenues produced in or assets located in Iran involve contracts with or provision of oil-related or mineral-extraction products or services to the Government of Iran or a project or consortium created exclusively by that government; and the Company has failed to take substantial action.
- (2) The Company has, on or after August 5, 1996, made an investment of \$20 million or more, or any combination of investments of at least \$10 million each that in the aggregate equals or exceeds \$20 million in any 12-month period, which directly or significantly contributes to the enhancement of Iran's ability to develop petroleum resources of Iran.

The terms "Business operations", "Company", "Mineral-extraction activities", "Oil-related activities", "Petroleum resources", and "Substantial action" are all defined in the Act.

Failure to make the disclosure required by the Act shall cause the bid, offer or proposal to be considered not responsive. The disclosure will be considered when evaluating the bid, offer, or proposal or awarding the contract. The name of each Company disclosed as doing business or having done business in Iran will be provided to the State Comptroller.

Check the appropriate statement:

Company has no business operations in Iran to disclose.

Company has business operations in Iran as disclosed the attached document.

NOTICE

**PA 95-0635 SUBSTANCE ABUSE PREVENTION PROGRAM (SAPP)
Effective January 1, 2008**

This Public Act requires that all contractors and subcontractors have a SAPP, meeting certain requirements, in place before starting work.

The as read low bidder is required to submit a correctly completed SAPP Certification Form BC 261 within seven (7) working days after the Letting. The Department will not accept a SAPP that does not meet the seven day submittal requirement and the bid will be declared not responsive. In the event the bid is declared not responsive due to failure to comply the Department may elect to cause the forfeiture of the penal sum of the bidder's proposal guaranty, may deny authorization to bid the project if re-advertised for bids and may not allow the bidder to participate on subsequent Lettings.

Submittal and approval of the bidder's SAPP is a condition of award.

The SAPP is to be submitted to the Bureau of Design & Environment, Contracts Office, Room 326, 2300 South Dirksen Parkway, Springfield, IL 62764. Voice 217-782-7806. Fax 217-785-1141. It is the bidder's responsibility to obtain confirmation of delivery.

The requirements of this Public Act are a material part of the contract, and the contractor shall require this provision to be included in all approved subcontracts. The contractor shall submit the correctly completed SAPP Certification Form BC 261 for each subcontractor with the Request for Approval of Subcontractor Form BC 260A.

TO BE RETURNED WITH BID

IV. DISCLOSURES

A. The disclosures hereinafter made by the bidder are each a material representation of fact upon which reliance is placed should the Department enter into the contract with the bidder. The Department may terminate the contract if it is later determined that the bidder rendered a false or erroneous disclosure, and the surety providing the performance bond shall be responsible for completion of the contract.

B. Financial Interests and Conflicts of Interest

1. Section 50-35 of the Illinois Procurement Code provides that all bids of more than \$10,000 shall be accompanied by disclosure of the financial interests of the bidder. This disclosed information for the successful bidder, will be maintained as public information subject to release by request pursuant to the Freedom of Information Act.

The financial interests to be disclosed shall include ownership or distributive income share that is in excess of 5%, or an amount greater than 60% of the annual salary of the Governor, of the bidding entity or its parent entity, whichever is less, unless the contractor or bidder is a publicly traded entity subject to Federal 10K reporting, in which case it may submit its 10K disclosure in place of the prescribed disclosure. If a bidder is a privately held entity that is exempt from Federal 10K reporting, but has more than 400 shareholders, it may submit the information that Federal 10K companies are required to report, and list the names of any person or entity holding any ownership share that is in excess of 5%. The disclosure shall include the names, addresses, and dollar or proportionate share of ownership of each person making the disclosure, their instrument of ownership or beneficial relationship, and notice of any potential conflict of interest resulting from the current ownership or beneficial interest of each person making the disclosure having any of the relationships identified in Section 50-35 and on the disclosure form.

In addition, all disclosures shall indicate any other current or pending contracts, proposals, leases, or other ongoing procurement relationships the bidding entity has with any other unit of state government and shall clearly identify the unit and the contract, proposal, lease, or other relationship.

2. Disclosure Forms. Disclosure Form A is attached for use concerning the individuals meeting the above ownership or distributive share requirements. Subject individuals should be covered each by one form. In addition, a second form (Disclosure Form B) provides for the disclosure of current or pending procurement relationships with other (non-IDOT) state agencies. **The forms must be included with each bid or incorporated by reference.**

C. Disclosure Form Instructions

Form A: For bidders that have previously submitted the information requested in Form A

The Department has retained the Form A disclosures submitted by all bidders responding to these requirements for the April 24, 1998 or any subsequent letting conducted by the Department. The bidder has the option of submitting the information again or the bidder may check the following certification statement indicating that the information previously submitted by the bidder is, as of the date of submission, current and accurate. Before checking this certification, the bidder should carefully review its prior submissions to ensure the Certification is correct. If the Bidder checks the Certification, the Bidder should proceed to Form B instructions.

CERTIFICATION STATEMENT

I have determined that the Form A disclosure information previously submitted is current and accurate, and all forms are hereby incorporated by reference in this bid. Any necessary additional forms or amendments to previously submitted forms are attached to this bid.

(Bidding Company)



Signature of Authorized Representative

Date

Form A: For bidders who have NOT previously submitted the information requested in Form A

If the bidder is a publicly traded entity subject to Federal 10K reporting, the 10K Report may be submitted to meet the requirements of Form A. If a bidder is a privately held entity that is exempt from Federal 10K reporting, but has more than 400 shareholders, it may submit the information that Federal 10K companies are required to report, and list the names of any person or entity holding any ownership share that is in excess of 5%. If a bidder is not subject to Federal 10K reporting, the bidder must determine if any individuals are required by law to complete a financial disclosure form. To do this, the bidder should answer each of the following questions. A "YES" answer indicates Form A must be completed. If the answer to each of the following questions is "NO", then the NOT APPLICABLE STATEMENT on the second page of Form A must be signed and dated by a person that is authorized to execute contracts for the bidding company. Note: These questions are for assistance only and are not required to be completed.

1. Does anyone in your organization have a direct or beneficial ownership share of greater than 5% of the bidding entity or parent entity? YES ___ NO ___
2. Does anyone in your organization have a direct or beneficial ownership share of less than 5%, but which has a value greater than \$102,600.00? YES ___ NO ___
3. Does anyone in your organization receive more than \$102,600.00 of the bidding entity's or parent entity's distributive income? (Note: Distributive income is, for these purposes, any type of distribution of profits. An annual salary is not distributive income.) YES ___ NO ___
4. Does anyone in your organization receive greater than 5% of the bidding entity's or parent entity's total distributive income, but which is less than \$102,600.00? YES ___ NO ___
(Note: Only one set of forms needs to be completed per person per bid even if a specific individual would require a yes answer to more than one question.)

A "YES" answer to any of these questions requires the completion of Form A. The bidder must determine each individual in the bidding entity or the bidding entity's parent company that would cause the questions to be answered "Yes". Each form must be signed and dated by a person that is authorized to execute contracts for your organization. **Photocopied or stamped signatures are not acceptable.** The person signing can be, but does not have to be, the person for which the form is being completed. The bidder is responsible for the accuracy of any information provided.

If the answer to each of the above questions is "NO", then the NOT APPLICABLE STATEMENT on page 2 of Form A must be signed and dated by a person that is authorized to execute contracts for your company.

Form B: Identifying Other Contracts & Procurement Related Information Disclosure Form B must be completed for each bid submitted by the bidding entity. *Note: Checking the NOT APPLICABLE STATEMENT on Form A does not allow the bidder to ignore Form B. Form B must be completed, checked, and dated or the bidder may be considered nonresponsive and the bid will not be accepted.*

The Bidder shall identify, by checking Yes or No on Form B, whether it has any pending contracts (including leases), bids, proposals, or other ongoing procurement relationship with any other (non-IDOT) State of Illinois agency. If "No" is checked, the bidder only needs to complete the check box on the bottom of Form B. If "Yes" is checked, the bidder must do one of the following:

Option I: If the bidder did not submit an Affidavit of Availability to obtain authorization to bid, the bidder must list all non-IDOT State of Illinois agency pending contracts, leases, bids, proposals, and other ongoing procurement relationships. These items may be listed on Form B or on an attached sheet(s). Do not include IDOT contracts. Contracts with cities, counties, villages, etc. are not considered State of Illinois agency contracts and are not to be included. Contracts with other State of Illinois agencies such as the Department of Natural Resources or the Capital Development Board must be included. Bidders who submit Affidavits of Availability are suggested to use Option II.

Option II: If the bidder is required and has submitted an Affidavit of Availability in order to obtain authorization to bid, the bidder may write or type "See Affidavit of Availability" which indicates that the Affidavit of Availability is incorporated by reference and includes all non-IDOT State of Illinois agency pending contracts, leases, bids, proposals, and other ongoing procurement relationships. For any contracts that are not covered by the Affidavit of Availability, the bidder must identify them on Form B or on an attached sheet(s). These might be such things as leases.

D. Bidders Submitting More Than One Bid

Bidders submitting multiple bids may submit one set of forms consisting of all required Form A disclosures and one Form B for use with all bids. Please indicate in the space provided below the bid item that contains the original disclosure forms and the bid items which incorporate the forms by reference.

- The bid submitted for letting item _____ contains the Form A disclosures or Certification Statement and the Form B disclosures. The following letting items incorporate the said forms by reference:

RETURN WITH BID/OFFER

**ILLINOIS DEPARTMENT
OF TRANSPORTATION**

**Form A
Financial Information &
Potential Conflicts of Interest
Disclosure**

Contractor Name		
Legal Address		
City, State, Zip		
Telephone Number	Email Address	Fax Number (if available)

Disclosure of the information contained in this Form is required by the Section 50-35 of the Illinois Procurement Code (30 ILCS 500). Vendors desiring to enter into a contract with the State of Illinois must disclose the financial information and potential conflict of interest information as specified in this Disclosure Form. This information shall become part of the publicly available contract file. This Form A must be completed for bids in excess of \$10,000, and for all open-ended contracts. **A publicly traded company may submit a 10K disclosure (or equivalent if applicable) in satisfaction of the requirements set forth in Form A. See Disclosure Form Instructions.**

DISCLOSURE OF FINANCIAL INFORMATION

1. Disclosure of Financial Information. The individual named below has an interest in the BIDDER (or its parent) in terms of ownership or distributive income share in excess of 5%, or an interest which has a value of more than \$102,600.00 (60% of the Governor's salary as of 7/1/07). **(Make copies of this form as necessary and attach a separate Disclosure Form A for each individual meeting these requirements)**

FOR INDIVIDUAL (type or print information)

NAME: _____

ADDRESS _____

Type of ownership/distributable income share:

stock _____ sole proprietorship _____ Partnership _____ other: (explain on separate sheet):
% or \$ value of ownership/distributable income share: _____

2. Disclosure of Potential Conflicts of Interest. Check "Yes" or "No" to indicate which, if any, of the following potential conflict of interest relationships apply. If the answer to any question is "Yes", please attach additional pages and describe.

(a) State employment, currently or in the previous 3 years, including contractual employment of services.

Yes ___ No ___

If your answer is yes, please answer each of the following questions.

- Are you currently an officer or employee of either the Capitol Development Board or the Illinois Toll Highway Authority? Yes ___ No ___
- Are you currently appointed to or employed by any agency of the State of Illinois? If you are currently appointed to or employed by any agency of the State of Illinois, and your annual salary exceeds \$102,600.00, (60% of the Governor's salary as of 7/1/07) provide the name the State agency for which you are employed and your annual salary. _____

RETURN WITH BID/OFFER

- 3. If you are currently appointed to or employed by any agency of the State of Illinois, and your annual salary exceeds \$102,600.00, (60% of the Governor's salary as of 7/1/07) are you entitled to receive (i) more than 7 1/2% of the total distributable income of your firm, partnership, association or corporation, or (ii) an amount in excess of the salary of the Governor? Yes ___ No ___

- 4. If you are currently appointed to or employed by any agency of the State of Illinois, and your annual salary exceeds \$102,600.00, (60% of the Governor's salary as of 7/1/07) are you and your spouse or minor children entitled to receive (i) more than 15% in aggregate of the total distributable income of your firm, partnership, association or corporation, or (ii) an amount in excess of 2 times the salary of the Governor? Yes ___ No ___

(b) State employment of spouse, father, mother, son, or daughter, including contractual employment for services in the previous 2 years.

Yes ___ No ___

If your answer is yes, please answer each of the following questions.

- 1. Is your spouse or any minor children currently an officer or employee of the Capitol Development Board or the Illinois Toll Highway Authority? Yes ___ No ___

- 2. Is your spouse or any minor children currently appointed to or employed by any agency of the State of Illinois? If your spouse or minor children is/are currently appointed to or employed by any agency of the State of Illinois, and his/her annual salary exceeds \$102,600.00, (60% of the Governor's salary as of 7/1/07) provide the name of the spouse and/or minor children, the name of the State agency for which he/she is employed and his/her annual salary. _____

- 3. If your spouse or any minor children is/are currently appointed to or employed by any agency of the State of Illinois, and his/her annual salary exceeds \$102,600.00, (60% of the salary of the Governor as of 7/1/07) are you entitled to receive (i) more than 7 1/2% of the total distributable income of your firm, partnership, association or corporation, or (ii) an amount in excess of the salary of the Governor? Yes ___ No ___

- 4. If your spouse or any minor children are currently appointed to or employed by any agency of the State of Illinois, and his/her annual salary exceeds \$102,600.00, (60% of the Governor's salary as of 7/1/07) are you and your spouse or any minor children entitled to receive (i) more than 15% in the aggregate of the total distributable income from your firm, partnership, association or corporation, or (ii) an amount in excess of 2 times the salary of the Governor? Yes ___ No ___

(c) Elective status; the holding of elective office of the State of Illinois, the government of the United States, any unit of local government authorized by the Constitution of the State of Illinois or the statutes of the State of Illinois currently or in the previous 3 years. Yes ___ No ___

(d) Relationship to anyone holding elective office currently or in the previous 2 years; spouse, father, mother, son, or daughter. Yes ___ No ___

(e) Appointive office; the holding of any appointive government office of the State of Illinois, the United State of America, or any unit of local government authorized by the Constitution of the State of Illinois or the statutes of the State of Illinois, which office entitles the holder to compensation in excess of the expenses incurred in the discharge of that office currently or in the previous 3 years. Yes ___ No ___

(f) Relationship to anyone holding appointive office currently or in the previous 2 years; spouse, father, mother, son, or daughter. Yes ___ No ___

(g) Employment, currently or in the previous 3 years, as or by any registered lobbyist of the State government. Yes ___ No ___

RETURN WITH BID/OFFER

(h) Relationship to anyone who is or was a registered lobbyist in the previous 2 years; spouse, father, mother, son, or daughter. Yes ___ No ___

(i) Compensated employment, currently or in the previous 3 years, by any registered election or reelection committee registered with the Secretary of State or any county clerk of the State of Illinois, or any political action committee registered with either the Secretary of State or the Federal Board of Elections. Yes ___ No ___

(j) Relationship to anyone; spouse, father, mother, son, or daughter; who was a compensated employee in the last 2 years by any registered election or re-election committee registered with the Secretary of State or any county clerk of the State of Illinois, or any political action committee registered with either the Secretary of State or the Federal Board of Elections. Yes ___ No ___

APPLICABLE STATEMENT

This Disclosure Form A is submitted on behalf of the INDIVIDUAL named on previous page.

Completed by: _____ Date _____
Signature of Individual or Authorized Representative

NOT APPLICABLE STATEMENT

I have determined that no individuals associated with this organization meet the criteria that would require the completion of this Form A.

This Disclosure Form A is submitted on behalf of the CONTRACTOR listed on the previous page.

_____ Date _____
Signature of Authorized Representative

RETURN WITH BID/OFFER

**ILLINOIS DEPARTMENT
OF TRANSPORTATION**

**Form B
Other Contracts &
Procurement Related Information
Disclosure**

Contractor Name		
Legal Address		
City, State, Zip		
Telephone Number	Email Address	Fax Number (if available)

Disclosure of the information contained in this Form is required by the Section 50-35 of the Illinois Procurement Act (30 ILCS 500). This information shall become part of the publicly available contract file. This Form B must be completed for bids in excess of \$10,000, and for all open-ended contracts.

DISCLOSURE OF OTHER CONTRACTS AND PROCUREMENT RELATED INFORMATION

1. Identifying Other Contracts & Procurement Related Information. The BIDDER shall identify whether it has any pending contracts (including leases), bids, proposals, or other ongoing procurement relationship with any other State of Illinois agency: Yes ___ No ___

If "No" is checked, the bidder only needs to complete the signature box on the bottom of this page.

2. If "Yes" is checked. Identify each such relationship by showing State of Illinois agency name and other descriptive information such as bid or project number (attach additional pages as necessary). SEE DISCLOSURE FORM INSTRUCTIONS:

THE FOLLOWING STATEMENT MUST BE CHECKED

<input type="checkbox"/>	_____	_____
	Signature of Authorized Representative	Date

RETURN WITH BID

SPECIAL NOTICE TO CONTRACTORS

The following requirements of the Illinois Department of Human Rights' Rules and Regulations are applicable to bidders on all construction contracts advertised by the Illinois Department of Transportation:

CONSTRUCTION EMPLOYEE UTILIZATION PROJECTION

- (a) All bidders on construction contracts shall complete and submit, along with and as part of their bids, a Bidder's Employee Utilization Form (Form BC-1256) setting forth a projection and breakdown of the total workforce intended to be hired and/or allocated to such contract work by the bidder including a projection of minority and female employee utilization in all job classifications on the contract project.
- (b) The Department of Transportation shall review the Employee Utilization Form, and workforce projections contained therein, of the contract awardee to determine if such projections reflect an underutilization of minority persons and/or women in any job classification in accordance with the Equal Employment Opportunity Clause and Section 7.2 of the Illinois Department of Human Rights' Rules and Regulations for Public Contracts adopted as amended on September 17, 1980. If it is determined that the contract awardee's projections reflect an underutilization of minority persons and/or women in any job classification, it shall be advised in writing of the manner in which it is underutilizing and such awardee shall be considered to be in breach of the contract unless, prior to commencement of work on the contract project, it submits revised satisfactory projections or an acceptable written affirmative action plan to correct such underutilization including a specific timetable geared to the completion stages of the contract.
- (c) The Department of Transportation shall provide to the Department of Human Rights a copy of the contract awardee's Employee Utilization Form, a copy of any required written affirmative action plan, and any written correspondence related thereto. The Department of Human Rights may review and revise any action taken by the Department of Transportation with respect to these requirements.

RETURN WITH BID

**Contract No. 76B36
MARION County
Section (29Z-2,30-2)RS-3
Project ACNHF-0322(084)
Route FAP 322
District 8 Construction Funds**

PART II. WORKFORCE PROJECTION - continued

- B. Included in "Total Employees" under Table A is the total number of **new hires** that would be employed in the event the undersigned bidder is awarded this contract.

The undersigned bidder projects that: (number) _____ new hires would be recruited from the area in which the contract project is located; and/or (number) _____ new hires would be recruited from the area in which the bidder's principal office or base of operation is located.

- C. Included in "Total Employees" under Table A is a projection of numbers of persons to be employed directly by the undersigned bidder as well as a projection of numbers of persons to be employed by subcontractors.

The undersigned bidder estimates that (number) _____ persons will be directly employed by the prime contractor and that (number) _____ persons will be employed by subcontractors.

PART III. AFFIRMATIVE ACTION PLAN

- A. The undersigned bidder understands and agrees that in the event the foregoing minority and female employee utilization projection included under **PART II** is determined to be an underutilization of minority persons or women in any job category, and in the event that the undersigned bidder is awarded this contract, he/she will, prior to commencement of work, develop and submit a written Affirmative Action Plan including a specific timetable (geared to the completion stages of the contract) whereby deficiencies in minority and/or female employee utilization are corrected. Such Affirmative Action Plan will be subject to approval by the contracting agency and the **Department of Human Rights**.
- B. The undersigned bidder understands and agrees that the minority and female employee utilization projection submitted herein, and the goals and timetable included under an Affirmative Action Plan if required, are deemed to be part of the contract specifications.

Company _____ Telephone Number _____

Address _____

NOTICE REGARDING SIGNATURE

The Bidder's signature on the Proposal Signature Sheet will constitute the signing of this form. The following signature block needs to be completed only if revisions are required.

Signature: _____ Title: _____ Date: _____

Instructions: All tables must include subcontractor personnel in addition to prime contractor personnel.

Table A - Include both the number of employees that would be hired to perform the contract work and the total number currently employed (Table B) that will be allocated to contract work, and include all apprentices and on-the-job trainees. The "Total Employees" column should include all employees including all minorities, apprentices and on-the-job trainees to be employed on the contract work.

Table B - Include all employees currently employed that will be allocated to the contract work including any apprentices and on-the-job trainees currently employed.

Table C - Indicate the racial breakdown of the total apprentices and on-the-job trainees shown in Table A.

RETURN WITH BID

ADDITIONAL FEDERAL REQUIREMENTS

In addition to the Required Contract Provisions for Federal-Aid Construction Contracts (FHWA 1273), all bidders make the following certifications.

- A. By the execution of this proposal, the signing bidder certifies that the bidding entity has not, either directly or indirectly, entered into any agreement, participated in any collusion, or otherwise taken any action, in restraint of free competitive bidding in connection with the submitted bid. This statement made by the undersigned bidder is true and correct under penalty of perjury under the laws of the United States.
- B. **CERTIFICATION, EQUAL EMPLOYMENT OPPORTUNITY:**
1. Have you participated in any previous contracts or subcontracts subject to the equal opportunity clause. YES _____ NO _____
 2. If answer to #1 is yes, have you filed with the Joint Reporting Committee, the Director of OFCC, any Federal agency, or the former President's Committee on Equal Employment Opportunity, all reports due under the applicable filing requirements of those organizations? YES _____ NO _____

RETURN WITH BID

**Contract No. 76B36
MARION County
Section (29Z-2,30-2)RS-3
Project ACNHF-0322(084)
Route FAP 322
District 8 Construction Funds**

PROPOSAL SIGNATURE SHEET

The undersigned bidder hereby makes and submits this bid on the subject Proposal, thereby assuring the Department that all requirements of the Invitation for Bids and rules of the Department have been met, that there is no misunderstanding of the requirements of paragraph 3 of this Proposal, and that the contract will be executed in accordance with the rules of the Department if an award is made on this bid.

(IF AN INDIVIDUAL) Firm Name _____
Signature of Owner _____
Business Address _____

(IF A CO-PARTNERSHIP) Firm Name _____
By _____
Business Address _____
Name and Address of All Members of the Firm: _____

(IF A CORPORATION) Corporate Name _____
By _____
Signature of Authorized Representative _____
Typed or printed name and title of Authorized Representative _____

(IF A JOINT VENTURE, USE THIS SECTION FOR THE MANAGING PARTY AND THE SECOND PARTY SHOULD SIGN BELOW) Attest _____
Signature _____
Business Address _____

(IF A JOINT VENTURE) Corporate Name _____
By _____
Signature of Authorized Representative _____
Typed or printed name and title of Authorized Representative _____

Attest _____
Signature _____
Business Address _____

If more than two parties are in the joint venture, please attach an additional signature sheet.



Return with Bid

Division of Highways
Proposal Bid Bond
(Effective November 1, 1992)

Item No. _____

Letting Date _____

KNOW ALL MEN BY THESE PRESENTS, That We _____

as PRINCIPAL, and _____

_____ as SURETY, are held jointly, severally and firmly bound unto the STATE OF ILLINOIS in the penal sum of 5 percent of the total bid price, or for the amount specified in Article 102.09 of the "Standard Specifications for Road and Bridge Construction" in effect on the date of invitation for bids, whichever is the lesser sum, well and truly to be paid unto said STATE OF ILLINOIS, for the payment of which we bind ourselves, our heirs, executors, administrators, successors and assigns.

THE CONDITION OF THE FOREGOING OBLIGATION IS SUCH, that whereas, the PRINCIPAL has submitted a bid proposal to the STATE OF ILLINOIS, acting through the Department of Transportation, for the improvement designated by the Transportation Bulletin Item Number and Letting Date indicated above.

NOW, THEREFORE, if the Department shall accept the bid proposal of the PRINCIPAL; and if the PRINCIPAL shall, within the time and as specified in the bidding and contract documents, submit a DBE Utilization Plan that is accepted and approved by the Department; and if, after award by the Department, the PRINCIPAL shall enter into a contract in accordance with the terms of the bidding and contract documents including evidence of the required insurance coverages and providing such bond as specified with good and sufficient surety for the faithful performance of such contract and for the prompt payment of labor and material furnished in the prosecution thereof; or if, in the event of the failure of the PRINCIPAL to make the required DBE submission or to enter into such contract and to give the specified bond, the PRINCIPAL pays to the Department the difference not to exceed the penalty hereof between the amount specified in the bid proposal and such larger amount for which the Department may contract with another party to perform the work covered by said bid proposal, then this obligation shall be null and void, otherwise, it shall remain in full force and effect.

IN THE EVENT the Department determines the PRINCIPAL has failed to comply with any requirement as set forth in the preceding paragraph, then Surety shall pay the penal sum to the Department within fifteen (15) days of written demand therefor. If Surety does not make full payment within such period of time, the Department may bring an action to collect the amount owed. Surety is liable to the Department for all its expenses, including attorney's fees, incurred in any litigation in which it prevails either in whole or in part.

In TESTIMONY WHEREOF, the said PRINCIPAL and the said SURETY have caused this instrument to be signed by

their respective officers this _____ day of _____ A.D., _____ .

PRINCIPAL

(Company Name)

(Company Name)

By: _____
(Signature & Title)

By: _____
(Signature of Attorney-in-Fact)

Notary Certification for Principal and Surety

STATE OF ILLINOIS,

County of _____

I, _____, a Notary Public in and for said County, do hereby certify that

_____ and _____
(Insert names of individuals signing on behalf of PRINCIPAL & SURETY)

who are each personally known to me to be the same persons whose names are subscribed to the foregoing instrument on behalf of PRINCIPAL and SURETY, appeared before me this day in person and acknowledged respectively, that they signed and delivered said instrument as their free and voluntary act for the uses and purposes therein set forth.

Given under my hand and notarial seal this _____ day of _____ A.D. _____

My commission expires _____

Notary Public

In lieu of completing the above section of the Proposal Bid Form, the Principal may file an Electronic Bid Bond. By signing the proposal and marking the check box next to the Signature and Title line below, the Principal is ensuring the identified electronic bid bond has been executed and the Principal and Surety are firmly bound unto the State of Illinois under the conditions of the bid bond as shown above.

Electronic Bid Bond ID# _____

Company / Bidder Name _____



Signature and Title _____

PROPOSAL ENVELOPE



PROPOSALS

for construction work advertised for bids by the Illinois Department of Transportation

Item No.	Item No.	Item No.

Submitted By:

Name:
Address:
Phone No.

Bidders should use an IDOT proposal envelope or affix this form to the front of a 10" x 13" envelope for the submittal of bids. If proposals are mailed, they should be enclosed in a second or outer envelope addressed to:

Engineer of Design and Environment - Room 326
Illinois Department of Transportation
2300 South Dirksen Parkway
Springfield, Illinois 62764

NOTICE

Individual bids, including Bid Bond and/or supplemental information if required, should be securely stapled.

CONTRACTOR OFFICE COPY OF CONTRACT SPECIFICATIONS

NOTICE

None of the following material needs to be returned with the bid package unless the special provisions require documentation and/or other information to be submitted.

**Contract No. 76B36
MARION County
Section (29Z-2,30-2)RS-3
Project ACNHF-0322(084)
Route FAP 322
District 8 Construction Funds**



Illinois Department of Transportation



NOTICE TO BIDDERS

- 1. TIME AND PLACE OF OPENING BIDS.** Sealed proposals for the improvement described herein will be received by the Department of Transportation at the Harry R. Hanley Building, 2300 South Dirksen Parkway, in Springfield, Illinois until 10:00 o'clock a.m., June 13, 2008. All bids will be gathered, sorted, publicly opened and read in the auditorium at the Department of Transportation's Harry R. Hanley Building shortly after the 10:00 a.m. cut off time.
- 2. DESCRIPTION OF WORK.** The proposed improvement is identified and advertised for bids in the Invitation for Bids as:

**Contract No. 76B36
MARION County
Section (29Z-2,30-2)RS-3
Project ACNHF-0322(084)
Route FAP 322
District 8 Construction Funds**

3.47 miles of milling and HMA surface on U.S. Route 51 from Calumet Street to the Jefferson County line in Centralia.

- 3. INSTRUCTIONS TO BIDDERS.** (a) This Notice, the invitation for bids, proposal and letter of award shall, together with all other documents in accordance with Article 101.09 of the Standard Specifications for Road and Bridge Construction, become part of the contract. Bidders are cautioned to read and examine carefully all documents, to make all required inspections, and to inquire or seek explanation of the same prior to submission of a bid.

(b) State law, and, if the work is to be paid wholly or in part with Federal-aid funds, Federal law requires the bidder to make various certifications as a part of the proposal and contract. By execution and submission of the proposal, the bidder makes the certification contained therein. A false or fraudulent certification shall, in addition to all other remedies provided by law, be a breach of contract and may result in termination of the contract.
- 4. AWARD CRITERIA AND REJECTION OF BIDS.** This contract will be awarded to the lowest responsive and responsible bidder considering conformity with the terms and conditions established by the Department in the rules, Invitation for Bids and contract documents. The issuance of plans and proposal forms for bidding based upon a prequalification rating shall not be the sole determinant of responsibility. The Department reserves the right to determine responsibility at the time of award, to reject any or all proposals, to readvertise the proposed improvement, and to waive technicalities.

By Order of the
Illinois Department of Transportation

Milton R. Sees, Secretary

BD 351 (Rev. 01/2003)

INDEX
FOR
SUPPLEMENTAL SPECIFICATIONS
AND RECURRING SPECIAL PROVISIONS

Adopted January 1, 2008

This index contains a listing of SUPPLEMENTAL SPECIFICATIONS and frequently used RECURRING SPECIAL PROVISIONS.

ERRATA Standard Specifications for Road and Bridge Construction (Adopted 1-1-07) (Revised 1-1-08)

SUPPLEMENTAL SPECIFICATIONS

<u>Std. Spec. Sec.</u>	<u>Page No.</u>
205 Embankment	1
251 Mulch	2
253 Planting Woody Plants	3
280 Temporary Erosion Control	5
443 Reflective Crack Control Treatment	6
502 Excavation for Structures	9
503 Concrete Structures	10
505 Steel Structures	11
540 Box Culverts	12
633 Removing and Reerecting Guardrail and Terminals	13
672 Sealing Abandoned Water Wells	14
701 Work Zone Traffic Control and Protection	15
838 Breakaway Devices	16
1004 Coarse Aggregates	17
1020 Portland Cement Concrete	18
1022 Concrete Curing Materials	20
1042 Precast Concrete Products	21
1062 Reflective Crack Control System	22
1069 Pole and Tower	24
1081 Materials for Planting	27
1083 Elastomeric Bearings	29
1102 Hot-Mix Asphalt Equipment	30

RECURRING SPECIAL PROVISIONS

The following RECURRING SPECIAL PROVISIONS indicated by an "X" are applicable to this contract and are included by reference:

<u>CHECK SHEET #</u>	<u>PAGE NO.</u>
1 X Additional State Requirements For Federal-Aid Construction Contracts (Eff. 2-1-69) (Rev. 1-1-07)	31
2 X Subletting of Contracts (Federal-Aid Contracts) (Eff. 1-1-88) (Rev. 5-1-93)	33
3 X EEO (Eff. 7-21-78) (Rev. 11-18-80)	34
4 Specific Equal Employment Opportunity Responsibilities Non Federal-Aid Contracts (Eff. 3-20-69) (Rev. 1-1-94)	44
5 Required Provisions - State Contracts (Eff. 4-1-65) (Rev. 1-1-07)	49
6 Reserved	54
7 Reserved	55
8 Haul Road Stream Crossings, Other Temporary Stream Crossings, and In-Stream Work Pads (Eff. 1-2-92) (Rev. 1-1-98)	56
9 Construction Layout Stakes Except for Bridges (Eff. 1-1-99) (Rev. 1-1-07)	57
10 Construction Layout Stakes (Eff. 5-1-93) (Rev. 1-1-07)	60
11 Use of Geotextile Fabric for Railroad Crossing (Eff. 1-1-95) (Rev. 1-1-07)	63
12 Subsealing of Concrete Pavements (Eff. 11-1-84) (Rev. 1-1-07)	65
13 Hot-Mix Asphalt Surface Removal (Cold Milling) (Eff. 11-1-87) (Rev. 1-1-07)	69
14 Pavement and Shoulder Resurfacing (Eff. 2-1-00) (Rev. 1-1-07)	71
15 PCC Partial Depth Hot-Mix Asphalt Patching (Eff. 1-1-98) (Rev. 1-1-07)	72
16 Patching with Hot-Mix Asphalt Overlay Removal (Eff. 10-1-95) (Rev. 1-1-07)	74
17 Polymer Concrete (Eff. 8-1-95) (Rev. 1-1-08)	75
18 PVC Pipeliner (Eff. 4-1-04) (Rev. 1-1-07)	77
19 Pipe Underdrains (Eff. 9-9-87) (Rev. 1-1-07)	78
20 Guardrail and Barrier Wall Delineation (Eff. 12-15-93) (Rev. 1-1-97)	79
21 Bicycle Racks (Eff. 4-1-94) (Rev. 1-1-07)	83
22 Temporary Modular Glare Screen System (Eff. 1-1-00) (Rev. 1-1-07)	85
23 Temporary Portable Bridge Traffic Signals (Eff. 8-1-03) (Rev. 1-1-07)	87
24 Work Zone Public Information Signs (Eff. 9-1-02) (Rev. 1-1-07)	89
25 Night Time Inspection of Roadway Lighting (Eff. 5-1-96)	90
26 English Substitution of Metric Bolts (Eff. 7-1-96)	91
27 English Substitution of Metric Reinforcement Bars (Eff. 4-1-96) (Rev. 1-1-03)	92
28 Calcium Chloride Accelerator for Portland Cement Concrete (Eff. 1-1-01)	93
29 Quality Control of Concrete Mixtures at the Plant-Single A (Eff. 8-1-00) (Rev. 1-1-04)	94
30 Quality Control of Concrete Mixtures at the Plant-Double A (Eff. 8-1-00) (Rev. 1-1-04)	100
31 Quality Control/Quality Assurance of Concrete Mixtures (Eff. 4-1-92) (Rev. 1-1-07)	108

TABLE OF CONTENTS

LOCATION OF PROJECT	1
DESCRIPTION OF PROJECT	1
MONTHLY LABOR SUMMARY AND ACTIVITY REPORTING SYSTEM	1
HOT-MIX ASPHALT SURFACE REMOVAL W/SKETCH OF ILLINOIS STANDARD W8-I106	4
TERMINAL SECTION REMOVAL, SINGLE RAIL	6
CONCRETE CURB (SPECIAL)	6
BITUMINOUS CURB REPAIR	6
MANHOLE FRAMES TO BE ADJUSTED	6
VALVE BOX FRAMES TO BE ADJUSTED	6
OFFICE COPY MACHINE	7
TELEPHONE ANSWERING MACHINE	7
TRAFFIC CONTROL PLAN	8
CONSTRUCTION AND MAINTENANCE SIGN SUPPORTS	8
STATUS OF UTILITIES TO BE ADJUSTED	8
AUTOMATED FLAGGER ASSISTANCE DEVICES (BDE).....	10
CEMENT (BDE)	11
WORKING DAYS (BDE)	14
DISADVANTAGED BUSINESS ENTERPRISE PARTICIPATION (BDE)	14
EQUIPMENT RENTAL RATES (BDE).....	22
HOT-MIX ASPHALT - FIELD VOIDS IN THE MINERAL AGGREGATE (BDE).....	23
HOT-MIX ASPHALT – PLANT TEST FREQUENCY (BDE).....	24
HOT-MIX ASPHALT – TRANSPORTATION (BDE)	26
PAYMENTS TO SUBCONTRACTORS (BDE)	26
PLASTIC BLOCKOUTS FOR GUARDRAIL (BDE)	27
RAILROAD PROTECTIVE LIABILITY INSURANCE (5 AND 10) (BDE).....	28
RECLAIMED ASPHALT PAVEMENT (RAP) (BDE)	28
REFLECTIVE SHEETING ON CHANNELIZING DEVICES (BDE)	34
STEEL PLATE BEAM GUARDRAIL (BDE)	35
SUBCONTRACTOR MOBILIZATION PAYMENTS (BDE)	35
THERMOPLASTIC PAVEMENT MARKINGS (BDE)	36
TRAINING SPECIAL PROVISIONS	37
WATER BLASTER WITH VACUUM RECOVERY (BDE).....	39
NORFOLK & SOUTHERN RAILROAD AGREEMENT FOR PROTECTION OF RAILWAY INTEREST ...	40
BITUMINOUS MATERIALS COST ADJUSTMENTS (BDE) (RETURN FORM WITH BID).....	54

STATE OF ILLINOIS

SPECIAL PROVISIONS

The following Special Provisions supplement the "Standard Specifications for Road and Bridge Construction," adopted January 1, 2007, the latest edition of the "Manual on Uniform Traffic Control Devices for Streets and Highways," and the "Manual of Test Procedures for Materials" in effect on the date of invitation for bids, and the Supplemental Specifications and Recurring Special Provisions indicated on the Check Sheet included herein which apply to and govern the construction of FAP Route 322 (US 51); Section (29Z-2, 30-2)RS-3; Marion County; Contract No. 76B36 and in case of conflict with any part or parts of said Specifications, the said Special Provisions shall take precedence and shall govern.

LOCATION OF PROJECT

US 51 from Calumet Street to Jefferson County Line in Centralia.

DESCRIPTION OF PROJECT

Milling, patching and resurfacing 3.47 miles of US 51.

Items of work include: Hot-Mix Asphalt Surface Removal, Hot-Mix Asphalt Surface Course, Leveling Binder (MM), Pavement Patching, Strip Reflective Crack Control Treatment, Aggregate Shoulders, Curb and Gutter Removal and Replacement, Hot-Mix Asphalt Shoulders, Raised Reflective Pavement Marker Removal and Replacement, Thermoplastic Pavement Marking, Traffic Control and all other necessary and collateral work required to complete the project.

MONTHLY LABOR SUMMARY AND ACTIVITY REPORTING SYSTEM

Effective: 1-1-1995

Revised June 2001

I. Monthly Labor Summary Report, Form SBE 148

The prime contractor and each first and second tier sub-contractor, (hereinafter referred to as "subcontractor") shall submit a certified Monthly Labor Summary Report directly to the District Engineer.

This report is in lieu of submittal of the Monthly Workforce Analysis Report, Form SBE 956.

This report must be received in District Eight no later than the tenth day of the next month.

This Report shall be submitted by the prime contractor and each subcontractor, for each consecutive month, from the start, to the completion of their work on the contract.

The data source for this Report will be a summation of all personnel and hours worked on each subject contract for the month based on weekly payrolls for that month.

The Monthly Labor Summary Report is required to be submitted in one of the following formats:

- a.) For contractors having IDOT contracts valued in the aggregate at \$250,000 or less, the report may be typed or clearly handwritten using Form SBE 148 for submittal to the District Engineer for District Eight.
- b.) For contractors having IDOT contracts valued in the aggregate at more than \$250,000, the report must be submitted in a specific "Fixed Length Comma Delimited ASCII Text File Format". The subject file format is detailed on the next page. Submittal of this file may be by 3.5 inch disk, modem, or by e-mail.

II. Monthly Contract Activity Report, Form SBE 248

The prime contractor and each subcontractor shall submit a monthly report directly to the District Engineer reflecting their contract activity on all Illinois Department of Transportation contracts they have in force in District Eight.

This report shall be submitted for each consecutive month, from the start, to the completion of all contracts in District Eight.

The report must be received in the District Office no later than the tenth day of the next month.

Monthly Labor Summary and Activity Reporting System Codes and Formats

Indicated below for your reference are the Employee Codes and File Formats required for this system.

I.) Monthly Labor Summary Report, Form SBE 148

The following employee codes are to be used to identify each individual on the Summary Report:

- 1. **Gender:** M - Male F - Female
- 2. **Ethnic Group:** 1 - White 2 - Black 3 - Hispanic
4 - American Indian/Alaskan Native 5 - Asian/Pacific Islander
- 3. **Work Classification:** OF - Official SU - Supervisor FO - Foremen
CL - Clerical CA - Carpenter EO - Operator ME - Mechanic
TD - Truck Driver IW - Ironworker PA - Painter OT - Other
EL - Electrician PP - Pipefitter TE - Technical LA - Laborer
CM - Cement Mason
- 4. **Employee Status:** O - Owner Operator J - Journeyman
C - Company A - Apprentice T - Trainee

Specific "Fixed Length Comma Delimited ASCII File Format"

Order	Field Name	Type	Size
1	Contractor Number	A	4
2	Contractor Reference Number	A	6
3	Contract Number	A	5
4	Period (07/28/2000)	D	10
5	SSN (111-11-1111)	A	11
6	Name	A	40
7	Gender	A	1
8	Ethnic Group	A	1
9	Work Classification	A	1
10	Employee Status	A	1
11	Total Hours (000060.00)	N	10

File Name Conventions: (Contractor Number + Report Month/Year).Txt
 i.e. 20001298.Txt

II.) Monthly Contract Activity Report, Form SBE 248

The following activity codes are to be used to identify the contractor's contract status each month on the Monthly Activity Report, Form SBE 248:

- A. Contract Status: 1 - Not Started 2 - Active 3 - No Work
 4 - Suspended 5 - Complete

Failure to comply with this special provision may result in the withholding of payments to the contractor, and/or cancellation, termination, or suspension of the contract in whole or part.

Compliance with this Special Provision shall be considered incidental to the cost of the contract and no additional compensation will be allowed for any costs incurred.

All prime and subcontractors having contracts in the aggregate exceeding \$250,000 must provide a "Fixed Length Comma Delimited ASCII File" for approval prior to the start of construction.

This Special Provision must be included in each subcontract agreement.

The Department of Transportation is requesting disclosure of information necessary to accomplish the statutory purpose as outlined under 23CFR part 230 and 41CFR part 60.4 and the Illinois Human Rights Act. Disclosure of this information is REQUIRED. Failure to comply with this special provision may result in the withholding of payments to the contractor, and/or cancellation, termination, or suspension of the contract in whole or part.

Compliance with this Special Provision shall be considered incidental to the cost of the contract and no additional compensation will be allowed for any costs incurred.

This Special Provision must be included in each subcontract agreement.

HOT-MIX ASPHALT SURFACE REMOVAL W/SKETCH OF ILLINOIS STANDARD W8-I106

Effective: October 1, 1985

Revised: August 10, 2007

This work shall consist of removing bituminous surface to the limits specified on the plans according to Section 440 of the Standard Specifications except as herein modified.

The cuttings from the hot-mix asphalt surface removal shall become the property of the Contractor, unless otherwise noted in the General Notes, and their salvage value shall be reflected in the contract unit price for HOT-MIX ASPHALT SURFACE REMOVAL.

Concrete patches which have to be partially removed will be paid for as HOT-MIX ASPHALT SURFACE REMOVAL.

Manholes and valve vaults which are exposed by the hot-mix asphalt surface removal and transverse cuts at the end of the day which are more than 1/2 inch (12 mm) deep shall be tamped with a bituminous cold mix. The cost of this temporary taper shall be included in HOT-MIX ASPHALT SURFACE REMOVAL.

When the removal width of the machine is less than the width of the lane, the operations shall be planned such that after the hot-mix asphalt surface for a portion of the lane has been removed the remaining portion shall have been removed by the end of the day so that the two passes begin and terminate even with each other.

If the depth of removal is greater than 1/2 inch (12 mm), the removal shall be tapered at the terminating point at the end of each day's operation when the lane is open to traffic.

All materials, equipment, and labor necessary to complete the work and maintenance of the tapers as specified above will be included in the contract unit bid price for HOT-MIX ASPHALT SURFACE REMOVAL.

Where hot-mix asphalt surface removal has been performed and water would be pocketed on the pavement prior to resurfacing, the Contractor shall construct temporary ditches through the shoulder to permit drainage as directed by the Engineer. Where the existing shoulders are hot-mix asphalt, narrow strips of surface removal to permit drainage will be done only on the specific instructions from the Engineer. The Contractor shall repair the shoulder to its original condition after the resurfacing is completed.

After any hot-mix asphalt removal operation has been performed, the Contractor shall erect special "ROUGH GROOVED SURFACE" signs, as shown on the attached sheet, in advance of the construction zone in both directions, if applicable. In addition, these signs shall also be erected along major side streets in advance of the construction zone.

These signs shall remain in place until they are no longer applicable as determined by the Engineer. They shall then be removed by the Contractor and become his property.

The cost of furnishing, erecting, maintaining, and removing these signs will not be paid for separately, but shall be considered in the cost of the HOT-MIX ASPHALT SURFACE REMOVAL.

At the end of each day's work, temporary pavement marking line shall be in place on the planed surface in accordance with Section 703 of the Standard Specifications.

ILLINOIS STANDARD W8-I106



COLOR: LEGEND AND BORDER — BLACK NON-REFLECTORIZED
 BACKGROUND — ORANGE REFLECTORIZED

SIGN SIZE	DIMENSIONS							
	A	B	C	D	E	F	G	H
36X36	36.0	17.2	2.2	24.3	23.5	5.5	10.5	2.5
48X48	48.0	24.1	3.0	34.0	33.0	6.0	13.0	3.5

SIGN SIZE	SERIES			MAR-GIN	BOR-DER	BLANK STD.
	LINES					
	1	2	3			
36X36	5C	5C	5C	0.6	0.8	B4-36D
48X48	7C	7C	7C	0.8	1.2	B4-48D

All dimensions in inches.

TERMINAL SECTION REMOVAL, SINGLE RAIL

This item shall include the removal of the existing terminal sections to be replaced at the locations shown on the plans in general accordance with Section 632 of the Standard Specifications for Road and Bridge Construction, 2007, the plans, and as modified by this Special Provision. The existing terminals shall not be removed until all materials required for installation of the new terminal sections are on site. All labor, equipment, and materials required for this work shall be paid for at the Contract unit price per EACH for TERMINAL SECTION REMOVAL, SINGLE RAIL.

CONCRETE CURB (SPECIAL)

This item shall include saw cutting and removal of the existing curb, power washing the existing PCC slab on which the new curb shall be installed, and installation of the new curb in general accordance with Section 606 of the Standard Specifications for Road and Bridge Construction, 2007, the plans, and as modified by this Special Provision. All labor, equipment, and materials, including rebar, required for this work shall be paid for at the Contract unit price per FOOT for CONCRETE CURB (SPECIAL).

BITUMINOUS CURB REPAIR

This item shall include saw cutting and removal of the damaged portions of the existing curb as directed by the Engineer, preparation of the existing base on which the new curb shall be installed, and installation of the new curb in general accordance with Section 661 of the Standard Specifications for Road and Bridge Construction, 2007, the plans, and as modified by this Special Provision. The curb shall be constructed by hand to match the section and profile of the existing curb. All labor, equipment, and materials required for this work shall be paid for at the Contract unit price per FOOT for BITUMINOUS CURB REPAIR.

MANHOLE FRAMES TO BE ADJUSTED

This item shall include adjustment of existing manholes to match proposed pavement grades as shown on the plans and as directed by the Engineer in general accordance with Section 603 of the Standard Specifications for Road and Bridge Construction, 2007, the plans, and as modified by this Special Provision. All labor, equipment, and materials required for this work shall be paid for at the Contract unit price per EACH for MANHOLE FRAMES TO BE ADJUSTED.

VALVE BOX FRAMES TO BE ADJUSTED

This items shall include adjustment of existing utility valve boxes to match proposed pavement grades as shown on the plans and as directed by the Engineer in general accordance with Section 603 of the Standard Specifications for Road and Bridge Construction, 2007, the plans, and as modified by this Special Provision. All labor, equipment, and materials required for this work shall be paid for at the Contract unit price per EACH for VALVE BOX FRAMES TO BE ADJUSTED.

OFFICE COPY MACHINE

Effective: January 1, 1987

Revised: November 1, 2006

The copier specified in Article 670.02 shall meet the following specifications:

- (1) Edge-to-edge copying.
- (2) Up to 11 in x 17 in (275 mm x 425 mm) size for copy-size capabilities.
- (3) A detachable platen cover in order to copy portions of large-bound documents.
- (4) A cabinet stand for the copier.

TELEPHONE ANSWERING MACHINE

Effective: January 11, 1990

Revised: November 1, 2006

The telephone answering machine specified in Article 670.02 shall meet the following minimum specifications:

- (1) Time/Day Indication - A computerized voice records the date and time that each message is received.
- (2) Beeperless Remote - Any remote touch-tone phone can be used to review all messages by the use of an access code.
- (3) Digital System - Pre-recorded and received messages are managed on separate cassettes.
- (4) Conversation Record - The operator can record any phone call.
- (5) Remote Turn-On - Any remote touch-tone phone can be used to turn on the answering machine by the use of an access code.
- (6) Full Message - The Caller is advised if the memory is insufficient to record the call.
- (7) Battery Back-Up - The settings and messages are protected from power failures.
- (8) Two-Line Capacity - Projects that have a second phone line through the provision of a 670.05 Engineer's Field Laboratory shall provide a single phone answering machine that services both lines.

Prior to the purchase of this item, the Contractor shall submit specifications for the proposed machine to the Engineer for his approval.

TRAFFIC CONTROL PLAN

Effective: July 12, 1993

Revised: May 12, 1997

Traffic control shall be in accordance with the applicable sections of the "Standard Specifications for Road and Bridge Construction", the applicable guidelines contained in the "National Manual on Uniform Traffic Control Devices for Streets and Highways", Illinois Supplement to the National Manual of Uniform Traffic Control Devices, these Special Provisions, and any special details and Highway Standards contained herein and in the plans.

Special attention is called to Articles 107.09 and 107.14 of the "Standard Specifications for Road and Bridge Construction and the following Highway Standards relating to traffic control:

701006	701011	701301	701306	701311	701336
701901	701421	701601	701606	701701	701801

In addition, the following Special Provision(s) will also govern traffic control for this project:

- Construction and Maintenance Sign Supports
- Reflective Sheeting on Channelizing Devices

CONSTRUCTION AND MAINTENANCE SIGN SUPPORTS

Effective: April 21, 1981

Revised: November 1, 2006

This work shall be done according to Section 1106 of the Standard Specifications and Highway Standard 702001 except as herein modified.

All construction signs mounted on permanent support for use in temporary traffic control having an area of 10 square feet (1 square meter) or more shall be mounted on two 4 in x 4 in (100 mm x 100 mm) or two 4 in x 6 in (100 mm x 150 mm) wood posts.

Type A metal post (two for each sign) conforming to Article 1006.29 of the Standard Specifications may be used in lieu of wood posts. Type A metal posts used for these signs may be unfinished.

This work shall not be paid for separately; but shall be considered included in the cost of the traffic control items in this contract.

STATUS OF UTILITIES TO BE ADJUSTED

NAME AND ADDRESS OF UTILITY	TYPE	LOCATION	ESTIMATED DATE RELOCATION COMPLETED
AT&T Illinois 210 N. Locust Street Floor 2 Centralia, IL 62801 Contact: Mr. Art Nall Phone: (618) 533-3411	Communications	No utility adjustment anticipated.	N/A

City of Centralia 222 S. Poplar Street P.O. Box 569 Centralia, IL 62801 Contact: Mr. Bob Lybarger Phone: (618) 533-7642	Water & Sanitary Sewer	No utility adjustment anticipated.	N/A
--	---------------------------	------------------------------------	-----

AmerenIP 1050 West Boulevard P.O. Box 428 Belleville, IL 62222-0428 Contact: Mr. Kelly Bauza Phone: (618) 236-4309	Gas & Electric	No utility adjustment anticipated.	N/A
---	----------------	------------------------------------	-----

McLeod Telecommunications, Inc. 102 E. Shafer Street Forsythe, IL 62535 Contact: Mr. Bob Miles Phone: (217) 876-7194 Ext.: 222	USA Communications	No utility adjustment anticipated.	N/A
--	---------------------------	------------------------------------	-----

Tri-County Electric Cooperative, Inc. 3906 West Broadway P.O. Box 309 Mt. Vernon, IL 62864-0309 Contact: Mr. Lynn A. Hawkins Phone: (618) 244-5151	Electric	No utility adjustment anticipated.	N/A
--	----------	------------------------------------	-----

City of Wamac 361 East 17 th Street Centralia, IL 62801 Contact: Mr. Jackie Mathus, Jr. Phone: (618) 532-1138	Water	No utility adjustment anticipated.	N/A
--	-------	------------------------------------	-----

Frontier Communications Company 117 W. Jefferson Mt. Pulaski, IL 62548 Contact: Mr. Randy Williams Phone: (217) 792-9224	Communications	No utility adjustment anticipated.	N/A
--	----------------	------------------------------------	-----

Charter Communications, Inc. 941 Charter Commons Town & Country, MO 63017 Contact: Mr. Larry A. Saafir Phone: (636) 220-2174	Cable TV	No utility adjustment anticipated.	N/A
--	----------	------------------------------------	-----

Village of Irvington
P.O. Box 515
Irvington, IL 62848
Contact: Mr. Tim Coats
Phone: (618) 249-6237

Water

No utility adjustment anticipated.

N/A

The above represents the best information of the Department and is only included for the convenience of the bidder. The applicable provisions of Section 102 and Articles 105.07 and 107.20 of the Standard Specifications for Road and Bridge Construction shall apply.

If any utility adjustment or removal has not been completed when required by the Contractor's operation, the Contractor should notify the Engineer in writing. A request for an extension of time will be considered to the extent the Contractor's operations were affected.

AUTOMATED FLAGGER ASSISTANCE DEVICES (BDE)

Effective: January 1, 2008

Description. This work shall consist of furnishing and operating automated flagger assistance devices (AFADs) as part of the work zone traffic control and protection for two-lane highways where two-way traffic is maintained over one lane of pavement. Use of these devices shall be at the option of the Contractor.

Equipment. AFADs shall be according to the FHWA memorandum, "MUTCD - Revised Interim Approval for the use of Automated Flagger Assistance Devices in Temporary Traffic Control Zones (IA-4R)", dated January 28, 2005. The devices shall be mounted on a trailer or a moveable cart and shall meet the requirements of NCHRP 350, Category 4.

The AFAD shall be the Stop/Slow type. This device uses remotely controlled "STOP" and "SLOW" signs to alternately control right-of-way.

Signs for the AFAD shall be according to Article 701.03 of the Standard Specifications and the MUTCD. The signs shall be 24 x 24 in. (600 x 600 mm) having an octagon shaped "STOP" sign on one side and a diamond shaped "SLOW" sign on the opposite side. The letters on the signs shall be 8 in. (200 mm) high. If the "STOP" sign has louvers, the full sign face shall be visible at a distance of 50 ft (15 m) and greater.

The signs shall be supplemented with one of the following types of lights.

- (a) Flashing Lights. When flashing lights are used, white or red flashing lights shall be mounted within the "STOP" sign face and white or yellow flashing lights within the "SLOW" sign face.
- (b) Stop and Warning Beacons. When beacons are used, a stop beacon shall be mounted 24 in. (600 mm) or less above the "STOP" sign face and a warning beacon mounted 24 in. (600 mm) or less above, below, or to the side of the "SLOW" sign face. As an option, a Type B warning light may be used in lieu of the warning beacon.

A "WAIT ON STOP" sign shall be placed on the right hand side of the roadway at a point where drivers are expected to stop. The sign shall be 24 x 30 in. (600 x 750 mm) with a black legend and border on a white background. The letters shall be at least 6 in. (150 mm) high.

This device may include a gate arm or mast arm that descends to a horizontal position when the "STOP" sign is displayed and rises to a vertical position when the "SLOW" sign is displayed. When included, the end of the arm shall reach at least to the center of the lane being controlled. The arm shall have alternating red and white retroreflective stripes, on both sides, sloping downward at 45 degrees toward the side on which traffic will pass. The stripes shall be 6 in. (150 mm) in width and at least 2 in. (50 mm) in height.

Flagging Requirements. Flaggers and flagging requirements shall be according to Article 701.13 of the Standard Specifications and the following.

AFADs shall be placed at each end of the traffic control, where a flagger is shown on the plans. The flaggers shall be able to view the face of the AFAD and approaching traffic during operation.

To stop traffic, the "STOP" sign shall be displayed, the corresponding lights/beacon shall flash, and when included, the gate arm shall descend to a horizontal position. To permit traffic to move, the "SLOW" sign shall be displayed, the corresponding lights/beacon shall flash, and when included, the gate arm shall rise to a vertical position.

If used at night, the AFAD location shall be illuminated according to Section 701 of the Standard Specifications.

When not in use, AFADs will be considered nonoperating equipment and shall be stored according to Article 701.11 of the Standard Specifications.

Basis of Payment. This work will not be paid for separately but shall be considered as included in the cost of the various traffic control items included in the contract.

CEMENT (BDE)

Effective: January 1, 2007

Revised: November 1, 2007

Revise Section 1001 of the Standard Specifications to read:

"SECTION 1001. CEMENT

1001.01 Cement Types. Cement shall be according to the following.

- (a) Portland Cement. Acceptance of portland cement shall be according to the current Bureau of Materials and Physical Research's Policy Memorandum, "Portland or Blended Cement Acceptance Procedure for Qualified and Non-Qualified Plants".

Portland cement shall be according to ASTM C 150, and shall meet the standard physical and chemical requirements. Type I or Type II may be used for cast-in-place,

precast, and precast prestressed concrete. Type III may be used according to Article 1020.04, or when approved by the Engineer. All other cements referenced in ASTM C 150 may be used when approved by the Engineer.

The total of all organic processing additions shall be a maximum of 1.0 percent by weight (mass) of the cement and the total of all inorganic processing additions shall be a maximum of 4.0 percent by weight (mass) of the cement. Organic processing additions shall be limited to grinding aids that improve the flowability of cement, reduce pack set, and improve grinding efficiency. Inorganic processing additions shall be limited to granulated blast-furnace slag according to the chemical requirements of AASHTO M 302 and Class C fly ash according to the chemical requirements of AASHTO M 295.

- (b) Portland-Pozzolan Cement. Acceptance of portland-pozzolan cement shall be according to the current Bureau of Materials and Physical Research's Policy Memorandum, "Portland or Blended Cement Acceptance Procedure for Qualified and Non-Qualified Plants".

Portland-pozzolan cement shall be according to ASTM C 595 and shall meet the standard physical and chemical requirements. Type IP or I(PM) may be used for cast-in-place, precast, and precast prestressed concrete, except when Class PP concrete is used. The pozzolan constituent for Type IP shall be a maximum of 21 percent of the weight (mass) of the portland-pozzolan cement. All other cements referenced in ASTM C 595 may be used when approved by the Engineer.

For cast-in-place construction, portland-pozzolan cements shall not be used in concrete mixtures when the air temperature is below 40 °F (4 °C) without permission of the Engineer. If permission is given, the mix design strength requirement may require the Contractor to increase the cement or eliminate the cement factor reduction for a water-reducing or high range water-reducing admixture which is permitted according to Article 1020.05(b).

The total of all organic processing additions shall be a maximum of 1.0 percent by weight (mass) of the cement. Organic processing additions shall be limited to grinding aids as defined in (a) above. Inorganic processing additions shall not be used.

- (c) Portland Blast-Furnace Slag Cement. Acceptance of portland blast-furnace slag cement shall be according to the current Bureau of Materials and Physical Research's Policy Memorandum, "Portland or Blended Cement Acceptance Procedure for Qualified and Non-Qualified Plants".

Portland blast-furnace slag cement shall be according to ASTM C 595 and shall meet the standard physical and chemical requirements. Type I(SM) slag-modified portland cement may be used for cast-in-place, precast, and precast prestressed concrete, except when Class PP concrete is used. All other cements referenced in ASTM C 595 may be used when approved by the Engineer.

For cast-in-place construction, portland blast-furnace slag cements shall not be used in concrete mixtures when the air temperature is below 40 °F (4 °C) without permission of the Engineer. If permission is given, the mix design strength requirement may require the Contractor to increase the cement or eliminate the cement factor reduction for a water-reducing or high range water-reducing admixture which is permitted according to Article 1020.05(b).

The total of all organic processing additions shall be a maximum of 1.0 percent by weight (mass) of the cement. Organic processing additions shall be limited to grinding aids as defined in (a) above. Inorganic processing additions shall not be used.

(d) Rapid Hardening Cement. Rapid hardening cement shall be used according to Article 1020.04 or when approved by the Engineer. The cement shall be on the Department's current "Approved List of Packaged, Dry, Rapid Hardening Cementitious Materials for Concrete Repairs", and shall be according to the following.

(1) The cement shall have a maximum final set of 25 minutes, according to Illinois Modified ASTM C 191.

(2) The cement shall have a minimum compressive strength of 2000 psi (13,800 kPa) at 3.0 hours, and 4000 psi (27,600 kPa) at 24.0 hours, according to Illinois Modified ASTM C 109.

(3) The cement shall have a maximum drying shrinkage of 0.050 percent at seven days, according to Illinois Modified ASTM C 596.

(4) The cement shall have a maximum expansion of 0.020 percent at 14 days, according to Illinois Modified ASTM C 1038.

(5) The cement shall have a minimum 80 percent relative dynamic modulus of elasticity; and shall not have a weight (mass) gain in excess of 0.15 percent or a weight (mass) loss in excess of 1.0 percent, after 100 cycles, according to Illinois Modified AASHTO T 161, Procedure B. At 100 cycles, the specimens are measured and weighed at 73 °F (23 °C).

(e) Calcium Aluminate Cement. Calcium aluminate cement shall be used when specified by the Engineer. The cement shall meet the standard physical requirements for Type I cement according to ASTM C 150, except the time of setting shall not apply. The chemical requirements shall be determined according to ASTM C 114 and shall be as follows: minimum 38 percent aluminum oxide (Al_2O_3), maximum 42 percent calcium oxide (CaO), maximum 1 percent magnesium oxide (MgO), maximum 0.4 percent sulfur trioxide (SO_3), maximum 1 percent loss on ignition, and maximum 3.5 percent insoluble residue.

1001.02 Uniformity of Color. Cement contained in single loads or in shipments of several loads to the same project shall not have visible differences in color.

1001.03 Mixing Brands and Types. Different brands or different types of cement from the same manufacturing plant, or the same brand or type from different plants shall not be mixed or used alternately in the same item of construction unless approved by the Engineer.

1001.04 Storage. Cement shall be stored and protected against damage, such as dampness which may cause partial set or hardened lumps. Different brands or different types of cement from the same manufacturing plant, or the same brand or type from different plants shall be kept separate.”

WORKING DAYS (BDE)

Effective: January 1, 2002

The Contractor shall complete the work within 75 working days.

DISADVANTAGED BUSINESS ENTERPRISE PARTICIPATION (BDE)

Effective: September 1, 2000

Revised: January 1, 2007

FEDERAL OBLIGATION. The Department of Transportation, as a recipient of federal financial assistance, is required to take all necessary and reasonable steps to ensure nondiscrimination in the award and administration of contracts. Consequently, the federal regulatory provisions of 49 CFR part 26 apply to this contract concerning the utilization of disadvantaged business enterprises. For the purposes of this Special Provision, a disadvantaged business enterprise (DBE) means a business certified by the Department in accordance with the requirements of 49 CFR part 26 and listed in the DBE Directory or most recent addendum.

STATE OBLIGATION. This Special Provision will also be used by the Department to satisfy the requirements of the Business Enterprise for Minorities, Females, and Persons with Disabilities Act, 30 ILCS 575. When this Special Provision is used to satisfy state law requirements on 100 percent state-funded contracts, the federal government has no involvement in such contracts (not a federal-aid contract) and no responsibility to oversee the implementation of this Special Provision by the Department on those contracts. DBE participation on 100 percent state-funded contracts will not be credited toward fulfilling the Department's annual overall DBE goal required by the US Department of Transportation to comply with the federal DBE program requirements.

CONTRACTOR ASSURANCE. The Contractor makes the following assurance and agrees to include the assurance in each subcontract that the Contractor signs with a subcontractor:

The Contractor, subrecipient, or subcontractor shall not discriminate on the basis of race, color, national origin, or sex in the performance of this contract. The Contractor shall carry out applicable requirements of 49 CFR part 26 in the award and administration of contracts funded in whole or in part with federal or state funds. Failure by the Contractor to carry out these requirements is a material breach of this contract, which may result in the termination of this contract or such other remedy as the recipient deems appropriate.

OVERALL GOAL SET FOR THE DEPARTMENT. As a requirement of compliance with 49 CFR part 26, the Department has set an overall goal for DBE participation in its federally assisted contracts. That goal applies to all federal-aid funds the Department will expend in its federally assisted contracts for the subject reporting fiscal year. The Department is required to make a good faith effort to achieve the overall goal. The dollar amount paid to all approved DBE firms performing work called for in this contract is eligible to be credited toward fulfillment of the Department's overall goal.

CONTRACT GOAL TO BE ACHIEVED BY THE CONTRACTOR. This contract includes a specific DBE utilization goal established by the Department. The goal has been included because the Department has determined that the work of this contract has subcontracting opportunities that may be suitable for performance by DBE companies. This determination is based on an assessment of the type of work, the location of the work, and the availability of DBE companies to do a part of the work. The assessment indicates that, in the absence of unlawful discrimination, and in an arena of fair and open competition, DBE companies can be expected to perform 5.0% of the work. This percentage is set as the DBE participation goal for this contract. Consequently, in addition to the other award criteria established for this contract, the Department will award this contract to a bidder who makes a good faith effort to meet this goal of DBE participation in the performance of the work. A bidder makes a good faith effort for award consideration if either of the following is done in accordance with the procedures set forth in this Special Provision:

- (a) The bidder documents that firmly committed DBE participation has been obtained to meet the goal; or
- (b) The bidder documents that a good faith effort has been made to meet the goal, even though the effort did not succeed in obtaining enough DBE participation to meet the goal.

DBE LOCATOR REFERENCES. Bidders may consult the DBE Directory as a reference source for DBE companies certified by the Department. In addition, the Department maintains a letting and item specific DBE locator information system whereby DBE companies can register their interest in providing quotes on particular bid items advertised for letting. Information concerning DBE companies willing to quote work for particular contracts may be obtained by contacting the Department's Bureau of Small Business Enterprises at telephone number (217)785-4611, or by visiting the Department's web site at www.dot.il.gov.

BIDDING PROCEDURES. Compliance with the bidding procedures of this Special Provision is required prior to the award of the contract and the failure of the as-read low bidder to comply will render the bid not responsive.

- (a) In order to assure the timely award of the contract, the as-read low bidder shall submit a Disadvantaged Business Utilization Plan on Department form SBE 2026 within seven working days after the date of letting. To meet the seven day requirement, the bidder may send the Plan by certified mail or delivery service within the seven working day period. If a question arises concerning the mailing date of a Plan, the mailing date will be established by the U.S. Postal Service postmark on the original certified mail receipt

from the U.S. Postal Service or the receipt issued by a delivery service. It is the responsibility of the bidder to ensure that the postmark or receipt date is affixed within the seven working days if the bidder intends to rely upon mailing or delivery to satisfy the submission day requirement. The Plan is to be submitted to the Department of Transportation, Bureau of Small Business Enterprises, Contract Compliance Section, 2300 South Dirksen Parkway, Room 319, Springfield, Illinois 62764 (Telefax: (217)785-1524). It is the responsibility of the bidder to obtain confirmation of telefax delivery. The Department will not accept a Utilization Plan if it does not meet the seven day submittal requirement and the bid will be declared not responsive. In the event the bid is declared not responsive due to a failure to submit a Plan or failure to comply with the bidding procedures set forth herein, the Department may elect to cause the forfeiture of the penal sum of the bidder's proposal guaranty, and may deny authorization to bid the project if re-advertised for bids. The Department reserves the right to invite any other bidder to submit a Utilization Plan at any time for award consideration or to extend the time for award.

- (b) The Utilization Plan shall indicate that the bidder either has obtained sufficient DBE participation commitments to meet the contract goal or has not obtained enough DBE participation commitments in spite of a good faith effort to meet the goal. The Utilization Plan shall further provide the name, telephone number, and telefax number of a responsible official of the bidder designated for purposes of notification of plan approval or disapproval under the procedures of this Special Provision.
- (c) The Utilization Plan shall include a DBE Participation Commitment Statement, Department form SBE 2025, for each DBE proposed for the performance of work to achieve the contract goal. The signatures on these forms must be original signatures. All elements of information indicated on the said form shall be provided, including but not limited to the following:
 - (1) The name and address of each DBE to be used;
 - (2) A description, including pay item numbers, of the commercially useful work to be done by each DBE;
 - (3) The price to be paid to each DBE for the identified work specifically stating the quantity, unit price, and total subcontract price for the work to be completed by the DBE. If partial pay items are to be performed by the DBE, indicate the portion of each item, a unit price where appropriate and the subcontract price amount;
 - (4) A commitment statement signed by the bidder and each DBE evidencing availability and intent to perform commercially useful work on the project; and
 - (5) If the bidder is a joint venture comprised of DBE firms and non-DBE firms, the plan must also include a clear identification of the portion of the work to be performed by the DBE partner(s).

- (d) The contract will not be awarded until the Utilization Plan submitted by the bidder is approved. The Utilization Plan will be approved by the Department if the Plan commits sufficient commercially useful DBE work performance to meet the contract goal. The Utilization Plan will not be approved by the Department if the Plan does not commit sufficient DBE performance to meet the contract goal unless the bidder documents that it made a good faith effort to meet the goal. The good faith procedures of Section VIII of this special provision apply. If the Utilization Plan is not approved because it is deficient in a technical matter, unless waived by the Department, the bidder will be notified and will be allowed no less than a five working day period in order to cure the deficiency.

CALCULATING DBE PARTICIPATION. The Utilization Plan values represent work anticipated to be performed and paid for upon satisfactory completion. The Department is only able to count toward the achievement of the overall goal and the contract goal the value of payments made for the work actually performed by DBE companies. In addition, a DBE must perform a commercially useful function on the contract to be counted. A commercially useful function is generally performed when the DBE is responsible for the work and is carrying out its responsibilities by actually performing, managing, and supervising the work involved. The Department and Contractor are governed by the provisions of 49 CFR part 26.55(c) on questions of commercially useful functions as it affects the work. Specific counting guidelines are provided in 49 CFR part 26.55, the provisions of which govern over the summary contained herein.

- (a) DBE as the Contractor: 100 percent goal credit for that portion of the work performed by the DBE's own forces, including the cost of materials and supplies. Work that a DBE subcontracts to a non-DBE firm does not count toward the DBE goals.
- (b) DBE as a joint venture Contractor: 100 percent goal credit for that portion of the total dollar value of the contract equal to the distinct, clearly defined portion of the work performed by the DBE's own forces.
- (c) DBE as a subcontractor: 100 percent goal credit for the work of the subcontract performed by the DBE's own forces, including the cost of materials and supplies, excluding the purchase of materials and supplies or the lease of equipment by the DBE subcontractor from the prime Contractor or its affiliates. Work that a DBE subcontractor in turn subcontracts to a non-DBE firm does not count toward the DBE goal.
- (d) DBE as a trucker: 100 percent goal credit for trucking participation provided the DBE is responsible for the management and supervision of the entire trucking operation for which it is responsible. At least one truck owned, operated, licensed, and insured by the DBE must be used on the contract. Credit will be given for the full value of all such DBE trucks operated using DBE employed drivers. Goal credit will be limited to the value of the reasonable fee or commission received by the DBE if trucks are leased from a non-DBE company.
- (e) DBE as a material supplier:
- (1) 60 percent goal credit for the cost of the materials or supplies purchased from a DBE regular dealer.

- (2) 100 percent goal credit for the cost of materials or supplies obtained from a DBE manufacturer.
- (3) 100 percent credit for the value of reasonable fees and commissions for the procurement of materials and supplies if not a regular dealer or manufacturer.

GOOD FAITH EFFORT PROCEDURES. If the bidder cannot obtain sufficient DBE commitments to meet the contract goal, the bidder must document in the Utilization Plan the good faith efforts made in the attempt to meet the goal. This means that the bidder must show that all necessary and reasonable steps were taken to achieve the contract goal. Necessary and reasonable steps are those which could reasonably be expected to obtain sufficient DBE participation. The Department will consider the quality, quantity, and intensity of the kinds of efforts that the bidder has made. Mere *pro forma* efforts are not good faith efforts; rather, the bidder is expected to have taken those efforts that would be reasonably expected of a bidder actively and aggressively trying to obtain DBE participation sufficient to meet the contract goal.

- (a) The following is a list of types of action that the Department will consider as part of the evaluation of the bidder's good faith efforts to obtain participation. These listed factors are not intended to be a mandatory checklist and are not intended to be exhaustive. Other factors or efforts brought to the attention of the Department may be relevant in appropriate cases, and will be considered by the Department.
 - (1) Soliciting through all reasonable and available means (e.g. attendance at pre-bid meetings, advertising and/or written notices) the interest of all certified DBE companies that have the capability to perform the work of the contract. The bidder must solicit this interest within sufficient time to allow the DBE companies to respond to the solicitation. The bidder must determine with certainty if the DBE companies are interested by taking appropriate steps to follow up initial solicitations.
 - (2) Selecting portions of the work to be performed by DBE companies in order to increase the likelihood that the DBE goals will be achieved. This includes, where appropriate, breaking out contract work items into economically feasible units to facilitate DBE participation, even when the prime Contractor might otherwise prefer to perform these work items with its own forces.
 - (3) Providing interested DBE companies with adequate information about the plans, specifications, and requirements of the contract in a timely manner to assist them in responding to a solicitation.
 - (4) a. Negotiating in good faith with interested DBE companies. It is the bidder's responsibility to make a portion of the work available to DBE subcontractors and suppliers and to select those portions of the work or material needs consistent with the available DBE subcontractors and suppliers, so as to facilitate DBE participation. Evidence of such negotiation includes the names, addresses, and telephone numbers of DBE companies that were considered; a description of the information provided regarding the plans and specifications for the work selected for subcontracting; and evidence as to why additional agreements could not be reached for DBE companies to perform the work.

- b. A bidder using good business judgment would consider a number of factors in negotiating with subcontractors, including DBE subcontractors, and would take a firm's price and capabilities as well as contract goals into consideration. However, the fact that there may be some additional costs involved in finding and using DBE companies is not in itself sufficient reason for a bidder's failure to meet the contract DBE goal, as long as such costs are reasonable. Also, the ability or desire of a bidder to perform the work of a contract with its own organization does not relieve the bidder of the responsibility to make good faith efforts. Bidders are not, however, required to accept higher quotes from DBE companies if the price difference is excessive or unreasonable.
- (5) Not rejecting DBE companies as being unqualified without sound reasons based on a thorough investigation of their capabilities. The bidder's standing within its industry, membership in specific groups, organizations, or associations and political or social affiliations (for example union vs. non-union employee status) are not legitimate causes for the rejection or non-solicitation of bids in the bidder's efforts to meet the project goal.
- (6) Making efforts to assist interested DBE companies in obtaining bonding, lines of credit, or insurance as required by the recipient or Contractor.
- (7) Making efforts to assist interested DBE companies in obtaining necessary equipment, supplies, materials, or related assistance or services.
- (8) Effectively using the services of available minority/women community organizations; minority/women contractors' groups; local, state, and federal minority/women business assistance offices; and other organizations as allowed on a case-by-case basis to provide assistance in the recruitment and placement of DBE companies.
- (b) If the Department determines that the bidder has made a good faith effort to secure the work commitment of DBE companies to meet the contract goal, the Department will award the contract provided that it is otherwise eligible for award. If the Department determines that a good faith effort has not been made, the Department will notify the bidder of that preliminary determination by contacting the responsible company official designated in the Utilization Plan. The preliminary determination shall include a statement of reasons why good faith efforts have not been found, and may include additional good faith efforts that the bidder could take. The notification will designate a five working day period during which the bidder shall take additional efforts. The bidder is not limited by a statement of additional efforts, but may take other action beyond any stated additional efforts in order to obtain additional DBE commitments. The bidder shall submit an amended Utilization Plan if additional DBE commitments to meet the contract goal are secured. If additional DBE commitments sufficient to meet the contract goal are not secured, the bidder shall report the final good faith efforts made in the time allotted. All additional efforts taken by the bidder will be considered as part of the bidder's good faith efforts. If the bidder is not able to meet the goal after taking additional efforts, the Department will make a pre-final determination of the good faith efforts of the bidder and will notify the designated responsible company official of the reasons for an adverse determination.

- (c) The bidder may request administrative reconsideration of a pre-final determination adverse to the bidder within the five working days after the notification date of the determination by delivering the request to the Department of Transportation, Bureau of Small Business Enterprises, Contract Compliance Section, 2300 South Dirksen Parkway, Room 319, Springfield, Illinois 62764 (Telefax: (217)785-1524). Deposit of the request in the United States mail on or before the fifth business day shall not be deemed delivery. The pre-final determination shall become final if a request is not made and delivered. A request may provide additional written documentation and/or argument concerning the issue of whether an adequate good faith effort was made to meet the contract goal. In addition, the request shall be considered a consent by the bidder to extend the time for award. The request will be forwarded to the Department's Reconsideration Officer. The Reconsideration Officer will extend an opportunity to the bidder to meet in person in order to consider all issues of whether the bidder made a good faith effort to meet the goal. After the review by the Reconsideration Officer, the bidder will be sent a written decision within ten working days after receipt of the request for reconsideration, explaining the basis for finding that the bidder did or did not meet the goal or make adequate good faith efforts to do so. A final decision by the Reconsideration Officer that a good faith effort was made shall approve the Utilization Plan submitted by the bidder and shall clear the contract for award. A final decision that a good faith effort was not made shall render the bid not responsive.

CONTRACT COMPLIANCE. Compliance with this Special Provision is an essential part of the contract. The Department is prohibited by federal regulations from crediting the participation of a DBE included in the Utilization Plan toward either the contract goal or the Department's overall goal until the amount to be applied toward the goals has been paid to the DBE. The following administrative procedures and remedies govern the compliance by the Contractor with the contractual obligations established by the Utilization Plan. After approval of the Plan and award of the contract, the Utilization Plan and individual DBE Participation Statements become part of the contract. If the Contractor did not succeed in obtaining enough DBE participation to achieve the advertised contract goal, and the Utilization Plan was approved and contract awarded based upon a determination of good faith, the total dollar value of DBE work calculated in the approved Utilization Plan as a percentage of the awarded contract value shall become the amended contract goal.

- (a) No amendment to the Utilization Plan may be made without prior written approval from the Department's Bureau of Small Business Enterprises. All requests for amendment to the Utilization Plan shall be submitted to the Department of Transportation, Bureau of Small Business Enterprises, Contract Compliance Section, 2300 South Dirksen Parkway, Room 319, Springfield, Illinois 62764. Telephone number (217) 785-4611. Telefax number (217) 785-1524.
- (b) All work indicated for performance by an approved DBE shall be performed, managed, and supervised by the DBE executing the Participation Statement. The Contractor shall not terminate for convenience a DBE listed in the Utilization Plan and then perform the work of the terminated DBE with its own forces, those of an affiliate or those of another subcontractor, whether DBE or not, without first obtaining the written consent of the Bureau of Small Business Enterprises to amend the Utilization Plan. If a DBE listed in the Utilization Plan is terminated for reasons other than convenience, or fails to complete

its work on the contract for any reason, the Contractor shall make good faith efforts to find another DBE to substitute for the terminated DBE. The good faith efforts shall be directed at finding another DBE to perform at least the same amount of work under the contract as the DBE that was terminated, but only to the extent needed to meet the contract goal or the amended contract goal. The Contractor shall notify the Bureau of Small Business Enterprises of any termination for reasons other than convenience, and shall obtain approval for inclusion of the substitute DBE in the Utilization Plan. If good faith efforts following a termination of a DBE for cause are not successful, the Contractor shall contact the Bureau and provide a full accounting of the efforts undertaken to obtain substitute DBE participation. The Bureau will evaluate the good faith efforts in light of all circumstances surrounding the performance status of the contract, and determine whether the contract goal should be amended.

- (c) The Contractor shall maintain a record of payments for work performed to the DBE participants. The records shall be made available to the Department for inspection upon request. After the performance of the final item of work or delivery of material by a DBE and final payment therefor to the DBE by the Contractor, but not later than thirty calendar days after payment has been made by the Department to the Contractor for such work or material, the Contractor shall submit a DBE Payment Report on Department form SBE 2115 to the Regional Engineer. If full and final payment has not been made to the DBE, the Report shall indicate whether a disagreement as to the payment required exists between the Contractor and the DBE or if the Contractor believes that the work has not been satisfactorily completed. If the Contractor does not have the full amount of work indicated in the Utilization Plan performed by the DBE companies indicated in the Plan, the Department will deduct from contract payments to the Contractor the amount of the goal not achieved as liquidated and ascertained damages.
- (d) The Department reserves the right to withhold payment to the Contractor to enforce the provisions of this Special Provision. Final payment shall not be made on the contract until such time as the Contractor submits sufficient documentation demonstrating achievement of the goal in accordance with this Special Provision or after liquidated damages have been determined and collected.
- (e) Notwithstanding any other provision of the contract, including but not limited to Article 109.09 of the Standard Specifications, the Contractor may request administrative reconsideration of a decision to deduct the amount of the goal not achieved as liquidated damages. A request to reconsider shall be delivered to the Contract Compliance Section and shall be handled and considered in the same manner as set forth in paragraph (c) of "Good Faith Effort Procedures" of this Special Provision, except a final decision that a good faith effort was not made during contract performance to achieve the goal agreed to in the Utilization Plan shall be the final administrative decision of the Department.

EQUIPMENT RENTAL RATES (BDE)

Effective: August 2, 2007

Revised: January 2, 2008

Replace the second and third paragraphs of Article 105.07(b)(4)a. of the Standard Specifications with the following:

“Equipment idled which cannot be used on other work, and which is authorized to standby on the project site by the Engineer, will be paid for according to Article 109.04(b)(4).”

Replace Article 109.04(b)(4) of the Standard Specifications with the following:

“(4) Equipment. Equipment used for extra work shall be authorized by the Engineer. The equipment shall be specifically described, be of suitable size and capacity for the work to be performed, and be in good operating condition. For such equipment, the Contractor will be paid as follows.

- a. Contractor Owned Equipment. Contractor owned equipment will be paid for by the hour using the applicable FHWA hourly rate from the “Equipment Watch Rental Rate Blue Book” (Blue Book) in effect when the force account work begins. The FHWA hourly rate is calculated as follows.

$$\text{FHWA hourly rate} = (\text{monthly rate}/176) \times (\text{model year adj.}) \times (\text{Illinois adj.}) + \text{EOC}$$

Where: EOC = Estimated Operating Costs per hour (from the Blue Book)

The time allowed will be the actual time the equipment is operating on the extra work. For the time required to move the equipment to and from the site of the extra work and any authorized idle (standby) time, payment will be made at the following hourly rate: $0.5 \times (\text{FHWA hourly rate} - \text{EOC})$.

All time allowed shall fall within the working hours authorized for the extra work.

The rates above include the cost of fuel, oil, lubrication, supplies, small tools, necessary attachments, repairs, overhaul and maintenance of any kind, depreciation, storage, overhead, profits, insurance, and all incidentals. The rates do not include labor.

The Contractor shall submit to the Engineer sufficient information for each piece of equipment and its attachments to enable the Engineer to determine the proper equipment category. If a rate is not established in the Blue Book for a particular piece of equipment, the Engineer will establish a rate for that piece of equipment that is consistent with its cost and use in the industry.

- b. Rented Equipment. Whenever it is necessary for the Contractor to rent equipment to perform extra work, the rental and transportation costs of the equipment plus five percent for overhead will be paid. In no case shall the rental rates exceed those of established distributors or equipment rental agencies.

All prices shall be agreed to in writing before the equipment is used.”

HOT-MIX ASPHALT - FIELD VOIDS IN THE MINERAL AGGREGATE (BDE)

Effective: April 1, 2007

Revised: April 1, 2008

Add the following to the table in Article 1030.05(d)(2)a. of the Standard Specifications:

"Parameter	Frequency of Tests	Frequency of Tests	Test Method See Manual of Test Procedures for Materials
	High ESAL Mixture Low ESAL Mixture	All Other Mixtures	
VMA Note 5.	Day's production ≥ 1200 tons: 1 per half day of production	N/A	Illinois-Modified AASHTO R 35
	Day's production < 1200 tons: 1 per half day of production for first 2 days and 1 per day thereafter (first sample of the day)		

Note 5. The G_{sb} used in the voids in the mineral aggregate (VMA) calculation shall be the same average G_{sb} value listed in the mix design.”

Add the following to the Control Limits table in Article 1030.05(d)(4) of the Standard Specifications:

"CONTROL LIMITS			
Parameter	High ESAL Low ESAL	High ESAL Low ESAL	All Other
	Individual Test	Moving Avg. of 4	Individual Test
VMA	-0.7 % ^{2/}	-0.5 % ^{2/}	N/A

2/ Allowable limit below minimum design VMA requirement”

Add the following to the table in Article 1030.05(d)(5) of the Standard Specifications:

"CONTROL CHART REQUIREMENTS	High ESAL Low ESAL	All Other
	VMA”	

Revise the heading of Article 1030.05(d)(6)a.1. of the Standard Specifications to read:

“1. Voids, VMA, and Asphalt Binder Content.”

Revise the first sentence of the first paragraph of Article 1030.05(d)(6)a.1.(a.) of the Standard Specifications to read:

“If the retest for voids, VMA, or asphalt binder content exceeds control limits, HMA production shall cease and immediate corrective action shall be instituted by the Contractor.”

Revise the table in Article 1030.05(e) of the Standard Specifications to read:

“Test Parameter	Acceptable Limits of Precision
% Passing: ^{1/}	
1/2 in. (12.5 mm)	5.0 %
No. 4 (4.75 mm)	5.0 %
No. 8 (2.36 mm)	3.0 %
No. 30 (600 μm)	2.0 %
Total Dust Content No. 200 (75 μm) ^{1/}	2.2 %
Asphalt Binder Content	0.3 %
Maximum Specific Gravity of Mixture	0.026
Bulk Specific Gravity	0.030
VMA	1.4 %
Density (% Compaction)	1.0 % (Correlated)

1/ Based on washed ignition.”

HOT-MIX ASPHALT – PLANT TEST FREQUENCY (BDE)

Effective: April 1, 2008

Revise the table in Article 1030.05(d)(2)a. of the Standard Specifications to read:

"Parameter	Frequency of Tests	Frequency of Tests	Test Method
	High ESAL Mixture Low ESAL Mixture	All Other Mixtures	See Manual of Test Procedures for Materials
Aggregate Gradation Hot bins for batch and continuous plants. Individual cold-feed or combined belt-feed for drier drum plants. % passing sieves: 1/2 in. (12.5 mm), No. 4 (4.75 mm), No. 8 (2.36 mm), No. 30 (600 μm) No. 200 (75 μm) Note 1.	1 dry gradation per day of production (either morning or afternoon sample). and 1 washed ignition oven test on the mix per day of production (conduct in the afternoon if dry gradation is conducted in the morning or vice versa). Note 3. Note 4.	1 gradation per day of production. The first day of production shall be a washed ignition oven test on the mix. Thereafter, the testing shall alternate between dry gradation and washed ignition oven test on the mix. Note 4.	Illinois Procedure
Asphalt Binder Content by Ignition Oven Note 2.	1 per half day of production	1 per day	Illinois-Modified AASHTO T 308
Air Voids Bulk Specific Gravity of Gyratory Sample	Day's production ≥ 1200 tons: 1 per half day of production Day's production < 1200 tons: 1 per half day of production for first 2 days and 1 per day thereafter (first sample of the day)	1 per day	Illinois-Modified AASHTO T 312
Maximum Specific Gravity of Mixture	Day's production ≥ 1200 tons: 1 per half day of production Day's production < 1200 tons: 1 per half day of production for first 2 days and 1 per day thereafter (first sample of the day)	1 per day	Illinois-Modified AASHTO T 209"

HOT-MIX ASPHALT – TRANSPORTATION (BDE)

Effective: April 1, 2008

Revise Article 1030.08 of the Standard Specifications to read:

“1030.08 Transportation. Vehicles used in transporting HMA shall have clean and tight beds. The beds shall be sprayed with asphalt release agents from the Department’s approved list. In lieu of a release agent, the Contractor may use a light spray of water with a light scatter of manufactured sand (FA 20 or FA 21) evenly distributed over the bed of the vehicle. After spraying, the bed of the vehicle shall be in a completely raised position and it shall remain in this position until all excess asphalt release agent or water has been drained.

When the air temperature is below 60 °F (15 °C), the bed, including the end, endgate, sides and bottom shall be insulated with fiberboard, plywood or other approved insulating material and shall have a thickness of not less than 3/4 in (20 mm). When the insulation is placed inside the bed, the insulation shall be covered with sheet steel approved by the Engineer. Each vehicle shall be equipped with a cover of canvas or other suitable material meeting the approval of the Engineer which shall be used if any one of the following conditions is present.

- (a) Ambient air temperature is below 60 °F (15 °C).
- (b) The weather is inclement.
- (c) The temperature of the HMA immediately behind the paver screed is below 250 °F (120 °C).

The cover shall extend down over the sides and ends of the bed for a distance of approximately 12 in. (300 mm) and shall be fastened securely. The covering shall be rolled back before the load is dumped into the finishing machine.”

PAYMENTS TO SUBCONTRACTORS (BDE)

Effective: June 1, 2000

Revised: January 1, 2006

Federal regulations found at 49 CFR §26.29 mandate the Department to establish a contract clause to require Contractors to pay subcontractors for satisfactory performance of their subcontracts and to set the time for such payments.

State law also addresses the timing of payments to be made to subcontractors and material suppliers. Section 7 of the Prompt Payment Act, 30 ILCS 540/7, requires that when a Contractor receives any payment from the Department, the Contractor shall make corresponding, proportional payments to each subcontractor and material supplier performing work or supplying material within 15 calendar days after receipt of the Department payment. Section 7 of the Act further provides that interest in the amount of two percent per month, in addition to the payment due, shall be paid to any subcontractor or material supplier by the Contractor if the payment required by the Act is withheld or delayed without reasonable cause. The Act also provides that the time for payment required and the calculation of any interest due applies to transactions between subcontractors and lower-tier subcontractors and material suppliers throughout the contracting chain.

This Special Provision establishes the required federal contract clause, and adopts the 15 calendar day requirement of the State Prompt Payment Act for purposes of compliance with the federal regulation regarding payments to subcontractors. This contract is subject to the following payment obligations.

When progress payments are made to the Contractor according to Article 109.07 of the Standard Specifications, the Contractor shall make a corresponding payment to each subcontractor and material supplier in proportion to the work satisfactorily completed by each subcontractor and for the material supplied to perform any work of the contract. The proportionate amount of partial payment due to each subcontractor and material supplier throughout the contracting chain shall be determined by the quantities measured or otherwise determined as eligible for payment by the Department and included in the progress payment to the Contractor. Subcontractors and material suppliers shall be paid by the Contractor within 15 calendar days after the receipt of payment from the Department. The Contractor shall not hold retainage from the subcontractors. These obligations shall also apply to any payments made by subcontractors and material suppliers to their subcontractors and material suppliers; and to all payments made to lower tier subcontractors and material suppliers throughout the contracting chain. Any payment or portion of a payment subject to this provision may only be withheld from the subcontractor or material supplier to whom it is due for reasonable cause.

This Special Provision does not create any rights in favor of any subcontractor or material supplier against the State or authorize any cause of action against the State on account of any payment, nonpayment, delayed payment, or interest claimed by application of the State Prompt Payment Act. The Department will not approve any delay or postponement of the 15 day requirement except for reasonable cause shown after notice and hearing pursuant to Section 7(b) of the State Prompt Payment Act. State law creates other and additional remedies available to any subcontractor or material supplier, regardless of tier, who has not been paid for work properly performed or material furnished. These remedies are a lien against public funds set forth in Section 23(c) of the Mechanics Lien Act, 770 ILCS 60/23(c), and a recovery on the Contractor's payment bond according to the Public Construction Bond Act, 30 ILCS 550.

PLASTIC BLOCKOUTS FOR GUARDRAIL (BDE)

Effective: November 1, 2004

Revised: January 1, 2007

Add the following to Article 630.02 of the Standard Specifications:

“(g) Plastic Blockouts (Note 1.)

Note 1. Plastic blockouts may be used in lieu of wood blockouts for steel plate beam guardrail. The plastic blockouts shall be the minimum dimensions shown on the plans and shall be on the Department's approved list.”

RAILROAD PROTECTIVE LIABILITY INSURANCE (5 AND 10) (BDE)

Effective: January 1, 2006

Description. Railroad Protective Liability and Property Damage Liability Insurance shall be carried according to Article 107.11 of the Standard Specifications, except the limits shall be a minimum of \$5,000,000 combined single limit per occurrence for bodily injury liability and property damage liability with an aggregate limit of \$10,000,000 over the life of the policy. A separate policy is required for each railroad unless otherwise noted.

NAMED INSURED & ADDRESS	NUMBER & SPEED OF PASSENGER TRAINS	NUMBER & SPEED OF FREIGHT TRAINS
Norfolk Southern Railway 1200 Peachtree St. Atlanta, GA 30309	None	16 trains per day @ 20 mph
DOT/AAR No.: (Southbound) 724801U (Northbound) 724800M RR Division: Illinois	RR Mile Post: 66.3	RR Sub-Division: St. Louis / Louisville
For Freight/Passenger Information Contact: Mike Craddock, Road Foreman Phone: (618) 322-5883		
For Insurance Information Contact: Mike Craddock, Road Foremen Phone: (618) 322-5886		

Approval of Insurance. The original and one certified copy of each required policy shall be submitted to the following address for approval:

Illinois Department of Transportation
 Bureau of Design and Environment
 2300 South Dirksen Parkway, Room 326
 Springfield, Illinois 62764

The Contractor will be advised when the Department has received approval of the insurance from the railroad(s). Before any work begins on railroad right-of-way, the Contractor shall submit to the Engineer evidence that the required insurance has been approved by the railroad(s). The Contractor shall also provide the Engineer with the expiration date of each required policy.

Basis of Payment. Providing Railroad Protective Liability and Property Damage Liability Insurance will be paid for at the contract unit price per Lump Sum for RAILROAD PROTECTIVE LIABILITY INSURANCE.

RECLAIMED ASPHALT PAVEMENT (RAP) (BDE)

Effective: January 1, 2007

Revised: August 1, 2007

In Article 1030.02(g), delete the last sentence of the first paragraph in (Note 2).

Revise Section 1031 of the Standard Specifications to read:

“SECTION 1031. RECLAIMED ASPHALT PAVEMENT

1031.01 Description. Reclaimed asphalt pavement (RAP) is reclaimed asphalt pavement resulting from cold milling or crushing of an existing dense graded hot-mix asphalt (HMA) pavement. The Contractor shall supply written documentation that the RAP originated from routes or airfields under federal, state, or local agency jurisdiction.

1031.02 Stockpiles. The Contractor shall construct individual, sealed RAP stockpiles meeting one of the following definitions. No additional RAP shall be added to the pile after the pile has been sealed. Stockpiles shall be sufficiently separated to prevent intermingling at the base. Stockpiles shall be identified by signs indicating the type as listed below (i.e. “Homogeneous Surface”).

Prior to milling, the Contractor shall request the District to provide verification of the quality of the RAP to clarify appropriate stockpile.

- (a) Homogeneous. Homogeneous RAP stockpiles shall consist of RAP from Class I, Superpave (High ESAL), HMA (High ESAL), or equivalent mixtures and represent:
1) the same aggregate quality, but shall be at least C quality; 2) the same type of crushed aggregate (either crushed natural aggregate, ACBF slag, or steel slag); 3) similar gradation; and 4) similar asphalt binder content. If approved by the Engineer, combined single pass surface/binder millings may be considered “homogenous” with a quality rating dictated by the lowest coarse aggregate quality present in the mixture.
- (b) Conglomerate 5/8. Conglomerate 5/8 RAP stockpiles shall consist of RAP from Class I, Superpave (High ESAL), HMA (High ESAL), or equivalent mixtures. The coarse aggregate in this RAP shall be crushed aggregate and may represent more than one aggregate type and/or quality but shall be at least C quality. This RAP may have an inconsistent gradation and/or asphalt binder content prior to processing. All conglomerate 5/8 RAP shall be processed prior to testing by crushing to where all RAP shall pass the 5/8 in. (16 mm) or smaller screen. Conglomerate 5/8 RAP stockpiles shall not contain steel slag or other expansive material as determined by the Department.
- (c) Conglomerate 3/8. Conglomerate 3/8 RAP stockpiles shall consist of RAP from Class I, Superpave (High ESAL), HMA (High ESAL), or equivalent mixtures. The coarse aggregate in this RAP shall be crushed aggregate and may represent more than one aggregate type and/or quality but shall be at least B quality. This RAP may have an inconsistent gradation and/or asphalt binder content prior to processing. All conglomerate 3/8 RAP shall be processed prior to testing by crushing to where all RAP shall pass the 3/8 in. (9.5 mm) or smaller screen. Conglomerate 3/8 RAP stockpiles shall not contain steel slag or other expansive material as determined by the Department.
- (d) Conglomerate “D” Quality (DQ). Conglomerate DQ RAP stockpiles shall consist of RAP from Class I, Superpave (High or Low ESAL), HMA (High or Low ESAL), or equivalent mixtures. The coarse aggregate in this RAP may be crushed or round but shall be at

least D quality. This RAP may have an inconsistent gradation and/or asphalt binder content. Conglomerate DQ RAP stockpiles shall not contain steel slag or other expansive material as determined by the Department.

- (e) Non-Quality. RAP stockpiles that do not meet the requirements of the stockpile categories listed above shall be classified as "Non-Quality".

RAP containing contaminants, such as earth, brick, sand, concrete, sheet asphalt, bituminous surface treatment (i.e. chip seal), pavement fabric, joint sealants, etc., will be unacceptable unless the contaminants are removed to the satisfaction of the Engineer. Sheet asphalt shall be stockpiled separately.

1031.03 Testing. When used in HMA, the RAP shall be sampled and tested either during or after stockpiling.

For testing during stockpiling, washed extraction samples shall be run at the minimum frequency of one sample per 500 tons (450 metric tons) for the first 2000 tons (1800 metric tons) and one sample per 2000 tons (1800 metric tons) thereafter. A minimum of five tests shall be required for stockpiles less than 4000 tons (3600 metric tons).

For testing after stockpiling, the Contractor shall submit a plan for approval to the District proposing a satisfactory method of sampling and testing the RAP pile either in-situ or by restockpiling. The sampling plan shall meet the minimum frequency required above and detail the procedure used to obtain representative samples throughout the pile for testing.

Before extraction, each field sample shall be split to obtain two samples of test sample size. One of the two test samples from the final split shall be labeled and stored for Department use. The Contractor shall extract the other test sample according to Department procedure. The Engineer reserves the right to test any sample (split or Department-taken) to verify Contractor test results.

- (a) Testing Conglomerate 3/8. In addition to the requirements above, conglomerate 3/8 RAP shall be tested for maximum theoretical specific gravity (G_{mm}) at a frequency of one sample per 500 tons (450 metric tons) for the first 2000 tons (1800 metric tons) and one sample per 2000 tons (1800 metric tons) thereafter. A minimum of five tests shall be required for stockpiles less than 4000 tons (3600 metric tons).
- (b) Evaluation of Test Results. All of the extraction results shall be compiled and averaged for asphalt binder content and gradation and, when applicable G_{mm} . Individual extraction test results, when compared to the averages, will be accepted if within the tolerances listed below.

Parameter	Homogeneous / Conglomerate	Conglomerate "D" Quality
1 in. (25 mm)		± 5 %
1/2 in. (12.5 mm)	± 8 %	± 15 %
No. 4 (4.75 mm)	± 6 %	± 13 %
No. 8 (2.36 mm)	± 5 %	
No. 16 (1.18 mm)		± 15 %
No. 30 (600 μm)	± 5 %	
No. 200 (75 μm)	± 2.0 %	± 4.0 %
Asphalt Binder	± 0.4 % ^{1/}	± 0.5 %
G _{mm}	± 0.02 ^{2/}	

1/ The tolerance for conglomerate 3/8 shall be ± 0.3 %.

2/ Applies only to conglomerate 3/8. When variation of the G_{mm} exceeds the ± 0.02 tolerance, a new conglomerate 3/8 stockpile shall be created which will also require an additional mix design.

If more than 20 percent of the individual sieves are out of the gradation tolerances, or if more than 20 percent of the asphalt binder content test results fall outside the appropriate tolerances, the RAP shall not be used in HMA unless the RAP representing the failing tests is removed from the stockpile. All test data and acceptance ranges shall be sent to the District for evaluation.

With the approval of the Engineer, the ignition oven may be substituted for extractions according to the Illinois Test Procedure, "Calibration of the Ignition Oven for the Purpose of Characterizing Reclaimed Asphalt Pavement (RAP)".

1031.04 Quality Designation of Aggregate in RAP. The quality of the RAP shall be set by the lowest quality of coarse aggregate in the RAP stockpile and are designated as follows.

- (a) RAP from Class I, Superpave (High ESAL), or HMA (High ESAL) surface mixtures are designated as containing Class B quality coarse aggregate.
- (b) RAP from Superpave (Low ESAL)/HMA (Low ESAL) IL-19.0L binder and IL-9.5L surface mixtures are designated as Class D quality coarse aggregate.
- (c) RAP from Class I, Superpave (High ESAL), or HMA (High ESAL) binder mixtures, bituminous base course mixtures, and bituminous base course widening mixtures are designated as containing Class C quality coarse aggregate.
- (d) RAP from bituminous stabilized subbase and BAM shoulders are designated as containing Class D quality coarse aggregate.

1031.05 Use of RAP in HMA. The use of RAP in HMA shall be as follows.

- (a) Coarse Aggregate Size. The coarse aggregate in all RAP shall be equal to or less than the nominal maximum size requirement for the HMA mixture to be produced.
- (b) Steel Slag Stockpiles. RAP stockpiles containing steel slag or other expansive material, as determined by the Department, shall be homogeneous and will be approved for use in HMA (High ESAL and Low ESAL) surface mixtures only.
- (c) Use in HMA Surface Mixtures (High and Low ESAL). RAP stockpiles for use in HMA surface mixtures (High and Low ESAL) shall be either homogeneous or conglomerate 3/8, in which the coarse aggregate is Class B quality or better.
- (d) Use in HMA Binder Mixtures (High and Low ESAL), HMA Base Course, and HMA Base Course Widening. RAP stockpiles for use in HMA binder mixtures (High and Low ESAL), HMA base course, and HMA base course widening shall be homogeneous, conglomerate 5/8, or conglomerate 3/8, in which the coarse aggregate is Class C quality or better.
- (e) Use in Shoulders and Subbase. RAP stockpiles for use in HMA shoulders and stabilized subbase (HMA) shall be homogeneous, conglomerate 5/8, conglomerate 3/8, or conglomerate DQ.
- (f) The use of RAP shall be a contractor's option when constructing HMA in all contracts. When the contractor chooses the RAP option, the percentage of RAP shall not exceed the amounts indicated in the table for a given N Design.

Max RAP Percentage

HMA MIXTURES ^{1/, 3/}	MAXIMUM % RAP		
	Binder/Leveling Binder	Surface	Polymer Modified
Ndesign 30	30	30	10
50	25	15	10
70	15 / 25 ^{2/}	10 / 15 ^{2/}	10
90	10	10	10
105	10	10	10

1/ For HMA Shoulder and Stabilized Sub-Base (HMA) N-30, the amount of RAP shall not exceed 50% of the mixture.

2/ Value of Max % RAP if 3/8 RAP is utilized.

3/ When RAP exceeds 20%, the high & low virgin asphalt binder grades shall each be reduced by one grade (i.e. 25% RAP would require a virgin asphalt binder grade of PG64-22 to be reduced to a PG58-28).

1031.06 HMA Mix Designs. At the Contractor's option, HMA mixtures may be constructed utilizing RAP material meeting the above detailed requirements.

RAP designs shall be submitted for volumetric verification. If additional RAP stockpiles are tested and found that no more than 20 percent of the results, as defined under "Testing" herein, are outside of the control tolerances set for the original RAP stockpile and HMA mix design, and meets all of the requirements herein, the additional RAP stockpiles may be used in the original mix design at the percent previously verified.

1031.07 HMA Production. The coarse aggregate in all RAP used shall be equal to or less than the nominal maximum size requirement for the HMA mixture being produced.

To remove or reduce agglomerated material, a scalping screen, crushing unit, or comparable sizing device approved by the Engineer shall be used in the RAP feed system to remove or reduce oversized material. If material passing the sizing device adversely affects the mix production or quality of the mix, the sizing device shall be set at a size specified by the Engineer.

If the RAP control tolerances or QC/QA test results require corrective action, the Contractor shall cease production of the mixture containing RAP and either switch to the virgin aggregate design or submit a new RAP design. When producing mixtures containing conglomerate 3/8 RAP, a positive dust control system shall be utilized.

HMA plants utilizing RAP shall be capable of automatically recording and printing the following information.

(a) Dryer Drum Plants.

- (1) Date, month, year, and time to the nearest minute for each print.
- (2) HMA mix number assigned by the Department.
- (3) Accumulated weight of dry aggregate (combined or individual) in tons (metric tons) to the nearest 0.1 ton (0.1 metric ton).
- (4) Accumulated dry weight of RAP in tons (metric tons) to the nearest 0.1 ton (0.1 metric ton).
- (5) Accumulated mineral filler in revolutions, tons (metric tons), etc. to the nearest 0.1 unit.
- (6) Accumulated asphalt binder in gallons (liters), tons (metric tons), etc. to the nearest 0.1 unit.
- (7) Residual asphalt binder in the RAP material as a percent of the total mix to the nearest 0.1 percent.
- (8) Aggregate and RAP moisture compensators in percent as set on the control panel. (Required when accumulated or individual aggregate and RAP are printed in wet condition.)

(b) Batch Plants.

- (1) Date, month, year, and time to the nearest minute for each print.
- (2) HMA mix number assigned by the Department.
- (3) Individual virgin aggregate hot bin batch weights to the nearest pound (kilogram).
- (4) Mineral filler weight to the nearest pound (kilogram).
- (5) RAP weight to the nearest pound (kilogram).
- (6) Virgin asphalt binder weight to the nearest pound (kilogram).
- (7) Residual asphalt binder in the RAP material as a percent of the total mix to the nearest 0.1 percent.

The printouts shall be maintained in a file at the plant for a minimum of one year or as directed by the Engineer and shall be made available upon request. The printing system will be inspected by the Engineer prior to production and verified at the beginning of each construction season thereafter.

1031.08 RAP in Aggregate Surface Course and Aggregate Shoulders. The use of RAP in aggregate surface course and aggregate shoulders shall be as follows.

- (a) Stockpiles and Testing. RAP stockpiles may be any of those listed in Article 1031.02, except "Other". The testing requirements of Article 1031.03 shall not apply.
- (b) Gradation. One hundred percent of the RAP material shall pass the 1 1/2 in. (37.5 mm) sieve. The RAP material shall be reasonably well graded from coarse to fine. RAP material that is gap-graded or single sized will not be accepted."

REFLECTIVE SHEETING ON CHANNELIZING DEVICES (BDE)

Effective: April 1, 2007

Revise the seventh paragraph of Article 1106.02 of the Standard Specifications to read:

"At the time of manufacturing, the retroreflective prismatic sheeting used on channelizing devices shall meet or exceed the initial minimum coefficient of retroreflection as specified in the following table. Measurements shall be conducted according to ASTM E 810, without averaging. Sheeting used on cones, drums and flexible delineators shall be reboundable as tested according to ASTM D 4956. Prestriped sheeting for rigid substrates on barricades shall be white and orange.

Initial Minimum Coefficient of Retroreflection candelas/foot candle/sq ft (candelas/lux/sq m) of material				
Observation Angle (deg.)	Entrance Angle (deg.)	White	Orange	Fluorescent Orange
0.2	-4	365	160	150
0.2	+30	175	80	70
0.5	-4	245	100	95
0.5	+30	100	50	40"

Revise the first sentence of the first paragraph of Article 1106.02(c) of the Standard Specifications to read:

“Barricades and vertical panels shall have alternating white and orange stripes sloping downward at 45 degrees toward the side on which traffic will pass.”

Revise the third sentence of the first paragraph of Article 1106.02(d) of the Standard Specifications to read:

“The bottom panels shall be 8 x 24 in. (200 x 600 mm) with alternating white and orange stripes sloping downward at 45 degrees toward the side on which traffic will pass.”

STEEL PLATE BEAM GUARDRAIL (BDE)

Effective: November 1, 2005

Revised: August 1, 2007

Revise the first paragraph of Article 1006.25 of the Standard Specifications to read:

"1006.25 Steel Plate Beam Guardrail. Steel plate beam guardrail, including bolts, nuts, and washers, shall be according to AASHTO M 180. The guardrail shall be Class A, with a Type II galvanized coating; except the weight (mass) of the coating for each side of the guardrail shall be at least 2.00 oz/sq ft (610 g/sq m). The coating will be determined for each side of the guardrail using the average of at least three non-destructive test readings taken on that side of the guardrail. The minimum average thickness for each side shall be 3.4 mils (86 µm).”

SUBCONTRACTOR MOBILIZATION PAYMENTS (BDE)

Effective: April 2, 2005

To account for the preparatory work and operations necessary for the movement of subcontractor personnel, equipment, supplies, and incidentals to the project site and for all other work or operations that must be performed or costs incurred when beginning work approved for subcontracting in accordance with Article 108.01 of the Standard Specifications, the Contractor shall make a mobilization payment to each subcontractor.

This mobilization payment shall be made at least 14 days prior to the subcontractor starting work. The amount paid shall be equal to 3 percent of the amount of the subcontract reported on form BC 260A submitted for the approval of the subcontractor’s work.

This provision shall be incorporated directly or by reference into each subcontract approved by the Department.

THERMOPLASTIC PAVEMENT MARKINGS (BDE)

Effective: January 1, 2007

Revise Article 1095.01(a)(2) of the Standard Specifications to read:

“(2) Pigment. The pigment used for the white thermoplastic compound shall be a high-grade pure (minimum 93 percent) titanium dioxide (TiO₂). The white pigment content shall be a minimum of ten percent by weight and shall be uniformly distributed throughout the thermoplastic compound.

The pigments used for the yellow thermoplastic compound shall not contain any hazardous materials listed in the Environmental Protection Agency Code of Federal Regulations (CFR) 40, Section 261.24, Table 1. The combined total of RCRA listed heavy metals shall not exceed 100 ppm when tested by X-ray fluorescence spectroscopy. The pigments shall also be heat resistant, UV stable and color-fast yellows, golds, and oranges, which shall produce a compound which shall match Federal Standard 595 Color No. 33538. The pigment shall be uniformly distributed throughout the thermoplastic compound.”

Revise Article 1095.01(b)(1)e. of the Standard Specifications to read:

“e. Daylight Reflectance and Color. The thermoplastic compound after heating for four hours ± five minutes at 425 ± 3 °F (218.3 ± 2 °C) and cooled at 77 °F (25 °C) shall meet the following requirements for daylight reflectance and color, when tested, using a color spectrophotometer with 45 degree circumferential/zero degree geometry, illuminant C, and two degree observer angle. The color instrument shall measure the visible spectrum from 380 to 720 nm with a wavelength measurement interval and spectral bandpass of 10 nm.

White: Daylight Reflectance75 percent min.

*Yellow: Daylight Reflectance45 percent min.

*Shall meet the coordinates of the following color tolerance chart.

x	0.490	0.475	0.485	0.530
y	0.470	0.438	0.425	0.456”

Revise Article 1095.01(b)(1)k. of the Standard Specifications to read:

“k. Accelerated Weathering. After heating the thermoplastic for four hours ± five minutes at 425 ± 3 °F (218.3 ± 2 °C) the thermoplastic shall be applied to a steel wool abraded aluminum alloy panel (Federal Test Std. No. 141, Method 2013) at a film thickness of 30 mils (0.70 mm) and allowed to cool for 24 hours at room

temperature. The coated panel shall be subjected to accelerated weathering using the light and water exposure apparatus (fluorescent UV - condensation type) for 75 hours according to ASTM G 53 (equipped with UVB-313 lamps).

The cycle shall consist of four hours UV exposure at 122 °F (50 °C) followed by four hours of condensation at 104 °F (40 °C). UVB 313 bulbs shall be used. At the end of the exposure period, the panel shall not exceed 10 Hunter Lab Delta E units from the original material.”

TRAINING SPECIAL PROVISIONS

This Training Special Provision supersedes Section 7b of the Special Provision entitled “Specific Equal Employment Opportunity Responsibilities,” and is in implementation of 23 U.S.C. 140(a).

As part of the contractor’s equal employment opportunity affirmative action program, training shall be provided as follows:

The contractor shall provide on-the-job training aimed at developing full journeyman in the type of trade or job classification involved. The number of trainees to be trained under this contract will be 2. In the event the contractor subcontracts a portion of the contract work, he shall determine how many, if any, of the trainees are to be trained by the subcontractor, provided however, that the contractor shall retain the primary responsibility for meeting the training requirements imposed by this special provision. The contractor shall also insure that this Training Special Provision is made applicable to such subcontract. Where feasible, 25 percent of apprentices or trainees in each occupation shall be in their first year of apprenticeship or training.

The number of trainees shall be distributed among the work classifications on the basis of the contractor’s needs and the availability of journeymen in the various classifications within the reasonable area of recruitment. Prior to commencing construction, the contractor shall submit to the Illinois Department of Transportation for approval the number of trainees to be trained in each selected classification and training program to be used. Furthermore, the contractor shall specify the starting time for training in each of the classifications. The contractor will be credited for each trainee employed by him on the contract work who is currently enrolled or becomes enrolled in an approved program and will be reimbursed for such trainees as provided hereinafter.

Training and upgrading of minorities and women toward journeyman status is a primary objective of this Training Special Provision. Accordingly, the contractor shall make every effort to enroll minority trainees and women (e.g. by conducting systematic and direct recruitment through public and private sources likely to yield minority and women trainees) to the extent such persons are available within a reasonable area of recruitment. The contractor will be responsible for demonstrating the steps that he has taken in pursuance thereof, prior to a determination as to whether the contractor is in compliance with this Training Special Provision. This training commitment is not intended, and shall not be used, to discriminate against any applicant for training, whether a member of a minority group or not.

No employee shall be employed as a trainee in any classification in which he has successfully completed a training course leading to journeyman status or in which he has been employed as a journeyman. The contractor should satisfy this requirement by including appropriate questions in the employee application or by other suitable means. Regardless of the method used the contractor's records should document the findings in each case.

The minimum length and type of training for each classification will be as established in the training program selected by the contractor and approved by the Illinois Department of Transportation and the Federal Highway Administration. The Illinois Department of Transportation and the Federal Highway Administration shall approve a program, if it is reasonably calculated to meet the equal employment opportunity obligations of the contractor and to qualify the average trainee for journeyman status in the classification concerned by the end of the training period. Furthermore, apprenticeship programs registered with the U.S. Department of Labor, Bureau of Apprenticeship and Training, or with a State apprenticeship agency recognized by the Bureau and training programs approved by not necessarily sponsored by the U.S. Department of Labor, Manpower Administration, Bureau of Apprenticeship and Training shall also be considered acceptable provided it is being administered in a manner consistent with the equal employment obligations of Federal-aid highway construction contracts. Approval or acceptance of a training program shall be obtained from the State prior to commencing work on the classification covered by the program. It is the intention of these provisions that training is to be provided in the construction crafts rather than clerk-typists or secretarial-type positions. Training is permissible in lower level management positions such as office engineers, estimators, timekeepers, etc., where the training is oriented toward construction applications. Training in the laborer classification may be permitted provided that significant and meaningful training is provided and approved by the Illinois Department of Transportation and the Federal Highway Administration. Some offsite training is permissible as long as the training is an integral part of an approved training program and does not comprise a significant part of the overall training.

Except as otherwise noted below, the contractor will be reimbursed 80 cents per hour of training given an employee on this contract in accordance with an approved training program. As approved by the Engineer, reimbursement will be made for training of persons in excess of the number specified herein. This reimbursement will be made even though the contractor receives additional training program funds from other sources, provided such other source does not specifically prohibit the contractor from receiving other reimbursement. Reimbursement for offsite training indicated above may only be made to the contractor where he does one or more of the following and the trainees are concurrently employed on a Federal-aid project; contributes to the cost of the training, provides the instruction to the trainee or pays the trainee's wages during the offsite training period.

No payment shall be made to the contractor if either the failure to provide the required training, or the failure to hire the trainee as a journeyman, is caused by the contractor and evidences a lack of good faith on the part of the contractor in meeting the requirement of this Training Special Provision. It is normally expected that a trainee will begin his training on the project as soon as feasible after start of work utilizing the skill involved and remain on the project as long as training opportunities exist in his work classification or until he has completed his training program.

It is not required that all trainees be on board for the entire length of the contract. A contractor will have fulfilled his responsibilities under this Training Special Provision if he has provided acceptable training to the number of trainees specified. The number trained shall be determined on the basis of the total number enrolled on the contract for a significant period.

Trainees will be paid at least 60 percent of the appropriate minimum journeyman's rate specified in the contract for the first half of the training period, 75 percent for the third quarter of the training period, and 90 percent for the last quarter of the training period, unless apprentices or trainees in an approved existing program are enrolled as trainees on this project. In that case, the appropriate rates approved by the Departments of Labor or Transportation in connection with the existing program shall apply to all trainees being trained for the same classification who are covered by this Training Special Provision.

The contractor shall furnish the trainee a copy of the program he will follow in providing the training. The contractor shall provide each trainee with a certification showing the type and length of training satisfactorily complete.

The contractor will provide for the maintenance of records and furnish periodic reports documenting his performance under this Training Special Provision.

METHOD OF MEASUREMENT The unit of measurement is in hours.

BASIS OF PAYMENT This work will be paid for at the contract unit price of 80 cents per hour for TRAINEES. The estimated total number of hours, unit price and total price have been included in the schedule of prices.

WATER BLASTER WITH VACUUM RECOVERY (BDE)

Effective: April 1, 2006

Revised: January 1, 2007

Add the following to Article 783.02 of the Standard Specifications.

“(c) Water Blaster with Vacuum Recovery 1101.12”

Revise Article 1101.12 of the Standard Specifications to read.

“1101.12 Water Blaster with Vacuum Recovery. The water blaster shall remove the stripe from the pavement using a high pressurized water spray with a vacuum recovery system to provide a clean, almost dry surface, without the use of a secondary cleanup process. The removal shall be to the satisfaction of the Engineer. The equipment shall contain a storage system that allows for the storage of the wastewater while retaining the debris. The operator shall be in immediate control of the blast head.”

NORFOLK & SOUTHERN RAILROAD AGREEMENT FOR PROTECTION OF RAILWAY INTEREST

**SPECIAL PROVISIONS FOR
PROTECTION OF RAILWAY INTEREST**

1. AUTHORITY OF RAILROAD ENGINEER AND DEPARTMENT ENGINEER:

The authorized representative of the Railroad Company, hereinafter referred to as Railroad Engineer, shall have final authority in all matters affecting the safe maintenance of Railroad traffic of his Company including the adequacy of the foundations and structures supporting the Railroad tracks.

The authorized representative of the Department, hereinafter referred to as the Engineer, shall have authority over all other matters as prescribed herein and in the Project Specifications.

2. NOTICE OF STARTING WORK:

A. The contractor shall not commence any work on railroad rights-of-way until he has complied with the following conditions:

a. Given the Railroad written notice, with copy to the Engineer who has been designated to be in charge of the work, at least ten days in advance of the date he proposes to begin work on Railroad rights-of-way.

Office of Chief Engineer
Bridges & Structures
Norfolk Southern Corporation
1200 Peachtree
Atlanta, Georgia 30309

b. Obtained written authorization from the Railroad to begin work on Railroad rights-of-way, such authorization to include an outline of specific conditions with which he must comply.

c. Obtained written approval from the Railroad of Railroad Protective Insurance Liability coverage as required by paragraph 14 herein.

d. Furnished a schedule for all work within the Railroad rights-of-way as required by paragraph 7,B,1.

B. The Railroad's written authorization to proceed with the work shall include the names, addresses, and telephone numbers of the Railroad's representatives who are to be notified as hereinafter required. Where more than one representative is designated, the area of responsibility of each representative shall be specified.

3. INTERFERENCE WITH RAILROAD OPERATIONS:

- A. The Contractor shall so arrange and conduct his work that there will be no interference with Railroad operations, including train, signal, telephone and telegraphic services, or damage to the property of the Railroad Company or to poles, wires, and other facilities of tenants on the rights-of-way of the Railroad Company. Whenever work is liable to affect the operations or safety of trains, the method of doing such work shall first be submitted to the Railroad Engineer for approval, but such approval shall not relieve the Contractor from liability. Any work to be performed by the Contractor which requires flagging service or inspection service shall be deferred by the Contractor until the flagging service or inspection service required by the Railroad is available at the job site.
- B. Whenever work within Railroad rights-of-way is of such a nature that impediment to Railroad operations such as use of runaround tracks or necessity for reduced speed is unavoidable, the Contractor shall schedule and conduct his operations so that such impediment is reduced to the absolute minimum.
- C. Should conditions arising from, or in connection with the work, require that immediate and unusual provisions be made to protect operations and property of the Railroad, the Contractor shall make such provisions. If in the judgment of the Railroad Engineer, or in his absence, the Engineer, such provisions is insufficient, either may require or provide such provisions as he deems necessary. In any event, such unusual provisions shall be at the Contractor's expense and without cost to the Railroad or the Department.

4. TRACK CLEARANCES:

- A. The minimum track clearances to be maintained by the Contractor during construction are shown on the Project Plans. However, before undertaking any work within Railroad right-of-way, or before placing any obstruction over any track, the Contractor shall:
 - 1. Notify the Railroad's representative at least 72 hours in advance of the work.
 - 2. Receive assurance from the Railroad's representative that arrangements have been made for flagging service as may be necessary.
 - 3. Receive permission from the Railroad's representative to proceed with the work.
 - 4. Ascertain that the Engineer has received copies of notice to the Railroad and of the Railroad's response thereto.

5. **CONSTRUCTION PROCEDURES:**

A. **General:**

Construction work and operations by the Contractor on Railroad property shall be:

1. Subject to the inspection and approval of the Railroad.
2. In accord with the Railroad's written outline of specific conditions.
3. In accord with the Railroad's general rules, regulations and requirements including those relating to safety, fall protection and personal protective equipment.
4. In accord with these Special Provisions.

B. **Excavation:**

The subgrade of an operated track shall be maintained with edge of beam at least 10'-0" from centerline of track and not more than 24- inches below top of rail. Contractor will not be required to make existing section meet this specification if substandard, in which case existing section will be maintained.

C. **Excavation for Structures:**

The Contractor will be required to take special precaution and care in connection with excavating and shoring pits, and in driving piles or sheeting for footings adjacent to tracks to provide adequate lateral support for the tracks and the loads which they carry, without disturbance of track alignment and surface, and to avoid obstructing track clearances with working equipment, tools or other material. All plans and calculations for shoring shall be prepared and signed by a Registered Professional Engineer. The Engineer will be responsible for the accuracy for all controlling dimensions as well as the selection of soil design values which will accurately reflect the actual field conditions. The procedure for doing such work, including need of and plans and calculations for shoring, shall first be approved by the Engineer and the Railroad Engineer, but such approval shall not relieve the Contractor from liability.

D. **Demolition, Erection, Hoisting**

1. Railroad tracks and other railroad property must be protected from damage during the procedure.

2. The Contractor is required to submit a plan showing the location of cranes, horizontally and vertically, operating radii, with delivery or disposal locations shown. The location of all tracks and other railroad facilities as well as all obstructions such as wire lines, poles, adjacent structures, etc. must also be shown.
3. Crane rating sheets showing cranes to be adequate for 150% of the actual weight of the pick. A complete set of crane charts, including crane, counterweight, and boom nomenclature is to be submitted.
4. Plans and computations showing the weight of the pick must be submitted. Calculations shall be made from plans of the existing and/or proposed structure showing complete and sufficient details with supporting data for the demolition or erection of the structure. If plans do not exist, lifting weights must be calculated from field measurements. The field measurements are to be made under the supervision of the Registered Professional Engineer submitting the procedure and calculations.
5. A data sheet must be submitted listing the types, size, and arrangements of all rigging and connection equipment.
6. A complete procedure is to be submitted, including the order of lifts, time required for each lift, and any repositioning or re-hitching of the crane or cranes.
7. All erection or demolition plans, procedures, data sheets, etc. submitted must be prepared, signed and sealed by a Registered Professional Engineer.
8. The Railroad's representative must be present at the site during the entire demolition and erection procedure period.
9. All procedures, plans and calculations shall first be approved by the Engineer and the Railroad Engineer, but such approval does not relieve the Contractor from liability.

E. Blasting:

1. The Contractor shall obtain advance approval of the Railroad Engineer and the Engineer for use of explosives on or adjacent to Railroad property. The request for permission to use explosives shall include a detailed blasting plan. If permission for use of explosives is granted, the Contractor will be required to comply with the following:

- (a) Blasting shall be done with light charges under the direct supervision of a responsible officer or employee of the Contractor and a licensed blaster.
- (b) Electric detonating fuses shall not be used because of the possibility of premature explosions resulting from operation of two-way radios.
- (c) No blasting shall be done without the presence of an authorized representative of the Railroad. At least 72 hours advance notice to the person designated in the Railroad's notice of authorization to proceed (see paragraph 2B) will be required to arrange for the presence of an authorized Railroad representative and such flagging as the Railroad may require.
- (d) Have at the job site adequate equipment, labor and materials and allow sufficient time to clean up debris resulting from the blasting without delay to trains, as well as correcting at his expense any track misalignment or other damage to Railroad property resulting from the blasting as directed by the Railway's authorized representative. If his actions result in delay of trains, the Contractor shall bear the entire cost thereof.

2. The Railroad representative will:

- (a) Determine approximate location of trains and advise the Contractor the appropriate amount of time available for the blasting operation and clean up.
- (b) Have the authority to order discontinuance of blasting if, in his opinion, blasting is too hazardous or is not in accord with these special provisions.

F. Maintenance of Railroad Facilities:

- 1. The Contractor will be required to maintain all ditches and drainage structures free of silt or other obstructions which may result from his operations and provide and maintain any erosion control measures as required. The Contractor will promptly repair eroded areas within Railroad rights-of-way and repair any other damage to the property of the Railroad or its tenants.
- 2. All such maintenance and repair of damages due to the Contractor's operations shall be done at the Contractor's expense.

G. Storage of Materials and Equipment:

Materials and equipment shall not be stored where they will interfere with Railroad operations, nor on the rights-of-way of the Railroad Company without first having obtained permission from the Railroad Engineer, and such permission will be with the understanding that the Railroad Company will not be liable for damage to such material and equipment from any cause and that the Railroad Engineer may move or require the Contractor to move, at the Contractor's expense, such material and equipment.

All grading or construction machinery that is left parked near the track unattended by a watchman shall be effectively immobilized so that it cannot be moved by unauthorized persons. The Contractor shall protect, defend, indemnify and save Railroad, and any associated, controlled or affiliated corporation, harmless from and against all losses, costs, expenses, claim or liability for loss or damage to property or the loss of life or personal injury, arising out of or incident to the Contractor's failure to immobilize grading or construction machinery.

H. Cleanup:

Upon completion of the work, the Contractor shall remove from within the limits of the Railroad rights-of-way, all machinery, equipment, surplus materials, falsework, rubbish or temporary buildings of the Contractor, and leave said rights-of-way in a neat condition satisfactory to the Chief Engineer of the Railroad or his authorized representative.

6. DAMAGES:

- A. The Contractor shall assume all liability for any and all damages to his work, employees, servants, equipment and materials caused by Railroad traffic.
- B. Any cost incurred by the Railroad for repairing damages to its property or to property of its tenants, caused by or resulting from the operations of the Contractor, shall be paid directly to the Railroad by the Contractor.

7. FLAGGING SERVICES:

A. When Required:

Under the terms of the agreement between the Department and the Railroad, the Railroad has sole authority to determine the need for flagging required to protect its operations. In general, the requirements of such services will be whenever the Contractor's personnel or equipment are or are likely to be, working on the Railroad's right-of-way, or across, over, adjacent to, or under a track, or when such work has disturbed or is likely to disturb a railroad structure or the railroad roadbed or surface and alignment of any track to such extent that the movement of trains must be controlled by flagging.

Normally, the Railroad will assign one flagman to a project; but in some cases, more than one may be necessary, such as yard limits where three (3) flagmen may be required. However, if the Contractor works within distances that violate instructions given by the Railroad's authorized representative or performs work that has not been scheduled with the Railroad's authorized representative, a flagman or flagmen may be required full time until the project has been completed.

B. Scheduling and Notification:

1. The Contractor's work requiring railroad flagging should be scheduled to limit the presence of a flagman at the site to a maximum of 50 hours per week. The Contractor shall receive Railroad approval of work schedules requiring a flagman's presence in excess of 40 hours per week.
- 2.. Not later than the time that approval is initially requested to begin work on Railroad right-of-way, Contractor shall furnish to the Railroad and the Department a schedule for all work required to complete the portion of the project within Railroad right-of-way and arrange for a job site meeting between the Contractor, the Department, and the Railroad's authorized representative. Flagman or Flagmen may not be provided until the job site meeting has been conducted and the Contractor's work scheduled.
3. The Contractor will be required to give the Railroad representative at least 10 working days of advance written notice of intent to begin work within Railroad right-of-way in accordance with this special provision. Once begun, when such work is then suspended at any time, or for any reason, the Contractor will be required to give the Railroad representative at least 3 working days of advance notice before resuming work on Railroad right-of-way. Such notices shall include sufficient details of the proposed work to enable the Railroad representative to determine if flagging will be required. If such notice is in writing, the Contractor shall furnish the Engineer a copy; if notice is given verbally, it shall be confirmed in writing with copy to the Engineer. If flagging is required, no work shall be undertaken until the flagman, or flagmen is present at the job site. It may take up to 30 days to obtain flagging initially from the Railroad. When flagging begins, the flagman is usually assigned by the Railroad to work at the project site on a continual basis until no longer needed and cannot be called for on a spot basis. If flagging becomes unnecessary and is suspended, it may take up to 30 days to again obtain from the Railroad. Due to Railroad labor agreements, it is necessary to give 5 working days notice before flagging service may be discontinued and responsibility for payment stopped.
- 4.. If, after the flagman is assigned to the project site, an emergency arises that requires the flagman's presence elsewhere, then the Contractor shall delay work on Railroad right-of-way until such time as the flagman is again available. Any additional costs resulting from such delay shall be borne by the Contractor and not the Department or Railroad.

C. Payment:

1. The Department's contractor pursuant to Section 107.12 of the State's "Standard Specifications for Road and Bridge Construction" adopted January 1, 2002 will be responsible for paying the Railroad directly for any and all costs of flagging which may be required to accomplish the construction.
2. The estimated cost of flagging is \$400.00 per day based on a 10-hour work day. This cost includes the base pay for the flagman, overhead, and includes an estimated \$50 per diem charge for travel expenses, meals and lodging. The charge to the Department by the Railroad will be the actual cost based on the rate of pay for the Railroad's employees who are available for flagging service at the time the service is required.
3. Work by a flagman in excess of 8 hours per day or 40 hours per week, but not more than 12 hours a day will result in overtime pay at 1 and 1/2 times the appropriate rate. Work by a flagman in excess of 12 hours per day will result in overtime at 2 times the appropriate rate. If work is performed on a holiday, the flagging rate is 2 and 1/2 times the normal rate.
4. Railroad work involved in preparing and handling bills will also be charged to the Department. Charges to the Department by the Railroad shall be in accordance with applicable provisions of Subchapter B, Part 140, Subpart I and Subchapter G, Part 646, Subpart B of the Federal-Aid Policy Guide issued by the Federal Highway Administration on December 9, 1991, including all current amendments. Flagging costs are subject to change. The above estimates of flagging costs are provided for information only and are not binding in any way.

D. Verification:

1. The Contractor and Department will review and sign the Railroad flagman's time sheet (Form 11123), attesting that the flagman was present during the time recorded. Flagmen may be removed by the Railroad if form is not signed. If flagman is removed, the Contractor will not be allowed to re-enter the Railroad right-of-way until the issue is resolved. Any complaints concerning flagman or flagmen must be resolved in a timely manner. If need for flagman or flagmen is questioned, please contact Railroad's System Engineer Public Improvements (404) 529-1641. All verbal complaints will be confirmed in writing by the Contractor within 5 working days with a copy to the Highway Engineer. Address all written correspondence to:

Office of Chief Engineer Attn: . D. Wyatt
Bridges & Structures System Engineer
Norfolk Southern Corporation Public Improvements
1200 Peachtree Street
Atlanta, Georgia 30309

2. The Railroad flagman assigned to the project will be responsible for notifying the Project Engineer upon arrival at the job site on the first day (or as soon thereafter as possible) that flagging services begin and on the last day that he performs such services for each separate period that services are provided. The Project Engineer will document such notification in the project records. When requested, the Project Engineer will also sign the flagman's diary showing daily time spent and activity at the project site.

8. HAUL ACROSS RAILROAD:

- A. Where the plans show or imply that materials of any nature must be hauled across a Railroad, unless the plans clearly show that the Department has included arrangements for such haul in its agreement with the Railroad, the Contractor will be required to make all necessary arrangements with the Railroad regarding means of transporting such materials across the Railroad. The Contractor will be required to bear all costs incidental to such crossings whether services are performed by his own forces or by Railroad personnel.
- B. No crossing may be established for use of the Contractor for transporting materials or equipment across the tracks of the Railroad Company unless specific authority for its installation, maintenance, necessary watching and flagging thereof and removal, until a private crossing agreement has been executed between the Contractor and Railroad.

9. WORK FOR THE BENEFIT OF THE CONTRACTOR:

- A. All temporary or permanent changes in wire lines or other facilities which are considered necessary to the project are shown on the plans; included in the force account agreement between the Department and the Railroad or will be covered by appropriate revisions to same which will be initiated and approved by the Department and/or the Railroad.
- B. Should the Contractor desire any changes in addition to the above, then he shall make separate arrangements with the Railroad for same to be accomplished at the Contractor's expense.

10. COOPERATION AND DELAYS:

- A. It shall be the Contractor's responsibility to arrange a schedule with the Railroad for accomplishing stage construction involving work by the Railroad or tenants of the Railroad. In arranging his schedule he shall ascertain, from the Railroad, the lead time required for assembling crews and materials and shall make due allowance therefore.

- B. No charge or claim of the Contractor against either the Department or the Railroad Company will be allowed for hindrance or delay on account of railway traffic; any work done by the Railway Company or other delay incident to or necessary for safe maintenance of railway traffic or for any delays due to compliance with these special provisions.

11. TRAINMAN'S WALKWAYS:

Along the outer side of each exterior track of multiple operated track, and on each side of single operated track, an unobstructed continuous space suitable for trainman's use in walking along trains, extending to a line not less than 10 feet from centerline of track, shall be maintained. Any temporary impediments to walkways and track drainage encroachments or obstructions allowed during work hours while Railway's protective service is provided shall be removed before the close of each work day. If there is any excavation near the walkway, a handrail, with 10'-0" minimum clearance from centerline of track, shall be placed.

12. GUIDELINES FOR PERSONNEL ON RAILROAD RIGHT-OF-WAY:

- A. All persons shall wear hard hats. Appropriate eye and hearing protection must be used. Working in shorts is prohibited. Shirts must cover shoulders, back and abdomen. Working in tennis or jogging shoes, sandals, boots with high heels, cowboy and other slip-on type boots is prohibited. Hard-sole, lace-up footwear, zippered boots or boots cinched up with straps which fit snugly about the ankle are adequate. Safety boots are strongly recommended.
- B. No one is allowed within 25' of the centerline of track without specific authorization from the flagman.
- C. All persons working near track while train is passing are to lookout for dragging bands, chains and protruding or shifted cargo.
- D. No one is allowed to cross tracks without specific authorization from the flagman.
- E. All welders and cutting torches working within 25' of track must stop when train is passing.
- F. No steel tape or chain will be allowed to cross or touch rails without permission.

13. GUIDELINES EQUIPMENT ON RAILROAD RIGHT-OF-WAY:

- A. No crane or boom equipment will be allowed to set up to work or park within boom distance plus 15' of centerline of track without specific permission from railroad official and flagman.
- B. No crane or boom equipment will be allowed to foul track or lift a load over the track without flag protection and track time.

- C. All employees will stay with their machines when crane or boom equipment is pointed toward track.
- D. All cranes and boom equipment under load will stop work while train is passing (including pile driving).
- E. Swinging loads must be secured to prevent movement while train is passing.
- F. No loads will be suspended above a moving train.
- G. No equipment will be allowed within 25' of centerline of track without specific authorization of the flagman.
- H. Trucks, tractors or any equipment will not touch ballast line without specific permission from railroad official and flagman.
- I. No equipment or load movement within 25' or above a standing train or railroad equipment without specific authorization of the flagman.
- J. All operating equipment within 25' of track must halt operations when a train is passing. All other operating equipment may be halted by the flagman if the flagman views the operation to be dangerous to the passing train.
- K. All equipment, loads and cables are prohibited from touching rails.
- L. While clearing and grubbing, no vegetation will be removed from railroad embankment with heavy equipment without specific permission from the Railroad Engineer and flagman.
- M. No equipment or materials will be parked or stored on Railroad's property unless specific authorization is granted from the Railroad Engineer.
- N. All unattended equipment that is left parked on Railroad property shall be effectively immobilized so that it cannot be moved by unauthorized persons.
- O. All cranes and boom equipment will be turned away from track after each work day or whenever unattended by an operator.

14. INSURANCE:

- A. In addition to any other forms of insurance or bonds required under the terms of the contract and specifications, the Prime Contractor will be required to carry insurance of the following kinds and amounts:

1. Commercial General Liability Insurance having a combined single limit of not less than \$2,000,000 per occurrence for all loss, damage, cost and expense, including attorneys' fees, arising out of bodily injury liability and property damage liability during the policy period. Said policy shall include "explosion, collapse, and underground hazard" ("XCU") coverage, shall be endorsed to name Railroad specified in item A.2 below as an additional insured, and shall include a severability of interests provision.

2. Railroad Protective Liability Insurance having a combined single limit of not less than \$2,000,000 each occurrence and \$6,000,000 in the aggregate applying separately to each annual period. If the project involves track over which passenger trains operate, the insurance limits required are not less than a combined single limit of \$5,000,000 each occurrence and \$10,000,000 in the aggregate applying separately to each annual period. Said policy shall provide coverage for all loss, damage or expense arising from bodily injury and property damage liability, and physical damage to property attributed to acts or omissions at the job site.

The standards for the Railroad Protective Liability Insurance are as follows:

The insurer must be rated A- or better by A.M. Best Company, Inc.

The policy must be written using one of the following combinations of Insurance Services Office ("ISO") Railroad Protective Liability Insurance Form Numbers:

CG 00 35 01 96 and CG 28 31 10 93; or CG 00 35 07 98 and CG 28 31 07 98.

The named insured shall read:

[Name of railroad that owns the track]; and

Norfolk Southern Railway Company

Three Commercial Place

Norfolk, Virginia 23510-2191

Attn: D. W. Fries, Director Risk Management

The description of operations must appear on the Declarations, must match the project description in this agreement, and must include the appropriate Department project and contract identification numbers.

The job location must appear on the Declarations and must include the city, state and appropriate highway name/number.

The name and address of the prime contractor must appear on the Declarations.

The name and address of the Department must be identified on the Declarations as the "Involved Governmental Authority or Other Contracting Party."

Other endorsements/forms that will be accepted are:

Broad Form Nuclear Exclusion – Form IL 00 21

30-day Advance Notice of Non-renewal or cancellation

Required State Cancellation Endorsement

Quick Reference or Index Form CL/IL 240

Endorsements/forms that are NOT acceptable are:

Any Pollution Exclusion Endorsement except CG 28 31

Any Punitive or Exemplary Damages Exclusion

Known injury or Damage Exclusion form CG 00 59

Any Common Policy Conditions form

Any other endorsement/form not specifically authorized in item no. 2.h above.

- B. If any part of the work is sublet, similar insurance, and evidence thereof as specified in A.1 above, shall be provided by or on behalf of the subcontractor to cover its operations on Railroad's right of way.

- C. Prior to entry on Railroad right-of-way, the original Railroad Protective Liability Insurance Policy shall be submitted by the Prime Contractor to the Department at the address below for its review and transmittal to the Railroad. In addition, certificates of insurance evidencing the Prime Contractor's and any subcontractors' Commercial General Liability Insurance shall be issued to the Railroad and the Department at the addresses below, and forwarded to the Department for its review and transmittal to the Railroad. The certificates of insurance shall state that the insurance coverage will not be suspended, voided, canceled, or reduced in coverage or limits without (30) days advance written notice to Railroad and the Department. No work will be permitted by Railroad on its right-of-way until it has reviewed and approved the evidence of insurance required herein.

DEPARTMENT:RAILROAD:

Mr. D. W. Fries, ARM
Risk Manager
Norfolk Southern Corporation
Three Commercial Place
Norfolk, VA 23510-2191

15. FAILURE TO COMPLY:

In the event the Contractor violates or fails to comply with any of the requirements of these Special Provisions:

- A. The Railroad Engineer may require that the Contractor vacate Railroad property.

- B. The Engineer may withhold all monies due the Contractor on monthly statements.

Any such orders shall remain in effect until the Contractor has remedied the situation to the satisfaction of the Railroad Engineer and the Engineer.

16. PAYMENT FOR COST OF COMPLIANCE:

No separate payment will be made for any extra cost incurred on account of compliance with these special provisions. All such costs shall be included in prices bid for other items of the work as specified in the payment items.

Office of Chief Engineer
Bridges & Structures
Norfolk Southern Corporation
Atlanta, GA 30309

Date:

File:

Milepost:

BITUMINOUS MATERIALS COST ADJUSTMENTS (BDE) (RETURN FORM WITH BID)

Effective: November 2, 2006

Revised: January 2, 2007

Description. For projects with at least 1200 tons (1100 metric tons) of work involving applicable bituminous materials, cost adjustments will be made to provide additional compensation to the Contractor, or credit to the Department, for fluctuations in the cost of bituminous materials when optioned by the Contractor. The adjustments shall apply to permanent and temporary hot-mix asphalt (HMA) mixtures, bituminous surface treatments (cover and seal coats), and pavement preservation type surface treatments. The adjustments shall not apply to bituminous prime coats, tack coats, crack filling/sealing, or joint filling/sealing.

The bidder shall indicate on the attached form whether or not this special provision will be part of the contract and submit the completed form with his/her bid. Failure to submit the form, or failure to fill out the form completely, shall make this contract exempt of bituminous materials cost adjustments.

Method of Adjustment. Bituminous materials cost adjustments will be computed as follows.

$$CA = (BPI_P - BPI_L) \times (\%AC_V / 100) \times Q$$

Where: CA = Cost Adjustment, \$.

BPI_P = Bituminous Price Index, as published by the Department for the month the work is performed, \$/ton (\$/metric ton).

BPI_L = Bituminous Price Index, as published by the Department for the month prior to the letting, \$/ton (\$/metric ton).

%AC_V = Percent of virgin Asphalt Cement in the Quantity being adjusted. For HMA mixtures, the % AC_V will be determined from the adjusted job mix formula. For bituminous materials applied, a performance graded or cutback asphalt will be considered to be 100% AC_V and undiluted emulsified asphalt will be considered to be 65% AC_V.

Q = Authorized construction Quantity, tons (metric tons) (see below).

For HMA mixtures measured in square yards: $Q, \text{ tons} = A \times D \times (G_{mb} \times 46.8) / 2000$. For HMA mixtures measured in square meters: $Q, \text{ metric tons} = A \times D \times (G_{mb} \times 24.99) / 1000$. When computing adjustments for full-depth HMA pavement, separate calculations will be made for the binder and surface courses to account for their different G_{mb} and % AC_V.

For bituminous materials measured in gallons: $Q, \text{ tons} = V \times 8.33 \text{ lb/gal} \times SG / 2000$

For bituminous materials measured in liters: $Q, \text{ metric tons} = V \times 1.0 \text{ kg/L} \times SG / 1000$

Where: A = Area of the HMA mixture, sq yd (sq m).

D = Depth of the HMA mixture, in. (mm).

G_{mb} = Average bulk specific gravity of the mixture, from the approved mix design.

V = Volume of the bituminous material, gal (L).

SG = Specific Gravity of bituminous material as shown on the bill of lading.

Basis of Payment. Bituminous materials cost adjustments may be positive or negative but will only be made when there is a difference between the BPI_L and BPI_P in excess of five percent, as calculated by:

$$\text{Percent Difference} = \{(BPI_L - BPI_P) \div BPI_L\} \times 100$$

Bituminous materials cost adjustments will be calculated for each calendar month in which applicable bituminous material is placed; and will be paid or deducted when all other contract requirements for the items of work are satisfied. The adjustments shall not apply during contract time subject to liquidated damages for completion of the entire contract.

01/31/2008
76236/0828-28.MHO.US_FL.CONTRACT NO 2 (SBUS 51)/CADD FILES/C COVER_SBEIDGN

STATE OF ILLINOIS

DEPARTMENT OF TRANSPORTATION

PLANS FOR PROPOSED

FAP RTE 322 (US 51)

SECTION (29-Z-2, 30-2)RS-3

MARION COUNTY

RESURFACING

C-98-006-08

PROJ.
ACNHF-
0322(084)

FOR INDEX OF SHEETS SEE SHEET NO. 2



LOCATION OF SECTION INDICATED THUS ■

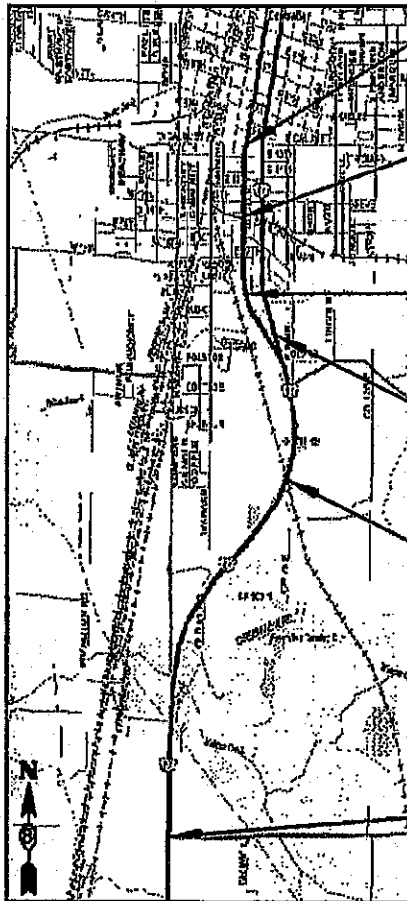

END PROJECT (S.B.)

STA. 1701+34±
CALUMET ST.

**OMISSION
RAILROAD**

STA. 1717+54±
TO 1717+80±

STATION EQUATION

STA. 1728+04.03 =
STA. 839+28.14

END PROJECT (N.B.)

STA. 813+37±

**OMISSION
BRIDGE**

STA. 780+90± (N.B.)
TO 785+42± (N.B.)
STA. 781+28± (S.B.)
TO 785+87± (S.B.)

BEGIN PROJECT

STA. 680+91±

D-98-013-08

<u>ADT</u>	
NORTH OF WALNUT HILL RD.	SOUTH OF WALNUT HILL RD.
2005 ADT = 5,300	2005 ADT = 6,500
2027 ADT = 6,900	2027 ADT = 8,500
4.4% SU	3.8% SU
2.2% MU	5.2% MU

JOINT UTILITY LOCATION
INFORMATION FOR EXCAVATIONS
PHONE: (800) 892-0123

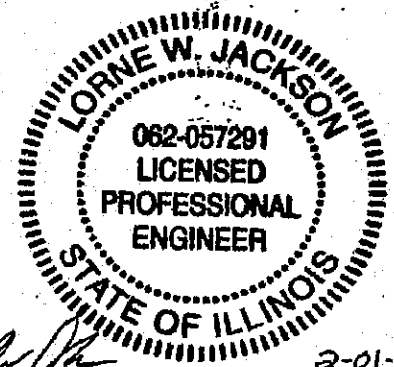

LORNE W. JACKSON, P.E.
LICENSED PROFESSIONAL ENGINEER IN ILLINOIS
LICENSE NO. 062-057291
LICENSE EXPIRES NOV. 30, 2009

PROJECT ENGINEER: PATTI LEBEAU PH. (618)-346-3179
SQUAD LEADER: CHERYL KEPLAR PH. (618)-346-3186

LOCATION MAP

OMISSIONS

STA. 1717+54± TO 1717+80± RAILROAD
STA. 780+90± TO 785+42± BRIDGE (NB)
STA. 781+28± TO 785+87± BRIDGE (SB)
GROSS LENGTH OF SECTION: 18,838'±
LENGTH OF OMISSIONS: 485'±
NET LENGTH OF SECTION: 18,353'±



PREPARED BY:
HENRY, MEISENHEIMER & GENDE, INC.
ENGINEERS
CARLYLE, ILLINOIS 62231
(618) 594-3711

CONTRACT NO. 76B36

SUBMITTED Feb 1 2008

Mary C Jamie
DISTRICT ENGINEER

PASSED _____

ENGINEER OF DESIGN & ENVIRONMENT

APPROVED _____

DIRECTOR, DIVISION OF HIGHWAYS

PRINTED BY THE AUTHORITY OF THE STATE OF ILLINOIS

INDEX OF SHEETS

TOTAL SHEETS	SHEET No.
41	2

CONTRACT NO. 76836

1. COVER SHEET
- 2.-3. INDEX OF SHEETS, GENERAL NOTES & STANDARDS
- 4.-5c. SUMMARY OF QUANTITIES
- 6.-16. QUANTITY SCHEDULES
- 17.-22. TYPICAL SECTIONS
23. SITE PLAN
- 24.-31. PAVEMENT MARKING PLANS
32. PAVEMENT MARKING DETAIL
- 33.-37. PAVING DETAILS
38. BUTT JOINT DETAILS
39. PAVEMENT TRANSITION DETAILS
40. SIDE ROAD & ENTRANCE TRANSITION DETAIL
41. INLET TRANSITION DETAIL AT BRIDGE APPROACH SHOULDER

GENERAL NOTES

1. THE STANDARDS AND REVISION NUMBERS LISTED SHALL APPLY TO THIS PROJECT.
2. ILLINOIS STATE LAW REQUIRES A 48 HOUR NOTICE BE GIVEN TO UTILITIES BEFORE DIGGING. FIELD MARKING OF FACILITIES MAY ALSO BE OBTAINED BY CONTACTING J.U.L.I.E. OR FOR NON-MEMBERS, THE UTILITY COMPANY DIRECTLY. AGENCIES KNOWN TO HAVE FACILITIES WITHIN THE PROJECT AREA ARE AS FOLLOWS:
 - *CITY OF CENTRALIA
 - *AMEREN IP
 - *CHARTER
 - *AT&T LOCAL
 - *FRONTIER
 - *McCLEOD
 - *TRI-COUNTY ELECTRIC CO-OP
 - *CITY OF WAMAC
- MEMBERS OF J.U.L.I.E. 1-800-892-0123 ARE INDICATED BY * . NON-J.U.L.I.E. MEMBERS MUST BE NOTIFIED INDIVIDUALLY.
3. THE THICKNESS OF THE HOT-MIX ASPHALT MIXTURE SHOWN ON THE PLANS IS THE NOMINAL THICKNESS. DEVIATIONS FROM THE NOMINAL THICKNESS WILL BE PERMITTED WHEN SUCH DEVIATIONS OCCUR DUE TO IRREGULARITIES IN THE EXISTING SURFACE ON WHICH THE HOT-MIX ASPHALT MIXTURE IS PLACED.
4. NO OVERNIGHT LANE CLOSURES SHALL BE ALLOWED ON THE PROJECT.
5. FLAGGERS SHALL BE PRESENT DURING ALL CLOSURE HOURS INCLUDING LUNCH HOUR AND NO ADDITIONAL COMPENSATION SHALL BE ALLOWED.
6. CARE SHALL BE TAKEN AT ALL SIDE ROADS DURING MILLING OPERATIONS TO ENSURE THAT THE PROPOSED RESURFACING WILL MEET THE EXISTING SIDE ROADS AS SHOWN ON THE DETAILS.
7. ROAD CONSTRUCTION AHEAD SIGNS SHALL BE PLACED AT THE BEGINNING AND END OF THE PROJECT PLUS THE INTERSECTING SIDE ROADS, AND WILL BE CONSIDERED INCLUDED IN THE TRAFFIC CONTROL PAY ITEMS. ALL CONSTRUCTION SIGNS SHALL BE FLUORESCENT ORANGE (48"X 48").
8. ALL STATIONING NOTED ON THE PLANS IS APPROXIMATE AND HAS BEEN ROUNDED TO THE NEAREST FOOT.

INDEX OF SHEETS & GENERAL NOTES

FAP RTE 322 (US 51)
SECTION (29-Z-2, 30-2)RS-3
MARION COUNTY

GENERAL NOTES

TOTAL SHEETS	SHEET NO.
41	3
CONTRACT NO. 76B36	

9. PRIOR TO ANY MILLING OPERATIONS THE RESIDENT ENGINEER SHALL ACCURATELY MARK AND DOCUMENT ALL EXISTING PAVEMENT MARKINGS, INCLUDING ALL LANE MARKINGS, CROSS-WALKS, STOP-BARS, AND SYMBOLS. AFTER ALL MILLING AND OVERLAY OPERATIONS HAVE BEEN COMPLETED THE PROPOSED THERMOPLASTIC PAVEMENT MARKING SHALL BE PLACED AT THE EXISTING DOCUMENTED LOCATIONS OR AS DIRECTED ON THE PLAN SHEETS. THIS WORK SHALL BE INCLUDED IN THE PAY ITEM THERMOPLASTIC PAVEMENT MARKING AND NO ADDITIONAL COMPENSATION SHALL BE ALLOWED.
10. SHORT TERM PAVEMENT MARKING SHALL BE APPLIED TO THE MILLED, BINDER, AND FINAL SURFACE COURSE, ONLY THE REMOVAL OF THE FINAL SURFACE APPLICATION WILL BE PAID FOR (WORK ZONE PAVEMENT MARKING REMOVAL - SQ FT).
11. STRIP REFLECTIVE CRACK CONTROL TREATMENT SHALL BE PROVIDED THROUGHOUT THE CURB AND GUTTER SECTION (URBAN) OF THE PROJECT. THE TREATMENT SHALL BE PROVIDED AT THE INTERSECTION OF THE DRIVING LANES AND PARKING LANES AT THE DISCRETION OF THE ENGINEER. THE TREATMENT SHALL BE INSTALLED AFTER THE PLACEMENT OF THE LEVEL BINDER AND PRIOR TO THE PLACEMENT OF THE SURFACE COURSE.
10. THE STATIONING PROVIDED IN THE PATCHING SCHEDULE IS APPROXIMATE AND THE ACTUAL LOCATIONS OF THE PATCHES MAY DEVIATE SOMEWHAT FROM WHAT IS SHOWN ON THE PLANS. THE AREAS TO BE PATCHED SHALL BE AT THE DISCRETION OF THE ENGINEER. THE DEPTH OF THE PAVEMENT PATCHING SHALL MATCH THE EXISTING PAVEMENT DEPTH. THE EXISTING PAVEMENT DEPTHS SHOWN ON THE PLANS WERE COLLECTED FROM PAST PLANS AS PROVIDED BY THE ILLINOIS DEPARTMENT OF TRANSPORTATION. THE ACTUAL PAVEMENT DEPTHS IN THE FIELD MAY DEVIATE SOMEWHAT FROM WHAT IS SHOWN ON THE PLANS.
APPLICABLE STANDARDS:

000001	630001	635006	701006	701306	701336	701601	701801	781001
442201	630301	635011	701011	701311	701421	701606	701901	
482011	631011	668001	701301			701701	780001	

11. THE FOLLOWING MIXTURE REQUIREMENTS ARE APPLICABLE FOR THIS PROJECT:

MIXTURE USE	SURFACE	LEVEL BINDER	BINDER/PATCHING	INCIDENTAL SURF.
AC/PG	SBS PG 76-22	PG 64-22	PG 64-22	PG 64-22
RAP % (MAX)	10%	15%	15%	10%
DESIGN AIR VOIDS	4.0% @ Ndes=70	4.0% @ Ndes=70	4.0% @ Ndes=70	4.0% @ Ndes=70
MIX COMPOSITION (GRADATION MIXTURE)				
FRICITION AGG	MIXTURE "D"	MIXTURE "C"	MIXTURE "B"	MIXTURE "C"
MIXTURE USE	PARTIAL DEPTH PATCH	SHOULDERS	TOP LIFT SHOULDERS	
AC/PG	PG 64-22	PG 58-22	PG 58-22	
RAP % (MAX)	15%	30%	30%	
DESIGN AIR VOIDS	4.0% @ Ndes=70	2.0% @ Ndes=30	**2.0% @ Ndes=30	
MIX COMPOSITION (GRADATION MIXTURE)				
FRICITION AGG	MIXTURE "D"	BAM	BAM	

** TOP LIFT SHOULDERS - DESIGN THIS MIX AT 2.0% VOIDS AND ADD ASPHALT TO REDUCE VOIDS TO 1.5%.
 PLAN QUANTITIES FOR BITUMINOUS CONCRETE SURFACE COURSE ITEMS ARE CALCULATED USING A UNIT WEIGHT OF 112 LB/SQ YD/IN (59.8 KG/SQ M/25 MM THICKNESS).

INDEX OF SHEETS & GENERAL NOTES

FAP RTE 322 (US 51)
 SECTION (29-Z-2, 30-2)RS-3
 MARION COUNTY

DATE: 01/31/2008
 /6020/6020.MAR.US.51/contract No 2 (SB US 51/Cadd Files/C.RK.S51.dgn

##DATE##
 DATE-TIME
 -DGN-SPEC-

SUMMARY OF QUANTITIES

Y025

CODE NO	ITEM	UNIT	URBAN TOTAL QUANTITIES	CONSTRUCTION TYPE CODE	
				80% FEDERAL 20% STATE	50% STATE CENTRALIA
40600200	BITUMINOUS MATERIALS (PRIME COAT)	TON	86.2	83	3.2
40600300	AGGREGATE (PRIME COAT)	TON	414	398	16
40600635	LEVELING BINDER (MACHINE METHOD), N70	TON	4279	4171	108
40600895	CONSTRUCTING TEST STRIP	EACH	1	1	
40600982	HOT-MIX ASPHALT SURFACE REMOVAL - BUTT JOINT	SQ YD	1779	1779	
40600990	TEMPORARY RAMP	SQ YD	1098	1098	
40603540	POLYMERIZED HOT-MIX ASPHALT SURFACE COURSE, MIX "D", N70	TON	8982	8550	432
40800050	INCIDENTAL HOT-MIX ASPHALT SURFACING	TON	58	58	
44000152	HOT-MIX ASPHALT SURFACE REMOVAL, 3/4"	SQ YD	118755	118755	
44000155	HOT-MIX ASPHALT SURFACE REMOVAL, 1 1/2"	SQ YD	7212	7212	
44000198	HOT-MIX ASPHALT SURFACE REMOVAL, VARIABLE DEPTH	SQ YD	11044	5899	5145
44000500	COMBINATION CURB AND GUTTER REMOVAL	FOOT	25	25	

TOTAL SHEETS	SHEET NO.
41	4
CONTRACT NO. Y6B36	

SUMMARY OF QUANTITIES

FAP RTE 322 (US 51)
 SECTION (29-Z-2,30-20)RS-3
 MARION COUNTY

PLOT DATE: DATE-TIME

DATE-TIME
 DATE-TIME
 DATE-TIME

SUMMARY OF QUANTITIES

1000 1025

CODE NO	ITEM	UNIT	URBAN TOTAL QUANTITIES	CONSTRUCTION TYPE		CODE
				80% FEDERAL 20% STATE	50% STATE 50% CENTRALIA	
44200144	PAVEMENT PATCHING, TYPE II, 12 INCH	SO YD	397	397		
44200148	PAVEMENT PATCHING, TYPE III, 12 INCH	SO YD	43	43		
44200150	PAVEMENT PATCHING, TYPE IV, 12 INCH	SO YD	58	58		
44300200	STRIP REFLECTIVE CRACK CONTROL TREATMENT	FOOT	5246	5246		
48102100	AGGREGATE WEDGE SHOULDERS, TYPE B	TON	720	720		
48203100	HOT-MIX ASPHALT SHOULDERS	TON	3895	3895		
60300350	MANHOLE FRAMES TO BE ADJUSTED	EACH	2	2		
60300405	VALVE BOX FRAMES TO BE ADJUSTED	EACH	7	7		
60600505	CONCRETE CURB (SPECIAL)	FOOT	20	20		
60603900	COMBINATION CONCRETE CURB AND GUTTER, TYPE B-6.12 (ABUTTING EXISTING PAVEMENT)	FOOT	25	25		
* 63100167	TRAFFIC BARRIER TERMINAL, TYPE 1 (SPECIAL) TANGENT	EACH	2	2		
* 63100169	TRAFFIC BARRIER TERMINAL, TYPE 1 (SPECIAL) FLARED	EACH	1	1		

TOTAL SHEETS	SHEET NO.
41	5
CONTRACT NO.: 76B36	

SUMMARY OF QUANTITIES

FAP RTE 322 (US 51)
 SECTION (29-Z-2,30-20)RS-3
 MARION COUNTY

PLOT DATE: DATE-TIME

*SPECIALTY ITEMS

SUMMARY OF QUANTITIES

1000 1025

CODE NO	ITEM	UNIT	URBAN TOTAL QUANTITIES	CONSTRUCTION TYPE CODE	
				80% FEDERAL 20% STATE	50% STATE 50% CENTRALIA
* 63304345	TERMINAL SECTION REMOVAL, SINGLE RAIL	EACH	3	3	
67000400	ENGINEER'S FIELD OFFICE, TYPE A	CAL MO	4	4	
67100100	MOBILIZATION	L SUM	1	1	
70100310	TRAFFIC CONTROL AND PROTECTION, STANDARD 701421	L SUM	1	1	
70100460	TRAFFIC CONTROL AND PROTECTION, STANDARD 701306	L SUM	1	1	
70100500	TRAFFIC CONTROL AND PROTECTION, STANDARD 701336	L SUM	1	1	
70102625	TRAFFIC CONTROL AND PROTECTION, STANDARD 701606	L SUM	1	1	
70102630	TRAFFIC CONTROL AND PROTECTION, STANDARD 701601	L SUM	1	1	
70102635	TRAFFIC CONTROL AND PROTECTION, STANDARD 701701	L SUM	1	1	
70102640	TRAFFIC CONTROL AND PROTECTION, STANDARD 701801	L SUM	1	1	

TOTAL SHEETS	SHEET NO.
41	5A
CONTRACT NO. 76B36	

* SPECIALTY ITEMS

SUMMARY OF QUANTITIES

FAP RTE 322 (US 51)
SECTION (29-Z-2,30-20)RS-3
MARION COUNTY

PLOT DATE: DATE-TIME

DATE
DATE-TIME
CHK-SPEC

SUMMARY OF QUANTITIES

1800 1025

CODE NO	ITEM	UNIT	URBAN TOTAL QUANTITIES	CONSTRUCTION TYPE		CODE
				80% FEDERAL 20% STATE	50% STATE CENTRALIA	
70300100	SHORT-TERM PAVEMENT MARKING	FOOT	12719	12719		
70300210	TEMPORARY PAVEMENT MARKING - LETTERS AND SYMBOLS	SQ FT	638	638		
70300220	TEMPORARY PAVEMENT MARKING - LINE 4"	FOOT	83295	83295		
70300250	TEMPORARY PAVEMENT MARKING - LINE 8"	FOOT	653	653		
70300260	TEMPORARY PAVEMENT MARKING - LINE 12"	FOOT	2364	2364		
70300280	TEMPORARY PAVEMENT MARKING - LINE 24"	FOOT	453	453		
70301000	WORK ZONE PAVEMENT MARKING REMOVAL	SQ FT	36313	36313		
*78000100	THERMOPLASTIC PAVEMENT MARKING - LETTERS AND SYMBOLS	SQ FT	638	638		
*78000200	THERMOPLASTIC PAVEMENT MARKING - LINE 4"	FOOT	83295	83295		
*78000500	THERMOPLASTIC PAVEMENT MARKING - LINE 8"	FOOT	653	653		
*78000600	THERMOPLASTIC PAVEMENT MARKING - LINE 12"	FOOT	2364	2364		

*SPECIALTY ITEMS

SUMMARY OF QUANTITIES

FAP RTE 322 (US 51)
SECTION (29-Z-2,30-20)RS-3
MARION COUNTY

PLOT DATE: DATE-TIME

SS-DATES
 -DATE-TIME-
 -CON-SPEC-

SUMMARY OF QUANTITIES

1800 7025

CODE NO	ITEM	UNIT	URBAN TOTAL QUANTITIES	CONSTRUCTION TYPE		CODE
				80% FEDERAL 20% STATE	50% STATE CENTRALIA	
* 78000650	THERMOPLASTIC PAVEMENT MARKING - LINE 24"	FOOT	453	453		
* 78100100	RAISED REFLECTIVE PAVEMENT MARKER	EACH	704	704		
* 78201000	TERMINAL MARKER - DIRECT APPLIED	EACH	3	3		
78300200	RAISED REFLECTIVE PAVEMENT MARKER REMOVAL	EACH	704	704		
X4400100	PORTLAND CEMENT CONCRETE SURFACE REMOVAL (VARIABLE DEPTH)	SQ YD	545	545		
X6610100	BITUMINOUS CURB REPAIR	FOOT	10	10		
Z0048665	RAILROAD PROTECTIVE LIABILITY INSURANCE	L SUM	1	1		
Z0076600	TRAINERS	HOLIR	1000	1000		

TOTAL SHEETS	SHEET NO.
41	5C
CONTRACT NO. 76B36	

SUMMARY OF QUANTITIES

FAP RTE 322 (US 51)
 SECTION (29-Z-2,30-20)RS-3
 MARION COUNTY

PLOT DATE: DATE-TIME

* SPECIALTY ITEMS
 @ Y080

Rev

DATE: 01/31/2008
 /6026/6022.MAD.US 51/Contract No. 2 09 US 50/Cadd Files/C-SCHEDULE.ES.0951.dgn

PATCHING SCHEDULE - US 51

LOCATION	PAVEMENT PATCHING						COMBINATION CURB AND GUTTER REMOVAL	COMB. CONCRETE CURB AND GUTTER, TYPE B-6J2 (ABUTTING EXISTING PAVEMENT)	CONCRETE CURB (SPECIAL)	BITUMINOUS CURB REPAIR				
	LENGTH		WIDTH		TYPE II,12						TYPE III, 12		TYPE IV, 12	
	FOOT	FOOT	FOOT	FOOT	SQ YD	SQ YD					SQ YD	SQ YD	SQ YD	FOOT
STATION	FOOT	FOOT	FOOT	FOOT	SQ YD	SQ YD	SQ YD	SQ YD	SQ YD	FOOT	FOOT	FOOT		
729+50	22	4	4	10										
729+50	19	4	4	8										
729+50	19	4	4	8										
729+50	22	4	4	10										
732+00	17	4	4	8										
732+00	17	4	4	8										
765+50	22	4	4	10										
765+50	19	4	4	8										
765+50	19	4	4	8										
765+50	22	4	4	10										
770+75	22	4	4	10										
770+75	26	4	4	12										
771+25 (S.B.)												10		
781+25	17	6	6	11								10		
781+25	17	6	6	11								10		
782+17 (S.B.)												10		
796+75 (S.B.)												10		
797+00	22	4	4	10										
797+00	26	4	4	12										
826+50	15	6	6	10										
826+50	15	6	6	10										
831+75	15	4	4	7										
831+75	15	4	4	7										
832+50	15	15	15						25					
832+50	15	15	15						25					
1727+00	21	4	4	9										
1725+00	21	6	6	14										

TOTAL SHEETS: 41
 SHEET NO.: 6
 CONTRACT NO. 76836

SCHEDULE CONTINUED ON NEXT SHEET

PATCHING SCHEDULE
 FAP RTE 322 (US 51)
 SECTION (29-Z-2, 30-2)RS-3
 MARION COUNTY

DATE: 01/31/2008
 /6620/6620.H10_US_51/Contract/No 2 US 51/Cadd/Files/C_SCHEDULES/8851.dgn

SCHEDULE CONTINUED FROM PREVIOUS SHEET

PATCHING SCHEDULE - US 51

LOCATION	PAVEMENT PATCHING						COMBINATION CURB AND GUTTER REMOVAL	COMB. CONCRETE CURB AND GUTTER, TYPE B-6.12 (ABUTTING EXISTING PAVEMENT)	CONCRETE CURB (SPECIAL)	BITUMINOUS CURB REPAIR
	LENGTH		WIDTH	TYPE II,12	TYPE III, 12	TYPE IV, 12				
	FOOT	FOOT								
STATION	FOOT	FOOT	FOOT	SQ YD	SQ YD	SQ YD	FOOT	FOOT	FOOT	
1725+00	21	6	14							
1722+00	21	4	9							
1722+00	21	4	9							
1720+00	21	8		19						
1720+00	21	8		19						
1717+00	21	6	14							
1717+00	21	6	14							
1714+00	21	6	14							
1714+00	21	6	14							
1711+75	21	4	9							
1711+75	21	4	9							
1710+50							10			
1708+00							5			
1705+75	21	6	14							
1705+75	21	6	14							
1704+00							10			
15% CONTINGENCY			52	6	43	58	25	25	10	
TOTALS			397	43	58	25	25	20	10	

* PATCHING QUANTITIES HAVE BEEN BROKEN UP FOR STAGING PURPOSES.

TOTAL SHEETS	SHEET NO.
41	7

CONTRACT NO. 76836

PATCHING SCHEDULE

FAP RTE 322 (US 51)
 SECTION (29-Z-2, 30-2)RS-3
 MARION COUNTY

DATE: 01/21/2008
 /6928/6998/REQ_US_51/Contract/No. 2 US 51/Case/Files/C_SCHEDULES_S851.dgn

SURFACE REMOVAL SCHEDULE - US 51

LOCATION		STATION		LT/RT	HOT-MIX ASPHALT SURFACE REMOVAL, 3/4"	HOT-MIX ASPHALT SURFACE REMOVAL, 1 1/2"	HOT-MIX ASPHALT SURFACE REMOVAL* VARIABLE DEPTH	PORTLAND CEMENT CONCRETE SURFACE REMOVAL (VARIABLE DEPTH)	HOT-MIX ASPHALT SURFACE REMOVAL - BUTT JOINT	TEMPORARY RAMP
STATION	TO	STATION	TO		SO YD	SO YD	SO YD	SO YD	SO YD	SO YD
US 51 SOUTHBOUND & NORTHBOUND										
680+91	TO	681+21		LT/RT						
681+21	TO	726+60		LT/RT	40,217.4		1,119.2	300.1	260.0	44.0
726+60	TO	771+20		LT/RT	40,538.9		679.5			327.0
771+20	TO	780+07		LT/RT	6,552.9		1,407.7			153.5
780+07 (N.B.)	TO	780+60 (N.B.)			141.6		56.8			22.2
780+07 (S.B.)	TO	780+97 (S.B.)			253.9		93.7			
780+60 (N.B.)	TO	780+90 (N.B.)							111.7	18.6
780+97 (S.B.)	TO	781+27 (S.B.)							111.7	18.6
780+90 (N.B.)	TO	781+70 (N.B.)			84.5					
781+27 (S.B.)	TO	782+07 (S.B.)			84.2					
BRIDGE OMISSION										
784+62 (N.B.)	TO	785+42 (N.B.)			84.6					
785+07 (S.B.)	TO	785+87 (S.B.)			84.3					
785+42 (N.B.)	TO	785+72 (N.B.)							111.7	18.6
785+87 (S.B.)	TO	786+17 (S.B.)							112.4	18.6
785+72 (N.B.)	TO	787+46 (N.B.)			463.3		184.4			
786+17 (S.B.)	TO	787+46 (S.B.)			377.2		133.1			
787+46	TO	796+82		LT/RT	6,794.6		1,536.9			19.1
796+82	TO	810+03		LT/RT	11,554.7		610.1	142.7		150.7

SCHEDULE CONTINUED ON NEXT SHEET

SURFACE REMOVAL SCHEDULE - US 51

FAP RTE 322 (US 51)
 SECTION (29-Z-2, 30-2)RS-3
 MARIÓN COUNTY

TOTAL SHEETS	SHEET NO.
41	8
CONTRACT NO. 76B36	

DATE: 01/31/2008

SCHEDULE CONTINUED FROM PREVIOUS SHEET

LOCATION		SURFACE REMOVAL SCHEDULE - US 51									
STATION	TO	STATION	LT/RT	HOT-MIX ASPHALT SURFACE REMOVAL, 3/4"	HOT-MIX ASPHALT SURFACE REMOVAL, 1 1/2"	HOT-MIX ASPHALT SURFACE REMOVAL, VARIABLE DEPTH	PORTLAND CEMENT CONCRETE SURFACE REMOVAL (VARIABLE DEPTH)	HOT-MIX ASPHALT SURFACE REMOVAL BUTT JOINT	TEMPORARY RAMP		
STATION	TO	STATION	LT/RT	SQ YD	SQ YD	SQ YD	SQ YD	SQ YD	SQ YD		
US 51 SOUTHBOUND											
810+03	TO	839+28.14	LT/RT	10,122.0		6.7	101.8		25.3		
STATION EQUATION											
1728+04.03	TO	1727+83	LT/RT	97.4							
1727+83	TO	1717+95	LT/RT		2,634.7	1,976.0					
1717+95	TO	1717+80	LT/RT					70.0	23.3		
RAILROAD OMISSION											
1717+54	TO	1717+39	LT/RT					70.0	24.0		
1717+39	TO	1701+49	LT/RT		4,240.0	3,180.0		70.0	23.3		
1701+49	TO	1701+34	LT/RT								
US 51 NORTHBOUND											
810+03	TO	813+07	LT/RT	1,308.5							
813+07	TO	813+37	LT/RT					100.0	16.7		
CONNECTOR ROAD				332.8				80.0	13.3		
TOTALS				118,755	7,212	11,044	545	1,097	917		

TOTAL SHEETS	SHEET NO.
41	9
CONTRACT NO. 76836	

SURFACE REMOVAL SCHEDULE - US 51

FAP RTE 322 (US 51)
SECTION (29-Z-2, 30-2)RS-3
MARION COUNTY

SURFACE REMOVAL SCHEDULE - SIDE ROADS						
LOCATION			* L	** W	HOT-MIX ASPHALT SURFACE REMOVAL - BUTT JOINT	TEMPORARY RAMP
STREET	STATION	RT/LT	FOOT	FOOT	SQ YD	SQ YD
17TH	1727+50	RT	10	36	49.3	13.3
17TH	1727+50	LT	10	36	49.3	13.3
15TH	1722+33	RT	10	40	56.0	14.8
15TH	1722+33	LT	10	40	56.0	14.8
14TH	1717+46	RT	10	16	20.1	5.9
14TH	1717+47	LT	10	14	18.0	5.2
13TH	1714+43	RT	10	33	48.3	12.2
13TH	1714+42	LT	10	33	48.3	12.2
12TH	1710+99	RT	10	40	56.0	14.8
12TH	1711+00	LT	10	40	56.0	14.8
11TH	1707+57	RT	10	40	56.0	14.8
11TH	1707+59	LT	10	40	56.0	14.8
10TH	1704+27	RT	10	40	56.0	14.8
10TH	1704+27	LT	10	40	56.0	14.8
TOTALS					682	181
<p>* L = LENGTH FROM THE FLAG OF GUTTER OF US 51 TO THE LIMIT OF IMPROVEMENTS FOR</p> <p>** W = WIDTH OF THE SIDE ROAD AT THE LIMIT OF IMPROVEMENTS</p>						

DATE: 01/31/2008
 /E:\2008\0228\IND\US 51\Contract No. 2 (S) US 51\Cadd Files\C SCHEDULES.SR1.dgn

**SURFACE REMOVAL
 SCHEDULE - SIDE ROADS**

FAP RTE 322 (US 51)
 SECTION (29-Z-2, 30-2)RS-3
 MARION COUNTY

DATE: 01/31/2008
 7:02:26/3026 1440 US 51/Center-st No 2 (S8 US 51/Cent-st File/C-SCHEDULES_S8S1.dgn

RESURFACING SCHEDULE - US 51

LOCATION		STATION	TO	STATION	LT/RT	BITUMINOUS MATERIALS (PRIME COAT)	AGGREGATE (PRIME COAT)	LEVELING BINDER (MACHINE METHOD), NTO	STRIP REFLECTIVE CRACK CONTROL TREATMENT	POLYMERIZED HOT-MIX ASPHALT SURFACE COURSE, MIX D, NTO	HOT-MIX ASPHALT SHOULDERS	AGGREGATE WEDGE SHOULDERS, TYPE B
STATION	TO	STATION	TO	STATION	LT/RT	TON	TON	TON	FOOT	TON	TON	TON
US 51 SOUTHBOUND & NORTHBOUND												
680+91	TO	681+21			LT/RT	0.08	0.39			28.0		2.3
681+21	TO	726+60			LT/RT	25.87	124.01	1,158.5		2,356.7	1,681.3	324.2
726+60	TO	771+20			LT/RT	25.79	123.66	1,325.8		2,670.6	1,173.3	153.5
771+20	TO	780+07			LT/RT	4.98	23.88	257.6		520.9	194.8	17.8
780+07 (N.B.)	TO	780+60 (N.B.)				0.12	0.60	5.9		11.9	6.0	
780+07 (S.B.)	TO	780+97 (S.B.)				0.22	1.04	11.6		23.2	9.8	
780+60 (N.B.)	TO	780+90 (N.B.)				0.03	0.17			11.7		
780+97 (S.B.)	TO	781+27 (S.B.)				0.03	0.17			11.7		
780+90 (N.B.)	TO	781+70 (N.B.)				0.03	0.13				7.1	
781+27 (S.B.)	TO	782+07 (S.B.)				0.03	0.13				7.1	
BRIDGE OMISSION												
784+62 (N.B.)	TO	785+42 (N.B.)				0.03	0.13				7.1	
785+07 (S.B.)	TO	785+97 (S.B.)				0.03	0.13				7.1	
785+42 (N.B.)	TO	785+72 (N.B.)				0.03	0.17			11.7		
785+97 (S.B.)	TO	786+17 (S.B.)				0.04	0.17			11.8		
785+72 (N.B.)	TO	787+46 (N.B.)				0.41	1.94	19.5		38.9	19.4	
786+17 (S.B.)	TO	787+46 (S.B.)				0.32	1.53	15.8		31.7	14.0	
787+46	TO	796+92			LT/RT	5.25	25.17	271.8		547.1	207.6	15.7
796+92	TO	810+03			LT/RT	7.61	36.49	406.8		834.5	282.5	84.0

SCHEDULE CONTINUED ON NEXT SHEET

RESURFACING SCHEDULE - US 51

FAP RTE 322 (US 51)
 SECTION (29-Z-2, 30-2)RS-3
 MARION COUNTY

TOTAL SHEETS	SHEET NO.
41	11

CONTRACT NO. 76B36

DATE 01/31/2008
 /6828/6950.MKD.US.51/Contract No. 2.098 US 51/Code Files/C-SCHEDULES_SBSI.dgn

SCHEDULE CONTINUED FROM PREVIOUS SHEET

RESURFACING SCHEDULE - US 51

LOCATION		STATION	TO	STATION	LT/RT	BITUMINOUS MATERIALS (PRIME COAT)	AGGREGATE (PRIME COAT)	LEVELING BINDER (MACHINE METHOD), N70	STRIP REFLECTIVE CRACK CONTROL TREATMENT	POLYMERIZED HOT-MIX ASPHALT SURFACE COURSE, MIX D, N70	HOT-MIX ASPHALT SHOULDERS	AGGREGATE WEDGE SHOULDERS, TYPE B
		TON		TON		TON	TON	TON	FOOT	TON	TON	TON
US 51 SOUTHBOUND												
		810+03	TO	839+28.14	LT/RT	6.34	30.39	335.0		673.1	271.1	103.3
STATION EQUATION												
		1728+04.03	TO	1727+83	LT/RT	0.06	0.29	4.1		8.2		0.5
		1727+83	TO	1717+95	LT/RT	2.89	13.83	152.2	1,976.0	387.3		
		1717+95	TO	1717+80	LT/RT	0.02	0.11		30.0	7.4		
RAILROAD OMISSION												
		1717+54	TO	1717+39	LT/RT	0.02	0.11		30.0	7.4		
		1717+39	TO	1701+49	LT/RT	4.64	22.26	244.9	3,180.0	623.3		
		1701+49	TO	1701+34	LT/RT	0.02	0.11		30.0	7.4		
US 51 NORTHBOUND												
		810+03	TO	813+07	LT/RT	0.82	3.93	55.0		109.9		11.5
		813+07	TO	813+37	LT/RT	0.03	0.15			10.5		1.1
CONNECTOR ROAD						0.23	1.12	14.0		36.4		5.0
TOTALS						86.0	413.0	4,279	5,246	8,982	3,895	720

TOTAL SHEETS	SHEET NO.
41	12
CONTRACT NO. 76B36	

RESURFACING SCHEDULE - US 51

FAP RTE 322 (US 51)
 SECTION (29-Z-2, 30-2)RS-3
 MARION COUNTY

RESURFACING SCHEDULE - SIDE ROADS

STREET	LOCATION		STATION	* L		** W	BITUMINOUS MATERIALS (PRIME COAT)		AGGREGATE (PRIME COAT)		INCIDENTAL BIT. SURFACING, SUPERPAVE	
	RT/LT	FOOT		FOOT	TON		TON	TON	TON			
17TH	RT	10	1727+50	36	0.02	0.07	4.1					
17TH	LT	10	1727+50	36	0.02	0.07	4.1					
15TH	RT	10	1722+33	40	0.02	0.08	4.7					
15TH	LT	10	1722+33	40	0.02	0.08	4.7					
14TH	RT	10	1717+46	16	0.01	0.03	1.7					
14TH	LT	10	1717+47	14	0.01	0.03	1.5					
13TH	RT	10	1714+43	33	0.02	0.07	4.1					
13TH	LT	10	1714+42	33	0.02	0.07	4.1					
12TH	RT	10	1710+99	40	0.02	0.08	4.7					
12TH	LT	10	1711+00	40	0.02	0.08	4.7					
11TH	RT	10	1707+57	40	0.02	0.08	4.7					
11TH	LT	10	1707+59	40	0.02	0.08	4.7					
10TH	RT	10	1704+27	40	0.02	0.08	4.7					
10TH	LT	10	1704+27	40	0.02	0.08	4.7					
TOTALS							0.2	1.0	58			

* L = LENGTH FROM THE FLAG OF GUTTER OF US 51 TO THE LIMIT OF IMPROVEMENTS
 ** W = WIDTH OF THE SIDE ROAD AT THE LIMIT OF IMPROVEMENTS

DATE: 01/31/2008
 /682B/682B.MXD US 51/Contract No. 2 688 US 51/Contd. Files/C:\SCHEDULES\8881.dgn

**RESURFACING
 SCHEDULE - SIDE ROADS**

FAP RTE 322 (US 51)
 SECTION (29-Z-2, 30-2)RS-3
 MARION COUNTY

TEMPORARY PAVEMENT MARKING SCHEDULE - US 51

LOCATION	TEMPORARY PAVEMENT MARKING											SHORT TERM PAVEMENT MARKING	WORK ZONE PAVEMENT MARKING REMOVAL							
	STATION	TO	STATION	FOOT	FOOT	FOOT	FOOT	FOOT	FOOT	FOOT	FOOT			FOOT	FOOT	FOOT	FOOT	FOOT	FOOT	SQ. FT.
US 51 SOUTHBOUND & NORTHBOUND																				
680+91	TO	810+03	28,006.2	6,456.0	36,640.4	652.6	127.5	1,664.3	421.2	11,108.7	30,024.6									
US 51 SOUTHBOUND																				
810+03	TO	839+28.14	2,925.1	1,462.6	2,905.0					797.8	2,694.1									
STATION EQUATION																				
1728+04.03	TO	1717+80	742.8	512.0						279.3	510.9									
RAILROAD OMISSION																				
1717+54	TO	1699+58	1,331.1	849.5			409.2		132.7	153.6	441.5	1,701.5								
US 51 NORTHBOUND																				
810+03	TO	813+37	334.0	167.0	334.0					91.1	308.4									
SIDE ROADS																				
BASELINE RD																				
									35.0		70.0									
TERMINAL RD																				
					160.0				54.0		161.3									
WABASH																				
			78.9		148.0				46.5	31.2	199.8									
CR-100N																				
			80.2		160.4				44.0	31.2	199.3									
PINE																				
									18.0		36.0									
ENTRANCE																				
									9.0		18.0									
ENTRANCE																				
									15.0		30.0									
WALNUT HILL																				
									64.0		128.0									
CALLUMET																				
									161.6		323.2									
SUBTOTALS																				
			33,499	9,448	40,348	653	699	1,665	453	638	12,719	36,313								
TOTALS																				
				83,295		653	2,364		453	638	12,719	36,313								

TEMPORARY PAVEMENT MARKING SCHEDULE

FAP RTE 322 (US 51)
SECTION (29-Z-2, 30-2)RS-3
MARION COUNTY

PERMANENT PAVEMENT MARKING SCHEDULE - US 51

LOCATION	THERMOPLASTIC PAVEMENT MARKING										RAISED REFLECTIVE PAVEMENT MARKER REMOVAL	RAISED REFLECTIVE PAVEMENT MARKER		
	SKIP-DASH WHITE, 4"	SOLID YELLOW, 4"	SOLID WHITE, 8"	SOLID WHITE, 12"	SOLID YELLOW, 12"	SOLID WHITE, 24"	LETTERS & SYMBOLS	FOOT	FOOT	FOOT			FOOT	SO FT
US 51 SOUTHBOUND & NORTHBOUND														
680+91 TO 810+03	28,006.2	6,456.0	36,640.4	652.6	127.5	1,664.3	421.2	629.4	629.4					
US 51 SOUTHBOUND														
810+03 TO 839+28.14	2,925.1	1,462.6	2,905.0										36.6	36.6
STATION EQUATION														
1728+04.03 TO 1717+60	742.8	512.0											12.8	12.8
RAILROAD OMISSION														
1717+54 TO 1699+58	1,331.1	849.5			409.2		132.7	153.6	20.2				20.2	20.2
US 51 NORTHBOUND														
810+03 TO 813+37	334.0	167.0	334.0										4.2	4.2
SIDE ROADS														
BASELINE RD							35.0							
TERMINAL RD		160.0					54.0							
WABASH	78.9	148.0					46.5	31.2						
CR-100N	80.2	160.4					44.0	31.2						
PINE							18.0							
ENTRANCE							9.0							
ENTRANCE							15.0							
WALNUT HILL							64.0							
CALLUMET					162.0		34.5							
SUBTOTALS	33,499	9,448	40,348	653	699	1,665	453	638	704	704	704	704	704	704
TOTALS		83,295		653	2,364		453	638	704	704	704	704	704	704

DATE: 01/20/2009
 /6826/8026.HRO.US 51/Contract No. 2 USB US 51/Code Files/C/SCHEDULES/SBS1.dgn

PERMANENT PAVEMENT MARKING SCHEDULE

FAP RTE 322 (US 51)
 SECTION (29-Z-2, 30-2)RS-3
 MARION COUNTY

GUARDRAIL SCHEDULE - US 51				
LOCATION	TERMINAL SECTION REMOVAL, SINGLE RAIL	TRAFFIC BARRIER TERMINAL TYPE 1, SPECIAL (TANGENT)	TRAFFIC BARRIER TERMINAL TYPE 1, SPECIAL (FLARED)	TERMINAL MARKER - DIRECT APPLIED
STATION	EACH	EACH	EACH	EACH
724+25 (S.B.)	1		1	1
776+45 (N.B.)	1	1		1
794+50 (S.B.)	1	1		1
TOTALS	3	2	1	3

UTILITY ADJUSTMENT SCHEDULE - US 51					
LOCATION				WATER VALVES TO BE ADJUSTED	MANHOLES TO BE ADJUSTED
				56109210	60255500
STATION	TO	STATION	LT/RT	EACH	EACH
US 51 SOUTHBOUND & NORTHBOUND					
680+91	TO	681+21	LT/RT		
681+21	TO	726+60	LT/RT	1	
726+60	TO	771+20	LT/RT		
771+20	TO	780+07	LT/RT		
780+07 (N.B.)	TO	780+90 (N.B.)			
780+07 (S.B.)	TO	781+28 (S.B.)			
780+90 (N.B.)	TO	781+70 (N.B.)			
781+28 (S.B.)	TO	782+08 (S.B.)			
BRIDGE OMISSION					
784+62 (N.B.)	TO	785+42 (N.B.)			
785+07 (S.B.)	TO	785+87 (S.B.)			
785+42 (N.B.)	TO	787+46 (N.B.)			
785+87 (S.B.)	TO	787+46 (S.B.)			
787+46	TO	796+82	LT/RT		
796+82	TO	810+03	LT/RT		
US 51 SOUTHBOUND					
810+03	TO	839+28.14	LT/RT		
STATION EQUATION					
1728+04.03	TO	1727+83	LT/RT		
1727+83	TO	1717+95	LT/RT	2	
1717+95	TO	1717+80	LT/RT		
RAILROAD OMISSION					
1717+54	TO	1717+39	LT/RT	1	1
1717+39	TO	1701+49	LT/RT	3	1
1701+49	TO	1701+34	LT/RT		
US 51 NORTHBOUND					
810+03	TO	813+07	LT/RT		
813+07	TO	813+37	LT/RT		
CONNECTOR ROAD					
TOTALS					
				7	2

GUARDRAIL & UTILITY ADJUSTMENT SCHEDULE

FAP RTE 322 (US 51)
SECTION (29-Z-2, 30-2)RS-3
MARION COUNTY

DATE: 01/31/2008 / 8020/6020.M40.US.DY/Cont-rect No. 2 (SB US 51/Cadd Files/C-SCHEDULES_SBS).dgn

DATE: 01/31/2008
 /B232/5222/460.US_51/Contract No. 2 688 US 51/Contd. Files/PC-TYPSECT-SBS3.dgn

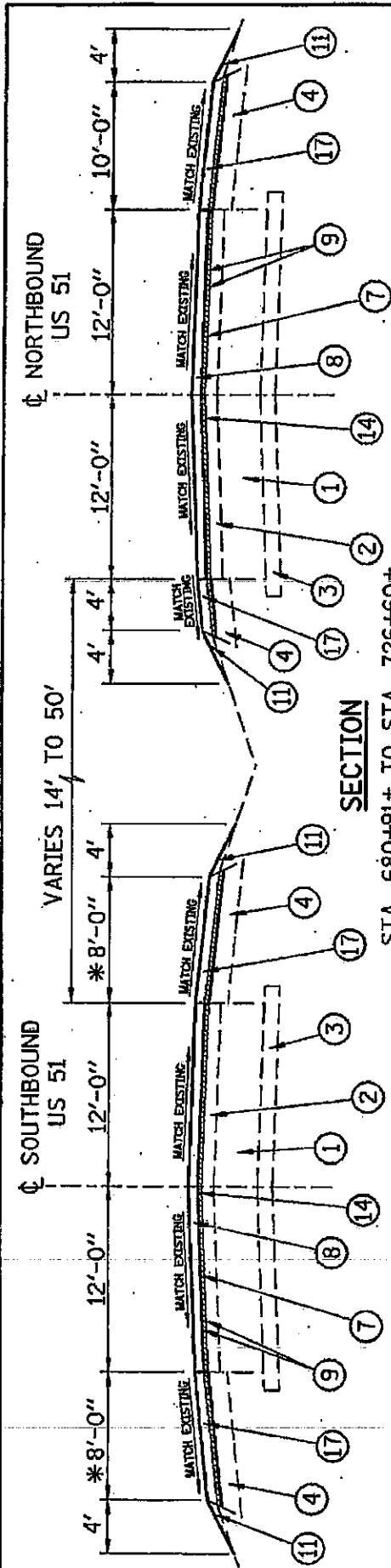

SECTION
 STA. 680+91± TO STA. 726+60±
 * STA. 713+51± TO STA. 726+60± (S.B.) : OUTSIDE SHLDR = 10', INSIDE SHLDR = 4'

LEGEND

- ① EXISTING PCC PAVEMENT 9"
- ② EXISTING HOT-MIX ASPHALT PAVEMENT
- ③ EXISTING AGGREGATE SUBBASE, 4"
- ④ EXISTING HOT-MIX ASPHALT SHOULDERS
- ⑤ EXISTING AGGREGATE SHOULDERS
- ⑥ EXISTING CURB & GUTTER
- ⑦ LEVELING BINDER (MACHINE METHOD), 3/4 "
- ⑧ POLYMERIZED HOT-MIX ASPHALT SURFACE COURSE, 1 1/2 "
- ⑨ BITUMINOUS MATERIALS & AGGREGATE (PRIME COAT)
- ⑩ LEVELING BINDER (MACHINE METHOD), (N70), VARIABLE DEPTH
- ⑪ AGGREGATE WEDGE SHOULDERS, TYPE B
- ⑫ EXISTING BITUMINOUS CURB
- ⑬ HOT-MIX ASPHALT SURFACE REMOVAL, VARIABLE DEPTH
- ⑭ HOT-MIX ASPHALT SURFACE REMOVAL, 3/4"
- ⑮ HOT-MIX ASPHALT SURFACE REMOVAL, 1 1/2 "
- ⑯ STRIP REFLECTIVE CRACK CONTROL TREATMENT
- ⑰ HOT-MIX ASPHALT SHOULDERS

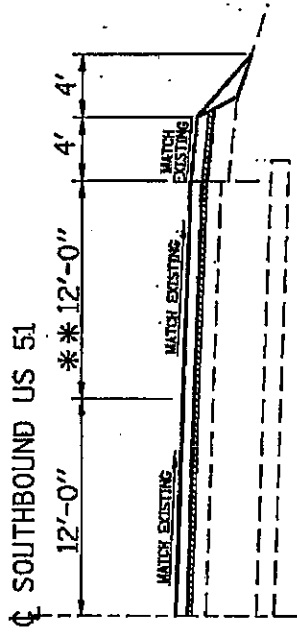

TYPICAL SECTION
 FAP RTE 322 (US 51)
 SECTION (29-Z-2, 30-2)RS-3
 MARION COUNTY

TOTAL SHEETS	SHEET NO.
41	17

CONTRACT NO. 76B36

** WHEN LEFT TURN LANE PRESENT (SIMILAR FOR N.B. LEFT TURN LANES)

DATE: 01/31/2008
 /6926/6926.HQ.US 51/Contract No. 2 198 US 51/Const File/RT-TYP/SECT.SBSL.dgn

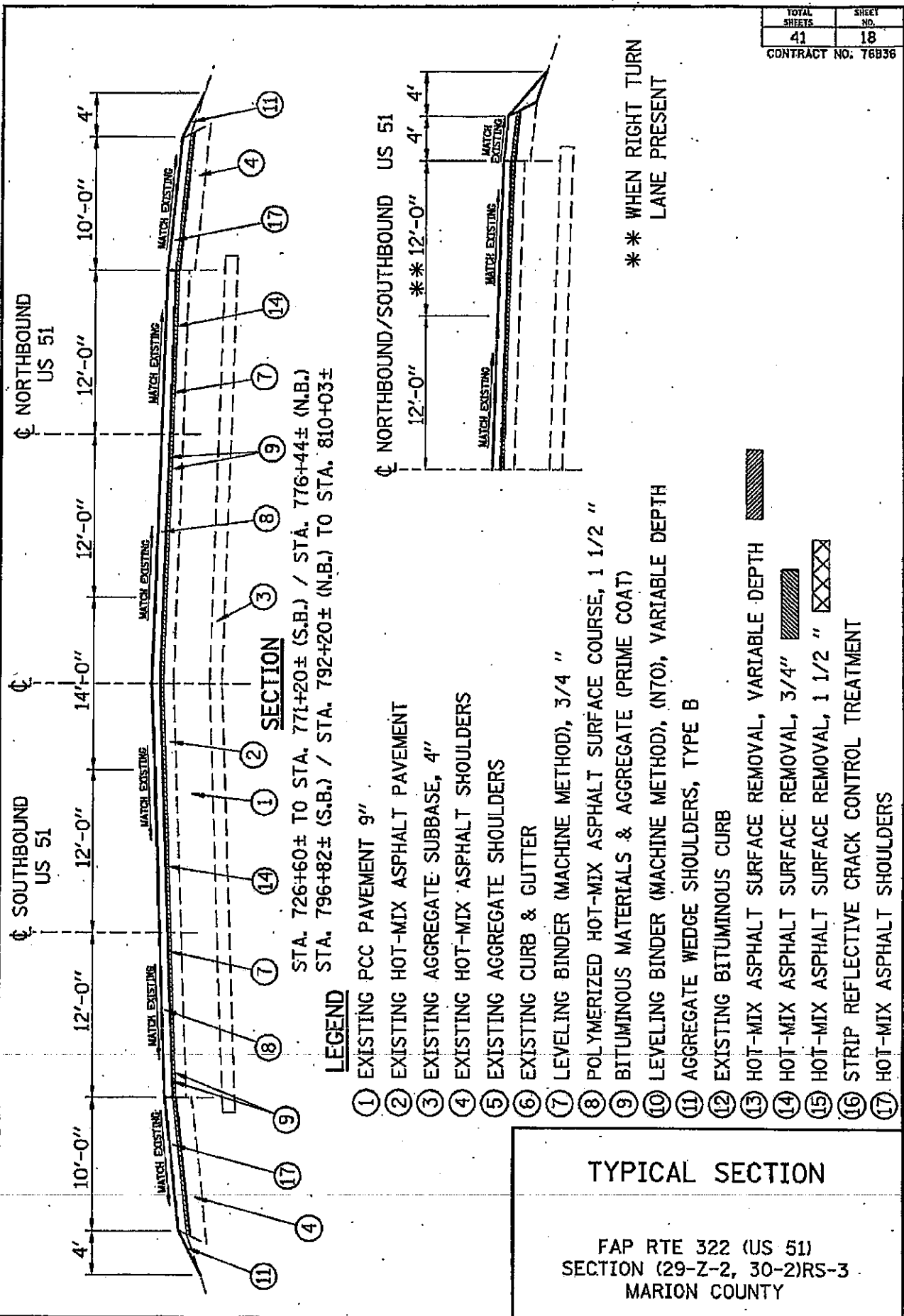

☐ NORTHBOUND
US 51

☐ SOUTHBOUND
US 51

SECTION

STA. 726+60± TO STA. 771+20± (S.B.) / STA. 776+44± (N.B.)
 STA. 796+82± (S.B.) / STA. 792+20± (N.B.) TO STA. 810+03±

LEGEND

- ① EXISTING PCC PAVEMENT 9"
- ② EXISTING HOT-MIX ASPHALT PAVEMENT
- ③ EXISTING AGGREGATE SUBBASE, 4"
- ④ EXISTING HOT-MIX ASPHALT SHOULDERS
- ⑤ EXISTING AGGREGATE SHOULDERS
- ⑥ EXISTING CURB & GUTTER
- ⑦ LEVELING BINDER (MACHINE METHOD), 3/4 "
- ⑧ POLYMERIZED HOT-MIX ASPHALT SURFACE COURSE, 1 1/2 "
- ⑨ BITUMINOUS MATERIALS & AGGREGATE (PRIME COAT)
- ⑩ LEVELING BINDER (MACHINE METHOD), (NTO), VARIABLE DEPTH
- ⑪ AGGREGATE WEDGE SHOULDERS, TYPE B
- ⑫ EXISTING BITUMINOUS CURB
- ⑬ HOT-MIX ASPHALT SURFACE REMOVAL, VARIABLE DEPTH
- ⑭ HOT-MIX ASPHALT SURFACE REMOVAL, 3/4"
- ⑮ HOT-MIX ASPHALT SURFACE REMOVAL, 1 1/2 "
- ⑯ STRIP REFLECTIVE CRACK CONTROL TREATMENT
- ⑰ HOT-MIX ASPHALT SHOULDERS

TYPICAL SECTION

FAP RTE 322 (US 51)
 SECTION (29-Z-2, 30-2)RS-3
 MARION COUNTY

** WHEN RIGHT TURN
LANE PRESENT

TOTAL SHEETS	SHEET NO.
41	18

CONTRACT NO: 76836

DATE: 01/31/2008
 /R222/6620_MARION_US 51/Contract No. 2 USB US 51/Cadd Files/C:\TYPSET\SS151.dgn

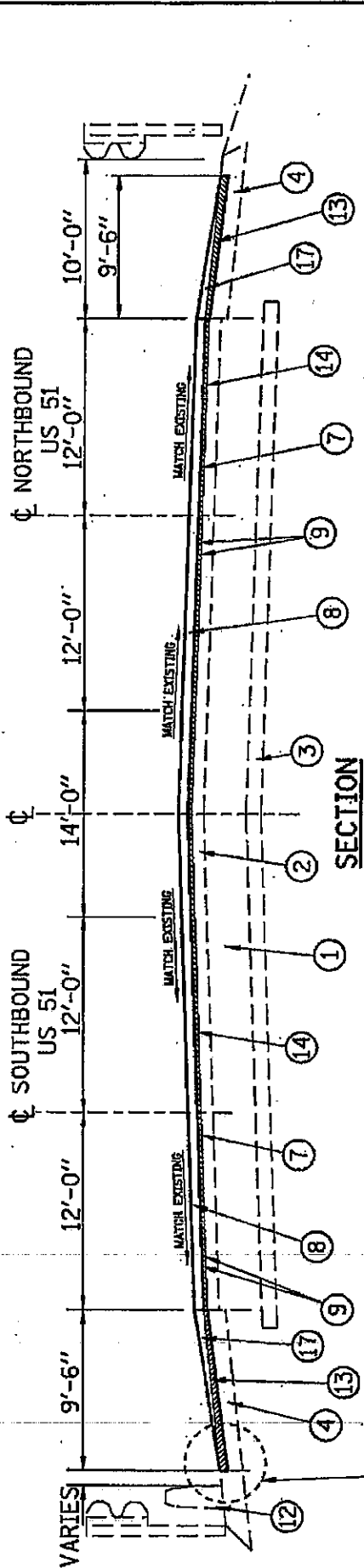

STA. 771+20± (S.B.) / STA. 776+44± (N.B.) TO STA. 780+07±
 STA. 787+46± TO STA. 796+82± (S.B.) / STA. 792+20± (N.B.)

LEGEND

- ① EXISTING PCC PAVEMENT 9"
- ② EXISTING HOT-MIX ASPHALT PAVEMENT
- ③ EXISTING AGGREGATE SUBBASE, 4"
- ④ EXISTING HOT-MIX ASPHALT SHOULDERS
- ⑤ EXISTING AGGREGATE SHOULDERS
- ⑥ EXISTING CURB & GUTTER
- ⑦ LEVELING BINDER (MACHINE METHOD); 3/4"
- ⑧ POLYMERIZED HOT-MIX ASPHALT SURFACE COURSE, 1 1/2"
- ⑨ BITUMINOUS MATERIALS & AGGREGATE (PRIME COAT)
- ⑩ LEVELING BINDER (MACHINE METHOD), (N70), VARIABLE DEPTH
- ⑪ AGGREGATE WEDGE SHOULDERS, TYPE B
- ⑫ EXISTING BITUMINOUS CURB
- ⑬ HOT-MIX ASPHALT SURFACE REMOVAL, VARIABLE DEPTH
- ⑭ HOT-MIX ASPHALT SURFACE REMOVAL, 3/4"
- ⑮ HOT-MIX ASPHALT SURFACE REMOVAL, 1/2"
- ⑯ STRIP REFLECTIVE CRACK CONTROL TREATMENT
- ⑰ HOT-MIX ASPHALT SHOULDERS

TYPICAL SECTION

FAP RTE 322 (US 51)
 SECTION (29-Z-2, 30-2)RS-3
 MARION COUNTY

TOTAL SHEETS	SHEET NO.
41	19

CONTRACT NO. 76836

DETAIL

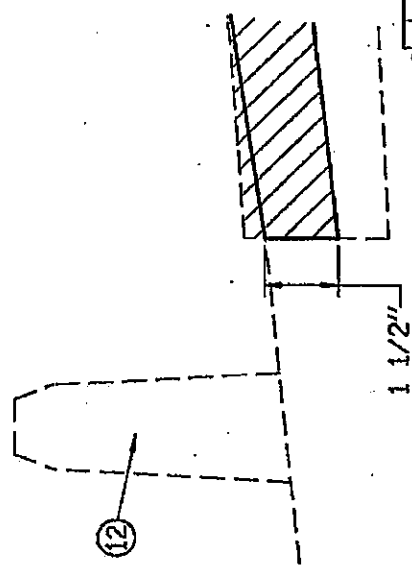

DATE: 01/21/2008
 /6828/6828.HLD.US 51/Contract No. 2 GB US 51/Cadd File/C-TYPSECT-SB1.dgn

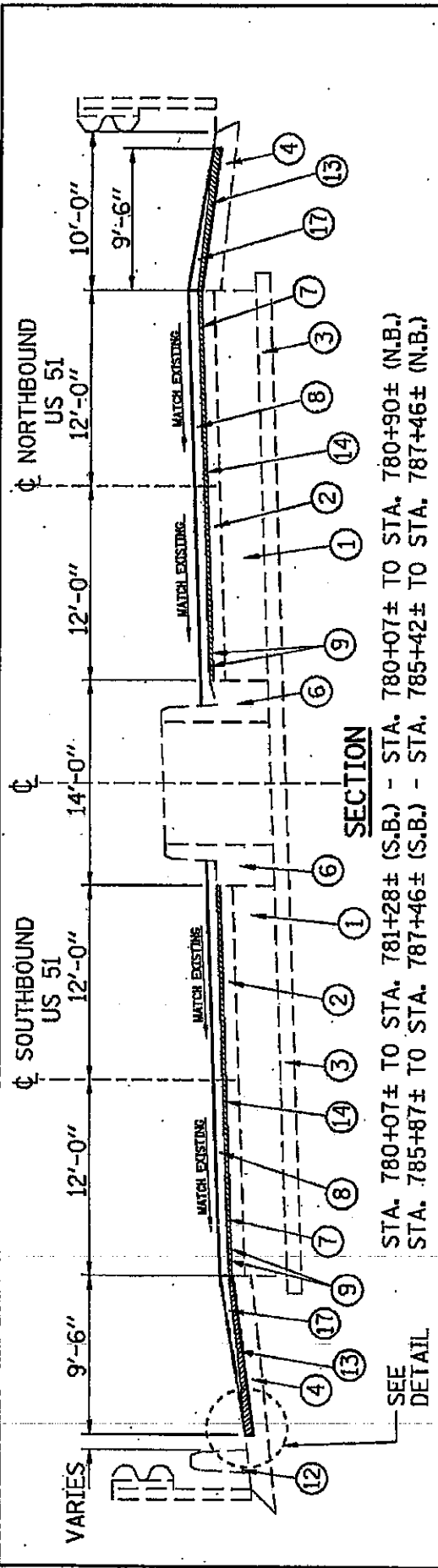

STA. 780+07± TO STA. 781+28± (S.B.) - STA. 780+07± TO STA. 780+90± (N.B.)
 STA. 785+87± TO STA. 787+46± (S.B.) - STA. 785+42± TO STA. 787+46± (N.B.)

LEGEND

- ① EXISTING PCC PAVEMENT 9"
- ② EXISTING HOT-MIX ASPHALT PAVEMENT
- ③ EXISTING AGGREGATE SUBBASE, 4"
- ④ EXISTING HOT-MIX ASPHALT SHOULDERS
- ⑤ EXISTING AGGREGATE SHOULDERS
- ⑥ EXISTING CURB & GUTTER
- ⑦ LEVELING BINDER (MACHINE METHOD), 3/4 "
- ⑧ POLYMERIZED HOT-MIX ASPHALT SURFACE COURSE, 1 1/2 "
- ⑨ BITUMINOUS MATERIALS & AGGREGATE (PRIME COAT)
- ⑩ LEVELING BINDER (MACHINE METHOD), (N70), VARIABLE DEPTH
- ⑪ AGGREGATE WEDGE SHOULDERS, TYPE B
- ⑫ EXISTING BITUMINOUS CURB
- ⑬ HOT-MIX ASPHALT SURFACE REMOVAL, VARIABLE DEPTH
- ⑭ HOT-MIX ASPHALT SURFACE REMOVAL, 3/4"
- ⑮ HOT-MIX ASPHALT SURFACE REMOVAL, 1 1/2"

- ⑯ STRIP REFLECTIVE CRACK CONTROL TREATMENT
- ⑰ HOT-MIX ASPHALT SHOULDERS

TYPICAL SECTION

FAP RTE 322 (US 51)
 SECTION (29-Z-2, 30-2)RS-3
 MARION COUNTY

TOTAL SHEETS	SHEET No.
41	20

CONTRACT NO. 76B36

DETAIL

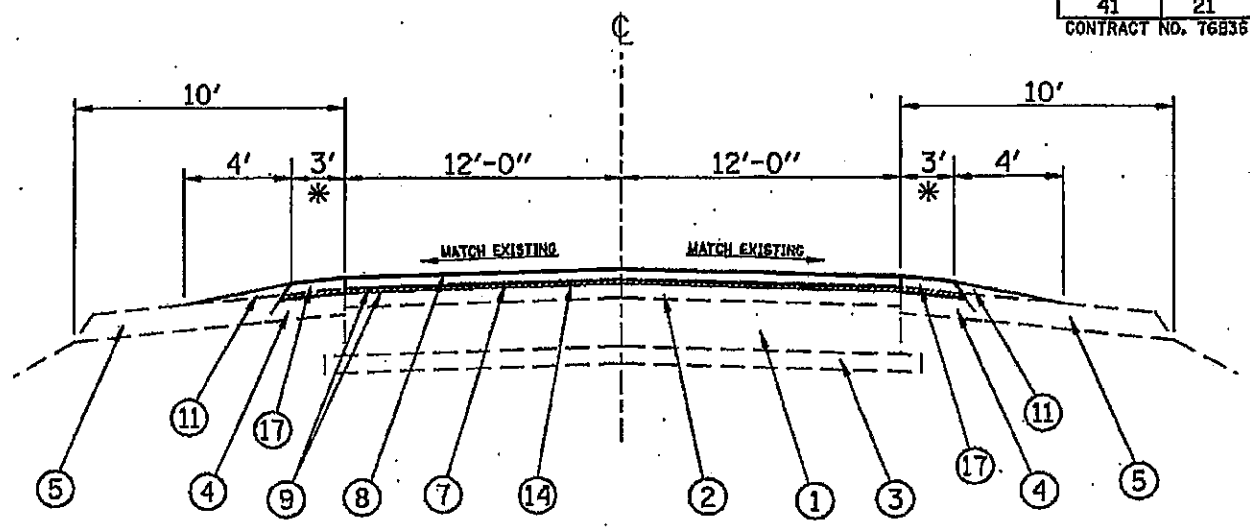

SECTION

STA. 810+03± TO STA. 839+28.14± (S.B.)
 STA. 1728+04.03± TO STA. 1727+83± (S.B.)
 STA. 810+03± TO STA. 813+37± (N.B.)

LEGEND

- | | |
|--|--|
| <ul style="list-style-type: none"> ① EXISTING PCC PAVEMENT 9" ② EXISTING HOT-MIX ASPHALT PAVEMENT ③ EXISTING AGGREGATE SUBBASE, 4" ④ EXISTING HOT-MIX ASPHALT SHOULDERS ⑤ EXISTING AGGREGATE SHOULDERS ⑥ EXISTING CURB & GUTTER ⑦ LEVELING BINDER (MACHINE METHOD), 3/4 " ⑧ POLYMERIZED HOT-MIX ASPHALT SURFACE COURSE, 1 1/2 " ⑨ BITUMINOUS MATERIALS & AGGREGATE (PRIME COAT) ⑩ LEVELING BINDER (MACHINE METHOD), (N70), VARIABLE DEPTH ⑪ AGGREGATE WEDGE SHOULDERS, TYPE B ⑫ EXISTING BITUMINOUS CURB ⑬ HOT-MIX ASPHALT SURFACE REMOVAL, VARIABLE DEPTH ⑭ HOT-MIX ASPHALT SURFACE REMOVAL, 3/4" ⑮ HOT-MIX ASPHALT SURFACE REMOVAL, 1 1/2 " ⑯ STRIP REFLECTIVE CRACK CONTROL TREATMENT ⑰ HOT-MIX ASPHALT SHOULDERS | <p>* FROM STATION 810+03± (MERGING OF US 51 S.B. AND US 51 N.B.) TO STATION 812+92± THE SHOULDER WIDTH VARIES AND FROM 837+49 THE SHOULDER WIDTH VARIES TO TRANSITION INTO THE CURB & GUTTER SECTION</p> |
|--|--|

TYPICAL SECTION

FAP RTE 322 (US 51)
 SECTION (29-Z-2, 30-2)RS-3
 MARION COUNTY

DATE: 01/31/2008 /6832/6832.MXD US 51/Contract No. 2, SB US 51/Contd. Files/C-TYPESET_SBB1.dwg

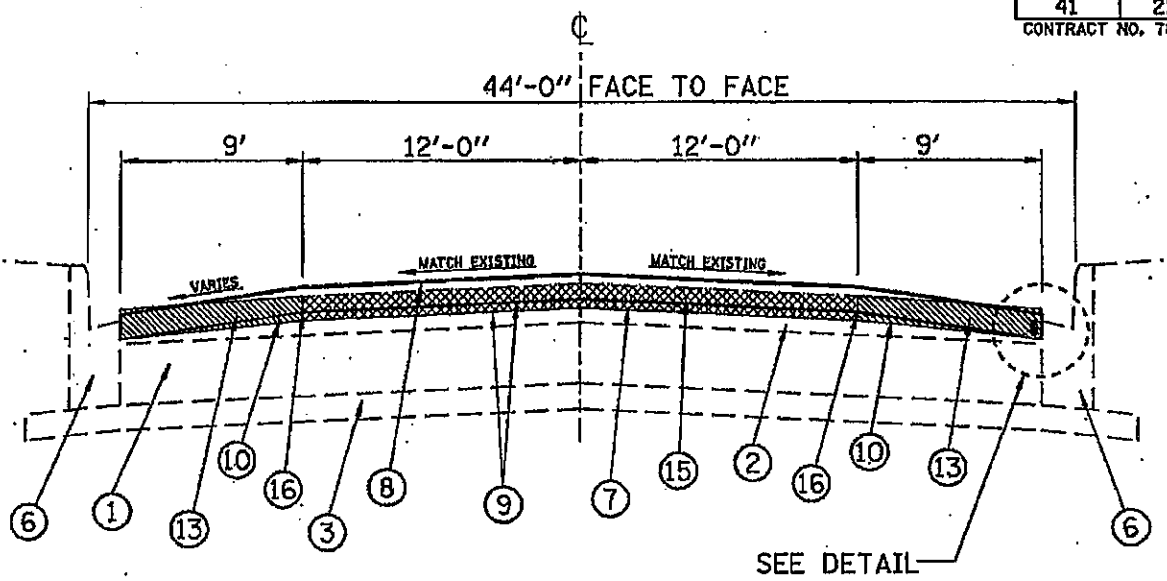

SECTION

STA. 1727+83± TO STA. 1717+80±
 STA. 1717+54± TO STA. 1701+34±

LEGEND

- ① EXISTING PCC PAVEMENT 9"
- ② EXISTING HOT-MIX ASPHALT PAVEMENT
- ③ EXISTING AGGREGATE SUBBASE, 4"
- ④ EXISTING HOT-MIX ASPHALT SHOULDERS
- ⑤ EXISTING AGGREGATE SHOULDERS
- ⑥ EXISTING CURB & GUTTER
- ⑦ LEVELING BINDER (MACHINE METHOD), 3/4 "
- ⑧ POLYMERIZED HOT-MIX ASPHALT SURFACE COURSE, 1 1/2 "
- ⑨ BITUMINOUS MATERIALS & AGGREGATE (PRIME COAT)
- ⑩ LEVELING BINDER (MACHINE METHOD), (N70), VARIABLE DEPTH
- ⑪ AGGREGATE WEDGE SHOULDERS, TYPE B
- ⑫ EXISTING BITUMINOUS CURB
- ⑬ HOT-MIX ASPHALT SURFACE REMOVAL, VARIABLE DEPTH
- ⑭ HOT-MIX ASPHALT SURFACE REMOVAL, 3/4"
- ⑮ HOT-MIX ASPHALT SURFACE REMOVAL, 1 1/2 "
- ⑯ STRIP REFLECTIVE CRACK CONTROL TREATMENT
- ⑰ HOT-MIX ASPHALT SHOULDERS

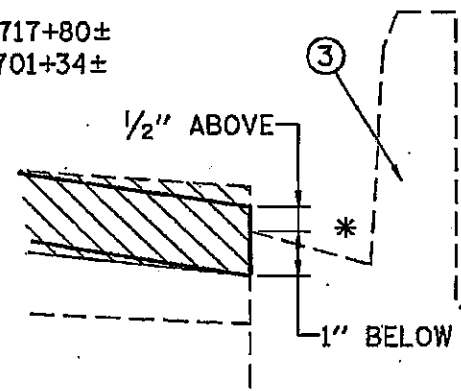

DETAIL

TYPICAL SECTION

FAP RTE 322 (US 51)
 SECTION (29-Z-2, 30-2)RS-3
 MARION COUNTY

DATE: 01/31/2008
 /8626/6826.MXD US 51/Contect No. 2 08 US 51/Cont. Files/C:\TYPSECT_9851.dgn

* REMOVE PREVIOUS OVERLAY OF THE GUTTERS WHEN PRESENT. WORK SHALL BE INCLUDED IN HMA SURFACE REMOVAL.

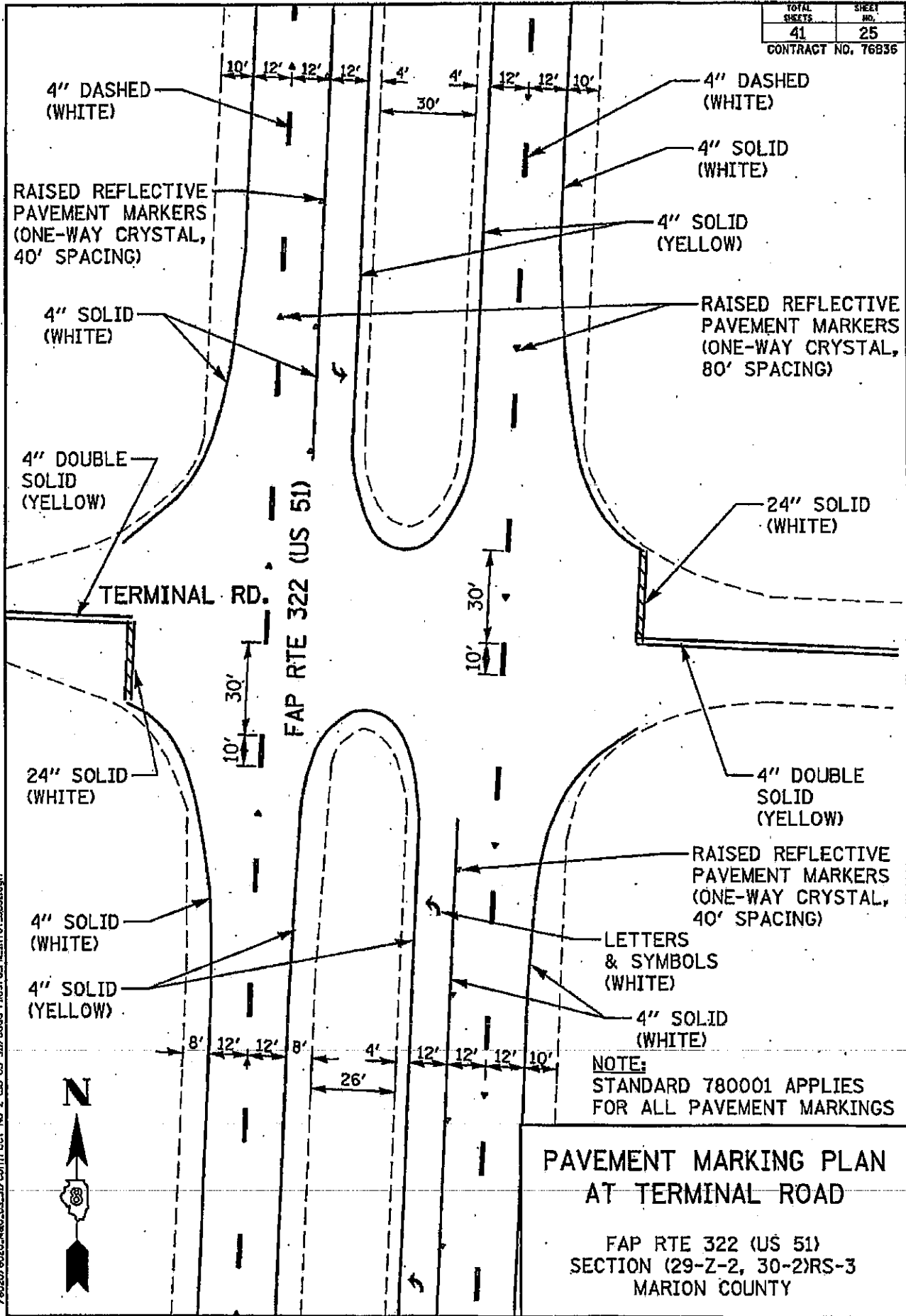

DATE: 01/31/2008
76020/6020_480_US_51/Contract No 2 US 51/Cadd Files/C_Plan_INT07_5851.dgn



NOTE:
STANDARD 780001 APPLIES FOR ALL PAVEMENT MARKINGS

**PAVEMENT MARKING PLAN
AT TERMINAL ROAD**

FAP RTE 322 (US 51)
SECTION (29-Z-2, 30-2)RS-3
MARION COUNTY

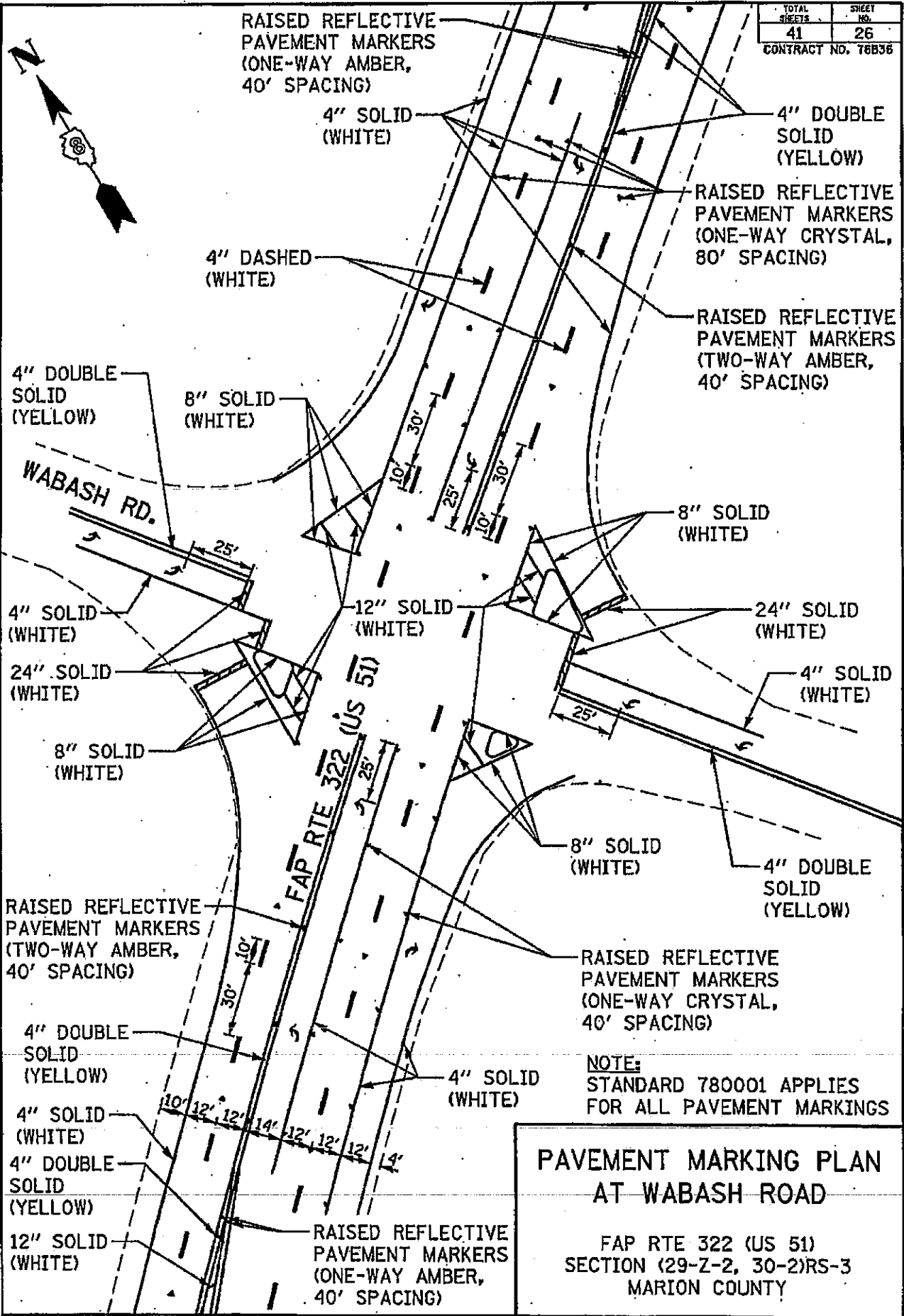

DATE: 07/31/2008
 7/8/20/6050.MED.US.SI/contract No. 2 08B US 51/Contd. Files/C:\P\INTDS_SBI1.dgn

NOTE:
 STANDARD 780001 APPLIES
 FOR ALL PAVEMENT MARKINGS

**PAVEMENT MARKING PLAN
 AT WABASH ROAD**

FAP RTE 322 (US 51)
 SECTION (29-Z-2, 30-2)RS-3
 MARION COUNTY

TOTAL SHEETS	SHEET NO.
41	27
CONTRACT NO. 76B35	

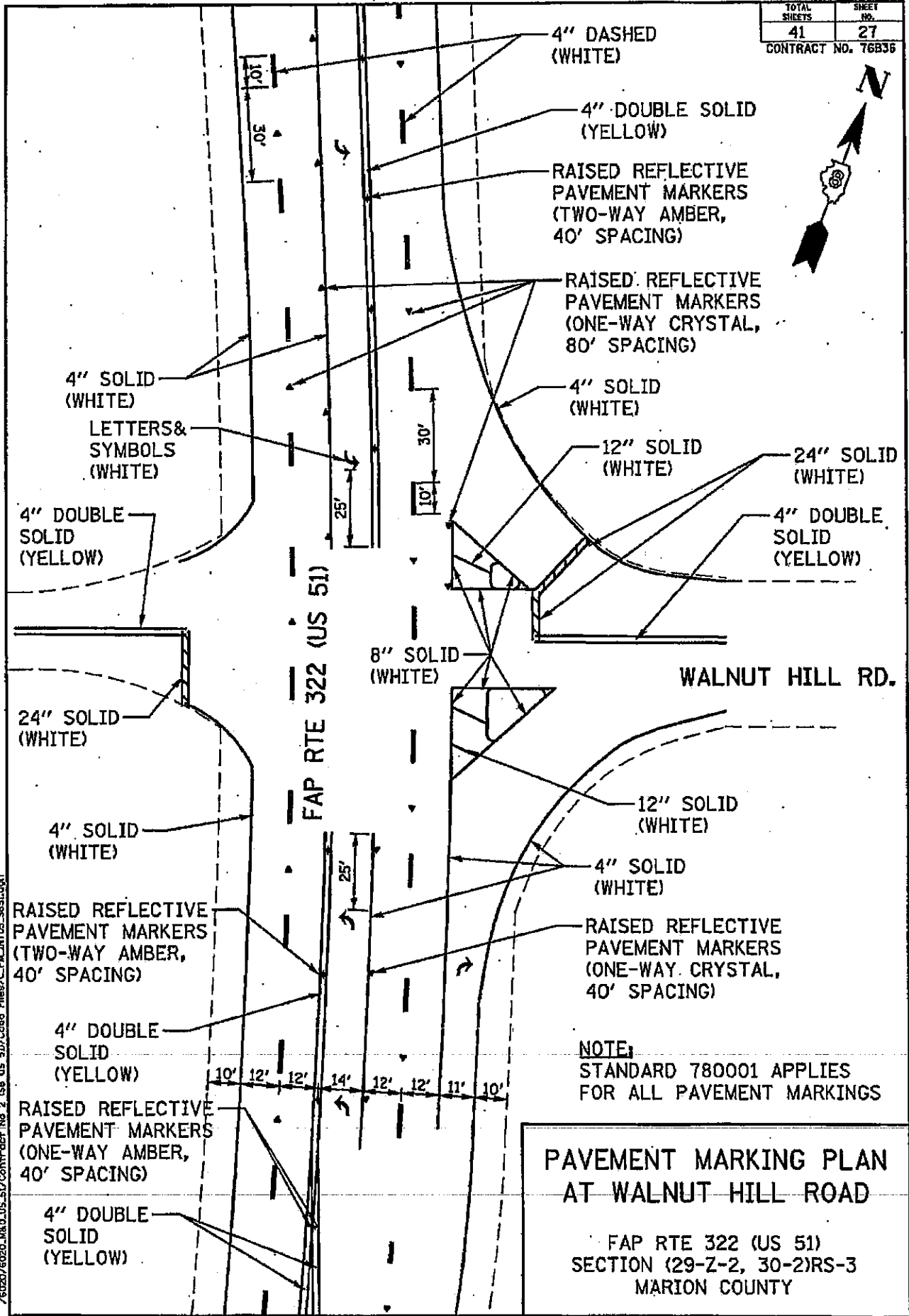

DATE: 01/31/2006 /6020/6020.MRD.US.51/Contract No. 2.68 US 51/Contd Files/C:\PLINTOS\5851.dgn

NOTE:
STANDARD 780001 APPLIES FOR ALL PAVEMENT MARKINGS

**PAVEMENT MARKING PLAN
AT WALNUT HILL ROAD**

FAP RTE 322 (US 51)
SECTION (29-Z-2, 30-2)RS-3
MARION COUNTY

TOTAL SHEETS	SHEET NO.
41	28
CONTRACT NO. 75B36	

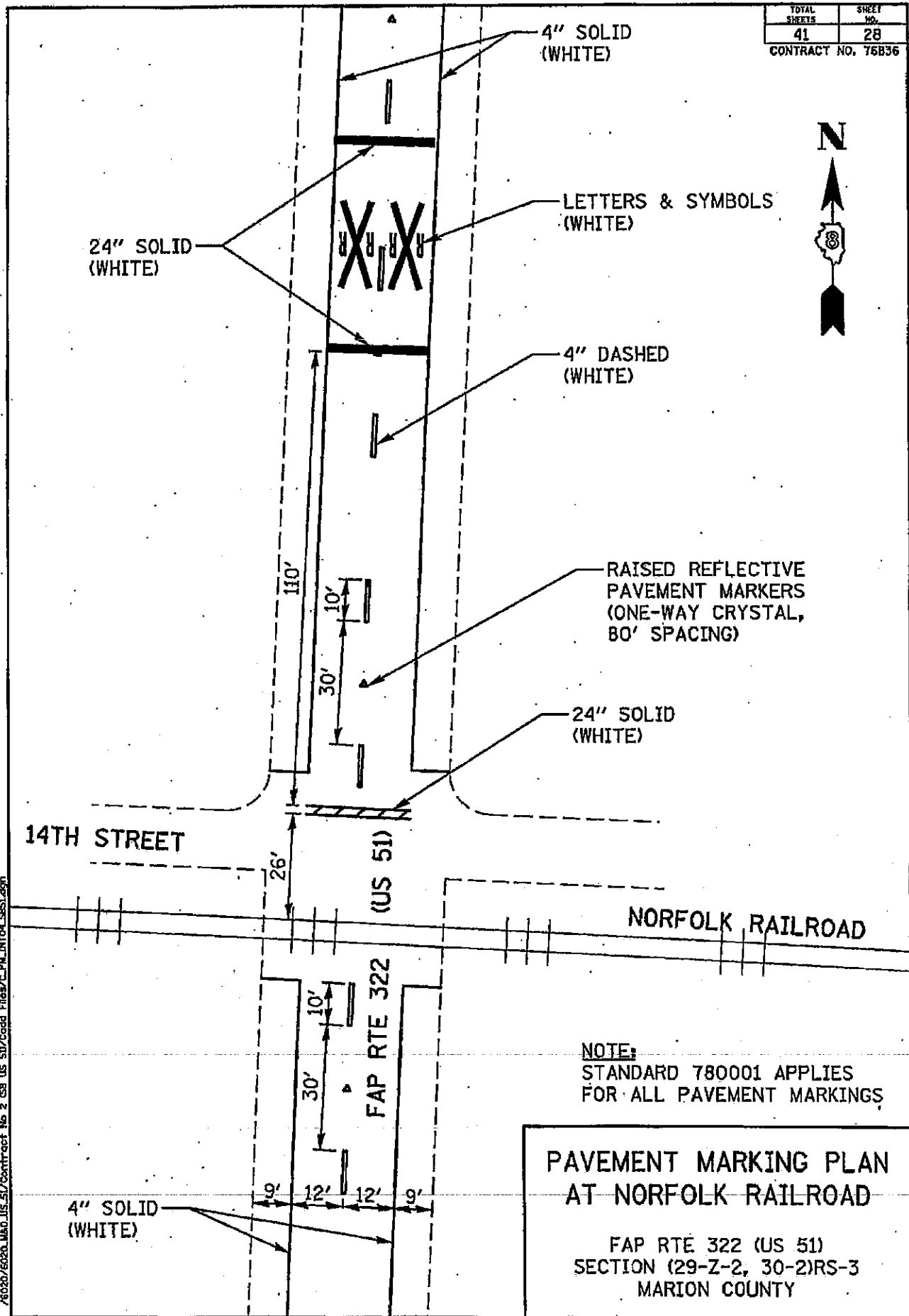

DATE: 01/31/2008
 /6020/6020.MXD US_S1/Contract No. 2 US S1/Cadd Files/C.PM.INTD4.SBSL.dgn

NOTE:
 STANDARD 780001 APPLIES
 FOR ALL PAVEMENT MARKINGS

**PAVEMENT MARKING PLAN
 AT NORFOLK RAILROAD**

FAP RTE 322 (US 51)
 SECTION (29-Z-2, 30-2)RS-3
 MARION COUNTY

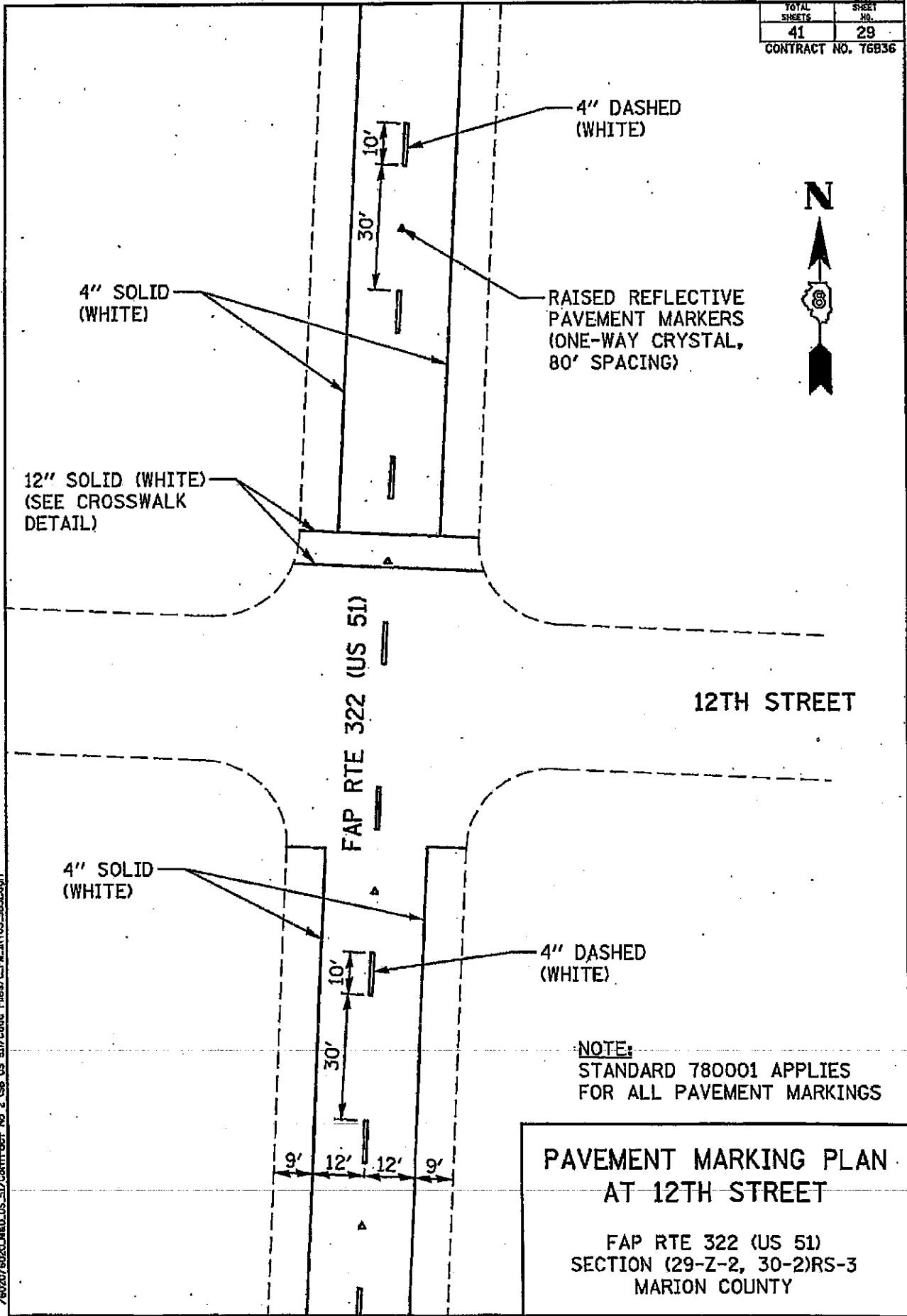

DATE: 01/31/2008 /6920/6620.M&D.US.51/contract No. 2 (SB US 51)/Cadd Files/C.L.PM.INT03.5851.dgn

NOTE:
STANDARD 780001 APPLIES FOR ALL PAVEMENT MARKINGS

PAVEMENT MARKING PLAN AT 12TH STREET

FAP RTE 322 (US 51)
SECTION (29-Z-2, 30-2)RS-3
MARION COUNTY

TOTAL SHEETS	SHEET NO.
41	30
CONTRACT NO. 76B36	

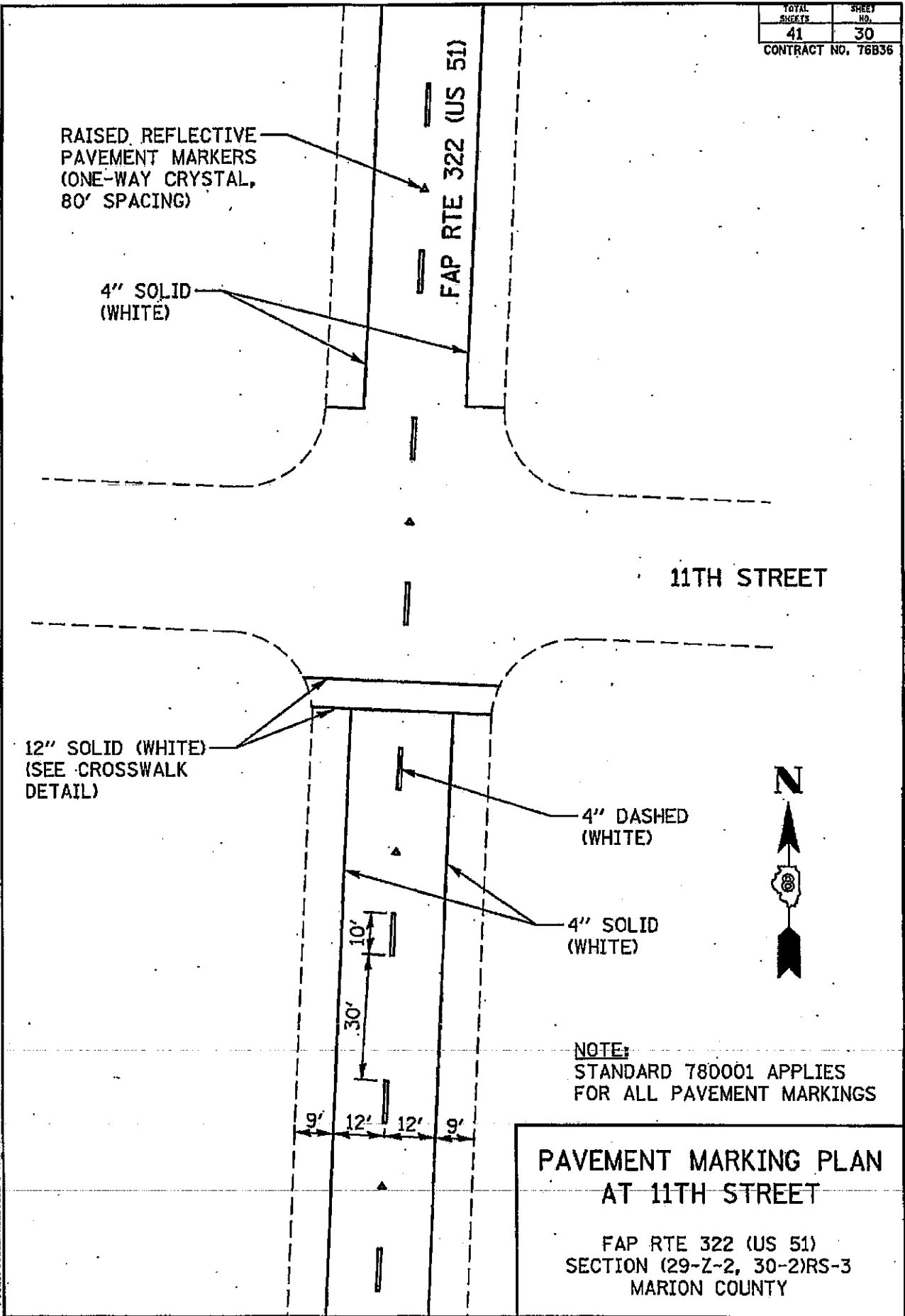

TOTAL SHEETS	SHEET NO.
41	31
CONTRACT NO. 75B36	

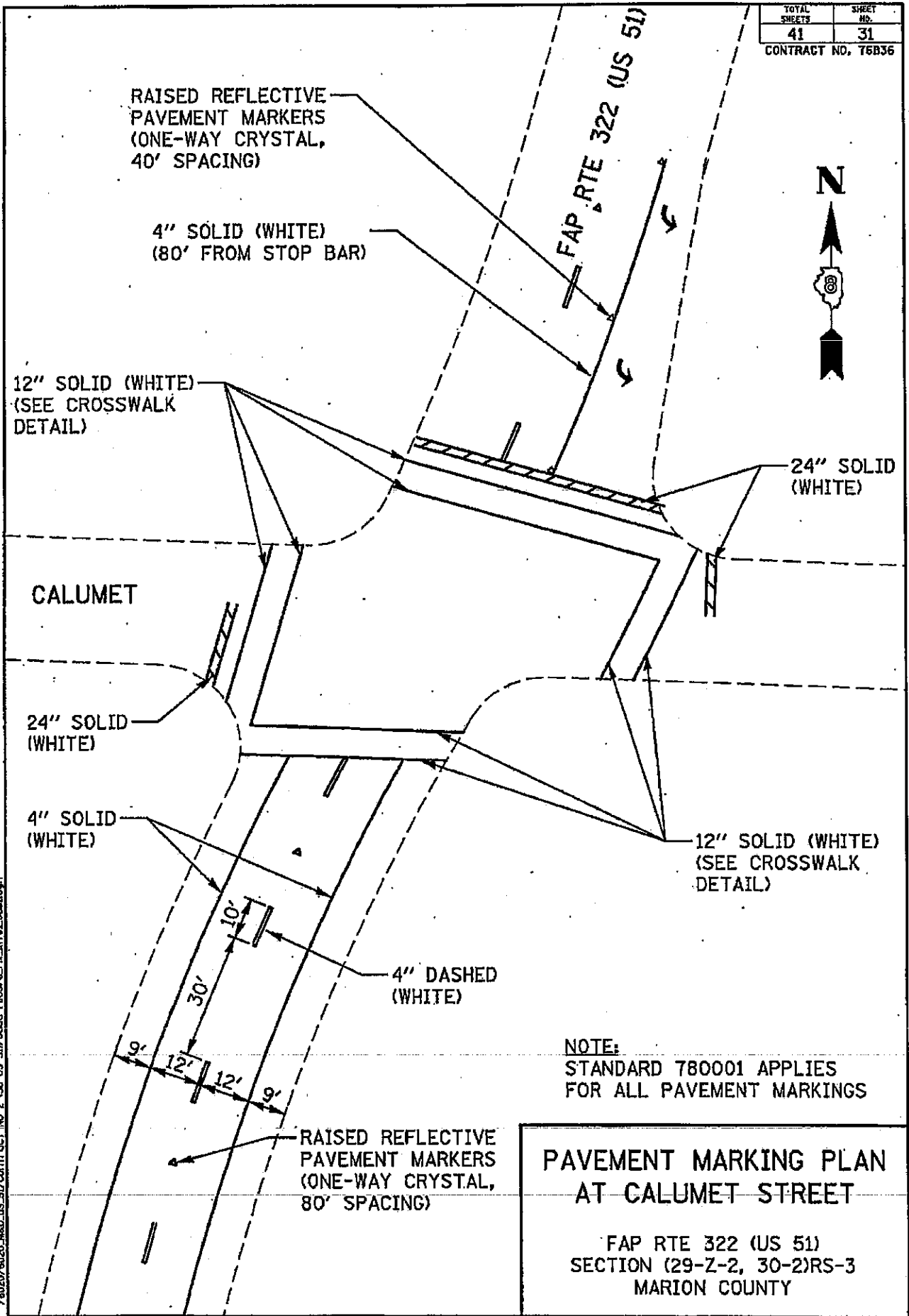

CALUMET

FAP RTE 322 (US 51)

NOTE:
STANDARD 780001 APPLIES
FOR ALL PAVEMENT MARKINGS

**PAVEMENT MARKING PLAN
AT CALUMET STREET**

FAP RTE 322 (US 51)
SECTION (29-Z-2, 30-2)RS-3
MARION COUNTY

DATE: 01/31/2008 / 6020/6020.MAO.US.51/Contract No. 2 698 US 51/Coord Files/C/P/L/INTOL.SBS1091

TOTAL SHEETS	SHEET NO.
41	32
CONTRACT NO. 78B36	

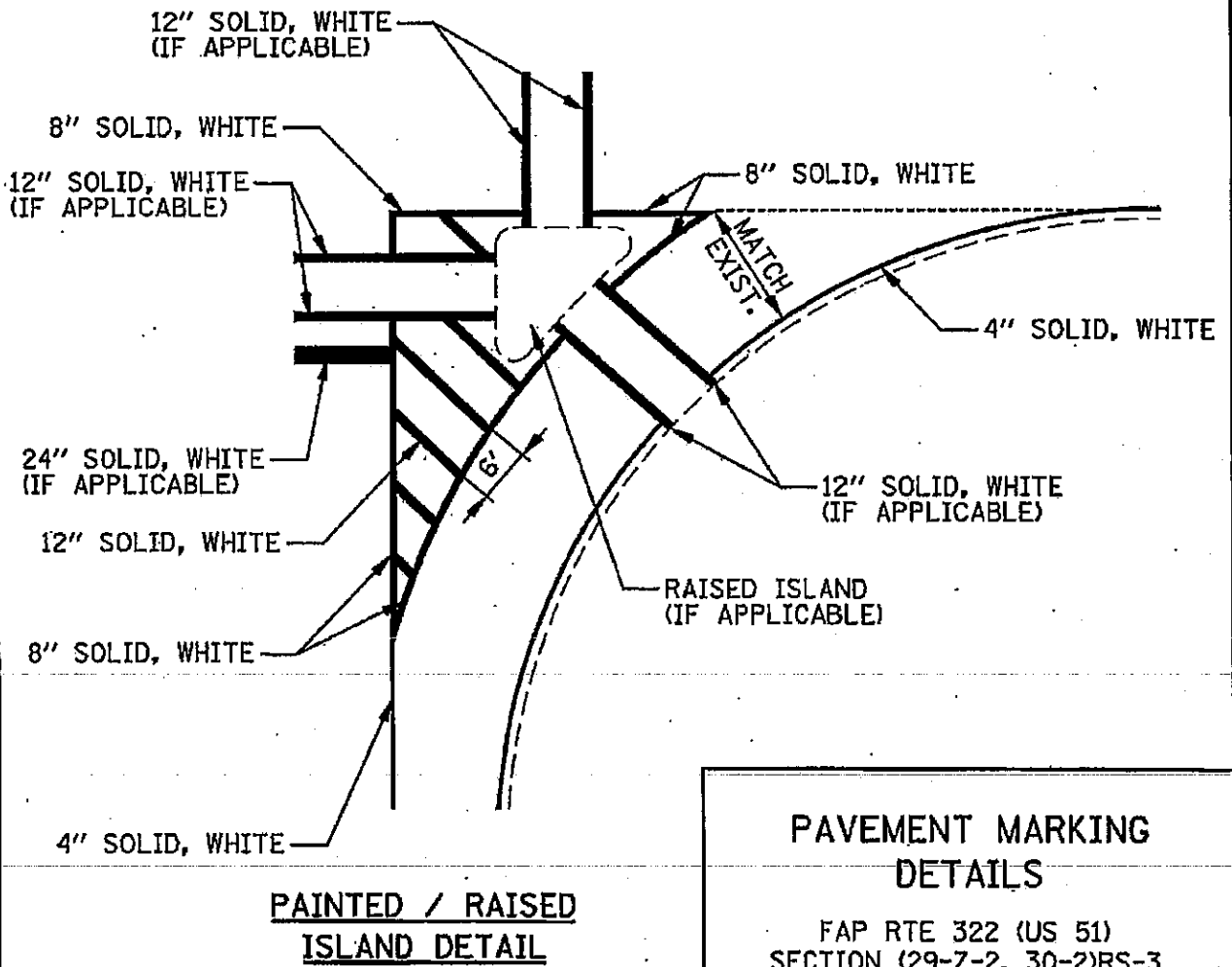
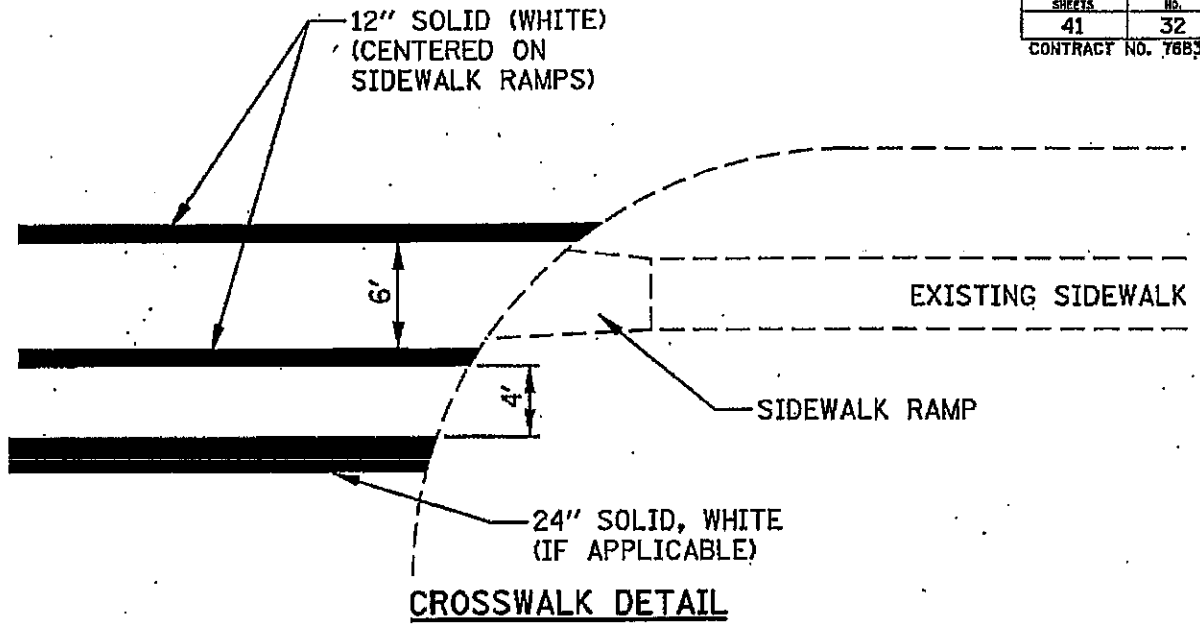

**PAVEMENT MARKING
DETAILS**

FAP RTE 322 (US 51)
SECTION (29-Z-2, 30-2)RS-3
MARION COUNTY

DATE: 01/31/2008 /6020/6020.MXD JIS SJ/Contract: No. 2 USR US 51/Coord Files/C:\PL\DTLS.SBS1.dgn

TOTAL SHEETS	SHEET NO.
41	34
CONTRACT NO. 76B36	

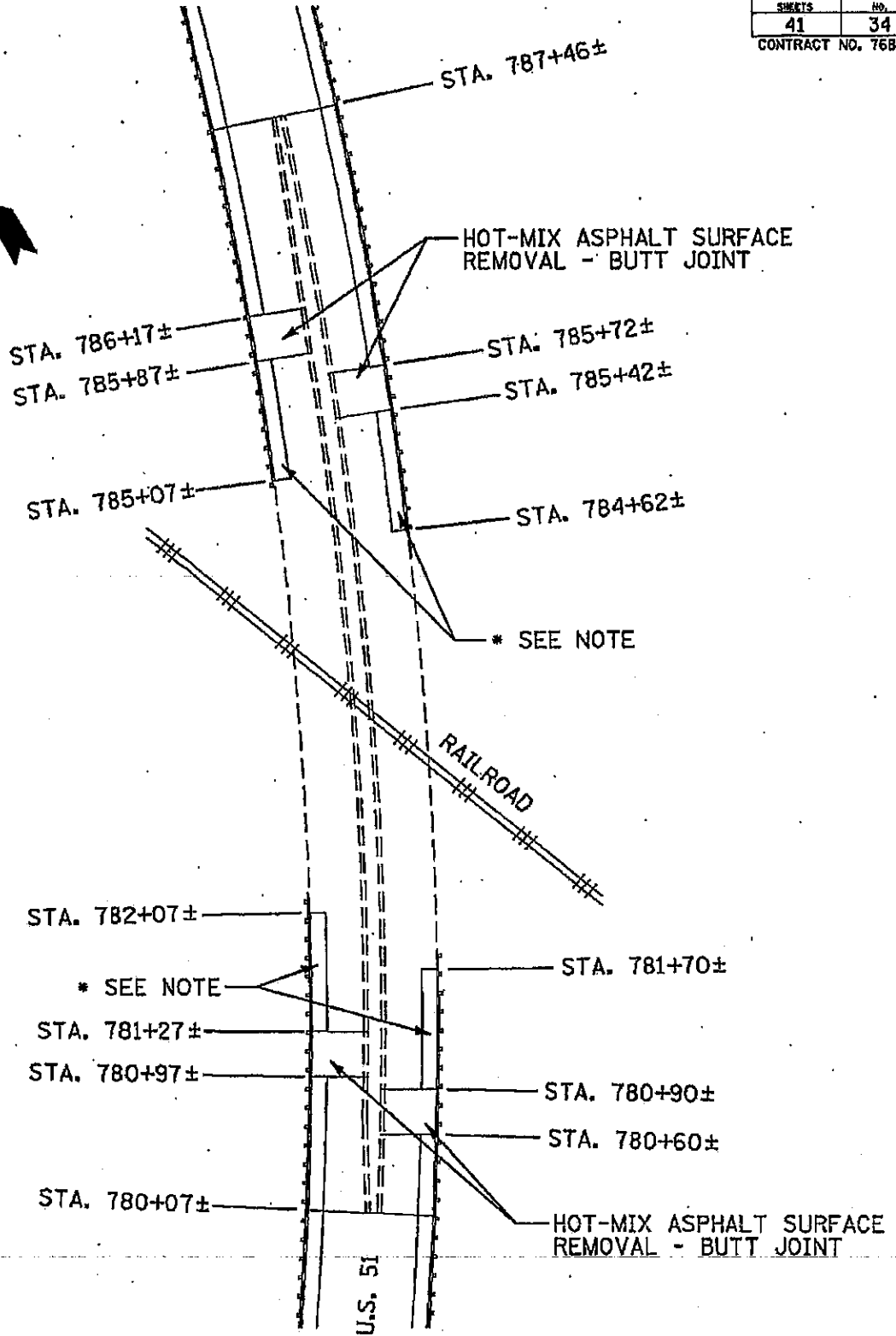

* HOT-MIX ASPHALT SURFACE REMOVAL, 1 1/2"
 HOT-MIX ASPHALT SHOULDER 1 1/2"

PAVING DETAIL AT RAILROAD BRIDGE

FAP RTE 322 (US 51)
 SECTION (29-Z-2, 30-2)RS-3
 MARION COUNTY

DATE: 01/31/2008 /6020/6020.M&O.US.Sy/Contract No. 2. 68. US 51/Coord Files/C.PAVING_DETAIL 2.dgn

TOTAL SHEETS	SHEET NO.
41	35
CONTRACT NO. 76B36	

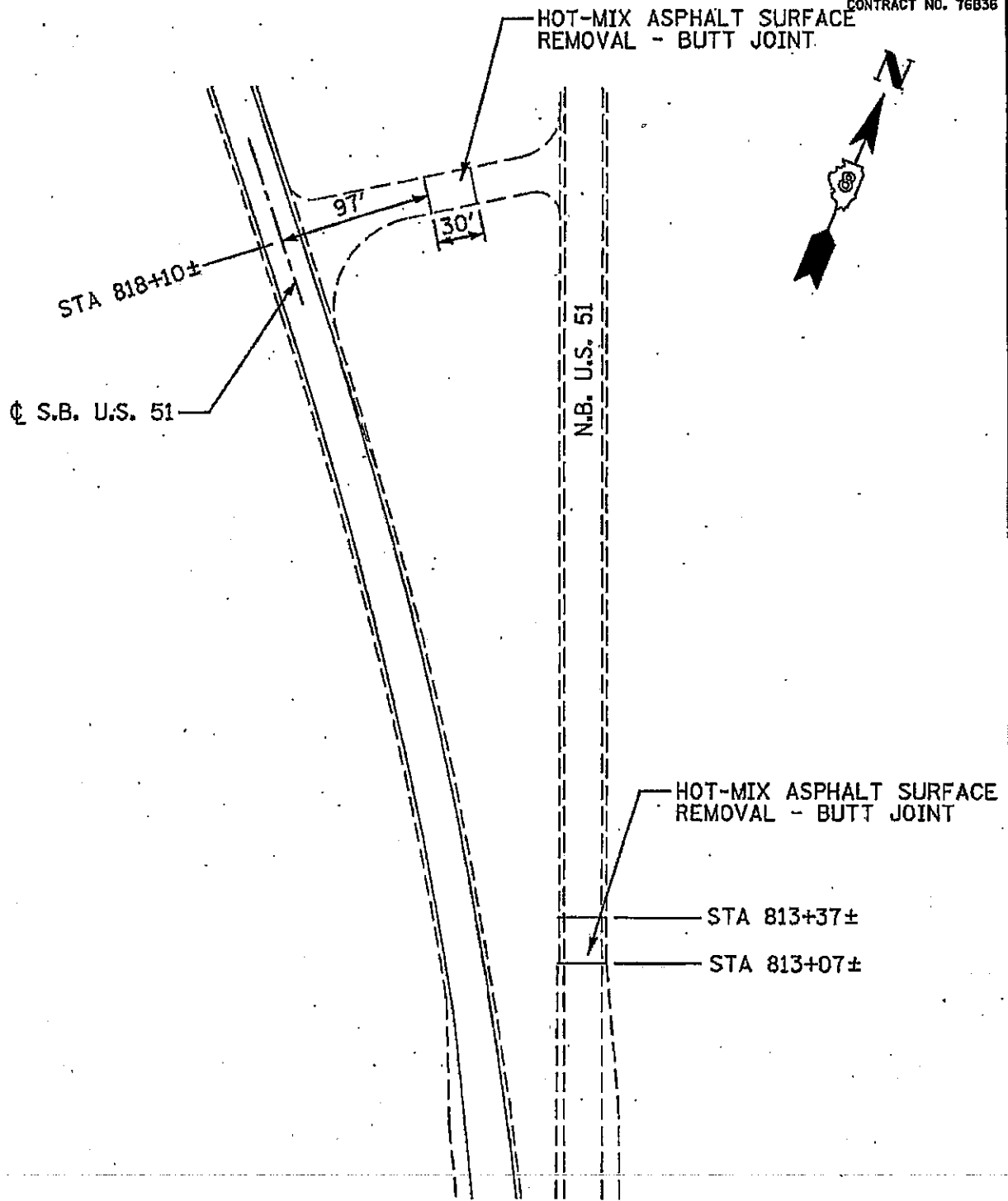

DATE: 01/31/2008
 /6020/6020.MAO.LIS.51/Contr.acf. No 2 US 51/Coadd. Files/C.PAVING.DETA13.dgn

**PAVING DETAIL AT
 CONNECTOR ROAD &
 NORTHBOUND END**
 FAP. RTE 322 (US 51)
 SECTION (29-Z-2, 30-2)RS-3
 MARION COUNTY

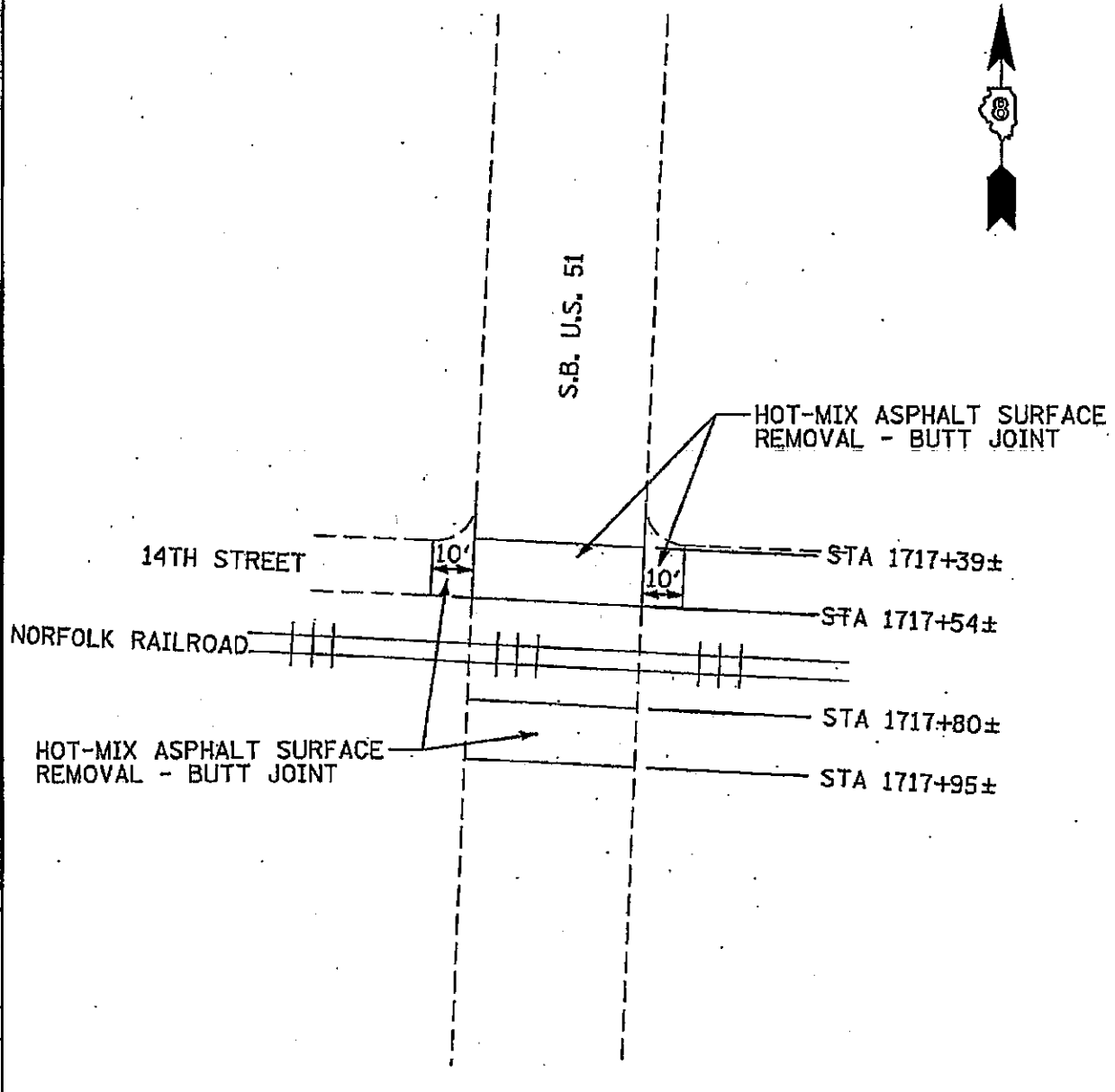

DATE: 01/31/2008 / 6020 / 6020.MR.O. US 51/Contrct No. 2 65B US 51/Cadd Files/C/Paving_Detail_4.dgn

**PAVING DETAIL AT
NORFOLK RAILROAD**

FAP RTE 322 (US 51)
SECTION (29-Z-2, 30-2)RS-3
MARION COUNTY

TOTAL SHEETS	SHEET NO.
41	37
CONTRACT NO. 76B36	

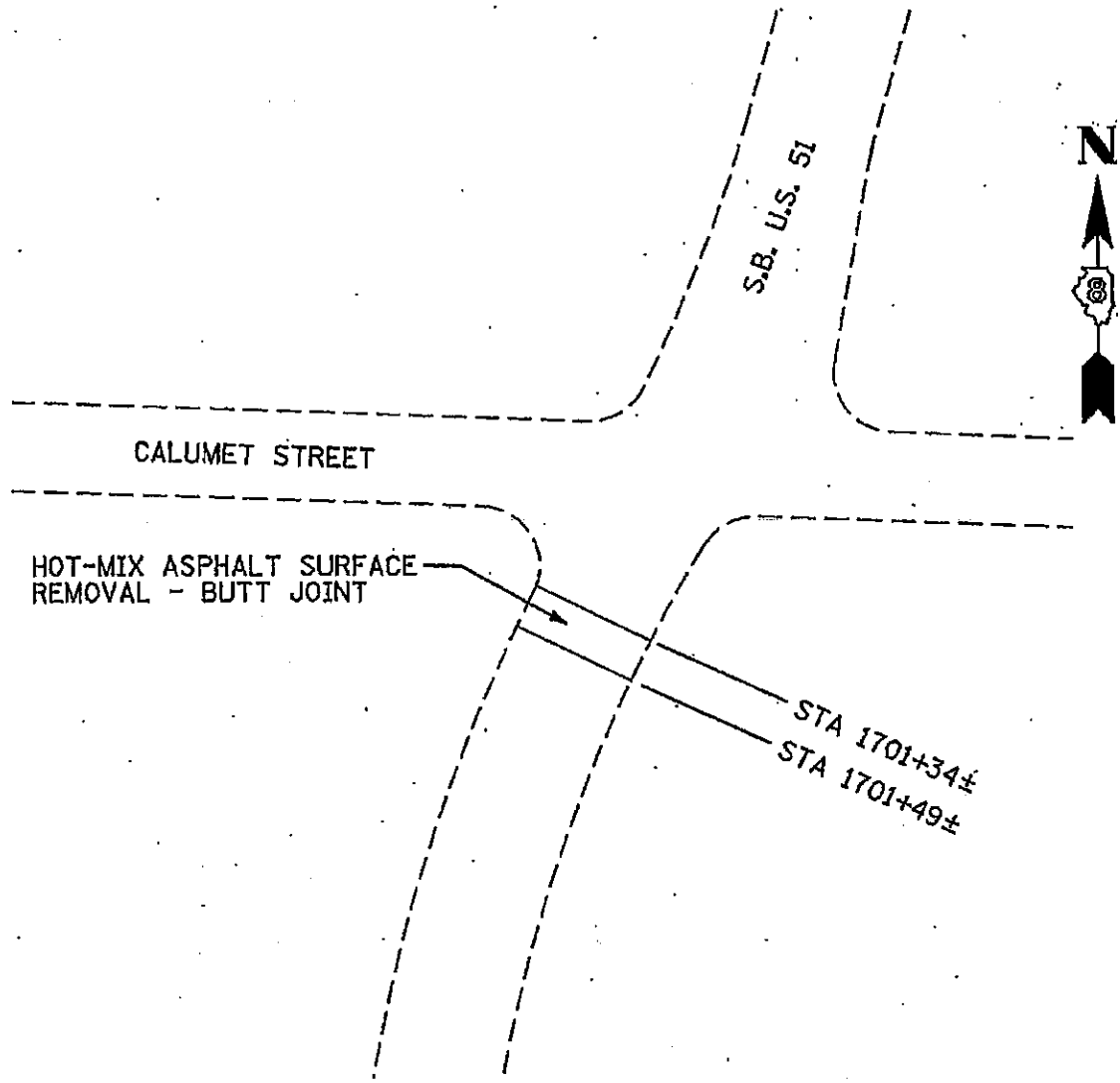

DATE: 01/31/2008
 /6020/6020.MAO.US.51/Contract No 2 658 US 51/Coord Files/C_PAVING_DETAILS.dgn

**PAVING DETAIL
 AT PROJECT END**

FAP RTE 322 (US 51)
 SECTION (29-Z-2, 30-2)RS-3
 MARION COUNTY

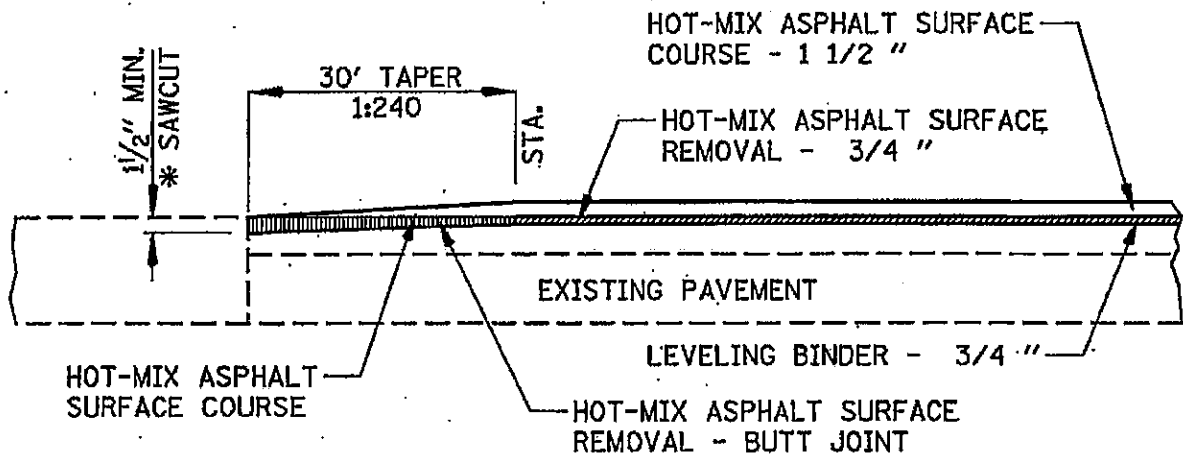

HOT-MIX ASPHALT SURFACE REMOVAL - BUTT JOINT

STA. 681+21±
 STA. 813+07±
 CONNECTOR ROAD: 97' RT. FROM ϕ AT STA. 818+10±

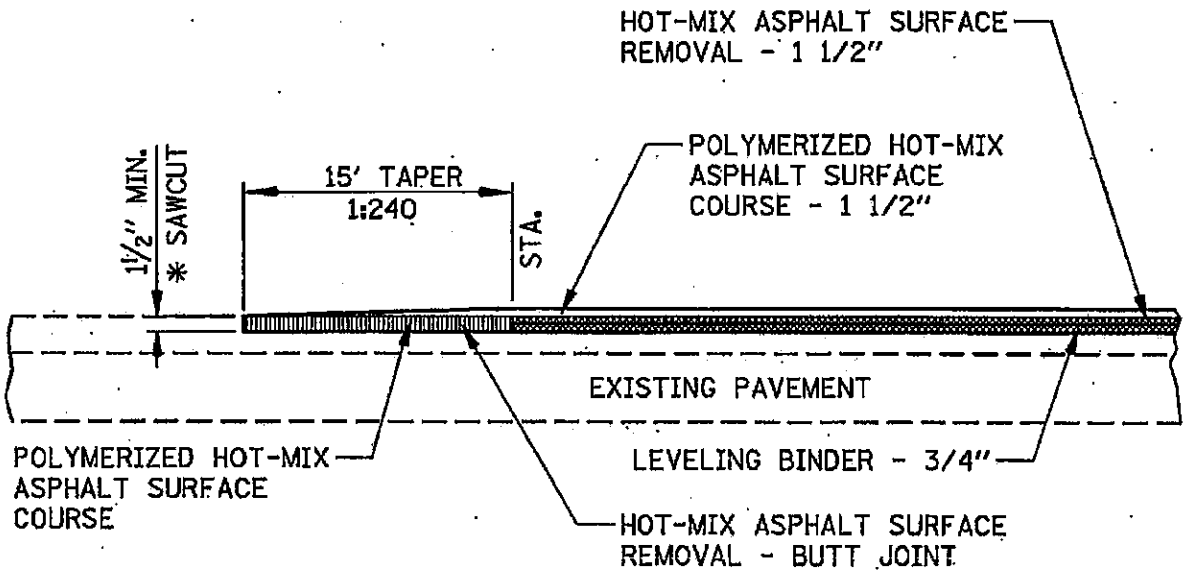

HOT-MIX ASPHALT SURFACE REMOVAL - BUTT JOINT

STA. 1717+95±
 STA. 1717+39±
 STA. 1701+49±

* COST OF SAWCUT TO BE INCLUDED IN HOT-MIX ASPHALT SURFACE REMOVAL - BUTT JOINT

BUTT JOINT DETAILS

FAP RTE 322 (US 51)
 SECTION (29-Z-2, 30-2)RS-3
 MARION COUNTY

DATE: 01/31/2008 / 6020/6020.MXD US 51/Contract No 2 USB US 50/2008 Files/C-PRINT-DTLS-595L.dgn

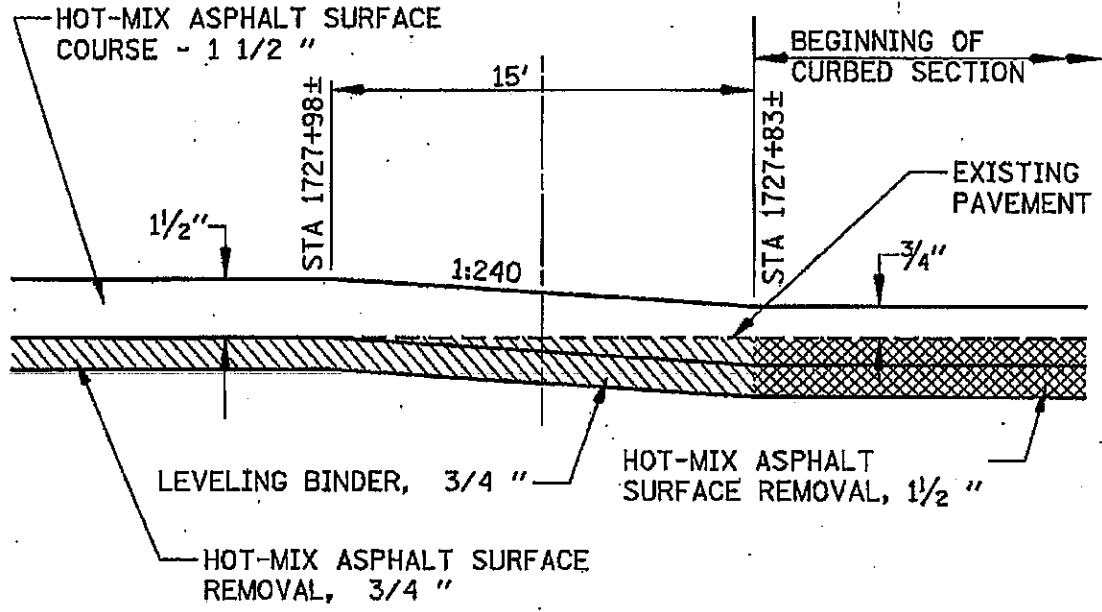

PAVING TRANSITION

STA 1727+98± TO STA 1727+83±

DATE: 01/31/2008 /6020/6020.M&O.US.51/Contract No 2 (SB US 51)/Codd Files/C-JOINT_DTLS_SBS1.dgn

**PAVEMENT TRANSITION
DETAILS**

FAP RTE 322 (US 51)
SECTION (29-Z-2, 30-2)RS-3
MARION COUNTY

TOTAL SHEETS	SHEET NO.
41	40
CONTRACT NO. T6B35	

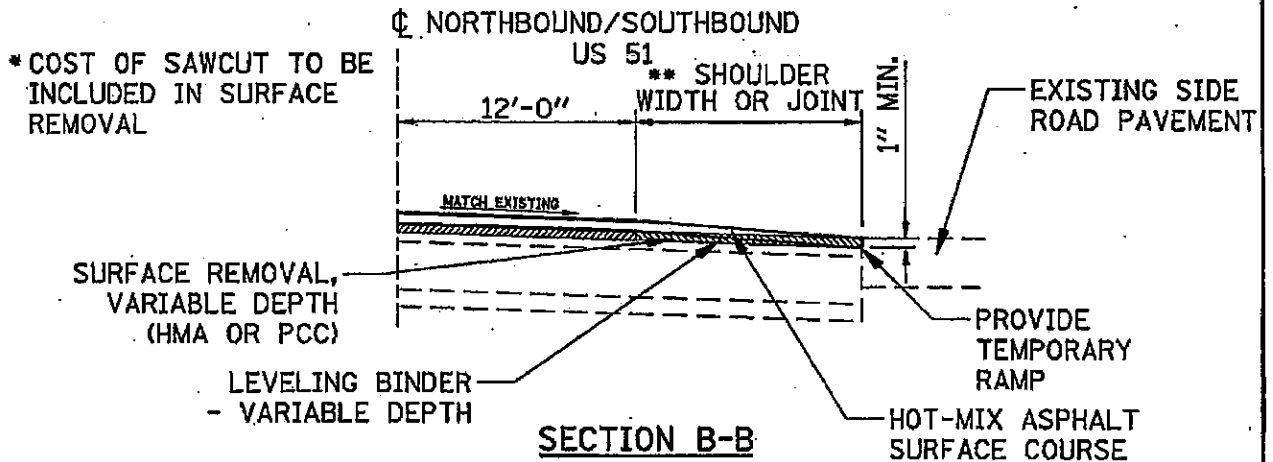
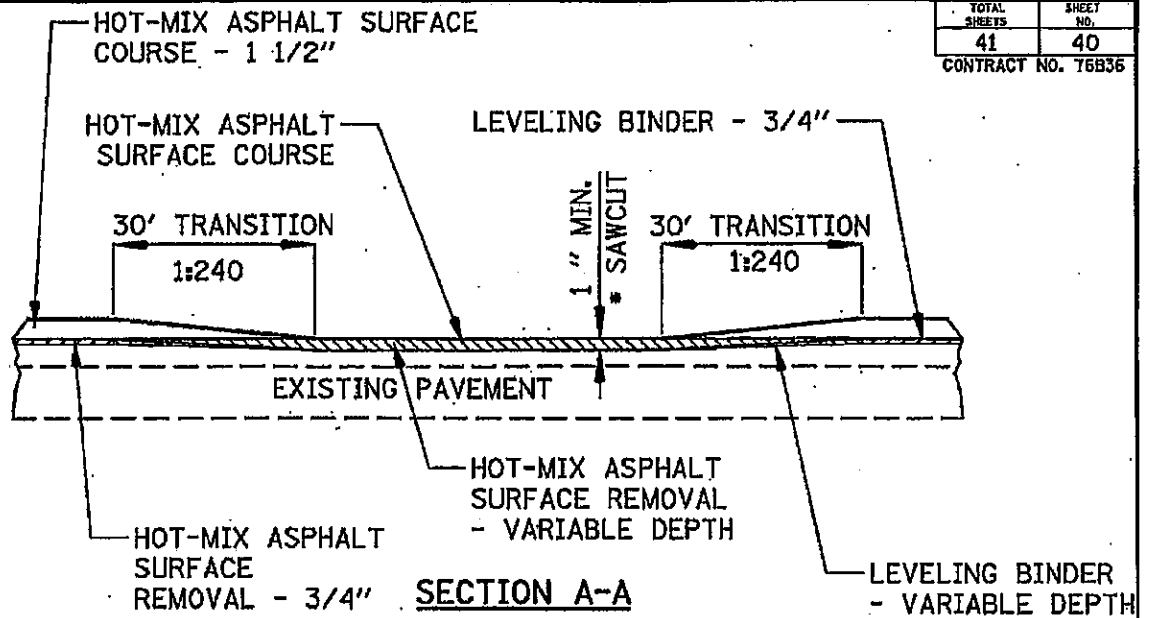

* COST OF SAWCUT TO BE INCLUDED IN SURFACE REMOVAL

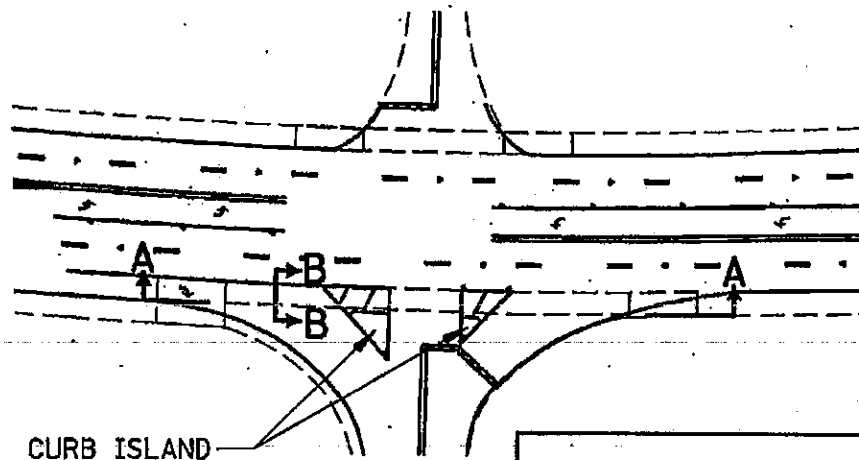

SIDE ROAD & ENTRANCE TRANSITION DETAIL

FAP RTE 322 (US 51)
SECTION (29-Z-2, 30-2)RS-3
MARION COUNTY

DATE: 01/31/2008
76020.6020.MILO.US.SI/Contract No. 2 US 51/Cadd Files/CADDINT-DTL.SBSL.dgn

TOTAL SHEETS	SHEET NO.
41	41
CONTRACT NO. 76B36	

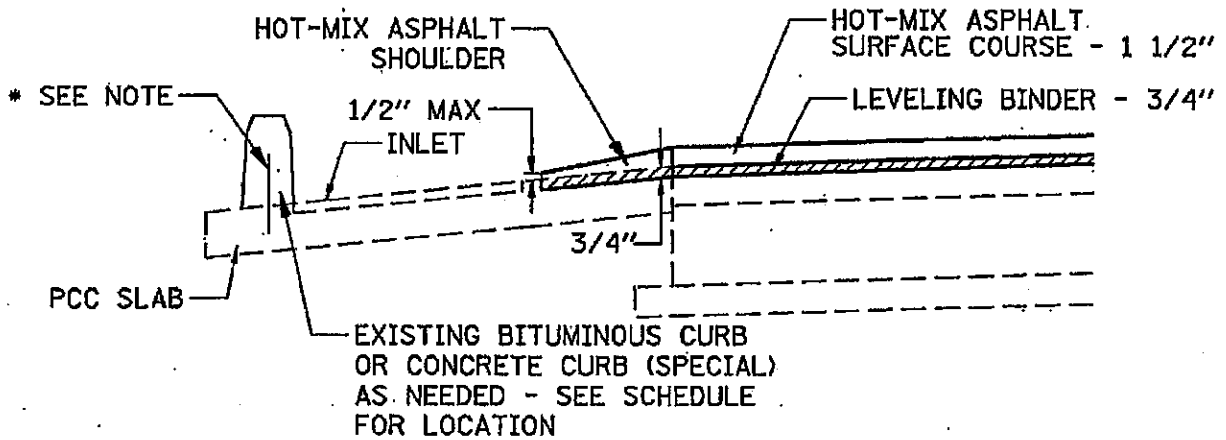
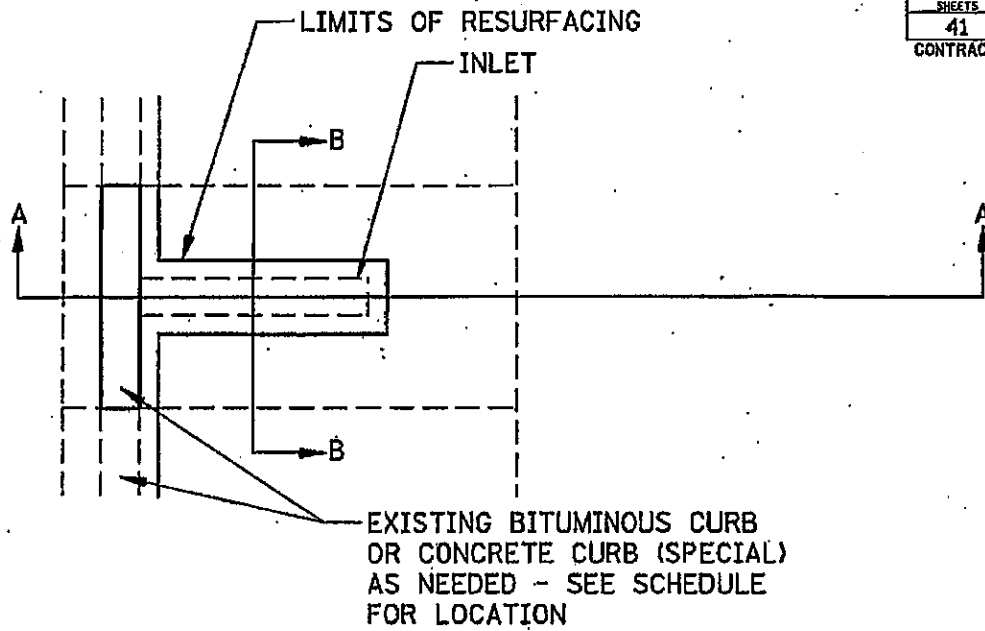

SECTION A-A

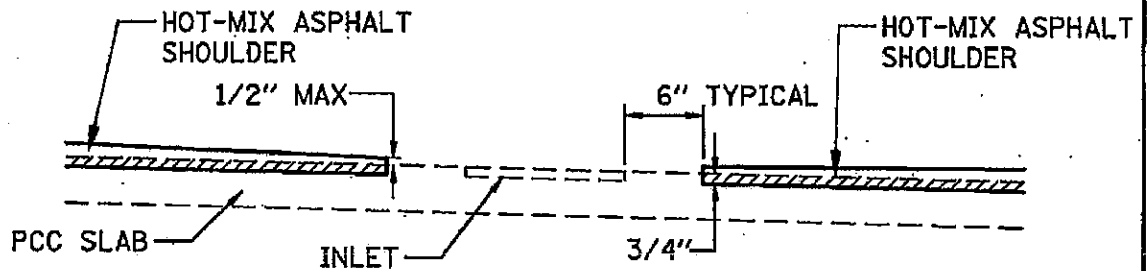

SECTION B-B

* 6" LONG #5 BARS DRILLED 3" INTO EXISTING SLAB - 24" O.C.

MATCH SECTION AND PROFILE OF EXISTING BITUMINOUS CURB

**INLET TRANSITION
DETAIL AT BRIDGE
APPROACH SHOULDER**

FAP RTE 322 (US 51)
SECTION (29-Z-2, 30-2)RS-3
MARION COUNTY

DATE: 01/31/2008 / 1620/1620.M&O.US 51/Contract No 2 (SB US 51/Cadd File/C-JOINT-DTLS.SBS1.dgn

**REQUIRED CONTRACT PROVISIONS
FEDERAL-AID CONSTRUCTION CONTRACTS**

	Page
I. General	1
II. Nondiscrimination	1
III. Nonsegregated Facilities	3
IV. Payment of Predetermined Minimum Wage.....	3
V. Statements and Payrolls	6
VI. Record of Materials, Supplies, and Labor.....	7
VIII. Safety: Accident Prevention	7
IX. False Statements Concerning Highway Projects.....	7
X. Implementation of Clean Air Act and Federal Water Pollution Control Act	8
XI. Certification Regarding Debarment, Suspension, Ineligibility, and Voluntary Exclusion	8
XII. Certification Regarding Use of Contract Funds for Lobbying	9

ATTACHMENTS

- A. Employment Preference for Appalachian Contracts
(included in Appalachian contracts only)

I. GENERAL

1. These contract provisions shall apply to all work performed on the contract by the contractor's own organization and with the assistance of workers under the contractor's immediate superintendence and to all work performed on the contract by piecework, station work, or by subcontract.

2. Except as otherwise provided for in each section, the contractor shall insert in each subcontract all of the stipulations contained in these Required Contract Provisions, and further require their inclusion in any lower tier subcontract or purchase order that may in turn be made. The Required Contract Provisions shall not be incorporated by reference in any case. The prime contractor shall be responsible for compliance by any subcontractor or lower tier subcontractor with these Required Contract Provisions.

3. A breach of any of the stipulations contained in these Required Contract Provisions shall be sufficient grounds for termination of the contract.

4. A breach of the following clauses of the Required Contract Provisions may also be grounds for debarment as provided in 29 CFR 5.12:

- Section I, paragraph 2;
- Section IV, paragraphs 1, 2, 3, 4 and 7;
- Section V, paragraphs 1 and 2a through 2g.

5. Disputes arising out of the labor standards provisions of Section IV (except paragraph 5) and Section V of these Required Contract Provisions shall not be subject to the general disputes clause of this contract. Such disputes shall be resolved in accordance with the procedures of the U.S. Department of Labor (DOL) as set forth in 29 CFR 5, 6 and 7. Disputes within the meaning of this clause include disputes between the contractor (or any of its subcontractors) and the contracting agency, the DOL, or the contractor's employees or their representatives.

6. Selection of Labor: During the performance of this contract, the contractor shall not:

- a. Discriminate against labor from any other State, possession, or territory of the United States (except for employment preference for Appalachian contracts, when applicable, as specified in Attachment A), or
- b. Employ convict labor for any purpose within the limits of the project unless it is labor performed by convicts who are on parole, supervised release, or probation.

II. NONDISCRIMINATION

1. Equal Employment Opportunity: Equal employment opportunity (EEO) requirements not to discriminate and to take affirmative action to assure equal opportunity as set forth under laws, executive orders, rules, regulations (28 CFR 35, 29 CFR 1630 and 41 CFR 60 (and orders of the Secretary of Labor as modified by the provisions prescribed herein, and imposed pursuant to 23 U.S.C. 140 shall constitute the EEO and specific affirmative action standards for the contractor's project activities under this contract. The Equal Opportunity Construction Contract Specifications set forth under 41 CFR 60-4.3 and the provisions of the American Disabilities Act of 1990 (42 U.S.C. 12101 et seq.) set forth under 28 CFR 35 and 29 CFR 1630 are incorporated by reference in this contract. In the execution of this contract, the contractor agrees to comply with the following minimum specific requirement activities of EEO:

a. The contractor will work with the State highway agency (SHA) and the Federal Government in carrying out EEO obligations and in their review of his/her activities under the contract.

b. The contractor will accept as his operating policy the following statement:

"It is the policy of this Company to assure that applicants are employed, and that employees are treated during employment, without regard to their race, religion, sex, color, national origin, age or disability. Such action shall include: employment, upgrading, demotion, or transfer; recruitment or recruitment advertising; layoff or termination; rates of pay or other forms of compensation; and selection for training, including apprenticeship, preapprenticeship, and/or on-the-job-training."

2. EEO Officer: The contractor will designate and make known to the SHA contracting officers an EEO Officer who will have the responsibility for an must be capable of effectively administering and promoting an active contractor program of EEO and who must be assigned adequate authority and responsibility to do so.

3. Dissemination of Policy: All members of the contractor's staff who are authorized to hire, supervise, promote, and discharge employees, or who recommend such action, or who are substantially involved in such action, will be made fully cognizant of, and will implement, the contractor's EEO policy and contractual responsibilities to provide EEO in each grade and classification of employment. To ensure that the above

agreement will be met, the following actions will be taken as a minimum:

a. Periodic meetings of supervisory and personnel office employees will be conducted before the start of work and then not less often than once every six months, at which time the contractor's EEO policy and its implementation will be reviewed and explained. The meetings will be conducted by the EEO Officer.

b. All new supervisory or personnel office employees will be given a thorough indoctrination by the EEO Officer, covering all major aspects of the contractor's EEO obligations within thirty days following their reporting for duty with the contractor.

c. All personnel who are engaged in direct recruitment for the project will be instructed by the EEO Officer in the contractor's procedures for locating and hiring minority group employees.

d. Notices and posters setting forth the contractor's EEO policy will be placed in areas readily accessible to employees, applicants for employment and potential employees.

e. The contractor's EEO policy and the procedures to implement such policy will be brought to the attention of employees by means of meetings, employee handbooks, or other appropriate means.

4. Recruitment: When advertising for employees, the contractor will include in all advertisements for employees the notation: "An Equal Opportunity Employer." All such advertisements will be placed in publications having a large circulation among minority groups in the area from which the project work force would normally be derived.

a. The contractor will, unless precluded by a valid bargaining agreement, conduct systematic and direct recruitment through public and private employees referral sources likely to yield qualified minority group applicants. To meet this requirement, the contractor will identify sources of potential minority group employees, and establish which such identified sources procedures whereby minority group applicants may be referred to the contractor for employment consideration.

b. In the event the contractor has a valid bargaining agreement providing for exclusive hiring hall referrals, he is expected to observe the provisions of that agreement to the extent that the system permits the contractor's compliance with EEO contract provisions. (The DOL has held that where implementation of such agreements have the effect of discriminating against minorities or women, or obligates the contractor to do the same, such implementation violates Executive Order 11246, as amended.)

c. The contractor will encourage his present employees to refer minority group applicants for employment. Information and procedures with regard to referring minority group applicants will be discussed with employees.

5. Personnel Actions: Wages, working conditions, and employee benefits shall be established and administered, and personnel actions of every type, including hiring, upgrading, promotion, transfer, demotion, layoff, and termination, shall be taken without regard to race, color, religion, sex, national origin, age or disability. The following procedures shall be followed:

a. The contractor will conduct periodic inspections of project sites to insure that working conditions and employee facilities do not indicate discriminatory treatment of project site personnel.

b. The contractor will periodically evaluate the spread of wages paid within each classification to determine any

evidence of discriminatory wage practices.

c. The contractor will periodically review selected personnel actions in depth to determine whether there is evidence of discrimination. Where evidence is found, the contractor will promptly take corrective action. If the review indicates that the discrimination may extend beyond the actions reviewed, such corrective action shall include all affected persons.

d. The contractor will promptly investigate all complaints of alleged discrimination made to the contractor in connection with his obligations under this contract, will attempt to resolve such complaints, and will take appropriate corrective action within a reasonable time. If the investigation indicates that the discrimination may affect persons other than the complainant, such corrective action shall include such other persons. Upon completion of each investigation, the contractor will inform every complainant of all of his avenues of appeal.

6. Training and Promotion:

a. The contractor will assist in locating, qualifying, and increasing the skills of minority group and women employees, and applicants for employment.

b. Consistent with the contractor's work force requirements and as permissible under Federal and State regulations, the contractor shall make full use of training programs, i.e., apprenticeship, and on-the-job training programs for the geographical area of contract performance. Where feasible, 25 percent of apprentices or trainees in each occupation shall be in their first year of apprenticeship or training. In the event a special provision for training is provided under this contract, this subparagraph will be superseded as indicated in the special provision.

c. The contractor will advise employees and applicants for employment of available training programs and entrance requirements for each.

d. The contractor will periodically review the training and promotion potential of minority group and women employees and will encourage eligible employees to apply for such training and promotion.

7. Unions: If the contractor relies in whole or in part upon unions as a source of employees, the contractor will use his/her best efforts to obtain the cooperation of such unions to increase opportunities for minority groups and women within the unions, and to effect referrals by such unions of minority and female employees. Actions by the contractor either directly or through a contractor's association acting as agent will include the procedures set forth below:

a. The contractor will use best efforts to develop, in cooperation with the unions, joint training programs aimed toward qualifying more minority group members and women for membership in the unions and increasing the skills of minority group employees and women so that they may qualify for higher paying employment.

b. The contractor will use best efforts to incorporate an EEO clause into each union agreement to the end that such union will be contractually bound to refer applicants without regard to their race, color, religion, sex, national origin, age or disability.

c. The contractor is to obtain information as to the referral practices and policies of the labor union except that to the extent such information is within the exclusive possession of the labor union and such labor union refuses to furnish such information to the contractor, the contractor shall so certify to

the SHA and shall set forth what efforts have been made to obtain such information.

d. In the event the union is unable to provide the contractor with a reasonable flow of minority and women referrals within the time limit set forth in the collective bargaining agreement, the contractor will, through independent recruitment efforts, fill the employment vacancies without regard to race, color, religion, sex, national origin, age or disability; making full efforts to obtain qualified and/or quailifiable minority group persons and women. (The DOL has held that it shall be no excuse that the union with which the contractor has a collective bargaining agreement providing for exclusive referral failed to refer minority employees.) In the event the union referral practice prevents the contractor from meeting the obligations pursuant to Executive Order 11246, as amended, and these special provisions, such contractor shall immediately notify the SHA.

8. Selection of Subcontractors, Procurement of Materials and Leasing of Equipment: The contractor shall not discriminate on the grounds of race, color, religion, sex, national origin, age or disability in the selection and retention of subcontractors, including procurement of materials and leases of equipment.

a. The contractor shall notify all potential subcontractors and suppliers of his/her EEO obligations under this contract.

b. Disadvantaged business enterprises (DBE), as defined in 49 CFR 23, shall have equal opportunity to compete for and perform subcontracts which the contractor enters into pursuant to this contract. The contractor will use his best efforts to solicit bids from and to utilize DBE subcontractors or subcontractors with meaningful minority group and female representation among their employees. Contractors shall obtain lists of DBE construction firms from SHA personnel.

c. The contractor will use his best efforts to ensure subcontractor compliance with their EEO obligations.

9. Records and Reports: The contractor shall keep such records as necessary to document compliance with the EEO requirements. Such records shall be retained for a period of three years following completion of the contract work and shall be available at reasonable times and places for inspection by authorized representatives of the SHA and the FHWA.

a. The records kept by the contractor shall document the following:

(1) The number of minority and non-minority group members and women employed in each work classification on the project;

(2) The progress and efforts being made in cooperation with unions, when applicable, to increase employment opportunities for minorities and women;

(3) The progress and efforts being made in locating, hiring, training, qualifying, and upgrading minority and female employees; and

(4) The progress and efforts being made in securing the services of DBE subcontractors or subcontractors with meaningful minority and female representation among their employees.

b. The contractors will submit an annual report to the SHA each July for the duration of the project, indicating the number of minority, women, and non-minority group employees currently engaged in each work classification required by the contract work. This information is to be reported on Form FHWA-1391. If on-the-job training is being required by special provision, the contractor will be required to collect and report training data.

III. NONSEGREGATED FACILITIES

(Applicable to all Federal-aid construction contracts and to all related subcontracts of \$10,000 or more.)

a. By submission of this bid, the execution of this contract or subcontract, or the consummation of this material supply agreement or purchase order, as appropriate, the bidder, Federal-aid construction contractor, subcontractor, material supplier, or vendor, as appropriate, certifies that the firm does not maintain or provide for its employees any segregated facilities at any of its establishments, and that the firm does not permit its employees to perform their services at any location, under its control, where segregated facilities are maintained. The firm agrees that a breach of this certification is a violation of the EEO provisions of this contract. The firm further certifies that no employee will be denied access to adequate facilities on the basis of sex or disability.

b. As used in this certification, the term "segregated facilities" means any waiting rooms, work areas, restrooms and washrooms, restaurants and other eating areas, timeclocks, locker rooms, and other storage or dressing areas, parking lots, drinking fountains, recreation or entertainment areas, transportation, and housing facilities provided for employees which are segregated by explicit directive, or are, in fact, segregated on the basis of race, color, religion, national origin, age or disability, because of habit, local custom, or otherwise. The only exception will be for the disabled when the demands for accessibility override (e.g. disabled parking).

c. The contractor agrees that it has obtained or will obtain identical certification from proposed subcontractors or material suppliers prior to award of subcontracts or consummation of material supply agreements of \$10,000 or more and that it will retain such certifications in its files.

IV. PAYMENT OF PREDETERMINED MINIMUM WAGE

(Applicable to all Federal-aid construction contracts exceeding \$2,000 and to all related subcontracts, except for projects located on roadways classified as local roads or rural minor collectors, which are exempt.)

1. General:

a. All mechanics and laborers employed or working upon the site of the work will be paid unconditionally and not less often than once a week and without subsequent deduction or rebate on any account [except such payroll deductions as are permitted by regulations (29 CFR 3) issued by the Secretary of Labor under the Copeland Act (40 U.S.C. 276c)] the full amounts of wages and bona fide fringe benefits (or cash equivalents thereof) due at time of payment. The payment shall be computed at wage rates not less than those contained in the wage determination of the Secretary of Labor (hereinafter "the wage determination") which is attached hereto and made a part hereof, regardless of any contractual relationship which may be alleged to exist between the

contractor or its subcontractors and such laborers and mechanics. The wage determination (including any additional classifications and wage rates conformed under paragraph 2 of this Section IV and the DOL poster (WH-1321) or Form FHWA-1495) shall be posted at all times by the contractor and its subcontractors at the site of the work in a prominent and accessible place where it can be easily seen by the workers. For the purpose of this Section, contributions made or costs reasonably anticipated for bona fide fringe benefits under Section 1(b)(2) of the Davis-Bacon Act (40 U.S.C. 276a) on behalf of laborers or mechanics are considered wages paid to such laborers or mechanics, subject to the provisions of Section IV, paragraph 3b, hereof. Also, for the purpose of this Section, regular contributions made or costs incurred for more than a weekly period (but not less often than quarterly) under plans, funds, or programs, which cover the particular weekly period, are deemed to be constructively made or incurred during such weekly period. Such laborers and mechanics shall be paid the appropriate wage rate and fringe benefits on the wage determination for the classification of work actually performed, without regard to skill, except as provided in paragraphs 4 and 5 of this Section IV.

b. Laborers or mechanics performing work in more than one classification may be compensated at the rate specified for each classification for the time actually worked therein, provided, that the employer's payroll records accurately set forth the time spent in each classification in which work is performed.

c. All rulings and interpretations of the Davis-Bacon Act and related acts contained in 29 CFR 1, 3, and 5 are herein incorporated by reference in this contract.

2. Classification:

a. The SHA contracting officer shall require that any class of laborers or mechanics employed under the contract, which is not listed in the wage determination, shall be classified in conformance with the wage determination.

b. The contracting officer shall approve an additional classification, wage rate and fringe benefits only when the following criteria have been met:

(1) the work to be performed by the additional classification requested is not performed by a classification in the wage determination;

(2) the additional classification is utilized in the area by the construction industry;

(3) the proposed wage rate, including any bona fide fringe benefits, bears a reasonable relationship to the wage rates contained in the wage determination; and

(4) with respect to helpers, when such a classification prevails in the area in which the work is performed.

c. If the contractor or subcontractors, as appropriate, the laborers and mechanics (if known) to be employed in the additional classification or their representatives, and the contracting officer agree on the classification and wage rate (including the amount designated for fringe benefits where appropriate), a report of the action taken shall be sent by the contracting officer to the DOL, Administrator of the Wage and Hour Division, Employment Standards Administration, Washington, D.C. 20210. The Wage and Hour Administrator, or an authorized representative, will approve, modify, or

disapprove every additional classification action within 30 days of receipt and so advise the contracting officer or will notify the contracting officer within the 30-day period that additional time is necessary.

d. In the event the contractor or subcontractors, as appropriate, the laborers or mechanics to be employed in the additional classification or their representatives, and the contracting officer do not agree on the proposed classification and wage rate (including the amount designated for fringe benefits, where appropriate), the contracting officer shall refer the question, including the views of all interested parties and the recommendation of the contracting officer, to the Wage and Hour Administrator for determination. Said Administrator, or an authorized representative, will issue a determination within 30 days of receipt and so advise the contracting officer or will notify the contracting officer within the 30-day period that additional time is necessary.

e. The wage rate (including fringe benefits where appropriate) determined pursuant to paragraph 2c or 2d of this Section IV shall be paid to all workers performing work in the additional classification from the first day on which work is performed in the classification.

3. Payment of Fringe Benefits:

a. Whenever the minimum wage rate prescribed in the contract for a class of laborers or mechanics includes a fringe benefit which is not expressed as an hourly rate, the contractor or subcontractors, as appropriate, shall either pay the benefit as stated in the wage determination or shall pay another bona fide fringe benefit or an hourly case equivalent thereof.

b. If the contractor or subcontractor, as appropriate, does not make payments to a trustee or other third person, he/she may consider as a part of the wages of any laborer or mechanic the amount of any cost reasonably anticipated in providing bona fide fringe benefits under a plan or program, provided that the Secretary of Labor has found, upon the written request of the contractor, that the applicable standards of the Davis-Bacon Act have been met. The Secretary of Labor may require the contractor to set aside in a separate account assets for the meeting of obligations under the plan or program.

4. Apprentices and Trainees (Programs of the U.S. DOL) and Helpers:

a. Apprentices:

(1) Apprentices will be permitted to work at less than the predetermined rate for the work they performed when they are employed pursuant to and individually registered in a bona fide apprenticeship program registered with the DOL, Employment and Training Administration, Bureau of Apprenticeship and Training, or with a State apprenticeship agency recognized by the Bureau, or if a person is employed in his/her first 90 days of probationary employment as an apprentice in such an apprenticeship program, who is not individually registered in the program, but who has been certified by the Bureau of Apprenticeship and Training or a State apprenticeship agency (where appropriate) to be eligible for probationary employment as an apprentice.

(2) The allowable ratio of apprentices to journeyman-level employees on the job site in any craft classification shall not

be greater than the ratio permitted to the contractor as to the entire work force under the registered program. Any employee listed on a payroll at an apprentice wage rate, who is not registered or otherwise employed as stated above, shall be paid not less than the applicable wage rate listed in the wage determination for the classification of work actually performed. In addition, any apprentice performing work on the job site in excess of the ratio permitted under the registered program shall be paid not less than the applicable wage rate on the wage determination for the work actually performed. Where a contractor or subcontractor is performing construction on a project in a locality other than that in which its program is registered, the ratios and wage rates (expressed in percentages of the journeyman-level hourly rate) specified in the contractor's or subcontractor's registered program shall be observed.

(3) Every apprentice must be paid at not less than the rate specified in the registered program for the apprentice's level of progress, expressed as a percentage of the journeyman-level hourly rate specified in the applicable wage determination. Apprentices shall be paid fringe benefits in accordance with the provisions of the apprenticeship program. If the apprenticeship program does not specify fringe benefits, apprentices must be paid the full amount of fringe benefits listed on the wage determination for the applicable classification. If the Administrator for the Wage and Hour Division determines that a different practice prevails for the applicable apprentice classification, fringes shall be paid in accordance with that determination.

(4) In the event the Bureau of Apprenticeship and Training, or a State apprenticeship agency recognized by the Bureau, withdraws approval of an apprenticeship program, the contractor or subcontractor will no longer be permitted to utilize apprentices at less than the applicable predetermined rate for the comparable work performed by regular employees until an acceptable program is approved.

b. Trainees:

(1) Except as provided in 29 CFR 5.16, trainees will not be permitted to work at less than the predetermined rate for the work performed unless they are employed pursuant to and individually registered in a program which has received prior approval, evidenced by formal certification by the DOL, Employment and Training Administration.

(2) The ratio of trainees to journeyman-level employees on the job site shall not be greater than permitted under the plan approved by the Employment and Training Administration. Any employee listed on the payroll at a trainee rate who is not registered and participating in a training plan approved by the Employment and Training Administration shall be paid not less than the applicable wage rate on the wage determination for the classification of work actually performed. In addition, any trainee performing work on the job site in excess of the ratio permitted under the registered program shall be paid not less than the applicable wage rate on the wage determination for the work actually performed.

(3) Every trainee must be paid at not less than the rate specified in the approved program for his/her level of progress, expressed as a percentage of the journeyman-level hourly rate specified in the applicable wage determination. Trainees shall be paid fringe benefits in accordance with the provisions of the trainee program. If the trainee program does not mention fringe benefits, trainees shall be paid the full amount of fringe benefits

Wage and Hour Division determines that there is an apprenticeship program associated with the corresponding journeyman-level wage rate on the wage determination which provides for less than full fringe benefits for apprentices, in which cases such trainees shall receive the same fringe benefits as apprentices.

(4) In the event the Employment and Training Administration withdraws approval of a training program, the contractor or subcontractor will no longer be permitted to utilize trainees at less than the applicable predetermined rate for the work performed until an acceptable program is approved.

c. Helpers:

Helpers will be permitted to work on a project if the helper classification is specified and defined on the applicable wage determination or is approved pursuant to the conformance procedure set forth in Section IV. 2. Any worker listed on a payroll at a helper wage rate, who is not a helper under a approved definition, shall be paid not less than the applicable wage rate on the wage determination for the classification of work actually performed.

5. Apprentices and Trainees (Programs of the U.S. DOT):

Apprentices and trainees working under apprenticeship and skill training programs which have been certified by the Secretary of Transportation as promoting EEO in connection with Federal-aid highway construction programs are not subject to the requirements of paragraph 4 of this Section IV. The straight time hourly wage rates for apprentices and trainees under such programs will be established by the particular programs. The ratio of apprentices and trainees to journeymen shall not be greater than permitted by the terms of the particular program.

6. Withholding:

The SHA shall upon its own action or upon written request of an authorized representative of the DOL withhold, or cause to be withheld, from the contractor or subcontractor under this contract or any other Federal contract with the same prime contractor or any other Federally-assisted contract subject to Davis-Bacon prevailing wage requirements which is held by the same prime contractor, as much of the accrued payments or advances as may be considered necessary to pay laborers and mechanics, including apprentices, trainee's and helpers, employed by the contractor or any subcontractor the full amount of wages required by the contract. In the event of failure to pay any laborer or mechanic, including any apprentice, trainee, or helper, employed or working on the site of the work, all or part of the wages required by the contract, the SHA contracting officer may, after written notice to the contractor, take such action as may be necessary to cause the suspension of any further payment, advance, or guarantee of funds until such violations have ceased.

7. Overtime Requirements:

No contractor or subcontractor contracting for any part of the contract work which may require or involve the employment of laborers, mechanics, watchmen, or guards (including apprentices, trainees, and helpers described in paragraphs 4 and 5 above) shall require or permit any laborer, mechanic, watchman, or guard in any workweek in which he/she is employed on such work, to work in excess of 40 hours in such workweek unless such laborer, mechanic, watchman, or guard receives compensation at a rate not less than one-and-one-half times his/her basic rate of pay for all hours worked in excess of 40 hours in such workweek.

8. Violation:

Liability for Unpaid Wages; Liquidated Damages: In the event of any violation of the clause set forth in paragraph 7 above, the contractor and any subcontractor responsible thereof shall be liable to the affected employee for his/her unpaid wages. In addition, such contractor and subcontractor shall be liable to the United States (in the case of work done under contract for the District of Columbia or a territory, to such District or to such territory) for liquidated damages. Such liquidated damages shall be computed with respect to each individual laborer, mechanic, watchman, or guard employed in violation of the clause set forth in paragraph 7, in the sum of \$10 for each calendar day on which such employee was required or permitted to work in excess of the standard work week of 40 hours without payment of the overtime wages required by the clause set forth in paragraph 7.

9. Withholding for Unpaid Wages and Liquidated Damages:

The SHA shall; upon its own action or upon written request of any authorized representative of the DOL withhold, or cause to be withheld, from any monies payable on account of work performed by the contractor or subcontractor under any such contract or any other Federal contract with the same prime contractor, or any other Federally-assisted contract subject to the Contract Work Hours and Safety Standards Act, which is held by the same prime contractor, such sums as may be determined to be necessary to satisfy any liabilities of such contractor or subcontractor for unpaid wages and liquidated damages as provided in the clause set forth in paragraph 8 above.

V. STATEMENTS AND PAYROLLS

(Applicable to all Federal-aid construction contracts exceeding \$2,000 and to all related subcontracts, except for projects located on roadways classified as local roads or rural collectors, which are exempt.)

1. Compliance with Copeland Regulations (29 CFR 3):

The contractor shall comply with the Copeland Regulations of the Secretary of Labor which are herein incorporated by reference.

2. Payrolls and Payroll Records:

a. Payrolls and basic records relating thereto shall be maintained by the contractor and each subcontractor during the course of the work and preserved for a period of 3 years from the date of completion of the contract for all laborers, mechanics, apprentices, trainees, watchmen, helpers, and guards working at the site of the work.

b. The payroll records shall contain the name, social security number, and address of each such employee; his or her correct classification; hourly rates of wages paid (including rates of contributions or costs anticipated for bona fide fringe benefits or cash equivalent thereof the types described in Section 1(b)(2)(B) of the Davis Bacon Act); daily and weekly number of hours worked; deductions made; and actual wages paid. In addition, for Appalachian contracts, the payroll records shall contain a notation indicating whether the employee does, or does not, normally reside in the labor area as defined in Attachment A, paragraph 1. Whenever the Secretary of Labor, pursuant to Section IV, paragraph 3b, has found that the wages of any laborer or mechanic include the amount of any costs reasonably anticipated in providing benefits under a plan

or program described in Section 1(b)(2)(B) of the Davis Bacon Act, the contractor and each subcontractor shall maintain records which show that the commitment to provide such benefits is enforceable, that the plan or program is financially responsible, that the plan or program has been communicated in writing to the laborers or mechanics affected, and show the cost anticipated or the actual cost incurred in providing benefits. Contractors or subcontractors employing apprentices or trainees under approved programs shall maintain written evidence of the registration of apprentices and trainees, and ratios and wage rates prescribed in the applicable programs.

c. Each contractor and subcontractor shall furnish, each week in which any contract work is performed, to the SHA resident engineer a payroll of wages paid each of its employees (including apprentices trainees, and helpers, described in Section IV, paragraphs 4 and 5, and watchmen and guards engaged on work during the preceding weekly payroll period).

The payroll submitted shall set out accurately and completely all of the information required to be maintained under paragraph 2b of this Section V.

This information may be submitted in any form desired. Optional Form WH-347 is available for this purpose and may be purchased from the Superintendent of Documents (Federal stock number 029-005-0014-1), U.S. Government Printing Office, Washington, D.C. 20402. The prime contractor is responsible for the submission of copies of payrolls by all subcontractors.

d. Each payroll submitted shall be accompanied by a "Statement of Compliance," signed by the Contractor or subcontractor or his/her agent who pays or supervises the payment of the persons employed under the contract and shall certify the following:

(1) that the payroll for the payroll period contains the information required to be maintained under paragraph 2b of this Section V and that such information is correct and complete;

(2) that such laborer or mechanic (including each helper, apprentice, and trainee) employed on the contract during the payroll period has been paid the full weekly wages earned, without rebate, either directly or indirectly, and that no deductions have been made either directly or indirectly from the full wages earned, other than permissible deductions as set forth in the Regulations, 29 CFR 3;

(3) that each laborer or mechanic has been paid not less than the applicable wage rate and fringe benefits or cash equivalent for the classification of work performed, as specified in the applicable wage determination incorporated into the contract.

e. The weekly submission of a properly executed certification set forth on the reverse side of Optional Form WH-347 shall satisfy the requirement for submission of the "Statement of Compliance" required by paragraph 2d of this Section V.

f. The falsification of any of the above certifications may subject the contractor to civil or criminal prosecution under 18 U/S. C. 1001 and 31 U.S.C. 231.

g. The contractor or subcontractor shall make the records required under paragraph 2b of this Section V available for

inspection, copying, or transcription by authorized representatives of the SHA, the FHWA, or the DOL, and shall permit such representatives to interview employees during working hours on the job. If the contractor or subcontractor fails to submit the required records or to make them available, the SHA, the FHWA, the DOL, or all may, after written notice to the contractor, sponsor, applicant, or owner, take such actions as may be necessary to cause the suspension of any further payment, advance, or guarantee of funds. Furthermore, failure to submit the required records upon request or to make such records available may be grounds for debarment action pursuant to 29 CFR 5.12.

VI. RECORD OF MATERIALS, SUPPLIES, AND LABOR

1. On all federal-aid contracts on the national highway system, except those which provide solely for the installation of protective devices at railroad grade crossings, those which are constructed on a force account or direct labor basis, highway beautification contracts, and contracts for which the total final construction cost for roadway and bridge is less than \$1,000,000 (23 CFR 635) the contractor shall:

- a. Become familiar with the list of specific materials and supplies contained in Form FHWA-47, "Statement of Materials and Labor Used by Contractor of Highway Construction Involving Federal Funds," prior to the commencement of work under this contract.
- b. Maintain a record of the total cost of all materials and supplies purchased for and incorporated in the work, and also of the quantities of those specific materials and supplies listed on Form FHWA-47, and in the units shown on Form FHWA-47.
- c. Furnish, upon the completion of the contract, to the SHA resident engineer on Form FHWA-47 together with the data required in paragraph 1b relative to materials and supplies, a final labor summary of all contract work indicating the total hours worked and the total amount earned.

2. At the prime contractor's option, either a single report covering all contract work or separate reports for the contractor and for each subcontract shall be submitted.

VII. SUBLETTING OR ASSIGNING THE CONTRACT

1. The contractor shall perform with its own organization contract work amounting to not less than 30 percent (or a greater percentage if specified elsewhere in the contract) of the total original contract price, excluding any specialty items designated by the State. Specialty items may be performed by subcontract and the amount of any such specialty items performed may be deducted from the total original contract price before computing the amount of work required to be performed by the contractors' own organization (23 CFR 635).

- a. "Its own organization" shall be construed to include only workers employed and paid directly by the prime contractor and equipment owned or rented by the prime contractor, with or without operators. Such term does not include employees or equipment of a subcontractor, assignee, or agent of the prime contractor.
- b. "Specialty Items" shall be construed to be limited to work that requires highly specialized knowledge, abilities, or equipment not ordinarily available in the type of contracting organizations qualified and expected to bid on the contract as a

whole and in general are to be limited to minor components of the overall contract.

2. The contract amount upon which the requirements set forth in paragraph 1 of Section VII is computed includes the cost of material and manufactured products which are to be purchased or produced by the contractor under the contract provisions.

3. The contractor shall furnish (a) a competent superintendent or supervisor who is employed by the firm, has full authority to direct performance of the work in accordance with the contract requirements, and is in charge of all construction operations (regardless of who performs the work) and (b) such other of its own organizational resources (supervision, management, and engineering services) as the SHA contracting officer determines is necessary to assure the performance of the contract.

4. No portion of the contract shall be sublet, assigned or otherwise disposed of except with the written consent of the SHA contracting officer, or authorized representative, and such consent when given shall not be construed to relieve the contractor of any responsibility for the fulfillment of the contract.

Written consent will be given only after the SHA has assured that each subcontract is evidenced in writing and that it contains all pertinent provisions and requirements of the prime contract.

VIII. SAFETY: ACCIDENT PREVENTION

1. In the performance of this contract the contractor shall comply with all applicable Federal, State, and local laws governing safety, health, and sanitation (23 CFR 635). The contractor shall provide all safeguards, safety devices and protective equipment and take any other needed actions as it determines, or as the SHA contracting officer may determine, to be reasonably necessary to protect the life and health of employees on the job and the safety of the public and to protect property in connection with the performance of the work covered by the contract.

2. It is a condition of this contract, and shall be made a condition of each subcontract, which the contractor enters into pursuant to this contract, that the contractor and any subcontractor shall not permit any employee, in performance of the contract, to work in surroundings or under conditions which are unsanitary, hazardous or dangerous to his/her health or safety, as determined under construction safety and health standards (29 CFR 1926) promulgated by the Secretary of Labor, in accordance with Section 107 of the Contract Work Hours and Safety Standards Act (40 U.S. C. 333).

3. Pursuant to 29 CFR 1926.3, it is a condition of this contract that the Secretary of Labor or authorized representative thereof, shall have right of entry to any site of contract performance to inspect or investigate the matter of compliance with the construction safety and health standards and to carry out the duties of the Secretary under Section 107 of the Contract Work Hours and Safety Standards Act (40 U.S.C. 333).

IX. FALSE STATEMENTS CONCERNING HIGHWAY PROJECTS

In order to assure high quality and durable construction in conformity with approved plans and specifications and a high degree of reliability on statements and representations made by engineers, contractors, suppliers, and workers on Federal-aid highway projects, it is essential that all persons concerned with the project perform their functions as carefully, thoroughly, and honestly as possible. Willful falsification,

distortion, or misrepresentation with respect to any facts related to the project is a violation of Federal law. To prevent any misunderstanding regarding the seriousness of these and similar acts, the following notice shall be posted on each Federal-aid highway project (23 CFR 635) in one or more places where it is readily available to all persons concerned with the project:

NOTICE TO ALL PERSONNEL ENGAGED ON FEDERAL-AID HIGHWAY PROJECTS

18 U.S.C. 1020 reads as follows:

“Whoever, being an officer, agent or employee of the United States, or of any State or Territory, or whoever, whether a person, association, firm, or corporation, knowingly makes any false statement, false representation, or false report as to the character, quality, quantity, or cost of the material used or to be used, or the quantity or quality of the work performed or to be performed, or the cost thereof in connection with the submission of plans, maps, specifications, contracts, or costs of construction on any highway or related project submitted for approval to the Secretary of Transportation; or

Whoever knowingly makes any false statement, false representation, false report or false claim with respect to the character, quality, quantity, or cost of any work performed or to be performed, or materials furnished or to be furnished, in connection with the construction of any highway or related project approved by the Secretary of Transportation; or

Whoever knowingly makes any false statement or false representation as to material fact in any statement, certificate, or report submitted pursuant to provisions of the Federal-aid Roads Act approved July 1, 1916, (39 Stat. 355), as amended and supplemented;

Shall be fined not more than \$10,000 or imprisoned not more than 5 years or both.”

X. IMPLEMENTATION OF CLEAN AIR ACT AND FEDERAL WATER POLLUTION CONTROL ACT

(Applicable to all Federal-aid construction contracts and to all related subcontracts of \$100,000 or more).

By submission of this bid or the execution of this contract, or subcontract, as appropriate, the bidder, Federal-aid construction contractor, or subcontractor, as appropriate, will be deemed to have stipulated as follows:

1. That any facility that is or will be utilized in the performance of this contract, unless such contract is exempt under the Clean Air Act, as amended (42 U.S.C. 1857 et seq., as amended by Pub.L. 91-604), and under the Federal Water Pollution Control Act, as amended (33 U.S.C. 1251 et seq., as amended by Pub.L. 92-500), Executive Order 11738, and regulations in implementation thereof (40 CFR 15) is not listed, on the date of contract award, on the U.S. Environmental Protection Agency (EPA) List of Violating Facilities pursuant to 40 CFR 15.20.

2. That the firm agrees to comply and remain in compliance with all the requirements of Section 114 of the Clean Air Act and Section 308 of the Federal Water Pollution Control Act and all regulations and guidelines listed thereunder.

3. That the firm shall promptly notify the SHA of the receipt of

any communication from the Director, Office of Federal Activities, EPA indicating that a facility that is or will be utilized for the contract is under consideration to be listed on the EPA List of Violating Facilities.

4. That the firm agrees to include or cause to be included the requirements of paragraph 1 through 4 of this Section X in every nonexempt subcontract, and further agrees to take such action as the government may direct as a means of enforcing such requirements.

XI. CERTIFICATION REGARDING DEBARMENT, SUSPENSION, INELIGIBILITY AND VOLUNTARY EXCLUSION

1. Instructions for Certification - Primary Covered Transactions:

(Applicable to all Federal-aid contracts - 49 CFR 29)

a. By signing and submitting this proposal, the prospective primary participant is providing the certification set out below.

b. The inability of a person to provide the certification set out below will not necessarily result in denial of participation in this covered transaction. The prospective participant shall submit an explanation of why it cannot provide the certification set out below. The certification or explanation will be considered in connection with the department or agency's determination whether to enter into this transaction. However, failure of the prospective primary participant to furnish a certification or an explanation shall disqualify such a person from participation in this transaction.

c. The certification in this clause is a material representation of fact upon which reliance was placed when the department or agency determined to enter into this transaction. If it is later determined that the prospective primary participant knowingly rendered an erroneous certification, in addition to other remedies available to the Federal Government, the department or agency may terminate this transaction for cause of default.

d. The prospective primary participant shall provide immediate written notice to the department or agency to whom this proposal is submitted if any time the prospective primary participant learns that its certification was erroneous when submitted or has become erroneous by reason of changed circumstances.

e. The terms “covered transaction,” “debarred,” “suspended,” “ineligible,” “lower tier covered transaction,” “participant,” “person,” “primary covered transaction,” “principal,” “proposal,” and “voluntarily excluded,” as used in this clause, have the meanings set out in the Definitions and Coverage sections of rules implementing Executive Order 12549. You may contact the department or agency to which this proposal is submitted for assistance in obtaining a copy of those regulations.

f. The prospective primary participant agrees by submitting this proposal that, should the proposed covered transaction be entered into, it shall not knowingly enter into any lower tier covered transaction with a person who is debarred, suspended, declared ineligible, or voluntarily excluded from participation in this covered transaction, unless authorized by the department or agency entering into this transaction.

g. The prospective primary participant further agrees by submitting this proposal that it will include the clause titled

"Certification Regarding Debarment, Suspension, Ineligibility and Voluntary Exclusion-Lower Tier Covered Transaction," provided by the department or agency entering into this covered transaction, without modification in all lower tier covered transactions and in all solicitations for lower tier covered transactions.

h. A participant in a covered transaction may rely upon a certification of a prospective participant in a lower tier covered transaction that is not debarred, suspended, ineligible, or voluntarily excluded from the covered transaction, unless it knows that the certification is erroneous. A participant may decide the method and frequency by which it determines the eligibility of its principals. Each participant may, but is not required to, check the nonprocurement portion of the "Lists of Parties Excluded from Federal Procurement or Nonprocurement Programs" (Nonprocurement List) which is compiled by the General Services Administration.

i. Nothing contained in the foregoing shall be construed to require establishment of a system of records in order to render in good faith the certification required by this clause. The knowledge and information of participant is not required to exceed that which is normally possessed by a prudent person in the ordinary course of business dealings.

j. Except for transactions authorized under paragraph f of these instructions, if a participant in a covered transaction knowingly enters into a lower tier covered transaction with a person who is suspended, debarred, ineligible, or voluntarily excluded from participation in this transaction, in addition to other remedies available to the Federal Government, the department or agency may terminate this transaction for cause or default.

Certification Regarding Debarment, Suspension, Ineligibility and Voluntary Exclusion-Primary Covered Transactions

1. The prospective primary participant certifies to the best of its knowledge and belief, that it and its principals:

- a. Are not presently debarred, suspended, proposed for debarment, declared ineligible, or voluntarily excluded from covered transactions by any Federal department or agency;
- b. Have not within a 3-year period preceding this proposal been convicted of or had a civil judgment rendered against them for commission of fraud or a criminal offense in connection with obtaining, attempting to obtain, or performing a public (Federal, State or local) transaction or contract under a public transaction; violation of Federal or State antitrust statutes or commission of embezzlement, theft, forgery, bribery, falsification or destruction of records, making false statements, or receiving stolen property;
- c. Are not presently indicted for or otherwise criminally or civilly charged by a governmental entity (Federal, State or local) with commission of any of the offenses enumerated in paragraph 1b of this certification; and
- d. Have not within a 3-year period preceding this application/proposal had one or more public transactions (Federal, State or local) terminated for cause or default.

2. Where the prospective primary participant is unable to certify to any of the statements in this certification, such prospective participant shall attach an explanation to this proposal.

2. Instructions for Certification - Lower Tier Covered Transactions:

(Applicable to all subcontracts, purchase orders and other lower tier transactions of \$25,000 or more - 49 CFR 29)

- a. By signing and submitting this proposal, the prospective lower tier is providing the certification set out below.
- b. The certification in this clause is a material representation of fact upon which reliance was placed when this transaction was entered into. If it is later determined that the prospective lower tier participant knowingly rendered an erroneous certification, in addition to other remedies available to the Federal Government, the department, or agency with which this transaction originated may pursue available remedies, including suspension and/or debarment.
- c. The prospective lower tier participant shall provide immediate written notice to the person to which this proposal is submitted if at any time the prospective lower tier participant learns that its certification was erroneous by reason of changed circumstances.
- d. The terms "covered transaction," "debarred," "suspended," "ineligible," "primary covered transaction," "participant," "person," "principal," "proposal," and "voluntarily excluded," as used in this clause, have the meanings set out in the Definitions and Coverage sections of rules implementing Executive Order 12549. You may contact the person to which this proposal is submitted for assistance in obtaining a copy of those regulations.
- e. The prospective lower tier participant agrees by submitting this proposal that, should the proposed covered transaction be entered into, it shall not knowingly enter into any lower tier covered transaction with a person who is debarred, suspended, declared ineligible, or voluntarily excluded from participation in this covered transaction, unless authorized by the department or agency with which this transaction originated.
- f. The prospective lower tier participant further agrees by submitting this proposal that it will include this clause titled "Certification Regarding Debarment, Suspension, Ineligibility and Voluntary Exclusion-Lower Tier Covered Transaction," without modification, in all lower tier covered transactions and in all solicitations for lower tier covered transactions.
- g. A participant in a covered transaction may rely upon a certification of a prospective participant in a lower tier covered transaction that is not debarred, suspended, ineligible, or voluntarily excluded from the covered transaction, unless it knows that the certification is erroneous. A participant may decide the method and frequency by which it determines the eligibility of its principals. Each participant may, but is not required to, check the Nonprocurement List.
- h. Nothing contained in the foregoing shall be construed to require establishment of a system of records in order to render in good faith the certification required by this clause. The knowledge and information of participant is not required to exceed that which is normally possessed by a prudent person in the ordinary course of business dealing.
- i. Except for transactions authorized under paragraph e of these instructions, if a participant in a covered transaction knowingly enters into a lower tier covered transaction with a person who is suspended, debarred, ineligible, or voluntarily

excluded from participation in this transaction, in addition to other remedies available to the Federal Government, the department or agency with which this transaction originated may pursue available remedies, including suspension and/or debarment.

Certification Regarding Debarment, Suspension, Ineligibility And Voluntary Exclusion-Lower Tier Covered Transactions:

1. The prospective lower tier participant certifies, by submission of this proposal, that neither it nor its principals is presently debarred, suspended, proposed for debarment, declared ineligible, or voluntarily excluded from participation in this transaction by any Federal department or agency.

2. Where the prospective lower tier participant is unable to certify to any of the statements in this certification, such prospective participant shall attach an explanation to this proposal.

XII. CERTIFICATION REGARDING USE OF CONTRACT FUNDS FOR LOBBYING

(Applicable to all Federal-aid construction contracts and to all related subcontracts which exceed \$100,000 - 49 CFR 20)

1. The prospective participant certifies, by signing and submitting this bid or proposal, to the best of his or her knowledge and belief, that:

a. No Federal appropriated funds have been paid or will be paid, by or on behalf of the undersigned, to any person for influencing or attempting to influence an officer or employee of any Federal agency, a Member of Congress, an officer or employee of Congress, or an employee of a Member of Congress in connection with the awarding of any Federal contract, the making of any Federal grant, the making of any Federal loan, the entering into of any cooperative agreement, and the extension, continuation, renewal, amendment, or modification of any Federal contract, grant, loan, or cooperative agreement.

b. If any funds other than Federal appropriated funds have been paid or will be paid to any person for influencing or attempting to influence an officer or employee of any Federal agency, a Member of Congress, an officer or employee of Congress, or an employee of a Member of Congress in connection with this Federal contract, grant, loan, or cooperative agreement, the undersigned shall complete and submit Standard Form-LLL, "Disclosure Form to Report Lobbying," in accordance with its instructions.

2. This certification is a material representation of fact upon which reliance was placed when this transaction was made or entered into. Submission of this certification is a prerequisite for making or entering into this transaction imposed by 31 U.S.C. 1352. Any person who fails to file the required certification shall be subject to a civil penalty of not less than \$10,000 and not more than \$100,000 for each such failure.

3. The prospective participant also agrees by submitting his or her bid or proposal that he or she shall require that the language of this certification be included in all lower tier subcontracts, which exceed \$100,000 and that all such recipients shall certify and disclose accordingly.

**MINIMUM WAGES FOR FEDERAL AND FEDERALLY
ASSISTED CONSTRUCTION CONTRACTS**

This project is funded, in part, with Federal-aid funds and, as such, is subject to the provisions of the Davis-Bacon Act of March 3, 1931, as amended (46 Sta. 1494, as amended, 40 U.S.C. 276a) and of other Federal statutes referred to in a 29 CFR Part 1, Appendix A, as well as such additional statutes as may from time to time be enacted containing provisions for the payment of wages determined to be prevailing by the Secretary of Labor in accordance with the Davis-Bacon Act and pursuant to the provisions of 29 CFR Part 1. The prevailing rates and fringe benefits shown in the General Wage Determination Decisions issued by the U.S. Department of Labor shall, in accordance with the provisions of the foregoing statutes, constitute the minimum wages payable on Federal and federally assisted construction projects to laborers and mechanics of the specified classes engaged on contract work of the character and in the localities described therein.

General Wage Determination Decisions, modifications and supersedes decisions thereto are to be used in accordance with the provisions of 29 CFR Parts 1 and 5. Accordingly, the applicable decision, together with any modifications issued, must be made a part of every contract for performance of the described work within the geographic area indicated as required by an applicable DBRA Federal prevailing wage law and 29 CFR Part 5. The wage rates and fringe benefits contained in the General Wage Determination Decision shall be the minimum paid by contractors and subcontractors to laborers and mechanics.

NOTICE

The most current **General Wage Determination Decisions** (wage rates) are available on the IDOT web site. They are located on the Letting and Bidding page at <http://www.dot.state.il.us/desenv/delett.html>.

In addition, ten (10) days prior to the letting, the applicable Federal wage rates will be e-mailed to subscribers. It is recommended that all contractors subscribe to the Federal Wage Rates List or the Contractor's Packet through IDOT's subscription service.

PLEASE NOTE: if you have already subscribed to the Contractor's Packet you will automatically receive the Federal Wage Rates.

The instructions for subscribing are at <http://www.dot.state.il.us/desenv/subsc.html>.

If you have any questions concerning the wage rates, please contact IDOT's Chief Contract Official at 217-782-7806.