

If you plan to submit a bid directly to the Department of Transportation

PREQUALIFICATION

Any contractor who desires to become pre-qualified to bid on work advertised by IDOT must submit the properly completed pre-qualification forms to the Bureau of Construction no later than 4:30 p.m. prevailing time twenty-one days prior to the letting of interest. This pre-qualification requirement applies to first time contractors, contractors renewing expired ratings, contractors maintaining continuous pre-qualification or contractors requesting revised ratings. To be eligible to bid, existing pre-qualification ratings must be effective through the date of letting.

REQUESTS FOR AUTHORIZATION TO BID

Contractors downloading and/or ordering CD-ROM's and are wanting to bid on items included in a particular letting must submit the properly completed "Request for Authorization to Bid/or Not For Bid Status" (BDE 124INT) and the ORIGINAL, signed and notarized, "Affidavit of Availability" (BC 57) to the proper office no later than 4:30 p.m. prevailing time, three (3) days prior to the letting date.

WHO CAN BID ?

Bids will be accepted from only those companies that request and receive written **Authorization to Bid** from IDOT's Central Bureau of Construction.

WHAT CONSTITUTES WRITTEN AUTHORIZATION TO BID? When a prospective prime bidder submits a "Request for Authorization to Bid/or Not For Bid Status"(BDE 124INT) he/she must indicate at that time which items are being requested For Bidding purposes. Only those items requested For Bidding will be analyzed. After the request has been analyzed, the bidder will be issued a **Proposal Denial and/or Authorization Form**, approved by the Central Bureau of Construction, that indicates which items have been approved For Bidding. If **Authorization to Bid** cannot be approved, the **Proposal Denial and/or Authorization Form** will indicate the reason for denial.

ABOUT AUTHORIZATION TO BID: Firms that have not received an authorization form within a reasonable time of complete and correct original document submittal should contact the department as to status. This is critical in the week before the letting. These documents must be received three days before the letting date. Firms unsure as to authorization status should call the Prequalification Section of the Bureau of Construction at the number listed at the end of these instructions.

ADDENDA AND REVISIONS: It is the contractor's responsibility to determine which, if any, addenda or revisions pertain to any project they may be bidding. Failure to incorporate all relevant addenda or revisions may cause the bid to be declared unacceptable.

Each addendum will be placed with the contract number. Addenda and revisions will also be placed on the Addendum/Revision Checklist and each subscription service subscriber will be notified by e-mail of each addendum and revision issued.

The Internet is the Department's primary way of doing business. The subscription server e-mails are an added courtesy the Department provides. It is suggested that bidder check IDOT's website <http://www.dot.il.gov/desenv/delett.html> before submitting final bid information.

IDOT is not responsible for any e-mail related failures.

Addenda Questions may be directed to the Contracts Office at (217)782-7806 or D&Econtracts@dot.il.gov

Technical Questions about downloading these files may be directed to Tim Garman (217)524-1642 or Timothy.Garman@illinois.gov.

WHAT MUST BE INCLUDED WHEN BIDS ARE SUBMITTED?: Bidders need not return the entire proposal when bids are submitted. That portion of the proposal that must be returned includes the following:

1. All documents from the Proposal Cover Sheet through the Proposal Bid Bond
2. Other special documentation and/or information that may be required by the contract special provisions

All proposal documents, including Proposal Guaranty Checks or Proposal Bid Bonds, should be stapled together to prevent loss when bids are processed by IDOT personnel.

ABOUT SUBMITTING BIDS: It is recommended that bidders deliver bids in person to insure they arrive at the proper location prior to the time specified for the receipt of bids. Any bid received at the place of letting after the time specified will not be accepted.

WHO SHOULD BE CALLED IF ASSISTANCE IS NEEDED?

Questions Regarding	Call
Prequalification and/or Authorization to Bid	(217)782-3413
Preparation and submittal of bids	(217)782-7806
Mailing of plans and proposals	(217)782-7806
Electronic plans and proposals	(217)524-1642

ADDENDUMS AND REVISIONS TO THE PROPOSAL FORMS

Planholders should verify that they have received and incorporated the addendum and/or revision prior to submitting their bid. Failure by the bidder to include an addendum could result in a bid being rejected as irregular.

237

RETURN WITH BID

Proposal Submitted By
Name
Address
City

Letting June 13, 2008

BIDDERS NEED NOT RETURN THE ENTIRE PROPOSAL
(See instructions inside front cover)

NOTICE TO PROSPECTIVE BIDDERS

This proposal can be used for bidding purposes by only those companies that request and receive written AUTHORIZATION TO BID from IDOT's Central Bureau of Construction.

(SEE INSTRUCTIONS ON THE INSIDE OF COVER)

Notice To Bidders, Specifications, Proposal, Contract and Contract Bond



Illinois Department
of Transportation

Springfield, Illinois 62764

Contract No. 64E02
ROCK ISLAND County
Section 48MFT-RS
Route FAP 599
Project ACF-0599(022)
District 2 Construction Funds

PLEASE MARK THE APPROPRIATE BOX BELOW:

- A Bid Bond is included.
- A Cashier's Check or a Certified Check is included

Plans Included
Herein

Prepared by

F

Checked by

(Printed by authority of the State of Illinois)

INSTRUCTIONS

ABOUT IDOT PROPOSALS: All proposals issued by IDOT are potential bidding proposals. Each proposal contains all Certifications and Affidavits, a Proposal Signature Sheet and a Proposal Bid Bond required for Prime Contractors to submit a bid after written **Authorization to Bid** has been issued by IDOT's Central Bureau of Construction.

WHO CAN BID?: Bids will be accepted from only those companies that request and receive written **Authorization to Bid** from IDOT's Central Bureau of Construction. To request authorization, a potential bidder must complete and submit Part B of the Request for Authorization to Bid/or Not For Bid Status form (BDE 124 INT) and submit an original Affidavit of Availability (BC 57).

WHAT CONSTITUTES WRITTEN AUTHORIZATION TO BID?: When a prospective prime bidder submits a "Request for Proposal Forms and Plans" he/she must indicate at that time which items are being requested For Bidding purposes. Only those items requested For Bidding will be analyzed. After the request has been analyzed, the bidder will be issued a **Proposal Denial and/or Authorization Form**, approved by the Central Bureau of Construction, that indicates which items have been approved For Bidding. If **Authorization to Bid** cannot be approved, the **Proposal Denial and/or Authorization Form** will indicate the reason for denial. If a contractor has requested to bid but has not received a **Proposal Denial and/or Authorization Form**, they should contact the Central Bureau of Construction in advance of the letting date.

WHAT MUST BE INCLUDED WHEN BIDS ARE SUBMITTED?: Bidders need not return the entire proposal when bids are submitted. That portion of the proposal that must be returned includes the following:

1. All documents from the Proposal Cover Sheet through the Proposal Bid Bond
2. Other special documentation and/or information that may be required by the contract special provisions

All proposal documents, including Proposal Guaranty Checks or Proposal Bid Bonds, should be stapled together to prevent loss when bids are processed by IDOT personnel.

ABOUT SUBMITTING BIDS: It is recommended that bidders deliver bids in person to insure they arrive at the proper location prior to the time specified for the receipt of bids. Any bid received at the place of letting after the time specified will not be accepted.

WHO SHOULD BE CALLED IF ASSISTANCE IS NEEDED?

Questions Regarding	Call
Prequalification and/or Authorization to Bid	217/782-3413
Preparation and submittal of bids	217/782-7806
Mailing of CD-ROMS	217/782-7806

RETURN WITH BID



PROPOSAL

TO THE DEPARTMENT OF TRANSPORTATION

1. Proposal of _____

Taxpayer Identification Number (Mandatory) _____

for the improvement identified and advertised for bids in the Invitation for Bids as:

**Contract No. 64E02
ROCK ISLAND County
Section 48MFT-RS
Project ACF-0599(022)
Route FAP 599
District 2 Construction Funds**

1.34 miles of milling, resurfacing and patching on IL Route 92 from Turkey Hollow Road to 0.3 mile east of IL Route 92 (north).

2. The undersigned bidder will furnish all labor, material and equipment to complete the above described project in a good and workmanlike manner as provided in the contract documents provided by the Department of Transportation. This proposal will become part of the contract and the terms and conditions contained in the contract documents shall govern performance and payments.

RETURN WITH BID

3. **ASSURANCE OF EXAMINATION AND INSPECTION/WAIVER.** The undersigned further declares that he/she has carefully examined the proposal, plans, specifications, form of contract and contract bond, and special provisions, and that he/she has inspected in detail the site of the proposed work, and that he/she has familiarized themselves with all of the local conditions affecting the contract and the detailed requirements of construction, and understands that in making this proposal he/she waives all right to plead any misunderstanding regarding the same.

4. **EXECUTION OF CONTRACT AND CONTRACT BOND.** The undersigned further agrees to execute a contract for this work and present the same to the department within fifteen (15) days after the contract has been mailed to him/her. The undersigned further agrees that he/she and his/her surety will execute and present within fifteen (15) days after the contract has been mailed to him/her contract bond satisfactory to and in the form prescribed by the Department of Transportation, in the penal sum of the full amount of the contract, guaranteeing the faithful performance of the work in accordance with the terms of the contract.

5. **PROPOSAL GUARANTY.** Accompanying this proposal is either a bid bond on the department form, executed by a corporate surety company satisfactory to the department, or a proposal guaranty check consisting of a bank cashier's check or a properly certified check for not less than 5 per cent of the amount bid or for the amount specified in the following schedule:

<u>Amount of Bid</u>		<u>Proposal Guaranty</u>	<u>Amount of Bid</u>		<u>Proposal Guaranty</u>	
Up to	\$5,000	\$150	\$2,000,000	to	\$3,000,000	\$100,000
\$5,000	to \$10,000	\$300	\$3,000,000	to	\$5,000,000	\$150,000
\$10,000	to \$50,000	\$1,000	\$5,000,000	to	\$7,500,000	\$250,000
\$50,000	to \$100,000	\$3,000	\$7,500,000	to	\$10,000,000	\$400,000
\$100,000	to \$150,000	\$5,000	\$10,000,000	to	\$15,000,000	\$500,000
\$150,000	to \$250,000	\$7,500	\$15,000,000	to	\$20,000,000	\$600,000
\$250,000	to \$500,000	\$12,500	\$20,000,000	to	\$25,000,000	\$700,000
\$500,000	to \$1,000,000	\$25,000	\$25,000,000	to	\$30,000,000	\$800,000
\$1,000,000	to \$1,500,000	\$50,000	\$30,000,000	to	\$35,000,000	\$900,000
\$1,500,000	to \$2,000,000	\$75,000	over		\$35,000,000	\$1,000,000

Bank cashier's checks or properly certified checks accompanying proposals shall be made payable to the Treasurer, State of Illinois, when the state is awarding authority; the county treasurer, when a county is the awarding authority; or the city, village, or town treasurer, when a city, village, or town is the awarding authority.

If a combination bid is submitted, the proposal guaranties which accompany the individual proposals making up the combination will be considered as also covering the combination bid.

The amount of the proposal guaranty check is _____ \$(_____). If this proposal is accepted and the undersigned shall fail to execute a contract bond as required herein, it is hereby agreed that the amount of the proposal guaranty shall become the property of the State of Illinois, and shall be considered as payment of damages due to delay and other causes suffered by the State because of the failure to execute said contract and contract bond; otherwise, the bid bond shall become void or the proposal guaranty check shall be returned to the undersigned.

Attach Cashier's Check or Certified Check Here

In the event that one proposal guaranty check is intended to cover two or more proposals, the amount must be equal to the sum of the proposal guaranties which would be required for each individual proposal. If the guaranty check is placed in another proposal, state below where it may be found.

The proposal guaranty check will be found in the proposal for:

Item _____

Section No. _____

County _____

Mark the proposal cover sheet as to the type of proposal guaranty submitted.

RETURN WITH BID

6. **COMBINATION BIDS.** The undersigned further agrees that if awarded the contract for the sections contained in the following combination, he/she will perform the work in accordance with the requirements of each individual proposal comprising the combination bid specified in the schedule below, and that the combination bid shall be prorated against each section in proportion to the bid submitted for the same. If an error is found to exist in the gross sum bid for one or more of the individual sections included in a combination, the combination bid shall be corrected as provided in the specifications.

When a combination bid is submitted, the schedule below must be completed in each proposal comprising the combination.

If alternate bids are submitted for one or more of the sections comprising the combination, a combination bid must be submitted for each alternate.

Schedule of Combination Bids

Combination No.	Sections Included in Combination	Combination Bid	
		Dollars	Cents

7. **SCHEDULE OF PRICES.** The undersigned bidder submits herewith, in accordance with the rules and instructions, a schedule of prices for the items of work for which bids are sought. The unit prices bid are in U.S. dollars and cents, and all extensions and summations have been made. The bidder understands that the quantities appearing in the bid schedule are approximate and are provided for the purpose of obtaining a gross sum for the comparison of bids. If there is an error in the extension of the unit prices, the unit prices shall govern. Payment to the contractor awarded the contract will be made only for actual quantities of work performed and accepted or materials furnished according to the contract. The scheduled quantities of work to be done and materials to be furnished may be increased, decreased or omitted as provided elsewhere in the contract.
8. **CERTIFICATE OF AUTHORITY.** The undersigned bidder, if a business organized under the laws of another State, assures the Department that it will furnish a copy of its certificate of authority to do business in the State of Illinois with the return of the executed contract and bond. Failure to furnish the certificate within the time provided for execution of an awarded contract may be cause for cancellation of the award and forfeiture of the proposal guaranty to the State.

ILLINOIS DEPARTMENT OF TRANSPORTATION
 SCHEDULE OF PRICES
 CONTRACT
 NUMBER - 64E02

State Job # - C-92-030-08
 PPS NBR - 2-10500-0000
 County Name - ROCK ISLAND- -
 Code - 161 - -
 District - 2 - -
 Section Number - 48MFT-RS

Project Number
 ACF-0599/022/

Route
 FAP 599

Item Number	Pay Item Description	Unit of Measure	Quantity	x	Unit Price	=	Total Price
XX005138	CLASS B PATCHES (SPECIAL)	SQ YD	115.000				
Z0013798	CONSTRUCTION LAYOUT	L SUM	1.000				
Z0028415	GEOTECHNICAL REINF	SQ YD	42.000				
Z0028700	GRAN SUBGRADE REPL	CU YD	4.000				
Z0048665	RR PROT LIABILITY INS	L SUM	1.000				
31100700	SUB GRAN MAT A 8	SQ YD	102.000				
40600200	BIT MATLS PR CT	TON	23.000				
40600300	AGG PR CT	TON	58.000				
40600535	LEV BIND HM N70	TON	35.000				
40600837	P LEV BIND MM N70	TON	1,753.000				
40600895	CONSTRUC TEST STRIP	EACH	1.000				
40600982	HMA SURF REM BUTT JT	SQ YD	82.000				
40600985	PCC SURF REM BUTT JT	SQ YD	183.000				
40600990	TEMPORARY RAMP	SQ YD	1,353.000				
40601005	HMA REPL OVER PATCH	TON	391.000				

ILLINOIS DEPARTMENT OF TRANSPORTATION
 SCHEDULE OF PRICES
 CONTRACT
 NUMBER - 64E02

State Job # - C-92-030-08
 PPS NBR - 2-10500-0000
 County Name - ROCK ISLAND- -
 Code - 161 - -
 District - 2 - -
 Section Number - 48MFT-RS

Project Number
 ACF-0599/022/

Route
 FAP 599

Item Number	Pay Item Description	Unit of Measure	Quantity	x	Unit Price	=	Total Price
40603310	HMA SC "C" N50	TON	668.000				
40603540	P HMA SC "D" N70	TON	2,557.000				
40800050	INCIDENTAL HMA SURF	TON	209.000				
44000158	HMA SURF REM 2 1/4	SQ YD	7,602.000				
44000198	HMA SURF REM VAR DP	SQ YD	2,634.000				
44002218	HMA RM OV PATCH 4 1/2	SQ YD	1,533.000				
44200108	PAVT PATCH T2 9	SQ YD	104.000				
44200112	PAVT PATCH T3 9	SQ YD	37.000				
44200114	PAVT PATCH T4 9	SQ YD	160.000				
48101200	AGGREGATE SHLDS B	TON	1,909.000				
48203021	HMA SHOULDERS 6	SQ YD	392.000				
60255500	MAN ADJUST	EACH	3.000				
60255800	MAN ADJ NEW T1F CL	EACH	3.000				
63200310	GUARDRAIL REMOV	FOOT	113.000				
67000400	ENGR FIELD OFFICE A	CAL MO	3.000				

ILLINOIS DEPARTMENT OF TRANSPORTATION
 SCHEDULE OF PRICES
 CONTRACT
 NUMBER - 64E02

State Job # - C-92-030-08
 PPS NBR - 2-10500-0000
 County Name - ROCK ISLAND- -
 Code - 161 - -
 District - 2 - -
 Section Number - 48MFT-RS

Project Number
 ACF-0599/022/

Route
 FAP 599

Item Number	Pay Item Description	Unit of Measure	Quantity	x	Unit Price	=	Total Price
67100100	MOBILIZATION	L SUM	1.000				
70100320	TRAF CONT-PROT 701422	L SUM	1.000				
70100450	TRAF CONT-PROT 701201	L SUM	1.000				
70100460	TRAF CONT-PROT 701306	L SUM	1.000				
70100500	TRAF CONT-PROT 701326	L SUM	1.000				
70102635	TR CONT & PROT 701701	L SUM	1.000				
70103815	TR CONT SURVEILLANCE	CAL DA	5.000				
70106800	CHANGEABLE MESSAGE SN	CAL MO	3.000				
70300100	SHORT-TERM PAVT MKING	FOOT	4,658.000				
70301000	WORK ZONE PAVT MK REM	SQ FT	518.000				
78000100	THPL PVT MK LTR & SYM	SQ FT	551.000				
78000200	THPL PVT MK LINE 4	FOOT	30,599.000				
78000500	THPL PVT MK LINE 8	FOOT	2,131.000				
78000600	THPL PVT MK LINE 12	FOOT	1,504.000				
78000650	THPL PVT MK LINE 24	FOOT	246.000				

ILLINOIS DEPARTMENT OF TRANSPORTATION
 SCHEDULE OF PRICES
 CONTRACT
 NUMBER - 64E02

State Job # - C-92-030-08
 PPS NBR - 2-10500-0000
 County Name - ROCK ISLAND- -
 Code - 161 - -
 District - 2 - -
 Section Number - 48MFT-RS

Project Number
 ACF-0599/022/

Route
 FAP 599

Item Number	Pay Item Description	Unit of Measure	Quantity	x	Unit Price	=	Total Price
78100100	RAISED REFL PAVT MKR	EACH	306.000				
78300200	RAISED REF PVT MK REM	EACH	219.000				
88600400	DET LOOP SPL	FOOT	2,146.000				

CONTRACT NUMBER

64E02

THIS IS THE TOTAL BID

\$ _____

NOTES:

- 1. Each PAY ITEM should have a UNIT PRICE and a TOTAL PRICE.**
- 2. The UNIT PRICE shall govern if no TOTAL PRICE is shown or if there is a discrepancy between the product of the UNIT PRICE multiplied by the QUANTITY.**
- 3. If a UNIT PRICE is omitted, the TOTAL PRICE will be divided by the QUANTITY in order to establish a UNIT PRICE.**
- 4. A bid may be declared UNACCEPTABLE if neither a unit price nor a total price is shown.**

RETURN WITH BID

STATE REQUIRED ETHICAL STANDARDS GOVERNING CONTRACT PROCUREMENT: ASSURANCES, CERTIFICATIONS AND DISCLOSURES

I. GENERAL

A. Article 50 of the Illinois Procurement Code establishes the duty of all State chief procurement officers, State purchasing officers, and their designees to maximize the value of the expenditure of public moneys in procuring goods, services, and contracts for the State of Illinois and to act in a manner that maintains the integrity and public trust of State government. In discharging this duty, they are charged by law to use all available information, reasonable efforts, and reasonable actions to protect, safeguard, and maintain the procurement process of the State of Illinois.

B. In order to comply with the provisions of Article 50 and to carry out the duty established therein, all bidders are to adhere to ethical standards established for the procurement process, and to make such assurances, disclosures and certifications required by law. By execution of the Proposal Signature Sheet, the bidder indicates that each of the mandated assurances has been read and understood, that each certification is made and understood, and that each disclosure requirement has been understood and completed.

C. In addition to all other remedies provided by law, failure to comply with any assurance, failure to make any disclosure or the making of a false certification shall be grounds for termination of the contract and the suspension or debarment of the bidder.

II. ASSURANCES

A. The assurances hereinafter made by the bidder are each a material representation of fact upon which reliance is placed should the Department enter into the contract with the bidder. The Department may terminate the contract if it is later determined that the bidder rendered a false or erroneous assurance, and the surety providing the performance bond shall be responsible for the completion of the contract.

B. Felons

1. The Illinois Procurement Code provides:

Section 50-10. Felons. Unless otherwise provided, no person or business convicted of a felony shall do business with the State of Illinois or any state agency from the date of conviction until 5 years after the date of completion of the sentence for that felony, unless no person held responsible by a prosecutorial office for the facts upon which the conviction was based continues to have any involvement with the business.

2. The bidder assures the Department that the award and execution of the contract would not cause a violation of Section 50-10.

C. Conflicts of Interest

1. The Illinois Procurement Code provides in pertinent part:

Section 50-13. Conflicts of Interest.

(a) Prohibition. It is unlawful for any person holding an elective office in this State, holding a seat in the General Assembly, or appointed to or employed in any of the offices or agencies of state government and who receives compensation for such employment in excess of 60% of the salary of the Governor of the State of Illinois, or who is an officer or employee of the Capital Development Board or the Illinois Toll Highway Authority, or who is the spouse or minor child of any such person to have or acquire any contract, or any direct pecuniary interest in any contract therein, whether for stationery, printing, paper, or any services, materials, or supplies, that will be wholly or partially satisfied by the payment of funds appropriated by the General Assembly of the State of Illinois or in any contract of the Capital Development Board or the Illinois Toll Highway authority.

(b) Interests. It is unlawful for any firm, partnership, association or corporation, in which any person listed in subsection (a) is entitled to receive (i) more than 7 1/2% of the total distributable income or (ii) an amount in excess of the salary of the Governor, to have or acquire any such contract or direct pecuniary interest therein.

(c) Combined interests. It is unlawful for any firm, partnership, association, or corporation, in which any person listed in subsection (a) together with his or her spouse or minor children is entitled to receive (i) more than 15%, in the aggregate, of the total distributable income or (ii) an amount in excess of 2 times the salary of the Governor, to have or acquire any such contract or direct pecuniary interest therein.

(d) Securities. Nothing in this Section invalidates the provisions of any bond or other security previously offered or to be offered for sale or sold by or for the State of Illinois.

(e) Prior interests. This Section does not affect the validity of any contract made between the State and an officer or employee of the State or member of the General Assembly, his or her spouse, minor child or any combination of those persons if that contract was in existence before his or her election or employment as an officer, member, or employee. The contract is voidable, however, if it cannot be completed within 365 days after the officer, member, or employee takes office or is employed.

The current salary of the Governor is \$171,000.00. Sixty percent of the salary is \$102,600.00.

RETURN WITH BID

2. The bidder assures the Department that the award and execution of the contract would not cause a violation of Section 50-13, or that an effective exemption has been issued by the Board of Ethics to any individual subject to the Section 50-13 prohibitions pursuant to the provisions of Section 50-20 of the Code and Executive Order Number 3 (1998). Information concerning the exemption process is available from the Department upon request.

D. Negotiations

1. The Illinois Procurement Code provides in pertinent part:

Section 50-15. Negotiations.

(a) It is unlawful for any person employed in or on a continual contractual relationship with any of the offices or agencies of State government to participate in contract negotiations on behalf of that office or agency with any firm, partnership, association, or corporation with whom that person has a contract for future employment or is negotiating concerning possible future employment.

2. The bidder assures the Department that the award and execution of the contract would not cause a violation of Section 50-15, and that the bidder has no knowledge of any facts relevant to the kinds of acts prohibited therein.

E. Inducements

1. The Illinois Procurement Code provides:

Section 50-25. Inducement. Any person who offers or pays any money or other valuable thing to any person to induce him or her not to bid for a State contract or as recompense for not having bid on a State contract is guilty of a Class 4 felony. Any person who accepts any money or other valuable thing for not bidding for a State contract or who withholds a bid in consideration of the promise for the payment of money or other valuable thing is guilty of a Class 4 felony.

2. The bidder assures the Department that the award and execution of the contract would not cause a violation of Section 50-25, and that the bidder has no knowledge of any facts relevant to the kinds of acts prohibited therein.

F. Revolving Door Prohibition

1. The Illinois Procurement Code provides:

Section 50-30. Revolving door prohibition. Chief procurement officers, associate procurement officers, State purchasing officers, their designees whose principal duties are directly related to State procurement, and executive officers confirmed by the Senate are expressly prohibited for a period of 2 years after terminating an affected position from engaging in any procurement activity relating to the State agency most recently employing them in an affected position for a period of at least 6 months. The prohibition includes, but is not limited to: lobbying the procurement process; specifying; bidding; proposing bid, proposal, or contract documents; on their own behalf or on behalf of any firm, partnership, association, or corporation. This Section applies only to persons who terminate an affected position on or after January 15, 1999.

2. The bidder assures the Department that the award and execution of the contract would not cause a violation of Section 50-30, and that the bidder has no knowledge of any facts relevant to the kinds of acts prohibited therein.

G. Reporting Anticompetitive Practices

1. The Illinois Procurement Code provides:

Section 50-40. Reporting anticompetitive practices. When, for any reason, any vendor, bidder, contractor, chief procurement officer, State purchasing officer, designee, elected official, or State employee suspects collusion or other anticompetitive practice among any bidders, offerors, contractors, proposers, or employees of the State, a notice of the relevant facts shall be transmitted to the Attorney General and the chief procurement officer.

2. The bidder assures the Department that it has not failed to report any relevant facts concerning the practices addressed in Section 50-40 which may involve the contract for which the bid is submitted.

H. Confidentiality

1. The Illinois Procurement Code provides:

Section 50-45. Confidentiality. Any chief procurement officer, State purchasing officer, designee, or executive officer who willfully uses or allows the use of specifications, competitive bid documents, proprietary competitive information, proposals, contracts, or selection information to compromise the fairness or integrity of the procurement, bidding, or contract process shall be subject to immediate dismissal, regardless of the Personnel code, any contract, or any collective bargaining agreement, and may in addition be subject to criminal prosecution.

2. The bidder assures the Department that it has no knowledge of any fact relevant to the practices addressed in Section 50-45 which may involve the contract for which the bid is submitted.

RETURN WITH BID

I. Insider Information

1. The Illinois Procurement Act provides:

Section 50-50. Insider information. It is unlawful for any current or former elected or appointed State official or State employee to knowingly use confidential information available only by virtue of that office or employment for actual or anticipated gain for themselves or another person.

2. The bidder assures the Department that it has no knowledge of any facts relevant to the practices addressed in Section 50-50 which may involve the contract for which the bid is submitted.

III. CERTIFICATIONS

A. The certifications hereinafter made by the bidder are each a material representation of fact upon which reliance is placed should the Department enter into the contract with the bidder. The Department may terminate the contract if it is later determined that the bidder rendered a false or erroneous certification, and the surety providing the performance bond shall be responsible for completion of the contract.

B. Bribery

1. The Illinois Procurement Code provides:

Section 50-5. Bribery.

(a) Prohibition. No person or business shall be awarded a contract or subcontract under this Code who:

(1) has been convicted under the laws of Illinois or any other state of bribery or attempting to bribe an officer or employee of the State of Illinois or any other state in that officer's or employee's official capacity; or

(2) has made an admission of guilt of that conduct that is a matter of record but has not been prosecuted for that conduct.

(b) Businesses. No business shall be barred from contracting with any unit of State or local government as a result of a conviction under this Section of any employee or agent of the business if the employee or agent is no longer employed by the business and:

(1) the business has been finally adjudicated not guilty; or

(2) the business demonstrates to the governmental entity with which it seeks to contract, and that entity finds that the commission of the offense was not authorized, requested, commanded, or performed by a director, officer, or high managerial agent on behalf of the business as provided in paragraph (2) of subsection (a) of Section 5-4 of the Criminal Code of 1961.

(c) Conduct on behalf of business. For purposes of this Section, when an official, agent, or employee of a business committed the bribery or attempted bribery on behalf of the business and in accordance with the direction or authorization of a responsible official of the business, the business shall be chargeable with the conduct.

(d) Certification. Every bid submitted to and contract executed by the State shall contain a certification by the contractor that the contractor is not barred from being awarded a contract or subcontract under this Section. A contractor who makes a false statement, material to the certification, commits a Class 3 felony.

2. The bidder certifies that it is not barred from being awarded a contract under Section 50.5.

C. Educational Loan

1. Section 3 of the Educational Loan Default Act provides:

§ 3. No State agency shall contract with an individual for goods or services if that individual is in default, as defined in Section 2 of this Act, on an educational loan. Any contract used by any State agency shall include a statement certifying that the individual is not in default on an educational loan as provided in this Section.

2. The bidder, if an individual as opposed to a corporation, partnership or other form of business organization, certifies that the bidder is not in default on an educational loan as provided in Section 3 of the Act.

D. Bid-Rigging/Bid Rotating

1. Section 33E-11 of the Criminal Code of 1961 provides:

§ 33E-11. (a) Every bid submitted to and public contract executed pursuant to such bid by the State or a unit of local government shall contain a certification by the prime contractor that the prime contractor is not barred from contracting with any unit of State or local government as a result of a violation of either Section 33E-3 or 33E-4 of this Article. The State and units of local government shall provide the appropriate forms for such certification.

RETURN WITH BID

(b) A contractor who makes a false statement, material to the certification, commits a Class 3 felony.

A violation of Section 33E-3 would be represented by a conviction of the crime of bid-rigging which, in addition to Class 3 felony sentencing, provides that any person convicted of this offense or any similar offense of any state or the United States which contains the same elements as this offense shall be barred for 5 years from the date of conviction from contracting with any unit of State or local government. No corporation shall be barred from contracting with any unit of State or local government as a result of a conviction under this Section of any employee or agent of such corporation if the employee so convicted is no longer employed by the corporation and: (1) it has been finally adjudicated not guilty or (2) if it demonstrates to the governmental entity with which it seeks to contract and that entity finds that the commission of the offense was neither authorized, requested, commanded, nor performed by a director, officer or a high managerial agent in behalf of the corporation.

A violation of Section 33E-4 would be represented by a conviction of the crime of bid-rotating which, in addition to Class 2 felony sentencing, provides that any person convicted of this offense or any similar offense of any state or the United States which contains the same elements as this offense shall be permanently barred from contracting with any unit of State or local government. No corporation shall be barred from contracting with any unit of State or local government as a result of a conviction under this Section of any employee or agent of such corporation if the employee so convicted is no longer employed by the corporation and: (1) it has been finally adjudicated not guilty or (2) if it demonstrates to the governmental entity with which it seeks to contract and that entity finds that the commission of the offense was neither authorized, requested, commanded, nor performed by a director, officer or a high managerial agent in behalf of the corporation.

2. The bidder certifies that it is not barred from contracting with the Department by reason of a violation of either Section 33E-3 or Section 33E-4.

E. International Anti-Boycott

1. Section 5 of the International Anti-Boycott Certification Act provides:

§ 5. State contracts. Every contract entered into by the State of Illinois for the manufacture, furnishing, or purchasing of supplies, material, or equipment or for the furnishing of work, labor, or services, in an amount exceeding the threshold for small purchases according to the purchasing laws of this State or \$10,000.00, whichever is less, shall contain certification, as a material condition of the contract, by which the contractor agrees that neither the contractor nor any substantially-owned affiliated company is participating or shall participate in an international boycott in violation of the provisions of the U.S. Export Administration Act of 1979 or the regulations of the U.S. Department of Commerce promulgated under that Act.

2. The bidder makes the certification set forth in Section 5 of the Act.

F. Drug Free Workplace

1. The Illinois "Drug Free Workplace Act" applies to this contract and it is necessary to comply with the provisions of the "Act" if the contractor is a corporation, partnership, or other entity (including a sole proprietorship) which has 25 or more employees.

2. The bidder certifies that if awarded a contract in excess of \$5,000 it will provide a drug free workplace by:

(a) Publishing a statement notifying employees that the unlawful manufacture, distribution, dispensation, possession or use of a controlled substance, including cannabis, is prohibited in the contractor's workplace; specifying the actions that will be taken against employees for violations of such prohibition; and notifying the employee that, as a condition of employment on such contract, the employee shall abide by the terms of the statement, and notify the employer of any criminal drug statute conviction for a violation occurring in the workplace no later than five (5) days after such conviction.

(b) Establishing a drug free awareness program to inform employees about the dangers of drug abuse in the workplace; the contractor's policy of maintaining a drug free workplace; any available drug counseling, rehabilitation, and employee assistance programs; and the penalties that may be imposed upon employees for drug violations.

(c) Providing a copy of the statement required by subparagraph (1) to each employee engaged in the performance of the contract and to post the statement in a prominent place in the workplace.

(d) Notifying the Department within ten (10) days after receiving notice from an employee or otherwise receiving actual notice of the conviction of an employee for a violation of any criminal drug statute occurring in the workplace.

(e) Imposing or requiring, within 30 days after receiving notice from an employee of a conviction or actual notice of such a conviction, an appropriate personnel action, up to and including termination, or the satisfactory participation in a drug abuse assistance or rehabilitation program approved by a federal, state or local health, law enforcement or other appropriate agency.

(f) Assisting employees in selecting a course of action in the event drug counseling, treatment, and rehabilitation is required and indicating that a trained referral team is in place.

(g) Making a good faith effort to continue to maintain a drug free workplace through implementation of the actions and efforts stated in this certification.

G. Debt Delinquency

1. The Illinois Procurement Code provides:

Section 50-11 and 50-12. Debt Delinquency.

The contractor or bidder certifies that it, or any affiliate, is not barred from being awarded a contract under 30 ILCS 500. Section 50-11 prohibits a person from entering into a contract with a State agency if it knows or should know that it, or any affiliate, is delinquent in the payment of any debt to the State as defined by the Debt Collection Board. Section 50-12 prohibits a person from entering into a contract with a State agency if it, or any affiliate, has failed to collect and remit Illinois Use Tax on all sales of tangible personal property into the State of Illinois in accordance with the provisions of the Illinois Use Tax Act. The contractor further acknowledges that the contracting State agency may declare the contract void if this certification is false or if the contractor, or any affiliate, is determined to be delinquent in the payment of any debt to the State during the term of the contract.

H. Sarbanes-Oxley Act of 2002

1. The Illinois Procurement Code, Section 50-60(c), provides:

The contractor certifies in accordance with 30 ILCS 500/50-10.5 that no officer, director, partner or other managerial agent of the contracting business has been convicted of a felony under the Sarbanes-Oxley Act of 2002 or a Class 3 or Class 2 felony under the Illinois Securities Law of 1953 for a period of five years prior to the date of the bid or contract. The contractor acknowledges that the contracting agency shall declare the contract void if this certification is false.

I. Addenda

The contractor or bidder certifies that all relevant addenda have been incorporated in to this contract. Failure to do so may cause the bid to be declared unacceptable.

J. Section 42 of the Environmental Protection Act

The contractor certifies in accordance with 30 ILCS 500/50-12 that the bidder or contractor is not barred from being awarded a contract under this Section which prohibits the bidding on or entering into contracts with the State of Illinois or a State agency by a person or business found by a court or the Pollution Control Board to have committed a willful or knowing violation of Section 42 of the Environmental Protection Act for a period of five years from the date of the order. The contractor acknowledges that the contracting agency may declare the contract void if this certification is false.

K. Apprenticeship and Training Certification (Does not apply to federal aid projects)

In accordance with the provisions of Section 30-22 (6) of the Illinois Procurement Code, the bidder certifies that it is a participant, either as an individual or as part of a group program, in the approved apprenticeship and training programs applicable to each type of work or craft that the bidder will perform with its own forces. The bidder further certifies for work that will be performed by subcontract that each of its subcontractors submitted for approval either (a) is, at the time of such bid, participating in an approved, applicable apprenticeship and training program; or (b) will, prior to commencement of performance of work pursuant to this contract, begin participation in an approved apprenticeship and training program applicable to the work of the subcontract. The Department, at any time before or after award, may require the production of a copy of each applicable Certificate of Registration issued by the United States Department of Labor evidencing such participation by the contractor and any or all of its subcontractors. Applicable apprenticeship and training programs are those that have been approved and registered with the United States Department of Labor. The bidder shall list in the space below, the official name of the program sponsor holding the Certificate of Registration for all of the types of work or crafts in which the bidder is a participant and that will be performed with the bidder's forces. Types of work or craft work that will be subcontracted shall be included and listed as subcontract work. The list shall also indicate any type of work or craft job category that does not have an applicable apprenticeship or training program. **The bidder is responsible for making a complete report and shall make certain that each type of work or craft job category that will be utilized on the project as reported on the Construction Employee Workforce Projection (Form BC-1256) and returned with the bid is accounted for and listed.**

NA - FEDERAL

The requirements of this certification and disclosure are a material part of the contract, and the contractor shall require this certification provision to be included in all approved subcontracts. In order to fulfill this requirement, it shall not be necessary that an applicable program sponsor be currently taking or that it will take applications for apprenticeship, training or employment during the performance of the work of this contract.

L. Executive Order Number 1 (2007) Regarding Lobbying on Government Procurements

The bidder hereby warrants and certifies that they have complied and will comply with the requirements set forth in this Order. The requirements of this warrant and certification are a material part of the contract, and the contractor shall require this warrant and certification provision to be included in all approved subcontracts.

M. Disclosure of Business Operations in Iran

Public Act 95-0616 provides that each bid, offer, or proposal submitted for a State contract shall include a disclosure of whether or not the Company acting as the bidder, offer or, or proposing entity, or any of its corporate parents or subsidiaries, within the 24 months before submission of the bid, offer, or proposal had business operations that involved contracts with or provision of supplies or services to the Government of Iran, companies in which the Government of Iran has any direct or indirect equity share, consortiums or projects commissioned by the Government of Iran, or companies involved in consortiums or projects commissioned by the Government of Iran and either of the following conditions apply:

- (1) More than 10% of the Company's revenues produced in or assets located in Iran involve oil-related activities or mineral-extraction activities; less than 75% of the Company's revenues produced in or assets located in Iran involve contracts with or provision of oil-related or mineral-extraction products or services to the Government of Iran or a project or consortium created exclusively by that government; and the Company has failed to take substantial action.
- (2) The Company has, on or after August 5, 1996, made an investment of \$20 million or more, or any combination of investments of at least \$10 million each that in the aggregate equals or exceeds \$20 million in any 12-month period, which directly or significantly contributes to the enhancement of Iran's ability to develop petroleum resources of Iran.

The terms "Business operations", "Company", "Mineral-extraction activities", "Oil-related activities", "Petroleum resources", and "Substantial action" are all defined in the Act.

Failure to make the disclosure required by the Act shall cause the bid, offer or proposal to be considered not responsive. The disclosure will be considered when evaluating the bid, offer, or proposal or awarding the contract. The name of each Company disclosed as doing business or having done business in Iran will be provided to the State Comptroller.

Check the appropriate statement:

Company has no business operations in Iran to disclose.

Company has business operations in Iran as disclosed the attached document.

NOTICE

**PA 95-0635 SUBSTANCE ABUSE PREVENTION PROGRAM (SAPP)
Effective January 1, 2008**

This Public Act requires that all contractors and subcontractors have a SAPP, meeting certain requirements, in place before starting work.

The as read low bidder is required to submit a correctly completed SAPP Certification Form BC 261 within seven (7) working days after the Letting. The Department will not accept a SAPP that does not meet the seven day submittal requirement and the bid will be declared not responsive. In the event the bid is declared not responsive due to failure to comply the Department may elect to cause the forfeiture of the penal sum of the bidder's proposal guaranty, may deny authorization to bid the project if re-advertised for bids and may not allow the bidder to participate on subsequent Lettings.

Submittal and approval of the bidder's SAPP is a condition of award.

The SAPP is to be submitted to the Bureau of Design & Environment, Contracts Office, Room 326, 2300 South Dirksen Parkway, Springfield, IL 62764. Voice 217-782-7806. Fax 217-785-1141. It is the bidder's responsibility to obtain confirmation of delivery.

The requirements of this Public Act are a material part of the contract, and the contractor shall require this provision to be included in all approved subcontracts. The contractor shall submit the correctly completed SAPP Certification Form BC 261 for each subcontractor with the Request for Approval of Subcontractor Form BC 260A.

TO BE RETURNED WITH BID

IV. DISCLOSURES

A. The disclosures hereinafter made by the bidder are each a material representation of fact upon which reliance is placed should the Department enter into the contract with the bidder. The Department may terminate the contract if it is later determined that the bidder rendered a false or erroneous disclosure, and the surety providing the performance bond shall be responsible for completion of the contract.

B. Financial Interests and Conflicts of Interest

1. Section 50-35 of the Illinois Procurement Code provides that all bids of more than \$10,000 shall be accompanied by disclosure of the financial interests of the bidder. This disclosed information for the successful bidder, will be maintained as public information subject to release by request pursuant to the Freedom of Information Act.

The financial interests to be disclosed shall include ownership or distributive income share that is in excess of 5%, or an amount greater than 60% of the annual salary of the Governor, of the bidding entity or its parent entity, whichever is less, unless the contractor or bidder is a publicly traded entity subject to Federal 10K reporting, in which case it may submit its 10K disclosure in place of the prescribed disclosure. If a bidder is a privately held entity that is exempt from Federal 10K reporting, but has more than 400 shareholders, it may submit the information that Federal 10K companies are required to report, and list the names of any person or entity holding any ownership share that is in excess of 5%. The disclosure shall include the names, addresses, and dollar or proportionate share of ownership of each person making the disclosure, their instrument of ownership or beneficial relationship, and notice of any potential conflict of interest resulting from the current ownership or beneficial interest of each person making the disclosure having any of the relationships identified in Section 50-35 and on the disclosure form.

In addition, all disclosures shall indicate any other current or pending contracts, proposals, leases, or other ongoing procurement relationships the bidding entity has with any other unit of state government and shall clearly identify the unit and the contract, proposal, lease, or other relationship.

2. **Disclosure Forms.** Disclosure Form A is attached for use concerning the individuals meeting the above ownership or distributive share requirements. Subject individuals should be covered each by one form. In addition, a second form (Disclosure Form B) provides for the disclosure of current or pending procurement relationships with other (non-IDOT) state agencies. **The forms must be included with each bid or incorporated by reference.**

C. Disclosure Form Instructions

Form A: For bidders that have previously submitted the information requested in Form A

The Department has retained the Form A disclosures submitted by all bidders responding to these requirements for the April 24, 1998 or any subsequent letting conducted by the Department. The bidder has the option of submitting the information again or the bidder may check the following certification statement indicating that the information previously submitted by the bidder is, as of the date of submission, current and accurate. Before checking this certification, the bidder should carefully review its prior submissions to ensure the Certification is correct. If the Bidder checks the Certification, the Bidder should proceed to Form B instructions.

CERTIFICATION STATEMENT

I have determined that the Form A disclosure information previously submitted is current and accurate, and all forms are hereby incorporated by reference in this bid. Any necessary additional forms or amendments to previously submitted forms are attached to this bid.

(Bidding Company)



Signature of Authorized Representative

Date

Form A: For bidders who have NOT previously submitted the information requested in Form A

If the bidder is a publicly traded entity subject to Federal 10K reporting, the 10K Report may be submitted to meet the requirements of Form A. If a bidder is a privately held entity that is exempt from Federal 10K reporting, but has more than 400 shareholders, it may submit the information that Federal 10K companies are required to report, and list the names of any person or entity holding any ownership share that is in excess of 5%. If a bidder is not subject to Federal 10K reporting, the bidder must determine if any individuals are required by law to complete a financial disclosure form. To do this, the bidder should answer each of the following questions. A "YES" answer indicates Form A must be completed. If the answer to each of the following questions is "NO", then the NOT APPLICABLE STATEMENT on the second page of Form A must be signed and dated by a person that is authorized to execute contracts for the bidding company. Note: These questions are for assistance only and are not required to be completed.

1. Does anyone in your organization have a direct or beneficial ownership share of greater than 5% of the bidding entity or parent entity? YES ___ NO ___
2. Does anyone in your organization have a direct or beneficial ownership share of less than 5%, but which has a value greater than \$102,600.00? YES ___ NO ___
3. Does anyone in your organization receive more than \$102,600.00 of the bidding entity's or parent entity's distributive income? (Note: Distributive income is, for these purposes, any type of distribution of profits. An annual salary is not distributive income.) YES ___ NO ___
4. Does anyone in your organization receive greater than 5% of the bidding entity's or parent entity's total distributive income, but which is less than \$102,600.00? YES ___ NO ___
(Note: Only one set of forms needs to be completed per person per bid even if a specific individual would require a yes answer to more than one question.)

A "YES" answer to any of these questions requires the completion of Form A. The bidder must determine each individual in the bidding entity or the bidding entity's parent company that would cause the questions to be answered "Yes". Each form must be signed and dated by a person that is authorized to execute contracts for your organization. **Photocopied or stamped signatures are not acceptable.** The person signing can be, but does not have to be, the person for which the form is being completed. The bidder is responsible for the accuracy of any information provided.

If the answer to each of the above questions is "NO", then the NOT APPLICABLE STATEMENT on page 2 of Form A must be signed and dated by a person that is authorized to execute contracts for your company.

Form B: Identifying Other Contracts & Procurement Related Information Disclosure Form B must be completed for each bid submitted by the bidding entity. Note: *Checking the NOT APPLICABLE STATEMENT on Form A does not allow the bidder to ignore Form B. Form B must be completed, checked, and dated or the bidder may be considered nonresponsive and the bid will not be accepted.*

The Bidder shall identify, by checking Yes or No on Form B, whether it has any pending contracts (including leases), bids, proposals, or other ongoing procurement relationship with any other (non-IDOT) State of Illinois agency. If "No" is checked, the bidder only needs to complete the check box on the bottom of Form B. If "Yes" is checked, the bidder must do one of the following:

Option I: If the bidder did not submit an Affidavit of Availability to obtain authorization to bid, the bidder must list all non-IDOT State of Illinois agency pending contracts, leases, bids, proposals, and other ongoing procurement relationships. These items may be listed on Form B or on an attached sheet(s). Do not include IDOT contracts. Contracts with cities, counties, villages, etc. are not considered State of Illinois agency contracts and are not to be included. Contracts with other State of Illinois agencies such as the Department of Natural Resources or the Capital Development Board must be included. Bidders who submit Affidavits of Availability are suggested to use Option II.

Option II: If the bidder is required and has submitted an Affidavit of Availability in order to obtain authorization to bid, the bidder may write or type "See Affidavit of Availability" which indicates that the Affidavit of Availability is incorporated by reference and includes all non-IDOT State of Illinois agency pending contracts, leases, bids, proposals, and other ongoing procurement relationships. For any contracts that are not covered by the Affidavit of Availability, the bidder must identify them on Form B or on an attached sheet(s). These might be such things as leases.

D. Bidders Submitting More Than One Bid

Bidders submitting multiple bids may submit one set of forms consisting of all required Form A disclosures and one Form B for use with all bids. Please indicate in the space provided below the bid item that contains the original disclosure forms and the bid items which incorporate the forms by reference.

- The bid submitted for letting item _____ contains the Form A disclosures or Certification Statement and the Form B disclosures. The following letting items incorporate the said forms by reference:

RETURN WITH BID/OFFER

**ILLINOIS DEPARTMENT
OF TRANSPORTATION**

**Form A
Financial Information &
Potential Conflicts of Interest
Disclosure**

Contractor Name		
Legal Address		
City, State, Zip		
Telephone Number	Email Address	Fax Number (if available)

Disclosure of the information contained in this Form is required by the Section 50-35 of the Illinois Procurement Code (30 ILCS 500). Vendors desiring to enter into a contract with the State of Illinois must disclose the financial information and potential conflict of interest information as specified in this Disclosure Form. This information shall become part of the publicly available contract file. This Form A must be completed for bids in excess of \$10,000, and for all open-ended contracts. **A publicly traded company may submit a 10K disclosure (or equivalent if applicable) in satisfaction of the requirements set forth in Form A. See Disclosure Form Instructions.**

DISCLOSURE OF FINANCIAL INFORMATION

1. Disclosure of Financial Information. The individual named below has an interest in the BIDDER (or its parent) in terms of ownership or distributive income share in excess of 5%, or an interest which has a value of more than \$102,600.00 (60% of the Governor's salary as of 7/1/07). **(Make copies of this form as necessary and attach a separate Disclosure Form A for each individual meeting these requirements)**

FOR INDIVIDUAL (type or print information)

NAME: _____

ADDRESS _____

Type of ownership/distributable income share:

stock _____ sole proprietorship _____ Partnership _____ other: (explain on separate sheet):
% or \$ value of ownership/distributable income share: _____

2. Disclosure of Potential Conflicts of Interest. Check "Yes" or "No" to indicate which, if any, of the following potential conflict of interest relationships apply. If the answer to any question is "Yes", please attach additional pages and describe.

(a) State employment, currently or in the previous 3 years, including contractual employment of services.

Yes ___ No ___

If your answer is yes, please answer each of the following questions.

- Are you currently an officer or employee of either the Capitol Development Board or the Illinois Toll Highway Authority? Yes ___ No ___
- Are you currently appointed to or employed by any agency of the State of Illinois? If you are currently appointed to or employed by any agency of the State of Illinois, and your annual salary exceeds \$102,600.00, (60% of the Governor's salary as of 7/1/07) provide the name the State agency for which you are employed and your annual salary. _____

RETURN WITH BID/OFFER

- 3. If you are currently appointed to or employed by any agency of the State of Illinois, and your annual salary exceeds \$102,600.00, (60% of the Governor's salary as of 7/1/07) are you entitled to receive (i) more than 7 1/2% of the total distributable income of your firm, partnership, association or corporation, or (ii) an amount in excess of the salary of the Governor? Yes ___ No ___

- 4. If you are currently appointed to or employed by any agency of the State of Illinois, and your annual salary exceeds \$102,600.00, (60% of the Governor's salary as of 7/1/07) are you and your spouse or minor children entitled to receive (i) more than 15% in aggregate of the total distributable income of your firm, partnership, association or corporation, or (ii) an amount in excess of 2 times the salary of the Governor? Yes ___ No ___

(b) State employment of spouse, father, mother, son, or daughter, including contractual employment for services in the previous 2 years.

Yes ___ No ___

If your answer is yes, please answer each of the following questions.

- 1. Is your spouse or any minor children currently an officer or employee of the Capitol Development Board or the Illinois Toll Highway Authority? Yes ___ No ___

- 2. Is your spouse or any minor children currently appointed to or employed by any agency of the State of Illinois? If your spouse or minor children is/are currently appointed to or employed by any agency of the State of Illinois, and his/her annual salary exceeds \$102,600.00, (60% of the Governor's salary as of 7/1/07) provide the name of the spouse and/or minor children, the name of the State agency for which he/she is employed and his/her annual salary. _____

- 3. If your spouse or any minor children is/are currently appointed to or employed by any agency of the State of Illinois, and his/her annual salary exceeds \$102,600.00, (60% of the salary of the Governor as of 7/1/07) are you entitled to receive (i) more than 7 1/2% of the total distributable income of your firm, partnership, association or corporation, or (ii) an amount in excess of the salary of the Governor? Yes ___ No ___

- 4. If your spouse or any minor children are currently appointed to or employed by any agency of the State of Illinois, and his/her annual salary exceeds \$102,600.00, (60% of the Governor's salary as of 7/1/07) are you and your spouse or any minor children entitled to receive (i) more than 15% in the aggregate of the total distributable income from your firm, partnership, association or corporation, or (ii) an amount in excess of 2 times the salary of the Governor? Yes ___ No ___

(c) Elective status; the holding of elective office of the State of Illinois, the government of the United States, any unit of local government authorized by the Constitution of the State of Illinois or the statutes of the State of Illinois currently or in the previous 3 years. Yes ___ No ___

(d) Relationship to anyone holding elective office currently or in the previous 2 years; spouse, father, mother, son, or daughter. Yes ___ No ___

(e) Appointive office; the holding of any appointive government office of the State of Illinois, the United State of America, or any unit of local government authorized by the Constitution of the State of Illinois or the statutes of the State of Illinois, which office entitles the holder to compensation in excess of the expenses incurred in the discharge of that office currently or in the previous 3 years. Yes ___ No ___

(f) Relationship to anyone holding appointive office currently or in the previous 2 years; spouse, father, mother, son, or daughter. Yes ___ No ___

(g) Employment, currently or in the previous 3 years, as or by any registered lobbyist of the State government. Yes ___ No ___

RETURN WITH BID/OFFER

(h) Relationship to anyone who is or was a registered lobbyist in the previous 2 years; spouse, father, mother, son, or daughter. Yes ___ No ___

(i) Compensated employment, currently or in the previous 3 years, by any registered election or reelection committee registered with the Secretary of State or any county clerk of the State of Illinois, or any political action committee registered with either the Secretary of State or the Federal Board of Elections. Yes ___ No ___

(j) Relationship to anyone; spouse, father, mother, son, or daughter; who was a compensated employee in the last 2 years by any registered election or re-election committee registered with the Secretary of State or any county clerk of the State of Illinois, or any political action committee registered with either the Secretary of State or the Federal Board of Elections. Yes ___ No ___

APPLICABLE STATEMENT

This Disclosure Form A is submitted on behalf of the INDIVIDUAL named on previous page.

Completed by: _____
Signature of Individual or Authorized Representative Date

NOT APPLICABLE STATEMENT

I have determined that no individuals associated with this organization meet the criteria that would require the completion of this Form A.

This Disclosure Form A is submitted on behalf of the CONTRACTOR listed on the previous page.

Signature of Authorized Representative Date

RETURN WITH BID/OFFER

**ILLINOIS DEPARTMENT
OF TRANSPORTATION**

**Form B
Other Contracts &
Procurement Related Information
Disclosure**

Contractor Name		
Legal Address		
City, State, Zip		
Telephone Number	Email Address	Fax Number (if available)

Disclosure of the information contained in this Form is required by the Section 50-35 of the Illinois Procurement Act (30 ILCS 500). This information shall become part of the publicly available contract file. This Form B must be completed for bids in excess of \$10,000, and for all open-ended contracts.

DISCLOSURE OF OTHER CONTRACTS AND PROCUREMENT RELATED INFORMATION

1. Identifying Other Contracts & Procurement Related Information. The BIDDER shall identify whether it has any pending contracts (including leases), bids, proposals, or other ongoing procurement relationship with any other State of Illinois agency: Yes ___ No ___

If "No" is checked, the bidder only needs to complete the signature box on the bottom of this page.

2. If "Yes" is checked. Identify each such relationship by showing State of Illinois agency name and other descriptive information such as bid or project number (attach additional pages as necessary). SEE DISCLOSURE FORM INSTRUCTIONS:

THE FOLLOWING STATEMENT MUST BE CHECKED

<input type="checkbox"/>	_____	_____
	Signature of Authorized Representative	Date

RETURN WITH BID

SPECIAL NOTICE TO CONTRACTORS

The following requirements of the Illinois Department of Human Rights' Rules and Regulations are applicable to bidders on all construction contracts advertised by the Illinois Department of Transportation:

CONSTRUCTION EMPLOYEE UTILIZATION PROJECTION

- (a) All bidders on construction contracts shall complete and submit, along with and as part of their bids, a Bidder's Employee Utilization Form (Form BC-1256) setting forth a projection and breakdown of the total workforce intended to be hired and/or allocated to such contract work by the bidder including a projection of minority and female employee utilization in all job classifications on the contract project.
- (b) The Department of Transportation shall review the Employee Utilization Form, and workforce projections contained therein, of the contract awardee to determine if such projections reflect an underutilization of minority persons and/or women in any job classification in accordance with the Equal Employment Opportunity Clause and Section 7.2 of the Illinois Department of Human Rights' Rules and Regulations for Public Contracts adopted as amended on September 17, 1980. If it is determined that the contract awardee's projections reflect an underutilization of minority persons and/or women in any job classification, it shall be advised in writing of the manner in which it is underutilizing and such awardee shall be considered to be in breach of the contract unless, prior to commencement of work on the contract project, it submits revised satisfactory projections or an acceptable written affirmative action plan to correct such underutilization including a specific timetable geared to the completion stages of the contract.
- (c) The Department of Transportation shall provide to the Department of Human Rights a copy of the contract awardee's Employee Utilization Form, a copy of any required written affirmative action plan, and any written correspondence related thereto. The Department of Human Rights may review and revise any action taken by the Department of Transportation with respect to these requirements.

RETURN WITH BID

**Contract No. 64E02
ROCK ISLAND County
Section 48MFT-RS
Project ACF-0599(022)
Route FAP 599
District 2 Construction Funds**

PART II. WORKFORCE PROJECTION - continued

- B. Included in "Total Employees" under Table A is the total number of **new hires** that would be employed in the event the undersigned bidder is awarded this contract.

The undersigned bidder projects that: (number) _____ new hires would be recruited from the area in which the contract project is located; and/or (number) _____ new hires would be recruited from the area in which the bidder's principal office or base of operation is located.

- C. Included in "Total Employees" under Table A is a projection of numbers of persons to be employed directly by the undersigned bidder as well as a projection of numbers of persons to be employed by subcontractors.

The undersigned bidder estimates that (number) _____ persons will be directly employed by the prime contractor and that (number) _____ persons will be employed by subcontractors.

PART III. AFFIRMATIVE ACTION PLAN

- A. The undersigned bidder understands and agrees that in the event the foregoing minority and female employee utilization projection included under **PART II** is determined to be an underutilization of minority persons or women in any job category, and in the event that the undersigned bidder is awarded this contract, he/she will, prior to commencement of work, develop and submit a written Affirmative Action Plan including a specific timetable (geared to the completion stages of the contract) whereby deficiencies in minority and/or female employee utilization are corrected. Such Affirmative Action Plan will be subject to approval by the contracting agency and the **Department of Human Rights**.
- B. The undersigned bidder understands and agrees that the minority and female employee utilization projection submitted herein, and the goals and timetable included under an Affirmative Action Plan if required, are deemed to be part of the contract specifications.

Company _____ Telephone Number _____

Address _____

NOTICE REGARDING SIGNATURE

The Bidder's signature on the Proposal Signature Sheet will constitute the signing of this form. The following signature block needs to be completed only if revisions are required.

Signature: _____ Title: _____ Date: _____

Instructions: All tables must include subcontractor personnel in addition to prime contractor personnel.

Table A - Include both the number of employees that would be hired to perform the contract work and the total number currently employed (Table B) that will be allocated to contract work, and include all apprentices and on-the-job trainees. The "Total Employees" column should include all employees including all minorities, apprentices and on-the-job trainees to be employed on the contract work.

Table B - Include all employees currently employed that will be allocated to the contract work including any apprentices and on-the-job trainees currently employed.

Table C - Indicate the racial breakdown of the total apprentices and on-the-job trainees shown in Table A.

RETURN WITH BID

ADDITIONAL FEDERAL REQUIREMENTS

In addition to the Required Contract Provisions for Federal-Aid Construction Contracts (FHWA 1273), all bidders make the following certifications.

- A. By the execution of this proposal, the signing bidder certifies that the bidding entity has not, either directly or indirectly, entered into any agreement, participated in any collusion, or otherwise taken any action, in restraint of free competitive bidding in connection with the submitted bid. This statement made by the undersigned bidder is true and correct under penalty of perjury under the laws of the United States.
- B. CERTIFICATION, EQUAL EMPLOYMENT OPPORTUNITY:
1. Have you participated in any previous contracts or subcontracts subject to the equal opportunity clause. YES _____ NO _____
 2. If answer to #1 is yes, have you filed with the Joint Reporting Committee, the Director of OFCC, any Federal agency, or the former President's Committee on Equal Employment Opportunity, all reports due under the applicable filing requirements of those organizations? YES _____ NO _____

RETURN WITH BID

**Contract No. 64E02
ROCK ISLAND County
Section 48MFT-RS
Project ACF-0599(022)
Route FAP 599
District 2 Construction Funds**

PROPOSAL SIGNATURE SHEET

The undersigned bidder hereby makes and submits this bid on the subject Proposal, thereby assuring the Department that all requirements of the Invitation for Bids and rules of the Department have been met, that there is no misunderstanding of the requirements of paragraph 3 of this Proposal, and that the contract will be executed in accordance with the rules of the Department if an award is made on this bid.

(IF AN INDIVIDUAL) Firm Name _____
Signature of Owner _____
Business Address _____

(IF A CO-PARTNERSHIP) Firm Name _____
By _____
Business Address _____
Name and Address of All Members of the Firm: _____

(IF A CORPORATION) Corporate Name _____
By _____
Signature of Authorized Representative _____
Typed or printed name and title of Authorized Representative _____

(IF A JOINT VENTURE, USE THIS SECTION FOR THE MANAGING PARTY AND THE SECOND PARTY SHOULD SIGN BELOW) Attest _____
Signature _____
Business Address _____

(IF A JOINT VENTURE) Corporate Name _____
By _____
Signature of Authorized Representative _____
Typed or printed name and title of Authorized Representative _____

Attest _____
Signature _____
Business Address _____

If more than two parties are in the joint venture, please attach an additional signature sheet.



Return with Bid

Division of Highways
Proposal Bid Bond
(Effective November 1, 1992)

Item No. _____

Letting Date _____

KNOW ALL MEN BY THESE PRESENTS, That We _____

as PRINCIPAL, and _____

_____ as SURETY, are held jointly, severally and firmly bound unto the STATE OF ILLINOIS in the penal sum of 5 percent of the total bid price, or for the amount specified in Article 102.09 of the "Standard Specifications for Road and Bridge Construction" in effect on the date of invitation for bids, whichever is the lesser sum, well and truly to be paid unto said STATE OF ILLINOIS, for the payment of which we bind ourselves, our heirs, executors, administrators, successors and assigns.

THE CONDITION OF THE FOREGOING OBLIGATION IS SUCH, that whereas, the PRINCIPAL has submitted a bid proposal to the STATE OF ILLINOIS, acting through the Department of Transportation, for the improvement designated by the Transportation Bulletin Item Number and Letting Date indicated above.

NOW, THEREFORE, if the Department shall accept the bid proposal of the PRINCIPAL; and if the PRINCIPAL shall, within the time and as specified in the bidding and contract documents, submit a DBE Utilization Plan that is accepted and approved by the Department; and if, after award by the Department, the PRINCIPAL shall enter into a contract in accordance with the terms of the bidding and contract documents including evidence of the required insurance coverages and providing such bond as specified with good and sufficient surety for the faithful performance of such contract and for the prompt payment of labor and material furnished in the prosecution thereof; or if, in the event of the failure of the PRINCIPAL to make the required DBE submission or to enter into such contract and to give the specified bond, the PRINCIPAL pays to the Department the difference not to exceed the penalty hereof between the amount specified in the bid proposal and such larger amount for which the Department may contract with another party to perform the work covered by said bid proposal, then this obligation shall be null and void, otherwise, it shall remain in full force and effect.

IN THE EVENT the Department determines the PRINCIPAL has failed to comply with any requirement as set forth in the preceding paragraph, then Surety shall pay the penal sum to the Department within fifteen (15) days of written demand therefor. If Surety does not make full payment within such period of time, the Department may bring an action to collect the amount owed. Surety is liable to the Department for all its expenses, including attorney's fees, incurred in any litigation in which it prevails either in whole or in part.

In TESTIMONY WHEREOF, the said PRINCIPAL and the said SURETY have caused this instrument to be signed by

their respective officers this _____ day of _____ A.D., _____ .

PRINCIPAL

(Company Name)

(Company Name)

By: _____
(Signature & Title)

By: _____
(Signature of Attorney-in-Fact)

Notary Certification for Principal and Surety

STATE OF ILLINOIS,

County of _____

I, _____, a Notary Public in and for said County, do hereby certify that

_____ and _____
(Insert names of individuals signing on behalf of PRINCIPAL & SURETY)

who are each personally known to me to be the same persons whose names are subscribed to the foregoing instrument on behalf of PRINCIPAL and SURETY, appeared before me this day in person and acknowledged respectively, that they signed and delivered said instrument as their free and voluntary act for the uses and purposes therein set forth.

Given under my hand and notarial seal this _____ day of _____ A.D. _____

My commission expires _____

Notary Public

In lieu of completing the above section of the Proposal Bid Form, the Principal may file an Electronic Bid Bond. By signing the proposal and marking the check box next to the Signature and Title line below, the Principal is ensuring the identified electronic bid bond has been executed and the Principal and Surety are firmly bound unto the State of Illinois under the conditions of the bid bond as shown above.

Electronic Bid Bond ID# _____

Company / Bidder Name _____



Signature and Title _____

PROPOSAL ENVELOPE



PROPOSALS

for construction work advertised for bids by the
Illinois Department of Transportation

Item No.	Item No.	Item No.

Submitted By:

Name:
Address:
Phone No.

Bidders should use an IDOT proposal envelope or affix this form to the front of a 10" x 13" envelope for the submittal of bids. If proposals are mailed, they should be enclosed in a second or outer envelope addressed to:

Engineer of Design and Environment - Room 326
Illinois Department of Transportation
2300 South Dirksen Parkway
Springfield, Illinois 62764

NOTICE

Individual bids, including Bid Bond and/or supplemental information if required, should be securely stapled.

CONTRACTOR OFFICE COPY OF CONTRACT SPECIFICATIONS

NOTICE

None of the following material needs to be returned with the bid package unless the special provisions require documentation and/or other information to be submitted.

**Contract No. 64E02
ROCK ISLAND County
Section 48MFT-RS
Project ACF-0599(022)
Route FAP 599
District 2 Construction Funds**



Illinois Department of Transportation



NOTICE TO BIDDERS

- 1. TIME AND PLACE OF OPENING BIDS.** Sealed proposals for the improvement described herein will be received by the Department of Transportation at the Harry R. Hanley Building, 2300 South Dirksen Parkway, in Springfield, Illinois until 10:00 o'clock a.m., June 13, 2008. All bids will be gathered, sorted, publicly opened and read in the auditorium at the Department of Transportation's Harry R. Hanley Building shortly after the 10:00 a.m. cut off time.
- 2. DESCRIPTION OF WORK.** The proposed improvement is identified and advertised for bids in the Invitation for Bids as:

**Contract No. 64E02
ROCK ISLAND County
Section 48MFT-RS
Project ACF-0599(022)
Route FAP 599
District 2 Construction Funds**

1.34 miles of milling, resurfacing and patching on IL Route 92 from Turkey Hollow Road to 0.3 mile east of IL Route 92 (north).

- 3. INSTRUCTIONS TO BIDDERS.** (a) This Notice, the invitation for bids, proposal and letter of award shall, together with all other documents in accordance with Article 101.09 of the Standard Specifications for Road and Bridge Construction, become part of the contract. Bidders are cautioned to read and examine carefully all documents, to make all required inspections, and to inquire or seek explanation of the same prior to submission of a bid.

(b) State law, and, if the work is to be paid wholly or in part with Federal-aid funds, Federal law requires the bidder to make various certifications as a part of the proposal and contract. By execution and submission of the proposal, the bidder makes the certification contained therein. A false or fraudulent certification shall, in addition to all other remedies provided by law, be a breach of contract and may result in termination of the contract.
- 4. AWARD CRITERIA AND REJECTION OF BIDS.** This contract will be awarded to the lowest responsive and responsible bidder considering conformity with the terms and conditions established by the Department in the rules, Invitation for Bids and contract documents. The issuance of plans and proposal forms for bidding based upon a prequalification rating shall not be the sole determinant of responsibility. The Department reserves the right to determine responsibility at the time of award, to reject any or all proposals, to readvertise the proposed improvement, and to waive technicalities.

By Order of the
Illinois Department of Transportation

Milton R. Sees, Secretary

BD 351 (Rev. 01/2003)

INDEX
FOR
SUPPLEMENTAL SPECIFICATIONS
AND RECURRING SPECIAL PROVISIONS

Adopted January 1, 2008

This index contains a listing of SUPPLEMENTAL SPECIFICATIONS and frequently used RECURRING SPECIAL PROVISIONS.

ERRATA Standard Specifications for Road and Bridge Construction (Adopted 1-1-07) (Revised 1-1-08)

SUPPLEMENTAL SPECIFICATIONS

<u>Std. Spec. Sec.</u>	<u>Page No.</u>
205 Embankment	1
251 Mulch	2
253 Planting Woody Plants	3
280 Temporary Erosion Control	5
443 Reflective Crack Control Treatment	6
502 Excavation for Structures	9
503 Concrete Structures	10
505 Steel Structures	11
540 Box Culverts	12
633 Removing and Reerecting Guardrail and Terminals	13
672 Sealing Abandoned Water Wells	14
701 Work Zone Traffic Control and Protection	15
838 Breakaway Devices	16
1004 Coarse Aggregates	17
1020 Portland Cement Concrete	18
1022 Concrete Curing Materials	20
1042 Precast Concrete Products	21
1062 Reflective Crack Control System	22
1069 Pole and Tower	24
1081 Materials for Planting	27
1083 Elastomeric Bearings	29
1102 Hot-Mix Asphalt Equipment	30

RECURRING SPECIAL PROVISIONS

The following RECURRING SPECIAL PROVISIONS indicated by an "X" are applicable to this contract and are included by reference:

<u>CHECK SHEET #</u>	<u>PAGE NO.</u>
1 X Additional State Requirements For Federal-Aid Construction Contracts (Eff. 2-1-69) (Rev. 1-1-07)	31
2 X Subletting of Contracts (Federal-Aid Contracts) (Eff. 1-1-88) (Rev. 5-1-93)	33
3 X EEO (Eff. 7-21-78) (Rev. 11-18-80)	34
4 Specific Equal Employment Opportunity Responsibilities Non Federal-Aid Contracts (Eff. 3-20-69) (Rev. 1-1-94)	44
5 Required Provisions - State Contracts (Eff. 4-1-65) (Rev. 1-1-07)	49
6 Reserved	54
7 Reserved	55
8 Haul Road Stream Crossings, Other Temporary Stream Crossings, and In-Stream Work Pads (Eff. 1-2-92) (Rev. 1-1-98)	56
9 Construction Layout Stakes Except for Bridges (Eff. 1-1-99) (Rev. 1-1-07)	57
10 X Construction Layout Stakes (Eff. 5-1-93) (Rev. 1-1-07)	60
11 Use of Geotextile Fabric for Railroad Crossing (Eff. 1-1-95) (Rev. 1-1-07)	63
12 Subsealing of Concrete Pavements (Eff. 11-1-84) (Rev. 1-1-07)	65
13 Hot-Mix Asphalt Surface Removal (Cold Milling) (Eff. 11-1-87) (Rev. 1-1-07)	69
14 X Pavement and Shoulder Resurfacing (Eff. 2-1-00) (Rev. 1-1-07)	71
15 PCC Partial Depth Hot-Mix Asphalt Patching (Eff. 1-1-98) (Rev. 1-1-07)	72
16 X Patching with Hot-Mix Asphalt Overlay Removal (Eff. 10-1-95) (Rev. 1-1-07)	74
17 Polymer Concrete (Eff. 8-1-95) (Rev. 1-1-08)	75
18 PVC Pipeliner (Eff. 4-1-04) (Rev. 1-1-07)	77
19 Pipe Underdrains (Eff. 9-9-87) (Rev. 1-1-07)	78
20 Guardrail and Barrier Wall Delineation (Eff. 12-15-93) (Rev. 1-1-97)	79
21 Bicycle Racks (Eff. 4-1-94) (Rev. 1-1-07)	83
22 Temporary Modular Glare Screen System (Eff. 1-1-00) (Rev. 1-1-07)	85
23 Temporary Portable Bridge Traffic Signals (Eff. 8-1-03) (Rev. 1-1-07)	87
24 Work Zone Public Information Signs (Eff. 9-1-02) (Rev. 1-1-07)	89
25 Night Time Inspection of Roadway Lighting (Eff. 5-1-96)	90
26 English Substitution of Metric Bolts (Eff. 7-1-96)	91
27 English Substitution of Metric Reinforcement Bars (Eff. 4-1-96) (Rev. 1-1-03)	92
28 Calcium Chloride Accelerator for Portland Cement Concrete (Eff. 1-1-01)	93
29 Quality Control of Concrete Mixtures at the Plant-Single A (Eff. 8-1-00) (Rev. 1-1-04)	94
30 Quality Control of Concrete Mixtures at the Plant-Double A (Eff. 8-1-00) (Rev. 1-1-04)	100
31 Quality Control/Quality Assurance of Concrete Mixtures (Eff. 4-1-92) (Rev. 1-1-07)	108

TABLE OF CONTENTS

LOCATION OF PROJECT 1

DESCRIPTION OF PROJECT 1

TRAFFIC CONTROL PLAN 1

IL 92 & CENTENNIAL EXPRESSWAY INTERSECTION TRAFFIC CONTROL 5

MAINTENANCE OF ROADWAYS 5

COMPACTION OF POLYMERIZED HOT-MIX ASPHALT CONCRETE 6

HOT-MIX ASPHALT SURFACE REMOVAL (VARIABLE DEPTH) 6

GUARDRAIL REMOVAL 6

GEOTECHNICAL REINFORCEMENT 6

CLASS B PATCHES (SPECIAL) 9

DETECTOR LOOP, SPECIAL 9

CONSTRUCTION LAYOUT 10

HOT-MIX ASPHALT SHOULDERS, 6" 10

ENGINEER'S FIELD OFFICE TYPE A 10

CEMENT (BDE) 11

DISADVANTAGED BUSINESS ENTERPRISE PARTICIPATION (BDE) 14

DOWEL BARS (BDE) 21

EQUIPMENT RENTAL RATES (BDE) 21

HOT-MIX ASPHALT - FIELD VOIDS IN THE MINERAL AGGREGATE (BDE) 22

HOT-MIX ASPHALT – PLANT TEST FREQUENCY (BDE) 24

HOT-MIX ASPHALT – TRANSPORTATION (BDE) 25

MULTILANE PAVEMENT PATCHING (BDE) 26

PAYMENTS TO SUBCONTRACTORS (BDE) 26

RECLAIMED ASPHALT PAVEMENT (RAP) (BDE) 27

REFLECTIVE SHEETING ON CHANNELIZING DEVICES (BDE) 33

STONE GRADATION TESTING (BDE) 33

SUBCONTRACTOR MOBILIZATION PAYMENTS (BDE) 34

THERMOPLASTIC PAVEMENT MARKINGS (BDE) 34

WORKING DAYS (BDE) 35

BITUMINOUS MATERIALS COST ADJUSTMENTS (BDE) (RETURN FORM WITH BID) 35

RAILROAD PROTECTIVE LIABILITY INSURANCE (BDE) 38

STATE OF ILLINOIS
SPECIAL PROVISIONS

The following Special Provisions supplement the "Standard Specifications for Road and Bridge Construction," adopted January 1, 2007, the latest edition of the "Manual on Uniform Traffic Control Devices for Streets and Highways," and the "Manual of Test Procedures for Materials" in effect on the date of invitation for bids, and the Supplemental Specifications and Recurring Special Provisions indicated on the Check Sheet included herein which apply to and govern the construction of FAP Route 599 (IL 92), Project ACF-0599 (022), Section 48MFT-RS, Rock Island County, Contract #64E02, and in case of conflict with any part or parts of said Specifications, the said Special Provisions shall take precedence and shall govern.

LOCATION OF PROJECT

IL 92 from 51st Street West to 0.3 mile East of IL 92 (N).

DESCRIPTION OF PROJECT

Cold milling, pavement patching, and hot-mix asphalt resurfacing.

TRAFFIC CONTROL PLAN

Effective January 14, 1999

Traffic Control shall be according to the applicable sections of the Standard Specifications for Road and Bridge Construction, the applicable guidelines contained in the National Manual on Uniform Traffic Control Devices for Streets and Highways, Illinois Supplement to the National Manual on Uniform Traffic Control Devices, these special provisions, and any special details and Highway Standards contained herein and in the plans.

Special attention is called to Articles 107.09 and 107.14 of the Standard Specifications for Road and Bridge Construction and the following Highway Standards relating to traffic control.

Standards:

701201	701301	701306	701311	701326
	701422	701701	701901	

Details:

Rough Grooved Surface Sign – (91.2)
Traffic Control for Road Closure – (40.1)
Traffic Control and Protection at Turn Bays (To Remain Open to Traffic) – (94.2)

Signs:

No bracing shall be allowed on post-mounted signs.

Post-mounted signs shall be installed using standard 720011, 728001, 729001, on 4"x4" wood posts, or on any other "break away" connection if accepted by the FHWA and corresponding letter is provided to the resident.

All signs are required on both sides of the road when the median is greater than 10 feet and on one way roadways.

"BUMP" (W8-1(O)48) signs shall be installed as directed by the Engineer.

"UNEVEN LANES" W8-11(O)48 signs shall be installed at 2 mile intervals or as directed by the Engineer on roadways where the posted speed limit is greater than 40 mph.

"LOW SHOULDER" W8-9(O)48 signs shall be installed at 2 mile intervals or as directed by the Engineer.

When covering existing Department signs, no tape shall be used on the reflective portion of the sign. Contact the District sign shop for covering techniques.

Devices:

A minimum of 3 drums spaced at 1.2 meters (4 feet) shall be placed at each return when the sideroad is open.

Direction Indicator Barricades shall exclusively be used in lane closure tapers. They shall be used only when traffic is being merged with an adjacent through lane or shifted onto a median crossover.

Lights:

Steady burn mono-directional lights are required on devices delineating a drop-off.

Flaggers:

Flaggers shall comply with all requirements contained in the Department's "Flagger Handbook" with the following exception: The ANSII Class 2 vest will not be supplied by the Department. At night, flaggers need pants (ANSII Class 2).

In addition to the flaggers shown on applicable standards, on major sideroads listed below, flaggers shall be required on all legs of the intersection. Major sideroads for this project shall be 51st Street W, 42nd Street W, and IL 92/Centennial intersection.

When the road is closed to through traffic and it is necessary to provide access for local traffic, all flaggers as shown on the applicable standards will be required. No reduction in the number of flaggers shall be allowed.

When required by the Resident Engineer, flaggers shall be considered included in the cost of the Traffic Control and Protection Standard being utilized.

Pavement Marking:

All temporary pavement markings that will be operational during the winter months (December through March) shall be painted.

Temporary pavement markings shall not be included in the cost of the standard rather it shall be paid for separately at the contract unit prices of specified temporary pavement marking items.

Highway Standards Application.

Traffic Control and Protection Standard 701422: This work shall be done according to Section 701 of the Standard Specifications. The Contractor shall be required to install the 701422 two (2) calendar days in advance of the areas to be patched for the protection of the State personnel laying out the locations for pavement patching.

The barricades as shown in Standard 701422 shall not encroach on the lane open to traffic at any time. The only exception to this will be in the immediate work area when workers are present, then the barricades may be moved out to permit the construction operation.

This work shall be included in the contract unit price per Lump Sum for TRAFFIC CONTROL AND PROTECTION STANDARD 701422.

Traffic Control and Protection, Standard 701326: This work shall be done according to Section 701 of the Standard Specifications and the Typical Applications of Traffic Control Devices for Highway Construction, Standard 701326, and as specified herein.

Additional barricades, flagger signs, Yield or Stop signs and flaggers shall be required at the intersections. Barricade spacing shall be at 4.5 m (15-foot) centers within these intersections and Yield or Stop signs shall be used to control traffic.

When work is within 60 m (200 feet) of an intersection, flagger signs and flaggers shall be required on the sideroad at the discretion of the Engineer.

These additional devices shall be paid for as part of Traffic Control and Protection 701326 and not as an addition to the contract.

Standard 701422: The Contractor shall equip all machinery and vehicles with revolving amber lights, installed so the illumination is visible from all directions.

The median crossover will not be available for Contractor use. Under no condition shall left turns be made to cross the median from lanes open to traffic.

Parking of personal vehicles within the expressway right of way will be strictly prohibited. Parking of construction equipment within the right of way will be permitted only at locations approved by the Engineer.

Traffic Control and Protection, Standard 701701: This work shall be done according to Section 701 of the Standard Specifications and the Typical Application of Traffic Control Devices for Highway Construction, Standard 701701, and as specified herein.

The "left" leg of the intersection shown on this standard also applies when the right turn lane is closed. When the right turn lane is closed, "RIGHT TURN LANE CLOSED AHEAD" shall be substituted for the "LEFT TURN LANE CLOSED AHEAD" and the set up would be a mirror image to what is shown.

This work shall be included in the contract unit price per Lump Sum for TRAFFIC CONTROL AND PROTECTION STANDARD 701701.

Class B Patch (Special) Traffic Control: The Class B Patch (Special) on 42nd Street W. will be completed by closing 42nd Street using the District Standard of "Traffic Control for Road Closure" (condition major side road). IL 92 shall be open at all times. The cost of this standard will be included in the cost of the Class B Patch (Special). Before closing the road, the Contractor shall notify the City of Rock Island Public Works Department (309/732-2200), the emergency response agencies (i.e.: fire, ambulance, police), bus companies, all businesses on 42nd Street, and provide the Department of Transportation with a written media notification of the road closure a minimum of ten business days (2 weeks) prior to closing the road. The media notification shall list the time and date of the closure, effective times of the closure, and time and date of opening. This media notification shall be delivered to and reviewed by the District Office, who will then distribute to local media outlets. Access will be maintained for 42nd Street W. off of 92nd Avenue W. using either 81st Avenue W. or 85th Avenue W. No additional cost shall be added for sideroad traffic control. This closure at 42nd Street West will only be allowed for one weekend beginning on Friday at 12:00 pm and opened to traffic by 6:00 am on the following Monday. All patching must be completed in this time frame.

If the Contractor fails to complete the work sufficiently such that the road cannot be used for two-way traffic by the above completion date, the Contractor shall be charged liquidated damages by the Department of TWO THOUSAND DOLLARS (\$2,000) a day for each day the road is not open to two-way traffic and all items of work noted above are not completed. If in the event additional traffic control and protection is required to open the road or after the road is open to traffic, it shall be at the Contractor's expense.

Maintenance of Traffic: The mainline shall be kept open to one-way traffic at all times during working hours and two-way traffic during non-working hours.

The Contractor shall be required to notify the Rock Island County Highway Department, the corresponding Township Commissioner, emergency response agencies (i.e.: fire, ambulance, police), Metrolink, school bus companies and the Department of Transportation (Bureau of Project Implementation) regarding any changes in traffic control.

The Contractor shall be required to notify the Rock Island County Highway Department and/or corresponding Township Commissioner for any sideroad closure or opening.

The sawing of patches, resurfacing and placing of shoulder aggregate shall be completed using Traffic Control and Protection Standard 701306.

The mainline pavement patching removal and replacement shall be completed using Traffic Control and Protection Standard 701201.

The Contractor shall have all lanes open on weekends, unless 24 hour prior approval is obtained from the Resident Engineer. Weekends shall begin at 3 PM Friday to Sunday at midnight.

Placing and removing pavement marking shall be completed using Traffic Control and Protection Standard 701306.

IL 92 & CENTENNIAL EXPRESSWAY INTERSECTION TRAFFIC CONTROL

Upon removal of flush painted median markings, the contractor shall delineate median areas with Type 2 barricades or Drums with lights per Art. 701.16 of the Standard Specifications for Road and Bridge Construction adopted January 1, 2007 until final pavement striping is in place. Barricades or Drums can be moved when work is being performed in the median areas. After work is completed, barricades or drums shall be replaced back to the median locations to establish original lane configurations.

Working in the intersection shall be accomplished using any combination of the following Traffic Control Standards: 701201, 701701, District Standard 94.2, and Traffic Control Detail Sheets No. 1 thru No. 3 included in plans or as determined during prior work meetings, as approved by the Resident Engineer.

Prior to Hot-Mix Asphalt Surface Removal and subsequent resurfacing work a meeting(s) shall be conducted to discuss work. Meetings shall be scheduled 5 days prior to beginning work and the Resident Engineer, Field Engineer, Contractor's Representative/Superintendent, applicable Sub-Contractors and Traffic Control Sub-Contractor performing work shall be present. The contractor shall present a plan on how to perform the work in the intersection and what traffic control they will use. If the Contractor opts to perform any work at night, no additional compensation will be granted.

The above requirements for working in IL 92 & Centennial Expressway Intersection Traffic Control shall be included in the unit price for applicable traffic control pay items included in the plans.

The lane closures on Centennial Expressway will be installed during HMA Surface Removal, Paving operations, Pavement Striping, or as directed by the Resident Engineer when in the IL 92/Centennial Expressway intersection. This work shall be included in the cost of Traffic Control Standard 701422.

MAINTENANCE OF ROADWAYS

Effective: June 26, 2003

Beginning on the date that work begins on this project, the Contractor shall assume responsibility for normal maintenance of all existing roadways within the limits of the improvement. This normal maintenance shall include all repair work such as patching, intermittent resurfacing, and shoulder work deemed necessary by the Engineer, but shall not include snow removal operations. Traffic control and protection for maintenance of roadways will be provided by the Contractor as required by the Engineer.

If items of work have not been provided in the contract, or otherwise specified for payment, such items, including the accompanying traffic control and protection required by the Engineer, will be paid for in accordance with Article 109.04 of the Standard Specifications.

COMPACTION OF POLYMERIZED HOT-MIX ASPHALT CONCRETE
Effective January 16, 2002

This work shall consist of furnishing a pneumatic tired roller as specified in Article 406, in addition to all other rollers specified in the Standard Specifications. The spray system shall be in good working order. The tires shall be in good condition and be constructed heavy enough to withstand 90 to 110 psi inflation pressures on a continual basis. An approved water based release agent shall be utilized on the tires similar to, but not limited to, Tech Shield that effectively prevents mix adhesion. The dilution rate shall be as per manufacturer's recommendations. The mixture compaction temperature will be the maximum possible without experiencing surface damage to the mix caused by adhesion to the tires. The recommended range is from 200° to 260° Fahrenheit. This work shall be included in the cost of the polymerized Hot-Mix Asphalt concrete of the type and size specified.

HOT-MIX ASPHALT SURFACE REMOVAL (VARIABLE DEPTH)
Effective February 10, 1995

This work shall consist of removing, by roto milling, with a machine and automatic grade control, according to Article 440.03 of the Standard Specifications, the necessary existing bituminous material from the existing surface at locations indicated in the plans. The purpose of grinding is to remove the rutting in the existing HMA surface and to transition the resurfaced pavement to full-depth milling sections.

This work will be paid for at the contract unit price per Square Meter (Square Yard) for HOT-MIX ASPHALT SURFACE REMOVAL (VARIABLE DEPTH).

GUARDRAIL REMOVAL
Effective August 20, 1990

Revised August 26, 1997

This work shall be done in accordance with Section 632 of the Standard Specifications except that all removed guardrail will become the property of the Contractor.

This work will be paid for at the contract unit price per meter (foot) for GUARDRAIL REMOVAL, measured from center-to-center of end post.

GEOTECHNICAL REINFORCEMENT
Revised September 1, 2004

Biaxial Geogrid Flat Installation

This work consists of furnishing and installing an integrally-formed polypropylene geotechnical grid reinforcement material. The grid shall have an aperture, rib and junction cross section sufficient to permit significant mechanical interlock with the material being reinforced. There shall be a high continuity of tensile strength through all ribs and junctions of the grid material to reinforce the embankment or subgrade as shown on the plans and specifications.

Materials: Each layer of geogrid shall conform to the property requirements listed below. Multilayer geogrid and multiple layers of lesser strength geogrids will not be accepted.

Reinforcement and Interlock

<u>Property</u>	<u>Test Method</u>	<u>Value</u>
<u>Tensile Modulus:</u>		
▪ True Tensile Modulus	ASTMD 6637	17,000 lb./ft. (Min.)
▪ True Tensile Strength @ 2% Strain		280 lb./ft. (Min.)
▪ True Tensile Strength @5% Strain		580 lb./ft. (Min.)
<u>Apertures:</u>		
▪ Aperture Stability	USACE*	2.7 in. – lb./deg. (min.)
▪ Open Area	COE Method Modified**	70% (Nom.)
* Resistance to in-plane rotational movement measured by applying a 20 kg-cm moment to the central junction of a 9 inch x 9 inch specimen restrained at its perimeter (U.S. Army Corps of Engineers Methodology for measurement of Torsional Rigidity).		
** Percent open area measured without magnification by Corps of Engineers method as specified in CW 02215 Civil Works Construction Guide, November, 1977.		

Structural Integrity:

▪ Flexural Stiffness	ASTM D-5732-95 ***	0.2 in.-lb. (Min.)
▪ Junction Efficiency	GRI GG2-87****	90% (Min.)
*** Resistance to bending force measured via ASTM D-5732-95, using specimens of width two ribs wide, with transverse ribs cut flush with exterior edges of longitudinal ribs (as a “ladder), and of length sufficiently long to enable measurement of the overhang dimension. The overall Flexural Stiffness is calculated as the square root of the product of machine-and cross-machine-direction Flexural Stiffness values.		
**** Load transfer capability measured via GRI-GG2-87. Expressed as a percentage of ultimate tensile strength.		

Material

Polypropylene	ASTM D 1401 Group I/Class 1/Grade 2	98% (Min.)
Carbon Black	ASTM 4218	0.5% (Min.)

The supplier should provide a certification that their product meets the above requirements.

The geotechnical reinforcement shall be placed as described herein or as shown on the cross sections.

Geogrid shall be delivered to the jobsite in such a manner as to facilitate handling and incorporation into the work without damage. Material shall be stored in such a manner as to prevent exposure to direct sunlight and damage by other construction activities.

Prior to the installation of the geogrid, the application surface shall be cleared of debris, sharp objects and trees. Tree stumps shall be cut to the level of the ground surface. If the stumps cannot be cut to the ground level, they shall be completely removed. In the case of subgrades, all wheel tracks or ruts in excess of 75 mm (3 inches) in depth shall be graded smooth or otherwise filled with soil to provide a reasonably smooth surface.

The geotechnical reinforcement shall be placed with the "roll length" parallel to the pavement. Fabric of insufficient width or length to fully cover the specified area shall be lapped a minimum of 600 mm (24 inches).

Installation:

The granular blanket shall be constructed to the width and depth required on the plans. Unless otherwise specified, the material shall be back-dumped on the Geogrid in a sequence of operations beginning at the outer edges of the treatment area with subsequent placement towards the middle.

Placement of material on the Geogrid shall be accomplished by spreading dumped material off of previously placed material with a bulldozer blade or endloader, in such a manner as to prevent tearing or shoving of the Geogrid. Dumping of material directly on the Geogrid will only be permitted to establish an initial working platform. No construction equipment shall be allowed on the Geogrid prior to placement of the granular blanket.

Unless otherwise specified in the plans or Special Provisions, the granular material, shall be placed to the full required thickness and compacted.

Geogrid which is damaged during installation or subsequent placement of granular material, due to failure of the Contractor to comply with these provisions, shall be repaired or replaced at his expense, including costs of removal and replacement of the granular material.

Torn Geogrid may be patched in-place by cutting and placing a piece of the same Geogrid over the tear. The dimensions of the patch shall be at least 600 mm (2 feet) larger than the largest dimension of the tear and it shall be weighted or otherwise secured to prevent the granular material from causing lap separation.

Method of Measurement: Geotechnical Reinforcement will be measured in square meters (square yards) for the surface area placed. The excavation, replacement and compaction of the granular layer shall be paid for separately. Each layer of geogrid will be paid for separately.

Basis of Payment: This work will be measured in place and the area computed in square yards. The work will be paid for at the contract unit price per Square Meter (Square Yard) for GEOTECHNICAL REINFORCEMENT.

CLASS B PATCHES (SPECIAL)

Description: This work shall consist of the removal and replacement of the pavement at the locations shown on the plans or as directed by the Engineer. Patching quantity shall be determined by the Department after the area has had HMA Surface Removal completed. The Contractor shall perform this work per the applicable sections of Section 442 in the Standard Specifications for Road and Bridge Construction adopted January 1, 2007. The pavement consists of PCC Pavement 9" and shall be replaced with Class B Patch (Special). Existing joints adjacent to the repairs shall be extended through the Class B Patch (Special). The doweled joints shall be perpendicular to 42nd Street centerline or as determined during the pavement removal operation. Joints running perpendicular to doweled joints shall have tie bars for load transfer devices or tie bars along the patches perimeter embedded 8 inches at 24 inch centers, according to Article 420.05(b). Pavement Fabric shall be included in all repair areas regardless of type.

Materials: Per Section 442 in the Standard Specifications for Road and Bridge Construction adopted January 1, 2007. The patches shall be opened to traffic per Art. 442.09 and Art. 701.17(e)(3)(b), Class PP-1 will not be allowed.

General: The sideroad of 42nd Street West will only be allowed to have patching performed on it for one weekend beginning on Friday at 12:00 p.m. and opened to traffic by 6 a.m. on the following Monday. See Class B Patch (Special) Traffic Control for complete details.

Basis of Payment: This work will be paid for at the contract unit price per Square Yard for Class B Patches (Special) which shall include all materials and labor necessary to complete the work. This includes saw cutting, dowel bars, tie bars and pavement fabric. The patching quantity will be adjusted for thickness per Art. 442.10 if field measurements differ from the plan thickness of 9" per the table.

DETECTOR LOOP, SPECIAL

This item shall consist of replacing detector loops, furnishing, installing, and testing in accordance with Section 886 of the "Standards Specifications for Road Bridge Construction."

This item shall include replacing all conduit stubs damaged during the surface grinding process.

For appropriate layout of Detector Loops, the Illinois DOT, Bureau of Operations, Scott Kullerstrand (815/284-5468) shall be contacted prior to reinstallation to mark the Detector Loop locations.

This work will be paid for at the contract unit price per Foot for DETECTOR LOOP, SPECIAL, which price shall include furnishing, installing all required components, and testing inductance to assure satisfactory operation.

CONSTRUCTION LAYOUT

Construction layout shall include stationing of job when directed by the Engineer. Stationing shall be completed before job starts and if stationing is lost throughout the duration of the job, the Contractor must re-station as directed by the Engineer. Also, Contractor shall be responsible for pavement striping verification and layout. Contractor shall verify all locations and stationing of existing striping prior to milling (HMA) removal and submit a copy to Resident Engineer.

HOT-MIX ASPHALT SHOULDERS, 6”

Approximately 88 cubic yards of earth excavation is required for shoulder and subbase core out. This work shall be included in the pay item of HOT-MIX ASPHALT SHOULDERS, 6”

ENGINEER’S FIELD OFFICE TYPE A

Effective: December 8, 2006

Revise Article 670.02 (i) of the Standard Specifications to read:

Provide a minimum of two (2) communication paths to each Field Office. The configuration would include (A) three (3) wireless CDMA based mobile phone connections, and (B) one (1) wireless data router with wireless data connection, encryption and WiFi capabilities to access the internet for the exclusive use of the Engineer(s). All wireless communication devices must have a single point of contact for support for the resident engineer and IDOT staff.

Each mobile phone must have the following capabilities:

1. A minimum of 500 anytime minutes per month
2. Voice Mail capabilities
3. On network free minutes
4. Unlimited Long Distance
5. Unlimited Roaming
6. Speaker Phone

Each Wireless Data Router must have the following capabilities:

Connection

1. CDMA wireless technology with authentication and identification system for security
2. CDMA based EV-DO(rev.A) transmission capabilities
3. EVDO (rev.A) must be backward compatible through both EVDO (rev0) and 1XRTT
4. Connection must be capable of Compression in order to optimize the connection speed.

Router

5. A minimum of four (4) Ethernet ports for wired connection
6. Be capable of 802.11b & g for wireless LAN Interface
7. Configurable ability to port data to fax capabilities through the router using efax or IP fax devices
8. Automatic receipt of IP addresses with DHCP server
9. Configurable OFDM (Orthogonal Frequency Division Multiplexing) technology

Security

10. Configurable capable of 64-bit or 128-bit WEP encryption, WPA-PSK authentication wireless security (WiFi Protected Access - Pre-shared Key Mode)
11. Configurable LAN Security: NAT with DHCP, PPTP VPN Pass-through, MAC Filtering, IP Filtering, Filter Scheduling
12. Configurable firewall security at the router

Misc.

13. Capable of operating temperatures between 32° to 131°F (0° to 55°C)

The contractor will be responsible for the installation, connection and disconnection of all service. These communication costs shall be contracted at the lowest cost available for the region of service. Any deviation from the desired configurations shall be subject to the approval of the District Construction Engineer.

Should the contractor need technical advice on potential providers or other clarification, they can contact the Regional IT Manager at (815) 284-5495.

CEMENT (BDE)

Effective: January 1, 2007

Revised: November 1, 2007

Revise Section 1001 of the Standard Specifications to read:

“SECTION 1001. CEMENT

1001.01 Cement Types. Cement shall be according to the following.

- (a) Portland Cement. Acceptance of portland cement shall be according to the current Bureau of Materials and Physical Research’s Policy Memorandum, “Portland or Blended Cement Acceptance Procedure for Qualified and Non-Qualified Plants”.

Portland cement shall be according to ASTM C 150, and shall meet the standard physical and chemical requirements. Type I or Type II may be used for cast-in-place, precast, and precast prestressed concrete. Type III may be used according to Article 1020.04, or when approved by the Engineer. All other cements referenced in ASTM C 150 may be used when approved by the Engineer.

The total of all organic processing additions shall be a maximum of 1.0 percent by weight (mass) of the cement and the total of all inorganic processing additions shall be a maximum of 4.0 percent by weight (mass) of the cement. Organic processing additions shall be limited to grinding aids that improve the flowability of cement, reduce pack set, and improve grinding efficiency. Inorganic processing additions shall be limited to granulated blast-furnace slag according to the chemical requirements of AASHTO M 302 and Class C fly ash according to the chemical requirements of AASHTO M 295.

- (b) Portland-Pozzolan Cement. Acceptance of portland-pozzolan cement shall be according to the current Bureau of Materials and Physical Research's Policy Memorandum, "Portland or Blended Cement Acceptance Procedure for Qualified and Non-Qualified Plants".

Portland-pozzolan cement shall be according to ASTM C 595 and shall meet the standard physical and chemical requirements. Type IP or I(PM) may be used for cast-in-place, precast, and precast prestressed concrete, except when Class PP concrete is used. The pozzolan constituent for Type IP shall be a maximum of 21 percent of the weight (mass) of the portland-pozzolan cement. All other cements referenced in ASTM C 595 may be used when approved by the Engineer.

For cast-in-place construction, portland-pozzolan cements shall not be used in concrete mixtures when the air temperature is below 40 °F (4 °C) without permission of the Engineer. If permission is given, the mix design strength requirement may require the Contractor to increase the cement or eliminate the cement factor reduction for a water-reducing or high range water-reducing admixture which is permitted according to Article 1020.05(b).

The total of all organic processing additions shall be a maximum of 1.0 percent by weight (mass) of the cement. Organic processing additions shall be limited to grinding aids as defined in (a) above. Inorganic processing additions shall not be used.

- (c) Portland Blast-Furnace Slag Cement. Acceptance of portland blast-furnace slag cement shall be according to the current Bureau of Materials and Physical Research's Policy Memorandum, "Portland or Blended Cement Acceptance Procedure for Qualified and Non-Qualified Plants".

Portland blast-furnace slag cement shall be according to ASTM C 595 and shall meet the standard physical and chemical requirements. Type I(SM) slag-modified portland cement may be used for cast-in-place, precast, and precast prestressed concrete, except when Class PP concrete is used. All other cements referenced in ASTM C 595 may be used when approved by the Engineer.

For cast-in-place construction, portland blast-furnace slag cements shall not be used in concrete mixtures when the air temperature is below 40 °F (4 °C) without permission of the Engineer. If permission is given, the mix design strength requirement may require the Contractor to increase the cement or eliminate the cement factor reduction for a water-reducing or high range water-reducing admixture which is permitted according to Article 1020.05(b).

The total of all organic processing additions shall be a maximum of 1.0 percent by weight (mass) of the cement. Organic processing additions shall be limited to grinding aids as defined in (a) above. Inorganic processing additions shall not be used.

(d) Rapid Hardening Cement. Rapid hardening cement shall be used according to Article 1020.04 or when approved by the Engineer. The cement shall be on the Department's current "Approved List of Packaged, Dry, Rapid Hardening Cementitious Materials for Concrete Repairs", and shall be according to the following.

- (1) The cement shall have a maximum final set of 25 minutes, according to Illinois Modified ASTM C 191.
- (2) The cement shall have a minimum compressive strength of 2000 psi (13,800 kPa) at 3.0 hours, and 4000 psi (27,600 kPa) at 24.0 hours, according to Illinois Modified ASTM C 109.
- (3) The cement shall have a maximum drying shrinkage of 0.050 percent at seven days, according to Illinois Modified ASTM C 596.
- (4) The cement shall have a maximum expansion of 0.020 percent at 14 days, according to Illinois Modified ASTM C 1038.
- (5) The cement shall have a minimum 80 percent relative dynamic modulus of elasticity; and shall not have a weight (mass) gain in excess of 0.15 percent or a weight (mass) loss in excess of 1.0 percent, after 100 cycles, according to Illinois Modified AASHTO T 161, Procedure B. At 100 cycles, the specimens are measured and weighed at 73 °F (23 °C).

(e) Calcium Aluminate Cement. Calcium aluminate cement shall be used when specified by the Engineer. The cement shall meet the standard physical requirements for Type I cement according to ASTM C 150, except the time of setting shall not apply. The chemical requirements shall be determined according to ASTM C 114 and shall be as follows: minimum 38 percent aluminum oxide (Al_2O_3), maximum 42 percent calcium oxide (CaO), maximum 1 percent magnesium oxide (MgO), maximum 0.4 percent sulfur trioxide (SO_3), maximum 1 percent loss on ignition, and maximum 3.5 percent insoluble residue.

1001.02 Uniformity of Color. Cement contained in single loads or in shipments of several loads to the same project shall not have visible differences in color.

1001.03 Mixing Brands and Types. Different brands or different types of cement from the same manufacturing plant, or the same brand or type from different plants shall not be mixed or used alternately in the same item of construction unless approved by the Engineer.

1001.04 Storage. Cement shall be stored and protected against damage, such as dampness which may cause partial set or hardened lumps. Different brands or different types of cement from the same manufacturing plant, or the same brand or type from different plants shall be kept separate."

DISADVANTAGED BUSINESS ENTERPRISE PARTICIPATION (DBE)

Effective: September 1, 2000

Revised: January 1, 2007

FEDERAL OBLIGATION. The Department of Transportation, as a recipient of federal financial assistance, is required to take all necessary and reasonable steps to ensure nondiscrimination in the award and administration of contracts. Consequently, the federal regulatory provisions of 49 CFR part 26 apply to this contract concerning the utilization of disadvantaged business enterprises. For the purposes of this Special Provision, a disadvantaged business enterprise (DBE) means a business certified by the Department in accordance with the requirements of 49 CFR part 26 and listed in the DBE Directory or most recent addendum.

STATE OBLIGATION. This Special Provision will also be used by the Department to satisfy the requirements of the Business Enterprise for Minorities, Females, and Persons with Disabilities Act, 30 ILCS 575. When this Special Provision is used to satisfy state law requirements on 100 percent state-funded contracts, the federal government has no involvement in such contracts (not a federal-aid contract) and no responsibility to oversee the implementation of this Special Provision by the Department on those contracts. DBE participation on 100 percent state-funded contracts will not be credited toward fulfilling the Department's annual overall DBE goal required by the US Department of Transportation to comply with the federal DBE program requirements.

CONTRACTOR ASSURANCE. The Contractor makes the following assurance and agrees to include the assurance in each subcontract that the Contractor signs with a subcontractor:

The Contractor, subrecipient, or subcontractor shall not discriminate on the basis of race, color, national origin, or sex in the performance of this contract. The Contractor shall carry out applicable requirements of 49 CFR part 26 in the award and administration of contracts funded in whole or in part with federal or state funds. Failure by the Contractor to carry out these requirements is a material breach of this contract, which may result in the termination of this contract or such other remedy as the recipient deems appropriate.

OVERALL GOAL SET FOR THE DEPARTMENT. As a requirement of compliance with 49 CFR part 26, the Department has set an overall goal for DBE participation in its federally assisted contracts. That goal applies to all federal-aid funds the Department will expend in its federally assisted contracts for the subject reporting fiscal year. The Department is required to make a good faith effort to achieve the overall goal. The dollar amount paid to all approved DBE firms performing work called for in this contract is eligible to be credited toward fulfillment of the Department's overall goal.

CONTRACT GOAL TO BE ACHIEVED BY THE CONTRACTOR. This contract includes a specific DBE utilization goal established by the Department. The goal has been included because the Department has determined that the work of this contract has subcontracting opportunities that may be suitable for performance by DBE companies. This determination is based on an assessment of the type of work, the location of the work, and the availability of DBE companies to do a part of the work. The assessment indicates that, in the absence of unlawful discrimination, and in an arena of fair and open competition, DBE companies can be expected to perform **4.0%** of the work. This percentage is set as the DBE participation goal for this contract. Consequently, in addition to the other award criteria established for this contract,

the Department will award this contract to a bidder who makes a good faith effort to meet this goal of DBE participation in the performance of the work. A bidder makes a good faith effort for award consideration if either of the following is done in accordance with the procedures set forth in this Special Provision:

- (a) The bidder documents that firmly committed DBE participation has been obtained to meet the goal; or
- (b) The bidder documents that a good faith effort has been made to meet the goal, even though the effort did not succeed in obtaining enough DBE participation to meet the goal.

DBE LOCATOR REFERENCES. Bidders may consult the DBE Directory as a reference source for DBE companies certified by the Department. In addition, the Department maintains a letting and item specific DBE locator information system whereby DBE companies can register their interest in providing quotes on particular bid items advertised for letting. Information concerning DBE companies willing to quote work for particular contracts may be obtained by contacting the Department's Bureau of Small Business Enterprises at telephone number (217)785-4611, or by visiting the Department's web site at www.dot.il.gov.

BIDDING PROCEDURES. Compliance with the bidding procedures of this Special Provision is required prior to the award of the contract and the failure of the as-read low bidder to comply will render the bid not responsive.

- (a) In order to assure the timely award of the contract, the as-read low bidder shall submit a Disadvantaged Business Utilization Plan on Department form SBE 2026 within seven working days after the date of letting. To meet the seven day requirement, the bidder may send the Plan by certified mail or delivery service within the seven working day period. If a question arises concerning the mailing date of a Plan, the mailing date will be established by the U.S. Postal Service postmark on the original certified mail receipt from the U.S. Postal Service or the receipt issued by a delivery service. It is the responsibility of the bidder to ensure that the postmark or receipt date is affixed within the seven working days if the bidder intends to rely upon mailing or delivery to satisfy the submission day requirement. The Plan is to be submitted to the Department of Transportation, Bureau of Small Business Enterprises, Contract Compliance Section, 2300 South Dirksen Parkway, Room 319, Springfield, Illinois 62764 (Telefax: (217)785-1524). It is the responsibility of the bidder to obtain confirmation of telefax delivery. The Department will not accept a Utilization Plan if it does not meet the seven day submittal requirement and the bid will be declared not responsive. In the event the bid is declared not responsive due to a failure to submit a Plan or failure to comply with the bidding procedures set forth herein, the Department may elect to cause the forfeiture of the penal sum of the bidder's proposal guaranty, and may deny authorization to bid the project if re-advertised for bids. The Department reserves the right to invite any other bidder to submit a Utilization Plan at any time for award consideration or to extend the time for award.
- (b) The Utilization Plan shall indicate that the bidder either has obtained sufficient DBE participation commitments to meet the contract goal or has not obtained enough DBE participation commitments in spite of a good faith effort to meet the goal. The Utilization

Plan shall further provide the name, telephone number, and telefax number of a responsible official of the bidder designated for purposes of notification of plan approval or disapproval under the procedures of this Special Provision.

- (c) The Utilization Plan shall include a DBE Participation Commitment Statement, Department form SBE 2025, for each DBE proposed for the performance of work to achieve the contract goal. The signatures on these forms must be original signatures. All elements of information indicated on the said form shall be provided, including but not limited to the following:
- (1) The name and address of each DBE to be used;
 - (2) A description, including pay item numbers, of the commercially useful work to be done by each DBE;
 - (3) The price to be paid to each DBE for the identified work specifically stating the quantity, unit price, and total subcontract price for the work to be completed by the DBE. If partial pay items are to be performed by the DBE, indicate the portion of each item, a unit price where appropriate and the subcontract price amount;
 - (4) A commitment statement signed by the bidder and each DBE evidencing availability and intent to perform commercially useful work on the project; and
 - (5) If the bidder is a joint venture comprised of DBE firms and non-DBE firms, the plan must also include a clear identification of the portion of the work to be performed by the DBE partner(s).
- (d) The contract will not be awarded until the Utilization Plan submitted by the bidder is approved. The Utilization Plan will be approved by the Department if the Plan commits sufficient commercially useful DBE work performance to meet the contract goal. The Utilization Plan will not be approved by the Department if the Plan does not commit sufficient DBE performance to meet the contract goal unless the bidder documents that it made a good faith effort to meet the goal. The good faith procedures of Section VIII of this special provision apply. If the Utilization Plan is not approved because it is deficient in a technical matter, unless waived by the Department, the bidder will be notified and will be allowed no less than a five working day period in order to cure the deficiency.

CALCULATING DBE PARTICIPATION. The Utilization Plan values represent work anticipated to be performed and paid for upon satisfactory completion. The Department is only able to count toward the achievement of the overall goal and the contract goal the value of payments made for the work actually performed by DBE companies. In addition, a DBE must perform a commercially useful function on the contract to be counted. A commercially useful function is generally performed when the DBE is responsible for the work and is carrying out its responsibilities by actually performing, managing, and supervising the work involved. The Department and Contractor are governed by the provisions of 49 CFR part 26.55(c) on questions of commercially useful functions as it affects the work. Specific counting guidelines are provided in 49 CFR part 26.55, the provisions of which govern over the summary contained herein.

- (a) DBE as the Contractor: 100 percent goal credit for that portion of the work performed by the DBE's own forces, including the cost of materials and supplies. Work that a DBE subcontracts to a non-DBE firm does not count toward the DBE goals.
- (b) DBE as a joint venture Contractor: 100 percent goal credit for that portion of the total dollar value of the contract equal to the distinct, clearly defined portion of the work performed by the DBE's own forces.
- (c) DBE as a subcontractor: 100 percent goal credit for the work of the subcontract performed by the DBE's own forces, including the cost of materials and supplies, excluding the purchase of materials and supplies or the lease of equipment by the DBE subcontractor from the prime Contractor or its affiliates. Work that a DBE subcontractor in turn subcontracts to a non-DBE firm does not count toward the DBE goal.
- (d) DBE as a trucker: 100 percent goal credit for trucking participation provided the DBE is responsible for the management and supervision of the entire trucking operation for which it is responsible. At least one truck owned, operated, licensed, and insured by the DBE must be used on the contract. Credit will be given for the full value of all such DBE trucks operated using DBE employed drivers. Goal credit will be limited to the value of the reasonable fee or commission received by the DBE if trucks are leased from a non-DBE company.
- (e) DBE as a material supplier:
 - (1) 60 percent goal credit for the cost of the materials or supplies purchased from a DBE regular dealer.
 - (2) 100 percent goal credit for the cost of materials or supplies obtained from a DBE manufacturer.
 - (3) 100 percent credit for the value of reasonable fees and commissions for the procurement of materials and supplies if not a regular dealer or manufacturer.

GOOD FAITH EFFORT PROCEDURES. If the bidder cannot obtain sufficient DBE commitments to meet the contract goal, the bidder must document in the Utilization Plan the good faith efforts made in the attempt to meet the goal. This means that the bidder must show that all necessary and reasonable steps were taken to achieve the contract goal. Necessary and reasonable steps are those which could reasonably be expected to obtain sufficient DBE participation. The Department will consider the quality, quantity, and intensity of the kinds of efforts that the bidder has made. Mere *pro forma* efforts are not good faith efforts; rather, the bidder is expected to have taken those efforts that would be reasonably expected of a bidder actively and aggressively trying to obtain DBE participation sufficient to meet the contract goal.

- (a) The following is a list of types of action that the Department will consider as part of the evaluation of the bidder's good faith efforts to obtain participation. These listed factors are not intended to be a mandatory checklist and are not intended to be exhaustive. Other factors or efforts brought to the attention of the Department may be relevant in appropriate cases, and will be considered by the Department.

- (1) Soliciting through all reasonable and available means (e.g. attendance at pre-bid meetings, advertising and/or written notices) the interest of all certified DBE companies that have the capability to perform the work of the contract. The bidder must solicit this interest within sufficient time to allow the DBE companies to respond to the solicitation. The bidder must determine with certainty if the DBE companies are interested by taking appropriate steps to follow up initial solicitations.
- (2) Selecting portions of the work to be performed by DBE companies in order to increase the likelihood that the DBE goals will be achieved. This includes, where appropriate, breaking out contract work items into economically feasible units to facilitate DBE participation, even when the prime Contractor might otherwise prefer to perform these work items with its own forces.
- (3) Providing interested DBE companies with adequate information about the plans, specifications, and requirements of the contract in a timely manner to assist them in responding to a solicitation.
- (4) a. Negotiating in good faith with interested DBE companies. It is the bidder's responsibility to make a portion of the work available to DBE subcontractors and suppliers and to select those portions of the work or material needs consistent with the available DBE subcontractors and suppliers, so as to facilitate DBE participation. Evidence of such negotiation includes the names, addresses, and telephone numbers of DBE companies that were considered; a description of the information provided regarding the plans and specifications for the work selected for subcontracting; and evidence as to why additional agreements could not be reached for DBE companies to perform the work.

b. A bidder using good business judgment would consider a number of factors in negotiating with subcontractors, including DBE subcontractors, and would take a firm's price and capabilities as well as contract goals into consideration. However, the fact that there may be some additional costs involved in finding and using DBE companies is not in itself sufficient reason for a bidder's failure to meet the contract DBE goal, as long as such costs are reasonable. Also, the ability or desire of a bidder to perform the work of a contract with its own organization does not relieve the bidder of the responsibility to make good faith efforts. Bidders are not, however, required to accept higher quotes from DBE companies if the price difference is excessive or unreasonable.
- (5) Not rejecting DBE companies as being unqualified without sound reasons based on a thorough investigation of their capabilities. The bidder's standing within its industry, membership in specific groups, organizations, or associations and political or social affiliations (for example union vs. non-union employee status) are not legitimate causes for the rejection or non-solicitation of bids in the bidder's efforts to meet the project goal.
- (6) Making efforts to assist interested DBE companies in obtaining bonding, lines of credit, or insurance as required by the recipient or Contractor.

- (7) Making efforts to assist interested DBE companies in obtaining necessary equipment, supplies, materials, or related assistance or services.
- (8) Effectively using the services of available minority/women community organizations; minority/women contractors' groups; local, state, and federal minority/women business assistance offices; and other organizations as allowed on a case-by-case basis to provide assistance in the recruitment and placement of DBE companies.
- (b) If the Department determines that the bidder has made a good faith effort to secure the work commitment of DBE companies to meet the contract goal, the Department will award the contract provided that it is otherwise eligible for award. If the Department determines that a good faith effort has not been made, the Department will notify the bidder of that preliminary determination by contacting the responsible company official designated in the Utilization Plan. The preliminary determination shall include a statement of reasons why good faith efforts have not been found, and may include additional good faith efforts that the bidder could take. The notification will designate a five working day period during which the bidder shall take additional efforts. The bidder is not limited by a statement of additional efforts, but may take other action beyond any stated additional efforts in order to obtain additional DBE commitments. The bidder shall submit an amended Utilization Plan if additional DBE commitments to meet the contract goal are secured. If additional DBE commitments sufficient to meet the contract goal are not secured, the bidder shall report the final good faith efforts made in the time allotted. All additional efforts taken by the bidder will be considered as part of the bidder's good faith efforts. If the bidder is not able to meet the goal after taking additional efforts, the Department will make a pre-final determination of the good faith efforts of the bidder and will notify the designated responsible company official of the reasons for an adverse determination.
- (c) The bidder may request administrative reconsideration of a pre-final determination adverse to the bidder within the five working days after the notification date of the determination by delivering the request to the Department of Transportation, Bureau of Small Business Enterprises, Contract Compliance Section, 2300 South Dirksen Parkway, Room 319, Springfield, Illinois 62764 (Telefax: (217)785-1524). Deposit of the request in the United States mail on or before the fifth business day shall not be deemed delivery. The pre-final determination shall become final if a request is not made and delivered. A request may provide additional written documentation and/or argument concerning the issue of whether an adequate good faith effort was made to meet the contract goal. In addition, the request shall be considered a consent by the bidder to extend the time for award. The request will be forwarded to the Department's Reconsideration Officer. The Reconsideration Officer will extend an opportunity to the bidder to meet in person in order to consider all issues of whether the bidder made a good faith effort to meet the goal. After the review by the Reconsideration Officer, the bidder will be sent a written decision within ten working days after receipt of the request for reconsideration, explaining the basis for finding that the bidder did or did not meet the goal or make adequate good faith efforts to do so. A final decision by the Reconsideration Officer that a good faith effort was made shall approve the Utilization Plan submitted by the bidder and shall clear the contract for award. A final decision that a good faith effort was not made shall render the bid not responsive.

CONTRACT COMPLIANCE. Compliance with this Special Provision is an essential part of the contract. The Department is prohibited by federal regulations from crediting the participation of a DBE included in the Utilization Plan toward either the contract goal or the Department's overall goal until the amount to be applied toward the goals has been paid to the DBE. The following administrative procedures and remedies govern the compliance by the Contractor with the contractual obligations established by the Utilization Plan. After approval of the Plan and award of the contract, the Utilization Plan and individual DBE Participation Statements become part of the contract. If the Contractor did not succeed in obtaining enough DBE participation to achieve the advertised contract goal, and the Utilization Plan was approved and contract awarded based upon a determination of good faith, the total dollar value of DBE work calculated in the approved Utilization Plan as a percentage of the awarded contract value shall become the amended contract goal.

- (a) No amendment to the Utilization Plan may be made without prior written approval from the Department's Bureau of Small Business Enterprises. All requests for amendment to the Utilization Plan shall be submitted to the Department of Transportation, Bureau of Small Business Enterprises, Contract Compliance Section, 2300 South Dirksen Parkway, Room 319, Springfield, Illinois 62764. Telephone number (217) 785-4611. Telefax number (217) 785-1524.
- (b) All work indicated for performance by an approved DBE shall be performed, managed, and supervised by the DBE executing the Participation Statement. The Contractor shall not terminate for convenience a DBE listed in the Utilization Plan and then perform the work of the terminated DBE with its own forces, those of an affiliate or those of another subcontractor, whether DBE or not, without first obtaining the written consent of the Bureau of Small Business Enterprises to amend the Utilization Plan. If a DBE listed in the Utilization Plan is terminated for reasons other than convenience, or fails to complete its work on the contract for any reason, the Contractor shall make good faith efforts to find another DBE to substitute for the terminated DBE. The good faith efforts shall be directed at finding another DBE to perform at least the same amount of work under the contract as the DBE that was terminated, but only to the extent needed to meet the contract goal or the amended contract goal. The Contractor shall notify the Bureau of Small Business Enterprises of any termination for reasons other than convenience, and shall obtain approval for inclusion of the substitute DBE in the Utilization Plan. If good faith efforts following a termination of a DBE for cause are not successful, the Contractor shall contact the Bureau and provide a full accounting of the efforts undertaken to obtain substitute DBE participation. The Bureau will evaluate the good faith efforts in light of all circumstances surrounding the performance status of the contract, and determine whether the contract goal should be amended.
- (c) The Contractor shall maintain a record of payments for work performed to the DBE participants. The records shall be made available to the Department for inspection upon request. After the performance of the final item of work or delivery of material by a DBE and final payment therefor to the DBE by the Contractor, but not later than thirty calendar days after payment has been made by the Department to the Contractor for such work or material, the Contractor shall submit a DBE Payment Report on Department form SBE 2115 to the Regional Engineer. If full and final payment has not been made to the DBE, the Report shall indicate whether a disagreement as to the

payment required exists between the Contractor and the DBE or if the Contractor believes that the work has not been satisfactorily completed. If the Contractor does not have the full amount of work indicated in the Utilization Plan performed by the DBE companies indicated in the Plan, the Department will deduct from contract payments to the Contractor the amount of the goal not achieved as liquidated and ascertained damages.

- (d) The Department reserves the right to withhold payment to the Contractor to enforce the provisions of this Special Provision. Final payment shall not be made on the contract until such time as the Contractor submits sufficient documentation demonstrating achievement of the goal in accordance with this Special Provision or after liquidated damages have been determined and collected.
- (e) Notwithstanding any other provision of the contract, including but not limited to Article 109.09 of the Standard Specifications, the Contractor may request administrative reconsideration of a decision to deduct the amount of the goal not achieved as liquidated damages. A request to reconsider shall be delivered to the Contract Compliance Section and shall be handled and considered in the same manner as set forth in paragraph (c) of "Good Faith Effort Procedures" of this Special Provision, except a final decision that a good faith effort was not made during contract performance to achieve the goal agreed to in the Utilization Plan shall be the final administrative decision of the Department.

DOWEL BARS (BDE)

Effective: April 1, 2007

Revised: January 1, 2008

Revise the fifth and sixth sentences of Article 1006.11(b) of the Standard Specifications to read:

"The bars shall be epoxy coated according to AASHTO M 284, except the thickness of the epoxy shall be 7 to 12 mils (0.18 to 0.30 mm) and patching of the ends will not be required. The epoxy coating applicator shall be certified according to the current Bureau of Materials and Physical Research Policy Memorandum, "Epoxy Coating Plant Certification Procedure". The Department will maintain an approved list."

EQUIPMENT RENTAL RATES (BDE)

Effective: August 2, 2007

Revised: January 2, 2008

Replace the second and third paragraphs of Article 105.07(b)(4)a. of the Standard Specifications with the following:

"Equipment idled which cannot be used on other work, and which is authorized to standby on the project site by the Engineer, will be paid for according to Article 109.04(b)(4)."

Replace Article 109.04(b)(4) of the Standard Specifications with the following:

“(4) Equipment. Equipment used for extra work shall be authorized by the Engineer. The equipment shall be specifically described, be of suitable size and capacity for the work to be performed, and be in good operating condition. For such equipment, the Contractor will be paid as follows.

- a. Contractor Owned Equipment. Contractor owned equipment will be paid for by the hour using the applicable FHWA hourly rate from the “Equipment Watch Rental Rate Blue Book” (Blue Book) in effect when the force account work begins. The FHWA hourly rate is calculated as follows.

$$\text{FHWA hourly rate} = (\text{monthly rate}/176) \times (\text{model year adj.}) \times (\text{Illinois adj.}) + \text{EOC}$$

Where: EOC = Estimated Operating Costs per hour (from the Blue Book)

The time allowed will be the actual time the equipment is operating on the extra work. For the time required to move the equipment to and from the site of the extra work and any authorized idle (standby) time, payment will be made at the following hourly rate: $0.5 \times (\text{FHWA hourly rate} - \text{EOC})$.

All time allowed shall fall within the working hours authorized for the extra work.

The rates above include the cost of fuel, oil, lubrication, supplies, small tools, necessary attachments, repairs, overhaul and maintenance of any kind, depreciation, storage, overhead, profits, insurance, and all incidentals. The rates do not include labor.

The Contractor shall submit to the Engineer sufficient information for each piece of equipment and its attachments to enable the Engineer to determine the proper equipment category. If a rate is not established in the Blue Book for a particular piece of equipment, the Engineer will establish a rate for that piece of equipment that is consistent with its cost and use in the industry.

- b. Rented Equipment. Whenever it is necessary for the Contractor to rent equipment to perform extra work, the rental and transportation costs of the equipment plus five percent for overhead will be paid. In no case shall the rental rates exceed those of established distributors or equipment rental agencies.

All prices shall be agreed to in writing before the equipment is used.”

HOT-MIX ASPHALT - FIELD VOIDS IN THE MINERAL AGGREGATE (BDE)

Effective: April 1, 2007

Revised: April 1, 2008

Add the following to the table in Article 1030.05(d)(2)a. of the Standard Specifications:

"Parameter	Frequency of Tests	Frequency of Tests	Test Method See Manual of Test Procedures for Materials
	High ESAL Mixture Low ESAL Mixture	All Other Mixtures	
VMA	Day's production ≥ 1200 tons: 1 per half day of production	N/A	Illinois-Modified AASHTO R 35
Note 5.	Day's production < 1200 tons: 1 per half day of production for first 2 days and 1 per day thereafter (first sample of the day)		

Note 5. The G_{sb} used in the voids in the mineral aggregate (VMA) calculation shall be the same average G_{sb} value listed in the mix design."

Add the following to the Control Limits table in Article 1030.05(d)(4) of the Standard Specifications:

"CONTROL LIMITS			
Parameter	High ESAL Low ESAL	High ESAL Low ESAL	All Other
	Individual Test	Moving Avg. of 4	Individual Test
VMA	-0.7 % ^{2/}	-0.5 % ^{2/}	N/A

2/ Allowable limit below minimum design VMA requirement"

Add the following to the table in Article 1030.05(d)(5) of the Standard Specifications:

"CONTROL CHART REQUIREMENTS	High ESAL Low ESAL	All Other
	VMA"	

Revise the heading of Article 1030.05(d)(6)a.1. of the Standard Specifications to read:

"1. Voids, VMA, and Asphalt Binder Content."

Revise the first sentence of the first paragraph of Article 1030.05(d)(6)a.1.(a.) of the Standard Specifications to read:

"If the retest for voids, VMA, or asphalt binder content exceeds control limits, HMA production shall cease and immediate corrective action shall be instituted by the Contractor."

Revise the table in Article 1030.05(e) of the Standard Specifications to read:

“Test Parameter	Acceptable Limits of Precision
% Passing: ^{1/}	
1/2 in. (12.5 mm)	5.0 %
No. 4 (4.75 mm)	5.0 %
No. 8 (2.36 mm)	3.0 %
No. 30 (600 μm)	2.0 %
Total Dust Content No. 200 (75 μm) ^{1/}	2.2 %
Asphalt Binder Content	0.3 %
Maximum Specific Gravity of Mixture	0.026
Bulk Specific Gravity	0.030
VMA	1.4 %
Density (% Compaction)	1.0 % (Correlated)

1/ Based on washed ignition.”

HOT-MIX ASPHALT – PLANT TEST FREQUENCY (BDE)

Effective: April 1, 2008

Revise the table in Article 1030.05(d)(2)a. of the Standard Specifications to read:

“Parameter	Frequency of Tests	Frequency of Tests	Test Method See Manual of Test Procedures for Materials
	High ESAL Mixture Low ESAL Mixture	All Other Mixtures	
Aggregate Gradation Hot bins for batch and continuous plants. Individual cold-feed or combined belt- feed for drier drum plants. % passing sieves: 1/2 in. (12.5 mm), No. 4 (4.75 mm), No. 8 (2.36 mm), No. 30 (600 μm) No. 200 (75 μm) Note 1.	1 dry gradation per day of production (either morning or afternoon sample). and 1 washed ignition oven test on the mix per day of production (conduct in the afternoon if dry gradation is conducted in the morning or vice versa). Note 3. Note 4.	1 gradation per day of production. The first day of production shall be a washed ignition oven test on the mix. Thereafter, the testing shall alternate between dry gradation and washed ignition oven test on the mix. Note 4.	Illinois Procedure

Asphalt Binder Content by Ignition Oven Note 2.	1 per half day of production	1 per day	Illinois-Modified AASHTO T 308
Air Voids Bulk Specific Gravity of Gyrotory Sample	Day's production ≥ 1200 tons: 1 per half day of production	1 per day	Illinois-Modified AASHTO T 312
	Day's production < 1200 tons: 1 per half day of production for first 2 days and 1 per day thereafter (first sample of the day)		
Maximum Specific Gravity of Mixture	Day's production ≥ 1200 tons: 1 per half day of production	1 per day	Illinois-Modified AASHTO T 209"
	Day's production < 1200 tons: 1 per half day of production for first 2 days and 1 per day thereafter (first sample of the day)		

HOT-MIX ASPHALT – TRANSPORTATION (BDE)

Effective: April 1, 2008

Revise Article 1030.08 of the Standard Specifications to read:

“1030.08 Transportation. Vehicles used in transporting HMA shall have clean and tight beds. The beds shall be sprayed with asphalt release agents from the Department’s approved list. In lieu of a release agent, the Contractor may use a light spray of water with a light scatter of manufactured sand (FA 20 or FA 21) evenly distributed over the bed of the vehicle. After spraying, the bed of the vehicle shall be in a completely raised position and it shall remain in this position until all excess asphalt release agent or water has been drained.

When the air temperature is below 60 °F (15 °C), the bed, including the end, endgate, sides and bottom shall be insulated with fiberboard, plywood or other approved insulating material and shall have a thickness of not less than 3/4 in (20 mm). When the insulation is placed inside the bed, the insulation shall be covered with sheet steel approved by the Engineer. Each vehicle shall be equipped with a cover of canvas or other suitable material meeting the approval of the Engineer which shall be used if any one of the following conditions is present.

- (a) Ambient air temperature is below 60 °F (15 °C).
- (b) The weather is inclement.
- (c) The temperature of the HMA immediately behind the paver screed is below 250 °F (120 °C).

The cover shall extend down over the sides and ends of the bed for a distance of approximately 12 in. (300 mm) and shall be fastened securely. The covering shall be rolled back before the load is dumped into the finishing machine.”

MULTILANE PAVEMENT PATCHING (BDE)

Effective: November 1, 2002

Pavement broken and holes opened for patching shall be completed prior to weekend or holiday periods. Should delays of any type or for any reason prevent the completion of the work, temporary patches shall be constructed. Material able to support the average daily traffic and meeting the approval of the Engineer shall be used for the temporary patches. The cost of furnishing, placing, maintaining, removing and disposing of the temporary work, including traffic control, shall be the responsibility of the Contractor.

PAYMENTS TO SUBCONTRACTORS (BDE)

Effective: June 1, 2000

Revised: January 1, 2006

Federal regulations found at 49 CFR §26.29 mandate the Department to establish a contract clause to require Contractors to pay subcontractors for satisfactory performance of their subcontracts and to set the time for such payments.

State law also addresses the timing of payments to be made to subcontractors and material suppliers. Section 7 of the Prompt Payment Act, 30 ILCS 540/7, requires that when a Contractor receives any payment from the Department, the Contractor shall make corresponding, proportional payments to each subcontractor and material supplier performing work or supplying material within 15 calendar days after receipt of the Department payment. Section 7 of the Act further provides that interest in the amount of two percent per month, in addition to the payment due, shall be paid to any subcontractor or material supplier by the Contractor if the payment required by the Act is withheld or delayed without reasonable cause. The Act also provides that the time for payment required and the calculation of any interest due applies to transactions between subcontractors and lower-tier subcontractors and material suppliers throughout the contracting chain.

This Special Provision establishes the required federal contract clause, and adopts the 15 calendar day requirement of the State Prompt Payment Act for purposes of compliance with the federal regulation regarding payments to subcontractors. This contract is subject to the following payment obligations.

When progress payments are made to the Contractor according to Article 109.07 of the Standard Specifications, the Contractor shall make a corresponding payment to each subcontractor and material supplier in proportion to the work satisfactorily completed by each subcontractor and for the material supplied to perform any work of the contract. The proportionate amount of partial payment due to each subcontractor and material supplier throughout the contracting chain shall be determined by the quantities measured or otherwise determined as eligible for payment by the Department and included in the progress payment to the Contractor. Subcontractors and material suppliers shall be paid by the Contractor within 15 calendar days after the receipt of payment from the Department. The Contractor shall not hold retainage from the subcontractors. These obligations shall also apply to any payments made by subcontractors and material suppliers to their subcontractors and material suppliers; and to all payments made to lower tier subcontractors and material suppliers throughout the contracting chain. Any payment or portion of a payment subject to this provision may only be withheld from the subcontractor or material supplier to whom it is due for reasonable cause.

This Special Provision does not create any rights in favor of any subcontractor or material supplier against the State or authorize any cause of action against the State on account of any payment, nonpayment, delayed payment, or interest claimed by application of the State Prompt Payment Act. The Department will not approve any delay or postponement of the 15 day requirement except for reasonable cause shown after notice and hearing pursuant to Section 7(b) of the State Prompt Payment Act. State law creates other and additional remedies available to any subcontractor or material supplier, regardless of tier, who has not been paid for work properly performed or material furnished. These remedies are a lien against public funds set forth in Section 23(c) of the Mechanics Lien Act, 770 ILCS 60/23(c), and a recovery on the Contractor's payment bond according to the Public Construction Bond Act, 30 ILCS 550.

RECLAIMED ASPHALT PAVEMENT (RAP) (BDE)

Effective: January 1, 2007

Revised: August 1, 2007

In Article 1030.02(g), delete the last sentence of the first paragraph in (Note 2).

Revise Section 1031 of the Standard Specifications to read:

"SECTION 1031. RECLAIMED ASPHALT PAVEMENT

1031.01 Description. Reclaimed asphalt pavement (RAP) is reclaimed asphalt pavement resulting from cold milling or crushing of an existing dense graded hot-mix asphalt (HMA) pavement. The Contractor shall supply written documentation that the RAP originated from routes or airfields under federal, state, or local agency jurisdiction.

1031.02 Stockpiles. The Contractor shall construct individual, sealed RAP stockpiles meeting one of the following definitions. No additional RAP shall be added to the pile after the pile has been sealed. Stockpiles shall be sufficiently separated to prevent intermingling at the base. Stockpiles shall be identified by signs indicating the type as listed below (i.e. "Homogeneous Surface").

Prior to milling, the Contractor shall request the District to provide verification of the quality of the RAP to clarify appropriate stockpile.

- (a) Homogeneous. Homogeneous RAP stockpiles shall consist of RAP from Class I, Superpave (High ESAL), HMA (High ESAL), or equivalent mixtures and represent: 1) the same aggregate quality, but shall be at least C quality; 2) the same type of crushed aggregate (either crushed natural aggregate, ACBF slag, or steel slag); 3) similar gradation; and 4) similar asphalt binder content. If approved by the Engineer, combined single pass surface/binder millings may be considered "homogenous" with a quality rating dictated by the lowest coarse aggregate quality present in the mixture.
- (b) Conglomerate 5/8. Conglomerate 5/8 RAP stockpiles shall consist of RAP from Class I, Superpave (High ESAL), HMA (High ESAL), or equivalent mixtures. The coarse aggregate in this RAP shall be crushed aggregate and may represent more than one aggregate type and/or quality but shall be at least C quality. This RAP may have an inconsistent gradation and/or asphalt binder content prior to processing. All conglomerate 5/8 RAP shall be processed prior to testing by crushing to where all RAP shall pass the 5/8 in. (16 mm) or smaller screen. Conglomerate 5/8 RAP stockpiles shall not contain steel slag or other expansive material as determined by the Department.
- (c) Conglomerate 3/8. Conglomerate 3/8 RAP stockpiles shall consist of RAP from Class I, Superpave (High ESAL), HMA (High ESAL), or equivalent mixtures. The coarse aggregate in this RAP shall be crushed aggregate and may represent more than one aggregate type and/or quality but shall be at least B quality. This RAP may have an inconsistent gradation and/or asphalt binder content prior to processing. All conglomerate 3/8 RAP shall be processed prior to testing by crushing to where all RAP shall pass the 3/8 in. (9.5 mm) or smaller screen. Conglomerate 3/8 RAP stockpiles shall not contain steel slag or other expansive material as determined by the Department.
- (d) Conglomerate "D" Quality (DQ). Conglomerate DQ RAP stockpiles shall consist of RAP from Class I, Superpave (High or Low ESAL), HMA (High or Low ESAL), or equivalent mixtures. The coarse aggregate in this RAP may be crushed or round but shall be at least D quality. This RAP may have an inconsistent gradation and/or asphalt binder content. Conglomerate DQ RAP stockpiles shall not contain steel slag or other expansive material as determined by the Department.
- (e) Non-Quality. RAP stockpiles that do not meet the requirements of the stockpile categories listed above shall be classified as "Non-Quality".

RAP containing contaminants, such as earth, brick, sand, concrete, sheet asphalt, bituminous surface treatment (i.e. chip seal), pavement fabric, joint sealants, etc., will be unacceptable unless the contaminants are removed to the satisfaction of the Engineer. Sheet asphalt shall be stockpiled separately.

1031.03 Testing. When used in HMA, the RAP shall be sampled and tested either during or after stockpiling.

For testing during stockpiling, washed extraction samples shall be run at the minimum frequency of one sample per 500 tons (450 metric tons) for the first 2000 tons (1800 metric tons) and one sample per 2000 tons (1800 metric tons) thereafter. A minimum of five tests shall be required for stockpiles less than 4000 tons (3600 metric tons).

For testing after stockpiling, the Contractor shall submit a plan for approval to the District proposing a satisfactory method of sampling and testing the RAP pile either in-situ or by restocking. The sampling plan shall meet the minimum frequency required above and detail the procedure used to obtain representative samples throughout the pile for testing.

Before extraction, each field sample shall be split to obtain two samples of test sample size. One of the two test samples from the final split shall be labeled and stored for Department use. The Contractor shall extract the other test sample according to Department procedure. The Engineer reserves the right to test any sample (split or Department-taken) to verify Contractor test results.

- (a) Testing Conglomerate 3/8. In addition to the requirements above, conglomerate 3/8 RAP shall be tested for maximum theoretical specific gravity (G_{mm}) at a frequency of one sample per 500 tons (450 metric tons) for the first 2000 tons (1800 metric tons) and one sample per 2000 tons (1800 metric tons) thereafter. A minimum of five tests shall be required for stockpiles less than 4000 tons (3600 metric tons).
- (b) Evaluation of Test Results. All of the extraction results shall be compiled and averaged for asphalt binder content and gradation and, when applicable G_{mm} . Individual extraction test results, when compared to the averages, will be accepted if within the tolerances listed below.

Parameter	Homogeneous / Conglomerate	Conglomerate "D" Quality
1 in. (25 mm)		± 5 %
1/2 in. (12.5 mm)	± 8 %	± 15 %
No. 4 (4.75 mm)	± 6 %	± 13 %
No. 8 (2.36 mm)	± 5 %	
No. 16 (1.18 mm)		± 15 %
No. 30 (600 μm)	± 5 %	
No. 200 (75 μm)	± 2.0 %	± 4.0 %
Asphalt Binder	± 0.4 % ^{1/}	± 0.5 %
G_{mm}	± 0.02 ^{2/}	

1/ The tolerance for conglomerate 3/8 shall be ± 0.3 %.

2/ Applies only to conglomerate 3/8. When variation of the G_{mm} exceeds the ± 0.02 tolerance, a new conglomerate 3/8 stockpile shall be created which will also require an additional mix design.

If more than 20 percent of the individual sieves are out of the gradation tolerances, or if more than 20 percent of the asphalt binder content test results fall outside the appropriate tolerances, the RAP shall not be used in HMA unless the RAP representing the failing tests is removed from the stockpile. All test data and acceptance ranges shall be sent to the District for evaluation.

With the approval of the Engineer, the ignition oven may be substituted for extractions according to the Illinois Test Procedure, "Calibration of the Ignition Oven for the Purpose of Characterizing Reclaimed Asphalt Pavement (RAP)".

1031.04 Quality Designation of Aggregate in RAP. The quality of the RAP shall be set by the lowest quality of coarse aggregate in the RAP stockpile and are designated as follows.

- (a) RAP from Class I, Superpave (High ESAL), or HMA (High ESAL) surface mixtures are designated as containing Class B quality coarse aggregate.
- (b) RAP from Superpave (Low ESAL)/HMA (Low ESAL) IL-19.0L binder and IL-9.5L surface mixtures are designated as Class D quality coarse aggregate.
- (c) RAP from Class I, Superpave (High ESAL), or HMA (High ESAL) binder mixtures, bituminous base course mixtures, and bituminous base course widening mixtures are designated as containing Class C quality coarse aggregate.
- (d) RAP from bituminous stabilized subbase and BAM shoulders are designated as containing Class D quality coarse aggregate.

1031.05 Use of RAP in HMA. The use of RAP in HMA shall be as follows.

- (a) Coarse Aggregate Size. The coarse aggregate in all RAP shall be equal to or less than the nominal maximum size requirement for the HMA mixture to be produced.
- (b) Steel Slag Stockpiles. RAP stockpiles containing steel slag or other expansive material, as determined by the Department, shall be homogeneous and will be approved for use in HMA (High ESAL and Low ESAL) surface mixtures only.
- (c) Use in HMA Surface Mixtures (High and Low ESAL). RAP stockpiles for use in HMA surface mixtures (High and Low ESAL) shall be either homogeneous or conglomerate 3/8, in which the coarse aggregate is Class B quality or better.
- (d) Use in HMA Binder Mixtures (High and Low ESAL), HMA Base Course, and HMA Base Course Widening. RAP stockpiles for use in HMA binder mixtures (High and Low ESAL), HMA base course, and HMA base course widening shall be homogeneous, conglomerate 5/8, or conglomerate 3/8, in which the coarse aggregate is Class C quality or better.
- (e) Use in Shoulders and Subbase. RAP stockpiles for use in HMA shoulders and stabilized subbase (HMA) shall be homogeneous, conglomerate 5/8, conglomerate 3/8, or conglomerate DQ.
- (f) The use of RAP shall be a contractor's option when constructing HMA in all contracts. When the contractor chooses the RAP option, the percentage of RAP shall not exceed the amounts indicated in the table for a given N Design.

Max RAP Percentage

HMA MIXTURES ^{1/, 3/}	MAXIMUM % RAP		
	Ndesign	Binder/Leveling Binder	Surface
30	30	30	10
50	25	15	10
70	15 / 25 ^{2/}	10 / 15 ^{2/}	10
90	10	10	10
105	10	10	10

- 1/ For HMA Shoulder and Stabilized Sub-Base (HMA) N-30, the amount of RAP shall not exceed 50% of the mixture.
- 2/ Value of Max % RAP if 3/8 RAP is utilized.
- 3/ When RAP exceeds 20%, the high & low virgin asphalt binder grades shall each be reduced by one grade (i.e. 25% RAP would require a virgin asphalt binder grade of PG64-22 to be reduced to a PG58-28).

1031.06 HMA Mix Designs. At the Contractor's option, HMA mixtures may be constructed utilizing RAP material meeting the above detailed requirements.

RAP designs shall be submitted for volumetric verification. If additional RAP stockpiles are tested and found that no more than 20 percent of the results, as defined under "Testing" herein, are outside of the control tolerances set for the original RAP stockpile and HMA mix design, and meets all of the requirements herein, the additional RAP stockpiles may be used in the original mix design at the percent previously verified.

1031.07 HMA Production. The coarse aggregate in all RAP used shall be equal to or less than the nominal maximum size requirement for the HMA mixture being produced.

To remove or reduce agglomerated material, a scalping screen, crushing unit, or comparable sizing device approved by the Engineer shall be used in the RAP feed system to remove or reduce oversized material. If material passing the sizing device adversely affects the mix production or quality of the mix, the sizing device shall be set at a size specified by the Engineer.

If the RAP control tolerances or QC/QA test results require corrective action, the Contractor shall cease production of the mixture containing RAP and either switch to the virgin aggregate design or submit a new RAP design. When producing mixtures containing conglomerate 3/8 RAP, a positive dust control system shall be utilized.

HMA plants utilizing RAP shall be capable of automatically recording and printing the following information.

- (a) Dryer Drum Plants.

- (1) Date, month, year, and time to the nearest minute for each print.
- (2) HMA mix number assigned by the Department.
- (3) Accumulated weight of dry aggregate (combined or individual) in tons (metric tons) to the nearest 0.1 ton (0.1 metric ton).
- (4) Accumulated dry weight of RAP in tons (metric tons) to the nearest 0.1 ton (0.1 metric ton).
- (5) Accumulated mineral filler in revolutions, tons (metric tons), etc. to the nearest 0.1 unit.
- (6) Accumulated asphalt binder in gallons (liters), tons (metric tons), etc. to the nearest 0.1 unit.
- (7) Residual asphalt binder in the RAP material as a percent of the total mix to the nearest 0.1 percent.
- (8) Aggregate and RAP moisture compensators in percent as set on the control panel. (Required when accumulated or individual aggregate and RAP are printed in wet condition.)

(b) Batch Plants.

- (1) Date, month, year, and time to the nearest minute for each print.
- (2) HMA mix number assigned by the Department.
- (3) Individual virgin aggregate hot bin batch weights to the nearest pound (kilogram).
- (4) Mineral filler weight to the nearest pound (kilogram).
- (5) RAP weight to the nearest pound (kilogram).
- (6) Virgin asphalt binder weight to the nearest pound (kilogram).
- (7) Residual asphalt binder in the RAP material as a percent of the total mix to the nearest 0.1 percent.

The printouts shall be maintained in a file at the plant for a minimum of one year or as directed by the Engineer and shall be made available upon request. The printing system will be inspected by the Engineer prior to production and verified at the beginning of each construction season thereafter.

1031.08 RAP in Aggregate Surface Course and Aggregate Shoulders. The use of RAP in aggregate surface course and aggregate shoulders shall be as follows.

- (a) Stockpiles and Testing. RAP stockpiles may be any of those listed in Article 1031.02, except "Other". The testing requirements of Article 1031.03 shall not apply.
- (b) Gradation. One hundred percent of the RAP material shall pass the 1 1/2 in. (37.5 mm) sieve. The RAP material shall be reasonably well graded from coarse to fine. RAP material that is gap-graded or single sized will not be accepted."

REFLECTIVE SHEETING ON CHANNELIZING DEVICES (BDE)

Effective: April 1, 2007

Revise the seventh paragraph of Article 1106.02 of the Standard Specifications to read:

"At the time of manufacturing, the retroreflective prismatic sheeting used on channelizing devices shall meet or exceed the initial minimum coefficient of retroreflection as specified in the following table. Measurements shall be conducted according to ASTM E 810, without averaging. Sheeting used on cones, drums and flexible delineators shall be reboundable as tested according to ASTM D 4956. Prestriped sheeting for rigid substrates on barricades shall be white and orange.

Initial Minimum Coefficient of Retroreflection candelas/foot candle/sq ft (candelas/lux/sq m) of material				
Observation Angle (deg.)	Entrance Angle (deg.)	White	Orange	Fluorescent Orange
0.2	-4	365	160	150
0.2	+30	175	80	70
0.5	-4	245	100	95
0.5	+30	100	50	40"

Revise the first sentence of the first paragraph of Article 1106.02(c) of the Standard Specifications to read:

"Barricades and vertical panels shall have alternating white and orange stripes sloping downward at 45 degrees toward the side on which traffic will pass."

Revise the third sentence of the first paragraph of Article 1106.02(d) of the Standard Specifications to read:

"The bottom panels shall be 8 x 24 in. (200 x 600 mm) with alternating white and orange stripes sloping downward at 45 degrees toward the side on which traffic will pass."

STONE GRADATION TESTING (BDE)

Effective: November 1, 2007

Revise the first sentence of note 1/ of the Erosion Protection and Sediment Control Gradations table of Article 1005.01(c)(1) of the Standard Specifications to read:

“A maximum of 15 percent of the total test sample by weight may be oversize material.”

SUBCONTRACTOR MOBILIZATION PAYMENTS (BDE)

Effective: April 2, 2005

To account for the preparatory work and operations necessary for the movement of subcontractor personnel, equipment, supplies, and incidentals to the project site and for all other work or operations that must be performed or costs incurred when beginning work approved for subcontracting in accordance with Article 108.01 of the Standard Specifications, the Contractor shall make a mobilization payment to each subcontractor.

This mobilization payment shall be made at least 14 days prior to the subcontractor starting work. The amount paid shall be equal to 3 percent of the amount of the subcontract reported on form BC 260A submitted for the approval of the subcontractor's work.

This provision shall be incorporated directly or by reference into each subcontract approved by the Department.

THERMOPLASTIC PAVEMENT MARKINGS (BDE)

Effective: January 1, 2007

Revise Article 1095.01(a)(2) of the Standard Specifications to read:

“(2) Pigment. The pigment used for the white thermoplastic compound shall be a high-grade pure (minimum 93 percent) titanium dioxide (TiO₂). The white pigment content shall be a minimum of ten percent by weight and shall be uniformly distributed throughout the thermoplastic compound.

The pigments used for the yellow thermoplastic compound shall not contain any hazardous materials listed in the Environmental Protection Agency Code of Federal Regulations (CFR) 40, Section 261.24, Table 1. The combined total of RCRA listed heavy metals shall not exceed 100 ppm when tested by X-ray fluorescence spectroscopy. The pigments shall also be heat resistant, UV stable and color-fast yellows, golds, and oranges, which shall produce a compound which shall match Federal Standard 595 Color No. 33538. The pigment shall be uniformly distributed throughout the thermoplastic compound.”

Revise Article 1095.01(b)(1)e. of the Standard Specifications to read:

“e. Daylight Reflectance and Color. The thermoplastic compound after heating for four hours ± five minutes at 425 ± 3 °F (218.3 ± 2 °C) and cooled at 77 °F (25 °C) shall meet the following requirements for daylight reflectance and color, when tested, using a color spectrophotometer with 45 degree circumferential/zero degree geometry, illuminant C, and two degree observer angle. The color instrument shall measure the visible spectrum from 380 to 720 nm with a wavelength measurement interval and spectral bandpass of 10 nm.

White: Daylight Reflectance75 percent min.
*Yellow: Daylight Reflectance45 percent min.

*Shall meet the coordinates of the following color tolerance chart.

x	0.490	0.475	0.485	0.530
y	0.470	0.438	0.425	0.456"

Revise Article 1095.01(b)(1)k. of the Standard Specifications to read:

- "k. Accelerated Weathering. After heating the thermoplastic for four hours \pm five minutes at 425 ± 3 °F (218.3 ± 2 °C) the thermoplastic shall be applied to a steel wool abraded aluminum alloy panel (Federal Test Std. No. 141, Method 2013) at a film thickness of 30 mils (0.70 mm) and allowed to cool for 24 hours at room temperature. The coated panel shall be subjected to accelerated weathering using the light and water exposure apparatus (fluorescent UV - condensation type) for 75 hours according to ASTM G 53 (equipped with UVB-313 lamps).

The cycle shall consist of four hours UV exposure at 122 °F (50 °C) followed by four hours of condensation at 104 °F (40 °C). UVB 313 bulbs shall be used. At the end of the exposure period, the panel shall not exceed 10 Hunter Lab Delta E units from the original material."

WORKING DAYS (BDE)

Effective: January 1, 2002

The Contractor shall complete the work within **45** working days.

BITUMINOUS MATERIALS COST ADJUSTMENTS (BDE) (RETURN FORM WITH BID)

Effective: November 2, 2006

Revised: January 2, 2007

Description. For projects with at least 1200 tons (1100 metric tons) of work involving applicable bituminous materials, cost adjustments will be made to provide additional compensation to the Contractor, or credit to the Department, for fluctuations in the cost of bituminous materials when optioned by the Contractor. The adjustments shall apply to permanent and temporary hot-mix asphalt (HMA) mixtures, bituminous surface treatments (cover and seal coats), and pavement preservation type surface treatments. The adjustments shall not apply to bituminous prime coats, tack coats, crack filling/sealing, or joint filling/sealing.

The bidder shall indicate on the attached form whether or not this special provision will be part of the contract and submit the completed form with his/her bid. Failure to submit the form, or failure to fill out the form completely, shall make this contract exempt of bituminous materials cost adjustments.

Method of Adjustment. Bituminous materials cost adjustments will be computed as follows.

$$CA = (BPI_P - BPI_L) \times (\%AC_V / 100) \times Q$$

- Where: CA = Cost Adjustment, \$.
BPI_P = Bituminous Price Index, as published by the Department for the month the work is performed, \$/ton (\$/metric ton).
BPI_L = Bituminous Price Index, as published by the Department for the month prior to the letting, \$/ton (\$/metric ton).
%AC_V = Percent of virgin Asphalt Cement in the Quantity being adjusted. For HMA mixtures, the % AC_V will be determined from the adjusted job mix formula. For bituminous materials applied, a performance graded or cutback asphalt will be considered to be 100% AC_V and undiluted emulsified asphalt will be considered to be 65% AC_V.
Q = Authorized construction Quantity, tons (metric tons) (see below).

For HMA mixtures measured in square yards: $Q, \text{ tons} = A \times D \times (G_{mb} \times 46.8) / 2000$. For HMA mixtures measured in square meters: $Q, \text{ metric tons} = A \times D \times (G_{mb} \times 24.99) / 1000$. When computing adjustments for full-depth HMA pavement, separate calculations will be made for the binder and surface courses to account for their different G_{mb} and % AC_V.

For bituminous materials measured in gallons: $Q, \text{ tons} = V \times 8.33 \text{ lb/gal} \times SG / 2000$
For bituminous materials measured in liters: $Q, \text{ metric tons} = V \times 1.0 \text{ kg/L} \times SG / 1000$

- Where: A = Area of the HMA mixture, sq yd (sq m).
D = Depth of the HMA mixture, in. (mm).
G_{mb} = Average bulk specific gravity of the mixture, from the approved mix design.
V = Volume of the bituminous material, gal (L).
SG = Specific Gravity of bituminous material as shown on the bill of lading.

Basis of Payment. Bituminous materials cost adjustments may be positive or negative but will only be made when there is a difference between the BPI_L and BPI_P in excess of five percent, as calculated by:

$$\text{Percent Difference} = \{(BPI_L - BPI_P) \div BPI_L\} \times 100$$

Bituminous materials cost adjustments will be calculated for each calendar month in which applicable bituminous material is placed; and will be paid or deducted when all other contract requirements for the items of work are satisfied. The adjustments shall not apply during contract time subject to liquidated damages for completion of the entire contract.

Return With Bid

**ILLINOIS DEPARTMENT
OF TRANSPORTATION**

**OPTION FOR
BITUMINOUS MATERIALS COST ADJUSTMENTS**

The bidder shall submit this completed form with his/her bid. Failure to submit the form, or failure to fill out the form completely, shall make this contract exempt of bituminous materials cost adjustments. After award, this form, when submitted, shall become part of the contract.

Contract No.: _____

Company Name: _____

Contractor's Option:

Is your company opting to include this special provision as part of the contract?

Yes No

Signature: _____ **Date:** _____

RAILROAD PROTECTIVE LIABILITY INSURANCE (BDE)

Effective: December 1, 1986

Revised: January 1, 2006

Description. Railroad Protective Liability and Property Damage Liability Insurance shall be carried according to Article 107.11 of the Standard Specifications. A separate policy is required for each railroad unless otherwise noted.

NAMED INSURED & ADDRESS	NUMBER & SPEED OF PASSENGER TRAINS	NUMBER & SPEED OF FREIGHT TRAINS
Iowa Interstate Railroad, Ltd. 5900 Sixth Street SW Cedar Rapids, Iowa 52404	0	2 per day at 20 MPH

Pat Sheldon, Manager of Public Projects

DOT/AAR No.: 604 311 W RR Mile Post: 2.81
RR Division: Illinois RR Sub-Division: Milan Branch

For Freight/Passenger Information Contact: Dennis Wilson Phone: 319-298-5427
For Insurance Information Contact: Sherry Sanchez Phone: 319-298-5411

COMMENTS: A Railroad Flagger is required when working within 25 feet, horizontally, of the tracks or whenever working over the tracks. Contact Dennis Wilson well in advance.

Approval of Insurance. The original and one certified copy of each required policy shall be submitted to the following address for approval:

Illinois Department of Transportation
Bureau of Design and Environment
2300 South Dirksen Parkway, Room 326
Springfield, Illinois 62764

The Contractor will be advised when the Department has received approval of the insurance from the railroad(s). Before any work begins on railroad right-of-way, the Contractor shall submit to the Engineer evidence that the required insurance has been approved by the railroad(s). The Contractor shall also provide the Engineer with the expiration date of each required policy.

Basis of Payment. Providing Railroad Protective Liability and Property Damage Liability Insurance will be paid for at the contract unit price per Lump Sum for RAILROAD PROTECTIVE LIABILITY INSURANCE.

FOR INDEX OF SHEETS, SEE SHEET NO. 2.
FOR STATE STANDARDS, SEE SHEET NO. 2.

STATE OF ILLINOIS
DEPARTMENT OF TRANSPORTATION
DIVISION OF HIGHWAYS

**PROPOSED
HIGHWAY PLANS**

FAP ROUTE 599 (IL 92)
SECTION 48MFT-RS
PROJECT **ACF-0599(022)**
ROCK ISLAND COUNTY
C-92-030-08

FAP RITE	SECTION	COUNTY	TOTAL SHEETS NO.
599	48MFT-RS	ROCK ISLAND	49
FED. ROAD DIST. NO. ILLINOIS			CONTRACT NO. 64E02

BLACKHAWK TOWNSHIP SECTION 16, 21

UTILITY
JOINT UTILITY LOCATOR INFORMATION FOR EXCAVATION
1-800-492-0123
OR 811

PROJECT ENGINEER: BOB WAGNER
SOULAD TECHNICIAN: LUCAS MEGLI (815)284-5362
CONTRACT NO. 64E02

FAP 599 (IL 92) SECTION 48MFT-RS ROCK ISLAND COUNTY

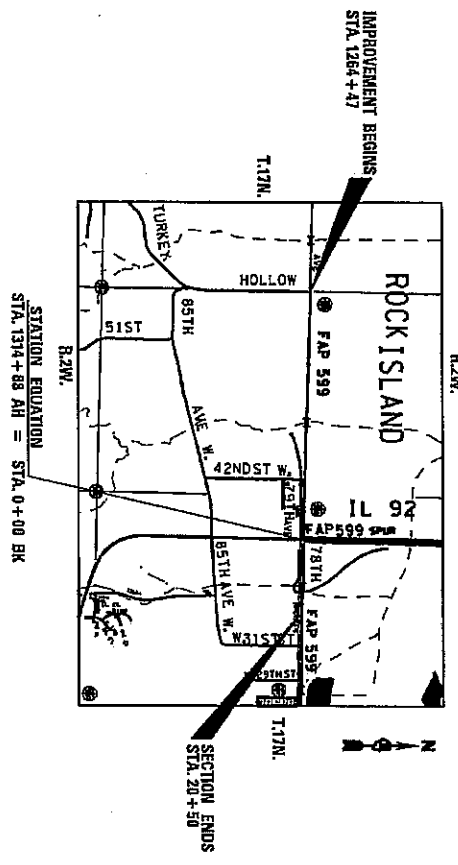

NET LENGTH OF PROJECT = 7095 LIN. FT = 1.34MILES
GROSS LENGTH OF PROJECT = 7099 LIN. FT = 1.34 MILES

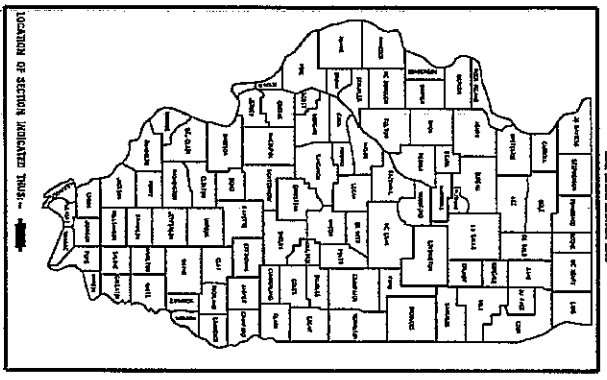

D-92-044-08

STATE OF ILLINOIS
DEPARTMENT OF TRANSPORTATION
DIVISION OF HIGHWAYS
SUBMITTED *March 13, 2008*
Lucas Megli
DEPARTMENT/SECTION OF HIGHWAYS, SOULAD ENGINEER
24
ENGINEER OF DESIGN AND ENVIRONMENT
24
SECTION OF HIGHWAYS, SOULAD ENGINEER

**PRINTED BY THE AUTHORITY
OF THE STATE OF ILLINOIS**

INDEX OF SHEETS

1	Cover Sheet
2	Index of Sheets
2	State Standards
3 - 5	Summary of Quantities
6 - 7	General Notes
8 - 22	Typical Sections
23 - 24	Patching Schedule
25 - 26	Bituminous Schedule
27 - 33	Schedule of Quantities
34 - 40	Plan Sheets and Striping Details
41	"Stay In Your Lane" Sign Detail
42	Pavement Patching for Hot-Mix Surfaced Pavement (32.4)
43	Subgrade Replacement (97.4)
44	Hot-Mix Asphalt Approaches and Mailbox Returns for Two Lifts (3P) Resurfacing Projects (47.2)
45	Rough-Grooved Surface Sign (91.2)
46	Traffic Control and Protection at Turn Bays (To Remain Open to Traffic) (94.2)
47	Traffic Control for Road Closure (40.1)
48 - 49	Typical Pavement Marking (41.1)

STATE STANDARDS

000001	- 05	Standard Symbols, Abbreviations, and Patterns
001006	- 02	Decimal of an Inch and of a Foot
420701	- 02	Pavement Fabric
442101	- 07	Class B Patches
604001	02	Frame and Lids Type 1
701201	- 02	Typical Application of Traffic Control Standard
701301	- 02	Typical Application of Traffic Control Standard
701306	- 01	Typical Application of Traffic Control Standard
701311	- 02	Typical Application of Traffic Control Standard
701326	- 02	Typical Application of Traffic Control Standard
701422	- 01	Typical Application of Traffic Control Standard
701901	- 01	Traffic Control Devices
780001	- 01	Typical Pavement Markings
781001	- 02	Typical Applications Raised Reflective Pavement Markers
886001	- 02	Detector Loop Installations
886006		Typical Layout for Detector Loops

SUMMARY OF QUANTITIES

URBAN 1000

CODE NUMBER	ITEM	UNIT	TOTAL QUANTITY	80% FED / 20% STATE
31100700	SUB-BASE GRANULAR MATERIAL, TYPE A, 8"	SQ YD	102	102
40600200	BITUMINOUS MATERIALS (PRIME COAT)	TON	23	23.0
40600300	AGGREGATE (PRIME COAT)	TON	58	58
40600535	LEVELING BINDER (HAND METHOD), N70	TON	35	35
40600837	POLYMERIZED LEVELING BINDER (MACHINE METHOD), N70	TON	1,753	1,753
40600895	CONSTRUCTING TEST STRIP	EACH	1	1
40600982	HOT-MIX ASPHALT SURFACE REMOVAL - BUTT JOINT	SQ YD	82	82
40600985	PORTLAND CEMENT CONCRETE SURFACE REMOVAL - BUTT JOINT	SQ YD	183	183
40600990	TEMPORARY RAMP	SQ YD	1,353	1,353
40601005	HOT-MIX ASPHALT REPLACEMENT OVER PATCHES	TON	391	391
40603310	HOT-MIX ASPHALT SURFACE COURSE, MIX "C", N50	TON	668	668
40603540	POLYMERIZED HOT-MIX ASPHALT SURFACE COURSE, MIX "D", N70	TON	2,557	2,557
40800050	INCIDENTAL HOT-MIX ASPHALT SURFACING	TON	209	209
44000158	HOT-MIX ASPHALT SURFACE REMOVAL, 2 1/4"	SQ YD	7,602	7,602
44000198	HOT-MIX ASPHALT SURFACE REMOVAL, VARIABLE DEPTH	SQ YD	2,634	2,634
44002218	HOT-MIX ASPHALT REMOVAL OVER PATCHES, 4 1/2"	SQ YD	1,533	1,533
44200108	PAVEMENT PATCHING, TYPE II, 9 INCH	SQ YD	104	104
44200112	PAVEMENT PATCHING, TYPE III, 9 INCH	SQ YD	37	37

SUMMARY OF QUANTITIES

URBAN 1000

CODE NUMBER	ITEM	UNIT	TOTAL QUANTITY	80% FED / 20% STATE
44200114	PAVEMENT PATCHING, TYPE IV, 9 INCH	SQ YD	160	160
48101200	AGGREGATE SHOULDERS, TYPE B	TON	1,909	1,909
48203021	HOT-MIX ASPHALT SHOULDERS, 6"	SQ YD	392	392
60255500	MANHOLES TO BE ADJUSTED	EACH	3	3
60255800	MANHOLES TO BE ADJUSTED WITH NEW TYPE 1 FRAME, CLOSED LID	EACH	3	3
63200310	GUARDRAIL REMOVAL	FOOT	113	113
67000400	ENGINEER'S FIELD OFFICE, TYPE A	CAL MO	3	3
67100100	MOBILIZATION	L SUM	1	1
70100320	TRAFFIC CONTROL AND PROTECTION, STANDARD 701422	L SUM	1	1
70100450	TRAFFIC CONTROL AND PROTECTION, STANDARD 701201	L SUM	1	1
70100460	TRAFFIC CONTROL AND PROTECTION, STANDARD 701306	L SUM	1	1
70100500	TRAFFIC CONTROL AND PROTECTION, STANDARD 701326	L SUM	1	1
70102635	TRAFFIC CONTROL AND PROTECTION, STANDARD 701701	L SUM	1	1
70103815	TRAFFIC CONTROL SURVEILLANCE	CAL DA	5	5
70106800	CHANGEABLE MESSAGE SIGN	CAL MO	3	3
70300100	SHORT-TERM PAVEMENT MARKING	FOOT	4,658	4,658
70301000	WORK ZONE PAVEMENT MARKING REMOVAL	SQ FT	518	518
78000100	THERMOPLASTIC PAVEMENT MARKING - LETTERS AND SYMBOLS	SQ FT	551	551

* SPECIALTY ITEM

GENERAL NOTES

Previously pugmilled stockpiles of "Type A" older than 1 month will not be approved for use until a moisture check is run to verify moisture content. Material shipped to projects without being tested will not be accepted.

The Engineer reserves the right to check all patches for smoothness by the use of a 10' rolling straight edge set to a 3/16" tolerance in the wheel paths. Any patch areas higher than 3/16" must be ground smooth with an approved grinding device consisting of multiple saws. The use of bushhammer or other impact devices will not be permitted. Any patch with depressions greater than 3/16" shall be repaired in a manner approved by the Engineer.

The minimum patch dimension for full-depth patches will be 1.2 m (four feet) and half-lane width. Half-lane patches shall be confined to the outside edges of the pavement.

Milling machines on this project shall be capable of removing a layer of bituminous a minimum 6' wide and 1-1/2 inches in depth in a single pass.

The following Mixture Requirements are applicable for this project:

Mixture Uses(s):	Surface	Top Shoulder	Level Binder (MM)	HMA Shoulder 6"
PG:	SBS PG 70-22	PG 58-22	SBS PG 70-22	PG 64-22
Design Air Voids	4.0 @ N70	3 @ N50	4.0 @ N70	2.0 @ N50
Mixture Composition (Gradation Mixture)	IL 9.5 or 12.5	IL 9.5 or 12.5	IL 9.5	BAM
Friction Aggregate	D	C	N/A	N/A
20 Year ESAL	4.3	N/A	4.3	N/A
Mix Unit Weight	112 lbs/sy/in	112 lbs/sy/in	112 lbs/sy/in	112 lbs/sy/in

Mixture Uses(s):	HMA over Patches
PG:	SBS PG 70-22
Design Air Voids	4.0 @ N70
Mixture Composition (Gradation Mixture)	IL 19.0
Friction Aggregate	N/A
20 Year ESAL	N/A
Mix Unit Weight	112 lbs/sy/in

The Contractor shall place temporary hot-mix asphalt tapers along all sides of the utility structures protruding above the milled surface. The temporary tapers shall extend 2' outside of the castings, except for the approach side to traffic shall have a 4' taper length. Hot-mix asphalt meeting the approval of the Engineer shall be used, no cold millings will be allowed. The cost of the material, placement, maintenance, removal and disposal of said work will be included in the Pay Item for Hot-Mix Asphalt Surface Removal.

The Contractor will be required to furnish 140 mm (5 1/2") high brass stencils as approved by the Engineer and install stationing at 250' intervals. Stationing shall be placed on both lanes of 2-lane highways and on the outside lanes in both directions on 4-lane highways. The stations shall be placed 150 mm (6") inside the pavement marking edge so they can be read from the shoulder. This work will be included in the cost of the final pavement surface.

To help avoid excess drop offs at the edge of pavement, the existing aggregate wedge or shoulder is to be pulled up and rolled to match the edge of pavement before placing any bituminous material. All costs associated with pulling up the shoulders shall be considered included in the contract unit price per TON for HOT-MIX ASPHALT SURFACE COURSE of the type specified.

If, during the grinding or resurfacing operations, the existing mailboxes become a hindrance, the Contractor shall be required to carefully remove and reinstall the mailboxes as directed by the Engineer. This work shall be included in the contract unit price for the INCIDENTAL HOT-MIX ASPHALT SURFACING.

All frames and grates of drainage structures to be removed or filled shall be carefully salvaged and shall remain the property of L.D.O.T.

The new manhole lids on this project shall have the word "STORM", "SANITARY", or "WATER" on the lid. The word to be used is noted on the plans. It will be the Contractor's responsibility to determine the word to be used on other lids not noted on the plans. No additional compensation will be allowed for this work.

Pavement Marking shall be done according to Standard 780001, except as follows:

1. All words, such as ONLY, shall be 2.4 m (8 feet) high.
2. All non-free-way arrows shall be the large size.
3. The distance between yellow no-passing lines shall be 200 mm (8"), not 180 mm (7") as shown in the detail of Typical Lane and Edge Lines.

The Contractor shall be responsible for protecting utility property during construction operations as outlined in Article 107.31 of the Standard Specifications. A minimum of 48 hours advance notice is required for non-emergency work. The JULIE number is 800-892-0123. The following listed utilities located within the project limits or immediately adjacent to the project construction limits are members of JULIE:

AT&T
Mediacom
MidAmerican Energy Co.
City of Rock Island

It shall be the Contractor's responsibility to contact the municipality to determine approved methods of utility structure adjustment. Utility structures may include, but are not limited to, manholes, water valves, handholes, etc. All materials and work necessary to complete adjustments per municipality requirements shall be considered included in the cost of the associated adjustment pay item.

All millings shall become the property of the State of Illinois. They shall be wasted at the State Maintenance Yard located at 6+40 Lt. within the project limits.

There is a gas valve located at 42nd Street that shall be adjusted by the utility company.

Construction activities in the IL 92/Centennial Expressway intersection, Stations 1312+43 to 2+38, prior to 9 a.m. and ending at 3 p.m. each day shall not be allowed unless approved by the Engineer. The Resident Engineer shall notify Scott Kullerstrand, District Operations Engineer, at 815/284-5468 prior to removal of the existing traffic signal detector loops. District Operations shall adjust signal timing and trouble shoot any problems. District shall include the City of Rock Island in all traffic issues.

Contractor shall verify existing cross slopes on the project prior to HMA surface removal to establish grades for paving and provide adequate drainage as approved by the Engineer.

Final striping shall be placed per plans, field verification, and standards. If discrepancies arise prior to placing final striping, contact Kurt Glazier at 815/284-5478, minimum 24 hour notice.

TYPICAL SECTION

IL 92

STA. 1264+47 - STA. 1269+37

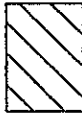
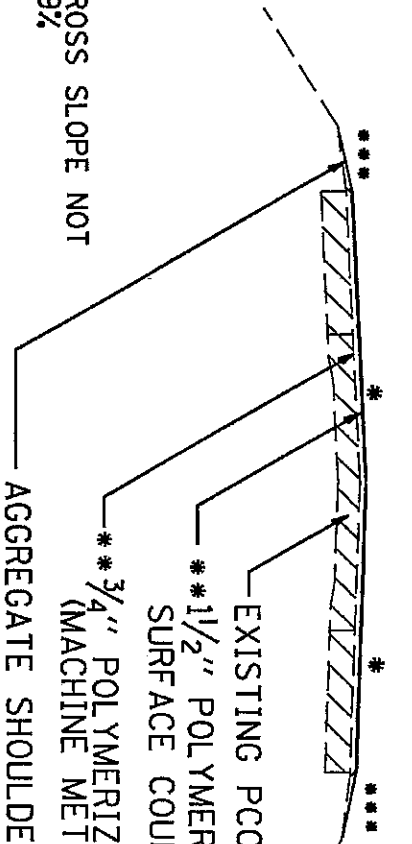
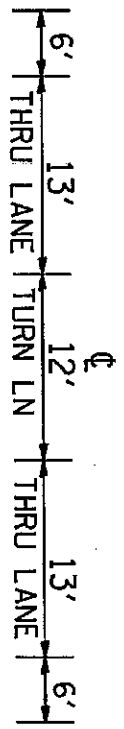

EXISTING

*** MAINTAIN EXISTING CROSS SLOPE OR 1/8" MIN.

*** 112 LBS/50 YD/IN

HMA SURFACE REMOVAL (VAR DEPTH)
 STA. 1264+47 - STA. 1267+92.5

FILE NAME = c:\projects\2004\08\084408\p04.dgn	USER NAME = mag111	STATE OF ILLINOIS DEPARTMENT OF TRANSPORTATION	F.A.P. RTE.	SECTION	COUNTY	TOTAL SHEETS	SHEET NO.
PLOT DATE = Thu Mar 19 13:42:03 2008			599	48MT-RS	ROCK ISLAND	49	8
			FED. ROAD DIST. NO.	ILLINOIS FED. AID PROJECT			
			CONTRACT NO. 64E02				

TYPICAL SECTION

IL 92

STA. 1269+37 - STA. 1273+75

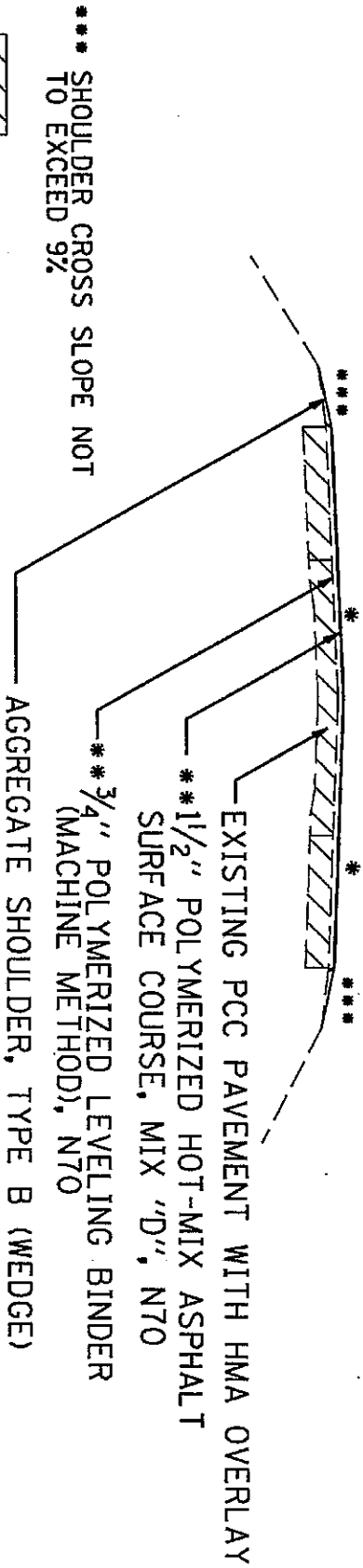
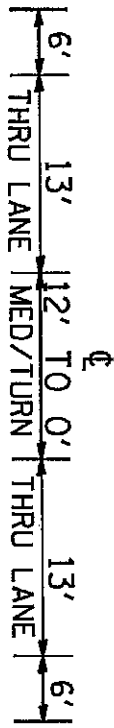

FILE NAME =	USER NAME =	STATE OF ILLINOIS	F.A.P. RTE.	SECTION	COUNTY	TOTAL SHEETS
c:\p\objects\2014\08\vd01408\p.dgn	meahlu	DEPARTMENT OF TRANSPORTATION	599	49MT-RS	ROCK ISLAND	9
	PLOT DATE = Thu Mar 13 13:42:03 2008		FED. ROAD DIST. NO.	ILLINOIS FED. AID PROJECT		CONTRACT NO. 64E02

TYPICAL SECTION

IL 92

STA. 1273+75 - STA. 1294+50

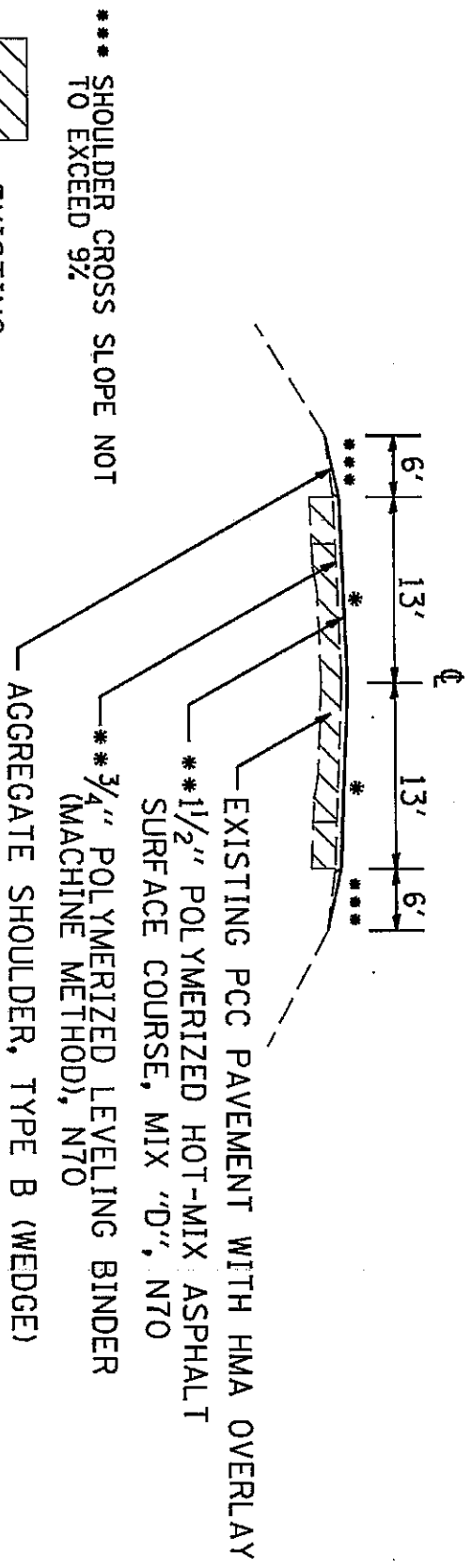

FILE NAME = c:\p\objects\204108\04108\p\dgn	USER NAME = mes111	STATE OF ILLINOIS DEPARTMENT OF TRANSPORTATION	F.A.P. RTE. 599	SECTION 48MT-RS	COUNTY ROCK ISLAND	TOTAL SHEETS 49	SHEET NO. 10
PLOT DATE = Thu Mar 13 13:42:03 2008			FED. ROAD DIST. NO.		ILLINOIS/FED. AID PROJECT		

TYPICAL SECTION

IL 92

STA. 1294+50 - STA. 1300+16

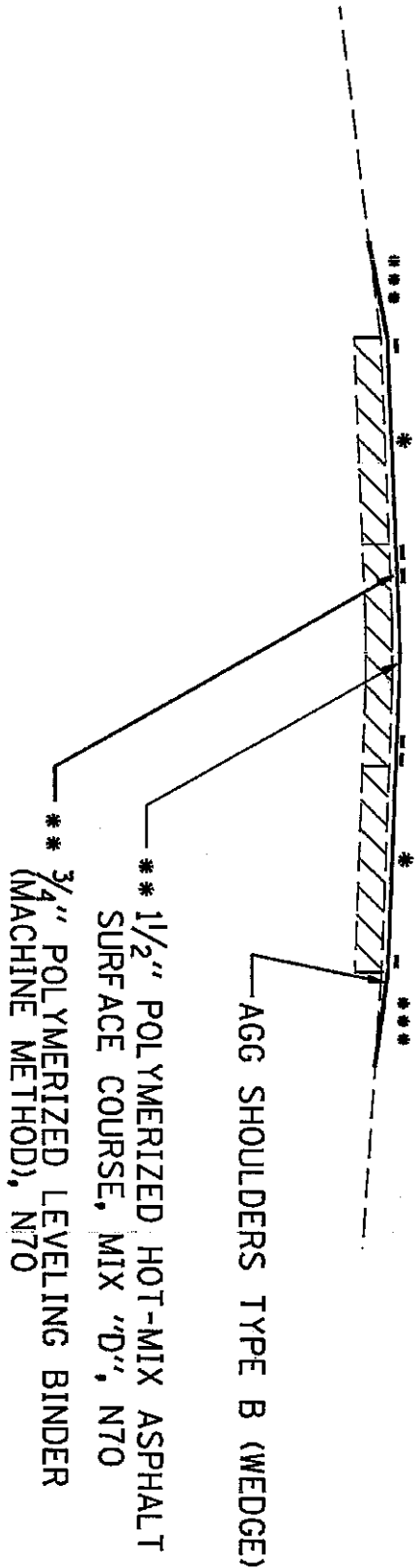
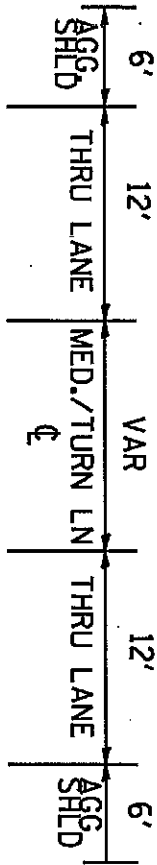

- *** SHOULDER CROSS SLOPE NOT TO EXCEED 9%
- * MAINTAIN EXISTING CROSS SLOPE OR 1/8" MIN.
- *** 112 LBS/SQ YD/IN

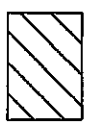

EXISTING PCC PAVEMENT WITH HMA OVERLAY

FILE NAME = c:\projects\204488\204488.dgn	USER NAME = mag11J	STATE OF ILLINOIS DEPARTMENT OF TRANSPORTATION	F.A.P. RTE. 599	SECTION 48MT-RS	COUNTY ROCK ISLAND	TOTAL SHEET NO. 49
PLOT DATE = Thu Mar 13 13:42:03 2008			CONTRACT NO. 64E02			
			FED. ROAD DIST. NO. ILLINOIS FED. AID PROJECT			

TYPICAL SECTION
 IL 92
 STA. 1300+16 - STA. 1304+70

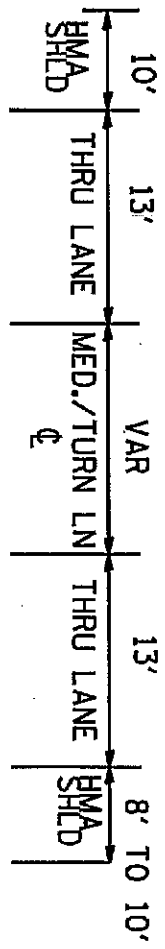

*** SHOULDER CROSS SLOPE NOT TO EXCEED 9%
 * MAINTAIN EXISTING CROSS SLOPE OR 1/8" MIN.
 ** 112 LBS/SO YD/IN

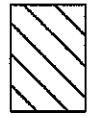

*** 2 1/4" TO 1" HOT -MIX ASPHALT SURFACE COURSE MIX "C", N50
 ** EXISTING PCC PAVEMENT WITH HMA OVERLAY

*** 1/2" POLYMERIZED HOT-MIX ASPHALT SURFACE COURSE, MIX "D", N70
 *** 3/4" POLYMERIZED LEVELLING BINDER (MACHINE METHOD), N70

2 1/4" TO 1" HOT -MIX ASPHALT SURFACE COURSE MIX "C", N50

HMA SHOULDER

FILE NAME = c:\projects\204108\04108.dwg	USER NAME = meglju	STATE OF ILLINOIS DEPARTMENT OF TRANSPORTATION	FED. ROAD DIST. NO. ILLINOIS FED. AID PROJECT
PLLOT DATE = Thu Mar-13 13:42:03 2008			
		SECTION	COUNTY
		48W/T-RS	ROCK ISLAND
			TOTAL SHEET NO.
			49
			12
			CONTRACT NO. 64E02

TYPICAL SECTION
 IL 92
 STA. 1304+70 - STA. 1310+00

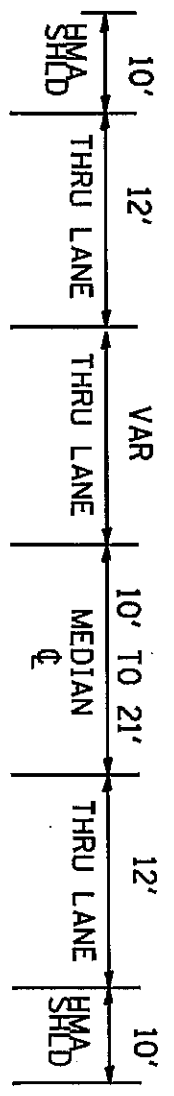

HMA SHOULDER

2 1/4" TO 1" HOT -MIX ASPHALT SURFACE COURSE MIX "C", N50

1 1/2" POLYMERIZED HOT-MIX ASPHALT SURFACE COURSE, MIX "D", N70

3/4" POLYMERIZED LEVELING BINDER (MACHINE METHOD), N70

- *** SHOULDER CROSS SLOPE NOT TO EXCEED 9%
- * MAINTAIN EXISTING CROSS SLOPE OR 1/8" MIN.
- ** 112 LBS/SO YD/IN

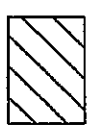

EXISTING PCC PAVEMENT WITH HMA OVERLAY

FILE NAME = c:\p\objects\2204108\10241081.pcdgn	USER NAME = meajlu	STATE OF ILLINOIS DEPARTMENT OF TRANSPORTATION	F.A.P. RITE. 599	SECTION 4816T-R5	COUNTY ROCK ISLAND	TOTAL SHEETS 49	SHEET NO. 13
PLOT DATE = Thu Mar 13 13:42:04 2008			FED. ROAD DIST. NO. ILLINOIS FED. AID PROJECT		CONTRACT NO. 64E02		

TYPICAL SECTION
 IL 92
 STA. 1310+00 - STA. 1312+40

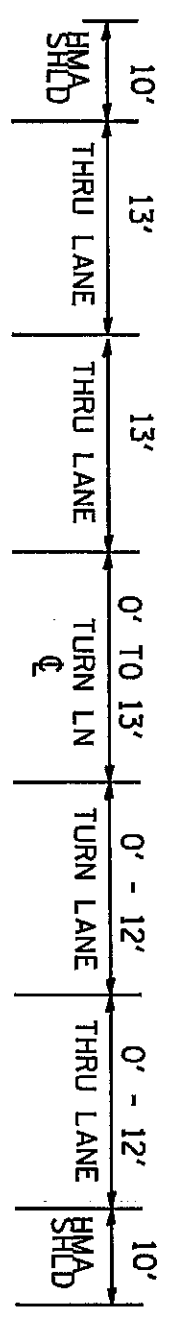

*** SHOULDER CROSS SLOPE NOT TO EXCEED 9%
 * MAINTAIN EXISTING CROSS SLOPE OR 1/8" MIN.
 *** 112 LBS/SO YD/IN

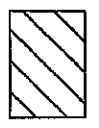

EXISTING PCC PAVEMENT WITH HMA OVERLAY

2 1/4" TO 1" HOT -MIX ASPHALT SURFACE COURSE MIX "C", N50
 HMA SHOULDER
 * 1 1/2" POLYMERIZED HOT-MIX ASPHALT SURFACE COURSE, MIX "D", N70
 * 3/4" POLYMERIZED LEVELLING BINDER (MACHINE METHOD), N70

FILE NAME = c:\projects\2304488\484+88sp.dgn	USER NAME = meglj	STATE OF ILLINOIS DEPARTMENT OF TRANSPORTATION	FED. ROAD DIST. NO. ILLINOIS FED. AID PROJECT
PLOT DATE = Thu Mar 13 13:42:04 2008			
		SECTION	COUNTY
		484ET-RS	ROCK ISLAND
			TOTAL SHEET NO.
			49
			14
		CONTRACT NO. 64E02	

TYPICAL SECTION
 IL 92
 STA. 1312+40 - STA. 1314+88

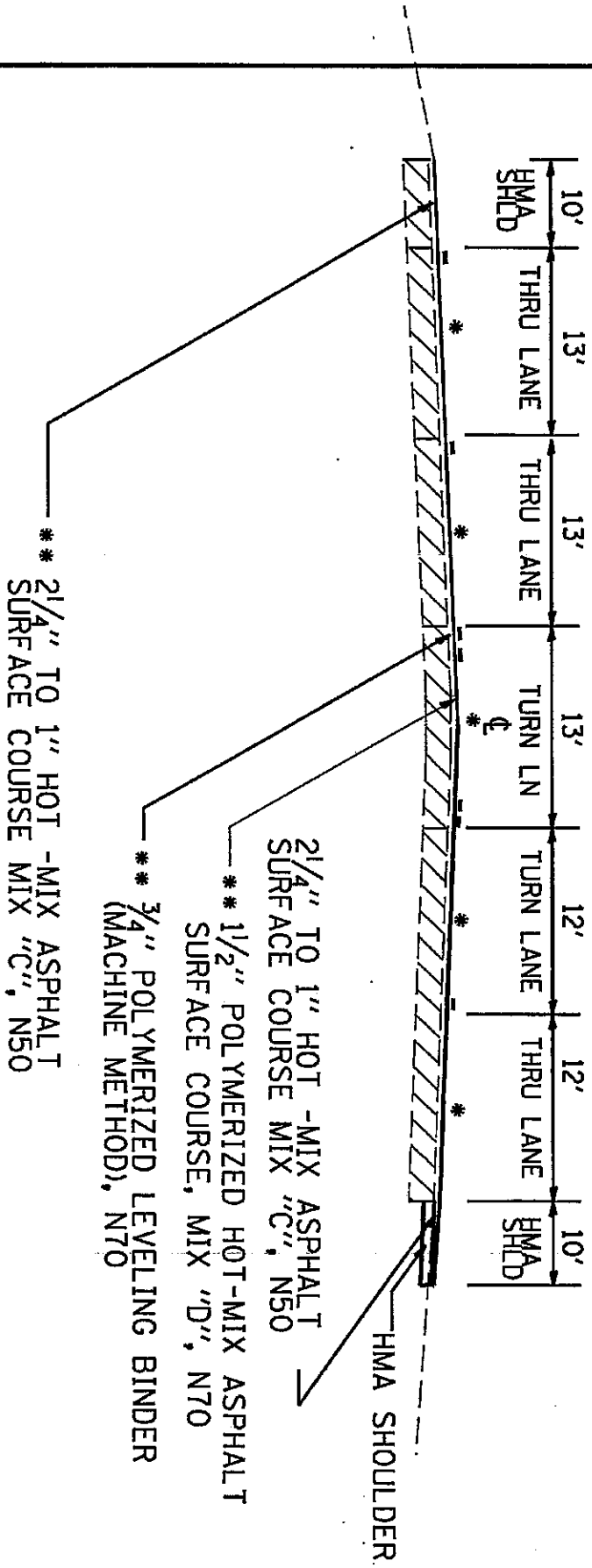

- *** SHOULDER CROSS SLOPE NOT TO EXCEED 9%
- *** MAINTAIN EXISTING CROSS SLOPE OR 1/8" MIN.
- *** 112 LBS/SO YD/IN

*** 2 1/4" TO 1" HOT -MIX ASPHALT SURFACE COURSE MIX "C", N50
 HMA SURFACE REMOVAL (VAR. DEPTH) STA 1312+43 - STA. 1314+88

EXISTING PCC PAVEMENT WITH HMA OVERLAY

- *** 2 1/4" TO 1" HOT -MIX ASPHALT SURFACE COURSE MIX "C", N50
- *** 1 1/2" POLYMERIZED HOT-MIX ASPHALT SURFACE COURSE, MIX "D", N70
- *** 3/4" POLYMERIZED LEVELING BINDER (MACHINE METHOD), N70

FILE NAME = c:\projects\2004\108\1084488\pav.dgn
 USER NAME = meglilj
 PLOT DATE = Thu Mar 13 13:42:04 2008
 STATE OF ILLINOIS DEPARTMENT OF TRANSPORTATION
 FED. ROAD DIST. NO. ILLINOIS FED. AID PROJECT

FAP RITE.	SECTION	COUNTY	TOTAL SHEETS NO.
599	48MFT-RS	ROCK ISLAND	49
			15

CONTRACT NO. 64E02

TYPICAL SECTION

78TH AVE WEST
 STA. 0+00 - STA. 2+63

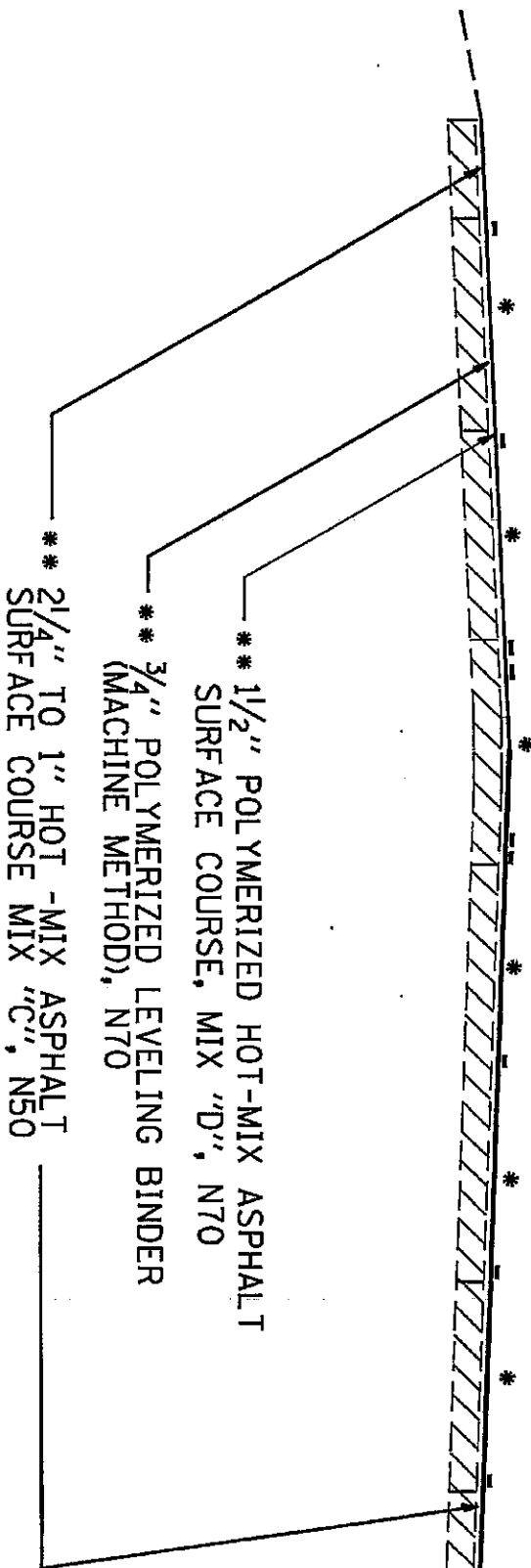
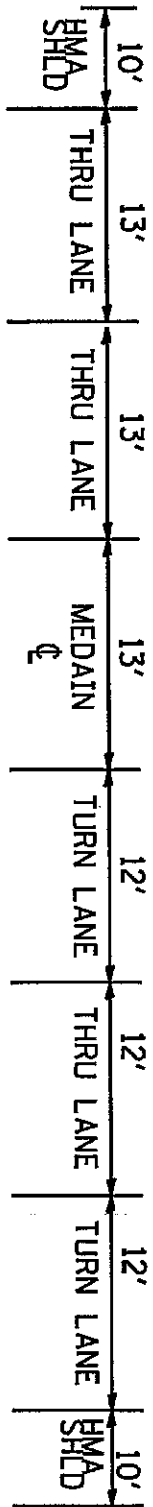

* MAINTAIN EXISTING CROSS SLOPE OR 1/8" MIN.

* 112 LBS/SQ YD/IN

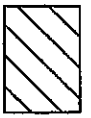

HMA SURFACE REMOVAL (VAR. DEPTH)
 STA 0+00 - STA. 2+38
 EXISTING PCC PAVEMENT
 WITH HMA OVERLAY

FILE NAME =	USER NAME = mag11J	STATE OF ILLINOIS	TOTAL SHEET NO.				
PROJECT: \2014108\2014108.dgn	PILOT DATE = Thu Mar 13 13:42:04 2008	DEPARTMENT OF TRANSPORTATION					
		F.A.P. RITE.	SECTION	COUNTY	ROCK ISLAND	SHEETS	NO.
		599	48FT-RS			49	16
		FED. ROAD DIST. NO.		ILLINOIS FED. AID PROJECT		CONTRACT NO. 64E02	

TYPICAL SECTION
 78TH AVE WEST
 STA. 2+63 - STA. 5+00

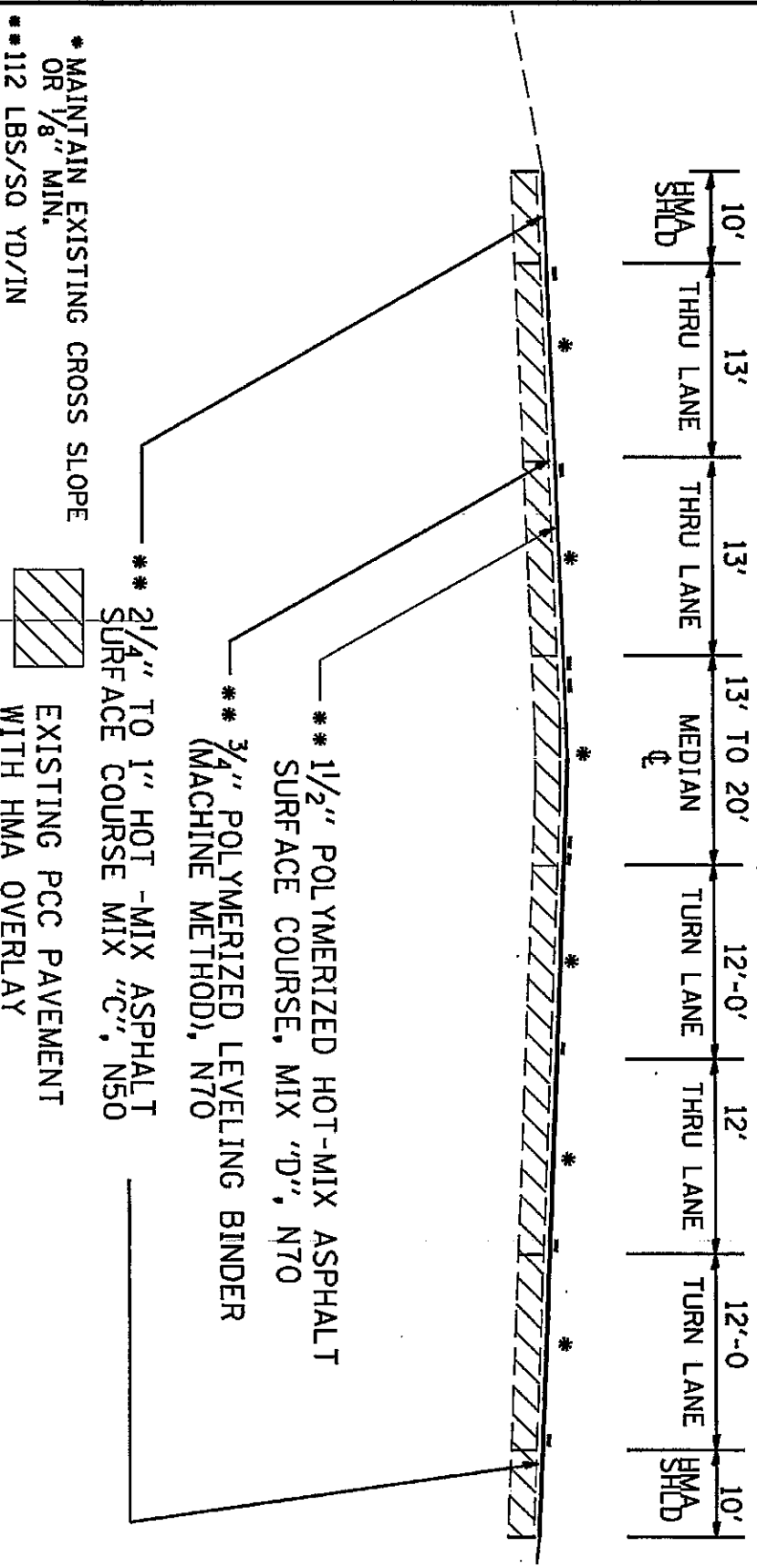

FILE NAME = c:\projects\2004\881\044188\p.dgn	USER NAME = meglju	STATE OF ILLINOIS DEPARTMENT OF TRANSPORTATION	F.A.P. RTE. 599	SECTION 48457-RS	COUNTY ROCK ISLAND	TOTAL SHEET NO. 49
PLOT DATE = Thu Mar 13 13:42:04 2008			FED. ROAD DIST. NO.	ILLINOIS FED. AID PROJECT	CONTRACT NO. 64E02	17

TYPICAL SECTION
 78TH AVE WEST
 STA. 5+00 - STA. 10+00

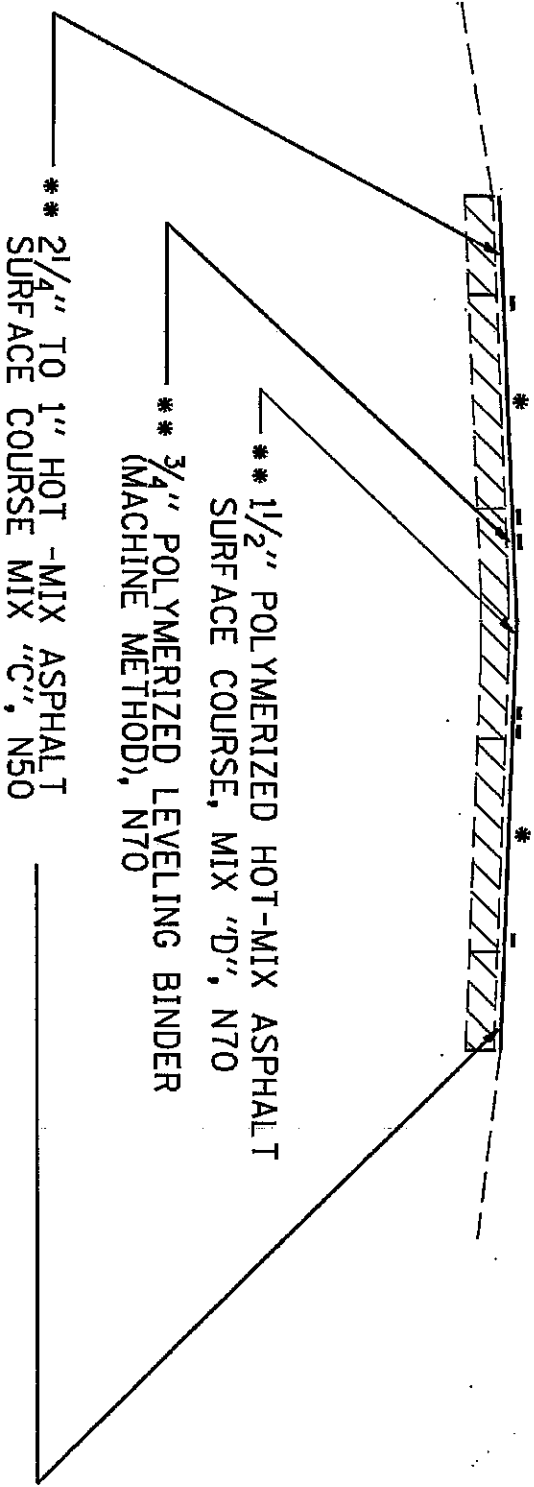
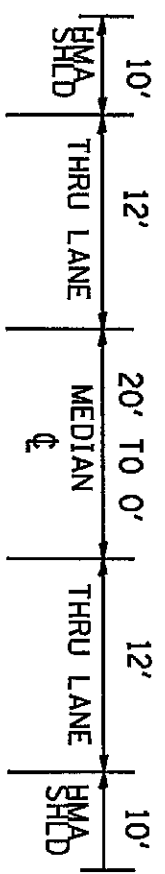

* MAINTAIN EXISTING CROSS SLOPE
 OR 1/8" MIN.
 * 112 LBS/SO YD/IN

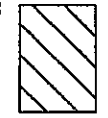

EXISTING PCC PAVEMENT
 WITH HMA OVERLAY

FILE NAME = c:\projects\204488\104488.dgn	USER NAME = meglj	STATE OF ILLINOIS DEPARTMENT OF TRANSPORTATION	F.A.P. RTE. 599	SECTION 484FT-RS	COUNTY ROCK ISLAND	TOTAL SHEETS 49	SHEET NO. 18
PLOT DATE = Thu Mar 13 13:42:55 2008			FED. ROAD DIST. NO.		ILLINOIS FED. AID PROJECT		
			CONTRACT NO.		64E02		

TYPICAL SECTION

78th AVE WEST

STA. 10+00 - STA. 20+50

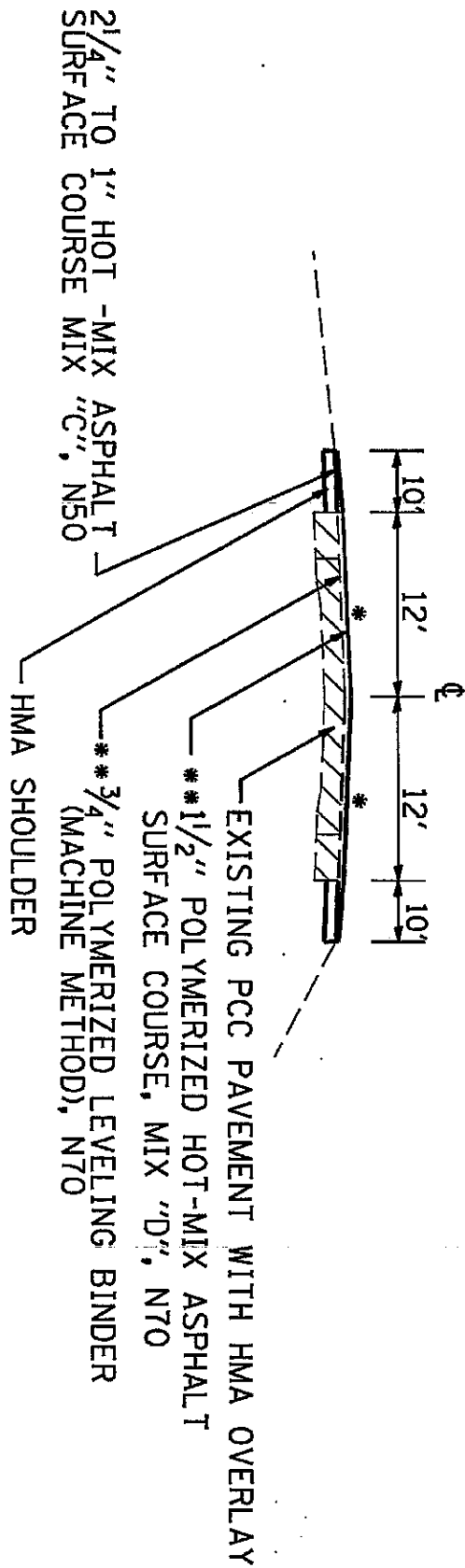

*** SHOULDER CROSS SLOPE NOT TO EXCEED 9%

HMA SURFACE REMOVAL (VAR. DEPTH) STA.19+32.5 - STA. 20+50

MAINTAIN EXISTING CROSS SLOPE OR 1/8" MIN.

112 LBS/SO YD/IN

FILE NAME = c:\projects\204488\04488.dgn	USER NAME = megjlj	STATE OF ILLINOIS DEPARTMENT OF TRANSPORTATION	F.A.P. RTE.	SECTION	COUNTY	TOTAL SHEETS	SHEET NO.
	PLOT DATE = Thu Mar 13 13:42:05 2008		599	484FT-RS	ROCK ISLAND	49	19
			FED. ROAD DIST. NO.	ILLINOIS/FED. AID PROJECT	CONTRACT NO. 64E02		

TYPICAL TAPER

78TH & FRONTAGE RD

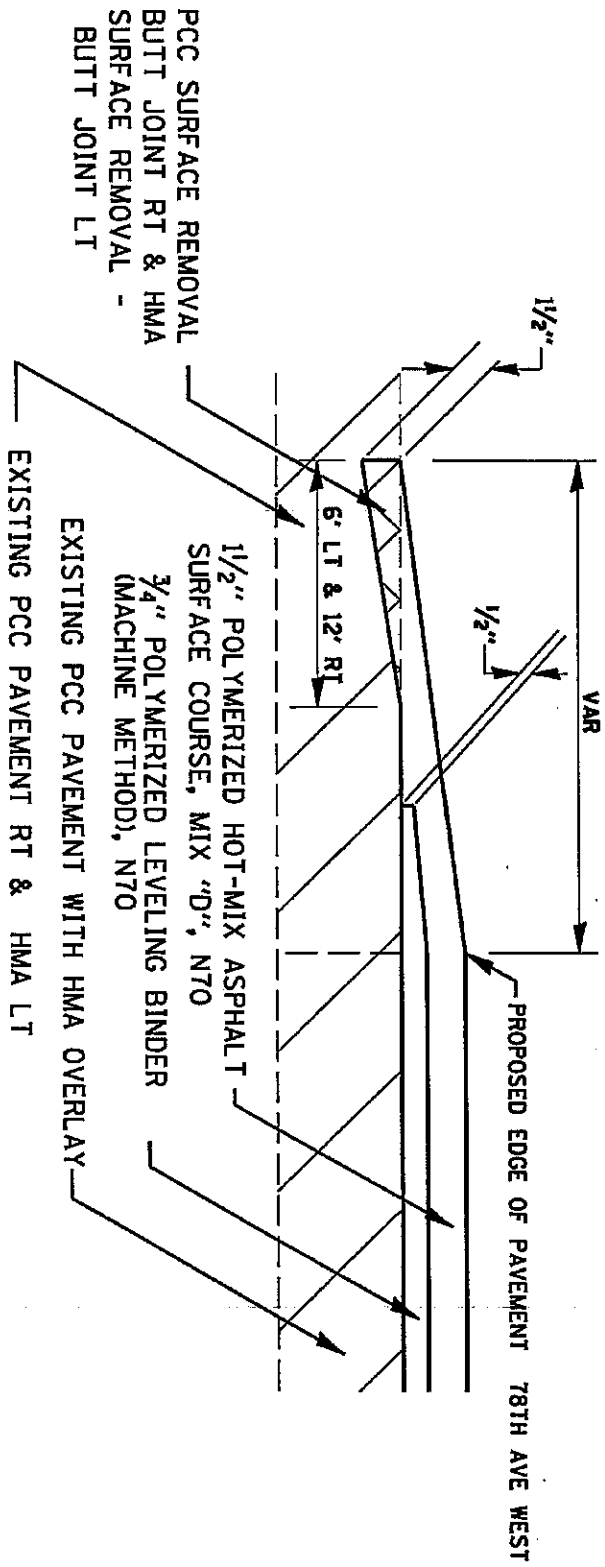

EXISTING

FILE NAME = c:\projects\201408\004108\p.dgn	USER NAME = meg11J	STATE OF ILLINOIS DEPARTMENT OF TRANSPORTATION	
PLOT DATE = Thu Mar 13 13:42:55 2008			
F.A.P. RTE.	SECTION	COUNTY	TOTAL SHEET SHEETS NO.
599	4845T-85	ROCK ISLAND	49 20
FED. ROAD DIST. NO.		ILLINOIS FED. AID PROJECT	
		CONTRACT NO. 64E02	

TYPICAL TAPER

DRIVEWAYS

- 16+13 CE LT HMA
- 18+52 CE RT PCC
- 19+24 CE RT HMA

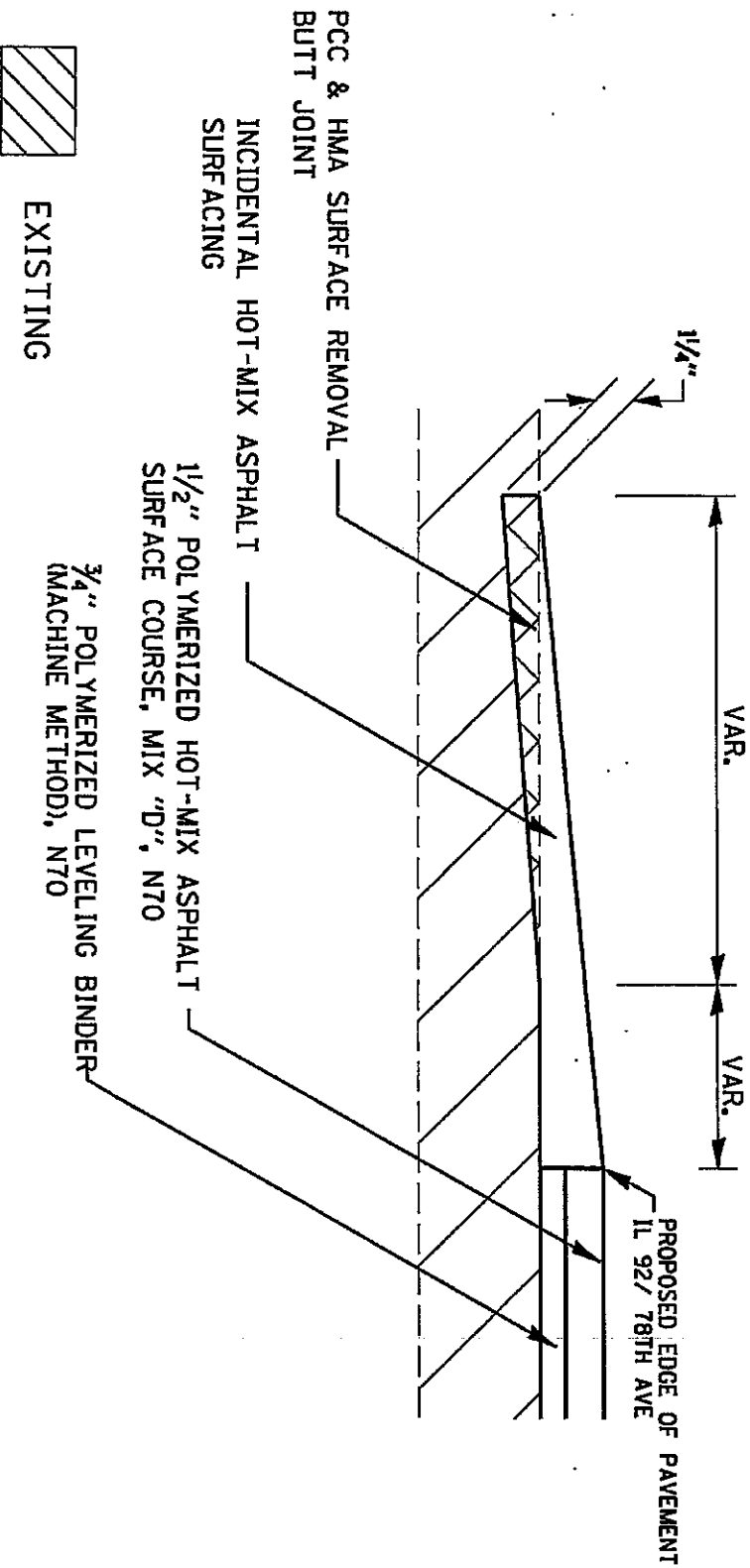

EXISTING

PCC & HMA SURFACE REMOVAL
BUTT JOINT

INCIDENTAL HOT-MIX ASPHALT

1/2" POLYMERIZED HOT-MIX ASPHALT
SURFACE COURSE, MIX "D", N70

3/4" POLYMERIZED LEVELING BINDER
(MACHINE METHOD), N70

PROPOSED EDGE OF PAVEMENT
IL 92 / 78TH AVE

FILE NAME = c:\projects\2284488\dd4488gpaden		USER NAME = megljlj		STATE OF ILLINOIS DEPARTMENT OF TRANSPORTATION		FED. ROAD DIST. NO. ILLINOIS/FED. AID PROJECT	
PLOT DATE = Thu Mar 13 13:42:05 2008						CONTRACT NO. 64E02	
		SECTION		COUNTRY		TOTAL SHEET	
FAP RIE.		48AFT-RS		ROCK ISLAND		SHEETS NO.	
599						49 22	

PATCHING SCHEDULE

FAP 609 (L.92)
SECTION 48A#F-RS
ROCK ISLAND COUNTY
CONTRACT #64E02
SHEET 23 OF 49

Quantities in bold print, are estimated by Designer to need full depth patch.

STATION	REMARKS	LENGTH OF PATCH INSIDE LN (foot) OUTSIDE LN (foot)	POSSIBLE AREAS OF PAVEMENT PATCHING, 9 INCH				HMA REMOVAL OVER PATCHES (4 1/2") (yd ²)	HMA REPLACEMENT OVER PATCHES (4 1/2") (ton)
			TYPE 2 INSIDE LANE (yd ²)	TYPE 3 OUTSIDE LANE (yd ²)	TYPE 4 INSIDE LANE (yd ²)	TYPE 4 OUTSIDE LANE (yd ²)		
1269 + 60	EAST BOUND	16					23.1	5.89
1272 + 85		6	8.7				10.1	2.58
1274 + 10		6	8.7				10.1	2.58
1275 + 30		6	8.7				10.1	2.58
1276 + 87		6	8.7				10.1	2.58
1280 + 82		6	8.7				10.1	2.58
1282 + 50		10	14.4				15.9	4.05
1284 + 88		6	8.7				10.1	2.58
1285 + 5		6	8.7				10.1	2.58
1285 + 74		6	8.7				10.1	2.58
1288 + 45	w/ 15' Pyrrnt Patch	20				21.7	30.3	7.73
1290 + 10		6	8.7				10.1	2.58
1300 + 73		6	8.7				10.1	2.58
1306 + 00		6	8.7				10.1	2.58
1307 + 00		10	14.4				15.9	4.05
1307 + 71		6	8.7				10.1	2.58
1309 + 8		6	8.7				10.1	2.58
1310 + 00		8	11.6				13.0	3.31
1310 + 40		6	8.7			36.1	10.1	2.58
	Sta. 1314+88=0+00							
3 + 00		6	8.7				10.1	2.58
4 + 00		6	8.7				10.1	2.58
5 + 00		6	8.7				10.1	2.58
10 + 28		6	8.7				10.1	2.58
11 + 00		6	8.7				10.1	2.58
11 + 70		6	8.7				10.1	2.58
13 + 90		6	8.7				10.1	2.58
14 + 50		6	8.7				10.1	2.58
16 + 00		6	8.7				10.1	2.58
17 + 48		6	8.7				10.1	2.58
19 + 17		6	8.7				10.1	2.58
	WEST BOUND							
1270 + 70		14				20.2	21.7	5.52
1271 + 49		8	11.6				13.0	3.31
1272 + 3		8	11.6				13.0	3.31
1272 + 58		8	11.6				13.0	3.31
1275 + 86		6	8.7				10.1	2.58
1280 + 20		6	8.7				10.1	2.58
1280 + 82		6	8.7				10.1	2.58
1281 + 16		6	8.7				10.1	2.58
1281 + 49	w/ 20' Pyrrnt Patch (Outside 1/2 Lt)	35				28.9	52.0	13.25
1283 + 89		8	11.6				13.0	3.31
1284 + 50		15				21.7	23.1	5.89
1284 + 88		6	8.7				10.1	2.58
1285 + 5		6	8.7				10.1	2.58
1285 + 74		6	8.7				10.1	2.58

HOT-MIX ASPHALT SCHEDULE

PAP 599 (IL 92)
 SECTION 48M-F-75
 ROCK ISLAND COUNTY
 CONTRACT 04E02
 SHEET 25 OF 49

Location	Remarks	Length	Proposed Surface		Bit Materials Prime Coat (2 Applications) Ton	Agg Prime Coat Ton	Incidental HMA Surfacing Ton	Short Term Part Marking Foot	Work Zone Pavement Marking Removal Sq Ft	HMA Surf Cse Mix "C" N50 Ton	Polymerized HMA Surf Cse Mix "D" N70 Ton	Polymerized Level Binder (MM), N70 Ton
			Width	Sq Yd								
IL 92												
Sia 1264 + 47 - 1265 + 90		143	49	779	0.45	1.2		42.9	4.8		65.4	
Sia 1265 + 90 - 1266 + 38		48	49.37	229	0.13	0.3		14.4	1.6		19.3	43.6
Sia 1266 + 38 - 1269 + 37		299	37	1228	0.70	1.8		89.7	10.0		103.3	12.8
Sia 1269 + 37 - 1273 + 75		438	37.27.5	1557	0.89	2.3		131.4	14.6		130.8	88.8
Sia 1273 + 75 - 1291 + 0		1725	26	4983	2.85	7.5		517.5	57.5		418.6	87.2
Sia 1291 + 0 - 1292 + 50		150	26.27	442	0.25	0.7		45.0	5.0		37.1	279.1
Sia 1292 + 50 - 1294 + 50		200	27	600	0.34	0.9		60.0	6.7		50.4	24.7
Sia 1294 + 50 - 1294 + 75		25	27.28	76	0.04	0.1		7.5	0.8		6.4	33.6
Sia 1294 + 75 - 1297 + 50		275	28.35	978	0.56	1.5		82.5	9.2		82.1	4.3
Sia 1297 + 50 - 1298 + 40		90	35.37	360	0.21	0.5		54.0	6.0		30.2	54.8
Sia 1298 + 40 - 1300 + 16		176	37.38	733	0.42	1.1		105.6	11.7		61.6	20.2
Sia 1300 + 16 - 1305 + 0		484	38	2044	1.17	3.1		290.4	32.3		171.7	41.1
Sia 1305 + 0 - 1307 + 50		250	38.47	1194	0.68	1.8		150.0	16.7		100.3	114.4
Sia 1307 + 50 - 1310 + 0		250	47.58	1472	0.84	2.2		300.0	33.3		123.7	66.9
Sia 1310 + 0 - 1312 + 40		240	58.64	1627	0.93	2.4		288.0	32.0		136.6	82.4
Sia 1312 + 40 - 1313 + 10		70	64	488	0.28	0.7		84.0	9.3		41.8	27.9
Sia 1313 + 10 - 1314 + 10		100	64.74	767	0.44	1.2		120.0	13.3		64.4	42.9
Sia 1314 + 10 - 1314 + 88		78	74	641	0.37	1.0		93.6	10.4		53.9	35.9
1314+88 (IL 92) = 0+00 (78th Ave West)												
78th Ave West												
Sia 0 + 0 - 0 + 75		75	74	617	0.35	0.9		90.0	10.0		51.8	34.5
Sia 0 + 75 - 1 + 65		90	74.76	750	0.43	1.1		108.0	12.0		63.0	42.0
Sia 1 + 65 - 2 + 63		98	76	828	0.47	1.2		117.6	13.1		69.5	46.3
Sia 2 + 63 - 4 + 60		197	76.74	1642	0.94	2.5		236.4	26.3		137.9	91.9
Sia 4 + 60 - 6 + 25		165	74.44	1082	0.62	1.6		198.0	22.0		90.9	60.6
Sia 6 + 25 - 7 + 50		125	44.34	681	0.39	1.0		37.5	4.2		57.2	38.1
Sia 7 + 50 - 9 + 35		185	34.26	617	0.35	0.9		55.5	6.2		51.8	34.5
Sia 9 + 35 - 11 + 58		223	26.24	619	0.35	0.9		267.6	29.7		52.0	34.7
Sia 11 + 58 - 20 + 50		892	24	2319	1.36	3.6		1070.4	118.9		199.8	133.2
PAGE 1 - TOTAL				29423	15.8	44.1	0	4657.5	517.5		2471.5	1647.7

HOT-MIX ASPHALT SCHEDULE

FAP 699 (IL 92)
 SECTION 484F-R3
 ROCK ISLAND COUNTY
 CONTRACT #4E02
 SHEET 28 OF 49

Location	Remarks	Length	Proposed Surface		Bit Materials Prime Coat (2 Applications) Ton	Agg Prime Coat Ton	Incidental HMA Surfacing Ton	Short Term Pavt Marking Foot	Work Zone Pavement Marking Removal Sq Ft	HMA Surf Cse Mix "C", N50 Ton	Polymerized HMA Surf Cse Mix "D", N70 Ton	Polymerized Level Binder (MM), N70 Ton
			Width	Sq Yd								
IL 92 Shoulders												
Sia 1300 + 0 - 1304 + 20	RT (new shldr)	420	10	467	0.27	0.7				45.7		
Sia 1304 + 20 - 1313 + 10	LT & RT	890	20	1978	1.13	3.0				193.8		
Sia 1313 + 10 - 1314 + 0	SW Return	106	10	118	0.07	0.2				11.5		
1314+88 (IL 92) = 0+00 (78th Ave West)												
78th Ave West Shoulders												
Sia 0 + 70 - 1 + 70	NE Return	87	10	97	0.06	0.1				9.5		
Sia 0 + 70 - 1 + 70	SE Return	97	10	108	0.06	0.2				10.6		
Sia 1 + 70 - 19 + 90	LT & RT	1820	20	4044	2.31	6.1				396.4		
Side Roads												
Sia 1299 + 23 (RT) 42nd St	Return	64	Variable	702	0.40	1.1					59.0	78.6
Sia 12 + 49 Front Rd RT	Return	15	Variable	236	0.13	0.4					19.8	19.8
Sia 12 + 49 Front Rd LT	Return	42	Variable	82	0.05	0.1					6.9	6.9
Driveways												
Sia 1271 + 11 FELT		5	27-11	12	0.01	0.0	1.7					
Sia 1282 + 43 PELT w/ MB		20	33-14	48	0.04	0.1	6.7					
Sia 1289 + 77 GE RT		22	55-26	100	0.09	0.2	14.0					
Sia 1291 + 28 FELT		5	28-12	12	0.01	0.0	1.7					
Sia 1292 + 34 PE RT		20	28-10	45	0.04	0.1	6.3					
Sia 1293 + 47 PE RT w/ MB		20	24-10	35	0.03	0.1	4.9					
Sia 1294 + 82 PE RT		20	40-14	76	0.07	0.1	10.6					
Sia 1297 + 6 CE RT		6	57-44	34	0.03	0.1	4.8					
Sia 6 + 40 CE LT		45	57-28	213	0.18	0.3	29.8					
Sia 15 + 37 CE RT		50	117-24	276	0.24	0.4	38.6					
Sia 16 + 13 CE LT		50	74-29	231	0.20	0.3	32.3					
Sia 18 + 52 CE RT		24	84-24	186	0.16	0.3	26.0					
Sia 19 + 24 CE RT		25	85-05	225	0.19	0.3	31.5					
PAGE 2 - TOTAL				9324	5.8	14.0	209.0	0.0	0.0	667.5	85.7	105.3
GRAND TOTAL				38747	22.6	58.1	209.0	4657.5	517.5	667.5	2557.2	1753.0

Schedule of Quantities

FAP 599 (IL 92)
SECTION 48MFT-RS
ROCK ISLAND COUNTY
CONTRACT #64E02
SHEET 27 OF 49

31100700 SUB-BASE GRANULAR MATERIAL, TYPE A 8"

SQ YD		LOCATION
IL 92	Sta	1300 + 00 - 1300 + 75 Rt (along return to 9' width)
102.0		TOTAL

40600982 HOT-MIX ASPHALT SURFACE REMOVAL - BUTT JT

SQ YD		LOCATION
78th Ave West	Sta	12 + 49 FRONTAGE ROAD LT (28'X6')
20.0	Sta	16 + 13 CE Lt (29'X6')
43.0	Sta	19 + 24 CE Rt (65'X6')
82.0		TOTAL

40600985 PORTLAND CEMENT CONCRETE SURFACE REMOVAL - BUTT JOINT

SQ YD		LOCATION
78th Ave West	Sta	12 + 49 FRONTAGE ROAD Rt (125'X12')
167.0	Sta	18 + 52 CE Rt (24'X6')
183.0		TOTAL

40600990 TEMPORARY RAMP

SQ YD		LOCATION
IL 92	Sta	1264 + 47 Header-Beginning of Project
68.1	Sta	1264 + 62 PE Lt (25')
34.7	Sta	1265 + 10 Along 51st St (143')
198.6	Sta	1299 + 23 42nd St (30')
41.7	Sta	1299 + 23 42nd St, Rt Turn Return (25')
34.7	Sta	1299 + 23 42nd St @ RLR Track (73')
48.6	Sta	1313 + 57 NW Return
36.1	Sta	1314 + 31 SW Return (35')
38.9	Sta	1314 + 55 S Bnd Thru Lns @ RLR Track (28')
83.3	Sta	1314 + 64 S Bnd Lt Turn & Thru Lns (60')
55.6	Sta	0 + 30 N Bnd Lns @ RLR Track (40')
38.9	Sta	0 + 36 N Bnd Thru Lns (28')
27.8	Sta	0 + 66 SE Rt Turn Ln Return (20')
38.9	Sta	0 + 78 NE Rt Turn Ln Return (28')
78th Ave West		
61.1	Sta	12 + 49 Frontage Road Rt (110')
15.6	Sta	12 + 49 Frontage Road Lt (28')
16.1	Sta	16 + 13 CE Lt (29')
13.3	Sta	18 + 52 CE Rt (24')
36.1	Sta	19 + 24 CE Rt (65')
13.3	Sta	20 + 50 Header-End of Project (24')
350.0		Misc Temporary Ramps during Paving
1,352.8		To Be Used as Directed by the Engineer
1,352.8		TOTAL

Schedule of Quantities

FAP 599 (IL 92)
SECTION 48MFT-RS
ROCK ISLAND COUNTY
CONTRACT #84E02
SHEET 28 OF 49

44000158 HOT-MIX ASPHALT SURFACE REMOVAL, 2 1/4"

LOCATION SQ YD

IL 92	Station	Description	Quantity
	1264 + 47 - 1267 + 25	49' to 37' Rdway width w/ 6' Rt Shldr	1,423.0
	1313 + 10 - 1314 + 88	64' to 74' Rdway width	3,375.0
	0 + 00 - 1 + 70	74' Rdway width	1,409.0
	20 + 00 - 20 + 50	74' Rdway width w/ 10' Shldr Lt	134.0
IL 92 & Centennial Expressway Intersection			262.0
		NE Return	496.0
		SW Return	503.0
		SE Return	603.0
TOTAL			7,602.0

44000198 HOT-MIX ASPHALT SURFACE REMOVAL, VARIABLE DEPTH

LOCATION SQ YD

IL 92	Station	Description	Quantity
	1267 + 25 - 1267 + 93	37' Rdway width w/ 6' Rt Shldr	326.0
	1312 + 43 - 1313 + 10	64' Rdway width w/ 10' Shldr	635.0
	1 + 70 - 2 + 38	76' Rdway width w/ 10' Shldr	725.0
	19 + 32 - 20 + 00	24' Rdway width w/ 10' Shldr Lt	246.0
	42nd St		702.0
TOTAL			2,634.0

48101200 AGGREGATE SHOULDERS, TYPE B

LOCATION SQ YD

IL 92	Station	Description	Quantity
	1264 + 47 - 1300 + 00	Rt-6' Wedge	607.0
	1267 + 25 - 1304 + 20	Lt-6' Wedge	631.2
	19 + 90 - 20 + 50	LT - 10'	17.1
	19 + 90 - 20 + 50	RT - 10'	17.1
TOTAL			1,272.4

48203021 HOT-MIX ASPHALT SHOULDERS, 6"

LOCATION SQ YD

IL 92	Station	Description	Quantity
	1300 + 00 - 1303 + 80	Rt (8' to 10' Shldr Width)	351.1
	1303 + 80 - 1304 + 20	Rt (8' to 10' Shldr Width)	40.0
TOTAL			391.1

Schedule of Quantities

FAP 599 (I.L. 92)
SECTION 48MFT-RS
ROCK ISLAND COUNTY
CONTRACT #64E02
SHEET 29 OF 49

60255500 MANHOLES TO BE ADJUSTED

EACH LOCATION

IL 92			
Sta	1264 + 89	1	
Rt	1297 + 41	*	
Sta	1306 + 92	*	
Rt	1 + 29	1	
Lt	1 + 62	*	
Lt	6 + 20	1	
Lt			
TOTAL		3	
* To be Adjusted by others			

60255800 MANHOLES TO BE ADJUSTED WITH NEW TYPE 1 FRAME, CLOSED LID

EACH LOCATION

IL 92			
Sta	1266 + 10	1	
Rt	1309 + 13	1	
Lt	1313 + 99	1	
Lt			
TOTAL		3	

63200310 GUARDRAIL REMOVAL

FOOT LOCATION

IL 92			
Sta	1288 + 44 - 1289 + 56	112.5	
TOTAL		112.5	

70106800 CHANGEABLE MESSAGE SIGN

CALMO LOCATION

IL 92			
Entire Project (approximately 2 weeks prior to beginning construction)	4 boards at various locations as Directed by Engineer	3.0	
TOTAL		3.0	

Schedule of Quantities

78000100 THERMOPLASTIC PAVEMENT MARKING - LETTERS AND SYMBOLS

SQ. FT. LOCATION

DESCRIPTION	AMOUNT	TOTAL
IL 92		550.2
Arrows		
Sta 1266 + 25 (LT Turn)	15.6	
Sta 1266 + 68 (LT Turn)	15.6	
Sta 1267 + 10 (LT Turn)	15.6	
Sta 1300 + 00 (LT Turn)	15.6	
Sta 1300 + 50 (LT Turn)	15.6	
Sta 1301 + 00 (LT Turn)	15.6	
Sta 1312 + 72 (2 LT Turns)	31.2	
Sta 1312 + 72 (Thru)	11.5	
Sta 1312 + 72 (RT Turn/Thru)	26.0	
Sta 1313 + 15 (2 LT Turns)	31.2	
Sta 1313 + 15 (Thru)	11.5	
Sta 1313 + 15 (RT Turn/Thru)	26.0	
Sta 1313 + 57 (2 LT Turns)	31.2	
Sta 1313 + 57 (Thru)	11.5	
Sta 1313 + 57 (RT Turn/Thru)	26.0	
78th Ave West		
Sta 1266 + 89 (LT Turn)	15.6	
Sta 1 + 14 (Thru)	11.5	
Sta 1 + 14 (RT Turn)	15.6	
Sta 1 + 14 (RT Turn)	15.6	
Sta 1 + 64 (Thru)	11.5	
Sta 1 + 64 (RT Turn)	15.6	
Sta 1 + 64 (RT Turn)	15.6	
Sta 1 + 97 (LT Turn)	15.6	
Sta 2 + 14 (Thru)	11.5	
Sta 2 + 14 (RT Turn)	15.6	
Sta 2 + 30 (LT Turn)	15.6	
IL 92		
Railroad Crossings		
Sta 1314 + 20 (SW Return)	7.2	
Sta 1314 + 20 Railroad "X" - (SW Return)	54.0	
78th Ave West		
Sta 1 + 39 Railroad "R" (2) - (LT Turn Lane)	7.2	
Sta 1 + 39 Railroad "X" - (LT Turn Lane)	54.0	
TOTAL		550.2

78000200 THERMOPLASTIC PAVEMENT MARKING - LINE 4"

FOOT LOCATION

DESCRIPTION	AMOUNT	TOTAL
IL 92		30,599
Yellow Painted Median Nose		
Sta 1264 + 47 - 1264 + 53	40.00	
Sta 1265 + 84 - 1267 + 72	376	
Sta 1267 + 72	2,600	
Sta 1273 + 72	647	
Sta 1278 + 89	230	
Sta 1278 + 89 - 1288 + 07	230	
Sta 1288 + 07	838	
Sta 1288 + 07 - 1294 + 75	838	
Sta 1294 + 75	1,760	
Sta 1294 + 75 - 1299 + 05	1,760	
Sta 1299 + 05	5,320	
Sta 1299 + 50 - 1312 + 30	110	
Sta 1309 + 60 - 1314 + 00	340	
78th Ave West		
Sta 0 + 64 - 9 + 40	3,504	
Sta 9 + 40 - 10 + 60	50	
Sta 0 + 64 - 2 + 63	240	
Sta 9 + 40 - 10 + 60	240	
Sta 10 + 60 - 16 + 40	730	
Sta 16 + 40 - 20 + 50	100	
IL 92		
Sta 1264 + 47 - 1313 + 75	4,928	
Sta 1265 + 84 - 1314 + 20	4,836	
78th Ave West		
Sta 0 + 75 - 20 + 50	3,950	
TOTAL		30,599

Schedule of Quantities

FAP 599 (IL 92)
SECTION 48M-F-RS
ROCK ISLAND COUNTY
CONTRACT #64E02
SHEET 31 OF 49

78000500 THERMOPLASTIC PAVEMENT MARKING - LINE 8"

FOOT	LOCATION	IL 92
7	Sta 1264 + 47 - 1264 + 53	White Lt Turn Lane Line
109	51st St - SE Island	White Island Perimeter & Dividers
167	Sta 1265 + 84 - 1267 + 51	White Lt Turn Lane Line
200	Sta 1299 + 50 - 1301 + 50	White Lt Turn Lane Line
103	42nd St - SE Island	White Island Perimeter
340	Sta 1312 + 30 - 1314 + 00	White Lt Turn Lane Line (2)
67	IL 92 - NW Island	White Island Perimeter
141	IL 92 - SW Island	White Island Perimeter
87	IL 92 - NE Island	White Island Perimeter
140	IL 92 - SE Island	White Island Perimeter
370	IL 92 - SE Quadrant	White RR X-ing Diagonals
400	Sta 0 + 64 - 2 + 64	White Rt & Lt Turn Lane Lines
2,131	TOTAL	

78000600 THERMOPLASTIC PAVEMENT MARKING - LINE 12"

FOOT	LOCATION	IL 92
40	51st St - SE Island	White Diagonals
168	Sta 1267 + 72 - 1273 + 72	Yellow Diagonals
120	Sta 1294 + 75 - 1299 + 05	Yellow Diagonals
74	42nd St - SE Island	White Diagonals
540	Sta 1299 + 50 - 1312 + 70	Yellow Diagonals
35	IL 92 - NW Island	White Diagonals
60	IL 92 - SW Island	White Diagonals
42	IL 92 - NE Island	White Diagonals
75	IL 92 - SE Island	White Diagonals
350	Sta 0 + 64 - 9 + 40	Yellow Diagonals
1,504	TOTAL	

78000650 THERMOPLASTIC PAVEMENT MARKING - LINE 24"

FOOT	LOCATION	IL 92
24	Sta 1264 + 53	White Stop Bar (EB Rt Turn & Thru Lane)
24	Sta 1265 + 84	White Stop Bar (WB Lt Turn & Thru Lane)
49	Sta 1314 + 00	White Stop Bar (EB Lt Turn & Thru Lanes)
40	IL 92 - SW Return	White Railroad Stop Bars
40	IL 92 NB Thru Lanes	White Stop Bar
20	IL 92 - SE Return	White Stop Bar
25	Sta 0 + 64	White Stop Bar (WB Lt Turn & Thru Lanes)
12	Sta 1 + 14	White Railroad Stop Bar (WB Lt Turn Lane)
12	Sta 1 + 64	White Railroad Stop Bar (WB Lt Turn Lane)
246	TOTAL	

Schedule of Quantities

FAP 599 (IL 92)
SECTION 48MFT-RS
ROCK ISLAND COUNTY
CONTRACT #84E02
SHEET 32 OF 48

78100100 RAISED REFLECTIVE PAVEMENT MARKER

EACH LOCATION

IL 92	Quantity	Description	Quantity	Quantity	Quantity	Quantity	TOTAL
	10	Sta - 1265 + 84 - 1267 + 72	1265 + 84	-	1267 + 51	5	5
	32	Sta 1267 + 72 - 1273 + 72	1267 + 72	-	1273 + 72	32	32
	27	Sta 1273 + 72 - 1294 + 75	1273 + 72	-	1294 + 75	27	27
	22	Sta 1294 + 75 - 1299 + 05	1294 + 75	-	1299 + 05	22	22
	6	Sta 1299 + 50 - 1301 + 50	1299 + 50	-	1301 + 50	6	6
	64	Sta 1299 + 50 - 1310 + 00	1299 + 50	-	1310 + 00	64	64
	7	Sta 1310 + 00 - 1312 + 30	1310 + 00	-	1312 + 30	7	7
	13	Sta 1310 + 00 - 1312 + 30	1310 + 00	-	1312 + 30	13	13
	5	Sta 1312 + 30 - 1314 + 00	1312 + 30	-	1314 + 00	5	5
	10.00	Sta 1312 + 30 - 1314 + 00	1312 + 30	-	1314 + 00	10.00	10.00
	20	Sta 1312 + 30 - 1314 + 00	1312 + 30	-	1314 + 00	20	20
78th Ave West							
	22	Sta 0 + 64 - 2 + 64	0 + 64	-	2 + 64	22	22
	22	Sta 0 + 64 - 2 + 64	0 + 64	-	2 + 64	22	22
	22	Sta 0 + 64 - 2 + 64	0 + 64	-	2 + 64	22	22
	36	Sta 2 + 64 - 9 + 40	2 + 64	-	9 + 40	36	36
	15	Sta 9 + 40 - 20 + 50	9 + 40	-	20 + 50	15	15
	306	Sta 9 + 40 - 20 + 50	9 + 40	-	20 + 50	306	306

78300200 RAISED REFLECTIVE PAVEMENT MARKER REMOVAL

EACH LOCATION

IL 92	Quantity	Description	Quantity	Quantity	Quantity	Quantity	TOTAL
	4	West Leg of Intersection				4	4
	4	Yellow crystal, around nose of painted median				4	4
	1	White crystal, E Bnd 8" white line				1	1
	1	East Leg of Intersection				1	1
	4	White crystal, W Bnd 8" white line				4	4
	6	Yellow crystal, Around Painted Median				6	6
	21	Yellow crystal, Around Painted Median				21	21
	45	Yellow crystal, Around Painted Median to Centennial Expr.				45	45
	45	Yellow crystal, Around Painted Median to Centennial Expr.				45	45
	10	White crystal, E Bnd 2 - 8" white lines				10	10
	6	White crystal, East Bnd along white skip-dashes				6	6
	see above	Yellow crystal, Around Painted Median to 42nd St West				see above	see above
	12	White crystal, West Bnd along 8" white line				12	12
	2	White crystal, East Bnd along white skip-dashes				2	2
	48	Yellow crystal, Around Painted Median				48	48
	13	Yellow crystal, Sta. 9+40 to 20+50, along Ctrline				13	13
	219.0	Yellow crystal, Sta. 9+40 to 20+50, along Ctrline				219.0	219.0

Schedule of Quantities

FAP 599 (IL 92)
 SECTION 48MFT-RS
 ROCK ISLAND COUNTY
 CONTRACT #64502
 SHEET 33 OF 49

88600400 DETECTOR LOOP, SPECIAL

FOOT LOCATION

IL 92

STATION	DESCRIPTION	QUANTITY	UNIT
1264 + 49	(E Bnd Thru Lane)	73.0	Sta
1265 + 35	(51st St Lt Turn Lane)	102.0	Sta
1265 + 65	(W Bnd Rt Turn Lane)	73.0	Sta
1265 + 95	(W Bnd Rt Turn Lane)	73.0	Sta
1265 + 95	(W Bnd Thru Lane)	63.0	Sta
1268 + 22	(W Bnd Thru Lane)	34.0	Sta
1314 + 00	(E Bnd 2 Thru Lanes)	244.0	Sta
1314 + 00	(E Bnd 2 Lt Turn Lanes)	280.0	Sta
1314 + 30	(E Bnd 2 Thru Lanes)	234.0	Sta
1314 + 30	(E Bnd 2 Lt Turn Lanes)	268.0	Sta
0 + 74	(W Bnd Thru Lane)	90.0	Sta
0 + 74	(W Bnd Lt Turn Lane)	104.0	Sta
1 + 10	(W Bnd Thru Lane)	110.0	Sta
1 + 10	(W Bnd Lt Turn Lane)	120.0	Sta
Centennial Expressway (South Leg)			
Lt Turn Lane-N Bnd		96.0	
2 Thru Lanes-N Bnd		182.0	
TOTAL		2,146	

XX005138 CLASS B PATCHES (SPECIAL)

SQ YD LOCATION

DESCRIPTION	QUANTITY	UNIT
42nd St West	70.0	SQ YD
Western half of intersection (18'x35')	45.0	SQ YD
TOTAL	115.0	

Z0028415 GEOTECHNICAL REINFORCEMENT

SQ YD LOCATION

DESCRIPTION	QUANTITY	UNIT
IL 92 - As Directed by the R.E.	22	SQ YD
Full Depth Patches	20	SQ YD
Around 42nd St Return below Sub-base Grnir Mfr	42	SQ YD
TOTAL	42	

Z0028700 GRANULAR SUBGRADE REPLACEMENT

CU YD LOCATION

DESCRIPTION	QUANTITY	UNIT
IL 92	4	CU YD
As Directed by the R.E. (Full Depth Patches)	4	CU YD
TOTAL	4	

PAVEMENT MARKING DETAILS

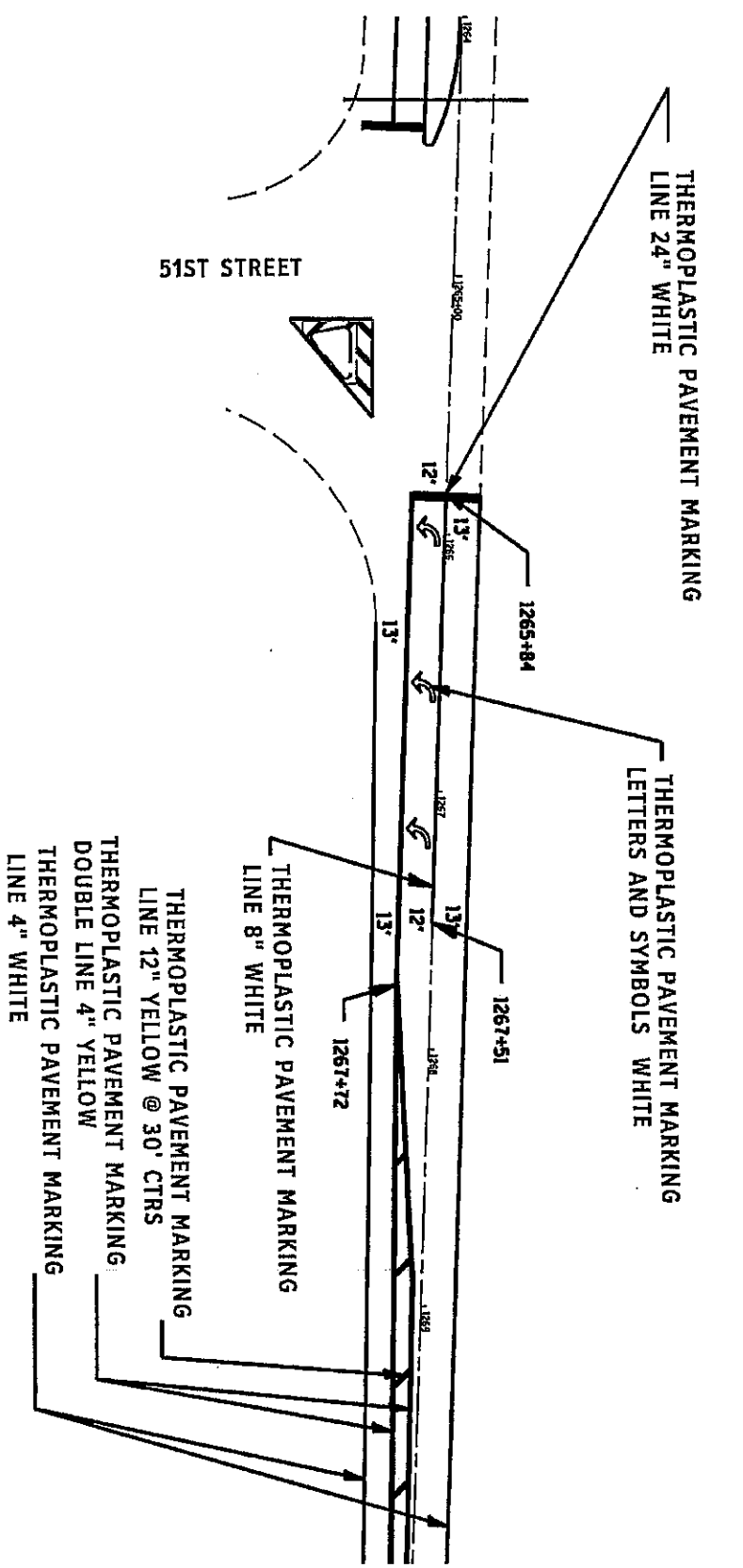

FILE NAME = c:\p\projects\14204408\408\408p\m.dgn	USER NAME = meg11j	PLOT DATE = Thu Mar 13 14:03:15 2008	STATE OF ILLINOIS DEPARTMENT OF TRANSPORTATION
DRAWING NOT TO SCALE		FEDERAL AID PROJECT NO. ILLINOIS	
F.A.P. RTE. 599	SECTION 48AFT-RS	COUNTY ROCK ISLAND	TOTAL SHEETS 49 SHEET NO. 34
FEDERAL ROAD DIST. NO.		ILLINOIS FED. AID PROJECT CONTRACT NO. 64E02	

PAVEMENT MARKING DETAILS

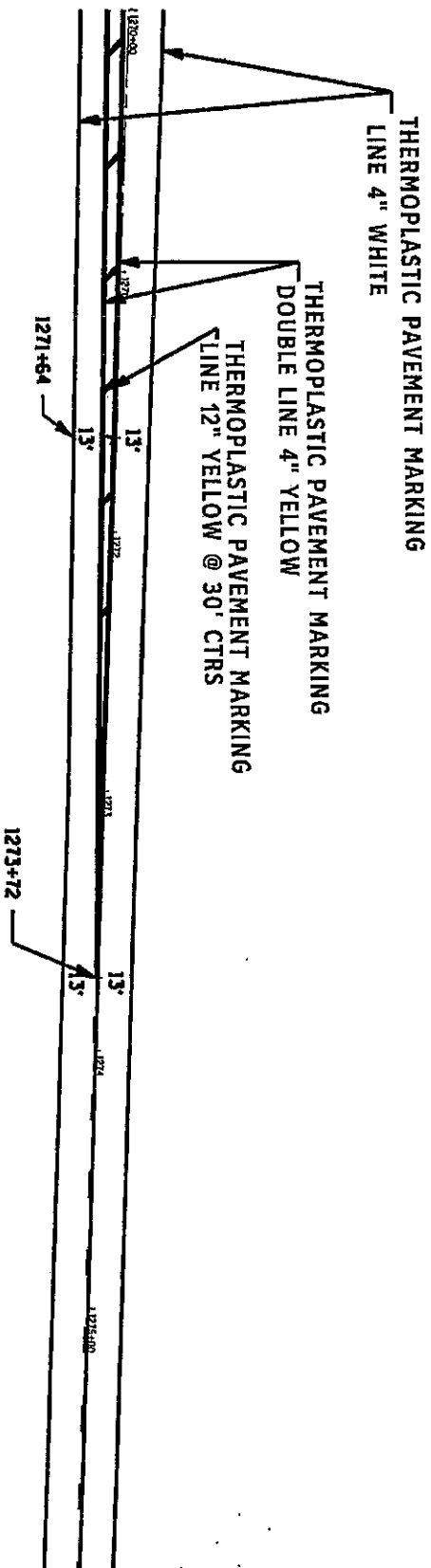

no passing W bound & skip dash E bound 1273+72 to 1278+89
 single skip dash 1278+89 to 1288+07
 no passing E bound & skip dash W bound 1288+07 to 1294+75

DRAWING NOT TO SCALE

FILE NAME = c:\projects\2004-108\1084108p.mxd	USER NAME = meglj	STATE OF ILLINOIS DEPARTMENT OF TRANSPORTATION																
PLOT DATE = Thu Nov 13 14:03:15 2008																		
			<table border="1" style="width: 100%; border-collapse: collapse;"> <tr> <th style="text-align: left;">F.A.P. RTE.</th> <th style="text-align: left;">SECTION</th> <th style="text-align: left;">COUNTY</th> <th style="text-align: left;">TOTAL SHEETS</th> <th style="text-align: left;">SHEET NO.</th> </tr> <tr> <td>599</td> <td>40MT-RS</td> <td>ROCK ISLAND</td> <td>49</td> <td>35</td> </tr> <tr> <td colspan="3">FED. ROAD DIST. NO. ILLINOIS/FED. AID PROJECT</td> <td colspan="2">CONTRACT NO. 64E02</td> </tr> </table>	F.A.P. RTE.	SECTION	COUNTY	TOTAL SHEETS	SHEET NO.	599	40MT-RS	ROCK ISLAND	49	35	FED. ROAD DIST. NO. ILLINOIS/FED. AID PROJECT			CONTRACT NO. 64E02	
F.A.P. RTE.	SECTION	COUNTY	TOTAL SHEETS	SHEET NO.														
599	40MT-RS	ROCK ISLAND	49	35														
FED. ROAD DIST. NO. ILLINOIS/FED. AID PROJECT			CONTRACT NO. 64E02															

PAVEMENT MARKING DETAILS

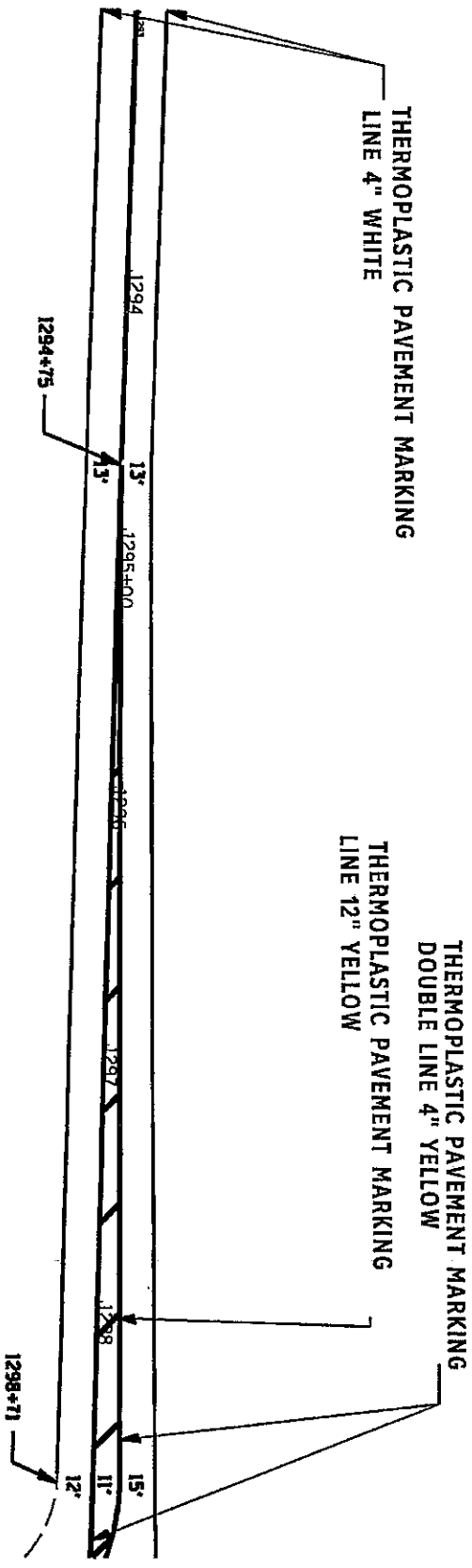

no passing W bound & skip dash E bound 1273+72 to 1278+89
 single skip dash 1278+89 to 1288+07
 no passing E bound & skip dash W bound 1288+07 to 1294+75

DRAWING NOT TO SCALE

FILE NAME = c:\projects\284+08\48+08pandgn	USER NAME = megl11	STATE OF ILLINOIS DEPARTMENT OF TRANSPORTATION	F.A.P. RTE. 599	SECTION 48MT-RS	COUNTY ROCK ISLAND	TOTAL SHEET NO. 49	SHEET NO. 35
PLOT DATE = Thu Mar 13 14:53:16 2008			FED. ROAD DIST. NO.		ILLINOIS FED. AID PROJECT		

PAVEMENT MARKING DETAILS

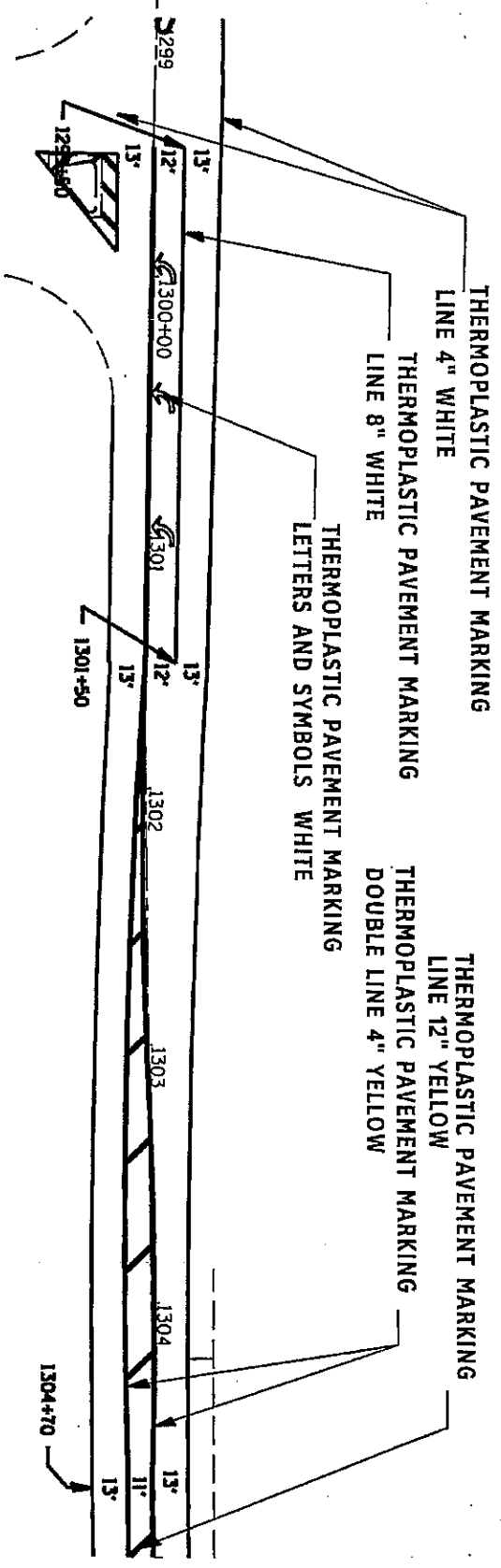

DRAWING NOT TO SCALE

FILE NAME = c:\projects\204408\04408pandgn	USER NAME = meglj	PLOT DATE = Thu Mar 13 14:30:16 2008	STATE OF ILLINOIS DEPARTMENT OF TRANSPORTATION												
<table border="1" style="width: 100%; border-collapse: collapse;"> <thead> <tr> <th style="text-align: left;">F.A.P. RTE.</th> <th style="text-align: left;">SECTION</th> <th style="text-align: left;">COUNTY</th> <th style="text-align: left;">TOTAL SHEETS</th> </tr> </thead> <tbody> <tr> <td>599</td> <td>484FT-RS</td> <td>ROCK ISLAND</td> <td>49</td> </tr> <tr> <td colspan="3"></td> <td style="text-align: right;">37</td> </tr> </tbody> </table>		F.A.P. RTE.	SECTION	COUNTY	TOTAL SHEETS	599	484FT-RS	ROCK ISLAND	49				37	CONTRACT NO. 54E02 FED. ROAD DIST. NO. ILLINOIS FED. AID PROJECT	
F.A.P. RTE.	SECTION	COUNTY	TOTAL SHEETS												
599	484FT-RS	ROCK ISLAND	49												
			37												

PAVEMENT MARKING DETAILS

THERMOPLASTIC PAVEMENT MARKING
LINE 4" WHITE

THERMOPLASTIC PAVEMENT MARKING
DOUBLE LINE 4" YELLOW

THERMOPLASTIC PAVEMENT MARKING
LINE 12" WHITE @ 30' CTRS

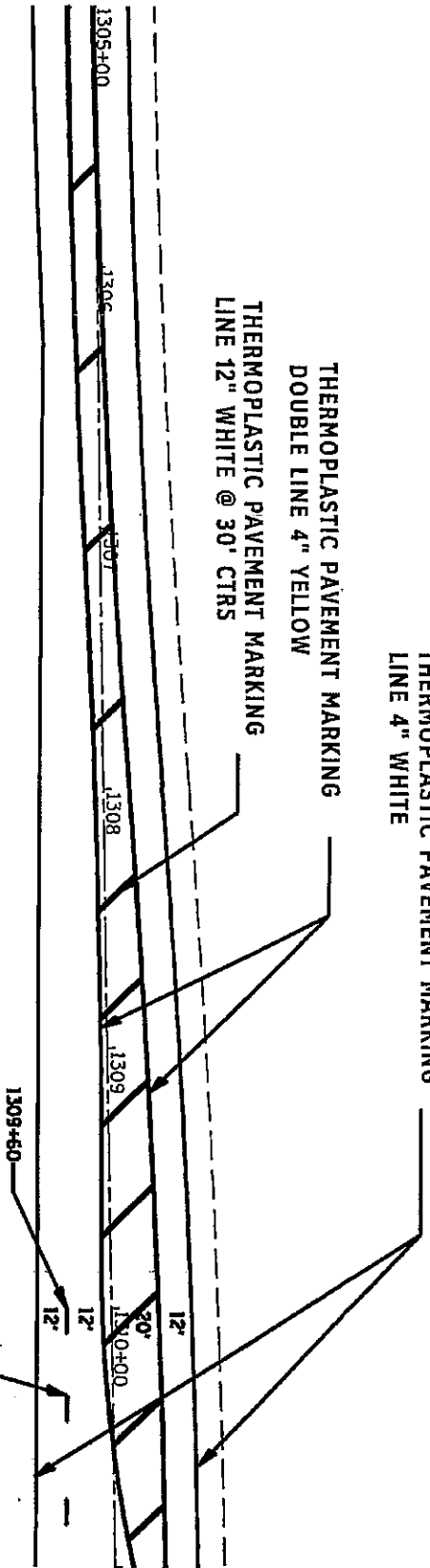

THERMOPLASTIC PAVEMENT MARKING
LINE 4" WHITE SKIP DASH

DRAWING NOT TO SCALE

FILE NAME = c:\p\projects\284488\04180pandgn		USER NAME = meglj		PLOT DATE = Thu Mar 13 14:03:16 2008	
STATE OF ILLINOIS DEPARTMENT OF TRANSPORTATION					
F.A.P. RTE.	SECTION	COUNTY	TOTAL SHEETS	SHEET NO.	
599	48FT-RS	ROCK ISLAND	49	38	
FED. ROAD DIST. NO.		ILLINOIS FED. AID PROJECT			
		CONTRACT NO. 6A602			

PAVEMENT MARKING DETAILS

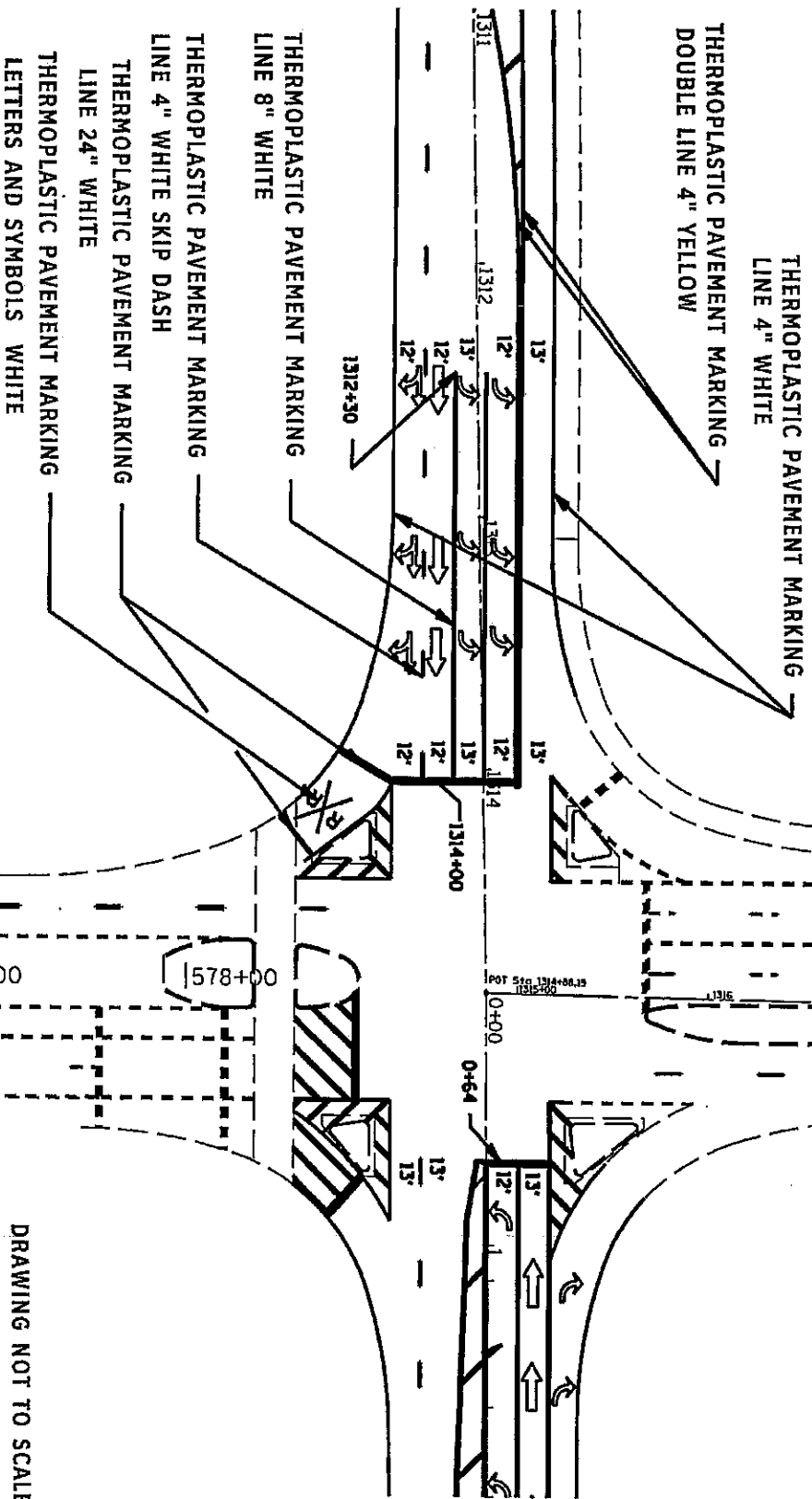

- THERMOPLASTIC PAVEMENT MARKING
LINE 4" WHITE
- THERMOPLASTIC PAVEMENT MARKING
DOUBLE LINE 4" YELLOW
- THERMOPLASTIC PAVEMENT MARKING
LINE 4" WHITE
- THERMOPLASTIC PAVEMENT MARKING
LINE 8" WHITE
- THERMOPLASTIC PAVEMENT MARKING
LINE 4" WHITE SKIP DASH
- THERMOPLASTIC PAVEMENT MARKING
LINE 24" WHITE
- THERMOPLASTIC PAVEMENT MARKING
LETTERS AND SYMBOLS WHITE

DRAWING NOT TO SCALE

FILE NAME = c:\projects\4204468\404486.pwdgn	USER NAME = megluj	PLOT DATE = Thu, Mar 13 14:03:17 2008	STATE OF ILLINOIS DEPARTMENT OF TRANSPORTATION
F.A.P. RITE 595		SECTION 48AFT-RS	COUNTY ROCK ISLAND
FEDERAL ROAD DIST. NO. ILLINOIS FED. AID PROJECT		TOTAL SHEETS 49	SHEET NO. 39

PAVEMENT MARKING DETAILS

median ends at 9+40
 no passing both lanes to 10+60
 no passing w bound & skip dash E bound lanes to 16+40
 single skip dash to 20+50

THERMOPLASTIC PAVEMENT MARKING
 LINE 4" WHITE

THERMOPLASTIC PAVEMENT MARKING
 LINE 24" WHITE

THERMOPLASTIC PAVEMENT MARKING
 LINE 8" WHITE

THERMOPLASTIC PAVEMENT MARKING
 LINE 12" YELLOW @ 30' CTRS

THERMOPLASTIC PAVEMENT MARKING
 DOUBLE LINE 4" YELLOW

THERMOPLASTIC PAVEMENT MARKING
 LETTERS AND SYMBOLS WHITE

THERMOPLASTIC PAVEMENT MARKING
 LINE 8" WHITE

DRAWING NOT TO SCALE

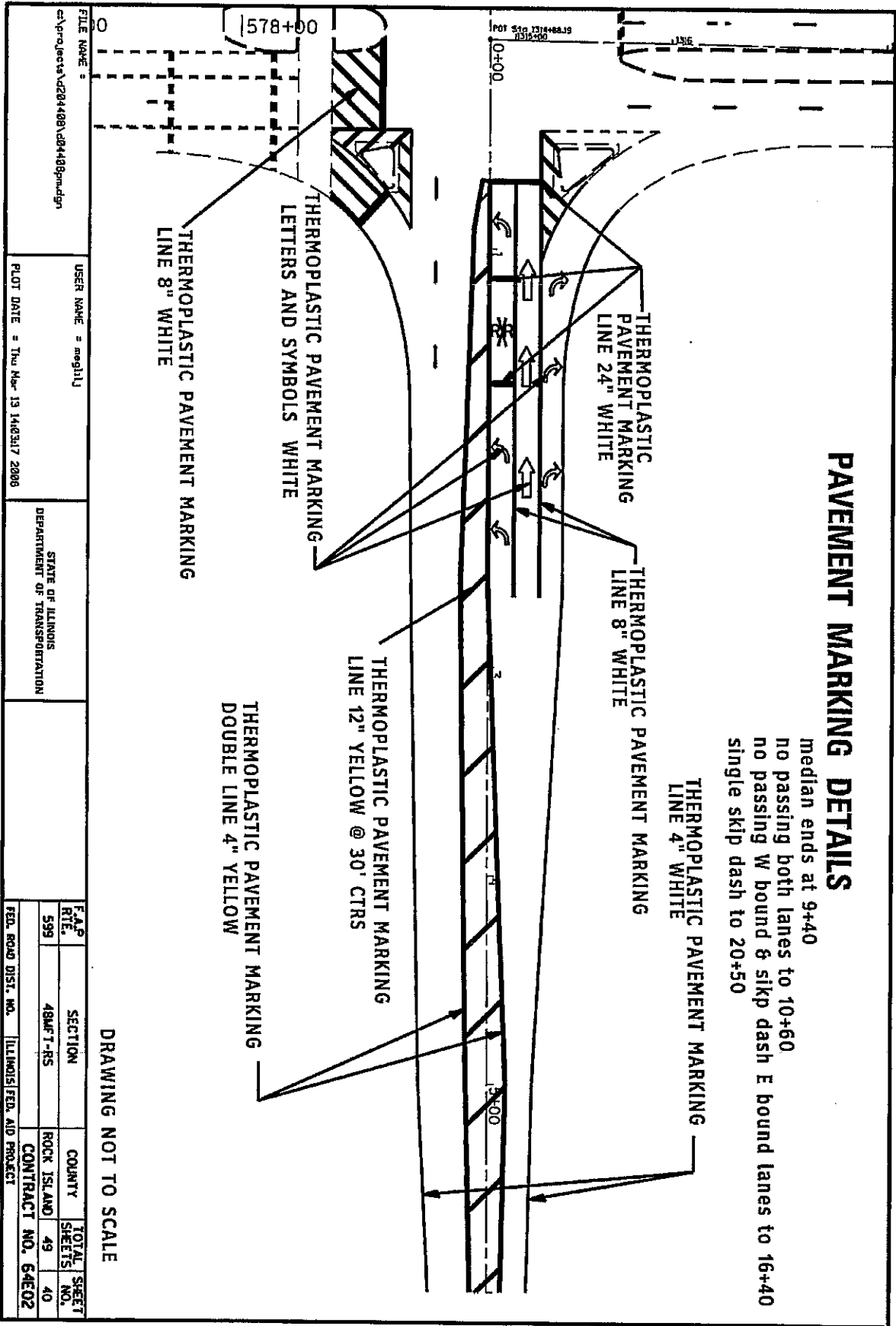

FILE NAME = c:\projects\2014\08\108\1081448p.mxd
 USER NAME = meghlj
 PLOT DATE = Thu Mar 13 14:03:17 2008

STATE OF ILLINOIS
 DEPARTMENT OF TRANSPORTATION

F&P RITE	SECTION	COUNTY	TOTAL SHEETS	SHEET NO.
599	48MFT-RS	ROCK ISLAND	49	40

FED. ROAD DIST. NO. ILLINOIS/FED. AID PROJECT

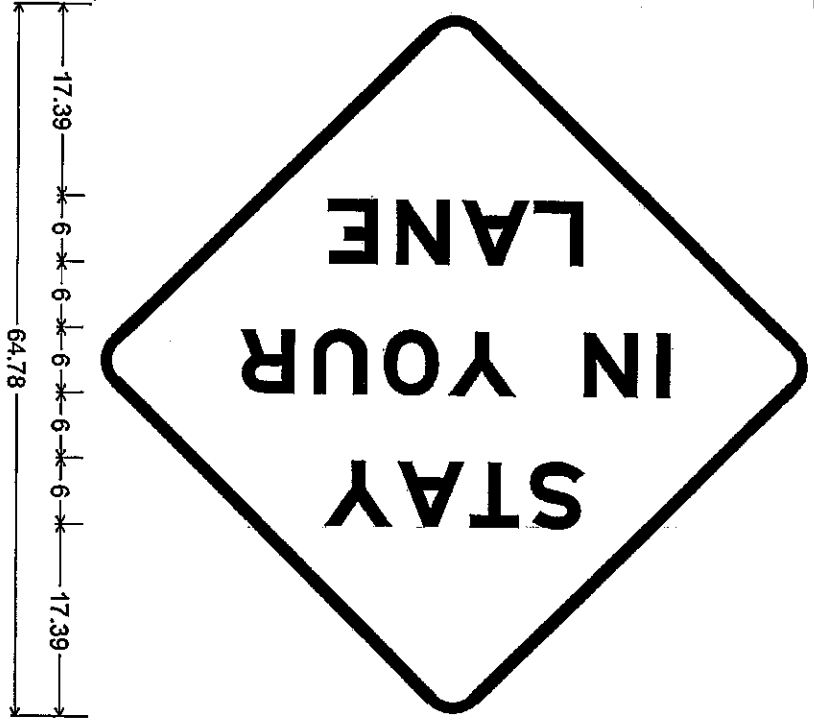

48.00" across sides 3.75" Radius, 1.00" Border, 0.63" Indent, Black on Orange;
 [STAY] E Mod 2K; [IN YOUR] E Mod 2K;
 [LANE] E Mod 2K;

Table of letter and object lefts.

S	20.75	T	26.51	A	31.43	Y	37.97
I	13.13	N	16.01	Y	26.87	O	33.77
L	20.93	A	25.73	N	32.87	E	39.41
						U	40.25
						R	46.79

FILE NAME = c:\projects\204408\04408ep1.dgn	USER NAME = meghj1	STATE OF ILLINOIS DEPARTMENT OF TRANSPORTATION	F.A.P. RTE.	SECTION	COUNTY	TOTAL SHEETS	SHEET NO.
	PLOT DATE = Thu Mar 13 14:04:26 2008		599	48MFT-RS	ROCK ISLAND	49	41
						CONTRACT NO. 64E02	
						ILLINOIS FED. AID PROJECT	

PAVEMENT PATCHING FOR HOT-MIX ASPHALT SURFACED PAVEMENT

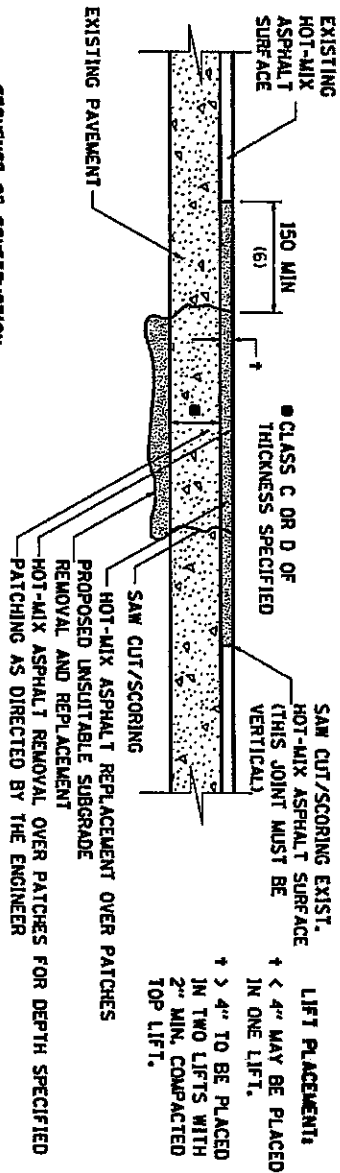

SEQUENCE OF CONSTRUCTION:

1. REMOVE THE EXISTING HOT-MIX ASPHALT SURFACE.
2. RESIDENT ENGINEER WILL DETERMINE IF LOCATION IS TO BE PATCHED OR TO ONLY REPLACE HOT-MIX ASPHALT SURFACE.
3. REMOVE AND REPLACE FULL DEPTH PATCHES AT LOCATIONS DIRECTED BY THE ENGINEER.
4. REPLACE HOT-MIX ASPHALT SURFACE OVER FULL DEPTH PATCHES AND AT LOCATIONS OF HOT-MIX ASPHALT SURFACE REMOVAL.

REVISED - 11-01-03

GENERAL NOTES:

1. THE WIDTH OF THE FULL DEPTH PATCH OVER A TRENCH SHALL BE 300 (12) WIDER ON EACH SIDE OF THE TRENCH.
 2. FOR BASIS OF PAYMENT; SEE THE RECURRING SPECIAL PROVISION "PATCHING WITH HOT-MIX ASPHALT OVERLAY REMOVAL".
- ALL DIMENSIONS ARE IN MILLIMETERS (INCHES) UNLESS OTHERWISE NOTED.

PAVEMENT PATCHING FOR HOT-MIX ASPHALT SURFACED PAVEMENT 32.4

FILE NAME = c:\projects\6294188\604188\p-dgn		USER NAME = megluj		PLOT DATE = Thu Mar 13 13:42:05 2008	
STATE OF ILLINOIS DEPARTMENT OF TRANSPORTATION					
F.A.P. RTE.	SECTION	COUNTY	TOTAL SHEETS	SHEET NO.	
599	484 FT-RS	ROCK ISLAND	49	42	
FED. ROAD DIST. NO. ILLINOIS FED. AID PROJECT			CONTRACT NO. 64E02		

HOT-MIX ASPHALT APPROACHES & MAILBOX RETURNS FOR TWO LIFT (3P) RESURFACING PROJECTS 47.2

BIT PRIME COAT T/M	0.06	0.08
INC HMA SURF 2" T/M	2.3	2.8
AGG BASE CSE T-B T/M	24.9	31.1
S	8	8

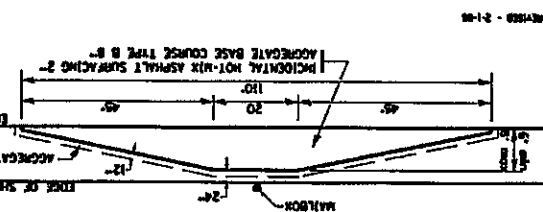

EXISTING AGG. MAILBOX TURNOUTS
Existing Agg. Mailbox Turnouts shall be constructed as shown below.

EXISTING AGG. SIDEROADS
Pavement 2" incidental Hot-Mix Asphalt Surfacing #4080050 on existing entrance to conform to the present configuration.
EXISTING AGG. P.E.S. & C.E.S.
Pavement 2" incidental Hot-Mix Asphalt Surfacing #4080050 on entrance to conform to the existing configuration.

NOTE: EXISTING HMA P.E.S., C.E.S., S.R.S. & MB TURNOUTS Place 2 1/4" incidental Hot-Mix Asphalt Surfacing #4080050 on entrance to conform to the existing configuration.

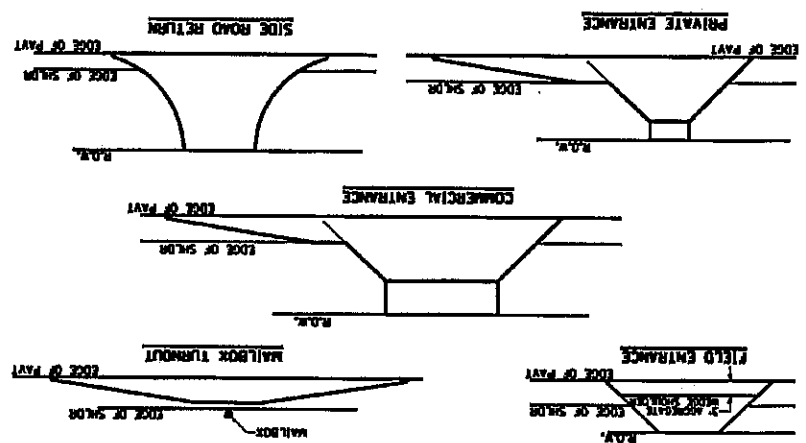

HOT-MIX ASPHALT APPROACHES & MAILBOX RETURNS FOR TWO LIFT (3P) RESURFACING PROJECTS

FILE NAME = c:\projects\261408\64408\up.dgn	USER NAME = meglj	STATE OF ILLINOIS DEPARTMENT OF TRANSPORTATION	F.A.P. RATE 599	SECTION 48MFT-RS	COUNTY ROCK ISLAND	TOTAL SHEETS	49
						SHEET NO.	44
PLOT DATE = Thu Mar 13 13:42:06 2008			FED. ROAD DIST. NO.		ILLINOIS	FED. AID PROJECT	
					CONTRACT NO. 64E02		

TRAFFIC CONTROL AND PROTECTION AT TURN BAYS (TO REMAIN OPEN TO TRAFFIC) 94.2

GENERAL NOTES

1. ALL DIMENSIONS ARE IN FEET AND INCHES (CHECK) UNLESS OTHERWISE NOTED.

2. ALL DIMENSIONS ARE TO FACE UNLESS OTHERWISE NOTED.

3. ALL DIMENSIONS ARE TO FACE UNLESS OTHERWISE NOTED.

4. ALL DIMENSIONS ARE TO FACE UNLESS OTHERWISE NOTED.

5. ALL DIMENSIONS ARE TO FACE UNLESS OTHERWISE NOTED.

6. ALL DIMENSIONS ARE TO FACE UNLESS OTHERWISE NOTED.

7. ALL DIMENSIONS ARE TO FACE UNLESS OTHERWISE NOTED.

8. ALL DIMENSIONS ARE TO FACE UNLESS OTHERWISE NOTED.

9. ALL DIMENSIONS ARE TO FACE UNLESS OTHERWISE NOTED.

10. ALL DIMENSIONS ARE TO FACE UNLESS OTHERWISE NOTED.

LEGEND

NON AREA

LANE OPEN TO TRAFFIC

TYPE I OR II BARRICADE ON DRIVE WITH FLASHING BURNING LIGHT

TYPE I OR II BARRICADE WITH STICKY BUM LIGHT

SHOW SEE DETAIL

TYPE I OR II CHECK BARRICADE WITH STICKY BUM LIGHT

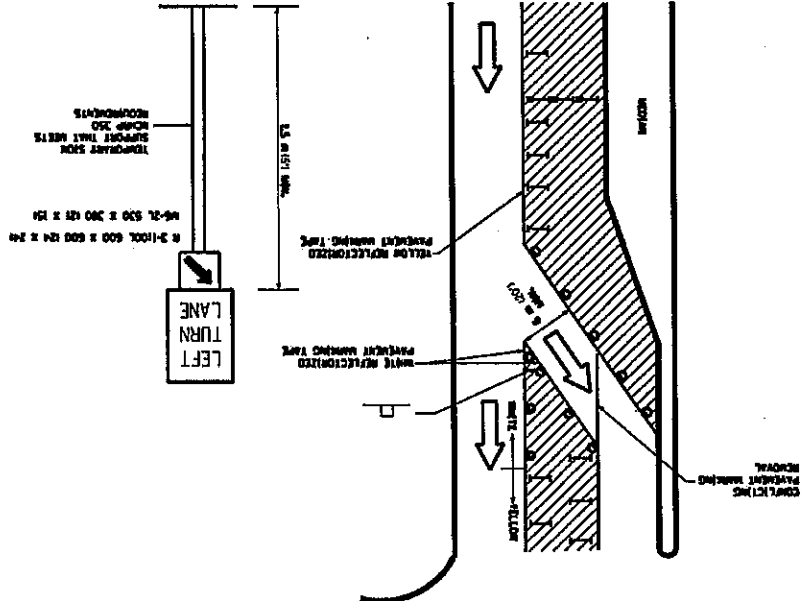

TRAFFIC CONTROL AND PROTECTION AT TURN BAYS (TO REMAIN OPEN TO TRAFFIC)

FILE NAME = c:\projects\j204488\d84488.dgn	USER NAME = meph1j	STATE OF ILLINOIS DEPARTMENT OF TRANSPORTATION	F.A.P. RTE. 599	SECTION 48AFT-RS	COUNTY ROCK ISLAND	TOTAL SHEETS 49	SHEET NO. 46
PLOT DATE = Thu Mar 13 13:42:07 2008		FED. ROAD DIST. NO.		ILLINOIS FED. AID PROJECT		CONTRACT NO. 64E02	

TRAFFIC CONTROL FOR ROAD CLOSURE

CONDITION II

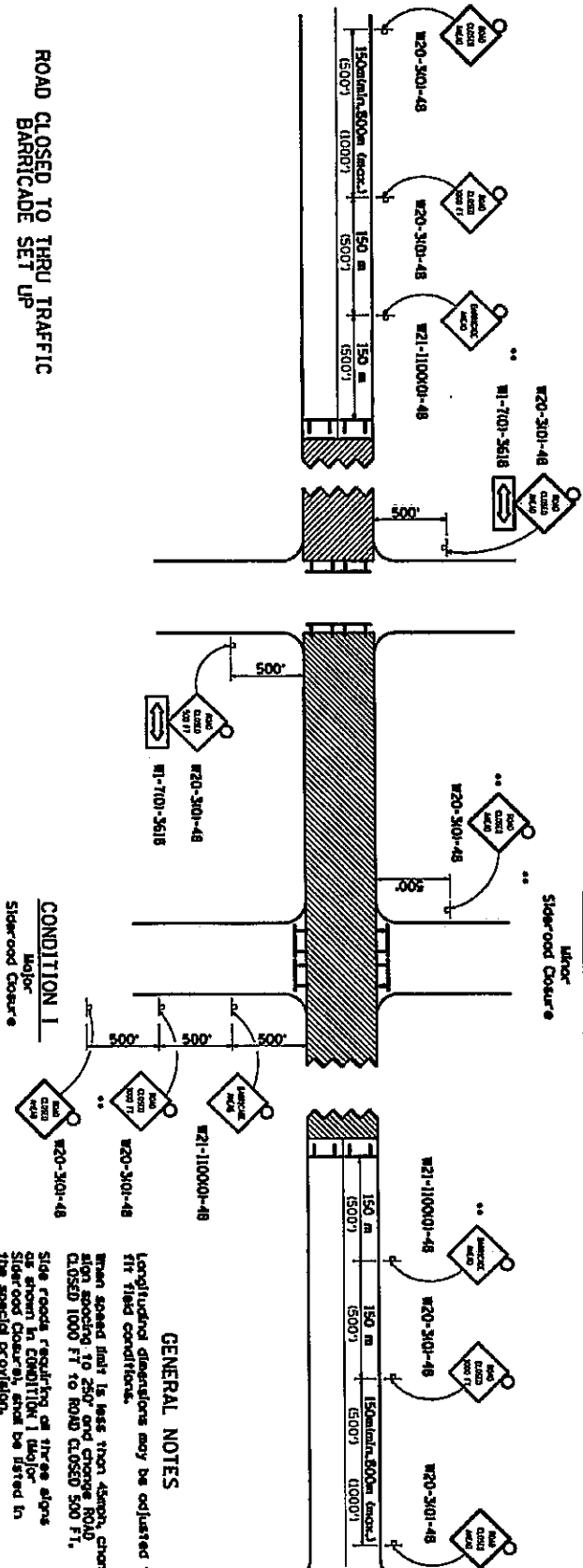

GENERAL NOTES

Longitudinal dimensions may be adjusted to fit field conditions.
 When speed limit is less than 45mph, change sign spacing to 200' and closure road closed 1000 ft to road closed 500 ft.
 Side roads requiring a three phase sign spacing in Condition I Major Side Road Closure, and be listed in the special provision.

** There local access is to be maintained, barricades are to be set up as shown in Road Closed to thru traffic. Type III Barricades and R11-2-4830 signs should be as shown in "Road Closed to thru traffic" detail on Highway Standard 70150L.

All dimensions are in millimeters (inches) unless otherwise shown.

TYPICAL APPLICATION FOR ROAD CLOSURE

ROAD CLOSED TO THRU TRAFFIC
BARRICADE SET UP

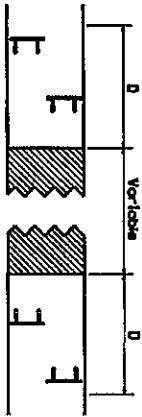

Type III Barricades and R11-2-4830 signs should be as shown in "Road Closed to thru traffic" detail on Highway Standard 70150L. In the distance of 150m (500ft) on each side of barricades and R11-2-4830 signs be placed at each end of the work area.

SYMBOLS

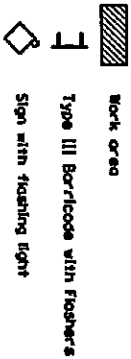

FILE NAME =		USER NAME = megalij	
PROJECT = 20411081-0041081pjdjgn		PLOT DATE = Thu Mar 13 13:42:08 2008	
STATE OF ILLINOIS DEPARTMENT OF TRANSPORTATION			
F.A.P. RITE.	SECTION	COUNTY	TOTAL SHEET
559	48A/7-RS	ROCK ISLAND	49 47
FED. ROAD DIST. NO.		ILLINOIS/FED. AID PROJECT	CONTRACT NO. 64E02
TRAFFIC CONTROL FOR ROAD CLOSURE		40/1	

TYPICAL PAVEMENT MARKINGS

TYPICAL PAVEMENT MARKING FOR FLUSH MEDIAN AT LEFT TURN LANE

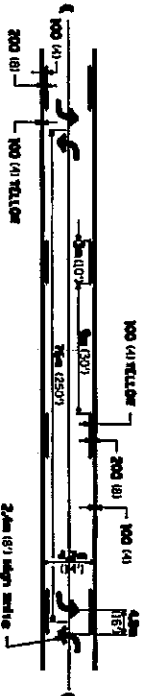
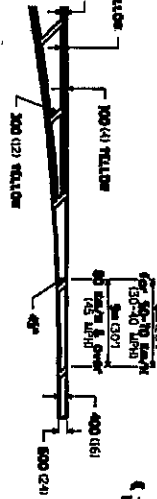
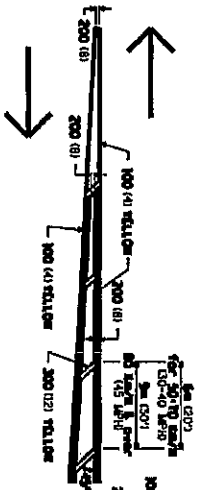

MEDIAN PAVEMENT MARKING

TYPICAL PARKING SPACING

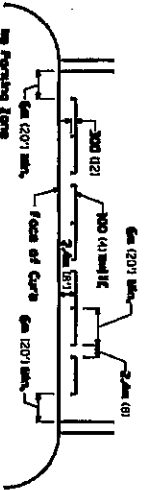
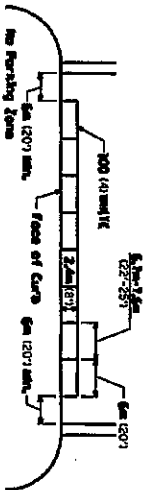

** ALL DIMENSIONS ARE IN MILLIMETERS (INCHES) UNLESS OTHERWISE NOTED.

STANDARD CROSSWALK MARKING

See Schedules for Locations

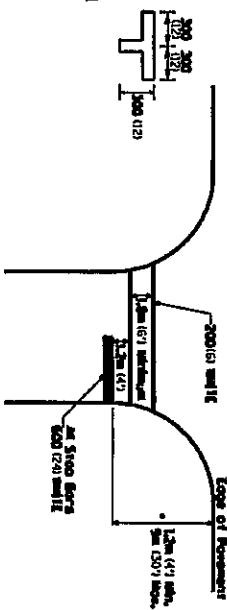

* Distances to the nearest edge of the intersecting roadway in the absence of a marked crosswalk.

TYPICAL ISLAND OFFSET SHOULDER WIDTH

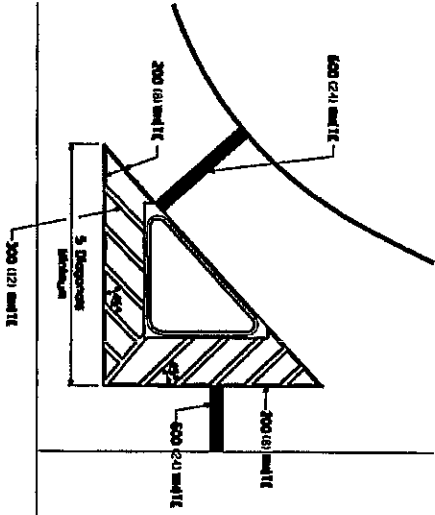

FILE NAME = c:\projects\2004\08\04\08\sup\edgn

USER NAME = megl11j

PLGT DATE = Thu Mar 13 13:42:08 2006

STATE OF ILLINOIS
DEPARTMENT OF TRANSPORTATION

F.A.P. RITE.	SECTION	COUNTY	TOTAL SHEET NO.
599	48AFT-RS	ROCK ISLAND	49 / 48

FED. ROAD DIST. NO. ILLINOIS/FED. AID PROJECT

TYPICAL PAVEMENT MARKINGS SHEET 1 OF 2 41.1

**REQUIRED CONTRACT PROVISIONS
FEDERAL-AID CONSTRUCTION CONTRACTS**

	Page
I. General	1
II. Nondiscrimination	1
III. Nonsegregated Facilities	3
IV. Payment of Predetermined Minimum Wage.....	3
V. Statements and Payrolls	6
VI. Record of Materials, Supplies, and Labor.....	7
VIII. Safety: Accident Prevention	7
IX. False Statements Concerning Highway Projects.....	7
X. Implementation of Clean Air Act and Federal Water Pollution Control Act	8
XI. Certification Regarding Debarment, Suspension, Ineligibility, and Voluntary Exclusion	8
XII. Certification Regarding Use of Contract Funds for Lobbying	9

ATTACHMENTS

- A. Employment Preference for Appalachian Contracts
(included in Appalachian contracts only)

I. GENERAL

1. These contract provisions shall apply to all work performed on the contract by the contractor's own organization and with the assistance of workers under the contractor's immediate superintendence and to all work performed on the contract by piecework, station work, or by subcontract.

2. Except as otherwise provided for in each section, the contractor shall insert in each subcontract all of the stipulations contained in these Required Contract Provisions, and further require their inclusion in any lower tier subcontract or purchase order that may in turn be made. The Required Contract Provisions shall not be incorporated by reference in any case. The prime contractor shall be responsible for compliance by any subcontractor or lower tier subcontractor with these Required Contract Provisions.

3. A breach of any of the stipulations contained in these Required Contract Provisions shall be sufficient grounds for termination of the contract.

4. A breach of the following clauses of the Required Contract Provisions may also be grounds for debarment as provided in 29 CFR 5.12:

- Section I, paragraph 2;
- Section IV, paragraphs 1, 2, 3, 4 and 7;
- Section V, paragraphs 1 and 2a through 2g.

5. Disputes arising out of the labor standards provisions of Section IV (except paragraph 5) and Section V of these Required Contract Provisions shall not be subject to the general disputes clause of this contract. Such disputes shall be resolved in accordance with the procedures of the U.S. Department of Labor (DOL) as set forth in 29 CFR 5, 6 and 7. Disputes within the meaning of this clause include disputes between the contractor (or any of its subcontractors) and the contracting agency, the DOL, or the contractor's employees or their representatives.

6. Selection of Labor: During the performance of this contract, the contractor shall not:

- a. Discriminate against labor from any other State, possession, or territory of the United States (except for employment preference for Appalachian contracts, when applicable, as specified in Attachment A), or
- b. Employ convict labor for any purpose within the limits of the project unless it is labor performed by convicts who are on parole, supervised release, or probation.

II. NONDISCRIMINATION

1. Equal Employment Opportunity: Equal employment opportunity (EEO) requirements not to discriminate and to take affirmative action to assure equal opportunity as set forth under laws, executive orders, rules, regulations (28 CFR 35, 29 CFR 1630 and 41 CFR 60 (and orders of the Secretary of Labor as modified by the provisions prescribed herein, and imposed pursuant to 23 U.S.C. 140 shall constitute the EEO and specific affirmative action standards for the contractor's project activities under this contract. The Equal Opportunity Construction Contract Specifications set forth under 41 CFR 60-4.3 and the provisions of the American Disabilities Act of 1990 (42 U.S.C. 12101 et seq.) set forth under 28 CFR 35 and 29 CFR 1630 are incorporated by reference in this contract. In the execution of this contract, the contractor agrees to comply with the following minimum specific requirement activities of EEO:

a. The contractor will work with the State highway agency (SHA) and the Federal Government in carrying out EEO obligations and in their review of his/her activities under the contract.

b. The contractor will accept as his operating policy the following statement:

"It is the policy of this Company to assure that applicants are employed, and that employees are treated during employment, without regard to their race, religion, sex, color, national origin, age or disability. Such action shall include: employment, upgrading, demotion, or transfer; recruitment or recruitment advertising; layoff or termination; rates of pay or other forms of compensation; and selection for training, including apprenticeship, preapprenticeship, and/or on-the-job-training."

2. EEO Officer: The contractor will designate and make known to the SHA contracting officers an EEO Officer who will have the responsibility for an must be capable of effectively administering and promoting an active contractor program of EEO and who must be assigned adequate authority and responsibility to do so.

3. Dissemination of Policy: All members of the contractor's staff who are authorized to hire, supervise, promote, and discharge employees, or who recommend such action, or who are substantially involved in such action, will be made fully cognizant of, and will implement, the contractor's EEO policy and contractual responsibilities to provide EEO in each grade and classification of employment. To ensure that the above

agreement will be met, the following actions will be taken as a minimum:

a. Periodic meetings of supervisory and personnel office employees will be conducted before the start of work and then not less often than once every six months, at which time the contractor's EEO policy and its implementation will be reviewed and explained. The meetings will be conducted by the EEO Officer.

b. All new supervisory or personnel office employees will be given a thorough indoctrination by the EEO Officer, covering all major aspects of the contractor's EEO obligations within thirty days following their reporting for duty with the contractor.

c. All personnel who are engaged in direct recruitment for the project will be instructed by the EEO Officer in the contractor's procedures for locating and hiring minority group employees.

d. Notices and posters setting forth the contractor's EEO policy will be placed in areas readily accessible to employees, applicants for employment and potential employees.

e. The contractor's EEO policy and the procedures to implement such policy will be brought to the attention of employees by means of meetings, employee handbooks, or other appropriate means.

4. Recruitment: When advertising for employees, the contractor will include in all advertisements for employees the notation: "An Equal Opportunity Employer." All such advertisements will be placed in publications having a large circulation among minority groups in the area from which the project work force would normally be derived.

a. The contractor will, unless precluded by a valid bargaining agreement, conduct systematic and direct recruitment through public and private employees referral sources likely to yield qualified minority group applicants. To meet this requirement, the contractor will identify sources of potential minority group employees, and establish which such identified sources procedures whereby minority group applicants may be referred to the contractor for employment consideration.

b. In the event the contractor has a valid bargaining agreement providing for exclusive hiring hall referrals, he is expected to observe the provisions of that agreement to the extent that the system permits the contractor's compliance with EEO contract provisions. (The DOL has held that where implementation of such agreements have the effect of discriminating against minorities or women, or obligates the contractor to do the same, such implementation violates Executive Order 11246, as amended.)

c. The contractor will encourage his present employees to refer minority group applicants for employment. Information and procedures with regard to referring minority group applicants will be discussed with employees.

5. Personnel Actions: Wages, working conditions, and employee benefits shall be established and administered, and personnel actions of every type, including hiring, upgrading, promotion, transfer, demotion, layoff, and termination, shall be taken without regard to race, color, religion, sex, national origin, age or disability. The following procedures shall be followed:

a. The contractor will conduct periodic inspections of project sites to insure that working conditions and employee facilities do not indicate discriminatory treatment of project site personnel.

b. The contractor will periodically evaluate the spread of wages paid within each classification to determine any

evidence of discriminatory wage practices.

c. The contractor will periodically review selected personnel actions in depth to determine whether there is evidence of discrimination. Where evidence is found, the contractor will promptly take corrective action. If the review indicates that the discrimination may extend beyond the actions reviewed, such corrective action shall include all affected persons.

d. The contractor will promptly investigate all complaints of alleged discrimination made to the contractor in connection with his obligations under this contract, will attempt to resolve such complaints, and will take appropriate corrective action within a reasonable time. If the investigation indicates that the discrimination may affect persons other than the complainant, such corrective action shall include such other persons. Upon completion of each investigation, the contractor will inform every complainant of all of his avenues of appeal.

6. Training and Promotion:

a. The contractor will assist in locating, qualifying, and increasing the skills of minority group and women employees, and applicants for employment.

b. Consistent with the contractor's work force requirements and as permissible under Federal and State regulations, the contractor shall make full use of training programs, i.e., apprenticeship, and on-the-job training programs for the geographical area of contract performance. Where feasible, 25 percent of apprentices or trainees in each occupation shall be in their first year of apprenticeship or training. In the event a special provision for training is provided under this contract, this subparagraph will be superseded as indicated in the special provision.

c. The contractor will advise employees and applicants for employment of available training programs and entrance requirements for each.

d. The contractor will periodically review the training and promotion potential of minority group and women employees and will encourage eligible employees to apply for such training and promotion.

7. Unions: If the contractor relies in whole or in part upon unions as a source of employees, the contractor will use his/her best efforts to obtain the cooperation of such unions to increase opportunities for minority groups and women within the unions, and to effect referrals by such unions of minority and female employees. Actions by the contractor either directly or through a contractor's association acting as agent will include the procedures set forth below:

a. The contractor will use best efforts to develop, in cooperation with the unions, joint training programs aimed toward qualifying more minority group members and women for membership in the unions and increasing the skills of minority group employees and women so that they may qualify for higher paying employment.

b. The contractor will use best efforts to incorporate an EEO clause into each union agreement to the end that such union will be contractually bound to refer applicants without regard to their race, color, religion, sex, national origin, age or disability.

c. The contractor is to obtain information as to the referral practices and policies of the labor union except that to the extent such information is within the exclusive possession of the labor union and such labor union refuses to furnish such information to the contractor, the contractor shall so certify to

the SHA and shall set forth what efforts have been made to obtain such information.

d. In the event the union is unable to provide the contractor with a reasonable flow of minority and women referrals within the time limit set forth in the collective bargaining agreement, the contractor will, through independent recruitment efforts, fill the employment vacancies without regard to race, color, religion, sex, national origin, age or disability; making full efforts to obtain qualified and/or quailifiable minority group persons and women. (The DOL has held that it shall be no excuse that the union with which the contractor has a collective bargaining agreement providing for exclusive referral failed to refer minority employees.) In the event the union referral practice prevents the contractor from meeting the obligations pursuant to Executive Order 11246, as amended, and these special provisions, such contractor shall immediately notify the SHA.

8. Selection of Subcontractors, Procurement of Materials and Leasing of Equipment: The contractor shall not discriminate on the grounds of race, color, religion, sex, national origin, age or disability in the selection and retention of subcontractors, including procurement of materials and leases of equipment.

a. The contractor shall notify all potential subcontractors and suppliers of his/her EEO obligations under this contract.

b. Disadvantaged business enterprises (DBE), as defined in 49 CFR 23, shall have equal opportunity to compete for and perform subcontracts which the contractor enters into pursuant to this contract. The contractor will use his best efforts to solicit bids from and to utilize DBE subcontractors or subcontractors with meaningful minority group and female representation among their employees. Contractors shall obtain lists of DBE construction firms from SHA personnel.

c. The contractor will use his best efforts to ensure subcontractor compliance with their EEO obligations.

9. Records and Reports: The contractor shall keep such records as necessary to document compliance with the EEO requirements. Such records shall be retained for a period of three years following completion of the contract work and shall be available at reasonable times and places for inspection by authorized representatives of the SHA and the FHWA.

a. The records kept by the contractor shall document the following:

(1) The number of minority and non-minority group members and women employed in each work classification on the project;

(2) The progress and efforts being made in cooperation with unions, when applicable, to increase employment opportunities for minorities and women;

(3) The progress and efforts being made in locating, hiring, training, qualifying, and upgrading minority and female employees; and

(4) The progress and efforts being made in securing the services of DBE subcontractors or subcontractors with meaningful minority and female representation among their employees.

b. The contractors will submit an annual report to the SHA each July for the duration of the project, indicating the number of minority, women, and non-minority group employees currently engaged in each work classification required by the contract work. This information is to be reported on Form FHWA-1391. If on-the-job training is being required by special provision, the contractor will be required to collect and report training data.

III. NONSEGREGATED FACILITIES

(Applicable to all Federal-aid construction contracts and to all related subcontracts of \$10,000 or more.)

a. By submission of this bid, the execution of this contract or subcontract, or the consummation of this material supply agreement or purchase order, as appropriate, the bidder, Federal-aid construction contractor, subcontractor, material supplier, or vendor, as appropriate, certifies that the firm does not maintain or provide for its employees any segregated facilities at any of its establishments, and that the firm does not permit its employees to perform their services at any location, under its control, where segregated facilities are maintained. The firm agrees that a breach of this certification is a violation of the EEO provisions of this contract. The firm further certifies that no employee will be denied access to adequate facilities on the basis of sex or disability.

b. As used in this certification, the term "segregated facilities" means any waiting rooms, work areas, restrooms and washrooms, restaurants and other eating areas, timeclocks, locker rooms, and other storage or dressing areas, parking lots, drinking fountains, recreation or entertainment areas, transportation, and housing facilities provided for employees which are segregated by explicit directive, or are, in fact, segregated on the basis of race, color, religion, national origin, age or disability, because of habit, local custom, or otherwise. The only exception will be for the disabled when the demands for accessibility override (e.g. disabled parking).

c. The contractor agrees that it has obtained or will obtain identical certification from proposed subcontractors or material suppliers prior to award of subcontracts or consummation of material supply agreements of \$10,000 or more and that it will retain such certifications in its files.

IV. PAYMENT OF PREDETERMINED MINIMUM WAGE

(Applicable to all Federal-aid construction contracts exceeding \$2,000 and to all related subcontracts, except for projects located on roadways classified as local roads or rural minor collectors, which are exempt.)

1. General:

a. All mechanics and laborers employed or working upon the site of the work will be paid unconditionally and not less often than once a week and without subsequent deduction or rebate on any account [except such payroll deductions as are permitted by regulations (29 CFR 3) issued by the Secretary of Labor under the Copeland Act (40 U.S.C. 276c)] the full amounts of wages and bona fide fringe benefits (or cash equivalents thereof) due at time of payment. The payment shall be computed at wage rates not less than those contained in the wage determination of the Secretary of Labor (hereinafter "the wage determination") which is attached hereto and made a part hereof, regardless of any contractual relationship which may be alleged to exist between the

contractor or its subcontractors and such laborers and mechanics. The wage determination (including any additional classifications and wage rates conformed under paragraph 2 of this Section IV and the DOL poster (WH-1321) or Form FHWA-1495) shall be posted at all times by the contractor and its subcontractors at the site of the work in a prominent and accessible place where it can be easily seen by the workers. For the purpose of this Section, contributions made or costs reasonably anticipated for bona fide fringe benefits under Section 1(b)(2) of the Davis-Bacon Act (40 U.S.C. 276a) on behalf of laborers or mechanics are considered wages paid to such laborers or mechanics, subject to the provisions of Section IV, paragraph 3b, hereof. Also, for the purpose of this Section, regular contributions made or costs incurred for more than a weekly period (but not less often than quarterly) under plans, funds, or programs, which cover the particular weekly period, are deemed to be constructively made or incurred during such weekly period. Such laborers and mechanics shall be paid the appropriate wage rate and fringe benefits on the wage determination for the classification of work actually performed, without regard to skill, except as provided in paragraphs 4 and 5 of this Section IV.

b. Laborers or mechanics performing work in more than one classification may be compensated at the rate specified for each classification for the time actually worked therein, provided, that the employer's payroll records accurately set forth the time spent in each classification in which work is performed.

c. All rulings and interpretations of the Davis-Bacon Act and related acts contained in 29 CFR 1, 3, and 5 are herein incorporated by reference in this contract.

2. Classification:

a. The SHA contracting officer shall require that any class of laborers or mechanics employed under the contract, which is not listed in the wage determination, shall be classified in conformance with the wage determination.

b. The contracting officer shall approve an additional classification, wage rate and fringe benefits only when the following criteria have been met:

(1) the work to be performed by the additional classification requested is not performed by a classification in the wage determination;

(2) the additional classification is utilized in the area by the construction industry;

(3) the proposed wage rate, including any bona fide fringe benefits, bears a reasonable relationship to the wage rates contained in the wage determination; and

(4) with respect to helpers, when such a classification prevails in the area in which the work is performed.

c. If the contractor or subcontractors, as appropriate, the laborers and mechanics (if known) to be employed in the additional classification or their representatives, and the contracting officer agree on the classification and wage rate (including the amount designated for fringe benefits where appropriate), a report of the action taken shall be sent by the contracting officer to the DOL, Administrator of the Wage and Hour Division, Employment Standards Administration, Washington, D.C. 20210. The Wage and Hour Administrator, or an authorized representative, will approve, modify, or

disapprove every additional classification action within 30 days of receipt and so advise the contracting officer or will notify the contracting officer within the 30-day period that additional time is necessary.

d. In the event the contractor or subcontractors, as appropriate, the laborers or mechanics to be employed in the additional classification or their representatives, and the contracting officer do not agree on the proposed classification and wage rate (including the amount designated for fringe benefits, where appropriate), the contracting officer shall refer the question, including the views of all interested parties and the recommendation of the contracting officer, to the Wage and Hour Administrator for determination. Said Administrator, or an authorized representative, will issue a determination within 30 days of receipt and so advise the contracting officer or will notify the contracting officer within the 30-day period that additional time is necessary.

e. The wage rate (including fringe benefits where appropriate) determined pursuant to paragraph 2c or 2d of this Section IV shall be paid to all workers performing work in the additional classification from the first day on which work is performed in the classification.

3. Payment of Fringe Benefits:

a. Whenever the minimum wage rate prescribed in the contract for a class of laborers or mechanics includes a fringe benefit which is not expressed as an hourly rate, the contractor or subcontractors, as appropriate, shall either pay the benefit as stated in the wage determination or shall pay another bona fide fringe benefit or an hourly case equivalent thereof.

b. If the contractor or subcontractor, as appropriate, does not make payments to a trustee or other third person, he/she may consider as a part of the wages of any laborer or mechanic the amount of any cost reasonably anticipated in providing bona fide fringe benefits under a plan or program, provided that the Secretary of Labor has found, upon the written request of the contractor, that the applicable standards of the Davis-Bacon Act have been met. The Secretary of Labor may require the contractor to set aside in a separate account assets for the meeting of obligations under the plan or program.

4. Apprentices and Trainees (Programs of the U.S. DOL) and Helpers:

a. Apprentices:

(1) Apprentices will be permitted to work at less than the predetermined rate for the work they performed when they are employed pursuant to and individually registered in a bona fide apprenticeship program registered with the DOL, Employment and Training Administration, Bureau of Apprenticeship and Training, or with a State apprenticeship agency recognized by the Bureau, or if a person is employed in his/her first 90 days of probationary employment as an apprentice in such an apprenticeship program, who is not individually registered in the program, but who has been certified by the Bureau of Apprenticeship and Training or a State apprenticeship agency (where appropriate) to be eligible for probationary employment as an apprentice.

(2) The allowable ratio of apprentices to journeyman-level employees on the job site in any craft classification shall not

listed on the wage determination unless the Administrator of the

be greater than the ratio permitted to the contractor as to the entire work force under the registered program. Any employee listed on a payroll at an apprentice wage rate, who is not registered or otherwise employed as stated above, shall be paid not less than the applicable wage rate listed in the wage determination for the classification of work actually performed. In addition, any apprentice performing work on the job site in excess of the ratio permitted under the registered program shall be paid not less than the applicable wage rate on the wage determination for the work actually performed. Where a contractor or subcontractor is performing construction on a project in a locality other than that in which its program is registered, the ratios and wage rates (expressed in percentages of the journeyman-level hourly rate) specified in the contractor's or subcontractor's registered program shall be observed.

(3) Every apprentice must be paid at not less than the rate specified in the registered program for the apprentice's level of progress, expressed as a percentage of the journeyman-level hourly rate specified in the applicable wage determination. Apprentices shall be paid fringe benefits in accordance with the provisions of the apprenticeship program. If the apprenticeship program does not specify fringe benefits, apprentices must be paid the full amount of fringe benefits listed on the wage determination for the applicable classification. If the Administrator for the Wage and Hour Division determines that a different practice prevails for the applicable apprentice classification, fringes shall be paid in accordance with that determination.

(4) In the event the Bureau of Apprenticeship and Training, or a State apprenticeship agency recognized by the Bureau, withdraws approval of an apprenticeship program, the contractor or subcontractor will no longer be permitted to utilize apprentices at less than the applicable predetermined rate for the comparable work performed by regular employees until an acceptable program is approved.

b. Trainees:

(1) Except as provided in 29 CFR 5.16, trainees will not be permitted to work at less than the predetermined rate for the work performed unless they are employed pursuant to and individually registered in a program which has received prior approval, evidenced by formal certification by the DOL, Employment and Training Administration.

(2) The ratio of trainees to journeyman-level employees on the job site shall not be greater than permitted under the plan approved by the Employment and Training Administration. Any employee listed on the payroll at a trainee rate who is not registered and participating in a training plan approved by the Employment and Training Administration shall be paid not less than the applicable wage rate on the wage determination for the classification of work actually performed. In addition, any trainee performing work on the job site in excess of the ratio permitted under the registered program shall be paid not less than the applicable wage rate on the wage determination for the work actually performed.

(3) Every trainee must be paid at not less than the rate specified in the approved program for his/her level of progress, expressed as a percentage of the journeyman-level hourly rate specified in the applicable wage determination. Trainees shall be paid fringe benefits in accordance with the provisions of the trainee program. If the trainee program does not mention fringe benefits, trainees shall be paid the full amount of fringe benefits

Wage and Hour Division determines that there is an apprenticeship program associated with the corresponding journeyman-level wage rate on the wage determination which provides for less than full fringe benefits for apprentices, in which cases such trainees shall receive the same fringe benefits as apprentices.

(4) In the event the Employment and Training Administration withdraws approval of a training program, the contractor or subcontractor will no longer be permitted to utilize trainees at less than the applicable predetermined rate for the work performed until an acceptable program is approved.

c. Helpers:

Helpers will be permitted to work on a project if the helper classification is specified and defined on the applicable wage determination or is approved pursuant to the conformance procedure set forth in Section IV. 2. Any worker listed on a payroll at a helper wage rate, who is not a helper under a approved definition, shall be paid not less than the applicable wage rate on the wage determination for the classification of work actually performed.

5. Apprentices and Trainees (Programs of the U.S. DOT):

Apprentices and trainees working under apprenticeship and skill training programs which have been certified by the Secretary of Transportation as promoting EEO in connection with Federal-aid highway construction programs are not subject to the requirements of paragraph 4 of this Section IV. The straight time hourly wage rates for apprentices and trainees under such programs will be established by the particular programs. The ratio of apprentices and trainees to journeymen shall not be greater than permitted by the terms of the particular program.

6. Withholding:

The SHA shall upon its own action or upon written request of an authorized representative of the DOL withhold, or cause to be withheld, from the contractor or subcontractor under this contract or any other Federal contract with the same prime contractor or any other Federally-assisted contract subject to Davis-Bacon prevailing wage requirements which is held by the same prime contractor, as much of the accrued payments or advances as may be considered necessary to pay laborers and mechanics, including apprentices, trainee's and helpers, employed by the contractor or any subcontractor the full amount of wages required by the contract. In the event of failure to pay any laborer or mechanic, including any apprentice, trainee, or helper, employed or working on the site of the work, all or part of the wages required by the contract, the SHA contracting officer may, after written notice to the contractor, take such action as may be necessary to cause the suspension of any further payment, advance, or guarantee of funds until such violations have ceased.

7. Overtime Requirements:

No contractor or subcontractor contracting for any part of the contract work which may require or involve the employment of laborers, mechanics, watchmen, or guards (including apprentices, trainees, and helpers described in paragraphs 4 and 5 above) shall require or permit any laborer, mechanic, watchman, or guard in any workweek in which he/she is employed on such work, to work in excess of 40 hours in such workweek unless such laborer, mechanic, watchman, or guard receives compensation at a rate not less than one-and-one-half times his/her basic rate of pay for all hours worked in excess of 40 hours in such workweek.

8. Violation:

Liability for Unpaid Wages; Liquidated Damages: In the event of any violation of the clause set forth in paragraph 7 above, the contractor and any subcontractor responsible thereof shall be liable to the affected employee for his/her unpaid wages. In addition, such contractor and subcontractor shall be liable to the United States (in the case of work done under contract for the District of Columbia or a territory, to such District or to such territory) for liquidated damages. Such liquidated damages shall be computed with respect to each individual laborer, mechanic, watchman, or guard employed in violation of the clause set forth in paragraph 7, in the sum of \$10 for each calendar day on which such employee was required or permitted to work in excess of the standard work week of 40 hours without payment of the overtime wages required by the clause set forth in paragraph 7.

9. Withholding for Unpaid Wages and Liquidated Damages:

The SHA shall; upon its own action or upon written request of any authorized representative of the DOL withhold, or cause to be withheld, from any monies payable on account of work performed by the contractor or subcontractor under any such contract or any other Federal contract with the same prime contractor, or any other Federally-assisted contract subject to the Contract Work Hours and Safety Standards Act, which is held by the same prime contractor, such sums as may be determined to be necessary to satisfy any liabilities of such contractor or subcontractor for unpaid wages and liquidated damages as provided in the clause set forth in paragraph 8 above.

V. STATEMENTS AND PAYROLLS

(Applicable to all Federal-aid construction contracts exceeding \$2,000 and to all related subcontracts, except for projects located on roadways classified as local roads or rural collectors, which are exempt.)

1. Compliance with Copeland Regulations (29 CFR 3):

The contractor shall comply with the Copeland Regulations of the Secretary of Labor which are herein incorporated by reference.

2. Payrolls and Payroll Records:

a. Payrolls and basic records relating thereto shall be maintained by the contractor and each subcontractor during the course of the work and preserved for a period of 3 years from the date of completion of the contract for all laborers, mechanics, apprentices, trainees, watchmen, helpers, and guards working at the site of the work.

b. The payroll records shall contain the name, social security number, and address of each such employee; his or her correct classification; hourly rates of wages paid (including rates of contributions or costs anticipated for bona fide fringe benefits or cash equivalent thereof the types described in Section 1(b)(2)(B) of the Davis Bacon Act); daily and weekly number of hours worked; deductions made; and actual wages paid. In addition, for Appalachian contracts, the payroll records shall contain a notation indicating whether the employee does, or does not, normally reside in the labor area as defined in Attachment A, paragraph 1. Whenever the Secretary of Labor, pursuant to Section IV, paragraph 3b, has found that the wages of any laborer or mechanic include the amount of any costs reasonably anticipated in providing benefits under a plan

or program described in Section 1(b)(2)(B) of the Davis Bacon Act, the contractor and each subcontractor shall maintain records which show that the commitment to provide such benefits is enforceable, that the plan or program is financially responsible, that the plan or program has been communicated in writing to the laborers or mechanics affected, and show the cost anticipated or the actual cost incurred in providing benefits. Contractors or subcontractors employing apprentices or trainees under approved programs shall maintain written evidence of the registration of apprentices and trainees, and ratios and wage rates prescribed in the applicable programs.

c. Each contractor and subcontractor shall furnish, each week in which any contract work is performed, to the SHA resident engineer a payroll of wages paid each of its employees (including apprentices trainees, and helpers, described in Section IV, paragraphs 4 and 5, and watchmen and guards engaged on work during the preceding weekly payroll period).

The payroll submitted shall set out accurately and completely all of the information required to be maintained under paragraph 2b of this Section V.

This information may be submitted in any form desired. Optional Form WH-347 is available for this purpose and may be purchased from the Superintendent of Documents (Federal stock number 029-005-0014-1), U.S. Government Printing Office, Washington, D.C. 20402. The prime contractor is responsible for the submission of copies of payrolls by all subcontractors.

d. Each payroll submitted shall be accompanied by a "Statement of Compliance," signed by the Contractor or subcontractor or his/her agent who pays or supervises the payment of the persons employed under the contract and shall certify the following:

(1) that the payroll for the payroll period contains the information required to be maintained under paragraph 2b of this Section V and that such information is correct and complete;

(2) that such laborer or mechanic (including each helper, apprentice, and trainee) employed on the contract during the payroll period has been paid the full weekly wages earned, without rebate, either directly or indirectly, and that no deductions have been made either directly or indirectly from the full wages earned, other than permissible deductions as set forth in the Regulations, 29 CFR 3;

(3) that each laborer or mechanic has been paid not less than the applicable wage rate and fringe benefits or cash equivalent for the classification of work performed, as specified in the applicable wage determination incorporated into the contract.

e. The weekly submission of a properly executed certification set forth on the reverse side of Optional Form WH-347 shall satisfy the requirement for submission of the "Statement of Compliance" required by paragraph 2d of this Section V.

f. The falsification of any of the above certifications may subject the contractor to civil or criminal prosecution under 18 U/S. C. 1001 and 31 U.S.C. 231.

g. The contractor or subcontractor shall make the records required under paragraph 2b of this Section V available for

inspection, copying, or transcription by authorized representatives of the SHA, the FHWA, or the DOL, and shall permit such representatives to interview employees during working hours on the job. If the contractor or subcontractor fails to submit the required records or to make them available, the SHA, the FHWA, the DOL, or all may, after written notice to the contractor, sponsor, applicant, or owner, take such actions as may be necessary to cause the suspension of any further payment, advance, or guarantee of funds. Furthermore, failure to submit the required records upon request or to make such records available may be grounds for debarment action pursuant to 29 CFR 5.12.

VI. RECORD OF MATERIALS, SUPPLIES, AND LABOR

1. On all federal-aid contracts on the national highway system, except those which provide solely for the installation of protective devices at railroad grade crossings, those which are constructed on a force account or direct labor basis, highway beautification contracts, and contracts for which the total final construction cost for roadway and bridge is less than \$1,000,000 (23 CFR 635) the contractor shall:

- a. Become familiar with the list of specific materials and supplies contained in Form FHWA-47, "Statement of Materials and Labor Used by Contractor of Highway Construction Involving Federal Funds," prior to the commencement of work under this contract.
- b. Maintain a record of the total cost of all materials and supplies purchased for and incorporated in the work, and also of the quantities of those specific materials and supplies listed on Form FHWA-47, and in the units shown on Form FHWA-47.
- c. Furnish, upon the completion of the contract, to the SHA resident engineer on Form FHWA-47 together with the data required in paragraph 1b relative to materials and supplies, a final labor summary of all contract work indicating the total hours worked and the total amount earned.

2. At the prime contractor's option, either a single report covering all contract work or separate reports for the contractor and for each subcontract shall be submitted.

VII. SUBLETTING OR ASSIGNING THE CONTRACT

1. The contractor shall perform with its own organization contract work amounting to not less than 30 percent (or a greater percentage if specified elsewhere in the contract) of the total original contract price, excluding any specialty items designated by the State. Specialty items may be performed by subcontract and the amount of any such specialty items performed may be deducted from the total original contract price before computing the amount of work required to be performed by the contractors' own organization (23 CFR 635).

- a. "Its own organization" shall be construed to include only workers employed and paid directly by the prime contractor and equipment owned or rented by the prime contractor, with or without operators. Such term does not include employees or equipment of a subcontractor, assignee, or agent of the prime contractor.
- b. "Specialty Items" shall be construed to be limited to work that requires highly specialized knowledge, abilities, or equipment not ordinarily available in the type of contracting organizations qualified and expected to bid on the contract as a

whole and in general are to be limited to minor components of the overall contract.

2. The contract amount upon which the requirements set forth in paragraph 1 of Section VII is computed includes the cost of material and manufactured products which are to be purchased or produced by the contractor under the contract provisions.

3. The contractor shall furnish (a) a competent superintendent or supervisor who is employed by the firm, has full authority to direct performance of the work in accordance with the contract requirements, and is in charge of all construction operations (regardless of who performs the work) and (b) such other of its own organizational resources (supervision, management, and engineering services) as the SHA contracting officer determines is necessary to assure the performance of the contract.

4. No portion of the contract shall be sublet, assigned or otherwise disposed of except with the written consent of the SHA contracting officer, or authorized representative, and such consent when given shall not be construed to relieve the contractor of any responsibility for the fulfillment of the contract.

Written consent will be given only after the SHA has assured that each subcontract is evidenced in writing and that it contains all pertinent provisions and requirements of the prime contract.

VIII. SAFETY: ACCIDENT PREVENTION

1. In the performance of this contract the contractor shall comply with all applicable Federal, State, and local laws governing safety, health, and sanitation (23 CFR 635). The contractor shall provide all safeguards, safety devices and protective equipment and take any other needed actions as it determines, or as the SHA contracting officer may determine, to be reasonably necessary to protect the life and health of employees on the job and the safety of the public and to protect property in connection with the performance of the work covered by the contract.

2. It is a condition of this contract, and shall be made a condition of each subcontract, which the contractor enters into pursuant to this contract, that the contractor and any subcontractor shall not permit any employee, in performance of the contract, to work in surroundings or under conditions which are unsanitary, hazardous or dangerous to his/her health or safety, as determined under construction safety and health standards (29 CFR 1926) promulgated by the Secretary of Labor, in accordance with Section 107 of the Contract Work Hours and Safety Standards Act (40 U.S. C. 333).

3. Pursuant to 29 CFR 1926.3, it is a condition of this contract that the Secretary of Labor or authorized representative thereof, shall have right of entry to any site of contract performance to inspect or investigate the matter of compliance with the construction safety and health standards and to carry out the duties of the Secretary under Section 107 of the Contract Work Hours and Safety Standards Act (40 U.S.C. 333).

IX. FALSE STATEMENTS CONCERNING HIGHWAY PROJECTS

In order to assure high quality and durable construction in conformity with approved plans and specifications and a high degree of reliability on statements and representations made by engineers, contractors, suppliers, and workers on Federal-aid highway projects, it is essential that all persons concerned with the project perform their functions as carefully, thoroughly, and honestly as possible. Willful falsification,

distortion, or misrepresentation with respect to any facts related to the project is a violation of Federal law. To prevent any misunderstanding regarding the seriousness of these and similar acts, the following notice shall be posted on each Federal-aid highway project (23 CFR 635) in one or more places where it is readily available to all persons concerned with the project:

NOTICE TO ALL PERSONNEL ENGAGED ON FEDERAL-AID HIGHWAY PROJECTS

18 U.S.C. 1020 reads as follows:

“Whoever, being an officer, agent or employee of the United States, or of any State or Territory, or whoever, whether a person, association, firm, or corporation, knowingly makes any false statement, false representation, or false report as to the character, quality, quantity, or cost of the material used or to be used, or the quantity or quality of the work performed or to be performed, or the cost thereof in connection with the submission of plans, maps, specifications, contracts, or costs of construction on any highway or related project submitted for approval to the Secretary of Transportation; or

Whoever knowingly makes any false statement, false representation, false report or false claim with respect to the character, quality, quantity, or cost of any work performed or to be performed, or materials furnished or to be furnished, in connection with the construction of any highway or related project approved by the Secretary of Transportation; or

Whoever knowingly makes any false statement or false representation as to material fact in any statement, certificate, or report submitted pursuant to provisions of the Federal-aid Roads Act approved July 1, 1916, (39 Stat. 355), as amended and supplemented;

Shall be fined not more than \$10,000 or imprisoned not more than 5 years or both.”

X. IMPLEMENTATION OF CLEAN AIR ACT AND FEDERAL WATER POLLUTION CONTROL ACT

(Applicable to all Federal-aid construction contracts and to all related subcontracts of \$100,000 or more).

By submission of this bid or the execution of this contract, or subcontract, as appropriate, the bidder, Federal-aid construction contractor, or subcontractor, as appropriate, will be deemed to have stipulated as follows:

1. That any facility that is or will be utilized in the performance of this contract, unless such contract is exempt under the Clean Air Act, as amended (42 U.S.C. 1857 et seq., as amended by Pub.L. 91-604), and under the Federal Water Pollution Control Act, as amended (33 U.S.C. 1251 et seq., as amended by Pub.L. 92-500), Executive Order 11738, and regulations in implementation thereof (40 CFR 15) is not listed, on the date of contract award, on the U.S. Environmental Protection Agency (EPA) List of Violating Facilities pursuant to 40 CFR 15.20.

2. That the firm agrees to comply and remain in compliance with all the requirements of Section 114 of the Clean Air Act and Section 308 of the Federal Water Pollution Control Act and all regulations and guidelines listed thereunder.

3. That the firm shall promptly notify the SHA of the receipt of

any communication from the Director, Office of Federal Activities, EPA indicating that a facility that is or will be utilized for the contract is under consideration to be listed on the EPA List of Violating Facilities.

4. That the firm agrees to include or cause to be included the requirements of paragraph 1 through 4 of this Section X in every nonexempt subcontract, and further agrees to take such action as the government may direct as a means of enforcing such requirements.

XI. CERTIFICATION REGARDING DEBARMENT, SUSPENSION, INELIGIBILITY AND VOLUNTARY EXCLUSION

1. Instructions for Certification - Primary Covered Transactions:

(Applicable to all Federal-aid contracts - 49 CFR 29)

a. By signing and submitting this proposal, the prospective primary participant is providing the certification set out below.

b. The inability of a person to provide the certification set out below will not necessarily result in denial of participation in this covered transaction. The prospective participant shall submit an explanation of why it cannot provide the certification set out below. The certification or explanation will be considered in connection with the department or agency's determination whether to enter into this transaction. However, failure of the prospective primary participant to furnish a certification or an explanation shall disqualify such a person from participation in this transaction.

c. The certification in this clause is a material representation of fact upon which reliance was placed when the department or agency determined to enter into this transaction. If it is later determined that the prospective primary participant knowingly rendered an erroneous certification, in addition to other remedies available to the Federal Government, the department or agency may terminate this transaction for cause of default.

d. The prospective primary participant shall provide immediate written notice to the department or agency to whom this proposal is submitted if any time the prospective primary participant learns that its certification was erroneous when submitted or has become erroneous by reason of changed circumstances.

e. The terms “covered transaction,” “debarred,” “suspended,” “ineligible,” “lower tier covered transaction,” “participant,” “person,” “primary covered transaction,” “principal,” “proposal,” and “voluntarily excluded,” as used in this clause, have the meanings set out in the Definitions and Coverage sections of rules implementing Executive Order 12549. You may contact the department or agency to which this proposal is submitted for assistance in obtaining a copy of those regulations.

f. The prospective primary participant agrees by submitting this proposal that, should the proposed covered transaction be entered into, it shall not knowingly enter into any lower tier covered transaction with a person who is debarred, suspended, declared ineligible, or voluntarily excluded from participation in this covered transaction, unless authorized by the department or agency entering into this transaction.

g. The prospective primary participant further agrees by submitting this proposal that it will include the clause titled

"Certification Regarding Debarment, Suspension, Ineligibility and Voluntary Exclusion-Lower Tier Covered Transaction," provided by the department or agency entering into this covered transaction, without modification in all lower tier covered transactions and in all solicitations for lower tier covered transactions.

h. A participant in a covered transaction may rely upon a certification of a prospective participant in a lower tier covered transaction that is not debarred, suspended, ineligible, or voluntarily excluded from the covered transaction, unless it knows that the certification is erroneous. A participant may decide the method and frequency by which it determines the eligibility of its principals. Each participant may, but is not required to, check the nonprocurement portion of the "Lists of Parties Excluded from Federal Procurement or Nonprocurement Programs" (Nonprocurement List) which is compiled by the General Services Administration.

i. Nothing contained in the foregoing shall be construed to require establishment of a system of records in order to render in good faith the certification required by this clause. The knowledge and information of participant is not required to exceed that which is normally possessed by a prudent person in the ordinary course of business dealings.

j. Except for transactions authorized under paragraph f of these instructions, if a participant in a covered transaction knowingly enters into a lower tier covered transaction with a person who is suspended, debarred, ineligible, or voluntarily excluded from participation in this transaction, in addition to other remedies available to the Federal Government, the department or agency may terminate this transaction for cause or default.

Certification Regarding Debarment, Suspension, Ineligibility and Voluntary Exclusion-Primary Covered Transactions

1. The prospective primary participant certifies to the best of its knowledge and belief, that it and its principals:

- a. Are not presently debarred, suspended, proposed for debarment, declared ineligible, or voluntarily excluded from covered transactions by any Federal department or agency;
- b. Have not within a 3-year period preceding this proposal been convicted of or had a civil judgment rendered against them for commission of fraud or a criminal offense in connection with obtaining, attempting to obtain, or performing a public (Federal, State or local) transaction or contract under a public transaction; violation of Federal or State antitrust statutes or commission of embezzlement, theft, forgery, bribery, falsification or destruction of records, making false statements, or receiving stolen property;
- c. Are not presently indicted for or otherwise criminally or civilly charged by a governmental entity (Federal, State or local) with commission of any of the offenses enumerated in paragraph 1b of this certification; and
- d. Have not within a 3-year period preceding this application/proposal had one or more public transactions (Federal, State or local) terminated for cause or default.

2. Where the prospective primary participant is unable to certify to any of the statements in this certification, such prospective participant shall attach an explanation to this proposal.

2. Instructions for Certification - Lower Tier Covered Transactions:

(Applicable to all subcontracts, purchase orders and other lower tier transactions of \$25,000 or more - 49 CFR 29)

- a. By signing and submitting this proposal, the prospective lower tier is providing the certification set out below.
- b. The certification in this clause is a material representation of fact upon which reliance was placed when this transaction was entered into. If it is later determined that the prospective lower tier participant knowingly rendered an erroneous certification, in addition to other remedies available to the Federal Government, the department, or agency with which this transaction originated may pursue available remedies, including suspension and/or debarment.
- c. The prospective lower tier participant shall provide immediate written notice to the person to which this proposal is submitted if at any time the prospective lower tier participant learns that its certification was erroneous by reason of changed circumstances.
- d. The terms "covered transaction," "debarred," "suspended," "ineligible," "primary covered transaction," "participant," "person," "principal," "proposal," and "voluntarily excluded," as used in this clause, have the meanings set out in the Definitions and Coverage sections of rules implementing Executive Order 12549. You may contact the person to which this proposal is submitted for assistance in obtaining a copy of those regulations.
- e. The prospective lower tier participant agrees by submitting this proposal that, should the proposed covered transaction be entered into, it shall not knowingly enter into any lower tier covered transaction with a person who is debarred, suspended, declared ineligible, or voluntarily excluded from participation in this covered transaction, unless authorized by the department or agency with which this transaction originated.
- f. The prospective lower tier participant further agrees by submitting this proposal that it will include this clause titled "Certification Regarding Debarment, Suspension, Ineligibility and Voluntary Exclusion-Lower Tier Covered Transaction," without modification, in all lower tier covered transactions and in all solicitations for lower tier covered transactions.
- g. A participant in a covered transaction may rely upon a certification of a prospective participant in a lower tier covered transaction that is not debarred, suspended, ineligible, or voluntarily excluded from the covered transaction, unless it knows that the certification is erroneous. A participant may decide the method and frequency by which it determines the eligibility of its principals. Each participant may, but is not required to, check the Nonprocurement List.
- h. Nothing contained in the foregoing shall be construed to require establishment of a system of records in order to render in good faith the certification required by this clause. The knowledge and information of participant is not required to exceed that which is normally possessed by a prudent person in the ordinary course of business dealing.
- i. Except for transactions authorized under paragraph e of these instructions, if a participant in a covered transaction knowingly enters into a lower tier covered transaction with a person who is suspended, debarred, ineligible, or voluntarily

excluded from participation in this transaction, in addition to other remedies available to the Federal Government, the department or agency with which this transaction originated may pursue available remedies, including suspension and/or debarment.

Certification Regarding Debarment, Suspension, Ineligibility And Voluntary Exclusion-Lower Tier Covered Transactions:

1. The prospective lower tier participant certifies, by submission of this proposal, that neither it nor its principals is presently debarred, suspended, proposed for debarment, declared ineligible, or voluntarily excluded from participation in this transaction by any Federal department or agency.

2. Where the prospective lower tier participant is unable to certify to any of the statements in this certification, such prospective participant shall attach an explanation to this proposal.

XII. CERTIFICATION REGARDING USE OF CONTRACT FUNDS FOR LOBBYING

(Applicable to all Federal-aid construction contracts and to all related subcontracts which exceed \$100,000 - 49 CFR 20)

1. The prospective participant certifies, by signing and submitting this bid or proposal, to the best of his or her knowledge and belief, that:

a. No Federal appropriated funds have been paid or will be paid, by or on behalf of the undersigned, to any person for influencing or attempting to influence an officer or employee of any Federal agency, a Member of Congress, an officer or employee of Congress, or an employee of a Member of Congress in connection with the awarding of any Federal contract, the making of any Federal grant, the making of any Federal loan, the entering into of any cooperative agreement, and the extension, continuation, renewal, amendment, or modification of any Federal contract, grant, loan, or cooperative agreement.

b. If any funds other than Federal appropriated funds have been paid or will be paid to any person for influencing or attempting to influence an officer or employee of any Federal agency, a Member of Congress, an officer or employee of Congress, or an employee of a Member of Congress in connection with this Federal contract, grant, loan, or cooperative agreement, the undersigned shall complete and submit Standard Form-LLL, "Disclosure Form to Report Lobbying," in accordance with its instructions.

2. This certification is a material representation of fact upon which reliance was placed when this transaction was made or entered into. Submission of this certification is a prerequisite for making or entering into this transaction imposed by 31 U.S.C. 1352. Any person who fails to file the required certification shall be subject to a civil penalty of not less than \$10,000 and not more than \$100,000 for each such failure.

3. The prospective participant also agrees by submitting his or her bid or proposal that he or she shall require that the language of this certification be included in all lower tier subcontracts, which exceed \$100,000 and that all such recipients shall certify and disclose accordingly.

**MINIMUM WAGES FOR FEDERAL AND FEDERALLY
ASSISTED CONSTRUCTION CONTRACTS**

This project is funded, in part, with Federal-aid funds and, as such, is subject to the provisions of the Davis-Bacon Act of March 3, 1931, as amended (46 Sta. 1494, as amended, 40 U.S.C. 276a) and of other Federal statutes referred to in a 29 CFR Part 1, Appendix A, as well as such additional statutes as may from time to time be enacted containing provisions for the payment of wages determined to be prevailing by the Secretary of Labor in accordance with the Davis-Bacon Act and pursuant to the provisions of 29 CFR Part 1. The prevailing rates and fringe benefits shown in the General Wage Determination Decisions issued by the U.S. Department of Labor shall, in accordance with the provisions of the foregoing statutes, constitute the minimum wages payable on Federal and federally assisted construction projects to laborers and mechanics of the specified classes engaged on contract work of the character and in the localities described therein.

General Wage Determination Decisions, modifications and supersedes decisions thereto are to be used in accordance with the provisions of 29 CFR Parts 1 and 5. Accordingly, the applicable decision, together with any modifications issued, must be made a part of every contract for performance of the described work within the geographic area indicated as required by an applicable DBRA Federal prevailing wage law and 29 CFR Part 5. The wage rates and fringe benefits contained in the General Wage Determination Decision shall be the minimum paid by contractors and subcontractors to laborers and mechanics.

NOTICE

The most current **General Wage Determination Decisions** (wage rates) are available on the IDOT web site. They are located on the Letting and Bidding page at <http://www.dot.state.il.us/desenv/delett.html>.

In addition, ten (10) days prior to the letting, the applicable Federal wage rates will be e-mailed to subscribers. It is recommended that all contractors subscribe to the Federal Wage Rates List or the Contractor's Packet through IDOT's subscription service.

PLEASE NOTE: if you have already subscribed to the Contractor's Packet you will automatically receive the Federal Wage Rates.

The instructions for subscribing are at <http://www.dot.state.il.us/desenv/subsc.html>.

If you have any questions concerning the wage rates, please contact IDOT's Chief Contract Official at 217-782-7806.