

PLAN

PLAN

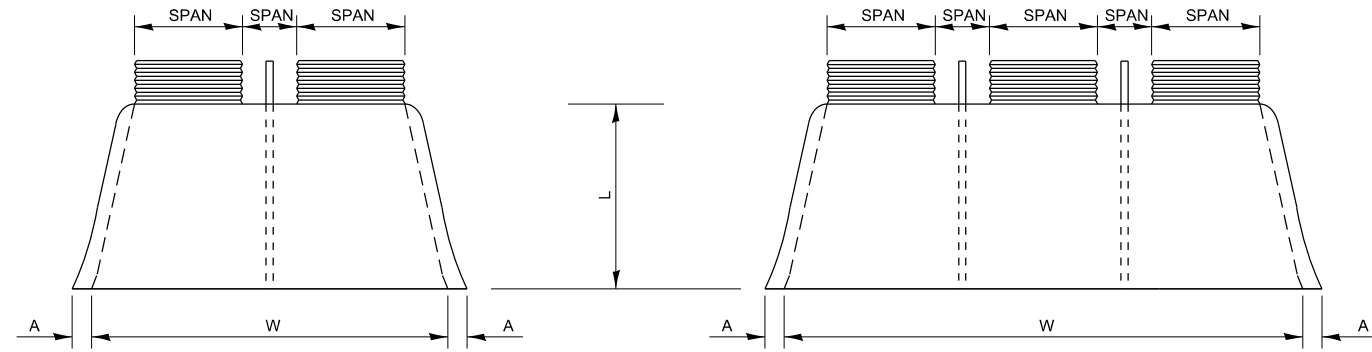

PLAN

PLAN

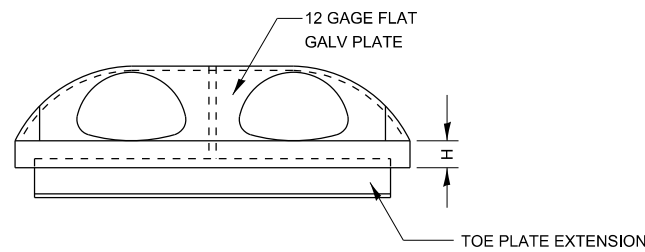

ELEVATION

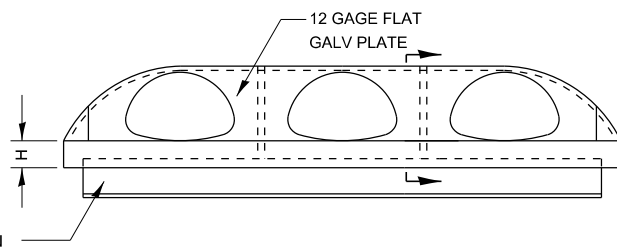

ELEVATION

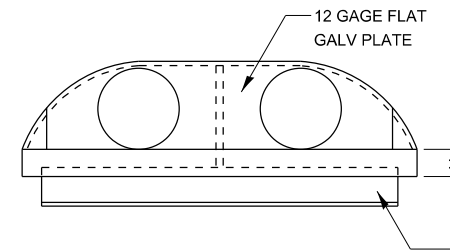

ELEVATION

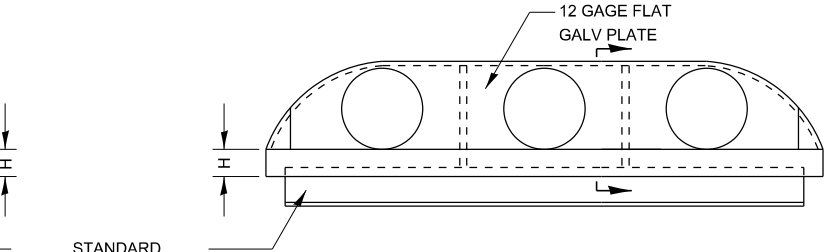

ELEVATION

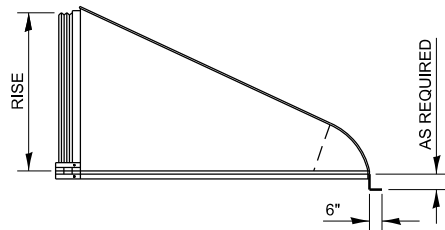

SIDE VIEW

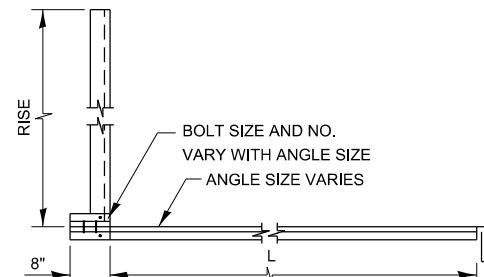

SECTION VIEW

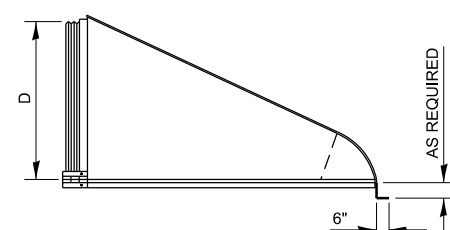

SIDE VIEW

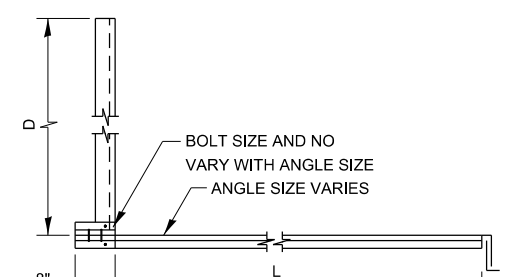

ANGLE SECTION VIEW

PIPE-ARCH MULTIPLE INLET END SECTIONS									
SPAN x RISE 2-2/3" x 1/2"	EQUIV ROUND	GAGE	SPA (IN)	A (IN)	H (IN)	L (IN)	DOUBLE W	TRIPLE W	REINFORCING ANGLE
17 x 13	15	16	12	6 1/2	6	20	59	88	2 x 2 x 1/4
21 x 15	18	16	12	7 1/2	6	24	69	102	2 x 2 x 1/4
24 x 18	21	16	12	8	6	28	78	114	2 x 2 x 1/4
28 x 20	24	16	12	8	6	32	88	128	5 x 3 x 1/4
35 x 24	30	14	12	10	6	39	107	154	5 x 3 x 1/4
42 x 29	36	14	14	12	7 1/2	46	131	187	5 x 3 x 1/4
49 x 33	42	12	17	13 1/2	9	53	150	216	5 x 3 x 1/4
57 x 38	48	12	19	18 1/2	12	62	166	242	6 x 4 x 3/8
64 x 43	54	12	22	18	12	69	188	274	6 x 4 x 3/8
71 x 47	60	12/10	24	18 1/2	12	77	209	304	6 x 4 x 3/8
77 x 62	66	12/10	26	18	12	77	229	332	6 x 4 x 3/8
83 x 67	72	12/10	28	18	12	77	243	354	6 x 4 x 3/8
SPAN x RISE 3"x1" & 5"x1"	EQUIV ROUND	GAGE	SPA (IN)	A (IN)	H (IN)	L (IN)	DOUBLE W	TRIPLE W	REINFORCING ANGLE
60 x 46	54	12	20	18	12	70	182	262	6 x 4 x 3/8
66 x 51	60	12/10	22	18	12	77	202	290	6 x 4 x 3/8
73 x 55	66	12/10	25	18	12	77	224	322	6 x 4 x 3/8
81 x 69	72	12/10	27	18	12	77	246	354	6 x 4 x 3/8

ROUND PIPE MULTIPLE INLET END SECTIONS								
PIPE DIA (D) (IN)	GAGE	SPA (IN)	A (IN)	H (IN)	L (IN)	DOUBLE W	TRIPLE W	REINFORCING ANGLE
12	16	12	6 1/2	6	21	48	72	2 x 2 x 1/4
15	16	12	7 1/2	6	26	57	84	2 x 2 x 1/4
18	16	12	8	6	31	66	96	2 x 2 x 1/4
21	16	12	10	6	36	75	108	2 x 2 x 1/4
24	16	12	10	6	41	84	120	5 x 3 x 1/4
30	14	15	12 1/4	8	51	102	147	5 x 3 x 1/4
36	14	18	14 1/2	9	60	126	180	5 x 3 x 1/4
42	12	21	17	10 1/2	69	147	210	5 x 3 x 1/4
48	12	24	18 1/2	12	79	162	234	6 x 4 x 1/16
54	12	27	18 1/2	12	84	183	264	6 x 4 x 1/16
60	12/10	30	18	12	88	204	294	6 x 4 x 1/16
66	12/10	33	18	12	87	219	318	6 x 4 x 1/16
72	12/10	36	18	12	88 1/2	228	336	6 x 4 x 1/16
78	12/10	36	18	12	87 1/2	252	366	6 x 4 x 1/16
84	12/10	36	18	12	87 1/2	254	384	6 x 4 x 1/16

MODEL det 3 d4tbl
 FILE Name: p:\w\sc\paw\benitez.com\PIV\DOT\Documents\DOT Office\District 3\Standards - District 3\DETAILS\SUBSTRUCT 3 STANDARD DETAILS_DGN\500-599 STRUCTURES.dgn

USER NAME = ronald.pohar	DESIGNED -	REVISED -
	DRAWN -	REVISED -
PLOT SCALE = 100.000 ' / in.	CHECKED -	REVISED -
PLOT DATE = 3/18/2024	DATE -	REVISED -

STATE OF ILLINOIS
DEPARTMENT OF TRANSPORTATION

CORRUGATED STEEL PIPE MULTIPLE END SECTIONS

SCALE: SHEET OF SHEETS STA. TO STA.

F.A. RTE.	SECTION	COUNTY	TOTAL SHEETS	SHEET NO.
CONTRACT NO.				
ILLINOIS FED. AID PROJECT				