

RETURN WITH BID

State of _____)
) ss.
County of _____)

AFFIDAVIT

_____, of _____,
(name of affiant) *(bidder)*

being first duly sworn upon oath, states as follows:

1. That I am the _____ of _____
(Officer or position) *(Bidder)*
and have personal knowledge of the facts herein stated.

2. That, if selected under this bid proposal, _____ will
(Bidder)
maintain a business office in the State of Illinois which will be located in _____
County, Illinois.

3. That this business office will serve as the primary place of employment for any persons
employed in the construction contemplated by this bid proposal.

4. That this Affidavit is given as a requirement of state law as provided in Section 30-22(8) of
the Illinois Procurement Code.

(Signature)

(Printed name of Affiant)

This instrument was signed and attested before me on the _____ day of _____, 20 ____

by _____.
(Notary Public Name)

(Notary Public Signature)

(NOTARY SEAL)

BID PROPOSAL INSTRUCTIONS

ABOUT IDOT PROPOSALS: All proposals are potential bidding proposals. Each proposal contains all certifications and affidavits, a proposal signature sheet and a proposal bid bond.

PREQUALIFICATION

Any contractor who desires to become pre-qualified to bid on work advertised by IDOT must submit the properly completed pre-qualification forms to the Bureau of Construction no later than 4:30 p.m. prevailing time twenty-one days prior to the letting of interest. This pre-qualification requirement applies to first time contractors, contractors renewing expired ratings, contractors maintaining continuous pre-qualification or contractors requesting revised ratings. To be eligible to bid, existing pre-qualification ratings must be effective through the date of letting.

WHO CAN BID ?

Bids will be accepted from only those companies that request and receive written Authorization to Bid from IDOT's Central Bureau of Construction.

REQUESTS FOR AUTHORIZATION TO BID

Contractors wanting to bid on items included in a particular letting must submit the properly completed "Request for Authorization to Bid/or Not For Bid Status" (BDE 124) and the ORIGINAL "Affidavit of Availability" (BC 57) to the proper office no later than 4:30 p.m. prevailing time, three (3) days prior to the letting date.

WHAT CONSTITUTES WRITTEN AUTHORIZATION TO BID?

When a prospective prime bidder submits a "Request for Authorization to Bid/or Not For Bid Status"(BDE 124) he/she must indicate at that time which items are being requested For Bidding purposes. Only those items requested For Bidding will be analyzed. After the request has been analyzed, the bidder will be issued an **Authorization to Bid or Not for Bid Report**, approved by the Central Bureau of Construction and the Chief Procurement Officer that indicates which items have been approved For Bidding. If **Authorization to Bid** cannot be approved, the **Authorization to Bid or Not for Bid Report** will indicate the reason for denial.

ABOUT AUTHORIZATION TO BID

Firms that have not received an Authorization to Bid or Not For Bid Report within a reasonable time of complete and correct original document submittal should contact the Department as to the status. Firms unsure as to authorization status should call the Prequalification Section of the Bureau of Construction at the number listed at the end of these instructions.

ADDENDA AND REVISIONS

It is the bidder's responsibility to determine which, if any, addenda or revisions pertain to any project they may be bidding. Failure to incorporate all relevant addenda or revisions may cause the bid to be declared unacceptable.

Each addendum or revision will be included with the Electronic Plans and Proposals. Addenda and revisions will also be placed on the Addendum/Revision Checklist and each subscription service subscriber will be notified by e-mail of each addendum and revision issued.

The Internet is the Department's primary way of doing business. The subscription service emails are an added courtesy the Department provides. It is suggested that bidders check IDOT's website at <http://www.idot.illinois.gov/doing-business/procurements/construction-services/construction-bulletins/transportation-bulletin/index#TransportationBulletin> before submitting final bid information.

IDOT IS NOT RESPONSIBLE FOR ANY E-MAIL FAILURES.

Addenda questions may be directed to the Contracts Office at (217)782-7806 or DOT.D&Econtracts@illinois.gov

Technical questions about downloading these files may be directed to Tim Garman at (217)524-1642 or Timothy.Garman@illinois.gov.

STANDARD GUIDELINES FOR SUBMITTING BIDS

- All pages should be single sided.
- Use the Cover Page that is provided in the Bid Proposal (posted on the IDOT Web Site) as the first page of your submitted bid. It has the item number in large bold type in the upper left-hand corner and lines provided for your company name and address in the upper right-hand corner.
- Do not use report covers, presentation folders or special bindings and do not staple multiple times on left side like a book. Use only 1 staple in the upper left hand corner. Make sure all elements of your bid are stapled together including the bid bond or guaranty check (if required).
- Do not include any certificates of eligibility, your authorization to bid, Addendum Letters or affidavit of availability.
- Do not include the Subcontractor Documentation with your bid (pages i – iii and pages a – g). This documentation is required only if you are awarded the project.
- Use the envelope cover sheet (provided with the proposal) as the cover for the proposal envelope.
- Do not rely on overnight services to deliver your proposal prior to 10 AM on letting day. It will not be read if it is delivered after 10 AM.
- Do not submit your Substance Abuse Prevention Program (SAPP) with your bid. If you are awarded the contract this form is to be submitted to the district engineer at the pre-construction conference.

BID SUBMITTAL CHECKLIST

- Cover page** (the sheet that has the item number on it) – This should be the first page of your bid proposal, **followed by your bid (the Schedule of Prices/Pay Items)**. If you are using special software or CBID to generate your schedule of prices, do not include the blank pages of the schedule of prices that came with the proposal package.
- Page 4 (Item 9)** – Check “YES” if you will use a subcontractor(s) with an annual value over \$50,000. Include the subcontractor(s) name, address, general type of work to be performed and the dollar amount. If you will use subcontractor(s) but are uncertain who or the dollar amount; check “YES” but leave the lines blank.
- After page 4** – Insert the following documents: The **Illinois Office Affidavit** (Not applicable to federally funded projects) followed by Cost Adjustments for Steel, Bituminous and Fuel (if applicable) and the Contractor Letter of Assent (if applicable). The general rule should be, if you don’t know where it goes, put it after page 4.
- Page 10 (Paragraph J)** – Check “YES” or “NO” whether your company has any business in Iran.
- Page 10 (Paragraph K)** – (Not applicable to federally funded projects) List the name of the apprenticeship and training program sponsor holding the certificate of registration from the US Department of Labor. If no applicable program exists, please indicate the work/job category. Do not include certificates with your bid. Keep the certificates in your office in case they are requested by IDOT.
- Page 11 (Paragraph L)** – A copy of your State Board of Elections certificate of registration is no longer required with your bid.
- Page 11 (Paragraph M)** – Indicate if your company has hired a lobbyist in connection with the job for which you are submitting the bid proposal.
- Page 12 (Paragraph C)** – This is a work sheet to determine if a completed Form A is required. It is not part of the form and you do not need to make copies for each completed Form A.
- Pages 14-17 (Form A)** – One Form A (4 pages) is required for each applicable person in your company. Copies of the forms can be used and only need to be changed when the information changes. The certification signature and date must be original for each letting. **Do not staple the forms together.** If you answered “NO” to all of the questions in Paragraph C (page 12), complete the first section (page 14) with your company information and then sign and date the Not Applicable statement on page 17.
- Page 18 (Form B)** - If you check “YES” to having other current or pending contracts it is acceptable to use the phrase, “See Affidavit of Availability on file”. **Ownership Certification** (at the bottom of the page) - Check N/A if the Form A(s) you submitted accounts for 100 percent of the company ownership. Check YES if any percentage of ownership falls outside of the parameters that require reporting on the Form A. Checking NO indicates that the Form A(s) you submitted is not correct and you will be required to submit a revised Form A.
- Page 20 (Workforce Projection)** – Be sure to include the Duration of the Project. It is acceptable to use the phrase “Per Contract Specifications”.

Proposal Bid Bond – (Insert after the proposal signature page) Submit your proposal Proposal Bid Bond (if applicable) using the current Proposal Bid Bond form provided in the proposal package. The Power of Attorney page should be stapled to the Proposal Bid Bond. If you are using an electronic bond, include your bid bond number on the Proposal Bid Bond and attach the Proof of Insurance printed from the Surety’s Web Site.

Disadvantaged Business Utilization Plan and/or Good Faith Effort – The last items in your bid should be the DBE Utilization Plan (SBE 2026), followed by the DBE Participation Statement (SBE 2025) and supporting paperwork. If you have documentation of a Good Faith Effort, it is to follow the SBE Forms.

The Bid Letting is now available in streaming Audio/Video from the IDOT Web Site. A link to the stream will be placed on the main page of the current letting on the day of the Letting. The stream will not begin until 10 AM. The actual reading of the bids does not begin until approximately 10:30 AM.

Following the Letting, the As-Read Tabulation of Bids will be posted by the end of the day. You will find the link on the main Web page for the current letting.

QUESTIONS: pre-letting up to execution of the contract

Contractor pre-qualification	217-782-3413
Small Business, Disadvantaged Business Enterprise (DBE)	217-785-4611
Contracts, Bids, Letting process or Internet downloads	217-782-7806
Estimates Unit.....	217-785-3483
Aeronautics.....	217-785-8515
IDNR (Land Reclamation, Water Resources, Natural Resources).....	217-782-6302

QUESTIONS: following contract execution

Subcontractor documentation, payments	217-782-3413
Railroad Insurance	217-785-0275

73

RETURN WITH BID

Proposal Submitted By
Name
Address
City

Letting November 21, 2014

NOTICE TO PROSPECTIVE BIDDERS

This proposal can be used for bidding purposes by only those companies that request and receive written **AUTHORIZATION TO BID** from IDOT's Central Bureau of Construction.
BIDDERS NEED NOT RETURN THE ENTIRE PROPOSAL

Notice to Bidders, Specifications, Proposal, Contract and Contract Bond



**Illinois Department
of Transportation**

Springfield, Illinois 62764

**Contract No. 70A76
DEWITT-MCCLEAN Counties
Section BRIDGE PAINTING 2015-2
Various Routes
District 5 Construction Funds**

PLEASE MARK THE APPROPRIATE BOX BELOW:

- A Bid Bond is included.
- A Cashier's Check or a Certified Check is included.
- An Annual Bid Bond is included or is on file with IDOT.

Plans Included
Herein

Prepared by

S

Checked by

(Printed by authority of the State of Illinois)

Page intentionally left blank

RETURN WITH BID



PROPOSAL

TO THE DEPARTMENT OF TRANSPORTATION

1. Proposal of _____

Taxpayer Identification Number (Mandatory) _____ a

For the improvement identified and advertised for bids in the Invitation for Bids as:

**Contract No. 70A76
DEWITT-MCCLEAN Counties
Section BRIDGE PAINTING 2015-2
Various Routes
District 5 Construction Funds**

This project consists of painting 3 bridge structures (SN 020-0024, 057-0132- 057-0110) at various locations in Dewitt and McLean Counties.

2. The undersigned bidder will furnish all labor, material and equipment to complete the above described project in a good and workmanlike manner as provided in the contract documents provided by the Department of Transportation. This proposal will become part of the contract and the terms and conditions contained in the contract documents will govern performance and payments.

RETURN WITH BID

- 3. ASSURANCE OF EXAMINATION AND INSPECTION/WAIVER. The undersigned bidder further declares that he/she has carefully examined the proposal, plans, specifications, addenda, form of contract and contract bond, and special provisions, and that he/she has inspected in detail the site of the proposed work, and that he/she has familiarized themselves with all of the local conditions affecting the contract and the detailed requirements of construction, and understands that in making this bid proposal he/she waives all right to plead any misunderstanding regarding the same.
4. EXECUTION OF CONTRACT AND CONTRACT BOND. The undersigned bidder further agrees to execute a contract for this work and present the same to the department within fifteen (15) days after the contract has been mailed to him/her. The undersigned further agrees that he/she and his/her surety will execute and present within fifteen (15) days after the contract has been mailed to him/her contract bond satisfactory to and in the form prescribed by the Department of Transportation, in the penal sum of the full amount of the contract, or as specified in the special provisions, guaranteeing the faithful performance of the work in accordance with the terms of the contract.
5. PROPOSAL GUARANTY. Accompanying this proposal is either a bid bond on the department form, executed by a corporate surety company satisfactory to the department, or a proposal guaranty check consisting of a bank cashier's check or a properly certified check for not less than 5 per cent of the amount bid or for the amount specified in the following schedule:

Table with 4 columns: Amount of Bid, Proposal Guaranty, Amount of Bid, Proposal Guaranty. It shows a schedule of bid amounts and their corresponding proposal guaranty percentages, ranging from \$5,000 to \$150,000 up to \$35,000,000 and over.

Bank cashier's checks or properly certified checks accompanying bid proposals will be made payable to the Treasurer, State of Illinois.

If a combination bid is submitted, the proposal guaranties which accompany the individual bid proposals making up the combination will be considered as also covering the combination bid.

The amount of the proposal guaranty check is _____ \$(). If this proposal is accepted and the undersigned will fail to execute a contract bond as required herein, it is hereby agreed that the amount of the proposal guaranty will become the property of the State of Illinois, and shall be considered as payment of damages due to delay and other causes suffered by the State because of the failure to execute said contract and contract bond; otherwise, the bid bond will become void or the proposal guaranty check will be returned to the undersigned.

Attach Cashier's Check or Certified Check Here

In the event that one proposal guaranty check is intended to cover two or more bid proposals, the amount must be equal to the sum of the proposal guaranties which would be required for each individual proposal. If the guaranty check is placed in another bid proposal, state below where it may be found.

The proposal guaranty check will be found in the bid proposal for: Item _____
Section No. _____
County _____

Mark the proposal cover sheet as to the type of proposal guaranty submitted.

RETURN WITH BID

6. **COMBINATION BIDS.** The undersigned bidder further agrees that if awarded the contract for the sections contained in the following combination, he/she will perform the work in accordance with the requirements of each individual contract comprising the combination bid specified in the schedule below, and that the combination bid shall be prorated against each section in proportion to the bid submitted for the same. If an error is found to exist in the gross sum bid for one or more of the individual sections included in a combination, the combination bid shall be corrected as provided in the specifications.

When a combination bid is submitted, the schedule below must be completed in each proposal comprising the combination.

If alternate bids are submitted for one or more of the sections comprising the combination, a combination bid must be submitted for each alternate.

Schedule of Combination Bids

Combination No.	Sections Included in Combination	Combination Bid	
		Dollars	Cents

7. **SCHEDULE OF PRICES.** The undersigned bidder submits herewith, in accordance with the rules and instructions, a schedule of prices for the items of work for which bids are sought. The unit prices bid are in U.S. dollars and cents, and all extensions and summations have been made. The bidder understands that the quantities appearing in the bid schedule are approximate and are provided for the purpose of obtaining a gross sum for the comparison of bids. If there is an error in the extension of the unit prices, the unit prices will govern. Payment to the contractor awarded the contract will be made only for actual quantities of work performed and accepted or materials furnished according to the contract. The scheduled quantities of work to be done and materials to be furnished may be increased, decreased or omitted as provided elsewhere in the contract.
8. **AUTHORITY TO DO BUSINESS IN ILLINOIS.** Section 20-43 of the Illinois Procurement Code (the Code) (30 ILCS 500/20-43) provides that a person (other than an individual acting as a sole proprietor) must be a legal entity authorized to do business in the State of Illinois prior to submitting the bid.
9. **EXECUTION OF CONTRACT:** The Department of Transportation will, in accordance with the rules governing Department procurements, execute the contract and shall be the sole entity having the authority to accept performance and make payments under the contract. Execution of the contract by the Chief Procurement Officer (CPO) or the State Purchasing Officer (SPO) is for approval of the procurement process and execution of the contract by the Department. Neither the CPO nor the SPO shall be responsible for administration of the contract or determinations respecting performance or payment there under except as otherwise permitted in the Code.

10. **The services of a subcontractor will be used.**

Check box Yes
 Check box No

For known subcontractors with subcontracts with an annual value of more than \$50,000, the contract shall include their name, address, general type of work to be performed, and the dollar allocation for each subcontractor.
 (30 ILCS 500/20-120)

ILLINOIS DEPARTMENT OF TRANSPORTATION
 SCHEDULE OF PRICES
 CONTRACT
 NUMBER -

State Job # - C-95-031-14

70A76

Project Number

Route

County Name - DEWITT- -

VARIOUS

Code - 39 - -

District - 5 - -

Section Number - BRIDGE PAINTING 2015-2

Item Number	Pay Item Description	Unit of Measure	Quantity	x	Unit Price	=	Total Price
X5060603	C&D N-LEAD PT C RS N3	L SUM	1.000				
X5067501	BR CLN & PT WAR #1	L SUM	1.000				
X5067502	BR CLN & PT WAR #2	L SUM	1.000				
X5067503	BR CLN & PT WAR #3	L SUM	1.000				
X7010410	SPEED DISPLAY TRAILER	CAL MO	3.000				
X7015005	CHANGEABLE MESSAGE SN	CAL DA	28.000				
Z0007101	C&D LEAD PT CL RS N1	L SUM	1.000				
Z0007102	C&D LEAD PT CL RS N2	L SUM	1.000				
Z0010501	CLEAN & PT STL BR N1	L SUM	1.000				
Z0010502	CLEAN & PT STL BR N2	L SUM	1.000				
Z0010503	CLEAN & PT STL BR N3	L SUM	1.000				
67100100	MOBILIZATION	L SUM	1.000				
70100420	TRAF CONT-PROT 701411	EACH	2.000				
70100450	TRAF CONT-PROT 701201	L SUM	1.000				
70100700	TRAF CONT-PROT 701406	L SUM	1.000				

CONTRACT NUMBER

70A76

THIS IS THE TOTAL BID

\$ _____

NOTES:

1. Each PAY ITEM should have a UNIT PRICE and a TOTAL PRICE.
2. The UNIT PRICE shall govern if no TOTAL PRICE is shown or if there is a discrepancy between the product of the UNIT PRICE multiplied by the QUANTITY.
3. If a UNIT PRICE is omitted, the TOTAL PRICE will be divided by the QUANTITY in order to establish a UNIT PRICE.
4. A bid may be declared UNACCEPTABLE if neither a unit price nor a total price is shown.

RETURN WITH BID

STATE REQUIRED ETHICAL STANDARDS GOVERNING CONTRACT PROCUREMENT: ASSURANCES, CERTIFICATIONS AND DISCLOSURES

I. GENERAL

A. Article 50 of the Code establishes the duty of all State CPOs, SPOs, and their designees to maximize the value of the expenditure of public moneys in procuring goods, services, and contracts for the State of Illinois and to act in a manner that maintains the integrity and public trust of State government. In discharging this duty, they are charged by law to use all available information, reasonable efforts, and reasonable actions to protect, safeguard, and maintain the procurement process of the State of Illinois.

B. In order to comply with the provisions of Article 50 and to carry out the duty established therein, all bidders are to adhere to ethical standards established for the procurement process, and to make such assurances, disclosures and certifications required by law. Except as otherwise required in subsection III, paragraphs J-M, by execution of the Proposal Signature Sheet, the bidder indicates that each of the mandated assurances have been read and understood, that each certification is made and understood, and that each disclosure requirement has been understood and completed.

C. In addition to all other remedies provided by law, failure to comply with any assurance, failure to make any disclosure or the making of a false certification shall be grounds for the CPO to void the contract, and may result in the suspension or debarment of the bidder or subcontractor. If a false certification is made by a subcontractor the contractor's submitted bid and the executed contract may not be declared void unless the contractor refuses to terminate the subcontract upon the State's request after a finding that the subcontractor's certification was false.

I acknowledge, understand and accept these terms and conditions.

II. ASSURANCES

The assurances hereinafter made by the bidder are each a material representation of fact upon which reliance is placed should the Department enter into the contract with the bidder.

A. Conflicts of Interest

Section 50-13. Conflicts of Interest.

(a) Prohibition. It is unlawful for any person holding an elective office in this State, holding a seat in the General Assembly, or appointed to or employed in any of the offices or agencies of state government and who receives compensation for such employment in excess of 60% of the salary of the Governor of the State of Illinois, or who is an officer or employee of the Capital Development Board or the Illinois State Toll Highway Authority, or who is the spouse or minor child of any such person to have or acquire any contract, or any direct pecuniary interest in any contract therein, whether for stationery, printing, paper, or any services, materials, or supplies, that will be wholly or partially satisfied by the payment of funds appropriated by the General Assembly of the State of Illinois or in any contract of the Capital Development Board or the Illinois State Toll Highway Authority.

(b) Interests. It is unlawful for any firm, partnership, association or corporation, in which any person listed in subsection (a) is entitled to receive (i) more than 7 1/2% of the total distributable income or (ii) an amount in excess of the salary of the Governor, to have or acquire any such contract or direct pecuniary interest therein.

(c) Combined interests. It is unlawful for any firm, partnership, association, or corporation, in which any person listed in subsection (a) together with his or her spouse or minor children is entitled to receive (i) more than 15%, in the aggregate, of the total distributable income or (ii) an amount in excess of 2 times the salary of the Governor, to have or acquire any such contract or direct pecuniary interest therein.

(d) Securities. Nothing in this Section invalidates the provisions of any bond or other security previously offered or to be offered for sale or sold by or for the State of Illinois.

(e) Prior interests. This Section does not affect the validity of any contract made between the State and an officer or employee of the State or member of the General Assembly, his or her spouse, minor child or any combination of those persons if that contract was in existence before his or her election or employment as an officer, member, or employee. The contract is voidable, however, if it cannot be completed within 365 days after the officer, member, or employee takes office or is employed.

The current salary of the Governor is \$177,412.00. Sixty percent of the salary is \$106,447.20.

RETURN WITH BID

The bidder assures the Department that the award and execution of the contract would not cause a violation of Section 50-13, or that an effective exemption has been issued by the Board of Ethics to any individual subject to the Section 50-13 prohibitions pursuant to the provisions of Section 50-20 of the Code. Information concerning the exemption process is available from the Department upon request.

B. Negotiations

Section 50-15. Negotiations.

It is unlawful for any person employed in or on a continual contractual relationship with any of the offices or agencies of State government to participate in contract negotiations on behalf of that office or agency with any firm, partnership, association, or corporation with whom that person has a contract for future employment or is negotiating concerning possible future employment.

The bidder assures the Department that the award and execution of the contract would not cause a violation of Section 50-15, and that the bidder has no knowledge of any facts relevant to the kinds of acts prohibited therein.

C. Inducements

Section 50-25. Inducement.

Any person who offers or pays any money or other valuable thing to any person to induce him or her not to bid for a State contract or as recompense for not having bid on a State contract is guilty of a Class 4 felony. Any person who accepts any money or other valuable thing for not bidding for a State contract or who withholds a bid in consideration of the promise for the payment of money or other valuable thing is guilty of a Class 4 felony.

The bidder assures the Department that the award and execution of the contract would not cause a violation of Section 50-25, and that the bidder has no knowledge of any facts relevant to the kinds of acts prohibited therein.

D. Revolving Door Prohibition

Section 50-30. Revolving door prohibition.

CPOs, SPOs, procurement compliance monitors, their designees whose principal duties are directly related to State procurement, and executive officers confirmed by the Senate are expressly prohibited for a period of 2 years after terminating an affected position from engaging in any procurement activity relating to the State agency most recently employing them in an affected position for a period of at least 6 months. The prohibition includes, but is not limited to: lobbying the procurement process; specifying; bidding; proposing bid, proposal, or contract documents; on their own behalf or on behalf of any firm, partnership, association, or corporation. This Section applies only to persons who terminate an affected position on or after January 15, 1999.

The bidder assures the Department that the award and execution of the contract would not cause a violation of Section 50-30, and that the bidder has no knowledge of any facts relevant to the kinds of acts prohibited therein.

E. Reporting Anticompetitive Practices

Section 50-40. Reporting anticompetitive practices.

When, for any reason, any vendor, bidder, contractor, CPO, SPO, designee, elected official, or State employee suspects collusion or other anticompetitive practice among any bidders, offerors, contractors, proposers, or employees of the State, a notice of the relevant facts shall be transmitted to the Attorney General and the CPO.

The bidder assures the Department that it has not failed to report any relevant facts concerning the practices addressed in Section 50-40 which may involve the contract for which the bid is submitted.

F. Confidentiality

Section 50-45. Confidentiality.

Any CPO, SPO, designee, or executive officer who willfully uses or allows the use of specifications, competitive bid documents, proprietary competitive information, proposals, contracts, or selection information to compromise the fairness or integrity of the procurement, bidding, or contract process shall be subject to immediate dismissal, regardless of the Personnel code, any contract, or any collective bargaining agreement, and may in addition be subject to criminal prosecution.

The bidder assures the Department that it has no knowledge of any fact relevant to the practices addressed in Section 50-45 which may involve the contract for which the bid is submitted.

RETURN WITH BID

G. Insider Information

Section 50-50. Insider information.

It is unlawful for any current or former elected or appointed State official or State employee to knowingly use confidential information available only by virtue of that office or employment for actual or anticipated gain for themselves or another person.

The bidder assures the Department that it has no knowledge of any facts relevant to the practices addressed in Section 50-50 which may involve the contract for which the bid is submitted.

I acknowledge, understand and accept these terms and conditions for the above assurances.

III. CERTIFICATIONS

The certifications hereinafter made by the bidder are each a material representation of fact upon which reliance is placed should the Department enter into the contract with the bidder. Section 50-2 of the Code provides that every person that has entered into a multi-year contract and every subcontractor with a multi-year subcontract shall certify, by July 1 of each fiscal year covered by the contract after the initial fiscal year, to the responsible CPO whether it continues to satisfy the requirements of Article 50 pertaining to the eligibility for a contract award. If a contractor or subcontractor is not able to truthfully certify that it continues to meet all requirements, it shall provide with its certification a detailed explanation of the circumstances leading to the change in certification status. A contractor or subcontractor that makes a false statement material to any given certification required under Article 50 is, in addition to any other penalties or consequences prescribed by law, subject to liability under the Whistleblower Reward and Protection Act for submission of a false claim.

A. Bribery

Section 50-5. Bribery.

(a) Prohibition. No person or business shall be awarded a contract or subcontract under this Code who:

(1) has been convicted under the laws of Illinois or any other state of bribery or attempting to bribe an officer or employee of the State of Illinois or any other state in that officer's or employee's official capacity; or

(2) has made an admission of guilt of that conduct that is a matter of record but has not been prosecuted for that conduct.

(b) Businesses. No business shall be barred from contracting with any unit of State or local government, or subcontracting under such a contract, as a result of a conviction under this Section of any employee or agent of the business if the employee or agent is no longer employed by the business and:

(1) the business has been finally adjudicated not guilty; or

(2) the business demonstrates to the governmental entity with which it seeks to contract, or which is signatory to the contract which the subcontract relates, and that entity finds that the commission of the offense was not authorized, requested, commanded, or performed by a director, officer, or high managerial agent on behalf of the business as provided in paragraph (2) of subsection (a) of Section 5-4 of the Criminal Code of 2012.

(c) Conduct on behalf of business. For purposes of this Section, when an official, agent, or employee of a business committed the bribery or attempted bribery on behalf of the business and in accordance with the direction or authorization of a responsible official of the business, the business shall be chargeable with the conduct.

(d) Certification. Every bid submitted to and contract executed by the State, and every subcontract subject to Section 20-120 of the Code shall contain a certification by the contractor or the subcontractor, respectively, that the contractor or subcontractor is not barred from being awarded a contract or subcontract under this Section and acknowledges that the CPO may declare the related contract void if any certifications required by this Section are false. A contractor who makes a false statement, material to the certification, commits a Class 3 felony.

The contractor or subcontractor certifies that it is not barred from being awarded a contract under Section 50.5.

B. Felons

Section 50-10. Felons.

(a) Unless otherwise provided, no person or business convicted of a felony shall do business with the State of Illinois or any State agency, or enter into a subcontract, from the date of conviction until 5 years after the date of completion of the sentence for that felony, unless no person held responsible by a prosecutorial office for the facts upon which the conviction was based continues to have any involvement with the business.

(b) Certification. Every bid submitted to and contract executed by the State and every subcontract subject to Section 20-120 of the Code shall contain a certification by the bidder or contractor or subcontractor, respectively, that the bidder, contractor, or subcontractor is not barred from being awarded a contract or subcontract under this Section and acknowledges that the CPO may declare the related contract void if any of the certifications required by this Section are false.

RETURN WITH BID

C. Debt Delinquency

Section 50-11 and 50-12. Debt Delinquency.

The contractor or bidder or subcontractor, respectively, certifies that it, or any affiliate, is not barred from being awarded a contract or subcontract under the Code. Section 50-11 prohibits a person from entering into a contract with a State agency, or entering into a subcontract, if it knows or should know that it, or any affiliate, is delinquent in the payment of any debt to the State as defined by the Debt Collection Board. Section 50-12 prohibits a person from entering into a contract with a State agency, or entering into a subcontract, if it, or any affiliate, has failed to collect and remit Illinois Use Tax on all sales of tangible personal property into the State of Illinois in accordance with the provisions of the Illinois Use Tax Act. The bidder or contractor or subcontractor, respectively, further acknowledges that the CPO may declare the related contract void if this certification is false or if the bidder, contractor, or subcontractor, or any affiliate, is determined to be delinquent in the payment of any debt to the State during the term of the contract.

D. Prohibited Bidders, Contractors and Subcontractors

Section 50-10.5 and 50-60(c). Prohibited bidders, contractors and subcontractors.

The bidder or contractor or subcontractor, respectively, certifies in accordance with 30 ILCS 500/50-10.5 that no officer, director, partner or other managerial agent of the contracting business has been convicted of a felony under the Sarbanes-Oxley Act of 2002 or a Class 3 or Class 2 felony under the Illinois Securities Law of 1953 or if in violation of Subsection (c) for a period of five years from the date of conviction. Every bid submitted to and contract executed by the State and every subcontract subject to Section 20-120 of the Code shall contain a certification by the bidder, contractor, or subcontractor, respectively, that the bidder, contractor, or subcontractor is not barred from being awarded a contract or subcontract under this Section and acknowledges that the CPO shall declare the related contract void if any of the certifications completed pursuant to this Section are false.

E. Section 42 of the Environmental Protection Act

The bidder or contractor or subcontractor, respectively, certifies in accordance with 30 ILCS 500/50-14 that the bidder, contractor, or subcontractor, is not barred from being awarded a contract or entering into a subcontract under this Section which prohibits the bidding on or entering into contracts with the State of Illinois or a State agency, or entering into any subcontract, that is subject to the Code by a person or business found by a court or the Pollution Control Board to have committed a willful or knowing violation of Section 42 of the Environmental Protection Act for a period of five years from the date of the order. The bidder or contractor or subcontractor, respectively, acknowledges that the CPO may declare the contract void if this certification is false.

F. Educational Loan

Section 3 of the Educational Loan Default Act provides no State agency shall contract with an individual for goods or services if that individual is in default, as defined in Section 2 of this Act, on an educational loan. Any contract used by any State agency shall include a statement certifying that the individual is not in default on an educational loan as provided in this Section.

The bidder, if an individual as opposed to a corporation, partnership or other form of business organization, certifies that the bidder is not in default on an educational loan as provided in Section 3 of the Act.

G. Bid-Rigging/Bid Rotating

Section 33E-11 of the Criminal Code of 2012 provides:

(a) Every bid submitted to and public contract executed pursuant to such bid by the State or a unit of local government shall contain a certification by the prime contractor that the prime contractor is not barred from contracting with any unit of State or local government as a result of a violation of either Section 33E-3 or 33E-4 of this Article

(b) A contractor who makes a false statement, material to the certification, commits a Class 3 felony.

A violation of Section 33E-3 would be represented by a conviction of the crime of bid-rigging which, in addition to Class 3 felony sentencing, provides that any person convicted of this offense or any similar offense of any state or the United States which contains the same elements as this offense shall be barred for 5 years from the date of conviction from contracting with any unit of State or local government. No corporation shall be barred from contracting with any unit of State or local government as a result of a conviction under this Section of any employee or agent of such corporation if the employee so convicted is no longer employed by the corporation and: (1) it has been finally adjudicated not guilty or (2) if it demonstrates to the governmental entity with which it seeks to contract and that entity finds that the commission of the offense was neither authorized, requested, commanded, nor performed by a director, officer or a high managerial agent in behalf of the corporation.

RETURN WITH BID

A violation of Section 33E-4 would be represented by a conviction of the crime of bid-rotating which, in addition to Class 2 felony sentencing, provides that any person convicted of this offense or any similar offense of any state or the United States which contains the same elements as this offense shall be permanently barred from contracting with any unit of State or local government. No corporation shall be barred from contracting with any unit of State or local government as a result of a conviction under this Section of any employee or agent of such corporation if the employee so convicted is no longer employed by the corporation and: (1) it has been finally adjudicated not guilty or (2) if it demonstrates to the governmental entity with which it seeks to contract and that entity finds that the commission of the offense was neither authorized, requested, commanded, nor performed by a director, officer or a high managerial agent in behalf of the corporation.

The bidder certifies that it is not barred from contracting with the Department by reason of a violation of either Section 33E-3 or Section 33E-4.

H. International Anti-Boycott

Section 5 of the International Anti-Boycott Certification Act provides every contract entered into by the State of Illinois for the manufacture, furnishing, or purchasing of supplies, material, or equipment or for the furnishing of work, labor, or services, in an amount exceeding the threshold for small purchases according to the purchasing laws of this State or \$10,000.00, whichever is less, shall contain certification, as a material condition of the contract, by which the contractor agrees that neither the contractor nor any substantially-owned affiliated company is participating or shall participate in an international boycott in violation of the provisions of the U.S. Export Administration Act of 1979 or the regulations of the U.S. Department of Commerce promulgated under that Act.

The bidder makes the certification set forth in Section 5 of the Act.

I. Drug Free Workplace

The Illinois "Drug Free Workplace Act" applies to this contract and it is necessary to comply with the provisions of the "Act" if the contractor is a corporation, partnership, or other entity (including a sole proprietorship) which has 25 or more employees.

The bidder certifies that if awarded a contract in excess of \$5,000 it will provide a drug free workplace in compliance with the provisions of the Act.

J. Disclosure of Business Operations in Iran

Section 50-36 of the Code, 30ILCS 500/50-36 provides that each bid, offer, or proposal submitted for a State contract shall include a disclosure of whether or not the Company acting as the bidder, offeror, or proposing entity, or any of its corporate parents or subsidiaries, within the 24 months before submission of the bid, offer, or proposal had business operations that involved contracts with or provision of supplies or services to the Government of Iran, companies in which the Government of Iran has any direct or indirect equity share, consortiums or projects commissioned by the Government of Iran, or companies involved in consortiums or projects commissioned by the Government of Iran and either of the following conditions apply:

- (1) More than 10% of the Company's revenues produced in or assets located in Iran involve oil-related activities or mineral-extraction activities; less than 75% of the Company's revenues produced in or assets located in Iran involve contracts with or provision of oil-related or mineral-extraction products or services to the Government of Iran or a project or consortium created exclusively by that government; and the Company has failed to take substantial action.
- (2) The Company has, on or after August 5, 1996, made an investment of \$20 million or more, or any combination of investments of at least \$10 million each that in the aggregate equals or exceeds \$20 million in any 12-month period, which directly or significantly contributes to the enhancement of Iran's ability to develop petroleum resources of Iran.

The terms "Business operations", "Company", "Mineral-extraction activities", "Oil-related activities", "Petroleum resources", and "Substantial action" are all defined in the Code.

Failure to make the disclosure required by the Code shall cause the bid, offer or proposal to be considered not responsive. The disclosure will be considered when evaluating the bid or awarding the contract. The name of each Company disclosed as doing business or having done business in Iran will be provided to the State Comptroller.

Check the appropriate statement:

Company has no business operations in Iran to disclose.

Company has business operations in Iran as disclosed the attached document.

RETURN WITH BID

K. Apprenticeship and Training Certification (Does not apply to federal aid projects)

In accordance with the provisions of Section 30-22 (6) of the Code, the bidder certifies that it is a participant, either as an individual or as part of a group program, in the approved apprenticeship and training programs applicable to each type of work or craft that the bidder will perform with its own forces. The bidder further certifies for work that will be performed by subcontract that each of its subcontractors submitted for approval either (a) is, at the time of such bid, participating in an approved, applicable apprenticeship and training program; or (b) will, prior to commencement of performance of work pursuant to this contract, begin participation in an approved apprenticeship and training program applicable to the work of the subcontract. The Department, at any time before or after award, may require the production of a copy of each applicable Certificate of Registration issued by the United States Department of Labor evidencing such participation by the contractor and any or all of its subcontractors. Applicable apprenticeship and training programs are those that have been approved and registered with the United States Department of Labor. The bidder shall list in the space below, the official name of the program sponsor holding the Certificate of Registration for all of the types of work or crafts in which the bidder is a participant and that will be performed with the bidder's forces. Types of work or craft work that will be subcontracted shall be included and listed as subcontract work. The list shall also indicate any type of work or craft job category that does not have an applicable apprenticeship or training program. **The bidder is responsible for making a complete report and shall make certain that each type of work or craft job category that will be utilized on the project as reported on the Construction Employee Workforce Projection (Form BC-1256) and returned with the bid is accounted for and listed.**

The requirements of this certification and disclosure are a material part of the contract, and the contractor shall require this certification provision to be included in all approved subcontracts. In order to fulfill this requirement, it shall not be necessary that an applicable program sponsor be currently taking or that it will take applications for apprenticeship, training or employment during the performance of the work of this contract.

TO BE RETURNED WITH BID

L. Political Contributions and Registration with the State Board of Elections

Sections 20-160 and 50-37 of the Code regulate political contributions from business entities and any affiliated entities or affiliated persons bidding on or contracting with the state. Generally under Section 50-37, any business entity, and any affiliated entity or affiliated person of the business entity, whose current year contracts with all state agencies exceed an awarded value of \$50,000, are prohibited from making any contributions to any political committees established to promote the candidacy of the officeholder responsible for the awarding of the contracts or any other declared candidate for that office for the duration of the term of office of the incumbent officeholder or a period 2 years after the termination of the contract, whichever is longer. Any business entity and affiliated entities or affiliated persons whose state contracts in the current year do not exceed an awarded value of \$50,000, but whose aggregate pending bids and proposals on state contracts exceed \$50,000, either alone or in combination with contracts not exceeding \$50,000, are prohibited from making any political contributions to any political committee established to promote the candidacy of the officeholder responsible for awarding the pending contract during the period beginning on the date the invitation for bids or request for proposals is issued and ending on the day after the date of award or selection if the entity was not awarded or selected. Section 20-160 requires certification of registration of affected business entities in accordance with procedures found in Section 9-35 of The Election Code.

By submission of a bid, the contractor business entity acknowledges and agrees that it has read and understands Sections 20-160 and 50-37 of the Code, and that it makes the following certification:

The undersigned bidder certifies that it has registered as a business with the State Board of Elections and acknowledges a continuing duty to update the registration in accordance with the above referenced statutes. If the business entity is required to register, the CPO shall verify that it is in compliance on the date the bid or proposal is due. The CPO shall not accept a bid or proposal if the business entity is not in compliance with the registration requirements.

These requirements and compliance with the above referenced statutory sections are a material part of the contract, and any breach thereof shall be cause to void the contract under Section 50-60 of the Code. This provision does not apply to Federal-aid contracts.

M. Lobbyist Disclosure

Section 50-38 of the Code requires that any bidder or offeror on a State contract that hires a person required to register under the Lobbyist Registration Act to assist in obtaining a contract shall:

- (i) Disclose all costs, fees, compensation, reimbursements, and other remunerations paid or to be paid to the lobbyist related to the contract,
- (ii) Not bill or otherwise cause the State of Illinois to pay for any of the lobbyist's costs, fees, compensation, reimbursements, or other remuneration, and
- (iii) Sign a verification certifying that none of the lobbyist's costs, fees, compensation, reimbursements, or other remuneration were billed to the State.

This information, along with all supporting documents, shall be filed with the agency awarding the contract and with the Secretary of State. The CPO shall post this information, together with the contract award notice, in the online Procurement Bulletin.

Pursuant to Subsection (c) of this Section, no person or entity shall retain a person or entity to attempt to influence the outcome of a procurement decision made under the Code for compensation contingent in whole or in part upon the decision or procurement. Any person who violates this subsection is guilty of a business offense and shall be fined not more than \$10,000.

Bidder acknowledges that it is required to disclose the hiring of any person required to register pursuant to the Illinois Lobbyist Registration Act (25 ILCS 170) in connection with this contract.

Bidder has not hired any person required to register pursuant to the Illinois Lobbyist Registration Act in connection with this contract.

Or

Bidder has hired the following persons required to register pursuant to the Illinois Lobbyist Registration Act in connection with the contract:

Name and address of person: _____
All costs, fees, compensation, reimbursements and other remuneration paid to said person: _____

I acknowledge, understand and accept these terms and conditions for the above certifications.

RETURN WITH BID

IV. DISCLOSURES

- A. The disclosures hereinafter made by the bidder are each a material representation of fact upon which reliance is placed should the Department enter into the contract with the bidder. The bidder further certifies that the Department has received the disclosure forms for each bid.

The CPO may void the bid, or contract, respectively, if it is later determined that the bidder or subcontractor rendered a false or erroneous disclosure. A contractor or subcontractor may be suspended or debarred for violations of the Code. Furthermore, the CPO may void the contract and the surety providing the performance bond shall be responsible for completion of the contract.

B. Financial Interests and Conflicts of Interest

1. Section 50-35 of the Code provides that all bids of more than \$25,000 shall be accompanied by disclosure of the financial interests of the bidder. This disclosed information for the successful bidder, will be maintained as public information subject to release by request pursuant to the Freedom of Information Act, filed with the Procurement Policy Board, and shall be incorporated as a material term of the contract. Furthermore, pursuant to Section 5-5, the Procurement Policy Board may review a proposal, bid, or contract and issue a recommendation to void a contract or reject a proposal or bid based on any violation of the Code or the existence of a conflict of interest as provided in subsections (b) and (d) of Section 50-35.

The financial interests to be disclosed shall include ownership or distributive income share that is in excess of 5%, or an amount greater than 60% of the annual salary of the Governor, of the bidding entity or its parent entity, whichever is less, unless the contractor or bidder is a publicly traded entity subject to Federal 10K reporting, in which case it may submit its 10K disclosure in place of the prescribed disclosure. If a bidder is a privately held entity that is exempt from Federal 10K reporting, but has more than 200 shareholders, it may submit the information that Federal 10K companies are required to report, and list the names of any person or entity holding any ownership share that is in excess of 5%. The disclosure shall include the names, addresses, and dollar or proportionate share of ownership of each person making the disclosure, their instrument of ownership or beneficial relationship, and notice of any potential conflict of interest resulting from the current ownership or beneficial interest of each person making the disclosure having any of the relationships identified in Section 50-35 and on the disclosure form.

The current annual salary of the Governor is \$177,412.00

In addition, all disclosures shall indicate any other current or pending contracts, proposals, leases, or other ongoing procurement relationships the bidding entity has with any other unit of state government and shall clearly identify the unit and the contract, proposal, lease, or other relationship.

2. Disclosure Forms. Disclosure Form A is attached for use concerning the individuals meeting the above ownership or distributive share requirements. A separate Disclosure Form A must be submitted with the bid for each individual meeting the above requirements. In addition, a second form (Disclosure Form B) provides for the disclosure of current or pending procurement relationships with other (non-IDOT) state agencies and a total ownership certification. **The forms must be included with each bid.**

C. Disclosure Form Instructions

Form A Instructions for Financial Information & Potential Conflicts of Interest

If the bidder is a publicly traded entity subject to Federal 10K reporting, the 10K Report may be submitted to meet the requirements of Form A. If a bidder is a privately held entity that is exempt from Federal 10K reporting, but has more than 200 shareholders, it may submit the information that Federal 10K companies are required to report, and list the names of any person or entity holding any ownership share that is in excess of 5%. If a bidder is not subject to Federal 10K reporting, the bidder must determine if any individuals are required by law to complete a financial disclosure form. To do this, the bidder should answer each of the following questions. A "YES" answer indicates Form A must be completed. If the answer to each of the following questions is "NO", then the NOT APPLICABLE STATEMENT on Form A must be signed and dated by a person that is authorized to execute contracts for the bidding company. Note: These questions are for assistance only and are not required to be completed.

1. Does anyone in your organization have a direct or beneficial ownership share of greater than 5% of the bidding entity or parent entity? YES ___ NO ___
2. Does anyone in your organization have a direct or beneficial ownership share of less than 5%, but which has a value greater than 60% of the annual salary of the Governor? YES ___ NO ___
3. Does anyone in your organization receive more than 60% of the annual salary of the Governor of the bidding entity's or parent entity's distributive income? YES ___ NO ___

(Note: Distributive income is, for these purposes, any type of distribution of profits. An annual salary is not distributive income.)

4. Does anyone in your organization receive greater than 5% of the bidding entity's or parent entity's total distributive income, but which is less than 60% of the annual salary of the Governor? YES ___ NO ___

(Note: Only one set of forms needs to be completed per person per bid even if a specific individual would require a yes answer to more than one question.)

A "YES" answer to any of these questions requires the completion of Form A. The bidder must determine each individual in the bidding entity or the bidding entity's parent company that would cause the questions to be answered "Yes". Each form must be signed and dated by a person that is authorized to execute contracts for your organization. **Photocopied or stamped signatures are not acceptable.** The person signing can be, but does not have to be, the person for which the form is being completed. The bidder is responsible for the accuracy of any information provided.

If the answer to each of the above questions is "NO", then the NOT APPLICABLE STATEMENT of Form A must be signed and dated by a person that is authorized to execute contracts for your company.

RETURN WITH BID

Form B: Instructions for Identifying Other Contracts & Procurement Related Information

Disclosure Form B must be completed for each bid submitted by the bidding entity. *Note: Checking the NOT APPLICABLE STATEMENT on Form A does not allow the bidder to ignore Form B. Form B must be completed, checked, and dated or the bidder may be considered nonresponsive and the bid will not be accepted.*

The Bidder shall identify, by checking Yes or No on Form B, whether it has any pending contracts (including leases), bids, proposals, or other ongoing procurement relationship with any other (non-IDOT) State of Illinois agency. If "No" is checked, the bidder only needs to complete the check box on the bottom of Form B. If "Yes" is checked, the bidder must do one of the following:

Option I: If the bidder did not submit an Affidavit of Availability to obtain authorization to bid, the bidder must list all non-IDOT State of Illinois agency pending contracts, leases, bids, proposals, and other ongoing procurement relationships. These items may be listed on Form B or on an attached sheet(s). Do not include IDOT contracts. Contracts with cities, counties, villages, etc. are not considered State of Illinois agency contracts and are not to be included. Contracts with other State of Illinois agencies such as the Department of Natural Resources or the Capital Development Board must be included. Bidders who submit Affidavits of Availability are suggested to use Option II.

Option II: If the bidder is required and has submitted an Affidavit of Availability in order to obtain authorization to bid, the bidder may write or type "See Affidavit of Availability" which indicates that the Affidavit of Availability is incorporated by reference and includes all non-IDOT State of Illinois agency pending contracts, leases, bids, proposals, and other ongoing procurement relationships. For any contracts that are not covered by the Affidavit of Availability, the bidder must identify them on Form B or on an attached sheet(s). These might be such things as leases.

**ILLINOIS DEPARTMENT
OF TRANSPORTATION**

**Form A
Financial Information &
Potential Conflicts of Interest
Disclosure**

Contractor Name		
Legal Address		
City, State, Zip		
Telephone Number	Email Address	Fax Number (if available)

Disclosure of the information contained in this Form is required by the Section 50-35 of the Code (30 ILCS 500). Vendors desiring to enter into a contract with the State of Illinois must disclose the financial information and potential conflict of interest information as specified in this Disclosure Form. This information shall become part of the publicly available contract file. This Form A must be completed for bids in excess of \$25,000, and for all open-ended contracts. **A publicly traded company may submit a 10K disclosure (or equivalent if applicable) in satisfaction of the requirements set forth in Form A. See Disclosure Form Instructions.**

The current annual salary of the Governor is \$177,412.00.

DISCLOSURE OF FINANCIAL INFORMATION

1. Disclosure of Financial Information. The individual named below has an interest in the BIDDER (or its parent) in terms of ownership or distributive income share in excess of 5%, or an interest which has a value of more than 60% of the annual salary of the Governor. **(Make copies of this form as necessary and attach a separate Disclosure Form A for each individual meeting these requirements)**

FOR INDIVIDUAL (type or print information)	
NAME:	_____
ADDRESS	_____
Type of ownership/distributable income share:	
stock _____ sole proprietorship _____ Partnership _____ other: (explain on separate sheet):	
% or \$ value of ownership/distributable income share:	_____

2. Disclosure of Potential Conflicts of Interest. Check "Yes" or "No" to indicate which, if any, of the following potential conflict of interest relationships apply. If the answer to any question is "Yes", please attach additional pages and describe.

- (a) State employment, currently or in the previous 3 years, including contractual employment of services. Yes ___ No ___

If your answer is yes, please answer each of the following questions.

- Are you currently an officer or employee of either the Capitol Development Board or the Illinois State Toll Highway Authority? Yes ___ No ___
- Are you currently appointed to or employed by any agency of the State of Illinois? If you are currently appointed to or employed by any agency of the State of Illinois, and your annual salary exceeds 60% of the annual salary of the Governor, provide the name the State agency for which you are employed and your annual salary. _____

RETURN WITH BID

3. If you are currently appointed to or employed by any agency of the State of Illinois, and your annual salary exceeds 60% of the annual salary of the Governor, are you entitled to receive (i) more than 7 1/2% of the total distributable income of your firm, partnership, association or corporation, or (ii) an amount in excess of 100% of the annual salary of the Governor?
Yes ___ No ___

4. If you are currently appointed to or employed by any agency of the State of Illinois, and your annual salary exceeds 60% of the annual salary of the Governor, are you and your spouse or minor children entitled to receive (i) more than 15 % in the aggregate of the total distributable income of your firm, partnership, association or corporation, or (ii) an amount in excess of two times the salary of the Governor?
Yes ___ No ___

(b) State employment of spouse, father, mother, son, or daughter, including contractual employment for services in the previous 2 years.

Yes ___ No ___

If your answer is yes, please answer each of the following questions.

1. Is your spouse or any minor children currently an officer or employee of the Capitol Development Board or the Illinois State Toll Highway Authority?
Yes ___ No ___

2. Is your spouse or any minor children currently appointed to or employed by any agency of the State of Illinois? If your spouse or minor children is/are currently appointed to or employed by any agency of the State of Illinois, and his/her annual salary exceeds 60% of the annual salary of the Governor, provide the name of your spouse and/or minor children, the name of the State agency for which he/she is employed and his/her annual salary. _____

3. If your spouse or any minor children is/are currently appointed to or employed by any agency of the State of Illinois, and his/her annual salary exceeds 60% of the annual salary of the Governor, are you entitled to receive (i) more than 7 1/2% of the total distributable income of your firm, partnership, association or corporation, or (ii) an amount in excess of 100% of the annual salary of the Governor?
Yes ___ No ___

4. If your spouse or any minor children are currently appointed to or employed by any agency of the State of Illinois, and his/her annual salary exceeds 60% of the annual salary of the Governor, are you and your spouse or minor children entitled to receive (i) more than 15 % in the aggregate of the total distributable income of your firm, partnership, association or corporation, or (ii) an amount in excess of two times the salary of the Governor?
Yes ___ No ___

(c) Elective status; the holding of elective office of the State of Illinois, the government of the United States, any unit of local government authorized by the Constitution of the State of Illinois or the statutes of the State of Illinois currently or in the previous 3 years.
Yes ___ No ___

(d) Relationship to anyone holding elective office currently or in the previous 2 years; spouse, father, mother, son, or daughter.
Yes ___ No ___

(e) Appointive office; the holding of any appointive government office of the State of Illinois, the United States of America, or any unit of local government authorized by the Constitution of the State of Illinois or the statutes of the State of Illinois, which office entitles the holder to compensation in excess of the expenses incurred in the discharge of that office currently or in the previous 3 years.
Yes ___ No ___

(f) Relationship to anyone holding appointive office currently or in the previous 2 years; spouse, father, mother, son, or daughter.
Yes ___ No ___

(g) Employment, currently or in the previous 3 years, as or by any registered lobbyist of the State government.
Yes ___ No ___

RETURN WITH BID

(h) Relationship to anyone who is or was a registered lobbyist in the previous 2 years; spouse, father, mother, son, or daughter. Yes ___ No ___

(i) Compensated employment, currently or in the previous 3 years, by any registered election or reelection committee registered with the Secretary of State or any county clerk of the State of Illinois, or any political action committee registered with either the Secretary of State or the Federal Board of Elections. Yes ___ No ___

(j) Relationship to anyone; spouse, father, mother, son, or daughter; who was a compensated employee in the last 2 years by any registered election or re-election committee registered with the Secretary of State or any county clerk of the State of Illinois, or any political action committee registered with either the Secretary of State or the Federal Board of Elections. Yes ___ No ___

3. Communication Disclosure.

Disclose the name and address of each lobbyist and other agent of the bidder or offeror who is not identified in Section 2 of this form, who is has communicated, is communicating, or may communicate with any State officer or employee concerning the bid or offer. This disclosure is a continuing obligation and must be promptly supplemented for accuracy throughout the process and throughout the term of the contract. If no person is identified, enter "None" on the line below:

Name and address of person(s): _____

RETURN WITH BID

4. Debarment Disclosure. For each of the persons identified under Sections 2 and 3 of this form, disclose whether any of the following has occurred within the previous 10 years: debarment from contracting with any governmental entity; professional licensure discipline; bankruptcies; adverse civil judgments and administrative findings; and criminal felony convictions. This disclosure is a continuing obligation and must be promptly supplemented for accuracy throughout the procurement process and term of the contract. If no person is identified, enter "None" on the line below:

Name of person(s): _____

Nature of disclosure: _____

APPLICABLE STATEMENT

This Disclosure Form A is submitted on behalf of the INDIVIDUAL named on previous page. Under penalty of perjury, I certify the contents of this disclosure to be true and accurate to the best of my knowledge.

Completed by: _____ Date _____
Signature of Individual or Authorized Representative

NOT APPLICABLE STATEMENT

Under penalty of perjury, I have determined that no individuals associated with this organization meet the criteria that would require the completion of this Form A.

This Disclosure Form A is submitted on behalf of the CONTRACTOR listed on the previous page.

_____ Date _____
Signature of Authorized Representative

The bidder has a continuing obligation to supplement these disclosures under Sec. 50-35 of the Code.

RETURN WITH BID

ILLINOIS DEPARTMENT OF TRANSPORTATION

Form B Other Contracts & Financial Related Information Disclosure

Contractor Name, Legal Address, City, State, Zip, Telephone Number, Email Address, Fax Number (if available)

Disclosure of the information contained in this Form is required by the Section 50-35 of the Code (30 ILCS 500). This information shall become part of the publicly available contract file. This Form B must be completed for bids in excess of \$25,000, and for all open-ended contracts.

DISCLOSURE OF OTHER CONTRACTS AND PROCUREMENT RELATED INFORMATION

1. Identifying Other Contracts & Procurement Related Information. The BIDDER shall identify whether it has any pending contracts (including leases), bids, proposals, or other ongoing procurement relationship with any other State of Illinois agency: Yes ___ No ___

If "No" is checked, the bidder only needs to complete the signature box on the bottom of this page.

2. If "Yes" is checked. Identify each such relationship by showing State of Illinois agency name and other descriptive information such as bid or project number (attach additional pages as necessary). SEE DISCLOSURE FORM INSTRUCTIONS:

THE FOLLOWING STATEMENT MUST BE CHECKED

Signature of Authorized Representative, Date

OWNERSHIP CERTIFICATION

Please certify that the following statement is true if the individuals for all submitted Form A disclosures do not total 100% of ownership.

Any remaining ownership interest is held by individuals receiving less than \$106,447.20 of the bidding entity's or parent entity's distributive income or holding less than a 5% ownership interest.

Yes No N/A (Form A disclosure(s) established 100% ownership)

RETURN WITH BID

SPECIAL NOTICE TO CONTRACTORS

The following requirements of the Illinois Department of Human Rights' Rules and Regulations are applicable to bidders on all construction contracts advertised by the Illinois Department of Transportation:

CONSTRUCTION EMPLOYEE UTILIZATION PROJECTION

- (a) All bidders on construction contracts shall complete and submit, along with and as part of their bids, a Bidder's Employee Utilization Form (Form BC-1256) setting forth a projection and breakdown of the total workforce intended to be hired and/or allocated to such contract work by the bidder including a projection of minority and female employee utilization in all job classifications on the contract project.
- (b) The Department of Transportation shall review the Employee Utilization Form, and workforce projections contained therein, of the contract awardee to determine if such projections reflect an underutilization of minority persons and/or women in any job classification in accordance with the Equal Employment Opportunity Clause and Section 7.2 of the Illinois Department of Human Rights' Rules and Regulations for Public Contracts adopted as amended on September 17, 1980. If it is determined that the contract awardee's projections reflect an underutilization of minority persons and/or women in any job classification, it shall be advised in writing of the manner in which it is underutilizing and such awardee shall be considered to be in breach of the contract unless, prior to commencement of work on the contract project, it submits revised satisfactory projections or an acceptable written affirmative action plan to correct such underutilization including a specific timetable geared to the completion stages of the contract.
- (c) The Department of Transportation shall provide to the Department of Human Rights a copy of the contract awardee's Employee Utilization Form, a copy of any required written affirmative action plan, and any written correspondence related thereto. The Department of Human Rights may review and revise any action taken by the Department of Transportation with respect to these requirements.

RETURN WITH BID

**Contract No. 70A76
DEWITT-MCCLEAN Counties
Section BRIDGE PAINTING 2015-2
Various Routes
District 5 Construction Funds**

PART II. WORKFORCE PROJECTION - continued

- B. Included in "Total Employees" under Table A is the total number of **new hires** that would be employed in the event the undersigned bidder is awarded this contract.

The undersigned bidder projects that: (number) _____ new hires would be recruited from the area in which the contract project is located; and/or (number) _____ new hires would be recruited from the area in which the bidder's principal office or base of operation is located.

- C. Included in "Total Employees" under Table A is a projection of numbers of persons to be employed directly by the undersigned bidder as well as a projection of numbers of persons to be employed by subcontractors.

The undersigned bidder estimates that (number) _____ persons will be directly employed by the prime contractor and that (number) _____ persons will be employed by subcontractors.

PART III. AFFIRMATIVE ACTION PLAN

- A. The undersigned bidder understands and agrees that in the event the foregoing minority and female employee utilization projection included under **PART II** is determined to be an underutilization of minority persons or women in any job category, and in the event that the undersigned bidder is awarded this contract, he/she will, prior to commencement of work, develop and submit a written Affirmative Action Plan including a specific timetable (geared to the completion stages of the contract) whereby deficiencies in minority and/or female employee utilization are corrected. Such Affirmative Action Plan will be subject to approval by the contracting agency and the **Department of Human Rights**.
- B. The undersigned bidder understands and agrees that the minority and female employee utilization projection submitted herein, and the goals and timetable included under an Affirmative Action Plan if required, are deemed to be part of the contract specifications.

Company _____ Telephone Number _____

Address _____

NOTICE REGARDING SIGNATURE

The Bidder's signature on the Proposal Signature Sheet will constitute the signing of this form. The following signature block needs to be completed if revisions are required.

Signature: _____ Title: _____ Date: _____

- Instructions: All tables must include subcontractor personnel in addition to prime contractor personnel.
- Table A - Include both the number of employees that would be hired to perform the contract work and the total number currently employed (Table B) that will be allocated to contract work, and include all apprentices and on-the-job trainees. The "Total Employees" column should include all employees including all minorities, apprentices and on-the-job trainees to be employed on the contract work.
- Table B - Include all employees currently employed that will be allocated to the contract work including any apprentices and on-the-job trainees currently employed.
- Table C - Indicate the racial breakdown of the total apprentices and on-the-job trainees shown in Table A.

RETURN WITH BID
Contract No. 70A76
DEWITT-MCCLEAN Counties
Section BRIDGE PAINTING 2015-2
Various Routes
District 5 Construction Funds

PROPOSAL SIGNATURE SHEET

The undersigned bidder hereby makes and submits this bid on the subject Proposal, thereby assuring the Department that all requirements of the Invitation for Bids and rules of the Department have been met, that there is no misunderstanding of the requirements of paragraph 3 of this Proposal, and that the contract will be executed in accordance with the rules of the Department if an award is made on this bid.

(IF AN INDIVIDUAL) Firm Name _____
Signature of Owner _____
Business Address _____

(IF A CO-PARTNERSHIP) Firm Name _____
By _____
Business Address _____
Name and Address of All Members of the Firm:

(IF A CORPORATION)
(IF A JOINT VENTURE, USE THIS SECTION FOR THE MANAGING PARTY AND THE SECOND PARTY SHOULD SIGN BELOW)

Corporate Name _____
By _____
Signature of Authorized Representative _____
Typed or printed name and title of Authorized Representative _____
Attest _____
Signature _____
Business Address _____

(IF A JOINT VENTURE)

Corporate Name _____
By _____
Signature of Authorized Representative _____
Typed or printed name and title of Authorized Representative _____
Attest _____
Signature _____
Business Address _____

If more than two parties are in the joint venture, please attach an additional signature sheet.



This Annual Proposal Bid Bond shall become effective at 12:01 AM (CDST) on _____ and shall be valid until _____ 11:59 PM (CDST).

KNOW ALL PERSONS BY THESE PRESENTS, That We _____

as PRINCIPAL, and _____

as SURETY, and held jointly, severally and firmly bound unto the STATE OF ILLINOIS in the penal sum of 5 percent of the total bid price, or for the amount specified in the bid proposal under "Proposal Guaranty" in effect on the date of the Invitation for Bids, whichever is the lesser sum, well and truly to be paid unto said STATE OF ILLINOIS, for the payment of which we bind ourselves, our heirs, executors, administrators, successors and assigns.

THE CONDITION OF THE FOREGOING OBLIGATION IS SUCH that whereas, the PRINCIPAL may submit bid proposal(s) to the STATE OF ILLINOIS, acting through the Department of Transportation, for various improvements published in the Transportation Bulletin during the effective term indicated above.

NOW, THEREFORE, if the Department shall accept the bid proposal(s) of the PRINCIPAL; and if the PRINCIPAL shall, within the time and as specified in the bidding and contract documents; and if, after award by the Department, the PRINCIPAL shall enter into a contract in accordance with the terms of the bidding and contract documents including evidence of the required insurance coverages and providing such bond as specified with good and sufficient surety for the faithful performance of such contract and for the prompt payment of labor and material furnished in the prosecution thereof; or if, in the event of the failure of the PRINCIPAL to enter into such contract and to give the specified bond, the PRINCIPAL pays to the Department the difference not to exceed the penalty hereof between the amount specified in the bid proposal and such larger amount for which the Department may contract with another party to perform the work covered by said bid proposal, then this obligation shall be null and void, otherwise, it shall remain in full force and effect.

IN THE EVENT the Department determines the PRINCIPAL has failed to comply with any requirement as set forth in the preceding paragraph, then Surety shall pay the penal sum to the Department within fifteen (15) days of written demand therefor. If Surety does not make full payment within such period of time, the Department may bring an action to collect the amount owed. Surety is liable to the Department for all its expenses, including attorney's fees, incurred in any litigation in which it prevails either in whole or in part.

In TESTIMONY WHEREOF, the said PRINCIPAL has caused this instrument to be signed by its officer _____ day of _____ A.D., _____

In TESTIMONY WHEREOF, the said SURETY has caused this instrument to be signed by its officer _____ day of _____ A.D., _____

(Company Name)

(Company Name)

By _____
(Signature and Title)

By _____
(Signature of Attorney-in-Fact)

Notary for PRINCIPAL

Notary for SURETY

STATE OF _____
COUNTY OF _____

STATE OF _____
COUNTY OF _____

Signed and attested before me on _____ (date)

Signed and attested before me on _____ (date)

by _____
(Name of Notary Public)

by _____
(Name of Notary Public)

(Seal) _____
(Signature of Notary Public)

(Seal) _____
(Signature of Notary Public)

(Date Commission Expires)

(Date Commission Expires)

In lieu of completing the above section of the Annual Proposal Bid Bond form, the Principal may file an Electronic Bid Bond. By signing the proposal(s) the Principal is ensuring the identified electronic bid bond has been executed and the Principal and Surety are firmly bound unto the State of Illinois under the conditions of the bid bond as shown above.

Electronic Bid Bond ID #	Company/Bidder Name	Signature and Title
--------------------------	---------------------	---------------------

This bond may be terminated, at Surety's request, upon giving not less than thirty (30) days prior written notice of the cancellation/termination of the bond. Said written notice shall be issued to the Illinois Department of Transportation, Chief Contracts Official, 2300 South Dirksen Parkway, Springfield, Illinois, 62764, and shall be served in person, by receipted courier delivery or certified or registered mail, return receipt requested. Said notice period shall commence on the first calendar day following the Department's receipt of written cancellation/termination notice. Surety shall remain firmly bound to all obligations herein for proposals submitted prior to the cancellation/termination. Surety shall be released and discharged from any obligation(s) for proposals submitted for any letting or date after the effective date of cancellation/termination.



Item No. _____

Letting Date _____

KNOW ALL PERSONS BY THESE PRESENTS, That We _____

as PRINCIPAL, and _____

as SURETY, and held jointly, severally and firmly bound unto the STATE OF ILLINOIS in the penal sum of 5 percent of the total bid price, or for the amount specified in the bid proposal under "Proposal Guaranty" in effect on the date of the Invitation for Bids, whichever is the lesser sum, well and truly to be paid unto said STATE OF ILLINOIS, for the payment of which we bind ourselves, our heirs, executors, administrators, successors and assigns.

THE CONDITION OF THE FOREGOING OBLIGATION IS SUCH that whereas, the PRINCIPAL has submitted a bid proposal to the STATE OF ILLINOIS, acting through the Department of Transportation, for the improvement designated by the Transportation Bulletin Item Number and Letting Date indicated above.

NOW, THEREFORE, if the Department shall accept the bid proposal of the PRINCIPAL; and if the PRINCIPAL shall, within the time and as specified in the bidding and contract documents; and if, after award by the Department, the PRINCIPAL shall enter into a contract in accordance with the terms of the bidding and contract documents including evidence of the required insurance coverages and providing such bond as specified with good and sufficient surety for the faithful performance of such contract and for the prompt payment of labor and material furnished in the prosecution thereof; or if, in the event of the failure of the PRINCIPAL to enter into such contract and to give the specified bond, the PRINCIPAL pays to the Department the difference not to exceed the penalty hereof between the amount specified in the bid proposal and such larger amount for which the Department may contract with another party to perform the work covered by said bid proposal, then this obligation shall be null and void, otherwise, it shall remain in full force and effect.

IN THE EVENT the Department determines the PRINCIPAL has failed to comply with any requirement as set forth in the preceding paragraph, then Surety shall pay the penal sum to the Department within fifteen (15) days of written demand therefor. If Surety does not make full payment within such period of time, the Department may bring an action to collect the amount owed. Surety is liable to the Department for all its expenses, including attorney's fees, incurred in any litigation in which it prevails either in whole or in part.

In TESTIMONY WHEREOF, the said PRINCIPAL has caused this instrument to be signed by its officer
_____ day of _____ A.D., _____ .

In TESTIMONY WHEREOF, the said SURETY has caused this instrument to be signed by its officer
_____ day of _____ A.D., _____ .

(Company Name)

(Company Name)

By _____
(Signature and Title)

By _____
(Signature of Attorney-in-Fact)

Notary for PRINCIPAL

Notary for SURETY

STATE OF _____
COUNTY OF _____

STATE OF _____
COUNTY OF _____

Signed and attested before me on _____ (date)
by _____
(Name of Notary Public)

Signed and attested before me on _____ (date)
by _____
(Name of Notary Public)

(Seal) _____
(Signature of Notary Public)

(Seal) _____
(Signature of Notary Public)

(Date Commission Expires)

(Date Commission Expires)

In lieu of completing the above section of the Proposal Bid Bond form, the Principal may file an Electronic Bid Bond. By signing the proposal the Principal is ensuring the identified electronic bid bond has been executed and the Principal and Surety are firmly bound unto the State of Illinois under the conditions of the bid bond as shown above.

Electronic Bid Bond ID # _____ Company/Bidder Name _____ Signature and Title _____



(1) Policy

It is public policy that disadvantageded businesses as defined in 49 CFR Part 26 and the Special Provision shall have the maximum opportunity to participate in the performance of contracts financed in whole or in part with Federal or State funds. Consequently the requirements of 49 CFR Part 26 apply to this contract.

(2) Obligation

The contractor agrees to ensure that disadvantageded businesses as defined in 49 CFR Part 26 and the Special Provision have the maximum opportunity to participate in the performance of contracts or subcontracts financed in whole or in part with Federal or State funds. The contractor shall take all necessary and reasonable steps in accordance with 49 CFR Part 26 and the Special Provision to ensure that said businesses have the maximum opportunity to compete for and perform under this contract. The contractor shall not discriminate on the basis of race, color, national origin or sex in the award and performance of contracts.

(3) Project and Bid Identification

Complete the following information concerning the project and bid:

Route _____

Section _____

Project _____

County _____

Letting Date _____

Contract No. _____

Letting Item No. _____

Total Bid _____

Contract DBE Goal _____

(Percent) (Dollar Amount)

(4) Assurance

I, acting in my capacity as an officer of the undersigned bidder (or bidders if a joint venture), hereby assure the Department that on this project my company : (check one)

- Meets or exceeds contract award goals and has provided documented participation as follows:
Disadvantaged Business Participation _____ percent

Attached are the signed participation statements, forms SBE 2025, required by the Special Provision evidencing availability and use of each business participating in this plan and assuring that each business will perform a commercially useful function in the work of the contract.

- Failed to meet contract award goals and has included good faith effort documentation to meet the goals and that my company has provided participation as follows:
Disadvantaged Business Participation _____ percent

The contract goals should be accordingly modified or waived. Attached is all information required by the Special Provision in support of this request including good faith effort. Also attached are the signed participation statements, forms SBE 2025, required by the Special Provision evidencing availability and use of each business participating in this plan and assuring that each business will perform a commercially useful function in the work of the contract.

_____ Company

By _____

Title _____

Date _____

The "as read" Low Bidder is required to comply with the Special Provision.

Submit only one utilization plan for each project. The utilization plan shall be submitted in accordance with the special provision.

Bureau of Small Business Enterprises **Local Let Projects**
2300 South Dirksen Parkway Submit forms to the
Springfield, Illinois 62764 Local Agency

The Department of Transportation is requesting disclosure of information that is necessary to accomplish the purpose as outlined under State and Federal law. Disclosure of this information is **REQUIRED**. Failure to provide any information will result in the contract not being awarded. This form has been approved by the State Forms Manager Center.



Illinois Department of Transportation

DBE Participation Statement

Subcontractor Registration Number _____

Letting _____

Participation Statement

Item No. _____

(1) Instructions

Contract No. _____

This form must be completed for each disadvantaged business participating in the Utilization Plan. This form shall be submitted in accordance with the special provision and will be attached to the Utilization Plan form. If additional space is needed complete an additional form for the firm.

(2) Work:

Please indicate: J/V _____ Manufacturer _____ Supplier (60%) _____ Subcontractor _____ Trucking _____

Pay Item No.	Description	Quantity	Unit Price	Total
Total				

(3) Partial Payment Items (For any of the above items which are partial pay items)

Description must be sufficient to determine a Commercially Useful Function, specifically describe the work and subcontract dollar amount:

(4) Commitment

When a DBE is to be a second-tier subcontractor, or if the first-tier DBE subcontractor is going to be subcontracting a portion of its subcontract, it must be clearly indicated on the DBE Participation Statement, and the details of the transaction fully explained.

In the event a DBE subcontractor second-tiers a portion of its subcontract to one or more subcontractors during the work of a contract, the prime must submit a DBE Participation Statement, with the details of the transaction(s) fully explained.

The undersigned certify that the information included herein is true and correct, and that the DBE firm listed below has agreed to perform a commercially useful function in the work of the contract item(s) listed above and to execute a contract with the prime contractor or 1st Tier subcontractor. The undersigned further understand that no changes to this statement may be made without prior approval from the Department's Bureau of Small Business Enterprises and that complete and accurate information regarding actual work performed on this project and the payment therefore must be provided to the Department.

Signature for Contractor __ 1st Tier __ 2nd Tier

Signature for DBE Firm __ 1st Tier __ 2nd Tier

Title _____

Title _____

Date _____

Date _____

Contact Person _____

Contact Person _____

Phone _____

Phone _____

Firm Name _____

Firm Name _____

Address _____

Address _____

City/State/Zip _____

City/State/Zip _____

E _____

WC _____

The Department of Transportation is requesting disclosure of information that is necessary to accomplish the statutory purpose as outlined under the state and federal law. Disclosure of this information is **REQUIRED**. Failure to provide any information will result in the contract not being awarded. This form has been approved by the State Forms Management Center.

PROPOSAL ENVELOPE



PROPOSALS

for construction work advertised for bids by the
Illinois Department of Transportation

Item No.	Item No.	Item No.

Submitted By:

Name:
Address:
Phone No.

Bidders should use an IDOT proposal envelope or affix this form to the front of a 10" x 13" envelope for the submittal of bids. If proposals are mailed, they should be enclosed in a second or outer envelope addressed to:

Engineer of Design and Environment - Room 326
Illinois Department of Transportation
2300 South Dirksen Parkway
Springfield, Illinois 62764

NOTICE

Individual bids, including Bid Bond and/or supplemental information if required, should be securely stapled.

CONTRACTOR OFFICE COPY OF CONTRACT SPECIFICATIONS

NOTICE

None of the following material needs to be returned with the bid package unless the special provisions require documentation and/or other information to be submitted.

**Contract No. 70A76
DEWITT-MCCLEAN Counties
Section BRIDGE PAINTING 2015-2
Various Routes
District 5 Construction Funds**



Illinois Department of Transportation

SUBCONTRACTOR DOCUMENTATION

Public Acts 96-0795, 96-0920, and 97-0895 enacted substantial changes to the provisions of the Code (30 ILCS 500). Among the changes are provisions affecting subcontractors. The Contractor awarded this contract will be required as a material condition of the contract to implement and enforce the contract requirements applicable to subcontractors that entered into a contractual agreement with a total value of \$50,000 or more with a person or entity who has a contract subject to the Code and approved in accordance with article 108.01 of the Standard Specifications for Road and Bridge Construction.

If the Contractor seeks approval of subcontractors to perform a portion of the work, and approval is granted by the Department, the Contractor shall provide a copy of the subcontract to the Illinois Department of Transportation's CPO upon request within 15 calendar days after execution of the subcontract.

Financial disclosures required pursuant to Sec. 50-35 of the Code must be submitted for all applicable subcontractors. The subcontract shall contain the certifications required to be made by subcontractors pursuant to Article 50 of the Code. This Notice to Bidders includes a document incorporating all required subcontractor certifications and disclosures for use by the Contractor in compliance with this mandate. The document is entitled State Required Ethical Standards Governing Subcontractors.

RETURN WITH SUBCONTRACT

STATE ETHICAL STANDARDS GOVERNING SUBCONTRACTORS

Article 50 of the Code establishes the duty of all State CPOs, SPOs, and their designees to maximize the value of the expenditure of public moneys in procuring goods, services, and contracts for the State of Illinois and to act in a manner that maintains the integrity and public trust of State government. In discharging this duty, they are charged by law to use all available information, reasonable efforts, and reasonable actions to protect, safeguard, and maintain the procurement process of the State of Illinois.

The certifications hereinafter made by the subcontractor are each a material representation of fact upon which reliance is placed should the Department approve the subcontractor. The CPO may terminate or void the contract approval if it is later determined that the bidder or subcontractor rendered a false or erroneous certification. If a false certification is made by a subcontractor the contractor's submitted bid and the executed contract may not be declared void unless the contractor refuses to terminate the subcontract upon the State's request after a finding that the subcontractor's certification was false.

Section 50-2 of the Code provides that every person that has entered into a multi-year contract and every subcontractor with a multi-year subcontract shall certify, by July 1 of each fiscal year covered by the contract after the initial fiscal year, to the responsible CPO whether it continues to satisfy the requirements of Article 50 pertaining to the eligibility for a contract award. If a contractor or subcontractor is not able to truthfully certify that it continues to meet all requirements, it shall provide with its certification a detailed explanation of the circumstances leading to the change in certification status. A contractor or subcontractor that makes a false statement material to any given certification required under Article 50 is, in addition to any other penalties or consequences prescribed by law, subject to liability under the Whistleblower Reward and Protection Act for submission of a false claim.

A. Bribery

Section 50-5. Bribery.

(a) Prohibition. No person or business shall be awarded a contract or subcontract under this Code who:

(1) has been convicted under the laws of Illinois or any other state of bribery or attempting to bribe an officer or employee of the State of Illinois or any other state in that officer's or employee's official capacity; or

(2) has made an admission of guilt of that conduct that is a matter of record but has not been prosecuted for that conduct.

(b) Businesses. No business shall be barred from contracting with any unit of State or local government, or subcontracting under such a contract, as a result of a conviction under this Section of any employee or agent of the business if the employee or agent is no longer employed by the business and:

(1) the business has been finally adjudicated not guilty; or

(2) the business demonstrates to the governmental entity with which it seeks to contract, or which is signatory to the contract to which the subcontract relates, and that entity finds that the commission of the offense was not authorized, requested, commanded, or performed by a director, officer, or high managerial agent on behalf of the business as provided in paragraph (2) of subsection (a) of Section 5-4 of the Criminal Code of 2012.

(c) Conduct on behalf of business. For purposes of this Section, when an official, agent, or employee of a business committed the bribery or attempted bribery on behalf of the business and in accordance with the direction or authorization of a responsible official of the business, the business shall be chargeable with the conduct.

(d) Certification. Every bid submitted to and contract executed by the State, and every subcontract subject to Section 20-120 of the Code shall contain a certification by the contractor or the subcontractor, respectively, that the contractor or subcontractor is not barred from being awarded a contract or subcontract under this Section and acknowledges that the CPO may declare the related contract void if any certifications required by this Section are false. A contractor who makes a false statement, material to the certification, commits a Class 3 felony.

The contractor or subcontractor certifies that it is not barred from being awarded a contract under Section 50.5.

B. Felons

Section 50-10. Felons.

Unless otherwise provided, no person or business convicted of a felony shall do business with the State of Illinois or any State agency, or enter into a subcontract, from the date of conviction until 5 years after the date of completion of the sentence for that felony, unless no person held responsible by a prosecutorial office for the facts upon which the conviction was based continues to have any involvement with the business.

Certification. Every bid submitted to and contract executed by the State and every subcontract subject to Section 20-120 of the Code shall contain a certification by the bidder or contractor or subcontractor, respectively, that the bidder, contractor, or subcontractor is not barred from being awarded a contract or subcontract under this Section and acknowledges that the CPO may declare the related contract void if any of the certifications required by this Section are false.

RETURN WITH SUBCONTRACT

C. Debt Delinquency

Section 50-11 and 50-12. Debt Delinquency.

The contractor or bidder or subcontractor, respectively, certifies that it, or any affiliate, is not barred from being awarded a contract or subcontract under the Code. Section 50-11 prohibits a person from entering into a contract with a State agency, or entering into a subcontract, if it knows or should know that it, or any affiliate, is delinquent in the payment of any debt to the State as defined by the Debt Collection Board. Section 50-12 prohibits a person from entering into a contract with a State agency, or entering into a subcontract, if it, or any affiliate, has failed to collect and remit Illinois Use Tax on all sales of tangible personal property into the State of Illinois in accordance with the provisions of the Illinois Use Tax Act. The bidder or contractor or subcontractor, respectively, further acknowledges that the CPO may declare the related contract void if this certification is false or if the bidder, contractor, or subcontractor, or any affiliate, is determined to be delinquent in the payment of any debt to the State during the term of the contract.

D. Prohibited Bidders, Contractors and Subcontractors

Section 50-10.5 and 50-60(c). Prohibited bidders, contractors and subcontractors.

The bidder or contractor or subcontractor, respectively, certifies in accordance with 30 ILCS 500/50-10.5 that no officer, director, partner or other managerial agent of the contracting business has been convicted of a felony under the Sarbanes-Oxley Act of 2002 or a Class 3 or Class 2 felony under the Illinois Securities Law of 1953 or if in violation of Subsection (c) for a period of five years from the date of conviction. Every bid submitted to and contract executed by the State and every subcontract subject to Section 20-120 of the Code shall contain a certification by the bidder, contractor, or subcontractor, respectively, that the bidder, contractor, or subcontractor is not barred from being awarded a contract or subcontract under this Section and acknowledges that the CPO shall declare the related contract void if any of the certifications completed pursuant to this Section are false.

E. Section 42 of the Environmental Protection Act

The bidder or contractor or subcontractor, respectively, certifies in accordance with 30 ILCS 500/50-14 that the bidder, contractor, or subcontractor, is not barred from being awarded a contract or entering into a subcontract under this Section which prohibits the bidding on or entering into contracts with the State of Illinois or a State agency, or entering into any subcontract, that is subject to the Code by a person or business found by a court or the Pollution Control Board to have committed a willful or knowing violation of Section 42 of the Environmental Protection Act for a period of five years from the date of the order. The bidder or contractor or subcontractor, respectively, acknowledges that the CPO may declare the contract void if this certification is false.

The undersigned, on behalf of the subcontracting company, has read and understands the above certifications and makes the certifications as required by law.

_____ Name of Subcontracting Company		
_____ Authorized Officer	_____ Date	

RETURN WITH SUBCONTRACT
SUBCONTRACTOR DISCLOSURES

I. DISCLOSURES

- A.** The disclosures hereinafter made by the subcontractor are each a material representation of fact upon which reliance is placed. The subcontractor further certifies that the Department has received the disclosure forms for each subcontract.

The CPO may void the bid, contract, or subcontract, respectively, if it is later determined that the bidder or subcontractor rendered a false or erroneous disclosure. A contractor or subcontractor may be suspended or debarred for violations of the Code. Furthermore, the CPO may void the contract.

B. Financial Interests and Conflicts of Interest

1. Section 50-35 of the Code provides that all subcontracts with a total value of \$50,000 or more from subcontractors identified in Section 20-120 of the Code, shall be accompanied by disclosure of the financial interests of the subcontractor. This disclosed information for the subcontractor, will be maintained as public information subject to release by request pursuant to the Freedom of Information Act, filed with the Procurement Policy Board, and shall be incorporated as a material term of the Prime Contractor's contract. Furthermore, pursuant to this Section, the Procurement Policy Board may recommend to allow or void a contract or subcontract based on a potential conflict of interest.

The financial interests to be disclosed shall include ownership or distributive income share that is in excess of 5%, or an amount greater than 60% of the annual salary of the Governor, of the subcontracting entity or its parent entity, whichever is less, unless the subcontractor is a publicly traded entity subject to Federal 10K reporting, in which case it may submit its 10K disclosure in place of the prescribed disclosure. If a subcontractor is a privately held entity that is exempt from Federal 10K reporting, but has more than 200 shareholders, it may submit the information that Federal 10K companies are required to report, and list the names of any person or entity holding any ownership share that is in excess of 5%. The disclosure shall include the names, addresses, and dollar or proportionate share of ownership of each person making the disclosure, their instrument of ownership or beneficial relationship, and notice of any potential conflict of interest resulting from the current ownership or beneficial interest of each person making the disclosure having any of the relationships identified in Section 50-35 and on the disclosure form.

The current annual salary of the Governor is \$177,412.00.

In addition, all disclosures shall indicate any other current or pending contracts, subcontracts, proposals, leases, or other ongoing procurement relationships the subcontracting entity has with any other unit of state government and shall clearly identify the unit and the contract, subcontract, proposal, lease, or other relationship.

2. Disclosure Forms. Disclosure Form A is attached for use concerning the individuals meeting the above ownership or distributive share requirements. A separate Disclosure Form A must be submitted with the bid for each individual meeting the above requirements. In addition, a second form (Disclosure Form B) provides for the disclosure of current or pending procurement relationships with other (non-IDOT) state agencies and a total ownership certification. **The forms must be included with each bid.**

C. Disclosure Form Instructions

Form A Instructions for Financial Information & Potential Conflicts of Interest

If the subcontractor is a publicly traded entity subject to Federal 10K reporting, the 10K Report may be submitted to meet the requirements of Form A. If a subcontractor is a privately held entity that is exempt from Federal 10K reporting, but has more than 200 shareholders, it may submit the information that Federal 10K companies are required to report, and list the names of any person or entity holding any ownership share that is in excess of 5%. If a subcontractor is not subject to Federal 10K reporting, the subcontractor must determine if any individuals are required by law to complete a financial disclosure form. To do this, the subcontractor should answer each of the following questions. A "YES" answer indicates Form A must be completed. If the answer to each of the following questions is "NO", then the **NOT APPLICABLE STATEMENT** on the second page of Form A must be signed and dated by a person that is authorized to execute contracts for the subcontracting company. Note: These questions are for assistance only and are not required to be completed.

1. Does anyone in your organization have a direct or beneficial ownership share of greater than 5% of the bidding entity or parent entity? YES ___ NO ___
2. Does anyone in your organization have a direct or beneficial ownership share of less than 5%, but which has a value greater than 60% of the annual salary of the Governor? YES ___ NO ___
3. Does anyone in your organization receive more than 60% of the annual salary of the Governor of the subcontracting entity's or parent entity's distributive income? YES ___ NO ___

(Note: Distributive income is, for these purposes, any type of distribution of profits. An annual salary is not distributive income.)

4. Does anyone in your organization receive greater than 5% of the subcontracting entity's or parent entity's total distributive income, but which is less than 60% of the annual salary of the Governor? YES ___ NO ___

(Note: Only one set of forms needs to be completed per person per subcontract even if a specific individual would require a yes answer to more than one question.)

A "YES" answer to any of these questions requires the completion of Form A. The subcontractor must determine each individual in the subcontracting entity or the subcontracting entity's parent company that would cause the questions to be answered "Yes". Each form must be signed and dated by a person that is authorized to execute contracts for your organization. **Photocopied or stamped signatures are not acceptable.** The person signing can be, but does not have to be, the person for which the form is being completed. The subcontractor is responsible for the accuracy of any information provided.

If the answer to each of the above questions is "NO", then the **NOT APPLICABLE STATEMENT** on page 2 of Form A must be signed and dated by a person that is authorized to execute contracts for your company.

RETURN WITH SUBCONTRACT

Form B: Instructions for Identifying Other Contracts & Procurement Related Information

Disclosure Form B must be completed for each subcontract submitted by the subcontracting entity. *Note: Checking the NOT APPLICABLE STATEMENT on Form A does not allow the subcontractor to ignore Form B. Form B must be completed, checked, and dated or the subcontract will not be approved.*

The Subcontractor shall identify, by checking Yes or No on Form B, whether it has any pending contracts, subcontracts, leases, bids, proposals, or other ongoing procurement relationship with any other (non-IDOT) State of Illinois agency. If "No" is checked, the subcontractor only needs to complete the check box on the bottom of Form B. If "Yes" is checked, the subcontractor must list all non-IDOT State of Illinois agency pending contracts, subcontracts, leases, bids, proposals, and other ongoing procurement relationships. These items may be listed on Form B or on an attached sheet(s). Contracts with cities, counties, villages, etc. are not considered State of Illinois agency contracts and are not to be included. Contracts or subcontracts with other State of Illinois agencies such as the Department of Natural Resources or the Capital Development Board must be included.

ILLINOIS DEPARTMENT OF TRANSPORTATION

Form A Subcontractor: Financial Information & Potential Conflicts of Interest Disclosure

Subcontractor Name, Legal Address, City, State, Zip, Telephone Number, Email Address, Fax Number (if available)

Disclosure of the information contained in this Form is required by the Section 50-35 of the Code (30 ILCS 500). Subcontractors desiring to enter into a subcontract of a State of Illinois contract must disclose the financial information and potential conflict of interest information as specified in this Disclosure Form.

The current annual salary of the Governor is \$177,412.00.

DISCLOSURE OF FINANCIAL INFORMATION

1. Disclosure of Financial Information. The individual named below has an interest in the SUBCONTRACTOR (or its parent) in terms of ownership or distributive income share in excess of 5%, or an interest which has a value of more than 60% of the annual salary of the Governor.

FOR INDIVIDUAL (type or print information) NAME: ADDRESS Type of ownership/distributable income share: stock sole proprietorship Partnership other: (explain on separate sheet): % or \$ value of ownership/distributable income share:

2. Disclosure of Potential Conflicts of Interest. Check "Yes" or "No" to indicate which, if any, of the following potential conflict of interest relationships apply. If the answer to any question is "Yes", please attach additional pages and describe.

(a) State employment, currently or in the previous 3 years, including contractual employment of services. Yes ___ No ___

If your answer is yes, please answer each of the following questions.

1. Are you currently an officer or employee of either the Capitol Development Board or the Illinois State Toll Highway Authority? Yes ___ No ___

2. Are you currently appointed to or employed by any agency of the State of Illinois? If you are currently appointed to or employed by any agency of the State of Illinois, and your annual salary exceeds 60% of the annual salary of the Governor, provide the name the State agency for which you are employed and your annual salary.

RETURN WITH SUBCONTRACT

3. If you are currently appointed to or employed by any agency of the State of Illinois, and your annual salary exceeds 60% of the annual salary of the Governor, are you entitled to receive (i) more than 7 1/2% of the total distributable income of your firm, partnership, association or corporation, or (ii) an amount in excess of 100% of the annual salary of the Governor?
Yes ___ No ___

4. If you are currently appointed to or employed by any agency of the State of Illinois, and your annual salary exceeds 60% of the annual salary of the Governor, are you and your spouse or minor children entitled to receive (i) more than 15 % in the aggregate of the total distributable income of your firm, partnership, association or corporation, or (ii) an amount in excess of two times the salary of the Governor?
Yes ___ No ___

(b) State employment of spouse, father, mother, son, or daughter, including contractual employment services in the previous 2 years.

Yes ___ No ___

If your answer is yes, please answer each of the following questions.

1. Is your spouse or any minor children currently an officer or employee of the Capitol Development Board or the Illinois Toll Highway Authority?
Yes ___ No ___

2. Is your spouse or any minor children currently appointed to or employed by any agency of the State of Illinois? If your spouse or minor children is/are currently appointed to or employed by any agency of the State of Illinois, and his/her annual salary exceeds 60% of the annual salary of the Governor, provide the name of your spouse and/or minor children, the name of the State agency for which he/she is employed and his/her annual salary. _____

3. If your spouse or any minor children is/are currently appointed to or employed by any agency of the State of Illinois, and his/her annual salary exceeds 60% of the annual salary of the Governor, as of 7/1/07) are you entitled to receive (i) more then 7 1/2% of the total distributable income of your firm, partnership, association or corporation, or (ii) an amount in excess of 100% of the annual salary of the Governor?
Yes ___ No ___

4. If your spouse or any minor children are currently appointed to or employed by any agency of the State of Illinois, and his/her annual salary exceeds 60% of the annual salary of the Governor, are you and your spouse or minor children entitled to receive (i) more than 15 % in the aggregate of the total distributable income of your firm, partnership, association or corporation, or (ii) an amount in excess of two times the annual salary of the Governor?
Yes ___ No ___

(c) Elective status; the holding of elective office of the State of Illinois, the government of the United States, any unit of local government authorized by the Constitution of the State of Illinois or the statutes of the State of Illinois currently or in the previous 3 years.
Yes ___ No ___

(d) Relationship to anyone holding elective office currently or in the previous 2 years; spouse, father, mother, son, or daughter.
Yes ___ No ___

(e) Appointive office; the holding of any appointive government office of the State of Illinois, the United States of America, or any unit of local government authorized by the Constitution of the State of Illinois or the statutes of the State of Illinois, which office entitles the holder to compensation in excess of the expenses incurred in the discharge of that office currently or in the previous 3 years.
Yes ___ No ___

(f) Relationship to anyone holding appointive office currently or in the previous 2 years; spouse, father, mother, son, or daughter.
Yes ___ No ___

(g) Employment, currently or in the previous 3 years, as or by any registered lobbyist of the State government.
Yes ___ No ___

RETURN WITH SUBCONTRACT

(h) Relationship to anyone who is or was a registered lobbyist in the previous 2 years; spouse, father, mother, son, or daughter. Yes ___ No ___

(i) Compensated employment, currently or in the previous 3 years, by any registered election or reelection committee registered with the Secretary of State or any county clerk of the State of Illinois, or any political action committee registered with either the Secretary of State or the Federal Board of Elections. Yes ___ No ___

(j) Relationship to anyone; spouse, father, mother, son, or daughter; who was a compensated employee in the last 2 years by any registered election or re-election committee registered with the Secretary of State or any county clerk of the State of Illinois, or any political action committee registered with either the Secretary of State or the Federal Board of Elections. Yes ___ No ___

3 Communication Disclosure.

Disclose the name and address of each lobbyist and other agent of the bidder or offeror who is not identified in Section 2 of this form, who is has communicated, is communicating, or may communicate with any State officer or employee concerning the bid or offer. This disclosure is a continuing obligation and must be promptly supplemented for accuracy throughout the process and throughout the term of the contract. If no person is identified, enter "None" on the line below:

Name and address of person(s): _____

RETURN WITH SUBCONTRACT

4. Debarment Disclosure. For each of the persons identified under Sections 2 and 3 of this form, disclose whether any of the following has occurred within the previous 10 years: debarment from contracting with any governmental entity; professional licensure discipline; bankruptcies; adverse civil judgments and administrative findings; and criminal felony convictions. This disclosure is a continuing obligation and must be promptly supplemented for accuracy throughout the procurement process and term of the contract. If no person is identified, enter "None" on the line below:

Name of person(s): _____

Nature of disclosure: _____

APPLICABLE STATEMENT

This Disclosure Form A is submitted on behalf of the INDIVIDUAL named on previous page. Under penalty of perjury, I certify the contents of this disclosure to be true and accurate to the best of my knowledge.

Completed by: _____ Date _____
Signature of Individual or Authorized Officer

NOT APPLICABLE STATEMENT

Under penalty of perjury, I have determined that no individuals associated with this organization meet the criteria that would require the completion of this Form A.

This Disclosure Form A is submitted on behalf of the SUBCONTRACTOR listed on the previous page.

_____ Date _____
Signature of Authorized Officer

RETURN WITH SUBCONTRACT

ILLINOIS DEPARTMENT OF TRANSPORTATION

Form B
Subcontractor: Other Contracts & Financial Related Information Disclosure

Form with fields: Subcontractor Name, Legal Address, City, State, Zip, Telephone Number, Email Address, Fax Number (if available)

Disclosure of the information contained in this Form is required by the Section 50-35 of the Code (30 ILCS 500). This information shall become part of the publicly available contract file. This Form B must be completed for subcontracts with a total value of \$50,000 or more, from subcontractors identified in Section 20-120 of the Code, and for all open-ended contracts.

DISCLOSURE OF OTHER CONTRACTS, SUBCONTRACTS, AND PROCUREMENT RELATED INFORMATION

1. Identifying Other Contracts & Procurement Related Information. The SUBCONTRACTOR shall identify whether it has any pending contracts, subcontracts, including leases, bids, proposals, or other ongoing procurement relationship with any other State of Illinois agency: Yes ___ No ___

If "No" is checked, the subcontractor only needs to complete the signature box on the bottom of this page.

2. If "Yes" is checked. Identify each such relationship by showing State of Illinois agency name and other descriptive information such as bid or project number (attach additional pages as necessary). SEE DISCLOSURE FORM INSTRUCTIONS:

THE FOLLOWING STATEMENT MUST BE CHECKED

Signature box with fields: Signature of Authorized Representative, Date

OWNERSHIP CERTIFICATION

Please certify that the following statement is true if the individuals for all submitted Form A disclosures do not total 100% of ownership

Any remaining ownership interest is held by individuals receiving less than \$106,447.20 of the bidding entity's or parent entity's distributive income or holding less than a 5% ownership interest.

Yes No N/A (Form A disclosure(s) established 100% ownership)



NOTICE TO BIDDERS

1. TIME AND PLACE OF OPENING BIDS. Sealed proposals for the improvement described herein will be received by the Department of Transportation. Electronic bids are to be submitted to the electronic bidding system (icx-Integrated Contractors Exchange). Paper-based bids are to be submitted to the Chief Procurement Officer for the Department of Transportation in care of the Chief Contracts Official at the Harry R. Hanley Building, 2300 South Dirksen Parkway, in Springfield, Illinois until 10:00 o'clock a.m. November 21, 2014. All bids will be gathered, sorted, publicly opened and read in the auditorium at the Department of Transportation's Harry R. Hanley Building shortly after the 10:00 a.m. cut off time.

2. DESCRIPTION OF WORK. The proposed improvement is identified and advertised for bids in the Invitation for Bids as:

**Contract No. 70A76
DEWITT-MCCLEAN Counties
Section BRIDGE PAINTING 2015-2
Various Routes
District 5 Construction Funds**

This project consists of painting 3 bridge structures (SN 020-0024, 057-0132- 057-0110) at various locations in Dewitt and McLean Counties.

3. INSTRUCTIONS TO BIDDERS. (a) This Notice, the invitation for bids, proposal and letter of award shall, together with all other documents in accordance with Article 101.09 of the Standard Specifications for Road and Bridge Construction, become part of the contract. Bidders are cautioned to read and examine carefully all documents, to make all required inspections, and to inquire or seek explanation of the same prior to submission of a bid.

(b) State law, and, if the work is to be paid wholly or in part with Federal-aid funds, Federal law requires the bidder to make various certifications as a part of the proposal and contract. By execution and submission of the proposal, the bidder makes the certification contained therein. A false or fraudulent certification shall, in addition to all other remedies provided by law, be a breach of contract and may result in termination of the contract.

4. AWARD CRITERIA AND REJECTION OF BIDS. This contract will be awarded to the lowest responsive and responsible bidder considering conformity with the terms and conditions established by the Department in the rules, Invitation for Bids and contract documents. The issuance of plans and proposal forms for bidding based upon a prequalification rating shall not be the sole determinant of responsibility. The Department reserves the right to determine responsibility at the time of award, to reject any or all proposals, to readvertise the proposed improvement, and to waive technicalities.

By Order of the
Illinois Department of Transportation

Erica J. Borggren,
Acting Secretary

INDEX
FOR
SUPPLEMENTAL SPECIFICATIONS
AND RECURRING SPECIAL PROVISIONS

Adopted January 1, 2014

This index contains a listing of SUPPLEMENTAL SPECIFICATIONS, frequently used RECURRING SPECIAL PROVISIONS, and LOCAL ROADS AND STREETS RECURRING SPECIAL PROVISIONS.

ERRATA Standard Specifications for Road and Bridge Construction (Adopted 1-1-12) (Revised 1-1-14)

SUPPLEMENTAL SPECIFICATIONS

<u>Std. Spec. Sec.</u>	<u>Page No.</u>
101 Definition of Terms	1
102 Advertisement, Bidding, Award, and Contract Execution	2
105 Control of Work	3
106 Control of Materials	5
107 Legal Regulations and Responsibility to Public	6
108 Prosecution and Progress	14
109 Measurement and Payment	15
202 Earth and Rock Excavation	17
211 Topsoil and Compost	18
253 Planting Woody Plants	19
280 Temporary Erosion and Sediment Control	21
312 Stabilized Subbase	22
406 Hot-Mix Asphalt Binder and Surface Course	23
407 Hot-Mix Asphalt Pavement (Full-Depth)	26
420 Portland Cement Concrete Pavement	30
424 Portland Cement Concrete Sidewalk	32
440 Removal of Existing Pavement and Appurtenances	33
503 Concrete Structures	34
504 Precast Concrete Structures	37
506 Cleaning and Painting New Steel Structures	38
512 Piling	39
516 Drilled Shafts	40
521 Bearings	41
540 Box Culverts	42
588 Bridge Relief Joint System	43
589 Elastic Joint Sealer	45
602 Catch Basin, Manhole, Inlet, Drainage Structure, and Valve Vault Construction, Adjustment, and Reconstruction	46
603 Adjusting Frames and Grates of Drainage and Utility Structures	47
606 Concrete Gutter, Curb, Median, and Paved Ditch	49
610 Shoulder Inlets with Curb	50
639 Precast Prestressed Concrete Sight Screen	51
642 Shoulder Rumble Strips	52
643 Impact Attenuators	53
644 High Tension Cable Median Barrier	55
701 Work Zone Traffic Control and Protection	57
706 Impact Attenuators, Temporary	60
707 Movable Traffic Barrier	63
708 Temporary Water Filled Barrier	65
730 Wood Sign Support	67
780 Pavement Striping	68
860 Master Controller	73
1001 Cement	74
1003 Fine Aggregates	75
1004 Coarse Aggregates	77
1006 Metals	81
1011 Mineral Filler	83

Various Routes
Section BRIDGE PAINTING 2015-2
DeWitt and McLean Counties
Contract 70A76

1017	Packaged, Dry, Combined Materials for Mortar	84
1018	Packaged Rapid Hardening Mortar or Concrete	85
1019	Controlled Low-Strength Material	86
1020	Portland Cement Concrete	87
1024	Grout and Nonshrink Grout	126
1030	Hot-Mix Asphalt	127
1040	Drain Pipe, Tile, Drainage Mat, and Wall Drain	132
1042	Precast Concrete Products	133
1070	Foundation and Breakaway Devices	134
1073	Controller	135
1081	Materials for Planting	136
1082	Prefomed Bearing Pads	137
1083	Elastomeric Bearings	138
1095	Pavement Markings	139
1101	General Equipment	142
1102	Hot-Mix Asphalt Equipment	144
1105	Pavement Marking Equipment	146
1106	Work Zone Traffic Control Devices	147

RECURRING SPECIAL PROVISIONS

The following RECURRING SPECIAL PROVISIONS indicated by an "X" are applicable to this contract and are included by reference:

<u>CHECK SHEET #</u>		<u>PAGE NO.</u>
1	Additional State Requirements for Federal-Aid Construction Contracts (Eff. 2-1-69) (Rev. 1-1-10)	149
2	Subletting of Contracts (Federal-Aid Contracts) (Eff. 1-1-88) (Rev. 5-1-93)	152
3	X EEO (Eff. 7-21-78) (Rev. 11-18-80)	153
4	X Specific Equal Employment Opportunity Responsibilities Non Federal-Aid Contracts (Eff. 3-20-69) (Rev. 1-1-94)	163
5	X Required Provisions - State Contracts (Eff. 4-1-65) (Rev. 1-1-13)	168
6	Asbestos Bearing Pad Removal (Eff. 11-1-03)	173
7	Asbestos Waterproofing Membrane and Asbestos Hot-Mix Asphalt Surface Removal (Eff. 6-1-89) (Rev. 1-1-09)	174
8	Haul Road Stream Crossings, Other Temporary Stream Crossings, and In-Stream Work Pads (Eff. 1-2-92) (Rev. 1-1-98)	175
9	Construction Layout Stakes Except for Bridges (Eff. 1-1-99) (Rev. 1-1-07)	176
10	Construction Layout Stakes (Eff. 5-1-93) (Rev. 1-1-07)	179
11	Use of Geotextile Fabric for Railroad Crossing (Eff. 1-1-95) (Rev. 1-1-07)	182
12	Subsealing of Concrete Pavements (Eff. 11-1-84) (Rev. 1-1-07)	184
13	Hot-Mix Asphalt Surface Correction (Eff. 11-1-87) (Rev. 1-1-09)	188
14	Pavement and Shoulder Resurfacing (Eff. 2-1-00) (Rev. 1-1-09)	190
15	PCC Partial Depth Hot-Mix Asphalt Patching (Eff. 1-1-98) (Rev. 1-1-07)	191
16	Patching with Hot-Mix Asphalt Overlay Removal (Eff. 10-1-95) (Rev. 1-1-07)	193
17	Polymer Concrete (Eff. 8-1-95) (Rev. 1-1-08)	194
18	PVC Pipeliner (Eff. 4-1-04) (Rev. 1-1-07)	196
19	Pipe Underdrains (Eff. 9-9-87) (Rev. 1-1-07)	197
20	X Guardrail and Barrier Wall Delineation (Eff. 12-15-93) (Rev. 1-1-12)	198
21	Bicycle Racks (Eff. 4-1-94) (Rev. 1-1-12)	202
22	Temporary Modular Glare Screen System (Eff. 1-1-00) (Rev. 1-1-07)	204
23	Temporary Portable Bridge Traffic Signals (Eff. 8-1-03) (Rev. 1-1-07)	206
24	X Work Zone Public Information Signs (Eff. 9-1-02) (Rev. 1-1-07)	208
25	Night Time Inspection of Roadway Lighting (Eff. 5-1-96)	209
26	English Substitution of Metric Bolts (Eff. 7-1-96)	210
27	English Substitution of Metric Reinforcement Bars (Eff. 4-1-96) (Rev. 1-1-03)	211
28	Calcium Chloride Accelerator for Portland Cement Concrete (Eff. 1-1-01) (Rev. 1-1-13)	212
29	Portland Cement Concrete Inlay or Overlay for Pavements (Eff. 11-1-08) (Rev. 1-1-13)	213
30	Quality Control of Concrete Mixtures at the Plant (Eff. 8-1-00) (Rev. 1-1-14)	216
31	Quality Control/Quality Assurance of Concrete Mixtures (Eff. 4-1-92) (Rev. 1-1-14)	224
32	Digital Terrain Modeling for Earthwork Calculations (Eff. 4-1-07)	240
33	Pavement Marking Removal (Eff. 4-1-09)	242
34	Preventive Maintenance – Bituminous Surface Treatment (Eff. 1-1-09) (Rev. 1-1-12)	243
35	Preventive Maintenance – Cape Seal (Eff. 1-1-09) (Rev. 1-1-12)	249
36	Preventive Maintenance – Micro-Surfacing (Eff. 1-1-09) (Rev. 1-1-12)	264
37	Preventive Maintenance – Slurry Seal (Eff. 1-1-09) (Rev. 1-1-12)	275
38	Temporary Raised Pavement Markers (Eff. 1-1-09) (Rev. 1-1-14)	285
39	Restoring Bridge Approach Pavements Using High-Density Foam (Eff. 1-1-09) (Rev. 1-1-12)	286

TABLE OF CONTENTS

INTENT OF PROJECT	1
DESCRIPTION OF WORK	1
TRAFFIC CONTROL PLAN.....	1
LONGITUDINAL TEMPORARY TRAFFIC BARRIER SYSTEM.....	3
PUBLIC NOTIFICATION.....	3
CHANGEABLE MESSAGE SIGN.....	4
PROJECT WORK HOURS	5
NO IN-STREAM WORK.....	5
WARRANTY FOR CLEANING AND PAINTING STEEL STRUCTURES	5
STATUS OF UTILITIES	14
CLEANING AND PAINTING EXISTING STEEL STRUCTURES	15
CONTAINMENT AND DISPOSAL OF LEAD PAINT CLEANING RESIDUES	34
CONTAINMENT AND DISPOSAL OF NON-LEAD PAINT CLEANING RESIDUES	58
CONTRACT CLAIMS (BDE).....	73
DISADVANTAGED BUSINESS ENTERPRISE PARTICIPATION (BDE).....	74
PAYROLLS AND PAYROLL RECORDS (BDE)	83
PROGRESS PAYMENTS (BDE)	85
REMOVAL AND DISPOSAL OF REGULATED SUBSTANCES (BDE).....	86
REMOVAL AND DISPOSAL OF SURPLUS MATERIALS (BDE).....	89
SPEED DISPLAY TRAILER (BDE).....	90
TRACKING THE USE OF PESTICIDES (BDE).....	91
WEEKLY DBE TRUCKING REPORTS (BDE).....	91
WORKING DAYS (BDE).....	92

STATE OF ILLINOIS
SPECIAL PROVISIONS

The following Special Provisions supplement the “Standard Specifications for Road and Bridge Construction, Adopted January 1, 2012”, the latest edition of the “Manual on Uniform Traffic Control Devices for Streets and Highways”, and the “Manual of Test Procedures for Materials” in effect on the date of invitation for bids, and the “Supplemental Specifications and Recurring Special Provisions” indicated on the Check Sheet included herein, which apply to and govern the construction of Various Routes, Section BRIDGE PAINTING 2015-2, in DeWitt and McLean Counties, Contract 70A76, and in case of conflict with any part, or parts, of said Specifications, the said Special Provisions shall take precedence and shall govern.

INTENT OF PROJECT

The intent of this project is to clean and paint the structural steel of 3 (three) existing bridges for improved maintenance with a minimum disruption to the motoring public and adjacent environment.

Location 1: SN 020-0024 I-74 at m.p. 154.8, W. of Farmer City in Dewitt County.

Location 2: SN 057-0132 I-74 at m.p. 149, Leroy exit in McLean County.

Location 3: SN 057-0110, IL route 165 over Mackinaw River S. of Colfax in McLean County.

DESCRIPTION OF WORK

Locations 1 thru 3: Clean structural steel to SSPC SP10 (near white blast), prime, and paint per individual location.

TRAFFIC CONTROL PLAN

Eff. 09-11-1990
Rev. 01-01-2014

Traffic control shall be in accordance with the applicable sections of the Standard Specifications for Road and Bridge Construction, the applicable guidelines contained in the Illinois Manual on Uniform Traffic Control Devices for Streets and Highways, these Special Provisions and any special details and highway standards contained herein and in the plans.

Special attention is called to Articles 107.09 and 107.14 of the Standard Specifications, the following Highway Standards relating to Traffic Control, and the listed Supplemental Specifications and Recurring Special Provisions.

Highway Standards: 701101 701106 701201 701400 701402 701406
701411 701901

Traffic: It is the intention of the Department that I-74 and IL-165 are kept open to traffic at all times during the construction of this section. At any particular location on I-74 or IL-165 when a lane is closed to traffic, the Contractor shall keep all equipment, materials, and vehicles out of the opposite lane and off the right-of-way.

The following traffic control standards shall be utilized during, but not limited to, the listed construction operations:

TRAFFIC CONTROL AND PROTECTION, STANDARD 701101

Traffic Control and Protection, Standard 701101 shall be used for storage of painting and blasting equipment while working on areas of the structure where equipment can be stored 2 to 15 feet off the pavement edge on multilane roadways, during working hours. Traffic Control and Protection, Standard 701101 will not be measured for payment.

TRAFFIC CONTROL AND PROTECTION, STANDARD 701106

Traffic Control and Protection, Standard 701106 shall be used where equipment can be placed 15 ft. or greater off roadway on multilane roadways with speed limits greater than or equal to 45 mph. Traffic Control and Protection, Standard 701106 will not be measured for payment.

TRAFFIC CONTROL AND PROTECTION, STANDARD 701201

Traffic Control and Protection, Standard 701201 shall be used at location 5 for daytime closures on IL-165. Two certified flaggers will be required at all times when Traffic Control and Protection, Standard 701201 is used. Traffic Control and Protection, Standard 701201 will be measured for payment on a lump sum basis for TRAFFIC CONTROL AND PROTECTION, STANDARD 701201.

TRAFFIC CONTROL AND PROTECTION, STANDARD 701400

Traffic Control and Protection, Standard 701400 shall be used where anytime a lane is closed on I-74 (mainline). Traffic Control and Protection, Standard 701400 will not be measured for payment.

TRAFFIC CONTROL AND PROTECTION, STANDARD 701402 & 701406

If the contractor chooses to use the water filled barrier wall, layout shall be per the requirements of Standard 701406.

Traffic Control and Protection, Standard 701402 shall be used for storage of wash, blast, recovery, and paint equipment while items related to cleaning and painting are completed. No temporary striping shall be required due to the short duration of the work. Water-filled barrier wall must have markers installed per Standard 701402. Vertical panels with steady burn lights or equivalent shall be at 25' centers on water filled barrier wall taper. Traffic control and protection required under standard 701402 will be measured for payment on a lump sum basis for TRAFFIC CONTROL AND PROTECTION, STANDARD 701406.

Traffic Control and Protection, Standard 701406 shall be used for storage of wash, blast, recovery, and paint equipment during work hours only, while items related to cleaning and painting are completed. Cones will be allowed during daytime operations with the approval of the Engineer. If water filled barrier option is used, a flagger will be required during set up and removal of barrier. After barrier is set up and filled, the flagger will not be required. Work zone speed limit signs and flagger traffic control and protection required under Standard 701406 will be measured for payment on a lump sum basis for TRAFFIC CONTROL AND PROTECTION, STANDARD 701406

TRAFFIC CONTROL AND PROTECTION, STANDARD 701411

Traffic Control and Protection, Standard 701411 shall be used where, at any time any vehicle, equipment, workers or their activities require a lane closure in close proximity of an exit or entrance ramp and supplements other traffic control standards for lane closures. Traffic Control and Protection, Standard 701411 is to be used at the I-74 east and west bound lanes, exit 149 at Leroy. Traffic control and protection required under Standard 701411 will be measured for payment on an each basis for TRAFFIC CONTROL AND PROTECTION, STANDARD 701411.

Each ramp will be considered one each per location listed above, regardless of the number of setups required.

ADDITIONAL TRAFFIC CONTROL SIGNS

At Location 2: "Road Construction Ahead" signs shall be added on the northbound and southbound lanes at FAS 1478 over I-74. The cost of furnishing, installing, maintaining, relocating, and removing of these signs will be included in TRAFFIC CONTROL PROTECTION, STANDARD 701406 with no additional compensation allowed.

LONGITUDINAL TEMPORARY TRAFFIC BARRIER SYSTEM

Description: This work shall consist of furnishing, installing, maintaining, relocating, and removing a temporary longitudinal traffic barrier system at locations shown on the plans. This work is not required, but is at the Contractor's option.

Materials shall be per the requirements of Article 1106.02(k) of the Standard Specifications.

Construction requirements shall be per the requirements of Article 708.03 of the Standard Specifications.

The cost of furnishing, installing, maintaining, relocating, and removing of a temporary longitudinal traffic barrier system will be included in TRAFFIC CONTROL PROTECTION, STANDARD 701406 with no additional compensation allowed.

PUBLIC NOTIFICATION

Changeable Message Signs shall be placed seven (7) days prior to the beginning of construction to inform the public of upcoming work. Changeable Message Signs shall be placed in advance of the project site at locations to be determined by the Engineer.

CHANGEABLE MESSAGE SIGN

Eff. 03-23-2004

Rev. 01-01-2014

This work shall consist of furnishing, placing, and maintaining changeable message sign(s) at the location(s) shown on the plans or as directed by the Engineer.

The sign(s) shall be trailer mounted. The message panel shall be at least 7 ft (2.1 m) above the pavement, present a level appearance, and be capable of displaying up to eight characters in each of three lines at a time. Character height shall be 18 inches (450 mm).

The message panel shall be of either a bulb matrix or disc matrix design controlled by an onboard computer capable of storing a minimum of 99 programmed messages for instant recall. The computer shall be capable of being programmed to accept messages created by the operator via an alpha-numeric keyboard and able to flash any six messages in sequence. The message panel shall also be capable of being controlled by a computer from a remote location via a cellular linkage. The Contractor shall supply the modem, the cellular phone, and the necessary software to run the sign from a remote computer at a location designated by the Engineer. The Contractor shall promptly program and/or reprogram the computer to provide the messages as directed by the Engineer.

The message panel shall be visible from $\frac{1}{4}$ mile (400 m) under both day and night conditions. The letters shall be legible from 750 ft (250 m).

The sign shall include automatic dimming for nighttime operation and a power supply capable of providing 24 hours of uninterrupted service.

The Contractor shall provide all preventive maintenance efforts s(he) deems necessary to achieve uninterrupted service. If service is interrupted for any cause and not restored within 24 hours, the Engineer will cause such work to be performed as may be necessary to provide this service. The cost of such work shall be borne by the Contractor or deducted from current or future compensation due the Contractor.

When the sign(s) are displaying messages, they shall be considered a traffic control device. At all times when no message is displayed, they shall be considered equipment.

Basis of Payment: When portable changeable message signs are shown on the Standard, this work will not be paid for separately, but shall be considered as included in the cost of the Standard.

For all other portable changeable message signs, this work will be paid for at the contract unit price per CALENDAR DAY for CHANGEABLE MESSAGE SIGN. Any portion of one calendar day during which the sign is operated as directed by the Engineer shall be paid as one full calendar day.

PROJECT WORK HOURS

In addition to the requirements of Article 107.09 of the Standard Specifications, all work on this contract will be limited to the hours of 6:00 a.m. to 7:30 p.m., Monday through Saturday. Any work performed outside of the listed times will not be eligible for payment.

NO IN-STREAM WORK

No in-stream work will be allowed on this project. A 404 Permit was not obtained for this project, prohibiting any type in-stream work. Construction haul roads, work pads, wing dams, rip rap placement, bank excavation or other such activities will not be needed or allowed for this project.

WARRANTY FOR CLEANING AND PAINTING STEEL STRUCTURES

Description: This work consists of providing a warranty for the cleaning and painting of existing steel structures as performed under the following pay items; CLEANING AND PAINTING STEEL BRIDGE and CONTAINMENT AND DISPOSAL OF LEAD PAINT CLEANING RESIDUES, and/or CONTAINMENT AND DISPOSAL OF NON-LEAD PAINT CLEANING RESIDUES at the designated location(s).

The Contractor shall unconditionally warrant to the Illinois Department of Transportation (IDOT) that all work completed under the above contract pay items, including all materials and workmanship furnished by the Contractor and subcontractors, shall comply with the Contract, and that the cleaning and painting system applied to the bridge be free of defects, as hereinafter defined for a period of two years after the Warranty Period Start Date.

The work associated with the above stated pay items shall be accomplished according to all contract documents and the Special Provisions for Cleaning and Painting Existing Steel Structures and Containment and Disposal of Lead Paint Cleaning Residues. Acceptance by the Engineer, of any portion of the work during the original contract for cleaning and painting, will not relieve the Contractor of the requirements of this warranty.

The Contractor guarantees that after receipt of notice from the Department as provided herein, he/she shall perform the warranty work specified in the notice in accordance with the original specifications including all necessary incidental work to complete the work and restore the complete facility. The Contractor shall also guarantee to repair all damage to adjoining structures caused by failure of the warranted work, including but not limited to removal, engineering, material procurement, reinstallation, or replacement all at the Contractor's cost and expense. The Department's remedies under this warranty are not exclusive but are in addition to any other remedies provided by this contract or law. The additional obligations undertaken by the Contractor to provide this express warranty and to perform in accordance herewith shall be secured by a performance and payment bond provided by the Contractor in a form furnished by the Department, and said bond to remain in full force and effect for the duration of the warranty period.

Definitions:

Conflict Resolution Team (CRT): A three-member team responsible for resolving disputes between the Department and the Contractor regarding any claims of non-compliance of the warranty requirements.

Warranty Bond: A bond that guarantees the cleaning and painting installed under the contract, against defects in materials and/or workmanship, which may develop after the Warranty Period Start Date for the specified Warranty Period. The warranty bond shall be in force continuously, from the date of the first Warranty Period Start Date, until release from the warranty on the last warranted portion of the work.

Warranted Distress: The cleaning and painting will be considered distressed if any occurrence of visible rust or rust breakthrough, paint blistering, peeling, or scaling are discovered during the Warranty Period.

Warranty Period: A two year duration initiating on the Warranty Period Start Date.

Warranty Period Start Date: The date the Engineer and Contractor document and execute the final inspection will constitute the start date for the warranty period for the project.

Under Contracts where the cleaning and painting of more than one structure is to be warranted under this item, the Warranty Period Start Date shall be the date the final inspection is executed for the last structure to be cleaned and painted.

Warranty Work: Corrective action taken to bring the Warranted Distress into compliance for release of the Warranty Bond. If corrective action is required for more than 40 percent of the structure during the warranty period, the paint system for the entire structure or structures shall be removed and replaced as directed by the Department.

Working Days: Any calendar day between May 1 and November 30 inclusive except Saturdays, Sundays, or legal holidays observed by the Contractor's entire workforce in Illinois.

Commencement of Warranty Period: At the final inspection according to Article 105.13, the Engineer and Contractor shall review the cleaning and painting for compliance with the contract, including any written documentation from the Contractor required by the contract. The Engineer and the Contractor shall document and execute the final inspection on a form furnished by the Department when the cleaning and painting of the structure(s) is determined by the Engineer to be in compliance with the Contract. This date is then the Warranty Period Start Date.

Acceptance by the Engineer of work that used material from deficient lots, or otherwise accepted per Article 105.03, will not relieve the Contractor of meeting the warranty requirements for the cleaning and painting of the structure(s).

Warranty Bond: The Contractor shall furnish the Department a performance and payment bond with good and sufficient sureties in the full amount equal to 20 percent of the as bid total for all the applicable pay items related to the cleaning and painting of the structure(s) in this contract as the penal sum. The surety shall be acceptable to the Department, shall waive notice of any changes and extensions of time, and shall submit its bond on the form furnished by the Department. The bond will ensure completion of required Warranty Work, including payments for all labor, equipment, materials, and closure periods used to remediate any Warranted Distress.

At the end of the two year Warranty Period and remedy of any distress occurring within the Warranty Period, the Contractor will be released, in writing, from further Warranty Work, provided all previous Warranty Work has been completed and approved by the Engineer.

Warranty Requirements: During the warranty period, the Contractor may monitor the warranted work using non-destructive procedures. All laboratories and equipment used for independent testing shall be approved by the Department.

The Department will notify the Contractor of the need for Warranty Work. If the Contractor disputes the Department's request for Warranty Work written notification of the dispute shall be provided to the Department within 30 days. However, any dispute by the Contractor shall be based on the appraisals and technical merit of a NACE Certified Inspector. If the Contractor and the Department are not able to resolve the matter between them, either party may seek resolution of the dispute by the Conflict Resolution Team (CRT). The Department will provide final notification to the Contractor within 14 days of receipt of the CRT's final judgment.

The Contractor shall perform Warranty Work promptly as defined in the notification. The notification will provide a requested start date for performance of Warranty Work covered by the notice, and a number of working days estimated to complete the Warranty Work. The Department and the Contractor may agree upon a start date and a reasonable period of performance to define prompt completion.

If the Contractor fails to promptly complete the warranty work specified in the notice or as specified by the CRT, or otherwise breaches its obligations under this provision, the Department may declare the Contractor to be in default, and may proceed to terminate the rights of the Contractor and to cause the completion of the work in the manner approved in Article 108.10 of the Standard Specifications. The Contractor agrees to indemnify and hold harmless the Department on account of default, including but not limited to the cost and expense of any future warranty work required.

The Contractor shall repair all distressed areas, identified by the Engineer, according to the original painting specifications. A repair procedure shall be submitted in writing to the Engineer for review and approval prior to commencing any work. All paint repair work will be done the same season as the inspection, unless the seasonal limitations stated in the painting specifications prevents the completion that season. In this case, the corrective work will be completed the following season. The Engineer shall be allowed full inspection of all operations and provided safe access to the areas being repaired.

The Contractor may perform preventative action with the approval of the Department, at no cost to the Department. Prior to proceeding with any work, the Contractor shall obtain a permit from the Department. A Traffic Control Plan shall be submitted and approved by the Department prior to any lane closures. The Department may restrict the time of work according to the traffic needs surrounding the structure.

Evaluation of the warranted work will be accomplished on a per bridge basis. Warranty work by the Contractor shall be approved by the Department and meet the same requirements of the original warranted work specified herein.

If warranty work or elective preventative action performed by the Contractor necessitates a corrective action to the structure, then such corrective action to those areas shall be the responsibility of the Contractor.

The Department may perform routine maintenance during the warranty such as Bridge washing, applying de-icing chemicals, repairs to safety appurtenances, etc. Such work shall not relieve the Contractor of their responsibilities as specified herein.

Rights and Responsibilities of the Department:

The Department:

- a. Is responsible for notifying the Contractor, in writing, of any required warranty work.
- b. Reserves the right to approve the date(s) and time(s) requested by the Contractor to perform preventative maintenance and warranty work.
- c. Reserves the right to approve all materials and methods used in preventative maintenance and warranty work.
- d. Reserves the right to determine if warranty work performed by the Contractor meets the contract requirements.
- e. Reserves the right to perform, or have performed, routine maintenance during the warranty period. This routine maintenance will not relieve the Contractor from meeting the warranty requirement of this Special Provision.
- f. Shall document the condition of the paint system prior to and after any warranty work.

Rights and Responsibilities of the Contractor:

The Contractor:

- a. Shall unconditionally warrant to the Department that the cleaning and painting of the structural steel shall be free of defects in materials and workmanship as defined by the warranty requirements as set forth above, for a period of two years from the Warranty Period Start Date for the project.
- b. Shall submit to the Department the warranty and the Warranty Bond, on forms furnished by the Department, prior to the Warranty Period Start Date.
- c. Is responsible for performing all warranty work, including, but not limited to, traffic control, obtaining railroad liability insurance where applicable at no additional cost to the Department.

- d. Shall retain all records for a period of one year beyond the end of the Warranty Period or the completion of any warranted repairs, whichever is later.
- e. Is responsible for replacing all temporary repairs, resulting from the painting system being in non-compliance with the warranty requirements, with Department approved materials and methods.
- f. Shall follow all traffic control and work zone safety requirements of the contract when any warranty work is performed.
- g. Shall complete all warranty work in a neat and uniform manner and shall meet the requirements specified in the contract.
- h. Is required to supply to the Department original documentation pursuant to Section 107 of the Standard Specifications that all insurance required by the contract is in effect during the period(s) that any warranty work is being performed.
- i. Shall notify the Department and shall submit a written course of action proposing appropriate corrective measures for the needed warranty work. Approval by the Department must be obtained prior to the anticipated commencement of any warranty work.

Conflict Resolution Team: The sole responsibility of the Conflict Resolution Team (CRT) is to provide a decision on disputed matters between the Department and the Contractor regarding the interpretation of non-compliance of the warranty requirements. It is the intention of the parties that the CRT be assembled with the full cooperation of both parties, and that the Contractor and Department will devote their full attention to the prompt consideration of the matter by the CRT. Neither party shall neglect its obligation of good faith hereunder nor shall unreasonable delay be imposed that would hinder the prompt decision of the CRT. The decision of the CRT shall be final and binding on the Contractor and Department.

The CRT will consist of three members:

- a. One selected, provided and compensated by the Department.
- b. One selected, provided and compensated by the Contractor.
- c. One third party, mutually selected by the Department and the Contractor. Compensation for the third party member will be equally shared by the Department and the Contractor.

The team members will be identified in writing at the preconstruction meeting and will be knowledgeable in the terms and conditions of this warranty, as well as the methods used to determine paint system distress. Changes to the team membership will be made in writing for the warranty period.

Basis of Payment: This work will be paid for at the contract unit price per lump sum for BRIDGE CLEANING AND PAINTING WARRANTY, at the designated location(s). Payment will be made at the commencement of the warranty period, after the Warranty Bond form has been submitted.

**ILLINOIS
DEPARTMENT OF TRANSPORTATION
DIVISION OF HIGHWAYS
WARRANTY
PAINT QUALITY
1 OF 2**

THIS WARRANTY, made by _____
(Contractor) of _____

hereinafter called "Warrantor", in favor of the Illinois Department of Transportation, hereinafter called "Department";

WITNESSETH:

RECITALS:

The Department has contracted for the cleaning and painting structural steel on the _____ Bridge(s) on the _____ Highway in _____ County, Illinois.

Under the provision of Contract No. _____, pertaining in part to painting of structural steel, entered into by

_____, and the Department,
(Contractor)

the _____ is required
(Contractor)

to furnish the Department a written warranty for the paint system warranting against defect as stated in said contract for a period(s) of two years from the date(s) of final inspection by the

Engineer, of _____'s work under said contract.
(Contractor)

**ILLINOIS
DEPARTMENT OF TRANSPORTATION
DIVISION OF HIGHWAYS**

**WARRANTY
PAINT QUALITY
2 OF 2**

NOW, THEREFORE, in consideration of the foregoing, Warrantor hereby agrees and warrants that in every case in which any defect, as described in Contract Number

_____, occurs within said two years period(s), Warrantor shall, forthwith upon receipt of written notice of such defect, repair said defective area.

It is expressly understood and agreed that the warranty and obligations herein set forth are made and undertaken by warrantor to and for the benefit of the Department.

IN WITNESS WHEREOF, Warrantor have set his/her hands as of this

_____ day of _____, 20_____.

(Contractor)

ATTEST:

By: _____

Title: _____

**ILLINOIS
DEPARTMENT OF TRANSPORTATION
DIVISION OF HIGHWAYS**

**SUPPLEMENTAL PERFORMANCE BOND
1 OF 2**

KNOW ALL MEN BY THESE PRESENTS,

That we _____ as principal,

and _____ as surety, a corporation duly organized and existing under and by virtue of the laws of the State of

_____ and duly authorized to transact the business of surety in the State of Illinois, are jointly and severally held and bound unto the Illinois Department of

Transportation in the sum of _____ Dollars, for the payment of which we jointly and severally bind ourselves, our heirs and executors, administrators, successors and assigns firmly by these presents.

Whereas, the principal herein has, on the _____ day of _____, 20____, made and entered into a certain agreement with the State of Illinois, by and through the Illinois Department of Transportation, which agreement is more fully described as

_____,
Contract Number _____, under which agreement the principal agrees to furnish certain materials and to perform certain work which he agrees to do in accordance with the terms, conditions, and requirements as set out in said agreement, and whereas, in connection with said contract, the principal has executed a written warranty, a copy of which warranty is attached hereto and by this reference made a part hereof;

And, whereas, the principal has therein undertaken to warrant the work of cleaning and painting structural steel against any defects, as therein defined, for a period(s) of at least two years from the date(s) of final inspection of the project by the Engineer.

**ILLINOIS
DEPARTMENT OF TRANSPORTATION
DIVISION OF HIGHWAYS**

**SUPPLEMENTAL PERFORMANCE BOND
2 OF 2**

NOW, THEREFORE, THE CONDITION OF THIS BOND IS SUCH THAT if the principal herein shall faithfully and truly observe and comply with the terms of such warranty and shall well and truly perform all matters and things by him/her undertaken to be performed under said warranty upon the terms proposed therein and shall do all things required of said principal by the laws of this state and shall indemnify and save the harmless the State of Illinois and Illinois Department of Transportation against any direct or indirect damages of every kind and description that shall be suffered or claimed to be suffered in connection with or arising out of the performance of the said warranty by the Contractor or subcontractors, then this obligation is to be void, otherwise to remain in full force and effect.

In no event shall the obligations under this bond be terminated without written consent of Illinois Department of Transportation.

Signed and sealed this _____ day of _____, 20__.

SURETY _____ PRINCIPAL _____

BY _____ BY _____
(Attorney-in-fact) (Official Capacity)

Countersigned:

(Resident Agent) Attest: _____
(Secretary)

STATUS OF UTILITIES

<u>Name & Address of Utility</u>	<u>Type</u>	<u>Location</u>	<u>Adjustment or Relocation</u>
Mr. David Burkybile Illinois Department of Transportation 13473 IL Hwy 133 P.O. Box 610 Paris, IL 61944 (217) 465-4181	IDOT owned facilities		Not required

Utility adjustments or relocations should not be required by this project. **The Illinois Underground Utility Facilities Damage Prevention Act** requires persons excavating to contact the one call system (J.U.L.I.E 800-892-0123 or 811) before digging.

NOTE: THE CONTRACTOR SHALL BE REQUIRED TO CONTACT THE ILLINOIS DEPARTMENT OF TRANSPORTATION FOR ANY HIGHWAY LIGHTING OR ELECTRICAL, WATER, OR OTHER CONDUITS OR PIPES ATTACHED TO STRUCTURE, AND TO PROTECT SAME FROM DAMAGE FROM THEIR PAINTING AND BLASTING OPERATIONS.

Status page 1 of 1

Toll Free J.U.L.I.E. Telephone Number (800) 892-0123

* = J.U.L.I.E. Member

CLEANING AND PAINTING EXISTING STEEL STRUCTURES

Effective: October 2, 2001

Revised: April 19, 2012

Description. This work shall consist of the preparation of all designated metal surfaces by the method(s) specified on the plans. This work also includes the painting of those designated surfaces with the paint system(s) specified on the plans. The Contractor shall furnish all materials, equipment, labor, and other essentials necessary to accomplish this work and all other work described herein and as directed by the Engineer.

Materials. All materials to be used on an individual structure shall be produced by the same manufacturer.

The Bureau of Materials and Physical Research has established a list of all products that have met preliminary requirements. Each batch of material, except for the penetrating sealer, must be tested and approved before use. The specified colors shall be produced in the coating manufacturer's facility. Tinting of the coating after it leaves the manufacturer's facility is not allowed.

The paint materials shall meet the following requirements of the Standard Specification and as noted below:

<u>Item</u>	<u>Article</u>
(a) Waterborne Acrylic	1008.04
(b) Aluminum Epoxy Mastic	1008.03
(c) Organic Zinc Rich Primer	1008.05
(d) Epoxy/ Aliphatic Urethane	1008.05
(e) Penetrating Sealer (Note 1)	
(f) Moisture Cured Zinc Rich Urethane Primer (Note 2)	
(g) Moisture Cured Aromatic/Aliphatic Urethane (Note 2)	
(h) Moisture Cured Penetrating Sealer (Note 3)	

Note 1: The Epoxy Penetrating Sealer shall be a cross-linked multi component sealer. The sealer shall have the following properties:

- (a) The volume solids shall be 98 percent (plus or minus 2 percent).
- (b) Shall be clear or slightly tinted color.

Note 2: These material requirements shall be according to the Special Provision for the Moisture Cured Urethane Paint System.

Note 3: The Moisture Cured Penetrating Sealer manufacturer's certification will be required.

Submittals. The Contractor shall submit for Engineer review and acceptance, the following plans and information for completing the work. The submittals shall be provided within 30 days of execution of the contract unless given written permission by the Engineer to submit them at a later date. Work cannot proceed until the submittals are accepted by the Engineer. Details for each of the plans are presented within the body of this specification.

- a) Contractor/Personnel Qualifications. Evidence of Contractor qualifications and the names and qualifications/experience/training of the personnel managing and implementing the Quality Control program and conducting the quality control tests.
- b) Quality Control (QC) Program. The QC Program shall identify the following; the instrumentation that will be used, a schedule of required measurements and observations, procedures for correcting unacceptable work, and procedures for improving surface preparation and painting quality as a result of quality control findings. The program shall incorporate at a minimum, the IDOT Quality Control Daily Report form as supplied by the Engineer.
- c) Inspection Access Plan. The inspection access plan for use by Contractor QC personnel for ongoing inspections and by the Engineer during Quality Assurance (QA) observations.
- d) Surface Preparation/Painting Plan. The surface preparation/painting plan shall include the methods of surface preparation and type of equipment to be utilized for washing, hand/power tool cleaning, removal of rust, mill scale, paint or foreign matter, abrasive blast or water jetting, and remediation of chloride. If detergents, additives, or inhibitors are incorporated into the water, the Contractor shall include the names of the materials and Material Safety Data Sheets (MSDS). The Contractor shall identify the solvents proposed for solvent cleaning together with MSDS.

The plan shall also include the methods of coating application and equipment to be utilized.

If the Contractor proposes to heat or dehumidify the containment, the methods and equipment proposed for use shall be included in the Plan for the Engineer's consideration.

- e) Paint Manufacturer Certifications and Letters. When a sealer is used, the Contractor shall provide the manufacturer's certification of compliance with IDOT testing requirements listed under "Materials" above. A certification regarding the compatibility of the sealer with the specified paint system shall also be included.

When rust inhibitors are used, the Contractor shall provide a letter from the coating manufacturer indicating that the inhibitor is compatible with, and will not adversely affect the performance of the coating system.

If the use of a chemical soluble salt remover is proposed by the Contractor, provide a letter from the coating manufacturer indicating that the material will not adversely effect the performance of the coating system.

The paint manufacturer's application and thinning instructions, MSDS and product data sheets shall be provided, with specific attention drawn to storage temperatures, and the temperatures of the material, surface and ambient air at the time of application.

A letter or written instructions from the coating manufacturer shall be provided indicating the length of time that each coat must be protected from cold or inclement weather (e.g., exposure to rain) during its drying period.

- f) Abrasives. Abrasives to be used for abrasive blast cleaning, including MSDS. For expendable abrasives, the Contractor shall provide certification from the abrasive supplier that the abrasive meets the requirements of SSPC-AB1. For steel grit abrasives, the certification shall indicate that the abrasive meets the requirements of SSPC-AB3.
- g) Protective Coverings. Plan for containing or controlling paint debris (droplets, spills, overspray, etc.). Any tarpaulins or protective coverings proposed for use shall be fire retardant. For submittal requirements involving the containment used to remove lead paint, the Contractor shall refer to Special Provision for Containment and Disposal of Lead Paint Cleaning Residues.
- h) Progress Schedule. Progress schedule shall be submitted per Article 108.02 and shall identify all major work items (e.g., installation of rigging/containment, surface preparation, and coating application).

When the Engineer accepts the submittals, the Contractor will receive written notification. The Contractor shall not begin any paint removal work until the Engineer has accepted the submittals. The Contractor shall not construe Engineer acceptance of the submittals to imply approval of any particular method or sequence for conducting the work, or for addressing health and safety concerns. Acceptance of the programs does not relieve the Contractor from the responsibility to conduct the work according to the requirements of Federal, State, or Local regulations and this specification, or to adequately protect the health and safety of all workers involved in the project and any members of the public who may be affected by the project. The Contractor remains solely responsible for the adequacy and completeness of the programs and work practices, and adherence to them.

Contractor Qualifications. Unless indicated otherwise on the contract plans, for non lead abatement projects, the painting Contractor shall possess current SSPC-QP1 certification. Unless indicated otherwise on the plans, for lead abatement projects the Contractor shall also possess current SSPC-QP2 certification. The Contractor shall maintain certified status throughout the duration of the painting work under the contract. The Department reserves the right to accept Contractors documented to be currently enrolled in the SSPC-QP7, Painting Contractor Introductory Program, Category 2, in lieu of the QP certifications noted above.

Quality Control (QC) Inspections. The Contractor shall perform first line, in process QC inspections. The Contractor shall implement the submitted and accepted QC Program to insure that the work accomplished complies with these specifications. The designated Quality Control inspector shall be onsite full time during any operations that affect the quality of the coating system (e.g., surface preparation and chloride remediation, coating mixing and application, and evaluations between coats and upon project completion). The Contractor shall use the IDOT Quality Control Daily Report form supplied by the Engineer to record the results of quality control tests. The completed reports shall be turned into the Engineer before work resumes the following day. The Engineer or designated representative will sign the report. The signature is an acknowledgment that the report has been received, but should not be construed as an agreement that any of the information documented therein is accurate.

Contractor QC inspections shall include, but not be limited to the following:

- Suitability of protective coverings and the means employed to control project debris and paint spills, overspray, etc.
- Ambient conditions
- Surface preparation (solvent cleaning, pressure washing including chalk tests, hand/power tool or abrasive blast cleaning, etc.)
- Chloride remediation
- Coating application (specified materials, mixing, thinning, and wet/dry film thickness)
- Recoat times and cleanliness between coats
- Coating continuity and coverage (freedom from runs, sags, overspray, dryspray, pinholes, shadow-through, skips, misses, etc.)

The personnel managing the Contractor's QC Program shall possess a minimum classification of Society of Protective Coatings (SSPC) BCI certified, National Association of Corrosion Engineers (NACE) Coating Inspector Level 2 - Certified, or shall provide evidence of successful inspection of 3 projects of similar or greater complexity and scope that have been completed in the last 2 years. Copies of the certification and/or experience shall be provided. References for experience shall be provided and shall include the name, address, and telephone number of a contact person employed by the bridge owner.

The personnel performing the QC tests shall be trained in coatings inspection and the use of the testing instruments. Documentation of training shall be provided. The QC personnel shall not perform hands on surface preparation or painting activities. Painters shall perform wet film thickness measurements, with QC personnel conducting random spot checks of the wet film. The Contractor shall not replace the QC personnel assigned to the project without advance notice to the Engineer, and acceptance of the replacement(s), by the Engineer.

The Contractor shall supply all necessary equipment to perform the QC inspections. Equipment shall include the following at a minimum:

- Psychrometer or comparable equipment for the measurement of dew point and relative humidity, together with all necessary weather bureau tables or psychrometric charts.
- Surface temperature thermometer
- SSPC Visual Standards VIS 1, Guide and Reference Photographs for Steel Surfaces Prepared by Dry Abrasive Blast Cleaning; SSPC-VIS 3, Visual Standard for Power and Hand-Tool Cleaned Steel; SSPC-VIS 4, Guide and Reference Photographs for Steel Prepared by Water Jetting, and/or SSPC-VIS 5, Guide and Reference Photographs for Steel Prepared by Wet Abrasive Blast Cleaning, as applicable.
- Commercially available putty knife of a minimum thickness of 40 mils (1mm) and a width between 1 and 3 in. (25 and 75 mm). Note that the putty knife is only required for projects in which the existing coating is being feathered and must be tested with a dull putty knife.
- Testex Press-O-Film Replica Tape and Spring Micrometer
- Bresle Cell Kits or CHLOR*TEST kits for chloride determinations, or equivalent
- Wet Film Thickness Gage

- Blotter paper for compressed air cleanliness checks
- Type 2 Electronic Dry Film Thickness Gage per SSPC - PA2, Measurement of Dry Coating Thickness with magnetic Gages
- Calibration standards for dry film thickness gage
- Light meter for measuring light intensity during paint removal, painting, and inspection activities
- All applicable ASTM and SSPC Standards used for the work (reference list attached)

The instruments shall be calibrated by the Contractor's personnel according to the equipment manufacturer's recommendations and the Contractor's QC Program. All inspection equipment shall be made available to the Engineer for QA observations on an as needed basis.

Hold Point Notification. Specific inspection items throughout this specification are designated as Hold Points. Unless other arrangements are made at the project site, the Contractor shall provide the Engineer with a minimum 4-hour notification before a Hold Point inspection will be reached. If the 4-hour notification is provided and the Work is ready for inspection at that time, the Engineer will conduct the necessary observations. If the Work is not ready at the appointed time, unless other arrangements are made, an additional 4-hour notification is required. Permission to proceed beyond a Hold Point without a QA inspection will be granted solely at the discretion of the Engineer, and only on a case by case basis.

Quality Assurance (QA) Observations. The Engineer will conduct QA observations of any or all phases of the work. The presence or activity of Engineer observations in no way relieves the Contractor of the responsibility to provide all necessary daily QC inspections of his/her own and to comply with all requirements of this Specification.

The Engineer has the right to reject any work that was performed without adequate provision for QA observations.

Inspection Access and Lighting. The Contractor shall facilitate the Engineer's observations as required, including allowing ample time to view the work. The Contractor shall furnish, erect and move scaffolding or other mechanical equipment to permit close observation of all surfaces to be cleaned and painted. This equipment shall be provided during all phases of the work. Examples of acceptable access structures include:

- Mechanical lifting equipment, such as, scissor trucks, hydraulic booms, etc.
- Platforms suspended from the structure comprised of trusses or other stiff supporting members and including rails and kick boards.
- Simple catenary supports are permitted only if independent life lines for attaching a fall arrest system according to Occupational Safety and Health Administration (OSHA) regulations are provided.

When the surface to be inspected is more than 6 ft. (1.8 m) above the ground or water surface, and fall prevention is not provided (e.g., guardrails are not provided), the Contractor shall provide the Engineer with a safety harness and a lifeline according to OSHA regulations. The lifeline and attachment shall not direct the fall into oncoming traffic. The Contractor shall provide a method of attaching the lifeline to the structure independent of the inspection facility or any support of the platform. When the inspection facility (e.g., platform) is more than 2 1/2 ft. (800 mm) above the ground, the Contractor shall provide an approved means of access onto the platform.

The Contractor shall provide artificial lighting in areas both inside and outside the containment where natural light is inadequate, as determined by the Engineer, to allow proper cleaning, inspection, and painting. Illumination for inspection shall be at least 30 foot candles (325 LUX). Illumination for cleaning and painting, including the working platforms, access and entryways shall be at least 20 foot candles (215 LUX). General work area illumination outside the containment shall be employed at the discretion of the Engineer and shall be at least 5 foot candles. The exterior lighting system shall be designed and operated so as to avoid glare that interferes with traffic, workers, and inspection personnel.

Surface Preparation and Painting Equipment. All cleaning and painting equipment shall include gages capable of accurately measuring fluid and air pressures and shall have valves capable of regulating the flow of air, water or paint as recommended by the equipment manufacturer. The equipment shall be maintained in proper working order.

Diesel or gasoline powered equipment shall be positioned or vented in a manner to prevent deposition of combustion contaminants on any part of the structure.

Hand tools, power tools, pressure washing, water jetting, abrasive blast cleaning equipment, brushes, rollers, and spray equipment shall be of suitable size and capacity to perform the work required by this specification. All power tools shall be equipped with vacuums and High Efficiency Particulate Air (HEPA) filtration. Appropriate filters, traps and dryers shall be provided for the compressed air used for abrasive blast cleaning and conventional spray application. Paint pots shall be equipped with air operated continuous mixing devices unless prohibited by the coating manufacturer.

Test Sections. Prior to surface preparation, the Contractor shall prepare a test section(s) on each structure to be painted in a location(s) which the Engineer considers to be representative of the existing surface condition and steel type for the structure as a whole. More than one test section may be needed to represent the various design configurations of the structure. The purpose of the test section(s) is to demonstrate the use of the tools and degree of cleaning required (cleanliness and profile) for each method of surface preparation that will be used on the project. Each test section shall be approximately 10 sq. ft. (0.93 sq m). The test section(s) shall be prepared using the same equipment, materials and procedures as the production operations. The Contractor shall prepare the test section(s) to the specified level of cleaning according to the appropriate SSPC visual standards, modified as necessary to comply with the requirements of this specification. The written requirements of the specification prevail in the event of a conflict with the SSPC visual standards. Only after the test section(s) have been approved shall the Contractor proceed with surface preparation operations. Additional compensation will not be allowed the Contractor for preparation of the test section(s).

For the production cleaning operations, the specifications and written definitions, the test section(s), and the SSPC visual standards shall be used in that order for determining compliance with the contractual requirements.

Protective Coverings and Damage. All portions of the structure that could be damaged by the surface preparation and painting operations (e.g., utilities), including any sound paint that is allowed to remain according to the contract documents, shall be protected by covering or shielding. Tarpaulins drop cloths, or other approved materials shall be employed. The Contractor shall comply with the provisions of the Illinois Environmental Protection Act. Paint drips, spills, and overspray are not permitted to escape into the air or onto any other surfaces or surrounding property not intended to be painted. Containment shall be used to control paint drips, spills, and overspray, and shall be dropped and all equipment secured when sustained wind speeds of 40 mph (64 kph) or greater occur, unless the containment design necessitates action at lower wind speeds. The contractor shall evaluate project-specific conditions to determine the specific type and extent of containment needed to control the paint emissions and shall submit a plan for containing or controlling paint debris (droplets, spills, overspray, etc.) to the Engineer for acceptance prior to starting the work. Acceptance by the Engineer shall not relieve the Contractor of their ultimate responsibility for controlling paint debris from escaping the work zone.

When the protective coverings need to be attached to the structure, they shall be attached by bolting, clamping, or similar means. Welding or drilling into the structure is prohibited unless approved by the Engineer in writing. When removing coatings containing lead the containment and disposal of the residues shall be as specified in the Special Provision for Containment and Disposal of Lead Paint Cleaning Residues contained elsewhere in this Contract. When removing coatings not containing lead the containment and disposal of the residues shall be as specified in the Special Provision for Containment and Disposal of Non-Lead Paint Cleaning Residues contained elsewhere in this Contract.

The Contractor shall be responsible for any damage caused to persons, vehicles, or property, except as indemnified by the Response Action Contractor Indemnification Act. Whenever the intended purposes of the controls or protective devices used by the Contractor are not being accomplished, as determined by the Engineer, work shall be immediately suspended until corrections are made. Damage to vehicles or property shall be repaired by the Contractor at the Contractor's expense. Painted surfaces damaged by any Contractor's operation shall be repaired, removed and/or repainted, as directed by the Engineer, at the Contractor's expense.

Weather Conditions. Surfaces to be painted after cleaning shall remain free of moisture and other contaminants. The Contractor shall control his/her operations to insure that dust, dirt, or moisture do not come in contact with surfaces cleaned or painted that day.

- a) The surface temperature shall be at least 5°F (3°C) above the dew point during final surface preparation operations. The manufacturers' published literature shall be followed for specific temperature, dew point, and humidity restrictions during the application of each coat.
- b) If the Contractor proposes to control the weather conditions inside containment, proposed methods and equipment for heating and/or dehumidification shall be included in the work plans for the Engineer's consideration. Any heating/dehumidification proposals accepted by the Engineer shall be implemented at no additional cost to the department.
- c) Cleaning and painting shall be done between April 15 and October 31 unless authorized otherwise by the Engineer in writing.

The Contractor shall monitor temperature, dew point, and relative humidity every 4 hours during surface preparation and coating application in the specific areas where the work is being performed. The frequency of monitoring shall increase if weather conditions are changing. If the weather conditions after application and during drying are forecast to be outside the acceptable limits established by the coating manufacturer, coating application shall not proceed. If the weather conditions are forecast to be borderline relative to the limits established by the manufacturer, monitoring shall continue at a minimum of 4-hour intervals throughout the drying period. The Engineer has the right to reject any work that was performed, or drying that took place, under unfavorable weather conditions. Rejected work shall be removed, recleaned, and repainted at the Contractor's expense.

Compressed Air Cleanliness. Prior to using compressed air for abrasive blast cleaning, blowing down the surfaces, and painting with conventional spray, the Contractor shall verify that the compressed air is free of moisture and oil contamination according to the requirements of ASTM D 4285. The tests shall be conducted at least one time each shift for each compressor system in operation. If air contamination is evident, the Contractor shall change filters, clean traps, add moisture separators or filters, or make other adjustments as necessary to achieve clean, dry air. The Contractor shall also examine the work performed since the last acceptable test for evidence of defects or contamination caused by the compressed air. Effected work shall be repaired at the Contractor's expense.

Low Pressure Water Cleaning and Solvent Cleaning (HOLD POINT). The Contractor shall notify the Engineer 24 hours in advance of beginning surface preparation operations.

- a) Water Cleaning of Lead Containing Coatings Prior to Overcoating. Prior to initiating any mechanical cleaning such as hand/power tool cleaning on surfaces that are painted with lead, all surfaces to be prepared and painted, and the tops of pier and abutment caps shall be washed. Washing is not required if the surfaces will be prepared by water jetting.

Washing shall involve the use of potable water at a minimum of 1000 psi (7 MPa) and less than 5000 psi (34 MPa) according to "Low Pressure Water Cleaning" of SSPC-SP12. Paint spray equipment shall not be used to perform the water cleaning. The cleaning shall be performed in such a manner as to remove dust, dirt, chalk, insect and animal nests, bird droppings, loose paint and other foreign matter prior to solvent cleaning. The water, debris, and any loose paint removed by water cleaning shall be collected for proper disposal. The washing shall be completed no more than 2 weeks prior to surface preparation.

If detergents or other additives are added to the water, the detergents/additives shall be included in the submittals and not used until accepted by the Engineer. When detergents or additives are used, the surface shall be rinsed with potable water before the detergent water dries.

After washing has been accepted by the Engineer, all traces of asphaltic cement, oil, grease, diesel fuel deposits, and other soluble contaminants which remain on the steel surfaces to be painted shall be removed by solvent cleaning according to SSPC – SP1, supplemented with scraping (e.g., to remove large deposits of asphaltic cement) as required. The solvent(s) used for cleaning shall be compatible with the existing coating system. The Contractor shall identify the proposed solvent(s) in the submittals. If the existing coating is softened, wrinkled, or shows other signs of attack from the solvents, the Contractor shall immediately discontinue their use. The name and composition of replacement solvents, together with MSDS, shall be submitted for Engineer acceptance prior to use.

Under no circumstances shall subsequent hand/power tool cleaning be performed in areas containing surface contaminants or in areas where the Engineer has not accepted the washing and solvent cleaning. Surfaces prepared by hand/power tool cleaning without approval of the washing and solvent cleaning may be rejected by the Engineer. Rejected surfaces shall be re-cleaned with both solvent and the specified mechanical means at the Contractor's expense.

After all washing and mechanical cleaning are completed, representative areas of the existing coating shall be tested to verify that the surface is free of chalk and other loose surface debris or foreign matter. The testing shall be performed according to ASTM D4214. Cleaning shall continue until a chalk rating of 6 or better is achieved in every case.

- b) Water Cleaning of Non-Lead Coatings Prior to Overcoating. Thoroughly clean the surfaces according to the steps defined above for "Water Cleaning of Lead Containing Coatings Prior to Overcoating," except that the wash water does not need to be collected, and if the shop primer is inorganic zinc, the chalk rating does not apply. All other provisions are applicable.
- c) Water Cleaning/Debris Removal Prior to Total Coating Removal. When total coating removal is specified, water cleaning of the surface prior to coating removal is not required by this specification and is at the option of the Contractor. If the Contractor chooses to use water cleaning, and the existing coating contains lead, all water and debris shall be collected for proper disposal.

Whether or not the surfaces are pre-cleaned using water, the tops of the pier caps and abutments shall be cleaned free of dirt, paint chips, insect and animal nests, bird droppings and other foreign matter and the debris collected for proper disposal.

Prior to mechanical cleaning, oil, grease, and other soluble contaminants on bare steel or rusted surfaces shall be removed by solvent cleaning according to SSPC-SP1.

- d) Water Cleaning Between Coats. When foreign matter has accumulated on a newly applied coat, washing shall be performed prior to the application of subsequent coats. The water does not need to be collected unless it contacts existing lead containing coatings.

Laminar and Stratified Rust. All laminar and stratified rust that has formed on the existing steel surfaces shall be removed. Pack rust formed along the perimeter of mating surfaces of connected plates or shapes of structural steel shall be removed to the extent feasible without mechanically detaching the mating surface. Any pack rust remaining after cleaning the mating surfaces shall be tight and intact when examined using a dull putty knife. The tools used to remove these corrosion products shall be identified in the submittals and accepted by the Engineer. If the surface preparation or removal of rust results in nicks or gouges, the work shall be suspended, and the damaged areas repaired to the satisfaction of the Engineer, at the Contractor's expense. The Contractor shall also demonstrate that he/she has made the necessary adjustments to prevent a reoccurrence of the damage prior to resuming work.

Surface Preparation (HOLD POINT). One or more of the following methods of surface preparation shall be used as specified on the plans. When a method of surface preparation is specified, it applies to the entire surface, including areas that may be concealed by the containment connection points. In each case, as part of the surface preparation process, soluble salts shall be remediated as specified under "Soluble Salt Remediation". The Contractor shall also note that the surface of the steel beneath the existing coating system may contain corrosion and/or mill scale. Removal of said corrosion and/or mill scale, when specified, shall be considered included in this work and no extra compensation will be allowed.

When a particular cleaning method is specified for use in distinct zones on the bridge, the cleaning shall extend into the existing surrounding paint until a sound border is achieved. The edge of the existing paint is considered to be sound and intact if it can not be lifted by probing the edge with a dull putty knife. The sound paint shall be feathered for a minimum of 1 1/2 in. (40 mm) to achieve a smooth transition between the prepared steel and the existing coatings. Sanders with vacuum attachments, which have been approved by the Engineer, shall be used as necessary to accomplish the feathering.

- a) Limited Access Areas: A best effort with the specified methods of cleaning shall be performed in limited access areas such as the backsides of rivets inside built up box members. The equipment being used for the majority of the cleaning may need to be supplemented with other commercially available equipment, such as angle nozzles, to properly clean the limited access areas. The acceptability of the best effort cleaning in these areas is at the sole discretion of the Engineer.
- b) Near White Metal Blast Cleaning: This surface preparation shall be accomplished according to the requirements of Near White Metal Blast Cleaning SSPC-SP 10. Unless otherwise specified in the contract, the designated surfaces shall be prepared by dry abrasive blast cleaning, wet abrasive blast cleaning, or water jetting with abrasive injection. A Near White Metal Blast Cleaned surface, when viewed without magnification, shall be free of all visible oil, grease, dirt, dust, mill scale, rust, paint, oxides, corrosion products, and other foreign matter, except for staining.

Random staining shall be limited to no more than 5 percent of each 9 sq. in. (58 sq. cm) of surface area and may consist of light shadows, slight streaks, or minor discoloration caused by stains of rust, stains of mill scale, or stains of previously applied paint. With the exception of crevices as defined below, surface discoloration is considered to be a residue that must be removed, rather than a stain, if it possesses enough mass or thickness that it can be removed as a powder or in chips when scraped with a pocketknife.

A surface profile shall be created on the steel as defined later under "Surface Profile."

At the discretion of the Engineer, after a best effort cleaning, slight traces of existing coating may be permitted to remain within crevices such as those created between rivets, bolts, and plates, and the underlying steel. When traces of coating are permitted to remain, the coating shall be tightly bonded when examined by probing with a dull putty knife. The traces of coating shall be confined to the bottom portion of the crevices only, and shall not extend onto the surrounding steel or plate or onto the outer surface of the rivets or bolts. Pitted steel is excluded from exemption considerations and shall be cleaned according to SSPC-SP10.

If hackles or slivers are visible on the steel surface after cleaning, the Contractor shall remove them by grinding followed by reblast cleaning. At the discretion of the Engineer, the use of power tools to clean the localized areas after grinding, and to establish a surface profile acceptable to the coating manufacturer, can be used in lieu of blast cleaning.

If the surfaces are prepared using wet abrasive methods, attention shall be paid to tightly configured areas to assure that the preparation is thorough. After surface preparation is completed, the surfaces, surrounding steel, and containment materials/scaffolding shall be rinsed to remove abrasive dust and debris. Potable water shall be used for all operations. An inhibitor may be added to the supply water and/or rinse water to prevent flash rusting. If a rust inhibitor is proposed, the Contractor shall provide a sample of the proposed inhibitor together with a letter from the coating manufacturer indicating that the inhibitor is suitable for use with their products. The surfaces shall be allowed to completely dry before the application of any coating.

- c) Commercial Grade Power Tool Cleaning: This surface preparation shall be accomplished according to the requirements of Commercial Grade Power Tool Cleaning, SSPC-SP15. The designated surfaces shall be completely cleaned with power tools. A Commercial Grade Power Tool Cleaned surface, when viewed without magnification, is free of all visible oil, grease, dirt, rust, coating, oxides, mill scale, corrosion products, and other foreign matter, except for staining. In previously pitted areas, slight residues of rust and paint may also be left in the bottoms of pits.

Random staining shall be limited to no more than 33 percent of each 9 sq. in. (58 sq. cm) of surface area. Allowable staining may consist of light shadows, slight streaks, or minor discoloration caused by stains of rust, stains of mill scale, or stains of previously applied paint. Surface discoloration is considered to be a residue that must be removed, rather than a stain, if it possesses enough mass or thickness that it can be removed as a powder or in chips when scraped with a pocketknife.

A surface profile shall be created on the steel as defined later under "Surface Profile."

At the Contractor's option, Near White Metal Blast Cleaning may be substituted for Power Tool Cleaning – Commercial Grade, as long as containment systems appropriate for abrasive blast cleaning are utilized and there is no additional cost to the Department.

- d) Power Tool Cleaning – Modified SP3: This surface preparation shall be accomplished according to the requirements of SSPC-SP3, Power Tool Cleaning except as modified as follows. The designated surfaces shall be cleaned with power tools. A power tool cleaned surface shall be free of all loose rust, loose mill scale, loose and peeling paint, and loose rust that is bleeding through and/or penetrating the coating. All locations of visible corrosion and rust bleed, exposed or lifting mill scale, and lifting or loose paint shall be prepared using the power tools.

Upon completion of the cleaning, rust, rust bleed, mill scale and surrounding paint are permitted to remain if they can not be lifted using a dull putty knife.

Power Tool Cleaning of Shop Primed Steel. When steel coated with only a prime coat of inorganic or organic zinc is specified to be cleaned, this work shall be accomplished as follows. After cleaning the surface as specified under "Water Cleaning of Non-Lead Coatings Prior to Overcoating," damaged and rusted areas shall be spot cleaned according Power Tool Cleaning -Modified SSPC-SP3. The edges of the coating surrounding the spot repairs shall be feathered.

Abrasives. Unless otherwise specified in the contract, when abrasive blast cleaning is specified, it shall be performed using either expendable abrasives (other than silica sand) or recyclable steel grit abrasives. Expendable abrasives shall be used one time and disposed of. Abrasive suppliers shall certify that the expendable abrasives meet the requirements of SSPC-AB1 and that recyclable steel grit abrasives meet AB3. On a daily basis, the Contractor shall verify that recycled abrasives are free of oil contamination by conducting oil content tests according to SSPC-AB2.

All surfaces prepared with abrasives not meeting the SSPC-AB1, AB2, or AB3 requirements, as applicable, shall be solvent cleaned or low pressure water cleaned as directed by the Engineer, and reblast cleaned at the Contractor's expense.

Surface Profile (HOLD POINT). The abrasives used for blast cleaning shall have a gradation such that the abrasive will produce a uniform surface profile of 1.5 to 4.5 mils (38 to 114 microns). If the profile requirements of the coating manufacturer are more restrictive, advise the Engineer and comply with the more restrictive requirements. For recycled abrasives, an appropriate operating mix shall be maintained in order to control the profile within these limits.

The surface profile for the Power Tool Cleaning - Commercial Grade shall be within the range specified by the coating manufacturer, but not less than 2.0 mils (50 microns).

The surface profile produced by the Contractor's surface preparation procedures shall be determined by replica tape and spring micrometer at the beginning of the work, and each day that surface preparation is performed. Areas having unacceptable measurements shall be further tested to determine the limits of the deficient area. The replica tape shall be attached to the daily report.

When unacceptable profiles are produced, work shall be suspended. The Contractor shall submit a plan for the necessary adjustments to insure that the correct surface profile is achieved on all surfaces. The Contractor shall not resume work until the new profile is verified by the QA observations, and the Engineer confirms, in writing, that the profile is acceptable.

Soluble Salt Remediation (HOLD POINT). The Contractor shall implement surface preparation procedures and processes that will remove chloride from the surfaces. Surfaces that may be contaminated with chloride include, but are not limited to, expansion joints and all areas that are subject to roadway splash or run off such as fascia beams and stringers.

Methods of chloride removal may include, but are not limited to, steam cleaning or pressure washing with or without the addition of a chemical soluble salt remover as approved by the coating manufacturer, and scrubbing before or after initial paint removal. The Contractor may also elect to clean the steel and allow it to rust overnight followed by recleaning, or by utilizing blends of fine and coarse abrasives during blast cleaning, wet abrasive/water jetting methods of preparation, or combinations of the above. If steam or water cleaning methods of chloride removal are utilized over surfaces where the coating has been completely removed, and the water does not contact any lead containing coatings, the water does not have to be collected. The Contractor shall provide the proposed procedures for chloride remediation in the Surface Preparation/Painting Plan.

Upon completion of the chloride remediation steps, the Contractor shall use cell methods of field chloride extraction and test procedures (e.g., silver dichromate) accepted by the Engineer, to test representative surfaces that were previously rusted (e.g., pitted steel) for the presence of remaining chlorides. Remaining chloride levels shall be no greater than $7\mu\text{g}/\text{sq cm}$ as read directly from the surface without any multiplier applied to the results. The testing must be performed, and the results must be acceptable, prior to painting each day.

A minimum of 5 tests per 1000 sq. ft. (93 sq. m) or fraction thereof completed in a given day, shall be conducted at project start up. If results greater than $7\mu\text{g}/\text{sq cm}$ are detected, the surfaces shall be recleaned and retested at the same frequency. If acceptable results are achieved on three consecutive days in which testing is conducted, the test frequency may be reduced to 1 test per 1000 sq. ft. (93 sq. m) prepared each day provided the chloride remediation process remains unchanged. If unacceptable results are encountered, or the methods of chloride remediation are changed, the Contractor shall resume testing at a frequency of 5 tests per 1000 sq. ft. (93 sq. m).

Following successful chloride testing the chloride test areas shall be cleaned. Commercial Grade Power Tool Cleaning can be used to clean the test locations when the specified degree of cleaning is SSPC-SP10.

Surface Condition Prior to Painting (HOLD POINT). Prepared surfaces, shall meet the requirements of the respective degrees of cleaning immediately prior to painting, and shall be painted before rusting appears on the surface. If rust appears or bare steel remains unpainted for more than 12 hours, the affected area shall be prepared again at the expense of the Contractor.

All loose paint and surface preparation cleaning residue on bridge steel surfaces, scaffolding and platforms, containment materials, and tops of abutments and pier caps shall be removed prior to painting. When lead paint is being disturbed, cleaning shall be accomplished by HEPA vacuuming unless it is conducted within a containment that is designed with a ventilation system capable of collecting the airborne dust and debris created by sweeping and blowing with compressed air.

The quality of surface preparation and cleaning of surface dust and debris must be accepted by the Engineer prior to painting. The Engineer has the right to reject any work that was performed without adequate provision for QA observations to accept the degree of cleaning. Rejected coating work shall be removed and replaced at the Contractor's expense.

General Paint Requirements. Paint storage, mixing, and application shall be accomplished according to these specifications and as specified in the paint manufacturer's written instructions and product data sheets for the paint system used. In the event of a conflict between these specifications and the coating manufacturers' instructions and data sheets, the Contractor shall advise the Engineer and comply with the Engineer's written resolution. Until a resolution is provided, the most restrictive conditions shall apply.

Unless noted otherwise, If a new concrete deck or repair to an existing deck is required, painting shall be done after the deck is placed and the forms have been removed.

- a) **Paint Storage and Mixing.** All Paint shall be stored according to the manufacturer's published instructions, including handling, temperatures, and warming as required prior to mixing. All coatings shall be supplied in sealed containers bearing the manufacturers name, product designation, batch number and mixing/thinning instructions. Leaking containers shall not be used.

Mixing shall be according to the manufacturer's instructions. Thinning shall be performed using thinner provided by the manufacturer, and only to the extent allowed by the manufacturer's written instructions. In no case shall thinning be permitted that would cause the coating to exceed the local Volatile Organic Compound (VOC) emission restrictions. For multiple component paints, only complete kits shall be mixed and used. Partial mixing is not allowed.

The ingredients in the containers of paint shall be thoroughly mixed by mechanical power mixers according to the manufacturer's instructions, in the original containers before use or mixing with other containers of paint. The paint shall be mixed in a manner that will break up all lumps, completely disperse pigment and result in a uniform composition. Paint shall be carefully examined after mixing for uniformity and to verify that no unmixed pigment remains on the bottom of the container. Excessive skinning or partial hardening due to improper or prolonged storage will be cause for rejection of the paint, even though it may have been previously inspected and accepted.

Multiple component coatings shall be discarded after the expiration of the pot life. Single component paint shall not remain in spray pots, painters buckets, etc. overnight. It shall be stored in a covered container and remixed before use.

The Engineer reserves the right to sample field paint (individual components and/or the mixed material) and have it analyzed. If the paint does not meet the product requirements due to excessive thinning or because of other field problems, the coating shall be removed from that section of the structure and replaced as directed by the Engineer.

- b) Application Methods. Unless prohibited by the coating manufacturer's written instructions, paint may be applied by spray methods, rollers, or brushes. If applied with conventional or airless spray methods, paint shall be applied in a uniform layer with overlapping at the edges of the spray pattern.

The painters shall monitor the wet film thickness of each coat during application. The wet film thickness shall be calculated based on the solids by volume of the material and the amount of thinner added. When the new coating is applied over an existing system, routine QC inspections of the wet film thickness shall be performed in addition to the painter's checks in order to establish that a proper film build is being applied.

When brushes or rollers are used to apply the coating, additional applications may be required to achieve the specified thickness per layer.

- c) Painting Shop Primed Steel. After cleaning, rusted and damaged areas shall be touched up using the same primer specified for painting the existing structure. The intermediate and finish coats specified for painting the existing structure shall be applied to the steel. When inorganic zinc has been used as the shop primer, a mist coat of the intermediate coat shall be applied first in order to prevent pinholing and bubbling.
- d) Recoating and Film Continuity (HOLD POINT for each coat). Paint shall be considered dry for recoating according to the time/temperature/humidity criteria provided in the manufacturer's instructions and when an additional coat can be applied without the development of film irregularities; such as lifting, wrinkling, or loss of adhesion of the under coat. If surfaces are contaminated, washing shall be accomplished prior to intermediate and final coats. Wash water does not have to be collected unless the water contacts existing lead containing coatings.

Painting shall be done in a neat and workmanlike manner. Each coat of paint shall be applied as a continuous film of uniform thickness free of defects including, but not limited to, runs, sags, overspray, dryspray, pinholes, voids, skips, misses, and shadow-through. Defects such as runs and sags shall be brushed out immediately during application.

Paint Systems. The paint system(s) from the list below shall be applied as specified.

The paint manufacturer's relative humidity, dew point, and material, surface, and ambient temperature restrictions shall be provided with the submittals and shall be strictly followed. Written recommendations from the paint manufacturer for the length of time each coat must be protected from cold or inclement weather (e.g., exposure to rain), during the drying period shall be included in the submittals. Upon acceptance by the Engineer, these times shall be used to govern the duration that protection must be maintained during drying.

Where stripe coats are indicated, the Contractor shall apply an additional coat to edges, rivets, bolts, crevices, welds, and similar surface irregularities. The stripe coat shall be applied by brush and/or spray to thoroughly work the coating into or on the irregular surfaces, and shall extend onto the surrounding steel a minimum of 1 in. (25 mm) in all directions. The purpose of the stripe coat is to build additional thickness and to assure complete coverage of these areas.

The stripe coat may be applied as part of the application of the full coat unless prohibited by the coating manufacturer. If applied as part of the application process of the full coat, the stripe coat shall be allowed to dry for a minimum of 10 minutes in order to allow Contractor QC personnel to verify that the coat was applied. If a wet-on-wet stripe coat is prohibited by the coating manufacturer or brush or roller application of the full coat pulls the underlying stripe coat, the stripe coat shall dry according to the manufacturers' recommended drying times prior to the application of the full coat. In the case of the prime coat, the full coat can also be applied first to protect the steel, followed by the stripe coat after the full coat has dried.

- a) System 1 – OZ/E/U – for Bare Steel: System 1 shall consist of the application of a full coat of organic (epoxy) zinc-rich primer, a full intermediate coat of epoxy, and a full finish coat of aliphatic urethane. Stripe coats of the prime and finish coats shall be applied. The film thicknesses of the full coats shall be as follows, measured according to SSPC-PA2:
- One full coat of organic zinc-rich primer between 3.5 and 5.0 mils (90 and 125 microns) dry film thickness. The prime coat shall be tinted to a color that contrasts with the steel surface.
 - One full intermediate coat of epoxy between 3.0 and 6.0 mils (75 and 150 microns) dry film thickness. The intermediate coat shall be a contrasting color to both the first coat and finish coat.
 - One full finish coat of aliphatic urethane between 2.5 and 4.0 mils (65 and 100 microns) dry film thickness. Finish coat color shall be according to contract plans.

The total dry film thickness for this system, exclusive of areas receiving the stripe coats, shall be between 9.0 and 15.0 mils (225 and 375 microns).

- b) System 2 – PS/EM/U – for Overcoating an Existing System: System 2 shall consist of the application of a full coat of epoxy penetrating sealer, a spot intermediate coat of aluminum epoxy mastic and a stripe and full finish coat of aliphatic urethane.

A full coat of epoxy penetrating sealer shall be applied to all surfaces following surface preparation. A spot intermediate coat shall consist of the application of one coat of the aluminum epoxy mastic on all areas where rust is evident and areas where the old paint has been removed, feathered and/or damaged prior to, during or after the cleaning and surface preparation operations. After the spot intermediate, a stripe coat and full finish coat of aliphatic urethane shall be applied. The film thicknesses shall be as follows, measured according to SSPC-PA2:

- One full coat of epoxy penetrating sealer between 1.0 and 2.0 mils (25 and 50 microns) dry film thickness.
- One spot coat of aluminum epoxy mastic between 5.0 and 7.0 mils (125 and 175 microns) dry film thickness. The color shall contrast with the finish coat.
- One full finish coat of aliphatic urethane between 2.5 and 4.0 mils (65 and 100 microns) dry film thickness. Finish coat color shall be according to contract plans.

The total dry film thickness for this system, exclusive of the stripe coat, shall be between 8.5 and 13.0 mils (215 and 325 microns). The existing coating thickness to remain under the overcoat must be verified in order to obtain accurate total dry film thickness measurements.

c) System 3 – EM/EM/AC – for Bare Steel: System 3 shall consist of the application of two full coats of aluminum epoxy mastic and a full finish coat of waterborne acrylic. Stripe coats for first coat of epoxy mastic and the finish coat shall be applied. The film thicknesses of the full coats shall be as follows, measured according to SSPC-PA2:

- One full coat of aluminum epoxy mastic between 5.0 and 7.0 mils (125 and 175 microns) dry film thickness. The first coat of aluminum epoxy mastic shall be tinted a contrasting color with the blast cleaned surface and the second coat.
- One full intermediate coat of aluminum epoxy mastic between 5.0 and 7.0 mils (125 and 175 microns) dry film thickness. The intermediate coat shall be a contrasting color to the first coat and the finish coat.
- A full finish coat of waterborne acrylic between 2.0 and 4.0 mils (50 and 100 microns) dry film thickness. Finish coat color shall be according to contract plans.

The total dry film thickness for this system, exclusive of areas receiving the stripe coats, shall be between 12.0 and 18.0 mils (360 and 450 microns).

d) System 4 – PS/EM/AC – for Overcoating an Existing System: System 4 shall consist of the application of a full coat of epoxy penetrating sealer, a spot intermediate coat of aluminum epoxy mastic and a stripe and full finish coat of waterborne acrylic.

A full coat of epoxy penetrating sealer shall be applied to all surfaces following surface preparation. A spot intermediate coat shall consist of the application of one coat of the aluminum epoxy mastic on all areas where rust is evident and areas where the old paint has been removed, feathered and/or damaged prior to, during or after the cleaning and surface preparation operations. After the spot intermediate, a stripe coat and full finish coat of waterborne acrylic shall be applied. The film thicknesses shall be as follows, measured according to SSPC-PA2:

- One full coat of epoxy penetrating sealer between 1.0 and 2.0 mils (25 and 50 microns) dry film thickness.
- One spot coat of aluminum epoxy mastic between 5.0 and 7.0 mils (125 and 175 microns) dry film thickness. The color shall contrast with the finish coat.

- One full finish coat of waterborne acrylic between 2.0 and 4.0 mils (50 and 100 microns) dry film thickness. Finish coat color shall be according to contract plans.

The total dry film thickness for this system, exclusive of the stripe coat, shall be between 8.0 and 13.0 mils (200 and 325 microns). The existing coating thickness to remain under the overcoat must be verified in order to obtain accurate total dry film thickness measurements.

- e) System 5 – MCU – for Bare Steel: System 5 shall consist of the application of a full coat of moisture cure urethane (MCU) zinc primer, a full coat of MCU intermediate, and a full coat of MCU finish. Stripe coats of the prime and finish coats shall be applied. The contractor shall comply with the manufacturer's requirements for drying times between the application of the stripe coats and the full coats. The film thicknesses of the full coats shall be as follows, measured according to SSPC-PA2:

- One full coat of MCU zinc primer between 3.0 and 5.0 mils (75 and 125 microns) dry film thickness. The prime coat shall be tinted to a color that contrasts with the steel surface.
- One full MCU intermediate coat between 3.0 and 4.0 mils (75 and 100 microns) dry film thickness. The intermediate coat shall be a contrasting color to both the first coat and finish coat.
- One full MCU finish coat between 2.0 and 4.0 mils (50 and 100 microns) dry film thickness. Finish coat color shall be according to contract plans.

The total dry film thickness for this system, exclusive of areas receiving the stripe coats, shall be between 8.0 and 13.0 mils (200 and 325 microns).

- f) System 6 – MCU – for Overcoating an Existing System: System 6 shall consist of the application of a full coat of moisture cure urethane (MCU) penetrating sealer, a spot coat of MCU intermediate, and a stripe and full coat of MCU finish.

A full coat of MCU penetrating sealer shall be applied to all surfaces following surface preparation. A spot intermediate coat shall consist of the application of one coat of MCU intermediate on all areas where rust is evident and areas where the old paint has been removed, feathered and/or damaged prior to, during or after the cleaning and surface preparation operations. After the spot intermediate, a stripe coat and full coat of MCU finish shall be applied. The contractor shall comply with the manufacturer's requirements for drying time between the application of the stripe coat and the full finish coat. The film thicknesses shall be as follows, measured according to SSPC-PA2:

- One full coat of MCU sealer between 1.0 and 2.0 mils (25 and 50 microns) dry film thickness.
- One full MCU intermediate coat between 3.0 and 4.0 mils (75 and 100 microns) dry film thickness. The color shall contrast with the finish coat.
- One full MCU finish coat 2.0 and 4.0 mils (50 and 100 microns) dry film thickness. Finish coat color shall be according to contract plans.

The total dry film thickness for this system, exclusive of areas receiving the stripe coats, shall be between 6.0 and 10.0 mils (150 and 250 microns). The existing coating thickness to remain under the overcoat must be verified in order to obtain accurate total dry film thickness measurements.

Repair of Damage to New Coating System and Areas Concealed by Containment. The Contractor shall repair all damage to the newly installed coating system and areas concealed by the containment/protective covering attachment points, at no cost to the Department. If the damage extends to the substrate and the original preparation involved abrasive blast cleaning, the damaged areas shall be prepared to Power Tool Cleaning - Commercial Grade. If the original preparation was other than blast cleaning or the damage does not extend to the substrate, the loose, fractured paint shall be cleaned to Power Tool Cleaning – Modified SP3.

The surrounding coating at each repair location shall be feathered for a minimum distance of 1 1/2 in. (40 mm) to achieve a smooth transition between the prepared areas and the existing coating.

If the bare steel is exposed, all coats shall be applied to the prepared area. If only the intermediate and finish coats are damaged, the intermediate and finish shall be applied. If only the finish coat is damaged, the finish shall be applied.

Special Instructions.

- a) At the completion of the work, the Contractor shall stencil the painting date and the paint code on the bridge. The letters shall be capitals, not less than 2 in. (50 mm) and not more than 3 in. (75 mm) in height.

The stencil shall contain the following wording "PAINTED BY (insert the name of the Contractor)" and shall show the month and year in which the painting was completed, followed by the appropriate code for the coating material applied, all stenciled on successive lines:

CODE U (for field applied System 3 or System 4).

CODE Z (for field applied System 1 or System 2).

CODE AA (for field applied System 5 or System 6).

This information shall be stenciled on the cover plate of a truss end post near the top of the railing, or on the outside face of an outside stringer near one end of the bridge, or at some equally visible surface near the end of the bridge, as designated by the Engineer.

- b) All surfaces painted inadvertently shall be cleaned immediately.

It is understood and agreed that the cost of all work outlined above, unless otherwise specified, has been included in the bid, and no extra compensation will be allowed.

Basis of Payment. This work shall be paid for at the contract Lump Sum price for CLEANING AND PAINTING STEEL BRIDGE, at the designated location, or for CLEANING AND PAINTING the structure or portions thereof described. Payment will not be authorized until all requirements for surface preparation and painting have been fulfilled as described in this specification, including the preparation and submittal of all QC documentation. Payment will also not be authorized for non-conforming work until the discrepancy is resolved in writing.

Appendix 1 – Reference List

The Contractor shall maintain the following regulations and references on site for the duration of the project:

- Illinois Environmental Protection Act
- ASTM D 4214, Standard Test Method for Evaluating Degree of Chalking of Exterior Paint Films
- ASTM D 4285, Standard Test Method for Indicating Oil or Water in Compressed Air
- SSPC-AB 1, Mineral and Slag Abrasives
- SSPC-AB 2, Specification for Cleanliness of Recycled Ferrous Metallic Abrasives
- SSPC-AB 3, Newly Manufactured or Re-Manufactured Steel Abrasives
- SSPC-PA 2, Measurement of Dry Coating Thickness with Magnetic Gages
- SSPC-QP 1, Standard Procedure for Evaluating Painting Contractors (Field Application to Complex Structures)
- SSPC-QP 2, Standard Procedure for Evaluating the Qualifications of Painting Contractors to Remove Hazardous Paint
- SSPC-SP 1, Solvent Cleaning
- SSPC-SP 3, Power Tool Cleaning
- SSPC-SP 10/NACE No. 2, Near White Metal Blast Cleaning
- SSPC-SP 12/NACE No. 5, Surface Preparation and Cleaning of Metals by Waterjetting Prior to Recoating
- SSPC-SP15, Commercial Grade Power Tool Cleaning
- SSPC-VIS 1, Guide and Reference Photographs for Steel Surfaces Prepared by Dry Abrasive Blast Cleaning
- SSPC-VIS 3, Visual Standard for Power- and Hand-Tool Cleaned Steel
- SSPC-VIS 4, Guide and Reference Photographs for Steel Cleaned by Water Jetting
- SSPC-VIS 5, Guide and Reference Photographs for Steel Prepared by Wet Abrasive Blast Cleaning
- The paint manufacturer's application instructions, MSDS and product data sheets

CONTAINMENT AND DISPOSAL OF LEAD PAINT CLEANING RESIDUES

Effective: October 2, 2001

Revised: April 30, 2010

Description. This work shall consist of the containment, collection, temporary storage, transportation and disposal of waste from lead paint removal projects. Waste requiring containment and control includes, but is not limited to, old paint, spent abrasives, corrosion products, mill scale, dirt, dust, grease, oil, salts, and water used for cleaning the surface of existing lead coatings prior to overcoating.

General. The existing coatings contain lead and may also contain other toxic metals. This specification provides the requirements for containment and for the protection of the public, and the environment from exposure to harmful levels of toxic metals that may be present in the paint being removed or repaired. The Contractor shall take reasonable and appropriate precautions to protect the public from the inhalation or ingestion of dust or debris from the operations, and is responsible for the clean-up of all spills of waste at no additional cost to the Department.

The Contractor shall comply with the requirements of this Specification and all applicable Federal, State, and Local laws, codes, and regulations, including, but not limited to the regulations of the United States Environmental Protection Agency (USEPA), Occupational Safety and Health Administration (OSHA), and Illinois Environmental Protection Agency (IEPA). The Contractor shall comply with all applicable regulations even if the regulation is not specifically referenced herein. If a Federal, State, or Local regulation is more restrictive than the requirements of this Specification, the more restrictive requirements shall prevail.

Submittals. The Contractor shall submit for Engineer review and acceptance, the following drawings and plans for accomplishing the work. The submittals shall be provided within 30 days of execution of the contract unless given written permission by the Engineer to submit them at a later date. Work cannot proceed until the submittals are accepted by the Engineer. Details for each of the plans are presented within the body of this specification. The Contractor shall also maintain on site, copies of the standards and regulations referenced herein (list provided in appendix 1).

- a) Containment Plans. The containment plans shall include drawings, equipment specifications, and calculations (wind load, air flow and ventilation when negative pressure is specified). The plans shall include copies of the manufacturer's specifications for the containment materials and equipment that will be used to accomplish containment and ventilation.

When required by the contract plans, the submittal shall provide calculations that assure the structural integrity of the bridge when it supports the containment and the calculations and drawings shall be signed and sealed by a Structural Engineer licensed in the state of Illinois.

When working over the railroad or navigable waterways, the Department will notify the respective agencies that work is being planned. Unless otherwise directed by the Engineer, the Contractor is responsible for follow up contact, and shall provide evidence that the railroad, Coast Guard, Corps of Engineers, and other applicable agencies are satisfied with the clearance provided and other safety measures that are proposed.

- b) Environmental Monitoring Plan. The Environmental Monitoring Plan shall address the visual inspections and clean up of the soil and water that the Contractor will perform, including final project inspection and cleanup. The plan shall address the daily visible emissions observations that will be performed and the corrective action that will be implemented in the event emissions or releases occur. When high volume ambient air monitoring is required, an Ambient Air Monitoring Plan shall be developed. The plan shall include:

- Proposed monitor locations and power sources in writing. A site sketch shall be included, indicating sensitive receptors, monitor locations, and distances and directions from work area.
 - Equipment specification sheet for monitors to be used, and a written commitment to calibrate and maintain the monitors.
 - Include a procedure for operation of monitors per 40 CFR 50, Appendix B, including use of field data chain-of-custody form. Include a sample chain of custody form.
 - Describe qualifications/training of monitor operator.
 - The name, contact information (person's name and number), and certification of the laboratory performing the filter analysis. Laboratory shall be accredited by one of the following: 1) the American Industrial Hygiene Association (AIHA) for lead (metals) analysis, 2) Environmental Lead Laboratory Accreditation Program (ELLAP) for metals analysis, 3) State or federal accreditation program for ambient air analysis or, 4) the EPA National Lead Laboratory Accreditation Program (NLLAP) for lead analysis. The laboratory shall provide evidence of certification, a sample laboratory chain-of-custody form, and sample laboratory report that provides the information required by this specification. The laboratory shall also provide a letter committing to do the analysis per 40 CFR 50, Appendix G. If the analysis will not be performed per 40 CFR Appendix G, a proposed alternate method shall be described, together with the rationale for using it. The alternate method can not be used unless specifically accepted by the Engineer in writing.
- c) Waste Management Plan. The Waste Management Plan shall address all aspects of waste handling, storage, testing, hauling and disposal. Include the names, addresses, and a contact person for the proposed licensed waste haulers and disposal facilities. Submit the name and qualifications of the laboratory proposed for Toxicity Characteristic Leaching Procedure (TCLP) analysis. If the use of abrasive additives is proposed, provide the name of the additive, the premixed ratio of additive to abrasive being provided by the supplier, and a letter from the supplier of the additive indicating IEPA acceptance of the material. Note that the use of any steel or iron based material, such as but not limited to grit, shot, fines, or filings as an abrasive additive is prohibited.
- d) Contingency Plan. The Contractor shall prepare a contingency plan for emergencies including fire, accident, failure of power, failure of dust collection system, failure of supplied air system or any other event that may require modification of standard operating procedures during lead removal. The plan shall include specific procedures to ensure safe egress and proper medical attention in the event of an emergency.

When the Engineer accepts the submittals, the Contractor will receive written notification. The Contractor shall not begin any work until the Engineer has accepted the submittals. The Contractor shall not construe Engineer acceptance of the submittals to imply approval of any particular method or sequence for conducting the work, or for addressing health and safety concerns. Acceptance of the plans does not relieve the Contractor from the responsibility to conduct the work according to the requirements of Federal, State, or Local regulations, this specification, or to adequately protect the health and safety of all workers involved in the project and any members of the public who may be affected by the project. The Contractor remains solely responsible for the adequacy and completeness of the programs and work practices, and adherence to them.

Quality Control (QC) Inspections. The Contractor shall perform first line, in process QC inspections of all environmental control and waste handling aspects of the project to verify compliance with these specification requirements and the accepted drawings and plans. The Contractor shall use the IDOT Environmental Daily Report form supplied by the Engineer to record the results of the inspections. The completed reports shall be turned into the Engineer before work resumes the following day. Contractor QC inspections shall include, but not be limited to the following:

- Proper installation and continued performance of the containment system(s) in accordance with the approved drawings.
- Visual inspections of emissions into the air and verification that the cause(s) for any unacceptable emissions is corrected.
- Set up, calibration, operation, and maintenance of the regulated area and high volume ambient air monitoring equipment, including proper shipment of cassettes/filters to the laboratory for analysis. Included is verification that the Engineer receives the results within the time frames specified and that appropriate steps are taken to correct work practices or containment in the event of unacceptable results.
- Visual inspections of spills or deposits of contaminated materials into the water or onto the ground, pavement, soil, or slope protection. Included is verification that proper cleanup is undertaken and that the cause(s) of unacceptable releases is corrected.
- Proper implementation of the waste management plan including laboratory analysis and providing the results to the Engineer within the time frames specified herein.
- Proper implementation of the contingency plans for emergencies.

The personnel providing the QC inspections shall possess current SSPC-C3 certification or equal, including the annual training necessary to maintain that certification (SSPC-C5 or equal), and shall provide evidence of successful completion of 2 projects of similar or greater complexity and scope that have been completed in the last 2 years. References shall include the name, address, and telephone number of a contact person employed by the bridge owner. Proof of initial certification and the current annual training shall also be provided.

Quality Assurance (QA) Observations. The Engineer will conduct QA observations of any or all of the QC monitoring inspections that are undertaken. The presence or activity of Engineer observations in no way relieves the Contractor of the responsibility to provide all necessary daily QC inspections of its own and to comply with all requirements of this Specification.

Containment Requirements. The Contractor shall install and maintain containment systems surrounding the work for the purpose of controlling emissions of dust and debris according to the requirements of this specification. Working platforms and containment materials that are used shall be firm and stable and platforms shall be designed to support the workers, inspectors, spent surface preparation media (e.g., abrasives), and equipment during all phases of surface preparation and painting. Platforms, cables, and other supporting structures shall be designed according to OSHA regulations. If the containment needs to be attached to the structure, the containment shall be attached by bolting, clamping, or similar means. Welding or drilling into the structure is prohibited unless approved by the Engineer in writing.

The containment shall be dropped in the event of sustained winds of 40 mph (64 kph) or greater and all materials and equipment secured.

The Contractor shall provide drawings showing the containment system and indicating the method(s) of supporting the working platforms and containment materials to each other and to the bridge. When the use of negative pressure and airflow inside containment is specified, the Contractor shall provide all ventilation calculations and details on the equipment that will be used for achieving the specified airflow and dust collection.

When directed in the contract plans, the Contractor shall submit calculations and drawings, signed and sealed by a Structural Engineer licensed in the state of Illinois, that assure the structural integrity of the bridge under the live and dead loads imposed, including the design wind loading.

When working over railroads, the Contractor shall provide evidence that the proposed clearance and the safety provisions that will be in place (e.g., flagman) are acceptable to the railroad. In the case of work over navigable waters, the Contractor shall provide evidence that the proposed clearance and provisions for installing or moving the containment out of navigation lanes is acceptable to authorities such as the Coast Guard and Army Corps of Engineers. The Contractor shall include plans for assuring that navigation lighting is not obscured, or if it is obscured, that temporary lighting is acceptable to the appropriate authorities (e.g., Coast Guard) and will be utilized.

Engineer review and acceptance of the drawings and calculations shall not relieve the Contractor from the responsibility for the safety of the working platforms and containment, and for providing ample ventilation to control worker and environmental exposures. After the work platforms and containment materials are erected additional measures may be needed to ensure worker safety according to OSHA regulations. The Contractor shall institute such measures at no additional cost to the Department.

Containment for the cleaning operation of this contract is defined as follows:

- The containment system shall maintain the work area free of visible emissions of dust and debris according to all provisions of this Specification, with no debris permitted outside of the regulated area at any time. All debris within the regulated area and within the containment shall be collected at the end of the last shift each day, and properly stored in sealed containers. Cleaning shall be accomplished by HEPA vacuuming unless it is conducted within a containment that is designed with a ventilation system capable of collecting the airborne dust and debris created by sweeping and blowing with compressed air. The ventilation system shall be in operation during the cleaning.
- The containment systems shall comply with the specified SSPC Guide 6 classifications as presented in Table 1 for the method of paint removal utilized.
- TSP-lead in the air at monitoring locations selected by the Contractor shall comply with the requirements specified herein.

The Contractor shall take appropriate action to avoid personnel injury or damage to the structure from the installation and use of the containment system. If the Engineer determines that there is the potential for structural damage caused by the installed containment system, the Contractor shall take appropriate action to correct the situation.

In addition to complying with the specific containment requirements in Table 1 for each method of removal, the Contractor shall provide and maintain coverage over the ground in the areas to be cleaned. This coverage shall be capable of catching and containing surface preparation media, paint chips, and paint dust in the event of an accidental escape from the primary containment. The containment materials shall be cleaned of loose material prior to relocation or dismantling. Acceptable methods of cleaning include blowing down the surfaces with compressed air while the ventilation system is in operation, HEPA vacuuming, and/or wet wiping. If paint chips or dust is observed escaping from the containment materials during moving, all associated operations shall be halted and the materials and components recleaned.

The containment systems shall also meet the following requirements:

a) Dry Abrasive Blast Cleaning - Full Containment with Negative Pressure (SSPC Class 1A)

The enclosure shall be designed, installed, and maintained to sustain maximum anticipated wind forces, including negative pressure. Flapping edges of containment materials are prohibited and the integrity of all containment materials, seams, and seals shall be maintained for the duration of the project. Airflow inside containment shall be designed to provide visibility and reduce worker exposures to toxic metals according to OSHA regulations and as specified in Table 1 and its accompanying text. When the location of the work on the bridge, or over lane closures permit, the blast enclosure shall extend a minimum of 3 ft. (1 m) beyond the limits of surface preparation to allow the workers to blast away from, rather than into the seam between the containment and the structure. The blast enclosure shall have an airlock or resealable door entryway to allow entrance and exit from the enclosure without allowing the escape of blasting residue.

If recyclable metallic abrasives are used, the Contractor shall operate the equipment in a manner that minimizes waste generation. Steps shall also be taken to minimize dust generation during the transfer of all abrasive/paint debris (expendable or recyclable abrasives) for recycling or disposal. Acceptable methods include, but are not limited to vacuuming, screw or belt conveyance systems, or manual conveyance. However manual conveyance is only permitted if the work is performed inside a containment that is equipped with an operating ventilation system capable of controlling the dust that is generated.

Appropriate filtration shall be used on the exhaust air of dust collection and abrasive recycling equipment as required to comply with IEPA regulations. The equipment shall be enclosed if visible dust and debris are being emitted and/or the regulated area or high volume monitor lead levels are not in compliance.

Areas beneath containment connection points that were shielded from abrasive blast cleaning shall be prepared by vacuum blast cleaning or vacuum-shrouded power tool cleaning after the containment is removed.

b) Vacuum Blast Cleaning within Containment (SSPC-Class 4A)

Vacuum blasting equipment shall be fully automatic and capable of cleaning and recycling the abrasive. The system shall be designed to deliver cleaned, recycled blasting abrasives and provide a closed system containment during blasting. The removed coating, mill scale, and corrosion shall be separated from the abrasive, and stored for disposal.

The Contractor shall attach containment materials around and under the work area to catch and contain abrasive and waste materials in the event of an accidental escape from the vacuum shroud. This containment is in addition to the ground covers specified earlier.

It is possible that the close proximity of some structural steel members, such as the end diaphragms or end cross-frames underneath transverse deck expansion joints, preclude the use of the vacuum blasting equipment for the removal of the old paint. For surfaces that are inaccessible for the nozzles of the vacuum blasting equipment, the Contractor shall remove the paint by means of full containment inside a complete enclosure as directed by the Engineer.

c) Vacuum-Shrouded Power Tool Cleaning within Containment (SSPC-Class 3P)

The Contractor shall utilize power tools equipped with vacuums and High Efficiency Particulate Air (HEPA) filters. The Contractor shall attach containment walls around the work area, and install containment materials beneath the work area to catch and contain waste materials in the event of an accidental escape from the vacuum shroud. This containment is in addition to the ground covers specified earlier and shall be installed within 10 ft. (3m) of the areas being cleaned.

d) Power Tool Cleaning without Vacuum, within Containment (SSPC-Class 2P)

When the use of power tools without vacuum attachments is authorized by the Engineer, the Contractor shall securely install containment walls and flooring around the work area to capture and collect all debris that is generated. The containment material requirements for this Class 2P are similar to Class 3P used for vacuum-shrouded tools, but the supporting structure will be more substantial in Class 2P to better secure the containment materials from excessive movement that could lead to the loss of waste paint chips and debris. Containment beneath the work shall be within 10 ft. (3m) of the areas being cleaned, and is in addition to the ground covers specified earlier.

e) Water Washing, Water Jetting or Wet Abrasive Blast Cleaning within Containment (SSPC Class 2W-3W)

Water washing of the bridge for the purpose of removing chalk, dirt, grease, oil, bird nests, and other surface debris, and water jetting or wet abrasive blast cleaning for the purpose of removing paint and surface debris shall be conducted within a containment designed, installed, and maintained in order to capture and contain all water and waste materials. The containment shall consist of impermeable floors and lower walls to prevent the water and debris from escaping. Permeable upper walls and ceilings are acceptable provided the paint chips, debris, and water, other than mists, are collected. A fine mist passing through the permeable upper walls is acceptable, provided the environmental controls specified below are met. If paint chips, debris, or water, other than mists, escape the containment system, impermeable walls and ceilings shall be installed.

When water is used for surface cleaning, the collected water shall be filtered to separate the particulate from the water. Recycling of the water is preferred in order to reduce the volume of waste that is generated. The water after filtration shall be collected and disposed of according to the waste handling portions of this specification.

When a slurry is created by injecting water into the abrasive blast stream, the slurry need not be filtered to separate water from the particulate.

Environmental Controls and Monitoring. The Contractor shall prepare and submit to the Engineer for review and acceptance, an Environmental Monitoring Plan. The purpose of the plan is to address the observations and equipment monitoring undertaken by the Contractor to confirm that project dust and debris are not escaping the containment into the surrounding air, soil, and water.

- a) **Soil and Water.** Containment systems shall be maintained to prevent the escape of paint chips, abrasives, and other debris into the water, and onto the ground, soil, slope protection, and pavements. Releases or spills of, paint chips, abrasives, dust and debris that have become deposited on surrounding property, structures, equipment or vehicles, and bodies of water are unacceptable. If there are inadvertent spills or releases, the Contractor shall immediately shut down the emissions-producing operations, clean up the debris, and change work practices, modify the containment, or take other appropriate corrective action as needed to prevent similar releases from occurring in the future.

Water booms, boats with skimmers, or other means as necessary shall be used to capture and remove paint chips or project debris that falls or escapes into the water.

At the end of each workday at a minimum, the work area inside and outside of containment, including ground tarpaulins, shall be inspected to verify that paint debris is not present. If debris is observed, it shall be removed by hand and HEPA-vacuuming. If wet methods of preparation are used, the damp debris can remain overnight provided it is protected from accidental release by securely covering the waste, folding the waste into the ground tarps, or by other acceptable methods. Prior to commencing work the next day, the debris from the folded ground tarps shall be removed.

Upon project completion, the ground and water in and around the project site are considered to have been properly cleaned if paint chips, paint removal media (e.g., spent abrasives), fuel, materials of construction, litter, or other project debris have been removed.

NOTE: All project debris must be removed even if the debris (e.g., spent abrasive and paint chips) was a pre-existing condition.

- b) **Visible Emissions.** The Contractor shall conduct observations of visible emissions and releases on an ongoing daily basis when dust-producing activities are underway, such as paint removal, clean up, waste handling, and containment dismantling or relocation. Note that visible emissions observations do not apply to the fine mist that may escape through permeable containment materials when wet methods of preparation are used.

Visible emissions in excess of SSPC Guide 6, Level 1 (1% of the workday) are unacceptable. In an 8-hour workday, this equates to emissions of a cumulative duration no greater than 4.8 minutes (288 seconds). This criterion applies to scattered, random emissions of short duration. Sustained emissions from a given location (e.g., 1 minute or longer), regardless of the total length of emissions for the workday, are unacceptable and action shall be initiated to halt the emission.

If unacceptable visible emissions or releases are observed, the Contractor shall immediately shut down the emission-producing operations, clean up the debris, and change work practices, modify the containment, or take other appropriate corrective action as needed to prevent similar releases from occurring in the future.

c) Ambient Air Monitoring. The Contractor shall perform ambient air monitoring according to the following:

- Monitor Siting. The Contractor shall collect and analyze air samples to evaluate levels of TSP-lead if there are sensitive receptors within 5 times the height of the structure or within 1000 ft. (305 m) of the structure, whichever is greater. If sensitive receptors are not located within these limits, monitoring is not required. Sensitive receptors are areas of public presence or access including, but not limited to, homes, schools, parks, playgrounds, shopping areas, livestock areas, and businesses. The motoring public is not considered to be a sensitive receptor for the purpose of ambient air monitoring.

The Contractor shall locate the monitors according to SSPC-TU-7, in areas of public exposure and in areas that will capture the maximum pollutant emissions resulting from the work. The Contractor shall identify the recommended monitoring sites in the Ambient Air Monitoring Plan, including a sketch identifying the above. The monitors shall not be sited until the Engineer accepts the proposed locations.

- Equipment Provided by Contractor. The Contractor shall provide up to 4 monitors per work site and all necessary calibration and support equipment, power to operate them, security (or arrangements to remove and replace the monitors daily), filters, flow chart recorders and overnight envelopes for shipping the filters to the laboratory. The number of monitors required will be indicated in the Plan Notes. Each monitor shall be tagged with the calibration date.
- Duration of Monitoring. Monitoring shall be performed for the duration of dust-producing operations (e.g., paint removal, waste handling, containment clean-up and movement, etc.) or a minimum of 8 hours each day (when work is performed).

The monitoring schedule shall be as follows:

1. For dry abrasive blast cleaning monitoring shall be conducted full time during all days of dust-producing operations (e.g., paint removal, waste handling, containment movement, etc.).
2. For wet abrasive blast cleaning, water jetting, or power tool cleaning, monitoring shall be conducted for the first 5 days of dust producing operations. If the results after 5 days are acceptable, monitoring may be discontinued. If the results are unacceptable, corrective action shall be initiated to correct the cause of the emissions, and monitoring shall continue for an additional 5 days. If the results are still unacceptable, the Engineer may direct that the monitoring continue full time.
3. When monitoring is discontinued, if visible emissions are observed and/or the Contractor's containment system changes during the course of the project, then air monitoring will again be required for a minimum of two consecutive days until compliance is shown.

- Background Monitoring. Background samples shall be collected for two days prior to the start of work while no dust producing operations are underway to provide a baseline. The background monitoring shall include one weekday and one weekend day. The background monitoring shall coincide with the anticipated working hours for the paint removal operations, but shall last for a minimum of 8 hours each day.
- Monitor Operation and Laboratory Analysis.

The Contractor shall calibrate the monitors according to the manufacturer's written instructions upon mobilization to the site and quarterly. Each monitor shall be tagged with the calibration date, and calibration information shall be provided to the Engineer upon request.

All ambient air monitoring shall be performed by the Contractor according to the accepted Ambient Air Monitoring Plan and according to EPA regulations 40 CFR Part 50 Appendix B, Reference Method for the Determination of Suspended Particulate Matter in the Atmosphere (High-Volume Method), and 40 CFR Part 50 Appendix G, Reference Method for the Determination of Lead in Suspended Particulate Matter Collected from Ambient Air.

Filters shall be placed in monitors and monitors operated each day prior to start of dust-producing operations and the filters removed upon completion each day. The Contractor shall advise the Engineer in advance when the filters will be removed and replaced. The monitor operator shall record the following information, at a minimum, on field data and laboratory chain-of-custody forms (or equivalent):

1. Monitor location and serial number
2. Flow rate, supported by flow charts
3. Start, stop times and duration of monitoring
4. Work activities and location of work during the monitoring period
5. Wind direction/speed

For the first 5 days of monitoring, the Contractor shall submit the filters, field data and laboratory chain-of-custody forms together with the flow chart recorders (i.e. monitor flow rate and the duration of monitoring) on a daily basis in an overnight envelope to the laboratory for analysis. The laboratory must provide the Engineer with written results no later than 72 hours after the completion of each day's monitoring. At the discretion of the Engineer, if the initial 5 days of monitoring on full time monitoring projects is acceptable, the filters may be sent to the laboratory every 3 days rather than every day. Written results must be provided to the Engineer no later than 5 days after the completion of monitoring for the latest of the 3 days.

- Ambient Air Monitoring Results. The laboratory shall provide the report directly to the Engineer with a copy to the contractor. The report shall include:

1. Monitor identification and location
2. Work location and activities performed during monitoring period
3. Monitor flow rate, duration, and volume of air sampled
4. Laboratory methods used for filter digestion / analysis
5. Sample results for the actual duration of monitoring
6. Sample results expressed in terms of a 24 hour time weighted average. Assume zero for period not monitored.
7. Comparison of the results with the acceptance criteria indicating whether the emissions are compliant.
8. Field data and chain-of-custody records used to derive results.

Should revised reports or any information regarding the analysis be issued by the laboratory directly to the Contractor at any time, the contractor shall immediately provide a copy to the Engineer and advise the laboratory that the Engineer is to receive all information directly from the laboratory.

- Acceptance Criteria. TSP-lead results at each monitor location shall be less than 1.5 $\mu\text{g}/\text{cu m}$ per calendar quarter converted to a daily allowance using the formulas from SSPC Guide 6 as follows, except that the maximum 24-hour daily allowance shall be no greater than 6 $\mu\text{g}/\text{cu m}$.

The formula for determining a 24-hour daily value based on the actual number of paint disturbance days expected to occur during the 90-day quarter is:

$$\text{DA} = (90 \div \text{PD}) \times 1.5 \mu\text{g}/\text{cu m}, \text{ where}$$

DA is the daily allowance, and

PD is the number of preparation days anticipated in the 90-day period

If the DA calculation is $> 6.0 \mu\text{g}/\text{cu m}$, use $6.0 \mu\text{g}/\text{cu m}$.

Regulated Areas. Physically demarcated regulated area(s) shall be established around exposure producing operations at the OSHA Action Level for the toxic metal(s) present in the coating. The Contractor shall provide all required protective clothing and equipment for personnel entering into a regulated area. Unprotected street clothing is not permitted within the regulated areas.

Hygiene Facilities/Protective Clothing/Blood Tests. The Contractor shall provide clean lavatory and hand washing facilities according to OSHA regulations and confirm that employees wash hands, forearms, and face before breaks. The facilities shall be located at the perimeter of the regulated area in close proximity to the paint removal operation. Shower facilities shall be provided when workers' exposures exceed the Permissible Exposure Limit. Showers shall be located at each bridge site, or if allowed by OSHA regulations, at a central location to service multiple bridges. The shower and wash facilities shall be cleaned at least daily during use.

All wash and shower water shall be filtered and containerized. The Contractor is responsible for filtration, testing, and disposal of the water.

The Contractor shall make available to all IDOT project personnel a base line and post project blood level screening determined by the whole blood lead method, utilizing the Vena-Puncture technique. This screening shall be made available every 2 months for the first 6 months, and every 6 months thereafter.

The Contractor shall provide IDOT project personnel with all required protective clothing and equipment, including disposal or cleaning. Clothing and equipment includes but is not limited to disposable coveralls with hood, booties, disposable surgical gloves, hearing protection, and safety glasses. The protective clothing and equipment shall be provided and maintained on the job site for the exclusive, continuous and simultaneous use by the IDOT personnel. This equipment shall be suitable to allow inspection access to any area in which work is being performed.

All handwash and shower facilities shall be fully available for use by IDOT project personnel.

Site Emergencies.

a) Stop Work. The Contractor shall stop work at any time the conditions are not within specifications and take the appropriate corrective action. The stoppage will continue until conditions have been corrected. Standby time and cost required for corrective action is at the Contractor's expense. The occurrence of the following events shall be reported in writing to IDOT and shall require the Contractor to automatically stop lead paint removal and initiate clean up activities.

- Airborne lead levels at any of the high volume ambient air monitoring locations that exceed the limits in this specification, or airborne lead in excess of the OSHA Action Level at the boundary of the regulated area.
- Break in containment barriers.
- Visible emissions in excess of the specification tolerances.
- Loss of negative air pressure when negative air pressure is specified (e.g., for dry abrasive blast cleaning).
- Serious injury within the containment area.
- Fire or safety emergency
- Respiratory system failure
- Power failure

b) Contingency Plans and Arrangements. The Engineer will refer to the contingency plan for site specific instructions in the case of emergencies.

The Contractor shall prepare a contingency plan for emergencies including fire, accident, failure of power, failure of dust collection system, failure of supplied air system or any other event that may require modification of standard operating procedures during lead removal. The plan shall include specific procedures to ensure safe egress and proper medical attention in the event of an emergency. The Contractor shall post the telephone numbers and locations of emergency services including fire, ambulance, doctor, hospital, police, power company and telephone company on clean side of personnel decontamination area.

A two-way radio, or equal, as approved by the Engineer, capable of summoning emergency assistance shall be available at each bridge during the time the Contractor's personnel are at the bridge site under this contract. The following emergency response equipment described in the contingency plan (generic form attached) shall be available during this time as well: an appropriate portable fire extinguisher, a 55 gal (208 L) drum, a 5 gal (19 L) pail, a long handled shovel, absorbent material (one bag).

A copy of the contingency plan shall be maintained at each bridge during cleaning operations and during the time the Contractor's personnel are at the bridge site under this contract. The Contractor shall designate the emergency coordinator(s) required who shall be responsible for the activities described.

An example of a contingency plan is included at the end of this Special Provision.

Collection, Temporary Storage, Transportation and Disposal of Waste. The Contractor and the Department are considered to be co-generators of the waste.

The Contractor is responsible for all aspects of waste collection, testing and identification, handling, storage, transportation, and disposal according to these specifications and all applicable Federal, State, and Local regulations. The Contractor shall provide for Engineer review and acceptance a Waste Management Plan that addresses all aspects of waste handling, storage, and testing, and provides the names, addresses, and a contact person for the proposed licensed waste haulers and disposal facilities. The Department will not perform any functions relating to the waste other than provide EPA identification numbers, provide the Contractor with the emergency response information, the emergency response telephone number required to be provided on the manifest, and to sign the waste manifest. The Engineer will obtain the identification numbers from the state and federal environmental protection agencies for the bridge(s) to be painted and furnish those to the Contractor.

All surface preparation/paint residues shall be collected daily and deposited in all-weather containers supplied by the Contractor as temporary storage. The storage area shall be secure to prevent unauthorized entry or tampering with the containers. Acceptable measures include storage within a fully enclosed (e.g., fenced in) and locked area, within a temporary building, or implementing other reasonable means to reduce the possibility of vandalism or exposure of the waste to the public or the environment (e.g., securing the lids or covers of waste containers and roll-off boxes). Waste shall not be stored outside of the containers. Waste shall be collected and transferred to bulk containers taking extra precautions as necessary to prevent the suspension of residues in air or contamination of surrounding surfaces. Precautions may include the transfer of the material within a tarpaulin enclosure. Transfer into roll-off boxes shall be planned to minimize the need for workers to enter the roll-off box.

No residues shall remain on surfaces overnight, either inside or outside of containment. Waste materials shall not be removed through floor drains or by throwing them over the side of the bridge. Flammable materials shall not be stored around or under any bridge structures.

The all-weather containers shall meet the requirements for the transportation of hazardous materials and as approved by the Department. Acceptable containers include covered roll-off boxes and 55-gallon drums (17H). The Contractor shall insure that no breaks and no deterioration of these containers occurs and shall maintain a written log of weekly inspections of the condition of the containers. A copy of the log shall be furnished to the Engineer upon request. The containers shall be kept closed and sealed from moisture except during the addition of waste. Each container shall be permanently identified with the date that waste was placed into the container, contract number, hazardous waste name and ID number, and other information required by the IEPA.

The Contractor shall have each waste stream sampled for each project and tested by TCLP and according to EPA and disposal company requirements. The Engineer shall be notified in advance when the samples will be collected. The samples shall be collected and shipped for testing within the first week of the project, with the results due back to the Engineer within 10 days. Testing shall be considered included in the pay item for "Containment and Disposal of Lead Paint Cleaning Residues." Copies of the test results shall be provided to the Engineer prior to shipping the waste.

Waste water generated from bridge washing, hygiene purposes, and cleaning of equipment shall be filtered on site to remove particulate and disposed of at a Publicly Owned Treatment Works (POTW) according to State regulations. The Contractor shall provide the Engineer with a letter from the POTW indicating that they will accept the waste water. If the POTW allows the filtered water to be placed into the sanitary sewer system, the Contractor shall provide a letter from the POTW indicating that based on the test results of the water, disposal in the sanitary sewer is acceptable to them. Water shall not be disposed of until the above letter(s) are provided to, and accepted by, the Engineer.

If approved abrasive additives are used that render the waste non-hazardous as determined by TCLP testing, the waste shall be classified as a non-hazardous special waste, transported by a licensed waste transporter, and disposed of at an IEPA permitted disposal facility in Illinois.

When paint is removed from the bridge without the use of abrasive additives, the paint, together with the surface preparation media (e.g. abrasive) shall be handled as a hazardous waste, regardless of the TCLP results. The waste shall be transported by a licensed hazardous waste transporter, treated by an IEPA permitted treatment facility to a non-hazardous special waste and disposed of at an IEPA permitted disposal facility in Illinois.

The treatment/disposal facilities shall be approved by the Engineer, and shall hold an IEPA permit for waste disposal and waste stream authorization for this cleaning residue. The IEPA permit and waste stream authorization must be obtained prior to beginning cleaning, except that if necessary, limited paint removal will be permitted in order to obtain samples of the waste for the disposal facilities. The waste shall be shipped to the facility within 90 days of the first accumulation of the waste in the containers. When permitted by the Engineer, waste from multiple bridges in the same contract may be transported by the Contractor to a central waste storage location(s) approved by the Engineer in order to consolidate the material for pick up, and to minimize the storage of waste containers at multiple remote sites after demobilization. Arrangements for the final waste pickup shall be made with the waste hauler by the time blast cleaning operations are completed or as required to meet the 90 day limit stated above.

The Contractor shall submit a waste accumulation inventory table to the Engineer no later than the 5th day of the month. The table shall show the number and size of waste containers filled each day in the preceding month and the amount of waste shipped that month, including the dates of shipments.

The Contractor shall prepare a manifest supplied by the IEPA for off-site treatment and disposal before transporting the hazardous waste off-site. The Contractor shall prepare a land ban notification for the waste to be furnished to the disposal facility. The Contractor shall obtain the handwritten signature of the initial transporter and date of the acceptance of the manifest. The Contractor shall send one copy of the manifest to the IEPA within two working days of transporting the waste off-site. The Contractor shall furnish the generator copy of the manifest and a copy of the land ban notification to the Engineer. The Contractor shall give the transporter the remaining copies of the manifest.

All other project waste shall be removed from the site according to Federal, State and Local regulations, with all waste removed from the site prior to final Contractor demobilization.

The Contractor shall make arrangements to have other hazardous waste, which he/she generates, such as used paint solvent, transported to the Contractor's facility at the end of each day that this waste is generated. These hazardous wastes shall be manifested using the Contractor's own generator number to a treatment or disposal facility from the Contractor's facility. The Contractor shall not combine solvents or other wastes with cleaning residue wastes. All waste streams shall be stored in separate containers.

The Contractor is responsible for the payment of any fines and undertaking any clean up activities mandated by State or federal environmental agencies for improper waste handling, storage, transportation, or disposal.

Contractor personnel shall be trained in the proper handling of hazardous waste, and the necessary notification and clean up requirements in the event of a spill. The Contractor shall maintain a copy of the personnel training records at each bridge site.

Basis of Payment. The soil, water, and air monitoring, containment, collection, temporary storage, transportation, testing and disposal of all project waste, and all other work described herein will be paid for at the contract lump sum price for CONTAINMENT AND DISPOSAL OF LEAD PAINT CLEANING RESIDUES at the designated location. Payment will not be authorized until all requirements have been fulfilled as described in this specification, including the preparation and submittal of all QC documentation, submittal of environmental monitoring and waste test results, and disposal of all waste.

Appendix 1 – Reference List

The Contractor shall maintain the following reference standards and regulations on site for the duration of the project:

- Illinois Environmental Protection Agency – Information Statement on the Removal of Lead-Based Paint from Exterior Surfaces, latest revision
- Illinois Environmental Protection Act
- SSPC Guide 6, Guide for Containing Debris Generated During Paint Removal Operations
- 29 CFR 1926.62, Lead in Construction
- 40 CFR Part 50, Appendix B, Reference Method for the Determination of Suspended Particulate Matter in the Atmosphere (High-Volume Method)
- 40 CFR Part 50, Appendix G, Reference Method for the Determination of Lead in Suspended Particulate Matter Collected from Ambient Air
- SSPC Guide 16, Guide to Specifying and Selecting Dust Collectors
- SSPC TU-7, Conducting Ambient Air, Soil, and Water Sampling Activities During Surface Preparation and Paint Disturbance Activities.

Table 1 Containment Criteria for Removal of Paint Containing Lead and Other Toxic Metals¹					
Removal Method	SSPC Class²	Containment Material Flexibility	Containment Material Permeability³	Containment Support Structure	Containment Material Joints⁴
Hand Tool Cleaning	3P ⁶	Rigid or Flexible	Permeable or Impermeable	Minimal	Partially Sealed
Power Tool Cleaning w/ Vacuum	3P ⁶	Rigid or Flexible	Permeable or Impermeable	Minimal	Partially Sealed
Power Tool Cleaning w/o Vacuum	2P	Rigid or Flexible	Permeable or Impermeable	Rigid or Flexible	Fully or Partially Sealed
Water Jetting Wet Ab Blast Water Cleaning ⁷	2W-3W	Rigid or Flexible	Permeable and Impermeable ⁷	Rigid, Flexible, or Minimal	Fully and Partially Sealed
Abrasive Blast Cleaning	1A	Rigid or Flexible	Impermeable	Rigid or Flexible	Fully Sealed
Vacuum Blast Cleaning	4A ⁶	Rigid or Flexible	Permeable	Minimal	Partially Sealed

Table 1 (Continued) Containment Criteria for Removal of Paint Containing Lead and Other Toxic Metals¹					
Removal Method	SSPC Class²	Containment Entryway	Ventilation System Required⁵	Negative Pressure Required	Exhaust Filtration Required
Hand Tool Cleaning	3P ⁶	Overlapping or Open Seam	Natural	No	No
Power Tool Cleaning w/ Vacuum	3P ⁶	Overlapping or Open Seam	Natural	No	No
Power Tool Cleaning w/o Vacuum	2P	Overlapping or Open Seam	Natural	No	No
Water Jetting Wet Ab Blast Water Cleaning ⁷	2W-3W	Overlapping or Open Seam	Natural	No	No
Abrasive Blast Cleaning	1A	Airlock or Resealable	Mechanical	Yes	Yes
Vacuum Blast Cleaning	4A ⁶	Open Seam	Natural	No	No

Notes:

¹This table provides general design criteria only. It does not guarantee that specific controls over emissions will occur because unique site conditions must be considered in the design. Other combinations of materials may provide controls over emissions equivalent to or greater than those combinations shown above.

²The SSPC Classification is based on SSPC Guide 6. Note that for work over water, water booms or boats with skimmers must be employed, where feasible, to contain spills or releases. Debris must be removed daily at a minimum.

³Permeability addresses both air and water as appropriate. In the case of water removal methods, the containment materials must be resistant to water. Ground covers should always be impermeable, and of sufficient strength to withstand the impact and weight of the debris and the equipment used for collection and clean-up. Ground covers must also extend beyond the containment boundary to capture escaping debris.

⁴ If debris escapes through the seams, then additional sealing of the seams and joints is required.

⁵When "Natural" is listed, ventilation is not required provided the emissions are controlled as specified in this Special Provision, and provided worker exposures are properly controlled. If unacceptable emissions or worker exposures to lead or other toxic metals occur, incorporate a ventilation system into the containment.

⁶Ground covers and wall tarpaulins may provide suitable controls over emissions without the need to completely enclose the work area.

⁷This method applies to water cleaning to remove surface contaminants, and water jetting (with and without abrasive) and wet abrasive blast cleaning where the goal is to remove paint. Although both permeable and impermeable containment materials are included, ground covers and the lower portions of the containment must be water impermeable with fully sealed joints, and of sufficient strength and integrity to facilitate the collection and holding of the water and debris for proper disposal. If water or debris, other than mist, escape through upper sidewalls or ceiling areas constructed of permeable materials, they shall be replaced with impermeable materials. Permeable materials for the purpose of this specification are defined as materials with openings measuring 25 mils (1 micron) or less in greatest dimension.

- A. Containment Components - The basic components that make up containment systems are defined below. The components are combined in Table 1 to establish the minimum containment system requirements for the method(s) of paint removal specified for the Contract.

1. R Rigidity of Containment Materials - Rigid containment materials consist of solid panels of plywood, aluminum, rigid metal, plastic, fiberglass, composites, or similar materials. Flexible materials consist of screens, tarps, drapes, plastic sheeting, or similar materials. When directed by the Engineer, do not use flexible materials for horizontal surfaces directly over traffic lanes or vertical surfaces in close proximity to traffic lanes. If the Engineer allows the use of flexible materials, The Contractor shall take special precautions to completely secure the materials to prevent any interference with traffic.
2. Permeability of Containment Materials - The containment materials are identified as air impenetrable if they are impervious to dust or wind such as provided by rigid panels, coated solid tarps, or plastic sheeting. Air penetrable materials are those that are formed or woven to allow air flow. Water impermeable materials are those that are capable of containing and controlling water when wet methods of preparation are used. Water permeable materials allow the water to pass through. Chemical resistant materials are those resistant to chemical and solvent stripping solutions. Use fire retardant materials in all cases.
3. Support Structure - Rigid support structures consist of scaffolding and framing to which the containment materials are affixed to minimize movement of the containment cocoon. Flexible support structures are comprised of cables, chains, or similar systems to which the containment materials are affixed. Use fire retardant materials in all cases.
4. Containment Joints - Fully sealed joints require that mating surfaces between the containment materials and to the structure being prepared are completely sealed. Sealing measures include tape, caulk, Velcro, clamps, or other similar material capable of forming a continuous, impenetrable or impermeable seal. When materials are overlapped, a minimum overlap of 8 in. (200 mm) is required.
5. Entryway - An airlock entryway involves a minimum of one stage that is fully sealed to the containment and which is maintained under negative pressure using the ventilation system of the containment. Resealable door entryways involve the use of flexible or rigid doors capable of being repeatedly opened and resealed. Sealing methods include the use of zippers, Velcro, clamps, or similar fasteners. Overlapping door tarpaulin entryways consist of two or three overlapping door tarpaulins.

6. Mechanical Ventilation - The requirement for mechanical ventilation is to ensure that adequate air movement is achieved to reduce worker exposure to toxic metals to as low as feasible according to OSHA regulations (e.g., 29 CFR 1926.62), and to enhance visibility. Design the system with proper exhaust ports or plenums, adequately sized ductwork, adequately sized discharge fans and air cleaning devices (dust collectors) and properly sized and distributed make-up air points to achieve a uniform air flow inside containment for visibility. The design target for airflow shall be a minimum of 100 ft. (30.5m) per minute cross-draft or 60 ft. (18.3 m) per minute downdraft. Increase these minimum airflow requirements if necessary to address worker lead exposures. Natural ventilation does not require the use of mechanical equipment for moving dust and debris through the work area.
7. Negative Pressure - When specified, achieve a minimum of 0.03 in. (7.5 mm) water column (W.C.) relative to ambient conditions, or confirm through visual assessments for the concave appearance of the containment enclosure.
8. Exhaust Ventilation - When mechanical ventilation systems are used, provide filtration of the exhaust air, to achieve a filtration efficiency of 99.9 percent at 0.02 mils (0.5 microns).

HAZARDOUS WASTE
CONTINGENCY PLAN
FOR
LEAD BASED PAINT REMOVAL PROJECTS

Bridge No.: _____
Location: _____
USEPA Generator No.: _____
IEPA Generator No.: _____

Note:

1. A copy of this plan must be kept at the bridge while the Contractor's employees are at the site.
2. A copy of the plan must be mailed to the police and fire departments and hospital identified herein.

Primary Emergency Coordinator

Name: _____
Address: _____
City: _____
Phone: (Work) _____
(Home) _____

Alternate Emergency Coordinator

Name: _____
Address: _____
City: _____
Phone: (Work) _____
(Home) _____

Emergency Response Agencies

POLICE:

1. State Police (if bridge not in city) Phone: _____
District No. _____
Address: _____
2. County Sheriff _____ Phone: _____
County: _____
Address: _____
3. City Police _____ Phone: _____
District No. _____
Address: _____

Arrangements made with police: (Describe arrangements or refusal by police to make arrangements):

FIRE:

1. City _____ Phone: _____
Name: _____
Address: _____
2. Fire District _____ Phone: _____
Name: _____
Address: _____

3. Other _____ Phone: _____

Name: _____

Address: _____

Arrangements made with fire departments: (Describe arrangements or refusal by fire departments to make arrangements):

HOSPITAL:

Name: _____ Phone: _____

Address: _____

Arrangements made with hospital: (Describe arrangements or refusal by hospital to make arrangements):

Properties of waste and hazard to health:

Places where employees working:

Location of Bridge:

Types of injuries or illness which could result:

Appropriate response to release of waste to the soil:

Appropriate response to release of waste to surface water:

Emergency Equipment at Bridge

Emergency Equipment List	Location of Equipment	Description of Equipment	Capability of Equipment
1. Two-way radio	Truck		Communication
2. Portable Fire Extinguisher	Truck		Extinguishes Fire
3. Absorbent Material	Truck		Absorbs Paint or Solvent Spills
4. Hand Shovel	Truck		Scooping Material
5. 55 Gallon (208 L) Drum	Truck		Storing Spilled Material
6. 5 Gallon (19 L) Pail	Truck		Storing Spilled Material

Emergency Procedure

1. Notify personnel at the bridge of the emergency and implement emergency procedure.
2. Identify the character, source, amount and extent of released materials.
3. Assess possible hazards to health or environment.
4. Contain the released waste or extinguish fire. Contact the fire department if appropriate.
5. If human health or the environment is threatened, contact appropriate police and fire department. In addition, the Emergency Services and Disaster Agency needs to be called using their 24-hour toll free number (800-782-7860) and the National Response Center using their 24-hour toll free number (800-824-8802).
6. Notify the Engineer that an emergency has occurred.
7. Store spilled material and soil contaminated by spill, if any, in a drum or pail. Mark and label the drum or pail for disposal.
8. Write a full account of the spill or fire incident including date, time, volume, material, and response taken.
9. Replenish stock of absorbent material or other equipment used in response.

CONTAINMENT AND DISPOSAL OF NON-LEAD PAINT CLEANING RESIDUES

Effective: November 25, 2004

Revised: March 6, 2009

Description. This work shall consist of the containment, collection, temporary storage, transportation and disposal of waste from non-lead paint removal projects. Waste requiring containment and control includes, but is not limited to, old paint, spent abrasives, corrosion products, mill scale, dirt, dust, grease, oil, and salts.

General. This specification provides the requirements for the control of paint removal waste when the existing coatings do not contain lead. If the coatings contain lead, use specification "Containment and Disposal of Lead Paint Cleaning Residues." The Contractor shall take reasonable and appropriate precautions to protect the public from the inhalation or ingestion of dust and debris from their paint removal and clean up operations and is responsible for the clean-up of all spills of waste at no additional cost to the Department.

The Contractor shall comply with the requirements of this Specification and all applicable Federal, State, and Local laws, codes, and regulations, including, but not limited to the regulations of the United States Environmental Protection Agency (USEPA), Occupational Safety and Health Administration (OSHA), and Illinois Environmental Protection Agency (IEPA). The Contractor shall comply with all applicable regulations even if the regulation is not specifically referenced herein. If a Federal, State, or Local regulation is more restrictive than the requirements of this Specification, the more restrictive requirements shall prevail.

Submittals. The Contractor shall submit for Engineer review and acceptance, the following drawings and plans for accomplishing the work. The submittals shall be provided within 30 days of execution of the contract unless given written permission by the Engineer to submit them at a later date. Work cannot proceed until the submittals are accepted by the Engineer. Details for each of the plans are presented within the body of this specification.

- f) Containment Plans. The containment plans shall include drawings, equipment specifications, and calculations (e.g., wind load). The plans shall include copies of the manufacturer's specifications for the containment materials and equipment that will be used to accomplish containment and ventilation.
- g) When required by the contract plans, the containment submittal shall provide calculations that assure the structural integrity of the bridge when it supports the containment and the calculations and drawings shall be signed and sealed by a Structural Engineer licensed in the state of Illinois.

When working over the railroad or navigable waterways, the Department will notify the respective agencies that work is being planned. Unless otherwise directed by the Engineer, the Contractor is responsible for follow up contact, and shall provide evidence that the railroad, Coast Guard, Corps of Engineers, and other applicable agencies are satisfied with the clearance provided and other safety measures that are proposed.

- h) Waste Management Plan. The Waste Management Plan shall address all aspects of waste handling, storage, testing, hauling and disposal. Include the names, addresses, and a contact person for the proposed licensed waste haulers and disposal facilities. Submit the name and qualifications of the laboratory proposed for Toxicity Characteristic Leaching Procedure (TCLP) analysis.
- i) Contingency Plan. The Contractor shall prepare a contingency plan for emergencies including fire, accident, failure of power, failure of supplied air system or any other event that may require modification of standard operating procedures. The plan shall include specific procedures to ensure safe egress and proper medical attention in the event of an emergency.

When the Engineer accepts the submittals, the Contractor will receive written notification. The Contractor shall not begin any work until the Engineer has accepted the submittals. The Contractor shall not construe Engineer acceptance of the submittals to imply approval of any particular method or sequence for conducting the work, or for addressing health and safety concerns. Acceptance of the plans does not relieve the Contractor from the responsibility to conduct the work according to the requirements of Federal, State, or Local regulations, this specification, or to adequately protect the health and safety of all workers involved in the project and any members of the public who may be affected by the project. The Contractor remains solely responsible for the adequacy and completeness of the programs and work practices, and adherence to them.

Quality Control (QC) Inspections. The Contractor shall perform first line, in process QC inspections of all environmental control and waste handling aspects of the project to verify compliance with these specification requirements and the accepted drawings and plans. Contractor QC inspections shall include, but not be limited to the following:

- Proper installation and continued performance of the containment system(s) in accordance with the approved drawings.
- Visual inspections of emissions into the air and verification that the cause(s) for any unacceptable emissions is corrected.
- Visual inspections of spills or deposits of contaminated materials into the water or onto the ground, pavement, soil, or slope protection. Included is verification that proper cleanup is undertaken and that the cause(s) of unacceptable releases is corrected.
- Proper implementation of the waste management plan including laboratory analysis and providing the results to the Engineer within the time frames specified herein.
- Proper implementation of the contingency plans for emergencies.

Quality Assurance (QA) Observations. The Engineer will conduct QA observations of any or all of the QC monitoring inspections that are undertaken. The presence or activity of Engineer observations in no way relieves the Contractor of the responsibility to provide all necessary daily QC inspections of its own and to comply with all requirements of this Specification.

Containment Requirements. The Contractor shall install and maintain containment systems surrounding the work for the purpose of controlling emissions of dust and debris according to the requirements of this specification. Working platforms and containment materials that are used shall be firm and stable and platforms shall be designed to support the workers, inspectors, spent surface preparation media (e.g., abrasives), and equipment during all phases of surface preparation and painting. Platforms, cables, and other supporting structures shall be designed according to OSHA regulations. If the containment needs to be attached to the structure, the containment shall be attached by bolting, clamping, or similar means. Welding or drilling into the structure is prohibited unless approved by the Engineer in writing.

The containment shall be dropped in the event of sustained winds of 40 mph (64 kph) or greater and all materials and equipment secured.

The Contractor shall provide drawings showing the containment system and indicating the method(s) of supporting the working platforms and containment materials to each other and to the bridge.

When directed in the contract plans, the Contractor shall submit calculations and drawings, signed and sealed by a Structural Engineer licensed in the state of Illinois, that assure the structural integrity of the bridge under the live and dead loads imposed, including the design wind loading.

When working over railroads, the Contractor shall provide evidence that the proposed clearance and the safety provisions that will be in place (e.g., flagman) are acceptable to the railroad. In the case of work over navigable waters, the Contractor shall provide evidence that the proposed clearance and provisions for installing or moving the containment out of navigation lanes is acceptable to authorities such as the Coast Guard and Army Corps of Engineers. The Contractor shall include plans for assuring that navigation lighting is not obscured, or if it is obscured, that temporary lighting is acceptable to the appropriate authorities (e.g., Coast Guard) and will be utilized.

Engineer review and acceptance of the drawings and calculations shall not relieve the Contractor from the responsibility for the safety of the working platforms and containment. After the work platforms and containment materials are erected additional measures may be needed to ensure worker safety according to OSHA regulations. The Contractor shall institute such measures at no additional cost to the Department.

Containment for the cleaning operation of this contract is defined as follows:

- The containment system shall confine emissions of dust and debris to the property line.
- The containment systems shall comply with the specified SSPC Guide 6 classifications, as applicable, as presented in Table 1 for the method of paint removal utilized.

The Contractor shall take appropriate action to avoid personnel injury or damage to the structure from the installation and use of the containment system. If the Engineer determines that there is the potential for structural damage caused by the installed containment system, the Contractor shall take appropriate action to correct the situation.

The containment systems shall also meet the following requirements:

a) Dry Abrasive Blast Cleaning - (SSPC Class 2A)

The enclosure shall be designed, installed, and maintained to sustain maximum anticipated wind forces. Flapping edges of containment materials are prohibited and the integrity of all containment materials shall be maintained for the duration of the project. When the location of the work on the bridge, or over lane closures permit, the blast enclosure shall extend a minimum of 3 ft (1 m) beyond the limits of surface preparation to allow the workers to blast away from, rather than into the seam between the containment and the structure.

b) Vacuum Blast Cleaning

Vacuum blasting equipment shall be fully automatic and capable of cleaning and recycling the abrasive. The system shall be designed to deliver cleaned, recycled blasting abrasives and provide a closed system containment during blasting. The removed coating, mill scale, and corrosion shall be separated from the abrasive, and stored for disposal. No additional containment is required but escaping abrasive, paint chips, and debris shall be cleaned from the work area at the end of each day.

c) Power Tool Cleaning (SSPC-Class 3P)

The Contractor shall use containment materials (e.g., tarpaulins) to capture removed paint chips, rust, mill scale and other debris.

d) Vacuum-Shrouded Power Tool Cleaning/Hand Tool Cleaning

The Contractor shall utilize hand tools or power tools equipped with vacuums and High Efficiency Particulate Air (HEPA) filters. No additional containment is required but escaping and paint chips and debris shall be cleaned from the work area at the end of each day.

e) Water Jetting or Wet Abrasive Blast Cleaning for the Removal of Paint (SSPC Class 4W)

Water jetting or wet abrasive blast cleaning for the purpose of removing paint and surface debris shall be conducted within a containment designed, installed, and maintained in order to capture paint chips and debris. Collection of the water is not required. Mesh containment materials that capture paint chips and debris while allowing the water to pass through shall have openings a maximum of 25 mils (625 microns) in greatest dimension.

f) Water Washing

Water washing of the bridge for the purpose of removing chalk, dirt, grease, oil, bird nests, and other surface debris can be performed without additional containment provided paint chips and removed debris are removed and collected prior to washing or are cleaned from the site after cleaning is completed each day. At the Contractor's option, SSPC Class 4W permeable containment materials described above under "Water Jetting or Wet Abrasive Blast Cleaning for the Removal of Paint" can be used to collect the debris while the washing is underway.

Environmental Controls

- a) Cleanliness of ground and water. At the end of each workday at a minimum, the work area outside of containment, including any ground tarpaulins that are used, shall be inspected to verify that paint removal debris (e.g., paint chips, abrasives, rust, etc.) is not present. If debris is observed, it shall be removed by hand, shoveling, sweeping, or vacuuming.

Upon project completion, the ground and water in and around the project site are considered to have been properly cleaned if paint chips, paint removal media (e.g., spent abrasives), fuel, materials of construction, litter, or other project debris have been removed, even if the material being cleaned was a pre-existing condition.

- b) Visible Emissions. Emissions of dust and debris from the project shall not extend beyond the property line. If unacceptable visible emissions or releases beyond the property line are observed, the Contractor shall immediately shut down the emission-producing operations, clean up the debris, and change work practices, modify the containment, or take other appropriate corrective action as needed to prevent similar releases from occurring in the future.

Hygiene Facilities/Protective Clothing. The Contractor shall provide clean lavatory and hand washing facilities according to OSHA regulations and make them available to IDOT project personnel.

The Contractor shall provide IDOT project personnel with all required protective clothing and equipment, including disposal or cleaning. Clothing and equipment includes but is not limited to disposable coveralls with hood, booties, disposable surgical gloves, hearing protection, and safety glasses. The protective clothing and equipment shall be provided and maintained on the job site for the exclusive, continuous and simultaneous use by the IDOT personnel. This equipment shall be suitable to allow inspection access to any area in which work is being performed.

Site Emergencies.

a) Stop Work. The Contractor shall stop work at any time the conditions are not within specifications and take the appropriate corrective action. The stoppage will continue until conditions have been corrected. Standby time and cost required for corrective action is at the Contractor's expense. The occurrence of the following events shall be reported in writing to IDOT and shall require the Contractor to automatically stop paint removal and initiate clean up activities.

- Break in containment barriers.
- Visible emissions in excess of the specification tolerances.
- Serious injury within the containment area.
- Fire or safety emergency
- Respiratory system failure
- Power failure

b) Contingency Plans and Arrangements. The Engineer will refer to the contingency plan for site specific instructions in the case of emergencies.

The Contractor shall prepare a contingency plan for emergencies including fire, accident, failure of power, failure of supplied air system or any other event that may require modification of standard operating procedures during paint removal and painting processes. The plan shall include specific procedures to ensure safe egress and proper medical attention in the event of an emergency. The Contractor shall post the telephone numbers and locations of emergency services including fire, ambulance, doctor, hospital, police, power company and telephone company.

A two-way radio, or equal, as approved by the Engineer, capable of summoning emergency assistance shall be available at each bridge during the time the Contractor's personnel are at the bridge site under this contract. The following emergency response equipment described in the contingency plan (generic form attached) shall be available during this time as well: an appropriate portable fire extinguisher, a 55 gal (208 L) drum, a 5 gal (19 L) pail, a long handled shovel, absorbent material (one bag).

A copy of the contingency plan shall be maintained at each bridge during cleaning operations and during the time the Contractor's personnel are at the bridge site under this contract. The Contractor shall designate the emergency coordinator(s) required who shall be responsible for the activities described.

An example of a contingency plan is included at the end of this Special Provision.

Collection, Temporary Storage, Transportation and Disposal of Waste.

All surface preparation/paint residues shall be collected daily and deposited in all-weather containers supplied by the Contractor as temporary storage. The storage area shall be secure to prevent unauthorized entry or tampering with the containers. Acceptable measures include storage within a fully enclosed (e.g., fenced in) and locked area, within a temporary building, or implementing other reasonable means to reduce the possibility of vandalism or exposure of the waste to the public or the environment (e.g., chains and locks to secure the covers of roll-off boxes). Waste shall not be stored outside of the containers.

No residues shall remain on uncontained surfaces overnight. Waste materials shall not be removed through floor drains or by throwing them over the side of the bridge. Flammable materials shall not be stored around or under any bridge structures.

The Contractor shall have each waste stream sampled for each project and tested by TCLP and according to EPA and disposal company requirements. The Engineer shall be notified in advance when the samples will be collected. The samples shall be collected and shipped for testing within the first week of the project, with the results due back to the Engineer within 10 days. Testing shall be considered included in the pay item for "Containment and Disposal of Non-Lead Paint Cleaning Residues." Copies of the test results shall be provided to the Engineer prior to shipping the waste. If the waste tests hazardous, the Contractor shall comply with all provision of "Collection, Temporary Storage, Transportation and Disposal of Waste" found in specification "Containment and Disposal of Lead Paint Cleaning Residues," except additional costs will be paid for according to Article 109.04.

If the waste is found to be non-hazardous as determined by TCLP testing, the waste shall be classified as a non-hazardous special waste, transported by a licensed waste transporter, and disposed of at an IEPA permitted disposal facility in Illinois.

The waste shall be shipped to the disposal facility within 90 days of the first accumulation of the waste in the containers. When permitted by the Engineer, waste from multiple bridges in the same contract may be transported by the Contractor to a central waste storage location(s) approved by the Engineer in order to consolidate the material for pick up, and to minimize the storage of waste containers at multiple remote sites after demobilization. Arrangements for the final waste pickup shall be made with the waste hauler by the time blast cleaning operations are completed or as required to meet the 90-day limit stated above.

All other project waste shall be removed from the site according to Federal, State and Local regulations, with all waste removed from the site prior to final Contractor demobilization.

The Contractor shall make arrangements to have other hazardous waste, which he/she generates, such as used paint solvent, transported to the Contractor's facility at the end of each day that this waste is generated. These hazardous wastes shall be manifested using the Contractor's own generator number to a treatment or disposal facility from the Contractor's facility. The Contractor shall not combine solvents or other wastes with cleaning residue wastes. All waste streams shall be stored in separate containers.

The Contractor is responsible for the payment of any fines and undertaking any clean up activities mandated by State or federal environmental agencies for improper waste handling, storage, transportation, or disposal.

Basis of Payment. The containment, collection, temporary storage, transportation, testing and disposal of all project waste, and all other work described herein will be paid for at the contract lump sum price for CONTAINMENT AND DISPOSAL OF NON-LEAD PAINT CLEANING RESIDUES at the designated location. Payment will not be authorized until all requirements have been fulfilled as described in this specification, including the submittal of waste test results, and disposal of all waste.

Table 1 Containment Criteria for Removal of Paint and Other Debris¹					
Removal Method	SSPC Class²	Containment Material Flexibility	Containment Material Permeability³	Containment Support Structure	Containment Material Joints
Hand Tool Cleaning	None	See Note 4	See Note 4	See Note 4	See Note 4
Power Tool Cleaning w/ Vacuum	None	See Note 4	See Note 4	See Note 4	See Note 4
Power Tool Cleaning w/o Vacuum ⁵	3P	Rigid or Flexible	Permeable	Minimal	Partially Sealed
Water Jetting, Wet Abrasive Blast ⁶	4W	Flexible	Permeable	Flexible or Minimal	Partially Sealed
Water Cleaning ⁷	None	See Note 7	See Note 7	See Note 7	See Note 7
Open Abrasive Blast Cleaning ⁸	2A	Rigid or Flexible	Impermeable	Rigid or Flexible	Fully Sealed
Vacuum Blast Cleaning	None	See Note 4	See Note 4	See Note 4	See Note 4

Table 1 (Continued) Containment Criteria for Removal of Paint and Other Debris¹					
Removal Method	SSPC Class²	Containment Entryway	Ventilation System Required	Negative Pressure Required	Exhaust Filtration Required
Hand Tool Cleaning	None	See Note 4	See Note 4	See Note 4	See Note 4
Power Tool Cleaning w/ Vacuum	None	See Note 4	See Note 4	See Note 4	See Note 4
Power Tool Cleaning w/o Vacuum ⁵	3P	Open Seam	No	No	No
Water Jetting, Wet Abrasive Blast ⁶	4W	Open Seam	No	No	No
Water Cleaning ⁷	None	See Note 7	See Note 7	See Note 7	See Note 7
Open Abrasive Blast Cleaning ⁸	2A	Resealable or Overlap	Yes	Yes	Yes
Vacuum Blast Cleaning	None	See Note 4	See Note 4	See Note 4	See Note 4

Notes:

¹This table provides general design criteria only. It does not guarantee that specific controls over emissions will occur because unique site conditions must be considered in the design. Other combinations of materials may provide controls over emissions equivalent to or greater than those combinations shown above.

²The SSPC Classification is based on SSPC Guide 6.

³Permeability addresses both air and water as appropriate. In the case of water removal methods, the containment materials must be resistant to water. When ground covers are used they shall be of sufficient strength to withstand the impact and weight of the debris and the equipment used for collection and clean-up.

⁴Containment is not required provided paint chips and debris are removed from the ground and surfaces in and around the worksite at the end of each day. Ground tarpaulins can be used to simplify the cleanup. At the Contractor's option, permeable containment materials may be suspended under the work area to capture the debris at the time of removal. Permeable materials for the purpose of this specification are defined as materials with openings measuring 25 mils or less in greatest dimension.

⁵This method involves open power tool cleaning. The containment consists of permeable materials suspended beneath the work area to capture debris. As an option, if the work is close to the ground or bridge deck, ground covers can be used to capture the paint chips and debris for proper disposal.

⁶This method involves water jetting (with and without abrasive) and wet abrasive blast cleaning where the goal is to remove paint. Permeable containment materials are used to capture removed paint chips, debris, and abrasives (in the case of wet abrasive blast cleaning) while allowing the water to pass through. Permeable materials for the purpose of this specification are defined as materials with openings measuring 25 mils (625 microns) or less in greatest dimension.

⁷Chips and debris can be removed from the ground at the end of each shift, or the Contractor can install a Class 4W containment in the work area to collect the debris while allowing the water to pass through (see note 6)

⁸This method involves dry abrasive blast cleaning. Dust and debris shall not be permitted to escape from the containment.

Containment Components - The basic components that make up containment systems are defined below. The components are combined in Table 1 to establish the minimum containment system requirements for the method(s) of paint removal specified for the Contract.

1. R Rigidity of Containment Materials - Rigid containment materials consist of solid panels of plywood, aluminum, rigid metal, plastic, fiberglass, composites, or similar materials. Flexible materials consist of screens, tarps, drapes, plastic sheeting, or similar materials. When directed by the Engineer, do not use flexible materials for horizontal surfaces directly over traffic lanes or vertical surfaces in close proximity to traffic lanes. If the Engineer allows the use of flexible materials, the Contractor shall take special precautions to completely secure the materials to prevent any interference with traffic.
2. Permeability of Containment Materials - The containment materials are identified as air impenetrable if they are impervious to dust or wind such as provided by rigid panels, coated solid tarps, or plastic sheeting. Air penetrable materials are those that are formed or woven to allow air flow. Water impermeable materials are those that are capable of containing and controlling water when wet methods of preparation are used. Water permeable materials allow the water to pass through. Chemical resistant materials are those resistant to chemical and solvent stripping solutions. Use fire retardant materials in all cases.
3. Support Structure - Rigid support structures consist of scaffolding and framing to which the containment materials are affixed to minimize movement of the containment cocoon. Flexible support structures are comprised of cables, chains, or similar systems to which the containment materials are affixed. Use fire retardant materials in all cases.
4. Containment Joints - Fully sealed joints require that mating surfaces between the containment materials and to the structure being prepared are completely sealed. Sealing measures include tape, caulk, Velcro, clamps, or other similar material capable of forming a continuous, impenetrable or impermeable seal. When materials are overlapped, a minimum overlap of 8 in. (200 mm) is required.
5. Entryway - An airlock entryway involves a minimum of one stage that is fully sealed to the containment and which is maintained under negative pressure using the ventilation system of the containment. Resealable door entryways involve the use of flexible or rigid doors capable of being repeatedly opened and resealed. Sealing methods include the use of zippers, Velcro, clamps, or similar fasteners. Overlapping door tarpaulin entryways consist of two or three overlapping door tarpaulins.
6. Mechanical Ventilation - The requirement for mechanical ventilation is to ensure that adequate air movement is achieved to reduce worker exposure to toxic metals to as low as feasible according to OSHA regulations (e.g., 29 CFR 1926.62), and to enhance visibility. Natural ventilation does not require the use of mechanical equipment for moving dust and debris through the work area.

7. Negative Pressure - When specified, achieve a minimum of 0.03 in.(7.5 mm) water column (W.C.) relative to ambient conditions, or confirm through visual assessments for the concave appearance of the containment enclosure.
8. Exhaust Ventilation - When mechanical ventilation systems are specified,, provide filtration of the exhaust air, to achieve a filtration efficiency of 99.9 percent at 0.5 microns.

CONTINGENCY PLAN
FOR
NON-LEAD BASED PAINT REMOVAL PROJECTS

Bridge No.: _____

Location: _____

Note:

1. A copy of this plan must be kept at the bridge while the Contractor's employees are at the site.
2. A copy of the plan must be mailed to the police and fire departments and hospital identified herein.

Primary Emergency Coordinator

Name: _____

Address: _____

City: _____

Phone: (Work) _____

(Home) _____

Alternate Emergency Coordinator

Name: _____

Address: _____

City: _____

Phone: (Work) _____

(Home) _____

Emergency Response Agencies

POLICE:

1. State Police (if bridge not in city) Phone: _____
District No. _____
Address: _____
2. County Sheriff _____ Phone: _____
County: _____
Address: _____
3. City Police _____ Phone: _____
District No. _____
Address: _____

Arrangements made with police: (Describe arrangements or refusal by police to make arrangements):

FIRE:

1. City _____ Phone: _____
Name: _____
Address: _____
2. Fire District _____ Phone: _____
Name: _____
Address: _____

3. Other _____ Phone: _____

Name: _____

Address: _____

Arrangements made with fire departments: (Describe arrangements or refusal by fire departments to make arrangements):

HOSPITAL:

Name: _____ Phone: _____

Address: _____

Arrangements made with hospital: (Describe arrangements or refusal by hospital to make arrangements):

Properties of waste and hazard to health:

Places where employees working:

Location of Bridge:

Types of injuries or illness which could result:

Appropriate response to release of waste to the soil:

Appropriate response to release of waste to surface water:

Emergency Equipment at Bridge

Emergency Equipment List	Location of Equipment	Description of Equipment	Capability of Equipment
1. Two-way radio	Truck		Communication
2. Portable Fire Extinguisher	Truck		Extinguishes Fire
3. Absorbent Material	Truck		Absorbs Paint or Solvent Spills
4. Hand Shovel	Truck		Scooping Material
5. 208 L (55 Gallon) Drum	Truck		Storing Spilled Material
6. 19 L (5 Gallon) Pail	Truck		Storing Spilled Material

Emergency Procedure

1. Notify personnel at the bridge of the emergency and implement emergency procedure.
2. Identify the character, source, amount and extent of released materials.
3. Assess possible hazards to health or environment.
4. Contain the released waste or extinguish fire. Contact the fire department if appropriate.
5. If human health or the environment is threatened, contact appropriate police and fire department. In addition, the Emergency Services and Disaster Agency needs to be called using their 24-hour toll free number (800-782-7860) and the National Response Center using their 24-hour toll free number (800-824-8802).
6. Notify the Engineer that an emergency has occurred.
7. Store spilled material and soil contaminated by spill, if any, in a drum or pail. Mark and label the drum or pail for disposal.
8. Write a full account of the spill or fire incident including date, time, volume, material, and response taken.
10. Replenish stock of absorbent material or other equipment used in response.

CONTRACT CLAIMS (BDE)

Effective: April 1, 2014

Revise the first paragraph of Article 109.09(a) of the Standard Specifications to read:

“(a) Submission of Claim. All claims filed by the Contractor shall be in writing and in sufficient detail to enable the Department to ascertain the basis and amount of the claim. As a minimum, the following information must accompany each claim submitted.”

Revise Article 109.09(e) of the Standard Specifications to read:

“(e) Procedure. The Department provides two administrative levels for claims review.

Level I Engineer of Construction
Level II Chief Engineer/Director of Highways or Designee

- (1) Level I. All claims shall first be submitted at Level I. Two copies each of the claim and supporting documentation shall be submitted simultaneously to the District and the Engineer of Construction. The Engineer of Construction, in consultation with the District, will consider all information submitted with the claim and render a decision on the claim within 90 days after receipt by the Engineer of Construction. Claims not conforming to this Article will be returned without consideration. The Engineer of Construction may schedule a claim presentation meeting if in the Engineer of Construction’s judgment such a meeting would aid in resolution of the claim, otherwise a decision will be made based on the claim documentation submitted. If a Level I decision is not rendered within 90 days of receipt of the claim, or if the Contractor disputes the decision, an appeal to Level II may be made by the Contractor.
- (2) Level II. An appeal to Level II shall be made in writing to the Engineer of Construction within 45 days after the date of the Level I decision. Review of the claim at Level II shall be conducted as a full evaluation of the claim. A claim presentation meeting may be scheduled if the Chief Engineer/Director of Highways determines that such a meeting would aid in resolution of the claim, otherwise a decision will be made based on the claim documentation submitted. A Level II final decision will be rendered within 90 days of receipt of the written request for appeal.

Full compliance by the Contractor with the provisions specified in this Article is a contractual condition precedent to the Contractor’s right to seek relief in the Court of Claims. The Director’s written decision shall be the final administrative action of the Department. Unless the Contractor files a claim for adjudication by the Court of Claims within 60 days after the date of the written decision, the failure to file shall constitute a release and waiver of the claim.”

DISADVANTAGED BUSINESS ENTERPRISE PARTICIPATION (DBE)

Effective: September 1, 2000

Revised: August 2, 2011

FEDERAL OBLIGATION. The Department of Transportation, as a recipient of federal financial assistance, is required to take all necessary and reasonable steps to ensure nondiscrimination in the award and administration of contracts. Consequently, the federal regulatory provisions of 49 CFR Part 26 apply to this contract concerning the utilization of disadvantaged business enterprises. For the purposes of this Special Provision, a disadvantaged business enterprise (DBE) means a business certified by the Department in accordance with the requirements of 49 CFR Part 26 and listed in the Illinois Unified Certification Program (IL UCP) DBE Directory.

STATE OBLIGATION. This Special Provision will also be used by the Department to satisfy the requirements of the Business Enterprise for Minorities, Females, and Persons with Disabilities Act, 30 ILCS 575. When this Special Provision is used to satisfy state law requirements on 100 percent state-funded contracts, the federal government has no involvement in such contracts (not a federal-aid contract) and no responsibility to oversee the implementation of this Special Provision by the Department on those contracts. DBE participation on 100 percent state-funded contracts will not be credited toward fulfilling the Department's annual overall DBE goal required by the US Department of Transportation to comply with the federal DBE program requirements.

CONTRACTOR ASSURANCE. The Contractor makes the following assurance and agrees to include the assurance in each subcontract that the Contractor signs with a subcontractor.

The Contractor, subrecipient, or subcontractor shall not discriminate on the basis of race, color, national origin, or sex in the performance of this contract. The Contractor shall carry out applicable requirements of 49 CFR Part 26 in the award and administration of contracts funded in whole or in part with federal or state funds. Failure by the Contractor to carry out these requirements is a material breach of this contract, which may result in the termination of this contract or such other remedy as the recipient deems appropriate.

OVERALL GOAL SET FOR THE DEPARTMENT. As a requirement of compliance with 49 CFR Part 26, the Department has set an overall goal for DBE participation in its federally assisted contracts. That goal applies to all federal-aid funds the Department will expend in its federally assisted contracts for the subject reporting fiscal year. The Department is required to make a good faith effort to achieve the overall goal. The dollar amount paid to all approved DBE companies performing work called for in this contract is eligible to be credited toward fulfillment of the Department's overall goal.

CONTRACT GOAL TO BE ACHIEVED BY THE CONTRACTOR. This contract includes a specific DBE utilization goal established by the Department. The goal has been included because the Department has determined that the work of this contract has subcontracting opportunities that may be suitable for performance by DBE companies. The determination is based on an assessment of the type of work, the location of the work, and the availability of DBE companies to do a part of the work. The assessment indicates that, in the absence of unlawful discrimination, and in an arena of fair and open competition, DBE companies can be expected to perform **0.00%** of the work. This percentage is set as the DBE participation goal for this contract. Consequently, in addition to the other award criteria established for this contract, the Department will only award this contract to a bidder who makes a good faith effort to meet this goal of DBE participation in the performance of the work. A bidder makes a good faith effort for award consideration if either of the following is done in accordance with the procedures set for in this Special Provision:

- (a) The bidder documents that enough DBE participation has been obtained to meet the goal: or
- (b) The bidder documents that a good faith effort has been made to meet the goal, even though the effort did not succeed in obtaining enough DBE participation to meet the goal.

DBE LOCATOR REFERENCES. Bidders shall consult the IL UCP DBE Directory as a reference source for DBE-certified companies. In addition, the Department maintains a letting and item specific DBE locator information system whereby DBE companies can register their interest in providing quotes on particular bid items advertised for letting. Information concerning DBE companies willing to quote work for particular contracts may be obtained by contacting the Department's Bureau of Small Business Enterprises at telephone number (217)785-4611, or by visiting the Department's website at www.dot.il.gov.

BIDDING PROCEDURES. Compliance with this Special Provision is a material bidding requirement. The failure of the bidder to comply will render the bid not responsive.

- (a) The bidder shall submit a Disadvantaged Business Utilization Plan on Department forms SBE 2025 and 2026 with the bid.
- (b) The Utilization Plan shall indicate that the bidder either has obtained sufficient DBE participation commitments to meet the contract goal or has not obtained enough DBE participation commitments in spite of a good faith effort to meet the goal. The Utilization Plan shall further provide the name, telephone number, and telefax number of a responsible official of the bidder designated for purposes of notification of plan approval or disapproval under the procedures of this Special Provision.
- (c) The Utilization Plan shall include a DBE Participation Commitment Statement, Department form SBE 2025, for each DBE proposed for the performance of work to achieve the contract goal. For bidding purposes, submission of the completed SBE 2025 forms, signed by the DBEs and faxed to the bidder will be acceptable as long as the original is available and provided upon request. All elements of information indicated on the said form shall be provided, including but not limited to the following:

- (1) The names and addresses of DBE firms that will participate in the contract;
- (2) A description, including pay item numbers, of the work each DBE will perform;
- (3) The dollar amount of the participation of each DBE firm participating. The dollar amount of participation for identified work shall specifically state the quantity, unit price, and total subcontract price for the work to be completed by the DBE. If partial pay items are to be performed by the DBE, indicate the portion of each item, a unit price where appropriate and the subcontract price amount;
- (4) DBE Participation Commitment Statements, form SBE 2025, signed by the bidder and each participating DBE firm documenting the commitment to use the DBE subcontractors whose participation is submitted to meet the contract goal;
- (5) if the bidder is a joint venture comprised of DBE companies and non-DBE companies, the plan must also include a clear identification of the portion of the work to be performed by the DBE partner(s); and,
- (6) If the contract goal is not met, evidence of good faith efforts.

GOOD FAITH EFFORT PROCEDURES. The contract will not be awarded until the Utilization Plan submitted by the apparent successful bidder is approved. All information submitted by the bidder must be complete, accurate and adequately document that enough DBE participation has been obtained or document that good faith efforts of the bidder, in the event enough DBE participation has not been obtained, before the Department will commit to the performance of the contract by the bidder. The Utilization Plan will be approved by the Department if the Utilization Plan documents sufficient commercially useful DBE work performance to meet the contract goal or the bidder submits sufficient documentation of a good faith effort to meet the contract goal pursuant to 49 CFR Part 26, Appendix A. The Utilization Plan will not be approved by the Department if the Utilization Plan does not document sufficient DBE participation to meet the contract goal unless the apparent successful bidder documented in the Utilization Plan that it made a good faith effort to meet the goal. This means that the bidder must show that all necessary and reasonable steps were taken to achieve the contract goal. Necessary and reasonable steps are those which, by their scope, intensity and appropriateness to the objective, could reasonably be expected to obtain sufficient DBE participation, even if they were not successful. The Department will consider the quality, quantity, and intensity of the kinds of efforts that the bidder has made. Mere *pro forma* efforts, in other words, efforts done as a matter of form, are not good faith efforts; rather, the bidder is expected to have taken genuine efforts that would be reasonably expected of a bidder actively and aggressively trying to obtain DBE participation sufficient to meet the contract goal.

- (a) The following is a list of types of action that the Department will consider as part of the evaluation of the bidder's good faith efforts to obtain participation. These listed factors are not intended to be a mandatory checklist and are not intended to be exhaustive. Other factors or efforts brought to the attention of the Department may be relevant in appropriate cases, and will be considered by the Department.

- (1) Soliciting through all reasonable and available means (e.g. attendance at pre-bid meetings, advertising and/or written notices) the interest of all certified DBE companies that have the capability to perform the work of the contract. The bidder must solicit this interest within sufficient time to allow the DBE companies to respond to the solicitation. The bidder must determine with certainty if the DBE companies are interested by taking appropriate steps to follow up initial solicitations.
- (2) Selecting portions of the work to be performed by DBE companies in order to increase the likelihood that the DBE goals will be achieved. This includes, where appropriate, breaking out contract work items into economically feasible units to facilitate DBE participation, even when the prime Contractor might otherwise prefer to perform these work items with its own forces.
- (3) Providing interested DBE companies with adequate information about the plans, specifications, and requirements of the contract in a timely manner to assist them in responding to a solicitation.
- (4) a. Negotiating in good faith with interested DBE companies. It is the bidder's responsibility to make a portion of the work available to DBE subcontractors and suppliers and to select those portions of the work or material needs consistent with the available DBE subcontractors and suppliers, so as to facilitate DBE participation. Evidence of such negotiation includes the names, addresses, and telephone numbers of DBE companies that were considered; a description of the information provided regarding the plans and specifications for the work selected for subcontracting; and evidence as to why additional agreements could not be reached for DBE companies to perform the work.

b. A bidder using good business judgment would consider a number of factors in negotiating with subcontractors, including DBE subcontractors, and would take a firm's price and capabilities as well as contract goals into consideration. However, the fact that there may be some additional costs involved in finding and using DBE companies is not in itself sufficient reason for a bidder's failure to meet the contract DBE goal, as long as such costs are reasonable. Also the ability or desire of a bidder to perform the work of a contract with its own organization does not relieve the bidder of the responsibility to make good faith efforts. Bidders are not, however, required to accept higher quotes from DBE companies if the price difference is excessive or unreasonable.
- (5) Not rejecting DBE companies as being unqualified without sound reasons based on a thorough investigation of their capabilities. The bidder's standing within its industry, membership in specific groups, organizations, or associations and political or social affiliations (for example union vs. non-union employee status) are not legitimate causes for the rejection or non-solicitation of bids in the bidder's efforts to meet the project goal.
- (6) Making efforts to assist interested DBE companies in obtaining bonding, lines of credit, or insurance as required by the recipient or Contractor.

- (7) Making efforts to assist interested DBE companies in obtaining necessary equipment, supplies, materials, or related assistance or services.
 - (8) Effectively using the services of available minority/women community organizations; minority/women contractors' groups; local, state, and federal minority/women business assistance offices; and other organizations as allowed on a case-by-case basis to provide assistance in the recruitment and placement of DBE companies.
- (b) If the Department determines that the apparent successful bidder has made a good faith effort to secure the work commitment of DBE companies to meet the contract goal, the Department will award the contract provided that it is otherwise eligible for award. If the Department determines that the bidder has failed to meet the requirements of this Special Provision or that a good faith effort has not been made, the Department will notify the responsible company official designated in the Utilization Plan that the bid is not responsive. The notification shall include a statement of reasons for the determination.
- (c) The bidder may request administrative reconsideration of a determination adverse to the bidder within the five working days after the receipt of the notification date of the determination by delivering the request to the Department of Transportation, Bureau of Small Business Enterprises, Contract Compliance Section, 2300 South Dirksen Parkway, Room 319, Springfield, Illinois 62764 (Telefax: (217)785-1524). Deposit of the request in the United States mail on or before the fifth business day shall not be deemed delivery. The determination shall become final if a request is not made and delivered. A request may provide additional written documentation and/or argument concerning the issues raised in the determination statement of reasons, provided the documentation and arguments address efforts made prior to submitting the bid. The request will be forwarded to the Department's Reconsideration Officer. The Reconsideration Officer will extend an opportunity to the bidder to meet in person in order to consider all issues of documentation and whether the bidder made a good faith effort to meet the goal. After the review by the Reconsideration Officer, the bidder will be sent a written decision within ten working days after receipt of the request for consideration, explaining the basis for finding that the bidder did or did not meet the goal or make adequate good faith efforts to do so. A final decision by the Reconsideration Officer that a good faith effort was made shall approve the Utilization Plan submitted by the bidder and shall clear the contract for award. A final decision that a good faith effort was not made shall render the bid not responsive.

CALCULATING DBE PARTICIPATION. The Utilization Plan values represent work anticipated to be performed and paid for upon satisfactory completion. The Department is only able to count toward the achievement of the overall goal and the contract goal the value of payments made for the work actually performed by DBE companies. In addition, a DBE must perform a commercially useful function on the contract to be counted. A commercially useful function is generally performed when the DBE is responsible for the work and is carrying out its responsibilities by actually performing, managing, and supervising the work involved. The Department and Contractor are governed by the provisions of 49 CFR Part 26.55(c) on questions of commercially useful functions as it affects the work. Specific counting guidelines are provided in 49 CFR Part 26.55, the provisions of which govern over the summary contained herein.

- (a) DBE as the Contractor: 100 percent goal credit for that portion of the work performed by the DBE's own forces, including the cost of materials and supplies. Work that a DBE subcontracts to a non-DBE does not count toward the DBE goals.
- (b) DBE as a joint venture Contractor: 100 percent goal credit for that portion of the total dollar value of the contract equal to the distinct, clearly defined portion of the work performed by the DBE's own forces.
- (c) DBE as a subcontractor: 100 percent goal credit for the work of the subcontract performed by the DBE's own forces, including the cost of materials and supplies, excluding the purchase of materials and supplies or the lease of equipment by the DBE subcontractor from the prime Contractor or its affiliates. Work that a DBE subcontractor in turn subcontracts to a non-DBE does not count toward the DBE goal.
- (d) DBE as a trucker: 100 percent goal credit for trucking participation provided the DBE is responsible for the management and supervision of the entire trucking operation for which it is responsible. At least one truck owned, operated, licensed, and insured by the DBE must be used on the contract. Credit will be given for the following:
 - (1) The DBE may lease trucks from another DBE firm, including an owner-operator who is certified as a DBE. The DBE who leases trucks from another DBE receives credit for the total value of the transportation services the lessee DBE provides on the contract.
 - (2) The DBE may also lease trucks from a non-DBE firm, including from an owner-operator. The DBE who leases trucks from a non-DBE is entitled to credit only for the fee or commission is receives as a result of the lease arrangement.
- (e) DBE as a material supplier:
 - (1) 60 percent goal credit for the cost of the materials or supplies purchased from a DBE regular dealer.
 - (2) 100 percent goal credit for the cost of materials of supplies obtained from a DBE manufacturer.
 - (3) 100 percent credit for the value of reasonable fees and commissions for the procurement of materials and supplies if not a regular dealer or manufacturer.

CONTRACT COMPLIANCE. Compliance with this Special Provision is an essential part of the contract. The Department is prohibited by federal regulations from crediting the participation of a DBE included in the Utilization Plan toward either the contract goal or the Department's overall goal until the amount to be applied toward the goals has been paid to the DBE. The following administrative procedures and remedies govern the compliance by the Contractor with the contractual obligations established by the Utilization Plan. After approval of the Utilization Plan and award of the contract, the Utilization Plan and individual DBE Participation Statements become part of the contract. If the Contractor did not succeed in obtaining enough DBE participation to achieve the advertised contract goal, and the Utilization Plan was approved and contract awarded based upon a determination of good faith, the total dollar value of DBE work calculated in the approved Utilization Plan as a percentage of the awarded contract value shall become the amended contract goal. All work indicated for performance by an approved DBE shall be performed, managed, and supervised by the DBE executing the Participation Statement.

- (a) **NO AMENDMENT.** No amendment to the Utilization Plan may be made without prior written approval from the Department's Bureau of Small Business Enterprises. All requests for amendment to the Utilization Plan shall be submitted to the Department of Transportation, Bureau of Small Business Enterprises, Contract Compliance Section, 2300 South Dirksen Parkway, Room 319, Springfield, Illinois 62764. Telephone number (217)785-4611. Telefax number (217)785-1524.
- (b) **TERMINATION OR REPLACEMENT.** The Contractor shall not terminate or replace a DBE listed on the approved Utilization Plan, or perform with other forces work designated for a listed DBE except as provided in the Special Provision.
- (c) **CHANGES TO WORK.** Any deviation from the DBE condition-of-award or contract plans, specifications, or special provisions must be approved, in writing, by the Department as provided elsewhere in the Contract. The Contractor shall notify affected DBEs in writing of any changes in the scope of work which result in a reduction in the dollar amount condition-of-award to the contract. Where the revision includes work committed to a new DBE subcontractor, not previously involved in the project, then a Request for Approval of Subcontractor, Department form BC 260A, must be signed and submitted. If the commitment of work is in the form of additional tasks assigned to an existing subcontract, then a new Request for Approval of Subcontractor shall not be required. However, the Contractor must document efforts to assure that the existing DBE subcontractor is capable of performing the additional work and has agreed in writing to the change.
- (d) **ALTERNATIVE WORK METHODS.** In addition to the above requirements for reductions in the condition of award, additional requirements apply to the two cases of Contractor-initiated work substitution proposals. Where the contract allows alternate work methods which serve to delete or create underruns in condition of award DBE work, and the Contractor selects that alternate method or, where the Contractor proposes a substitute work method or material that serves to diminish or delete work committed to a DBE and replace it with other work, then the Contractor must demonstrate one of the following:
 - (1) That the replacement work will be performed by the same DBE (as long as the DBE is certified in the respective item of work) in a modification of the condition of award;
or

- (2) That the DBE is aware that its work will be deleted or will experience underruns and has agreed in writing to the change. If this occurs, the Contractor shall substitute other work of equivalent value to a certified DBE or provide documentation of good faith efforts to do so; or
 - (3) That the DBE is not capable of performing the replacement work or has declined to perform the work at a reasonable competitive price. If this occurs, the Contractor shall substitute other work of equivalent value to a certified DBE or provide documentation of good faith efforts to do so.
- (e) TERMINATION AND REPLACEMENT PROCEDURES. The Contractor shall not terminate or replace a DBE subcontractor listed in the approved Utilization Plan without prior written consent. This includes, but is not limited to, instances in which the Contractor seeks to perform work originally designated for a DBE subcontractor with its own forces or those of an affiliate, a non-DBE firm, or with another DBE firm. Written consent will be granted only if the Bureau of Small Business Enterprises agrees, for reasons stated in its concurrence document, that the Contractor has good cause to terminate or replace the DBE firm. Before transmitting to the Bureau of Small Business Enterprises any request to terminate and/or substitute a DBE subcontractor, the Contractor shall give notice in writing to the DBE subcontractor, with a copy to the Bureau, of its intent to request to terminate and/or substitute, and the reason for the request. The Contractor shall give the DBE five days to respond to the Contractor's notice. The DBE so notified shall advise the Bureau and the Contractor of the reasons, if any, why it objects to the proposed termination of its subcontract and why the Bureau should not approve the Contractor's action. If required in a particular case as a matter of public necessity, the Bureau may provide a response period shorter than five days.

For purposes of this paragraph, good cause includes the following circumstances:

- (1) The listed DBE subcontractor fails or refuses to execute a written contract;
- (2) The listed DBE subcontractor fails or refuses to perform the work of its subcontract in a way consistent with normal industry standards. Provided, however, that good cause does not exist if the failure or refusal of the DBE subcontractor to perform its work on the subcontract results from the bad faith or discriminatory action of the prime contractor;
- (3) The listed DBE subcontractor fails or refuses to meet the prime Contractor's reasonable, nondiscriminatory bond requirements;
- (4) The listed DBE subcontractor becomes bankrupt, insolvent, or exhibits credit unworthiness;
- (5) The listed DBE subcontractor is ineligible to work on public works projects because of suspension and debarment proceedings pursuant 2 CFR Parts 180, 215 and 1,200 or applicable state law.
- (6) You have determined that the listed DBE subcontractor is not a responsible contractor;

- (7) The listed DBE subcontractor voluntarily withdraws from the projects and provides to you written notice of its withdrawal;
- (8) The listed DBE is ineligible to receive DBE credit for the type of work required;
- (9) A DBE owner dies or becomes disabled with the result that the listed DBE contractor is unable to complete its work on the contract;
- (10) Other documented good cause that compels the termination of the DBE subcontractor. Provided, that good cause does not exist if the prime Contractor seeks to terminate a DBE it relied upon to obtain the contract so that the prime Contractor can self-perform the work for which the DBE contractor was engaged or so that the prime Contractor can substitute another DBE or non-DBE contractor after contract award.

When a DBE is terminated, or fails to complete its work on the Contract for any reason the Contractor shall make a good faith effort to find another DBE to substitute for the original DBE to perform at least the same amount of work under the contract as the terminated DBE to the extent needed to meet the established Contract goal.

- (f) PAYMENT RECORDS. The Contractor shall maintain a record of payments for work performed to the DBE participants. The records shall be made available to the Department for inspection upon request. After the performance of the final item of work or delivery of material by a DBE and final payment therefore to the DBE by the Contractor, but not later than thirty calendar days after payment has been made by the Department to the Contractor for such work or material, the Contractor shall submit a DBE Payment Agreement on Department form SBE 2115 to the Regional Engineer. If full and final payment has not been made to the DBE, the DBE Payment Agreement shall indicate whether a disagreement as to the payment required exists between the Contractor and the DBE or if the Contractor believes that the work has not been satisfactorily completed. If the Contractor does not have the full amount of work indicated in the Utilization Plan performed by the BDE companies indicated in the Utilization Plan and after good faith efforts are reviewed, the Department may deduct from contract payments to the Contractor the amount of the goal not achieved as liquidated and ascertained damages. The Contractor may request an administrative reconsideration of any amount deducted as damages pursuant to subsection (h) of this part.
- (g) ENFORCEMENT. The Department reserves the right to withhold payment to the Contractor to enforce the provisions of this Special Provision. Final payment shall not be made on the contract until such time as the Contractor submits sufficient documentation demonstrating achievement of the goal in accordance with this Special Provision or after liquidated damages have been determined and collected.

- (h) RECONSIDERATION. Notwithstanding any other provision of the contract, including but not limited to Article 109.09 of the Standard Specifications, the Contractor may request administrative reconsideration of a decision to deduct the amount of the goal not achieved as liquidated damages. A request to reconsider shall be delivered to the Contract Compliance Section and shall be handled and considered in the same manner as set forth in paragraph (c) of "Good Faith Effort Procedures" of this Special Provision, except a final decision that a good faith effort was not made during contract performance to achieve the goal agreed to in the Utilization Plan shall be the final administrative decision of the Department.

PAYROLLS AND PAYROLL RECORDS (BDE)

Effective: January 1, 2014

FEDERAL AID CONTRACTS. Revise the following section of Check Sheet #1 of the Recurring Special Provisions to read:

"STATEMENTS AND PAYROLLS

The payroll records shall include the worker's name, the worker's address, the worker's telephone number when available, the worker's social security number, the worker's classification or classifications, the worker's gross and net wages paid in each pay period, the worker's number of hours worked each day, the worker's starting and ending times of work each day. However, any Contractor or subcontractor who remits contributions to a fringe benefit fund that is not jointly maintained and jointly governed by one or more employers and one or more labor organization must additionally submit the worker's hourly wage rate, the worker's hourly overtime wage rate, the worker's hourly fringe benefit rates, the name and address of each fringe benefit fund, the plan sponsor of each fringe benefit, if applicable, and the plan administrator of each fringe benefit, if applicable.

The Contractor and each subcontractor shall submit payroll records to the Engineer each week from the start to the completion of their respective work, except that full social security numbers and home addresses shall not be included on weekly transmittals. Instead, the payrolls shall include an identification number for each employee (e.g., the last four digits of the employee's social security number). In addition, starting and ending times of work each day may be omitted from the payroll records submitted to the Engineer. The submittals shall be on the Department's form SBE 48, or an approved facsimile. When there has been no activity during a work week, a payroll record shall still be submitted with the appropriate box ("No Work", "Suspended", or "Complete") checked on the form."

STATE CONTRACTS. Revise Section IV of Check Sheet #5 of the Recurring Special Provisions to read:

“IV. COMPLIANCE WITH THE PREVAILING WAGE ACT

1. **Prevailing Wages.** All wages paid by the Contractor and each subcontractor shall be in compliance with The Prevailing Wage Act (820 ILCS 130), as amended, except where a prevailing wage violates a federal law, order, or ruling, the rate conforming to the federal law, order, or ruling shall govern. The Contractor shall be responsible to notify each subcontractor of the wage rates set forth in this contract and any revisions thereto. If the Department of Labor revises the wage rates, the Contractor will not be allowed additional compensation on account of said revisions.
2. **Payroll Records.** The Contractor and each subcontractor shall make and keep, for a period of five years from the later of the date of final payment under the contract or completion of the contract, records of the wages paid to his/her workers. The payroll records shall include the worker's name, the worker's address, the worker's telephone number when available, the worker's social security number, the worker's classification or classifications, the worker's gross and net wages paid in each pay period, the worker's number of hours worked each day, the worker's starting and ending times of work each day. However, any contractor or subcontractor who remits contributions to a fringe benefit fund that is not jointly maintained and jointly governed by one or more employers and one or more labor organization must additionally submit the worker's hourly wage rate, the worker's hourly overtime wage rate, the worker's hourly fringe benefit rates, the name and address of each fringe benefit fund, the plan sponsor of each fringe benefit, if applicable, and the plan administrator of each fringe benefit, if applicable. Upon seven business days' notice, these records shall be available at a location within the State, during reasonable hours, for inspection by the Department or the Department of Labor; and Federal, State, or local law enforcement agencies and prosecutors.
3. **Submission of Payroll Records.** The Contractor and each subcontractor shall submit payroll records to the Engineer each week from the start to the completion of their respective work, except that full social security numbers and home addresses shall not be included on weekly transmittals. Instead the payrolls shall include an identification number for each employee (e.g., the last four digits of the employee's social security number). In addition, starting and ending times of work each day may be omitted from the payroll records submitted to the Engineer. The submittals shall be on the Department's form SBE 48, or an approved facsimile. When there has been no activity during a work week, a payroll record shall still be submitted with the appropriate box (“No Work”, “Suspended”, or “Complete”) checked on the form.

Each submittal shall be accompanied by a statement signed by the Contractor or subcontractor, or an officer, employee, or officer thereof, which avers that: (i) he or she has examined the records and such records are true and accurate; (ii) the hourly rate paid to each worker is not less than the general prevailing rate of hourly wages required by the Act; and (iii) the Contractor or subcontractor is aware that filing a payroll record that he/she knows to be false is a Class A misdemeanor.

4. Employee Interviews. The Contractor and each subcontractor shall permit his/her employees to be interviewed on the job, during working hours, by compliance investigators of the Department or the Department of Labor.”

PROGRESS PAYMENTS (BDE)

Effective: November 2, 2013

Revise Article 109.07(a) of the Standard Specifications to read:

- “(a) Progress Payments. At least once each month, the Engineer will make a written estimate of the quantity of work performed in accordance with the contract, and the value thereof at the contract unit prices. The amount of the estimate approved as due for payment will be vouchered by the Department and presented to the State Comptroller for payment. No amount less than \$1000.00 will be approved for payment other than the final payment.

Progress payments may be reduced by liens filed pursuant to Section 23(c) of the Mechanics’ Lien Act, 770 ILCS 60/23(c).

If a Contractor or subcontractor has defaulted on a loan issued under the Department’s Disadvantaged Business Revolving Loan Program (20 ILCS 2705/2705-610), progress payments may be reduced pursuant to the terms of that loan agreement. In such cases, the amount of the estimate related to the work performed by the Contractor or subcontractor, in default of the loan agreement, will be offset, in whole or in part, and vouchered by the Department to the Working Capital Revolving Fund or designated escrow account. Payment for the work shall be considered as issued and received by the Contractor or subcontractor on the date of the offset voucher. Further, the amount of the offset voucher shall be a credit against the Department’s obligation to pay the Contractor, the Contractor’s obligation to pay the subcontractor, and the Contractor’s or subcontractor’s total loan indebtedness to the Department. The offset shall continue until such time as the entire loan indebtedness is satisfied. The Department will notify the Contractor and Fund Control Agent in a timely manner of such offset. The Contractor or subcontractor shall not be entitled to additional payment in consideration of the offset.

The failure to perform any requirement, obligation, or term of the contract by the Contractor shall be reason for withholding any progress payments until the Department determines that compliance has been achieved.”

REMOVAL AND DISPOSAL OF REGULATED SUBSTANCES (BDE)

Effective: January 1, 2012

Revised: November 2, 2012

Revise Article 669.01 of the Standard Specifications to read:

“669.01 Description. This work shall consist of the transportation and proper disposal of contaminated soil and water. This work shall also consist of the removal, transportation, and proper disposal of underground storage tanks (UST), their content and associated underground piping to the point where the piping is above the ground, including determining the content types and estimated quantities.”

Revise Article 669.08 of the Standard Specifications to read:

“669.08 Contaminated Soil and/or Groundwater Monitoring. The Contractor shall hire a qualified environmental firm to monitor the area containing the regulated substances. The affected area shall be monitored with a photoionization detector (PID) utilizing a lamp of 10.6eV or greater or a flame ionization detector (FID). Any field screen reading on the PID or FID in excess of background levels indicates the potential presence of contaminated material requiring handling as a non-special waste, special waste, or hazardous waste. No excavated soils can be taken to a clean construction and demolition debris (CCDD) facility or an uncontaminated soil fill operation with detectable PID or FID meter readings that are above background. The PID or FID meter shall be calibrated on-site and background level readings taken and recorded daily. All testing shall be done by a qualified engineer/technician. Such testing and monitoring shall be included in the work. The Contractor shall identify the exact limits of removal of non-special waste, special waste, or hazardous waste. All limits shall be approved by the Engineer prior to excavation. The Contractor shall take all necessary precautions.

Based upon the land use history of the subject property and/or PID or FID readings indicating contamination, a soil or groundwater sample shall be taken from the same location and submitted to an approved laboratory. Soil or groundwater samples shall be analyzed for the contaminants of concern, including pH, based on the property's land use history or the parameters listed in the maximum allowable concentration (MAC) for chemical constituents in uncontaminated soil established pursuant to Subpart F of 35 Illinois Administrative Code 1100.605. The analytical results shall serve to document the level of soil contamination. Soil and groundwater samples may be required at the discretion of the Engineer to verify the level of soil and groundwater contamination.

Samples shall be grab samples (not combined with other locations). The samples shall be taken with decontaminated or disposable instruments. The samples shall be placed in sealed containers and transported in an insulated container to the laboratory. The container shall maintain a temperature of 39 °F (4 °C). All samples shall be clearly labeled. The labels shall indicate the sample number, date sampled, location and elevation, and any other observations.

The laboratory shall use analytical methods which are able to meet the lowest appropriate practical quantitation limits (PQL) or estimated quantitation limit (EQL) specified in "Test Methods for Evaluating Solid Wastes, Physical/Chemical Methods", EPA Publication No. SW-846 and "Methods for the Determination of Organic Compounds in Drinking Water", EPA, EMSL, EPA-600/4-88/039. For parameters where the specified cleanup objective is below the acceptable detection limit (ADL), the ADL shall serve as the cleanup objective. For other parameters the ADL shall be equal to or below the specified cleanup objective."

Replace the first two paragraphs of Article 669.09 of the Standard Specifications with the following:

"669.09 Contaminated Soil and/or Groundwater Management and Disposal. The management and disposal of contaminated soil and/or groundwater shall be according to the following:

- (a) Soil Analytical Results Exceed Most Stringent MAC. When the soil analytical results indicate that detected levels exceed the most stringent maximum allowable concentration (MAC) for chemical constituents in uncontaminated soil established pursuant to Subpart F of 35 Illinois Administrative Code 1100.605, the soil shall be managed as follows:
 - (1) When analytical results indicate inorganic chemical constituents exceed the most stringent MAC but they are still considered within area background levels by the Engineer, the excavated soil can be utilized within the construction limits as fill, when suitable. Such soil excavated for storm sewers can be placed back into the excavated trench as backfill, when suitable, unless trench backfill is specified. If the soils cannot be utilized within the construction limits, they shall be managed and disposed of off-site as a non-special waste, special waste, or hazardous waste as applicable.
 - (2) When analytical results indicate chemical constituents exceed the most stringent MAC but do not exceed the MAC for a Metropolitan Statistical Area (MSA) County, the excavated soil can be utilized within the construction limits as fill, when suitable, or managed and disposed of off-site as "uncontaminated soil" at a CCDD facility or an uncontaminated soil fill operation within an MSA County provided the pH of the soil is within the range of 6.25 - 9.0, inclusive.
 - (3) When analytical results indicate chemical constituents exceed the most stringent MAC but do not exceed the MAC for an MSA County excluding Chicago, or the MAC within the Chicago corporate limits, the excavated soil can be utilized within the construction limits as fill, when suitable, or managed and disposed of off-site as "uncontaminated soil" at a CCDD facility or an uncontaminated soil fill operation within an MSA County excluding Chicago or within the Chicago corporate limits provided the pH of the soil is within the range of 6.25 - 9.0, inclusive.

- (4) When analytical results indicate chemical constituents exceed the most stringent MAC but do not exceed the MAC for an MSA County excluding Chicago, the excavated soil can be utilized within the construction limits as fill, when suitable, or managed and disposed of off-site as “uncontaminated soil” at a CCDD facility or an uncontaminated soil fill operation within an MSA County excluding Chicago provided the pH of the soil is within the range of 6.25 - 9.0, inclusive.
- (5) When the Engineer determines soil cannot be managed according to Articles 669.09(a)(1) through (a)(4) above, the soil shall be managed and disposed of off-site as a non-special waste, special waste, or hazardous waste as applicable.
- (b) Soil Analytical Results Do Not Exceed Most Stringent MAC. When the soil analytical results indicate that detected levels do not exceed the most stringent MAC but the pH of the soil is less than 6.25 or greater than 9.0, the excavated soil can be utilized within the construction limits or managed and disposed of off-site as “uncontaminated soil” according to Article 202.03. However the excavated soil cannot be taken to a CCDD facility or an uncontaminated soil fill operation.
- (c) Groundwater. When groundwater analytical results indicate the detected levels are above Appendix B, Table E of 35 Illinois Administrative Code 742, the most stringent Tier 1 Groundwater Remediation Objectives for Groundwater Component of the Groundwater Ingestion Route for Class 1 groundwater, the groundwater shall be managed off-site as a special waste.

All groundwater encountered within lateral trenches may be managed within the trench and allowed to infiltrate back into the ground. If the groundwater cannot be managed within the trench it must be removed as a special or hazardous waste. The Contractor is prohibited from managing groundwater within the trench by discharging it through any existing or new storm sewer. The Contractor shall install backfill plugs within the area of groundwater contamination.

One backfill plug shall be placed down gradient to the area of groundwater contamination. Backfill plugs shall be installed at intervals not to exceed 50 ft (15 m). Backfill plugs are to be 4 ft (1.2 m) long, measured parallel to the trench, full trench width and depth. Backfill plugs shall not have any fine aggregate bedding or backfill, but shall be entirely cohesive soil or any class of concrete. The Contractor shall provide test data that the material has a permeability of less than 10^{-7} cm/sec according to ASTM D 5084, Method A or per another test method approved by the Engineer.”

Revise Article 669.14 of the Standard Specifications to read:

“669.14 Final Environmental Construction Report. At the end of the project, the Contractor will prepare and submit three copies of the Environmental Construction Report on the activities conducted during the life of the project, one copy shall be submitted to the Resident Engineer, one copy shall be submitted to the District's Environmental Studies Unit, and one copy shall be submitted with an electronic copy in Adode.pdf format to the Geologic and Waste Assessment Unit, Bureau of Design and Environment, IDOT, 2300 South Dirksen Parkway, Springfield, Illinois 62764. The technical report shall include all pertinent information regarding the project including, but not limited to:

- (a) Measures taken to identify, monitor, handle, and dispose of soil or groundwater containing regulated substances, to prevent further migration of regulated substances, and to protect workers,
- (b) Cost of identifying, monitoring, handling, and disposing of soil or groundwater containing regulated substances, the cost of preventing further migration of regulated substances, and the cost for worker protection from the regulated substances. All cost should be in the format of the contract pay items listed in the contract plans (identified by the preliminary environmental site investigation (PESA) site number),
- (c) Plan sheets showing the areas containing the regulated substances,
- (d) Field sampling and testing results used to identify the nature and extent of the regulated substances,
- (e) Waste manifests (identified by the preliminary environmental site investigation (PESA) site number) for special or hazardous waste disposal, and
- (f) Landfill tickets (identified by the preliminary environmental site investigation (PESA) site number) for non-special waste disposal.”

Revise the second paragraph of Article 669.16 of the Standard Specifications to read:

“The transportation and disposal of soil and other materials from an excavation determined to be contaminated will be paid for at the contract unit price per cubic yard (cubic meter) for NON-SPECIAL WASTE DISPOSAL, SPECIAL WASTE DISPOSAL, or HAZARDOUS WASTE DISPOSAL.”

REMOVAL AND DISPOSAL OF SURPLUS MATERIALS (BDE)

Effective: November 2, 2012

Revise the first four paragraphs of Article 202.03 of the Standard Specifications to read:

“202.03 Removal and Disposal of Surplus, Unstable, Unsuitable, and Organic Materials. Suitable excavated materials shall not be wasted without permission of the Engineer. The Contractor shall dispose of all surplus, unstable, unsuitable, and organic materials, in such a manner that public or private property will not be damaged or endangered.

Suitable earth, stones and boulders naturally occurring within the right-of-way may be placed in fills or embankments in lifts and compacted according to Section 205. Broken concrete without protruding metal bars, bricks, rock, stone, reclaimed asphalt pavement with no expansive aggregate, or uncontaminated dirt and sand generated from construction or demolition activities may be used in embankment or in fill. If used in fills or embankments, these materials shall be placed and compacted to the satisfaction of the Engineer; shall be buried under a minimum of 2 ft (600 mm) of earth cover (except when the materials include only uncontaminated dirt); and shall not create an unsightly appearance or detract from the natural topographic features of an area. Broken concrete without protruding metal bars, bricks, rock, or stone may be used as riprap as approved by the Engineer. If the materials are used for fill in locations within the right-of-way but outside project construction limits, the Contractor must specify to the Engineer, in writing, how the landscape restoration of the fill areas will be accomplished. Placement of fill in such areas shall not commence until the Contractor's landscape restoration plan is approved by the Engineer.

Aside from the materials listed above, all other construction and demolition debris or waste shall be disposed of in a licensed landfill, recycled, reused, or otherwise disposed of as allowed by State or Federal laws and regulations. When the Contractor chooses to dispose of uncontaminated soil at a clean construction and demolition debris (CCDD) facility or at an uncontaminated soil fill operation, it shall be the Contractor's responsibility to have the pH of the material tested to ensure the value is between 6.25 and 9.0, inclusive. A copy of the pH test results shall be provided to the Engineer.

A permit shall be obtained from IEPA and made available to the Engineer prior to open burning of organic materials (i.e., plant refuse resulting from pruning or removal of trees or shrubs) or other construction or demolition debris. Organic materials originating within the right-of-way limits may be chipped or shredded and placed as mulch around landscape plantings within the right-of-way when approved by the Engineer. Chipped or shredded material to be placed as mulch shall not exceed a depth of 6 in. (150 mm)."

SPEED DISPLAY TRAILER (BDE)

Effective: April 2, 2014

Add the following to Article 701.15(l) of the Standard Specifications:

"(l) Speed Display Trailer. A speed display trailer shall be utilized on freeways and expressways as part of Highway Standard 701400. The trailer shall be placed on the right hand side of the roadway adjacent to, or within 100 ft (30 m) beyond, the first work zone speed limit sign.

Whenever the speed display trailer is not in use, it shall be considered non-operating equipment and shall be stored according to Article 701.11."

Add the following to Article 701.20 of the Standard Specifications:

"(k) Speed Display Trailer will be paid for at the contract unit price per calendar month or fraction thereof for each trailer as SPEED DISPLAY TRAILER."

Add the following to Article 1106.02 of the Standard Specifications:

“(o) Speed Display Trailer. The speed display trailer shall consist of a LED speed indicator display with self-contained, one-direction radar mounted on an orange see-through trailer. The height of the display and radar shall be such that it will function and be visible when located behind concrete barrier.

The speed measurement shall be by radar and provide a minimum detection distance of 1000 ft (300 m). The radar shall have an accuracy of ± 1 mile per hour.

The speed indicator display shall face approaching traffic and shall have a sign legend of “YOUR SPEED” immediately above or below the speed display. The digital speed display shall show two digits (00 to 99) in mph. The color of the changeable message legend shall be a yellow legend on a black background. The minimum height of the numerals shall be 18 in. (450 mm), and the nominal legibility distance shall be at least 750 ft (250 m).

The speed indicator display shall be equipped with a violation alert that flashes the displayed detected speed when the posted limit is exceeded. The speed indicator shall have a maximum speed cutoff. The display shall include automatic dimming for nighttime operation.

The speed indicator measurement and display functions shall be equipped with the power supply capable of providing 24 hours of uninterrupted service.”

TRACKING THE USE OF PESTICIDES (BDE)

Effective: August 1, 2012

Add the following paragraph after the first paragraph of Article 107.23 of the Standard Specifications:

“Within 48 hours of the application of pesticides, including but not limited to herbicides, insecticides, algacides, and fungicides, the Contractor shall complete and return to the Engineer, Operations form “OPER 2720”.”

WEEKLY DBE TRUCKING REPORTS (BDE)

Effective: June 2, 2012

The Contractor shall provide a weekly report of Disadvantaged Business Enterprise (DBE) trucks hired by the Contractor or subcontractors (i.e. not owned by the Contractor or subcontractors) that are used on the jobsite; or used for the delivery and/or removal of equipment/material to and from the jobsite. The jobsite shall also include offsite locations, such as plant sites or storage sites, when those locations are used solely for this contract.

The report shall be submitted on the form provided by the Department within ten business days following the reporting period. The reporting period shall be Monday through Sunday for each week reportable trucking activities occur. The report shall be submitted to the Engineer and a copy shall be provided to the district EEO Officer.

Any costs associated with providing weekly DBE trucking reports shall be considered as included in the contract unit prices bid for the various items of work involved and no additional compensation will be allowed.

WORKING DAYS (BDE)

Effective: January 1, 2002

The Contractor shall complete the work within 95 working days.

F.A. RTE.	SECTION	COUNTY	TOTAL SHEETS	SHEET NO.
VAR.	*	VARIOUS	23	1

D-95-031-14 **

*BRIDGE PAINTING 2015-2

** 23 + 2 = 25 TOTAL SHEETS

**STATE OF ILLINOIS
DEPARTMENT OF TRANSPORTATION
DIVISION OF HIGHWAYS**

**VARIOUS ROUTES
SECTION BRIDGE PAINTING 2015-2
PROJECT
DEWITT & MCLEAN COUNTIES**

**C-95-031-14
BRIDGE PAINTING**

FOR LOCATION MAP, SEE SHEET NO. 2-3

FOR SUMMARY OF QUANTITIES, SEE SHEET NO. 5

INDEX OF SHEETS

- 1 COVER SHEET
- 2 DISTRICT LOCATION MAP
- 3-5 LOCATION MAP - CHAMPAIGN COUNTY
- 6 GENERAL NOTES
- 7 SUMMARY OF QUANTITIES
- 8 BRIDGE DESCRIPTION LOC # 1 S.N. 020-0024
- * 9-12 BRIDGE INFORMATION LOC # 1 S.N. 020-0024
- 13 BRIDGE DESCRIPTION LOC # 2 S.N. 057-0132
- * 14-17 BRIDGE INFORMATION LOC # 2 S.N. 057-0132
- 18 BRIDGE DESCRIPTION LOC # 3 S.N. 057-0110
- 19-23 BRIDGE INFORMATION LOC # 3 S.N. 057-0110

- * INCLUDES SHEET 10A
- ** INCLUDES SHEET 15A

STATE OF ILLINOIS
DEPARTMENT OF TRANSPORTATION
DIVISION OF HIGHWAYS

Submitted July 30 2014

Randa Starnes
Deputy Director of Highways, Region Engineer

Examined _____ 20 _____

Engineer of Design and Environment

Approved _____ 20 _____

Director of Highways, Chief Engineer

LIST OF STANDARDS

- 000001-06 STANDARD SYMBOLS, ABBREVIATIONS AND PATTERNS
- 701101-04 OFF ROAD OPERATIONS, MULTILANE, 15' (4.5 m) TO 24" (600 mm) FROM PAVEMENT EDGE
- 701106-02 OFF-RD OPERATIONS, MULTILANE, MORE THAN 15' (4.5 m) AWAY
- 701201-04 LANE CLOSURE, 2L, 2V, DAY ONLY, FOR SPEEDS ≥ 45 MPH
- 701400-07 APPROACH TO LANE CLOSURE, FREEWAY/EXPRESSWAY
- 701402-09 LANE CLOSURE, FREEWAY/EXPRESSWAY, WITH BARRIER
- 701406-08 LANE CLOSURE, FREEWAY/EXPRESSWAY, DAY OPERATIONS ONLY
- 701411-08 LANE CLOSURE, MULTILANE, AT ENTRANCE OR EXIT RAMP, FOR SPEEDS ≥ 45 MPH
- 701901-03 TRAFFIC CONTROL DEVICES

Project Engineer: Nancy Faslg

Designed By: Byron Smith

Contract No.: 70A76

Traffic Data: ADT N/A ; PV N/A %; SU N/A %; MU N/A %

Toll Free JULIE Telephone No.: 1-800-892-0123 _____ Township

Printed by Authority of the State of Illinois

RECEIVED

AUG 04 2014

DESIGNER: _____

F.A. RTE.	SECTION	COUNTY	TOTAL SHEETS	SHEET NO.
VAR.	*	VARIOUS	23	2

D-95-031-14
 •BRIDGE PAINTING 2015-2

LOCATION MAP REGION 3 – DISTRICT 5

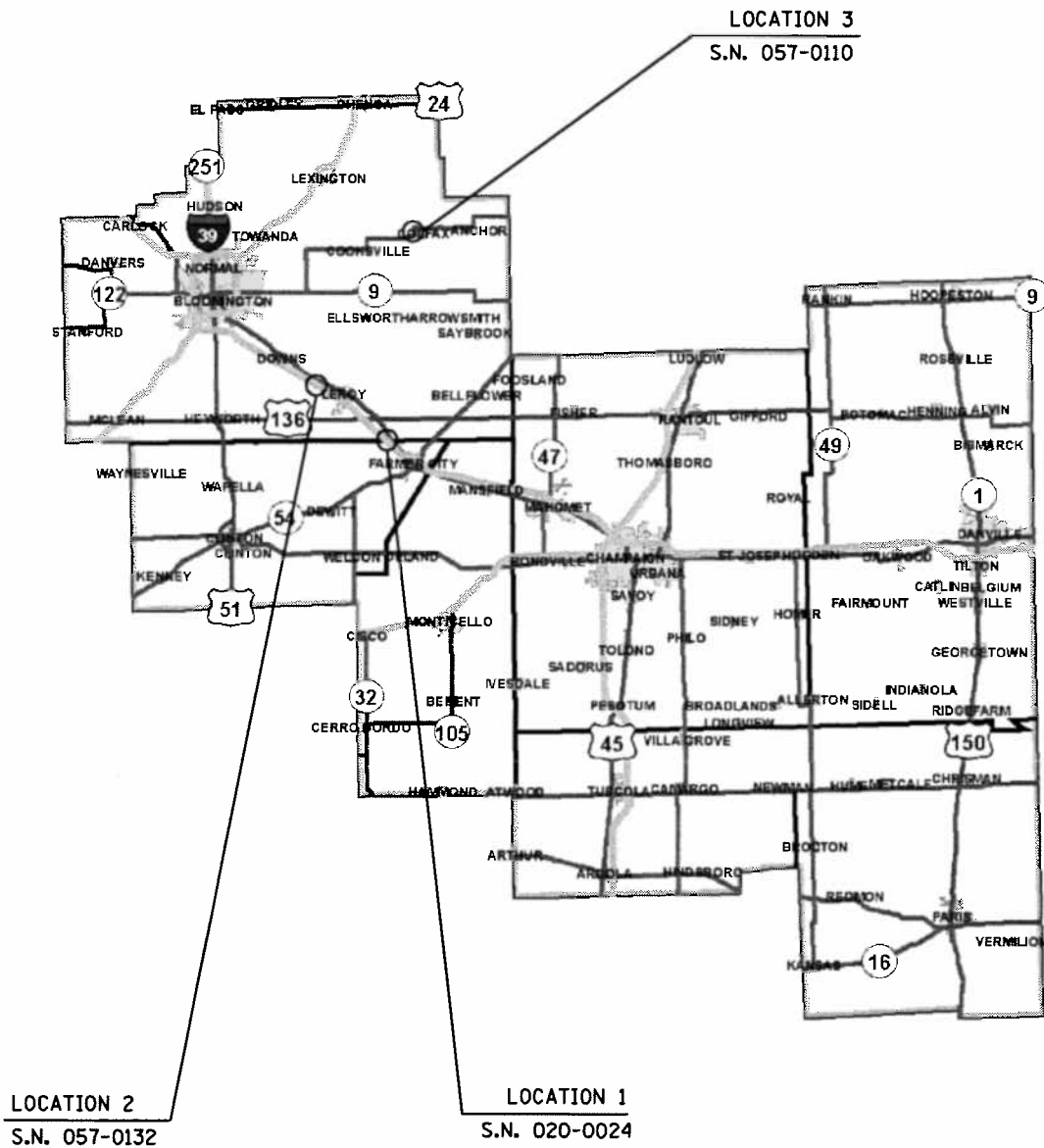

F.A. RTE.	SECTION	COUNTY	TOTAL SHEETS	SHEET NO.
VAR.	•	VARIOUS	23	3

D-95-031-14
 •BRIDGE PAINTING 2015-2

LOCATION #1
DEWITT COUNTY

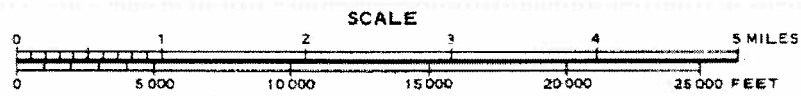
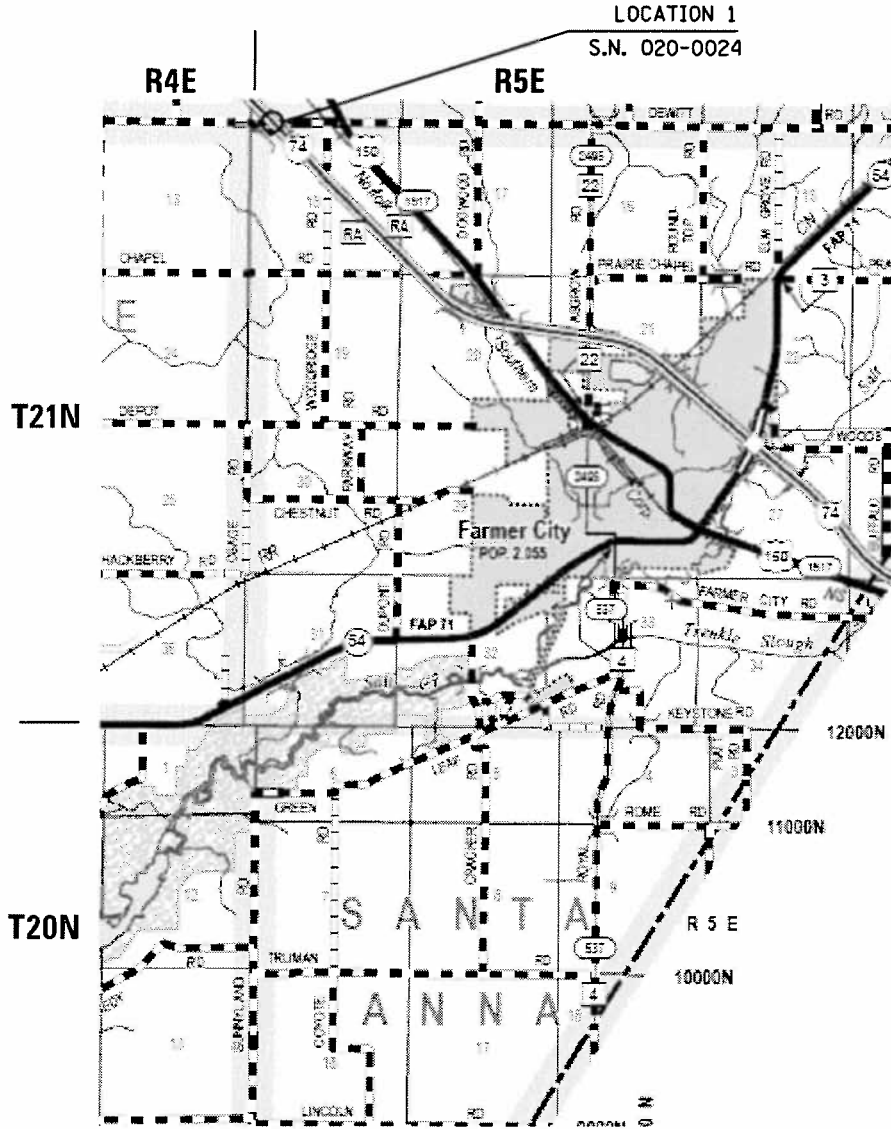

F.A. RTE.	SECTION	COUNTY	TOTAL SHEETS	SHEET NO.
VAR.	•	VARIOUS	23	4

D-95-031-14
 •BRIDGE PAINTING 2015-2

LOCATION #2
MCLEAN COUNTY

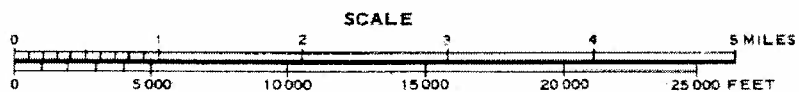
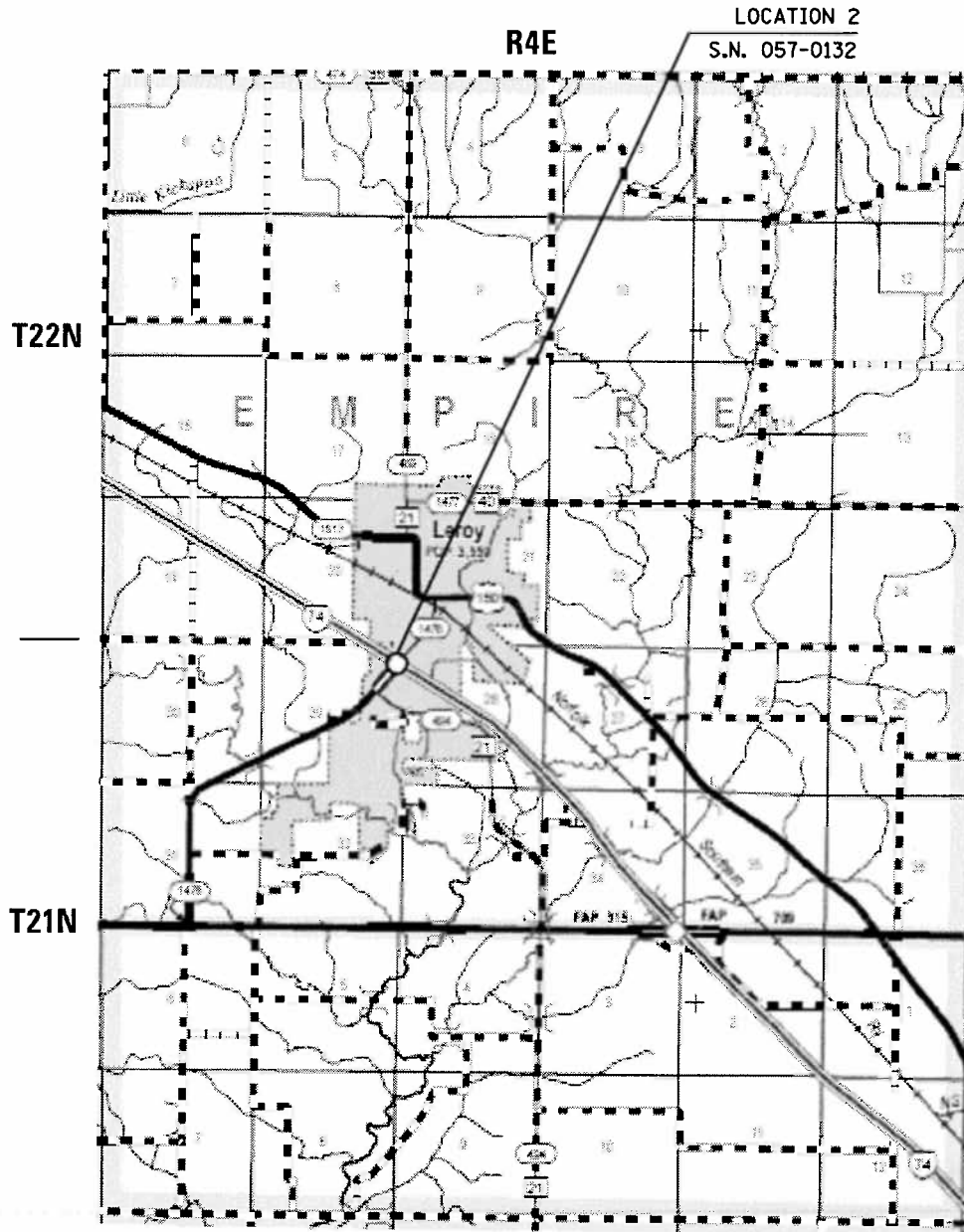

F.A. RTE.	SECTION	COUNTY	TOTAL SHEETS	SHEET NO.
VAR.	•	VARIOUS	23	5

D-95-031-14
 •BRIDGE PAINTING 2015-2

LOCATION #3
MCLEAN COUNTY

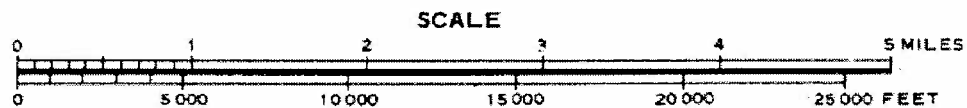
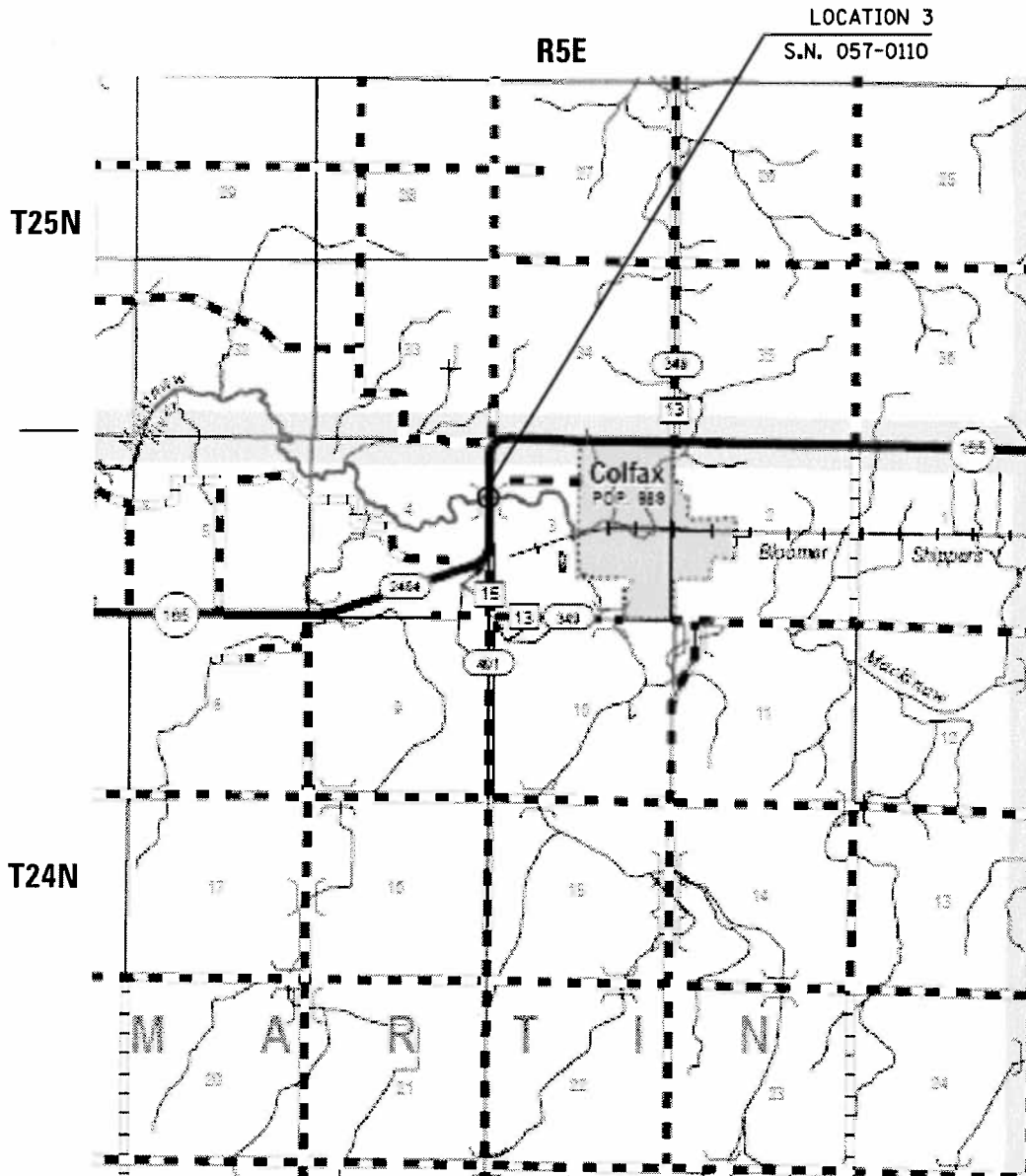

F.A. RTE.	SECTION	COUNTY	TOTAL SHEETS	SHEET NO.
VAR.	**	VARIOUS	23	6

D-95-031-14

**BRIDGE PAINTING 2015-2

GENERAL NOTES

G.N.-100

ENGLISH UNITS OF MEASURE SHALL GOVERN OVER AND SUPERSEDE ANY METRIC UNITS SHOWN IN THIS CONTRACT. WHERE INCLUDED, METRIC UNITS ARE FOR INFORMATION ONLY.

G.N.-100A

ELECTRONIC FILES AND/OR ELECTRONIC SURVEY INFORMATION INCLUDING CADD FILES WILL NOT BE AVAILABLE TO THE CONTRACTOR.

G.N.-501A

THE EXISTING STRUCTURAL STEEL COATING CONTAINS LEAD. THE CONTRACTOR SHALL FOLLOW THE GUIDE BRIDGE SPECIAL PROVISIONS FOR CONTAINMENT AND DISPOSAL OF LEAD PAINT CLEANING RESIDUES.

ONLY STRUCTUAL STEEL AND OTHER DESIGNATED SURFACES SHALL BE PAINTED. ALL OTHER SURFACES SHALL BE PROTECTED FROM CONTRACTORS BLASTING AND PAINTING OPERATIONS. ANY OVERSPRAY OR DAMAGED AREAS WILL BE REMOVED OR REPAIRED AT THE CONTRACTORS EXSPENSE AND NO ADDITIONAL COMPENSATION WILL BE ALLOWED.

THE SSPC-QP1 AND QP2 PAINTING CONTRACTOR CERTIFICATIONS WILL BE REQUIRED FOR THIS CONTRACT.

ALL TRASH AND PAINTING DEBRIS, EXCLUDING WASTE BARRELS OR ROLL-OFF DUMPSTERS, SHALL BE REMOVED BEFORE BEGINNING WORK AT ANOTHER LOCATION.

2 YEAR PAINT WARRANTY REQUIRED FOR LOCATIONS 1-3

7/2/2014

CONTRACT NO. 70A76

SUMMARY OF QUANTITIES

LOCATION: LOC. NO. 1 LOC. NO. 2 LOC. NO. 3
 F.A.I. 74 F.A.I. 74 IL RT. 165
 S.N. 020-0024 S.N. 057-0132 S.N. 057-0110
 DEWITT MCLEAN MCLEAN
 COUNTY COUNTY COUNTY
 100 % STATE 100 % STATE 100 % STATE
 0014 0014 0014

CONSTRUCTION TYPE CODE:
 TOTAL QUANTITY

CODE NO.	DESCRIPTION	UNIT	QUANTITY	QUANTITY	QUANTITY	QUANTITY
67100100	MOBILIZATION	L SUM	1.0	0.3	0.3	0.4
70100420	TRAFFIC CONTROL AND PROTECTION STANDARD 701411	EACH	2.0		2.0	
70100450	TRAFFIC CONTROL AND PROTECTION STANDARD 701201	L SUM	1.0			1.0
70100700	TRAFFIC CONTROL AND PROTECTION STANDARD 701406	L SUM	1.0	0.5	0.5	
X5067501	BRIDGE CLEANING AND PAINTING WARRANTY NUMBER 1	L SUM	1.0	1.0		
X5067502	BRIDGE CLEANING AND PAINTING WARRANTY NUMBER 2	L SUM	1.0		1.0	
X5067503	BRIDGE CLEANING AND PAINTING WARRANTY NUMBER 3	L SUM	1.0			1.0
X7010410	SPEED DISPLAY TRAILER	CAL MO	3.0	1.5	1.5	
X7015005	CHANGEABLE MESSAGE SIGN	CAL DA	28.0	14.0	14.0	
Z0007101	CONTAINMENT AND DISPOSAL OF LEAD PAINT CLEANING RESIDUES NO. 1	L SUM	1.0	1.0		
Z0007102	CONTAINMENT AND DISPOSAL OF LEAD PAINT CLEANING RESIDUES NO. 2	L SUM	1.0		1.0	
X5060603	CONTAINMENT AND DISPOSAL OF LEAD PAINT CLEANING RESIDUES NO. 3	L SUM	1.0			1.0
Z0010501	CLEANING AND PAINTING STEEL BRIDGE NO.1	L SUM	1.0	1.0		
Z0010502	CLEANING AND PAINTING STEEL BRIDGE NO.2	L SUM	1.0		1.0	
Z0010503	CLEANING AND PAINTING STEEL BRIDGE NO.3	L SUM	1.0			1.0

*BRIDGE PAINTING 2015-2

D-95-031-14

F.A. RTE. VAR.	SECTION	COUNTY	TOTAL SHEET SHEETS NO.
		VARIOUS	23
			7

g:\p_w\work\k\pww\tda\h\coombess\F\cd0402864\N05170A76-sht-plant.dgn

15

7/2/2014

CONTRACT NO. 70A76

F.A. RTE.	SECTION	COUNTY	TOTAL SHEETS	SHEET NO.
VAR.	**	VARIOUS	23	8

D-95-031-14

**BRIDGE PAINTING 2015-2

LOCATION #1

DESCRIPTION: F.A.I. 74 MM 154.8 W. OF FARMER CITY
COUNTY: DEWITT
ROUTE: F.A.I. - 74 @ T.R.5
MARKED ROUTE: F.A.I. - 74 @ T.R.5
SECTION: BRIDGE PAINTING 2015-2
STRUCTURE NO.: 020-0024
TYPE OF STRUCTURE: 2 SPAN STEEL OPEN GIRDER WITH 4 BEAM LINES

CLEANING AND PAINTING OF THE EXISTING STRUCTURAL STEEL SHALL BE AS SPECIFIED IN THE SPECIAL PROVISIONS FOR "CLEANING AND PAINTING EXISTING STEEL STRUCTURES." ALL BEAMS, BEARINGS AND OTHER STRUCTURAL STEEL SHALL BE CLEANED PER NEAR WHITE BLASTING SSPC-SP10.

THE DESIGNATED AREAS CLEANED PER NEAR WHITE BLAST CLEANING SSPC-SP10 SHALL BE PAINTED ACCORDING TO THE REQUIREMENTS OF PAINT SYSTEM 1 OZ/E/U. THE COLOR OF THE FINAL FINISH COAT FOR ALL INTERIOR STEEL SURFACES SHALL BE GRAY, MUNSELL NO. 5B 7/1. THE COLOR OF THE FINAL FINISH COAT FOR ALL EXTERIOR AND BOTTOM FLANGE OF THE FASCIA BEAMS SHALL BE INTERSTATE GREEN (MUNSELL COLOR STANDARD 7.5G 4/8).

2 (TWO) YEAR PAINT WARRANTY REQUIRED FOR THIS STRUCTURE.

A MINIMUM OF TWO (2) HIGH VOLUME AIR MONITORS WILL BE REQUIRED TO MONITOR AIR QUALITY DURING DUST PRODUCING OPERATIONS AT THIS SITE. SEE SPECIAL PROVISIONS FOR CONTAINMENT AND DISPOSAL OF LEAD PAINT CLEANING RESIDUES.

NOTE: DECK DRAINS TO BE PAINTED AT NO ADDITIONAL COST.

BLAST, CLEAN AND PAINT TWO (2) VAULT DOORS AT NO ADDITIONAL COST.

F.A. RTE. VAR.	SECTION	COUNTY	TOTAL SHEETS	SHEET NO.
	•	VARIOUS	23	10

D-95-031-14
•BRIDGE PAINTING 2015-2

FOR INFORMATION ONLY
S.N. 020-0024

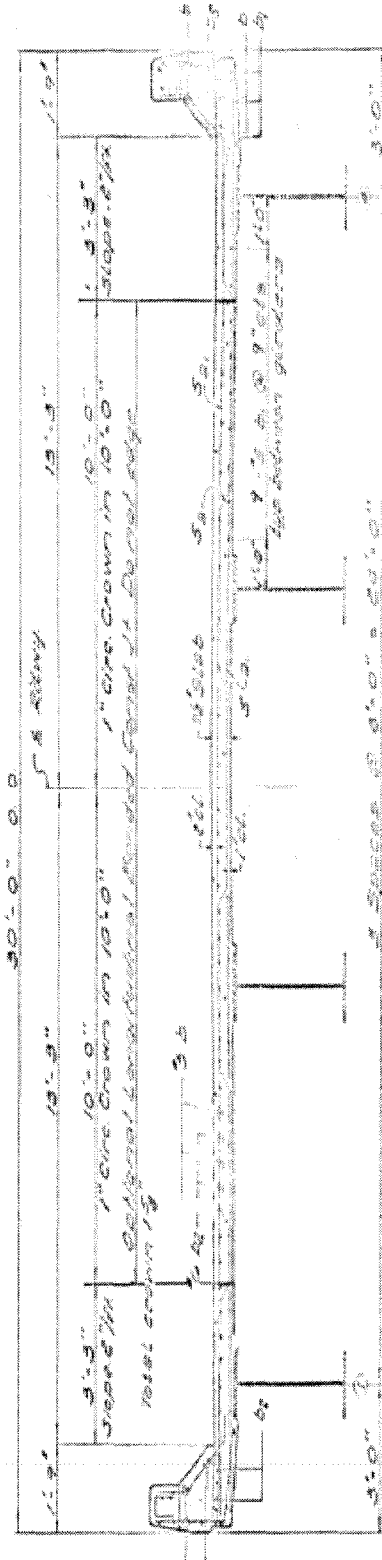

NEAR PIER CROSS SECTION

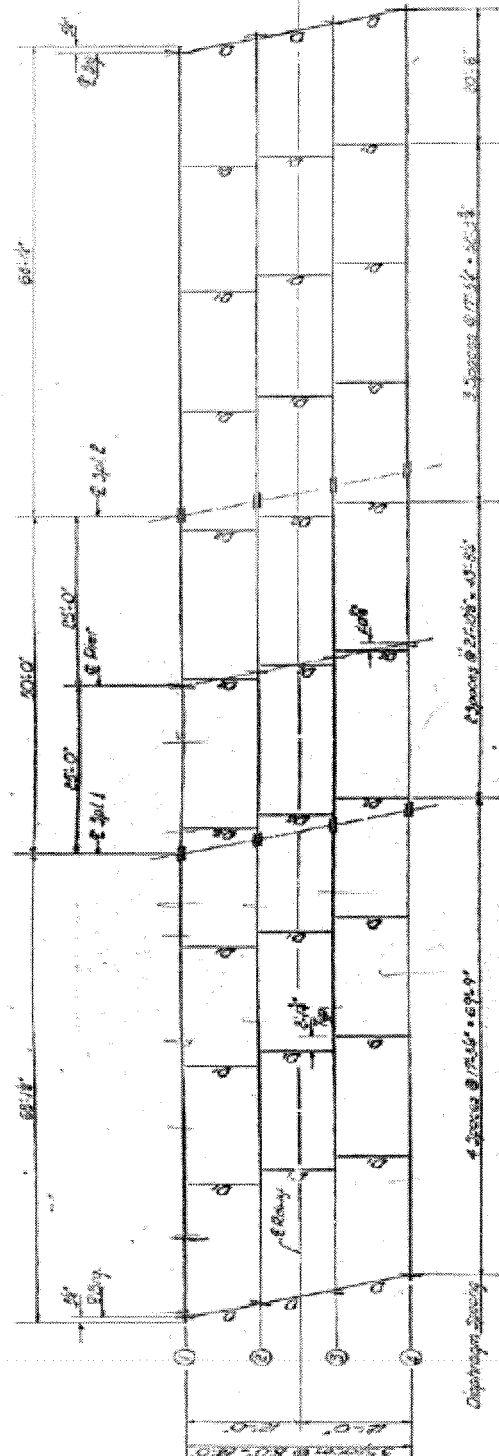

FRAMING PLAN

WORK LIMITS INCLUDE ALL STRUCTURAL STEEL AT THIS BRIDGE

F.A. RTE.	SECTION	COUNTY	TOTAL SHEETS	SHEET NO.
VAR.	*	VARIOUS	23	10A

D-95-031-14

• BRIDGE PAINTING 2015-2

FOR INFORMATION ONLY
S.N. 020-0024

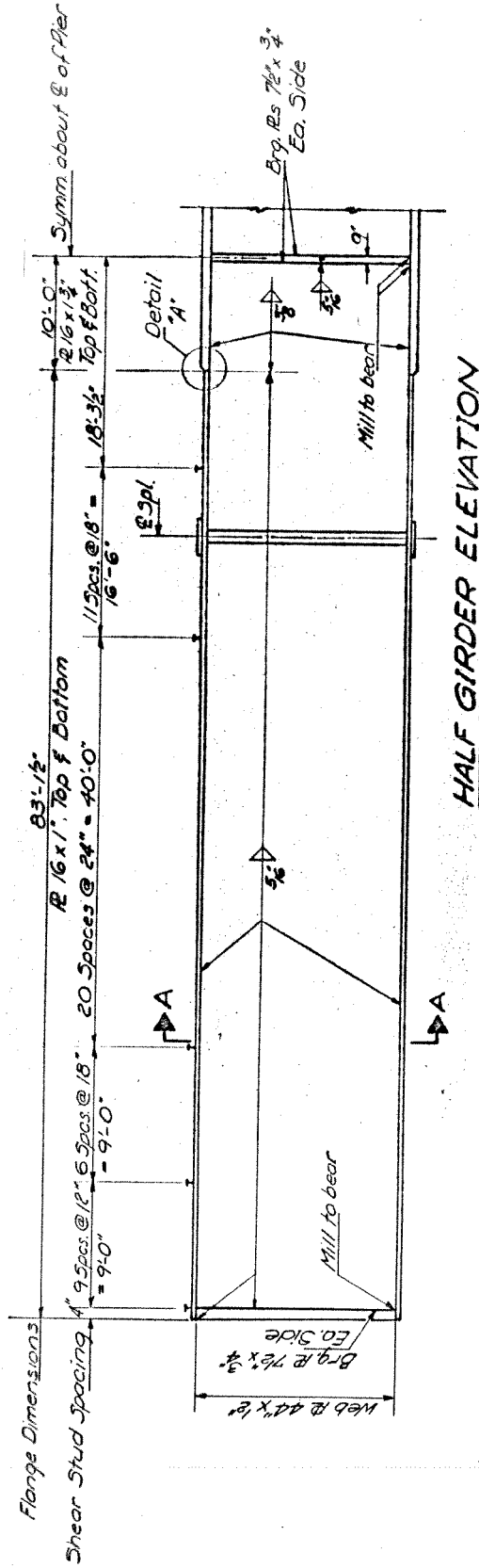

HALF GIRDER ELEVATION

WORK LIMITS INCLUDE ALL STRUCTURAL STEEL AT THIS BRIDGE

F.A. RTE.	SECTION	COUNTY	TOTAL SHEETS	SHEET NO.
VAR.	*	VARIOUS	23	11

D-95-031-14

•BRIDGE PAINTING 2015-2

FOR INFORMATION ONLY

S.N. 020-0024

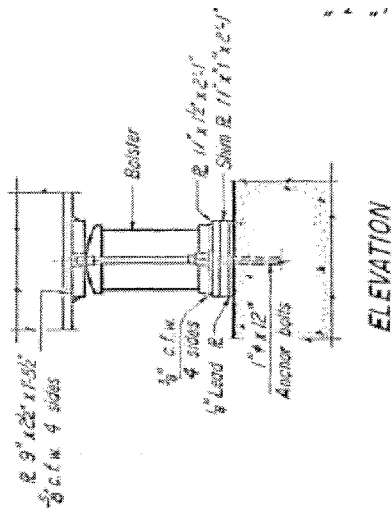

ELEVATION

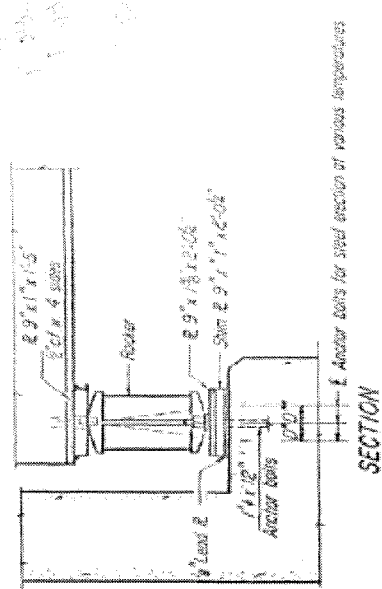

SECTION

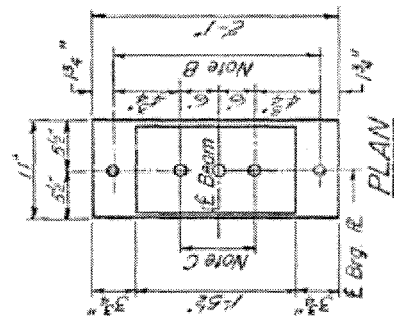

PLAN

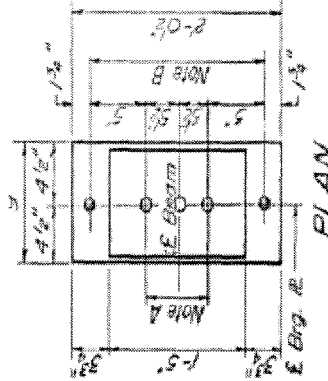

PLAN

AT ABUTMENT

AT PIER

WORK LIMITS INCLUDE ALL STRUCTURAL STEEL AT THIS BRIDGE

F.A. RTE.	SECTION	COUNTY	TOTAL SHEETS	SHEET NO.
VAR.	*	VARIOUS	23	12

D-95-031-14

•BRIDGE PAINTING 2015-2

FOR INFORMATION ONLY
S.N. 020-0024

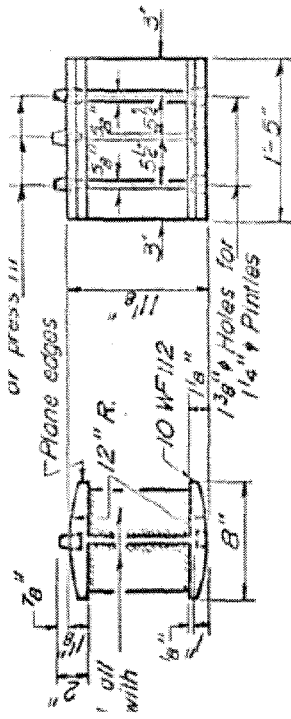

ROCKER

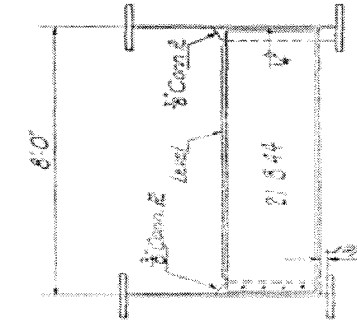

DIAPHRAGM D2

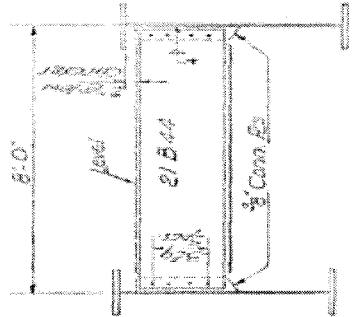

DIAPHRAGM D1

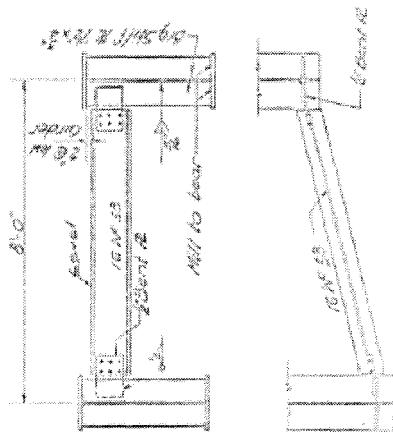

DIAPHRAGM D

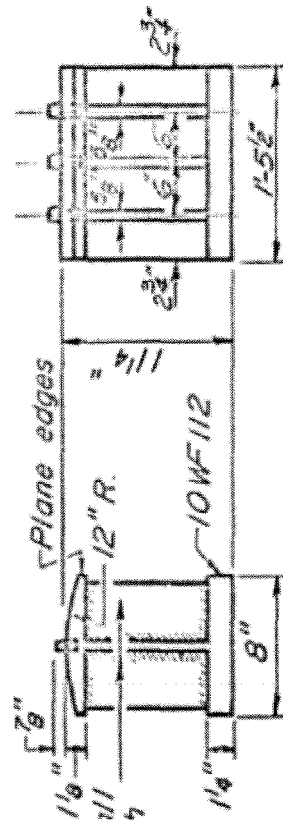

BOLSTER

WORK LIMITS INCLUDE ALL STRUCTURAL STEEL AT THIS BRIDGE

F.A. RTE.	SECTION	COUNTY	TOTAL SHEETS	SHEET NO.
VAR.	**	VARIOUS	23	13

D-95-031-14

**BRIDGE PAINTING 2015-2

LOCATION #2

DESCRIPTION: FAI-74 MM 149, LEROY EXIT
 COUNTY: McLEAN
 ROUTE: F.A.I. - 74 @ F.A.S. 1478
 MARKED ROUTE: F.A.I. - 74 @ F.A.S. 1478
 SECTION: BRIDGE PAINTING 2015-2
 STRUCTURE NO.: 057-0132
 TYPE OF STRUCTURE: 2 SPAN STEEL OPEN GIRDER WITH 9 BEAM LINES

CLEANING AND PAINTING OF THE EXISTING STRUCTURAL STEEL SHALL BE AS SPECIFIED IN THE SPECIAL PROVISIONS FOR "CLEANING AND PAINTING EXISTING STEEL STRUCTURES." ALL BEAMS, BEARINGS AND OTHER STRUCTURAL STEEL SHALL BE CLEANED PER NEAR WHITE BLASTING SSPC-SP10.

THE DESIGNATED AREAS CLEANED PER NEAR WHITE BLAST CLEANING SSPC-SP10 SHALL BE PAINTED ACCORDING TO THE REQUIREMENTS OF PAINT SYSTEM 1 OZ/E/U. THE COLOR OF THE FINAL FINISH COAT FOR ALL INTERIOR STEEL SURFACES SHALL BE GRAY, MUNSELL NO. 5B 7/1. THE COLOR OF THE FINAL FINISH COAT FOR ALL EXTERIOR AND BOTTOM FLANGE OF THE FASCIA BEAMS SHALL BE REDDISH BROWN, MUNSELL NO. 25 YR 3/4.

2 (TWO) YEAR PAINT WARRANTY REQUIRED FOR THIS STRUCTURE.

A MINIMUM OF FOUR (4) HIGH VOLUME AIR MONITORS WILL BE REQUIRED TO MONITOR AIR QUALITY DURING DUST PRODUCING OPERATIONS AT THIS SITE. SEE SPECIAL PROVISIONS FOR CONTAINMENT AND DISPOSAL OF LEAD PAINT CLEANING RESIDUES.

NOTES: DECK DRAINS TO BE PAINTED AT NO ADDITIONAL COST.

F.A. RTE.	SECTION	COUNTY	TOTAL SHEETS	SHEET NO.
VAR.	*	VARIOUS	23	14

D-95-031-14

•BRIDGE PAINTING 2015-2

FOR INFORMATION ONLY
S.N. 057-0132

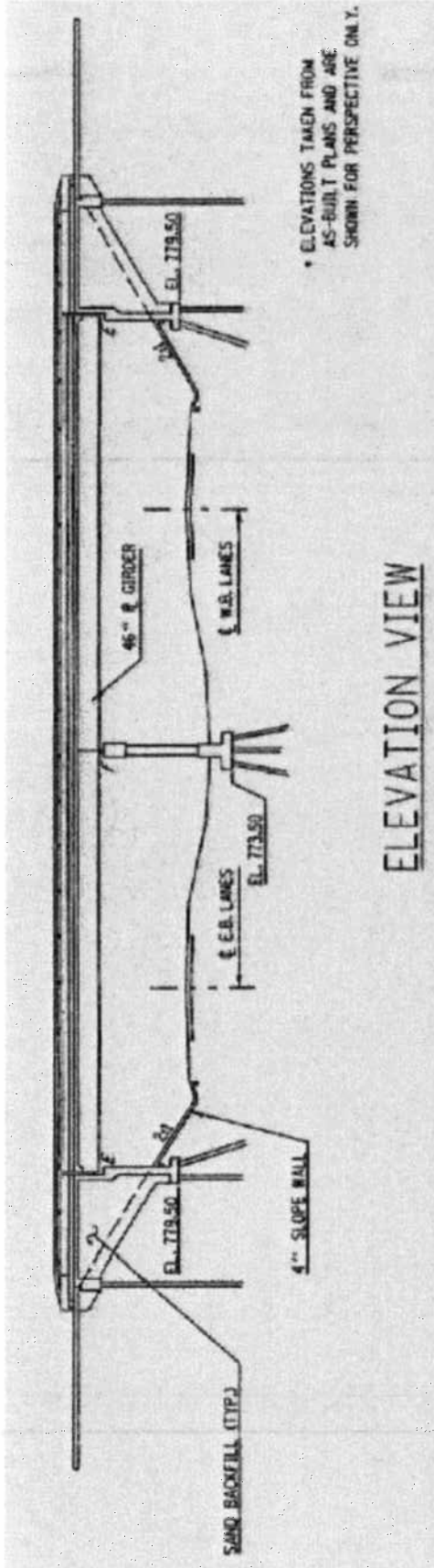

ELEVATION VIEW

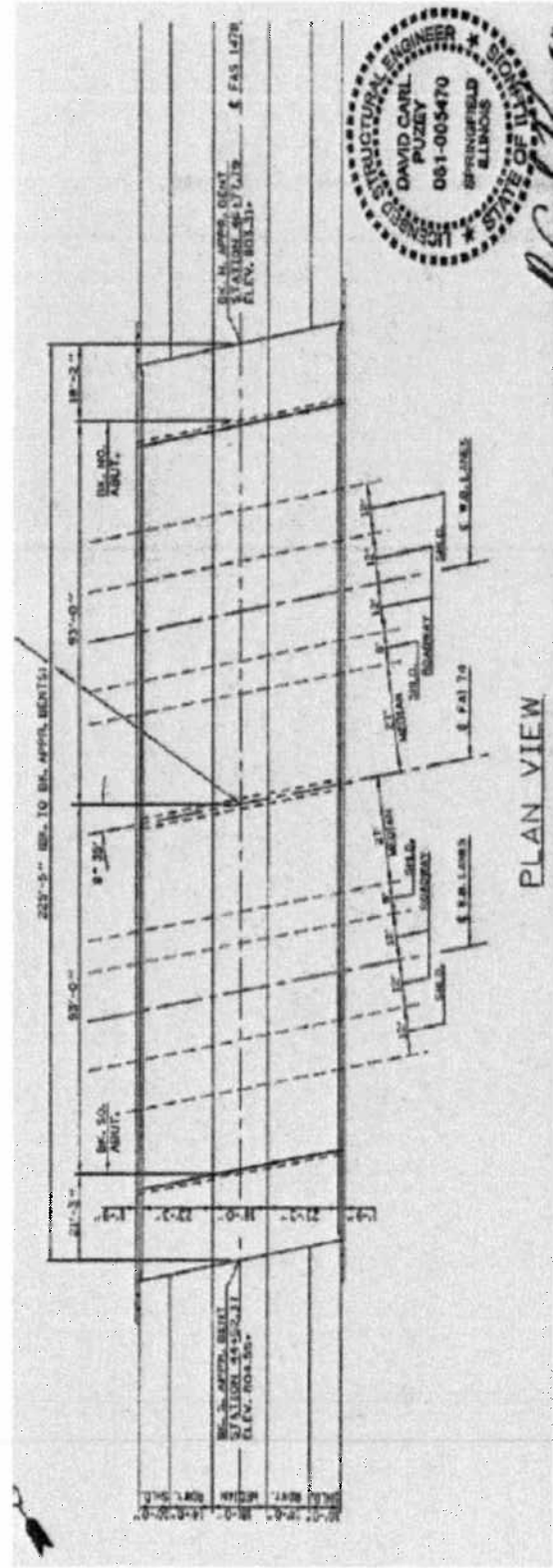

PLAN VIEW

WORK LIMITS INCLUDE ALL STRUCTURAL STEEL AT THIS BRIDGE

F.A. RTE.	SECTION	COUNTY	TOTAL SHEETS	SHEET NO.
VAR.	*	VARIOUS	23	15

D-95-031-14

•BRIDGE PAINTING 2015-2

FOR INFORMATION ONLY
S.N. 057-0132

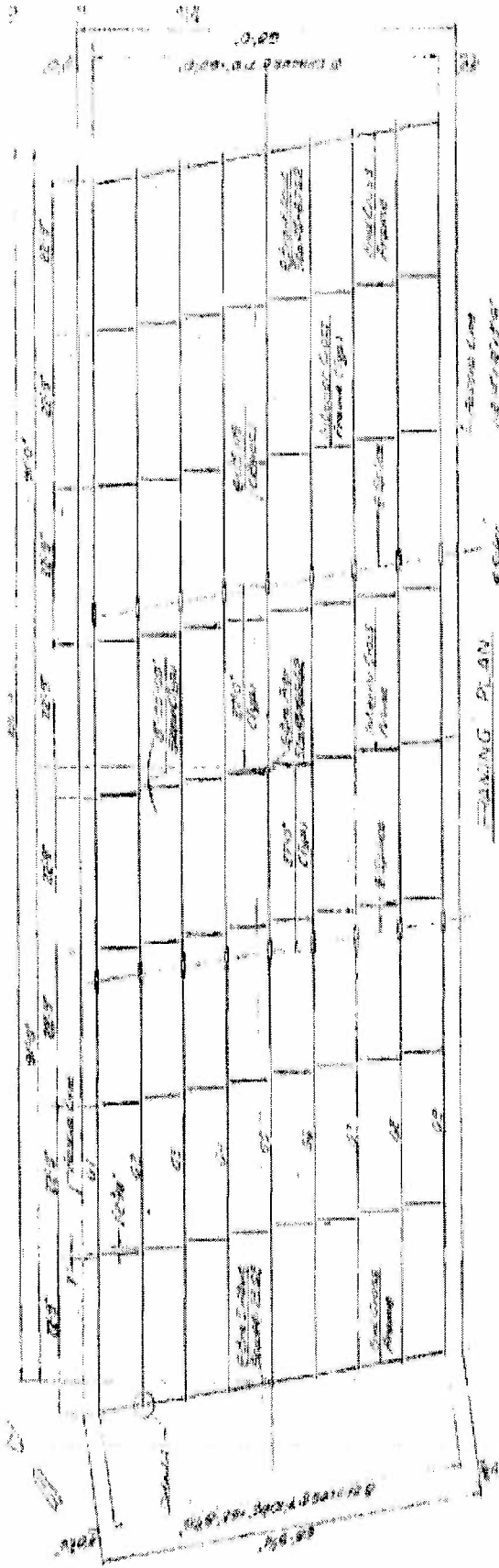

PLAN - STRURAL STEEL LAYOUT

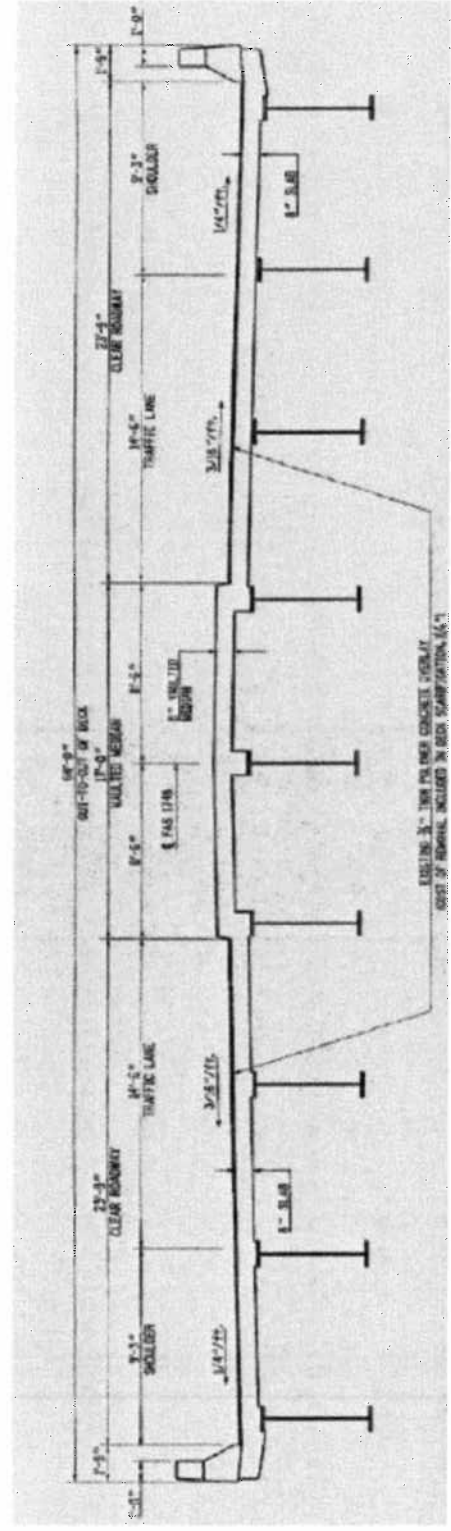

WORK LIMITS INCLUDE ALL STRUCTURAL STEEL AT THIS BRIDGE

F.A. RTE.	SECTION	COUNTY	TOTAL SHEETS	SHEET NO.
VAR.	*	VARIOUS	23	15a

D-95-031-14

•BRIDGE PAINTING 2015-2

FOR INFORMATION ONLY
 S.N. 057-0132

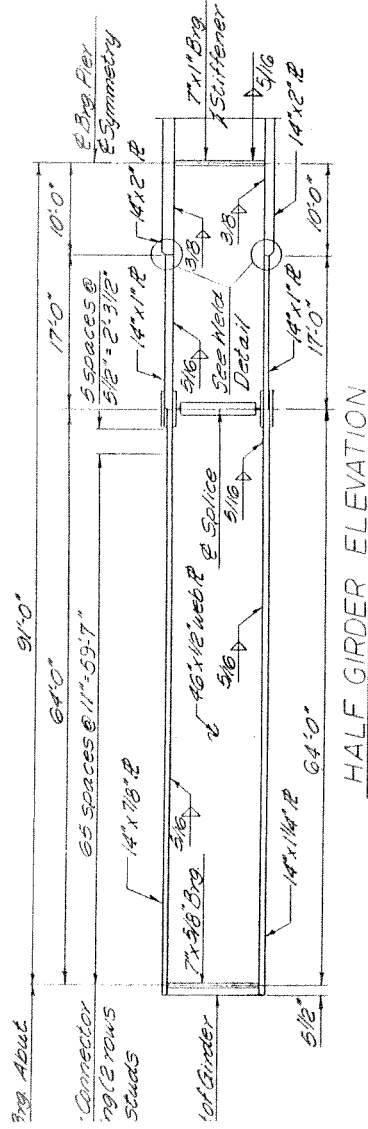

HALF GIRDER ELEVATION

WORK LIMITS INCLUDE ALL STRUCTURAL STEEL AT THIS BRIDGE

F.A. RTE.	SECTION	COUNTY	TOTAL SHEETS	SHEET NO.
VAR.	*	VARIOUS	23	17

D-95-031-14

•BRIDGE PAINTING 2015-2

**FOR INFORMATION ONLY
S.N. 057-0132**

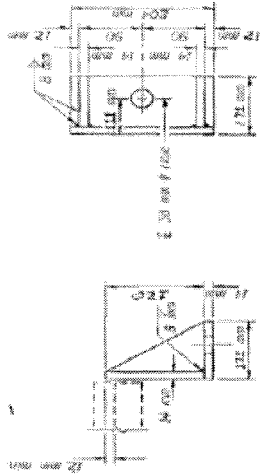

SIDE RETAINER

Equipment rated engine with softeners will be mounted in lieu of welded blocks.

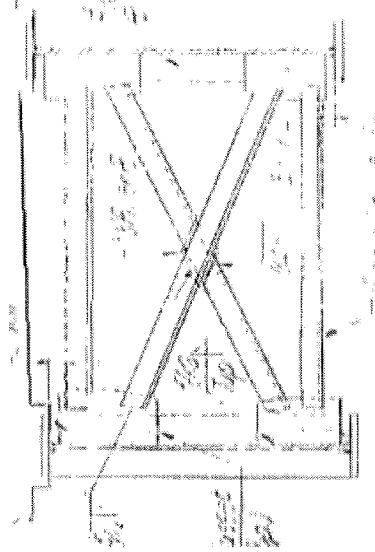

**INTERIOR CROSS FRAME
56 REQUIRED**

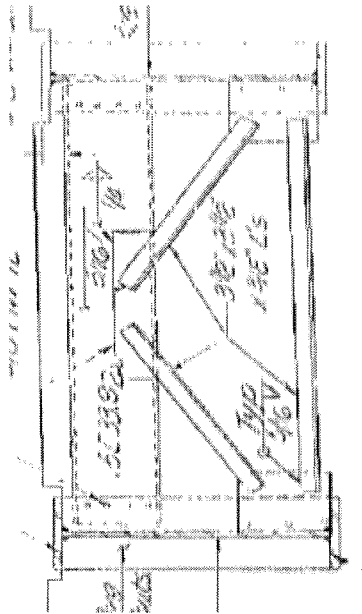

**END CROSS FRAME
16 REQUIRED**

WORK LIMITS INCLUDE ALL STRUCTURAL STEEL AT THIS BRIDGE

7/2/2014

CONTRACT NO. 70A76

F.A. RTE.	SECTION	COUNTY	TOTAL SHEETS	SHEET NO.
VAR.	**	VARIOUS	23	18

D-95-031-14

••BRIDGE PAINTING 2015-2

LOCATION #3

DESCRIPTION: IL. RTE. 165 OVER MACKINAW RIVER SOUTH OF COLFAX
COUNTY: McLEAN
ROUTE: RTE. 165
MARKED ROUTE: RTE. 165
SECTION: BRIDGE PAINTING 2015-2
STRUCTURE NO.: 057-0110
TYPE OF STRUCTURE: 4 SPAN - STEEL WITH 5 BEAM LINES

CLEANING AND PAINTING OF THE EXISTING STRUCTURAL STEEL SHALL BE AS SPECIFIED IN THE SPECIAL PROVISIONS FOR "CLEANING AND PAINTING EXISTING STEEL STRUCTURES." ALL BEAMS, BEARINGS AND OTHER STRUCTURAL STEEL SHALL BE CLEANED PER NEAR WHITE BLASTING SSPC-SP10.

THE DESIGNATED AREAS CLEANED PER NEAR WHITE BLAST CLEANING SSPC-SP10 SHALL BE PAINTED ACCORDING TO THE REQUIREMENTS OF PAINT SYSTEM 1OZ/E/U. THE COLOR OF THE FINAL FINISH COAT FOR ALL INTERIOR STEEL SURFACES SHALL BE GRAY, MUNSELL NO. 5B 7/1. THE COLOR OF THE FINAL FINISH COAT FOR ALL EXTERIOR AND BOTTOM FLANGE OF THE FASCIA BEAMS SHALL BE REDDISH BROWN, MUNSELL NO. 25 YR 3/4 .

2 (TWO) YEAR PAINT WARRANTY REQUIRED FOR THIS STRUCTURE.

NOTES: DECK DRAINS TO BE PAINTED AT NO ADDITIONAL COST.

F.A. RTE.	SECTION	COUNTY	TOTAL SHEETS	SHEET NO.
VAR.	*	VARIOUS	23	19

D-95-031-14
 •BRIDGE PAINTING 2015-2

FOR INFORMATION ONLY
 S.N. 057-0110

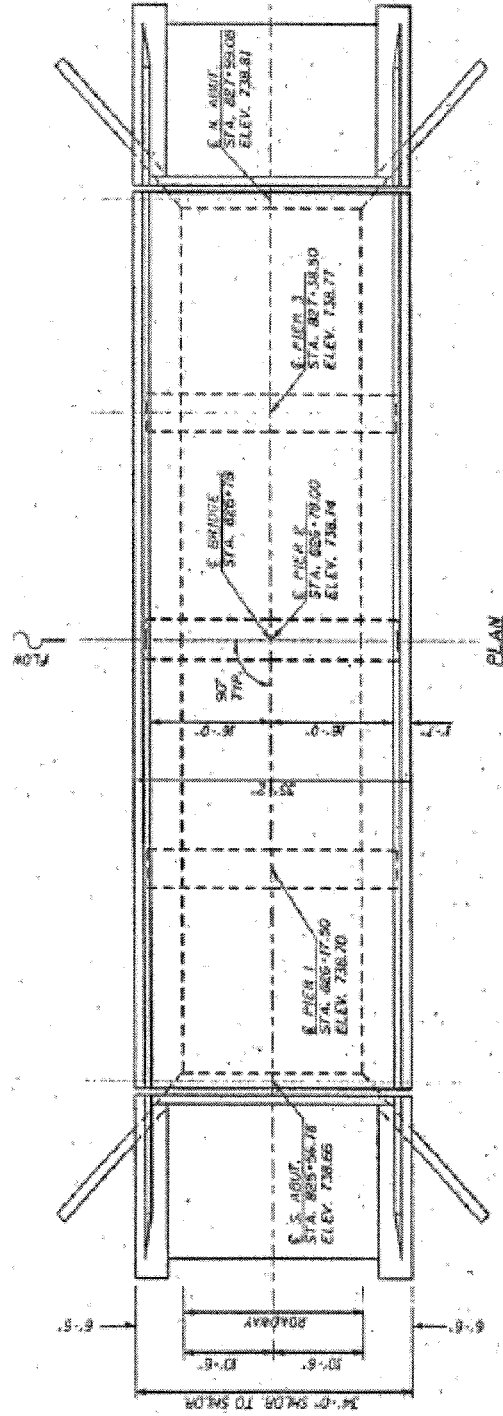
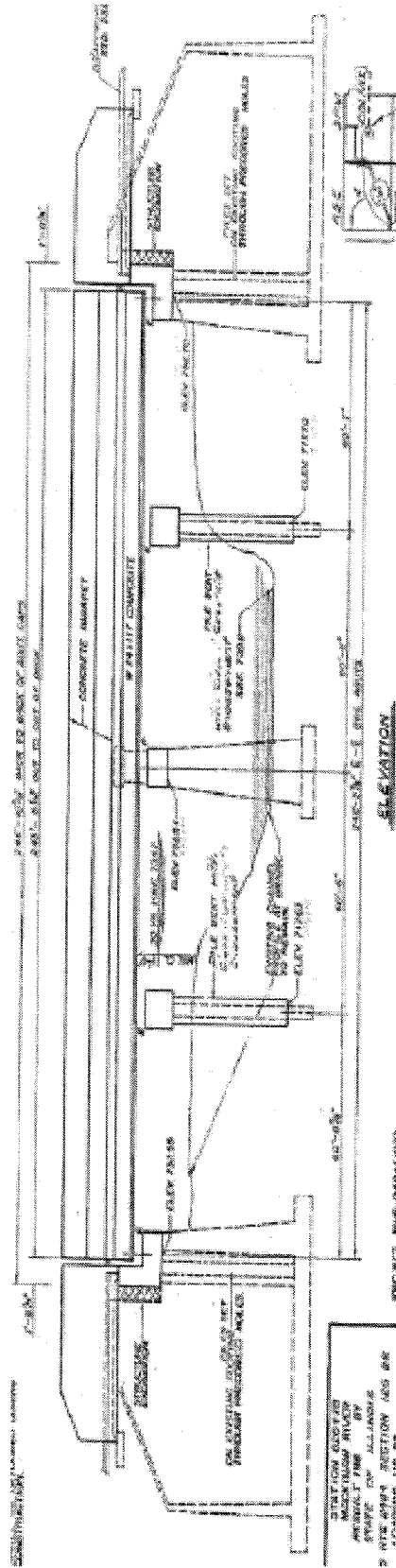

WORK LIMITS INCLUDE ALL STRUCTURAL STEEL AT THIS BRIDGE

F.A. RTE. VAR.	SECTION	COUNTY	TOTAL SHEETS	SHEET NO.
		VARIOUS	23	20

D-95-031-14
 •BRIDGE PAINTING 2015-2

FOR INFORMATION ONLY
 S.N. 057-0110

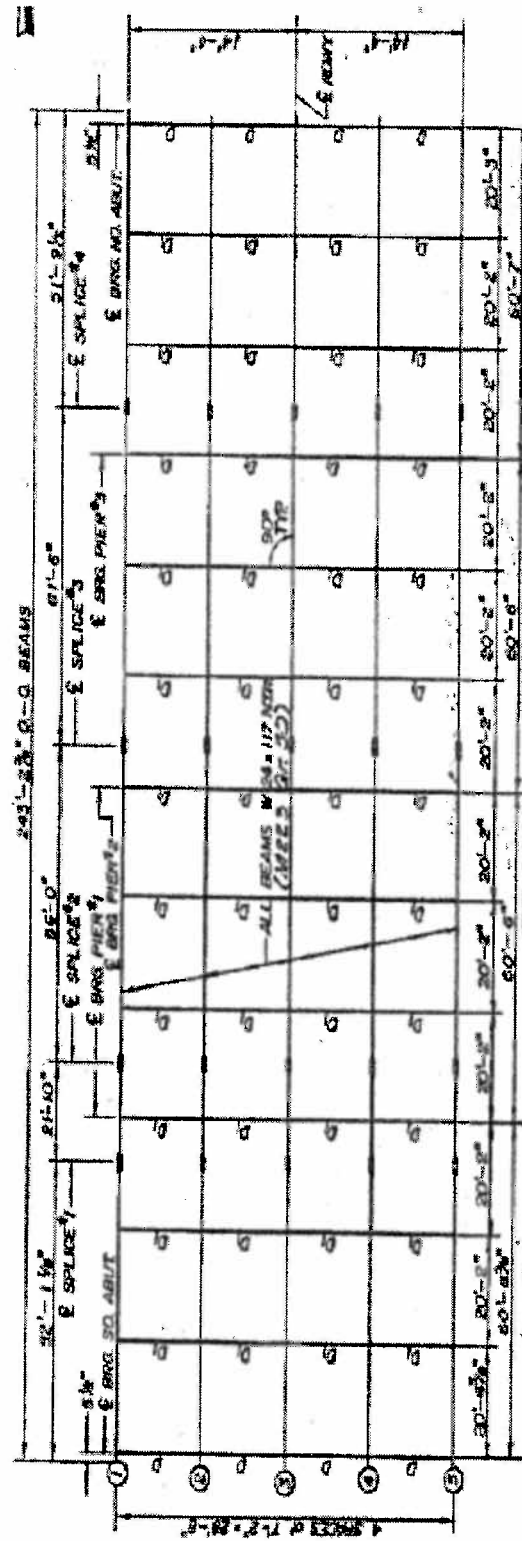
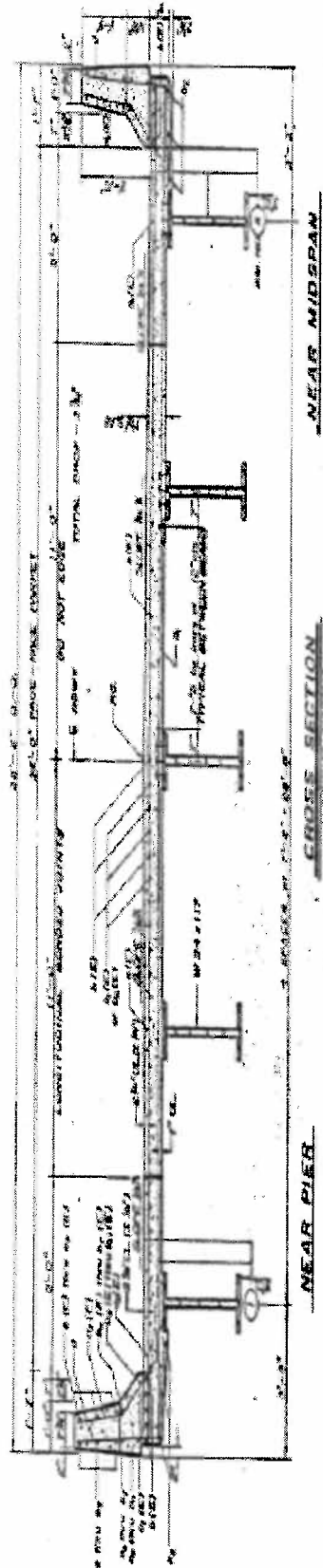

WORK LIMITS INCLUDE ALL STRUCTURAL STEEL AT THIS BRIDGE

F.A. RTE.	SECTION	COUNTY	TOTAL SHEETS	SHEET NO.
VAR.	*	VARIOUS	23	21

D-95-031-14

•BRIDGE PAINTING 2015-2

FOR INFORMATION ONLY
S.N. 057-0110

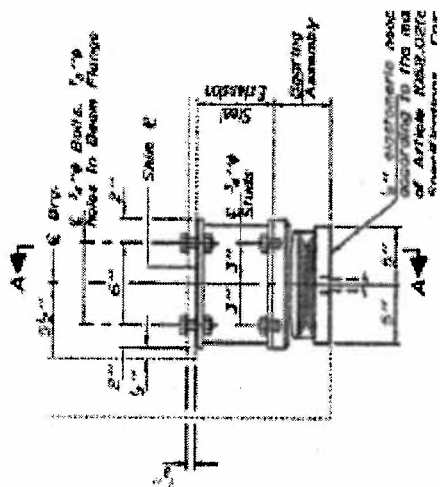

SECTION AT ABUTMENT

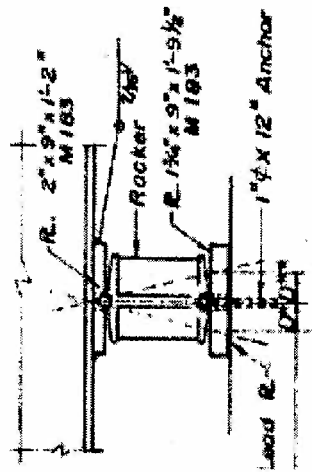

PIER 1 & 3

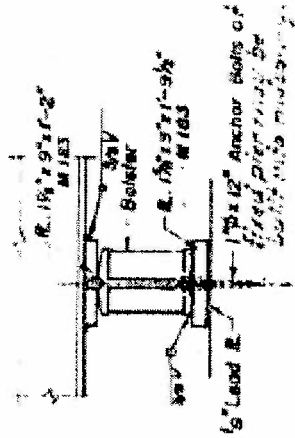

PIER 2

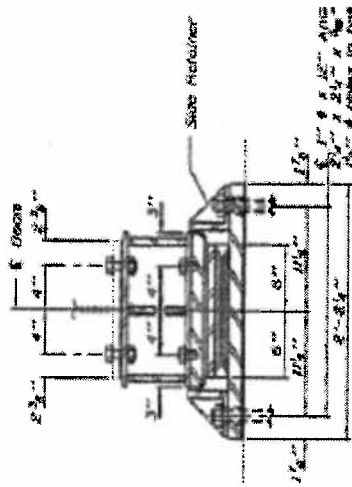

SECTION A-A

PLAN

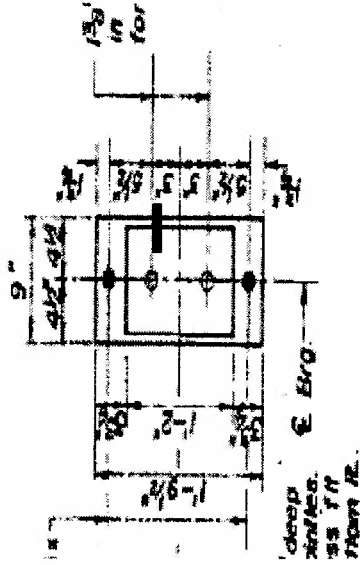
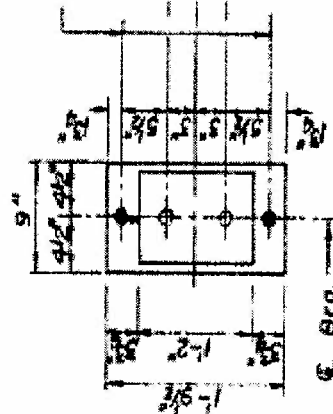

WORK LIMITS INCLUDE ALL STRUCTURAL STEEL AT THIS BRIDGE

F.A. RTE.	SECTION	COUNTY	TOTAL SHEETS	SHEET NO.
VAR.	.	VARIOUS	23	22

D-95-031-14

•BRIDGE PAINTING 2015-2

FOR INFORMATION ONLY
S.N. 057-0110

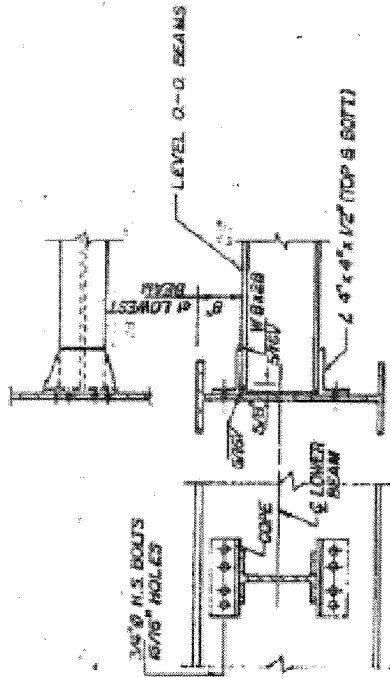

DIAPHRAGM D1

(as Required)
ALL DIAPHR & THEIR CONNECTIONS SHALL BE IN 155

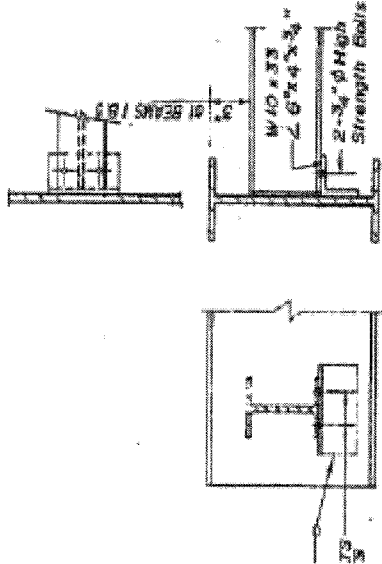

DIAPHRAGM D

(as Required)

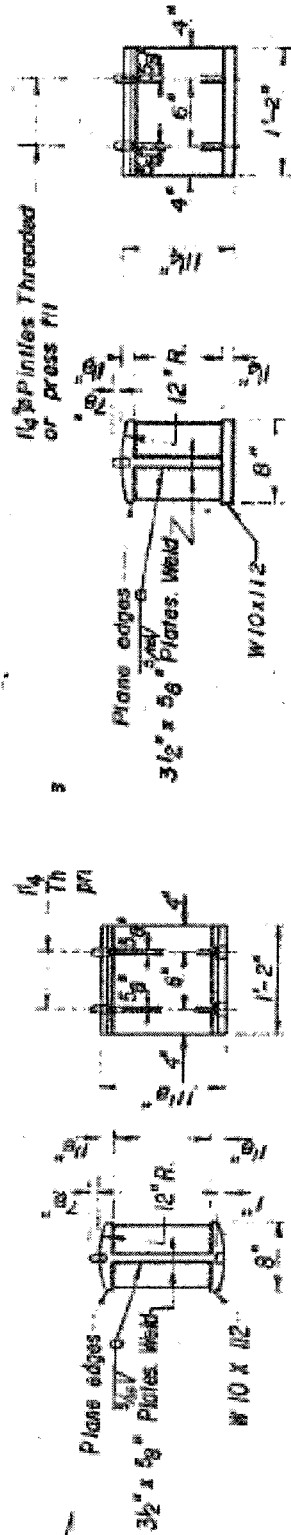

DETAIL OF ROCKER AT PIERS 1&3

DETAIL OF BOLSTER AT PIER 2

WORK LIMITS INCLUDE ALL STRUCTURAL STEEL AT THIS BRIDGE

F.A. RTE.	SECTION	COUNTY	TOTAL SHEETS	SHEET NO.
VAR.	*	VARIOUS	23	23

D-95-031-14

•BRIDGE PAINTING 2015-2

FOR INFORMATION ONLY
S.N. 057-0110

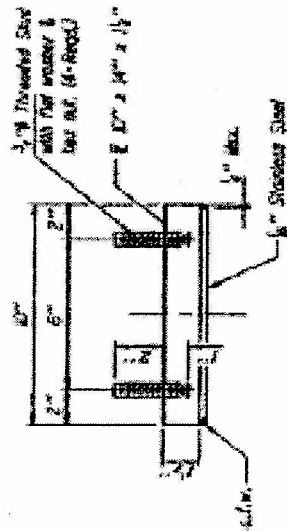

TOP BEARING ASSEMBLY

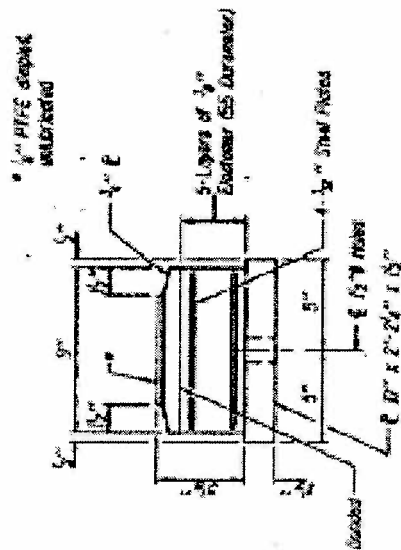

BOTTOM BEARING ASSEMBLY

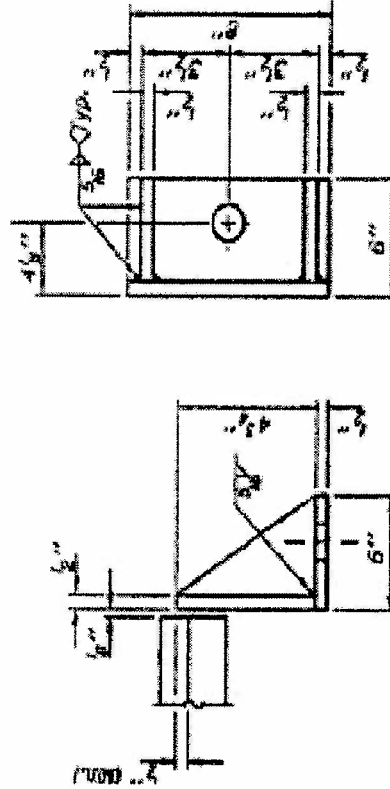

SIDE RETAINER

Equivalent rolled angle with stiffeners will be obtained in lieu of welded plates.

WORK LIMITS INCLUDE ALL STRUCTURAL STEEL AT THIS BRIDGE

REVISIONS TO THE ILLINOIS PREVAILING WAGE RATES

The Prevailing rates of wages are included in the Contract proposals which are subject to Check Sheet #5 of the Supplemental Specifications and Recurring Special Provisions. The rates have been ascertained and certified by the Illinois Department of Labor for the locality in which the work is to be performed and for each craft or type of work or mechanic needed to execute the work of the Contract. As required by Prevailing Wage Act (820 ILCS 130/0.01, et seq.) and Check Sheet #5 of the Contract, not less than the rates of wages ascertained by the Illinois Department of Labor and as revised during the performance of a Contract shall be paid to all laborers, workers and mechanics performing work under the Contract. Post the scale of wages in a prominent and easily accessible place at the site of work.

If the Illinois Department of Labor revises the prevailing rates of wages to be paid as listed in the specification of rates, the contractor shall post the revised rates of wages and shall pay not less than the revised rates of wages. Current wage rate information shall be obtained by visiting the Illinois Department of Labor web site at <http://www.state.il.us/agency/idol/> or by calling 312-793-2814. It is the responsibility of the contractor to review the rates applicable to the work of the contract at regular intervals in order to insure the timely payment of current rates. Provision of this information to the contractor by means of the Illinois Department of Labor web site satisfies the notification of revisions by the Department to the contractor pursuant to the Act, and the contractor agrees that no additional notice is required. The contractor shall notify each of its subcontractors of the revised rates of wages.