

# **BID PROPOSAL INSTRUCTIONS**

**ABOUT IDOT PROPOSALS:** All proposals are potential bidding proposals. Each proposal contains all certifications and affidavits, a proposal signature sheet and a proposal bid bond.

## **PREQUALIFICATION**

Any contractor who desires to become pre-qualified to bid on work advertised by IDOT must submit the properly completed pre-qualification forms to the Bureau of Construction no later than 4:30 p.m. prevailing time twenty-one days prior to the letting of interest. This pre-qualification requirement applies to first time contractors, contractors renewing expired ratings, contractors maintaining continuous pre-qualification or contractors requesting revised ratings. To be eligible to bid, existing pre-qualification ratings must be effective through the date of letting.

## **WHO CAN BID ?**

Bids will be accepted from only those companies that request and receive written Authorization to Bid from IDOT's Central Bureau of Construction.

## **REQUESTS FOR AUTHORIZATION TO BID**

Contractors wanting to bid on items included in a particular letting must submit the properly completed "Request for Authorization to Bid/or Not For Bid Status" (BDE 124) and the ORIGINAL "Affidavit of Availability" (BC 57) to the proper office no later than 4:30 p.m. prevailing time, three (3) days prior to the letting date.

## **WHAT CONSTITUTES WRITTEN AUTHORIZATION TO BID?**

When a prospective prime bidder submits a "Request for Authorization to Bid/or Not For Bid Status"(BDE 124) he/she must indicate at that time which items are being requested For Bidding purposes. Only those items requested For Bidding will be analyzed. After the request has been analyzed, the bidder will be issued an **Authorization to Bid or Not for Bid Report**, approved by the Central Bureau of Construction and the Chief Procurement Officer that indicates which items have been approved For Bidding. If **Authorization to Bid** cannot be approved, the **Authorization to Bid or Not for Bid Report** will indicate the reason for denial.

## **ABOUT AUTHORIZATION TO BID**

Firms that have not received an Authorization to Bid or Not For Bid Report within a reasonable time of complete and correct original document submittal should contact the Department as to the status. Firms unsure as to authorization status should call the Prequalification Section of the Bureau of Construction at the number listed at the end of these instructions.

## **ADDENDA AND REVISIONS**

It is the bidder's responsibility to determine which, if any, addenda or revisions pertain to any project they may be bidding. Failure to incorporate all relevant addenda or revisions may cause the bid to be declared unacceptable.

Each addendum or revision will be included with the Electronic Plans and Proposals. Addenda and revisions will also be placed on the Addendum/Revision Checklist and each subscription service subscriber will be notified by e-mail of each addendum and revision issued.

The Internet is the Department's primary way of doing business. The subscription service emails are an added courtesy the Department provides. It is suggested that bidders check IDOT's website at <http://www.idot.illinois.gov/doing-business/procurements/construction-services/construction-bulletins/transportation-bulletin/index#TransportationBulletin> before submitting final bid information.

***IDOT IS NOT RESPONSIBLE FOR ANY E-MAIL FAILURES.***

Addenda questions may be directed to the Contracts Office at (217)782-7806 or [DOT.DE-Contracts@illinois.gov](mailto:DOT.DE-Contracts@illinois.gov)

Technical questions about downloading these files may be directed to Tim Garman at (217)524-1642 or [Timothy.Garman@illinois.gov](mailto:Timothy.Garman@illinois.gov).

## **STANDARD GUIDELINES FOR SUBMITTING PAPER BIDS**

- All pages should be single sided.
- Use the Cover Page that is provided in the Bid Proposal (posted on the IDOT Web Site) as the first page of your submitted bid. It has the item number in large bold type in the upper left-hand corner and lines provided for your company name and address in the upper right-hand corner.
- Do not use report covers, presentation folders or special bindings and do not staple multiple times on left side like a book. Use only 1 staple in the upper left hand corner. Make sure all elements of your bid are stapled together including the bid bond or guaranty check (if required).
- **Do not include any certificates of eligibility, your authorization to bid, Addendum Letters or affidavit of availability.**
- Do not include the Subcontractor Documentation with your bid (pages i – iii and pages a – g). This documentation is required only if you are awarded the project.
- Use the envelope cover sheet (provided with the proposal) as the cover for the proposal envelope.
- Do not rely on overnight services to deliver your proposal prior to 10 AM on letting day. It will not be read if it is delivered after 10 AM.
- Do not submit your Substance Abuse Prevention Program (SAPP) with your bid. If you are awarded the contract this form is to be submitted to the district engineer at the pre-construction conference.

## **BID SUBMITTAL CHECKLIST**

- Cover page** (the sheet that has the item number on it) – This should be the first page of your bid proposal, **followed by your bid (the Schedule of Prices/Pay Items)**. If you are using special software or CBID to generate your schedule of prices, do not include the blank pages of the schedule of prices that came with the proposal package.
- Page 4 (Item 9)** – Check “YES” if you will use a subcontractor(s) with an annual value over \$50,000. Include the subcontractor(s) name, address, general type of work to be performed and the dollar amount. If you will use subcontractor(s) but are uncertain who or the dollar amount; check “YES” but leave the lines blank.
- After page 4** – Insert the following documents: Cost Adjustments for Steel, Bituminous and Fuel (if applicable) and the Contractor Letter of Assent (if applicable). The general rule should be, if you don’t know where it goes, put it after page 4.
- Page 10 (Paragraph J)** – Check “YES” or “NO” whether your company has any business in Iran.
- Page 10 (Paragraph K)** – (Not applicable to federally funded projects) List the name of the apprenticeship and training program sponsor holding the certificate of registration from the US Department of Labor. If no applicable program exists, please indicate the work/job category. **Do not include certificates with your bid.** Keep the certificates in your office in case they are requested by IDOT.
- Page 11 (Paragraph L)** – Your State Board of Elections certificate of registration is no longer required with your bid.
- Page 11 (Paragraph M)** – Indicate if your company has hired a lobbyist in connection with the job for which you are submitting the bid proposal.
- Page 12 (Paragraph C)** – This is a work sheet to determine if a completed Form A is required. It is not part of the form and you do not need to make copies for each completed Form A.
- Pages 14-17 (Form A)** – One Form A (4 pages) is required for each applicable person in your company. Copies of the forms can be used and only need to be changed when the information changes. The certification signature and date must be original for each letting. **Do not staple the forms together.** If you answered “NO” to all of the questions in Paragraph C (page 12), complete the first section (page 14) with your company information and then sign and date the Not Applicable statement on page 17.
- Page 18 (Form B)** - If you check “YES” to having other current or pending contracts it is acceptable to use the phrase, “See Affidavit of Availability on file”. **Ownership Certification** (at the bottom of the page) - Check N/A if the Form A(s) you submitted accounts for 100 percent of the company ownership. Check YES if any percentage of ownership falls outside of the parameters that require reporting on the Form A. Checking NO indicates that the Form A(s) you submitted is not correct and you will be required to submit a revised Form A.
- Page 20 (Workforce Projection)** – Be sure to include the Duration of the Project. It is acceptable to use the phrase “Per Contract Specifications”.

- Proposal Bid Bond** – (Insert after the proposal signature page) Submit your Proposal Bid Bond (if applicable) using the current Proposal Bid Bond form provided in the proposal package. The Power of Attorney page should be stapled to the Proposal Bid Bond. If you are using an electronic bond, include your bid bond number on the Proposal Bid Bond and attach the Proof of Insurance printed from the Surety’s Web Site.
- Disadvantaged Business Utilization Plan and/or Good Faith Effort – Do Not Submit with Bid** The bidder shall submit a Disadvantaged Business Utilization Plan on completed Department forms SBE 2025 and 2026. (1) The final Utilization Plan must be submitted within five calendar days after the date of the letting. (2) To meet the five day requirement, the bidder may send the Utilization Plan electronically by scanning and sending to [DOT.DBE.UP@illinois.gov](mailto:DOT.DBE.UP@illinois.gov) or faxing to (217) 785-1524. The subject line must include the bid Item Number and the Letting date. The Utilization Plan should be sent as one .pdf file, rather than multiple files and emails for the same Item Number. It is the responsibility of the bidder to obtain confirmation of email or fax delivery.

Alternatively, the Utilization Plan may be sent by certified mail or delivery service within the five calendar day period. If a question arises concerning the mailing date of a Utilization Plan, the mailing date will be established by the U.S. Postal Service postmark on the certified mail receipt from the U.S. Postal Service or the receipt issued by a delivery service. It is the responsibility of the bidder to ensure the postmark or receipt date is affixed within the five days if the bidder intends to rely upon mailing or delivery to satisfy the submission day requirement. The Utilization Plan is to be submitted to:

Illinois Department of Transportation  
 Bureau of Small Business Enterprises  
 Contract Compliance Section  
 2300 South Dirksen Parkway, Room 319  
 Springfield, Illinois 62764

**The Bid Letting is now available in streaming Audio/Video from the IDOT Web Site.** A link to the stream will be placed on the main page of the current letting on the day of the Letting. The stream will not begin until 10 AM.

Following the Letting, the As-Read Tabulation of Bids will be posted by the end of the day. You will find the link on the main Web page for the current letting.

**QUESTIONS: pre-letting up to execution of the contract**

Contractor pre-qualification .....	217-782-3413
Small Business, Disadvantaged Business Enterprise (DBE) .....	217-785-4611
Contracts, Bids, Letting process or Internet downloads .....	217-782-7806
Estimates Unit.....	217-785-3483
Aeronautics.....	217-785-8515
IDNR (Land Reclamation, Water Resources, Natural Resources).....	217-782-6302

**QUESTIONS: following contract execution**

Subcontractor documentation, payments .....	217-782-3413
Railroad Insurance .....	217-785-0275

# 45

RETURN WITH BID

Proposal Submitted By
Name
Address
City

## Letting November 4, 2016

### NOTICE TO PROSPECTIVE BIDDERS

This proposal can be used for bidding purposes by only those companies that request and receive written AUTHORIZATION TO BID from IDOT's Central Bureau of Construction.

**BIDDERS NEED NOT RETURN THE ENTIRE PROPOSAL**

# Notice to Bidders, Specifications, Proposal, Contract and Contract Bond



**Illinois Department  
of Transportation**

Springfield, Illinois 62764

**Contract No. 64L61  
Various Counties  
Section D2 BC 2017-2  
Various Routes  
District 2 Construction Funds**

PLEASE MARK THE APPROPRIATE BOX BELOW:

- A Bid Bond is included.
- A Cashier's Check or a Certified Check is included.
- An Annual Bid Bond is included or is on file with IDOT.

Plans Included  
Herein

Prepared by

S

Checked by

(Printed by authority of the State of Illinois)

**Page intentionally left blank**

RETURN WITH BID



PROPOSAL

TO THE DEPARTMENT OF TRANSPORTATION

1. Proposal of \_\_\_\_\_

\_\_\_\_\_  
Taxpayer Identification Number (Mandatory) \_\_\_\_\_

For the improvement identified and advertised for bids in the Invitation for Bids as:

**Contract No. 64L61  
Various Counties  
Section D2 BC 2017-2  
Various Routes  
District 2 Construction Funds**

**This project consists of washing 14 bridges at various locations in Henry and Rock Island Counties (SN 037-0003, 037-0004, 037-0031, 037-0032, 037-0100, 081-0038, 081-0039, 081-0040, 081-0089, 081-0125, 081-0159, 081-0160, 081-0161 and 081-0162).**

2. The undersigned bidder will furnish all labor, material and equipment to complete the above described project in a good and workmanlike manner as provided in the contract documents provided by the Department of Transportation. This proposal will become part of the contract and the terms and conditions contained in the contract documents will govern performance and payments.

**RETURN WITH BID**

3. **ASSURANCE OF EXAMINATION AND INSPECTION/WAIVER.** The undersigned bidder further declares that he/she has carefully examined the proposal, plans, specifications, addenda form of contract and contract bond, and special provisions, and that he/she has inspected in detail the site of the proposed work, and that he/she has familiarized themselves with all of the local conditions affecting the contract and the detailed requirements of construction, and understands that in making this bid proposal he/she waives all right to plead any misunderstanding regarding the same.
  
4. **EXECUTION OF CONTRACT AND CONTRACT BOND.** The undersigned bidder further agrees to execute a contract for this work and present the same to the department within fifteen (15) days after the contract has been mailed to him/her. The undersigned further agrees that he/she and his/her surety will execute and present within fifteen (15) days after the contract has been mailed to him/her contract bond satisfactory to and in the form prescribed by the Department of Transportation, in the penal sum of the full amount of the contract, or as specified in the special provisions, guaranteeing the faithful performance of the work in accordance with the terms of the contract.

**NUMBER 5 BELOW DOES NOT APPLY TO SMALL BUSINESS INITIATIVES**

5. **PROPOSAL GUARANTY.** Accompanying this proposal is either a bid bond on the department form, executed by a corporate surety company satisfactory to the department, or a proposal guaranty check consisting of a bank cashier's check or a properly certified check for not less than 5 per cent of the amount bid or for the amount specified in the following schedule:

<u>Amount of Bid</u>		<u>Proposal Guaranty</u>	<u>Amount of Bid</u>		<u>Proposal Guaranty</u>	
Up to		\$5,000 .....	\$150	\$2,000,000	to \$3,000,000 .....	\$100,000
\$5,000	to	\$10,000 .....	\$300	\$3,000,000	to \$5,000,000 .....	\$150,000
\$10,000	to	\$50,000 .....	\$1,000	\$5,000,000	to \$7,500,000 .....	\$250,000
\$50,000	to	\$100,000 .....	\$3,000	\$7,500,000	to \$10,000,000 .....	\$400,000
\$100,000	to	\$150,000 .....	\$5,000	\$10,000,000	to \$15,000,000 .....	\$500,000
\$150,000	to	\$250,000 .....	\$7,500	\$15,000,000	to \$20,000,000 .....	\$600,000
\$250,000	to	\$500,000 .....	\$12,500	\$20,000,000	to \$25,000,000 .....	\$700,000
\$500,000	to	\$1,000,000 .....	\$25,000	\$25,000,000	to \$30,000,000 .....	\$800,000
\$1,000,000	to	\$1,500,000 .....	\$50,000	\$30,000,000	to \$35,000,000 .....	\$900,000
\$1,500,000	to	\$2,000,000 .....	\$75,000	over	\$35,000,000 .....	\$1,000,000

Bank cashier's checks or properly certified checks accompanying bid proposals will be made payable to the Treasurer, State of Illinois.

If a combination bid is submitted, the proposal guaranties which accompany the individual bid proposals making up the combination will be considered as also covering the combination bid.

The amount of the proposal guaranty check is \_\_\_\_\_ \$(\_\_\_\_\_). If this proposal is accepted and the undersigned will fail to execute a contract bond as required herein, it is hereby agreed that the amount of the proposal guaranty will become the property of the State of Illinois, and shall be considered as payment of damages due to delay and other causes suffered by the State because of the failure to execute said contract and contract bond; otherwise, the bid bond will become void or the proposal guaranty check will be returned to the undersigned.

**Attach Cashier's Check or Certified Check Here**

In the event that one proposal guaranty check is intended to cover two or more bid proposals, the amount must be equal to the sum of the proposal guaranties which would be required for each individual bid proposal. If the guaranty check is placed in another bid proposal, state below where it may be found.

The proposal guaranty check will be found in the bid proposal for:

Item \_\_\_\_\_

Section No. \_\_\_\_\_

County \_\_\_\_\_

**Mark the proposal cover sheet as to the type of proposal guaranty submitted.**

**RETURN WITH BID**

6. **COMBINATION BIDS.** The undersigned bidder further agrees that if awarded the contract for the sections contained in the following combination, he/she will perform the work in accordance with the requirements of each individual contract comprising the combination bid specified in the schedule below, and that the combination bid shall be prorated against each section in proportion to the bid submitted for the same. If an error is found to exist in the gross sum bid for one or more of the individual sections included in a combination, the combination bid shall be corrected as provided in the specifications.

**When a combination bid is submitted, the schedule below must be completed in each proposal comprising the combination.**

**If alternate bids are submitted for one or more of the sections comprising the combination, a combination bid must be submitted for each alternate.**

**Schedule of Combination Bids**

Combination No.	Sections Included in Combination	Combination Bid	
		Dollars	Cents

7. **SCHEDULE OF PRICES.** The undersigned bidder submits herewith, in accordance with the rules and instructions, a schedule of prices for the items of work for which bids are sought. The unit prices bid are in U.S. dollars and cents, and all extensions and summations have been made. The bidder understands that the quantities appearing in the bid schedule are approximate and are provided for the purpose of obtaining a gross sum for the comparison of bids. If there is an error in the extension of the unit prices, the unit prices will govern. Payment to the contractor awarded the contract will be made only for actual quantities of work performed and accepted or materials furnished according to the contract. The scheduled quantities of work to be done and materials to be furnished may be increased, decreased or omitted as provided elsewhere in the contract.
8. **AUTHORITY TO DO BUSINESS IN ILLINOIS.** Section 20-43 of the Illinois Procurement Code (the Code) (30 ILCS 500/20-43) provides that a person (other than an individual acting as a sole proprietor) must be a legal entity authorized to transact business or conduct affairs in the State of Illinois prior to submitting the bid.
9. **EXECUTION OF CONTRACT:** The Department of Transportation will, in accordance with the rules governing Department procurements, execute the contract and shall be the sole entity having the authority to accept performance and make payments under the contract. Execution of the contract by the Chief Procurement Officer (CPO) or the State Purchasing Officer (SPO) is for approval of the procurement process and execution of the contract by the Department. Neither the CPO nor the SPO shall be responsible for administration of the contract or determinations respecting performance or payment there under except as otherwise permitted in the Code.

10. **The services of a subcontractor will be used.**

Check box Yes   
 Check box No

For known subcontractors with subcontracts with an annual value of more than \$50,000, the contract shall include their name, address, general type of work to be performed, and the dollar allocation for each subcontractor. (30 ILCS 500/20-120)

---



---



ILLINOIS DEPARTMENT OF TRANSPORTATION  
 SCHEDULE OF PRICES  
 CONTRACT  
 NUMBER - 64L61

State Job # - C-92-110-16

Project Number

Route

County Name - VARIOUS- -

VARIOUS

Code - 0 - -

District - 2 - -

Section Number - D2 BC 2017-2

Item Number	Pay Item Description	Unit of Measure	Quantity	x	Unit Price	=	Total Price
X7010410	SPEED DISPLAY TRAILER	CAL MO	1.000				
Z0048665	RR PROT LIABILITY INS	L SUM	1.000				
59200101	BRIDGE WASHING N1	EACH	1.000				
59200102	BRIDGE WASHING N2	EACH	1.000				
59200103	BRIDGE WASHING N3	EACH	1.000				
59200104	BRIDGE WASHING N4	EACH	1.000				
59200105	BRIDGE WASHING N5	EACH	1.000				
59200106	BRIDGE WASHING N6	EACH	1.000				
59200107	BRIDGE WASHING N7	EACH	1.000				
59200108	BRIDGE WASHING N8	EACH	1.000				
59200109	BRIDGE WASHING N9	EACH	1.000				
59200110	BRIDGE WASHING N10	EACH	1.000				
59200111	BRIDGE WASHING N11	EACH	1.000				
59200112	BRIDGE WASHING N12	EACH	1.000				
59200113	BRIDGE WASHING N13	EACH	1.000				

ILLINOIS DEPARTMENT OF TRANSPORTATION  
 SCHEDULE OF PRICES  
 CONTRACT  
 NUMBER - 64L61

State Job # - C-92-110-16

Project Number

Route

County Name - VARIOUS- -

VARIOUS

Code - 0 - -

District - 2 - -

Section Number - D2 BC 2017-2

Item Number	Pay Item Description	Unit of Measure	Quantity	x	Unit Price	=	Total Price
59200114	BRIDGE WASHING N14	EACH	1.000				
67100100	MOBILIZATION	L SUM	1.000				
70100420	TRAF CONT-PROT 701411	EACH	6.000				
70100450	TRAF CONT-PROT 701201	L SUM	1.000				
70100700	TRAF CONT-PROT 701406	L SUM	1.000				
70102620	TR CONT & PROT 701501	L SUM	1.000				
70102625	TR CONT & PROT 701606	L SUM	1.000				



## RETURN WITH BID

### **STATE REQUIRED ETHICAL STANDARDS GOVERNING CONTRACT PROCUREMENT: ASSURANCES, CERTIFICATIONS AND DISCLOSURES**

#### I. GENERAL

A. Article 50 of the Code establishes the duty of all State CPOs, SPOs, and their designees to maximize the value of the expenditure of public moneys in procuring goods, services, and contracts for the State of Illinois and to act in a manner that maintains the integrity and public trust of State government. In discharging this duty, they are charged by law to use all available information, reasonable efforts, and reasonable actions to protect, safeguard, and maintain the procurement process of the State of Illinois.

B. In order to comply with the provisions of Article 50 and to carry out the duty established therein, all bidders are to adhere to ethical standards established for the procurement process, and to make such assurances, disclosures and certifications required by law. Except as otherwise required in subsection III, paragraphs J-M, by execution of the Proposal Signature Sheet, the bidder indicates that each of the mandated assurances have been read and understood, that each certification is made and understood, and that each disclosure requirement has been understood and completed.

C. In addition to all other remedies provided by law, failure to comply with any assurance, failure to make any disclosure or the making of a false certification shall be grounds for the CPO to void the contract, and may result in the suspension or debarment of the bidder or subcontractor. If a false certification is made by a subcontractor the contractor's submitted bid and the executed contract may not be declared void unless the contractor refuses to terminate the subcontract upon the State's request after a finding that the subcontractor's certification was false.

I acknowledge, understand and accept these terms and conditions.

#### II. ASSURANCES

The assurances hereinafter made by the bidder are each a material representation of fact upon which reliance is placed should the Department enter into the contract with the bidder.

##### A. **Conflicts of Interest**

Section 50-13. Conflicts of Interest.

(a) Prohibition. It is unlawful for any person holding an elective office in this State, holding a seat in the General Assembly, or appointed to or employed in any of the offices or agencies of state government and who receives compensation for such employment in excess of 60% of the salary of the Governor of the State of Illinois, or who is an officer or employee of the Capital Development Board or the Illinois State Toll Highway Authority, or who is the spouse or minor child of any such person to have or acquire any contract, or any direct pecuniary interest in any contract therein, whether for stationery, printing, paper, or any services, materials, or supplies, that will be wholly or partially satisfied by the payment of funds appropriated by the General Assembly of the State of Illinois or in any contract of the Capital Development Board or the Illinois State Toll Highway Authority.

(b) Interests. It is unlawful for any firm, partnership, association or corporation, in which any person listed in subsection (a) is entitled to receive (i) more than 7 1/2% of the total distributable income or (ii) an amount in excess of the salary of the Governor, to have or acquire any such contract or direct pecuniary interest therein.

(c) Combined interests. It is unlawful for any firm, partnership, association, or corporation, in which any person listed in subsection (a) together with his or her spouse or minor children is entitled to receive (i) more than 15%, in the aggregate, of the total distributable income or (ii) an amount in excess of 2 times the salary of the Governor, to have or acquire any such contract or direct pecuniary interest therein.

(d) Securities. Nothing in this Section invalidates the provisions of any bond or other security previously offered or to be offered for sale or sold by or for the State of Illinois.

(e) Prior interests. This Section does not affect the validity of any contract made between the State and an officer or employee of the State or member of the General Assembly, his or her spouse, minor child or any combination of those persons if that contract was in existence before his or her election or employment as an officer, member, or employee. The contract is voidable, however, if it cannot be completed within 365 calendar days after the officer, member, or employee takes office or is employed. The current salary of the Governor is \$177,412.00. Sixty percent of the salary is \$106,447.20.

## RETURN WITH BID

The bidder assures the Department that the award and execution of the contract would not cause a violation of Section 50-13, or that an effective exemption has been issued by the Board of Ethics to any individual subject to the Section 50-13 prohibitions pursuant to the provisions of Section 50-20 of the Code. Information concerning the exemption process is available from the Department upon request.

### **B. Negotiations**

Section 50-15. Negotiations.

It is unlawful for any person employed in or on a continual contractual relationship with any of the offices or agencies of State government to participate in contract negotiations on behalf of that office or agency with any firm, partnership, association, or corporation with whom that person has a contract for future employment or is negotiating concerning possible future employment.

The bidder assures the Department that the award and execution of the contract would not cause a violation of Section 50-15, and that the bidder has no knowledge of any facts relevant to the kinds of acts prohibited therein.

### **C. Inducements**

Section 50-25. Inducement.

Any person who offers or pays any money or other valuable thing to any person to induce him or her not to provide a submission to a vendor portal or to bid for a State contract or as recompense for not having bid on a State contract is guilty of a Class 4 felony. Any person who accepts any money or other valuable thing for not bidding for a State contract, not making a submission to a vendor portal, or who withholds a bid or submission to a vendor portal in consideration of the promise for the payment of money or other valuable thing is guilty of a Class 4 felony.

The bidder assures the Department that the award and execution of the contract would not cause a violation of Section 50-25, and that the bidder has no knowledge of any facts relevant to the kinds of acts prohibited therein.

### **D. Revolving Door Prohibition**

Section 50-30. Revolving door prohibition.

CPOs, SPOs, procurement compliance monitors, their designees whose principal duties are directly related to State procurement, and executive officers confirmed by the Senate are expressly prohibited for a period of 2 years after terminating an affected position from engaging in any procurement activity relating to the State agency most recently employing them in an affected position for a period of at least 6 months. The prohibition includes, but is not limited to: lobbying the procurement process; specifying; bidding; proposing bid, proposal, or contract documents; on their own behalf or on behalf of any firm, partnership, association, or corporation. This Section applies only to persons who terminate an affected position on or after January 15, 1999.

The bidder assures the Department that the award and execution of the contract would not cause a violation of Section 50-30, and that the bidder has no knowledge of any facts relevant to the kinds of acts prohibited therein.

### **E. Reporting Anticompetitive Practices**

Section 50-40. Reporting anticompetitive practices.

When, for any reason, any vendor, bidder, contractor, CPO, SPO, designee, elected official, or State employee suspects collusion or other anticompetitive practice among any bidders, offerors, contractors, proposers, or employees of the State, a notice of the relevant facts shall be transmitted to the Attorney General and the CPO.

The bidder assures the Department that it has not failed to report any relevant facts concerning the practices addressed in Section 50-40 which may involve the contract for which the bid or submission to a vendor portal is submitted.

### **F. Confidentiality**

Section 50-45. Confidentiality.

Any CPO, SPO, designee, or executive officer who willfully uses or allows the use of specifications, competitive bid documents, proprietary competitive information, proposals, contracts, or selection information to compromise the fairness or integrity of the procurement, bidding, or contract process shall be subject to immediate dismissal, regardless of the Personnel code, any contract, or any collective bargaining agreement, and may in addition be subject to criminal prosecution.

The bidder assures the Department that it has no knowledge of any fact relevant to the practices addressed in Section 50-45 which may involve the contract for which the bid is submitted.

## RETURN WITH BID

### **G. Insider Information**

Section 50-50. Insider information.

It is unlawful for any current or former elected or appointed State official or State employee to knowingly use confidential information available only by virtue of that office or employment for actual or anticipated gain for themselves or another person.

The bidder assures the Department that it has no knowledge of any facts relevant to the practices addressed in Section 50-50 which may involve the contract for which the bid is submitted.

I acknowledge, understand and accept these terms and conditions for the above assurances.

### **III. CERTIFICATIONS**

The certifications hereinafter made by the bidder are each a material representation of fact upon which reliance is placed should the Department enter into the contract with the bidder. Section 50-2 of the Code provides that every person that has entered into a multi-year contract and every subcontractor with a multi-year subcontract shall certify, by July 1 of each fiscal year covered by the contract after the initial fiscal year, to the responsible CPO whether it continues to satisfy the requirements of Article 50 pertaining to the eligibility for a contract award. If a contractor or subcontractor is not able to truthfully certify that it continues to meet all requirements, it shall provide with its certification a detailed explanation of the circumstances leading to the change in certification status. A contractor or subcontractor that makes a false statement material to any given certification required under Article 50 is, in addition to any other penalties or consequences prescribed by law, subject to liability under the Whistleblower Reward and Protection Act for submission of a false claim.

#### **A. Bribery**

Section 50-5. Bribery.

(a) Prohibition. No person or business shall be awarded a contract or subcontract under this Code who:

(1) has been convicted under the laws of Illinois or any other state of bribery or attempting to bribe an officer or employee of the State of Illinois or any other state in that officer's or employee's official capacity; or

(2) has made an admission of guilt of that conduct that is a matter of record but has not been prosecuted for that conduct.

(b) Businesses. No business shall be barred from contracting with any unit of State or local government, or subcontracting under such a contract, as a result of a conviction under this Section of any employee or agent of the business if the employee or agent is no longer employed by the business and:

(1) the business has been finally adjudicated not guilty; or

(2) the business demonstrates to the governmental entity with which it seeks to contract, or which is signatory to the contract which the subcontract relates, and that entity finds that the commission of the offense was not authorized, requested, commanded, or performed by a director, officer, or high managerial agent on behalf of the business as provided in paragraph (2) of subsection (a) of Section 5-4 of the Criminal Code of 2012.

(c) Conduct on behalf of business. For purposes of this Section, when an official, agent, or employee of a business committed the bribery or attempted bribery on behalf of the business and in accordance with the direction or authorization of a responsible official of the business, the business shall be chargeable with the conduct.

(d) Certification. Every bid submitted to and contract executed by the State, and every subcontract subject to Section 20-120 of the Code shall contain a certification by the contractor or the subcontractor, respectively, that the contractor or subcontractor is not barred from being awarded a contract or subcontract under this Section and acknowledges that the CPO may declare the related contract void if any certifications required by this Section are false. A contractor who makes a false statement, material to the certification, commits a Class 3 felony.

The contractor or subcontractor certifies that it is not barred from being awarded a contract under Section 50-5.

#### **B. Felons**

Section 50-10. Felons.

(a) Unless otherwise provided, no person or business convicted of a felony shall do business with the State of Illinois or any State agency, or enter into a subcontract, from the date of conviction until 5 years after the date of completion of the sentence for that felony, unless no person held responsible by a prosecutorial office for the facts upon which the conviction was based continues to have any involvement with the business.

(b) Certification. Every bid submitted to and contract executed by the State and every subcontract subject to Section 20-120 of the Code and every vendor's submission to a vendor portal shall contain a certification by the bidder or contractor or subcontractor, respectively, that the bidder, contractor, or subcontractor is not barred from being awarded a contract or subcontract under this Section and acknowledges that the CPO may declare the related contract void if any of the certifications required by this Section are false.

## RETURN WITH BID

### **C. Debt Delinquency**

Section 50-11 and 50-12. Debt Delinquency.

The contractor or bidder or subcontractor, respectively, certifies that it, or any affiliate, is not barred from being awarded a contract or subcontract under the Code. Section 50-11 prohibits a person from entering into a contract with a State agency, or entering into a subcontract, if it knows or should know that it, or any affiliate, is delinquent in the payment of any debt to the State as defined by the Debt Collection Board. Section 50-12 prohibits a person from entering into a contract with a State agency, or entering into a subcontract, if it, or any affiliate, has failed to collect and remit Illinois Use Tax on all sales of tangible personal property into the State of Illinois in accordance with the provisions of the Illinois Use Tax Act. The bidder or contractor or subcontractor, respectively, further acknowledges that the CPO may declare the related contract void if this certification is false or if the bidder, contractor, or subcontractor, or any affiliate, is determined to be delinquent in the payment of any debt to the State during the term of the contract.

### **D. Prohibited Bidders, Contractors and Subcontractors**

Section 50-10.5 and 50-60(c). Prohibited bidders, contractors and subcontractors.

The bidder or contractor or subcontractor, respectively, certifies in accordance with Section 50-10.5 that no officer, director, partner or other managerial agent of the contracting business has been convicted of a felony under the Sarbanes-Oxley Act of 2002 or a Class 3 or Class 2 felony under the Illinois Securities Law of 1953 or if in violation of Subsection (c) for a period of five years from the date of conviction. Every bid submitted to and contract executed by the State and every subcontract subject to Section 20-120 of the Code shall contain a certification by the bidder, contractor, or subcontractor, respectively, that the bidder, contractor, or subcontractor is not barred from being awarded a contract or subcontract under this Section and acknowledges that the CPO shall declare the related contract void if any of the certifications completed pursuant to this Section are false.

### **E. Section 42 of the Environmental Protection Act**

Section 50-14 Environmental Protection Act violations.

The bidder or contractor or subcontractor, respectively, certifies in accordance with Section 50-14 that the bidder, contractor, or subcontractor, is not barred from being awarded a contract or entering into a subcontract under this Section which prohibits the bidding on or entering into contracts with the State of Illinois or a State agency, or entering into any subcontract, that is subject to the Code by a person or business found by a court or the Pollution Control Board to have committed a willful or knowing violation of Section 42 of the Environmental Protection Act for a period of five years from the date of the order. The bidder or contractor or subcontractor, respectively, acknowledges that the CPO may declare the contract void if this certification is false.

### **F. Educational Loan**

Section 3 of the Educational Loan Default Act, 5 ILCS 385/3.

Pursuant to the Educational Loan Default Act no State agency shall contract with an individual for goods or services if that individual is in default on an educational loan.

The bidder, if an individual as opposed to a corporation, partnership or other form of business organization, certifies that the bidder is not in default on an educational loan as provided in Section 3 of the Act.

### **G. Bid-Rigging/Bid Rotating**

Section 33E-11 of the Criminal Code of 2012, 720 ILCS 5/33E-11.:

(a) Every bid submitted to and public contract executed pursuant to such bid by the State or a unit of local government shall contain a certification by the prime contractor that the prime contractor is not barred from contracting with any unit of State or local government as a result of a violation of either Section 33E-3 or 33E-4 of this Article

(b) A contractor who makes a false statement, material to the certification, commits a Class 3 felony.

A violation of Section 33E-3 would be represented by a conviction of the crime of bid-rigging which, in addition to Class 3 felony sentencing, provides that any person convicted of this offense or any similar offense of any state or the United States which contains the same elements as this offense shall be barred for 5 years from the date of conviction from contracting with any unit of State or local government. No corporation shall be barred from contracting with any unit of State or local government as a result of a conviction under this Section of any employee or agent of such corporation if the employee so convicted is no longer employed by the corporation and: (1) it has been finally adjudicated not guilty or (2) if it demonstrates to the governmental entity with which it seeks to contract and that entity finds that the commission of the offense was neither authorized, requested, commanded, nor performed by a director, officer or a high managerial agent in behalf of the corporation.

The bidder certifies that it is not barred from contracting with the Department by reason of a violation of either Section 33E-3 or Section 33E-4.

## RETURN WITH BID

### **H. International Anti-Boycott**

Section 5 of the International Anti-Boycott Certification Act provides every contract entered into by the State of Illinois for the manufacture, furnishing, or purchasing of supplies, material, or equipment or for the furnishing of work, labor, or services, in an amount exceeding the threshold for small purchases according to the purchasing laws of this State or \$10,000.00, whichever is less, shall contain certification, as a material condition of the contract, by which the contractor agrees that neither the contractor nor any substantially-owned affiliated company is participating or shall participate in an international boycott in violation of the provisions of the U.S. Export Administration Act of 1979 or the regulations of the U.S. Department of Commerce promulgated under that Act.

The bidder makes the certification set forth in Section 5 of the Act.

### **I. Drug Free Workplace**

The Illinois "Drug Free Workplace Act" applies to this contract and it is necessary to comply with the provisions of the "Act" if the contractor is a corporation, partnership, or other entity (including a sole proprietorship) which has 25 or more employees.

The bidder certifies that if awarded a contract in excess of \$5,000 it will provide a drug free workplace in compliance with the provisions of the Act.

### **J. Disclosure of Business Operations in Iran**

Section 50-36 of the Code provides that each bid, offer, or proposal submitted for a State contract shall include a disclosure of whether or not the Company acting as the bidder, offeror, or proposing entity, or any of its corporate parents or subsidiaries, within the 24 months before submission of the bid, offer, or proposal had business operations that involved contracts with or provision of supplies or services to the Government of Iran, companies in which the Government of Iran has any direct or indirect equity share, consortiums or projects commissioned by the Government of Iran, or companies involved in consortiums or projects commissioned by the Government of Iran and either of the following conditions apply:

- (1) More than 10% of the Company's revenues produced in or assets located in Iran involve oil-related activities or mineral-extraction activities; less than 75% of the Company's revenues produced in or assets located in Iran involve contracts with or provision of oil-related or mineral-extraction products or services to the Government of Iran or a project or consortium created exclusively by that government; and the Company has failed to take substantial action.
- (2) The Company has, on or after August 5, 1996, made an investment of \$20 million or more, or any combination of investments of at least \$10 million each that in the aggregate equals or exceeds \$20 million in any 12-month period, which directly or significantly contributes to the enhancement of Iran's ability to develop petroleum resources of Iran.

The terms "Business operations", "Company", "Mineral-extraction activities", "Oil-related activities", "Petroleum resources", and "Substantial action" are all defined in the Code.

Failure to make the disclosure required by the Code may cause the bid, offer or proposal to be considered not responsive. The disclosure will be considered when evaluating the bid or awarding the contract. The name of each Company disclosed as doing business or having done business in Iran will be provided to the State Comptroller.

Check the appropriate statement:

Company has no business operations in Iran to disclose.

Company has business operations in Iran as disclosed on the attached document.



**RETURN WITH BID**

**K. Apprenticeship and Training Certification (Does not apply to federal aid projects)**

In accordance with the provisions of Section 30-22 (6) of the Code, the bidder certifies that it is a participant, either as an individual or as part of a group program, in the approved apprenticeship and training programs applicable to each type of work or craft that the bidder will perform with its own forces. The bidder further certifies for work that will be performed by subcontract that each of its subcontractors submitted for approval either (a) is, at the time of such bid, participating in an approved, applicable apprenticeship and training program; or (b) will, prior to commencement of performance of work pursuant to this contract, begin participation in an approved apprenticeship and training program applicable to the work of the subcontract. The Department, at any time before or after award, may require the production of a copy of each applicable Certificate of Registration issued by the United States Department of Labor evidencing such participation by the contractor and any or all of its subcontractors. Applicable apprenticeship and training programs are those that have been approved and registered with the United States Department of Labor. The bidder shall list in the space below, the official name of the program sponsor holding the Certificate of Registration for all of the types of work or crafts in which the bidder is a participant and that will be performed with the bidder's forces. Types of work or craft work that will be subcontracted shall be included and listed as subcontract work. The list shall also indicate any type of work or craft job category that does not have an applicable apprenticeship or training program. **The bidder is responsible for making a complete report and shall make certain that each type of work or craft job category that will be utilized on the project as reported on the Construction Employee Workforce Projection (Form BC-1256) and returned with the bid is accounted for and listed.**

Additionally, Section 30-22 of the Code requires that the bidder certify that an Illinois office be maintained as the primary place of employment for persons employed for this contract.

---

---

---

The requirements of these certifications and disclosures are a material part of the contract, and the contractor shall require these certification provisions to be included in all approved subcontracts. In order to fulfill this requirement, it shall not be necessary that an applicable program sponsor be currently taking, or that it will take applications for apprenticeship, training or employment during the performance of the work of this contract.

**TO BE RETURNED WITH BID**

**L. Political Contributions and Registration with the State Board of Elections**

Sections 20-160 and 50-37 of the Code regulate political contributions from business entities and any affiliated entities or affiliated persons bidding on or contracting with the state. Generally under Section 50-37, any business entity, and any affiliated entity or affiliated person of the business entity, whose current year contracts with all state agencies exceed an awarded value of \$50,000, are prohibited from making any contributions to any political committees established to promote the candidacy of the officeholder responsible for the awarding of the contracts or any other declared candidate for that office for the duration of the term of office of the incumbent officeholder or a period 2 years after the termination of the contract, whichever is longer. Any business entity and affiliated entities or affiliated persons whose state contracts in the current year do not exceed an awarded value of \$50,000, but whose aggregate pending bids and proposals on state contracts exceed \$50,000, either alone or in combination with contracts not exceeding \$50,000, are prohibited from making any political contributions to any political committee established to promote the candidacy of the officeholder responsible for awarding the pending contract during the period beginning on the date the invitation for bids or request for proposals or any other procurement opportunity is issued and ending on the day after the date of award or selection if the entity was not awarded or selected. Section 20-160 requires certification of registration of affected business entities in accordance with procedures found in Section 9-35 of The Election Code.

By submission of a bid, the contractor business entity acknowledges and agrees that it has read and understands Sections 20-160 and 50-37 of the Code, and that it makes the following certification:

**The undersigned bidder certifies that it has registered as a business with the State Board of Elections and acknowledges a continuing duty to update the registration in accordance with the above referenced statutes. If the business entity is required to register, the CPO shall verify that it is in compliance on the date the bid or proposal is due. The CPO shall not accept a bid or proposal if the business entity is not in compliance with the registration requirements.**

These requirements and compliance with the above referenced statutory sections are a material part of the contract, and any breach thereof shall be cause to void the contract under Section 50-60 of the Code. This provision does not apply to Federal-aid contracts.

**M. Lobbyist Disclosure**

Section 50-38 of the Code requires that any bidder or offeror on a State contract that hires a person required to register under the Lobbyist Registration Act to assist in obtaining a contract shall:

- (i) Disclose all costs, fees, compensation, reimbursements, and other remunerations paid or to be paid to the lobbyist related to the contract,
- (ii) Not bill or otherwise cause the State of Illinois to pay for any of the lobbyist's costs, fees, compensation, reimbursements, or other remuneration, and
- (iii) Sign a verification certifying that none of the lobbyist's costs, fees, compensation, reimbursements, or other remuneration were billed to the State.

This information, along with all supporting documents, shall be filed with the agency awarding the contract and with the Secretary of State. The CPO shall post this information, together with the contract award notice, in the online Procurement Bulletin.

Pursuant to Subsection (c) of this Section, no person or entity shall retain a person or entity to attempt to influence the outcome of a procurement decision made under the Code for compensation contingent in whole or in part upon the decision or procurement. Any person who violates this subsection is guilty of a business offense and shall be fined not more than \$10,000.

Bidder acknowledges that it is required to disclose the hiring of any person required to register pursuant to the Illinois Lobbyist Registration Act (25 ILCS 170) in connection with this contract.

Bidder has not hired any person required to register pursuant to the Illinois Lobbyist Registration Act in connection with this contract.

Or

Bidder has hired the following persons required to register pursuant to the Illinois Lobbyist Registration Act in connection with the contract:

Name and address of person: \_\_\_\_\_  
All costs, fees, compensation, reimbursements and other remuneration paid to said person: \_\_\_\_\_  
\_\_\_\_\_  
\_\_\_\_\_

I acknowledge, understand and accept these terms and conditions for the above certifications.

RETURN WITH BID

**Illinois Department of Transportation  
Qualification and Equipment Inventory  
Certification Form  
for  
Small Business Initiative Projects**

The undersigned authorized representative of Bidder certifies that the attached qualification information provided to the Department is true and correct, and that it is submitted with the understanding that the Department will use and rely upon the accuracy and currency of the information in the evaluation of Bidder's responsibility for award of this public contract.

Bidding Organization

---

---

Signature

Date

Printed Name

Title

Address

City/State

Zip Code

Telephone

Facsimile

E-mail

**Bidders that are currently prequalified by the Department are cautioned that they must complete these forms.**

RETURN WITH BID

**PART I**  
**Business and Directory Information**

- (a) Name of business (official name and assumed names): \_\_\_\_\_
- (b) Business headquarters: \_\_\_\_\_  
Address: \_\_\_\_\_  
Telephone: \_\_\_\_\_ Facsimile: \_\_\_\_\_
- (c) Billing address: \_\_\_\_\_
- (d) Type of organization (Sole Proprietor, Corporation, Partnership, etc. – should be the same as on the Taxpayer ID form Part V): \_\_\_\_\_
- (e) State of incorporation, State of formation or State of organization: \_\_\_\_\_
- (f) If a division or subsidiary of another organization provide the name and address of the parent: \_\_\_\_\_
- (g) Businesses are affiliates when either one directly or indirectly controls or has the power to control the other, or, when a third party or parties controls or has the power to control both. In determining whether concerns are independently owned and operated and whether affiliation exists, consideration will be given to all appropriate factors, including the use of common facilities, common ownership and management and contractual arrangements. Identify all affiliated businesses and companies: \_\_\_\_\_  
\_\_\_\_\_  
\_\_\_\_\_
- (h) Description of business: \_\_\_\_\_
- (i) Length of time in business: \_\_\_\_\_
- (j) Number of full-time employees (average from most recent Fiscal Year): \_\_\_\_\_
- (k) Total annual sales and receipts for the most recently completed Fiscal Year including any parent and all related and affiliated organizations (tax returns for the relevant year may be required for verification): \_\_\_\_\_
- (l) Name and title of all officers/managers: \_\_\_\_\_  
\_\_\_\_\_
- (m) Identify and specify the location(s) and telephone numbers of the major offices and other facilities that would relate to performance under the terms of the contract if awarded: \_\_\_\_\_  
\_\_\_\_\_
- (n) Identify accounting firm: \_\_\_\_\_

**RETURN WITH BID**

- (o) The successful business will be required to register to do business in Illinois. If already registered, provide the date of the registration to do business in Illinois and the name of the registered agent in the State: \_\_\_\_\_  
\_\_\_\_\_
- (p) Business web site: \_\_\_\_\_
- (q) Is this business currently prequalified by the Department of Transportation? If yes, list all work ratings issued: \_\_\_\_\_  
\_\_\_\_\_
- (r) Has this business performed contracts awarded by the Department as prime contractor? If yes, list the three most recent: \_\_\_\_\_  
\_\_\_\_\_
- (s) Has this business participated as a subcontractor under contracts awarded by the Department? If yes, list the three most recent identifying the prime contractor: \_\_\_\_\_  
\_\_\_\_\_

RETURN WITH BID

**PART II  
References**

Provide references from established firms or government agencies, (four preferred; two of each type preferred) other than the Department, that can attest to your experience and ability to perform the work of the contract for which this bid is submitted. **Bidders that have current work ratings issued by the Prequalification Section need only list references for this contract if more than 50% of the work as determined by the advertised quantities is not covered by an issued work rating.**

(1) Government Agency (Name): \_\_\_\_\_  
Contact Person Name: \_\_\_\_\_  
Address: \_\_\_\_\_  
Phone: \_\_\_\_\_ E-mail Address: \_\_\_\_\_  
Types of services provided and dates provided: \_\_\_\_\_  
\_\_\_\_\_

(2) Governmental Agency (Name): \_\_\_\_\_  
Contact Person Name: \_\_\_\_\_  
Address: \_\_\_\_\_  
Phone: \_\_\_\_\_ E-mail Address: \_\_\_\_\_  
Types of services provided and dates provided: \_\_\_\_\_  
\_\_\_\_\_

(3) Private Firm (Name): \_\_\_\_\_  
Contact Person Name: \_\_\_\_\_  
Address: \_\_\_\_\_  
Phone: \_\_\_\_\_ E-mail Address: \_\_\_\_\_  
Types of services provided and dates provided: \_\_\_\_\_  
\_\_\_\_\_

(4) Private Firm (Name): \_\_\_\_\_  
Contact Person Name: \_\_\_\_\_  
Address: \_\_\_\_\_  
Phone: \_\_\_\_\_ E-mail Address: \_\_\_\_\_  
Types of services provided and dates provided: \_\_\_\_\_  
\_\_\_\_\_



**RETURN WITH BID**

**PART IV  
Department of Human Rights (DHR)  
Public Contract Number**

If the bidder has employed fifteen (15) or more full-time employees at any time during the 365-day period immediately preceding the publication of this invitation for bids, the bidder must have a current Public Contract Number or have proof of having submitted a completed application for one prior to the letting date. If the Department cannot confirm compliance, it will not be able to consider the bid or offer. Please complete the appropriate sections below.

Name of Company (and D/B/A): \_\_\_\_\_  
\_\_\_\_\_

DHR Public Contracts Number: \_\_\_\_\_

(Check if applicable) The number is not required because the company has employed 14 or less full-time employees during the 365-day period immediately preceding the publication of this invitation.

IF NUMBER HAS NOT YET BEEN ISSUED:

Date completed application was submitted to DHR: \_\_\_\_\_

Date of Expiration: \_\_\_\_\_



RETURN WITH BID

**PART V**  
**Taxpayer Identification Number**

I certify that:

1. The number shown on this form is my correct taxpayer identification number (or I am waiting for a number to be issued to me), **and**
2. I am not subject to backup withholding because: (a) I am exempt from backup withholding, or (b) I have not been notified by the Internal Revenue Service (IRS) that I am subject to backup withholding as a result of a failure to report all interest or dividends, or (c) the IRS has notified me that I am no longer subject to backup withholding, **and**
3. I am a U.S. person (including a U.S. resident alien), and
4. I am authorized as a legal entity, in accordance with 30 ILCS 500/20-43, to do business in the state of Illinois.

**Name (Printed):** \_\_\_\_\_

**Taxpayer Identification Number:**

Social Security Number \_\_\_\_\_  
or  
Employer Identification Number \_\_\_\_\_

Legal Status (check one):

- |  |  |
|--|--|
| <input type="checkbox"/> Individual                    | <input type="checkbox"/> Governmental    |
| <input type="checkbox"/> Sole Proprietorship           | <input type="checkbox"/> Estate or Trust |
| <input type="checkbox"/> Partnership/Legal Corporation | <input type="checkbox"/> Other _____     |
| <input type="checkbox"/> Tax-exempt                    |  |

**RETURN WITH BID**

**PART VI  
Information Regarding Terminations,  
Litigation, Suspension and Debarment**

1. During the last five (5) years, has the Bidder had a contract for services terminated for any reason? \_\_\_\_\_ If so, provide full details related to the termination. \_\_\_\_\_

\_\_\_\_\_  
\_\_\_\_\_  
\_\_\_\_\_

2. During the last (5) years, describe any damages or penalties or anything of value traded or given up by the Bidder under any of its existing or past contracts as it relates to services performed that are similar to the services contemplated by this invitation and the contemplated Contract. If so, indicate the reason for the penalty or exchange of property or services and the estimated amount of the cost of that incident to the Bidder. \_\_\_\_\_

\_\_\_\_\_  
\_\_\_\_\_  
\_\_\_\_\_

3. During the last five (5) years, describe any order, judgment or decree of any Federal or State authority barring, suspending or otherwise limiting the right of the Bidder to engage in any business, practice or activity. \_\_\_\_\_

\_\_\_\_\_  
\_\_\_\_\_  
\_\_\_\_\_

4. During the last five (5) years, list and summarize pending or threatened litigation, administrative or regulatory proceedings, or similar matters that could affect the ability of the Bidder to perform the required services. The Bidder must also state whether it or any owners, officers, or primary partners have ever been convicted of a felony. Failure to disclose these matters may result in rejection of the bid or in termination of any subsequent contract. This is a continuing disclosure requirement. Any such matter commencing after submission of a bid, and with respect to the successful Bidder after the execution of a contract, must be disclosed in a timely manner in a written statement to the Department. \_\_\_\_\_

\_\_\_\_\_  
\_\_\_\_\_  
\_\_\_\_\_

5. During the last five (5) years, have any irregularities been discovered in any of the accounts maintained by the Bidder on behalf of others? \_\_\_\_\_  
If so, describe the circumstances of irregularities or variances and disposition of resolving the irregularities or variances. \_\_\_\_\_

\_\_\_\_\_  
\_\_\_\_\_  
\_\_\_\_\_

## RETURN WITH BID

### IV. DISCLOSURES

- A. The disclosures hereinafter made by the bidder are each a material representation of fact upon which reliance is placed should the Department enter into the contract with the bidder. The bidder further certifies that the Department has received the disclosure forms for each bid.

The CPO may void the bid, or contract, respectively, if it is later determined that the bidder or subcontractor rendered a false or erroneous disclosure. A contractor or subcontractor may be suspended or debarred for violations of the Code. Furthermore, the CPO may void the contract and the surety providing the performance bond shall be responsible for completion of the contract.

### B. Financial Interests and Conflicts of Interest

1. Section 50-35 of the Code provides that all bids of more than \$50,000 and all submissions to a vendor portal shall be accompanied by disclosure of the financial interests of the bidder. This disclosed information for the successful bidder, will be maintained as public information subject to release by request pursuant to the Freedom of Information Act, filed with the Procurement Policy Board, and shall be incorporated as a material term of the contract. Furthermore, pursuant to Section 5-5, the Procurement Policy Board may review a proposal, bid, or contract and issue a recommendation to void a contract or reject a proposal or bid based on any violation of the Code or the existence of a conflict of interest as provided in subsections (b) and (d) of Section 50-35.

The financial interests to be disclosed shall include ownership or distributive income share that is in excess of 5%, or an amount greater than 60% of the annual salary of the Governor, of the bidding entity or its parent entity, whichever is less, unless the contractor or bidder is a publicly traded entity subject to Federal 10K reporting, in which case it may submit its 10K disclosure in place of the prescribed disclosure. If a bidder is a privately held entity that is exempt from Federal 10K reporting, but has more than 100 shareholders, it may submit the information that Federal 10K companies are required to report, and list the names of any person or entity holding any ownership share that is in excess of 5%. The disclosure shall include the names, addresses, and dollar or proportionate share of ownership of each individual making the disclosure, their instrument of ownership or beneficial relationship, and notice of any potential conflict of interest resulting from the current ownership or beneficial interest of each individual making the disclosure having any of the relationships identified in Section 50-35 and on the disclosure form.

**The current annual salary of the Governor is \$177,412.00**

In addition, all disclosures shall indicate any other current or pending contracts, proposals, leases, or other ongoing procurement relationships the bidding entity has with any other unit of state government and shall clearly identify the unit and the contract, proposal, lease, or other relationship.

2. Disclosure Forms. Disclosure Form A is attached for use concerning the individuals meeting the above ownership or distributive share requirements. A separate Disclosure Form A must be submitted with the bid for each individual meeting the above requirements. In addition, a second form (Disclosure Form B) provides for the disclosure of current or pending procurement relationships with other (non-IDOT) state agencies and a total ownership certification. **The forms must be included with each bid.**

### C. Disclosure Form Instructions

#### Form A Instructions for Financial Information & Potential Conflicts of Interest

If the bidder is a publicly traded entity subject to Federal 10K reporting, the 10K Report may be submitted to meet the requirements of Form A. If a bidder is a privately held entity that is exempt from Federal 10K reporting, but has more than 100 shareholders, it may submit the information that Federal 10K companies are required to report, and list the names of any person or entity holding any ownership share that is in excess of 5%. If a bidder is not subject to Federal 10K reporting, the bidder must determine if any individuals are required by law to complete a financial disclosure form. To do this, the bidder should answer each of the following questions. A "YES" answer indicates Form A must be completed. If the answer to each of the following questions is "NO", then the NOT APPLICABLE STATEMENT on Form A must be signed and dated by an individual that is authorized to execute contracts for the bidding company. Note: These questions are for assistance only and are not required to be completed.

1. Does anyone in your organization have a direct or beneficial ownership share of greater than 5% of the bidding entity or parent entity? YES \_\_\_ NO \_\_\_
2. Does anyone in your organization have a direct or beneficial ownership share of less than 5%, but which has a value greater than 60% of the annual salary of the Governor? YES \_\_\_ NO \_\_\_
3. Does anyone in your organization receive more than 60% of the annual salary of the Governor of the bidding entity's or parent entity's distributive income? YES \_\_\_ NO \_\_\_

(Note: Distributive income is, for these purposes, any type of distribution of profits. An annual salary is not distributive income.)

4. Does anyone in your organization receive greater than 5% of the bidding entity's or parent entity's total distributive income, but which is less than 60% of the annual salary of the Governor? YES \_\_\_ NO \_\_\_

(Note: Only one set of forms needs to be completed per individual per bid even if a specific individual would require a yes answer to more than one question.)

A "YES" answer to any of these questions requires the completion of Form A. The bidder must determine each individual in the bidding entity or the bidding entity's parent company that would cause the questions to be answered "Yes". Each form must be signed and dated by an individual that is authorized to execute contracts for your organization. The individual signing can be, but does not have to be, the individual for which the form is being completed. The bidder is responsible for the accuracy of any information provided.

If the answer to each of the above questions is "NO", then the NOT APPLICABLE STATEMENT of Form A must be signed and dated by an individual that is authorized to execute contracts for your company.

## RETURN WITH BID

### **Form B: Instructions for Identifying Other Contracts & Procurement Related Information**

Disclosure Form B must be completed for each bid submitted by the bidding entity. *Note: Checking the NOT APPLICABLE STATEMENT on Form A does not allow the bidder to ignore Form B. Form B must be completed, checked, and dated or the bidder may be considered nonresponsive and the bid will not be accepted.*

The Bidder shall identify, by checking Yes or No on Form B, whether it has any pending contracts (including leases), bids, proposals, or other ongoing procurement relationship with any other (non-IDOT) State of Illinois agency. If "No" is checked, the bidder only needs to complete the check box on the bottom of Form B. If "Yes" is checked, the bidder must do one of the following:

Option I: If the bidder did not submit an Affidavit of Availability to obtain authorization to bid, the bidder must list all non-IDOT State of Illinois agency pending contracts, leases, bids, proposals, and other ongoing procurement relationships. These items may be listed on Form B or on an attached sheet(s). Do not include IDOT contracts. Contracts with cities, counties, villages, etc. are not considered State of Illinois agency contracts and are not to be included. Contracts with other State of Illinois agencies such as the Department of Natural Resources or the Capital Development Board must be included. Bidders who submit Affidavits of Availability are suggested to use Option II.

Option II: If the bidder is required and has submitted an Affidavit of Availability in order to obtain authorization to bid, the bidder may write or type "See Affidavit of Availability" which indicates that the Affidavit of Availability is incorporated by reference and includes all non-IDOT State of Illinois agency pending contracts, leases, bids, proposals, and other ongoing procurement relationships. For any contracts that are not covered by the Affidavit of Availability, the bidder must identify them on Form B or on an attached sheet(s). These might be such things as leases.

**ILLINOIS DEPARTMENT  
OF TRANSPORTATION**

**Form A  
Financial Information &  
Potential Conflicts of Interest  
Disclosure**

Contractor Name		
Legal Address		
City, State, Zip		
Telephone Number	Email Address	Fax Number (if available)

Disclosure of the information contained in this Form is required by Section 50-35 of the Code (30 ILCS 500). Vendors desiring to enter into a contract with the State of Illinois must disclose the financial information and potential conflict of interest information as specified in this Disclosure Form. This information shall become part of the publicly available contract file. This Form A must be completed for bids in excess of \$50,000, and for all open-ended contracts. **A publicly traded company may submit a 10K disclosure (or equivalent if applicable) in satisfaction of the requirements set forth in Form A. See Disclosure Form Instructions.**

*The current annual salary of the Governor is \$177,412.00.*

**DISCLOSURE OF FINANCIAL INFORMATION**

**1. Disclosure of Financial Information.** The individual named below has an interest in the BIDDER (or its parent) in terms of ownership or distributive income share in excess of 5%, or an interest which has a value of more than 60% of the annual salary of the Governor. **(Make copies of this form as necessary and attach a separate Disclosure Form A for each individual meeting these requirements)**

<p><b>FOR INDIVIDUAL (type or print information)</b></p> <p><b>NAME:</b> _____</p> <p><b>ADDRESS</b> _____</p> <p>_____</p> <p><b>Type of ownership/distributable income share:</b></p> <p>stock _____ sole proprietorship _____ Partnership _____ other: (explain on separate sheet): _____</p> <p>% or \$ value of ownership/distributable income share: _____</p>
--

**2. Disclosure of Potential Conflicts of Interest.** Check "Yes" or "No" to indicate which, if any, of the following potential conflict of interest relationships apply. If the answer to any question is "Yes", please attach additional pages and describe.

(a) State employment, currently or in the previous 3 years, including contractual employment of services. Yes \_\_\_ No \_\_\_

If your answer is yes, please answer each of the following questions.

1. Are you currently an officer or employee of either the Capitol Development Board or the Illinois State Toll Highway Authority? Yes \_\_\_ No \_\_\_

2. Are you currently appointed to or employed by any agency of the State of Illinois? If you are currently appointed to or employed by any agency of the State of Illinois, and your annual salary exceeds 60% of the annual salary of the Governor, provide the name the State agency for which you are employed and your annual salary. \_\_\_\_\_

**RETURN WITH BID**

3. If you are currently appointed to or employed by any agency of the State of Illinois, and your annual salary exceeds 60% of the annual salary of the Governor, are you entitled to receive (i) more than 7 1/2% of the total distributable income of your firm, partnership, association or corporation, or (ii) an amount in excess of 100% of the annual salary of the Governor?  
Yes \_\_\_ No \_\_\_

4. If you are currently appointed to or employed by any agency of the State of Illinois, and your annual salary exceeds 60% of the annual salary of the Governor, are you and your spouse or minor children entitled to receive (i) more than 15 % in the aggregate of the total distributable income of your firm, partnership, association or corporation, or (ii) an amount in excess of two times the salary of the Governor?  
Yes \_\_\_ No \_\_\_

---

(b) State employment of spouse, father, mother, son, or daughter, including contractual employment for services in the previous 2 years.  
Yes \_\_\_ No \_\_\_

If your answer is yes, please answer each of the following questions.

1. Is your spouse or any minor children currently an officer or employee of the Capitol Development Board or the Illinois State Toll Highway Authority?  
Yes \_\_\_ No \_\_\_

2. Is your spouse or any minor children currently appointed to or employed by any agency of the State of Illinois? If your spouse or minor children is/are currently appointed to or employed by any agency of the State of Illinois, and his/her annual salary exceeds 60% of the annual salary of the Governor, provide the name of your spouse and/or minor children, the name of the State agency for which he/she is employed and his/her annual salary. \_\_\_\_\_  
\_\_\_\_\_

3. If your spouse or any minor children is/are currently appointed to or employed by any agency of the State of Illinois, and his/her annual salary exceeds 60% of the annual salary of the Governor, are you entitled to receive (i) more than 7 1/2% of the total distributable income of your firm, partnership, association or corporation, or (ii) an amount in excess of 100% of the annual salary of the Governor?  
Yes \_\_\_ No \_\_\_

4. If your spouse or any minor children are currently appointed to or employed by any agency of the State of Illinois, and his/her annual salary exceeds 60% of the annual salary of the Governor, are you and your spouse or minor children entitled to receive (i) more than 15 % in the aggregate of the total distributable income of your firm, partnership, association or corporation, or (ii) an amount in excess of two times the salary of the Governor?  
Yes \_\_\_ No \_\_\_

---

(c) Elective status; the holding of elective office of the State of Illinois, the government of the United States, any unit of local government authorized by the Constitution of the State of Illinois or the statutes of the State of Illinois currently or in the previous 3 years.  
Yes \_\_\_ No \_\_\_

---

(d) Relationship to anyone holding elective office currently or in the previous 2 years; spouse, father, mother, son, or daughter.  
Yes \_\_\_ No \_\_\_

---

(e) Appointive office; the holding of any appointive government office of the State of Illinois, the United States of America, or any unit of local government authorized by the Constitution of the State of Illinois or the statutes of the State of Illinois, which office entitles the holder to compensation in excess of the expenses incurred in the discharge of that office currently or in the previous 3 years.  
Yes \_\_\_ No \_\_\_

---

(f) Relationship to anyone holding appointive office currently or in the previous 2 years; spouse, father, mother, son, or daughter.  
Yes \_\_\_ No \_\_\_

---

(g) Employment, currently or in the previous 3 years, as or by any registered lobbyist of the State government.  
Yes \_\_\_ No \_\_\_

---

**RETURN WITH BID**

- (h) Relationship to anyone who is or was a registered lobbyist in the previous 2 years; spouse, father, mother, son, or daughter. Yes \_\_\_ No \_\_\_

---
- (i) Compensated employment, currently or in the previous 3 years, by any registered election or reelection committee registered with the Secretary of State or any county clerk of the State of Illinois, or any political action committee registered with either the Secretary of State or the Federal Board of Elections. Yes \_\_\_ No \_\_\_

---
- (j) Relationship to anyone; spouse, father, mother, son, or daughter; who was a compensated employee in the last 2 years by any registered election or re-election committee registered with the Secretary of State or any county clerk of the State of Illinois, or any political action committee registered with either the Secretary of State or the Federal Board of Elections. Yes \_\_\_ No \_\_\_

---

**3. Communication Disclosure.**

Disclose the name and address of each lobbyist and other agent of the bidder or offeror who is not identified in Section 2 of this form, who is has communicated, is communicating, or may communicate with any State officer or employee concerning the bid or offer. This disclosure is a continuing obligation and must be promptly supplemented for accuracy throughout the process and throughout the term of the contract. If no person is identified, enter "None" on the line below:

Name and address of person(s): \_\_\_\_\_  
\_\_\_\_\_  
\_\_\_\_\_  
\_\_\_\_\_

**RETURN WITH BID**

**4. Suspension or Debarment Disclosure.** For each of the persons identified under Sections 2 and 3 of this form, disclose whether any of the following has occurred within the previous 10 years: suspension or debarment from contracting with any governmental entity; professional licensure discipline; bankruptcies; adverse civil judgments and administrative findings; and criminal felony convictions. This disclosure is a continuing obligation and must be promptly supplemented for accuracy throughout the procurement process and term of the contract. If no person is identified, enter "None" on the line below:

Name of person(s): \_\_\_\_\_

Nature of disclosure: \_\_\_\_\_

\_\_\_\_\_  
\_\_\_\_\_

**APPLICABLE STATEMENT**

**This Disclosure Form A is submitted on behalf of the INDIVIDUAL named on previous page. Under penalty of perjury, I certify the contents of this disclosure to be true and accurate to the best of my knowledge.**

Completed by:  \_\_\_\_\_ Date \_\_\_\_\_  
Signature of Individual or Authorized Representative

**NOT APPLICABLE STATEMENT**

**Under penalty of perjury, I have determined that no individuals associated with this organization meet the criteria that would require the completion of this Form A.**

**This Disclosure Form A is submitted on behalf of the CONTRACTOR listed on the previous page.**

\_\_\_\_\_ Date \_\_\_\_\_  
Signature of Authorized Representative

**The bidder has a continuing obligation to supplement these disclosures under Sec. 50-35 of the Code.**



RETURN WITH BID

ILLINOIS DEPARTMENT OF TRANSPORTATION

Form B Other Contracts & Financial Related Information Disclosure

Contractor Name, Legal Address, City, State, Zip, Telephone Number, Email Address, Fax Number (if available)

Disclosure of the information contained in this Form is required by Section 50-35 of the Code (30 ILCS 500). This information shall become part of the publicly available contract file. This Form B must be completed for all bids.

DISCLOSURE OF OTHER CONTRACTS AND PROCUREMENT RELATED INFORMATION

1. Identifying Other Contracts & Procurement Related Information. The BIDDER shall identify whether it has any pending contracts (including leases), bids, proposals, or other ongoing procurement relationship with any other State of Illinois agency: Yes \_\_\_ No \_\_\_

If "No" is checked, the bidder only needs to complete the signature box on this page.

2. If "Yes" is checked. Identify each such relationship by showing State of Illinois agency name and other descriptive information such as bid or project number (attach additional pages as necessary). SEE DISCLOSURE FORM INSTRUCTIONS:

THE FOLLOWING STATEMENT MUST BE CHECKED

Signature of Authorized Representative, Date

OWNERSHIP CERTIFICATION

Please certify that the following statement is true if the individuals for all submitted Form A disclosures do not total 100% of ownership.

Any remaining ownership interest is held by individuals receiving less than \$106,447.20 of the bidding entity's or parent entity's distributive income or holding less than a 5% ownership interest.

Yes No N/A (Form A disclosure(s) established 100% ownership)

## **RETURN WITH BID**

### **SPECIAL NOTICE TO CONTRACTORS**

The following requirements of the Illinois Department of Human Rights Act are applicable to bidders on all construction contracts advertised by the Illinois Department of Transportation:

#### **CONSTRUCTION EMPLOYEE UTILIZATION PROJECTION**

- (a) All bidders on construction contracts shall complete and submit, along with and as part of their bids, a Bidder's Employee Utilization Form (Form BC-1256) setting forth a projection and breakdown of the total workforce intended to be hired and/or allocated to such contract work by the bidder including a projection of minority and female employee utilization in all job classifications on the contract project.
- (b) The Department of Transportation shall review the Employee Utilization Form, and workforce projections contained therein, of the contract awardee to determine if such projections reflect an underutilization of minority persons and/or women in any job classification in accordance with the Equal Employment Opportunity Clause and Title 44, Illinois Administrative Code, Section 750.120. If it is determined that the contract awardee's projections reflect an underutilization of minority persons and/or women in any job classification, it shall be advised in writing of the manner in which it is underutilizing and such awardee shall be considered to be in breach of the contract unless, prior to commencement of work on the contract project, it submits revised satisfactory projections or an acceptable written affirmative action plan to correct such underutilization including a specific timetable geared to the completion stages of the contract.
- (c) The Department of Transportation shall provide to the Department of Human Rights a copy of the contract awardee's Employee Utilization Form, a copy of any required written affirmative action plan, and any written correspondence related thereto. The Department of Human Rights may review and revise any action taken by the Department of Transportation with respect to these requirements.



**RETURN WITH BID**

**Contract No. 64L61  
Various Counties  
Section D2 BC 2017-2  
Various Routes  
District 2 Construction Funds**

**PART II. WORKFORCE PROJECTION - continued**

- B. Included in "Total Employees" under Table A is the total number of **new hires** that would be employed in the event the undersigned bidder is awarded this contract.

The undersigned bidder projects that: (number) \_\_\_\_\_ new hires would be recruited from the area in which the contract project is located; and/or (number) \_\_\_\_\_ new hires would be recruited from the area in which the bidder's principal office or base of operation is located.

- C. Included in "Total Employees" under Table A is a projection of numbers of persons to be employed directly by the undersigned bidder as well as a projection of numbers of persons to be employed by subcontractors.

The undersigned bidder estimates that (number) \_\_\_\_\_ persons will be directly employed by the prime contractor and that (number) \_\_\_\_\_ persons will be employed by subcontractors.

**PART III. AFFIRMATIVE ACTION PLAN**

- A. The undersigned bidder understands and agrees that in the event the foregoing minority and female employee utilization projection included under **PART II** is determined to be an underutilization of minority persons or women in any job category, and in the event that the undersigned bidder is awarded this contract, he/she will, prior to commencement of work, develop and submit a written Affirmative Action Plan including a specific timetable (geared to the completion stages of the contract) whereby deficiencies in minority and/or female employee utilization are corrected. Such Affirmative Action Plan will be subject to approval by the contracting agency and the **Illinois Department of Human Rights**.

- B. The undersigned bidder understands and agrees that the minority and female employee utilization projection submitted herein, and the goals and timetable included under an Affirmative Action Plan if required, are deemed to be part of the contract specifications.

Company \_\_\_\_\_  
\_\_\_\_\_

Telephone Number \_\_\_\_\_

Address \_\_\_\_\_  
\_\_\_\_\_

**NOTICE REGARDING SIGNATURE**

The Bidder's signature on the Proposal Signature Sheet will constitute the signing of this form. The following signature block needs to be completed if revisions are required.

Signature:  \_\_\_\_\_ Title: \_\_\_\_\_ Date: \_\_\_\_\_

Instructions: All tables must include subcontractor personnel in addition to prime contractor personnel.

Table A - Include both the number of employees that would be hired to perform the contract work and the total number currently employed (Table B) that will be allocated to contract work, and include all apprentices and on-the-job trainees. The "Total Employees" column should include all employees including all minorities, apprentices and on-the-job trainees to be employed on the contract work.

Table B - Include all employees currently employed that will be allocated to the contract work including any apprentices and on-the-job trainees currently employed.

Table C - Indicate the racial breakdown of the total apprentices and on-the-job trainees shown in Table A.

**RETURN WITH BID**  
**Contract No. 64L61**  
**Various Counties**  
**Section D2 BC 2017-2**  
**Various Routes**  
**District 2 Construction Funds**

PROPOSAL SIGNATURE SHEET

The undersigned bidder hereby makes and submits this bid on the subject Proposal, thereby assuring the Department that all requirements of the Invitation for Bids and rules of the Department have been met, that there is no misunderstanding of the requirements of paragraph 3 of this Proposal, and that the contract will be executed in accordance with the rules of the Department if an award is made on this bid.

(IF AN INDIVIDUAL)

Firm Name \_\_\_\_\_

Signature of Owner \_\_\_\_\_

Business Address \_\_\_\_\_

\_\_\_\_\_

---

---

(IF A CO-PARTNERSHIP)

Firm Name \_\_\_\_\_

By \_\_\_\_\_

Business Address \_\_\_\_\_

\_\_\_\_\_

Name and Address of All Members of the Firm:

\_\_\_\_\_

\_\_\_\_\_

---

---

(IF A CORPORATION)

Corporate Name \_\_\_\_\_

By \_\_\_\_\_

Signature of Authorized Representative

\_\_\_\_\_

Typed or printed name and title of Authorized Representative

Attest \_\_\_\_\_

Signature

(IF A JOINT VENTURE, USE THIS SECTION FOR THE MANAGING PARTY AND THE SECOND PARTY SHOULD SIGN BELOW)

Business Address \_\_\_\_\_

\_\_\_\_\_

---

---

(IF A JOINT VENTURE)

Corporate Name \_\_\_\_\_

By \_\_\_\_\_

Signature of Authorized Representative

\_\_\_\_\_

Typed or printed name and title of Authorized Representative

Attest \_\_\_\_\_

Signature

Business Address \_\_\_\_\_

\_\_\_\_\_

---

---

If more than two parties are in the joint venture, please attach an additional signature sheet.

---

---



This Annual Proposal Bid Bond shall become effective at 12:01 AM (CDST) on \_\_\_\_\_ and shall be valid until \_\_\_\_\_ 11:59 PM (CDST).

KNOW ALL PERSONS BY THESE PRESENTS, That We \_\_\_\_\_

as PRINCIPAL, and \_\_\_\_\_

as SURETY, and held jointly, severally and firmly bound unto the STATE OF ILLINOIS in the penal sum of 5 percent of the total bid price, or for the amount specified in the bid proposal under "Proposal Guaranty" in effect on the date of the Invitation for Bids, whichever is the lesser sum, well and truly to be paid unto said STATE OF ILLINOIS, for the payment of which we bind ourselves, our heirs, executors, administrators, successors and assigns.

THE CONDITION OF THE FOREGOING OBLIGATION IS SUCH that whereas, the PRINCIPAL may submit bid proposal(s) to the STATE OF ILLINOIS, acting through the Department of Transportation, for various improvements published in the Transportation Bulletin during the effective term indicated above.

NOW, THEREFORE, if the Department shall accept the bid proposal(s) of the PRINCIPAL; and if the PRINCIPAL shall, within the time and as specified in the bidding and contract documents; and if, after award by the Department, the PRINCIPAL shall enter into a contract in accordance with the terms of the bidding and contract documents including evidence of the required insurance coverages and providing such bond as specified with good and sufficient surety for the faithful performance of such contract and for the prompt payment of labor and material furnished in the prosecution thereof; or if, in the event of the failure of the PRINCIPAL to enter into such contract and to give the specified bond, the PRINCIPAL pays to the Department the difference not to exceed the penalty hereof between the amount specified in the bid proposal and such larger amount for which the Department may contract with another party to perform the work covered by said bid proposal, then this obligation shall be null and void, otherwise, it shall remain in full force and effect.

IN THE EVENT the Department determines the PRINCIPAL has failed to comply with any requirement as set forth in the preceding paragraph, then Surety shall pay the penal sum to the Department within fifteen (15) days of written demand therefor. If Surety does not make full payment within such period of time, the Department may bring an action to collect the amount owed. Surety is liable to the Department for all its expenses, including attorney's fees, incurred in any litigation in which it prevails either in whole or in part.

In TESTIMONY WHEREOF, the said PRINCIPAL has caused this instrument to be signed by its officer \_\_\_\_\_ day of \_\_\_\_\_ A.D., \_\_\_\_\_.

In TESTIMONY WHEREOF, the said SURETY has caused this instrument to be signed by its officer \_\_\_\_\_ day of \_\_\_\_\_ A.D., \_\_\_\_\_.

\_\_\_\_\_  
(Company Name)

\_\_\_\_\_  
(Company Name)

By \_\_\_\_\_  
(Signature and Title)

By \_\_\_\_\_  
(Signature of Attorney-in-Fact)

**Notary for PRINCIPAL**

**Notary for SURETY**

STATE OF \_\_\_\_\_  
COUNTY OF \_\_\_\_\_

STATE OF \_\_\_\_\_  
COUNTY OF \_\_\_\_\_

Signed and attested before me on \_\_\_\_\_ (date)

Signed and attested before me on \_\_\_\_\_ (date)

by \_\_\_\_\_  
(Name of Notary Public)

by \_\_\_\_\_  
(Name of Notary Public)

(Seal) \_\_\_\_\_  
(Signature of Notary Public)

(Seal) \_\_\_\_\_  
(Signature of Notary Public)

\_\_\_\_\_  
(Date Commission Expires)

\_\_\_\_\_  
(Date Commission Expires)

In lieu of completing the above section of the Annual Proposal Bid Bond form, the Principal may file an Electronic Bid Bond. By signing the proposal(s) the Principal is ensuring the identified electronic bid bond has been executed and the Principal and Surety are firmly bound unto the State of Illinois under the conditions of the bid bond as shown above.

---

Electronic Bid Bond ID #	Company/Bidder Name	Signature and Title
--------------------------	---------------------	---------------------

This bond may be terminated, at Surety's request, upon giving not less than thirty (30) days prior written notice of the cancellation/termination of the bond. Said written notice shall be issued to the Illinois Department of Transportation, Chief Contracts Official, 2300 South Dirksen Parkway, Springfield, Illinois, 62764, and shall be served in person, by receipted courier delivery or certified or registered mail, return receipt requested. Said notice period shall commence on the first calendar day following the Department's receipt of written cancellation/termination notice. Surety shall remain firmly bound to all obligations herein for proposals submitted prior to the cancellation/termination. Surety shall be released and discharged from any obligation(s) for proposals submitted for any letting or date after the effective date of cancellation/termination.



**Illinois Department  
of Transportation**

**Return with Bid**

**Division of Highways  
Annual Proposal Bid Bond**

This Annual Proposal Bid Bond shall become effective at 12:01 AM (CDST) on \_\_\_\_\_ and shall be valid until \_\_\_\_\_ 11:59 PM (CDST).

KNOW ALL PERSONS BY THESE PRESENTS, That We \_\_\_\_\_

as PRINCIPAL, and \_\_\_\_\_

as SURETY, and held jointly, severally and firmly bound unto the STATE OF ILLINOIS in the penal sum of 5 percent of the total bid price, or for the amount specified in the bid proposal under "Proposal Guaranty" in effect on the date of the Invitation for Bids, whichever is the lesser sum, well and truly to be paid unto said STATE OF ILLINOIS, for the payment of which we bind ourselves, our heirs, executors, administrators, successors and assigns.

THE CONDITION OF THE FOREGOING OBLIGATION IS SUCH that whereas, the PRINCIPAL may submit bid proposal(s) to the STATE OF ILLINOIS, acting through the Department of Transportation, for various improvements published in the Transportation Bulletin during the effective term indicated above.

NOW, THEREFORE, if the Department shall accept the bid proposal(s) of the PRINCIPAL; and if the PRINCIPAL shall, within the time and as specified in the bidding and contract documents; and if, after award by the Department, the PRINCIPAL shall enter into a contract in accordance with the terms of the bidding and contract documents including evidence of the required insurance coverages and providing such bond as specified with good and sufficient surety for the faithful performance of such contract and for the prompt payment of labor and material furnished in the prosecution thereof; or if, in the event of the failure of the PRINCIPAL to enter into such contract and to give the specified bond, the PRINCIPAL pays to the Department the difference not to exceed the penalty hereof between the amount specified in the bid proposal and such larger amount for which the Department may contract with another party to perform the work covered by said bid proposal, then this obligation shall be null and void, otherwise, it shall remain in full force and effect.

IN THE EVENT the Department determines the PRINCIPAL has failed to comply with any requirement as set forth in the preceding paragraph, then Surety shall pay the penal sum to the Department within fifteen (15) days of written demand therefor. If Surety does not make full payment within such period of time, the Department may bring an action to collect the amount owed. Surety is liable to the Department for all its expenses, including attorney fees, incurred in any litigation in which it prevails either in whole or in part.

In TESTIMONY WHEREOF, the said PRINCIPAL has caused this instrument to be signed by its officer \_\_\_\_\_ day of \_\_\_\_\_ A.D., \_\_\_\_\_

In TESTIMONY WHEREOF, the said SURETY has caused this instrument to be signed by its officer \_\_\_\_\_ day of \_\_\_\_\_ A.D., \_\_\_\_\_

(Company Name)

(Company Name)

By \_\_\_\_\_  
(Signature and Title)

By \_\_\_\_\_  
(Signature of Attorney-in-Fact)

**Notary for PRINCIPAL**

**Notary for SURETY**

STATE OF \_\_\_\_\_  
COUNTY OF \_\_\_\_\_

STATE OF \_\_\_\_\_  
COUNTY OF \_\_\_\_\_

Signed and attested before me on \_\_\_\_\_ (date)

Signed and attested before me on \_\_\_\_\_ (date)

by \_\_\_\_\_  
(Name of Notary Public)

by \_\_\_\_\_  
(Name of Notary Public)

(Seal) \_\_\_\_\_  
(Signature of Notary Public)

(Seal) \_\_\_\_\_  
(Signature of Notary Public)

(Date Commission Expires)

(Date Commission Expires)

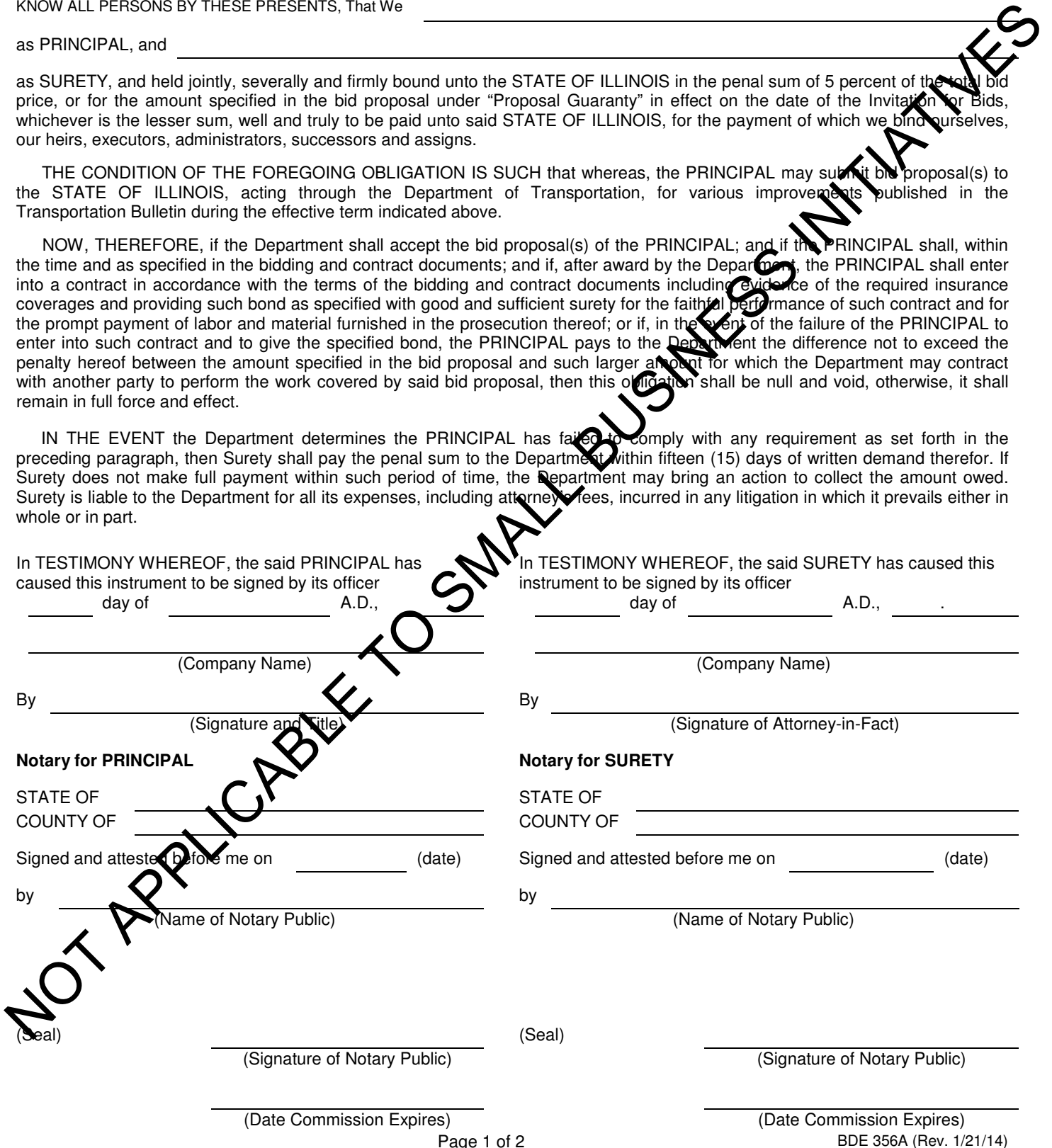



In lieu of completing the above section of the Annual Proposal Bid Bond form, the Principal may file an Electronic Bid Bond. By signing the proposal(s) the Principal is ensuring the identified electronic bid bond has been executed and the Principal and Surety are firmly bound unto the State of Illinois under the conditions of the bid bond as shown above.

---

Electronic Bid Bond ID #	Company/Bidder Name	Signature and Title
--------------------------	---------------------	---------------------

This bond may be terminated, at Surety's request, upon giving not less than thirty (30) days prior written notice of the cancellation/termination of the bond. Said written notice shall be issued to the Illinois Department of Transportation, Chief Contracts Official, 2300 South Dirksen Parkway, Springfield, Illinois, 62764, and shall be served in person, by receipted courier delivery or certified or registered mail, return receipt requested. Said notice period shall commence on the first calendar day following the Department's receipt of written cancellation/termination notice. Surety shall remain firmly bound to all obligations herein for proposals submitted prior to the cancellation/termination. Surety shall be released and discharged from any obligation(s) for proposals submitted for any letting or date after the effective date of cancellation/termination.

**NOT APPLICABLE TO SMALL BUSINESS INITIATIVES**



**Illinois Department  
of Transportation**

**Return with Bid**

**Division of Highways  
Proposal Bid Bond**

Item No. \_\_\_\_\_

Letting Date \_\_\_\_\_

KNOW ALL PERSONS BY THESE PRESENTS, That We \_\_\_\_\_

as PRINCIPAL, and \_\_\_\_\_

as SURETY, and held jointly, severally and firmly bound unto the STATE OF ILLINOIS in the penal sum of 5 percent of the total bid price, or for the amount specified in the bid proposal under "Proposal Guaranty" in effect on the date of the Invitation for Bids, whichever is the lesser sum, well and truly to be paid unto said STATE OF ILLINOIS, for the payment of which we bind ourselves, our heirs, executors, administrators, successors and assigns.

THE CONDITION OF THE FOREGOING OBLIGATION IS SUCH that whereas, the PRINCIPAL has submitted a bid proposal to the STATE OF ILLINOIS, acting through the Department of Transportation, for the improvement designated by the Transportation Bulletin Item Number and Letting Date indicated above.

NOW, THEREFORE, if the Department shall accept the bid proposal of the PRINCIPAL; and if the PRINCIPAL shall, within the time and as specified in the bidding and contract documents; and if, after award by the Department, the PRINCIPAL shall enter into a contract in accordance with the terms of the bidding and contract documents including evidence of the required insurance coverages and providing such bond as specified with good and sufficient surety for the faithful performance of such contract and for the prompt payment of labor and material furnished in the prosecution thereof; or if, in the event of the failure of the PRINCIPAL to enter into such contract and to give the specified bond, the PRINCIPAL pays to the Department the difference not to exceed the penalty hereof between the amount specified in the bid proposal and such larger amount for which the Department may contract with another party to perform the work covered by said bid proposal, then this obligation shall be null and void, otherwise, it shall remain in full force and effect.

IN THE EVENT the Department determines the PRINCIPAL has failed to comply with any requirement as set forth in the preceding paragraph, then Surety shall pay the penal sum to the Department within fifteen (15) days of written demand therefor. If Surety does not make full payment within such period of time, the Department may bring an action to collect the amount owed. Surety is liable to the Department for all its expenses, including attorney's fees, incurred in any litigation in which it prevails either in whole or in part.

In TESTIMONY WHEREOF, the said PRINCIPAL has caused this instrument to be signed by its officer \_\_\_\_\_ day of \_\_\_\_\_ A.D., \_\_\_\_\_

In TESTIMONY WHEREOF, the said SURETY has caused this instrument to be signed by its officer \_\_\_\_\_ day of \_\_\_\_\_ A.D., \_\_\_\_\_

\_\_\_\_\_  
(Company Name)

\_\_\_\_\_  
(Company Name)

By \_\_\_\_\_  
(Signature and Title)

By \_\_\_\_\_  
(Signature of Attorney-in-Fact)

**Notary for PRINCIPAL**

**Notary for SURETY**

STATE OF \_\_\_\_\_  
COUNTY OF \_\_\_\_\_

STATE OF \_\_\_\_\_  
COUNTY OF \_\_\_\_\_

Signed and attested before me on \_\_\_\_\_ (date)  
by \_\_\_\_\_

Signed and attested before me on \_\_\_\_\_ (date)  
by \_\_\_\_\_

(Name of Notary Public)

(Name of Notary Public)

(Seal) \_\_\_\_\_  
(Signature of Notary Public)

(Seal) \_\_\_\_\_  
(Signature of Notary Public)

\_\_\_\_\_  
(Date Commission Expires)

\_\_\_\_\_  
(Date Commission Expires)

In lieu of completing the above section of the Proposal Bid Bond form, the Principal may file an Electronic Bid Bond. By signing the proposal the Principal is ensuring the identified electronic bid bond has been executed and the Principal and Surety are firmly bound unto the State of Illinois under the conditions of the bid bond as shown above.

\_\_\_\_\_  
Electronic Bid Bond ID #                      Company/Bidder Name                      Signature and Title

# PROPOSAL ENVELOPE



## PROPOSALS

for construction work advertised for bids by the  
Illinois Department of Transportation

Item No.	Item No.	Item No.

Submitted By:

Name:
Address:
Phone No.

Bidders should use an IDOT proposal envelope or affix this form to the front of a 10" x 13" envelope for the submittal of bids. If proposals are mailed, they should be enclosed in a second or outer envelope addressed to:

Engineer of Design and Environment - Room 326  
Illinois Department of Transportation  
2300 South Dirksen Parkway  
Springfield, Illinois 62764

### **NOTICE**

**Individual bids, including Bid Bond and/or supplemental information if required, should be securely stapled.**

# CONTRACTOR OFFICE COPY OF CONTRACT SPECIFICATIONS

---

## NOTICE

None of the following material needs to be returned with the bid package unless the special provisions require documentation and/or other information to be submitted.

**Contract No. 64L61  
Various Counties  
Section D2 BC 2017-2  
Various Routes  
District 2 Construction Funds**

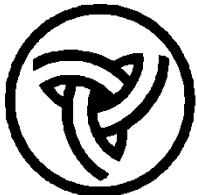

**Illinois Department of Transportation**

## **SUBCONTRACTOR DOCUMENTATION**

Public Acts 96-0795, 96-0920, and 97-0895 enacted substantial changes to the provisions of the Code (30 ILCS 500). Among the changes are provisions affecting subcontractors. The Contractor awarded this contract will be required as a material condition of the contract to implement and enforce the contract requirements applicable to subcontractors that entered into a contractual agreement with a total value of \$50,000 or more with a person or entity who has a contract subject to the Code and approved in accordance with article 108.01 of the Standard Specifications for Road and Bridge Construction.

If the Contractor seeks approval of subcontractors to perform a portion of the work, and approval is granted by the Department, the Contractor shall provide a copy of the subcontract to the Illinois Department of Transportation's CPO upon request within 15 calendar days after execution of the subcontract.

Financial disclosures required pursuant to Sec. 50-35 of the Code must be submitted for all applicable subcontractors. The subcontract shall contain the certifications required to be made by subcontractors pursuant to Article 50 of the Code. This Notice to Bidders includes a document incorporating all required subcontractor certifications and disclosures for use by the Contractor in compliance with this mandate. The document is entitled State Required Ethical Standards Governing Subcontractors.

## RETURN WITH SUBCONTRACT

### STATE ETHICAL STANDARDS GOVERNING SUBCONTRACTORS

Article 50 of the Code establishes the duty of all State CPOs, SPOs, and their designees to maximize the value of the expenditure of public moneys in procuring goods, services, and contracts for the State of Illinois and to act in a manner that maintains the integrity and public trust of State government. In discharging this duty, they are charged by law to use all available information, reasonable efforts, and reasonable actions to protect, safeguard, and maintain the procurement process of the State of Illinois.

The certifications hereinafter made by the subcontractor are each a material representation of fact upon which reliance is placed should the Department approve the subcontractor. The CPO may terminate or void the contract approval if it is later determined that the bidder or subcontractor rendered a false or erroneous certification. If a false certification is made by a subcontractor the contractor's submitted bid and the executed contract may not be declared void unless the contractor refuses to terminate the subcontract upon the State's request after a finding that the subcontractor's certification was false.

Section 50-2 of the Code provides that every person that has entered into a multi-year contract and every subcontractor with a multi-year subcontract shall certify, by July 1 of each fiscal year covered by the contract after the initial fiscal year, to the responsible CPO whether it continues to satisfy the requirements of Article 50 pertaining to the eligibility for a contract award. If a contractor or subcontractor is not able to truthfully certify that it continues to meet all requirements, it shall provide with its certification a detailed explanation of the circumstances leading to the change in certification status. A contractor or subcontractor that makes a false statement material to any given certification required under Article 50 is, in addition to any other penalties or consequences prescribed by law, subject to liability under the Whistleblower Reward and Protection Act for submission of a false claim.

#### **A. Bribery**

Section 50-5. Bribery.

(a) Prohibition. No person or business shall be awarded a contract or subcontract under this Code who:

(1) has been convicted under the laws of Illinois or any other state of bribery or attempting to bribe an officer or employee of the State of Illinois or any other state in that officer's or employee's official capacity; or

(2) has made an admission of guilt of that conduct that is a matter of record but has not been prosecuted for that conduct.

(b) Businesses. No business shall be barred from contracting with any unit of State or local government, or subcontracting under such a contract, as a result of a conviction under this Section of any employee or agent of the business if the employee or agent is no longer employed by the business and:

(1) the business has been finally adjudicated not guilty; or

(2) the business demonstrates to the governmental entity with which it seeks to contract, or which is signatory to the contract to which the subcontract relates, and that entity finds that the commission of the offense was not authorized, requested, commanded, or performed by a director, officer, or high managerial agent on behalf of the business as provided in paragraph (2) of subsection (a) of Section 5-4 of the Criminal Code of 2012.

(c) Conduct on behalf of business. For purposes of this Section, when an official, agent, or employee of a business committed the bribery or attempted bribery on behalf of the business and in accordance with the direction or authorization of a responsible official of the business, the business shall be chargeable with the conduct.

(d) Certification. Every bid submitted to and contract executed by the State, and every subcontract subject to Section 20-120 of the Code shall contain a certification by the contractor or the subcontractor, respectively, that the contractor or subcontractor is not barred from being awarded a contract or subcontract under this Section and acknowledges that the CPO may declare the related contract void if any certifications required by this Section are false. A contractor who makes a false statement, material to the certification, commits a Class 3 felony.

The contractor or subcontractor certifies that it is not barred from being awarded a contract under Section 50-5.

#### **B. Felons**

Section 50-10. Felons.

Unless otherwise provided, no person or business convicted of a felony shall do business with the State of Illinois or any State agency, or enter into a subcontract, from the date of conviction until 5 years after the date of completion of the sentence for that felony, unless no person held responsible by a prosecutorial office for the facts upon which the conviction was based continues to have any involvement with the business.

Certification. Every bid submitted to and contract executed by the State and every subcontract subject to Section 20-120 of the Code shall contain a certification by the bidder or contractor or subcontractor, respectively, that the bidder, contractor, or subcontractor is not barred from being awarded a contract or subcontract under this Section and acknowledges that the CPO may declare the related contract void if any of the certifications required by this Section are false.

## RETURN WITH SUBCONTRACT

### **C. Debt Delinquency**

Section 50-11 and 50-12. Debt Delinquency.

The contractor or bidder or subcontractor, respectively, certifies that it, or any affiliate, is not barred from being awarded a contract or subcontract under the Code. Section 50-11 prohibits a person from entering into a contract with a State agency, or entering into a subcontract, if it knows or should know that it, or any affiliate, is delinquent in the payment of any debt to the State as defined by the Debt Collection Board. Section 50-12 prohibits a person from entering into a contract with a State agency, or entering into a subcontract, if it, or any affiliate, has failed to collect and remit Illinois Use Tax on all sales of tangible personal property into the State of Illinois in accordance with the provisions of the Illinois Use Tax Act. The bidder or contractor or subcontractor, respectively, further acknowledges that the CPO may declare the related contract void if this certification is false or if the bidder, contractor, or subcontractor, or any affiliate, is determined to be delinquent in the payment of any debt to the State during the term of the contract.

### **D. Prohibited Bidders, Contractors and Subcontractors**

Section 50-10.5 and 50-60(c). Prohibited bidders, contractors and subcontractors.

The bidder or contractor or subcontractor, respectively, certifies in accordance with 30 ILCS 500/50-10.5 that no officer, director, partner or other managerial agent of the contracting business has been convicted of a felony under the Sarbanes-Oxley Act of 2002 or a Class 3 or Class 2 felony under the Illinois Securities Law of 1953 or if in violation of Subsection (c) for a period of five years from the date of conviction. Every bid submitted to and contract executed by the State and every subcontract subject to Section 20-120 of the Code shall contain a certification by the bidder, contractor, or subcontractor, respectively, that the bidder, contractor, or subcontractor is not barred from being awarded a contract or subcontract under this Section and acknowledges that the CPO shall declare the related contract void if any of the certifications completed pursuant to this Section are false.

### **E. Section 42 of the Environmental Protection Act**

The bidder or contractor or subcontractor, respectively, certifies in accordance with 30 ILCS 500/50-14 that the bidder, contractor, or subcontractor, is not barred from being awarded a contract or entering into a subcontract under this Section which prohibits the bidding on or entering into contracts with the State of Illinois or a State agency, or entering into any subcontract, that is subject to the Code by a person or business found by a court or the Pollution Control Board to have committed a willful or knowing violation of Section 42 of the Environmental Protection Act for a period of five years from the date of the order. The bidder or contractor or subcontractor, respectively, acknowledges that the CPO may declare the contract void if this certification is false.

**The undersigned, on behalf of the subcontracting company, has read and understands the above certifications and makes the certifications as required by law.**

\_\_\_\_\_  
Name of Subcontracting Company

\_\_\_\_\_  
Authorized Officer

\_\_\_\_\_  
Date

**RETURN WITH SUBCONTRACT**  
**SUBCONTRACTOR DISCLOSURES**

**I. DISCLOSURES**

**A.** The disclosures hereinafter made by the subcontractor are each a material representation of fact upon which reliance is placed. The subcontractor further certifies that the Department has received the disclosure forms for each subcontract.

The CPO may void the bid, contract, or subcontract, respectively, if it is later determined that the bidder or subcontractor rendered a false or erroneous disclosure. A contractor or subcontractor may be suspended or debarred for violations of the Code. Furthermore, the CPO may void the contract.

**B. Financial Interests and Conflicts of Interest**

1. Section 50-35 of the Code provides that all subcontracts with a total value of \$50,000 or more from subcontractors identified in Section 20-120 of the Code, shall be accompanied by disclosure of the financial interests of the subcontractor. This disclosed information for the subcontractor, will be maintained as public information subject to release by request pursuant to the Freedom of Information Act, filed with the Procurement Policy Board, and shall be incorporated as a material term of the Prime Contractor's contract. Furthermore, pursuant to this Section, the Procurement Policy Board may recommend to allow or void a contract or subcontract based on a potential conflict of interest.

The financial interests to be disclosed shall include ownership or distributive income share that is in excess of 5%, or an amount greater than 60% of the annual salary of the Governor, of the subcontracting entity or its parent entity, whichever is less, unless the subcontractor is a publicly traded entity subject to Federal 10K reporting, in which case it may submit its 10K disclosure in place of the prescribed disclosure. If a subcontractor is a privately held entity that is exempt from Federal 10K reporting, but has more than 100 shareholders, it may submit the information that Federal 10K companies are required to report, and list the names of any individual or entity holding any ownership share that is in excess of 5%. The disclosure shall include the names, addresses, and dollar or proportionate share of ownership of each individual making the disclosure, their instrument of ownership or beneficial relationship, and notice of any potential conflict of interest resulting from the current ownership or beneficial interest of each individual making the disclosure having any of the relationships identified in Section 50-35 and on the disclosure form.

**The current annual salary of the Governor is \$177,412.00.**

In addition, all disclosures shall indicate any other current or pending contracts, subcontracts, proposals, leases, or other ongoing procurement relationships the subcontracting entity has with any other unit of state government and shall clearly identify the unit and the contract, subcontract, proposal, lease, or other relationship.

2. Disclosure Forms. Disclosure Form A is attached for use concerning the individuals meeting the above ownership or distributive share requirements. A separate Disclosure Form A must be submitted with the bid for each individual meeting the above requirements. In addition, a second form (Disclosure Form B) provides for the disclosure of current or pending procurement relationships with other (non-IDOT) state agencies and a total ownership certification.

**C. Disclosure Form Instructions**

**Form A Instructions for Financial Information & Potential Conflicts of Interest**

If the subcontractor is a publicly traded entity subject to Federal 10K reporting, the 10K Report may be submitted to meet the requirements of Form A. If a subcontractor is a privately held entity that is exempt from Federal 10K reporting, but has more than 100 shareholders, it may submit the information that Federal 10K companies are required to report, and list the names of any individual or entity holding any ownership share that is in excess of 5%. If a subcontractor is not subject to Federal 10K reporting, the subcontractor must determine if any individuals are required by law to complete a financial disclosure form. To do this, the subcontractor should answer each of the following questions. A "YES" answer indicates Form A must be completed. If the answer to each of the following questions is "NO", then the NOT APPLICABLE STATEMENT on the second page of Form A must be signed and dated by an individual that is authorized to execute contracts for the subcontracting company. Note: These questions are for assistance only and are not required to be completed.

1. Does anyone in your organization have a direct or beneficial ownership share of greater than 5% of the bidding entity or parent entity? YES \_\_\_ NO \_\_\_
2. Does anyone in your organization have a direct or beneficial ownership share of less than 5%, but which has a value greater than 60% of the annual salary of the Governor? YES \_\_\_ NO \_\_\_
3. Does anyone in your organization receive more than 60% of the annual salary of the Governor of the subcontracting entity's or parent entity's distributive income? YES \_\_\_ NO \_\_\_

(Note: Distributive income is, for these purposes, any type of distribution of profits. An annual salary is not distributive income.)

4. Does anyone in your organization receive greater than 5% of the subcontracting entity's or parent entity's total distributive income, but which is less than 60% of the annual salary of the Governor? YES \_\_\_ NO \_\_\_

(Note: Only one set of forms needs to be completed per individual per subcontract even if a specific individual would require a yes answer to more than one question.)

A "YES" answer to any of these questions requires the completion of Form A. The subcontractor must determine each individual in the subcontracting entity or the subcontracting entity's parent company that would cause the questions to be answered "Yes". Each form must be signed and dated by an individual that is authorized to execute contracts for your organization. The individual signing can be, but does not have to be, the individual for which the form is being completed. The subcontractor is responsible for the accuracy of any information provided.

If the answer to each of the above questions is "NO", then the NOT APPLICABLE STATEMENT on page 2 of Form A must be signed and dated by an individual that is authorized to execute contracts for your company.



## RETURN WITH SUBCONTRACT

### **Form B: Instructions for Identifying Other Contracts & Procurement Related Information**

Disclosure Form B must be completed for each subcontract submitted by the subcontracting entity. *Note: Checking the NOT APPLICABLE STATEMENT on Form A does not allow the subcontractor to ignore Form B. Form B must be completed, checked, and dated or the subcontract will not be approved.*

The Subcontractor shall identify, by checking Yes or No on Form B, whether it has any pending contracts, subcontracts, leases, bids, proposals, or other ongoing procurement relationship with any other (non-IDOT) State of Illinois agency. If "No" is checked, the subcontractor only needs to complete the check box on the bottom of Form B. If "Yes" is checked, the subcontractor must list all non-IDOT State of Illinois agency pending contracts, subcontracts, leases, bids, proposals, and other ongoing procurement relationships. These items may be listed on Form B or on an attached sheet(s). Contracts with cities, counties, villages, etc. are not considered State of Illinois agency contracts and are not to be included. Contracts or subcontracts with other State of Illinois agencies such as the Department of Natural Resources or the Capital Development Board must be included.

RETURN WITH SUBCONTRACT

**ILLINOIS DEPARTMENT  
OF TRANSPORTATION**

**Form A  
Subcontractor: Financial  
Information & Potential Conflicts  
of Interest Disclosure**

Subcontractor Name		
Legal Address		
City, State, Zip		
Telephone Number	Email Address	Fax Number (if available)

Disclosure of the information contained in this Form is required by Section 50-35 of the Code (30 ILCS 500). Subcontractors desiring to enter into a subcontract of a State of Illinois contract must disclose the financial information and potential conflict of interest information as specified in this Disclosure Form. This information shall become part of the publicly available contract file. This Form A must be completed for subcontracts with a total value of \$50,000 or more, from subcontractors identified in Section 20-120 of the Code, and for all open-ended contracts. **A publicly traded company may submit a 10K disclosure (or equivalent if applicable) in satisfaction of the requirements set forth in Form A. See Disclosure Form Instructions.**

*The current annual salary of the Governor is \$177,412.00.*

**DISCLOSURE OF FINANCIAL INFORMATION**

**1. Disclosure of Financial Information.** The individual named below has an interest in the SUBCONTRACTOR (or its parent) in terms of ownership or distributive income share in excess of 5%, or an interest which has a value of more than 60% of the annual salary of the Governor. **(Make copies of this form as necessary and attach a separate Disclosure Form A for each individual meeting these requirements)**

<b>FOR INDIVIDUAL (type or print information)</b>	
<b>NAME:</b>	_____
<b>ADDRESS</b>	_____
<b>Type of ownership/distributable income share:</b>	
stock _____ sole proprietorship _____ Partnership _____ other: (explain on separate sheet):	
% or \$ value of ownership/distributable income share:	_____

**2. Disclosure of Potential Conflicts of Interest.** Check "Yes" or "No" to indicate which, if any, of the following potential conflict of interest relationships apply. If the answer to any question is "Yes", please attach additional pages and describe.

(a) State employment, currently or in the previous 3 years, including contractual employment of services.

Yes \_\_\_ No \_\_\_

If your answer is yes, please answer each of the following questions.

1. Are you currently an officer or employee of either the Capitol Development Board or the Illinois State Toll Highway Authority? Yes \_\_\_ No \_\_\_

2. Are you currently appointed to or employed by any agency of the State of Illinois? If you are currently appointed to or employed by any agency of the State of Illinois, and your annual salary exceeds 60% of the annual salary of the Governor, provide the name the State agency for which you are employed and your annual salary. \_\_\_\_\_

**RETURN WITH SUBCONTRACT**

3. If you are currently appointed to or employed by any agency of the State of Illinois, and your annual salary exceeds 60% of the annual salary of the Governor, are you entitled to receive (i) more than 7 1/2% of the total distributable income of your firm, partnership, association or corporation, or (ii) an amount in excess of 100% of the annual salary of the Governor?  
Yes \_\_\_ No \_\_\_

4. If you are currently appointed to or employed by any agency of the State of Illinois, and your annual salary exceeds 60% of the annual salary of the Governor, are you and your spouse or minor children entitled to receive (i) more than 15 % in the aggregate of the total distributable income of your firm, partnership, association or corporation, or (ii) an amount in excess of two times the salary of the Governor?  
Yes \_\_\_ No \_\_\_

---

(b) State employment of spouse, father, mother, son, or daughter, including contractual employment services in the previous 2 years.

Yes \_\_\_ No \_\_\_

If your answer is yes, please answer each of the following questions.

1. Is your spouse or any minor children currently an officer or employee of the Capitol Development Board or the Illinois Toll Highway Authority?  
Yes \_\_\_ No \_\_\_

2. Is your spouse or any minor children currently appointed to or employed by any agency of the State of Illinois? If your spouse or minor children is/are currently appointed to or employed by any agency of the State of Illinois, and his/her annual salary exceeds 60% of the annual salary of the Governor, provide the name of your spouse and/or minor children, the name of the State agency for which he/she is employed and his/her annual salary. \_\_\_\_\_

3. If your spouse or any minor children is/are currently appointed to or employed by any agency of the State of Illinois, and his/her annual salary exceeds 60% of the annual salary of the Governor, as of 7/1/07) are you entitled to receive (i) more then 7 1/2% of the total distributable income of your firm, partnership, association or corporation, or (ii) an amount in excess of 100% of the annual salary of the Governor?  
Yes \_\_\_ No \_\_\_

4. If your spouse or any minor children are currently appointed to or employed by any agency of the State of Illinois, and his/her annual salary exceeds 60% of the annual salary of the Governor, are you and your spouse or minor children entitled to receive (i) more than 15 % in the aggregate of the total distributable income of your firm, partnership, association or corporation, or (ii) an amount in excess of two times the annual salary of the Governor?  
Yes \_\_\_ No \_\_\_

---

(c) Elective status; the holding of elective office of the State of Illinois, the government of the United States, any unit of local government authorized by the Constitution of the State of Illinois or the statutes of the State of Illinois currently or in the previous 3 years.  
Yes \_\_\_ No \_\_\_

---

(d) Relationship to anyone holding elective office currently or in the previous 2 years; spouse, father, mother, son, or daughter.  
Yes \_\_\_ No \_\_\_

---

(e) Appointive office; the holding of any appointive government office of the State of Illinois, the United States of America, or any unit of local government authorized by the Constitution of the State of Illinois or the statutes of the State of Illinois, which office entitles the holder to compensation in excess of the expenses incurred in the discharge of that office currently or in the previous 3 years.  
Yes \_\_\_ No \_\_\_

---

(f) Relationship to anyone holding appointive office currently or in the previous 2 years; spouse, father, mother, son, or daughter.  
Yes \_\_\_ No \_\_\_

---

(g) Employment, currently or in the previous 3 years, as or by any registered lobbyist of the State government.  
Yes \_\_\_ No \_\_\_

---

**RETURN WITH SUBCONTRACT**

(h) Relationship to anyone who is or was a registered lobbyist in the previous 2 years; spouse, father, mother, son, or daughter. Yes \_\_\_ No \_\_\_

(i) Compensated employment, currently or in the previous 3 years, by any registered election or reelection committee registered with the Secretary of State or any county clerk of the State of Illinois, or any political action committee registered with either the Secretary of State or the Federal Board of Elections. Yes \_\_\_ No \_\_\_

(j) Relationship to anyone; spouse, father, mother, son, or daughter; who was a compensated employee in the last 2 years by any registered election or re-election committee registered with the Secretary of State or any county clerk of the State of Illinois, or any political action committee registered with either the Secretary of State or the Federal Board of Elections. Yes \_\_\_ No \_\_\_

**3 Communication Disclosure.**

Disclose the name and address of each lobbyist and other agent of the bidder or offeror who is not identified in Section 2 of this form, who is has communicated, is communicating, or may communicate with any State officer or employee concerning the bid or offer. This disclosure is a continuing obligation and must be promptly supplemented for accuracy throughout the process and throughout the term of the contract. If no person is identified, enter "None" on the line below:

Name and address of person(s): \_\_\_\_\_  
\_\_\_\_\_  
\_\_\_\_\_  
\_\_\_\_\_

**RETURN WITH SUBCONTRACT**

**4. Suspension or Debarment Disclosure.** For each of the persons identified under Sections 2 and 3 of this form, disclose whether any of the following has occurred within the previous 10 years: suspension or debarment from contracting with any governmental entity; professional licensure discipline; bankruptcies; adverse civil judgments and administrative findings; and criminal felony convictions. This disclosure is a continuing obligation and must be promptly supplemented for accuracy throughout the procurement process and term of the contract. If no person is identified, enter "None" on the line below:

Name of person(s): \_\_\_\_\_

Nature of disclosure: \_\_\_\_\_  
\_\_\_\_\_  
\_\_\_\_\_

**APPLICABLE STATEMENT**

**This Disclosure Form A is submitted on behalf of the INDIVIDUAL named on previous page. Under penalty of perjury, I certify the contents of this disclosure to be true and accurate to the best of my knowledge.**

Completed by:  \_\_\_\_\_ Date \_\_\_\_\_  
Signature of Individual or Authorized Officer

**NOT APPLICABLE STATEMENT**

**Under penalty of perjury, I have determined that no individuals associated with this organization meet the criteria that would require the completion of this Form A.**

**This Disclosure Form A is submitted on behalf of the SUBCONTRACTOR listed on the previous page.**

\_\_\_\_\_ Date \_\_\_\_\_  
Signature of Authorized Officer

RETURN WITH SUBCONTRACT

ILLINOIS DEPARTMENT OF TRANSPORTATION

Form B Subcontractor: Other Contracts & Financial Related Information Disclosure

Form with fields: Subcontractor Name, Legal Address, City, State, Zip, Telephone Number, Email Address, Fax Number (if available)

Disclosure of the information contained in this Form is required by Section 50-35 of the Code (30 ILCS 500). This information shall become part of the publicly available contract file. This Form B must be completed for subcontracts with a total value of \$50,000 or more, from subcontractors identified in Section 20-120 of the Code, and for all open-ended contracts.

DISCLOSURE OF OTHER CONTRACTS, SUBCONTRACTS, AND PROCUREMENT RELATED INFORMATION

1. Identifying Other Contracts & Procurement Related Information. The SUBCONTRACTOR shall identify whether it has any pending contracts, subcontracts, including leases, bids, proposals, or other ongoing procurement relationship with any other State of Illinois agency: Yes \_\_\_ No \_\_\_

If "No" is checked, the subcontractor only needs to complete the signature box on this page.

2. If "Yes" is checked. Identify each such relationship by showing State of Illinois agency name and other descriptive information such as bid or project number (attach additional pages as necessary). SEE DISCLOSURE FORM INSTRUCTIONS:

THE FOLLOWING STATEMENT MUST BE CHECKED

Signature box with fields: Signature of Authorized Representative, Date

OWNERSHIP CERTIFICATION

Please certify that the following statement is true if the individuals for all submitted Form A disclosures do not total 100% of ownership

Any remaining ownership interest is held by individuals receiving less than \$106,447.20 of the bidding entity's or parent entity's distributive income or holding less than a 5% ownership interest.

Yes No N/A (Form A disclosure(s) established 100% ownership)



## NOTICE TO BIDDERS

**1. TIME AND PLACE OF OPENING BIDS.** Sealed proposals for the improvement described herein will be received by the Department of Transportation. Electronic bids are to be submitted to the electronic bidding system (iCX-Integrated Contractors Exchange). Paper-based bids are to be submitted to the Chief Procurement Officer for the Department of Transportation in care of the Chief Contracts Official at the Harry R. Hanley Building, 2300 South Dirksen Parkway, in Springfield, Illinois until 10:00 a.m. November 4, 2016. All bids will be gathered, sorted, publicly opened and read in the auditorium at the Department of Transportation's Harry R. Hanley Building shortly after 10:00 a.m.

**2. DESCRIPTION OF WORK.** The proposed improvement is identified and advertised for bids in the Invitation for Bids as:

**Contract No. 64L61  
Various Counties  
Section D2 BC 2017-2  
Various Routes  
District 2 Construction Funds**

**This project consists of washing 14 bridges at various locations in Henry and Rock Island Counties (SN 037-0003, 037-0004, 037-0031, 037-0032, 037-0100, 081-0038, 081-0039, 081-0040, 081-0089, 081-0125, 081-0159, 081-0160, 081-0161 and 081-0162).**

**3. INSTRUCTIONS TO BIDDERS.** (a) This Notice, the invitation for bids, proposal and letter of award shall, together with all other documents in accordance with Article 101.09 of the Standard Specifications for Road and Bridge Construction, become part of the contract. Bidders are cautioned to read and examine carefully all documents, to make all required inspections, and to inquire or seek explanation of the same prior to submission of a bid.

(b) State law, and, if the work is to be paid wholly or in part with Federal-aid funds, Federal law requires the bidder to make various certifications as a part of the proposal and contract. By execution and submission of the proposal, the bidder makes the certification contained therein. A false or fraudulent certification shall, in addition to all other remedies provided by law, be a breach of contract and may result in termination of the contract.

**4. AWARD CRITERIA AND REJECTION OF BIDS.** This contract will be awarded to the lowest responsive and responsible bidder considering conformity with the terms and conditions established by the Department in the rules, Invitation for Bids and contract documents. The issuance of plans and proposal forms for bidding based upon a prequalification rating shall not be the sole determinant of responsibility. The Department reserves the right to determine responsibility at the time of award, to reject any or all proposals, to readvertise the proposed improvement, and to waive technicalities.

By Order of the  
Illinois Department of Transportation

Randall S. Blankenhorn,  
Secretary

INDEX  
FOR  
SUPPLEMENTAL SPECIFICATIONS  
AND RECURRING SPECIAL PROVISIONS

Adopted April 1, 2016

This index contains a listing of SUPPLEMENTAL SPECIFICATIONS, frequently used RECURRING SPECIAL PROVISIONS, and LOCAL ROADS AND STREETS RECURRING SPECIAL PROVISIONS.

No ERRATA this year.

SUPPLEMENTAL SPECIFICATIONS

Std. Spec. Sec.

Page No.

No Supplemental Specifications this year.



RECURRING SPECIAL PROVISIONS

The following RECURRING SPECIAL PROVISIONS indicated by an "X" are applicable to this contract and are included by reference:

<u>CHECK SHEET #</u>		<u>PAGE NO.</u>
1	Additional State Requirements for Federal-Aid Construction Contracts .....	1
2	Subletting of Contracts (Federal-Aid Contracts) .....	4
3	X EEO .....	5
4	X Specific EEO Responsibilities Non Federal-Aid Contracts .....	15
5	X Required Provisions - State Contracts .....	20
6	Asbestos Bearing Pad Removal .....	26
7	Asbestos Waterproofing Membrane and Asbestos HMA Surface Removal .....	27
8	Temporary Stream Crossings and In-Stream Work Pads .....	28
9	Construction Layout Stakes Except for Bridges .....	29
10	Construction Layout Stakes .....	32
11	Use of Geotextile Fabric for Railroad Crossing .....	35
12	Subsealing of Concrete Pavements .....	37
13	Hot-Mix Asphalt Surface Correction .....	41
14	Pavement and Shoulder Resurfacing .....	43
15	Patching with Hot-Mix Asphalt Overlay Removal .....	44
16	Polymer Concrete .....	45
17	PVC Pipeliner .....	47
18	Bicycle Racks .....	48
19	Temporary Portable Bridge Traffic Signals .....	50
20	X Work Zone Public Information Signs .....	52
21	Nighttime Inspection of Roadway Lighting .....	53
22	English Substitution of Metric Bolts .....	54
23	Calcium Chloride Accelerator for Portland Cement Concrete .....	55
24	Quality Control of Concrete Mixtures at the Plant .....	56
25	Quality Control/Quality Assurance of Concrete Mixtures .....	64
26	Digital Terrain Modeling for Earthwork Calculations .....	80
27	Pavement Marking Removal .....	82
28	Preventive Maintenance – Bituminous Surface Treatment .....	83
29	Preventive Maintenance – Cape Seal .....	89
30	Preventive Maintenance – Micro-Surfacing .....	104
31	Preventive Maintenance – Slurry Seal .....	115
32	Temporary Raised Pavement Markers .....	125
33	Restoring Bridge Approach Pavements Using High-Density Foam .....	126

## TABLE OF CONTENTS

LOCATION OF PROJECT .....	1
DESCRIPTION OF PROJECT .....	1
TRAFFIC CONTROL PLAN .....	1
BRIDGE WASHING .....	5
NAVIGATIONAL CONSIDERATIONS AND CONSTRUCTION OVER NAVIGABLE WATERS...	9
RAILROAD PROTECTIVE LIABILITY INSURANCE (5 AND 10) (BDE) .....	11
DISADVANTAGED BUSINESS ENTERPRISE PARTICIPATION (BDE) .....	12
EQUAL EMPLOYMENT OPPORTUNITY (BDE) .....	24
ERRATA FOR THE 2016 STANDARD SPECIFICATIONS (BDE) .....	27
PROGRESS PAYMENTS (BDE) .....	31
SPEED DISPLAY TRAILER (BDE) .....	32
WEEKLY DBE TRUCKING REPORTS (BDE) .....	33
WORKING DAYS (BDE) .....	33
VETERAN BUSINESS PROGRAM .....	34

## STATE OF ILLINOIS

---

### SPECIAL PROVISIONS

The following Special Provisions supplement the “Standard Specifications for Road and Bridge Construction, Adopted April 1, 2016”, the latest edition of the “Manual on Uniform Traffic Control Devices for Streets and Highways”, and the “Manual of Test Procedures for Materials” in effect on the date of invitation for bids, and the “Supplemental Specifications and Recurring Special Provisions” indicated on the Check Sheet included herein, which apply to and govern the construction of Various Routes, Section D2 BC 2017-2, Various Counties, Contract No. 64L61 and in case of conflict with any part, or parts, of said Specifications, the said Special Provisions shall take precedence and shall govern.

#### LOCATION OF PROJECT

This project is located on various bridges throughout the district.

#### DESCRIPTION OF PROJECT

The work under this contract shall consist of washing in whole or part of fourteen (14) structures at eight (8) locations in Henry and Rock Island Counties. Work on the project shall not begin prior to April 17, 2017.

#### TRAFFIC CONTROL PLAN

Effective: January 14, 1999

Revised: April 12, 2016

Traffic Control shall be according to the applicable sections of the Standard Specifications for Road and Bridge Construction, the applicable guidelines contained in the National Manual on Uniform Traffic Control Devices for Streets and Highways, Illinois Supplement to the National Manual on Uniform Traffic Control Devices, these special provisions, and any special details and Highway Standards contained herein and in the plans.

Special attention is called to Articles 107.09 and 107.14 of the Standard Specifications for Road and Bridge Construction and the following Highway Standards relating to traffic control.

#### Standards:

701006	701101	701201	701301	701400	701406
701411	701501	701606	701901		

#### General:

Where construction activities involve sidewalks on both sides of the street, the work shall be staged so that both sidewalks are not out of service at the same time.

Signs:

No bracing shall be allowed on post-mounted signs.

Post-mounted signs shall be installed using standard 720011, 728001, 729001, on 4"x4" wood posts, or on any other "break away" connection if accepted by the FHWA and corresponding letter is provided to the resident.

All signs are required on both sides of the road when the median is greater than 10 feet and on one way roadways.

When covering existing Department signs, no tape shall be used on the reflective portion of the sign. Contact the District sign shop for covering techniques.

All regulatory signs shall be maintained at a 5 foot minimum bottom (rural), 7 foot minimum (urban).

Any plates or direct applied sheeting used to alter signs shall have the same sheeting as the base sign.

No more than one kind of alteration shall be used to alter a sign.

Any post stubs without a sign in place and visible shall have a reflector placed on each post.

Devices:

Cones or reflectorized cones shall not be used during hours of darkness.

A minimum of 3 drums spaced at 4 feet shall be placed at each return when the sideroad is open.

On all standards and devices listed in Section 701 of the Standard Specifications, the device spacing shall be revised to the following dimensions:

- Where the spacing shown on the standard is 25 feet, the devices shall be placed at 20 feet.
- Where the spacing shown on the standard is 50 feet, the devices shall be placed at 40 feet.
- Where the spacing shown on the standard is 100 feet, the devices shall be placed at 80 feet.

Direction Indicator Barricades shall exclusively be used in lane closure tapers. The backside of the direction indicator barricades shall be striped like a type II barricade when opposing traffic is within 12 feet of the device. The taper shall be continuous. It shall not be broken for access to turn lanes, side roads, ramps, or large commercial driveways. The taper shall be moved further away and shall be completed prior to the access point.

Vertical barricades shall not be used in weaves, and in the gore areas on Highway Standard 701411.

Vertical barricades shall not be used as a device where the existing speed limit is 65 mph or greater.

Flaggers:

Flagger at Sideroads and Commercial Entrances:

Effective: August 1, 2011

Revised: December 29, 2015

Flaggers shall comply with all requirements and signaling methods contained in the Department's "Traffic Control Field Manual" current at the time of letting. The flagger equipment listed for flaggers employed by the Illinois Department of Transportation shall apply to all flaggers

All workers and flaggers shall wear ANSI Class E pants and an ANSI Class 2 vest that in combination meet the requirements of ANSI/ISEA 107-2004 for Conspicuity Class 3 garments during hours of darkness.

In addition to the flaggers shown on applicable standards, on major sideroads, flaggers shall be required on all legs of the intersection. Major sideroads for this project shall be none.

In addition to the flaggers shown on applicable standards, a flagger shall be required on high volume commercial entrances listed below. High volume commercial entrances for this project shall be none.

When the mainline flagger is within 200 feet of an intersection, the sideroad flagger shall be required.

When the road is closed to through traffic and it is necessary to provide access for local traffic, all flaggers as shown on the applicable standards will be required. No reduction in the number of flaggers shall be allowed.

Revise Article 701.20(i) of the Standard Specifications to read:

"Signs, barricades, other traffic control devices, or flaggers required by the Engineer, over and above those shown in the contract documents, will be paid for according to Article 109.04."

Traffic Control and Protection Standard 701400:

This work shall be done according to Section 701 of the Standard Specifications and the Typical Application of Traffic Control Devices for Highway Construction, Standard 701400, and as specified herein.

The message boards shown shall be placed two weeks before the start of the work, informing the public of the lanes closures.

The "ROAD CONSTRUCTION AHEAD" (W20-I103(O)-48) 3 MILES" (W16-3A(O)-3612), the Work Zone Public Information Sign, and portable changeable message board shown shall be relocated during the project so that they are located 3 miles in advance of the lane closure. If there is more than one lane closure in a given direction, these signs and the message board shall be located in advance of each lane closure, if there is 3 miles or more between the closures.

This work will not be measured for payment.

Traffic Control and Protection Standard 701411:

Method of Measurement. Each ramp will be measured as a separate location and will be considered as a separate location for payment, regardless of the number of installations at that ramp.

Interstates and multi-lane divided highways where the existing speed is greater than 45 mph:  
The Contractor shall equip all machinery and vehicles with flashing amber lights, installed so the illumination is visible from all directions.

The median crossover will generally not be available for Contractor use. It may be used only when both lanes adjacent to the median are closed. Under no condition shall left turn lanes be made to cross the median from lanes open to traffic. Where interchanges are not available, the Contractor shall only be allowed to turn around where left turn lanes are present.

Parking of personal vehicles within the right-of-way will be strictly prohibited. Parking of construction equipment within the right-of-way will be permitted only at locations approved by the Engineer.

## **BRIDGE WASHING**

The work under this contract shall consist of washing, in whole or in part, 14 structures. The location, description, and extent of washing of the bridges are herein described. The method of washing bridges shall be in accordance with Section 592 of the Standard Specifications.

As a reminder for the contractor, simply spraying the bridge with water does not necessarily wash the bridge. All spider webs, bird nests, and any other foreign material must be removed. If water does not suffice, the contractor shall use compressed air, hand tools or whatever is considered appropriate and necessary, subject to approval by the Engineer, to remove accumulated foreign material. When bridge deck surface and parapet type washing is specified, it shall be done by high volume low pressure methods, even if the contractor elects to mechanically sweep the deck. Other areas, such as slopewalls and piers may be washed by high volume low pressure methods subject to approval by the Engineer.

Specialized equipment with significant boom length/reach will be required to gain access to the areas described below. Under bridge inspection vehicles that can span over the deck and sidewalks/parapets and reach back halfway across the structure or other equivalent vehicles will be required to properly wash the structures as described below. It is the contractor's responsibility to determine and utilize the method and equipment to reach all areas of the structure. The contractor shall submit a list of proposed equipment to be used at the pre-construction conference.

### Location 1, Structure Numbers 037-0003 and 037-0004

These 9 span bridges are located on I-74 and 280 over US 6, the Burlington Northern Railroad, and Township Road 38 in Henry County near Green Rock. These bridges are each 475 feet long by 42 feet wide.

The entire deck surface, all deck shoulders and parapet walls, all deck drains and extensions, all deck joints, approach pavements and approach shoulders must be washed and free of all debris.

Also to be washed is 10 feet of all steel from the expansion joints, the entire length of the outside face and bottom flange of the fascia beams, the abutment caps, wingwalls, pier caps under expansion joints, and solid concrete portion of the slopewalls.

Use Traffic Control Standards 701400 and 701406 to close a lane on the structure. Use Traffic Control Standard 701201 to close a lane on the Township Road and US 6 under the structures.

No washing, crew member, or equipment will be allowed within 25 feet of either side of the railroad tracks below the structure. However, the deck surfaces shall be washed over the tracks.

This item will be paid for as Bridge Washing No.1 and Bridge Washing No.2.

Location 2, Structure Numbers 037-0031 and 037-0032

These 4 span bridges are located on I-80 over I-74, 3 miles southeast of Colona in Henry County. These bridges are each 275 feet long by 53 feet wide.

The entire deck surface, all deck shoulders and parapet walls, all deck drains and extensions, all deck joints, approach pavements and approach shoulders must be washed and free of all debris.

Also to be washed is the entire steel superstructure, the abutment caps, all pier caps, and wingwalls.

Use Traffic Control Standards 701400, 701406, and 701411 to close a lane on the structure.

Use Traffic Control Standards 701400, 701406, and 701411 to close a lane under the structures.

This item will be paid for as Bridge Washing No.3 and Bridge Washing No.4.

Location 3, Structure Number 037-0100

This single span bridge carries Ulah Road over Edwards Rivers, 1.2 miles south of IL 81. This bridge is 100 feet long by 22 feet wide.

The entire steel superstructure, concrete deck and approach pavements and railings shall be washed. Also both abutments shall be washed.

Traffic Control Standard 701201 shall be used when washing this structure.

This item will be paid for as Bridge Washing No.5.

Location 4, Structure Numbers 081-0038, 081-0039 and 081-0040

These 3 multi-span tied arch/plate girder structures are carrying US 67 over the Rock River between Milan and Rock Island. The bridges are approximately 706 feet, 395 feet, and 703 in length respectively all by 63 feet wide.

Areas to be washed include the entire deck, all shoulders, sidewalks, parapet walls, railings, deck drains, deck joints, approach pavements, approach shoulders, and all steel on the tied arches.

Also to be washed are 10 feet of all steel each side of the deck joints, bearings, abutment caps, backwalls, pier caps under deck joints, and wingwalls. On the plate girder spans, the outside and bottom face of the fascia girders shall be washed.

On the tied arch spans, wash all steel outside of and including the exterior stringers outside and bottom faces. All floorbeams shall be washed entirely.



Traffic Control Standards 701606 and District Standard 35.1 shall be utilized when working on this structure.

This item will be paid for as Bridge Washing No.6, Bridge Washing No.7, and Bridge Washing No.8.

Location 5, Structure Number 081-0089

This 4 span structure is located on Campbell Island Road over a branch of the Mississippi River at the northeast edge of East Moline off of IL 84. This structure is 360 feet long by 32 feet wide.

The entire deck surface, all deck shoulders and parapet walls, all deck drains and extensions, all deck joints, approach pavements, and approach shoulders must be washed and free of all debris.

Also to be washed are 10 feet of all steel each side of the deck joints, abutment caps, backwalls, and wingwalls.

Traffic Control Standard 701201 shall be used when washing this structure.

This item will be paid for as Each for Bridge Washing No.9.

Location 6, Structure Number 081-0125

This 2 span multi-plate girder bridge carries IL 92 over I-88 located 8 miles east of Silvis, near Joslin. The bridge is 357 feet long by 69 feet wide.

The entire structure shall be washed including, but not limited to, the deck surface, deck joints, drains, medians, parapet wall, approach pavements and shoulders, steel superstructure, bearings, piers, abutments and slopewalls.

Traffic Control Standards 701201 on the structure, 701400 and 701406 under the structure shall be used when working on this location.

This item will be paid for as Bridge Washing No. 10.

Location 7, Structure Number 081-0159 and 081-0160

These 2 span bridges are located on I-74 & US 6 over I-280 in the city of Moline in Rock Island County. These bridges are each approximately 237 feet long by 53 feet wide.

The entire deck surface, all deck shoulders and parapet walls, all deck drains and extensions, all deck joints, approach pavements and approach shoulders must be washed and free of all debris.

Also to be washed is the entire steel superstructure, the abutment backwalls, wingwalls and slopewalls.

For southbound lane closures, use Traffic Control Standards 701400, 701406, and 701411 to close a lane on the structure. For northbound lane closures, use sign spacing shown on 701601 and the taper such in 701406. Place same signing on all legs of the intersection with arrow plates (W1-6(0) – 36 x 18) below each sign. Place the speed limit signs on I-74 northbound.

No lane closures will be allowed at this location Monday through Thursday between the hours of 2:00 PM to 6:00 PM and on Friday no lane closures from 7:00 AM to 9:00 AM & 2:00 PM to 6:00 PM.

These items will be paid for as Bridge Washing No.11 and Bridge Washing No.12.

Location 8, Structures 081-0161 and 081-0162

These 7 span bridges are located on I-74 & US 6 over the Rock River and sideroads in the city of Moline, in Rock Island County. These bridges are each approximately 889 feet long by 43 feet wide.

The entire deck surface, all deck shoulders and parapet walls, all deck drains and extensions, all deck joints, approach pavements and approach shoulders must be washed and free of all debris.

Also to be washed is 10 feet of all steel from either side of expansion joints, finger joint troughs, and pier caps below expansion joints, abutment backwalls, and wingwalls.

For southbound lane closures, use Traffic Control Standards 701400, 701406, and 701411 to close a lane on the structure. For northbound lane closures, use sign spacing showed on 701601 and the taper such in 701406. Place same signing on all legs of the intersection with arrow plates (W1-6(0) – 36 x 18) below each sign. Place the speed limit signs on I-74 northbound.

No lane closures will be allowed at this location Monday through Thursday between the hours of 2:00 PM to 6:00 PM and on Friday no lane closures from 7:00 AM to 9:00 AM & 2:00 PM to 6:00 PM.

These items will be paid for as Bridge Washing No.13 and Bridge Washing No.14.

## **NAVIGATIONAL CONSIDERATIONS AND CONSTRUCTION OVER NAVIGABLE WATERS**

Effective January 18, 2012

The proposed plans, schedule and sequence of operations shall first be submitted to the Engineer for review and approval. The submittal to the United States Army Corps of Engineers (Corps) and the United States Coast Guard, shall not be made until it has been reviewed and approved by the Engineer.

The Contractor shall then submit to the Corps and the United States Coast Guard, through the contracting authority, for review and approval, four (4) copies of the proposed plan, schedule and sequence of operations. The submittal shall be made within 7 calendar days, prior to any field work on the bridge.

No deviation from the approved plans, schedule and sequence of operations will be permitted unless the proposed deviation has had the prior approval of the Engineer, the Coast Guard and the Corps.

The work shall be performed in accordance with the requirements of the Corps and the Coast Guard.

The Corps and Coast Guard requirements include, but may not be limited to the requirements specified hereinafter.

The Contractor shall, during the bidding period, determine by his own means and to his own satisfaction any and all other Corps and Coast Guard requirements for the performance of the work of this contract. The Contractor shall determine all costs of compliance with Corps and Coast Guard requirements and shall include said costs in the unit bid price for the scheduled items in the proposal.

At no time during the performance of the work shall the river be closed to navigation.

Scaffolding, rigging, associated supports, and equipment shall not interfere with normal navigation under the bridge.

No existing bridge navigation light shall be blocked.

If permanent bridge or fender navigation lighting cannot be maintained operable, then identical temporary battery- or power-operated lights shall be installed at the same locations. These temporary lights shall be visible for a distance of 2,000 meters on 90 percent of the nights of the year. Generally, a lamp of 20 candlepower will meet these requirements. The temporary lights shall be in place until the project has been completed or permanent navigational lighting has been reinstalled and determined to be operating satisfactorily. Plans for temporary lighting, if used, during periods of project work shall be submitted to the Corps and Coast Guard for written approval. If temporary lights are not installed in the same location as the permanent lights, specific information regarding proposed locations compared to the permanent position shall be provided. Deviations from the approved temporary lighting shall be permitted only upon written authorization from the Corps and Coast Guard.

During the progress of work, should any material, machinery or equipment be lost, dumped, thrown overboard, dropped off the bridge, or sunk so as to obstruct, interfere with or hazard navigation, immediate notice shall be given to the Corps and the object removed as soon as possible. Until removal can be performed, the obstruction shall be properly marked in order to protect navigation. Notice to the Corps shall give a description and location of any such object and action taken or being taken to protect navigation and removal of the obstruction.

Spillage of oil and hazardous substances is specifically prohibited by section 311 of the federal water pollution control act of 1972, as amended. Preventive measures shall be taken including: (1) proper maintenance of construction equipment; (2) arrangement of fuel and hazardous substance handling areas so as to ensure that the any spills are contained before reaching navigable waterways or their adjoining shorelines; (3) instructions to personnel not to dispose of oil or hazardous substances into drains or the navigable waterways directly or onto adjoining shoreline; and (4) other procedures to prevent spillage. If in spite of such planning, oil or hazardous substances are spilled into navigable waterways or adjoining shorelines, the Corps and the U.S. Coast Guard National Response Center (Telephone: 800-424-8802) shall be notified immediately. A supply of an absorbent material shall be retained on hand so that it may be rapidly deployed to soak up any possible spillage, pending arrival of the Corps/ Coast Guard on the scene. The use of chemical dispersing agents and emulsifiers is not authorized without prior, specific, Corps / Coast Guard approval.

It shall be the responsibility of the Contractor to ensure that channel depths are not affected by the project work. Should it be suspected that channel depths have been impaired or that an obstruction resulting from the project work may exist, the Contractor shall upon request of the Corps or the Coast Guard, provide the necessary equipment and personnel to undertake a survey to determine the presence of such impairment or obstruction. The cost for this work shall be the responsibility of the Contractor, at no additional cost to the Department.

Should the Contractor fail to comply with these requirements and should the federal government be required to take some action for the protection of navigation or for the protection of the environment, the government reserves the right to recover costs for any such action from the Contractor, at no additional cost to the Department.

The federal government and the Department assume no responsibility for any damages sustained or caused by the Contractor's equipment at the site of the work. Any approval shall not act as a waiver of liability for any damage that may result from the Contractor's operation.

The Contractor shall completely remove any project related debris from the river at no additional cost to the Department.

Final payment will not be made unless and until any such project related debris has been removed.

Positive precautions shall be taken to prevent the accidental dropping of spark-producing, flame-producing, lighted or other damaging objects onto barges or vessels passing beneath the bridge. All flame-cutting, welding, and similar spark-producing operations shall be ceased over the channel when vessels are passing beneath the bridge.

If scaffolding or nets are to be suspended below low steel in the navigation span, the U.S. Coast Guard, Second District Office, St. Louis, Missouri, shall be advised so that the temporary reduction in clearance for river traffic can be checked for reasonableness, and appropriate notices can be published. Such scaffolding or nets shall be removed during non-daylight hours.

When removing materials from the bridge, positive precautions shall be taken to ensure that none of the material falls into the river.

### **RAILROAD PROTECTIVE LIABILITY INSURANCE (5 AND 10) (BDE)**

Effective: January 1, 2006

Description. Railroad Protective Liability and Property Damage Liability Insurance shall be carried according to Article 107.11 of the Standard Specifications, except the limits shall be a minimum of \$5,000,000 combined single limit per occurrence for bodily injury liability and property damage liability with an aggregate limit of \$10,000,000 over the life of the policy. A separate policy is required for each railroad unless otherwise noted.

---

NAMED INSURED & ADDRESS	NUMBER & SPEED OF PASSENGER TRAINS	NUMBER & SPEED OF FREIGHT TRAINS
The BNSF Railway Company 80 – 44 <sup>th</sup> Avenue N.E. Minneapolis, Minnesota 55421	0	27 per day at 30 MPH
Calvin Nutt, Manager of Public Projects – IA,IL,WI		
DOT/AAR No.: 065 658R RR Division: Chicago	RR Mile Post: 38.44 RR Sub-Division: Barstow	
For Freight/Passenger Information Contact: Manager of Track Maintenance (MTM)	Brian Langloss	Phone: 406-670-9935 <a href="mailto:brian.langloss@bnsf.com">brian.langloss@bnsf.com</a>
For Insurance Information Contact:	Rosa Martinez (Marsh USA)	Phone: 214-303-8519

---

**Comments:** Railroad flaggers are required if working within 25 feet, horizontally, of the tracks or whenever working over the tracks. Contact Brian Langloss at least one week in advance to schedule a flagger.

Approval of Insurance. The original and one certified copy of each required policy shall be submitted to the following address for approval:

Illinois Department of Transportation  
Bureau of Design and Environment  
2300 South Dirksen Parkway, Room 326  
Springfield, Illinois 62764

The Contractor will be advised when the Department has received approval of the insurance from the railroad(s). Before any work begins on railroad right-of-way, the Contractor shall submit to the Engineer evidence that the required insurance has been approved by the railroad(s). The Contractor shall also provide the Engineer with the expiration date of each required policy.

Basis of Payment. Providing Railroad Protective Liability and Property Damage Liability Insurance will be paid for at the contract unit price per Lump Sum for RAILROAD PROTECTIVE LIABILITY INSURANCE.

80157

**DISADVANTAGED BUSINESS ENTERPRISE PARTICIPATION (BDE)**

Effective: September 1, 2000

Revised: July 2, 2016

FEDERAL OBLIGATION. The Department of Transportation, as a recipient of federal financial assistance, is required to take all necessary and reasonable steps to ensure nondiscrimination in the award and administration of contracts. Consequently, the federal regulatory provisions of 49 CFR Part 26 apply to this contract concerning the utilization of disadvantaged business enterprises. For the purposes of this Special Provision, a disadvantaged business enterprise (DBE) means a business certified by the Department in accordance with the requirements of 49 CFR Part 26 and listed in the Illinois Unified Certification Program (IL UCP) DBE Directory.

STATE OBLIGATION. This Special Provision will also be used by the Department to satisfy the requirements of the Business Enterprise for Minorities, Females, and Persons with Disabilities Act, 30 ILCS 575. When this Special Provision is used to satisfy state law requirements on 100 percent state-funded contracts, the federal government has no involvement in such contracts (not a federal-aid contract) and no responsibility to oversee the implementation of this Special Provision by the Department on those contracts. DBE participation on 100 percent state-funded contracts will not be credited toward fulfilling the Department's annual overall DBE goal required by the US Department of Transportation to comply with the federal DBE program requirements.

CONTRACTOR ASSURANCE. The Contractor makes the following assurance and agrees to include the assurance in each subcontract that the Contractor signs with a subcontractor.

The Contractor, subrecipient, or subcontractor shall not discriminate on the basis of race, color, national origin, or sex in the performance of this contract. The Contractor shall carry out applicable requirements of 49 CFR Part 26 in the award and administration of contracts funded in whole or in part with federal or state funds. Failure by the Contractor to carry out these requirements is a material breach of this contract, which may result in the termination of this contract or such other remedy as the recipient deems appropriate, which may include, but is not limited to:

- (a) Withholding progress payments;
- (b) Assessing sanctions;
- (c) Liquidated damages; and/or
- (d) Disqualifying the Contractor from future bidding as non-responsible.

OVERALL GOAL SET FOR THE DEPARTMENT. As a requirement of compliance with 49 CFR Part 26, the Department has set an overall goal for DBE participation in its federally assisted contracts. That goal applies to all federal-aid funds the Department will expend in its federally assisted contracts for the subject reporting fiscal year. The Department is required to make a good faith effort to achieve the overall goal. The dollar amount paid to all approved DBE companies performing work called for in this contract is eligible to be credited toward fulfillment of the Department's overall goal.

CONTRACT GOAL TO BE ACHIEVED BY THE CONTRACTOR. This contract includes a specific DBE utilization goal established by the Department. The goal has been included because the Department has determined that the work of this contract has subcontracting opportunities that may be suitable for performance by DBE companies. The determination is based on an assessment of the type of work, the location of the work, and the availability of DBE companies to do a part of the work. The assessment indicates that, in the absence of unlawful discrimination, and in an arena of fair and open competition, DBE companies can be expected to perform **0.00%** of the work. This percentage is set as the DBE participation goal for this contract. Consequently, in addition to the other award criteria established for this contract, the Department will only award this contract to a bidder who makes a good faith effort to meet this goal of DBE participation in the performance of the work. A bidder makes a good faith effort for award consideration if either of the following is done in accordance with the procedures set for in this Special Provision:

- (a) The bidder documents that enough DBE participation has been obtained to meet the goal or,
- (b) The bidder documents that a good faith effort has been made to meet the goal, even though the effort did not succeed in obtaining enough DBE participation to meet the goal.

DBE LOCATOR REFERENCES. Bidders shall consult the IL UCP DBE Directory as a reference source for DBE-certified companies. In addition, the Department maintains a letting and item specific DBE locator information system whereby DBE companies can register their interest in providing quotes on particular bid items advertised for letting. Information concerning DBE companies willing to quote work for particular contracts may be obtained by contacting the Department's Bureau of Small Business Enterprises at telephone number (217) 785-4611, or by visiting the Department's website at: <http://www.idot.illinois.gov/doing-business/certifications/disadvantaged-business-enterprise-certification/il-ucp-directory/index>.

BIDDING PROCEDURES. Compliance with this Special Provision is required prior to the award of the contract and the failure of the low bidder to comply will render the bid not responsive.

In order to assure the timely award of the contract, the low bidder shall submit:

- (a) The bidder shall submit a DBE Utilization Plan on completed Department forms SBE 2025 and 2026.
  - (1) The final Utilization Plan must be submitted within five calendar days after the date of the letting in accordance with subsection (a)(2) of Bidding Procedures herein.
  - (2) To meet the five day requirement, the bidder may send the Utilization Plan electronically by scanning and sending to **[DOT.DBE.UP@illinois.gov](mailto:DOT.DBE.UP@illinois.gov)** or faxing to (217) 785-1524. The subject line must include the bid Item Number and the Letting date. The Utilization Plan should be sent as one .pdf file, rather than multiple files and emails for the same Item Number. It is the responsibility of the bidder to obtain confirmation of email or fax delivery.

Alternatively, the Utilization Plan may be sent by certified mail or delivery service within the five calendar day period. If a question arises concerning the mailing date of a Utilization Plan, the mailing date will be established by the U.S. Postal Service postmark on the certified mail receipt from the U.S. Postal Service or the receipt issued by a delivery service when the Utilization Plan is received by the Department. It is the responsibility of the bidder to ensure the postmark or receipt date is affixed within the five days if the bidder intends to rely upon mailing or delivery to satisfy the submission day requirement. The Utilization Plan is to be submitted to:

Illinois Department of Transportation  
Bureau of Small Business Enterprises  
Contract Compliance Section  
2300 South Dirksen Parkway, Room 319  
Springfield, Illinois 62764



The Department will not accept a Utilization Plan if it does not meet the five day submittal requirement and the bid will be declared not responsive. In the event the bid is declared not responsive due to a failure to submit a Utilization Plan or failure to comply with the bidding procedures set forth herein, the Department may elect to cause the forfeiture of the penal sum of the bidder's proposal guaranty, and may deny authorization to bid the project if re-advertised for bids. The Department reserves the right to invite any other bidder to submit a Utilization Plan at any time for award consideration.

- (b) The Utilization Plan shall indicate that the bidder either has obtained sufficient DBE participation commitments to meet the contract goal or has not obtained enough DBE participation commitments in spite of a good faith effort to meet the goal. The Utilization Plan shall further provide the name, telephone number, and telefax number of a responsible official of the bidder designated for purposes of notification of Utilization Plan approval or disapproval under the procedures of this Special Provision.
- (c) The Utilization Plan shall include a DBE Participation Commitment Statement, Department form SBE 2025, for each DBE proposed for the performance of work to achieve the contract goal. For bidding purposes, submission of the completed SBE 2025 forms, signed by the DBEs and scanned or faxed to the bidder will be acceptable as long as the original is available and provided upon request. All elements of information indicated on the said form shall be provided, including but not limited to the following:
  - (1) The names and addresses of DBE firms that will participate in the contract;
  - (2) A description, including pay item numbers, of the work each DBE will perform;
  - (3) The dollar amount of the participation of each DBE firm participating. The dollar amount of participation for identified work shall specifically state the quantity, unit price, and total subcontract price for the work to be completed by the DBE. If partial pay items are to be performed by the DBE, indicate the portion of each item, a unit price where appropriate and the subcontract price amount;
  - (4) DBE Participation Commitment Statements, form SBE 2025, signed by the bidder and each participating DBE firm documenting the commitment to use the DBE subcontractors whose participation is submitted to meet the contract goal;
  - (5) If the bidder is a joint venture comprised of DBE companies and non-DBE companies, the Utilization Plan must also include a clear identification of the portion of the work to be performed by the DBE partner(s); and,
  - (6) If the contract goal is not met, evidence of good faith efforts; the documentation of good faith efforts must include copies of each DBE and non-DBE subcontractor quote submitted to the bidder when a non-DBE subcontractor is selected over a DBE for work on the contract.

GOOD FAITH EFFORT PROCEDURES. The contract will not be awarded until the Utilization Plan submitted by the apparent successful bidder is approved. All information submitted by the bidder must be complete, accurate and adequately document that enough DBE participation has been obtained or document that good faith efforts of the bidder, in the event enough DBE participation has not been obtained, before the Department will commit to the performance of the contract by the bidder. The Utilization Plan will be approved by the Department if the Utilization Plan documents sufficient commercially useful DBE work to meet the contract goal or the bidder submits sufficient documentation of a good faith effort to meet the contract goal pursuant to 49 CFR Part 26, Appendix A. The Utilization Plan will not be approved by the Department if the Utilization Plan does not document sufficient DBE participation to meet the contract goal unless the apparent successful bidder documented in the Utilization Plan that it made a good faith effort to meet the goal. This means that the bidder must show that all necessary and reasonable steps were taken to achieve the contract goal. Necessary and reasonable steps are those which, by their scope, intensity and appropriateness to the objective, could reasonably be expected to obtain sufficient DBE participation, even if they were not successful. The Department will consider the quality, quantity, and intensity of the kinds of efforts that the bidder has made. Mere *pro forma* efforts, in other words, efforts done as a matter of form, are not good faith efforts; rather, the bidder is expected to have taken genuine efforts that would be reasonably expected of a bidder actively and aggressively trying to obtain DBE participation sufficient to meet the contract goal.

- (a) The following is a list of types of action that the Department will consider as part of the evaluation of the bidder's good faith efforts to obtain participation. These listed factors are not intended to be a mandatory checklist and are not intended to be exhaustive. Other factors or efforts brought to the attention of the Department may be relevant in appropriate cases, and will be considered by the Department.
- (1) Soliciting through all reasonable and available means (e.g. attendance at pre-bid meetings, advertising and/or written notices) the interest of all certified DBE companies that have the capability to perform the work of the contract. The bidder must solicit this interest within sufficient time to allow the DBE companies to respond to the solicitation. The bidder must determine with certainty if the DBE companies are interested by taking appropriate steps to follow up initial solicitations.
  - (2) Selecting portions of the work to be performed by DBE companies in order to increase the likelihood that the DBE goals will be achieved. This includes, where appropriate, breaking out contract work items into economically feasible units to facilitate DBE participation, even when the prime Contractor might otherwise prefer to perform these work items with its own forces.
  - (3) Providing interested DBE companies with adequate information about the plans, specifications, and requirements of the contract in a timely manner to assist them in responding to a solicitation.

- (4) a. Negotiating in good faith with interested DBE companies. It is the bidder's responsibility to make a portion of the work available to DBE subcontractors and suppliers and to select those portions of the work or material needs consistent with the available DBE subcontractors and suppliers, so as to facilitate DBE participation. Evidence of such negotiation includes the names, addresses, and telephone numbers of DBE companies that were considered; a description of the information provided regarding the plans and specifications for the work selected for subcontracting; and evidence as to why additional agreements could not be reached for DBE companies to perform the work.
  - b. A bidder using good business judgment would consider a number of factors in negotiating with subcontractors, including DBE subcontractors, and would take a firm's price and capabilities as well as contract goals into consideration. However, the fact that there may be some additional costs involved in finding and using DBE companies is not in itself sufficient reason for a bidder's failure to meet the contract DBE goal, as long as such costs are reasonable. Also the ability or desire of a bidder to perform the work of a contract with its own organization does not relieve the bidder of the responsibility to make good faith efforts. Bidders are not, however, required to accept higher quotes from DBE companies if the price difference is excessive or unreasonable. In accordance with subsection (c)(6) of the above Bidding Procedures, the documentation of good faith efforts must include copies of each DBE and non-DBE subcontractor quote submitted to the bidder when a non-DBE subcontractor was selected over a DBE for work on the contract.
- (5) Not rejecting DBE companies as being unqualified without sound reasons based on a thorough investigation of their capabilities. The bidder's standing within its industry, membership in specific groups, organizations, or associations and political or social affiliations (for example union vs. non-union employee status) are not legitimate causes for the rejection or non-solicitation of bids in the bidder's efforts to meet the project goal.
  - (6) Making efforts to assist interested DBE companies in obtaining bonding, lines of credit, or insurance as required by the recipient or Contractor.
  - (7) Making efforts to assist interested DBE companies in obtaining necessary equipment, supplies, materials, or related assistance or services.
  - (8) Effectively using the services of available minority/women community organizations; minority/women contractors' groups; local, state, and federal minority/women business assistance offices; and other organizations as allowed on a case-by-case basis to provide assistance in the recruitment and placement of DBE companies.

- (b) If the Department determines that the apparent successful bidder has made a good faith effort to secure the work commitment of DBE companies to meet the contract goal, the Department will award the contract provided that it is otherwise eligible for award. If the Department determines that the bidder has failed to meet the requirements of this Special Provision or that a good faith effort has not been made, the Department will notify the responsible company official designated in the Utilization Plan that the bid is not responsive. The notification shall include a statement of reasons for the determination. If the Utilization Plan is not approved because it is deficient as a technical matter, unless waived by the Department, the bidder will be notified and will be allowed no more than a five calendar day period in order to cure the deficiency.
- (c) The bidder may request administrative reconsideration of a determination adverse to the bidder within the five working days after the receipt of the notification date of the determination by delivering the request to the Department of Transportation, Bureau of Small Business Enterprises, Contract Compliance Section, 2300 South Dirksen Parkway, Room 319, Springfield, Illinois 62764 (Telefax: (217) 785-1524). Deposit of the request in the United States mail on or before the fifth business day shall not be deemed delivery. The determination shall become final if a request is not made and delivered. A request may provide additional written documentation or argument concerning the issues raised in the determination statement of reasons, provided the documentation and arguments address efforts made prior to submitting the bid. The request will be forwarded to the Department's Reconsideration Officer. The Reconsideration Officer will extend an opportunity to the bidder to meet in person in order to consider all issues of documentation and whether the bidder made a good faith effort to meet the goal. After the review by the Reconsideration Officer, the bidder will be sent a written decision within ten working days after receipt of the request for consideration, explaining the basis for finding that the bidder did or did not meet the goal or make adequate good faith efforts to do so. A final decision by the Reconsideration Officer that a good faith effort was made shall approve the Utilization Plan submitted by the bidder and shall clear the contract for award. A final decision that a good faith effort was not made shall render the bid not responsive.

CALCULATING DBE PARTICIPATION. The Utilization Plan values represent work anticipated to be performed and paid for upon satisfactory completion. The Department is only able to count toward the achievement of the overall goal and the contract goal the value of payments made for the work actually performed by DBE companies. In addition, a DBE must perform a commercially useful function on the contract to be counted. A commercially useful function is generally performed when the DBE is responsible for the work and is carrying out its responsibilities by actually performing, managing, and supervising the work involved. The Department and Contractor are governed by the provisions of 49 CFR Part 26.55(c) on questions of commercially useful functions as it affects the work. Specific counting guidelines are provided in 49 CFR Part 26.55, the provisions of which govern over the summary contained herein.

- (a) DBE as the Contractor: 100 percent goal credit for that portion of the work performed by the DBE's own forces, including the cost of materials and supplies. Work that a DBE subcontracts to a non-DBE does not count toward the DBE goals.

- (b) DBE as a joint venture Contractor: 100 percent goal credit for that portion of the total dollar value of the contract equal to the distinct, clearly defined portion of the work performed by the DBE's own forces.
- (c) DBE as a subcontractor: 100 percent goal credit for the work of the subcontract performed by the DBE's own forces, including the cost of materials and supplies, excluding the purchase of materials and supplies or the lease of equipment by the DBE subcontractor from the prime Contractor or its affiliates. Work that a DBE subcontractor in turn subcontracts to a non-DBE does not count toward the DBE goal.
- (d) DBE as a trucker: 100 percent goal credit for trucking participation provided the DBE is responsible for the management and supervision of the entire trucking operation for which it is responsible. At least one truck owned, operated, licensed, and insured by the DBE must be used on the contract. Credit will be given for the following:
  - (1) The DBE may lease trucks from another DBE firm, including an owner-operator who is certified as a DBE. The DBE who leases trucks from another DBE receives credit for the total value of the transportation services the lessee DBE provides on the contract.
  - (2) The DBE may also lease trucks from a non-DBE firm, including from an owner-operator. The DBE who leases trucks from a non-DBE is entitled to credit only for the fee or commission is receives as a result of the lease arrangement.
- (e) DBE as a material supplier:
  - (1) 60 percent goal credit for the cost of the materials or supplies purchased from a DBE regular dealer.
  - (2) 100 percent goal credit for the cost of materials of supplies obtained from a DBE manufacturer.
  - (3) 100 percent credit for the value of reasonable fees and commissions for the procurement of materials and supplies if not a DBE regular dealer or DBE manufacturer.

CONTRACT COMPLIANCE. Compliance with this Special Provision is an essential part of the contract. The Department is prohibited by federal regulations from crediting the participation of a DBE included in the Utilization Plan toward either the contract goal or the Department's overall goal until the amount to be applied toward the goals has been paid to the DBE. The following administrative procedures and remedies govern the compliance by the Contractor with the contractual obligations established by the Utilization Plan. After approval of the Utilization Plan and award of the contract, the Utilization Plan and individual DBE Participation Statements become part of the contract. If the Contractor did not succeed in obtaining enough DBE participation to achieve the advertised contract goal, and the Utilization Plan was approved and contract awarded based upon a determination of good faith, the total dollar value of DBE work calculated in the approved Utilization Plan as a percentage of the awarded contract value shall become the amended contract goal. All work indicated for performance by an approved DBE shall be performed, managed, and supervised by the DBE executing the DBE Participation Commitment Statement.

- (a) NO AMENDMENT. No amendment to the Utilization Plan may be made without prior written approval from the Department's Bureau of Small Business Enterprises. All requests for amendment to the Utilization Plan shall be submitted to the Department of Transportation, Bureau of Small Business Enterprises, Contract Compliance Section, 2300 South Dirksen Parkway, Room 319, Springfield, Illinois 62764. Telephone number (217) 785-4611. Telefax number (217) 785-1524.
- (b) CHANGES TO WORK. Any deviation from the DBE condition-of-award or contract plans, specifications, or special provisions must be approved, in writing, by the Department as provided elsewhere in the Contract. The Contractor shall notify affected DBEs in writing of any changes in the scope of work which result in a reduction in the dollar amount condition-of-award to the contract. Where the revision includes work committed to a new DBE subcontractor, not previously involved in the project, then a Request for Approval of Subcontractor, Department form BC 260A or AER 260A, must be signed and submitted. If the commitment of work is in the form of additional tasks assigned to an existing subcontract, then a new Request for Approval of Subcontractor shall not be required. However, the Contractor must document efforts to assure that the existing DBE subcontractor is capable of performing the additional work and has agreed in writing to the change.
- (c) SUBCONTRACT. The Contractor must provide DBE subcontracts to IDOT upon request. Subcontractors shall ensure that all lower tier subcontracts or agreements with DBEs to supply labor or materials be performed in accordance with this Special Provision.

- (d) ALTERNATIVE WORK METHODS. In addition to the above requirements for reductions in the condition of award, additional requirements apply to the two cases of Contractor-initiated work substitution proposals. Where the contract allows alternate work methods which serve to delete or create underruns in condition of award DBE work, and the Contractor selects that alternate method or, where the Contractor proposes a substitute work method or material that serves to diminish or delete work committed to a DBE and replace it with other work, then the Contractor must demonstrate one of the following:
- (1) That the replacement work will be performed by the same DBE (as long as the DBE is certified in the respective item of work) in a modification of the condition of award; or
  - (2) That the DBE is aware that its work will be deleted or will experience underruns and has agreed in writing to the change. If this occurs, the Contractor shall substitute other work of equivalent value to a certified DBE or provide documentation of good faith efforts to do so; or
  - (3) That the DBE is not capable of performing the replacement work or has declined to perform the work at a reasonable competitive price. If this occurs, the Contractor shall substitute other work of equivalent value to a certified DBE or provide documentation of good faith efforts to do so.
- (e) TERMINATION AND REPLACEMENT PROCEDURES. The Contractor shall not terminate or replace a DBE listed on the approved Utilization Plan, or perform with other forces work designated for a listed DBE except as provided in this Special Provision. The Contractor shall utilize the specific DBEs listed to perform the work and supply the materials for which each is listed unless the Contractor obtains the Department's written consent as provided in subsection (a) of this part. Unless Department consent is provided for termination of a DBE subcontractor, the Contractor shall not be entitled to any payment for work or material unless it is performed or supplied by the DBE in the Utilization Plan.

As stated above, the Contractor shall not terminate or replace a DBE subcontractor listed in the approved Utilization Plan without prior written consent. This includes, but is not limited to, instances in which the Contractor seeks to perform work originally designated for a DBE subcontractor with its own forces or those of an affiliate, a non-DBE firm, or with another DBE firm. Written consent will be granted only if the Bureau of Small Business Enterprises agrees, for reasons stated in its concurrence document, that the Contractor has good cause to terminate or replace the DBE firm. Before transmitting to the Bureau of Small Business Enterprises any request to terminate and/or substitute a DBE subcontractor, the Contractor shall give notice in writing to the DBE subcontractor, with a copy to the Bureau, of its intent to request to terminate and/or substitute, and the reason for the request. The Contractor shall give the DBE five days to respond to the Contractor's notice. The DBE so notified shall advise the Bureau and the Contractor of the reasons, if any, why it objects to the proposed termination of its subcontract and why the Bureau should not approve the Contractor's action. If required in a particular case as a matter of public necessity, the Bureau may provide a response period shorter than five days.

For purposes of this paragraph, good cause includes the following circumstances:

- (1) The listed DBE subcontractor fails or refuses to execute a written contract;
- (2) The listed DBE subcontractor fails or refuses to perform the work of its subcontract in a way consistent with normal industry standards. Provided, however, that good cause does not exist if the failure or refusal of the DBE subcontractor to perform its work on the subcontract results from the bad faith or discriminatory action of the prime contractor;
- (3) The listed DBE subcontractor fails or refuses to meet the prime Contractor's reasonable, nondiscriminatory bond requirements;
- (4) The listed DBE subcontractor becomes bankrupt, insolvent, or exhibits credit unworthiness;
- (5) The listed DBE subcontractor is ineligible to work on public works projects because of suspension and debarment proceedings pursuant 2 CFR Parts 180, 215 and 1200 or applicable state law.
- (6) You have determined that the listed DBE subcontractor is not a responsible contractor;
- (7) The listed DBE subcontractor voluntarily withdraws from the projects and provides to you written notice of its withdrawal;
- (8) The listed DBE is ineligible to receive DBE credit for the type of work required;
- (9) A DBE owner dies or becomes disabled with the result that the listed DBE subcontractor is unable to complete its work on the contract;
- (10) Other documented good cause that compels the termination of the DBE subcontractor. Provided, that good cause does not exist if the prime Contractor seeks to terminate a DBE it relied upon to obtain the contract so that the prime Contractor can self-perform the work for which the DBE contractor was engaged or so that the prime Contractor can substitute another DBE or non-DBE contractor after contract award.

When a DBE is terminated, or fails to complete its work on the Contract for any reason the Contractor shall make a good faith effort to find another DBE to substitute for the original DBE to perform at least the same amount of work under the contract as the terminated DBE to the extent needed to meet the established Contract goal. The good faith efforts shall be documented by the Contractor. If the Department requests documentation under this provision, the Contractor shall submit the documentation within seven days, which may be extended for an additional seven days if necessary at the request of the Contractor. The Department shall provide a written determination to the Contractor stating whether or not good faith efforts have been demonstrated.



- (f) PAYMENT RECORDS. The Contractor shall maintain a record of payments for work performed to the DBE participants. The records shall be made available to the Department for inspection upon request. After the performance of the final item of work or delivery of material by a DBE and final payment therefore to the DBE by the Contractor, but not later than thirty calendar days after payment has been made by the Department to the Contractor for such work or material, the Contractor shall submit a DBE Payment Agreement on Department form SBE 2115 to the Resident Engineer. If full and final payment has not been made to the DBE, the DBE Payment Agreement shall indicate whether a disagreement as to the payment required exists between the Contractor and the DBE or if the Contractor believes that the work has not been satisfactorily completed. If the Contractor does not have the full amount of work indicated in the Utilization Plan performed by the DBE companies indicated in the Utilization Plan and after good faith efforts are reviewed, the Department may deduct from contract payments to the Contractor the amount of the goal not achieved as liquidated and ascertained damages. The Contractor may request an administrative reconsideration of any amount deducted as damages pursuant to subsection (h) of this part.
- (g) ENFORCEMENT. The Department reserves the right to withhold payment to the Contractor to enforce the provisions of this Special Provision. Final payment shall not be made on the contract until such time as the Contractor submits sufficient documentation demonstrating achievement of the goal in accordance with this Special Provision or after liquidated damages have been determined and collected.
- (h) RECONSIDERATION. Notwithstanding any other provision of the contract, including but not limited to Article 109.09 of the Standard Specifications, the Contractor may request administrative reconsideration of a decision to deduct the amount of the goal not achieved as liquidated damages. A request to reconsider shall be delivered to the Contract Compliance Section and shall be handled and considered in the same manner as set forth in paragraph (c) of "Good Faith Effort Procedures" of this Special Provision, except a final decision that a good faith effort was not made during contract performance to achieve the goal agreed to in the Utilization Plan shall be the final administrative decision of the Department. The result of the reconsideration process is not administratively appealable to the U.S. Department of Transportation.

**EQUAL EMPLOYMENT OPPORTUNITY (BDE)**

Effective: April 1, 2015

FEDERAL AID CONTRACTS. Revise the following section of Check Sheet #1 of the Recurring Special Provisions to read:

"EQUAL EMPLOYMENT OPPORTUNITY

In the event of the Contractor's noncompliance with the provisions of this Equal Employment Opportunity Clause, the Illinois Human Rights Act, or the Illinois Department of Human Rights Rules and Regulations, the Contractor may be declared ineligible for future contracts or subcontracts with the State of Illinois or any of its political sub-divisions or municipal corporations, and the contract may be cancelled or voided in whole or in part, and such other sanctions or penalties may be imposed or remedies invoked as provided by statute or regulation.

During the performance of this Contract, the Contractor agrees as follows:

- (1) That it will not discriminate against any employee or applicant for employment because of race, color, religion, sex, sexual orientation, marital status, order of protection status, national origin or ancestry, citizenship status, age, physical or mental disability unrelated to ability, military status, or an unfavorable discharge from military service; and further that it will examine all job classifications to determine if minority persons or women are underutilized and will take appropriate affirmative action to rectify any such underutilization.
- (2) That, if it hires additional employees in order to perform this contract or any portion hereof, it will determine the availability (according to the Illinois Department of Human Rights Rules and Regulations) of minorities and women in the area(s) from which it may reasonably recruit and it will hire for each job classification for which employees are hired in such a way that minorities and women are not underutilized.
- (3) That, in all solicitations or advertisements for employees placed by it or on its behalf, it will state that all applicants will be afforded equal opportunity without discrimination because of race, color, religion, sex, sexual orientation, marital status, order of protection status, national origin or ancestry, citizenship status, age, physical or mental disability unrelated to ability, military status or an unfavorable discharge from military service.

- (4) That it will send to each labor organization or representative of workers with which it has or is bound by a collective bargaining or other agreement or understanding, a notice advising such labor organization or representative of the Contractor's obligations under the Illinois Human Rights Act and the Illinois Department of Human Rights Rules and Regulations. If any labor organization or representative fails or refuses to cooperate with the Contractor in its efforts to comply with such Act and Rules and Regulations, the Contractor will promptly so notify the Illinois Department of Human Rights and IDOT and will recruit employees from other sources when necessary to fulfill its obligations thereunder.
- (5) That it will submit reports as required by the Illinois Department of Human Rights Rules and Regulations, furnish all relevant information as may from time to time be requested by the Illinois Department of Human Rights or IDOT, and in all respects comply with the Illinois Human Rights Act and the Illinois Department of Human Rights Rules and Regulations.
- (6) That it will permit access to all relevant books, records, accounts, and work sites by personnel of IDOT and the Illinois Department of Human Rights for purposes of investigation to ascertain compliance with the Illinois Human Rights Act and the Illinois Department of Human Rights Rules and Regulations.
- (7) That it will include verbatim or by reference the provisions of this clause in every subcontract it awards under which any portion of the contract obligations are undertaken or assumed, so that the provisions will be binding upon the subcontractor. In the same manner as with other provisions of this contract, the Contractor will be liable for compliance with applicable provisions of this clause by subcontractors; and further it will promptly notify IDOT and the Illinois Department of Human Rights in the event any subcontractor fails or refuses to comply with these provisions. In addition, the Contractor will not utilize any subcontractor declared by the Illinois Human Rights Commission to be ineligible for contracts or subcontracts with the State of Illinois or any of its political subdivisions or municipal corporations."

STATE CONTRACTS. Revise Section II of Check Sheet #5 of the Recurring Special Provisions to read:

"II. EQUAL EMPLOYMENT OPPORTUNITY

In the event of the Contractor's noncompliance with the provisions of this Equal Employment Opportunity Clause, the Illinois Human Rights Act or the Illinois Department of Human Rights Rules and Regulations, the Contractor may be declared ineligible for future contracts or subcontracts with the State of Illinois or any of its political sub-divisions or municipal corporations, and the contract may be cancelled or voided in whole or in part, and such other sanctions or penalties may be imposed or remedies invoked as provided by statute or regulation.

During the performance of this Contract, the Contractor agrees as follows:

1. That it will not discriminate against any employee or applicant for employment because of race, color, religion, sex, sexual orientation, marital status, order of protection status, national origin or ancestry, citizenship status, age, physical or mental disability unrelated to ability, military status, or an unfavorable discharge from military service; and further that it will examine all job classifications to determine if minority persons or women are underutilized and will take appropriate affirmative action to rectify any such underutilization.
2. That, if it hires additional employees in order to perform this contract or any portion hereof, it will determine the availability (according to the Illinois Department of Human Rights Rules and Regulations) of minorities and women in the area(s) from which it may reasonably recruit and it will hire for each job classification for which employees are hired in such a way that minorities and women are not underutilized.
3. That, in all solicitations or advertisements for employees placed by it or on its behalf, it will state that all applicants will be afforded equal opportunity without discrimination because of race, color, religion, sex, sexual orientation, marital status, order of protection status, national origin or ancestry, citizenship status, age, physical or mental disability unrelated to ability, military status, or an unfavorable discharge from military service.
4. That it will send to each labor organization or representative of workers with which it has or is bound by a collective bargaining or other agreement or understanding, a notice advising such labor organization or representative of the Contractor's obligations under the Illinois Human Rights Act and the Illinois Department of Human Rights Rules and Regulations. If any labor organization or representative fails or refuses to cooperate with the Contractor in its efforts to comply with such Act and Rules and Regulations, the Contractor will promptly so notify the Illinois Department of Human Rights and IDOT and will recruit employees from other sources when necessary to fulfill its obligations thereunder.
5. That it will submit reports as required by the Illinois Department of Human Rights Rules and Regulations, furnish all relevant information as may from time to time be requested by the Illinois Department of Human Rights or IDOT, and in all respects comply with the Illinois Human Rights Act and the Illinois Department of Human Rights Rules and Regulations.
6. That it will permit access to all relevant books, records, accounts and work sites by personnel of IDOT and the Illinois Department of Human Rights for purposes of investigation to ascertain compliance with the Illinois Human Rights Act and the Illinois Department of Human Rights Rules and Regulations.

7. That it will include verbatim or by reference the provisions of this clause in every subcontract it awards under which any portion of the contract obligations are undertaken or assumed, so that the provisions will be binding upon the subcontractor. In the same manner as with other provisions of this contract, the Contractor will be liable for compliance with applicable provisions of this clause by subcontractors; and further it will promptly notify IDOT and the Illinois Department of Human Rights in the event any subcontractor fails or refuses to comply with these provisions. In addition, the Contractor will not utilize any subcontractor declared by the Illinois Human Rights Commission to be ineligible for contracts or subcontracts with the State of Illinois or any of its political subdivisions or municipal corporations.”

### **ERRATA FOR THE 2016 STANDARD SPECIFICATIONS (BDE)**

Effective: April 1, 2016

- Page 84 Article 204.02. In the seventh line of the first paragraph change “AASHTO T 99 (Method C)” to “Illinois Modified AASHTO T 99 (Method C)”.
- Page 90 Article 205.06. In the first sentence of the third paragraph change “AASHTO T 99 (Method C)” to “Illinois Modified AASHTO T 99 (Method C)”.
- Page 91 Article 205.06. In the first sentence of the fourth paragraph change “AASHTO T 99 (Method C)” to “Illinois Modified AASHTO T 99 (Method C)”, and in the second sentence change “AASHTO T 224” to “Illinois Modified AASHTO T 99 (Annex A1)”.
- Page 91 Article 205.06. In the second line of the fifth paragraph change “AASHTO T 191” to “Illinois Modified AASHTO T 191”.
- Page 91 Article 205.06. In the sixth line of the eighth paragraph change “AASHTO T 99 (Method C)” to “Illinois Modified AASHTO T 99 (Method C)”.
- Page 148 Article 302.09. In the second sentence of the fifth paragraph change “AASHTO T 191” to “Illinois Modified AASHTO T 191”, and in the third sentence change “AASHTO T 99” to “Illinois Modified AASHTO T 99”.
- Page 152 Article 310.09. In the second sentence of the second paragraph change “AASHTO T 191” to “Illinois Modified AASHTO T 191”, and in the third sentence change “AASHTO T 99” to “Illinois Modified AASHTO T 99”.
- Page 155 Article 311.05(a). In the first sentence of the fifth paragraph change “AASHTO T 99 (Method C)” to “Illinois Modified AASHTO T 99 (Method C)”, and in the second sentence change “AASHTO T 224” to “Illinois Modified AASHTO T 99 (Annex A1)”.
- Page 155 Article 311.05(a). In the second line of the sixth paragraph change “AASHTO T 191” to “Illinois Modified AASHTO T 191”.

- Page 163 Article 351.05(a). In the second sentence of the fifth paragraph change “AASHTO T 99 (Method C)” to “Illinois Modified AASHTO T 99 (Method C)”, and in the third sentence change “AASHTO T 224” to “Illinois Modified AASHTO T 99 (Annex A1)”.
- Page 163 Article 351.05(a). In the second line of the sixth paragraph change “AASHTO T 191” to “Illinois Modified AASHTO T 191”.
- Page 169 Article 352.11. In the second sentence of the fourth paragraph change “AASHTO T 191” to “Illinois Modified AASHTO T 191”, and in the third sentence change “AASHTO T 134 (Method B)” to “Illinois Modified AASHTO T 134 (Method B)”.
- Page 169 Article 352.12. In the first sentence of the first paragraph change “AASHTO T 22” to “Illinois Modified AASHTO T 22”, and in the second sentence change “AASHTO T 134 (Method B)” to “Illinois Modified AASHTO T 134 (Method B)”.
- Page 196 Article 406.07(a). After the footnotes in Table 1 - Minimum Roller Requirements for HMA add the following:

“EQUIPMENT DEFINITION

- V<sub>s</sub> - Vibratory roller, static mode, minimum 125 lb/in. (2.2 kg/mm) of roller width. Maximum speed = 3 mph (5 km/h) or 264 ft/min (80 m/min). If the vibratory roller does not eliminate roller marks, its use shall be discontinued and a tandem roller, adequately ballasted to remove roller marks, shall be used.
- V<sub>D</sub> - Vibratory roller, dynamic mode, operated at a speed to produce not less than 10 impacts/ft (30 impacts/m).
- P - Pneumatic-tired roller, max. speed 3 1/2 mph (5.5 km/h) or 308 ft/min (92 m/min). The pneumatic-tired roller shall have a minimum tire pressure of 80 psi (550 kPa) and shall be equipped with heat retention shields. The self-propelled pneumatic-tired roller shall develop a compression of not less than 300 lb (53 N) nor more than 500 lb (88 N) per in. (mm) of width of the tire tread in contact with the HMA surface.
- T<sub>B</sub> - Tandem roller for breakdown rolling, 8 to 12 tons (7 to 11 metric tons), 250 to 400 lb/in. (44 to 70 N/mm) of roller width, max. speed = 3 1/2 mph (5.5 km/h) or 308 ft/min (92 m/min).
- T<sub>F</sub> - Tandem roller for final rolling, 200 to 400 lb/in. (35 to 70 N/mm) of roller width with minimum roller width of 50 in. (1.25 m). Ballast shall be increased if roller marks are not eliminated. Ballast shall be decreased if the mat shoves or distorts.
- 3W- Three wheel roller, max. speed = 3 mph (5 km/h) or 264 ft/min (80 m/min), 300 to 400 lb/in. (53 to 70 N/mm) of roller width. The three-wheel roller shall weigh 10 to 12 tons (9 to 11 metric tons).”

- Page 331 Article 505.04(p). Under Range of Clearance in the first table change “in. x 10<sup>-6</sup>” to “in. x 10<sup>-3</sup>”.
- Page 444 Article 542.03. In the Notes in Table IIIB add “CPP Corrugated Polypropylene (CPP) pipe with smooth interior”.
- Page 445 Article 542.03. In the fourth column in Table IIIB (metric) change the heading for Type 5 pipe from “CPE” to “CPP”.
- Page 445 Article 542.03. In the Notes in Table IIIB (metric) change “PE Polyethylene (PE) pipe with a smooth interior” to “CPP Corrugated Polypropylene (CPP) pipe with smooth interior”.
- Page 449 Article 542.04(f)(2). In the third line of the second paragraph change “AASHTO T 99 (Method C)” to “Illinois Modified AASHTO T 99 (Method C)”.
- Page 544 Article 639.03. In the first sentence of the first paragraph change “AASHTO Standard Specifications for Structural Supports for Highway Signs, Luminaires, Traffic Signals,” to “AASHTO “LRFD Specifications for Structural Supports for Highway Signs, Luminaires, and Traffic Signals,””.
- Page 546 Article 640.03. In the first sentence of the first paragraph change “AASHTO Standard Specifications for Structural Supports for Highway Signs, Luminaires, and Traffic Signals” to “AASHTO “LRFD Specifications for Structural Supports for Highway Signs, Luminaires, and Traffic Signals””.
- Page 548 Article 641.03. In the first sentence of the first paragraph change “AASHTO Standard Specifications for Structural Supports for Highway Signs, Luminaire and Traffic Signals,” to “AASHTO “LRFD Specifications for Structural Supports for Highway Signs, Luminaires, and Traffic Signals,””.
- Page 621 Article 727.03. In the first sentence of the third paragraph change “AASHTO Standard Specifications for Structural Supports for Highway Signs, Luminaires and Traffic Signals” to “AASHTO “LRFD Specifications for Structural Supports for Highway Signs, Luminaires, and Traffic Signals””.
- Page 629 Article 734.03(a). In the fourth line of the second paragraph change “AASHTO T 99 (Method C)” to “Illinois Modified AASHTO T 99 (Method C)”.
- Page 649 Article 801.02. In the first sentence of the first paragraph change “AASHTO’s Standard Specifications for Structural Supports for Highway Signs, Luminaires, and Traffic Signals” to “AASHTO “LRFD Specifications for Structural Supports for Highway Signs, Luminaires, and Traffic Signals””.
- Page 742 Article 1003.04(c). Under Gradation in the table change “(see Article 1003.02(c))” to “(see Article 1003.01(c))”.

- Page 755 Article 1004.03(b). Revise the third sentence of the first paragraph to read “For Class A (seal or cover coat), and other binder courses, the coarse aggregate shall be Class C quality or better.”.
- Page 809 Article 1020.04(e). In the third line of the first paragraph change “ITP SCC-3” to “ITP SCC-4”.
- Page 945 Article 1069.05. In the first sentence of the tenth paragraph change ““Standard Specifications for Structural Supports for Highway Signs, Luminaires, and Traffic Signals”” to “AASHTO “LRFD Specifications for Structural Supports for Highway Signs, Luminaires, and Traffic Signals””.
- Page 961 Article 1070.04(b)(1). In the third sentence of the first paragraph change ““Standard Specifications of Structural Supports for Highway Signs, Luminaires and Traffic Signals” published by AASHTO” to “AASHTO “LRFD Specifications for Structural Supports for Highway Signs, Luminaires, and Traffic Signals””.
- Page 989 Article 1077.01. In the second sentence of the first paragraph change “Standard Specifications for Structural Supports for Highway Signs, Luminaires, and Traffic Signals, as published by AASHTO” to “AASHTO “LRFD Specifications for Structural Supports for Highway Signs, Luminaires, and Traffic Signals””.
- Page 1121 Article 1103.13(a). In the first line of the first paragraph change “Bridge Deck Approach Slabs.” to “Bridge Deck and Approach Slabs.”.



**PROGRESS PAYMENTS (BDE)**

Effective: November 2, 2013

Revise Article 109.07(a) of the Standard Specifications to read:

“(a) Progress Payments. At least once each month, the Engineer will make a written estimate of the quantity of work performed in accordance with the contract, and the value thereof at the contract unit prices. The amount of the estimate approved as due for payment will be vouchered by the Department and presented to the State Comptroller for payment. No amount less than \$1000.00 will be approved for payment other than the final payment.

Progress payments may be reduced by liens filed pursuant to Section 23(c) of the Mechanics’ Lien Act, 770 ILCS 60/23(c).

If a Contractor or subcontractor has defaulted on a loan issued under the Department’s Disadvantaged Business Revolving Loan Program (20 ILCS 2705/2705-610), progress payments may be reduced pursuant to the terms of that loan agreement. In such cases, the amount of the estimate related to the work performed by the Contractor or subcontractor, in default of the loan agreement, will be offset, in whole or in part, and vouchered by the Department to the Working Capital Revolving Fund or designated escrow account. Payment for the work shall be considered as issued and received by the Contractor or subcontractor on the date of the offset voucher. Further, the amount of the offset voucher shall be a credit against the Department’s obligation to pay the Contractor, the Contractor’s obligation to pay the subcontractor, and the Contractor’s or subcontractor’s total loan indebtedness to the Department. The offset shall continue until such time as the entire loan indebtedness is satisfied. The Department will notify the Contractor and Fund Control Agent in a timely manner of such offset. The Contractor or subcontractor shall not be entitled to additional payment in consideration of the offset.

The failure to perform any requirement, obligation, or term of the contract by the Contractor shall be reason for withholding any progress payments until the Department determines that compliance has been achieved.”

**SPEED DISPLAY TRAILER (BDE)**

Effective: April 2, 2014

Revised: April 1, 2016

Add the following to Article 701.15 of the Standard Specifications:

“(m) Speed Display Trailer. A speed display trailer shall be utilized on freeways and expressways as part of Highway Standard 701400. The trailer shall be placed on the right hand side of the roadway adjacent to, or within 100 ft (30 m) beyond, the first work zone speed limit sign.

Whenever the speed display trailer is not in use, it shall be considered non-operating equipment and shall be stored according to Article 701.11.”

Add the following to Article 701.20 of the Standard Specifications:

“(k) Speed Display Trailer will be paid for at the contract unit price per calendar month or fraction thereof for each trailer as SPEED DISPLAY TRAILER.”

Add the following to Article 1106.02 of the Standard Specifications:

“(o) Speed Display Trailer. The speed display trailer shall consist of a LED speed indicator display with self-contained, one-direction radar mounted on an orange see-through trailer. The height of the display and radar shall be such that it will function and be visible when located behind concrete barrier.

The speed measurement shall be by radar and provide a minimum detection distance of 1000 ft (300 m). The radar shall have an accuracy of  $\pm 1$  mile per hour.

The speed indicator display shall face approaching traffic and shall have a sign legend of “YOUR SPEED” immediately above or below the speed display. The digital speed display shall show two digits (00 to 99) in mph. The color of the changeable message legend shall be a yellow legend on a black background. The minimum height of the numerals shall be 18 in. (450 mm), and the nominal legibility distance shall be at least 750 ft (250 m).

The speed indicator display shall be equipped with a violation alert that flashes the displayed detected speed when the posted limit is exceeded. The speed indicator shall have a maximum speed cutoff. The display shall include automatic dimming for nighttime operation.

The speed indicator measurement and display functions shall be equipped with the power supply capable of providing 24 hours of uninterrupted service.”

**WEEKLY DBE TRUCKING REPORTS (BDE)**

Effective: June 2, 2012

Revised: April 2, 2015

The Contractor shall submit a weekly report of Disadvantaged Business Enterprise (DBE) trucks hired by the Contractor or subcontractors (i.e. not owned by the Contractor or subcontractors) that are used for DBE goal credit.

The report shall be submitted to the Engineer on Department form "SBE 723" within ten business days following the reporting period. The reporting period shall be Monday through Sunday for each week reportable trucking activities occur.

Any costs associated with providing weekly DBE trucking reports shall be considered as included in the contract unit prices bid for the various items of work involved and no additional compensation will be allowed.

**WORKING DAYS (BDE)**

Effective: January 1, 2002

The Contractor shall complete the work within 35 working days.

**VETERAN BUSINESS PROGRAM**

Effective: November 6, 2014

STATE OBLIGATION. This special provision will be used by the Department to satisfy the requirements of the Illinois Procurement Code, 30 ILCS 500/45-57. It is the goal of the State to promote and encourage the continued economic development of small businesses owned and controlled by qualified veterans and that qualified Service-Disabled Veteran-Owned Small Businesses (SDVOSB) and Veteran-Owned Small Businesses (VOSB) participate in the State's procurement process as both prime contractors and subcontractors.

CONTRACT GOAL TO BE ACHIEVED BY THE CONTRACTOR. This contract includes a specific Veteran Small Business participation goal of **0.00%** based on the availability of CMS certified veteran-owned and service-disabled veteran-owned small business (VOSB/SDVOSB) vendors to perform or provide the anticipated services and/or supplies required by this contract.

The Veteran Small Business participation goal is applicable to all bids. In addition to the other award criteria established for this contract, the Department will award this contract to a Vendor that meets the goal or makes good faith efforts to meet the goal. This goal is also applicable to change orders and allowances within the scope of work provided by the certified VOSB/SDVOSB vendor. If Vendor is a CMS certified VOSB/SDVOSB vendor, the entire goal is met and no subcontracting with a CMS certified VOSB/SDVOSB vendor is required; however, Vendor must submit a Utilization Plan indicating that the goal will be met by self-performance.

VETERAN SMALL BUSINESS CERTIFIED VENDOR LOCATOR REFERENCES. Vendors may consult CMS' Veteran Small Business Vendor Directory at [www.sell2.illinois.gov/cms/business](http://www.sell2.illinois.gov/cms/business) as well as the directories of other certifying agencies, but firms must be certified with CMS as VOSB/SDVOSB vendors at the time of bid/offer (see Title 44 Illinois Administrative Code Sec. 20.530).

BIDDING PROCEDURES. Compliance with this Special Provision is a material bidding requirement. The failure of the bidder to comply with this special provision will render the bid nonresponsive or not responsible.

At the time of the bid, Vendor, or Vendor's proposed subcontractor, must be certified with CMS as a VOSB or SDVOSB.

Following are guidelines for Vendor's completion of the Utilization Plan.

- (a) The bidder shall submit a Veteran Business Program (VBP) Utilization Plan. The format for the VBP Utilization Plan is included in this special provision.
- (b) Vendor should include any additional information that will add clarity to Vendor's proposed utilization of certified Veteran Small Business vendors to meet the targeted goal. The Utilization Plan must demonstrate that Vendor has either:
  - (1) met the entire contract goal;
  - (2) made good faith efforts towards meeting the entire goal; or
  - (3) made good faith efforts towards meeting a portion of the goal. Any submission of good faith efforts by Vendor shall be considered as a request for a full or partial waiver.
- (c) If the bidder is a joint venture comprised of Veteran Business Enterprises (VBE) companies and non-VBE companies, the plan must also include:
  - (1) A clear identification of the portion of work to be performed by the VOSB/SDVOSB partner(s); and
  - (2) An agreement between a vendor and a certified VOSB/SDVOSB vendor in which a certified VOSB/SDVOSB vendor promises not to provide subcontracting or pricing quotations to other vendors is prohibited. The Department may request additional information to demonstrate compliance. Vendor agrees to cooperate promptly with the Department in submitting to interviews, allowing entry to places of business, providing further documentation, and to soliciting the cooperation of a proposed certified VOSB/SDVOSB vendor. Failure to cooperate by Vendor and certified VOSB/SDVOSB vendor may render the bidder nonresponsive or not responsible. The contract will not be awarded to Vendor unless Vendor's Utilization Plan is approved.

GOOD FAITH EFFORT PROCEDURES. Vendor must submit a Utilization Plans and Letters of Intent that meet or exceed the published goal. If Vendor cannot meet the stated goal, Vendor must document and explain within the Utilization Plan the good faith efforts it undertook to meet the goal. Utilization Plans are due at the time of bid. Vendors may not be permitted to correct goal deficiencies after bid due dates. The Department will consider the quality, quantity, and intensity of Vendor's efforts but if the Department determines that a Vendor did not demonstrate good faith efforts towards meeting the goal on the bid, the bid may be deemed nonresponsive or not responsible.

The Utilization Plan contains a checklist of actions that the Department will consider as evidence of Vendor's good faith efforts to meet the goal. Other factors or efforts brought to the attention of the Department may be relevant in appropriate cases.

- (a) In evaluating Vendor's good faith efforts, the Department may consider whether the ability of other bidders to meet the contract goal suggests that good faith efforts could have resulted in Vendor meeting the goal.
- (b) If the Department determines that Vendor has made good faith efforts to meet the goal, the Department may award the contract provided that Vendor is otherwise eligible for award.
- (c) If the Department determines that good faith efforts have not been met, the bidder may be determined to be nonresponsive or not responsible.

CALCULATING CERTIFIED VOSB/SDVOSB VENDOR PARTICIPATION. The Utilization Plan documents work anticipated to be performed by all certified VOSB/SDVOSB vendors and paid for upon satisfactory completion. The Department is only able to count toward the achievement of the overall goal and the contract goal the value of payments made for the work actually performed by the VOSB/SDVOSB vendors. Applicable guidelines for counting payments attributable to contract goals are listed below:

- (a) A Vendor shall count towards the goal only expenditures to firms that perform a commercially useful function in the work of the contract.
  - (1) A firm is considered to perform a commercially useful function when it is responsible for execution of a distinct element of the work of a contract and carries out its responsibilities by actually performing, managing, and supervising the work involved. The certified VOSB/SDVOSB vendor must also be responsible, with respect to materials or supplies used on the contract, for negotiating price, determining quality and quantity, ordering the materials or supplies, and installing the materials (where applicable) and paying for the material or supplies. To determine whether a firm is performing a commercially useful function, the Department shall evaluate the amount of work subcontracted, whether the amount the firm is to be paid under the contract is commensurate with the work it is actually performing and the credit claimed for its performance of the work, industry practices, and other relevant factors.
  - (2) A certified VOSB/SDVOSB vendor does not perform a commercially useful function if its role is limited to that of an extra participant in a transaction or contract through which funds are passed through in order to obtain certified VOSB/SDVOSB vendor participation. In determining whether a certified VOSB/SDVOSB vendor is such an extra participant, the Department shall examine similar transactions, particularly those in which certified VOSB/SDVOSB vendors do not participate, and industry practices.
- (b) The value of the work actually performed or goods/equipment provided by the certified VOSB/SDVOSB vendor shall be counted towards the goal. The entire amount of that portion of the contract that is performed by the certified VOSB/SDVOSB vendor, including supplies purchased or equipment leased by the certified VOSB/SDVOSB vendor shall be counted, except supplies purchased and equipment rented from the Prime Vendor submitting this bid.

- (c) A vendor shall count the portion of the total dollar value of the Veteran Small Business contract equal to the distinct, clearly defined portion of the work of the contract that the certified VOSB/SDVOSB vendor performs toward the goal. A vendor shall also count the dollar value of work subcontracted to other certified VOSB/SDVOSB vendor. Work performed by the non-certified VOSB/SDVOSB party shall not be counted toward the goal. Work that a certified VOSB/SDVOSB vendor subcontracts to a non-certified VOSB/SDVOSB vendor will not count towards the goal.
- (d) A Vendor shall count toward the goal 100% of its expenditures for materials and supplies required under the contract and obtained from a certified VOSB/SDVOSB vendor manufacturer, regular dealer, or supplier. A Vendor shall count toward the goal the following expenditures to certified VOSB/SDVOSB vendors that are not manufacturers, regular dealers, or suppliers.
- (1) The fees or commissions charged for providing a bona fide service, such as professional, technical, consultant or managerial services and assistance in the procurement of essential personnel, facilities, equipment, materials or supplies required for performance of the contract, provided that the fee or commission is determined by the Department to be reasonable and not excessive as compared with fees customarily allowed for similar services.
  - (2) The fees charged for delivery of materials and supplies required by the contract (but not the cost of the materials and supplies themselves) when the hauler, trucker, or delivery service is not also the manufacturer or a supplier of the materials and supplies being procured, provided that the fee is determined by the Department to be reasonable and not excessive as compared with fees customarily allowed for similar services. The certified VOSB/SDVOSB vendor's trucking firm must be responsible for the management and supervision of the entire trucking operation for which it is responsible on the contract, and must itself own and operate at least one fully licensed, insured and operational truck used on the contract.
  - (3) The fees or commissions charged for providing any bonds or insurance specifically required for the performance of the contract, provided that the fee or commission is determined by the Department to be reasonable and not excessive as compared with fees customarily allowed for similar services.
- (e) Certified VOSB/SDVOSB vendors who are performing on contract as second tier subcontractors may be counted in meeting the established Veteran Small Business goal for this contract as long as the Prime Vendor can provide documentation indicating the utilization of these vendors.
- (f) A Vendor shall not count towards the goal expenditures that are not direct, necessary and related to the work of the contract. Only the amount of services or goods that are directly attributable to the performance of the contract shall be counted. Ineligible expenditures include general office overhead or other Vendor support activities.

**CONTRACT COMPLIANCE.** Compliance with this section is an essential part of the contract. The following administrative procedures and remedies govern Vendor's compliance with the contractual obligations established by the Utilization Plan. After approval of the Plan and award of the contract, the Utilization Plan becomes part of the contract. If Vendor did not succeed in obtaining certified VOSB/SDVOSB vendor participation to achieve the goal and the Utilization Plan was approved and contract awarded based upon a determination of good faith, the total dollar value of certified VOSB/SDVOSB vendor work calculated in the approved Utilization Plan as a percentage of the awarded contract value shall become the contract goal. Vendors are encouraged to seek VOSB/SDVOSB firms during the course of performing the contract.

- (a) **NO AMENDMENT.** The Utilization Plan may not be amended after contract execution without the Department's prior written approval.
- (b) **CHANGES TO WORK.** Vendor may not make changes to its contractual certified VOSB/SDVOSB vendor commitments or substitute certified VOSB/SDVOSB vendors without the prior written approval of the Department. Unauthorized changes or substitutions, including performing the work designated for a certified VOSB/SDVOSB vendor with Vendor's own forces, shall be a violation of the utilization plan and a breach of the contract, and shall be cause to terminate the contract, and/or seek other contract remedies or sanctions. The facts supporting the request for changes must not have been known nor reasonably should have been known by the parties prior to entering into the subcontract. Vendor must negotiate with the certified VOSB/SDVOSB vendor to resolve the problem. Where there has been a mistake or disagreement about the scope of work or goods/equipment, provided the certified VOSB/SDVOSB vendor can be substituted only where agreement cannot be reached for a reasonable price or schedule for the correct scope of work, goods or equipment.

Substitutions of a certified VOSB/SDVOSB vendor may be permitted under the following circumstances and possibly others on a case-by-case basis:

- (1) Unavailability after receipt of reasonable notice to proceed;
- (2) Failure of performance;
- (3) Financial incapacity;
- (4) Refusal by the certified VOSB/SDVOSB vendor to honor the bid or proposal price or scope;
- (5) Material mistake of fact or law about the elements of the scope of work of a solicitation where a reasonable price cannot be agreed;
- (6) Failure of the certified VOSB/SDVOSB vendor to meet insurance, licensing or bonding requirements;
- (7) The certified VOSB/SDVOSB vendor's withdrawal of its bid or offer; or
- (8) Decertification of the certified VOSB/SDVOSB vendor.



If it becomes necessary to substitute a certified VOSB/SDVOSB vendor or otherwise change the Utilization Plan, Vendor must notify the Department in writing of the request to substitute a certified VOSB/SDVOSB vendor or otherwise change the Utilization Plan. The request must state specific reasons for the substitution or change. The Department will approve or deny a request for substitution or other change in the Utilization Plan within five business days of receipt of the request.

Where Vendor has established the basis for the substitution to the Department's satisfaction, it must make good faith efforts to meet the contract goal by substituting a certified VOSB/SDVOSB vendor. Documentation of a replacement certified VOSB/SDVOSB vendor, or of good faith efforts to replace the certified VOSB/SDVOSB vendor, must meet the requirements of the initial Utilization Plan. If the goal cannot be reached and good faith efforts have been made, Vendor may substitute with a non-certified VOSB/SDVOSB vendor or Vendor may perform the work.

When adding a VOSB/SDVOSB, a new certified VOSB/SDVOSB vendor agreement should be executed and submitted to the Department with the appropriate subcontractor approval forms prior to the subcontractor's performance of work on the project.

Vendor shall maintain a record of all relevant data with respect to the utilization of certified VOSB/SDVOSB vendors. Full access to these records shall be granted by Vendor upon 48 hours written demand by the Department to any duly authorized representative thereof, or to any municipal, state or federal authorities. The Department shall have the right to obtain from Vendor any additional data reasonably related or necessary to verify any representations by Vendor. After the performance of the final item of work or delivery of material by the certified VOSB/SDVOSB vendor and final payment to the certified VOSB/SDVOSB vendor by Vendor, but not later than 15 calendar days after such payment, Vendor shall submit a statement confirming the final payment and the total payments made to the certified VOSB/SDVOSB vendor under the contract.

The Department will periodically review Vendor's compliance with these provisions and the terms of its contract. Without limitation, Vendor's failure to comply with these provisions or its contractual commitments as contained in the Utilization Plan, failure to cooperate in providing information regarding its compliance with these provisions or its Utilization Plan, or provision of false or misleading information or statements concerning compliance, certification status or eligibility of the certified VOSB/SDVOSB vendor, good faith efforts or any other material fact or representation shall constitute a material breach of this contract and entitle the Department to declare a default, terminate the contract, or exercise those remedies provided for in the contract or at law or in equity.

The Department reserves the right to withhold payment to Vendor to enforce these provisions and Vendor's contractual commitments. Final payment shall not be made pursuant to the contract until Vendor submits sufficient documentation demonstrating compliance with its Utilization Plan.

**\*\*RETURN WITH BID\*\***

**VETERAN BUSINESS PROGRAM (VBP) UTILIZATION PLAN**

The VBP Utilization Plan includes the Letters of Intent and Good Faith Efforts.

(Vendor)\_\_\_\_\_ submits the following Utilization Plan as part of our bid or offer in accordance with the requirements of the (VBP). We understand that all subcontractors must be certified with the CMS Veteran Small Business Program at the time of submission of all bids. We understand that compliance with this section is an essential part of this contract and that the Utilization Plan will become a part of the contract, if awarded.

Vendor submits the following statement:

- \_\_\_ Vendor is a certified VOSB/SDVOSB and plans to fully meet the goal through self-performance.
- \_\_\_ Vendor has identified certified VOSB/SDVOSB subcontractor(s) to fully meet the established goal and submits the attached completed Letter(s) of Intent; or
- \_\_\_ Vendor has made good faith efforts towards meeting the entire goal, or a portion of the goal, and hereby requests a waiver (complete checklist below).

**\*\*RETURN WITH BID\*\***

Vendor's person responsible for compliance:

Name: Title:  
Telephone: Email

**DEMONSTRATION OF GOOD FAITH EFFORTS TO ACHIEVE GOAL AND REQUEST FOR WAIVER**

If the Veteran Small Business participation goal was not achieved, the Good Faith Efforts Procedures and Guidelines outlined in Contract Compliance will be used to evaluate submitted utilization plans. Vendors providing Good Faith Effort documentation and request for waiver must complete and submit the Good Faith Effort Contact Log with the bid or offer. Failure to submit Good Faith Effort documentation in its entirety shall render Vendor's bid nonresponsive or not responsible and cause it to be rejected or render Vendor ineligible for contract award. Insufficient Good Faith Effort documentation may render the bidder nonresponsive or not responsible.

Below is a checklist of actions that will be used to evaluate a Vendor's Demonstration of Good Faith Efforts and Request for Waiver. Please check the actions which you completed. If any of the following actions are not completed, please attach a detailed written explanation indicating why such action was not completed. If any other efforts were made to obtain Veteran Small Business participation in addition to the items listed below, attach a detailed description of such efforts.

- \_\_\_\_\_ Utilize the Sell2Illinois website: [www2.illinois.gov/cms/business](http://www2.illinois.gov/cms/business) to identify certified VOSB/SDVOSB vendors within the respective commodity/service codes denoted above and at a minimum email all listed vendors and solicit quotes from all vendors who express an interest via follow-up emails or telephone calls.
- \_\_\_\_\_ Solicit through all reasonable and available means (e.g., attendance at a vendor conference, advertising and/or written notices) the interest of certified VOSB/SDVOSB vendors that have the capability to perform the work of the contract. Vendor must solicit this interest within sufficient time to allow the certified VOSB/SDVOSB vendors to respond to the solicitation. Vendor must determine with certainty if the certified VOSB/SDVOSB vendors are interested by taking appropriate steps to follow up initial solicitations and encourage them to submit a bid or proposal. Vendor must provide interested certified VOSB/SDVOSB vendors with adequate information about the plans, specifications, and requirements of the contract in a timely manner to assist them in responding promptly to the solicitation.
- \_\_\_\_\_ Select portions of the work to be performed by certified VOSB/SDVOSB vendors in order to increase the likelihood that the goal will be achieved. This includes, where appropriate, breaking out contract work items into economically feasible units to facilitate certified VOSB/SDVOSB vendor participation, even when Vendor might otherwise prefer to perform these work items with its own forces.
- \_\_\_\_\_ Make a portion of the work available to certified VOSB/SDVOSB vendors and selecting those portions of the work or material needs consistent with their availability, so as to facilitate certified VOSB/SDVOSB vendor participation.

**\*\*RETURN WITH BID\*\***

- \_\_\_\_\_ Negotiate in good faith with interested certified VOSB/SDVOSB vendors. Evidence of such negotiation must include the names, addresses, email addresses, and telephone numbers of certified VOSB/SDVOSB vendors that were considered; a description of the information provided regarding the plans and specifications for the work selected for subcontracting and evidence as to why additional agreements could not be reached for certified VOSB/SDVOSB vendors to perform the work. A Vendor using good business judgment may consider a number of factors in negotiating with certified VOSB/SDVOSB vendors and may take a firm's price and capabilities into consideration. The fact that there may be some additional costs involved in finding and using certified VOSB/SDVOSB vendors may not be in itself sufficient reason for a Vendor's failure to meet the goal, as long as such costs are reasonable. Vendors are not required to accept higher quotes from certified VOSB/SDVOSB vendors if the price difference is excessive or unreasonable.
  
- \_\_\_\_\_ Thoroughly investigate the capabilities of certified VOSB/SDVOSB vendors and not reject them as unqualified without documented reasons.
  
- \_\_\_\_\_ Make efforts to assist interested certified VOSB/SDVOSB vendors in obtaining lines of credit or insurance as required by the State.
  
- \_\_\_\_\_ Make efforts to assist interested certified VOSB/SDVOSB vendors in obtaining necessary equipment, supplies, materials, or related assistance or services.

**\*\*RETURN WITH BID\*\***

**GOOD FAITH EFFORTS CONTACT LOG**

Use this Log to document all contacts and responses (telephone, e-mail, fax, etc.) regarding the solicitation of certified VOSB/SDVOSB vendors within the specific scope of work selected. It is not necessary to show contacts with certified VOSB/SDVOSB vendors who are identified on the Letter(s) of Intent. Keep and submit copies of all emails sent and received from prospective vendors. Include a copy of the commodity list or scope of work you solicited prospective vendors to perform. Duplicate this log as necessary; do not limit your contacts to the number of spaces shown.

Name of Certified Veteran Small Business Vendor	Date	Method of Contact	Scope of Work Solicited	Reason Agreement Was Not Reached

**\*\*RETURN WITH BID\*\***

**LETTER OF INTENT (LOI)**

**BETWEEN PRIME VENDOR AND CERTIFIED VETERAN SMALL BUSINESS VENDOR**

Instructions: The Bidder is required to submit a separate, signed LOI from each identified certified VOSB/SDVOSB vendor (hereinafter "certified vendors"). **LOIs must be submitted with the Bid and must be signed by both parties.** The Prime Bidder shall not prohibit or otherwise limit certified vendor(s) from providing bids or quotes to other potential bidders. Each LOI shall include the dollar amount, percentage, and scope of work to be performed by each identified certified vendor. All LOI's shall be subject to Department approval.

Any changes involving or affecting the identified certified vendor(s) may not be permitted without written approval of the Department.

Contract Number:

Name of Vendor:

Name of Contact Person:

Address:

City, State and Zip:

Telephone: Fax: Email:

Name of Certified Veteran Small Business Vendor: Name of Contact Person:

Address:

City, State and Zip:

Telephone: Fax: Email:

Proposed % of Contract to be performed by the certified vendor firm: \_\_\_\_\_%

Proposed dollar amount of Contract to be performed by the certified vendor: \$\_\_\_\_\_

Description of work to be performed by the certified vendor firm:

Vendor and the Certified vendor above hereby agree that upon the execution of a contract for the above-named project between Bidder and the State of Illinois, the certified vendor will perform the scope of work for the percentage as indicated above.

Bidder (Company Name or D/B/A):

Certified Vendor (Company Name or D/B/A):

Signature:

Signature:

Printed Name:

Printed Name:

Title:

Title:

Date:

Date:

STATE OF ILLINOIS  
 DEPARTMENT OF TRANSPORTATION  
 DIVISION OF HIGHWAYS

D-92-081-16

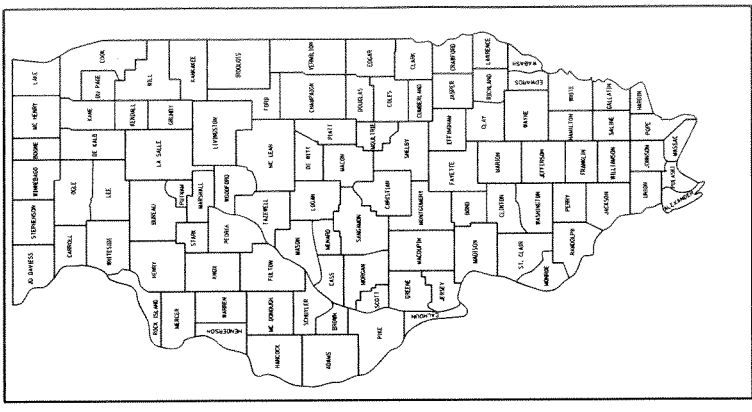

- INDEX OF SHEETS**
1. COVER SHEET, INDEX OF SHEETS, STATE STANDARDS
  2. SUMMARY OF QUANTITIES
  3. SCHEDULE OF QUANTITIES
  4. LOCATION MAP HENRY COUNTY
  5. LOCATION MAP ROCK ISLAND COUNTY
  6. URBAN LANE INSIDE CLOSURE, MULTILANE, 2W, WITH MOUNTABLE MEDIAN (DIST STD 35.1)
  - 7.-10. TRAFFIC CONTROL FOR TRANSITION AREAS (DIST STD 38.1)

**PROPOSED  
 HIGHWAY PLANS**

VARIOUS ROUTES  
 D2 BC 2017-2  
 VARIOUS COUNTIES

C-92-110-16

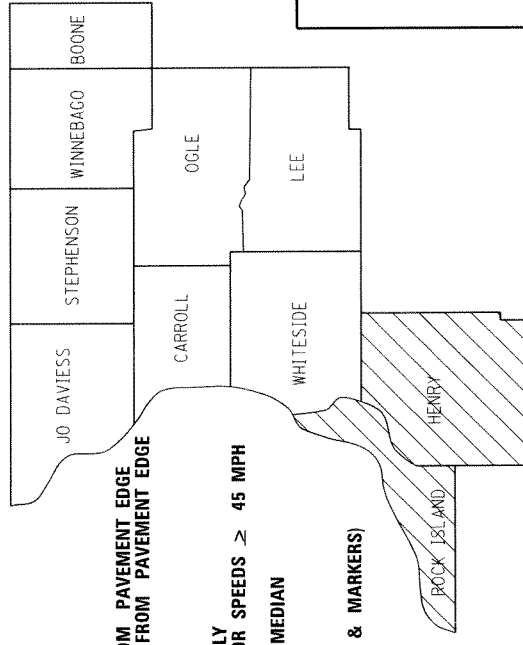

LOCATION OF SECTION INDICATED THIS: - [Hatched Box]

**STATE STANDARDS**

- 701006-05 OFF-ROAD OPERATIONS, 2L, 2W, 15'(4.5m) TO 24" (600mm) FROM PAVEMENT EDGE
- 701101-05 OFF-ROAD OPERATIONS, MULTILANE, 15'(4.5m) TO 24" (600mm) FROM PAVEMENT EDGE
- 701201-04 LANE CLOSURE, 2L, 2W, DAY ONLY, FOR SPEEDS  $\geq$  45 MPH
- 701301-04 LANE CLOSURE, 2L, 2W, SHORT TIME OPERATIONS
- 701400-08 APPROACH TO LANE CLOSURE, FREEWAY/EXPRESSWAY
- 701406-10 LANE CLOSURE, FREEWAY/EXPRESSWAY, DAY OPERATIONS ONLY
- 701411-09 LANE CLOSURE, MULTILANE, AT ENTRANCE OR EXIT RAMP FOR SPEEDS  $\geq$  45 MPH
- 701501-06 URBAN LANE CLOSURE, 2L, 2W, UNDIVIDED
- 701606-10 URBAN LANE CLOSURE, MULTILANE, 2W WITH MOUNTABLE MEDIAN
- 701901-05 TRAFFIC CONTROL DEVICES
- 720011-01 METAL POSTS FOR SIGNS, MARKERS AND DELINEATORS
- 728001-01 TELESCOPING STEEL SIGN SUPPORT
- 729001-01 APPLICATIONS OF TYPES A & B METAL POSTS (FOR SIGNS & MARKERS)

JULIE  
 JOINT UTILITY LOCATION INFORMATION FOR EXCAVATION  
 1-800-892-0123  
 OR 311

PROJECT ENGINEER: DAVID DOSS (815) 284-5416  
 PROJECT MANAGER: MAHMOUD ETEMADI (815) 284-5393

CONTRACT NO. 64L61

STATE OF ILLINOIS  
 DEPARTMENT OF TRANSPORTATION  
 DIVISION OF HIGHWAYS

SUBMITTED Aug 4 2016  
*K. E. Marshall*  
 DEPUTY DIRECTOR OF HIGHWAYS, REGION ENGINEER

\_\_\_\_\_  
 20  
 ENGINEER OF DESIGN AND ENVIRONMENT

\_\_\_\_\_  
 20  
 DIRECTOR OF HIGHWAYS, CHIEF ENGINEER

**PRINTED BY THE AUTHORITY  
 OF THE STATE OF ILLINOIS**

**Summary of Quantities**

Paycode	Description	Units	Quantity		Total
			0014		
			State Funds		
			Urban	Rural	
59200101	BRIDGE WASHING NO. 1	EACH	1		1
59200102	BRIDGE WASHING NO. 2	EACH	1		1
59200103	BRIDGE WASHING NO. 3	EACH	1		1
59200104	BRIDGE WASHING NO. 4	EACH	1		1
59200105	BRIDGE WASHING NO. 5	EACH		1	1
59200106	BRIDGE WASHING NO. 6	EACH	1		1
59200107	BRIDGE WASHING NO. 7	EACH	1		1
59200108	BRIDGE WASHING NO. 8	EACH	1		1
59200109	BRIDGE WASHING NO. 9	EACH	1		1
59200110	BRIDGE WASHING NO. 10	EACH		1	1
59200111	BRIDGE WASHING NO. 11	EACH	1		1
59200112	BRIDGE WASHING NO. 12	EACH	1		1
59200113	BRIDGE WASHING NO. 13	EACH	1		1
59200114	BRIDGE WASHING NO. 14	EACH	1		1
67100100	MOBILIZATION	L SUM	0.85	0.15	1
70100420	TRAFFIC CONTROL AND PROTECTION, STANDARD 701411	EACH	6		6
70100450	TRAFFIC CONTROL AND PROTECTION, STANDARD 701201	L SUM	0.60	0.40	1
70100700	TRAFFIC CONTROL AND PROTECTION, STANDARD 701406	L SUM	1		1
70102620	TRAFFIC CONTROL AND PROTECTION, STANDARD 701501	L SUM	1		1
70102625	TRAFFIC CONTROL AND PROTECTION, STANDARD 701606	L SUM	1		1
Z0048665	RAILROAD PROTECTIVE LIABILITY INSURANCE	L SUM	1		1
X7010410	SPEED DISPLAY TRAILER	CAL MO	1	0	1

22



**Schedule of Bridge Washing**

Pay Item	Project Location	SN	Facility Carried	Feature Crossed	Bridge Location	Traffic Control Standard							District Standard 35.1	
						701201	701400	701406	701411	701501	701606			
BRIDGE WASHING NO. 1		0370003	FAI 74 & 280 EB	US6, BN RR, & TR38	1 MI SW OF GREEN ROCK	X	X	X						
BRIDGE WASHING NO. 2	1	0370004	FAI 74 & 280 WB	US6, BN RR, & TR38	1 MI SW OF GREEN ROCK	X	X	X						
BRIDGE WASHING NO. 3		0370031	FAI 80 SB	FAI 74	3 MI SE COLONA		X	X	X					
BRIDGE WASHING NO. 4	2	0370032	FAI 80 NB	FAI 74	3 MI SE COLONA		X	X	X					
BRIDGE WASHING NO. 5	3	0370100	ULAH ROAD	EDWARDS RIVER	1.2 MI S JCT IL 81	X								
BRIDGE WASHING NO. 6		0810038	US RT 67	N CHANNEL ROCK RIVER	S EDGE ROCK ISLAND								X	X
BRIDGE WASHING NO. 7	5	0810039	US RT 67	C CHANNEL ROCK RIVER	N EDGE MILAN								X	X
BRIDGE WASHING NO. 8		0810040	US RT 67	S CHANNEL ROCK RIVER	N EDGE MILAN								X	X
BRIDGE WASHING NO. 9	7	0810089	CAMPBELL ISLAND RD	BRANCH OF MISS RIVER	0.3 MI NW OF ILL 84	X								
BRIDGE WASHING NO. 10	8	0810125	IL 92	I-88	8.0 MI. E. SILVIS	X	X	X						
BRIDGE WASHING NO. 11		0810159	FAI 74 SB	FAI 280	I74 OVER I280 S OF RR		X	X	X					
BRIDGE WASHING NO. 12	9	0810160	FAI 74 NB	FAI 280	I74 OVER I280 S OF RR		X	X	X					
BRIDGE WASHING NO. 13		0810161	FAI 74 SB	ROCK RIVER SIDE RDS	S EDGE MOLINE		X	X	X	X				
BRIDGE WASHING NO. 14	10	0810162	FAI 74 NB	ROCK RIVER SIDE RDS	S EDGE MOLINE		X	X	X	X				

# HENRY COUNTY

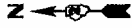

LOCATION 1  
 SN 037-0003  
 BRIDGE WASHING NO. 1  
 SN 037-0004  
 BRIDGE WASHING NO. 2

LOCATION 2  
 SN 037-0031  
 BRIDGE WASHING NO. 3  
 SN 037-0032  
 BRIDGE WASHING NO. 4

LOCATION 3  
 SN 037-0100  
 BRIDGE WASHING NO. 5

FILE NAME = 0:\BR\Doss\Brdge Washing\2017\64L61 Bridge Washing (14 Structures)\CAD\64L61-sht-cover.dwg		HENRY COUNTY LOCATION MAP		STATE OF ILLINOIS DEPARTMENT OF TRANSPORTATION		F.A. RTE.		SECTION		COUNTY		TOTAL SHEET SHEETS		SHEET NO.	
USER NAME = dossdd						VAR.		D2 BC 2017-2		VARIOUS		10		4	
PLOT DATE = Jul-13-2016 11:48:43 AM								ILLINOIS		ILLINOIS		CONTRACT NO.		64L61	
								FED. ROAD DIST. NO.		FED. AID PROJECT					

# ROCK ISLAND COUNTY

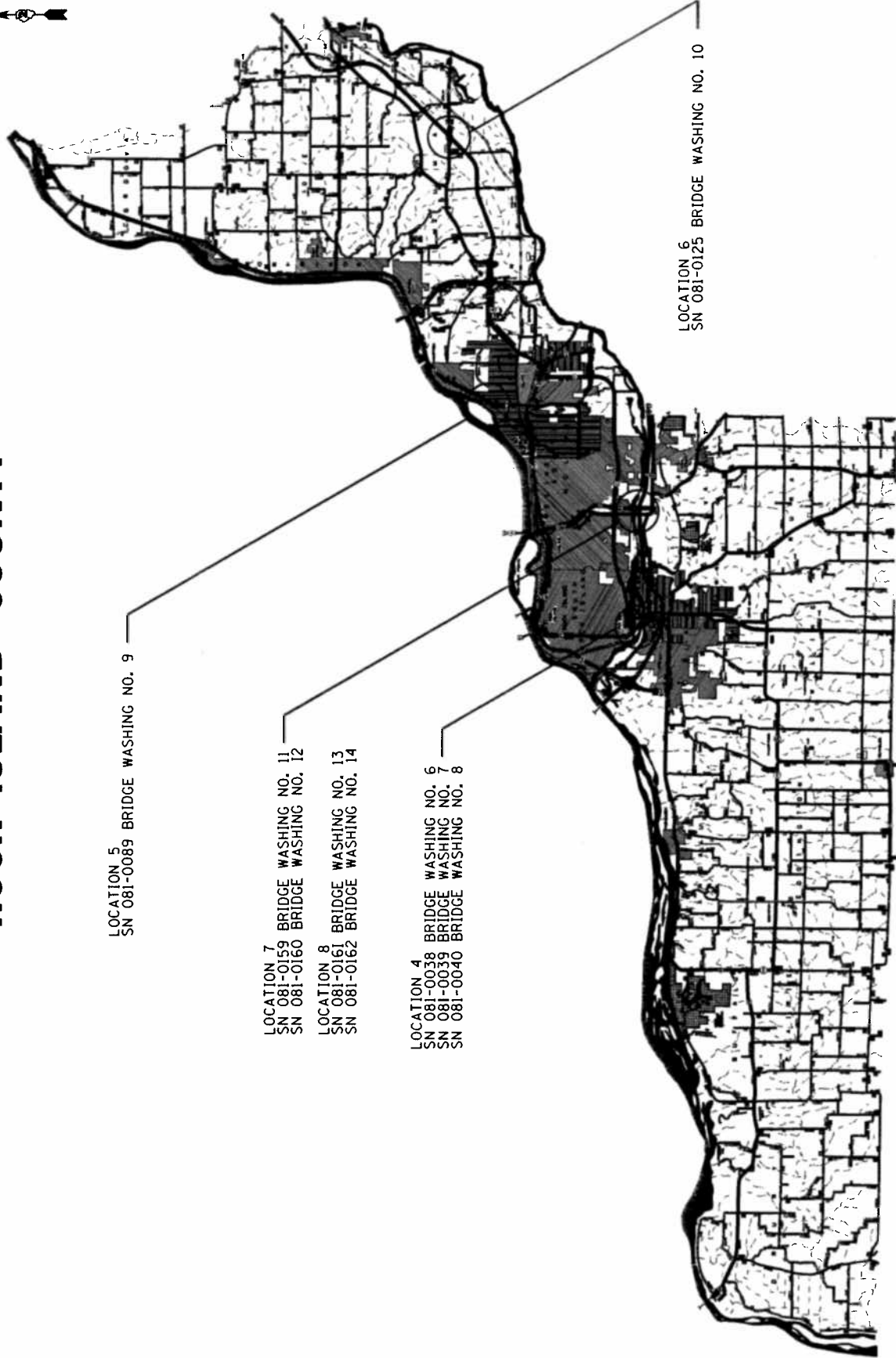

LOCATION 5  
SN 081-0089 BRIDGE WASHING NO. 9

LOCATION 7  
SN 081-0159 BRIDGE WASHING NO. 11  
SN 081-0160 BRIDGE WASHING NO. 12

LOCATION 8  
SN 081-0161 BRIDGE WASHING NO. 13  
SN 081-0162 BRIDGE WASHING NO. 14

LOCATION 4  
SN 081-0038 BRIDGE WASHING NO. 6  
SN 081-0039 BRIDGE WASHING NO. 7  
SN 081-0040 BRIDGE WASHING NO. 8

LOCATION 6  
SN 081-0125 BRIDGE WASHING NO. 10

FILE NAME = D:\BR\Loss\Brdge Washing\2017\64L61 Bridge Washing (14 Structure)\CAD00\64L61-shr-cover.dgn		ROCK ISLAND COUNTY LOCATION MAP		TOTAL SHEETS NO. 5	
USER NAME = dossdd		DEPARTMENT OF TRANSPORTATION		COUNTY VARIOUS	
PLOT DATE = Jul-13-2016 11:48:53 AM		STATE OF ILLINOIS		SECTION D2 BC 2017-2	
		FED. ROAD DIST. NO. _ ILLINOIS   FED. AID PROJECT		CONTRACT NO. 64L61	

# URBAN LANE INSIDE CLOSURE, MULTILANE, 2-WAY, WITH MOUNTABLE MEDIAN

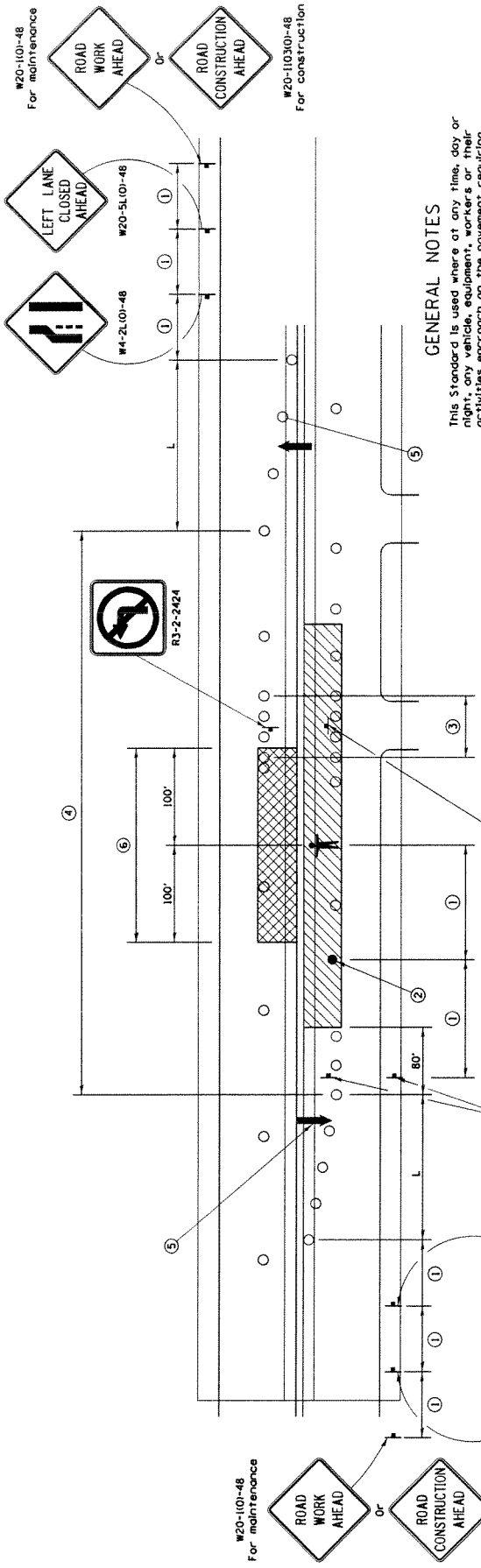

**GENERAL NOTES**

This Standard is used where at any time, day or night, any vehicle, equipment, workers or their equipment on the pavement require the closure of one or more traffic lanes in an urban area.

Calculate L as follows:

SPEED LIMIT	FORMULAS
40 mph (70 km/h) or less:	English L = WS/2 Metric L = WS/150
45 mph (80 km/h) or greater:	English L = (WWS) / 0.65 Metric L = (0.65WWS)

- ① Refer to SIGN SPACING TABLE for distances.
- ② Use flagger and flagger sign only when flagger is required per Article 701.13 (b).
- ③ Devices at 10' centers from edge of road return to edge of radius return when left turns are prohibited due to actively working in the intersection.
- ④ Cones of 20' (6 m) centers for 250' (75 m). Additional cones may be placed at 40' (12 m) centers. When drums or Type I or Type II barricades are used, the interval between devices may be doubled excluding devices in intersections.
- ⑤ Cones, drums or barricades at 20' (6 m) centers in taper.
- ⑥ No equipment, materials, vehicles, or other hazards shall be in the closed lane in the opposite direction within 100' of a worker on foot.

### SYMBOLS

- WORK AREA
- CLOSED LANE
- ARROW BOARD
- SIGN ON PORTABLE OR PERMANENT SUPPORT
- CONE, DRUM OR BARRICADE
- FLAGGER WITH TRAFFIC CONTROL SIGN
- WORKER ON FOOT

Posted Speed	Sign Spacing
35	500-1150 m
50/45	300-1100 m
45	200-1000 m

FILE NAME = 0:\BR\Doss\Brdge Washing\2017\64L61 Bridge Washing (14 Structures)\CAD\64L61-shr-cover.dgn  
 USER NAME = dossd  
 PLOT DATE = Aug-03-2016 09:16:15 AM

F.A. RTE.	SECTION	COUNTY	TOTAL SHEET NO.
VAR.	D2 BC 2017-2	VARIOUS	10 6
REGION 2 / DISTRICT 2 STANDARD		CONTRACT NO. 64L61	
STATE OF ILLINOIS DEPARTMENT OF TRANSPORTATION			
URBAN LANE INSIDE CLOSURE, MULTILANE, 2W, WITH MOUNTABLE MEDIAN			

# TRAFFIC CONTROL FOR TRANSITION AREAS

## CASE 1

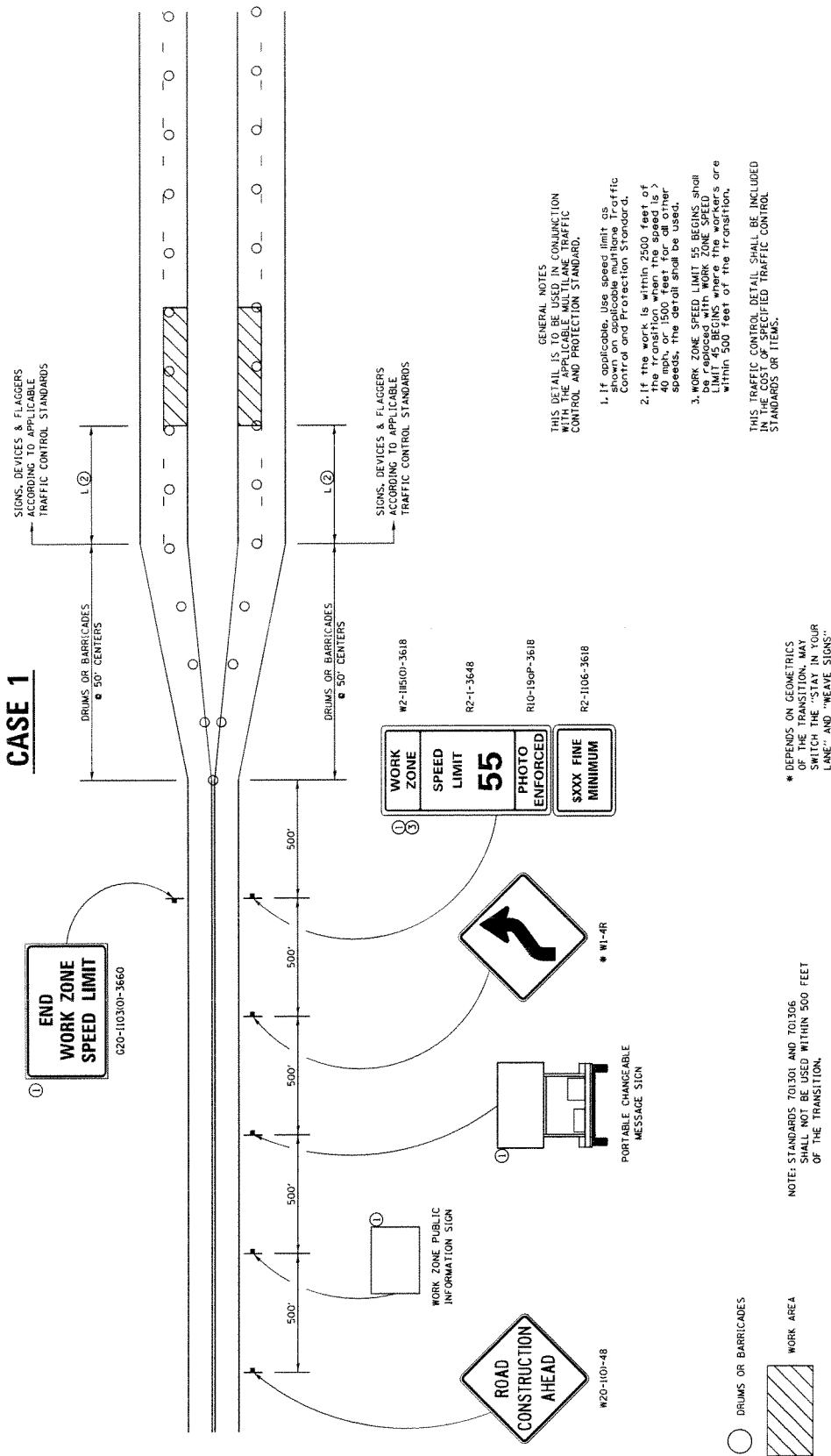

**GENERAL NOTES**  
 THIS DETAIL IS TO BE USED IN CONJUNCTION WITH THE APPLICABLE MULTILANE TRAFFIC CONTROL AND PROTECTION STANDARD.

1. If applicable, use speed limit signs and signs for Traffic Control and Protection Standard.
2. If the work is within 2500 feet of a transition, the speed limit shall be 40 mph, or 1500 feet for all other speeds, the detail shall be used.
3. WORK ZONE SPEED LIMIT 55 BEGINS shall be placed with WORK ZONE SPEED LIMIT 45 BEGINS where the workers are within 500 feet of the transition.

THIS TRAFFIC CONTROL DETAIL SHALL BE INCLUDED IN THE COST OF SPECIFIED TRAFFIC CONTROL STANDARDS OR ITEMS.

\* DEPENDS ON GEOMETRICS OF THE TRANSITION. MAY SWITCH THE "STAY IN YOUR LANE" AND "WEAVE SIGNS."

NOTE: STANDARDS 701301 AND 701306 SHALL NOT BE USED WITHIN 500 FEET OF THE TRANSITION.

FILE NAME = O:\BR\Doss\Brdge Washing\2017\64L61 Bridge Washing (14 Structure)\CAD00\64L61-shit-cover.dgn	REGION 2 / DISTRICT 2 STANDARD	F.A. RTE. VAR.	SECTION D2 BC 2017-2	COUNTY VARIOUS	TOTAL SHEETS 10	SHEET NO. 7
USER NAME = dossdd	STATE OF ILLINOIS DEPARTMENT OF TRANSPORTATION	CONTRACT NO. 64L61		FED. ROAD DIST. NO. ILLINOIS FED. AID PROJECT		
PLOT DATE = Aug-03-2016 09:15:26 AM	TRAFFIC CONTROL FOR TRANSITION AREAS					

# TRAFFIC CONTROL FOR TRANSITION AREAS

## CASE 2

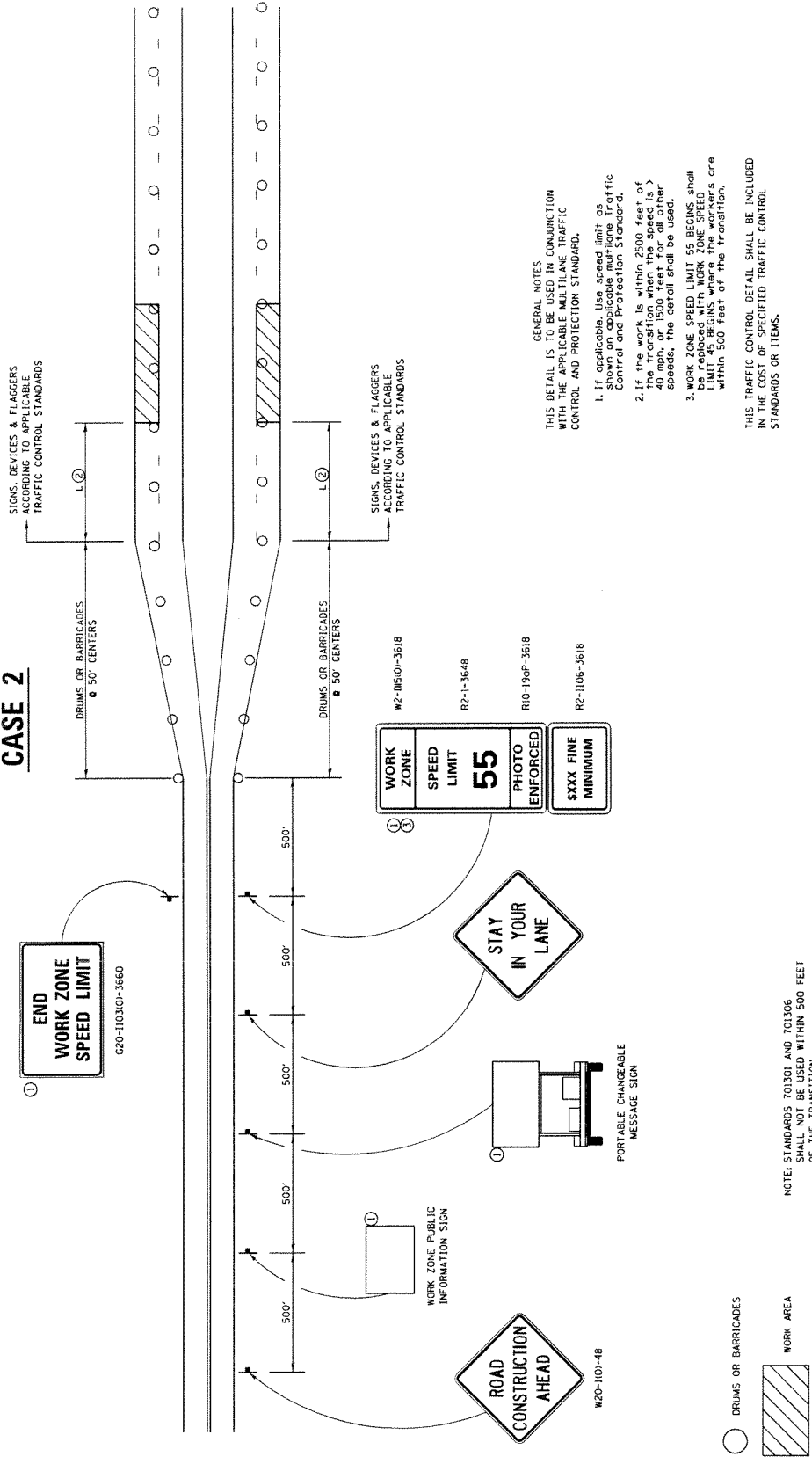

**GENERAL NOTES**  
 THIS DETAIL IS TO BE USED IN CONSTRUCTION WITH THE APPLICABLE MULTILANE TRAFFIC CONTROL AND PROTECTION STANDARD.

- If applicable, use speed limit signs shown on appropriate traffic control and protection standard.
- If the work is within 2500 feet of the work area, the speed limit shall be 40 mph, or 1500 feet for all other speeds, the detail shall be used.
- WORK ZONE SPEED LIMIT 55 BEGINS shall be replaced with WORK ZONE SPEED LIMIT 45 BEGINS where the workers are within 500 feet of the transition.

THIS TRAFFIC CONTROL DETAIL SHALL BE INCLUDED IN THE LIST OF SPECIFIED TRAFFIC CONTROL STANDARDS OR ITEMS.

NOTE: STANDARDS 701301 AND 701306 SHALL NOT BE USED WITHIN 500 FEET OF THE TRANSITION.

FILE NAME = D:\BRD\loss\B-ridge Washing\2017\G4L61 Bridge Washing (14 Structures)\CAD\G4L61-shr-cover.dgn	REGION 2 / DISTRICT 2 STANDARD	F.A. RTE.	SECTION	COUNTY	TOTAL SHEETS	SHEET NO.
USER NAME = dossdd	DEPARTMENT OF TRANSPORTATION	VAR.	D2 BC 2017-2	VARIIOUS	10	8
PLOT DATE = Aug-03-2016 09:16:35 AM		FED. ROAD DIST. NO.	ILLINOIS	FED. AID PROJECT	CONTRACT NO.	64L61

# TRAFFIC CONTROL FOR TRANSITION AREAS

## CASE 3

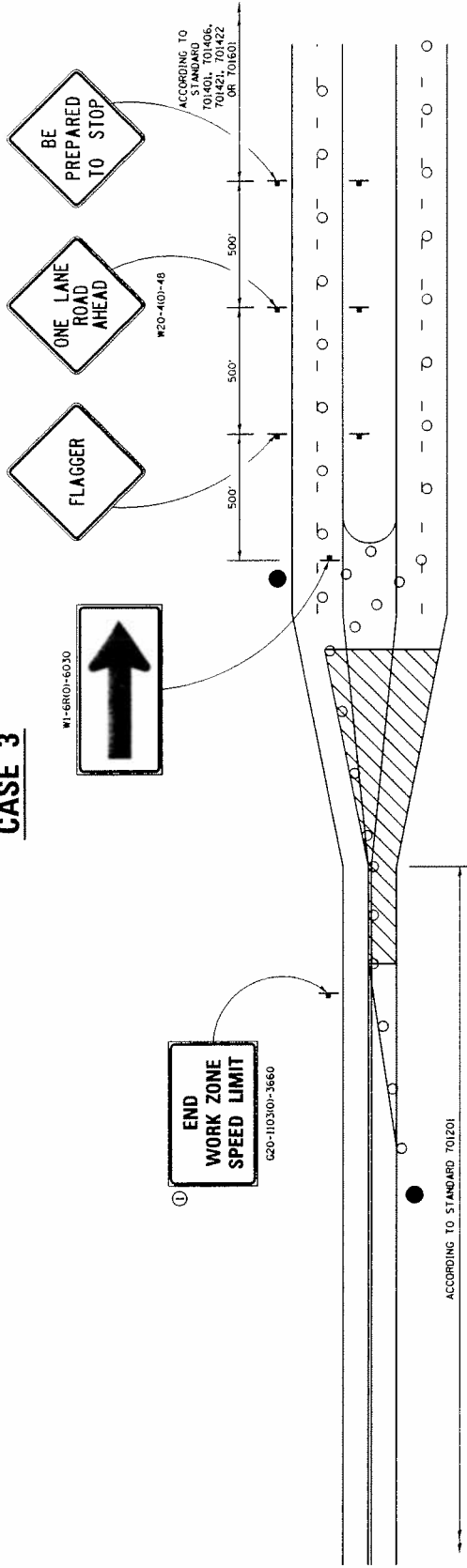

GENERAL NOTES  
THIS DETAIL IS TO BE USED IN CONJUNCTION  
WITH THE APPLICABLE MULTILANE TRAFFIC  
CONTROL AND PROTECTION STANDARD.

1. If applicable, use speed limit as shown on applicable multilane Traffic Control and Protection Standard.
2. If the work is within 2500 feet of the transition, when the speed is > 45 mph, the speed limit for other speeds, the detail shall be used.
3. WORK ZONE SPEED LIMIT 45 BEGINS AND LIMIT 45 BEGINS WITH WORK ZONE SPEED LIMIT 45 BEGINS where the workers are within 500 feet of the transition.

THIS TRAFFIC CONTROL DETAIL SHALL BE INCLUDED  
IN THE LIST OF ITEMS FOR SPECIFIED TRAFFIC CONTROL  
STANDARDS OR ITEMS.

NOTE: STANDARDS T01Z01 AND T01Z06  
SHALL NOT BE USED WITHIN 500 FEET  
OF THE TRANSITION.

● FLAGGER WITH TRAFFIC CONTROL SIGN

○ DRUMS OR BARRICADES

▨ WORK AREA

FILE NAME = 0:\BRYDoss\Brdge Washing\2017\64L61 Bridge Washing (14 Structures)\CAD\64L61-shr-cover.dgn	REGION 2 / DISTRICT 2 STANDARD	F.A. RTE.	SECTION	COUNTY	TOTAL SHEET SHEETS	SHEET NO.
USER NAME = dossed	STATE OF ILLINOIS DEPARTMENT OF TRANSPORTATION	VAR.	D2 BC 2017-2	VARI0US	10	9
PLOT DATE = Aug-03-2016 09:16:43 AM		FED. ROAD DIST. NO.	ILLINOIS	FED. AID PROJECT	CONTRACT NO.	64L61

# TRAFFIC CONTROL FOR TRANSITION AREAS

## CASE 4

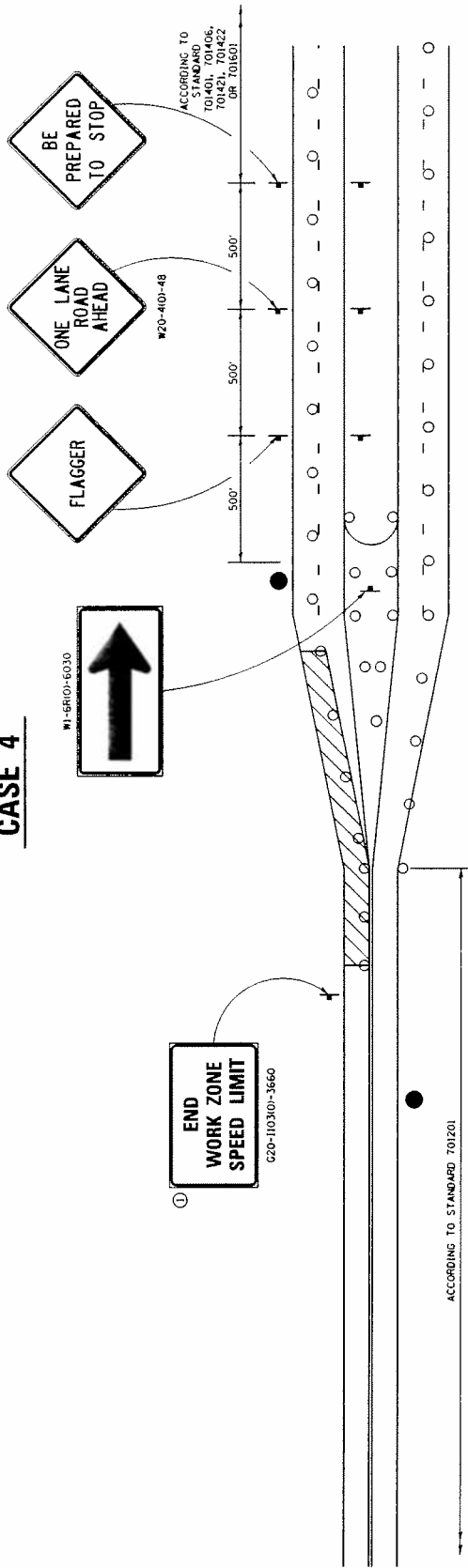

GENERAL NOTES  
 THIS DETAIL IS TO BE USED IN CONJUNCTION WITH THE APPLICABLE MULTILANE TRAFFIC CONTROL AND PROTECTION STANDARD.

1. If applicable, use speed limit signs and traffic control and protection Standard.
  2. If the work is within 2500 feet of the transition when the speed limit is 40 mph or 1500 feet for all other speeds, the detail shall be used.
  3. WORK ZONE SPEED LIMIT 55 BEGINS shall be replaced with WORK ZONE SPEED LIMIT 45 BEGINS where the workers are within 500 feet of the transition.
- THIS TRAFFIC CONTROL DETAIL SHALL BE INCLUDED IN THE COST OF SPECIFIED TRAFFIC CONTROL STANDARDS OR ITEMS.

NOTES: STANDARDS 701301 AND 701306 SHALL NOT BE USED WITHIN 500 FEET OF THE TRANSITION.

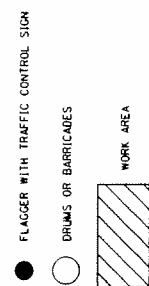

FILE NAME = G:\BRNDoss\Brdge Washing\2017\64L61 Brdge Washing (14 Structures)\CAD\64L61-shr-ctr-cover.dgn	REGION 2 / DISTRICT 2 STANDARD	F.A. RTE.	SECTION	COUNTY	TOTAL SHEETS	SHEET NO.
DEPARTMENT OF TRANSPORTATION		VAR.	D2 BC 2017-2	VARIOUS	10	10
USER NAME = dossed				CONTRACT NO.	64L61	
PLOT DATE = Aug-03-2016 09:16:55 AM				FED. ROAD DIST. NO.	ILLINOIS   FED. AID PROJECT	



## **REVISIONS TO THE ILLINOIS PREVAILING WAGE RATES**

The Prevailing rates of wages are included in the Contract proposals which are subject to Check Sheet #5 of the Supplemental Specifications and Recurring Special Provisions. The rates have been ascertained and certified by the Illinois Department of Labor for the locality in which the work is to be performed and for each craft or type of work or mechanic needed to execute the work of the Contract. As required by Prevailing Wage Act (820 ILCS 130/0.01, et seq.) and Check Sheet #5 of the Contract, not less than the rates of wages ascertained by the Illinois Department of Labor and as revised during the performance of a Contract shall be paid to all laborers, workers and mechanics performing work under the Contract. Post the scale of wages in a prominent and easily accessible place at the site of work.

If the Illinois Department of Labor revises the prevailing rates of wages to be paid as listed in the specification of rates, the contractor shall post the revised rates of wages and shall pay not less than the revised rates of wages. Current wage rate information shall be obtained by visiting the Illinois Department of Labor web site at <http://www.state.il.us/agency/idol/> or by calling 312-793-2814. It is the responsibility of the contractor to review the rates applicable to the work of the contract at regular intervals in order to insure the timely payment of current rates. Provision of this information to the contractor by means of the Illinois Department of Labor web site satisfies the notification of revisions by the Department to the contractor pursuant to the Act, and the contractor agrees that no additional notice is required. The contractor shall notify each of its subcontractors of the revised rates of wages.