

19

September 22, 17 Letting

Notice to Bidders, Specifications and Proposal



**Illinois Department
of Transportation**

Springfield, Illinois 62764

**Contract No. 64M54
ROCK ISLAND County
Section D2 RS 2018-1
Route FAS 1205
District 2 Construction Funds**

Plans Included
Herein

Prepared by

S

Checked by

(Printed by authority of the State of Illinois)



NOTICE TO BIDDERS

- 1. TIME AND PLACE OF OPENING BIDS.** Electronic bids are to be submitted to the electronic bidding system (iCX-Integrated Contractors Exchange). All bids must be submitted to the iCX system prior to 10:00 a.m. September 22, 17 prevailing time at which time the bids will be publicly opened from the iCX SecureVault.
- 2. DESCRIPTION OF WORK.** The proposed improvement is identified and advertised for bids in the Invitation for Bids as:

**Contract No. 64M54
ROCK ISLAND County
Section D2 RS 2018-1
Route FAS 1205
District 2 Construction Funds**

Cold-In-Place recycling with HMA overlay on IL 192 from 123rd St. west to 105th St. West.

- 3. INSTRUCTIONS TO BIDDERS.** (a) This Notice, the invitation for bids, proposal and letter of award shall, together with all other documents in accordance with Article 101.09 of the Standard Specifications for Road and Bridge Construction, become part of the contract. Bidders are cautioned to read and examine carefully all documents, to make all required inspections, and to inquire or seek explanation of the same prior to submission of a bid.

(b) State law, and, if the work is to be paid wholly or in part with Federal-aid funds, Federal law requires the bidder to make various certifications as a part of the proposal and contract. By execution and submission of the proposal, the bidder makes the certification contained therein. A false or fraudulent certification shall, in addition to all other remedies provided by law, be a breach of contract and may result in termination of the contract.
- 4. AWARD CRITERIA AND REJECTION OF BIDS.** This contract will be awarded to the lowest responsive and responsible bidder considering conformity with the terms and conditions established by the Department in the rules, Invitation for Bids and contract documents. The issuance of plans and proposal forms for bidding based upon a prequalification rating shall not be the sole determinant of responsibility. The Department reserves the right to determine responsibility at the time of award, to reject any or all proposals, to readvertise the proposed improvement, and to waive technicalities.

By Order of the
Illinois Department of Transportation

Randall S. Blankenhorn,
Secretary

INDEX
FOR
SUPPLEMENTAL SPECIFICATIONS
AND RECURRING SPECIAL PROVISIONS

Adopted January 1, 2017

This index contains a listing of SUPPLEMENTAL SPECIFICATIONS and frequently used RECURRING SPECIAL PROVISIONS.

ERRATA Standard Specifications for Road and Bridge Construction (Adopted 4-1-16) (Revised 1-1-17)

SUPPLEMENTAL SPECIFICATIONS

<u>Std. Spec. Sec.</u>	<u>Page No.</u>
106 Control of Materials	1
403 Bituminous Surface Treatment (Class A-1, A-2, A-3)	2
420 Portland Cement Concrete Pavement	3
502 Excavation for Structures	5
503 Concrete Structures	7
504 Precast Concrete Structures	10
542 Pipe Culverts	11
586 Sand Backfill for Vaulted Abutments	12
670 Engineer's Field Office and Laboratory	14
704 Temporary Concrete Barrier	15
888 Pedestrian Push-Button	17
1003 Fine Aggregates	18
1004 Coarse Aggregates	19
1006 Metals	21
1020 Portland Cement Concrete	22
1103 Portland Cement Concrete Equipment	24

RECURRING SPECIAL PROVISIONS

The following RECURRING SPECIAL PROVISIONS indicated by an "X" are applicable to this contract and are included by reference:

<u>CHECK SHEET #</u>		<u>PAGE NO.</u>
1	Additional State Requirements for Federal-Aid Construction Contracts	26
2	Subletting of Contracts (Federal-Aid Contracts)	29
3	X EEO	30
4	X Specific EEO Responsibilities Non Federal-Aid Contracts	40
5	X Required Provisions - State Contracts	45
6	Asbestos Bearing Pad Removal	51
7	Asbestos Waterproofing Membrane and Asbestos HMA Surface Removal	52
8	Temporary Stream Crossings and In-Stream Work Pads	53
9	Construction Layout Stakes Except for Bridges	54
10	Construction Layout Stakes	57
11	Use of Geotextile Fabric for Railroad Crossing	60
12	Subsealing of Concrete Pavements	62
13	Hot-Mix Asphalt Surface Correction	66
14	Pavement and Shoulder Resurfacing	68
15	Patching with Hot-Mix Asphalt Overlay Removal	69
16	Polymer Concrete	70
17	PVC Pipeliner	72
18	Bicycle Racks	73
19	Temporary Portable Bridge Traffic Signals	75
20	Work Zone Public Information Signs	77
21	Nighttime Inspection of Roadway Lighting	78
22	English Substitution of Metric Bolts	79
23	Calcium Chloride Accelerator for Portland Cement Concrete	80
24	Quality Control of Concrete Mixtures at the Plant	81
25	Quality Control/Quality Assurance of Concrete Mixtures	89
26	Digital Terrain Modeling for Earthwork Calculations	105
27	Reserved	107
28	Preventive Maintenance – Bituminous Surface Treatment (A-1)	108
29	Preventive Maintenance – Cape Seal	114
30	Preventive Maintenance – Micro-Surfacing	129
31	Preventive Maintenance – Slurry Seal	140
32	Temporary Raised Pavement Markers	149
33	Restoring Bridge Approach Pavements Using High-Density Foam	150
34	Portland Cement Concrete Inlay or Overlay	153

TABLE OF CONTENTS

LOCATION OF PROJECT	1
DESCRIPTION OF PROJECT	1
TRAFFIC CONTROL PLAN	1
HOT-MIX ASPHALT SURFACE COURSE, LEVEL BINDER, AND BINDER	4
PCC AUTOMATIC BATCHING EQUIPMENT	4
PCC QC/QA ELECTRONIC REPORTS SUBMITTAL	4
COLD IN-PLACE RECYCLING (CIR) WITH EMULSIFIED ASPHALT	5
AUTOMATED FLAGGER ASSISTANCE DEVICES (BDE)	14
BUTT JOINTS (BDE)	16
COMPENSABLE DELAY COSTS (BDE)	17
CONCRETE MIX DESIGN – DEPARTMENT PROVIDED (BDE)	21
DISADVANTAGED BUSINESS ENTERPRISE PARTICIPATION (BDE)	22
HOT MIX ASPHALT – QUALITY CONTROL FOR PERFORMANCE (BDE)	33
HOT-MIX ASPHALT – TACK COAT (BDE)	38
PROGRESS PAYMENTS (BDE)	39
RECLAIMED ASPHALT PAVEMENT AND RECLAIMED ASPHALT SHINGLES (BDE)	40
TEMPORARY PAVEMENT MARKING (BDE)	50
WARM MIX ASPHALT (BDE)	52
WEEKLY DBE TRUCKING REPORTS (BDE)	54
WORKING DAYS (BDE)	54
BITUMINOUS MATERIALS COST ADJUSTMENTS (BDE)	54

STATE OF ILLINOIS

SPECIAL PROVISIONS

The following Special Provisions supplement the “Standard Specifications for Road and Bridge Construction, Adopted April 1, 2016”, the latest edition of the “Manual on Uniform Traffic Control Devices for Streets and Highways”, and the “Manual of Test Procedures for Materials” in effect on the date of invitation for bids, and the “Supplemental Specifications and Recurring Special Provisions” indicated on the Check Sheet included herein, which apply to and govern the construction of FAS Route 1205 (IL 192), Section D2 RS 2018-1, Rock Island County, Contract No. 64M54 and in case of conflict with any part, or parts, of said Specifications, the said Special Provisions shall take precedence and shall govern.

LOCATION OF PROJECT

IL 192 from 123rd Street West to 0.2 mile east of 105th Street West.

DESCRIPTION OF PROJECT

Cold-in-place recycling with hot-mix asphalt overlay.

TRAFFIC CONTROL PLAN

Effective: January 14, 1999

Revised: January 13, 2017

Traffic Control shall be according to the applicable sections of the Standard Specifications for Road and Bridge Construction, the applicable guidelines contained in the National Manual on Uniform Traffic Control Devices for Streets and Highways, Illinois Supplement to the National Manual on Uniform Traffic Control Devices, these special provisions, and any special details and Highway Standards contained herein and in the plans.

Special attention is called to Articles 107.09 and 107.14 of the Standard Specifications for Road and Bridge Construction and the following Highway Standards relating to traffic control.

Standards:

701001 701006 701011 701301 701306 701311
701901

Signs:

No bracing shall be allowed on post-mounted signs.

Post-mounted signs shall be installed using standard 720011, 728001, 729001, on 4"x4" wood posts, or on any other "break away" connection if accepted by the FHWA and corresponding letter is provided to the resident.

"BUMP" (W8-1(O)48) signs shall be installed as directed by the Engineer.

"UNEVEN LANES" W8-11(O)48 signs shall be installed at 1 mile intervals or as directed by the Engineer.

"LOW SHOULDER" W8-9(O)48 signs shall be installed at 1 mile intervals or as directed by the Engineer.

When covering existing Department signs, no tape shall be used on the reflective portion of the sign. Contact the District sign shop for covering techniques.

All regulatory signs shall be maintained at a 5 foot minimum bottom (rural), 7 foot minimum (urban).

Any plates or direct applied sheeting used to alter signs shall have the same sheeting as the base sign.

No more than one kind of alteration shall be used to alter a sign.

Any post stubs without a sign in place and visible shall have a reflector placed on each post.

Devices:

Cones or reflectorized cones shall not be used during hours of darkness.

A minimum of 3 drums spaced at 4 feet shall be placed at each return when the sideroad is open.

On all standards and devices listed in Section 701 of the Standard Specifications, the device spacing shall be revised to the following dimensions:

- Where the spacing shown on the standard is 25 feet, the devices shall be placed at 20 feet.
- Where the spacing shown on the standard is 50 feet, the devices shall be placed at 40 feet.
- Where the spacing shown on the standard is 100 feet, the devices shall be placed at 80 feet.

Flaggers:

Flagger at Sideroads and Commercial Entrances:

Effective: August 1, 2011

Revised: December 29, 2015

Flaggers shall comply with all requirements and signaling methods contained in the Department's "Traffic Control Field Manual" current at the time of letting. The flagger equipment listed for flaggers employed by the Illinois Department of Transportation shall apply to all flaggers.

All workers and flaggers shall wear ANSI Class E pants and an ANSI Class 2 vest that in combination meet the requirements of ANSI/ISEA 107-2004 for Conspicuity Class 3 garments during hours of darkness.

In addition to the flaggers shown on applicable standards, on major sideroads, flaggers shall be required on all legs of the intersection. Major sideroads for this project shall be none.

In addition to the flaggers shown on applicable standards, a flagger shall be required on high volume commercial entrances listed below. High volume commercial entrances for this project shall be none.

When the mainline flagger is within 200 feet of an intersection, the sideroad flagger shall be required.

When the road is closed to through traffic and it is necessary to provide access for local traffic, all flaggers as shown on the applicable standards will be required. No reduction in the number of flaggers shall be allowed.

Revise Article 701.20(i) of the Standard Specifications to read:

"Signs, barricades, other traffic control devices, or flaggers required by the Engineer, over and above those shown in the contract documents, will be paid for according to Article 109.04."

Pavement Marking:

Short term pavement markings on a milled surface shall be paint.

Maintenance of Traffic:

The mainline shall be kept open to one-way traffic at all times during working hours and two-way traffic during non-working hours.

The Contractor shall have all lanes open from 7:00 PM Friday until 6:00 AM Monday, unless prior approval is obtained from the Resident Engineer.

The cold-in-place recycling, resurfacing and placing of shoulder aggregate shall be completed using Traffic Control and Protection Standard 701306.

Placing and removing pavement marking shall be completed using Traffic Control and Protection Standard 701306 or 701311.

HOT-MIX ASPHALT SURFACE COURSE, LEVEL BINDER, AND BINDER

Effective: June 15, 2010

Revised: June 23, 2014

The maximum allowed average bulk specific gravity for the approved mix design (Gmb) will be:

2.460 for Mixture C

2.470 for Mixture D

2.610 for Mixture E

2.710 for Mixture F

The maximum allowed average bulk specific gravity for the approved mix design (Gmb) for all other uses will be 2.470.

PCC AUTOMATIC BATCHING EQUIPMENT

Effective: January 1, 2015

Revised: April 12, 2016

Portland cement concrete provided shall be produced from batch plants that conform to the requirements of Article 1103.03 (a) and (b) of the Standard Specifications for Road and Bridge Construction. Semi-automatic batching will not be allowed.

Plants shall have computerized batching interfaced with a printer. Batch weights, aggregate mixtures, water added, amount of each admixture or additive, and percent variance from design shall be printed for each batch. Tickets shall state the actual water-cement ratio as batched, and the amount of water that can be added to the batch without exceeding the maximum water-cement ratio. Truck delivery tickets are still required as per Article 1020.11(a)(7) of the Standard Specifications.

PCC QC/QA ELECTRONIC REPORTS SUBMITTAL

Effective: January 1, 2015

Revised: April 12, 2016

The Contractor's QC personnel shall be responsible for electronically submitting BMPR MI654 "Concrete Air, Slump, and Quantity," BMPR MI655 "P.C. Concrete Strength," and BMPR MI504 "Aggregate Gradation" reports to the Department. The format for the electronic submittals shall be the QC/QA package reporting program, which will be provided by the Department. Microsoft Excel 2007 or newer and Microsoft Outlook is required for this program which shall be provided by the Contractor.

COLD IN-PLACE RECYCLING (CIR) WITH EMULSIFIED ASPHALT

Effective: April 1, 2012

Revised: September 3, 2015

All references to Divisions, Sections, and Articles in this Special Provision shall be construed to mean specific Divisions, Sections and Articles in the Standard Specifications for Road and Bridge Construction adopted by the Department of Transportation.

Description. This work shall consist of cold milling and pulverizing existing bituminous layers to a specified depth and maximum size; mixing emulsified asphalt, water, and additives with the recycled material; and spreading and compacting mixture.

Materials. Materials shall be according to the following Articles of Division 1000 – Materials.

<u>Item</u>	<u>Article/Section</u>
(a) Portland Cement (Note 1).....	1001
(b) Water.....	1002
(c) Fine Aggregate (Note2).....	1003
(d) Coarse Aggregate (Note 2).....	1004
(e) Fly Ash (Note 1).....	1010.02
(f) Lime Slurry (Note 1).....	1012.04
(g) Reclaimed Asphalt Pavement (Note 3).....	1031
(h) Emulsified Asphalt (Note 4).....	1032.06
(i) Cold Pulverized Material (Note 5)	
(j) Mix Design (Note 6)	

Note 1. If necessary, the mix design may require additional additives to increase fines in the mix. The type and allowable percentage will be described in the mix design.

Note 2. The mix design will specify gradation and quality of any additional aggregate. Any additional fine aggregate shall meet Class B quality as a minimum. Any additional coarse aggregate shall meet Class C quality as a minimum.

Note 3. The Engineer may allow reclaimed asphalt pavement (RAP) from Conglomerate “D” Quality or better RAP stockpiles as specified in Article 1031.02 or from millings of the existing highway. The RAP material shall not exceed the maximum size requirement of the cold pulverized material, and when blended with the cold pulverized material shall produce a product which meets the specifications of the mix design.

Note 4. The emulsified asphalt shall be selected for the project by the emulsified asphalt supplier based on the Contractor’s mixture design. The penetration of the supplied emulsified asphalt shall be within ± 25 percent of the penetration of the design emulsified asphalt. A representative from the emulsified asphalt supplier shall be on the job site at the beginning of the project to monitor the characteristics and performance of the emulsified asphalt. Throughout the job, the representative shall be available to check on the project and make adjustments to the emulsified asphalt formation as required. The emulsified asphalt shall be received on the job site at a temperature no greater than 120^o F (49^oC).

The emulsified asphalt shall meet the following requirements:

CIR-FDR EMULSIFIED ASPHALT MATERIAL SPECIFICATION			
Test	Procedure	Minimum	Maximum
Viscosity, Saybolt Furol, at 77°F (25°C), SFS	AASHTO T 59	20	100
Sieve Test, No. 20 (850 µm), retained on sieve, %	AASHTO T 59		0.10
Storage Stability Test, 24hr, %	AAHSTO T 59		1.0
Distillation Test, Residue from distillation to 347 ± 9°F (175±5°C), %	AASHTO T 59 ¹	64.0	
Oil distillate by volume, %	AASHTO T 59		1.0
Penetration, 77°F (25°C), 100 g, 5 s, dmm	AASHTO T 49	75	200

Note: 1. Modified AASHTO T 59 Procedure—distillation temperature of 347 ± 9°F (175 ± 5 °C) with a 20 minute hold.

Note 5. Prior to the addition of the emulsified asphalt, the gradation of the cold pulverized material shall meet the following:

COLD PULVERIZED MATERIAL GRADATIONS		
Grad No.	Sieve Size and Percent Passing	
	1 1/2 in. (37.5 mm)	1 in. (25 mm)
PM 1	100	
PM 2 ¹		100

PM 2 shall only be used when a finer gradation of RAP is required by the mix design.

Note 6. A mix design for each District section shall be submitted to the Department prior to construction using actual materials (in-situ sampled by the Contractor and new materials from the Contractor's material suppliers) proposed for the project. The job mix formula shall meet the following criteria and be approved by the Engineer.

CIR WITH EMULSIFIED ASPHALT MIX DESIGN REQUIREMENTS		
Test Method	CIR	Test Purpose
Gradation for Design Millings, AASHTO T 27	Report	
Design Moisture Content	Report	Dispersion of Emulsion
Superpave Gyratory Compaction, 1.25° angle, 87 psi (600 kPa)	30 gyrations at 4 in. (100 mm) ¹	Laboratory Density Indicator
Bulk Specific Gravity (Density), ASTM D 6752 or ASTM D 2726	Report	Laboratory Density Indicator
Rice (Maximum Theoretical) Specific Gravity, ASTM D 2041	Report	Laboratory Density Indicator
Air Voids	Report	Laboratory Density Indicator
Marshall Stability, ASTM D 1559, lbs (kg)	1250 (567) minimum ¹	Stability Indicator
Retained Stability, %	70 minimum	Moisture Damage Resistance
Raveling Test, 50° F (10 °C), %	2 maximum	Raveling Resistance
Additional Additive(s) ² Coarse Aggregate Fine Aggregate RAP Fly Ash Cement, %	Report Report Report Report 1.0 maximum	
Emulsified Asphalt ² Distillation Residue, % Residue Penetration, dmm Optimum Emulsion Content, % Residual Asphalt to Cement Content Ratio	Report Report Report 3:1 minimum	

- Notes: 1. 6 in. (150 mm) samples may be used; however, if 6 in. (150mm) samples are used, the Marshall Stability is required to be 2,500 lb (1134 kg) minimum.
 2. Report shall include type/gradation and producer/supplier.

Equipment Equipment shall be according to the following Articles of Division 1100 – Equipment.

<u>Item</u>	<u>Article/Section</u>
(a) Self-Propelled Pneumatic-Tired Rollers (Note 1).....	1101.01(c)
(b) Steel Wheel Tandem Rollers.....	1101.01(e)(1)
(c) Vibratory Roller (Note 2).....	1101.01(g)
(d) Mechanical Sweeper.....	1101.03
(e) Self-Propelled Milling Machine.....	1101.16(a)
(f) Spreading and Finishing Machine.....	1102.03
(g) Multi-unit Recycling Train (Note 3, 5)	
(h) Single-unit Recycler (Note 4, 5)	
(i) Pick-Up Machine (Note 6)	

Note 1. The self-propelled pneumatic-tired roller shall have a gross weight (mass) of not less than 25 tons (23 metric tons).

Note 2. The double drum vibratory rollers shall have a gross operating weight (mass) of not less than 10 tons (9 metric tons) and a width of 78 in. (1950 mm).

Note 3. The multi-unit recycling train shall contain the following.

- a. A self-propelled cold milling machine that is capable of pulverizing the existing bituminous material in a single pass to the depth show on the plans and to a minimum width of not less than one lane width in each pass. The machine shall have automatic depth controls to maintain the cutting depth to within ± 0.25 in. (6mm) of that shown on the plans, and shall have a positive means for controlling cross slope elevations. The use of heating device to soften the pavement will not be permitted.
- b. A material sizing unit having screening and crushing capabilities to reduce the cold pulverized material to the appropriate size. The screening and crushing unit shall have a closed circuit system capable of continuously returning oversized material to the crusher. All of the pulverized material (100 percent) shall be processed to the maximum size requirements as specified.
- c. A mixing unit equipped with a belt scale for the continuous weighing of the pulverized and sized bituminous material and a coupled/interlocked computer controlled liquid metering device. The mixing unit shall be an on-board completely self-contained pugmill. The liquid metering device shall be capable of automatically adjusting the flow of emulsified asphalt to compensate for any variation in the weight of pulverized material coming into the mixer. The metering device shall deliver the amount of emulsified asphalt to within ± 0.2 percent of the required amount by weight of pulverized bituminous material (for example, if the design requires 3.0 percent, the metering device shall maintain between 2.8 percent to 3.2 percent). The emulsified asphalt pump should be of sufficient capacity to allow emulsion contents up to 3.5 percent by weight of pulverized bituminous material. Also, automatic digital readings will be displayed for both the flow rate and total amount of pulverized bituminous material and emulsified asphalt in appropriate units of weight and time.

- Note 4. The single-unit recycler shall be a self-propelled cold milling machine/cold recycling machine with a down cutting cutter head capable of pulverizing and recycling the existing hot-mix asphalt pavement to a maximum depth of 5 in. (125 mm), incorporate the emulsified asphalt and water, and mix the materials to produce a homogeneous material. The minimum power of this machine is 900 hp (670 kW). The machine shall be capable of pulverizing and recycling not less than one lane width in each pass. The machine shall have two systems for adding emulsified asphalt and water, with each system having a full-width spray bar with a positive displacement pump interlocked to the machine's ground speed to insure that the amount of emulsified asphalt and water being added is automatically adjusted with changes to the machine's ground speed. Each additive system shall have its own spray bar equipped with 2 nozzles per ft (6 nozzles per m) of spray bar and be capable of incorporating up to 7gal/sq yd (31.7 L/sq m) of emulsified asphalt and/or water. Individual valves on the spray bar shall be capable of being turned off as necessary to minimize emulsified asphalt and water overlap on subsequent passes.
- Note 5. Any additives such as water, lime slurry, etc. added by the recycling equipment at the mill head or mixing unit shall be controlled through liquid metering devices capable of automatically adjusting for the variation in the weight of the pulverized material going into the mixing unit. The metering devices shall be capable of delivering the amount of additive to within ± 0.2 percent of the required amount by weight of the pulverized bituminous material. A capability of adding up to 5% water by weight of the pulverized bituminous material, if necessary based on environmental and material requirements, is mandatory. It will not be required to meter the water added at the milling machine to control dust in the screens, belts or crushers/material sizing unit.
- Note 6 The pick-up machine shall be capable of removing the entire windrow down to the remaining underlying material, with adequate hopper capacity to provide a uniformed feed to the paver, regardless of the variability in the windrow size.

CONSTRUCTION REQUIREMENTS

Weather Limitations. The work shall be performed when the atmospheric temperature in the shade and away from the artificial heat is 50°F (10°C) and rising. Also, the weather shall not be foggy or rainy. The weather forecast shall not call for freezing temperature within 48 hours after placement of any portion of the project. The Engineer may restrict work when the heat index is greater than 100°F (38°C).

Preparation of Existing Pavement. Grass and other vegetation shall be removed from the edge of the existing pavement to prevent contamination of the pulverized bituminous material during the milling operation.

The existing pavement shall be milled to the required depth and width as indicated on the plans. Recycling shall be in a manner that does not disturb the underlying material in the existing roadway. The milling operation shall be conducted so that the amount of fines occurring along the vertical faces of the cut and the underlying surface prior to the windrow placement will not prevent bonding of the cold recycled material. Additional hand cleaning or compressed air may be needed to clean the vertical face or underlying pavement prior to windrow placement or paving. The pulverized bituminous material shall be processed to the required gradation specified. When a paving fabric is encountered during the CIR operation, the Contractor shall make necessary adjustments in equipment or operations so that at least 90 percent of the shredded fabric in the recycled material is no more than 5 sq in. (3200 sq mm). Additionally, no fabric piece shall have any dimension exceeding a length of 4 in. (100 mm). These changes may include, but not be limited to, adjusting the milling rate or screens in order to obtain a recycled material meeting specification requirements. The Contractor shall be required to waste material containing over-sized pieces of paving fabric as directed by the Engineer. When the Contractor is aware that paving fabric exists, such as indicated on the plans, the Contractor will not receive additional payment. However, if the Contractor is not made aware of the paving fabric, then the Contractor shall receive additional payment for any necessary adjustments in equipment and operations.

Mixing Operations. The pulverized material shall be processed through a mixing unit capable of combining the pulverized material, emulsified asphalt, and any additives to produce a homogeneous recycled mixture. The emulsified asphalt shall be incorporated into the pulverized bituminous material at the initial rate determined by the mix design(s) and approved by the Engineer. Sampling and mix design may determine different levels of emulsified asphalt at various portions of the project.

Spreading and Finishing. The recycled material shall be spread using a self-propelled paver. A pick-up machine shall be used to transfer the windrowed recycled material into the spreading and finishing machine. The pickup machine / paver shall have adequate hopper capacity to accommodate variability in the windrow size. The pick-up machine must be within 150 ft (45 m) of the mixing unit, and brought up tight to mixing machine during delays in milling. The recycled material shall be spread by a spreading and finishing machine full-lane width in one continuous pass, without segregation, and to the lines and grades established by the Engineer.

Compaction. The compacted recycled material shall be at a thickness of 2.5 to 5.0 in. (63 to 125 mm). The recycled material shall be compacted according to the following.

- (a) Growth Curve. Compaction shall be accomplished by performing a growth curve within the first one-half mile production. If an adjustment is made to emulsified asphalt application rate or recycled depth, the Engineer reserves the right to request an additional growth curve. The growth curve, consisting of a plot of lb/cu ft (kg/cu m) versus number of passes with the project breakdown roller, shall be developed. Roller speed during the growth curve testing shall be the same as the normal paving operation. This curve shall be established by use of nuclear gauge. Tests shall be taken after each pass until the highest lb/cu ft (kg/cu m) is obtained. This value shall be the target density. The result of the growth curve must be within 10% of the mix design density.

A new growth curve is required if the rollers used on the growth curve are placed with a new roller during production. The target density shall apply only to the specific gauge used. If additional gauges are to be used to determine density specification compliance, the Contractor shall establish a unique minimum allowable target density from the growth curve location for each gauge

- (b) Rollers. Immediately after processing and final shaping, the recycled material shall be compacted with equipment meeting the following requirements.

MINIMUM ROLLER REQUIREMENTS FOR CIR			
Breakdown Roller (one of the following) ¹	Intermediate Roller ¹	Final Roller (one or more of the following) ¹	Density Requirement
V _s , V _D	P	V _s , T _F	95 – 102 percent of the target density obtained on the growth curve

Note): 1. Equipment definitions in Table 1 of Article 406.07.

- (c) Rolling. Breakdown rolling shall be achieved by using a vibratory roller either operating in a static or vibratory mode. Vibratory mode should only be use if it is shown to not damage the pavement. Intermediate rolling shall be completed by a self-propelled pneumatic-tired roller(s) until no displacement is occurring or until the pneumatic-tired roller(s) is walking out of the mixture. Final rolling to eliminate tire marks and to achieve density shall be done by a separate double drum steel roller(s) operating in static mode.

Rolling shall start no more than 30 minutes behind the paver. Finish rolling shall be completed no more than one hour after milling is completed. Rolling should be completed right to the paver during delays. When possible, rolling shall not be started or stopped on uncompacted material but with rolling patterns established so that they begin or end on previously compacted material or the existing pavement.

Opening to Traffic. After the completion of compaction of the recycled material, no traffic, including that of the Contractor, shall be permitted on the completed recycled material for at least two hours. After two hours, rolling traffic may be permitted on the recycled material. This time may be adjusted by the Engineer to allow establishment of sufficient cure so traffic will not initiate raveling or permanent deformation. All loose particles that may develop on the pavement surface shall be removed by power brooming.

After opening to traffic, the surface of the recycled pavement shall be maintained in a condition suitable for the safe movement of traffic.

Maintenance. The Contractor shall maintain the recycled pavement in a manner satisfactory to the Engineer until the wearing course has been constructed. Maintenance related to Contractor construction procedures or quality of work, shall not be paid for separately.

Curing. Before placing the specified wearing course, the recycled pavement shall be allowed to cure until the moisture of the material is reduced to 2.0 percent or less, as determined by the method recommended by the QC staff, from samples obtained by the contractor or approval of the Engineer. Unless otherwise directed by the Engineer, the specified wearing course shall be placed within two weeks of the recycled pavement final cure, but no later than November 1.

Surface Tests. The completed recycled pavement will be tested for smoothness in the wheel paths with a 16 ft (5 m) straightedge.

For each variation in the recycled pavement that exceeds 3/8 in. (10 mm), the entire area affected shall be corrected by a self-propelled milling machine. The recycled pavement shall be swept by a mechanical broom to remove all loose material from the recycled pavement before opening to traffic.

Severe segregation areas or areas unable to be milled correct, shall be milled to ½ the depth of the recycled pavement, and replaced with a suitable single lift of HMA.

The Contractor shall furnish a 16 ft (5 m) straightedge and shall provide for its jobsite transportation at no additional cost to the Department.

Quality Assurance/ Quality Control (QC/QA).

(a) Quality Control by the Contractor. The Contractor shall perform or have performed the inspection and tests required to assure conformance to contract requirements. Control includes the recognition of obvious defects and their immediate correction. This may require increased testing, communication of test results to the job site, modification of operations, suspension of the work, or other actions as appropriate.

The Engineer shall be immediately notified of any failing tests and subsequent remedial action. Passing tests shall be reported to the Engineer no later than the start of the next work day. All test results shall be submitted to the engineer within 2 days of completion of the project, prior to payment for the work.

(b) Quality Assurance by the Engineer. The Engineer will conduct independent assurance tests on split samples taken by the Contractor for quality control testing. In addition, the Engineer will witness the sampling and splitting of these samples and will immediately retain witnessed split samples for quality assurance testing.

(c) Tests Methods and Frequency.

(1) Depth of Pulverization (Milling). The nominal depth at the centerline shall be required. Anytime depth changes are made or equipment is idle, a depth check shall be taken.

(2) Pulverized Material Sizing and Gradation. A sample shall be obtained before emulsified asphalt addition and screened using a 1.5 in. (37.5 mm) sieve (or smaller sieve if required) to determine if meeting the maximum particle size requirement. Gradations shall be performed each day on the moist millings using the following sieves: 1.5 in., 1.0 in., ¾ in., ½ in., 3/8 in., No. 4, No 8. No. 16 and No. 30. The resulting gradation shall be compared to the mix design gradations to determine any necessary changes to emulsion content.

Sampling procedures shall generally be in accordance with ASTM D 979 or AASHTO T 168. When the Engineer determines the location for a gradation sample, the Contractor will be notified to turn off the emulsified asphalt and mark the location continuing to pulverize the hot-mix asphalt pavement until the Engineer is satisfied with the length of material pulverized without the addition of the emulsified asphalt. The maximum length of pulverization without the addition of the emulsified asphalt shall not exceed 100 ft (30 m). After the Contractor collects the gradation sample, the machine will be backed up to the location where the emulsified asphalt was turned off, then re-pulverize this material, adding the required amount of emulsified asphalt to the pulverized material.

- (3) Emulsified Asphalt Content. The Engineer shall be notified any time emulsified asphalt content is changed. The emulsified asphalt content shall be checked and recorded for each segment in which the percentage is changed. Emulsified asphalt content changes shall be made based upon mix design recommendations, which are based upon different mix designs for road segments of varying construction. The emulsified asphalt content shall be checked from the belt scale totalizer or emulsified asphalt pump totalizer.
- (4) Water Content. The Engineer shall be notified any time the water content is changed. Water content at the milling head shall be checked and recorded for each segment in which the percentage is changed. This information shall be gathered from the water metering device, which can be checked from the belt scale totalizer to verify daily quantities used. Water content changes shall be made based on mixture consistency, coating, and dispersion of the recycled materials.
- (5) Compacted Density. A wet density shall be determined using a nuclear moisture-density gauge generally following the procedures for ASTM D 2950, backscatter measurement. This measurement shall be compared to the target density obtained by the growth curve.
- (6) Frequency. The following table provides the minimum frequency for tests; however, the Engineer may increase the testing frequency if the construction process is experiencing problems or unknown conditions are encountered.

QC/QA TESTING FREQUENCY		
Test	QC Frequency ¹	QA Frequency ¹
Depth of Pulverization	1 per 500 ft (150 m)	1 per 1000 ft (300 m)
Pulverized Material Sizing and Gradation	1 per 0.5 day of production	1 per day of production
Emulsified Asphalt Content	1 per 500 ft (150 m)	1 per 1000 ft (300 m)
Water Content	1 per 500 ft (150 m)	1 per 1000 ft (300 m)
Compact Density	1 per 0.25 mile (0.4 km)	1 per mile (1.6 km)

Note: 1. The contractor shall perform all quality control tests within the first 500 ft (150m) after startup or any change in the mix. The Department will also run the split samples at these locations.

Method of Measurement.

Bituminous materials will be measured for payment as specified in Section 1032.

Coarse aggregate will be measured in square yards.

The cold in-place recycling will be measured in square yards of the recycled pavement.

Basis of Payment.

The bituminous material will be paid for at the contract unit price per Gallon for CIR-FDR EMULSIFIED ASPHALT.

The coarse aggregate will be paid for at the contract unit price per Square Yard for ADD ROCK.

The cold in-place recycling will be paid for at the contract unit price per Square Yard for COLD IN-PLACE RECYCLING, of the thickness specified.

AUTOMATED FLAGGER ASSISTANCE DEVICES (BDE)

Effective: January 1, 2008

Description. This work shall consist of furnishing and operating automated flagger assistance devices (AFADs) as part of the work zone traffic control and protection for two-lane highways where two-way traffic is maintained over one lane of pavement. Use of these devices shall be at the option of the Contractor.

Equipment. AFADs shall be according to the FHWA memorandum, "MUTCD - Revised Interim Approval for the use of Automated Flagger Assistance Devices in Temporary Traffic Control Zones (IA-4R)", dated January 28, 2005. The devices shall be mounted on a trailer or a moveable cart and shall meet the requirements of NCHRP 350, Category 4.

The AFAD shall be the Stop/Slow type. This device uses remotely controlled "STOP" and "SLOW" signs to alternately control right-of-way.

Signs for the AFAD shall be according to Article 701.03 of the Standard Specifications and the MUTCD. The signs shall be 24 x 24 in. (600 x 600 mm) having an octagon shaped "STOP" sign on one side and a diamond shaped "SLOW" sign on the opposite side. The letters on the signs shall be 8 in. (200 mm) high. If the "STOP" sign has louvers, the full sign face shall be visible at a distance of 50 ft (15 m) and greater.

The signs shall be supplemented with one of the following types of lights.

- (a) Flashing Lights. When flashing lights are used, white or red flashing lights shall be mounted within the "STOP" sign face and white or yellow flashing lights within the "SLOW" sign face.
- (b) Stop and Warning Beacons. When beacons are used, a stop beacon shall be mounted 24 in. (600 mm) or less above the "STOP" sign face and a warning beacon mounted 24 in. (600 mm) or less above, below, or to the side of the "SLOW" sign face. As an option, a Type B warning light may be used in lieu of the warning beacon.

A "WAIT ON STOP" sign shall be placed on the right hand side of the roadway at a point where drivers are expected to stop. The sign shall be 24 x 30 in. (600 x 750 mm) with a black legend and border on a white background. The letters shall be at least 6 in. (150 mm) high.

This device may include a gate arm or mast arm that descends to a horizontal position when the "STOP" sign is displayed and rises to a vertical position when the "SLOW" sign is displayed. When included, the end of the arm shall reach at least to the center of the lane being controlled. The arm shall have alternating red and white retroreflective stripes, on both sides, sloping downward at 45 degrees toward the side on which traffic will pass. The stripes shall be 6 in. (150 mm) in width and at least 2 in. (50 mm) in height.

Flagging Requirements. Flaggers and flagging requirements shall be according to Article 701.13 of the Standard Specifications and the following.

AFADs shall be placed at each end of the traffic control, where a flagger is shown on the plans. The flaggers shall be able to view the face of the AFAD and approaching traffic during operation.

To stop traffic, the "STOP" sign shall be displayed, the corresponding lights/beacon shall flash, and when included, the gate arm shall descend to a horizontal position. To permit traffic to move, the "SLOW" sign shall be displayed, the corresponding lights/beacon shall flash, and when included, the gate arm shall rise to a vertical position.

If used at night, the AFAD location shall be illuminated according to Section 701 of the Standard Specifications.

When not in use, AFADs will be considered nonoperating equipment and shall be stored according to Article 701.11 of the Standard Specifications.

Basis of Payment. This work will not be paid for separately but shall be considered as included in the cost of the various traffic control items included in the contract.

BUTT JOINTS (BDE)

Effective: July 1, 2016

Add the following to Article 406.08 of the Standard Specifications.

“(c) Temporary Plastic Ramps. Temporary plastic ramps shall be made of high density polyethylene meeting the properties listed below. Temporary plastic ramps shall only be used on roadways with permanent posted speeds of 55 mph or less. The ramps shall have a minimum taper rate of 1:30 (V:H). The leading edge of the plastic ramp shall have a maximum thickness of 1/4 in. (6 mm) and the trailing edge shall match the height of the adjacent pavement \pm 1/4 in. (\pm 6 mm).

The ramp will be accepted by certification. The Contractor shall furnish a certification from the manufacturer stating the temporary plastic ramp meets the following requirements.

Physical Property	Test Method	Requirement
Melt Index	ASTM D 1238	8.2 g/10 minutes
Density	ASTM D 1505	0.965 g/cc
Tensile Strength @ Break	ASTM D 638	2223 psi (15 MPa)
Tensile Strength @ Yield	ASTM D 638	4110 psi (28 MPa)
Elongation @ Yield ^{1/} , percent	ASTM D 638	7.3 min.
Durometer Hardness, Shore D	ASTM D 2240	65
Heat Deflection Temperature, 66 psi	ASTM D 648	176 °F (80 °C)
Low Temperature Brittleness, F ₅₀	ASTM D 746	<-105 °F (<-76 °C)

1/ Crosshead speed -2 in./minute

The temporary plastic ramps shall be installed according to the manufacturer’s specifications and fastened with anchors meeting the manufacturer’s recommendations. Temporary plastic ramps that fail to stay in place or create a traffic hazard shall be replaced immediately with temporary HMA ramps at the Contractor’s expense.”

COMPENSABLE DELAY COSTS (BDE)

Effective: June 2, 2017

Revise Article 107.40(b) of the Standard Specifications to read:

“(b) Compensation. Compensation will not be allowed for delays, inconveniences, or damages sustained by the Contractor from conflicts with facilities not meeting the above definition; or if a conflict with a utility in an unanticipated location does not cause a shutdown of the work or a documentable reduction in the rate of progress exceeding the limits set herein. The provisions of Article 104.03 notwithstanding, compensation for delays caused by a utility in an unanticipated location will be paid according to the provisions of this Article governing minor and major delays or reduced rate of production which are defined as follows.

- (1) Minor Delay. A minor delay occurs when the work in conflict with the utility in an unanticipated location is completely stopped for more than two hours, but not to exceed two weeks.
- (2) Major Delay. A major delay occurs when the work in conflict with the utility in an unanticipated location is completely stopped for more than two weeks.
- (3) Reduced Rate of Production Delay. A reduced rate of production delay occurs when the rate of production on the work in conflict with the utility in an unanticipated location decreases by more than 25 percent and lasts longer than seven calendar days.”

Revise Article 107.40(c) of the Standard Specifications to read:

“(c) Payment. Payment for Minor, Major, and Reduced Rate of Production Delays will be made as follows.

- (1) Minor Delay. Labor idled which cannot be used on other work will be paid for according to Article 109.04(b)(1) and (2) for the time between start of the delay and the minimum remaining hours in the work shift required by the prevailing practice in the area.

Equipment idled which cannot be used on other work, and which is authorized to standby on the project site by the Engineer, will be paid for according to Article 109.04(b)(4).

- (2) Major Delay. Labor will be the same as for a minor delay.

Equipment will be the same as for a minor delay, except Contractor-owned equipment will be limited to two weeks plus the cost of move-out to either the Contractor's yard or another job and the cost to re-mobilize, whichever is less. Rental equipment may be paid for longer than two weeks provided the Contractor presents adequate support to the Department (including lease agreement) to show retaining equipment on the job is the most economical course to follow and in the public interest.

- (3) Reduced Rate of Production Delay. The Contractor will be compensated for the reduced productivity for labor and equipment time in excess of the 25 percent threshold for that portion of the delay in excess of seven calendar days. Determination of compensation will be in accordance with Article 104.02, except labor and material additives will not be permitted.

Payment for escalated material costs, escalated labor costs, extended project overhead, and extended traffic control will be determined according to Article 109.13."

Revise Article 108.04(b) of the Standard Specifications to read:

"(b) No working day will be charged under the following conditions.

- (1) When adverse weather prevents work on the controlling item.
- (2) When job conditions due to recent weather prevent work on the controlling item.
- (3) When conduct or lack of conduct by the Department or its consultants, representatives, officers, agents, or employees; delay by the Department in making the site available; or delay in furnishing any items required to be furnished to the Contractor by the Department prevents work on the controlling item.
- (4) When delays caused by utility or railroad adjustments prevent work on the controlling item.
- (5) When strikes, lock-outs, extraordinary delays in transportation, or inability to procure critical materials prevent work on the controlling item, as long as these delays are not due to any fault of the Contractor.
- (6) When any condition over which the Contractor has no control prevents work on the controlling item."

Revise Article 109.09(f) of the Standard Specifications to read:

“(f) Basis of Payment. After resolution of a claim in favor of the Contractor, any adjustment in time required for the work will be made according to Section 108. Any adjustment in the costs to be paid will be made for direct labor, direct materials, direct equipment, direct jobsite overhead, direct offsite overhead, and other direct costs allowed by the resolution. Adjustments in costs will not be made for interest charges, loss of anticipated profit, undocumented loss of efficiency, home office overhead and unabsorbed overhead other than as allowed by Article 109.13, lost opportunity, preparation of claim expenses and other consequential indirect costs regardless of method of calculation.

The above Basis of Payment is an essential element of the contract and the claim cost recovery of the Contractor shall be so limited.”

Add the following to Section 109 of the Standard Specifications.

“**109.13 Payment for Contract Delay.** Compensation for escalated material costs, escalated labor costs, extended project overhead, and extended traffic control will be allowed when such costs result from a delay meeting the criteria in the following table.

Contract Type	Cause of Delay	Length of Delay
Working Days	Article 108.04(b)(3) or Article 108.04(b)(4)	No working days have been charged for two consecutive weeks.
Completion Date	Article 108.08(b)(1) or Article 108.08(b)(7)	The Contractor has been granted a minimum two week extension of contract time, according to Article 108.08.

Payment for each of the various costs will be according to the following.

(a) Escalated Material and/or Labor Costs. When the delay causes work, which would have otherwise been completed, to be done after material and/or labor costs have increased, such increases will be paid. Payment for escalated material costs will be limited to the increased costs substantiated by documentation furnished by the Contractor. Payment for escalated labor costs will be limited to those items in Article 109.04(b)(1) and (2), except the 35 percent and 10 percent additives will not be permitted.

(b) Extended Project Overhead. For the duration of the delay, payment for extended project overhead will be paid as follows.

(1) Direct Jobsite and Offsite Overhead. Payment for documented direct jobsite overhead and documented direct offsite overhead, including onsite supervisory and administrative personnel, will be allowed according to the following table.

Original Contract Amount	Supervisory and Administrative Personnel
Up to \$5,000,000	One Project Superintendent
Over \$ 5,000,000 - up to \$25,000,000	One Project Manager, One Project Superintendent or Engineer, and One Clerk
Over \$25,000,000 - up to \$50,000,000	One Project Manager, One Project Superintendent, One Engineer, and One Clerk
Over \$50,000,000	One Project Manager, Two Project Superintendents, One Engineer, and One Clerk

(2) Home Office and Unabsorbed Overhead. Payment for home office and unabsorbed overhead will be calculated as 8 percent of the total delay cost.

(c) Extended Traffic Control. Traffic control required for an extended period of time due to the delay will be paid. For working day contracts the payment will be made according to Article 109.04. For completion date contracts, an adjustment will be determined as follows.

Extended Traffic Control occurs between April 1 and November 30:

$$\text{ETCP Adjustment (\$)} = \text{TE} \times (\% / 100 \times \text{CUP} / \text{OCT})$$

Extended Traffic Control occurs between December 1 and March 31:

$$\text{ETCP Adjustment (\$)} = \text{TE} \times 1.5 (\% / 100 \times \text{CUP} / \text{OCT})$$

Where: TE = Duration of approved time extension in calendar days.
% = Percent maintenance for the traffic control, % (see table below).
CUP = Contract unit price for the traffic control pay item in place during the delay.
OCT = Original contract time in calendar days.

Original Contract Amount	Percent Maintenance
Up to \$2,000,000	65%
\$2,000,000 to \$10,000,000	75%
\$10,000,000 to \$20,000,000	85%
Over \$20,000,000	90%

When an ETCP adjustment is paid under this provision, an adjusted unit price as provided for in Article 701.20(a) for increase or decrease in the value of work by more than ten percent will not be paid.

Upon payment for a contract delay under this provision, the Contractor shall assign subrogation rights to the Department for the Department's efforts of recovery from any other party for monies paid by the Department as a result of any claim under this provision. The Contractor shall fully cooperate with the Department in its efforts to recover from another party any money paid to the Contractor for delay damages under this provision."

CONCRETE MIX DESIGN – DEPARTMENT PROVIDED (BDE)

Effective: January 1, 2012

Revised: April 1, 2016

For the concrete mix design requirements in Article 1020.05(a) of the Standard Specifications, the Contractor has the option to request the Engineer determine mix design material proportions for Class PV, PP, RR, BS, DS, SC, and SI concrete. A single mix design for each class of concrete will be provided. Acceptance by the Contractor to use the mix design developed by the Engineer shall not relieve the Contractor from meeting specification requirements.

DISADVANTAGED BUSINESS ENTERPRISE PARTICIPATION (DBE)

Effective: September 1, 2000

Revised: July 2, 2016

FEDERAL OBLIGATION. The Department of Transportation, as a recipient of federal financial assistance, is required to take all necessary and reasonable steps to ensure nondiscrimination in the award and administration of contracts. Consequently, the federal regulatory provisions of 49 CFR Part 26 apply to this contract concerning the utilization of disadvantaged business enterprises. For the purposes of this Special Provision, a disadvantaged business enterprise (DBE) means a business certified by the Department in accordance with the requirements of 49 CFR Part 26 and listed in the Illinois Unified Certification Program (IL UCP) DBE Directory.

STATE OBLIGATION. This Special Provision will also be used by the Department to satisfy the requirements of the Business Enterprise for Minorities, Females, and Persons with Disabilities Act, 30 ILCS 575. When this Special Provision is used to satisfy state law requirements on 100 percent state-funded contracts, the federal government has no involvement in such contracts (not a federal-aid contract) and no responsibility to oversee the implementation of this Special Provision by the Department on those contracts. DBE participation on 100 percent state-funded contracts will not be credited toward fulfilling the Department's annual overall DBE goal required by the US Department of Transportation to comply with the federal DBE program requirements.

CONTRACTOR ASSURANCE. The Contractor makes the following assurance and agrees to include the assurance in each subcontract that the Contractor signs with a subcontractor.

The Contractor, subrecipient, or subcontractor shall not discriminate on the basis of race, color, national origin, or sex in the performance of this contract. The Contractor shall carry out applicable requirements of 49 CFR Part 26 in the award and administration of contracts funded in whole or in part with federal or state funds. Failure by the Contractor to carry out these requirements is a material breach of this contract, which may result in the termination of this contract or such other remedy as the recipient deems appropriate, which may include, but is not limited to:

- (a) Withholding progress payments;
- (b) Assessing sanctions;
- (c) Liquidated damages; and/or
- (d) Disqualifying the Contractor from future bidding as non-responsible.

OVERALL GOAL SET FOR THE DEPARTMENT. As a requirement of compliance with 49 CFR Part 26, the Department has set an overall goal for DBE participation in its federally assisted contracts. That goal applies to all federal-aid funds the Department will expend in its federally assisted contracts for the subject reporting fiscal year. The Department is required to make a good faith effort to achieve the overall goal. The dollar amount paid to all approved DBE companies performing work called for in this contract is eligible to be credited toward fulfillment of the Department's overall goal.

CONTRACT GOAL TO BE ACHIEVED BY THE CONTRACTOR. This contract includes a specific DBE utilization goal established by the Department. The goal has been included because the Department has determined that the work of this contract has subcontracting opportunities that may be suitable for performance by DBE companies. The determination is based on an assessment of the type of work, the location of the work, and the availability of DBE companies to do a part of the work. The assessment indicates that, in the absence of unlawful discrimination, and in an arena of fair and open competition, DBE companies can be expected to perform 3.00% of the work. This percentage is set as the DBE participation goal for this contract. Consequently, in addition to the other award criteria established for this contract, the Department will only award this contract to a bidder who makes a good faith effort to meet this goal of DBE participation in the performance of the work. A bidder makes a good faith effort for award consideration if either of the following is done in accordance with the procedures set for in this Special Provision:

- (a) The bidder documents that enough DBE participation has been obtained to meet the goal or,
- (b) The bidder documents that a good faith effort has been made to meet the goal, even though the effort did not succeed in obtaining enough DBE participation to meet the goal.

DBE LOCATOR REFERENCES. Bidders shall consult the IL UCP DBE Directory as a reference source for DBE-certified companies. In addition, the Department maintains a letting and item specific DBE locator information system whereby DBE companies can register their interest in providing quotes on particular bid items advertised for letting. Information concerning DBE companies willing to quote work for particular contracts may be obtained by contacting the Department's Bureau of Small Business Enterprises at telephone number (217) 785-4611, or by visiting the Department's website at:
<http://www.idot.illinois.gov/doing-business/certifications/disadvantaged-business-enterprise-certification/il-ucp-directory/index>.

BIDDING PROCEDURES. Compliance with this Special Provision is required prior to the award of the contract and the failure of the low bidder to comply will render the bid not responsive.

In order to assure the timely award of the contract, the low bidder shall submit:

- (a) The bidder shall submit a DBE Utilization Plan on completed Department forms SBE 2025 and 2026.
 - (1) The final Utilization Plan must be submitted within five calendar days after the date of the letting in accordance with subsection (a)(2) of Bidding Procedures herein.
 - (2) To meet the five day requirement, the bidder may send the Utilization Plan electronically by scanning and sending to **DOT.DBE.UP@illinois.gov** or faxing to (217) 785-1524. The subject line must include the bid Item Number and the Letting date. The Utilization Plan should be sent as one .pdf file, rather than multiple files and emails for the same Item Number. It is the responsibility of the bidder to obtain confirmation of email or fax delivery.

Alternatively, the Utilization Plan may be sent by certified mail or delivery service within the five calendar day period. If a question arises concerning the mailing date of a Utilization Plan, the mailing date will be established by the U.S. Postal Service postmark on the certified mail receipt from the U.S. Postal Service or the receipt issued by a delivery service when the Utilization Plan is received by the Department. It is the responsibility of the bidder to ensure the postmark or receipt date is affixed within the five days if the bidder intends to rely upon mailing or delivery to satisfy the submission day requirement. The Utilization Plan is to be submitted to:

Illinois Department of Transportation
Bureau of Small Business Enterprises
Contract Compliance Section
2300 South Dirksen Parkway, Room 319
Springfield, Illinois 62764

The Department will not accept a Utilization Plan if it does not meet the five day submittal requirement and the bid will be declared not responsive. In the event the bid is declared not responsive due to a failure to submit a Utilization Plan or failure to comply with the bidding procedures set forth herein, the Department may elect to cause the forfeiture of the penal sum of the bidder's proposal guaranty, and may deny authorization to bid the project if re-advertised for bids. The Department reserves the right to invite any other bidder to submit a Utilization Plan at any time for award consideration.

- (b) The Utilization Plan shall indicate that the bidder either has obtained sufficient DBE participation commitments to meet the contract goal or has not obtained enough DBE participation commitments in spite of a good faith effort to meet the goal. The Utilization Plan shall further provide the name, telephone number, and telefax number of a responsible official of the bidder designated for purposes of notification of Utilization Plan approval or disapproval under the procedures of this Special Provision.
- (c) The Utilization Plan shall include a DBE Participation Commitment Statement, Department form SBE 2025, for each DBE proposed for the performance of work to achieve the contract goal. For bidding purposes, submission of the completed SBE 2025 forms, signed by the DBEs and scanned or faxed to the bidder will be acceptable as long as the original is available and provided upon request. All elements of information indicated on the said form shall be provided, including but not limited to the following:
 - (1) The names and addresses of DBE firms that will participate in the contract;
 - (2) A description, including pay item numbers, of the work each DBE will perform;
 - (3) The dollar amount of the participation of each DBE firm participating. The dollar amount of participation for identified work shall specifically state the quantity, unit price, and total subcontract price for the work to be completed by the DBE. If partial pay items are to be performed by the DBE, indicate the portion of each item, a unit price where appropriate and the subcontract price amount;

- (4) DBE Participation Commitment Statements, form SBE 2025, signed by the bidder and each participating DBE firm documenting the commitment to use the DBE subcontractors whose participation is submitted to meet the contract goal;
- (5) If the bidder is a joint venture comprised of DBE companies and non-DBE companies, the Utilization Plan must also include a clear identification of the portion of the work to be performed by the DBE partner(s); and,
- (6) If the contract goal is not met, evidence of good faith efforts; the documentation of good faith efforts must include copies of each DBE and non-DBE subcontractor quote submitted to the bidder when a non-DBE subcontractor is selected over a DBE for work on the contract.

GOOD FAITH EFFORT PROCEDURES. The contract will not be awarded until the Utilization Plan submitted by the apparent successful bidder is approved. All information submitted by the bidder must be complete, accurate and adequately document that enough DBE participation has been obtained or document that good faith efforts of the bidder, in the event enough DBE participation has not been obtained, before the Department will commit to the performance of the contract by the bidder. The Utilization Plan will be approved by the Department if the Utilization Plan documents sufficient commercially useful DBE work to meet the contract goal or the bidder submits sufficient documentation of a good faith effort to meet the contract goal pursuant to 49 CFR Part 26, Appendix A. The Utilization Plan will not be approved by the Department if the Utilization Plan does not document sufficient DBE participation to meet the contract goal unless the apparent successful bidder documented in the Utilization Plan that it made a good faith effort to meet the goal. This means that the bidder must show that all necessary and reasonable steps were taken to achieve the contract goal. Necessary and reasonable steps are those which, by their scope, intensity and appropriateness to the objective, could reasonably be expected to obtain sufficient DBE participation, even if they were not successful. The Department will consider the quality, quantity, and intensity of the kinds of efforts that the bidder has made. Mere *pro forma* efforts, in other words, efforts done as a matter of form, are not good faith efforts; rather, the bidder is expected to have taken genuine efforts that would be reasonably expected of a bidder actively and aggressively trying to obtain DBE participation sufficient to meet the contract goal.

- (a) The following is a list of types of action that the Department will consider as part of the evaluation of the bidder's good faith efforts to obtain participation. These listed factors are not intended to be a mandatory checklist and are not intended to be exhaustive. Other factors or efforts brought to the attention of the Department may be relevant in appropriate cases, and will be considered by the Department.
 - (1) Soliciting through all reasonable and available means (e.g. attendance at pre-bid meetings, advertising and/or written notices) the interest of all certified DBE companies that have the capability to perform the work of the contract. The bidder must solicit this interest within sufficient time to allow the DBE companies to respond to the solicitation. The bidder must determine with certainty if the DBE companies are interested by taking appropriate steps to follow up initial solicitations.

- (2) Selecting portions of the work to be performed by DBE companies in order to increase the likelihood that the DBE goals will be achieved. This includes, where appropriate, breaking out contract work items into economically feasible units to facilitate DBE participation, even when the prime Contractor might otherwise prefer to perform these work items with its own forces.
- (3) Providing interested DBE companies with adequate information about the plans, specifications, and requirements of the contract in a timely manner to assist them in responding to a solicitation.
- (4) a. Negotiating in good faith with interested DBE companies. It is the bidder's responsibility to make a portion of the work available to DBE subcontractors and suppliers and to select those portions of the work or material needs consistent with the available DBE subcontractors and suppliers, so as to facilitate DBE participation. Evidence of such negotiation includes the names, addresses, and telephone numbers of DBE companies that were considered; a description of the information provided regarding the plans and specifications for the work selected for subcontracting; and evidence as to why additional agreements could not be reached for DBE companies to perform the work.
 - b. A bidder using good business judgment would consider a number of factors in negotiating with subcontractors, including DBE subcontractors, and would take a firm's price and capabilities as well as contract goals into consideration. However, the fact that there may be some additional costs involved in finding and using DBE companies is not in itself sufficient reason for a bidder's failure to meet the contract DBE goal, as long as such costs are reasonable. Also the ability or desire of a bidder to perform the work of a contract with its own organization does not relieve the bidder of the responsibility to make good faith efforts. Bidders are not, however, required to accept higher quotes from DBE companies if the price difference is excessive or unreasonable. In accordance with subsection (c)(6) of the above Bidding Procedures, the documentation of good faith efforts must include copies of each DBE and non-DBE subcontractor quote submitted to the bidder when a non-DBE subcontractor was selected over a DBE for work on the contract.
- (5) Not rejecting DBE companies as being unqualified without sound reasons based on a thorough investigation of their capabilities. The bidder's standing within its industry, membership in specific groups, organizations, or associations and political or social affiliations (for example union vs. non-union employee status) are not legitimate causes for the rejection or non-solicitation of bids in the bidder's efforts to meet the project goal.
- (6) Making efforts to assist interested DBE companies in obtaining bonding, lines of credit, or insurance as required by the recipient or Contractor.
- (7) Making efforts to assist interested DBE companies in obtaining necessary equipment, supplies, materials, or related assistance or services.

- (8) Effectively using the services of available minority/women community organizations; minority/women contractors' groups; local, state, and federal minority/women business assistance offices; and other organizations as allowed on a case-by-case basis to provide assistance in the recruitment and placement of DBE companies.
- (b) If the Department determines that the apparent successful bidder has made a good faith effort to secure the work commitment of DBE companies to meet the contract goal, the Department will award the contract provided that it is otherwise eligible for award. If the Department determines that the bidder has failed to meet the requirements of this Special Provision or that a good faith effort has not been made, the Department will notify the responsible company official designated in the Utilization Plan that the bid is not responsive. The notification shall include a statement of reasons for the determination. If the Utilization Plan is not approved because it is deficient as a technical matter, unless waived by the Department, the bidder will be notified and will be allowed no more than a five calendar day period in order to cure the deficiency.
- (c) The bidder may request administrative reconsideration of a determination adverse to the bidder within the five working days after the receipt of the notification date of the determination by delivering the request to the Department of Transportation, Bureau of Small Business Enterprises, Contract Compliance Section, 2300 South Dirksen Parkway, Room 319, Springfield, Illinois 62764 (Telefax: (217) 785-1524). Deposit of the request in the United States mail on or before the fifth business day shall not be deemed delivery. The determination shall become final if a request is not made and delivered. A request may provide additional written documentation or argument concerning the issues raised in the determination statement of reasons, provided the documentation and arguments address efforts made prior to submitting the bid. The request will be forwarded to the Department's Reconsideration Officer. The Reconsideration Officer will extend an opportunity to the bidder to meet in person in order to consider all issues of documentation and whether the bidder made a good faith effort to meet the goal. After the review by the Reconsideration Officer, the bidder will be sent a written decision within ten working days after receipt of the request for consideration, explaining the basis for finding that the bidder did or did not meet the goal or make adequate good faith efforts to do so. A final decision by the Reconsideration Officer that a good faith effort was made shall approve the Utilization Plan submitted by the bidder and shall clear the contract for award. A final decision that a good faith effort was not made shall render the bid not responsive.

CALCULATING DBE PARTICIPATION. The Utilization Plan values represent work anticipated to be performed and paid for upon satisfactory completion. The Department is only able to count toward the achievement of the overall goal and the contract goal the value of payments made for the work actually performed by DBE companies. In addition, a DBE must perform a commercially useful function on the contract to be counted. A commercially useful function is generally performed when the DBE is responsible for the work and is carrying out its responsibilities by actually performing, managing, and supervising the work involved. The Department and Contractor are governed by the provisions of 49 CFR Part 26.55(c) on questions of commercially useful functions as it affects the work. Specific counting guidelines are provided in 49 CFR Part 26.55, the provisions of which govern over the summary contained herein.

- (a) DBE as the Contractor: 100 percent goal credit for that portion of the work performed by the DBE's own forces, including the cost of materials and supplies. Work that a DBE subcontracts to a non-DBE does not count toward the DBE goals.
- (b) DBE as a joint venture Contractor: 100 percent goal credit for that portion of the total dollar value of the contract equal to the distinct, clearly defined portion of the work performed by the DBE's own forces.
- (c) DBE as a subcontractor: 100 percent goal credit for the work of the subcontract performed by the DBE's own forces, including the cost of materials and supplies, excluding the purchase of materials and supplies or the lease of equipment by the DBE subcontractor from the prime Contractor or its affiliates. Work that a DBE subcontractor in turn subcontracts to a non-DBE does not count toward the DBE goal.
- (d) DBE as a trucker: 100 percent goal credit for trucking participation provided the DBE is responsible for the management and supervision of the entire trucking operation for which it is responsible. At least one truck owned, operated, licensed, and insured by the DBE must be used on the contract. Credit will be given for the following:
 - (1) The DBE may lease trucks from another DBE firm, including an owner-operator who is certified as a DBE. The DBE who leases trucks from another DBE receives credit for the total value of the transportation services the lessee DBE provides on the contract.
 - (2) The DBE may also lease trucks from a non-DBE firm, including from an owner-operator. The DBE who leases trucks from a non-DBE is entitled to credit only for the fee or commission is receives as a result of the lease arrangement.

(e) DBE as a material supplier:

- (1) 60 percent goal credit for the cost of the materials or supplies purchased from a DBE regular dealer.
- (2) 100 percent goal credit for the cost of materials of supplies obtained from a DBE manufacturer.
- (3) 100 percent credit for the value of reasonable fees and commissions for the procurement of materials and supplies if not a DBE regular dealer or DBE manufacturer.

CONTRACT COMPLIANCE. Compliance with this Special Provision is an essential part of the contract. The Department is prohibited by federal regulations from crediting the participation of a DBE included in the Utilization Plan toward either the contract goal or the Department's overall goal until the amount to be applied toward the goals has been paid to the DBE. The following administrative procedures and remedies govern the compliance by the Contractor with the contractual obligations established by the Utilization Plan. After approval of the Utilization Plan and award of the contract, the Utilization Plan and individual DBE Participation Statements become part of the contract. If the Contractor did not succeed in obtaining enough DBE participation to achieve the advertised contract goal, and the Utilization Plan was approved and contract awarded based upon a determination of good faith, the total dollar value of DBE work calculated in the approved Utilization Plan as a percentage of the awarded contract value shall become the amended contract goal. All work indicated for performance by an approved DBE shall be performed, managed, and supervised by the DBE executing the DBE Participation Commitment Statement.

- (a) NO AMENDMENT. No amendment to the Utilization Plan may be made without prior written approval from the Department's Bureau of Small Business Enterprises. All requests for amendment to the Utilization Plan shall be submitted to the Department of Transportation, Bureau of Small Business Enterprises, Contract Compliance Section, 2300 South Dirksen Parkway, Room 319, Springfield, Illinois 62764. Telephone number (217) 785-4611. Telefax number (217) 785-1524.
- (b) CHANGES TO WORK. Any deviation from the DBE condition-of-award or contract plans, specifications, or special provisions must be approved, in writing, by the Department as provided elsewhere in the Contract. The Contractor shall notify affected DBEs in writing of any changes in the scope of work which result in a reduction in the dollar amount condition-of-award to the contract. Where the revision includes work committed to a new DBE subcontractor, not previously involved in the project, then a Request for Approval of Subcontractor, Department form BC 260A or AER 260A, must be signed and submitted. If the commitment of work is in the form of additional tasks assigned to an existing subcontract, then a new Request for Approval of Subcontractor shall not be required. However, the Contractor must document efforts to assure that the existing DBE subcontractor is capable of performing the additional work and has agreed in writing to the change.

- (c) SUBCONTRACT. The Contractor must provide DBE subcontracts to IDOT upon request. Subcontractors shall ensure that all lower tier subcontracts or agreements with DBEs to supply labor or materials be performed in accordance with this Special Provision.
- (d) ALTERNATIVE WORK METHODS. In addition to the above requirements for reductions in the condition of award, additional requirements apply to the two cases of Contractor-initiated work substitution proposals. Where the contract allows alternate work methods which serve to delete or create underruns in condition of award DBE work, and the Contractor selects that alternate method or, where the Contractor proposes a substitute work method or material that serves to diminish or delete work committed to a DBE and replace it with other work, then the Contractor must demonstrate one of the following:
- (1) That the replacement work will be performed by the same DBE (as long as the DBE is certified in the respective item of work) in a modification of the condition of award; or
 - (2) That the DBE is aware that its work will be deleted or will experience underruns and has agreed in writing to the change. If this occurs, the Contractor shall substitute other work of equivalent value to a certified DBE or provide documentation of good faith efforts to do so; or
 - (3) That the DBE is not capable of performing the replacement work or has declined to perform the work at a reasonable competitive price. If this occurs, the Contractor shall substitute other work of equivalent value to a certified DBE or provide documentation of good faith efforts to do so.
- (e) TERMINATION AND REPLACEMENT PROCEDURES. The Contractor shall not terminate or replace a DBE listed on the approved Utilization Plan, or perform with other forces work designated for a listed DBE except as provided in this Special Provision. The Contractor shall utilize the specific DBEs listed to perform the work and supply the materials for which each is listed unless the Contractor obtains the Department's written consent as provided in subsection (a) of this part. Unless Department consent is provided for termination of a DBE subcontractor, the Contractor shall not be entitled to any payment for work or material unless it is performed or supplied by the DBE in the Utilization Plan.

As stated above, the Contractor shall not terminate or replace a DBE subcontractor listed in the approved Utilization Plan without prior written consent. This includes, but is not limited to, instances in which the Contractor seeks to perform work originally designated for a DBE subcontractor with its own forces or those of an affiliate, a non-DBE firm, or with another DBE firm. Written consent will be granted only if the Bureau of Small Business Enterprises agrees, for reasons stated in its concurrence document, that the Contractor has good cause to terminate or replace the DBE firm. Before transmitting to the Bureau of Small Business Enterprises any request to terminate and/or substitute a DBE subcontractor, the Contractor shall give notice in writing to the DBE subcontractor, with a copy to the Bureau, of its intent to request to terminate and/or substitute, and the reason for the request. The Contractor shall give the DBE five days to respond to the Contractor's notice. The DBE so notified shall advise the Bureau and the Contractor of the reasons, if any, why it objects to the proposed termination of its subcontract and why the Bureau should not approve the Contractor's action. If required in a particular case as a matter of public necessity, the Bureau may provide a response period shorter than five days.

For purposes of this paragraph, good cause includes the following circumstances:

- (1) The listed DBE subcontractor fails or refuses to execute a written contract;
- (2) The listed DBE subcontractor fails or refuses to perform the work of its subcontract in a way consistent with normal industry standards. Provided, however, that good cause does not exist if the failure or refusal of the DBE subcontractor to perform its work on the subcontract results from the bad faith or discriminatory action of the prime contractor;
- (3) The listed DBE subcontractor fails or refuses to meet the prime Contractor's reasonable, nondiscriminatory bond requirements;
- (4) The listed DBE subcontractor becomes bankrupt, insolvent, or exhibits credit unworthiness;
- (5) The listed DBE subcontractor is ineligible to work on public works projects because of suspension and debarment proceedings pursuant 2 CFR Parts 180, 215 and 1200 or applicable state law.
- (6) You have determined that the listed DBE subcontractor is not a responsible contractor;
- (7) The listed DBE subcontractor voluntarily withdraws from the projects and provides to you written notice of its withdrawal;
- (8) The listed DBE is ineligible to receive DBE credit for the type of work required;
- (9) A DBE owner dies or becomes disabled with the result that the listed DBE subcontractor is unable to complete its work on the contract;

- (10) Other documented good cause that compels the termination of the DBE subcontractor. Provided, that good cause does not exist if the prime Contractor seeks to terminate a DBE it relied upon to obtain the contract so that the prime Contractor can self-perform the work for which the DBE contractor was engaged or so that the prime Contractor can substitute another DBE or non-DBE contractor after contract award.

When a DBE is terminated, or fails to complete its work on the Contract for any reason the Contractor shall make a good faith effort to find another DBE to substitute for the original DBE to perform at least the same amount of work under the contract as the terminated DBE to the extent needed to meet the established Contract goal. The good faith efforts shall be documented by the Contractor. If the Department requests documentation under this provision, the Contractor shall submit the documentation within seven days, which may be extended for an additional seven days if necessary at the request of the Contractor. The Department shall provide a written determination to the Contractor stating whether or not good faith efforts have been demonstrated.

- (f) PAYMENT RECORDS. The Contractor shall maintain a record of payments for work performed to the DBE participants. The records shall be made available to the Department for inspection upon request. After the performance of the final item of work or delivery of material by a DBE and final payment therefore to the DBE by the Contractor, but not later than thirty calendar days after payment has been made by the Department to the Contractor for such work or material, the Contractor shall submit a DBE Payment Agreement on Department form SBE 2115 to the Resident Engineer. If full and final payment has not been made to the DBE, the DBE Payment Agreement shall indicate whether a disagreement as to the payment required exists between the Contractor and the DBE or if the Contractor believes that the work has not been satisfactorily completed. If the Contractor does not have the full amount of work indicated in the Utilization Plan performed by the DBE companies indicated in the Utilization Plan and after good faith efforts are reviewed, the Department may deduct from contract payments to the Contractor the amount of the goal not achieved as liquidated and ascertained damages. The Contractor may request an administrative reconsideration of any amount deducted as damages pursuant to subsection (h) of this part.
- (g) ENFORCEMENT. The Department reserves the right to withhold payment to the Contractor to enforce the provisions of this Special Provision. Final payment shall not be made on the contract until such time as the Contractor submits sufficient documentation demonstrating achievement of the goal in accordance with this Special Provision or after liquidated damages have been determined and collected.

- (h) **RECONSIDERATION.** Notwithstanding any other provision of the contract, including but not limited to Article 109.09 of the Standard Specifications, the Contractor may request administrative reconsideration of a decision to deduct the amount of the goal not achieved as liquidated damages. A request to reconsider shall be delivered to the Contract Compliance Section and shall be handled and considered in the same manner as set forth in paragraph (c) of “Good Faith Effort Procedures” of this Special Provision, except a final decision that a good faith effort was not made during contract performance to achieve the goal agreed to in the Utilization Plan shall be the final administrative decision of the Department. The result of the reconsideration process is not administratively appealable to the U.S. Department of Transportation.

HOT MIX ASPHALT – QUALITY CONTROL FOR PERFORMANCE (BDE)

Effective: April 1, 2017

Revised: April 2, 2017

Description. This special provision describes the procedures for production, placement and payment of hot-mix asphalt (HMA) under the quality control for performance (QCP) program; as well as the requirements for intelligent compaction. This special provision shall apply to the HMA mixtures specified in the plans. This work shall be according to the Standard Specifications except as modified herein.

Delete Articles:	406.06(b)(1), 2 nd Paragraph	(Temperature Requirements)
	406.06(b)(2)d.	(Temperature Requirements)
	406.06(b)(3)b.	(Temperature Requirements)
	406.06(e), 3 rd Paragraph	(Paver Speed Requirements)
	406.07(b)	(Rolling)
	406.07(c)	(Density)
	1030.05(a)(4, 5, 9,)	(QC/QA Documents)
	1030.05(d)(2)a.	(Plant Tests)
	1030.05(d)(2)b.	(Dust-to-Asphalt and Moisture Content)
	1030.05(d)(2)d.	(Small Tonnage)
	1030.05(d)(2)f.	(HMA Sampling)
	1030.05(d)(3)	(Required Field Tests)
	1030.05(d)(4)	(Control Limits)
	1030.05(d)(5)	(Control Charts)
	1030.05(d)(7)	(Corrective Action for Field Tests (Density))
	1030.05(e)	(Quality Assurance by the Engineer)
	1030.05(f)	(Acceptance by the Engineer)
	1030.06(a), 2 nd paragraph	(Before start-up...)

Definitions.

- (a) Quality Control (QC). All production and construction activities by the Contractor required to achieve the required level of quality.
- (b) Quality Assurance (QA). All monitoring and testing activities by the Engineer required to assess product quality, level of payment, and acceptability of the product.

- c) Pay Parameters. Pay parameters shall be field voids in the mineral aggregate (Field VMA), voids, and density. Field VMA will be calculated using the combined aggregates bulk specific gravity (G_{sb}) from the mix design.
- (d) Mixture Lot. A mixture lot shall begin once an acceptable test strip has been completed and the adjusted job mix formula has been determined. If the test strip is waived, a mixture lot shall begin with the start of production. A mixture lot shall consist of four sublots unless it is the last or only lot, in which case it may consist of as few as one subplot.
- (e) Mixture Sublot. A mixture subplot for Field VMA, voids, and dust/AC shall be a maximum of 1000 tons (910 metric tons).
- (1) If the remaining quantity is greater than 200 tons (180 metric tons) but less than 1000 tons (910 metric tons), the last mixture subplot will be that quantity.
- (2) If the remaining quantity is 200 tons (180 metric tons) or less, the quantity shall be combined with the previous mixture subplot.
- (f) Density Interval. Density intervals shall be every 0.2 miles (320 m) for lift thicknesses of 3 in. (75 mm) or less and 0.1 miles (160 m) for lift thicknesses greater than 3 in. (75 mm). If a density interval is less than 200 ft (60 m), it will be combined with the previous density interval.
- (g) Density Sublot. A density subplot shall be the average of five consecutive density intervals.
- (1) If less than three density intervals remain outside a density subplot, they shall be included in the previous density subplot.
- (2) If three or more density intervals remain, they shall be considered a density subplot.
- (h) Density Test. A density test shall consist of a core taken at a random location within each density interval.

When establishing the target density, the HMA maximum theoretical gravity (G_{mm}) shall be based on the running average of four Department test results. Initial G_{mm} shall be based on the average of the first four test results. If less than four G_{mm} results are available, an average of all available Department G_{mm} test results shall be used.

Quality Control (QC) by the Contractor. The Contractor’s QC plan shall include the schedule of testing for both pay parameters and non-pay parameters required to control the product such as asphalt binder content and mixture gradation. The minimum test frequency shall be according to the following table.

Minimum Quality Control Sampling and Testing Requirements		
Quality Characteristic	Minimum Test Frequency	
Mixture Gradation	1 per subplot	
Asphalt Binder Content		
Dust/AC Ratio		
Field VMA		
Voids		G_{mb}
		G_{mm}

The Contractor’s splits in conjunction with other quality control tests shall be used to control production.

The Contractor shall submit split jobsite mix sample test results to the Engineer within 48 hours of the time of sampling. All QC testing shall be performed in a qualified laboratory by personnel who have successfully completed the Department’s HMA Level I training.

Intelligent Compaction. When a “Number of Roller Passes” is specified in the HMA Mixture Requirements table on the plans, the Contractor may opt to use intelligent compaction (IC) in lieu of density testing.

The IC equipment shall be mounted on the breakdown roller(s) and shall record GPS location data, roller pass counts, roller speeds, and HMA mat temperatures. Each day, the accuracy of the GPS and temperature data shall be verified and documented. If the verification fails or is not performed, the IC data will not be used for the affected density sublots.

The IC data for each density subplot shall be analyzed using Veta software to determine the average roller speed, percent roller coverage, and average mat surface temperature for the final roller pass. The Contractor shall submit these summary results, and if requested the raw data from the IC equipment and the data analysis software, to the Engineer within 24 hours of each day of paving using IC.

The required number of roller passes shall be as specified on the plans. The roller speeds shall be according to Article 406.07. The minimum roller coverage shall be 95 percent. The average HMA mat temperature for the final roller pass shall be according to the following table.

Asphalt Mixture Type	Temperature Range (°F (°C))
Warm Mix Asphalt	215-275 °F (102-135 °C)
IL-4.75	310-350 °F (155-175 °C)
HMA using SBS PG76-22	310-350 °F (155-175 °C)
HMA using SBS PG76-28	310-350 °F (155-175 °C)
Other HMA not listed above	260-325 °F (125-165 °C)

Quality Assurance (QA) by the Engineer. Quality Assurance by the Engineer will be as follows.

- (a) Voids, Field VMA and Dust/AC Ratio. The Engineer will determine the random tonnage and the Contractor shall be responsible for obtaining the sample according to the Department's Manual of Test Procedures for Materials "PFP Hot-Mix Asphalt Random Jobsite Sampling Procedure".
- (b) Density: After final rolling, the Engineer will identify the random core locations within each density testing interval according to the Department's Manual of Test Procedures for Materials "PFP and QCP Random Density Procedure".

The Contractor shall cut the 4 in. (100 mm) cores within the same day and prior to opening to traffic unless otherwise approved by the Engineer. All core holes shall be filled immediately upon completion of coring. All water shall be removed from the core holes prior to filling. All core holes shall be filled with a rapid hardening mortar or concrete which shall be mixed in a separate container prior to placement in the hole. Any depressions in the surface of the filled core holes greater than 1/4 in. (6 mm) at the time of final inspection will require removal of the fill material to the depth of the lift thickness and replacement.

The Engineer will witness and secure all mixture and density samples. The Contractor shall transport the secured sample to a location designated by the Engineer.

The Engineer will test one or all of the randomly selected split samples from each lot for voids, Field VMA and dust/AC ratio. The Engineer will test a minimum of one sample per project. The Engineer will test all of the pavement cores for density unless intelligent compaction is used. All QA testing will be performed in a qualified laboratory by personnel who have successfully completed the Department's HMA Level I training. QA test results will be available to the Contractor within ten working days from receipt of secured cores and split mixture samples.

The Engineer will maintain a complete record of all Department test results and copies will be provided to the Contractor with each set of subplot results. The records will contain, at a minimum, the originals of all Department test results and raw data, random numbers used and resulting calculations for sampling locations, and quality level analysis calculations.

If the QA results do not meet the 100 percent subplot pay factor limits or do not compare to QC results within the precision limits listed below, the Engineer will test all split mix samples for the lot.

Test Parameter	Limits of Precision
G _{mb}	0.030
G _{mm}	0.026
Field VMA	1.0 %

Acceptance by the Engineer. All of the Department's tests shall be within the acceptable limits listed below:

Parameter		Acceptable Limits
Field VMA		-1.0 – +3.0% ^{1/}
Voids		2.0 – 6.0%
Density	IL-9.5, IL-19.0, IL-4.75, IL-9.5FG ^{3/}	90.0 – 98.0%
	SMA	92.0 – 98.0%
Dust / AC Ratio		0.4 – 1.6 ^{2/}

1/ Based on minimum required VMA from mix design

2/ Does not apply to SMA.

3/ Acceptable density limits for IL-9.5FG placed less than 1 1/4 in. (32 mm) shall be 89.0% - 98.0%

In addition, no visible pavement distresses shall be present such as, but not limited to, segregation, excessive coarse aggregate fracturing or flushing.

Basis of Payment. Payment will be based on the calculation of the composite pay factor using QA test results for each mixture according to the Department's Manual of Test Procedures for Materials "QCP Pay Calculation" document.

If intelligent compaction is successfully implemented, the Contractor will receive 100 percent for the density pay factor in Equation 1 of the "QCP Pay Calculation" document for each applicable HMA mixture; otherwise, the density tests and pay adjustments will apply. The pay factor for each density subplot will be based upon either intelligent compaction or density tests and the two will not be mixed.

Dust/AC Ratio. A monetary deduction will be made using the pay adjustment table below for dust/AC ratios that deviate from the 0.6 to 1.2 range. If the tested mixture subplot is outside of this range, the Department will test the remaining sublots for dust/AC pay adjustment.

Dust/AC Pay Adjustment Table ^{1/}	
Range	Deduct / subplot
$0.6 \leq X \leq 1.2$	\$0
$0.5 \leq X < 0.6$ or $1.2 < X \leq 1.4$	\$1000
$0.4 \leq X < 0.5$ or $1.4 < X \leq 1.6$	\$3000
$X < 0.4$ or $X > 1.6$	Shall be removed and replaced

1/ Does not apply to SMA.

HOT-MIX ASPHALT – TACK COAT (BDE)

Effective: November 1, 2016

Revise Article 1032.06(a) of the Standard Specifications to read:

“(a) Anionic Emulsified Asphalt. Anionic emulsified asphalts shall be according to AASHTO M 140. SS-1h emulsions used as a tack coat shall have the cement mixing test waived.”

PROGRESS PAYMENTS (BDE)

Effective: November 2, 2013

Revise Article 109.07(a) of the Standard Specifications to read:

“(a) Progress Payments. At least once each month, the Engineer will make a written estimate of the quantity of work performed in accordance with the contract, and the value thereof at the contract unit prices. The amount of the estimate approved as due for payment will be vouchered by the Department and presented to the State Comptroller for payment. No amount less than \$1000.00 will be approved for payment other than the final payment.

Progress payments may be reduced by liens filed pursuant to Section 23(c) of the Mechanics’ Lien Act, 770 ILCS 60/23(c).

If a Contractor or subcontractor has defaulted on a loan issued under the Department’s Disadvantaged Business Revolving Loan Program (20 ILCS 2705/2705-610), progress payments may be reduced pursuant to the terms of that loan agreement. In such cases, the amount of the estimate related to the work performed by the Contractor or subcontractor, in default of the loan agreement, will be offset, in whole or in part, and vouchered by the Department to the Working Capital Revolving Fund or designated escrow account. Payment for the work shall be considered as issued and received by the Contractor or subcontractor on the date of the offset voucher. Further, the amount of the offset voucher shall be a credit against the Department’s obligation to pay the Contractor, the Contractor’s obligation to pay the subcontractor, and the Contractor’s or subcontractor’s total loan indebtedness to the Department. The offset shall continue until such time as the entire loan indebtedness is satisfied. The Department will notify the Contractor and Fund Control Agent in a timely manner of such offset. The Contractor or subcontractor shall not be entitled to additional payment in consideration of the offset.

The failure to perform any requirement, obligation, or term of the contract by the Contractor shall be reason for withholding any progress payments until the Department determines that compliance has been achieved.”

RECLAIMED ASPHALT PAVEMENT AND RECLAIMED ASPHALT SHINGLES (BDE)

Effective: November 1, 2012

Revise: April 1, 2016

Revise Section 1031 of the Standard Specifications to read:

“SECTION 1031. RECLAIMED ASPHALT PAVEMENT AND RECLAIMED ASPHALT SHINGLES

1031.01 Description. Reclaimed asphalt pavement and reclaimed asphalt shingles shall be according to the following.

- (a) Reclaimed Asphalt Pavement (RAP). RAP is the material produced by cold milling or crushing an existing hot-mix asphalt (HMA) pavement. The Contractor shall supply written documentation that the RAP originated from routes or airfields under federal, state, or local agency jurisdiction.
- (b) Reclaimed Asphalt Shingles (RAS). Reclaimed asphalt shingles (RAS). RAS is from the processing and grinding of preconsumer or post-consumer shingles. RAS shall be a clean and uniform material with a maximum of 0.5 percent unacceptable material, as defined in Bureau of Materials and Physical Research Policy Memorandum, “Reclaimed Asphalt Shingle (RAS) Sources”, by weight of RAS. All RAS used shall come from a Bureau of Materials and Physical Research approved processing facility where it shall be ground and processed to 100 percent passing the 3/8 in. (9.5 mm) sieve and 93 percent passing the #4 (4.75 mm) sieve based on a dry shake gradation. RAS shall be uniform in gradation and asphalt binder content and shall meet the testing requirements specified herein. In addition, RAS shall meet the following Type 1 or Type 2 requirements.
 - (1) Type 1. Type 1 RAS shall be processed, preconsumer asphalt shingles salvaged from the manufacture of residential asphalt roofing shingles.
 - (2) Type 2. Type 2 RAS shall be processed post-consumer shingles only, salvaged from residential, or four unit or less dwellings not subject to the National Emission Standards for Hazardous Air Pollutants (NESHAP).

1031.02 Stockpiles. RAP and RAS stockpiles shall be according to the following.

(a) RAP Stockpiles. The Contractor shall construct individual, sealed RAP stockpiles meeting one of the following definitions. No additional RAP shall be added to the pile after the pile has been sealed. Stockpiles shall be sufficiently separated to prevent intermingling at the base. Stockpiles shall be identified by signs indicating the type as listed below (i.e. "Homogeneous Surface").

Prior to milling, the Contractor shall request the District provide documentation on the quality of the RAP to clarify the appropriate stockpile.

(1) Fractionated RAP (FRAP). FRAP shall consist of RAP from Class I, HMA (High and Low ESAL) mixtures. The coarse aggregate in FRAP shall be crushed aggregate and may represent more than one aggregate type and/or quality, but shall be at least C quality. All FRAP shall be fractionated prior to testing by screening into a minimum of two size fractions with the separation occurring on or between the #4 (4.75 mm) and 1/2 in. (12.5 mm) sieves. Agglomerations shall be minimized such that 100 percent of the RAP shall pass the sieve size specified below for the mix into which the FRAP will be incorporated.

Mixture FRAP will be used in:	Sieve Size that 100 % of FRAP Shall Pass
IL-19.0	1 1/2 in. (40 mm)
IL-9.5	3/4 in. (20 mm)
IL-4.75	1/2 in. (13 mm)

(2) Homogeneous. Homogeneous RAP stockpiles shall consist of RAP from Class I, HMA (High and Low ESAL) mixtures and represent: 1) the same aggregate quality, but shall be at least C quality; 2) the same type of crushed aggregate (either crushed natural aggregate, ACBF slag, or steel slag); 3) similar gradation; and 4) similar asphalt binder content. If approved by the Engineer, combined single pass surface/binder millings may be considered "homogeneous" with a quality rating dictated by the lowest coarse aggregate quality present in the mixture.

(3) Conglomerate. Conglomerate RAP stockpiles shall consist of RAP from Class I, HMA (High and Low ESAL) mixtures. The coarse aggregate in this RAP shall be crushed aggregate and may represent more than one aggregate type and/or quality, but shall be at least C quality. This RAP may have an inconsistent gradation and/or asphalt binder content prior to processing. All conglomerate RAP shall be processed prior to testing by crushing to where all RAP shall pass the 5/8 in. (16 mm) or smaller screen. Conglomerate RAP stockpiles shall not contain steel slag.

(4) Non-Quality. RAP stockpiles that do not meet the requirements of the stockpile categories listed above shall be classified as "Non-Quality".

RAP/FRAP containing contaminants, such as earth, brick, sand, concrete, sheet asphalt, bituminous surface treatment (i.e. chip seal), pavement fabric, joint sealants, etc., will be unacceptable unless the contaminants are removed to the satisfaction of the Engineer. Sheet asphalt shall be stockpiled separately.

- (b) RAS Stockpiles. Type 1 and Type 2 RAS shall be stockpiled separately and shall not be intermingled. Each stockpile shall be signed indicating what type of RAS is present.

Unless otherwise specified by the Engineer, mechanically blending manufactured sand (FM 20 or FM 22) up to an equal weight of RAS with the processed RAS will be permitted to improve workability. The sand shall be "B Quality" or better from an approved Aggregate Gradation Control System source. The sand shall be accounted for in the mix design and during HMA production.

Records identifying the shingle processing facility supplying the RAS, RAS type, and lot number shall be maintained by project contract number and kept for a minimum of three years.

1031.03 Testing. RAP/FRAP and RAS testing shall be according to the following.

- (a) RAP/FRAP Testing. When used in HMA, the RAP/FRAP shall be sampled and tested either during or after stockpiling.

(1) During Stockpiling. For testing during stockpiling, washed extraction samples shall be run at the minimum frequency of one sample per 500 tons (450 metric tons) for the first 2000 tons (1800 metric tons) and one sample per 2000 tons (1800 metric tons) thereafter. A minimum of five tests shall be required for stockpiles less than 4000 tons (3600 metric tons).

(2) After Stockpiling. For testing after stockpiling, the Contractor shall submit a plan for approval to the District proposing a satisfactory method of sampling and testing the RAP/FRAP pile either in-situ or by restockpiling. The sampling plan shall meet the minimum frequency required above and detail the procedure used to obtain representative samples throughout the pile for testing.

Each sample shall be split to obtain two equal samples of test sample size. One of the two test samples from the final split shall be labeled and stored for Department use. The Contractor shall extract the other test sample according to Department procedure. The Engineer reserves the right to test any sample (split or Department-taken) to verify Contractor test results.

- (b) RAS Testing. RAS or RAS blended with manufactured sand shall be sampled and tested during stockpiling according to Bureau of Materials and Physical Research Policy Memorandum, "Reclaimed Asphalt Shingle (RAS) Source".

Samples shall be collected during stockpiling at the minimum frequency of one sample per 200 tons (180 metric tons) for the first 1000 tons (900 metric tons) and one sample per 250 tons (225 metric tons) thereafter. A minimum of five samples are required for stockpiles less than 1000 tons (900 metric tons). Once a ≤ 1000 ton (900 metric ton), five-sample/test stockpile has been established it shall be sealed. Additional incoming RAS or RAS blended with manufactured sand shall be stockpiled in a separate working pile as designated in the Quality Control plan and only added to the sealed stockpile when the test results of the working pile are complete and are found to meet the tolerances specified herein for the original sealed RAS stockpile.

Before testing, each sample shall be split to obtain two test samples. One of the two test samples from the final split shall be labeled and stored for Department use. The Contractor shall perform a washed extraction and test for unacceptable materials on the other test sample according to Department procedures. The Engineer reserves the right to test any sample (split or Department-taken) to verify Contractor test results.

If the sampling and testing was performed at the shingle processing facility in accordance with the QC Plan, the Contractor shall obtain and make available all of the test results from start of the initial stockpile.

1031.04 Evaluation of Tests. Evaluation of test results shall be according to the following.

- (a) Evaluation of RAP/FRAP Test Results. All of the extraction results shall be compiled and averaged for asphalt binder content and gradation, and when applicable G_{mm} . Individual extraction test results, when compared to the averages, will be accepted if within the tolerances listed below.

Parameter	FRAP/Homogeneous/ Conglomerate
1 in. (25 mm)	
1/2 in. (12.5 mm)	± 8 %
No. 4 (4.75 mm)	± 6 %
No. 8 (2.36 mm)	± 5 %
No. 16 (1.18 mm)	
No. 30 (600 μm)	± 5 %
No. 200 (75 μm)	± 2.0 %
Asphalt Binder	± 0.4 % ^{1/}
G_{mm}	± 0.03

1/ The tolerance for FRAP shall be ± 0.3 %.

If more than 20 percent of the individual sieves and/or asphalt binder content tests are out of the above tolerances, the RAP/FRAP shall not be used in HMA unless the RAP/FRAP representing the failing tests is removed from the stockpile. All test data and acceptance ranges shall be sent to the District for evaluation.

With the approval of the Engineer, the ignition oven may be substituted for extractions according to the ITP, "Calibration of the Ignition Oven for the Purpose of Characterizing Reclaimed Asphalt Pavement (RAP)".

- (b) Evaluation of RAS and RAS Blended with Manufactured Sand Test Results. All of the test results, with the exception of percent unacceptable materials, shall be compiled and averaged for asphalt binder content and gradation. Individual test results, when compared to the averages, will be accepted if within the tolerances listed below.

Parameter	RAS
No. 8 (2.36 mm)	± 5 %
No. 16 (1.18 mm)	± 5 %
No. 30 (600 µm)	± 4 %
No. 200 (75 µm)	± 2.0 %
Asphalt Binder Content	± 1.5 %

If more than 20 percent of the individual sieves and/or asphalt binder content tests are out of the above tolerances, or if the percent unacceptable material exceeds 0.5 percent by weight of material retained on the # 4 (4.75 mm) sieve, the RAS or RAS blend shall not be used in Department projects. All test data and acceptance ranges shall be sent to the District for evaluation.

1031.05 Quality Designation of Aggregate in RAP/FRAP.

- (a) RAP. The aggregate quality of the RAP for homogeneous and conglomerate stockpiles shall be set by the lowest quality of coarse aggregate in the RAP stockpile and are designated as follows.

- (1) RAP from Class I, Superpave/HMA (High ESAL), or (Low ESAL) IL-9.5L surface mixtures are designated as containing Class B quality coarse aggregate.
- (2) RAP from Class I binder, Superpave/HMA (High ESAL) binder, or (Low ESAL) IL-19.0L binder mixtures are designated as containing Class C quality coarse aggregate.

- (b) FRAP. If the Engineer has documentation of the quality of the FRAP aggregate, the Contractor shall use the assigned quality provided by the Engineer.

If the quality is not known, the quality shall be determined as follows. Coarse and fine FRAP stockpiles containing plus #4 (4.75 mm) sieve coarse aggregate shall have a maximum tonnage of 5000 tons (4500 metric tons). The Contractor shall obtain a representative sample witnessed by the Engineer. The sample shall be a minimum of 50 lb (25 kg). The sample shall be extracted according to Illinois Modified AASHTO T 164 by a consultant laboratory prequalified by the Department for the specified testing. The consultant laboratory shall submit the test results along with the recovered aggregate to the District Office. The cost for this testing shall be paid by the Contractor. The District will forward the sample to the Bureau of Materials and Physical Research Aggregate Lab for MicroDeval Testing, according to ITP 327. A maximum loss of 15.0 percent will be applied for all HMA applications.

1031.06 Use of RAP/FRAP and/or RAS in HMA. The use of RAP/FRAP and/or RAS shall be the Contractor's option when constructing HMA in all contracts.

(a) RAP/FRAP. The use of RAP/FRAP in HMA shall be as follows.

- (1) Coarse Aggregate Size. The coarse aggregate in all RAP shall be equal to or less than the nominal maximum size requirement for the HMA mixture to be produced.
- (2) Steel Slag Stockpiles. Homogeneous RAP stockpiles containing steel slag will be approved for use in all HMA (High ESAL and Low ESAL) Surface and Binder Mixture applications.
- (3) Use in HMA Surface Mixtures (High and Low ESAL). RAP/FRAP stockpiles for use in HMA surface mixtures (High and Low ESAL) shall be FRAP or homogeneous in which the coarse aggregate is Class B quality or better. RAP/FRAP from Conglomerate stockpiles shall be considered equivalent to limestone for frictional considerations. Known frictional contributions from plus #4 (4.75 mm) homogeneous RAP and FRAP stockpiles will be accounted for in meeting frictional requirements in the specified mixture.
- (4) Use in HMA Binder Mixtures (High and Low ESAL), HMA Base Course, and HMA Base Course Widening. RAP/FRAP stockpiles for use in HMA binder mixtures (High and Low ESAL), HMA base course, and HMA base course widening shall be FRAP, homogeneous, or conglomerate, in which the coarse aggregate is Class C quality or better.
- (5) Use in Shoulders and Subbase. RAP/FRAP stockpiles for use in HMA shoulders and stabilized subbase (HMA) shall be FRAP, homogeneous, or conglomerate.
- (6) When the Contractor chooses the RAP option, the percentage of RAP shall not exceed the amounts indicated in Article 1031.06(c)(1) below for a given Ndesign.

(b) RAS. RAS meeting Type 1 or Type 2 requirements will be permitted in all HMA applications as specified herein.

(c) RAP/FRAP and/or RAS Usage Limits. Type 1 or Type 2 RAS may be used alone or in conjunction with RAP or FRAP in HMA mixtures up to a maximum of 5.0 percent by weight of the total mix.

(1) RAP/RAS. When RAP is used alone or RAP is used in conjunction with RAS, the percentage of virgin asphalt binder replacement shall not exceed the amounts listed in the Max RAP/RAS ABR table listed below for the given Ndesign.

RAP/RAS Maximum Asphalt Binder Replacement (ABR) Percentage

HMA Mixtures <i>1/, 2/</i>	RAP/RAS Maximum ABR %		
Ndesign	Binder/Leveling Binder	Surface	Polymer Modified
30	30	30	10
50	25	15	10
70	15	10	10
90	10	10	10

1/ For Low ESAL HMA shoulder and stabilized subbase, the RAP/RAS ABR shall not exceed 50 percent of the mixture.

2/ When RAP/RAS ABR exceeds 20 percent, the high and low virgin asphalt binder grades shall each be reduced by one grade (i.e. 25 percent ABR would require a virgin asphalt binder grade of PG 64-22 to be reduced to a PG 58-28). If warm mix asphalt (WMA) technology is utilized and production temperatures do not exceed 275 °F (135 °C), the high and low virgin asphalt binder grades shall each be reduced by one grade when RAP/RAS ABR exceeds 25 percent (i.e. 26 percent RAP/RAS ABR would require a virgin asphalt binder grade of PG 64-22 to be reduced to a PG 58-28).

(2) FRAP/RAS. When FRAP is used alone or FRAP is used in conjunction with RAS, the percentage of virgin asphalt binder replacement shall not exceed the amounts listed in the FRAP/RAS table listed below for the given Ndesign.

FRAP/RAS Maximum Asphalt Binder Replacement (ABR) Percentage

HMA Mixtures <i>1/, 2/</i>	FRAP/RAS Maximum ABR %		
Ndesign	Binder/Leveling Binder	Surface	Polymer Modified ^{3/, 4/}
30	50	40	10
50	40	35	10
70	40	30	10
90	40	30	10

- 1/ For Low ESAL HMA shoulder and stabilized subbase, the FRAP/RAS ABR shall not exceed 50 percent of the mixture.
- 2/ When FRAP/RAS ABR exceeds 20 percent for all mixes, the high and low virgin asphalt binder grades shall each be reduced by one grade (i.e. 25 percent ABR would require a virgin asphalt binder grade of PG 64-22 to be reduced to a PG 58-28). If warm mix asphalt (WMA) technology is utilized and production temperatures do not exceed 275 °F (135 °C), the high and low virgin asphalt binder grades shall each be reduced by one grade when FRAP/RAS ABR exceeds 25 percent (i.e. 26 percent ABR would require a virgin asphalt binder grade of PG 64-22 to be reduced to a PG 58-28).
- 3/ For SMA the FRAP/RAS ABR shall not exceed 20 percent.
- 4/ For IL-4.75 mix the FRAP/RAS ABR shall not exceed 30 percent.

1031.07 HMA Mix Designs. At the Contractor's option, HMA mixtures may be constructed utilizing RAP/FRAP and/or RAS material meeting the detailed requirements specified herein.

- (a) RAP/FRAP and/or RAS. RAP/FRAP and/or RAS mix designs shall be submitted for verification. If additional RAP/FRAP and/or RAS stockpiles are tested and found that no more than 20 percent of the results, as defined under "Testing" herein, are outside of the control tolerances set for the original RAP/FRAP and/or RAS stockpile and HMA mix design, and meets all of the requirements herein, the additional RAP/FRAP and/or RAS stockpiles may be used in the original mix design at the percent previously verified.
- (b) RAS. Type 1 and Type 2 RAS are not interchangeable in a mix design. A RAS stone bulk specific gravity (Gsb) of 2.300 shall be used for mix design purposes.

1031.08 HMA Production. HMA production utilizing RAP/FRAP and/or RAS shall be as follows.

- (a) RAP/FRAP. The coarse aggregate in all RAP/FRAP used shall be equal to or less than the nominal maximum size requirement for the HMA mixture being produced.

To remove or reduce agglomerated material, a scalping screen, gator, crushing unit, or comparable sizing device approved by the Engineer shall be used in the RAP feed system to remove or reduce oversized material. If material passing the sizing device adversely affects the mix production or quality of the mix, the sizing device shall be set at a size specified by the Engineer.

If the RAP/FRAP control tolerances or QC/QA test results require corrective action, the Contractor shall cease production of the mixture containing RAP/FRAP and either switch to the virgin aggregate design or submit a new RAP/FRAP design.

- (b) RAS. RAS shall be incorporated into the HMA mixture either by a separate weight depletion system or by using the RAP weigh belt. Either feed system shall be interlocked with the aggregate feed or weigh system to maintain correct proportions for all rates of production and batch sizes. The portion of RAS shall be controlled accurately to within ± 0.5 percent of the amount of RAS utilized. When using the weight depletion system, flow indicators or sensing devices shall be provided and interlocked with the plant controls such that the mixture production is halted when RAS flow is interrupted.
- (c) RAP/FRAP and/or RAS. HMA plants utilizing RAP/FRAP and/or RAS shall be capable of automatically recording and printing the following information.

(1) Dryer Drum Plants.

- a. Date, month, year, and time to the nearest minute for each print.
- b. HMA mix number assigned by the Department.
- c. Accumulated weight of dry aggregate (combined or individual) in tons (metric tons) to the nearest 0.1 ton (0.1 metric ton).
- d. Accumulated dry weight of RAP/FRAP/RAS in tons (metric tons) to the nearest 0.1 ton (0.1 metric ton).
- e. Accumulated mineral filler in revolutions, tons (metric tons), etc. to the nearest 0.1 unit.
- f. Accumulated asphalt binder in gallons (liters), tons (metric tons), etc. to the nearest 0.1 unit.
- g. Residual asphalt binder in the RAP/FRAP material as a percent of the total mix to the nearest 0.1 percent.
- h. Aggregate and RAP/FRAP moisture compensators in percent as set on the control panel. (Required when accumulated or individual aggregate and RAP/FRAP are printed in wet condition.)

(2) Batch Plants.

- a. Date, month, year, and time to the nearest minute for each print.
- b. HMA mix number assigned by the Department.
- c. Individual virgin aggregate hot bin batch weights to the nearest pound (kilogram).
- d. Mineral filler weight to the nearest pound (kilogram).
- e. RAP/FRAP/RAS weight to the nearest pound (kilogram).
- f. Virgin asphalt binder weight to the nearest pound (kilogram).
- g. Residual asphalt binder in the RAP/FRAP/RAS material as a percent of the total mix to the nearest 0.1 percent.

The printouts shall be maintained in a file at the plant for a minimum of one year or as directed by the Engineer and shall be made available upon request. The printing system will be inspected by the Engineer prior to production and verified at the beginning of each construction season thereafter.

1031.09 RAP in Aggregate Surface Course and Aggregate Wedge Shoulders, Type B.

The use of RAP in aggregate surface course (temporary access entrances only) and aggregate wedge shoulders, Type B shall be as follows.

- (a) Stockpiles and Testing. RAP stockpiles may be any of those listed in Article 1031.02, except "Non-Quality" and "FRAP". The testing requirements of Article 1031.03 shall not apply. RAP used shall be according to the current Bureau of Materials and Physical Research Policy Memorandum, "Reclaimed Asphalt Pavement (RAP) for Aggregate Applications".
- (b) Gradation. One hundred percent of the RAP material shall pass the 1 1/2 in. (37.5 mm) sieve. The RAP material shall be reasonably well graded from coarse to fine. RAP material that is gap-graded or single sized will not be accepted."

TEMPORARY PAVEMENT MARKING (BDE)

Effective: April 1, 2012

Revised: April 1, 2017

Revise Article 703.02 of the Standard Specifications to read:

“703.02 Materials. Materials shall be according to the following.

- (a) Pavement Marking Tape, Type I and Type III 1095.06
- (b) Paint Pavement Markings 1095.02
- (c) Pavement Marking Tape, Type IV 1095.11”

Revise the second paragraph of Article 703.05 of the Standard Specifications to read:

“Type I marking tape or paint shall be used at the option of the Contractor, except paint shall not be applied to the final wearing surface unless authorized by the Engineer for late season applications where tape adhesion would be a problem. Type III or Type IV marking tape shall be used on the final wearing surface when the temporary pavement marking will conflict with the permanent pavement marking such as on tapers, crossovers and lane shifts.”

Revise Article 703.07 of the Standard Specifications to read:

“703.07 Basis of Payment. This work will be paid for as follows.

- a) Short Term Pavement Marking. Short term pavement marking will be paid for at the contract unit price per foot (meter) for SHORT TERM PAVEMENT MARKING. Removal of short term pavement markings will be paid for at the contract unit price per square foot (square meter) for SHORT TERM PAVEMENT MARKING REMOVAL.
- b) Temporary Pavement Marking. Where the Contractor has the option of material type, temporary pavement marking will be paid for at the contract unit price per foot (meter) for TEMPORARY PAVEMENT MARKING of the line width specified, and at the contract unit price per square foot (square meter) for TEMPORARY PAVEMENT MARKING LETTERS AND SYMBOLS.

Where the Department specifies the use of pavement marking tape, the Type III or Type IV temporary pavement marking will be paid for at the contract unit price per foot (meter) for PAVEMENT MARKING TAPE, TYPE III or PAVEMENT MARKING TAPE, TYPE IV of the line width specified and at the contract unit price per square feet (square meter) for PAVEMENT MARKING TAPE, TYPE III - LETTERS AND SYMBOLS or PAVEMENT MARKING TAPE, TYPE IV – LETTERS AND SYMBOLS.

Removal of temporary pavement markings will be paid for at the contract unit price per square foot (square meter) for TEMPORARY PAVEMENT MARKING REMOVAL.

When temporary pavement marking is shown on the Standard, the cost of the temporary pavement marking and its removal will be included in the cost of the Standard.”

Add the following to Section 1095 of the Standard Specifications:

“1095.11 Pavement Marking Tape, Type IV. The temporary, preformed, patterned markings shall consist of a white or yellow tape with wet retroreflective media incorporated to provide immediate and continuing retroreflection during both wet and dry conditions. The tape shall be manufactured without the use of heavy metals including lead chromate pigments or other similar, lead-containing chemicals.

The white and yellow Type IV marking tape shall meet the Type III requirements of Article 1095.06 and the following.

- (a) Composition. The retroreflective pliant polymer pavement markings shall consist of a mixture of high-quality polymeric materials, pigments and glass beads distributed throughout its base cross-sectional area, with a layer of wet retroreflective media bonded to a durable polyurethane topcoat surface. The patterned surface shall have approximately 40% ± 10% of the surface area raised and presenting a near vertical face to traffic from any direction. The channels between the raised areas shall be substantially free of exposed beads or particles.
- (b) Retroreflectance. The white and yellow markings shall meet the following for initial dry and wet retroreflectance.
 - (1) Dry Retroreflectance. Dry retroreflectance shall be measured under dry conditions according to ASTM D 4061 and meet the values described in Article 1095.06 for Type III tape.
 - (2) Wet Retroreflectance. Wet retroreflectance shall be measured under wet conditions according to ASTM E 2177 and meet the values shown in the following table.

Wet Retroreflectance, Initial R_L

Color	R_L 1.05/88.76
White	300
Yellow	200

- (c) Color. The material shall meet the following requirements for daylight reflectance and color, when tested, using a color spectrophotometer with 45 degrees circumferential/zero degree geometry, illuminant D65, and a two degree observer angle. The color instrument shall measure the visible spectrum from 380 to 720 nm with a wavelength measurement interval and spectral bandpass of 10 nm.

Color	Daylight Reflectance %Y
White	65 minimum
*Yellow	36-59

*Shall match Federal 595 Color No. 33538 and the chromaticity limits as follows.

x	0.490	0.475	0.485	0.530
y	0.470	0.438	0.425	0.456

- (d) Skid Resistance. The surface of the markings shall provide an average minimum skid resistance of 50 BPN when tested according to ASTM E 303.
- (e) Sampling, Testing, Acceptance, and Certification. Prior to approval and use of the wet reflective, temporary, removable pavement marking tape, the manufacturer shall submit a notarized certification from an independent laboratory, together with the results of all tests, stating that the material meets the requirements as set forth herein. The certification test report shall state the lot tested, manufacturer's name, and date of manufacture.

After approval by the Department, samples and certification by the manufacturer shall be submitted for each batch used. The manufacturer shall submit a certification stating that the material meets the requirements as set forth herein and is essentially identical to the material sent for qualification. The certification shall state the lot tested, manufacturer's name, and date of manufacture.

All costs of testing (other than tests conducted by the Department) shall be borne by the manufacturer."

WARM MIX ASPHALT (BDE)

Effective: January 1, 2012

Revised: April 1, 2016

Description. This work shall consist of designing, producing and constructing Warm Mix Asphalt (WMA) in lieu of Hot Mix Asphalt (HMA) at the Contractor's option. Work shall be according to Sections 406, 407, 408, 1030, and 1102 of the Standard Specifications, except as modified herein. In addition, any references to HMA in the Standard Specifications, or the special provisions shall be construed to include WMA.

WMA is an asphalt mixture which can be produced at temperatures lower than allowed for HMA utilizing approved WMA technologies. WMA technologies are defined as the use of additives or processes which allow a reduction in the temperatures at which HMA mixes are produced and placed. WMA is produced by the use of additives, a water foaming process, or combination of both. Additives include minerals, chemicals or organics incorporated into the asphalt binder stream in a dedicated delivery system. The process of foaming injects water into the asphalt binder stream, just prior to incorporation of the asphalt binder with the aggregate.

Approved WMA technologies may also be used in HMA provided all the requirements specified herein, with the exception of temperature, are met. However, asphalt mixtures produced at temperatures in excess of 275 °F (135 °C) will not be considered WMA when determining the grade reduction of the virgin asphalt binder grade.

Equipment.

Revise the first paragraph of Article 1102.01 of the Standard Specifications to read:

“1102.01 Hot-Mix Asphalt Plant. The hot-mix asphalt (HMA) plant shall be the batch-type, continuous-type, or dryer drum plant. The plants shall be evaluated for prequalification rating and approval to produce HMA according to the current Bureau of Materials and Physical Research Policy Memorandum, “Approval of Hot-Mix Asphalt Plants and Equipment”. Once approved, the Contractor shall notify the Bureau of Materials and Physical Research to obtain approval of all plant modifications. The plants shall not be used to produce mixtures concurrently for more than one project or for private work unless permission is granted in writing by the Engineer. The plant units shall be so designed, coordinated and operated that they will function properly and produce HMA having uniform temperatures and compositions within the tolerances specified. The plant units shall meet the following requirements.”

Add the following to Article 1102.01(a) of the Standard Specifications.

“(11) Equipment for Warm Mix Technologies.

- a. Foaming. Metering equipment for foamed asphalt shall have an accuracy of ± 2 percent of the actual water metered. The foaming control system shall be electronically interfaced with the asphalt binder meter.
- b. Additives. Additives shall be introduced into the plant according to the supplier’s recommendations and shall be approved by the Engineer. The system for introducing the WMA additive shall be interlocked with the aggregate feed or weigh system to maintain correct proportions for all rates of production and batch sizes.”

Mix Design Verification.

Add the following to Article 1030.04 of the Standard Specifications.

“(e) Warm Mix Technologies.

- (1) Foaming. WMA mix design verification will not be required when foaming technology is used alone (without WMA additives). However, the foaming technology shall only be used on HMA designs previously approved by the Department.
- (2) Additives. WMA mix designs utilizing additives shall be submitted to the Engineer for mix design verification.”

Construction Requirements.

Revise the second paragraph of Article 406.06(b)(1) of the Standard Specifications to read:

“The HMA shall be delivered at a temperature of 250 to 350 °F (120 to 175 °C). WMA shall be delivered at a minimum temperature of 215 °F (102 °C).”

Basis of Payment.

This work will be paid at the contract unit price bid for the HMA pay items involved. Anti-strip will not be paid for separately, but shall be considered as included in the cost of the work.

WEEKLY DBE TRUCKING REPORTS (BDE)

Effective: June 2, 2012

Revised: April 2, 2015

The Contractor shall submit a weekly report of Disadvantaged Business Enterprise (DBE) trucks hired by the Contractor or subcontractors (i.e. not owned by the Contractor or subcontractors) that are used for DBE goal credit.

The report shall be submitted to the Engineer on Department form "SBE 723" within ten business days following the reporting period. The reporting period shall be Monday through Sunday for each week reportable trucking activities occur.

Any costs associated with providing weekly DBE trucking reports shall be considered as included in the contract unit prices bid for the various items of work involved and no additional compensation will be allowed.

WORKING DAYS (BDE)

Effective: January 1, 2002

The Contractor shall complete the work within 20 working days.

BITUMINOUS MATERIALS COST ADJUSTMENTS (BDE)

Effective: November 2, 2006

Revised: August 1, 2017

Description. Bituminous material cost adjustments will be made to provide additional compensation to the Contractor, or credit to the Department, for fluctuations in the cost of bituminous materials when optioned by the Contractor. The bidder shall indicate with their bid whether or not this special provision will be part of the contract.

The adjustments shall apply to permanent and temporary hot-mix asphalt (HMA) mixtures, bituminous surface treatments (cover and seal coats), and preventative maintenance type surface treatments that are part of the original proposed construction, or added as extra work and paid for by agreed unit prices. The adjustments shall not apply to bituminous prime coats, tack coats, crack filling/sealing, joint filling/sealing, or extra work paid for at a lump sum price or by force account.

Method of Adjustment. Bituminous materials cost adjustments will be computed as follows.

$$CA = (BPI_P - BPI_L) \times (\%AC_V / 100) \times Q$$

- Where: CA = Cost Adjustment, \$.
BPI_P = Bituminous Price Index, as published by the Department for the month the work is performed, \$/ton (\$/metric ton).
BPI_L = Bituminous Price Index, as published by the Department for the month prior to the letting for work paid for at the contract price; or for the month the agreed unit price letter is submitted by the Contractor for extra work paid for by agreed unit price, \$/ton (\$/metric ton).
%AC_V = Percent of virgin Asphalt Cement in the Quantity being adjusted. For HMA mixtures, the % AC_V will be determined from the adjusted job mix formula. For bituminous materials applied, a performance graded or cutback asphalt will be considered to be 100% AC_V and undiluted emulsified asphalt will be considered to be 65% AC_V.
Q = Authorized construction Quantity, tons (metric tons) (see below).

For HMA mixtures measured in square yards: $Q, \text{ tons} = A \times D \times (G_{mb} \times 46.8) / 2000$. For HMA mixtures measured in square meters: $Q, \text{ metric tons} = A \times D \times (G_{mb} \times 1) / 1000$. When computing adjustments for full-depth HMA pavement, separate calculations will be made for the binder and surface courses to account for their different G_{mb} and % AC_V.

For bituminous materials measured in gallons: $Q, \text{ tons} = V \times 8.33 \text{ lb/gal} \times SG / 2000$
For bituminous materials measured in liters: $Q, \text{ metric tons} = V \times 1.0 \text{ kg/L} \times SG / 1000$

- Where: A = Area of the HMA mixture, sq yd (sq m).
D = Depth of the HMA mixture, in. (mm).
 G_{mb} = Average bulk specific gravity of the mixture, from the approved mix design.
V = Volume of the bituminous material, gal (L).
SG = Specific Gravity of bituminous material as shown on the bill of lading.

Basis of Payment. Bituminous materials cost adjustments may be positive or negative but will only be made when there is a difference between the BPI_L and BPI_P in excess of five percent, as calculated by:

$$\text{Percent Difference} = \{(BPI_L - BPI_P) \div BPI_L\} \times 100$$

Bituminous materials cost adjustments will be calculated for each calendar month in which applicable bituminous material is placed; and will be paid or deducted when all other contract requirements for the work placed during the month are satisfied. The adjustments shall not apply during contract time subject to liquidated damages for completion of the entire contract.

STATE OF ILLINOIS
DEPARTMENT OF TRANSPORTATION
DIVISION OF HIGHWAYS

**PROPOSED
HIGHWAY PLANS**
FAS ROUTE 1205 (IL 192)
SECTION D2 RS 2018-1
ROCK ISLAND COUNTY
C-92-078-17

FOR INDEX OF SHEETS, SEE SHEET NO. 2
FOR STATE STANDARDS, SEE SHEET NO. 2

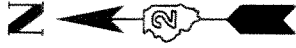

D-92-065-17

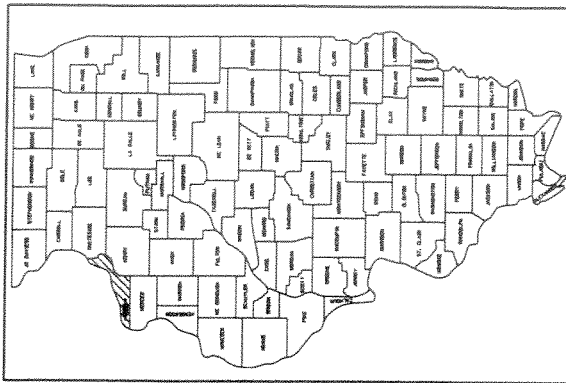

LOCATION OF SECTION INDICATED THEREIN

STATE OF ILLINOIS
DEPARTMENT OF TRANSPORTATION
DIVISION OF HIGHWAYS

SUBMITTED

20

DEPUTY DIRECTOR OF HIGHWAYS, REGION ENGINEER

Kathleen M. ...
June 22, 2017

ENGINEER OF DESIGN AND ENVIRONMENT

20

DIRECTOR OF PROGRAM DEVELOPMENT

PRINTED BY THE AUTHORITY
OF THE STATE OF ILLINOIS

DISTRICT 2, DIXON

SECTION BEGINS
STA. 240 + 00

R-3-W

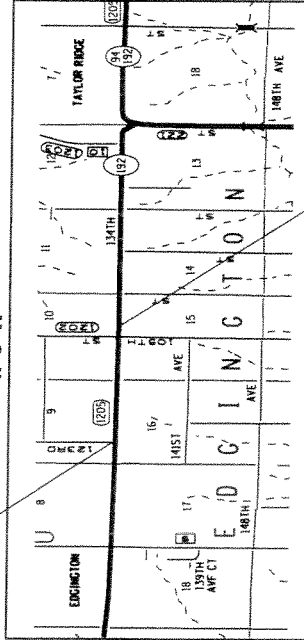

T-16-N

SECTION ENDS
STA. 315 + 85

EDGINGTON TOWNSHIP,
SECTIONS 9, 10, 15, 16

JULIE
JOINT UTILITY LOCATION INFORMATION FOR EXCAVATION
1-800-882-8123

SQUAD LEADER: LANCE NICKLAUS 815-284-5407
PROJECT ENGINEER: SCOTT KULLERSTRAND

GROSS LENGTH = 7585 LIN. FT. (IL 192) = 1.43 MILES
NET LENGTH = 7585 LIN. FT. (IL 192) = 1.43 MILES

CONTRACT 64M54

FAS 1205 (IL 192)

SECTION D2 RS 2018-1

ROCK ISLAND COUNTY

INDEX

FAS 1205 (IL 192)
SECTION D2 RS 2018-1
ROCK ISLAND COUNTY
CONTRACT NO. 64M54
Sheet 2 of 26

1	Cover Sheet
2	Index of Sheets / State Standards
3-4	Summary of Quantities
5-6	General Notes
7-10	Typical Sections
11-18	Plan Sheets
19	Hot-Mix-Asphalt Schedule
20	Sideroad & Entrance Schedule
21-22	Schedule Of Quantities
23	Safety Edge (SMART Projects) (48.2)
24-26	Typical Pavement Markings (41.1)

STATE STANDARDS

701001-02	OFF-ROAD OPERATIONS, 2L, 2W, MORE THAN 15' (4.5m) AWAY
701006-05	OFF-ROAD OPERATIONS, 2L, 2W, 15'(4.5M) TO 24"(600M) FROM PAVEMENT EDGE
701011-04	OFF-ROAD MOVING OPERATIONS, 2L, 2W, DAY ONLY
701301-04	LANE CLOSURE; 2L, 2W, SHORT TIME OPERATIONS
701306-03	LANE CLOSURE; 2L, 2W, SLOW MOVING OPERATIONS DAY ONLY, FOR SPEEDS \geq 45 MPH
701311-03	LANE CLOSURE; 2L, 2W, MOVING OPERATIONS, DAY ONLY
701901-06	TRAFFIC CONTROL DEVICES
720011-01	METAL POST FOR SIGNS, MARKERS AND DELINEATORS
728001-01	TELESCOPING STEEL SIGN SUPPORT
729001-01	APPLICATIONS OF TYPES A AND B METAL POST (FOR SIGNS & MARKERS)
780001-05	TYPICAL PAVEMENT MARKINGS
781001-04	TYPICAL APPLICATIONS RAISED REFLECTIVE PAVEMENT MARKERS

SUMMARY OF QUANTITIES

FAS 1205 (IL 192)
SECTION D2 RS 2018-1
ROCK ISLAND COUNTY
CONTRACT # 64M54
SHEET 3 OF 26

RURAL
100% State
0005

CODE NO.	ITEM	UNIT	TOTAL QUANTITY
40600290	BITUMINOUS MATERIALS (TACK COAT)	POUND	13,039
40600982	HOT-MIX ASPHALT SURFACE REMOVAL - BUTT JOINT	SQ YD	338
40603310	HOT-MIX ASPHALT SURFACE COURSE, MIX 'C', N50	TON	2,095
40800050	INCIDENTAL HOT-MIX ASPHALT SURFACING	TON	533
42300300	PORTLAND CEMENT CONCRETE DRIVEWAY PAVEMENT, 7 INCH	SQ YD	124
44000200	DRIVEWAY PAVEMENT REMOVAL	SQ YD	124
48102100	AGGREGATE WEDGE SHOULDER, TYPE B	TON	657
67100100	MOBILIZATION	L SUM	1
70100460	TRAFFIC CONTROL AND PROTECTION, STANDARD 701306	L SUM	1
70300100	SHORT TERM PAVEMENT MARKING	FOOT	1517
70300150	SHORT TERM PAVEMENT MARKING REMOVAL	SQ FT	253

*Specialty Items

SUMMARY OF QUANTITIES

FAS 1205 (IL 192)
SECTION D2 RS 2018-1
ROCK ISLAND COUNTY
CONTRACT # 64M54
SHEET 4 OF 26

100% State
0005
RURAL

CODE NO.	ITEM	UNIT	TOTAL QUANTITY
78000100	THERMOPLASTIC PAVEMENT MARKING - LETTERS AND SYMBOLS	SQ.FT	78
78000200	THERMOPLASTIC PAVEMENT MARKING - LINE 4"	FOOT	8776
78000500	THERMOPLASTIC PAVEMENT MARKING - LINE 8"	FOOT	577
78000600	THERMOPLASTIC PAVEMENT MARKING - LINE 12"	FOOT	306
78000650	THERMOPLASTIC PAVEMENT MARKING - LINE 24"	FOOT	77
78001110	PAINT PAVEMENT MARKING - LINE 4"	FOOT	26604
78100100	RAISED REFLECTIVE PAVEMENT MARKERS	EACH	57
78300200	RAISED REFLECTIVE PAVEMENT MARKER REMOVAL	EACH	30
<i>X4200001</i>	CIR - FDR EMULSIFIED ASPHALT	GALLON	36324
<i>X4200002</i>	COLD - IN PLACE RECYCLING 4.0"	SQ.YD	24216

*Specialty Items

GENERAL NOTES

The final top 4 inches of soil in any right-of-way area disturbed by the Contractor must be capable of supporting vegetation. The soil must be from the A horizon (zero to 2' deep) of soil profiles of local soils. The cost of this work shall be included in the unit prices bid and no additional compensation will be allowed.

All Borrow/Waste/Use sites must be approved by the Department prior to removing any material from the project or initiating any earthmoving activities, including temporary stockpiling outside the limits of construction.

The Contractor shall seed all disturbed areas within the project limits. Seeding Class 4 or 2A shall be used, except in front of properties where the grass will be mowed, then use Seeding, Class 1A. Class 2A shall be used on front slopes and ditch bottoms. Class 4 shall be used behind Type A gutter, on all backslopes and areas behind the backslope, and beyond the toe of front slope on fill sections without ditches. This work will be included in the contract unit price per Ton for AGGREGATE WEDGE SHOULDER, TYPE B.

Fertilizer shall be applied to all disturbed areas and incorporated into the seedbed prior to seeding or placement of sod at the rate specified in Sections 250 and 252 of the Standard Specifications. This work shall be included in the cost of AGGREGATE WEDGE SHOULDER, TYPE B.

Mulch Method II shall be applied over all seeded areas. This shall be included in the cost of the AGGREGATE WEDGE SHOULDER, TYPE B.

The existing hot-mix asphalt on private and commercial entrances shall be bladed off or milled and disposed of outside the project limits. This could be the entire entrance or tapered at the end depending on if the mainline is resurfaced or milled and resurfaced. The cost of the blading, milling, rolling, and disposal is included in the contract unit price for INCIDENTAL HOT-MIX ASPHALT SURFACING.

The drop off that occurs at entrance edges as a result of resurfacing of the entrance shall be corrected using aggregate shoulder material. This work shall be paid for by the TON for Aggregate Shoulders of the type specified in the plans.

The following Mixture Requirements are applicable for this project:

Location(s):	IL 192		
Mixture Use(s):	Surface		
PG:	PG 64-22		
Design Air Voids:	4.0 @ N50		
Mixture Composition (Mixture Gradation):	IL 9.5		
Friction Aggregate:	C		
Mixture Weight:	112 lb.		
Quality Management Program:	QCP		
Sublot Size:	N/A		
Number of Roller Passes ¹⁾ :	N/A		

1) When a number of roller passes is specified, the Contractor may opt to use intelligent compaction in lieu of density testing under the Quality Control for Performance (QCP) program.

The Contractor will be required to furnish 5 1/2" high brass stencils as approved by the Engineer and install stationing at 250' intervals. Stationing shall be placed on both lanes of 2-lane highways and on the

outside lanes in both directions on 4-lane highways. The stations shall be placed 6" inside the pavement marking edge so they can be read from the shoulder. This work will be included in the cost of the final pavement surface.

The area to be tacked or primed shall be limited to that which can be covered with HMA on the next day's production, but no more than five days in advance of the placement of the HMA, unless approved by the Engineer.

If, during the grinding or resurfacing operations, the existing mailboxes become a hindrance, the Contractor shall be required to carefully remove and reinstall the mailboxes as directed by the Engineer. This work shall be included in the contract unit price for the INCIDENTAL HOT-MIX ASPHALT SURFACING.

Pavement Marking shall be done according to Standard 780001, except as follows:

1. All words, such as ONLY, shall be 8 feet high.
2. All non-freeway arrows shall be the large size.
3. The distance between yellow no-passing lines shall be 8 inches, not 7 inches, as shown in the detail of Typical Lane and Edge Lines.
4. Centerline Skip Dash Pavement Marking on multi-lane divided, multi-lane undivided, and one-way roadway shall be according to District Standard 41.1.

The Contractor shall be responsible for locating and protecting utility property during construction operations as outlined in Article 107.39 of the Standard Specifications. A minimum of 48 hours advance notice is required for non-emergency work. The JULIE number is 800-892-0123. The following listed utilities located within the project limits or immediately adjacent to the project construction limits are members of JULIE:

(Type name & phone number of JULIE companies from attached utility form.)

IDOT is not a member of JULIE. If you are near any overhead lighting, intersection lighting or traffic signals, contact the IDOT Traffic Office at 815/284-5469 at least 48 hours prior to work.

The contractor should be aware that during the cold-in-place recycling milling operations the likelihood of milling up area reflective crack control in the area is highly likely. The depth of the crack control varies within from 2 ½ to 4 inches.

TYPICAL SECTION

CL IL 192

STA. 240+00 - 299+11

STA. 314+72 - 315+85

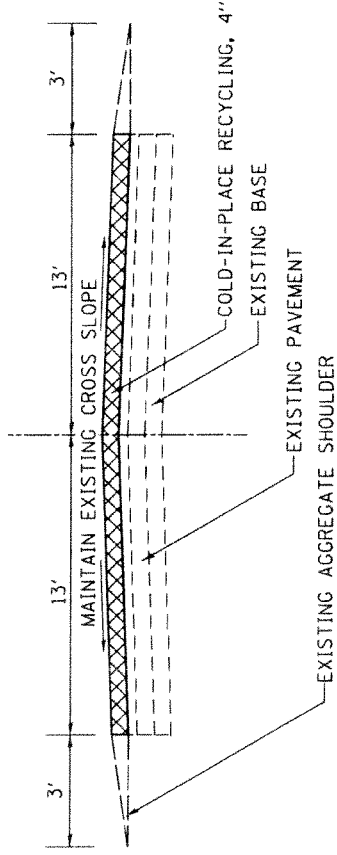

STA. 299+11 - 315+85

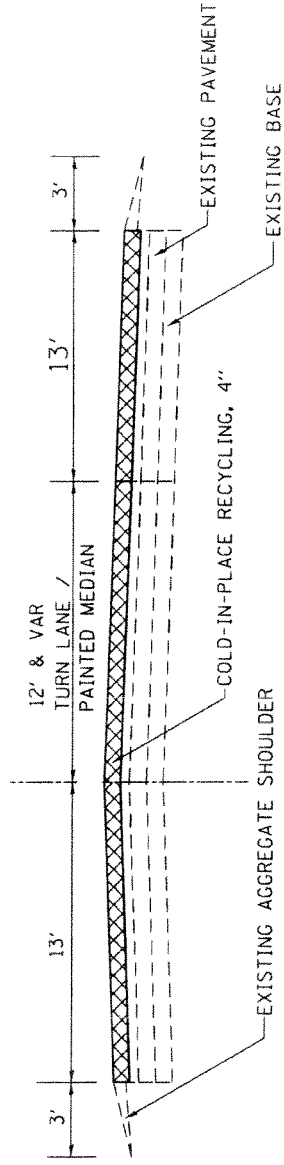

FILE NAME = G:\PL\Nicklaus\FY 18 Jobs\Dave S\IL 192\overgood.dgn	USER NAME = nicklauslo overgood.dgn	STATE OF ILLINOIS DEPARTMENT OF TRANSPORTATION	TYPICAL SECTIONS	FAS RIE.	SECTION	COUNTY	TOTAL SHEETS	SHEET NO.
				1205	D2 RS 2018-1	ROCK ISLAND	26	7
PLOT DATE = Jun-12-2017 02:29:41 PM				FED. ROAD DIST. NO.		ILLINOIS FED. AID PROJECT		CONTRACT NO. 64M54

TYPICAL SECTION

NOTE 1:
SAFETY EDGE TO BE PLACED
WITH COLD-IN-PLACE RECYCLING
AND HOT-MIX-ASPHALT OVERLAY

CL IL 192

STA. 240+00 - 299+11

STA. 314+72 - 315+85

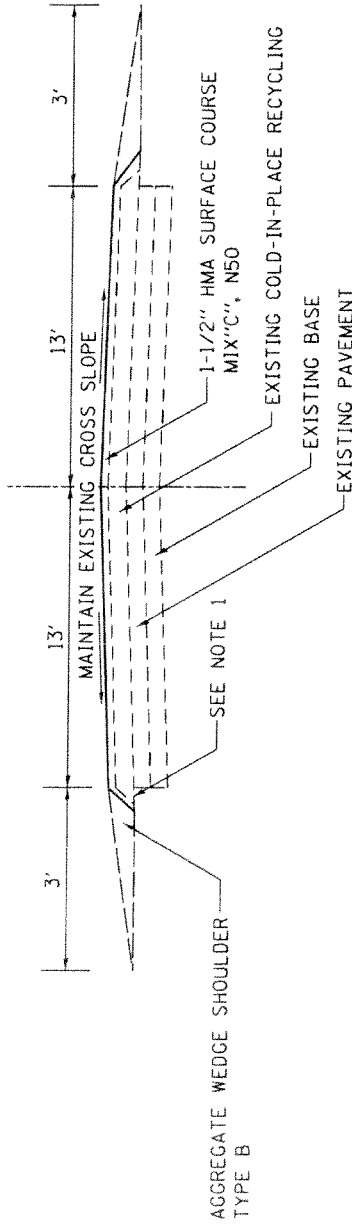

STA. 299+11 - 315+85

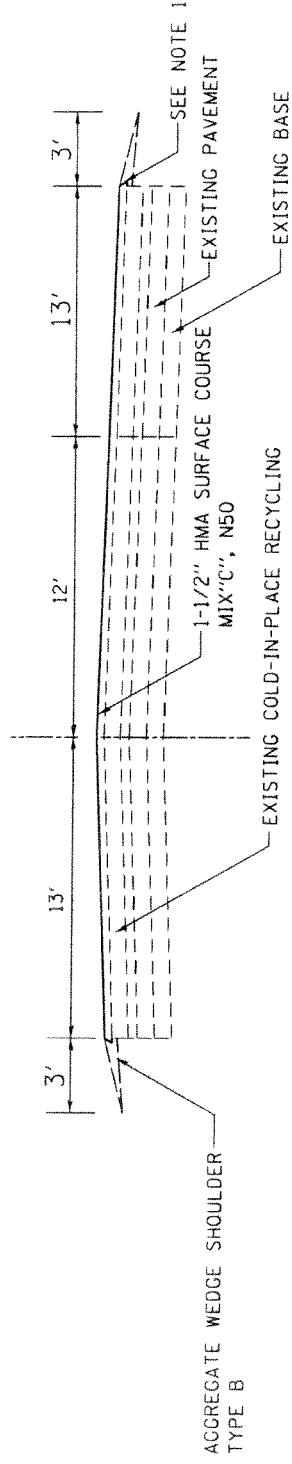

FILE NAME =

D:\NPL\Nicklaus\FY 18 Jobs\Dave SNL 192\covergood.dgn

PLOT DATE = Jun-12-2017 02:29:22 PM

STATE OF ILLINOIS
DEPARTMENT OF TRANSPORTATION

TYPICAL SECTIONS

FAS
RTE.

1205

SECTION

D2 RS 2018-1

COUNTY

ROCK ISLAND

TOTAL SHEETS

26

SHEET NO.

8

CONTRACT NO. 64M54

FED. ROAD DIST. NO. ILLINDIST. FED. AID PROJECT

TYPICAL SECTIONS

HOT-MIX ASPHALT SURFACE REMOVAL - BUTT JOINT

FAS 1205 (IL 192)
SECTION D2 RS 2018-1
ROCK ISLAND COUNTY
SHEET 9 of 26
CONTRACT NUMBER: 64M54

STA. 240 + 00 - 240 + 45
STA. 315 + 40 - 315 + 85

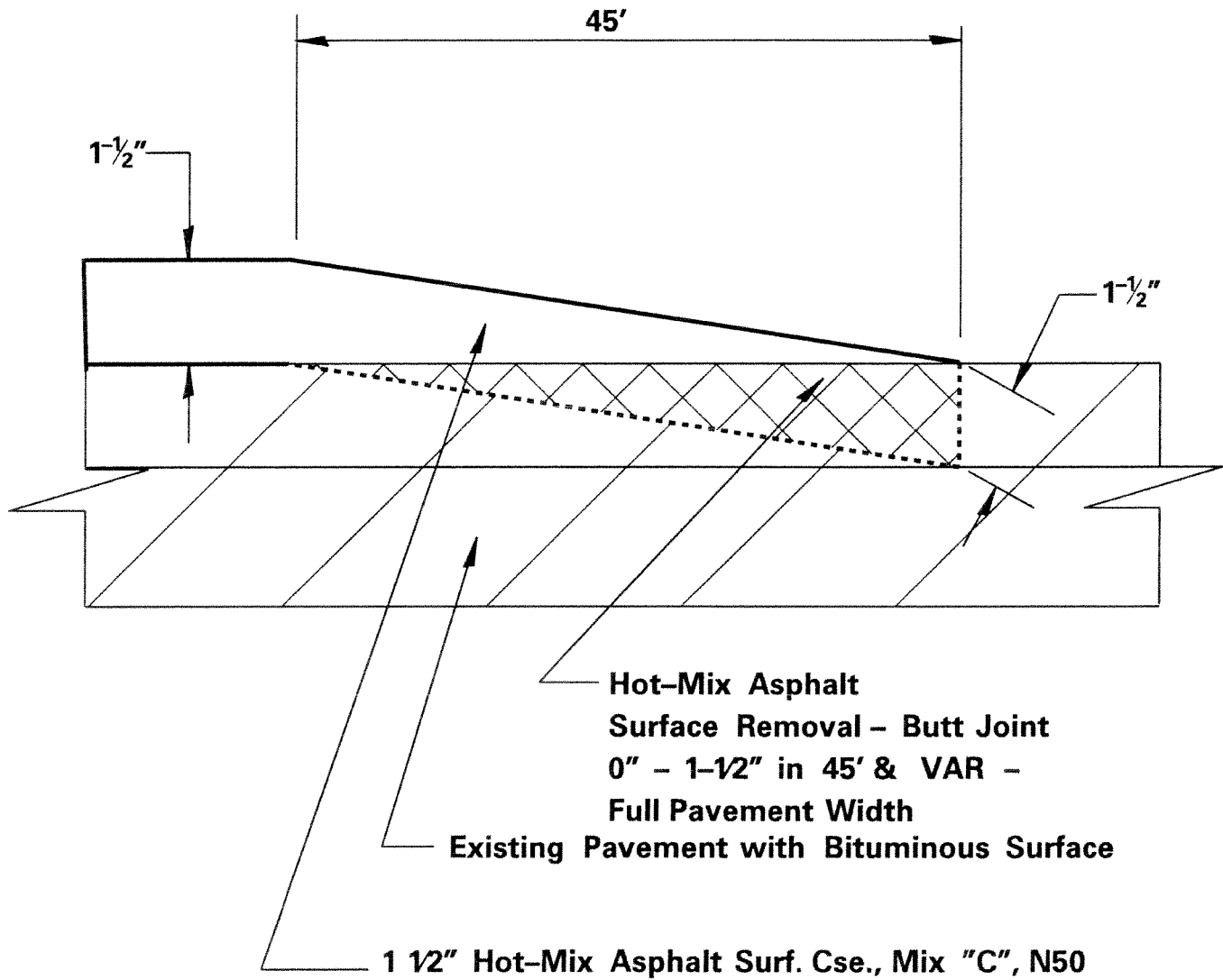

TYPICAL SECTION ENTRANCES

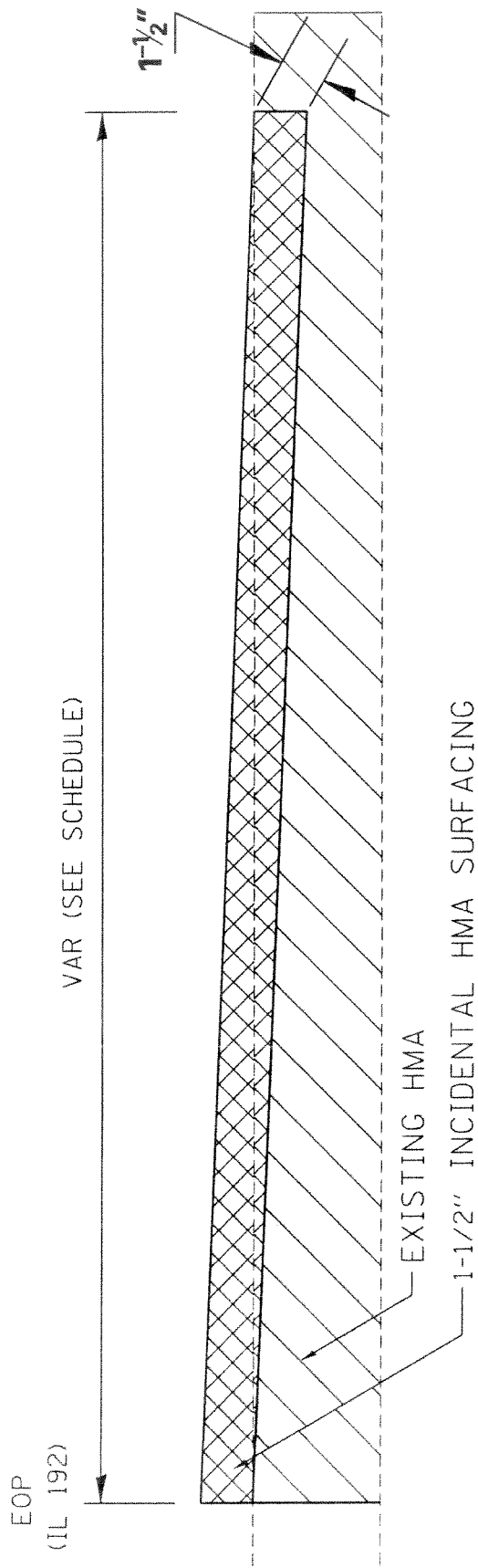

INCIDENTAL HMA SURFACE
 EXISTING

INCIDENTAL HMA SURFACING 112 LBS/ SQ YD/ IN

TITLE BLOCK DATE: _____ DRAWN: _____ CHECKED: _____ DATE: _____	DESIGNED: _____ DATE: _____	REVISIONS REVISED _____ REVISED _____ REVISED _____		STATE OF ILLINOIS DEPARTMENT OF TRANSPORTATION		SCALE: _____ OF _____ SHEETS: _____ OF _____	
		PROJECT NO.: _____ SHEET NO.: _____	SECTION: _____ OF _____	COUNTY: _____ ROCK ISLAND CO.	SHEET NO.: _____ OF _____	CONTRACT NO.: _____ 6-48854	PROJECT: _____ TO STA.: _____

PLAN SHEET

123RD STREET

240+89

STA. 240+00
SECTION BEGINS

247+00

247+85
CONCRETE

248+47



FILE NAME		DESIGNED		STATE OF ILLINOIS		SCALE		SHEET		OF		SHEETS		STA.		TO STA.	
DRAWN		CHECKED		DEPARTMENT OF TRANSPORTATION		CONTRACT NO.		NO.		OF		SHEETS		NO.		OF	
DATE		DATE				CONTRACT NO.		NO.		OF		SHEETS		NO.		OF	
DATE		DATE				CONTRACT NO.		NO.		OF		SHEETS		NO.		OF	

PLAN SHEET

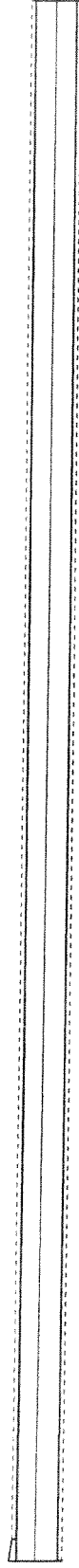

FILE NO. 1	DATE	DESIGNED BY	DRAWN BY	CHECKED BY	DATE	REVISED	REVISED	REVISED	REVISED	SCALE	SHEET	OF	SHEETS	STA.	TO STA.	COMMIT.	TOTAL SHEETS	
																		STATE OF ILLINOIS
100-100-100	10/10/10	J. Smith	A. Brown	C. Green	10/10/10	1	1	1	1	1" = 100'	1	1	1	1	1	1	1	1

PLAN SHEET



263+25
CONCRETE

265+50

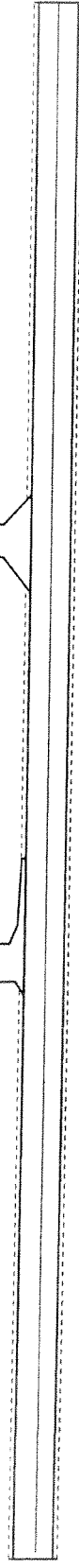

STATE OF ILLINOIS DEPARTMENT OF TRANSPORTATION	SHEET NO. _____ TOTAL SHEETS _____	COUNTY _____ DISTRICT NO. _____	SECTION _____ OF NO. _____	TOTAL SHEETS _____ SHEETS IN THIS CONTRACT _____
	DESIGNED BY _____ CHECKED BY _____ DATE _____	REVISED BY _____ REVISED BY _____ REVISED BY _____	SCALE: _____ SHEET _____ OF _____ SHEETS STA. _____ TO STA. _____	PROJECT NO. _____ CONTRACT NO. _____

PLAN SHEET



278+36

274+35

274+16

272+65
AGC

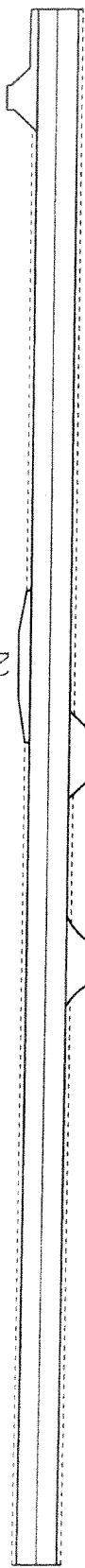

FILE NO. 11	STATE OF ILLINOIS	SCALE: SHEET OF SHEETS STA. TO STA.	SECTION OF THE CONTRACT	CONTRACT NO.	TOTAL SHEETS
DATE: 11/10/01	DEPARTMENT OF TRANSPORTATION				
DESIGNED BY: [blank]	DESIGNED DATE: [blank]	REVISED BY: [blank]	REVISED DATE: [blank]	REVISED BY: [blank]	REVISED DATE: [blank]
CHECKED BY: [blank]	CHECKED DATE: [blank]	CHECKED BY: [blank]	CHECKED DATE: [blank]	CHECKED BY: [blank]	CHECKED DATE: [blank]

PLAN SHEET



288+35

288+15

FILE NO. 1 STATE OF ILLINOIS DEPARTMENT OF TRANSPORTATION DISTRICT OFFICE CHICAGO, ILL.	DRAWN BY CHECKED BY DATE	DESIGNED BY DATE	REVISIONS NO. DESCRIPTION DATE			STATE OF ILLINOIS DEPARTMENT OF TRANSPORTATION	SCALE: _____ SHEET _____ OF _____ SHEETS STA. _____ TO STA. _____	PROJECT NO. CONTRACT NO.	COUNTY DISTRICT	SECTION (OR PROJECT)	TOTAL SHEETS OF	SHEET NO.
			PROJECT NO. CONTRACT NO.									

PLAN SHEET



288+35

291+16

291+16

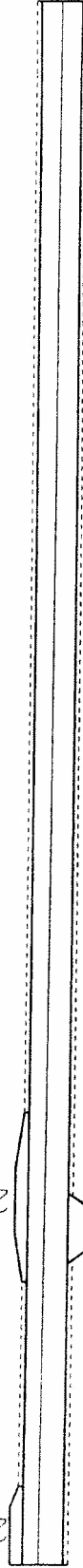

FILE NO. 1 STATE OF ILLINOIS DEPARTMENT OF TRANSPORTATION	SCALE: SHEET OF SHEETS STA. TO STA.	COUNTY PROJECT NO. 108-1 CONTRACT NO. 108-1	TOTAL SHEETS 10	SHEET NO. 10
DESIGNED BY CHECKED BY DATE	REVISIONS METHOD METHOD	STATE OF ILLINOIS DEPARTMENT OF TRANSPORTATION		

PLAN SHEET

105TH STREET

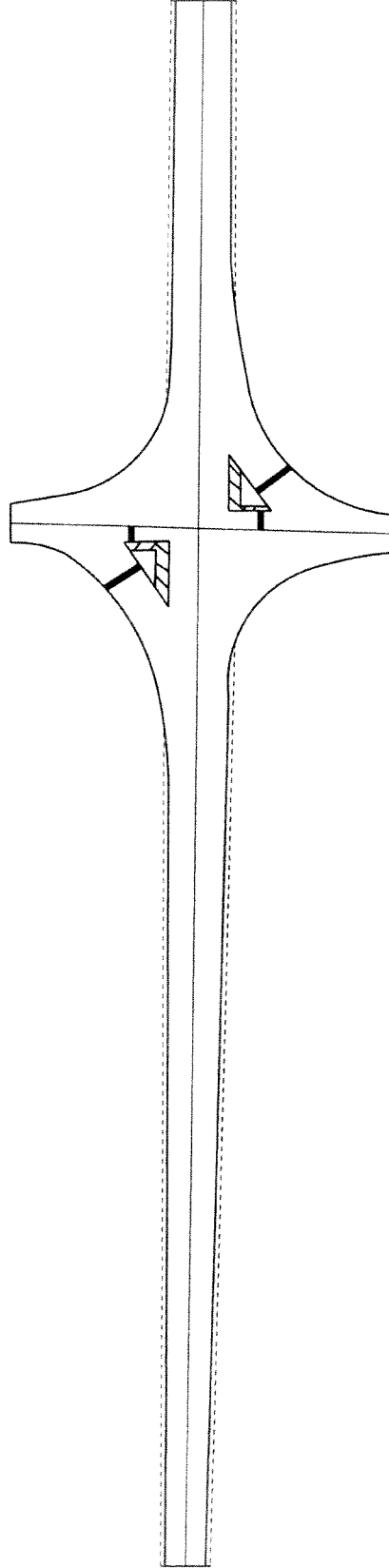

FULL NAME STATE OF ILLINOIS DEPARTMENT OF TRANSPORTATION	DESIGNED BY DRAWN BY CHECKED BY DATE	REVISED BY REVISED BY REVISED BY REVISED BY	STATE OF ILLINOIS DEPARTMENT OF TRANSPORTATION		SCALE:	SHEET OF	SHEETS	STA. TO STA.	TOTAL SHEETS
			PROJECT NO.	CONTRACT NO.	COUNTY	SECTION OF PROJECT	PROJECT NO.	CONTRACT NO.	COUNTY

HMA SCHEDULE

Location	Remarks	Length	Proposed Surface		Bit Materials Tack Coat	HMA Surface Removal Butt-Joint Sq Yd	Short Term Pavt Marking Foot	Short Term Pavement Marking Removal Sq Ft	Hot-Mix Asphalt Surf Cse Mix C N50 Ton	CIR-FDR EMULSIFIED ASPHALT Gallon	Cold-In Place Recycling 4 inch Sq Yd	Aggregate Wedge Shoulders Type B Ton
			Width	Sq Yd								
IL 192												
Sta 240 + 0 - 240 + 45		45	26	130	58.5	130.0	9.0	1.5	10.9	195.0	130.0	3.9
Sta 240 + 45 - 299 + 11		5866	26	16946	7625.8		1173.2	195.5	1423.5	25419.3	16946	507.7
Sta 299 + 11 - 314 + 72		1561	VAR	6813	3065.9		312.2	52.0	572.3	10219.5	6813.0	135.1
Sta 314 + 72 - 315 + 40		68	26	196	88.4		13.6	2.3	16.5	294.7	196.4	5.9
Sta 315 + 40 - 315 + 85		45	26	130	58.5	130.0	9.0	1.5	10.9	195.0	130.0	3.9
3% for Safety Edge									61.0			
TOTAL		7,585.0		24,215.7	10,897.1	260.0	1,517.0	252.8	2,095.1	36,323.5	24,215.7	656.5

SIDERoadS & ENTRANCES

IL 192

STATION	L/R	REMARKS	OPENING @ EDGE OF PAVEMENT FT	DISTANCE FROM EOP TO BACK OF RETURN	THROAT WIDTH FT	DISTANCE BEYOND THROAT	FINAL WIDTH FT	AREA SQ. YD	40800050 INCIDENTAL HMA SURFACING TONS	40600290 BIT MTRL TACK COAT POUNDS	44000200 DRIVEWAY PAVT REM SQ. YD	42300300 PCC DRIVEWAY PAVT .7 INCH SQ. YD	40600982 HMA SURFACE REM. BUTT JOINT SQ. YD
240 + 89	LT	MBTO	108	8	108			96.0	10.8	43.20			
242 + 65	RT	FE											
247 + 00	RT	PE	39	20	27			73.3	8.2	33.00			
247 + 85	RT	PE CONCRETE						50.0			50.0	50.0	
248 + 47	LT	MBTO	98	8	98			87.1	9.8	39.20			
260 + 00	LT	FE											
263 + 25	LT	PE/MBTO CONCRETE						74.0			74.0	74.0	
265 + 50	LT	PE	60	26	24			121.3	13.6	54.60			
272 + 65	RT	PE											
274 + 16	RT	PE	28	15	24			43.3	4.9	19.50			
274 + 35	LT	MBTO	104	8	104			92.4	10.4	41.60			
278 + 36	LT	FE HMA	44	20	24			75.6	8.5	34.00			
278 + 36	LT	MBTO	55	8	55			48.9	5.5	22.00			
279 + 14	RT	FE											
283 + 82	LT	FE											
288 + 15	RT	PE	69	28	24			144.7	16.2	65.10			
288 + 35	LT	MBTO	106	8	106			94.2	10.6	42.40			
291 + 16	RT	PE	45	28	24			107.3	12.0	48.30			
291 + 16	LT	MBTO	108	8	108			96.0	10.8	43.20			
298 + 40	LT	FE											
305 + 75	RT	105TH STREET	277	104	35			1802.7	201.9	811.20			38.9
305 + 75	LT	105TH STREET	266	102	35			1876.2	210.1	844.31			38.9
IL 192 TOTALS									533.0	2141.6	124.0	124.0	77.8

Schedule of Quantities

78000100 THERMOPLASTIC PAVEMENT MARKING - LETTERS & SYMBOLS

<u>SQ FT</u>	<u>LOCATION</u>		
	IL 192		
15.6	Sta	304 + 11	Left Turn Arrow
15.6	Sta	304 + 96	Left Turn Arrow
15.6	Sta	306 + 36	Left Turn Arrow
15.6	Sta	307 + 08	Left Turn Arrow
15.6	Sta	308 + 34	Left Turn Arrow
78.0	TOTAL		

78000200 THERMOPLASTIC PAVEMENT MARKING - LINE 4"

<u>FOOT</u>	<u>LOCATION</u>			
	IL 192			
3,690.0	Sta	299 + 11	- 315 + 85	White Edge Lines
1,800.0	Sta	299 + 11	- 303 + 61	Double Yellow Island
310.0	Sta	303 + 61	- 305 + 16	Double Yellow
590.0	Sta	306 + 17	- 309 + 12	Double Yellow
2,240.0	Sta	309 + 12	- 314 + 72	Double Yellow Island
136.0	Sta	314 + 72	- 315 + 40	Double Yellow
10.0	Sta	315 + 40	- 315 + 85	Yellow Skip Dash
8,776.0	TOTAL			

78000500 THERMOPLASTIC PAVEMENT MARKING - LINE 8"

<u>FOOT</u>	<u>LOCATION</u>			
	IL 192			
118	Sta	303 + 98	- 305 + 16	Left Turn Lane
237	Sta	306 + 17	- 308 + 54	Left Turn Lane
222	Island outline 105th RT and LT			
577	TOTAL			

78000600 THERMOPLASTIC PAVEMENT MARKING - LINE 12"

<u>FOOT</u>	<u>LOCATION</u>			
	IL 192			
108	Sta	299 + 11	- 303 + 61	Yellow Island Hashes W. of 105th
108	Sta	309 + 12	314 + 72	Yellow Island Hashes E. of 105th
90	White Island Hashes 105th RT and LT			
306	TOTAL			

78000650 THERMOPLASTIC PAVEMENT MARKING - LINE 24"

<u>FOOT</u>	<u>LOCATION</u>		
	IL 192		
37	105th Street RT		Stop Bars
40	105th Street LT		Stop Bars
77	TOTAL		

Schedule of Quantities

78001110 PAINT PAVEMENT MARKING - LINE 4"

<u>FOOT</u>	<u>LOCATION</u>			
	IL 192			
11,822.0	Sta 240 + 00 - 299 + 11			White Edge Lines Up to Painted Islands
1,480.0	Sta 240 + 00 - 299 + 11			Yellow Skip Dash
<u>13,302.0</u>	Sub-Total			
X 2	2 applications			
<u>26,604.0</u>	TOTAL			

78100100 RAISED REFLECTIVE PAVEMENT MARKER

<u>EACH</u>	<u>LOCATION</u>			
7	Sta 299 + 11 - 315 + 40			Turn Lanes (One-way Crystal)
50	Sta 299 + 11 - 315 + 40			Painted Medians (Two-way Amber)
<u>57</u>	Total Two-way Amber			

78300200 RAISED REFLECTIVE PAVEMENT MARKER REMOVAL

<u>EACH</u>	<u>LOCATION</u>			
30	Sta 299 + 11 - 315 + 40			
<u>30</u>	TOTAL			

SAFETY EDGE (SMART PROJECT)

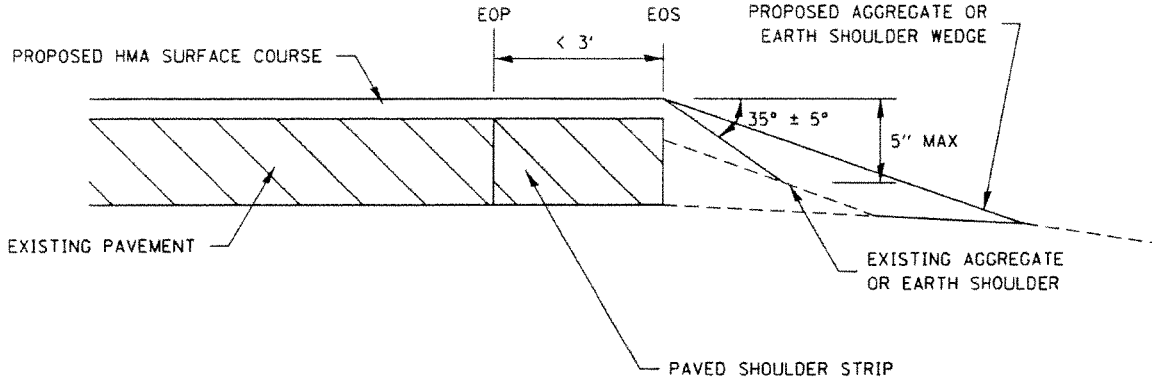

NO MILLING: ADJACENT SHOULDER FLUSH WITH OR LOWER THAN EXISTING PAVEMENT

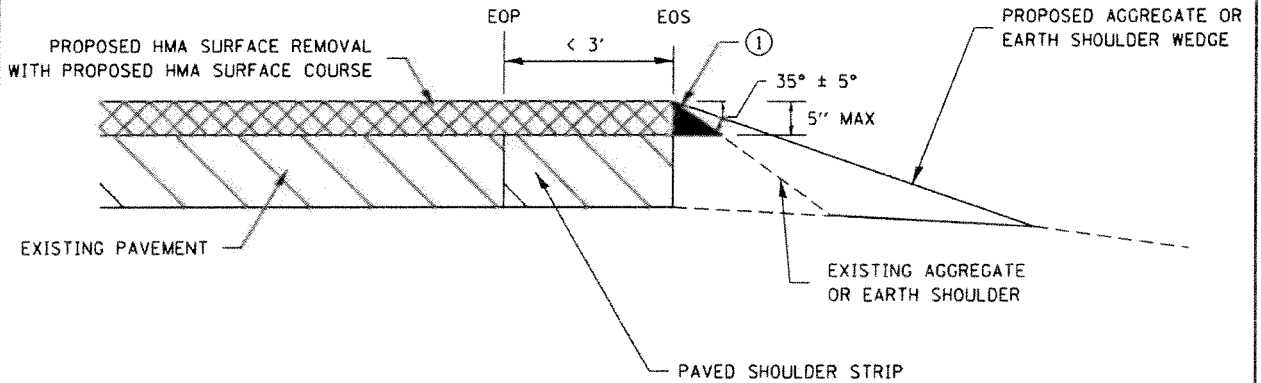

MILLING: WITH ADJACENT SHOULDER FLUSH WITH OR HIGHER THAN MILLED SURFACE

NOTES : THE DEVICE WHICH FORMS THE SAFETY EDGE SHALL BE MOUNTED ON THE PAVER SCREED AGAINST THE END GATE AND SHALL BE REMOVABLE OR BE ABLE TO BE LIFTED WHEN NOT IN USE. THE DEVICE SHALL BE DESIGNED TO MAINTAIN CONTACT WITH SURFACE OF THE SHOULDER AND ALLOW AUTOMATIC TRANSITION TO CROSS ROADS, DRIVEWAYS AND OBSTRUCTIONS. THE DEVICE SHALL ALSO CONSTRAIN THE HMA MATERIAL AND INCREASE THE CONSOLIDATION OF THE EXTRUDED PROFILE. THE USE OF A CONVENTIONAL SINGLE PLATE STRIKE-OFF WILL NOT BE ALLOWED.

ROLLERS WILL NOT BE ALLOWED ON THE SLOPED FACE OF THE SAFETY EDGE.

① PRIOR TO THE PLACEMENT OF THE HMA SAFETY EDGE, IF THE ADJACENT AGGREGATE OR EARTH SHOULDER IS HIGHER THAN THE MILLED SURFACE, THE AREA REQUIRED FOR PLACEMENT OF THE SAFETY EDGE SHALL BE BROUGHT FLUSH WITH THE MILLED SURFACE IN A MANNER APPROVED BY THE ENGINEER. THIS WORK SHALL BE CONSIDERED INCLUDED IN THE CONTRACT UNIT PRICE PER TON FOR HOT-MIX ASPHALT SURFACE COURSE OF THE TYPE SPECIFIED.

PLOT DATE: Jun-12-2017 02:48:17 PM

REVISED - 1-05-16	REGION 2 / DISTRICT 2 STANDARD	F.A.S. RTE.	SECTION	COUNTY	TOTAL SHEETS	SHEET NO.
REVISED - 10-11-13		1205	D2 RS 2018-1	ROCK ISLAND	26	23
REVISED -		CONTRACT NO. 64MS4				
REVISED -		SCALE: 1/8" = 1'-0"	SHEET NO. OF SHEETS		STA. TO STA.	FED. ROAD DIST. NO. ILLINOIS FED. AID PROJECT

TYPICAL PAVEMENT MARKINGS

MEDIAN PAVEMENT MARKING

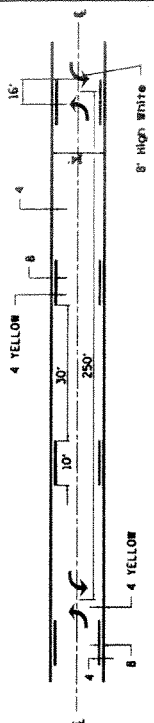

TYPICAL PAVEMENT MARKING FOR FLUSH MEDIAN AT LEFT TURN LANE

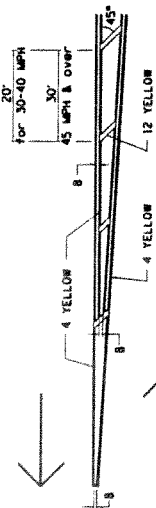
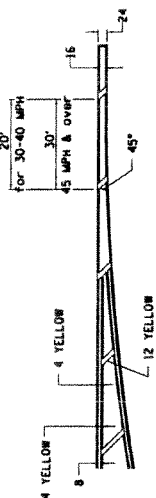

** ALL DIMENSIONS ARE IN INCHES UNLESS OTHERWISE NOTED.

TYPICAL ISLAND OFFSET SHOULDER WIDTH

TYPICAL MARKING FOR PAINTED ISLANDS

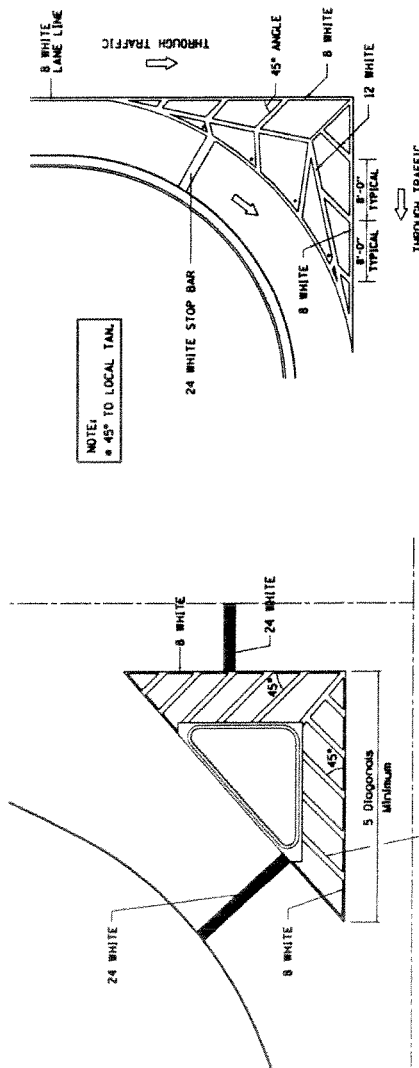

STANDARD CROSSWALK MARKING

See Schedules for Locations

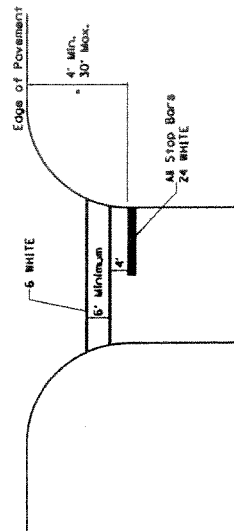

* Distance to the nearest edge of the intersecting roadway in the absence of a marked crosswalk.

FILE NO. 10 STATE OF ILLINOIS CONTRACT NO. 18-1000-0000-1000	DESIGNED	5-27-14	DESIGNED	5-27-14	F&S	SECTION	COUNTY	TOTAL SHEETS
	DRAWN	3-05-12	DRAWN	3-05-12	1000	02 RS 208-1	BOONE COUNTY	24
PROJECT SCALE 1"=100' PLAN DATE 2-24-12 REV. 001/07/13	CHECKED		CHECKED		1000	02 RS 208-1	BOONE COUNTY	24
PLAN DATE 2-24-12 REV. 001/07/13	DATE		DATE		1000	02 RS 208-1	BOONE COUNTY	24
STATE OF ILLINOIS DEPARTMENT OF TRANSPORTATION				REGION 2 / DISTRICT 2 STANDARD		CONTRACT NO. 18-1000-0000-1000		
SCALE: 1"=100'				SHEET NO. 09		SHEETS 10 TOTAL		

TYPICAL PAVEMENT MARKINGS SHEET 1 OF 3 41.1

TYPICAL PAVEMENT MARKINGS

ARROW LAYOUT

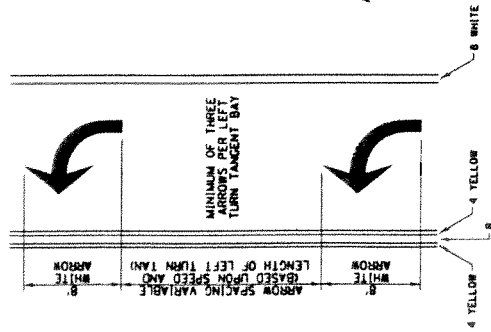

- ◀ ONE-WAY AMBER MARKER
- ◁ ONE-WAY CRYSTAL MARKER
- ◆ TWO-WAY AMBER MARKER

ALL DIMENSIONS ARE IN INCHES UNLESS OTHERWISE NOTED.

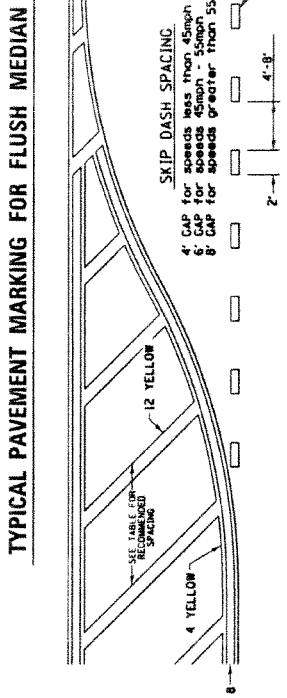
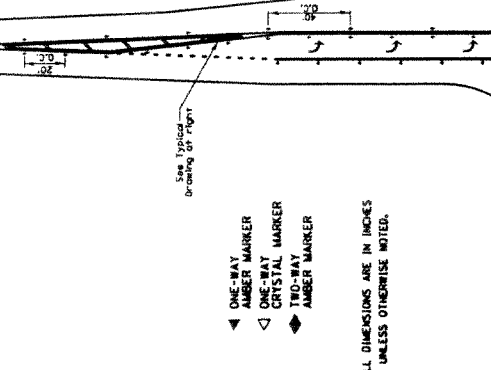

RECOMMENDED SPACING BETWEEN DIAGONALS (IN FEET)

Speed Limit Range	Continuous Median Area	Intersection Channelization	Objects (Islands)
less than 30MPH	50'	15'	10'
30-40MPH	75'	20'	15'
45MPH & over	75'	30'	20'

NOTE: If the spacing recommended in the Table does not permit at least five diagonal lines in the area being marked, the spacing from the next lowest speed range should be used. The recommended spacing is measured parallel to the pavement center line.

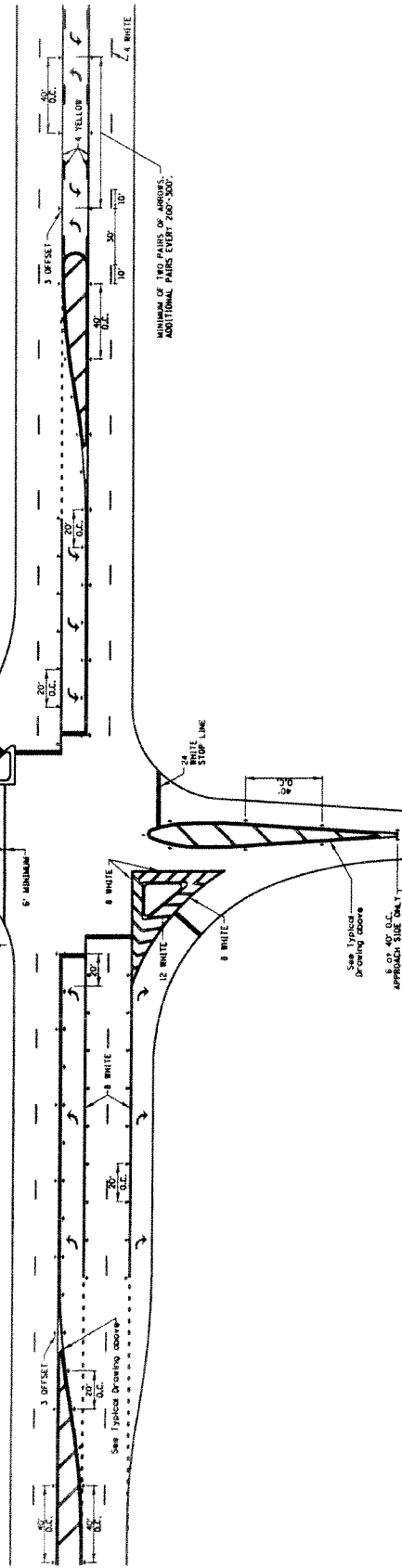

FILE NAME	DATE	DESIGNED	6-27-14	REGION 2 / DISTRICT 2 STANDARD	SHEET NO. OF SHEETS	10 OF 17
DATE	3-10-12	DRAWN		SCALE	1" = 10'	
DATE		CHECKED				
DATE		DATE				

STATE OF ILLINOIS	SECTION	LOCAL	SHEET
DEPARTMENT OF TRANSPORTATION	OF RS. 2018-1	NO. 1540	25
	ILLINOIS	CONTRACT NO.	64864

TYPICAL PAVEMENT MARKINGS

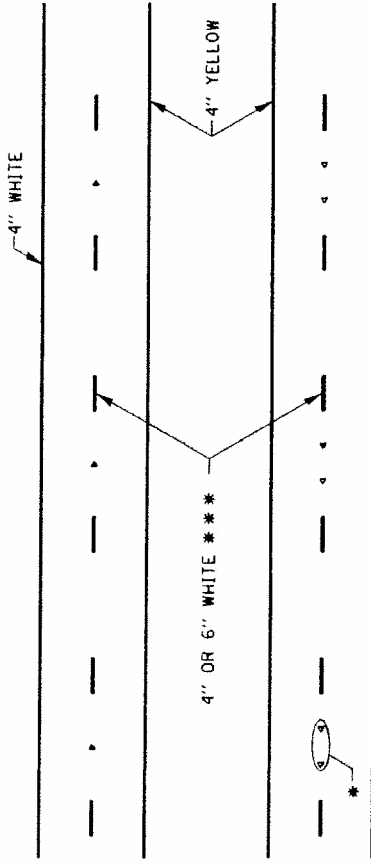

* SEE HIGHWAY STANDARD 781001 FOR SPACING DETAILS.
USE DOUBLE MARKERS WHEN ADT > 20,000.

MULTI-LANE / DIVIDED

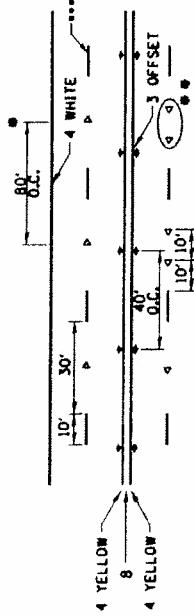

* REDUCE TO 40' O.C. ON CURVES WHERE ADVISORY SPEEDS ARE 10 MPH LOWER THAN POSTED SPEEDS.

** USE DOUBLE MARKERS WHEN ADT > 20,000

*** CENTERLINE SKIP DASH PAVEMENT MARKING SPEED LIMIT LESS THAN 40 MPH USE 4" LINE. SPEED LIMIT 40 MPH AND OVER USE 6" LINE.

MULTI-LANE / UNDIVIDED & ONE WAY

FOR MULTI-LANE UNDIVIDED HIGHWAYS USE THIS DETAIL NOT HIGHWAY STANDARD 781001

TYPICAL PARKING SPACING

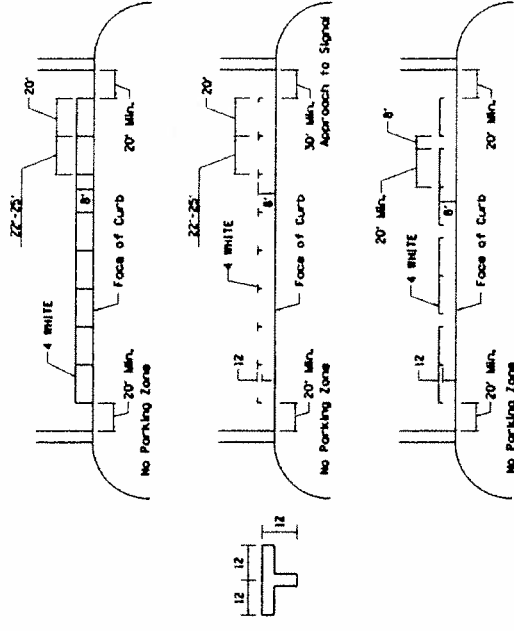

TYPICAL PAVEMENT MARKING FOR TWO LANE SECTION - NO PASSING ZONES

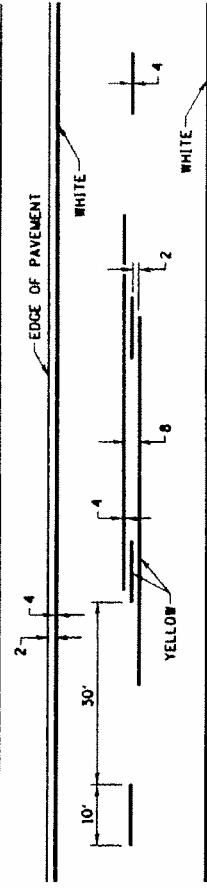

SYMBOLS

FILE NO.	DESIGNED BY	DATE	REVISION	DATE	BY
STATE OF ILLINOIS DEPARTMENT OF TRANSPORTATION			REGION 2 / DISTRICT 2 STANDARD		
SHEET NO. OF			SHEETS		
SCALE			TO STA.		
PROJECT NO.			SECTION		
COUNTY			NO.		
DRAWN BY			NO.		
CHECKED BY			NO.		
DATE			NO.		

REVISIONS TO THE ILLINOIS PREVAILING WAGE RATES

The Prevailing rates of wages are included in the Contract proposals which are subject to Check Sheet #5 of the Supplemental Specifications and Recurring Special Provisions. The rates have been ascertained and certified by the Illinois Department of Labor for the locality in which the work is to be performed and for each craft or type of work or mechanic needed to execute the work of the Contract. As required by Prevailing Wage Act (820 ILCS 130/0.01, et seq.) and Check Sheet #5 of the Contract, not less than the rates of wages ascertained by the Illinois Department of Labor and as revised during the performance of a Contract shall be paid to all laborers, workers and mechanics performing work under the Contract. Post the scale of wages in a prominent and easily accessible place at the site of work.

If the Illinois Department of Labor revises the prevailing rates of wages to be paid as listed in the specification of rates, the contractor shall post the revised rates of wages and shall pay not less than the revised rates of wages. Current wage rate information shall be obtained by visiting the Illinois Department of Labor web site at <http://www.state.il.us/agency/idol/> or by calling 312-793-2814. It is the responsibility of the contractor to review the rates applicable to the work of the contract at regular intervals in order to insure the timely payment of current rates. Provision of this information to the contractor by means of the Illinois Department of Labor web site satisfies the notification of revisions by the Department to the contractor pursuant to the Act, and the contractor agrees that no additional notice is required. The contractor shall notify each of its subcontractors of the revised rates of wages.