

# **BID PROPOSAL INSTRUCTIONS**

**ABOUT IDOT PROPOSALS:** All proposals are potential bidding proposals. Each proposal contains all certifications and affidavits, a proposal signature sheet and a proposal bid bond.

## **PREQUALIFICATION**

Any contractor who desires to become pre-qualified to bid on work advertised by IDOT must submit the properly completed pre-qualification forms to the Bureau of Construction no later than 4:30 p.m. prevailing time twenty-one days prior to the letting of interest. This pre-qualification requirement applies to first time contractors, contractors renewing expired ratings, contractors maintaining continuous pre-qualification or contractors requesting revised ratings. To be eligible to bid, existing pre-qualification ratings must be effective through the date of letting.

## **WHO CAN BID ?**

Bids will be accepted from only those companies that request and receive written Authorization to Bid from IDOT's Central Bureau of Construction.

## **REQUESTS FOR AUTHORIZATION TO BID**

Contractors wanting to bid on items included in a particular letting must submit the properly completed "Request for Authorization to Bid/or Not For Bid Status" (BDE 124) and the ORIGINAL "Affidavit of Availability" (BC 57) to the proper office no later than 4:30 p.m. prevailing time, three (3) days prior to the letting date.

## **WHAT CONSTITUTES WRITTEN AUTHORIZATION TO BID?**

When a prospective prime bidder submits a "Request for Authorization to Bid/or Not For Bid Status"(BDE 124) he/she must indicate at that time which items are being requested For Bidding purposes. Only those items requested For Bidding will be analyzed. After the request has been analyzed, the bidder will be issued an **Authorization to Bid or Not for Bid Report**, approved by the Central Bureau of Construction and the Chief Procurement Officer that indicates which items have been approved For Bidding. If **Authorization to Bid** cannot be approved, the **Authorization to Bid or Not for Bid Report** will indicate the reason for denial.

## **ABOUT AUTHORIZATION TO BID**

Firms that have not received an Authorization to Bid or Not For Bid Report within a reasonable time of complete and correct original document submittal should contact the Department as to the status. Firms unsure as to authorization status should call the Prequalification Section of the Bureau of Construction at the number listed at the end of these instructions.

## **ADDENDA AND REVISIONS**

It is the bidder's responsibility to determine which, if any, addenda or revisions pertain to any project they may be bidding. Failure to incorporate all relevant addenda or revisions may cause the bid to be declared unacceptable.

Each addendum or revision will be included with the Electronic Plans and Proposals. Addenda and revisions will also be placed on the Addendum/Revision Checklist and each subscription service subscriber will be notified by e-mail of each addendum and revision issued.

The Internet is the Department's primary way of doing business. The subscription service emails are an added courtesy the Department provides. It is suggested that bidders check IDOT's website at <http://www.dot.il.gov/desenv/delett.html> before submitting final bid information.

## ***IDOT IS NOT RESPONSIBLE FOR ANY E-MAIL FAILURES.***

Addenda questions may be directed to the Contracts Office at (217)782-7806 or [DOT.D&Econtracts@illinois.gov](mailto:DOT.D&Econtracts@illinois.gov)

Technical questions about downloading these files may be directed to Tim Garman at (217)524-1642 or [Timothy.Garman@illinois.gov](mailto:Timothy.Garman@illinois.gov).

## **STANDARD GUIDELINES FOR SUBMITTING BIDS**

- All pages should be single sided.
- Use the Cover Page that is provided in the Bid Proposal (posted on the IDOT Web Site) as the first page of your submitted bid. It has the item number in large bold type in the upper left-hand corner and lines provided for your company name and address in the upper right-hand corner.
- Do not use report covers, presentation folders or special bindings and do not staple multiple times on left side like a book. Use only 1 staple in the upper left hand corner. Make sure all elements of your bid are stapled together including the bid bond or guaranty check (if required).
- Do not include any certificates of eligibility, your authorization to bid, Addendum Letters or affidavit of availability.
- Do not include the Subcontractor Documentation with your bid (pages i – iii and pages a – g). This documentation is required only if you are awarded the project.
- Use the envelope cover sheet (provided with the proposal) as the cover for the proposal envelope.
- Do not rely on overnight services to deliver your proposal prior to 10 AM on letting day. It will not be read if it is delivered after 10 AM.
- Do not submit your Substance Abuse Prevention Program (SAPP) with your bid. If you are awarded the contract this form is to be submitted to the district engineer at the pre-construction conference.

## **BID SUBMITTAL CHECKLIST**

- Cover page** (the sheet that has the item number on it) – This should be the first page of your bid proposal, **followed by your bid (the Schedule of Prices/Pay Items)**. If you are using special software or CBID to generate your schedule of prices, do not include the blank pages of the schedule of prices that came with the proposal package.
- Page 4 (Item 9)** – Check “YES” if you will use a subcontractor(s) with an annual value over \$50,000. Include the subcontractor(s) name, address, general type of work to be performed and the dollar amount. If you will use subcontractor(s) but are uncertain who or the dollar amount; check “YES” but leave the lines blank.
- After page 4** – Insert the following documents: The **Illinois Office Affidavit** (Not applicable to federally funded projects) followed by Cost Adjustments for Steel, Bituminous and Fuel (if applicable) and the Contractor Letter of Assent (if applicable). The general rule should be, if you don’t know where it goes, put it after page 4.
- Page 10 (Paragraph J)** – Check “YES” or “NO” whether your company has any business in Iran.
- Page 10 (Paragraph K)** – (Not applicable to federally funded projects) List the name of the apprenticeship and training program sponsor holding the certificate of registration from the US Department of Labor. If no applicable program exists, please indicate the work/job category. Do not include certificates with your bid. Keep the certificates in your office in case they are requested by IDOT.
- Page 11 (Paragraph L)** – A copy of your State Board of Elections certificate of registration is no longer required with your bid.
- Page 11 (Paragraph M)** – Indicate if your company has hired a lobbyist in connection with the job for which you are submitting the bid proposal.
- Page 12 (Paragraph C)** – This is a work sheet to determine if a completed Form A is required. It is not part of the form and you do not need to make copies for each completed Form A.
- Pages 14-17 (Form A)** – One Form A (4 pages) is required for each applicable person in your company. Copies of the forms can be used and only need to be changed when the information changes. The certification signature and date must be original for each letting. **Do not staple the forms together.** If you answered “NO” to all of the questions in Paragraph C (page 12), complete the first section (page 14) with your company information and then sign and date the Not Applicable statement on page 17.
- Page 18 (Form B)** - If you check “YES” to having other current or pending contracts it is acceptable to use the phrase, “See Affidavit of Availability on file”. **Ownership Certification** (at the bottom of the page) - Check N/A if the Form A(s) you submitted accounts for 100 percent of the company ownership. Check YES if any percentage of ownership falls outside of the parameters that require reporting on the Form A. Checking NO indicates that the Form A(s) you submitted is not correct and you will be required to submit a revised Form A.
- Page 20 (Workforce Projection)** – Be sure to include the Duration of the Project. It is acceptable to use the phrase “Per Contract Specifications”.

**Proposal Bid Bond** – (Insert after the proposal signature page) Submit your proposal Proposal Bid Bond (if applicable) using the current Proposal Bid Bond form provided in the proposal package. The Power of Attorney page should be stapled to the Proposal Bid Bond. If you are using an electronic bond, include your bid bond number on the Proposal Bid Bond and attach the Proof of Insurance printed from the Surety’s Web Site.

**Disadvantaged Business Utilization Plan and/or Good Faith Effort** – The last items in your bid should be the DBE Utilization Plan (SBE 2026), followed by the DBE Participation Statement (SBE 2025) and supporting paperwork. If you have documentation of a Good Faith Effort, it is to follow the SBE Forms.

**The Bid Letting is now available in streaming Audio/Video from the IDOT Web Site.** A link to the stream will be placed on the main page of the current letting on the day of the Letting. The stream will not begin until 10 AM. The actual reading of the bids does not begin until approximately 10:30 AM.

Following the Letting, the As-Read Tabulation of Bids will be posted by the end of the day. You will find the link on the main Web page for the current letting.

**QUESTIONS: pre-letting up to execution of the contract**

Contractor pre-qualification .....	217-782-3413
Small Business, Disadvantaged Business Enterprise (DBE) .....	217-785-4611
Contracts, Bids, Letting process or Internet downloads .....	217-782-7806
Estimates Unit.....	217-785-3483
Aeronautics.....	217-785-8515
IDNR (Land Reclamation, Water Resources, Natural Resources).....	217-782-6302

**QUESTIONS: following contract execution**

Subcontractor documentation, payments .....	217-782-3413
Railroad Insurance .....	217-785-0275

# 24

RETURN WITH BID

Proposal Submitted By
Name
Address
City

## Letting September 19, 2014

### NOTICE TO PROSPECTIVE BIDDERS

This proposal can be used for bidding purposes by only those companies that request and receive written AUTHORIZATION TO BID from IDOT's Central Bureau of Construction.

**BIDDERS NEED NOT RETURN THE ENTIRE PROPOSAL**

# Notice to Bidders, Specifications, Proposal, Contract and Contract Bond



**Illinois Department  
of Transportation**

Springfield, Illinois 62764

**Contract No. 63843  
MCHENRY County  
Section 08-00106-00-FP (Crystal Lake)  
Route FAU 124 (South Main Street)  
Project M-9003(685)  
District 1 Construction Funds**

PLEASE MARK THE APPROPRIATE BOX BELOW:

- A Bid Bond is included.
- A Cashier's Check or a Certified Check is included
- An Annual Bid Bond is included or is on file with IDOT.

Prepared by

Checked by

F

(Printed by authority of the State of Illinois)



**Page intentionally left blank**

RETURN WITH BID



PROPOSAL

TO THE DEPARTMENT OF TRANSPORTATION

1. Proposal of \_\_\_\_\_  
\_\_\_\_\_

Taxpayer Identification Number (Mandatory) \_\_\_\_\_

For the improvement identified and advertised for bids in the Invitation for Bids as:

**Contract No. 63843  
MCHENRY County  
Section 08-00106-00-FP (Crystal Lake)  
Project M-9003(685)  
Route FAU 124 (South Main Street)  
District 1 Construction Funds**

**This project consists of milling, base course widening, binder and surface courses, patching, curb and gutter replacement, sidewalk replacement, storm sewer and drainage structure adjustment, roadway lighting, traffic signal installation, landscaping and striping on South Main Street from US Route 14 to James R. Rakow Road in the City of Crystal Lake.**

2. The undersigned bidder will furnish all labor, material and equipment to complete the above described project in a good and workmanlike manner as provided in the contract documents provided by the Department of Transportation. This proposal will become part of the contract and the terms and conditions contained in the contract documents will govern performance and payments.

**RETURN WITH BID**

3. **ASSURANCE OF EXAMINATION AND INSPECTION/WAIVER.** The undersigned bidder further declares that he/she has carefully examined the proposal, plans, specifications, addenda form of contract and contract bond, and special provisions, and that he/she has inspected in detail the site of the proposed work, and that he/she has familiarized themselves with all of the local conditions affecting the contract and the detailed requirements of construction, and understands that in making this bid proposal he/she waives all right to plead any misunderstanding regarding the same.
  
4. **EXECUTION OF CONTRACT AND CONTRACT BOND.** The undersigned bidder further agrees to execute a contract for this work and present the same to the department within fifteen (15) days after the contract has been mailed to him/her. The undersigned further agrees that he/she and his/her surety will execute and present within fifteen (15) days after the contract has been mailed to him/her contract bond satisfactory to and in the form prescribed by the Department of Transportation, in the penal sum of the full amount of the contract, or as specified in the special provisions, guaranteeing the faithful performance of the work in accordance with the terms of the contract.
  
5. **PROPOSAL GUARANTY.** Accompanying this proposal is either a bid bond on the department form, executed by a corporate surety company satisfactory to the department, or a proposal guaranty check consisting of a bank cashier's check or a properly certified check for not less than 5 per cent of the amount bid or for the amount specified in the following schedule:

<u>Amount of Bid</u>		<u>Proposal Guaranty</u>	<u>Amount of Bid</u>		<u>Proposal Guaranty</u>	
Up to	\$5,000 .....	\$150	\$2,000,000	to	\$3,000,000 .....	\$100,000
\$5,000	to \$10,000 .....	\$300	\$3,000,000	to	\$5,000,000 .....	\$150,000
\$10,000	to \$50,000 .....	\$1,000	\$5,000,000	to	\$7,500,000 .....	\$250,000
\$50,000	to \$100,000 .....	\$3,000	\$7,500,000	to	\$10,000,000 .....	\$400,000
\$100,000	to \$150,000 .....	\$5,000	\$10,000,000	to	\$15,000,000 .....	\$500,000
\$150,000	to \$250,000 .....	\$7,500	\$15,000,000	to	\$20,000,000 .....	\$600,000
\$250,000	to \$500,000 .....	\$12,500	\$20,000,000	to	\$25,000,000 .....	\$700,000
\$500,000	to \$1,000,000 .....	\$25,000	\$25,000,000	to	\$30,000,000 .....	\$800,000
\$1,000,000	to \$1,500,000 .....	\$50,000	\$30,000,000	to	\$35,000,000 .....	\$900,000
\$1,500,000	to \$2,000,000 .....	\$75,000	over		\$35,000,000 .....	\$1,000,000

Bank cashier's checks or properly certified checks accompanying bid proposals will be made payable to the Treasurer, State of Illinois.

If a combination bid is submitted, the proposal guaranties which accompany the individual bid proposals making up the combination will be considered as also covering the combination bid.

The amount of the proposal guaranty check is \_\_\_\_\_ \$( \_\_\_\_\_ ). If this proposal is accepted and the undersigned will fail to execute a contract bond as required herein, it is hereby agreed that the amount of the proposal guaranty will become the property of the State of Illinois, and shall be considered as payment of damages due to delay and other causes suffered by the State because of the failure to execute said contract and contract bond; otherwise, the bid bond will become void or the proposal guaranty check will be returned to the undersigned.

**Attach Cashier's Check or Certified Check Here**

In the event that one proposal guaranty check is intended to cover two or more bid proposals, the amount must be equal to the sum of the proposal guaranties which would be required for each individual bid proposal. If the guaranty check is placed in another bid proposal, state below where it may be found.

The proposal guaranty check will be found in the bid proposal for:

Item \_\_\_\_\_

Section No. \_\_\_\_\_

County \_\_\_\_\_

**Mark the proposal cover sheet as to the type of proposal guaranty submitted.**

**RETURN WITH BID**

6. **COMBINATION BIDS.** The undersigned bidder further agrees that if awarded the contract for the sections contained in the following combination, he/she will perform the work in accordance with the requirements of each individual contract comprising the combination bid specified in the schedule below, and that the combination bid shall be prorated against each section in proportion to the bid submitted for the same. If an error is found to exist in the gross sum bid for one or more of the individual sections included in a combination, the combination bid shall be corrected as provided in the specifications.

**When a combination bid is submitted, the schedule below must be completed in each proposal comprising the combination.**

**If alternate bids are submitted for one or more of the sections comprising the combination, a combination bid must be submitted for each alternate.**

**Schedule of Combination Bids**

Combination No.	Sections Included in Combination	Combination Bid	
		Dollars	Cents

7. **SCHEDULE OF PRICES.** The undersigned bidder submits herewith, in accordance with the rules and instructions, a schedule of prices for the items of work for which bids are sought. The unit prices bid are in U.S. dollars and cents, and all extensions and summations have been made. The bidder understands that the quantities appearing in the bid schedule are approximate and are provided for the purpose of obtaining a gross sum for the comparison of bids. If there is an error in the extension of the unit prices, the unit prices will govern. Payment to the contractor awarded the contract will be made only for actual quantities of work performed and accepted or materials furnished according to the contract. The scheduled quantities of work to be done and materials to be furnished may be increased, decreased or omitted as provided elsewhere in the contract.
8. **AUTHORITY TO DO BUSINESS IN ILLINOIS.** Section 20-43 of the Illinois Procurement Code (the Code) (30 ILCS 500/20-43) provides that a person (other than an individual acting as a sole proprietor) must be a legal entity authorized to do business in the State of Illinois prior to submitting the bid.
9. **EXECUTION OF CONTRACT:** The Department of Transportation will, in accordance with the rules governing Department procurements, execute the contract and shall be the sole entity having the authority to accept performance and make payments under the contract. Execution of the contract by the Chief Procurement Officer (CPO) or the State Purchasing Officer (SPO) is for approval of the procurement process and execution of the contract by the Department. Neither the CPO nor the SPO shall be responsible for administration of the contract or determinations respecting performance or payment there under except as otherwise permitted in the Code.
10. **The services of a subcontractor will be used.**

Check box Yes   
 Check box No

For known subcontractors with subcontracts with an annual value of more than \$50,000, the contract shall include their name, address, general type of work to be performed, and the dollar allocation for each subcontractor.  
 (30 ILCS 500/20-120)

---



---

STATE JOB #- C-91-722-10  
 PPS NBR -

COUNTY NAME	CODE	DIST	SECTION NUMBER	PROJECT NUMBER	ROUTE
MCHENRY	111	01	08-00106-00-FP (CRYSTAL LAKE)	M-9003/685/000	FAU 124

ITEM NUMBER	PAY ITEM DESCRIPTION	UNIT OF MEASURE	QUANTITY	UNIT PRICE		TOTAL PRICE	
				DOLLARS	CENTS	DOLLARS	CTS
A2005016	T-GYMNOCCLA DIO 2	EACH	4.000 X	=	=	=	=
A2008518	T-ULMUS MRTN G TREL M2	EACH	4.000 X	=	=	=	=
B2005716	T-PYRUS C CH TF 2	EACH	5.000 X	=	=	=	=
K0029618	WEED CONT BROADLF TRF	GALLON	10.000 X	=	=	=	=
K1005481	SHRED BARK MULCH 3	SQ YD	724.000 X	=	=	=	=
XX000503	SPLIT RAIL FENCE	FOOT	150.000 X	=	=	=	=
XX002948	TEMPORARY ACCESS WALK	EACH	8.000 X	=	=	=	=
XX006646	TREATMENT STRUCTURES	EACH	1.000 X	=	=	=	=
XX006852	EXPLORATION TRENCH SP	CU YD	140.000 X	=	=	=	=
XX007759	ADJ SAN SEW CLEANOUT	EACH	3.000 X	=	=	=	=
XZ127900	RETAINING WALL REMOV	FOOT	210.000 X	=	=	=	=
X0324585	SAN SEW SERV REM/REPL	EACH	1.000 X	=	=	=	=
X0325714	FL BEACON P MTD SP IN	EACH	2.000 X	=	=	=	=
X0325938	TEMP WIR INTERCON COM	L SUM	1.000 X	=	=	=	=
X0326885	VIDEO DETECT SYS	EACH	1.000 X	=	=	=	=

ITEM NUMBER	PAY ITEM DESCRIPTION	UNIT OF MEASURE	QUANTITY	UNIT PRICE		TOTAL PRICE	
				DOLLARS	CENTS	DOLLARS	CTS
X0327036	BIKE PATH REM	SQ YD	450.000 X	=	=	=	=
X0327698	LED IN IL STNAME SIGN	EACH	8.000 X	=	=	=	=
X3540050	PCC BASE CSE W 10 1/2	SQ YD	1,072.000 X	=	=	=	=
X4022000	TEMP ACCESS- COM ENT	EACH	10.000 X	=	=	=	=
X4023000	TEMP ACCESS- ROAD	EACH	2.000 X	=	=	=	=
X4401198	HMA SURF REM VAR DP	SQ YD	21,846.000 X	=	=	=	=
X5537800	SS CLEANED 12	FOOT	535.000 X	=	=	=	=
X5538000	SS CLEANED 18	FOOT	107.000 X	=	=	=	=
X5538100	SS CLEANED 21	FOOT	7.000 X	=	=	=	=
X5610748	WM LINE STOP 8	EACH	1.000 X	=	=	=	=
X6020096	MH TA 6D W/2 T1FCL RP	EACH	2.000 X	=	=	=	=
X6021660	CB TD 3 DIA W/SPL F&G	EACH	2.000 X	=	=	=	=
X6026050	SANITARY MANHOLE ADJ	EACH	5.000 X	=	=	=	=
X6030310	FR & LIDS ADJUST SPL	EACH	10.000 X	=	=	=	=
X6060052	COMB CC&G TB6.24 SPL	FOOT	1,847.000 X	=	=	=	=

FAU 124  
 08-00106-00-FP (CRYSTAL LAKE)  
 MCHENRY

ILLINOIS DEPARTMENT OF TRANSPORTATION  
 SCHEDULE OF PRICES  
 CONTRACT NUMBER - 63843

ECMS002 DTGECM03 ECMR003 PAGE 3  
 RUN DATE - 08/08/14  
 RUN TIME - 183202

ITEM NUMBER	PAY ITEM DESCRIPTION	UNIT OF MEASURE	QUANTITY	UNIT PRICE		TOTAL PRICE	
				DOLLARS	CENTS	DOLLARS	CTS
X6064200	COMB CC&G TB6.12 SPL	FOOT	2,727.000 X	=	=	=	=
X6640300	CH LK FENCE REMOV	FOOT	819.000 X	=	=	=	=
X7010216	TRAF CONT & PROT SPL	L SUM	1.000 X	=	=	=	=
X7270025	REM EX SIGN SUPPORT	EACH	2.000 X	=	=	=	=
X7280105	TELES STL SIN SUP SPL	FOOT	169.000 X	=	=	=	=
X7810300	REC REF PVT MARKER	EACH	335.000 X	=	=	=	=
X8210425	LUM SL HPS 250W 240V	EACH	26.000 X	=	=	=	=
X8250505	LIGHT CONTROLLER SPL	EACH	1.000 X	=	=	=	=
X8730250	ELCBL C 20 3C TW SH	FOOT	2,730.000 X	=	=	=	=
Z0004538	HMA DRIVEWAY PAVT 10	SQ YD	1,075.000 X	=	=	=	=
Z0013302	SEGMENT CONC BLK WALL	SQ FT	1,232.000 X	=	=	=	=
Z0013798	CONSTRUCTION LAYOUT	L SUM	1.000 X	=	=	=	=
Z0030850	TEMP INFO SIGNING	SQ FT	313.000 X	=	=	=	=
Z0033046	RE-OPTIMIZE SIG SYS 2	EACH	1.000 X	=	=	=	=
Z0051398	REM EX SIGN POST	EACH	2.000 X	=	=	=	=

ITEM NUMBER	PAY ITEM DESCRIPTION	UNIT OF MEASURE	QUANTITY	UNIT PRICE		TOTAL PRICE	
				DOLLARS	CENTS	DOLLARS	CTS
Z0056608	STORM SEW WM REQ 12	FOOT	92.000 X	=	=	=	=
Z0062456	TEMP PAVEMENT	SQ YD	3,346.000 X	=	=	=	=
Z0073510	TEMP TR SIGNAL TIMING	EACH	8.000 X	=	=	=	=
Z0076600	TRAINEES	HOUR	1,500.000 X	=	0.80	=	1,200.00
Z0076604	TRAINEES TPG	HOUR	1,500.000 X	=	15.00	=	22,500.00
20100110	TREE REMOV 6-15	UNIT	254.000 X	=	=	=	=
20100210	TREE REMOV OVER 15	UNIT	66.000 X	=	=	=	=
20101000	TEMPORARY FENCE	FOOT	400.000 X	=	=	=	=
20101200	TREE ROOT PRUNING	EACH	10.000 X	=	=	=	=
20101300	TREE PRUN 1-10	EACH	5.000 X	=	=	=	=
20101350	TREE PRUN OVER 10	EACH	5.000 X	=	=	=	=
20200100	EARTH EXCAVATION	CU YD	8,628.000 X	=	=	=	=
20201200	REM & DISP UNS MATL	CU YD	4,345.000 X	=	=	=	=
20800150	TRENCH BACKFILL	CU YD	6,842.000 X	=	=	=	=
21001000	GEOTECH FAB F/GR STAB	SQ YD	10,000.000 X	=	=	=	=



ITEM NUMBER	PAY ITEM DESCRIPTION	UNIT OF MEASURE	QUANTITY	UNIT PRICE		TOTAL PRICE	
				DOLLARS	CENTS	DOLLARS	CTS
21101615	TOPSOIL F & P 4	SQ YD	9,898.000 X	=			
21101645	TOPSOIL F & P 12	SQ YD	723.000 X	=			
25000400	NITROGEN FERT NUTR	POUND	132.000 X	=			
25000500	PHOSPHORUS FERT NUTR	POUND	132.000 X	=			
25000600	POTASSIUM FERT NUTR	POUND	132.000 X	=			
25000750	MOWING	ACRE	2.000 X	=			
25100635	HD EROS CONTR BLANKET	SQ YD	10,188.000 X	=			
25200110	SODDING SALT TOLERANT	SQ YD	10,188.000 X	=			
25200200	SUPPLE WATERING	UNIT	32.000 X	=			
28000250	TEMP EROS CONTR SEED	POUND	220.000 X	=			
28000400	PERIMETER EROS BAR	FOOT	9,330.000 X	=			
28000500	INLET & PIPE PROTECT	EACH	3.000 X	=			
28000510	INLET FILTERS	EACH	58.000 X	=			
30300001	AGG SUBGRADE IMPROVE	CU YD	2,050.000 X	=			
30300112	AGG SUBGRADE IMPR 12	SQ YD	13,795.000 X	=			

ITEM NUMBER	PAY ITEM DESCRIPTION	UNIT OF MEASURE	QUANTITY	UNIT PRICE		TOTAL PRICE	
				DOLLARS	CENTS	DOLLARS	CTS
31101200	SUB GRAN MAT B 4	SQ YD	2,168.000 X	=	=	=	=
35102100	AGG BASE CSE B 9	SQ YD	399.000 X	=	=	=	=
35600708	HMA BC WID 8	SQ YD	9,350.000 X	=	=	=	=
40600275	BIT MATLS PR CT	POUND	41,486.000 X	=	=	=	=
40600400	MIX CR JTS FLANGEWYS	TON	30.000 X	=	=	=	=
40600895	CONSTRUC TEST STRIP	EACH	2.000 X	=	=	=	=
40600982	HMA SURF REM BUTT JT	SQ YD	177.000 X	=	=	=	=
40603085	HMA BC IL-19.0 N70	TON	8,678.000 X	=	=	=	=
40603335	HMA SC "D" N50	TON	68.000 X	=	=	=	=
40603340	HMA SC "D" N70	TON	3,853.000 X	=	=	=	=
42001300	PROTECTIVE COAT	SQ YD	6,500.000 X	=	=	=	=
42400200	PC CONC SIDEWALK 5	SQ FT	6,875.000 X	=	=	=	=
42400800	DETECTABLE WARNINGS	SQ FT	323.000 X	=	=	=	=
44000100	PAVEMENT REM	SQ YD	5,730.000 X	=	=	=	=
44000157	HMA SURF REM 2	SQ YD	6,881.000 X	=	=	=	=

ITEM NUMBER	PAY ITEM DESCRIPTION	UNIT OF MEASURE	QUANTITY	UNIT PRICE		TOTAL PRICE	
				DOLLARS	CENTS	DOLLARS	CTS
44000165	HMA SURF REM 4	SQ YD	4,825.000 X	=	=	=	=
44000200	DRIVE PAVEMENT REM	SQ YD	2,355.000 X	=	=	=	=
44000500	COMB CURB GUTTER REM	FOOT	10,110.000 X	=	=	=	=
44000600	SIDEWALK REM	SQ FT	4,275.000 X	=	=	=	=
44003100	MEDIAN REMOVAL	SQ FT	1,248.000 X	=	=	=	=
44004250	PAVED SHLD REMOVAL	SQ YD	429.000 X	=	=	=	=
44201737	CL D PATCH T1 8	SQ YD	821.000 X	=	=	=	=
44201741	CL D PATCH T2 8	SQ YD	821.000 X	=	=	=	=
44201745	CL D PATCH T3 8	SQ YD	821.000 X	=	=	=	=
44201747	CL D PATCH T4 8	SQ YD	857.000 X	=	=	=	=
44300200	STRIP REF CR CON TR	FOOT	6,052.000 X	=	=	=	=
550A2320	SS RG CL A 1 12	FOOT	91.000 X	=	=	=	=
550A2520	SS RG CL A 2 12	FOOT	1,809.000 X	=	=	=	=
550A2540	SS RG CL A 2 18	FOOT	40.000 X	=	=	=	=
550A2560	SS RG CL A 2 24	FOOT	16.000 X	=	=	=	=

ITEM NUMBER	PAY ITEM DESCRIPTION	UNIT OF MEASURE	QUANTITY	UNIT PRICE		TOTAL PRICE	
				DOLLARS	CENTS	DOLLARS	CTS
550A2600	SS RG CL A 2 36	FOOT	842.000	X	=	=	=
550A2610	SS RG CL A 2 42	FOOT	1,018.000	X	=	=	=
550A2620	SS RG CL A 2 48	FOOT	1,695.000	X	=	=	=
550A2720	SS RG CL A 3 12	FOOT	32.000	X	=	=	=
550A2800	SS RG CL A 3 36	FOOT	8.000	X	=	=	=
55100500	STORM SEWER REM 12	FOOT	536.000	X	=	=	=
55100900	STORM SEWER REM 18	FOOT	106.000	X	=	=	=
55101200	STORM SEWER REM 24	FOOT	323.000	X	=	=	=
56106500	ADJ WATER MAIN 10	FOOT	30.000	X	=	=	=
56106600	ADJ WATER MAIN 12	FOOT	60.000	X	=	=	=
56300300	ADJ WATER SERV LINES	FOOT	50.000	X	=	=	=
56400100	FIRE HYDNPTS TO BE MVD	EACH	4.000	X	=	=	=
56400500	FIRE HYDNPTS TO BE REM	EACH	1.000	X	=	=	=
56400820	FIRE HYD W/AUX V & VB	EACH	1.000	X	=	=	=
60107600	PIPE UNDERDRAINS 4	FOOT	1,485.000	X	=	=	=

ITEM NUMBER	PAY ITEM DESCRIPTION	UNIT OF MEASURE	QUANTITY	UNIT PRICE		TOTAL PRICE	
				DOLLARS	CENTS	DOLLARS	CTS
60200205	CB TA 4 DIA T1F CL	EACH	1.000 X	=	=	=	=
60201330	CB TA 4 DIA T23F&G	EACH	6.000 X	=	=	=	=
60201340	CB TA 4 DIA T24F&G	EACH	20.000 X	=	=	=	=
60207605	CB TC T8G	EACH	2.000 X	=	=	=	=
60208230	CB TC T23F&G	EACH	1.000 X	=	=	=	=
60208240	CB TC T24F&G	EACH	3.000 X	=	=	=	=
60221100	MAN TA 5 DIA T1F CL	EACH	7.000 X	=	=	=	=
60223800	MAN TA 6 DIA T1F CL	EACH	6.000 X	=	=	=	=
60224446	MAN TA 7 DIA T1F CL	EACH	10.000 X	=	=	=	=
60237460	INLETS TA T23F&G	EACH	7.000 X	=	=	=	=
60237470	INLETS TA T24F&G	EACH	12.000 X	=	=	=	=
60240327	INLETS TB T23F&G	EACH	4.000 X	=	=	=	=
60240328	INLETS TB T24F&G	EACH	2.000 X	=	=	=	=
60250200	CB ADJUST	EACH	7.000 X	=	=	=	=
60252800	CB RECONST	EACH	2.000 X	=	=	=	=

ITEM NUMBER	PAY ITEM DESCRIPTION	UNIT OF MEASURE	QUANTITY	UNIT PRICE		TOTAL PRICE	
				DOLLARS	CENTS	DOLLARS	CTS
60255500	MAN ADJUST	EACH	3.000 X	=			
60255700	MAN ADJ NEW T1F OL	EACH	2.000 X	=			
60257900	MAN RECONST	EACH	2.000 X	=			
60265700	VV ADJUST	EACH	9.000 X	=			
60266100	VV RECONST	EACH	1.000 X	=			
60406100	FR & LIDS T1 CL	EACH	27.000 X	=			
60500040	REMOV MANHOLES	EACH	27.000 X	=			
60500050	REMOV CATCH BAS	EACH	20.000 X	=			
60500060	REMOV INLETS	EACH	24.000 X	=			
60603800	COMB CC&G TB6.12	FOOT	1,919.000 X	=			
60605000	COMB CC&G TB6.24	FOOT	4,676.000 X	=			
60618300	CONC MEDIAN SURF 4	SQ FT	100.000 X	=			
60618740	CONC MED TM2.12	SQ FT	1,821.000 X	=			
66900200	NON SPL WASTE DISPOS	CU YD	100.000 X	=			
66900205	SPL WASTE DISPOSAL	CU YD	625.000 X	=			

ITEM NUMBER	PAY ITEM DESCRIPTION	UNIT OF MEASURE	QUANTITY	UNIT PRICE		TOTAL PRICE	
				DOLLARS	CENTS	DOLLARS	CTS
66900450	SPL WASTE PLNS/REPORT	L SUM	1.000 X	=			
66900530	SOIL DISPOSAL ANALY	EACH	5.000 X	=			
67000400	ENGR FIELD OFFICE A	CAL MO	12.000 X	=			
67100100	MOBILIZATION	L SUM	1.000 X	=			
70106800	CHANGEABLE MESSAGE SN	CAL MO	24.000 X	=			
70300100	SHORT TERM PAVT MKING	FOOT	2,418.000 X	=			
70300210	TEMP PVT MK LTR & SYM	SQ FT	692.000 X	=			
70300220	TEMP PVT MK LINE 4	FOOT	57,833.000 X	=			
70300240	TEMP PVT MK LINE 6	FOOT	4,273.000 X	=			
70300260	TEMP PVT MK LINE 12	FOOT	660.000 X	=			
70300280	TEMP PVT MK LINE 24	FOOT	201.000 X	=			
70301000	WORK ZONE PAVT MK REM	SQ FT	2,300.000 X	=			
72000100	SIGN PANEL T1	SQ FT	172.000 X	=			
72000200	SIGN PANEL T2	SQ FT	30.000 X	=			
72400100	REMOV SIN PAN ASSY TA	EACH	21.000 X	=			

ITEM NUMBER	PAY ITEM DESCRIPTION	UNIT OF MEASURE	QUANTITY	UNIT PRICE		TOTAL PRICE	
				DOLLARS	CENTS	DOLLARS	CTS
72400500	RELOC SIN PAN ASSY TA	EACH	19.000 X	=	=	=	=
72900100	METAL POST TY A	FOOT	351.000 X	=	=	=	=
72900200	METAL POST TY B	FOOT	78.000 X	=	=	=	=
78000100	THPL PVT MK LTR & SYM	SQ FT	988.000 X	=	=	=	=
78000200	THPL PVT MK LINE 4	FOOT	24,712.000 X	=	=	=	=
78000400	THPL PVT MK LINE 6	FOOT	5,296.000 X	=	=	=	=
78000600	THPL PVT MK LINE 12	FOOT	2,040.000 X	=	=	=	=
78000650	THPL PVT MK LINE 24	FOOT	365.000 X	=	=	=	=
78300100	PAVT MARKING REMOVAL	SQ FT	2,667.000 X	=	=	=	=
78300200	RAISED REF PVT MK REM	EACH	50.000 X	=	=	=	=
80400100	ELECT SERV INSTALL	EACH	1.000 X	=	=	=	=
80400200	ELECT UTIL SERV CONN	L SUM	1.000 X	=	=	2,500 00	2,500 00
80500010	SERV INSTALL GRND MT	EACH	2.000 X	=	=	=	=
81028200	UNDRGRD C GALVS 2	FOOT	5,296.000 X	=	=	=	=
81028210	UNDRGRD C GALVS 2 1/2	FOOT	830.000 X	=	=	=	=



ITEM NUMBER	PAY ITEM DESCRIPTION	UNIT OF MEASURE	QUANTITY	UNIT PRICE		TOTAL PRICE	
				DOLLARS	CENTS	DOLLARS	CTS
81028220	UNDRGRD C GALVS 3	FOOT	149.000 X	=	=	=	=
81028240	UNDRGRD C GALVS 4	FOOT	1,049.000 X	=	=	=	=
81400100	HANDHOLE	EACH	14.000 X	=	=	=	=
81400200	HD HANDHOLE	EACH	4.000 X	=	=	=	=
81400300	DBL HANDHOLE	EACH	4.000 X	=	=	=	=
81603051	UD 3#6#8G XLPUSE 1.25	FOOT	3,559.000 X	=	=	=	=
81702130	EC C XLP USE 1C 6	FOOT	4,793.000 X	=	=	=	=
81702400	EC C XLP USE 3-1C 2	FOOT	100.000 X	=	=	=	=
83008600	LT P A 40MH 15MA	EACH	18.000 X	=	=	=	=
83600355	LP F M 15BC 8" X 6'	EACH	18.000 X	=	=	=	=
83800205	BKWY DEV TR B 15BC	EACH	18.000 X	=	=	=	=
84200600	REM LT U NO SALV	EACH	4.000 X	=	=	=	=
84200804	REM POLE FDN	EACH	1.000 X	=	=	=	=
85700200	FAC T4 CAB	EACH	2.000 X	=	=	=	=
86200300	UNINTER POWER SUP EXT	EACH	2.000 X	=	=	=	=

ITEM NUMBER	PAY ITEM DESCRIPTION	UNIT OF MEASURE	QUANTITY	UNIT PRICE		TOTAL PRICE	
				DOLLARS	CENTS	DOLLARS	CTS
86400100	TRANSCEIVER - FIB OPT	EACH	2.000 X	=	=	=	=
87100160	FO CAB C 62.5/125 24F	FOOT	2,100.000 X	=	=	=	=
87300925	ELCBL C TRACER 14 1C	FOOT	2,100.000 X	=	=	=	=
87301215	ELCBL C SIGNAL 14 2C	FOOT	3,619.000 X	=	=	=	=
87301225	ELCBL C SIGNAL 14 3C	FOOT	2,306.000 X	=	=	=	=
87301245	ELCBL C SIGNAL 14 5C	FOOT	3,675.000 X	=	=	=	=
87301255	ELCBL C SIGNAL 14 7C	FOOT	4,795.000 X	=	=	=	=
87301305	ELCBL C LEAD 14 1PR	FOOT	2,708.000 X	=	=	=	=
87301805	ELCBL C SERV 6 2C	FOOT	400.000 X	=	=	=	=
87301900	ELCBL C EGRDC 6 1C	FOOT	2,004.000 X	=	=	=	=
87502500	TS POST GALVS 16	EACH	8.000 X	=	=	=	=
87502520	TS POST GALVS 18	EACH	1.000 X	=	=	=	=
87700150	S MAA & P 22	EACH	2.000 X	=	=	=	=
87702920	STL COMB MAA&P 38	EACH	1.000 X	=	=	=	=
87702930	STL COMB MAA&P 40	EACH	1.000 X	=	=	=	=

ITEM NUMBER	PAY ITEM DESCRIPTION	UNIT OF MEASURE	QUANTITY	UNIT PRICE		TOTAL PRICE	
				DOLLARS	CENTS	DOLLARS	CTS
87702940	STL COMB MAA&P 42	EACH	1.000 X	=	=	=	=
87702950	STL COMB MAA&P 44	EACH	2.000 X	=	=	=	=
87702970	STL COMB MAA&P 48	EACH	3.000 X	=	=	=	=
87800100	CONC FDN TY A	FOOT	36.000 X	=	=	=	=
87800150	CONC FDN TY C	FOOT	8.000 X	=	=	=	=
87800400	CONC FDN TY E 30D	FOOT	20.000 X	=	=	=	=
87800415	CONC FDN TY E 36D	FOOT	108.000 X	=	=	=	=
88030020	SH LED 1F 3S MAM	EACH	12.000 X	=	=	=	=
88030050	SH LED 1F 3S BM	EACH	2.000 X	=	=	=	=
88030100	SH LED 1F 5S BM	EACH	10.000 X	=	=	=	=
88030110	SH LED 1F 5S MAM	EACH	12.000 X	=	=	=	=
88102717	PED SH LED 1F BM CDT	EACH	10.000 X	=	=	=	=
88200210	TS BACKPLATE LOU ALUM	EACH	24.000 X	=	=	=	=
88500100	INDUCTIVE LOOP DETECT	EACH	10.000 X	=	=	=	=
88600100	DET LOOP T1	FOOT	995.000 X	=	=	=	=

ITEM NUMBER	PAY ITEM DESCRIPTION	UNIT OF MEASURE	QUANTITY	UNIT PRICE		TOTAL PRICE	
				DOLLARS	CENTS	DOLLARS	CTS
88700200	LIGHT DETECTOR	EACH	10.000 X	=			
88700300	LIGHT DETECTOR AMP	EACH	2.000 X	=			
88800100	PED PUSH-BUTTON	EACH	10.000 X	=			
89000100	TEMP TR SIG INSTALL	EACH	2.000 X	=			
89500120	REM EX SERV INSTALL	EACH	2.000 X	=			
89502300	REM ELCBL FR CON	FOOT	880.000 X	=			
89502375	REMOV EX TS EQUIP	EACH	2.000 X	=			
89502380	REMOV EX HANDHOLE	EACH	23.000 X	=			
89502382	REMOV EX DBL HANDHOLE	EACH	3.000 X	=			
89502385	REMOV EX CONC FDN	EACH	19.000 X	=			

TOTAL \$

- NOTE:
1. EACH PAY ITEM SHOULD HAVE A UNIT PRICE AND A TOTAL PRICE.
  2. THE UNIT PRICE SHALL GOVERN IF NO TOTAL PRICE IS SHOWN OR IF THERE IS A DISCREPANCY BETWEEN THE PRODUCT OF THE UNIT PRICE MULTIPLIED BY THE QUANTITY.
  3. IF A UNIT PRICE IS OMITTED, THE TOTAL PRICE WILL BE DIVIDED BY THE QUANTITY IN ORDER TO ESTABLISH A UNIT PRICE.
  4. A BID MAY BE DECLARED UNACCEPTABLE IF NEITHER A UNIT PRICE NOR A TOTAL PRICE IS SHOWN.

## RETURN WITH BID

### **STATE REQUIRED ETHICAL STANDARDS GOVERNING CONTRACT PROCUREMENT: ASSURANCES, CERTIFICATIONS AND DISCLOSURES**

#### I. GENERAL

A. Article 50 of the Code establishes the duty of all State CPOs, SPOs, and their designees to maximize the value of the expenditure of public moneys in procuring goods, services, and contracts for the State of Illinois and to act in a manner that maintains the integrity and public trust of State government. In discharging this duty, they are charged by law to use all available information, reasonable efforts, and reasonable actions to protect, safeguard, and maintain the procurement process of the State of Illinois.

B. In order to comply with the provisions of Article 50 and to carry out the duty established therein, all bidders are to adhere to ethical standards established for the procurement process, and to make such assurances, disclosures and certifications required by law. Except as otherwise required in subsection III, paragraphs J-M, by execution of the Proposal Signature Sheet, the bidder indicates that each of the mandated assurances have been read and understood, that each certification is made and understood, and that each disclosure requirement has been understood and completed.

C. In addition to all other remedies provided by law, failure to comply with any assurance, failure to make any disclosure or the making of a false certification shall be grounds for the CPO to void the contract, and may result in the suspension or debarment of the bidder or subcontractor. If a false certification is made by a subcontractor the contractor's submitted bid and the executed contract may not be declared void unless the contractor refuses to terminate the subcontract upon the State's request after a finding that the subcontractor's certification was false.

I acknowledge, understand and accept these terms and conditions.

#### II. ASSURANCES

The assurances hereinafter made by the bidder are each a material representation of fact upon which reliance is placed should the Department enter into the contract with the bidder.

##### A. Conflicts of Interest

Section 50-13. Conflicts of Interest.

(a) Prohibition. It is unlawful for any person holding an elective office in this State, holding a seat in the General Assembly, or appointed to or employed in any of the offices or agencies of state government and who receives compensation for such employment in excess of 60% of the salary of the Governor of the State of Illinois, or who is an officer or employee of the Capital Development Board or the Illinois State Toll Highway Authority, or who is the spouse or minor child of any such person to have or acquire any contract, or any direct pecuniary interest in any contract therein, whether for stationery, printing, paper, or any services, materials, or supplies, that will be wholly or partially satisfied by the payment of funds appropriated by the General Assembly of the State of Illinois or in any contract of the Capital Development Board or the Illinois State Toll Highway Authority.

(b) Interests. It is unlawful for any firm, partnership, association or corporation, in which any person listed in subsection (a) is entitled to receive (i) more than 7 1/2% of the total distributable income or (ii) an amount in excess of the salary of the Governor, to have or acquire any such contract or direct pecuniary interest therein.

(c) Combined interests. It is unlawful for any firm, partnership, association, or corporation, in which any person listed in subsection (a) together with his or her spouse or minor children is entitled to receive (i) more than 15%, in the aggregate, of the total distributable income or (ii) an amount in excess of 2 times the salary of the Governor, to have or acquire any such contract or direct pecuniary interest therein.

(d) Securities. Nothing in this Section invalidates the provisions of any bond or other security previously offered or to be offered for sale or sold by or for the State of Illinois.

(e) Prior interests. This Section does not affect the validity of any contract made between the State and an officer or employee of the State or member of the General Assembly, his or her spouse, minor child or any combination of those persons if that contract was in existence before his or her election or employment as an officer, member, or employee. The contract is voidable, however, if it cannot be completed within 365 days after the officer, member, or employee takes office or is employed.

The current salary of the Governor is \$177,412.00. Sixty percent of the salary is \$106,447.20.

## RETURN WITH BID

The bidder assures the Department that the award and execution of the contract would not cause a violation of Section 50-13, or that an effective exemption has been issued by the Board of Ethics to any individual subject to the Section 50-13 prohibitions pursuant to the provisions of Section 50-20 of the Code. Information concerning the exemption process is available from the Department upon request.

### **B. Negotiations**

Section 50-15. Negotiations.

It is unlawful for any person employed in or on a continual contractual relationship with any of the offices or agencies of State government to participate in contract negotiations on behalf of that office or agency with any firm, partnership, association, or corporation with whom that person has a contract for future employment or is negotiating concerning possible future employment.

The bidder assures the Department that the award and execution of the contract would not cause a violation of Section 50-15, and that the bidder has no knowledge of any facts relevant to the kinds of acts prohibited therein.

### **C. Inducements**

Section 50-25. Inducement.

Any person who offers or pays any money or other valuable thing to any person to induce him or her not to bid for a State contract or as recompense for not having bid on a State contract is guilty of a Class 4 felony. Any person who accepts any money or other valuable thing for not bidding for a State contract or who withholds a bid in consideration of the promise for the payment of money or other valuable thing is guilty of a Class 4 felony.

The bidder assures the Department that the award and execution of the contract would not cause a violation of Section 50-25, and that the bidder has no knowledge of any facts relevant to the kinds of acts prohibited therein.

### **D. Revolving Door Prohibition**

Section 50-30. Revolving door prohibition.

CPOs, SPOs, procurement compliance monitors, their designees whose principal duties are directly related to State procurement, and executive officers confirmed by the Senate are expressly prohibited for a period of 2 years after terminating an affected position from engaging in any procurement activity relating to the State agency most recently employing them in an affected position for a period of at least 6 months. The prohibition includes, but is not limited to: lobbying the procurement process; specifying; bidding; proposing bid, proposal, or contract documents; on their own behalf or on behalf of any firm, partnership, association, or corporation. This Section applies only to persons who terminate an affected position on or after January 15, 1999.

The bidder assures the Department that the award and execution of the contract would not cause a violation of Section 50-30, and that the bidder has no knowledge of any facts relevant to the kinds of acts prohibited therein.

### **E. Reporting Anticompetitive Practices**

Section 50-40. Reporting anticompetitive practices.

When, for any reason, any vendor, bidder, contractor, CPO, SPO, designee, elected official, or State employee suspects collusion or other anticompetitive practice among any bidders, offerors, contractors, proposers, or employees of the State, a notice of the relevant facts shall be transmitted to the Attorney General and the CPO.

The bidder assures the Department that it has not failed to report any relevant facts concerning the practices addressed in Section 50-40 which may involve the contract for which the bid is submitted.

### **F. Confidentiality**

Section 50-45. Confidentiality.

Any CPO, SPO, designee, or executive officer who willfully uses or allows the use of specifications, competitive bid documents, proprietary competitive information, proposals, contracts, or selection information to compromise the fairness or integrity of the procurement, bidding, or contract process shall be subject to immediate dismissal, regardless of the Personnel code, any contract, or any collective bargaining agreement, and may in addition be subject to criminal prosecution.

The bidder assures the Department that it has no knowledge of any fact relevant to the practices addressed in Section 50-45 which may involve the contract for which the bid is submitted.

## RETURN WITH BID

### G. Insider Information

Section 50-50. Insider information.

It is unlawful for any current or former elected or appointed State official or State employee to knowingly use confidential information available only by virtue of that office or employment for actual or anticipated gain for themselves or another person.

The bidder assures the Department that it has no knowledge of any facts relevant to the practices addressed in Section 50-50 which may involve the contract for which the bid is submitted.

I acknowledge, understand and accept these terms and conditions for the above assurances.

### III. CERTIFICATIONS

The certifications hereinafter made by the bidder are each a material representation of fact upon which reliance is placed should the Department enter into the contract with the bidder. Section 50-2 of the Code provides that every person that has entered into a multi-year contract and every subcontractor with a multi-year subcontract shall certify, by July 1 of each fiscal year covered by the contract after the initial fiscal year, to the responsible CPO whether it continues to satisfy the requirements of Article 50 pertaining to the eligibility for a contract award. If a contractor or subcontractor is not able to truthfully certify that it continues to meet all requirements, it shall provide with its certification a detailed explanation of the circumstances leading to the change in certification status. A contractor or subcontractor that makes a false statement material to any given certification required under Article 50 is, in addition to any other penalties or consequences prescribed by law, subject to liability under the Whistleblower Reward and Protection Act for submission of a false claim.

#### A. Bribery

Section 50-5. Bribery.

(a) Prohibition. No person or business shall be awarded a contract or subcontract under this Code who:

(1) has been convicted under the laws of Illinois or any other state of bribery or attempting to bribe an officer or employee of the State of Illinois or any other state in that officer's or employee's official capacity; or

(2) has made an admission of guilt of that conduct that is a matter of record but has not been prosecuted for that conduct.

(b) Businesses. No business shall be barred from contracting with any unit of State or local government, or subcontracting under such a contract, as a result of a conviction under this Section of any employee or agent of the business if the employee or agent is no longer employed by the business and:

(1) the business has been finally adjudicated not guilty; or

(2) the business demonstrates to the governmental entity with which it seeks to contract, or which is signatory to the contract which the subcontract relates, and that entity finds that the commission of the offense was not authorized, requested, commanded, or performed by a director, officer, or high managerial agent on behalf of the business as provided in paragraph (2) of subsection (a) of Section 5-4 of the Criminal Code of 2012.

(c) Conduct on behalf of business. For purposes of this Section, when an official, agent, or employee of a business committed the bribery or attempted bribery on behalf of the business and in accordance with the direction or authorization of a responsible official of the business, the business shall be chargeable with the conduct.

(d) Certification. Every bid submitted to and contract executed by the State, and every subcontract subject to Section 20-120 of the Code shall contain a certification by the contractor or the subcontractor, respectively, that the contractor or subcontractor is not barred from being awarded a contract or subcontract under this Section and acknowledges that the CPO may declare the related contract void if any certifications required by this Section are false. A contractor who makes a false statement, material to the certification, commits a Class 3 felony.

The contractor or subcontractor certifies that it is not barred from being awarded a contract under Section 50.5.

#### B. Felons

Section 50-10. Felons.

(a) Unless otherwise provided, no person or business convicted of a felony shall do business with the State of Illinois or any State agency, or enter into a subcontract, from the date of conviction until 5 years after the date of completion of the sentence for that felony, unless no person held responsible by a prosecutorial office for the facts upon which the conviction was based continues to have any involvement with the business.

(b) Certification. Every bid submitted to and contract executed by the State and every subcontract subject to Section 20-120 of the Code shall contain a certification by the bidder or contractor or subcontractor, respectively, that the bidder, contractor, or subcontractor is not barred from being awarded a contract or subcontract under this Section and acknowledges that the CPO may declare the related contract void if any of the certifications required by this Section are false.

## RETURN WITH BID

### **C. Debt Delinquency**

Section 50-11 and 50-12. Debt Delinquency.

The contractor or bidder or subcontractor, respectively, certifies that it, or any affiliate, is not barred from being awarded a contract or subcontract under the Code. Section 50-11 prohibits a person from entering into a contract with a State agency, or entering into a subcontract, if it knows or should know that it, or any affiliate, is delinquent in the payment of any debt to the State as defined by the Debt Collection Board. Section 50-12 prohibits a person from entering into a contract with a State agency, or entering into a subcontract, if it, or any affiliate, has failed to collect and remit Illinois Use Tax on all sales of tangible personal property into the State of Illinois in accordance with the provisions of the Illinois Use Tax Act. The bidder or contractor or subcontractor, respectively, further acknowledges that the CPO may declare the related contract void if this certification is false or if the bidder, contractor, or subcontractor, or any affiliate, is determined to be delinquent in the payment of any debt to the State during the term of the contract.

### **D. Prohibited Bidders, Contractors and Subcontractors**

Section 50-10.5 and 50-60(c). Prohibited bidders, contractors and subcontractors.

The bidder or contractor or subcontractor, respectively, certifies in accordance with 30 ILCS 500/50-10.5 that no officer, director, partner or other managerial agent of the contracting business has been convicted of a felony under the Sarbanes-Oxley Act of 2002 or a Class 3 or Class 2 felony under the Illinois Securities Law of 1953 or if in violation of Subsection (c) for a period of five years from the date of conviction. Every bid submitted to and contract executed by the State and every subcontract subject to Section 20-120 of the Code shall contain a certification by the bidder, contractor, or subcontractor, respectively, that the bidder, contractor, or subcontractor is not barred from being awarded a contract or subcontract under this Section and acknowledges that the CPO shall declare the related contract void if any of the certifications completed pursuant to this Section are false.

### **E. Section 42 of the Environmental Protection Act**

The bidder or contractor or subcontractor, respectively, certifies in accordance with 30 ILCS 500/50-14 that the bidder, contractor, or subcontractor, is not barred from being awarded a contract or entering into a subcontract under this Section which prohibits the bidding on or entering into contracts with the State of Illinois or a State agency, or entering into any subcontract, that is subject to the Code by a person or business found by a court or the Pollution Control Board to have committed a willful or knowing violation of Section 42 of the Environmental Protection Act for a period of five years from the date of the order. The bidder or contractor or subcontractor, respectively, acknowledges that the CPO may declare the contract void if this certification is false.

### **F. Educational Loan**

Section 3 of the Educational Loan Default Act provides no State agency shall contract with an individual for goods or services if that individual is in default, as defined in Section 2 of this Act, on an educational loan. Any contract used by any State agency shall include a statement certifying that the individual is not in default on an educational loan as provided in this Section.

The bidder, if an individual as opposed to a corporation, partnership or other form of business organization, certifies that the bidder is not in default on an educational loan as provided in Section 3 of the Act.

### **G. Bid-Rigging/Bid Rotating**

Section 33E-11 of the Criminal Code of 2012 provides:

(a) Every bid submitted to and public contract executed pursuant to such bid by the State or a unit of local government shall contain a certification by the prime contractor that the prime contractor is not barred from contracting with any unit of State or local government as a result of a violation of either Section 33E-3 or 33E-4 of this Article.

(b) A contractor who makes a false statement, material to the certification, commits a Class 3 felony.

A violation of Section 33E-3 would be represented by a conviction of the crime of bid-rigging which, in addition to Class 3 felony sentencing, provides that any person convicted of this offense or any similar offense of any state or the United States which contains the same elements as this offense shall be barred for 5 years from the date of conviction from contracting with any unit of State or local government. No corporation shall be barred from contracting with any unit of State or local government as a result of a conviction under this Section of any employee or agent of such corporation if the employee so convicted is no longer employed by the corporation and: (1) it has been finally adjudicated not guilty or (2) if it demonstrates to the governmental entity with which it seeks to contract and that entity finds that the commission of the offense was neither authorized, requested, commanded, nor performed by a director, officer or a high managerial agent in behalf of the corporation.



## RETURN WITH BID

A violation of Section 33E-4 would be represented by a conviction of the crime of bid-rotating which, in addition to Class 2 felony sentencing, provides that any person convicted of this offense or any similar offense of any state or the United States which contains the same elements as this offense shall be permanently barred from contracting with any unit of State or local government. No corporation shall be barred from contracting with any unit of State or local government as a result of a conviction under this Section of any employee or agent of such corporation if the employee so convicted is no longer employed by the corporation and: (1) it has been finally adjudicated not guilty or (2) if it demonstrates to the governmental entity with which it seeks to contract and that entity finds that the commission of the offense was neither authorized, requested, commanded, nor performed by a director, officer or a high managerial agent in behalf of the corporation.

The bidder certifies that it is not barred from contracting with the Department by reason of a violation of either Section 33E-3 or Section 33E-4.

### **H. International Anti-Boycott**

Section 5 of the International Anti-Boycott Certification Act provides every contract entered into by the State of Illinois for the manufacture, furnishing, or purchasing of supplies, material, or equipment or for the furnishing of work, labor, or services, in an amount exceeding the threshold for small purchases according to the purchasing laws of this State or \$10,000.00, whichever is less, shall contain certification, as a material condition of the contract, by which the contractor agrees that neither the contractor nor any substantially-owned affiliated company is participating or shall participate in an international boycott in violation of the provisions of the U.S. Export Administration Act of 1979 or the regulations of the U.S. Department of Commerce promulgated under that Act.

The bidder makes the certification set forth in Section 5 of the Act.

### **I. Drug Free Workplace**

The Illinois "Drug Free Workplace Act" applies to this contract and it is necessary to comply with the provisions of the "Act" if the contractor is a corporation, partnership, or other entity (including a sole proprietorship) which has 25 or more employees.

The bidder certifies that if awarded a contract in excess of \$5,000 it will provide a drug free workplace in compliance with the provisions of the Act.

### **J. Disclosure of Business Operations in Iran**

Section 50-36 of the Code, 30ILCS 500/50-36 provides that each bid, offer, or proposal submitted for a State contract shall include a disclosure of whether or not the Company acting as the bidder, offeror, or proposing entity, or any of its corporate parents or subsidiaries, within the 24 months before submission of the bid, offer, or proposal had business operations that involved contracts with or provision of supplies or services to the Government of Iran, companies in which the Government of Iran has any direct or indirect equity share, consortiums or projects commissioned by the Government of Iran, or companies involved in consortiums or projects commissioned by the Government of Iran and either of the following conditions apply:

- (1) More than 10% of the Company's revenues produced in or assets located in Iran involve oil-related activities or mineral-extraction activities; less than 75% of the Company's revenues produced in or assets located in Iran involve contracts with or provision of oil-related or mineral-extraction products or services to the Government of Iran or a project or consortium created exclusively by that government; and the Company has failed to take substantial action.
- (2) The Company has, on or after August 5, 1996, made an investment of \$20 million or more, or any combination of investments of at least \$10 million each that in the aggregate equals or exceeds \$20 million in any 12-month period, which directly or significantly contributes to the enhancement of Iran's ability to develop petroleum resources of Iran.

The terms "Business operations", "Company", "Mineral-extraction activities", "Oil-related activities", "Petroleum resources", and "Substantial action" are all defined in the Code.

Failure to make the disclosure required by the Code shall cause the bid, offer or proposal to be considered not responsive. The disclosure will be considered when evaluating the bid or awarding the contract. The name of each Company disclosed as doing business or having done business in Iran will be provided to the State Comptroller.

Check the appropriate statement:

Company has no business operations in Iran to disclose.

Company has business operations in Iran as disclosed the attached document.

## RETURN WITH BID

### **K. Apprenticeship and Training Certification (Does not apply to federal aid projects)**

In accordance with the provisions of Section 30-22 (6) of the Code, the bidder certifies that it is a participant, either as an individual or as part of a group program, in the approved apprenticeship and training programs applicable to each type of work or craft that the bidder will perform with its own forces. The bidder further certifies for work that will be performed by subcontract that each of its subcontractors submitted for approval either (a) is, at the time of such bid, participating in an approved, applicable apprenticeship and training program; or (b) will, prior to commencement of performance of work pursuant to this contract, begin participation in an approved apprenticeship and training program applicable to the work of the subcontract. The Department, at any time before or after award, may require the production of a copy of each applicable Certificate of Registration issued by the United States Department of Labor evidencing such participation by the contractor and any or all of its subcontractors. Applicable apprenticeship and training programs are those that have been approved and registered with the United States Department of Labor. The bidder shall list in the space below, the official name of the program sponsor holding the Certificate of Registration for all of the types of work or crafts in which the bidder is a participant and that will be performed with the bidder's forces. Types of work or craft work that will be subcontracted shall be included and listed as subcontract work. The list shall also indicate any type of work or craft job category that does not have an applicable apprenticeship or training program. **The bidder is responsible for making a complete report and shall make certain that each type of work or craft job category that will be utilized on the project as reported on the Construction Employee Workforce Projection (Form BC-1256) and returned with the bid is accounted for and listed.**

**NA-FEDERAL**

---

---

---

The requirements of this certification and disclosure are a material part of the contract, and the contractor shall require this certification provision to be included in all approved subcontracts. In order to fulfill this requirement, it shall not be necessary that an applicable program sponsor be currently taking or that it will take applications for apprenticeship, training or employment during the performance of the work of this contract.

**RETURN WITH BID**

**L. Political Contributions and Registration with the State Board of Elections**

Sections 20-160 and 50-37 of the Code regulate political contributions from business entities and any affiliated entities or affiliated persons bidding on or contracting with the state. Generally under Section 50-37, any business entity, and any affiliated entity or affiliated person of the business entity, whose current year contracts with all state agencies exceed an awarded value of \$50,000, are prohibited from making any contributions to any political committees established to promote the candidacy of the officeholder responsible for the awarding of the contracts or any other declared candidate for that office for the duration of the term of office of the incumbent officeholder or a period 2 years after the termination of the contract, whichever is longer. Any business entity and affiliated entities or affiliated persons whose state contracts in the current year do not exceed an awarded value of \$50,000, but whose aggregate pending bids and proposals on state contracts exceed \$50,000, either alone or in combination with contracts not exceeding \$50,000, are prohibited from making any political contributions to any political committee established to promote the candidacy of the officeholder responsible for awarding the pending contract during the period beginning on the date the invitation for bids or request for proposals is issued and ending on the day after the date of award or selection if the entity was not awarded or selected. Section 20-160 requires certification of registration of affected business entities in accordance with procedures found in Section 9-35 of The Election Code.

By submission of a bid, the contractor business entity acknowledges and agrees that it has read and understands Sections 20-160 and 50-37 of the Code, and that it makes the following certification:

**The undersigned bidder certifies that it has registered as a business with the State Board of Elections and acknowledges a continuing duty to update the registration in accordance with the above referenced statutes. If the business entity is required to register, the CPO shall verify that it is in compliance on the date the bid or proposal is due. The CPO shall not accept a bid or proposal if the business entity is not in compliance with the registration requirements.**

These requirements and compliance with the above referenced statutory sections are a material part of the contract, and any breach thereof shall be cause to void the contract under Section 50-60 of the Code. This provision does not apply to Federal-aid contracts.

**M. Lobbyist Disclosure**

Section 50-38 of the Code requires that any bidder or offeror on a State contract that hires a person required to register under the Lobbyist Registration Act to assist in obtaining a contract shall:

- (i) Disclose all costs, fees, compensation, reimbursements, and other remunerations paid or to be paid to the lobbyist related to the contract,
- (ii) Not bill or otherwise cause the State of Illinois to pay for any of the lobbyist's costs, fees, compensation, reimbursements, or other remuneration, and
- (iii) Sign a verification certifying that none of the lobbyist's costs, fees, compensation, reimbursements, or other remuneration were billed to the State.

This information, along with all supporting documents, shall be filed with the agency awarding the contract and with the Secretary of State. The CPO shall post this information, together with the contract award notice, in the online Procurement Bulletin.

Pursuant to Subsection (c) of this Section, no person or entity shall retain a person or entity to attempt to influence the outcome of a procurement decision made under the Code for compensation contingent in whole or in part upon the decision or procurement. Any person who violates this subsection is guilty of a business offense and shall be fined not more than \$10,000.

Bidder acknowledges that it is required to disclose the hiring of any person required to register pursuant to the Illinois Lobbyist Registration Act (25 ILCS 170) in connection with this contract.

Bidder has not hired any person required to register pursuant to the Illinois Lobbyist Registration Act in connection with this contract.

Or

Bidder has hired the following persons required to register pursuant to the Illinois Lobbyist Registration Act in connection with the contract:

Name and address of person: \_\_\_\_\_  
All costs, fees, compensation, reimbursements and other remuneration paid to said person: \_\_\_\_\_  
\_\_\_\_\_  
\_\_\_\_\_

I acknowledge, understand and accept these terms and conditions for the above certifications.

## RETURN WITH BID

### IV. DISCLOSURES

- A. The disclosures hereinafter made by the bidder are each a material representation of fact upon which reliance is placed should the Department enter into the contract with the bidder. The bidder further certifies that the Department has received the disclosure forms for each bid.

The CPO may void the bid, or contract, respectively, if it is later determined that the bidder or subcontractor rendered a false or erroneous disclosure. A contractor or subcontractor may be suspended or debarred for violations of the Code. Furthermore, the CPO may void the contract and the surety providing the performance bond shall be responsible for completion of the contract.

### B. Financial Interests and Conflicts of Interest

1. Section 50-35 of the Code provides that all bids of more than \$25,000 shall be accompanied by disclosure of the financial interests of the bidder. This disclosed information for the successful bidder, will be maintained as public information subject to release by request pursuant to the Freedom of Information Act, filed with the Procurement Policy Board, and shall be incorporated as a material term of the contract. Furthermore, pursuant to Section 5-5, the Procurement Policy Board may review a proposal, bid, or contract and issue a recommendation to void a contract or reject a proposal or bid based on any violation of the Code or the existence of a conflict of interest as provided in subsections (b) and (d) of Section 50-35.

The financial interests to be disclosed shall include ownership or distributive income share that is in excess of 5%, or an amount greater than 60% of the annual salary of the Governor, of the bidding entity or its parent entity, whichever is less, unless the contractor or bidder is a publicly traded entity subject to Federal 10K reporting, in which case it may submit its 10K disclosure in place of the prescribed disclosure. If a bidder is a privately held entity that is exempt from Federal 10K reporting, but has more than 200 shareholders, it may submit the information that Federal 10K companies are required to report, and list the names of any person or entity holding any ownership share that is in excess of 5%. The disclosure shall include the names, addresses, and dollar or proportionate share of ownership of each person making the disclosure, their instrument of ownership or beneficial relationship, and notice of any potential conflict of interest resulting from the current ownership or beneficial interest of each person making the disclosure having any of the relationships identified in Section 50-35 and on the disclosure form.  
**The current annual salary of the Governor is \$177,412.00.**

In addition, all disclosures shall indicate any other current or pending contracts, proposals, leases, or other ongoing procurement relationships the bidding entity has with any other unit of state government and shall clearly identify the unit and the contract, proposal, lease, or other relationship.

2. Disclosure Forms. Disclosure Form A is attached for use concerning the individuals meeting the above ownership or distributive share requirements. A separate Disclosure Form A must be submitted with the bid for each individual meeting the above requirements. In addition, a second form (Disclosure Form B) provides for the disclosure of current or pending procurement relationships with other (non-IDOT) state agencies and a total ownership certification. **The forms must be included with each bid.**

### C. Disclosure Form Instructions

#### Form A Instructions for Financial Information & Potential Conflicts of Interest

If the bidder is a publicly traded entity subject to Federal 10K reporting, the 10K Report may be submitted to meet the requirements of Form A. If a bidder is a privately held entity that is exempt from Federal 10K reporting, but has more than 200 shareholders, it may submit the information that Federal 10K companies are required to report, and list the names of any person or entity holding any ownership share that is in excess of 5%. If a bidder is not subject to Federal 10K reporting, the bidder must determine if any individuals are required by law to complete a financial disclosure form. To do this, the bidder should answer each of the following questions. A "YES" answer indicates Form A must be completed. If the answer to each of the following questions is "NO", then the NOT APPLICABLE STATEMENT on Form A must be signed and dated by a person that is authorized to execute contracts for the bidding company. Note: These questions are for assistance only and are not required to be completed.

1. Does anyone in your organization have a direct or beneficial ownership share of greater than 5% of the bidding entity or parent entity? YES \_\_\_ NO \_\_\_
2. Does anyone in your organization have a direct or beneficial ownership share of less than 5%, but which has a value greater than 60% of the annual salary of the Governor? YES \_\_\_ NO \_\_\_
3. Does anyone in your organization receive more than 60% of the annual salary of the Governor of the bidding entity's or parent entity's distributive income? YES \_\_\_ NO \_\_\_
4. Does anyone in your organization receive greater than 5% of the bidding entity's or parent entity's total distributive income, but which is less than 60% of the annual salary of the Governor? YES \_\_\_ NO \_\_\_

(Note: Only one set of forms needs to be completed per person per bid even if a specific individual would require a yes answer to more than one question.)

A "YES" answer to any of these questions requires the completion of Form A. The bidder must determine each individual in the bidding entity or the bidding entity's parent company that would cause the questions to be answered "Yes". Each form must be signed and dated by a person that is authorized to execute contracts for your organization. **Photocopied or stamped signatures are not acceptable.** The person signing can be, but does not have to be, the person for which the form is being completed. The bidder is responsible for the accuracy of any information provided.

If the answer to each of the above questions is "NO", then the NOT APPLICABLE STATEMENT of Form A must be signed and dated by a person that is authorized to execute contracts for your company.

## RETURN WITH BID

### **Form B: Instructions for Identifying Other Contracts & Procurement Related Information**

Disclosure Form B must be completed for each bid submitted by the bidding entity. *Note: Checking the NOT APPLICABLE STATEMENT on Form A does not allow the bidder to ignore Form B. Form B must be completed, checked, and dated or the bidder may be considered nonresponsive and the bid will not be accepted.*

The Bidder shall identify, by checking Yes or No on Form B, whether it has any pending contracts (including leases), bids, proposals, or other ongoing procurement relationship with any other (non-IDOT) State of Illinois agency. If "No" is checked, the bidder only needs to complete the check box on the bottom of Form B. If "Yes" is checked, the bidder must do one of the following:

Option I: If the bidder did not submit an Affidavit of Availability to obtain authorization to bid, the bidder must list all non-IDOT State of Illinois agency pending contracts, leases, bids, proposals, and other ongoing procurement relationships. These items may be listed on Form B or on an attached sheet(s). Do not include IDOT contracts. Contracts with cities, counties, villages, etc. are not considered State of Illinois agency contracts and are not to be included. Contracts with other State of Illinois agencies such as the Department of Natural Resources or the Capital Development Board must be included. Bidders who submit Affidavits of Availability are suggested to use Option II.

Option II: If the bidder is required and has submitted an Affidavit of Availability in order to obtain authorization to bid, the bidder may write or type "See Affidavit of Availability" which indicates that the Affidavit of Availability is incorporated by reference and includes all non-IDOT State of Illinois agency pending contracts, leases, bids, proposals, and other ongoing procurement relationships. For any contracts that are not covered by the Affidavit of Availability, the bidder must identify them on Form B or on an attached sheet(s). These might be such things as leases.

RETURN WITH BID

ILLINOIS DEPARTMENT OF TRANSPORTATION

Form A Financial Information & Potential Conflicts of Interest Disclosure

Contractor Name, Legal Address, City, State, Zip, Telephone Number, Email Address, Fax Number (if available)

Disclosure of the information contained in this Form is required by the Section 50-35 of the Code (30 ILCS 500). Vendors desiring to enter into a contract with the State of Illinois must disclose the financial information and potential conflict of interest information as specified in this Disclosure Form. This information shall become part of the publicly available contract file. This Form A must be completed for bids in excess of \$25,000, and for all open-ended contracts. A publicly traded company may submit a 10K disclosure (or equivalent if applicable) in satisfaction of the requirements set forth in Form A. See Disclosure Form Instructions.

The current annual salary of the Governor is \$177,412.00.

DISCLOSURE OF FINANCIAL INFORMATION

- 1. Disclosure of Financial Information. The individual named below has an interest in the BIDDER (or its parent) in terms of ownership or distributive income share in excess of 5%, or an interest which has a value of more than 60% of the annual salary of the Governor. (Make copies of this form as necessary and attach a separate Disclosure Form A for each individual meeting these requirements)

FOR INDIVIDUAL (type or print information) NAME: ADDRESS Type of ownership/distributable income share: stock sole proprietorship Partnership other: (explain on separate sheet): % or \$ value of ownership/distributable income share:

- 2. Disclosure of Potential Conflicts of Interest. Check "Yes" or "No" to indicate which, if any, of the following potential conflict of interest relationships apply. If the answer to any question is "Yes", please attach additional pages and describe.

(a) State employment, currently or in the previous 3 years, including contractual employment of services. Yes \_\_\_ No \_\_\_

If your answer is yes, please answer each of the following questions.

- 1. Are you currently an officer or employee of either the Capitol Development Board or the Illinois State Toll Highway Authority? Yes \_\_\_ No \_\_\_
2. Are you currently appointed to or employed by any agency of the State of Illinois? If you are currently appointed to or employed by any agency of the State of Illinois, and your annual salary exceeds 60% of the annual salary of the Governor provide the name the State agency for which you are employed and your annual salary.

**RETURN WITH BID**

3. If you are currently appointed to or employed by any agency of the State of Illinois, and your annual salary exceeds 60% of the annual salary of the Governor, are you entitled to receive (i) more than 7 1/2% of the total distributable income of your firm, partnership, association or corporation, or (ii) an amount in excess of 100% of the annual salary of the Governor? Yes \_\_\_ No \_\_\_
4. If you are currently appointed to or employed by any agency of the State of Illinois, and your annual salary exceeds 60% of the annual salary of the Governor, are you and your spouse or minor children entitled to receive (i) more than 15% in aggregate of the total distributable income of your firm, partnership, association or corporation, or (ii) an amount in excess of two times the salary of the Governor? Yes \_\_\_ No \_\_\_

---

(b) State employment of spouse, father, mother, son, or daughter, including contractual employment for services in the previous 2 years.

Yes \_\_\_ No \_\_\_

If your answer is yes, please answer each of the following questions.

1. Is your spouse or any minor children currently an officer or employee of the Capitol Development Board or the Illinois State Toll Highway Authority? Yes \_\_\_ No \_\_\_
2. Is your spouse or any minor children currently appointed to or employed by any agency of the State of Illinois? If your spouse or minor children is/are currently appointed to or employed by any agency of the State of Illinois, and his/her annual salary exceeds 60% of the annual salary of the Governor, provide the name of the spouse and/or minor children, the name of the State agency for which he/she is employed and his/her annual salary. \_\_\_\_\_
- 
3. If your spouse or any minor children is/are currently appointed to or employed by any agency of the State of Illinois, and his/her annual salary exceeds 60% of the annual salary of the Governor, are you entitled to receive (i) more than 7 1/2% of the total distributable income of your firm, partnership, association or corporation, or (ii) an amount in excess 100% of the annual salary of the Governor? Yes \_\_\_ No \_\_\_
4. If your spouse or any minor children are currently appointed to or employed by any agency of the State of Illinois, and his/her annual salary exceeds 60% of the annual salary of the Governor, are you and your spouse or any minor children entitled to receive (i) more than 15% in the aggregate of the total distributable income from your firm, partnership, association or corporation, or (ii) an amount in excess of two times the salary of the Governor? Yes \_\_\_ No \_\_\_

---

(c) Elective status; the holding of elective office of the State of Illinois, the government of the United States, any unit of local government authorized by the Constitution of the State of Illinois or the statutes of the State of Illinois currently or in the previous 3 years. Yes \_\_\_ No \_\_\_

---

(d) Relationship to anyone holding elective office currently or in the previous 2 years; spouse, father, mother, son, or daughter. Yes \_\_\_ No \_\_\_

---

(e) Appointive office; the holding of any appointive government office of the State of Illinois, the United State of America, or any unit of local government authorized by the Constitution of the State of Illinois or the statutes of the State of Illinois, which office entitles the holder to compensation in excess of the expenses incurred in the discharge of that office currently or in the previous 3 years. Yes \_\_\_ No \_\_\_

---

(f) Relationship to anyone holding appointive office currently or in the previous 2 years; spouse, father, mother, son, or daughter. Yes \_\_\_ No \_\_\_

---

(g) Employment, currently or in the previous 3 years, as or by any registered lobbyist of the State government. Yes \_\_\_ No \_\_\_

---

**RETURN WITH BID**

(h) Relationship to anyone who is or was a registered lobbyist in the previous 2 years; spouse, father, mother, son, or daughter. Yes \_\_\_ No \_\_\_

---

(i) Compensated employment, currently or in the previous 3 years, by any registered election or reelection committee registered with the Secretary of State or any county clerk of the State of Illinois, or any political action committee registered with either the Secretary of State or the Federal Board of Elections. Yes \_\_\_ No \_\_\_

---

(j) Relationship to anyone; spouse, father, mother, son, or daughter; who was a compensated employee in the last 2 years by any registered election or re-election committee registered with the Secretary of State or any county clerk of the State of Illinois, or any political action committee registered with either the Secretary of State or the Federal Board of Elections. Yes \_\_\_ No \_\_\_

---

**3. Communication Disclosure.**

Disclose the name and address of each lobbyist and other agent of the bidder or offeror who is not identified in Section 2 of this form, who is has communicated, is communicating, or may communicate with any State officer or employee concerning the bid or offer. This disclosure is a continuing obligation and must be promptly supplemented for accuracy throughout the process and throughout the term of the contract. If no person is identified, enter "None" on the line below:

Name and address of person(s): \_\_\_\_\_  
\_\_\_\_\_  
\_\_\_\_\_  
\_\_\_\_\_



**RETURN WITH BID**

**4. Debarment Disclosure.** For each of the persons identified under Sections 2 and 3 of this form, disclose whether any of the following has occurred within the previous 10 years: debarment from contracting with any governmental entity; professional licensure discipline; bankruptcies; adverse civil judgments and administrative findings; and criminal felony convictions. This disclosure is a continuing obligation and must be promptly supplemented for accuracy throughout the procurement process and term of the contract. If no person is identified, enter "None" on the line below:

Name of person(s): \_\_\_\_\_

Nature of disclosure: \_\_\_\_\_  
\_\_\_\_\_  
\_\_\_\_\_

**APPLICABLE STATEMENT**

**This Disclosure Form A is submitted on behalf of the INDIVIDUAL named on previous page. Under penalty of perjury, I certify the contents of this disclosure to be true and accurate to the best of my knowledge.**

Completed by:  \_\_\_\_\_ Date \_\_\_\_\_  
Signature of Individual or Authorized Representative

**NOT APPLICABLE STATEMENT**

**Under penalty of perjury, I have determined that no individuals associated with this organization meet the criteria that would require the completion of this Form A.**

**This Disclosure Form A is submitted on behalf of the CONTRACTOR listed on the previous page.**

\_\_\_\_\_ Date \_\_\_\_\_  
Signature of Authorized Representative

The bidder has a continuing obligation to supplement these disclosures under Sec. 50-35 of the Code.

RETURN WITH BID

ILLINOIS DEPARTMENT OF TRANSPORTATION

Form B Other Contracts & Financial Related Information Disclosure

Contractor Name
Legal Address
City, State, Zip
Telephone Number Email Address Fax Number (if available)

Disclosure of the information contained in this Form is required by the Section 50-35 of the Code (30 ILCS 500). This information shall become part of the publicly available contract file. This Form B must be completed for bids in excess of \$25,000, and for all open-ended contracts.

DISCLOSURE OF OTHER CONTRACTS AND PROCUREMENT RELATED INFORMATION

1. Identifying Other Contracts & Procurement Related Information. The BIDDER shall identify whether it has any pending contracts (including leases), bids, proposals, or other ongoing procurement relationship with any other State of Illinois agency: Yes \_\_\_ No \_\_\_

If "No" is checked, the bidder only needs to complete the signature box on the bottom of this page.

2. If "Yes" is checked. Identify each such relationship by showing State of Illinois agency name and other descriptive information such as bid or project number (attach additional pages as necessary). SEE DISCLOSURE FORM INSTRUCTIONS:

THE FOLLOWING STATEMENT MUST BE CHECKED

Signature of Authorized Representative Date

OWNERSHIP CERTIFICATION

Please certify that the following statement is true if the individuals for all submitted Form A disclosures do not total 100% of ownership.

Any remaining ownership interest is held by individuals receiving less than \$106,447.20 of the bidding entity's or parent entity's distributive income or holding less than a 5% ownership interest.

Yes No N/A (Form A disclosure(s) established 100% ownership)

## **RETURN WITH BID**

### **SPECIAL NOTICE TO CONTRACTORS**

The following requirements of the Illinois Department of Human Rights' Rules and Regulations are applicable to bidders on all construction contracts advertised by the Illinois Department of Transportation:

#### **CONSTRUCTION EMPLOYEE UTILIZATION PROJECTION**

- (a) All bidders on construction contracts shall complete and submit, along with and as part of their bids, a Bidder's Employee Utilization Form (Form BC-1256) setting forth a projection and breakdown of the total workforce intended to be hired and/or allocated to such contract work by the bidder including a projection of minority and female employee utilization in all job classifications on the contract project.
- (b) The Department of Transportation shall review the Employee Utilization Form, and workforce projections contained therein, of the contract awardee to determine if such projections reflect an underutilization of minority persons and/or women in any job classification in accordance with the Equal Employment Opportunity Clause and Section 7.2 of the Illinois Department of Human Rights' Rules and Regulations for Public Contracts adopted as amended on September 17, 1980. If it is determined that the contract awardee's projections reflect an underutilization of minority persons and/or women in any job classification, it shall be advised in writing of the manner in which it is underutilizing and such awardee shall be considered to be in breach of the contract unless, prior to commencement of work on the contract project, it submits revised satisfactory projections or an acceptable written affirmative action plan to correct such underutilization including a specific timetable geared to the completion stages of the contract.
- (c) The Department of Transportation shall provide to the Department of Human Rights a copy of the contract awardee's Employee Utilization Form, a copy of any required written affirmative action plan, and any written correspondence related thereto. The Department of Human Rights may review and revise any action taken by the Department of Transportation with respect to these requirements.



**RETURN WITH BID**

**Contract No. 63843  
 MCHENRY County  
 Section 08-00106-00-FP (Crystal Lake)  
 Project M-9003(685)  
 Route FAU 124 (South Main Street)  
 District 1 Construction Funds**

**PART I. IDENTIFICATION**

Dept. Human Rights # \_\_\_\_\_ Duration of Project: \_\_\_\_\_

Name of Bidder: \_\_\_\_\_

**PART II. WORKFORCE PROJECTION**

A. The undersigned bidder has analyzed minority group and female populations, unemployment rates and availability of workers for the location in which this contract work is to be performed, and for the locations from which the bidder recruits employees, and hereby submits the following workforce projection including a projection for minority and female employee utilization in all job categories in the workforce to be allocated to this contract:

TABLE A

TABLE B

TOTAL Workforce Projection for Contract													CURRENT EMPLOYEES TO BE ASSIGNED TO CONTRACT				
JOB CATEGORIES	TOTAL EMPLOYEES		MINORITY EMPLOYEES						TRAINEES				TOTAL EMPLOYEES		MINORITY EMPLOYEES		
	M	F	BLACK		HISPANIC		*OTHER MINOR.		APPRENTICES		ON THE JOB TRAINEES		M	F	M	F	
			M	F	M	F	M	F	M	F	M	F					
OFFICIALS (MANAGERS)																	
SUPERVISORS																	
FOREMEN																	
CLERICAL																	
EQUIPMENT OPERATORS																	
MECHANICS																	
TRUCK DRIVERS																	
IRONWORKERS																	
CARPENTERS																	
CEMENT MASONS																	
ELECTRICIANS																	
PIPEFITTERS, PLUMBERS																	
PAINTERS																	
LABORERS, SEMI-SKILLED																	
LABORERS, UNSKILLED																	
<b>TOTAL</b>																	

TABLE C

TOTAL Training Projection for Contract								
EMPLOYEES IN TRAINING	TOTAL EMPLOYEES		BLACK		HISPANIC		*OTHER MINOR.	
	M	F	M	F	M	F	M	F
APPRENTICES								
ON THE JOB TRAINEES								

\*Other minorities are defined as Asians (A) or Native Americans (N).  
 Please specify race of each employee shown in Other Minorities column.

FOR DEPARTMENT USE ONLY

BC 1256 (Rev. 12/11/07)

**Note: See instructions on page 2**

**RETURN WITH BID**

**Contract No. 63843  
MCHENRY County  
Section 08-00106-00-FP (Crystal Lake)  
Project M-9003(685)  
Route FAU 124 (South Main Street)  
District 1 Construction Funds**

**PART II. WORKFORCE PROJECTION - continued**

- B. Included in "Total Employees" under Table A is the total number of **new hires** that would be employed in the event the undersigned bidder is awarded this contract.

The undersigned bidder projects that: (number) \_\_\_\_\_ new hires would be recruited from the area in which the contract project is located; and/or (number) \_\_\_\_\_ new hires would be recruited from the area in which the bidder's principal office or base of operation is located.

- C. Included in "Total Employees" under Table A is a projection of numbers of persons to be employed directly by the undersigned bidder as well as a projection of numbers of persons to be employed by subcontractors.

The undersigned bidder estimates that (number) \_\_\_\_\_ persons will be directly employed by the prime contractor and that (number) \_\_\_\_\_ persons will be employed by subcontractors.

**PART III. AFFIRMATIVE ACTION PLAN**

- A. The undersigned bidder understands and agrees that in the event the foregoing minority and female employee utilization projection included under **PART II** is determined to be an underutilization of minority persons or women in any job category, and in the event that the undersigned bidder is awarded this contract, he/she will, prior to commencement of work, develop and submit a written Affirmative Action Plan including a specific timetable (geared to the completion stages of the contract) whereby deficiencies in minority and/or female employee utilization are corrected. Such Affirmative Action Plan will be subject to approval by the contracting agency and the **Department of Human Rights**.
- B. The undersigned bidder understands and agrees that the minority and female employee utilization projection submitted herein, and the goals and timetable included under an Affirmative Action Plan if required, are deemed to be part of the contract specifications.

Company \_\_\_\_\_ Telephone Number \_\_\_\_\_

Address \_\_\_\_\_

**NOTICE REGARDING SIGNATURE**

The Bidder's signature on the Proposal Signature Sheet will constitute the signing of this form. The following signature block needs to be completed only if revisions are required.

Signature:  \_\_\_\_\_ Title: \_\_\_\_\_ Date: \_\_\_\_\_

- Instructions: All tables must include subcontractor personnel in addition to prime contractor personnel.
- Table A - Include both the number of employees that would be hired to perform the contract work and the total number currently employed (Table B) that will be allocated to contract work, and include all apprentices and on-the-job trainees. The "Total Employees" column should include all employees including all minorities, apprentices and on-the-job trainees to be employed on the contract work.
- Table B - Include all employees currently employed that will be allocated to the contract work including any apprentices and on-the-job trainees currently employed.
- Table C - Indicate the racial breakdown of the total apprentices and on-the-job trainees shown in Table A.

**RETURN WITH BID**

**ADDITIONAL FEDERAL REQUIREMENTS**

In addition to the Required Contract Provisions for Federal-Aid Construction Contracts (FHWA 1273), all bidders make the following certifications.

- A. By the execution of this proposal, the signing bidder certifies that the bidding entity has not, either directly or indirectly, entered into any agreement, participated in any collusion, or otherwise taken any action, in restraint of free competitive bidding in connection with the submitted bid. This statement made by the undersigned bidder is true and correct under penalty of perjury under the laws of the United States.
- B. CERTIFICATION, EQUAL EMPLOYMENT OPPORTUNITY:
1. Have you participated in any previous contracts or subcontracts subject to the equal opportunity clause. YES \_\_\_\_\_ NO \_\_\_\_\_
  2. If answer to #1 is yes, have you filed with the Joint Reporting Committee, the Director of OFCC, any Federal agency, or the former President's Committee on Equal Employment Opportunity, all reports due under the applicable filing requirements of those organizations? YES \_\_\_\_\_ NO \_\_\_\_\_

**RETURN WITH BID**

**Contract No. 63843  
MCHENRY County  
Section 08-00106-00-FP (Crystal Lake)  
Project M-9003(685)  
Route FAU 124 (South Main Street)  
District 1 Construction Funds**

PROPOSAL SIGNATURE SHEET

The undersigned bidder hereby makes and submits this bid on the subject Proposal, thereby assuring the Department that all requirements of the Invitation for Bids and rules of the Department have been met, that there is no misunderstanding of the requirements of paragraph 3 of this Proposal, and that the contract will be executed in accordance with the rules of the Department if an award is made on this bid.

(IF AN INDIVIDUAL)

Firm Name \_\_\_\_\_  
Signature of Owner \_\_\_\_\_  
Business Address \_\_\_\_\_  
\_\_\_\_\_

(IF A CO-PARTNERSHIP)

Firm Name \_\_\_\_\_  
By \_\_\_\_\_  
Business Address \_\_\_\_\_  
Name and Address of All Members of the Firm: \_\_\_\_\_  
\_\_\_\_\_

(IF A CORPORATION)

Corporate Name \_\_\_\_\_  
By \_\_\_\_\_  
Signature of Authorized Representative \_\_\_\_\_  
Typed or printed name and title of Authorized Representative \_\_\_\_\_  
Attest \_\_\_\_\_  
Signature \_\_\_\_\_  
(IF A JOINT VENTURE, USE THIS SECTION FOR THE MANAGING PARTY AND THE SECOND PARTY SHOULD SIGN BELOW)  
Business Address \_\_\_\_\_

(IF A JOINT VENTURE)

Corporate Name \_\_\_\_\_  
By \_\_\_\_\_  
Signature of Authorized Representative \_\_\_\_\_  
Typed or printed name and title of Authorized Representative \_\_\_\_\_  
Attest \_\_\_\_\_  
Signature \_\_\_\_\_  
Business Address \_\_\_\_\_  
\_\_\_\_\_

If more than two parties are in the joint venture, please attach an additional signature sheet.



This Annual Proposal Bid Bond shall become effective at 12:01 AM (CDST) on \_\_\_\_\_ and shall be valid until \_\_\_\_\_ 11:59 PM (CDST).

KNOW ALL PERSONS BY THESE PRESENTS, That We \_\_\_\_\_

as PRINCIPAL, and \_\_\_\_\_

as SURETY, and held jointly, severally and firmly bound unto the STATE OF ILLINOIS in the penal sum of 5 percent of the total bid price, or for the amount specified in the bid proposal under "Proposal Guaranty" in effect on the date of the Invitation for Bids, whichever is the lesser sum, well and truly to be paid unto said STATE OF ILLINOIS, for the payment of which we bind ourselves, our heirs, executors, administrators, successors and assigns.

THE CONDITION OF THE FOREGOING OBLIGATION IS SUCH that whereas, the PRINCIPAL may submit bid proposal(s) to the STATE OF ILLINOIS, acting through the Department of Transportation, for various improvements published in the Transportation Bulletin during the effective term indicated above.

NOW, THEREFORE, if the Department shall accept the bid proposal(s) of the PRINCIPAL; and if the PRINCIPAL shall, within the time and as specified in the bidding and contract documents; and if, after award by the Department, the PRINCIPAL shall enter into a contract in accordance with the terms of the bidding and contract documents including evidence of the required insurance coverages and providing such bond as specified with good and sufficient surety for the faithful performance of such contract and for the prompt payment of labor and material furnished in the prosecution thereof; or if, in the event of the failure of the PRINCIPAL to enter into such contract and to give the specified bond, the PRINCIPAL pays to the Department the difference not to exceed the penalty hereof between the amount specified in the bid proposal and such larger amount for which the Department may contract with another party to perform the work covered by said bid proposal, then this obligation shall be null and void, otherwise, it shall remain in full force and effect.

IN THE EVENT the Department determines the PRINCIPAL has failed to comply with any requirement as set forth in the preceding paragraph, then Surety shall pay the penal sum to the Department within fifteen (15) days of written demand therefor. If Surety does not make full payment within such period of time, the Department may bring an action to collect the amount owed. Surety is liable to the Department for all its expenses, including attorney's fees, incurred in any litigation in which it prevails either in whole or in part.

In TESTIMONY WHEREOF, the said PRINCIPAL has caused this instrument to be signed by its officer \_\_\_\_\_ day of \_\_\_\_\_ A.D., \_\_\_\_\_

In TESTIMONY WHEREOF, the said SURETY has caused this instrument to be signed by its officer \_\_\_\_\_ day of \_\_\_\_\_ A.D., \_\_\_\_\_

\_\_\_\_\_  
(Company Name)

\_\_\_\_\_  
(Company Name)

By \_\_\_\_\_  
(Signature and Title)

By \_\_\_\_\_  
(Signature of Attorney-in-Fact)

**Notary for PRINCIPAL**

**Notary for SURETY**

STATE OF \_\_\_\_\_  
COUNTY OF \_\_\_\_\_

STATE OF \_\_\_\_\_  
COUNTY OF \_\_\_\_\_

Signed and attested before me on \_\_\_\_\_ (date)

Signed and attested before me on \_\_\_\_\_ (date)

by \_\_\_\_\_  
(Name of Notary Public)

by \_\_\_\_\_  
(Name of Notary Public)

(Seal) \_\_\_\_\_  
(Signature of Notary Public)

(Seal) \_\_\_\_\_  
(Signature of Notary Public)

\_\_\_\_\_  
(Date Commission Expires)

\_\_\_\_\_  
(Date Commission Expires)



In lieu of completing the above section of the Annual Proposal Bid Bond form, the Principal may file an Electronic Bid Bond. By signing the proposal(s) the Principal is ensuring the identified electronic bid bond has been executed and the Principal and Surety are firmly bound unto the State of Illinois under the conditions of the bid bond as shown above.

---

Electronic Bid Bond ID #	Company/Bidder Name	Signature and Title
--------------------------	---------------------	---------------------

This bond may be terminated, at Surety's request, upon giving not less than thirty (30) days prior written notice of the cancellation/termination of the bond. Said written notice shall be issued to the Illinois Department of Transportation, Chief Contracts Official, 2300 South Dirksen Parkway, Springfield, Illinois, 62764, and shall be served in person, by receipted courier delivery or certified or registered mail, return receipt requested. Said notice period shall commence on the first calendar day following the Department's receipt of written cancellation/termination notice. Surety shall remain firmly bound to all obligations herein for proposals submitted prior to the cancellation/termination. Surety shall be released and discharged from any obligation(s) for proposals submitted for any letting or date after the effective date of cancellation/termination.



Item No. \_\_\_\_\_

Letting Date \_\_\_\_\_

KNOW ALL PERSONS BY THESE PRESENTS, That We \_\_\_\_\_

as PRINCIPAL, and \_\_\_\_\_

as SURETY, and held jointly, severally and firmly bound unto the STATE OF ILLINOIS in the penal sum of 5 percent of the total bid price, or for the amount specified in the bid proposal under "Proposal Guaranty" in effect on the date of the Invitation for Bids, whichever is the lesser sum, well and truly to be paid unto said STATE OF ILLINOIS, for the payment of which we bind ourselves, our heirs, executors, administrators, successors and assigns.

THE CONDITION OF THE FOREGOING OBLIGATION IS SUCH that whereas, the PRINCIPAL has submitted a bid proposal to the STATE OF ILLINOIS, acting through the Department of Transportation, for the improvement designated by the Transportation Bulletin Item Number and Letting Date indicated above.

NOW, THEREFORE, if the Department shall accept the bid proposal of the PRINCIPAL; and if the PRINCIPAL shall, within the time and as specified in the bidding and contract documents; and if, after award by the Department, the PRINCIPAL shall enter into a contract in accordance with the terms of the bidding and contract documents including evidence of the required insurance coverages and providing such bond as specified with good and sufficient surety for the faithful performance of such contract and for the prompt payment of labor and material furnished in the prosecution thereof; or if, in the event of the failure of the PRINCIPAL to enter into such contract and to give the specified bond, the PRINCIPAL pays to the Department the difference not to exceed the penalty hereof between the amount specified in the bid proposal and such larger amount for which the Department may contract with another party to perform the work covered by said bid proposal, then this obligation shall be null and void, otherwise, it shall remain in full force and effect.

IN THE EVENT the Department determines the PRINCIPAL has failed to comply with any requirement as set forth in the preceding paragraph, then Surety shall pay the penal sum to the Department within fifteen (15) days of written demand therefor. If Surety does not make full payment within such period of time, the Department may bring an action to collect the amount owed. Surety is liable to the Department for all its expenses, including attorney's fees, incurred in any litigation in which it prevails either in whole or in part.

In TESTIMONY WHEREOF, the said PRINCIPAL has caused this instrument to be signed by its officer \_\_\_\_\_ day of \_\_\_\_\_ A.D., \_\_\_\_\_

In TESTIMONY WHEREOF, the said SURETY has caused this instrument to be signed by its officer \_\_\_\_\_ day of \_\_\_\_\_ A.D., \_\_\_\_\_

\_\_\_\_\_  
(Company Name)

\_\_\_\_\_  
(Company Name)

By \_\_\_\_\_  
(Signature and Title)

By \_\_\_\_\_  
(Signature of Attorney-in-Fact)

**Notary for PRINCIPAL**

**Notary for SURETY**

STATE OF \_\_\_\_\_  
COUNTY OF \_\_\_\_\_

STATE OF \_\_\_\_\_  
COUNTY OF \_\_\_\_\_

Signed and attested before me on \_\_\_\_\_ (date)  
by \_\_\_\_\_

Signed and attested before me on \_\_\_\_\_ (date)  
by \_\_\_\_\_

\_\_\_\_\_  
(Name of Notary Public)

\_\_\_\_\_  
(Name of Notary Public)

(Seal) \_\_\_\_\_  
(Signature of Notary Public)

(Seal) \_\_\_\_\_  
(Signature of Notary Public)

\_\_\_\_\_  
(Date Commission Expires)

\_\_\_\_\_  
(Date Commission Expires)

In lieu of completing the above section of the Proposal Bid Bond form, the Principal may file an Electronic Bid Bond. By signing the proposal the Principal is ensuring the identified electronic bid bond has been executed and the Principal and Surety are firmly bound unto the State of Illinois under the conditions of the bid bond as shown above.

Electronic Bid Bond ID # \_\_\_\_\_ Company/Bidder Name \_\_\_\_\_ Signature and Title \_\_\_\_\_

**(1) Policy**

It is public policy that disadvantageded businesses as defined in 49 CFR Part 26 and the Special Provision shall have the maximum opportunity to participate in the performance of contracts financed in whole or in part with Federal or State funds. Consequently the requirements of 49 CFR Part 26 apply to this contract.

**(2) Obligation**

The contractor agrees to ensure that disadvantageded businesses as defined in 49 CFR Part 26 and the Special Provision have the maximum opportunity to participate in the performance of contracts or subcontracts financed in whole or in part with Federal or State funds. The contractor shall take all necessary and reasonable steps in accordance with 49 CFR Part 26 and the Special Provision to ensure that said businesses have the maximum opportunity to compete for and perform under this contract. The contractor shall not discriminate on the basis of race, color, national origin or sex in the award and performance of contracts.

**(3) Project and Bid Identification**

Complete the following information concerning the project and bid:

Route _____	Total Bid _____
Section _____	Contract DBE Goal _____ (Percent) _____ (Dollar Amount)
Project _____	
County _____	
Letting Date _____	
Contract No. _____	
Letting Item No. _____	

**(4) Assurance**

I, acting in my capacity as an officer of the undersigned bidder (or bidders if a joint venture), hereby assure the Department that on this project my company : (check one)

- Meets or exceeds contract award goals and has provided documented participation as follows:  
Disadvantaged Business Participation \_\_\_\_\_ percent

Attached are the signed participation statements, forms SBE 2025, required by the Special Provision evidencing availability and use of each business participating in this plan and assuring that each business will perform a commercially useful function in the work of the contract.

- Failed to meet contract award goals and has included good faith effort documentation to meet the goals and that my company has provided participation as follows:

Disadvantaged Business Participation \_\_\_\_\_ percent

The contract goals should be accordingly modified or waived. Attached is all information required by the Special Provision in support of this request including good faith effort. Also attached are the signed participation statements, forms SBE 2025, required by the Special Provision evidencing availability and use of each business participating in this plan and assuring that each business will perform a commercially useful function in the work of the contract.

\_\_\_\_\_  
Company

By \_\_\_\_\_

Title \_\_\_\_\_

Date \_\_\_\_\_

The "as read" Low Bidder is required to comply with the Special Provision.	
Submit only one utilization plan for each project. The utilization plan shall be submitted in accordance with the special provision.	
Bureau of Small Business Enterprises 2300 South Dirksen Parkway Springfield, Illinois 62764	<b>Local Let Projects</b> Submit forms to the Local Agency



# Illinois Department of Transportation

## DBE Participation Statement

Subcontractor Registration Number \_\_\_\_\_

Letting \_\_\_\_\_

### Participation Statement

Item No. \_\_\_\_\_

#### (1) Instructions

Contract No. \_\_\_\_\_

This form must be completed for each disadvantaged business participating in the Utilization Plan. This form shall be submitted in accordance with the special provision and will be attached to the Utilization Plan form. If additional space is needed complete an additional form for the firm.

#### (2) Work:

**Please indicate:** J/V \_\_\_\_\_ Manufacturer \_\_\_\_\_ Supplier (60%) \_\_\_\_\_ Subcontractor \_\_\_\_\_ Trucking \_\_\_\_\_

Pay Item No.	Description	Quantity	Unit Price	Total
<b>Total</b>				

#### (3) Partial Payment Items (For any of the above items which are partial pay items)

Description must be sufficient to determine a Commercially Useful Function, specifically describe the work and subcontract dollar amount:

#### (4) Commitment

When a DBE is to be a second-tier subcontractor, or if the first-tier DBE subcontractor is going to be subcontracting a portion of its subcontract, it must be clearly indicated on the DBE Participation Statement, and the details of the transaction fully explained.

In the event a DBE subcontractor second-tiers a portion of its subcontract to one or more subcontractors during the work of a contract, the prime must submit a DBE Participation Statement, with the details of the transaction(s) fully explained.

The undersigned certify that the information included herein is true and correct, and that the DBE firm listed below has agreed to perform a commercially useful function in the work of the contract item(s) listed above and to execute a contract with the prime contractor or 1<sup>st</sup> Tier subcontractor. The undersigned further understand that no changes to this statement may be made without prior approval from the Department's Bureau of Small Business Enterprises and that complete and accurate information regarding actual work performed on this project and the payment therefore must be provided to the Department.

\_\_\_\_\_  
Signature for Contractor \_\_ 1<sup>st</sup> Tier \_\_ 2<sup>nd</sup> Tier

\_\_\_\_\_  
Signature for DBE Firm \_\_ 1<sup>st</sup> Tier \_\_ 2<sup>nd</sup> Tier

Title \_\_\_\_\_

Title \_\_\_\_\_

Date \_\_\_\_\_

Date \_\_\_\_\_

Contact Person \_\_\_\_\_

Contact Person \_\_\_\_\_

Phone \_\_\_\_\_

Phone \_\_\_\_\_

Firm Name \_\_\_\_\_

Firm Name \_\_\_\_\_

Address \_\_\_\_\_

Address \_\_\_\_\_

City/State/Zip \_\_\_\_\_

City/State/Zip \_\_\_\_\_

E \_\_\_\_\_

WC \_\_\_\_\_

The Department of Transportation is requesting disclosure of information that is necessary to accomplish the statutory purpose as outlined under the state and federal law. Disclosure of this information is **REQUIRED**. Failure to provide any information will result in the contract not being awarded. This form has been approved by the State Forms Management Center.

# PROPOSAL ENVELOPE



## PROPOSALS

for construction work advertised for bids by the  
Illinois Department of Transportation

Item No.	Item No.	Item No.

Submitted By:

Name:
Address:
Phone No.

Bidders should use an IDOT proposal envelope or affix this form to the front of a 10" x 13" envelope for the submittal of bids. If proposals are mailed, they should be enclosed in a second or outer envelope addressed to:

Engineer of Design and Environment - Room 326  
Illinois Department of Transportation  
2300 South Dirksen Parkway  
Springfield, Illinois 62764

### **NOTICE**

**Individual bids, including Bid Bond and/or supplemental information if required, should be securely stapled.**

# CONTRACTOR OFFICE COPY OF CONTRACT SPECIFICATIONS

## NOTICE

None of the following material needs to be returned with the bid package unless the special provisions require documentation and/or other information to be submitted.

**Contract No. 63843  
MCHENRY County  
Section 08-00106-00-FP (Crystal Lake)  
Project M-9003(685)  
Route FAU 124 (South Main Street)  
District 1 Construction Funds**



**Illinois Department of Transportation**

## **SUBCONTRACTOR DOCUMENTATION**

Public Acts 96-0795, 96-0920, and 97-0895 enacted substantial changes to the provisions of the Code (30 ILCS 500). Among the changes are provisions affecting subcontractors. The Contractor awarded this contract will be required as a material condition of the contract to implement and enforce the contract requirements applicable to subcontractors that entered into a contractual agreement with a total value of \$50,000 or more with a person or entity who has a contract subject to the Code and approved in accordance with article 108.01 of the Standard Specifications for Road and Bridge Construction.

If the Contractor seeks approval of subcontractors to perform a portion of the work, and approval is granted by the Department, the Contractor shall provide a copy of the subcontract to the Illinois Department of Transportation's CPO upon request within 15 calendar days after execution of the subcontract.

Financial disclosures required pursuant to Sec. 50-35 of the Code must be submitted for all applicable subcontractors. The subcontract shall contain the certifications required to be made by subcontractors pursuant to Article 50 of the Code. This Notice to Bidders includes a document incorporating all required subcontractor certifications and disclosures for use by the Contractor in compliance with this mandate. The document is entitled State Required Ethical Standards Governing Subcontractors.

## RETURN WITH SUBCONTRACT

### STATE ETHICAL STANDARDS GOVERNING SUBCONTRACTORS

Article 50 of the Code establishes the duty of all State CPOs, SPOs, and their designees to maximize the value of the expenditure of public moneys in procuring goods, services, and contracts for the State of Illinois and to act in a manner that maintains the integrity and public trust of State government. In discharging this duty, they are charged by law to use all available information, reasonable efforts, and reasonable actions to protect, safeguard, and maintain the procurement process of the State of Illinois.

The certifications hereinafter made by the subcontractor are each a material representation of fact upon which reliance is placed should the Department approve the subcontractor. The CPO may terminate or void the contract approval if it is later determined that the bidder or subcontractor rendered a false or erroneous certification. If a false certification is made by a subcontractor the contractor's submitted bid and the executed contract may not be declared void unless the contractor refuses to terminate the subcontract upon the State's request after a finding that the subcontractor's certification was false.

Section 50-2 of the Code provides that every person that has entered into a multi-year contract and every subcontractor with a multi-year subcontract shall certify, by July 1 of each fiscal year covered by the contract after the initial fiscal year, to the responsible CPO whether it continues to satisfy the requirements of Article 50 pertaining to the eligibility for a contract award. If a contractor or subcontractor is not able to truthfully certify that it continues to meet all requirements, it shall provide with its certification a detailed explanation of the circumstances leading to the change in certification status. A contractor or subcontractor that makes a false statement material to any given certification required under Article 50 is, in addition to any other penalties or consequences prescribed by law, subject to liability under the Whistleblower Reward and Protection Act for submission of a false claim.

#### **A. Bribery**

Section 50-5. Bribery.

(a) Prohibition. No person or business shall be awarded a contract or subcontract under this Code who:

(1) has been convicted under the laws of Illinois or any other state of bribery or attempting to bribe an officer or employee of the State of Illinois or any other state in that officer's or employee's official capacity; or

(2) has made an admission of guilt of that conduct that is a matter of record but has not been prosecuted for that conduct.

(b) Businesses. No business shall be barred from contracting with any unit of State or local government, or subcontracting under such a contract, as a result of a conviction under this Section of any employee or agent of the business if the employee or agent is no longer employed by the business and:

(1) the business has been finally adjudicated not guilty; or

(2) the business demonstrates to the governmental entity with which it seeks to contract, or which is signatory to the contract to which the subcontract relates, and that entity finds that the commission of the offense was not authorized, requested, commanded, or performed by a director, officer, or high managerial agent on behalf of the business as provided in paragraph (2) of subsection (a) of Section 5-4 of the Criminal Code of 2012.

(c) Conduct on behalf of business. For purposes of this Section, when an official, agent, or employee of a business committed the bribery or attempted bribery on behalf of the business and in accordance with the direction or authorization of a responsible official of the business, the business shall be chargeable with the conduct.

(d) Certification. Every bid submitted to and contract executed by the State, and every subcontract subject to Section 20-120 of the Code shall contain a certification by the contractor or the subcontractor, respectively, that the contractor or subcontractor is not barred from being awarded a contract or subcontract under this Section and acknowledges that the CPO may declare the related contract void if any certifications required by this Section are false. A contractor who makes a false statement, material to the certification, commits a Class 3 felony.

The contractor or subcontractor certifies that it is not barred from being awarded a contract under Section 50.5.

#### **B. Felons**

Section 50-10. Felons.

(a) Unless otherwise provided, no person or business convicted of a felony shall do business with the State of Illinois or any State agency, or enter into a subcontract, from the date of conviction until 5 years after the date of completion of the sentence for that felony, unless no person held responsible by a prosecutorial office for the facts upon which the conviction was based continues to have any involvement with the business.

(b) Certification. Every bid submitted to and contract executed by the State and every subcontract subject to Section 20-120 of the Code shall contain a certification by the bidder or contractor or subcontractor, respectively, that the bidder, contractor, or subcontractor is not barred from being awarded a contract or subcontract under this Section and acknowledges that the CPO may declare the related contract void if any of the certifications required by this Section are false.



## RETURN WITH SUBCONTRACT

### **C. Debt Delinquency**

Section 50-11 and 50-12. Debt Delinquency.

The contractor or bidder or subcontractor, respectively, certifies that it, or any affiliate, is not barred from being awarded a contract or subcontract under the Code. Section 50-11 prohibits a person from entering into a contract with a State agency, or entering into a subcontract, if it knows or should know that it, or any affiliate, is delinquent in the payment of any debt to the State as defined by the Debt Collection Board. Section 50-12 prohibits a person from entering into a contract with a State agency, or entering into a subcontract, if it, or any affiliate, has failed to collect and remit Illinois Use Tax on all sales of tangible personal property into the State of Illinois in accordance with the provisions of the Illinois Use Tax Act. The bidder or contractor or subcontractor, respectively, further acknowledges that the CPO may declare the related contract void if this certification is false or if the bidder, contractor, or subcontractor, or any affiliate, is determined to be delinquent in the payment of any debt to the State during the term of the contract.

### **D. Prohibited Bidders, Contractors and Subcontractors**

Section 50-10.5 and 50-60(c). Prohibited bidders, contractors and subcontractors.

The bidder or contractor or subcontractor, respectively, certifies in accordance with 30 ILCS 500/50-10.5 that no officer, director, partner or other managerial agent of the contracting business has been convicted of a felony under the Sarbanes-Oxley Act of 2002 or a Class 3 or Class 2 felony under the Illinois Securities Law of 1953 or if in violation of Subsection (c) for a period of five years from the date of conviction. Every bid submitted to and contract executed by the State and every subcontract subject to Section 20-120 of the Code shall contain a certification by the bidder, contractor, or subcontractor, respectively, that the bidder, contractor, or subcontractor is not barred from being awarded a contract or subcontract under this Section and acknowledges that the CPO shall declare the related contract void if any of the certifications completed pursuant to this Section are false.

### **E. Section 42 of the Environmental Protection Act**

The bidder or contractor or subcontractor, respectively, certifies in accordance with 30 ILCS 500/50-14 that the bidder, contractor, or subcontractor, is not barred from being awarded a contract or entering into a subcontract under this Section which prohibits the bidding on or entering into contracts with the State of Illinois or a State agency, or entering into any subcontract, that is subject to the Code by a person or business found by a court or the Pollution Control Board to have committed a willful or knowing violation of Section 42 of the Environmental Protection Act for a period of five years from the date of the order. The bidder or contractor or subcontractor, respectively, acknowledges that the CPO may declare the contract void if this certification is false.

**The undersigned, on behalf of the subcontracting company, has read and understands the above certifications and makes the certifications as required by law.**

<hr style="border: 0; border-top: 1px solid black; margin-bottom: 5px;"/>		
Name of Subcontracting Company		
<hr style="border: 0; border-top: 1px solid black; margin-bottom: 5px;"/>		
Authorized Officer	<hr style="border: 0; border-top: 1px solid black; margin-bottom: 5px;"/>	Date

**RETURN WITH SUBCONTRACT**  
**SUBCONTRACTOR DISCLOSURES**

**I. DISCLOSURES**

- A.** The disclosures hereinafter made by the subcontractor are each a material representation of fact upon which reliance is placed. The subcontractor further certifies that the Department has received the disclosure forms for each subcontract.

The CPO may void the bid, contract, or subcontract, respectively, if it is later determined that the bidder or subcontractor rendered a false or erroneous disclosure. A contractor or subcontractor may be suspended or debarred for violations of the Code. Furthermore, the CPO may void the contract.

**B. Financial Interests and Conflicts of Interest**

1. Section 50-35 of the Code provides that all subcontracts with a total value of \$50,000 or more, from subcontractors identified in Section 20-120 of the Code, shall be accompanied by disclosure of the financial interests of the subcontractor. This disclosed information for the subcontractor, will be maintained as public information subject to release by request pursuant to the Freedom of Information Act, filed with the Procurement Policy Board, and shall be incorporated as a material term of the Prime Contractor's contract. Furthermore, pursuant to this Section, the Procurement Policy Board may recommend to allow or void a contract or subcontract based on a potential conflict of interest.

The financial interests to be disclosed shall include ownership or distributive income share that is in excess of 5%, or an amount greater than 60% of the annual salary of the Governor, of the subcontracting entity or its parent entity, whichever is less, unless the subcontractor is a publicly traded entity subject to Federal 10K reporting, in which case it may submit its 10K disclosure in place of the prescribed disclosure. If a subcontractor is a privately held entity that is exempt from Federal 10K reporting, but has more than 200 shareholders, it may submit the information that Federal 10K companies are required to report, and list the names of any person or entity holding any ownership share that is in excess of 5%. The disclosure shall include the names, addresses, and dollar or proportionate share of ownership of each person making the disclosure, their instrument of ownership or beneficial relationship, and notice of any potential conflict of interest resulting from the current ownership or beneficial interest of each person making the disclosure having any of the relationships identified in Section 50-35 and on the disclosure form.

**The current annual salary of the Governor is \$177,412.00.**

In addition, all disclosures shall indicate any other current or pending contracts, subcontracts, proposals, leases, or other ongoing procurement relationships the subcontracting entity has with any other unit of state government and shall clearly identify the unit and the contract, subcontract, proposal, lease, or other relationship.

2. Disclosure Forms. Disclosure Form A is attached for use concerning the individuals meeting the above ownership or distributive share requirements. A separate Disclosure Form A must be submitted with the bid for each individual meeting the above requirements. In addition, a second form (Disclosure Form B) provides for the disclosure of current or pending procurement relationships with other (non-IDOT) state agencies and a total ownership certification. **The forms must be included with each bid.**

**C. Disclosure Form Instructions**

**Form A Instructions for Financial Information & Potential Conflicts of Interest**

If the subcontractor is a publicly traded entity subject to Federal 10K reporting, the 10K Report may be submitted to meet the requirements of Form A. If a subcontractor is a privately held entity that is exempt from Federal 10K reporting, but has more than 200 shareholders, it may submit the information that Federal 10K companies are required to report, and list the names of any person or entity holding any ownership share that is in excess of 5%. If a subcontractor is not subject to Federal 10K reporting, the subcontractor must determine if any individuals are required by law to complete a financial disclosure form. To do this, the subcontractor should answer each of the following questions. A "YES" answer indicates Form A must be completed. If the answer to each of the following questions is "NO", then the **NOT APPLICABLE STATEMENT** on the second page of Form A must be signed and dated by a person that is authorized to execute contracts for the subcontracting company. Note: These questions are for assistance only and are not required to be completed.

1. Does anyone in your organization have a direct or beneficial ownership share of greater than 5% of the bidding entity or parent entity? YES \_\_\_ NO \_\_\_
2. Does anyone in your organization have a direct or beneficial ownership share of less than 5%, but which has a value greater than 60% of the annual salary of the Governor? YES \_\_\_ NO \_\_\_
3. Does anyone in your organization receive more than 60% of the annual salary of the Governor of the subcontracting entity's or parent entity's distributive income? YES \_\_\_ NO \_\_\_

(Note: Distributive income is, for these purposes, any type of distribution of profits. An annual salary is not distributive income.)

4. Does anyone in your organization receive greater than 5% of the subcontracting entity's or parent entity's total distributive income, but which is less than 60% of the annual salary of the Governor? YES \_\_\_ NO \_\_\_

(Note: Only one set of forms needs to be completed per person per subcontract even if a specific individual would require a yes answer to more than one question.)

A "YES" answer to any of these questions requires the completion of Form A. The subcontractor must determine each individual in the subcontracting entity or the subcontracting entity's parent company that would cause the questions to be answered "Yes". Each form must be signed and dated by a person that is authorized to execute contracts for your organization. **Photocopied or stamped signatures are not acceptable.** The person signing can be, but does not have to be, the person for which the form is being completed. The subcontractor is responsible for the accuracy of any information provided.

If the answer to each of the above questions is "NO", then the **NOT APPLICABLE STATEMENT** on page 2 of Form A must be signed and dated by a person that is authorized to execute contracts for your company.

## RETURN WITH SUBCONTRACT

### **Form B: Instructions for Identifying Other Contracts & Procurement Related Information**

Disclosure Form B must be completed for each subcontract submitted by the subcontracting entity. *Note: Checking the NOT APPLICABLE STATEMENT on Form A does not allow the subcontractor to ignore Form B. Form B must be completed, checked, and dated or the subcontract will not be approved.*

The Subcontractor shall identify, by checking Yes or No on Form B, whether it has any pending contracts, subcontracts, leases, bids, proposals, or other ongoing procurement relationship with any other (non-IDOT) State of Illinois agency. If "No" is checked, the subcontractor only needs to complete the check box on the bottom of Form B. If "Yes" is checked, the subcontractor must list all non-IDOT State of Illinois agency pending contracts, subcontracts, leases, bids, proposals, and other ongoing procurement relationships. These items may be listed on Form B or on an attached sheet(s). Contracts with cities, counties, villages, etc. are not considered State of Illinois agency contracts and are not to be included. Contracts or subcontracts with other State of Illinois agencies such as the Department of Natural Resources or the Capital Development Board must be included.

**ILLINOIS DEPARTMENT  
OF TRANSPORTATION**

**Form A  
Subcontractor: Financial  
Information & Potential Conflicts  
of Interest Disclosure**

Subcontractor Name		
Legal Address		
City, State, Zip		
Telephone Number	Email Address	Fax Number (if available)

Disclosure of the information contained in this Form is required by the Section 50-35 of the Code (30 ILCS 500). Subcontractors desiring to enter into a subcontract of a State of Illinois contract must disclose the financial information and potential conflict of interest information as specified in this Disclosure Form. This information shall become part of the publicly available contract file. This Form A must be completed for subcontracts with a total value of \$50,000 or more, from subcontractors identified in Section 20-120 of the Code, and for all open-ended contracts. **A publicly traded company may submit a 10K disclosure (or equivalent if applicable) in satisfaction of the requirements set forth in Form A. See Disclosure Form Instructions.**

*The current annual salary of the Governor is \$177,412.00.*

**DISCLOSURE OF FINANCIAL INFORMATION**

**1. Disclosure of Financial Information.** The individual named below has an interest in the SUBCONTRACTOR (or its parent) in terms of ownership or distributive income share in excess of 5%, or an interest which has a value of more than 60% of the annual salary of the Governor. **(Make copies of this form as necessary and attach a separate Disclosure Form A for each individual meeting these requirements)**

<b>FOR INDIVIDUAL (type or print information)</b>	
<b>NAME:</b>	_____
<b>ADDRESS</b>	_____
<b>Type of ownership/distributable income share:</b>	
stock _____ sole proprietorship _____ Partnership _____ other: (explain on separate sheet):	
% or \$ value of ownership/distributable income share:	_____

**2. Disclosure of Potential Conflicts of Interest.** Check "Yes" or "No" to indicate which, if any, of the following potential conflict of interest relationships apply. If the answer to any question is "Yes", please attach additional pages and describe.

(a) State employment, currently or in the previous 3 years, including contractual employment of services.

Yes \_\_\_ No \_\_\_

If your answer is yes, please answer each of the following questions.

1. Are you currently an officer or employee of either the Capitol Development Board or the Illinois State Toll Highway Authority? Yes \_\_\_ No \_\_\_

2. Are you currently appointed to or employed by any agency of the State of Illinois? If you are currently appointed to or employed by any agency of the State of Illinois, and your annual salary exceeds 60% of the annual salary of the Governor, provide the name the State agency for which you are employed and your annual salary. \_\_\_\_\_

**RETURN WITH SUBCONTRACT**

3. If you are currently appointed to or employed by any agency of the State of Illinois, and your annual salary exceeds 60% of the annual salary of the Governor, are you entitled to receive (i) more than 7 1/2% of the total distributable income of your firm, partnership, association or corporation, or (ii) an amount in excess of 100% of the annual salary of the Governor?  
Yes \_\_\_ No \_\_\_

4. If you are currently appointed to or employed by any agency of the State of Illinois, and your annual salary exceeds 60% of the annual salary of the Governor, are you and your spouse or minor children entitled to receive (i) more than 15 % in the aggregate of the total distributable income of your firm, partnership, association or corporation, or (ii) an amount in excess of two times the salary of the Governor?  
Yes \_\_\_ No \_\_\_

---

(b) State employment of spouse, father, mother, son, or daughter, including contractual employment services in the previous 2 years.

Yes \_\_\_ No \_\_\_

If your answer is yes, please answer each of the following questions.

1. Is your spouse or any minor children currently an officer or employee of the Capitol Development Board or the Illinois State Toll Highway Authority?  
Yes \_\_\_ No \_\_\_

2. Is your spouse or any minor children currently appointed to or employed by any agency of the State of Illinois? If your spouse or minor children is/are currently appointed to or employed by any agency of the State of Illinois, and his/her annual salary exceeds 60% of the annual salary of the Governor, provide the name of your spouse and/or minor children, the name of the State agency for which he/she is employed and his/her annual salary. \_\_\_\_\_

3. If your spouse or any minor children is/are currently appointed to or employed by any agency of the State of Illinois, and his/her annual salary exceeds 60% of the annual salary of the Governor, are you entitled to receive (i) more than 7 1/2% of the total distributable income of your firm, partnership, association or corporation, or (ii) an amount in excess of 100% of the annual salary of the Governor?  
Yes \_\_\_ No \_\_\_

4. If your spouse or any minor children are currently appointed to or employed by any agency of the State of Illinois, and his/her annual salary exceeds 60% of the annual salary of the Governor, are you and your spouse or minor children entitled to receive (i) more than 15 % in the aggregate of the total distributable income of your firm, partnership, association or corporation, or (ii) an amount in excess of two times the salary of the Governor?  
Yes \_\_\_ No \_\_\_

---

(c) Elective status; the holding of elective office of the State of Illinois, the government of the United States, any unit of local government authorized by the Constitution of the State of Illinois or the statutes of the State of Illinois currently or in the previous 3 years.  
Yes \_\_\_ No \_\_\_

---

(d) Relationship to anyone holding elective office currently or in the previous 2 years; spouse, father, mother, son, or daughter.  
Yes \_\_\_ No \_\_\_

---

(e) Appointive office; the holding of any appointive government office of the State of Illinois, the United States of America, or any unit of local government authorized by the Constitution of the State of Illinois or the statutes of the State of Illinois, which office entitles the holder to compensation in excess of the expenses incurred in the discharge of that office currently or in the previous 3 years.  
Yes \_\_\_ No \_\_\_

---

(f) Relationship to anyone holding appointive office currently or in the previous 2 years; spouse, father, mother, son, or daughter.  
Yes \_\_\_ No \_\_\_

---

(g) Employment, currently or in the previous 3 years, as or by any registered lobbyist of the State government.  
Yes \_\_\_ No \_\_\_

**RETURN WITH SUBCONTRACT**

(h) Relationship to anyone who is or was a registered lobbyist in the previous 2 years; spouse, father, mother, son, or daughter. Yes \_\_\_ No \_\_\_

(i) Compensated employment, currently or in the previous 3 years, by any registered election or reelection committee registered with the Secretary of State or any county clerk of the State of Illinois, or any political action committee registered with either the Secretary of State or the Federal Board of Elections. Yes \_\_\_ No \_\_\_

(j) Relationship to anyone; spouse, father, mother, son, or daughter; who was a compensated employee in the last 2 years by any registered election or re-election committee registered with the Secretary of State or any county clerk of the State of Illinois, or any political action committee registered with either the Secretary of State or the Federal Board of Elections. Yes \_\_\_ No \_\_\_

**3 Communication Disclosure.**

Disclose the name and address of each lobbyist and other agent of the bidder or offeror who is not identified in Section 2 of this form, who is has communicated, is communicating, or may communicate with any State officer or employee concerning the bid or offer. This disclosure is a continuing obligation and must be promptly supplemented for accuracy throughout the process and throughout the term of the contract. If no person is identified, enter "None" on the line below:

Name and address of person(s): \_\_\_\_\_  
\_\_\_\_\_  
\_\_\_\_\_  
\_\_\_\_\_

**RETURN WITH SUBCONTRACT**

**4. Debarment Disclosure.** For each of the persons identified under Sections 2 and 3 of this form, disclose whether any of the following has occurred within the previous 10 years: debarment from contracting with any governmental entity; professional licensure discipline; bankruptcies; adverse civil judgments and administrative findings; and criminal felony convictions. This disclosure is a continuing obligation and must be promptly supplemented for accuracy throughout the procurement process and term of the contract. If no person is identified, enter "None" on the line below:

Name of person(s): \_\_\_\_\_

Nature of disclosure: \_\_\_\_\_  
\_\_\_\_\_  
\_\_\_\_\_

**APPLICABLE STATEMENT**

**This Disclosure Form A is submitted on behalf of the INDIVIDUAL named on previous page. Under penalty of perjury, I certify the contents of this disclosure to be true and accurate to the best of my knowledge.**

Completed by:  \_\_\_\_\_ Date \_\_\_\_\_  
Signature of Individual or Authorized Officer

**NOT APPLICABLE STATEMENT**

**Under penalty of perjury, I have determined that no individuals associated with this organization meet the criteria that would require the completion of this Form A.**

**This Disclosure Form A is submitted on behalf of the SUBCONTRACTOR listed on the previous page.**

\_\_\_\_\_ Date \_\_\_\_\_  
Signature of Authorized Officer

RETURN WITH SUBCONTRACT

ILLINOIS DEPARTMENT OF TRANSPORTATION

Form B Subcontractor: Other Contracts & Financial Related Information Disclosure

Form with fields: Subcontractor Name, Legal Address, City, State, Zip, Telephone Number, Email Address, Fax Number (if available)

Disclosure of the information contained in this Form is required by the Section 50-35 of the Code (30 ILCS 500). This information shall become part of the publicly available contract file. This Form B must be completed for subcontracts with a total value of \$50,000 or more, from subcontractors identified in Section 20-120 of the Code, and for all open-ended contracts.

DISCLOSURE OF OTHER CONTRACTS, SUBCONTRACTS, AND PROCUREMENT RELATED INFORMATION

1. Identifying Other Contracts & Procurement Related Information. The SUBCONTRACTOR shall identify whether it has any pending contracts, subcontracts, including leases, bids, proposals, or other ongoing procurement relationship with any other State of Illinois agency: Yes \_\_\_ No \_\_\_

If "No" is checked, the subcontractor only needs to complete the signature box on the bottom of this page.

2. If "Yes" is checked. Identify each such relationship by showing State of Illinois agency name and other descriptive information such as bid or project number (attach additional pages as necessary). SEE DISCLOSURE FORM INSTRUCTIONS:

THE FOLLOWING STATEMENT MUST BE CHECKED

Signature box with fields: Signature of Authorized Officer, Date

OWNERSHIP CERTIFICATION

Please certify that the following statement is true if the individuals for all submitted Form A disclosures do not total 100% of ownership

Any remaining ownership interest is held by individuals receiving less than \$106,447.20 of the bidding entity's or parent entity's distributive income or holding less than a 5% ownership interest.

Yes No N/A (Form A disclosure(s) established 100% ownership)





- 1. TIME AND PLACE OF OPENING BIDS.** Sealed proposals for the improvement described herein will be received by the Department of Transportation. Electronic bids are to be submitted to the electronic bidding system (ics-Integrated Contractors Exchange). Paper-based bids are to be submitted to the Chief Procurement Officer for the Department of Transportation in care of the Chief Contracts Official at the Harry R. Hanley Building, 2300 South Dirksen Parkway, in Springfield, Illinois until 10:00 o'clock a.m. September 19, 2014. All bids will be gathered, sorted, publicly opened and read in the auditorium at the Department of Transportation's Harry R. Hanley Building shortly after the 10:00 a.m. cut off time.
- 2. DESCRIPTION OF WORK.** The proposed improvement is identified and advertised for bids in the Invitation for Bids as:

**Contract No. 63843  
MCHENRY County  
Section 08-00106-00-FP (Crystal Lake)  
Project M-9003(685)  
Route FAU 124 (South Main Street)  
District 1 Construction Funds**

**This project consists of milling, base course widening, binder and surface courses, patching, curb and gutter replacement, sidewalk replacement, storm sewer and drainage structure adjustment, roadway lighting, traffic signal installation, landscaping and striping on South Main Street from US Route 14 to James R. Rakow Road in the City of Crystal Lake.**

- 3. INSTRUCTIONS TO BIDDERS.** (a) This Notice, the invitation for bids, proposal and letter of award shall, together with all other documents in accordance with Article 101.09 of the Standard Specifications for Road and Bridge Construction, become part of the contract. Bidders are cautioned to read and examine carefully all documents, to make all required inspections, and to inquire or seek explanation of the same prior to submission of a bid.  
  
(b) State law, and, if the work is to be paid wholly or in part with Federal-aid funds, Federal law requires the bidder to make various certifications as a part of the proposal and contract. By execution and submission of the proposal, the bidder makes the certification contained therein. A false or fraudulent certification shall, in addition to all other remedies provided by law, be a breach of contract and may result in termination of the contract.
- 4. AWARD CRITERIA AND REJECTION OF BIDS.** This contract will be awarded to the lowest responsive and responsible bidder considering conformity with the terms and conditions established by the Department in the rules, Invitation for Bids and contract documents. The issuance of plans and proposal forms for bidding based upon a prequalification rating shall not be the sole determinant of responsibility. The Department reserves the right to determine responsibility at the time of award, to reject any or all proposals, to readvertise the proposed improvement, and to waive technicalities.

By Order of the  
Illinois Department of Transportation

Erica J. Borggren,  
Acting Secretary

INDEX  
FOR  
SUPPLEMENTAL SPECIFICATIONS  
AND RECURRING SPECIAL PROVISIONS

Adopted January 1, 2014

This index contains a listing of SUPPLEMENTAL SPECIFICATIONS, frequently used RECURRING SPECIAL PROVISIONS, and LOCAL ROADS AND STREETS RECURRING SPECIAL PROVISIONS.

ERRATA Standard Specifications for Road and Bridge Construction (Adopted 1-1-12) (Revised 1-1-14)

SUPPLEMENTAL SPECIFICATIONS

<u>Std. Spec. Sec.</u>	<u>Page No.</u>
101 Definition of Terms .....	1
102 Advertisement, Bidding, Award, and Contract Execution .....	2
105 Control of Work .....	3
106 Control of Materials .....	5
107 Legal Regulations and Responsibility to Public .....	6
108 Prosecution and Progress .....	14
109 Measurement and Payment .....	15
202 Earth and Rock Excavation .....	17
211 Topsoil and Compost .....	18
253 Planting Woody Plants .....	19
280 Temporary Erosion and Sediment Control .....	21
312 Stabilized Subbase .....	22
406 Hot-Mix Asphalt Binder and Surface Course .....	23
407 Hot-Mix Asphalt Pavement (Full-Depth) .....	26
420 Portland Cement Concrete Pavement .....	30
424 Portland Cement Concrete Sidewalk .....	32
440 Removal of Existing Pavement and Appurtenances .....	33
503 Concrete Structures .....	34
504 Precast Concrete Structures .....	37
506 Cleaning and Painting New Steel Structures .....	38
512 Piling .....	39
516 Drilled Shafts .....	40
521 Bearings .....	41
540 Box Culverts .....	42
588 Bridge Relief Joint System .....	43
589 Elastic Joint Sealer .....	45
602 Catch Basin, Manhole, Inlet, Drainage Structure, and Valve Vault Construction, Adjustment, and Reconstruction .....	46
603 Adjusting Frames and Grates of Drainage and Utility Structures .....	47
606 Concrete Gutter, Curb, Median, and Paved Ditch .....	49
610 Shoulder Inlets with Curb .....	50
639 Precast Prestressed Concrete Sight Screen .....	51
642 Shoulder Rumble Strips .....	52
643 Impact Attenuators .....	53
644 High Tension Cable Median Barrier .....	55
701 Work Zone Traffic Control and Protection .....	57
706 Impact Attenuators, Temporary .....	60
707 Movable Traffic Barrier .....	63
708 Temporary Water Filled Barrier .....	65
730 Wood Sign Support .....	67
780 Pavement Striping .....	68
860 Master Controller .....	73

1001	Cement .....	74
1003	Fine Aggregates .....	75
1004	Coarse Aggregates .....	77
1006	Metals .....	81
1011	Mineral Filler .....	83
1017	Packaged, Dry, Combined Materials for Mortar .....	84
1018	Packaged Rapid Hardening Mortar or Concrete .....	85
1019	Controlled Low-Strength Material .....	86
1020	Portland Cement Concrete .....	87
1024	Grout and Nonshrink Grout .....	126
1030	Hot-Mix Asphalt .....	127
1040	Drain Pipe, Tile, Drainage Mat, and Wall Drain .....	132
1042	Precast Concrete Products .....	133
1070	Foundation and Breakaway Devices .....	134
1073	Controller .....	135
1081	Materials for Planting .....	136
1082	Preformed Bearing Pads .....	137
1083	Elastomeric Bearings .....	138
1095	Pavement Markings .....	139
1101	General Equipment .....	142
1102	Hot-Mix Asphalt Equipment .....	144
1105	Pavement Marking Equipment .....	146
1106	Work Zone Traffic Control Devices .....	147

RECURRING SPECIAL PROVISIONS

The following RECURRING SPECIAL PROVISIONS indicated by an "X" are applicable to this contract and are included by reference:

<u>CHECK SHEET #</u>	<u>PAGE NO.</u>
1 X Additional State Requirements for Federal-Aid Construction Contracts (Eff. 2-1-69) (Rev. 1-1-10) .....	149
2 X Subletting of Contracts (Federal-Aid Contracts) (Eff. 1-1-88) (Rev. 5-1-93) .....	152
3 X EEO (Eff. 7-21-78) (Rev. 11-18-80) .....	153
4 Specific Equal Employment Opportunity Responsibilities Non Federal-Aid Contracts (Eff. 3-20-69) (Rev. 1-1-94) .....	163
5 Required Provisions - State Contracts (Eff. 4-1-65) (Rev. 1-1-13) .....	168
6 Asbestos Bearing Pad Removal (Eff. 11-1-03) .....	173
7 Asbestos Waterproofing Membrane and Asbestos Hot-Mix Asphalt Surface Removal (Eff. 6-1-89) (Rev. 1-1-09) .....	174
8 Haul Road Stream Crossings, Other Temporary Stream Crossings, and In-Stream Work Pads (Eff. 1-2-92) (Rev. 1-1-98) .....	175
9 Construction Layout Stakes Except for Bridges (Eff. 1-1-99) (Rev. 1-1-07) .....	176
10 X Construction Layout Stakes (Eff. 5-1-93) (Rev. 1-1-07) .....	179
11 Use of Geotextile Fabric for Railroad Crossing (Eff. 1-1-95) (Rev. 1-1-07) .....	182
12 Subsealing of Concrete Pavements (Eff. 11-1-84) (Rev. 1-1-07) .....	184
13 Hot-Mix Asphalt Surface Correction (Eff. 11-1-87) (Rev. 1-1-09) .....	188
14 Pavement and Shoulder Resurfacing (Eff. 2-1-00) (Rev. 1-1-09) .....	190
15 PCC Partial Depth Hot-Mix Asphalt Patching (Eff. 1-1-98) (Rev. 1-1-07) .....	191
16 Patching with Hot-Mix Asphalt Overlay Removal (Eff. 10-1-95) (Rev. 1-1-07) .....	193
17 Polymer Concrete (Eff. 8-1-95) (Rev. 1-1-08) .....	194
18 PVC Pipeliner (Eff. 4-1-04) (Rev. 1-1-07) .....	196
19 X Pipe Underdrains (Eff. 9-9-87) (Rev. 1-1-07) .....	197
20 Guardrail and Barrier Wall Delineation (Eff. 12-15-93) (Rev. 1-1-12) .....	198
21 Bicycle Racks (Eff. 4-1-94) (Rev. 1-1-12) .....	202
22 Temporary Modular Glare Screen System (Eff. 1-1-00) (Rev. 1-1-07) .....	204
23 Temporary Portable Bridge Traffic Signals (Eff. 8-1-03) (Rev. 1-1-07) .....	206
24 Work Zone Public Information Signs (Eff. 9-1-02) (Rev. 1-1-07) .....	208
25 Night Time Inspection of Roadway Lighting (Eff. 5-1-96) .....	209
26 English Substitution of Metric Bolts (Eff. 7-1-96) .....	210
27 English Substitution of Metric Reinforcement Bars (Eff. 4-1-96) (Rev. 1-1-03) .....	211
28 Calcium Chloride Accelerator for Portland Cement Concrete (Eff. 1-1-01) (Rev. 1-1-13) .....	212
29 Portland Cement Concrete Inlay or Overlay for Pavements (Eff. 11-1-08) (Rev. 1-1-13) .....	213
30 Quality Control of Concrete Mixtures at the Plant (Eff. 8-1-00) (Rev. 1-1-14) .....	216
31 X Quality Control/Quality Assurance of Concrete Mixtures (Eff. 4-1-92) (Rev. 1-1-14) .....	224
32 Digital Terrain Modeling for Earthwork Calculations (Eff. 4-1-07) .....	240
33 X Pavement Marking Removal (Eff. 4-1-09) .....	242
34 Preventive Maintenance – Bituminous Surface Treatment (Eff. 1-1-09) (Rev. 1-1-12) .....	243
35 Preventive Maintenance – Cape Seal (Eff. 1-1-09) (Rev. 1-1-12) .....	249
36 Preventive Maintenance – Micro-Surfacing (Eff. 1-1-09) (Rev. 1-1-12) .....	264
37 Preventive Maintenance – Slurry Seal (Eff. 1-1-09) (Rev. 1-1-12) .....	275
38 Temporary Raised Pavement Markers (Eff. 1-1-09) (Rev. 1-1-14) .....	285
39 Restoring Bridge Approach Pavements Using High-Density Foam (Eff. 1-1-09) (Rev. 1-1-12) .....	286

LOCAL ROADS AND STREETS RECURRING SPECIAL PROVISIONS

The following LOCAL ROADS AND STREETS RECURRING SPECIAL PROVISIONS indicated by an "X" are applicable to this contract and are included by reference:

Table of Contents

<u>CHECK SHEET #</u>	<u>PAGE NO.</u>
LRS 1 <b>Reserved</b> .....	290
LRS 2 <input type="checkbox"/> Furnished Excavation .....	291
LRS 3 <input checked="" type="checkbox"/> Work Zone Traffic Control Surveillance .....	292
LRS 4 <input checked="" type="checkbox"/> Flaggers in Work Zones .....	293
LRS 5 <input type="checkbox"/> Contract Claims .....	294
LRS 6 <input type="checkbox"/> Bidding Requirements and Conditions for Contract Proposals .....	295
LRS 7 <input type="checkbox"/> Bidding Requirements and Conditions for Material Proposals .....	301
LRS 8 <b>Reserved</b> .....	307
LRS 9 <input type="checkbox"/> Bituminous Surface Treatments .....	308
LRS 10 <b>Reserved</b> .....	309
LRS 11 <input type="checkbox"/> Employment Practices .....	310
LRS 12 <input type="checkbox"/> Wages of Employees on Public Works .....	312
LRS 13 <input type="checkbox"/> Selection of Labor .....	314
LRS 14 <input type="checkbox"/> Paving Brick and Concrete Paver Pavements and Sidewalks .....	315
LRS 15 <input type="checkbox"/> Partial Payments .....	318
LRS 16 <input type="checkbox"/> Protests on Local Lettings .....	319
LRS 17 <input type="checkbox"/> Substance Abuse Prevention Program.....	320
LRS 18 <input type="checkbox"/> Multigrade Cold Mix Asphalt .....	321

Index of Special Provisions

PAGE NO.

LOCATION OF PROJECT .....	1
DESCRIPTION OF PROJECT.....	1
MAINTENANCE OF ROADWAYS .....	1
STATUS OF UTILITIES TO BE ADJUSTED.....	2
TRAFFIC CONTROL PLAN.....	3
COMPLETION DATE PLUS WORKING DAYS .....	4
TRAFFIC CONTROL AND PROTECTION (ARTERIALS) .....	4
FINE AGGREGATE FOR HOT- MIX ASPHALT (HMA) (D-1) .....	5
COARSE AGGREGATE FOR BACKFILL, TRENCH BACKFILL AND BEDDING (D-1) .....	5
TEMPORARY INFORMATION SIGNING.....	6
RECLAIMED ASPHALT PAVEMENT AND RECLAIMED ASPHALT SHINGLES (D-1)	8
HMA MIXTURE DESIGN REQUIREMENTS (D-1).....	18
FRICITION SURFACE AGGREGATE (D1) .....	24
GROUND TIRE RUBBER (GTR) MODIFIED ASPHALT BINDER (D-1).....	27
AGGREGATE SUBGRADE IMPROVEMENT (D-1) .....	28

TRENCH BACKFILL .....	31
ADJUSTMENTS AND RECONSTRUCTIONS .....	31
FRAMES AND LIDS TO BE ADJUSTED (SPECIAL).....	32
DRAINAGE AND INLET PROTECTION UNDER TRAFFIC (D-1).....	32
PUBLIC CONVENIENCE AND SAFETY (D-1) .....	34
FIRE HYDRANTS TO BE REMOVED.....	34
RECESSED REFLECTIVE PAVEMENT MARKER.....	35
TEMPORARY PAVEMENT .....	36
TREATMENT STRUCTURES.....	36
CHAIN LINK FENCE REMOVAL .....	41
COMBINATION CONCRETE CURB AND GUTTER, TYPE B-6.12 (SPECIAL) AND .....	41
COMBINATION CONCRETE CURB AND GUTTER, TYPE B-6.24 (SPECIAL).....	41
HOT-MIX ASPHALT SURFACE REMOVAL, VARIABLE DEPTH .....	42
MANHOLES, TYPE A, 6'-DIAMETER, WITH 2 TYPE 1 FRAME, CLOSED LID, RESTRICTOR PLATE.....	43
BIKE PATH REMOVAL .....	43
STORM SEWER ADJACENT TO OR CROSSING WATER MAIN .....	43
STORM SEWER, RUBBER GASKET.....	44

RETAINING WALL REMOVAL.....44

TELESCOPING STEEL SIGN SUPPORT (SPECIAL).....45

HOT-MIX ASPHALT DRIVEWAY PAVEMENT, 10” .....45

SANITARY MANHOLES TO BE ADJUSTED.....46

ADJUSTING WATER MAIN.....46

SHREDDED BARK MULCH 3” .....47

FLASHING BEACON, POST MOUNTED, SOLAR POWERED INSTALLATION .....48

REMOVE EXISTING SIGN SUPPORT .....48

REMOVE EXISTING SIGN POST .....49

SPLIT RAIL FENCE.....49

AGGREGATE SURFACE COURSE FOR TEMPORARY ACCESS .....49

EMBANKMENT II.....51

FIRE HYDRANT WITH AUXILIARY VALVE AND VALVE BOX.....52

PORTLAND CEMENT CONCRETE BASE COURSE WIDENING, 10 ½”.....52

SANITARY SEWER SERVICE REMOVAL AND REPLACEMENT:.....52

ADJUSTING SANITARY SEWER CLEANOUT .....53

WEED CONTROL, BROADLEAF IN TURF.....53



EXPLORATION TRENCH (SPECIAL).....54

FLY ASH RESTRICTION .....55

HOT-MIX ASPHALT – PRIME COAT (D-1) .....55

RECLAIMED WATER (D-1) .....59

WATER MAIN LINE STOP 8” .....61

REMOVE EXISTING HANDHOLE .....61

REMOVE EXISTING DOUBLE HANDHOLE.....62

REMOVE EXISTING CONCRETE FOUNDATION .....62

**TRAFFIC SIGNAL SPECIFICATIONS (MCDOT) .....62**

MAST ARM SIGN PANELS. ....63

SUBMITTALS. ....63

MARKING PROPOSED LOCATIONS .....65

INSPECTION OF ELECTRICAL SYSTEMS.....65

MAINTENANCE AND RESPONSIBILITY.....65

DAMAGE TO TRAFFIC SIGNAL SYSTEM.....67

TRAFFIC SIGNAL INSPECTION (TURN-ON).....67

LOCATING UNDERGROUND FACILITIES.....72

RESTORATION OF WORK AREA.....72

ELECTRIC SERVICE INSTALLATION.....72

GROUNDING OF TRAFFIC SIGNAL SYSTEMS. ....75

GROUNDING EXISTING HANDHOLE FRAME AND COVER.....76

COILABLE NON-METALLIC CONDUIT.....77

UNDERGROUND RACEWAYS. ....78

HANDHOLES. ....78

GROUNDING CABLE. ....79

RAILROAD INTERCONNECT CABLE. ....79

FIBER OPTIC TRACER CABLE.....80

MAINTENANCE OF EXISTING TRAFFIC SIGNAL INSTALLATION.....80

TRAFFIC ACTUATED CONTROLLER. ....82

MASTER CONTROLLER.....83

UNINTERRUPTIBLE POWER SUPPLY.....85

FIBER OPTIC CABLE.....86

MAST ARM ASSEMBLY AND POLE. ....86

CONCRETE FOUNDATIONS.....88

LIGHT EMITTING DIODE (LED) SIGNAL HEAD AND OPTICALLY PROGRAMMED LED SIGNAL HEAD. ....	89
LIGHT EMITTING DIODE (LED), SIGNAL HEAD, RETROFIT .....	89
LIGHT EMITTING DIODE (LED) PEDESTRIAN SIGNAL HEAD .....	90
DETECTOR LOOP. ....	90
EMERGENCY VEHICLE PRIORITY SYSTEM. ....	93
EMERGENCY VEHICLE PRIORITY SYSTEM LINE SENSOR CABLE, NO. 20 3/C .....	93
TEMPORARY TRAFFIC SIGNAL INSTALLATION.....	94
REMOVE EXISTING TRAFFIC SIGNAL EQUIPMENT. ....	101
TRAFFIC SIGNAL PAINTING.....	101
ILLUMINATED STREET NAME SIGN .....	103
RE-OPTIMIZE TRAFFIC SIGNAL SYSTEM.....	103
OPTIMIZE TRAFFIC SIGNAL SYSTEM .....	106
TEMPORARY TRAFFIC SIGNAL TIMING .....	109
MODIFYING EXISTING CONTROLLER CABINET.....	110
PEDESTRIAN PUSH-BUTTON. ....	111
CONTROLLER CABINET AND PERIPHERAL EQUIPMENT.....	111
RAILROAD, FULL-ACTUATED CONTROLLER AND CABINET.....	113

UNINTERRUPTIBLE POWER SUPPLY (UPS) .....	113
ELECTRIC CABLE. ....	116
TRAFFIC SIGNAL POST.....	116
PEDESTRIAN PUSH-BUTTON POST.....	116
MAST ARM ASSEMBLY AND POLE. ....	117
LIGHT EMITTING DIODE (LED) TRAFFIC SIGNAL HEAD. ....	117
LIGHT EMITTING DIODE (LED) PEDESTRIAN COUNTDOWN SIGNAL HEAD. ....	121
TRAFFIC SIGNAL BACKPLATE.....	122
INDUCTIVE LOOP DETECTOR.....	123
ILLUMINATED SIGN, LIGHT EMITTING DIODE.....	123
ILLUMINATED STREET NAME SIGN. ....	123
FULL-ACTUATED CONTROLLER AND TYPE IV CABINET, SPECIAL.....	126
ELECTRIC CABLE IN CONDUIT, SIGNAL, NO. 18, 3/C.....	127
VIDEO DETECTION SYSTEM, (COMPLETE INTERSECTION).....	127
<b>CITY OF CRYSTAL LAKE TRAFFIC SIGNAL SPECIFICATIONS .....</b>	<b>132</b>
SECTION 720 SIGNING .....	132
MAST ARM SIGN PANELS.....	132

DIVISION 800 ELECTRICAL .....133

SUBMITTALS. ....133

INSPECTION OF ELECTRICAL SYSTEMS.....134

MAINTENANCE AND RESPONSIBILITY.....134

DAMAGE TO TRAFFIC SIGNAL SYSTEM.....136

TRAFFIC SIGNAL INSPECTION (TURN-ON).....137

LOCATING UNDERGROUND FACILITIES. ....140

RESTORATION OF WORK AREA.....141

ELECTRIC SERVICE INSTALLATION.....141

GROUNDING OF TRAFFIC SIGNAL SYSTEMS. ....144

GROUNDING EXISTING HANDHOLE FRAME AND COVER.....145

COILABLE NON-METALLIC CONDUIT.....146

HANDHOLES. ....147

GROUNDING CABLE. ....147

RAILROAD INTERCONNECT CABLE. ....148

FIBER OPTIC TRACER CABLE.....148

MAINTENANCE OF EXISTING TRAFFIC SIGNAL INSTALLATION.....149

TRAFFIC ACTUATED CONTROLLER.....	151
MASTER CONTROLLER.....	151
UNINTERRUPTIBLE POWER SUPPLY.....	153
FIBER OPTIC CABLE.....	154
MAST ARM ASSEMBLY AND POLE.....	155
CONCRETE FOUNDATIONS.....	157
LIGHT EMITTING DIODE (LED) SIGNAL HEAD AND OPTICALLY PROGRAMMED LED SIGNAL HEAD.....	157
LIGHT EMITTING DIODE (LED), SIGNAL HEAD, RETROFIT.....	158
LIGHT EMITTING DIODE (LED) PEDESTRIAN SIGNAL HEAD.....	158
DETECTOR LOOP.....	159
EMERGENCY VEHICLE PRIORITY SYSTEM.....	161
TEMPORARY TRAFFIC SIGNAL INSTALLATION.....	162
REMOVE EXISTING TRAFFIC SIGNAL EQUIPMENT.....	169
TRAFFIC SIGNAL PAINTING.....	170
ILLUMINATED STREET NAME SIGN.....	171
RE-OPTIMIZE TRAFFIC SIGNAL SYSTEM.....	172
OPTIMIZE TRAFFIC SIGNAL SYSTEM.....	174

TEMPORARY TRAFFIC SIGNAL TIMINGS .....	177
MODIFYING EXISTING CONTROLLER CABINET.....	178
PEDESTRIAN PUSH-BUTTON. ....	179
CONTROLLER CABINET AND PERIPHERAL EQUIPMENT.....	179
RAILROAD, FULL-ACTUATED CONTROLLER AND CABINET.....	181
UNINTERRUPTIBLE POWER SUPPLY (UPS). ....	181
ELECTRIC CABLE. ....	183
TRAFFIC SIGNAL POST.....	184
PEDESTRIAN PUSH-BUTTON POST.....	184
MAST ARM ASSEMBLY AND POLE. ....	184
LIGHT EMITTING DIODE (LED) TRAFFIC SIGNAL HEAD. ....	184
LIGHT EMITTING DIODE (LED) PEDESTRIAN COUNTDOWN SIGNAL HEAD. ....	188
TRAFFIC SIGNAL BACKPLATE.....	190
INDUCTIVE LOOP DETECTOR.....	190
ILLUMINATED SIGN, LIGHT EMITTING DIODE.....	191
ILLUMINATED STREET NAME SIGN .....	191
ELECTRIC CABLE IN CONDUIT NO. 20 3/C, TWISTED, SHIELDED.....	194

LED INTERNALLY ILLUMINATED STREET NAME SIGN .....195

**ROADWAY LIGHTING SPECIFICATIONS .....196**

GENERAL ELECTRICAL REQUIREMENTS.....196

UNIT DUCT .....201

TEMPORARY WOOD POLE, INSTALL ONLY .....202

ELECTRIC SERVICE INSTALLATION.....203

ELECTRIC UTILITY SERVICE CONNECTION (COMED).....204

UNDERGROUND RACEWAYS .....205

LUMINAIRE SAFETY CABLE ASSEMBLY.....206

LUMINAIRE .....207

MAINTENANCE OF LIGHTING SYSTEMS .....214

WIRE AND CABLE.....218

ELECTRIC SERVICE DISCONNECT, LIGHTING AND TRAFFIC SIGNAL.....219

UNDERPASS LUMINAIRE, HPS, STAINLESS STEEL HOUSING .....221

    JUNCTION BOX EMBEDDED IN STRUCTURE.....239

LIGHTING CONTROLLER, RADIO CONTROL, DUPLEX CONSOLE TYPE, WITH  
    SCADA.....240

LIGHT TOWER .....251



PROTECTION AND MAINTENANCE OF EXISTING UNDERPASS LUMINAIRES .....	280
EXPOSED RACEWAYS .....	282
TEMPORARY LIGHTING FOR SINGLE LANE STAGING.....	286
LIGHTING CONTROLLER, SPECIAL.....	290
STORM SEWERS TO BE CLEANED.....	292
IDOT TRAINING PROGRAM GRADUATE ON-THE-JOB TRAINING SPECIAL PROVISION (TPG)	293
PSI SPECIAL WASTE AND NON-SPECIAL WASTE	296
SITE HEALTH AND SAFETY SUPPLEMENT	301
STORM WATER POLLUTION PREVENTION PLAN, NOT, ION, AND NOT	367

INDEX LOCAL ROADS AND STREETS SPECIAL PROVISIONS

<u>LR #</u>	<u>Pg #</u>	<u>Special Provision Title</u>	<u>Effective</u>	<u>Revised</u>
LR SD12		<input type="checkbox"/> Slab Movement Detection Device	Nov. 11, 1984	Jan. 1, 2007
LR SD13		<input type="checkbox"/> Required Cold Milled Surface Texture	Nov. 1, 1987	Jan. 1, 2007
LR SD406		<input type="checkbox"/> <b>RESCINDED</b>		
LR 102-2		<input type="checkbox"/> Bidding Requirements and Conditions for Contract Proposals	Jan. 1, 2001	Jan. 1, 2014
LR 105	381	<input checked="" type="checkbox"/> Cooperation with Utilities	Jan. 1, 1999	Jan. 1, 2007
LR 107-2		<input type="checkbox"/> Railroad Protective Liability Insurance for Local Lettings	Mar. 1, 2005	Jan. 1, 2006
LR 107-4	384	<input checked="" type="checkbox"/> Insurance	Feb. 1, 2007	Aug. 1, 2007
LR 107-7		<input type="checkbox"/> Wages of Employees on Public Works	Jan. 1, 1999	Jan. 1, 2014
LR 108		<input type="checkbox"/> Combination Bids	Jan. 1, 1994	Mar. 1, 2005
LR 109		<input type="checkbox"/> Equipment Rental Rates	Jan. 1, 2012	
LR 212		<input type="checkbox"/> Shaping Roadway	Aug. 1, 1969	Jan. 1, 2002
LR 355-1		<input type="checkbox"/> Bituminous Stabilized Base Course, Road Mix or Traveling Plant Mix	Oct. 1, 1973	Jan. 1, 2007
LR 355-2		<input type="checkbox"/> Bituminous Stabilized Base Course, Plant Mix	Feb. 20, 1963	Jan. 1, 2007
LR 400-1		<input type="checkbox"/> Bituminous Treated Earth Surface	Jan. 1, 2007	Apr. 1, 2012
LR 400-2		<input type="checkbox"/> Bituminous Surface Plant Mix (Class B)	Jan. 1, 2008	
LR 400-3		<input type="checkbox"/> Hot In-Place Recycling (HIR) – Surface Recycling	Jan. 1, 2012	
LR 400-4		<input type="checkbox"/> Full-Depth Reclamation (FDR) with Emulsified Asphalt	Apr. 1, 2012	Jun. 1, 2012
LR 400-5		<input type="checkbox"/> Cold In-Place Recycling (CIR) With Emulsified Asphalt	Apr. 1, 2012	Jun. 1, 2012
LR 400-6		<input type="checkbox"/> Cold In Place Recycling (CIR) with Foamed Asphalt	June 1, 2012	
LR 400-7		<input type="checkbox"/> Full-Depth Reclamation (FDR) with Foamed Asphalt	June 1, 2012	
LR 402		<input type="checkbox"/> Salt Stabilized Surface Course	Feb. 20, 1963	Jan. 1, 2007
LR 403-1		<input type="checkbox"/> Surface Profile Milling of Existing, Recycled or Reclaimed Flexible Pavement	Apr. 1, 2012	Jun. 1, 2012
LR 403-2		<input type="checkbox"/> Bituminous Hot Mix Sand Seal Coat	Aug. 1, 1969	Jan. 1, 2007
LR 406		<input type="checkbox"/> Filling HMA Core Holes with Non-shrink Grout	Jan. 1, 2008	
LR 420		<input type="checkbox"/> PCC Pavement (Special)	May 12, 1964	Jan. 2, 2007
LR 442		<input type="checkbox"/> Bituminous Patching Mixtures for Maintenance Use	Jan. 1, 2004	Jun. 1, 2007
LR 451		<input type="checkbox"/> Crack Filling Bituminous Pavement with Fiber-Asphalt	Oct. 1, 1991	Jan. 1, 2007
LR 503-1		<input type="checkbox"/> Furnishing Class Sl Concrete	Oct. 1, 1973	Jan. 1, 2002
LR 503-2		<input type="checkbox"/> Furnishing Class Sl Concrete (Short Load)	Jan. 1, 1989	Jan. 1, 2002
LR 542		<input type="checkbox"/> Pipe Culverts, Type _____ (Furnished)	Sep. 1, 1964	Jan. 1, 2007
LR 663		<input type="checkbox"/> Calcium Chloride Applied	Jun. 1, 1958	Jan. 1, 2007
LR 702		<input type="checkbox"/> Construction and Maintenance Signs	Jan. 1, 2004	Jun. 1, 2007
LR 1000-1		<input type="checkbox"/> Cold In-Place Recycling (CIR) and Full Depth Reclamation (FDR) with Emulsified Asphalt Mix Design Procedures	Apr. 1, 2012	Jun. 1, 2012
LR 1000-2		<input type="checkbox"/> Cold In-Place Recycling (CIR) and Full Depth Reclamation (FDR) with Foamed Asphalt Mix Design Procedures	June 1, 2012	
LR 1004		<input type="checkbox"/> Coarse Aggregate for Bituminous Surface Treatment	Jan. 1, 2002	Jan. 1, 2007
LR 1030		<input type="checkbox"/> Growth Curve	Mar. 1, 2008	Jan. 1, 2010
LR 1032-1		<input type="checkbox"/> Emulsified Asphalts	Jan. 1, 2007	Feb. 7, 2008
LR 1102		<input type="checkbox"/> Road Mix or Traveling Plan Mix Equipment	Jan. 1, 2007	

**BDE SPECIAL PROVISIONS**  
For the August 1 and September 19, 2014 Lettings

The following special provisions indicated by an "x" are applicable to this contract. An \* indicates a new or revised special provision for the letting.

<u>File Name</u>	<u>Pg.</u>		<u>Special Provision Title</u>	<u>Effective</u>	<u>Revised</u>
80240			Above Grade Inlet Protection	July 1, 2009	Jan. 1, 2012
80099			Accessible Pedestrian Signals (APS)	April 1, 2003	Jan. 1, 2014
80274			Aggregate Subgrade Improvement	April 1, 2012	Jan. 1, 2013
80192			Automated Flagger Assistance Device	Jan. 1, 2008	
80173	385	X	Bituminous Materials Cost Adjustments	Nov. 2, 2006	Aug. 1, 2013
80241			Bridge Demolition Debris	July 1, 2009	
50261			Building Removal-Case I (Non-Friable and Friable Asbestos)	Sept. 1, 1990	April 1, 2010
50481			Building Removal-Case II (Non-Friable Asbestos)	Sept. 1, 1990	April 1, 2010
50491			Building Removal-Case III (Friable Asbestos)	Sept. 1, 1990	April 1, 2010
50531			Building Removal-Case IV (No Asbestos)	Sept. 1, 1990	April 1, 2010
80292			Coarse Aggregate in Bridge Approach Slabs/Footings	April 1, 2012	April 1, 2013
* 80310	388	X	Coated Galvanized Steel Conduit	Jan. 1, 2013	Aug. 1, 2014
* 80341	390	X	Coilable Nonmetallic Conduit	Aug. 1, 2014	
80198			Completion Date (via calendar days)	April 1, 2008	
80199			Completion Date (via calendar days) Plus Working Days	April 1, 2008	
80293			Concrete Box Culverts with Skews > 30 Degrees and Design Fills ≤ 5 Feet	April 1, 2012	April 1, 2014
80294			Concrete Box Culverts with Skews ≤ 30 Degrees Regardless of Design Fill and Skews > 30 Degrees with Design Fills > 5 Feet	April 1, 2012	April 1, 2014
80311			Concrete End Sections for Pipe Culverts	Jan. 1, 2013	
* 80334	391	X	Concrete Gutter, Curb, Median, and Paved Ditch	April 1, 2014	Aug. 1, 2014
80277			Concrete Mix Design – Department Provided	Jan. 1, 2012	Jan. 1, 2014
80261	392	X	Construction Air Quality – Diesel Retrofit	June 1, 2010	Jan. 1, 2014
80335	395	X	Contract Claims	April 1, 2014	
80029	396	X	Disadvantaged Business Enterprise Participation	Sept. 1, 2000	Aug. 2, 2011
80265			Friction Aggregate	Jan. 1, 2011	
80229			Fuel Cost Adjustment	April 1, 2009	July 1, 2009
80329			Glare Screen	Jan. 1, 2014	
80303	406	X	Granular Materials	Nov. 1, 2012	
* 80304			Grooving for Recessed Pavement Markings	Nov. 1, 2012	Aug. 1, 2014
80246	407	X	Hot-Mix Asphalt – Density Testing of Longitudinal Joints	Jan. 1, 2010	April 1, 2012
80322			Hot-Mix Asphalt – Mixture Design Composition and Volumetric Requirements	Nov 1, 2013	
80323			Hot-Mix Asphalt – Mixture Design Verification and Production	Nov 1, 2013	
80315			Insertion Lining of Culverts	Jan. 1, 2013	Nov 1, 2013
80336			Longitudinal Joint and Crack Patching	April 1, 2014	
80324			LRFD Pipe Culvert Burial Tables	Nov 1, 2013	April 1, 2014
80325	409	X	LRFD Storm Sewer Burial Tables	Nov 1, 2013	
* 80045			Material Transfer Device	June 15, 1999	Aug. 1, 2014
* 80342			Mechanical Side Tie Bar Inserter	Aug. 1, 2014	
80165			Moisture Cured Urethane Paint System	Nov. 1, 2006	Jan. 1, 2010
80337	419	X	Paved Shoulder Removal	April 1, 2014	
80330	420	X	Pavement Marking for Bike Symbol	Jan. 1, 2014	
80298			Pavement Marking Tape Type IV	April 1, 2012	
80254	421	X	Pavement Patching	Jan. 1, 2010	
80331	422	X	Payrolls and Payroll Records	Jan. 1, 2014	
80332			Portland Cement Concrete – Curing of Abutments and Piers	Jan. 1, 2014	
80326	424	X	Portland Cement Concrete Equipment	Nov 1, 2013	

<u>File Name</u>	<u>Pg.</u>		<u>Special Provision Title</u>	<u>Effective</u>	<u>Revised</u>
80338			Portland Cement Concrete Partial Depth Hot-Mix Asphalt Patching	April 1, 2014	
* 80343	425	X	Precast Concrete Handhole	Aug. 1, 2014	
80300			Preformed Plastic Pavement Marking Type D - Inlaid	April 1, 2012	
80328	426	X	Progress Payments	Nov. 2, 2013	
80281	427	X	Quality Control/Quality Assurance of Concrete Mixes	Jan. 1, 2012	Jan. 1, 2014
34261			Railroad Protective Liability Insurance	Dec. 1, 1986	Jan. 1, 2006
80157			Railroad Protective Liability Insurance (5 and 10)	Jan. 1, 2006	
80306			Reclaimed Asphalt Pavement (RAP) and Reclaimed Asphalt Shingles (RAS)	Nov. 1, 2012	April 1, 2014
80327			Reinforcement bars	Nov 1, 2013	
80283	428	X	Removal and Disposal of Regulated Substances	Jan. 1, 2012	Nov. 2, 2012
80319	432	X	Removal and Disposal of Surplus Materials	Nov. 2, 2012	
* 80344	433	X	Rigid Metal Conduit	Aug. 1, 2014	
80307			Seeding	Nov. 1, 2012	
* 80340			Speed Display Trailer	April 2, 2014	
80339			Stabilized Subbase	April 1, 2014	
80127			Steel Cost Adjustment	April 2, 2004	April 1, 2009
80317			Surface Testing of Hot-Mix Asphalt Overlays	Jan. 1, 2013	
80301	434	X	Tracking the Use of Pesticides	Aug. 1, 2012	
80333			Traffic Control Setup and Removal Freeway/Expressway	Jan. 1, 2014	
20338	435	X	Training Special Provisions	Oct. 15, 1975	
80318			Traversable Pipe Grate	Jan. 1, 2013	April 1, 2014
* 80345			Underpass Luminaire	Aug. 1, 2014	
* 80346			Waterway Obstruction Warning Luminaire	Aug. 1, 2014	
80288	438	X	Warm Mix Asphalt	Jan. 1, 2012	Nov. 1, 2013
80302	442	X	Weekly DBE Trucking Reports	June 2, 2012	
80289			Wet Reflective Thermoplastic Pavement Marking	Jan. 1, 2012	
80071			Working Days	Jan. 1, 2002	

The following special provisions are in the 2014 Supplemental Specifications and Recurring Special Provisions:

<u>File Name</u>	<u>Special Provision Title</u>	<u>New Location</u>	<u>Effective</u>	<u>Revised</u>
80309	Anchor Bolts	Articles 1006.09, 1070.01, and 1070.03	Jan. 1, 2013	
80276	Bridge Relief Joint Sealer	Article 503.19 and Sections 588 and 589	Jan. 1, 2012	Aug. 1, 2012
80312	Drain Pipe, Tile, Drainage Mat, and Wall Drain	Article 101.01, 1040.03, and 1040.04	Jan. 1, 2013	
80313	Fabric Bearing Pads	Article 1082.01	Jan. 1, 2013	
80169	High Tension Cable Median Barrier	Section 644 and Article 1106.02	Jan. 1, 2007	Jan. 1, 2013
80320	Liquidated Damages	Article 108.09	April 1, 2013	
80297	Modified Urethane Pavement Marking	Section 780, Articles 1095.09 and 1105.04	April 1, 2012	
80253	Moveable Traffic Barrier	Section 707 and Article 1106.02	Jan. 1, 2010	Jan. 1, 2013
80231	Pavement Marking Removal	Recurring CS #33	April 1, 2009	
80321	Pavement Removal	Article 440.07	April 1, 2013	
80022	Payments to Subcontractors	Article 109.11	June 1, 2000	Jan. 1, 2006
80316	Placing and Consolidating Concrete	Articles 503.06, 503.07, and 516.12	Jan. 1, 2013	
80278	Planting Woody Plants	Section 253 and Article 1081.01	Jan. 1, 2012	Aug. 1, 2012
80305	Polyurea Pavement Markings	Article 780.14	Nov. 1, 2012	Jan. 1, 2013

<u>File Name</u>	<u>Special Provision Title</u>	<u>New Location</u>	<u>Effective</u>	<u>Revised</u>
80279	Portland Cement Concrete	Sections 312, 503, 1003, 1004, 1019, and 1020	Jan. 1, 2012	Nov. 1, 2013
80218	Preventive Maintenance – Bituminous Surface Treatment	Recurring CS #34	Jan. 1, 2009	April 1, 2012
80219	Preventive Maintenance – Cape Seal	Recurring CS #35	Jan. 1, 2009	April 1, 2012
80220	Preventive Maintenance – Micro Surfacing	Recurring CS #36	Jan. 1, 2009	April 1, 2012
80221	Preventive Maintenance – Slurry Seal	Recurring CS #37	Jan. 1, 2009	April 1, 2012
80224	Restoring Bridge Approach Pavements Using High-Density Foam	Recurring CS #39	Jan. 1, 2009	Jan. 1, 2012
80255	Stone Matrix Asphalt	Sections 406, 1003, 1004, 1030, and 1011	Jan. 1, 2010	Aug. 1, 2013
80143	Subcontractor Mobilization Payments	Article 109.12	April 2, 2005	April 1, 2011
80308	Synthetic Fibers in Concrete Gutter, Curb, Median and Paved Ditch	Articles 606.02 and 606.11	Nov. 1, 2012	
80286	Temporary Erosion and Sediment Control	Articles 280.04 and 280.08	Jan. 1, 2012	
80225	Temporary Raised Pavement Marker	Recurring CS #38	Jan. 1, 2009	
80256	Temporary Water Filled Barrier	Section 708 and Article 1106.02	Jan. 1, 2010	Jan. 1, 2013
80273	Traffic Control Deficiency Deduction	Article 105.03	Aug. 1, 2011	
80270	Utility Coordination and Conflicts	Articles 105.07, 107.19, 107.31, 107.37, 107.38, 107.39 and 107.40	April 1, 2011	Jan. 1, 2012

The following special provisions require additional information from the designer. The Special Provisions are:

- Bridge Demolition Debris
- Building Removal-Case I
- Building Removal-Case II
- Building Removal-Case III
- Building Removal-Case IV
- Completion Date
- Completion Date Plus Working Days
- DBE Participation
- Material Transfer Device
- Railroad Protective Liability Insurance
- Training Special Provisions
- Working Days

**GUIDE BRIDGE SPECIAL PROVISION INDEX/CHECK SHEET**

Effective as of the: June 13, 2014 Letting

Pg #	√	File Name	Title	Effective	Revised
		GBSP 4	Polymer Modified Portland Cement Mortar	June 7, 1994	July 26, 2013
		GBSP 12	Drainage System	June 10, 1994	Jan 1, 2007
		GBSP 13	High-Load Multi-Rotational Bearings	Oct 13, 1988	Oct 30, 2012
		GBSP 14	Jack and Remove Existing Bearings	April 20, 1994	Jan 1, 2007
		GBSP 15	Three Sided Precast Concrete Structure	July 12, 1994	Oct 15, 2011
		GBSP 16	Jacking Existing Superstructure	Jan 11, 1993	Jan 1, 2007
		GBSP 17	Bonded Preformed Joint Seal	July 12, 1994	Jan 1, 2007
		GBSP 18	Modular Expansion Joint	May 19, 1994	April 18, 2014
		GBSP 21	Cleaning and Painting Contact Surface Areas of Existing Steel Structures	June 30, 2003	May 18, 2011
		GBSP 25	Cleaning and Painting Existing Steel Structures	Oct 2, 2001	April 19, 2012
		GBSP 26	Containment and Disposal of Lead Paint Cleaning Residues	Oct 2, 2001	April 30, 2010
		GBSP 28	Deck Slab Repair	May 15, 1995	Oct 15, 2011
		GBSP 29	Bridge Deck Microsilica Concrete Overlay	May 15, 1995	Oct 30, 2012
		GBSP 30	Bridge Deck Latex Concrete Overlay	May 15, 1995	Jan 18, 2011
		GBSP 31	Bridge Deck High-Reactivity Metakaolin (HRM) Conc Overlay	Jan 21, 2000	Oct 30, 2012
		GBSP 32	Temporary Sheet Piling	Sept 2, 1994	Jan 31, 2012
		GBSP 33	Pedestrian Truss Superstructure	Jan 13, 1998	April 18, 2014
		GBSP 34	Concrete Wearing Surface	June 23, 1994	Feb 6, 2013
		GBSP 35	Silicone Bridge Joint Sealer	Aug 1, 1995	Oct 15, 2011
		GBSP 38	Mechanically Stabilized Earth Retaining Walls	Feb 3, 1999	April 18, 2014
		GBSP 42	Drilled Soldier Pile Retaining Wall	Sept 20, 2001	Jan 3, 2014
		GBSP 43	Driven Soldier Pile Retaining Wall	Nov 13, 2002	Jan 3, 2014
		GBSP 44	Temporary Soil Retention System	Dec 30, 2002	May 11, 2009
		GBSP 45	Bridge Deck Thin Polymer Overlay	May 7, 1997	Feb 6, 2013
		GBSP 46	Geotextile Retaining Walls	Sept 19, 2003	July 26, 2013
		GBSP 51	Pipe Underdrain for Structures	May 17, 2000	Jan 22, 2010
		GBSP 53	Structural Repair of Concrete	Mar 15, 2006	April 18, 2014
		GBSP 55	Erection of Curved Steel Structures	June 1, 2007	
		GBSP 56	Setting Piles in Rock	Nov 14, 1996	April 19, 2012
		GBSP 57	Temporary Mechanically Stabilized Earth Retaining Walls	Jan 6, 2003	April 18, 2014
		GBSP 59	Diamond Grinding and Surface Testing Bridge Sections	Dec 6, 2004	Jan 3, 2014
		GBSP 60	Containment and Disposal of Non-Lead Paint Cleaning Residues	Nov 25, 2004	Mar 6, 2009
		GBSP 61	Slipform Parapet	June 1, 2007	Aug 17, 2012
		GBSP 62	Concrete Deck Beams	June 13, 2008	Oct 9, 2009
443	X	GBSP 64	Segmental Concrete Block Wall	Jan 7, 1999	Oct 30, 2012
		GBSP 65	Precast Modular Retaining Walls	Mar 19, 2001	Jan 3, 2014
		GBSP 67	Structural Assessment Reports for Contractor's Means and Methods	Mar 6, 2009	
		GBSP 70	Braced Excavation	Aug 9, 1995	May 18, 2011
		GBSP 71	Aggregate Column Ground Improvement	Jan 15, 2009	Oct 15, 2011

	GBSP 72	Bridge Deck Fly Ash or GGBF Slag Concrete Overlay	Jan 18, 2011	Oct 15, 2011
	GBSP 73	Cofferdams	Oct 15, 2011	
	GBSP 74	Permanent Steel Sheet Piling (LRFD)	Jan 31, 2012	Aug 17, 2012
	GBSP 75	Bond Breaker for Prestressed Concrete Bulb-T Beams	April 19, 2012	
	GBSP 76	Granular Backfill for Structures	April 19, 2012	Oct 30, 2012
	GBSP 77	Weep Hole Drains for Abutments, Wingwalls, Retaining Walls And Culverts	April 19, 2012	Oct 22, 2013
	GBSP 78	Bridge Deck Construction	Oct 22, 2013	April 18, 2014

LIST ANY ADDITIONAL SPECIAL PROVISIONS BELOW

The following Guide Bridge Special Provisions have been incorporated into the 2012 Standard Specifications:

File Name	Title	Std Spec Location
GBSP22	Cleaning and Painting New Metal Structures	506
GBSP36	Surface Preparation and Painting Req. for Weathering Steel	506
GBSP50	Removal of Existing Non-composite Bridge Decks	501
GBSP58	Mechanical Splicers	508
GBSP63	Demolition Plans for Removal of Existing Structures	501
GBSP68	Piling	512
GBSP69	Freeze-Thaw Aggregates for Concrete Superstructures Poured on Grade	1004

The following Guide Bridge Special Provisions have been discontinued or have been superseded:

File Name	Title	Disposition:
GBSP37	Underwater Structure Excavation Protection	Replaced by GBSP73
GBSP11	Permanent Steel Sheet Piling	Replaced by GBSP74
GBSP47	High Performance Concrete Structures	Discontinued
GBSP52	Porous Granular Embankment (Special)	Replaced by GBSP76
GBSP66	Wave Equation Analysis of Piles	Discontinued

**STATE OF ILLINOIS**

**SPECIAL PROVISIONS**

The following Special Provisions supplement the "Standard Specifications for Road and Bridge Construction," adopted January 1, 2012, (hereinafter referred to as the Standard Specifications); the latest edition of the "Illinois Manual on Uniform Traffic Control Devices for Streets and Highways" in effect on the date of invitation for bids; and the "Manual of Test Procedures for Materials" in effect on the date of invitation for bids; and the Supplemental Specifications and Recurring Special Provisions indicated on the Check Sheet included herein which apply to and govern the construction of FAU Route 0124 (South Main Street), Section: 08-00106-00-FP, Project No. M-9003(685), Job No. C-91-722-10 in McHenry County, City of Crystal Lake and in case of conflict with any part or parts of said specifications, the said Special Provisions shall take precedence and shall govern.

**CONTRACT NO. 63843**

**LOCATION OF PROJECT**

The project is located along Pyott Road/South Main Street, beginning at station 19+48.69, a point on the centerline of Pyott Road 1,000 feet north of the centerline of Rakow Road and extends in a northerly direction for a gross and net length of 3,549.27 feet (0.67 miles) to station 54+97.96 just south of Liberty Road, within the City of Crystal Lake, McHenry County.

**DESCRIPTION OF PROJECT**

The work consists of HMA pavement milling, HMA base course widening, HMA binder, HMA surface course, Class D patches, curb and gutter replacement, sidewalk replacement, storm sewer and drainage structure adjustments and installation, roadway lighting, traffic signal installation, landscaping, striping, and all incidental and collateral work as necessary to complete the improvement shown herein and as described in the specifications.

**MAINTENANCE OF ROADWAYS**

Effective: September 30, 1985

Revised: November 1, 1996

Beginning on the date that work begins on this project, the Contractor shall assume responsibility for normal maintenance of all existing roadways within the limits of the improvement. This normal maintenance shall include all repair work deemed necessary by the



Engineer, but shall not include snow removal operations. Traffic control and protection for maintenance of roadways will be provided by the Contractor as required by the Engineer.

If items of work have not been provided in the contract or otherwise specified for payment, such items, including the traffic control and protection required by the Engineer, will be paid for in accordance with Article 109.04 of the Standard Specifications.

**STATUS OF UTILITIES TO BE ADJUSTED**

Effective: January 30, 1987

Revised: January 24, 2013

Utilities companies involved in this project have provided the following estimated durations:

Name of Utility	Type	Location	Estimated Duration of Time for the Completion of Relocation or Adjustments
AT&T 1000 Commerce Drive Floor 2 Oak Brook, IL 60523 Attn: Scott Fox (847) 888-6869	Telephone	Along Entire Project	Utility work has been completed.
Comcast 688 Industrial Drive Elmhurst, IL 60126 Attn: Pat Goheen 773-241-0245	Cable	Along Entire Project	Utility work has been completed.
Nicor Gas 1844 Ferry Road Naperville, IL 60563 Attn: Constance Lane (630) 388-3830	Natural Gas	Along Entire Project	Utility work has been completed.
ComEd Attn: Tom Stutzman (630) 437-2236	Electricity	Along Entire Project	Utility work has been completed.

The above represents the best information available to the Department and is included for the convenience of the bidder. The applicable portions of Articles 105.07 and 107.31 of the Standard Specifications shall apply.

In accordance with 605 ILCS 5/9-113 of the Illinois Compiled Statutes, utility companies have 90 days to complete the relocation of their facilities after receipt of written notice from the Department. The 90-day written notice will be sent to the utility companies after the following occurs:

- 1) Proposed right of way is clear for contract award.
- 2) Final plans have been sent to and received by the utility company.
- 3) Utility permit is received by the Department and the Department is ready to issue said permit.
- 4) If a permit has not been submitted, a 15 day letter is sent to the utility company notifying them they have 15 days to provide their permit application. After allowing 15 days for submission of the permit the 90 day notice is sent to the utility company.
- 5) Any time within the 90 day relocation period the utility company may request a waiver for additional time to complete their relocation. The Department has 10 days to review and respond to a waiver request.

### **TRAFFIC CONTROL PLAN**

Traffic Control shall be according to the applicable sections of the Standard Specifications, the Supplemental Specifications, the "Illinois Manual of Uniform Traffic Control Devices for Streets and Highways", any special details and Highway Standards contained in the plans, and the Special Provisions contained herein.

Special attention is called to Articles 107.09 of the Standard Specifications and the following Highway Standards, Details, Special Provisions, and Recurring Special Provisions contained herein, relating to traffic control.

The Contractor shall contact the City of Crystal Lake, IDOT District 1, and McHenry County DOT at least 72 hours in advance of beginning work.

STANDARDS: 701101-04, 701427-02, 701501-06, 701601-09, 701602-07, 701701-09, 701801-05, 701901-03, 780001-04

DETAILS: TC-10 – Traffic Control and Protection for Side Roads, Intersections, and Driveways  
TC-11– Typical Applications Raised Reflective Pavement Markers (Snow-Plow Resistant)  
TC-13 – District One Typical Pavement Markings  
TC-14 –Traffic Control and Protection at Turn Bays (To Remain Open To Traffic)  
TC-16 – Pavement Marking Letters and Symbols for Traffic Staging  
TC-22 – Arterial Road Information Sign

TC-26 – Driveway Entrance Signing  
Suggested Traffic Control Plans – Typical Sections  
Suggested Traffic Control Plans – Stage 1  
Suggested Traffic Control Plans – Stage 2  
Traffic Control Cross Sections

SPECIAL PROVISIONS: Maintenance of Roadways  
Traffic Control and Protection (Arterials)  
Temporary Information Signing  
Public Convenience and Safety

RECURRING SPECIAL PROVISIONS: LRS 3 – Work Zone Traffic Control Surveillance  
LRS 4 – Flaggers in Work Zones

### **COMPLETION DATE PLUS WORKING DAYS**

Revise Article 108.05 (b) of the Standard Specifications as follows:

"When a completion date plus working days is specified, the Contractor shall complete all contract items and safely open all roadways to traffic by 11:59 PM on November 20, 2015 except as specified herein.

The Contractor will be allowed to complete all clean-up work and punch list items within 5 working days after the completion date for opening the roadway to traffic. Under extenuating circumstances the Engineer may direct that certain items of work, not affecting the safe opening of the roadway to traffic, may be completed within the working days allowed for clean up work and punch list items. Temporary lane closures for this work may be allowed at the discretion of the Engineer.

Article 108.09 or the Special Provision for "Failure to Complete the Work on Time", if included in this contract, shall apply to both the completion date and the number of working days.

### **TRAFFIC CONTROL AND PROTECTION (ARTERIALS)**

Effective: February 1, 1996

Revised: March 1, 2011

Specific traffic control plan details and Special Provisions have been prepared for this contract. This work shall include all labor, materials, transportation, handling and incidental work necessary to furnish, install, maintain and remove all traffic control devices required as indicated in the plans and as approved by the Engineer.

When traffic is to be directed over a detour route, the Contractor shall furnish, erect, maintain and remove all applicable traffic control devices along the detour route according to the details shown in the plans.

Method of Measurement: All traffic control (except Traffic Control and Protection (Expressways) and temporary pavement markings) indicated on the traffic control plan details and specified in the Special Provisions will be measured for payment on a lump sum basis.

Basis of Payment: All traffic control and protection will be paid for at the contract lump sum price for TRAFFIC CONTROL AND PROTECTION, (SPECIAL).

Temporary pavement markings will be paid for separately unless shown on a Standard.

#### **FINE AGGREGATE FOR HOT- MIX ASPHALT (HMA) (D-1)**

Effective: May 1, 2007

Revised: January 1, 2012

Revise Article 1003.03 (c) of the Standard Specifications to read:

- “ (c) Gradation. The fine aggregate gradation for all HMA shall be FA1, FA 2, FA 20, FA 21 or FA 22. When Reclaimed Asphalt Pavement (RAP) is incorporated in the HMA design, the use of FA 21 Gradation will not be permitted.

#### **COARSE AGGREGATE FOR BACKFILL, TRENCH BACKFILL AND BEDDING (D-1)**

Effective: November 1, 2011

Revised: November 1, 2013

This work shall be according to Section 1004.05 of the Standard Specifications except for the following:

Reclaimed Asphalt Pavement (RAP) maybe blended with gravel, crushed gravel, crushed stone crushed concrete, crushed slag, chats, crushed sand stone or wet bottom boiler slag. The RAP used shall be according to the current Bureau of Materials and Physical Research Policy

Memorandum, "Reclaimed Asphalt Pavement (RAP) for Aggregate Applications". The RAP shall be uniformly graded and shall pass the 1.0 in. (25 mm) screen. When RAP is blended with any of the coarse aggregate listed above, the blending shall be done mechanically with calibrated feeders. The feeders shall have an accuracy of  $\pm 2.0$  percent of the actual quantity of material delivered. The final blended product shall not contain more than 40 percent by weight RAP.

The coarse aggregate listed above shall meet CA 6 and CA 10 gradations prior to being blended with the processed and uniformly graded RAP. Gradation deleterious count shall not exceed 10% of total RAP and 5% of other by total weight.

### **TEMPORARY INFORMATION SIGNING**

Effective: November 13, 1996

Revised: January 2, 2007

#### Description.

This work shall consist of furnishing, installing, maintaining, relocating for various states of construction and eventually removing temporary informational signs. Included in this item may be ground mount signs, skid mount signs, truss mount signs, bridge mount signs, and overlay sign panels which cover portions of existing signs.

#### Materials.

Materials shall be according to the following Articles of Section 1000 - Materials:

	<b><u>Item</u></b>	<b><u>Article/Section</u></b>
a.)	Sign Base (Notes 1 & 2)	1090
b.)	Sign Face ( Note 3)	1091
c.)	Sign Legends	1091
d.)	Sign Supports	1093
e.)	Overlay Panels (Note 4)	1090.02

Note 1. The Contractor may use 5/8 inch (16 mm) instead of 3/4 inch (19 mm) thick plywood.

Note 2. Type A sheeting can be used on the plywood base.

Note 3. All sign faces shall be Type A except all orange signs shall meet the requirements of Article 1106.01.

Note 4. The overlay panels shall be 0.08 inch (2 mm) thick.

### **GENERAL CONSTRUCTION**

#### Installation.

The sign sizes and legend sizes shall be verified by the Contractor prior to fabrication.

Signs which are placed along the roadway and/or within the construction zone shall be installed according to the requirements of Article 701.14 and Article 720.04. The signs shall be 7 ft (2.1 m) above the near edge of the pavement and shall be a minimum of 2 ft (600 mm) beyond the edge of the paved shoulder. A minimum of two (2) posts shall be used.

The attachment of temporary signs to existing sign structures or sign panels shall be approved by the Engineer. Any damage to the existing signs due to the Contractor's operations shall be repaired or signs replaced, as determined by the Engineer, at the Contractor's expense.

Signs which are placed on overhead bridge structures shall be fastened to the handrail with stainless steel bands. These signs shall rest on the concrete parapet where possible. The Contractor shall furnish mounting details for approval by the Engineer.

Method Of Measurement.

This work shall be measured for payment in square feet (square meters) edge to edge (horizontally and vertically).

All hardware, posts or skids, supports, bases for ground mounted signs, connections, which are required for mounting these signs will be included as part of this pay item.

Basis Of Payment.

This work shall be paid for at the contract unit price per square foot (square meter) for TEMPORARY INFORMATION SIGNING.

## **RECLAIMED ASPHALT PAVEMENT AND RECLAIMED ASPHALT SHINGLES (D-1)**

Effective: November 1, 2012

Revise: August 15, 2014

Revise Section 1031 of the Standard Specifications to read:

### **"SECTION 1031. RECLAIMED ASPHALT PAVEMENT AND RECLAIMED ASPHALT SHINGLES**

**1031.01 Description.** Reclaimed asphalt pavement and reclaimed asphalt shingles shall be according to the following.

- (a) Reclaimed Asphalt Pavement (RAP). RAP is the material resulting from cold milling or crushing an existing hot-mix asphalt (HMA) pavement. RAP will be considered processed FRAP after completion of both crushing and screening to size. The Contractor shall supply written documentation that the RAP originated from routes or airfields under federal, state, or local agency jurisdiction.
- (b) Reclaimed Asphalt Shingles (RAS). Reclaimed asphalt shingles (RAS). RAS is from the processing and grinding of preconsumer or post-consumer shingles. RAS shall be a clean and uniform material with a maximum of 0.5 percent unacceptable material, as defined in Bureau of Materials and Physical Research Policy Memorandum "Reclaimed Asphalt Shingle (RAS) Sources", by weight of RAS. All RAS used shall come from a Bureau of Materials and Physical Research approved processing facility where it shall be ground and processed to 100 percent passing the 3/8 in. (9.5 mm) sieve and 90 percent passing the #4 (4.75 mm) sieve . RAS shall meet the testing requirements specified herein. In addition, RAS shall meet the following Type 1 or Type 2 requirements.
  - (1) Type 1. Type 1 RAS shall be processed, preconsumer asphalt shingles salvaged from the manufacture of residential asphalt roofing shingles.
  - (2) Type 2. Type 2 RAS shall be processed post-consumer shingles only, salvaged from residential, or four unit or less dwellings not subject to the National Emission Standards for Hazardous Air Pollutants (NESHAP).

**1031.02 Stockpiles.** RAP and RAS stockpiles shall be according to the following.

- (a) RAP Stockpiles. The Contractor shall construct individual, sealed RAP stockpiles meeting one of the following definitions. Additional processed RAP (FRAP) shall be stockpiled in a separate working pile, as designated in the QC Plan, and only added to the sealed stockpile when test results for the working pile are complete and are found to meet tolerances specified herein for the original sealed FRAP stockpile. Stockpiles shall be sufficiently separated to prevent intermingling at the base. All stockpiles (including

unprocessed RAP and FRAP) shall be identified by signs indicating the type as listed below (i.e. "Non- Quality, FRAP -#4 or Type 2 RAS", etc...).

- (1) Fractionated RAP (FRAP). FRAP shall consist of RAP from Class I, Superpave HMA (High and Low ESAL) or equivalent mixtures. The coarse aggregate in FRAP shall be crushed aggregate and may represent more than one aggregate type and/or quality but shall be at least C quality. All FRAP shall be processed prior to testing and sized into fractions with the separation occurring on or between the #4 (4.75 mm) and 1/2 in. (12.5 mm) sieves. Agglomerations shall be minimized such that 100 percent of the RAP in the coarse fraction shall pass the maximum sieve size specified for the mix the FRAP will be used in.
- (2) Restricted FRAP (B quality) stockpiles shall consist of RAP from Class I, Superpave (High ESAL), or HMA (High ESAL). If approved by the Engineer, the aggregate from a maximum 3.0 inch single combined pass of surface/binder milling will be classified as B quality. All millings from this application will be processed into FRAP as described previously.
- (3) Conglomerate. Conglomerate RAP stockpiles shall consist of RAP from Class I, Superpave HMA (High and Low ESAL) or equivalent mixtures. The coarse aggregate in this RAP shall be crushed aggregate and may represent more than one aggregate type and/or quality but shall be at least C quality. This RAP may have an inconsistent gradation and/or asphalt binder content prior to processing. All conglomerate RAP shall be processed (FRAP) prior to testing. Conglomerate RAP stockpiles shall not contain steel slag or other expansive material as determined by the Department.
- (4) Conglomerate "D" Quality (DQ). Conglomerate DQ RAP stockpiles shall consist of RAP from HMA shoulders, bituminous stabilized subbases or Superpave (Low ESAL)/HMA (Low ESAL) IL-19.0L binder mixture. The coarse aggregate in this RAP may be crushed or round but shall be at least D quality. This RAP may have an inconsistent gradation and/or asphalt binder content. Conglomerate DQ RAP stockpiles shall not contain steel slag or other expansive material as determined by the Department.
- (5) Non-Quality. RAP stockpiles that do not meet the requirements of the stockpile categories listed above shall be classified as "Non-Quality".

RAP or FRAP containing contaminants, such as earth, brick, sand, concrete, sheet asphalt, bituminous surface treatment (i.e. chip seal), pavement fabric, joint sealants, plant cleanout etc., will be unacceptable unless the contaminants are removed to the satisfaction of the Engineer. Sheet asphalt shall be stockpiled separately.

- (b) RAS Stockpiles. Type 1 and Type 2 RAS shall be stockpiled separately and shall be sufficiently separated to prevent intermingling at the base. Each stockpile shall be signed indicating what type of RAS is present.



However, a RAS source may submit a written request to the Department for approval to blend mechanically a specified ratio of type 1 RAS with type 2 RAS. The source will not be permitted to change the ratio of the blend without the Department prior written approval. The Engineer's written approval will be required, to mechanically blend RAS with any fine aggregate produced under the AGCS, up to an equal weight of RAS, to improve workability. The fine aggregate shall be "B Quality" or better from an approved Aggregate Gradation Control System source. The fine aggregate shall be one that is approved for use in the HMA mixture and accounted for in the mix design and during HMA production.

Records identifying the shingle processing facility supplying the RAS, RAS type and lot number shall be maintained by project contract number and kept for a minimum of three years.

**1031.03 Testing.** FRAP and RAS testing shall be according to the following.

(a) FRAP Testing. When used in HMA, the FRAP shall be sampled and tested either during processing or after stockpiling. It shall also be sampled during HMA production.

(1) During Stockpiling. For testing during stockpiling, washed extraction samples shall be run at the minimum frequency of one sample per 500 tons (450 metric tons) for the first 2000 tons (1800 metric tons) and one sample per 2000 tons (1800 metric tons) thereafter. A minimum of five tests shall be required for stockpiles less than 4000 tons (3600 metric tons).

(2) Incoming Material. For testing as incoming material, washed extraction samples shall be run at a minimum frequency of one sample per 2000 tons (1800 metric tons) or once per week, whichever comes first.

(3) After Stockpiling. For testing after stockpiling, the Contractor shall submit a plan for approval to the District proposing a satisfactory method of sampling and testing the RAP/FRAP pile either in-situ or by restockpiling. The sampling plan shall meet the minimum frequency required above and detail the procedure used to obtain representative samples throughout the pile for testing.

Before extraction, each field sample of FRAP, shall be split to obtain two samples of test sample size. One of the two test samples from the final split shall be labeled and stored for Department use. The Contractor shall extract the other test sample according to Department procedure. The Engineer reserves the right to test any sample (split or Department-taken) to verify Contractor test results.

(b) RAS Testing. RAS shall be sampled and tested during stockpiling according to Bureau of Materials and Physical Research Policy Memorandum, "Reclaimed Asphalt Shingle (RAS) Sources". The Contractor shall also sample as incoming material at the HMA plant.

- (1) During Stockpiling. Washed extraction and testing for unacceptable materials shall be run at the minimum frequency of one sample per 200 tons (180 metric tons) for the first 1000 tons (900 metric tons) and one sample per 1000 tons (900 metric tons) thereafter. A minimum of five samples are required for stockpiles less than 1000 tons (900 metric tons). Once a  $\leq 1000$  ton (900 metric ton), five-sample/test stockpile has been established it shall be sealed. Additional incoming RAS shall be in a separate working pile as designated in the Quality Control plan and only added to the sealed stockpile when the test results of the working pile are complete and are found to meet the tolerances specified herein for the original sealed RAS stockpile.
- (2) Incoming Material. For testing as incoming material at the HMA plant, washed extraction shall be run at the minimum frequency of one sample per 250 tons (227 metric tons). A minimum of five samples are required for stockpiles less than 1000 tons (900 metric tons). The incoming material test results shall meet the tolerances specified herein.

The Contractor shall obtain and make available all test results from start of the initial stockpile sampled and tested at the shingle processing facility in accordance with the facility's QC Plan.

Before extraction, each field sample shall be split to obtain two samples of test sample size. One of the two test samples from the final split shall be labeled and stored for Department use. The Contractor shall extract the other test sample according to Department procedures. The Engineer reserves the right to test any sample (split or Department-taken) to verify Contractor test results.

**1031.04 Evaluation of Tests.** Evaluation of tests results shall be according to the following.

- (a) Evaluation of FRAP Test Results. All test results shall be compiled to include asphalt binder content, gradation and, when applicable (for slag),  $G_{mm}$ . A five test average of results from the original pile will be used in the mix designs. Individual extraction test results run thereafter, shall be compared to the average used for the mix design, and will be accepted if within the tolerances listed below.

Parameter	FRAP
No. 4 (4.75 mm)	$\pm 6 \%$
No. 8 (2.36 mm)	$\pm 5 \%$
No. 30 (600 $\mu\text{m}$ )	$\pm 5 \%$
No. 200 (75 $\mu\text{m}$ )	$\pm 2.0 \%$
Asphalt Binder	$\pm 0.3 \%$
$G_{mm}$	$\pm 0.03$ <sup>1/</sup>

- 1/ For stockpile with slag or steel slag present as determined in the current Manual of Test Procedures Appendix B 21, "Determination of Reclaimed Asphalt Pavement Aggregate Bulk Specific Gravity".

If any individual sieve and/or asphalt binder content tests are out of the above tolerances when compared to the average used for the mix design, the FRAP stockpile shall not be used in Hot-Mix Asphalt unless the FRAP representing those tests is removed from the stockpile. All test data and acceptance ranges shall be sent to the District for evaluation.

The Contractor shall maintain a representative moving average of five tests to be used for Hot-Mix Asphalt production.

With the approval of the Engineer, the ignition oven may be substituted for extractions according to the Illinois Test Procedure, "Calibration of the Ignition Oven for the Purpose of Characterizing Reclaimed Asphalt Pavement (RAP)" or Illinois Modified AASHTO T-164-11, Test Method A.

- (b) Evaluation of RAS Test Results. All of the test results, with the exception of percent unacceptable materials, shall be compiled and averaged for asphalt binder content and gradation. A five test average of results from the original pile will be used in the mix designs. Individual test results run thereafter, when compared to the average used for the mix design, will be accepted if within the tolerances listed below.

Parameter	RAS
No. 8 (2.36 mm)	± 5 %
No. 16 (1.18 mm)	± 5 %
No. 30 (600 µm)	± 4 %
No. 200 (75 µm)	± 2.5 %
Asphalt Binder Content	± 2.0 %

If any individual sieve and/or asphalt binder content tests are out of the above tolerances when compared to the average used for the mix design, the RAS shall not be used in Hot-Mix Asphalt unless the RAS representing those tests is removed from the stockpile. All test data and acceptance ranges shall be sent to the District for evaluation.

- (c) Quality Assurance by the Engineer. The Engineer may witness the sampling and splitting conduct assurance tests on split samples taken by the Contractor for quality control testing a minimum of once a month.

The overall testing frequency will be performed over the entire range of Contractor samples for asphalt binder content and gradation. The Engineer may select any or all split samples for assurance testing. The test results will be made available to the Contractor as soon as they become available.

The Engineer will notify the Contractor of observed deficiencies.

Differences between the Contractor's and the Engineer's split sample test results will be considered acceptable if within the following limits.

Test Parameter	Acceptable Limits of Precision	
	FRAP	RAS
% Passing: <sup>1/</sup>		
1 / 2 in.	5.0%	
No. 4	5.0%	
No. 8	3.0%	4.0%
No. 30	2.0%	3.0%
No. 200	2.2%	2.5%
Asphalt Binder Content	0.3%	1.0%
G <sub>mm</sub>	0.030	

1/ Based on washed extraction.

In the event comparisons are outside the above acceptable limits of precision, the Engineer will immediately investigate.

- (d) Acceptance by the Engineer. Acceptable of the material will be based on the validation of the Contractor's quality control by the assurance process.

**1031.05 Quality Designation of Aggregate in RAP and FRAP.**

- (a) RAP. The aggregate quality of the RAP for homogenous, conglomerate, and conglomerate "D" quality stockpiles shall be set by the lowest quality of coarse aggregate in the RAP stockpile and are designated as follows.

- (1) RAP from Class I, Superpave/HMA (High ESAL), or (Low ESAL) IL-9.5L surface mixtures are designated as containing Class B quality coarse aggregate.
- (2) RAP from Superpave/HMA (Low ESAL) IL-19.0L binder mixture is designated as Class D quality coarse aggregate.
- (3) RAP from Class I, Superpave/HMA (High ESAL) binder mixtures, bituminous base course mixtures, and bituminous base course widening mixtures are designated as containing Class C quality coarse aggregate.
- (4) RAP from bituminous stabilized subbase and BAM shoulders are designated as containing Class D quality coarse aggregate.

- (b) FRAP. If the Engineer has documentation of the quality of the FRAP aggregate, the Contractor shall use the assigned quality provided by the Engineer.

If the quality is not known, the quality shall be determined as follows. Fractionated RAP stockpiles containing plus #4 (4.75 mm) sieve coarse aggregate shall have a maximum tonnage of 5,000 tons (4,500 metric tons). The Contractor shall obtain a representative sample witnessed by the Engineer. The sample shall be a minimum of 50 lb (25 kg). The sample shall be extracted according to Illinois Modified AASHTO T 164 by a consultant prequalified by the Department for the specified testing. The consultant shall submit the test results along with the recovered aggregate to the District Office. The cost for this testing shall be paid by the Contractor. The District will forward the sample to the BMPR Aggregate Lab for MicroDeval Testing, according to Illinois Modified AASHTO T 327. A maximum loss of 15.0 percent will be applied for all HMA applications. The fine aggregate portion of the fractionated RAP shall not be used in any HMA mixtures that require a minimum of "B" quality aggregate or better, until the coarse aggregate fraction has been determined to be acceptable thru a MicroDeval Testing.

**1031.06 Use of FRAP and/or RAS in HMA.** The use of FRAP and/or RAS shall be a Contractor's option when constructing HMA in all contracts.

- (a) FRAP. The use of FRAP in HMA shall be as follows.

- (1) Coarse Aggregate Size (after extraction). The coarse aggregate in all FRAP shall be equal to or less than the nominal maximum size requirement for the HMA mixture to be produced.
- (2) Steel Slag Stockpiles. FRAP stockpiles containing steel slag or other expansive material, as determined by the Department, shall be homogeneous and will be approved for use in HMA (High ESAL and Low ESAL) mixtures regardless of lift or mix type.
- (3) Use in HMA Surface Mixtures (High and Low ESAL). FRAP stockpiles for use in HMA surface mixtures (High and Low ESAL) shall have coarse aggregate that is Class B quality or better. FRAP shall be considered equivalent to limestone for frictional considerations unless produced/screened to minus 3/8 inch.
- (4) Use in HMA Binder Mixtures (High and Low ESAL), HMA Base Course, and HMA Base Course Widening. FRAP stockpiles for use in HMA binder mixtures (High and Low ESAL), HMA base course, and HMA base course widening shall be FRAP in which the coarse aggregate is Class C quality or better.
- (5) Use in Shoulders and Subbase. FRAP stockpiles for use in HMA shoulders and stabilized subbase (HMA) shall be FRAP, Restricted FRAP, conglomerate, or conglomerate DQ.

- (b) RAS. RAS meeting Type 1 or Type 2 requirements will be permitted in all HMA applications as specified herein.
- (c) FRAP and/or RAS Usage Limits. Type 1 or Type 2 RAS may be used alone or in conjunction with FRAP in HMA mixtures up to a maximum of 5.0% by weight of the total mix.

When FRAP is used alone or FRAP is used in conjunction with RAS, the percent of virgin asphalt binder replacement (ABR) shall not exceed the amounts indicated in the table below for a given N Design.

Max Asphalt Binder Replacement for FRAP with RAS Combination

HMA Mixtures <sup>1/2/</sup>	Maximum % ABR		
	Binder/Leveling Binder	Surface	Polymer Modified <sup>3/</sup>
30L	50	40	10
50	40	35	10
70	40	30	10
90	40	30	10 <sup>4/</sup>
4.75 mm N-50			30
SMA N-80			20

- 1/ For HMA "All Other" (shoulder and stabilized subbase) N-30, the percent asphalt binder replacement shall not exceed 50% of the total asphalt binder in the mixture.
- 2/ When the binder replacement exceeds 15 percent for all mixes, except for SMA and IL-4.75, the high and low virgin asphalt binder grades shall each be reduced by one grade (i.e. 25 percent binder replacement using a virgin asphalt binder grade of PG64-22 will be reduced to a PG58-28). When constructing full depth HMA and the ABR is less than 15 percent, the required virgin asphalt binder grade shall be PG64-28.
- 3/ When the ABR for SMA or IL-4.75 is 15 percent or less, the required virgin asphalt binder shall be SBS PG76-22 and the elastic recovery shall be a minimum of 80. When the ABR for SMA or IL-4.75 exceeds 15%, the virgin asphalt binder grade shall be SBS PG70-28 and the elastic recovery shall be a minimum of 80.
- 4/ For polymerized surface mix used for overlays, with up to 10 percent ABR, a SBS PG70-22 will be required. However, if used in full depth HMA, a SBS PG70-28 will be required.

**1031.07 HMA Mix Designs.** At the Contractor's option, HMA mixtures may be constructed utilizing RAP/FRAP and/or RAS material meeting the detailed requirements specified herein.

- (a) FRAP and/or RAS. FRAP and /or RAS mix designs shall be submitted for verification. If additional FRAP or RAS stockpiles are tested and found to be within tolerance, as defined under "Evaluation of Tests" herein, and meet all requirements herein, the additional FRAP or RAS stockpiles may be used in the original design at the percent previously verified.
- (b) RAS. Type 1 and Type 2 RAS are not interchangeable in a mix design. A RAS stone bulk specific gravity (Gsb) of 2.500 shall be used for mix design purposes.

**1031.08 HMA Production.** HMA production utilizing FRAP and/or RAS shall be as follows.

To remove or reduce agglomerated material, a scalping screen, gator, crushing unit, or comparable sizing device approved by the Engineer shall be used in the RAS and FRAP feed system to remove or reduce oversized material. If material passing the sizing device adversely affects the mix production or quality of the mix, the sizing device shall be set at a size specified by the Engineer.

If during mix production, corrective actions fail to maintain FRAP, RAS or QC/QA test results within control tolerances or the requirements listed herein the Contractor shall cease production of the mixture containing FRAP or RAS and conduct an investigation that may require a new mix design.

- (a) RAS. RAS shall be incorporated into the HMA mixture either by a separate weight depletion system or by using the RAP weigh belt. Either feed system shall be interlocked with the aggregate feed or weigh system to maintain correct proportions for all rates of production and batch sizes. The portion of RAS shall be controlled accurately to within  $\pm 0.5$  percent of the amount of RAS utilized. When using the weight depletion system, flow indicators or sensing devices shall be provided and interlocked with the plant controls such that the mixture production is halted when RAS flow is interrupted.
- (b) HMA Plant Requirements. HMA plants utilizing FRAP and/or RAS shall be capable of automatically recording and printing the following information.
  - (1) Dryer Drum Plants.
    - a. Date, month, year, and time to the nearest minute for each print.
    - b. HMA mix number assigned by the Department.
    - c. Accumulated weight of dry aggregate (combined or individual) in tons (metric tons) to the nearest 0.1 ton (0.1 metric ton).

- d. Accumulated dry weight of RAS and FRAP in tons (metric tons) to the nearest 0.1 ton (0.1 metric ton).
  - e. Accumulated mineral filler in revolutions, tons (metric tons), etc. to the nearest 0.1 unit.
  - f. Accumulated asphalt binder in gallons (liters), tons (metric tons), etc. to the nearest 0.1 unit.
  - g. Residual asphalt binder in the RAS and FRAP material as a percent of the total mix to the nearest 0.1 percent.
  - h. Aggregate RAS and FRAP moisture compensators in percent as set on the control panel. (Required when accumulated or individual aggregate and RAS and FRAP are printed in wet condition.)
  - i. When producing mixtures with FRAP and/or RAS, a positive dust control system shall be utilized.
  - j. Accumulated mixture tonnage.
  - k. Dust Removed (accumulated to the nearest 0.1 ton)
- (2) Batch Plants.
- a. Date, month, year, and time to the nearest minute for each print.
  - b. HMA mix number assigned by the Department.
  - c. Individual virgin aggregate hot bin batch weights to the nearest pound (kilogram).
  - d. Mineral filler weight to the nearest pound (kilogram).
  - f. RAS and FRAP weight to the nearest pound (kilogram).
  - g. Virgin asphalt binder weight to the nearest pound (kilogram).
  - h. Residual asphalt binder in the RAS and FRAP material as a percent of the total mix to the nearest 0.1 percent.

The printouts shall be maintained in a file at the plant for a minimum of one year or as directed by the Engineer and shall be made available upon request. The printing system will be inspected by the Engineer prior to production and verified at the beginning of each construction season thereafter.

**1031.09 RAP in Aggregate Surface Course and Aggregate Shoulders.** The use of



RAP or FRAP in aggregate surface course and aggregate shoulders shall be as follows.

- (a) Stockpiles and Testing. RAP stockpiles may be any of those listed in Article 1031.02, except "Non-Quality" and "FRAP". The testing requirements of Article 1031.03 shall not apply. RAP used to construct aggregate surface course and aggregate shoulders shall be according to the current Bureau of Materials and Physical Research's Policy Memorandum, "Reclaimed Asphalt Pavement (RAP) for Aggregate Applications"
- (b) Gradation. One hundred percent of the RAP material shall pass the 1 1/2 in. (37.5mm) sieve. The RAP material shall be reasonably well graded from coarse to fine. RAP material that is gap-graded, FRAP, or single sized will not be accepted for use as Aggregate Surface Course and Aggregate Shoulders."

## **HMA MIXTURE DESIGN REQUIREMENTS (D-1)**

Effective: January 1, 2013

Revised: November 1, 2013

Revise Article 406.14(b) of the Standard Specifications to read.

“(b) If the HMA placed during the initial test strip (1) is determined to be unacceptable to remain in place by the Engineer, and (2) was not produced within 2.0 to 6.0 percent air voids or within the individual control limits of the JMF, the mixture and test strip will not be paid for and the mixture shall be removed at the Contractor’s expense. An additional test strip and mixture will be paid for in full, if produced within 2.0 to 6.0 percent air voids and within the individual control limits of the JMF.”

Revise Article 406.14(c) of the Standard Specifications to read.

“(c) If the HMA placed during the initial test strip (1) is determined to be unacceptable to remain in place by the Engineer, and (2) was produced within 2.0 to 6.0 percent air voids and within the individual control limits of the JMF, the mixture shall be removed. Removal will be paid in accordance to Article 109.04 of the Standard Specifications. This initial mixture and test strip will be paid for at the contract unit

prices. The additional mixture will be paid for at the contract unit price, and any additional test strips will be paid for at one half the unit price of each test strip.”

**1) Design Composition and Volumetric Requirements**

Revise the following table in Article 1030.01 of the Standard Specifications to read.

High ESAL	IL-25.0 binder; IL-19.0 binder; IL-12.5 surface; IL-9.5 surface; IL-4.75, SMA
-----------	---

Revise the following table in Article 1030.04(a)(1):

“(1) High ESAL Mixtures. The Job Mix Formula (JMF) shall fall within the following limits.

High ESAL, MIXTURE COMPOSITION (% PASSING) <sup>1/</sup>														
Sieve Size	IL-25.0 mm		IL-19.0 mm		IL-12.5 mm		IL-9.5 mm		IL-4.75 mm		SMA <sup>4/</sup> IL-12.5 mm		SMA <sup>4/</sup> IL-9.5 mm	
	Min	max	min	max	min	max	min	max	min	max	min	max	min	max
1 1/2 in. (37.5 mm)		100												
1 in. (25 mm)	90	100		100										
3/4 in. (19 mm)		90	82	100		100						100		
1/2 in. (12.5 mm)	45	75	50	85	90	100		100		100	80	100		100
3/8 in. (9.5 mm)						89	90	100		100		65	90	100
#4 (4.75 mm)	24	42 <sup>2/</sup>	24	50 <sup>2/</sup>	28	65	32	69	90	100	20	30	36	50
#8 (2.36 mm)	16	31	20	36	28	48 <sup>3/</sup>	32	52 <sup>3/</sup>	70	90	16	24 <sup>5/</sup>	16	32
#16 (1.18 mm)	10	22	10	25	10	32	10	32	50	65				
#30 (600 μm)											12	16	12	18
#50 (300 μm)	4	12	4	12	4	15	4	15	15	30				

#100 (150 μm)	3	9	3	9	3	10	3	10	10	18				
#200 (75 μm)	3	6	3	6	4	6	4	6	7	9 <sup>6/</sup>	7.0	9.0 <sup>6/</sup>	7.5	9.5 <sup>6/</sup>
Ratio Dust/Asphalt Binder		1.0		1.0		1.0		1.0		1.0		1.5		1.5

- 1/ Based on percent of total aggregate weight.
- 2/ The mixture composition shall not exceed 40 percent passing the #4 (4.75 mm) sieve for binder courses with Ndesign ≥ 90.
- 3/ The mixture composition shall not exceed 44 percent passing the #8 (2.36 mm) sieve for surface courses with Ndesign ≥ 90.
- 4/ The maximum percent passing the 20 μm sieve shall be ≤ 3 percent.
- 5/ When establishing the Adjusted Job Mix Formula (AJMF) the #8 (2.36mm) sieve shall not be adjusted above 24 percent.
- 6/ Additional minus No. 200 (0.075 mm) material required by the mix design shall be mineral filler, unless otherwise approved by the Engineer.”

Delete Article 1030.04(a)(4) of the Standard Specifications.

Revise Article 1030.04(b)(1) of the Standard Specifications to read.

“(1) High ESAL Mixtures. The target value for the air voids of the HMA shall be 4.0 percent and for IL-4.75 it shall be 3.5 percent at the design number of gyrations. The VMA and VFA of the HMA design shall be based on the nominal maximum size of the aggregate in the mix, and shall conform to the following requirements.

VOLUMETRIC REQUIREMENTS High ESAL						
Ndesign	Voids in the Mineral Aggregate (VMA), % minimum					Voids Filled with Asphalt Binder (VFA), %
	IL-25.0	IL-19.0	IL-12.5	IL-9.5	IL-4.75 <sup>1/</sup>	
50	12.0	13.0	14.0	15.0	18.5	65 – 78 <sup>2/</sup>
70						65 - 75

90						
105						

- 1/ Maximum Draindown for IL-4.75 shall be 0.3%
- 2/ VFA for IL-4.75 shall be 72-85%”

Delete Article 1030.04(b) (4) of the Standard Specifications.

Revise table in Article 1030.04(b)(5) as follows:

“(5) SMA Mixtures.

Volumetric Requirements SMA <sup>1/</sup>			
Ndesign	Design Air Voids Target %	Voids in the Mineral Aggregate (VMA), % min.	Voids Filled with Asphalt (VFA), %
80 <sup>4/</sup>	3.5	17 <sup>2/</sup>	75 - 83
		16 <sup>3/</sup>	

- 1/ Maximum Draindown shall be 0.3%.
- 2/ Applies when specific gravity of coarse aggregate is  $\geq 2.760$ .
- 3/ Applies when specific gravity of coarse aggregate is  $< 2.760$ .
- 4/ For surface course, coarse aggregate shall be Class B Quality; the coarse aggregate can be crushed steel slag, crystalline crushed stone or crushed sandstone.\*  
 For binder course, coarse aggregate shall be crushed stone (dolomite), crushed gravel, crystalline crushed stone, or crushed sandstone.\*

\*Blending of different types of aggregate will not be permitted.

**2) Design Verification and Production**

Description. The following states the requirements for Hamburg Wheel and Tensile Strength testing for High ESAL, IL-4.75, and Stone Matrix Asphalt (SMA) hot-mix asphalt (HMA) mixes during mix design verification and production.

When the options of Warm Mix Asphalt, Reclaimed Asphalt Shingles, or Reclaimed Asphalt Pavement are used by the Contractor, the Hamburg Wheel and tensile strength requirements in this special provision will be superseded by the special provisions for Warm Mix Asphalt and/or by the District special provision for Reclaimed Asphalt Pavement and Reclaimed Asphalt Shingles as applicable.

Mix Design Testing. Add the following to Article 1030.04 of the Standard Specifications:

“(d) Verification Testing. High ESAL, IL-4.75, and SMA mix designs submitted for verification will be tested to ensure that the resulting mix designs will pass the required criteria for the Hamburg Wheel Test (IL mod AASHTO T-324) and the Tensile Strength Test (IL mod AASHTO T-283). The Department will perform a verification test on gyratory specimens compacted by the Contractor. If the mix fails the Department’s verification test, the Contractor shall make the necessary changes to the mix and resubmit compacted specimens to the Department for verification. If the mix fails again, the mix design will be rejected.

All new and renewal mix designs will be required to be tested, prior to submittal for Department verification meeting the following requirements:

(1)Hamburg Wheel Test criteria.

Asphalt Binder Grade	# Repetitions	Max Rut Depth (mm)
PG 70 -XX (or higher)	20,000	12.5
PG 64 -XX (or lower)	10,000	12.5

Note: For SMA Designs (N-80) the maximum rut depth is 6.0 mm at 20,000 repetitions.

For IL 4.75mm Designs (N-50) the maximum rut depth is 9.0mm at 15,000 repetitions.

(2) Tensile Strength Criteria. The minimum allowable conditioned tensile strength shall be 415 kPa (60 psi) for non-polymer modified performance graded (PG) asphalt binder and 550 kPa (80 psi) for polymer modified PG asphalt binder. The maximum allowable unconditioned tensile strength shall be 1380 kPa (200 psi).”

Production Testing.

Revise first paragraph of Article 1030.06(a) to read:

“(a) High ESAL and IL-4.75 Mixtures. For each contract, a 300 ton (275 metric tons)

test strip, except for IL -4.75 it will be 400 ton (363 metric ton), will be required at the beginning of HMA production for each mixture with a quantity of 3000 tons (2750 metric tons) or more according to the Manual of Test Procedures for Materials “Hot Mix Asphalt Test Strip Procedures”.”

Delete second paragraph of Article 1030.06 (a).

Revise first sentence in fourth paragraph of Article 1030.06 (a) to read:

“Before constructing the test strip, target values shall be determined by applying gradation correction factors to the JMF when applicable.”

Mixture sampled to represent the test strip shall include additional material sufficient for the Department to conduct Hamburg Wheel testing according to Illinois Modified AASHTO T324 (approximately 60 lb (27 kg) total).

Add the following to Article 1030.06 of the Standard Specifications:

- “ (c) Hamburg Wheel Test. All HMA mixtures shall be sampled within the first 500 tons (450 metric tons) on the first day of production or during start up with a split reserved for the Department. The mix sample shall be tested according to the Illinois Modified AASHTO T 324 and shall meet the requirements specified herein. Mix production shall not exceed 1500 tons (1350 metric tons) or one day’s production, whichever comes first, until the testing is completed and the mixture is found to be in conformance. The requirement to cease mix production may be waived if the plant produced mixture demonstrates conformance prior to start of mix production for a contract.
- The Department may conduct additional Hamburg Wheel Tests on production material as determined by the Engineer. If the mixture fails to meet the Hamburg Wheel criteria, no further mixture will be accepted until the Contractor takes such action as is necessary to furnish a mixture meeting the criteria”

The Contractor shall immediately cease production upon notification by the Engineer of failing Hamburg Wheel test. All prior produced material may be paved out provided all other mixture criteria are being met. No additional mixture shall be produced until the Engineer receives passing Hamburg Wheel tests.

Basis of Payment. Revise the seventh paragraph of Article 406.14 of the Standard Specifications to read:

“For all mixes designed and verified under the Hamburg Wheel criteria, the cost of furnishing and introducing anti-stripping additives in the HMA will not be paid for

separately, but shall be considered as included in the contract unit price of the HMA item involved.

No additional compensation will be awarded to the Contractor because of reduced production rates associated with the addition of the anti-stripping additive.”

**FRICITION SURFACE AGGREGATE (D1)**

Effective: January 1, 2011

Revised: November 1, 2013

Revise Article 1004.01(a)(4) of the Standard Specifications to read:

- “ (4) Crushed Stone. Crushed stone shall be the angular fragments resulting from crushing undisturbed, consolidated deposits of rock by mechanical means. Crushed stone shall be divided into the following, when specified.
- a. Carbonate Crushed Stone. Carbonate crushed stone shall be either dolomite or limestone. Dolomite shall contain 11.0 percent or more magnesium oxide (MgO). Limestone shall contain less than 11.0 percent magnesium oxide (MgO).
  - b. Crystalline Crushed Stone. Crystalline crushed stone shall be either metamorphic or igneous stone, including but is not limited to, quartzite, granite, rhyolite and diabase.”

Revise Article 1004.03(a) of the Standard Specifications to read:

“**1004.03 Coarse Aggregate for Hot-Mix Asphalt (HMA).** The aggregate shall be according to Article 1004.01 and the following revisions.

(a) Description. The coarse aggregate for HMA shall be according to the following table.

Use	Mixture	Aggregates Allowed
-----	---------	--------------------



Use	Mixture	Aggregates Allowed
Class A	Seal or Cover	<u>Allowed Alone or in Combination:</u> Gravel Crushed Gravel Carbonate Crushed Stone Crystalline Crushed Stone Crushed Sandstone Crushed Slag (ACBF) Crushed Steel Slag Crushed Concrete
HMA All Other	Shoulders	<u>Allowed Alone or in Combination:</u> Gravel Crushed Gravel Carbonate Crushed Stone Crystalline Crushed Stone Crushed Sandstone Crushed Slag (ACBF) <sup>1/</sup> Crushed Steel Slag <sup>1/</sup> Crushed Concrete
HMA High ESAL Low ESAL	C Surface IL-12.5,IL-9.5, or IL-9.5L	<u>Allowed Alone or in Combination:</u> Crushed Gravel Carbonate Crushed Stone Crystalline Crushed Stone Crushed Sandstone Crushed Slag (ACBF) <sup>1/</sup> Crushed Steel Slag <sup>1/</sup> Crushed Concrete
HMA High ESAL	D Surface IL-12.5 or IL-9.5	<u>Allowed Alone or in Combination:</u> Crushed Gravel Carbonate Crushed Stone (other than Limestone) Crystalline Crushed Stone Crushed Sandstone Crushed Slag (ACBF) <sup>1/</sup> Crushed Steel Slag <sup>1/</sup> Crushed Concrete

Use	Mixture	Aggregates Allowed	
		<u>Other Combinations Allowed:</u>	
		<i>Up to...</i>	<i>With...</i>
		25% Limestone	Dolomite
		50% Limestone	Any Mixture D aggregate other than Dolomite
		75% Limestone	Crushed Slag (ACBF) <sup>1/</sup> or Crushed Sandstone
HMA High ESAL	F Surface IL-12.5 or IL-9.5	<u>Allowed Alone or in Combination:</u>	
		Crystalline Crushed Stone Crushed Sandstone Crushed Slag (ACBF) <sup>1/</sup> Crushed Steel Slag <sup>1/</sup>	
		No Limestone or no Crushed Gravel alone.	
		<u>Other Combinations Allowed:</u>	
		<i>Up to...</i>	<i>With...</i>
		50% Crushed Gravel, or Dolomite	Crushed Sandstone, Crushed Slag (ACBF) <sup>1/</sup> , Crushed Steel Slag <sup>1/</sup> , or Crystalline Crushed Stone
HMA High ESAL	SMA Ndesign 80 Surface	Crystalline Crushed Stone Crushed Sandstone Crushed Steel Slag	

1/ When either slag is used, the blend percentages listed shall be by volume.

Add the following to Article 1004.03 (b):

“ When using Crushed Concrete, the quality shall be determined as follows. The Contractor shall obtain a representative sample from the stockpile, witnessed by the Engineer, at a frequency of 2500 tons (2300 metric tons). The sample shall be a minimum of 50 lb (25 kg). The Contractor shall submit the sample to the District Office. The District will forward the sample to the BMPR Aggregate Lab for MicroDeval Testing, according to Illinois Modified AASHTO T 327. A maximum loss of 15.0 percent by weight will be applied for acceptance. The stockpile shall be sealed until test results are complete and found to meet the specifications above.”

**GROUND TIRE RUBBER (GTR) MODIFIED ASPHALT BINDER (D-1)**

Effective: June 26, 2006

Revised: January 1, 2013

Add the following to the end of article 1032.05 of the Standard Specifications:

“(c) Ground Tire Rubber (GTR) Modified Asphalt Binder. A quantity of 10.0 to 14.0 percent GTR (Note 1) shall be blended by dry unit weight with a PG 64-28 to make a GTR 70-28 or a PG 58-28 to make a GTR 64-28. The base PG 64-28 and PG 58-28 asphalt binders shall meet the requirements of Article 1032.05(a). Compatible polymers may be added during production. The GTR modified asphalt binder shall meet the requirements of the following table.

Test	Asphalt Grade GTR 70-28	Asphalt Grade GTR 64-28
Flash Point (C.O.C.), AASHTO T 48, °F (°C), min.	450 (232)	450 (232)
Rotational Viscosity, AASHTO T 316 @ 275 °F (135 °C), Poises, Pa-s, max.	30 (3)	30 (3)
Softening Point, AASHTO T 53, °F (°C), min.	135 (57)	130 (54)
Elastic Recovery, ASTM D 6084, Procedure A (sieve waived) @ 77 °F, (25 °C), aged, ss, 100 mm elongation, 5 cm/min., cut immediately, %, min.	65	65

Note 1. GTR shall be produced from processing automobile and/or light truck tires by the ambient grinding method. GTR shall not exceed 1/16 in. (2 mm) in any dimension and shall contain no free metal particles or other materials. A mineral powder (such as talc) meeting

the requirements of AASHTO M 17 may be added, up to a maximum of four percent by weight of GTR to reduce sticking and caking of the GTR particles. When tested in accordance with Illinois modified AASHTO T 27, a 50 g sample of the GTR shall conform to the following gradation requirements:

Sieve Size	Percent Passing
No. 16 (1.18 mm)	100
No. 30 (600 μm)	95 ± 5
No. 50 (300 μm)	> 20

Add the following to the end of Note 1. of article 1030.03 of the Standard Specifications:

“A dedicated storage tank for the Ground Tire Rubber (GTR) modified asphalt binder shall be provided. This tank must be capable of providing continuous mechanical mixing throughout by continuous agitation and recirculation of the asphalt binder to provide a uniform mixture. The tank shall be heated and capable of maintaining the temperature of the asphalt binder at 300 °F to 350 °F (149 °C to 177 °C). The asphalt binder metering systems of dryer drum plants shall be calibrated with the actual GTR modified asphalt binder material with an accuracy of ± 0.40 percent.”

Revise 1030.02(c) of the Standard Specifications to read:

“(c) RAP Materials (Note 3) .....1031”

Add the following note to 1030.02 of the Standard Specifications:

Note 3. When using reclaimed asphalt pavement and/or reclaimed asphalt shingles, the maximum asphalt binder replacement percentage shall be according to the most recent special provision for recycled materials.

**AGGREGATE SUBGRADE IMPROVEMENT (D-1)**

Effective: February 22, 2012  
 Revised: November 1, 2013

Add the following Section to the Standard Specifications:

**“SECTION 303. AGGREGATE SUBGRADE IMPROVEMENT**

**303.01 Description.** This work shall consist of constructing an aggregate subgrade improvement.

**303.02 Materials.** Materials shall be according to the following.

Item	Article/Section
(a) Coarse Aggregate .....	1004
(b) Reclaimed Asphalt Pavement (RAP) (Notes 1, 2 and 3) .....	1031

Note 1. Crushed RAP, from either full depth or single lift removal, may be mechanically blended with aggregate gradations CS 01 or CS 02 but shall not exceed 40 percent of the total product. The top size of the Coarse RAP shall be less than 4 in. (100 mm) and well graded.

Note 2. RAP having 100 percent passing the 1 1/2 in. (37.5 mm) sieve and being well graded, may be used as capping aggregate in the top 3 in. (75 mm) when aggregate gradations CS 01 or CS 02 are used in lower lifts. When RAP is blended with any of the coarse aggregates, the blending shall be done with mechanically calibrated feeders.

Note 3. The RAP used for aggregate subgrade improvement shall be according to the current Bureau of Materials and Physical Research Policy Memorandum, "Reclaimed Asphalt Pavement (RAP) for Aggregate Applications".

**303.03 Equipment.** The vibratory machine shall be according to Article 1101.01, or as approved by the Engineer.

**303.04 Soil Preparation.** The stability of the soil shall be according to the Department's Subgrade Stability Manual for the aggregate thickness specified.

**303.05 Placing Aggregate.** The maximum nominal lift thickness of aggregate gradations CS 01 or CS 02 shall be 24 in. (600 mm).

**303.06 Capping Aggregate.** The top surface of the aggregate subgrade shall consist of a minimum 3 in. (75 mm) of aggregate gradations CA 06 or CA 10. When Reclaimed Asphalt Pavement (RAP) is used, it shall be crushed and screened where 100 percent is passing the 1 1/2 in. (37.5 mm) sieve and being well graded. RAP that has been fractionated to size will not be permitted for use in capping. Capping aggregate will not be required when the aggregate subgrade improvement is used as a cubic yard pay item for undercut applications. When RAP is blended with any of the coarse aggregates, the blending shall be done with mechanically calibrated feeders.

**303.07 Compaction.** All aggregate lifts shall be compacted to the satisfaction of the Engineer. If the moisture content of the material is such that compaction cannot be obtained, sufficient water shall be added so that satisfactory compaction can be obtained.

**303.08 Finishing and Maintenance of Aggregate Subgrade Improvement.** The aggregate subgrade improvement shall be finished to the lines, grades, and cross sections shown on the plans, or as directed by the Engineer. The aggregate subgrade improvement shall be maintained in a smooth and compacted condition.

**303.09 Method of Measurement.** This work will be measured for payment according to Article 311.08.

**303.10 Basis of Payment.** This work will be paid for at the contract unit price per cubic yard (cubic meter) for AGGREGATE SUBGRADE IMPROVEMENT or at the contract unit price per square yard (square meter) for AGGREGATE SUBGRADE IMPROVEMENT, of the thickness specified.

Add the following to Section 1004 of the Standard Specifications:

“ **1004.06 Coarse Aggregate for Aggregate Subgrade Improvement.** The aggregate shall be according to Article 1004.01 and the following.

- (a) Description. The coarse aggregate shall be crushed gravel, crushed stone, or crushed concrete.
- (b) Quality. The coarse aggregate shall consist of sound durable particles reasonably free of deleterious materials.
- (c) Gradation.
  - (1) The coarse aggregate gradation for total subgrade thicknesses of 12 in. (300 mm) or greater shall be CS 01 or CS 02.

Grad No.	COARSE AGGREGATE SUBGRADE GRADATIONS				
	Sieve Size and Percent Passing				
	8"	6"	4"	2"	#4
CS 01	100	97 ± 3	90 ± 10	45 ± 25	20 ± 20
CS 02		100	80 ± 10	25 ± 15	

Grad No.	COARSE AGGREGATE SUBGRADE GRADATIONS (Metric)				
	Sieve Size and Percent Passing				
	200 mm	150 mm	100 mm	50 mm	4.75 mm

CS 01	100	97 ± 3	90 ± 10	45 ± 25	20 ± 20
CS 02		100	80 ± 10	25 ± 15	

- (2) The 3 in. (75 mm) capping aggregate shall be gradation CA 6 or CA 10.
- (3) Gradation deleterious count shall not exceed 10% of total RAP and 5% of other by total weight.

**TRENCH BACKFILL**

Trench backfill shall be compacted in accordance with Method 1 or Method 3 described in Article 550.07 of the Standard Specifications. Method 2 (ponding) will not be allowed.

Trench Backfill shall be measured in accordance with Article 208.03 of the Standard Specifications. This work will be paid for at the Contract unit price per cubic yard for TRENCH BACKFILL.

**ADJUSTMENTS AND RECONSTRUCTIONS**

Effective: March 15, 2011

Revise the first paragraph of Article 602.04 to read:

**“602.04 Concrete.** Cast-in-place concrete for structures shall be constructed of Class SI concrete according to the applicable portions of Section 503. Cast-in-place concrete for pavement patching around adjustments and reconstructions shall be constructed of Class PP-1 concrete, unless otherwise noted in the plans, according to the applicable portions of Section 1020.”

Revise the third, fourth and fifth sentences of the second paragraph of Article 602.11(c) to read:

“Castings shall be set to the finished pavement elevation so that no subsequent adjustment will be necessary, and the space around the casting shall be filled with Class PP-1 concrete, unless otherwise noted in the plans, to the elevation of the surface of the base course or binder course. HMA surface or binder course material shall not be allowed. The pavement may be opened to traffic according to Article 701.17(e)(3)b.”

Revise Article 603.05 to read:

**“603.05 Replacement of Existing Flexible Pavement.** After the castings have been adjusted, the surrounding space shall be filled with Class PP-1 concrete, unless otherwise noted in the plans, to the elevation of the surface of the base course or binder course. HMA surface or

binder course material shall not be allowed. The pavement may be opened to traffic according to Article 701.17(e)(3)b.”

Revise Article 603.06 to read:

**“603.06 Replacement of Existing Rigid Pavement.** After the castings have been adjusted, the pavement and HMA that was removed, shall be replaced with Class PP-1 concrete, unless otherwise noted in the plans, not less than 9 in. (225 mm) thick. The pavement may be opened to traffic according to Article 701.17(e)(3)b.

The surface of the Class PP concrete shall be constructed flush with the adjacent surface.”

Revise the first sentence of Article 603.07 to read:

**“603.07 Protection Under Traffic.** After the casting has been adjusted and the Class PP concrete has been placed, the work shall be protected by a barricade and two lights according to Article 701.17(e)(3)b.”

#### **FRAMES AND LIDS TO BE ADJUSTED (SPECIAL)**

This work shall conform to the requirements of Section 603 of the Standard Specifications and District Detail BD-08 “Details for Frames and Lids Adjustment with Milling” for adjustment of structures in resurfacing sections of the project.

This work shall include replacement of existing broken adjustment rings and patching inside the structures between pipes and structures with hydraulic cement at locations as directed by the engineer. If the structure is a combination sewer or sanitary manhole then chimney seals shall be provided.

This work shall be paid for at the contract unit price per each for “FRAMES AND LIDS TO BE ADJUSTED (SPECIAL)” which payment will be full compensation for constructing this item as detailed.

#### **DRAINAGE AND INLET PROTECTION UNDER TRAFFIC (D-1)**

Effective: April 1, 2011

Revised: April 2, 2011



Add the following to Article 603.02 of the Standard Specifications:

- “(i) Temporary Hot-Mix Asphalt (HMA) Ramp (Note 1) .....1030
- (j) Temporary Rubber Ramps (Note 2)

Note 1. The HMA shall have maximum aggregate size of 3/8 in. (95 mm).

Note 2. The rubber material shall be according to the following.

Property	Test Method	Requirement
Durometer Hardness, Shore A	ASTM D 2240	75 ±15
Tensile Strength, psi (kPa)	ASTM D 412	300 (2000) min
Elongation, percent	ASTM D 412	90 min
Specific Gravity	ASTM D 792	1.0 - 1.3
Brittleness, °F (°C)	ASTM D 746	-40 (-40)”

Revise Article 603.07 of the Standard Specifications to read:

“**603.07 Protection Under Traffic.** After the casting has been adjusted and the Class PP concrete has been placed, the work shall be protected by a barricade and two lights according to Article 701.17(e)(3)b.

When castings are under traffic before the final surfacing operation has been started, properly sized temporary ramps shall be placed around the drainage and/or utility castings according to the following methods.

- (a) Temporary Asphalt Ramps. Temporary hot-mix asphalt ramps shall be placed around the casting, flush with its surface and decreasing to a featheredge in a distance of 2 ft (600 mm) around the entire surface of the casting.
- (b) Temporary Rubber Ramps. Temporary rubber ramps shall only be used on roadways with permanent posted speeds of 40 mph or less and when the height of the casting to be protected meets the proper sizing requirements for the rubber ramps as shown below.

Dimension	Requirement
Inside Opening	Outside dimensions of casting + 1 in. (25 mm)
Thickness at inside edge	Height of casting ± 1/4 in. (6 mm)
Thickness at outside edge	1/4 in. (6 mm) max.

Width, measured from inside opening to outside edge	8 1/2 in. (215 mm) min
---	------------------------

Placement shall be according to the manufacturer's specifications.

Temporary ramps for castings shall remain in place until surfacing operations are undertaken within the immediate area of the structure. Prior to placing the surface course, the temporary ramp shall be removed. Excess material shall be disposed of according to Article 202.03."

**PUBLIC CONVENIENCE AND SAFETY (D-1)**

Effective: May 1, 2012

Revised: July 15, 2012

Add the following to the end of the fourth paragraph of Article 107.09:

"If the holiday is on a Saturday or Sunday, and is legally observed on a Friday or Monday, the length of Holiday Period for Monday or Friday shall apply."

Add the following sentence after the Holiday Period table in the fourth paragraph of Article 107.09:

"The Length of Holiday Period for Thanksgiving shall be from 5:00 AM the Wednesday prior to 11:59 PM the Sunday After"

Delete the fifth paragraph of Article 107.09 of the Standard Specifications:

"On weekends, excluding holidays, roadways with Average Daily Traffic of 25,000 or greater, all lanes shall be open to traffic from 3:00 P.M. Friday to midnight Sunday except where structure construction or major rehabilitation makes it impractical."

**FIRE HYDRANTS TO BE REMOVED**

Description. This work shall consist of removing fire hydrants, auxiliary valves, valve boxes and associated connecting water main at the locations shown on the plans and as directed by the Engineer.

The void resulting from the removal of fire hydrants, auxiliary valves, valve boxes and associated connecting water main shall be backfilled by Method 1 in accordance with the requirements of Article 550.07. The backfill material shall meet the approval of the Engineer. The backfill material for voids made in the subgrade of the proposed improvement, and voids

where the inner edge of the void is within two feet of the proposed edge of pavement, curb, curb and gutter, stabilized shoulder or sidewalk shall be aggregate and shall meet the requirements of Article 208.02.

The fire hydrants, auxiliary valves, valve boxes and associated connecting water main that are removed shall be delivered and unloaded, as directed by the Engineer, at the City of Crystal Lake Municipal Center during normal City of Crystal Lake Municipal Center working hours.

Any fire hydrants, auxiliary valves, valve boxes and associated connecting water main that are damaged by the Contractor shall be repaired before they are delivered and unloaded at the City of Crystal Lake Municipal Center.

All materials removed that are not salvaged, as determined by the Engineer, shall be disposed of according to Article 202.03.

Basis of Payment. This work will be paid for at the contract unit price each for FIRE HYDRANTS TO BE REMOVED, which price shall include all excavation; backfilling including fine aggregate and disposal of surplus materials. The removal of auxiliary valves will not be paid for separately but shall be included in the cost of FIRE HYDRANTS TO BE REMOVED.

### **RECESSED REFLECTIVE PAVEMENT MARKER**

This work shall be according to Section 781 of the Standard Specifications except as modified herein.

Installation: The recessed reflective pavement markers shall be constructed by removing a 5" x 24" area of the HMA pavement at a depth of  $\frac{3}{4}$ ". This depressed area shall be tapered vertically from the full depth of  $\frac{3}{4}$  inches to 0 inches in 30 inches at both ends for the two-way markers and at the approach end only for the one-way markers. The depressed area shall be orientated lengthwise and longitudinally with respect to the roadway.

The pavement marker shall be placed and cemented with epoxy in the center of the  $\frac{3}{4}$ " deep depressed area.

The recessed area shall be cleaned free of all loose material by means of sand blasting and also free of moisture before the placement of the pavement marker. All excess material resulting from the construction of the recessed area shall be completely removed from the surface of the roadway by means of vacuum sweeper truck.

Basis of Payment: This work shall be measure and paid for at the contract unit price per each for RECESSED REFLECTIVE PAVEMENT MARKER, which price shall be payment in full for all labor, materials, and equipment necessary to complete the work as described herein.

## **TEMPORARY PAVEMENT**

Effective: March 1, 2003

Revised: April 10, 2008

Description. This work shall consist of constructing a temporary pavement at the locations shown on the plans or as directed by the engineer.

The contractor shall use either Portland cement concrete according to Sections 353 and 354 of the Standard Specifications or HMA according to Sections 355, 356, 406 of the Standard Specifications, and other applicable HMA special provisions as contained herein. The HMA mixtures to be used shall be specified in the plans. The thickness of the Temporary Pavement shall be as described in the plans. The contractor shall have the option of constructing either material type if both Portland cement concrete and HMA are shown in the plans.

Articles 355.08 and 406.11 of the Standard Specifications shall not apply.

The removal of the Temporary Pavement, if required, shall conform to Section 440 of the Standard Specification.

Method of Measurement. Temporary pavement will be measured in place and the area computed in square yards (square meters).

Basis of Payment. This work will be paid for at the contract unit price per square yard (square meter) for TEMPORARY PAVEMENT and TEMPORARY PAVEMENT (INTERSTATE).

Removal of temporary pavement will be paid for at the contract unit price per square yard (square meter) for PAVEMENT REMOVAL.

## **TREATMENT STRUCTURES**

This work shall be in accordance with applicable portions of Section 602 of the IDOT Standard Specifications and the following for construction of the storm treatment structures as shown on the plans:

### **PART 1 – GENERAL**

#### **1.1 DESCRIPTION**

The work covered by this section consists of the construction of a structural underground stormwater oil and sediment separator unit. The Contractor shall furnish all equipment, tools, labor and materials necessary to complete the work in accordance with the plans and specifications.

## 1.2 REFERENCE STANDARDS

ASTM D-4097: Contact Molded Glass Fiber Reinforced Chemical Resistant Tanks

ASTM C 478: Standard Specification for Precast Reinforced Concrete Manhole Sections

ASTM C 443: Standard Specification for Joints for Concrete Pipe and Manholes, Using Rubber Gaskets

## 1.3 SHOP DRAWINGS

1.3.1 Shop drawings consisting of catalog cuts or fabricator drawings showing the structure and frames, grates, or covers shall be submitted by the Contractor to the Engineer for approval.

1.3.2 Where an external bypass is required, the manufacturer must provide calculations and designs for all structures, piping and any other required material applicable to the proper functioning of the system, stamped by a Professional Engineer.

## 1.4 HANDLING AND STORAGE

Care shall be taken in loading, transporting, and unloading to prevent damage to materials during storage and handling

## **PART 2 – PRODUCTS**

### 2.1 GENERAL

The separator shall be circular and constructed from pre-cast concrete circular riser and slab components. The internal fiberglass insert shall be bolted and sealed watertight inside the reinforced concrete component. The separator shall be capable to be used as a bend or junction structure within the stormwater drainage system.

### 2.2 PRECAST CONCRETE SECTIONS

All precast concrete components shall be designed and manufactured to a minimum live load of AASHTO HS-20 truck loading or greater based on local regulatory specifications.

### 2.3 JOINTS

The concrete joints shall be water-tight and meet the design criteria according to ASTM C-443. Mastic sealants or butyl tape are not an acceptable alternative.

### 2.4 FRAME AND COVER

The frame and cover shall include an indented top design with lettering of the unit's name cast into the cover to allow for easy identification in the field.

### 2.5 CONCRETE

All reinforced concrete components shall be manufactured according to local specifications and shall meet the requirements of ASTM C 478.

## 2.6 FIBERGLASS

The fiberglass portion of the water treatment device shall be constructed in accordance with the following standard: ASTM D-4097: Contact Molded Glass Fiber Reinforced Chemical Resistant Tanks.

## 2.7 INSPECTION

All precast concrete sections shall be inspected to ensure that dimensions, appearance and quality of the product meet local specifications and ASTM C 478

# **PART 3 – PERFORMANCE**

## 3.1 GENERAL

The stormwater quality treatment device shall remove oil and sediment from stormwater. The Stormwater separator unit is equipped with an internal high flow bypass that regulates the flow rate into the treatment chamber and conveys high flows directly to the outlet so that scour and/or resuspension of material previously collected in the separator does not occur. Simple substitution by dimensional equivalents or flow rates shall not be considered equivalent. Substitutions shall include site specific design modeling with supportive test data for any formal review and must be pre-approved a minimum of ten (10) business days prior to bid to be considered. Any substitution from the specified product requires a new submittal with no additional expense incurred to the owner.

## 3.3 TOTAL SUSPENDED SOLIDS

The treatment device shall be capable of removing 80 percent of the average annual total suspended solids (TSS) load without scouring previously captured pollutants. Design methodologies shall provide calculations substantiating removal efficiencies and correlation to field monitoring results using both particle size and TSS removal efficiency. All manufactures shall provide performance data that the stormwater quality treatment system does not scour previously captured pollutants based on the particle size distribution specified in section 3.5. Performance data should be laboratory testing with an initial sediment load of 50 percent of the unit's sediment capacity at an operating rate of 125% or greater. Particle size distribution (PSD) shall conform to table 3.5 and should include site specific calculations for TSS removal of the stormwater quality unit.

## 3.4 FREE OIL

3.4.1 The separator must be capable of removing 95 percent of the floatable free oil.

3.4.2 The first 16 inches (405 mm) of hydrocarbon storage shall be lined with fiberglass to provide a double wall containment of the hydrocarbon materials.

### 3.5 PARTICLE SIZE

3.5.1 The separator must be capable of trapping fine sand, silt, clay and organic particles in addition to larger sand, gravel particles and small floatables.

3.5.2 The stormwater quality treatment device shall be sized to a specific Particle Size Distribution, PSD that is clearly identified in both diameter and specific gravity.

Table 3.5 – Particle Size Distribution

Amount	Diameter	Specific Gravity
20%	20 micron	1.3
20%	60 micron	1.8
20%	150 micron	2.65
20%	400 micron	2.65
20%	2000 micron	2.65

## PART 4 – EXECUTION

### 4.1 INSTALLATION

The installation of the pre-cast concrete stormwater quality treatment device should conform to state highway, municipal or local specifications for the construction of manholes. Selected sections of a general specification that are applicable are summarized below.

### 4.2 EXCAVATION

4.2.1 Excavation for the installation of the stormwater quality treatment device should conform to state highway, municipal or local specifications.

4.2.2 The stormwater quality treatment device should not be installed on frozen ground. Excavation should allow for adequate compaction around the structure. If the bottom of the excavation provides an unsuitable foundation additional excavation may be required.

4.2.3 In areas with a high water table, continuous dewatering should be provided to ensure that the excavation is stable and free of water.

### 4.3 BACKFILLING

Backfill material should conform to state highway, municipal or local specifications. Backfill material should be placed in uniform layers not exceeding 12 inches (300 mm) in depth and compacted to state highway, municipal or local specifications.

### 4.4 WATER QUALITY DEVICE CONSTRUCTION SEQUENCE

4.4.1 The concrete water quality device is installed in sections in the following sequence:

- aggregate base
- base slab
- treatment chamber section(s)
- transition slab (if required)
- bypass section
- connect inlet and outlet pipes
- riser section and/or transition slab (if required)
- maintenance riser section(s) (if required)
- frame and access cover

4.4.2 The precast base should be placed level at the specified grade. The entire base should be in contact with the underlying compacted granular material. Subsequent sections, complete with gasketed joint seals, should be installed in accordance with the precast concrete manufacturer's recommendations.

4.4.3 Adjustment of the stormwater quality treatment device can be performed by lifting the upper sections free of the excavated area, re-leveling the base, and re-installing the sections. Damaged sections and gaskets should be repaired or replaced as necessary. Once the stormwater quality treatment device has been constructed, any lift holes must be plugged with mortar.

#### 4.5 DROP PIPE AND RISER PIPE

Once the upper chamber has been attached to the lower chamber, the inlet drop tee, and riser pipe must be attached. Pipe installation instructions and required materials shall be provided with the insert.

#### 4.6 INLET AND OUTLET PIPES

Inlet and outlet pipes should be securely set into the upper chamber using non-shrink grout or approved pipe seals (flexible boot connections, where applicable) so that the structure is watertight.

#### 4.7 FRAME AND COVER OR FRAME AND GRATE INSTALLATION

The grade adjustment units should be laid in a full bed of mortar with successive units being joined using sealant recommended by the manufacturer. Frames for the cover should be set in a full bed of mortar at the elevation specified.

Basis of Payment: This work shall be measured and paid for at the contract unit price per each for TREATMENT STRUCTURES, which price shall be payment in full for all labor, materials, and equipment necessary to complete the work.



### **CHAIN LINK FENCE REMOVAL**

This work shall consist of the removal of fence as shown in the plans or otherwise directed by the Engineer. The removal shall include post foundations, fittings, gates, posts and accessories. All holes left by the removal of the fence posts and post foundations shall be filled with crushed stone screenings. The furnishing and placing of the screenings shall be included in the cost of the Fence Removal. The Contractor shall do so at locations shown on the plans or as directed by the Engineer. The existing fence shall be carefully removed and delivered to the owners or properly disposed of as directed by the Engineer. Any part of the fence that is damaged that is not called for to be removed will be replaced at the Contractor's expense.

**Method of Measurement.** Fence Removal will be measured per lineal foot measured along the top of the fence.

**Basis of Payment.** This work will be paid for at the contract unit price per linear foot for CHAIN LINK FENCE REMOVAL, which includes all equipment, labor and materials necessary to remove, deliver, furnish, place, and dispose of the fence, crushed stone screenings, and miscellaneous accessories (posts, gates, fittings, etc.).

### **COMBINATION CONCRETE CURB AND GUTTER, TYPE B-6.12 (SPECIAL) AND COMBINATION CONCRETE CURB AND GUTTER, TYPE B-6.24 (SPECIAL)**

This work shall consist of the construction of new Type B-6.12 or Type B-6.24 curb and gutter at locations shown on the plans. This work shall be done in accordance with Section 606 of the Standard Specifications and the plan typical section details.

All curb and gutter removed shall be formed within 2 working days of removal. New curb and gutter shall be poured within 1 working day of being formed. The forms shall be removed within 1 working day after the concrete pour and the backfilling behind the new curb shall be done within 24 hours after removal of the forms. All low areas shall be filled in to match the surrounding grades within 72 hours of the curb being poured.

After removing the existing curb and gutter by saw cutting between the existing edge of pavement and the curb and gutter, Combination Concrete Curb and Gutter, Type B-6.12 (Special) or Combination Concrete Curb and Gutter, Type B-6.24 (Special) shall be constructed so that the bottom of the proposed curb and gutter matches the bottom of the existing HMA Base Course. Due to the differences in the elevations between the existing edge of pavement and the proposed edge of pavement, the gutter depths will vary. When the proposed edge of pavement is between 1' and 4' wider than the existing edge of pavement, 1' to 4' wide PCC Base Course shall be poured monolithically with the curb and gutter and shall be included in the cost of this item.

The method of measurement shall conform to Article 606.14 (b) of the Standard Specifications.

This work shall be paid for at the contract unit price per foot for COMBINATION CONCRETE CURB AND GUTTER, TYPE B-6.12 (SPECIAL) or COMBINATION CONCRETE CURB AND GUTTER, TYPE B-6.24 (SPECIAL), which price shall include all labor, materials, and equipment necessary to construct the work.

### **HOT-MIX ASPHALT SURFACE REMOVAL, VARIABLE DEPTH**

This work shall consist of grinding the existing pavement surface, including around utility castings as necessary. It shall also include street cleaning and providing all equipment, tools, labor, and incidentals necessary to complete the work in accordance with Article 440.03 of the Standard Specifications and the paving details sheets of the plans.

The roadway shall be ground from a variable depth of minimum 1.5" to a maximum of 4.25" according to the pavement details sheets of the plans.

Removal of the grindings shall be the responsibility of the Contractor. The Contractor shall also remove all loose and deleterious material including but not limited to broken concrete, exposed rock of any size, loose grindings, or any other material necessary to prepare the roadway for paving, as directed by the Engineer. The roadway shall be swept following the grinding operation and prior to paving. This work will include a base proof roll test, as directed by the Engineer. **Removal of loose material and street sweeping shall be considered included in the cost of this item.**

The Contractor shall construct and maintain temporary ramps at all ends of the areas removed. This includes the north and south project limits and any other locations, as required by the Engineer. The temporary ramps are to be constructed immediately upon completion of the removal operation and shall be removed prior to placing the proposed surface or binder course. Cold-milled bituminous tailings may be used to construct the temporary ramps. The Engineer can direct the Contractor to replace the milled material with binder or surface course if the millings can not withstand traffic exposure. **Temporary ramps shall be considered included in the cost of this item.**

At the City's request, any load, a maximum of 300 tons, of pavement grindings shall be delivered to the City Municipal Services Facility, the exact location to be determined by the Street Division Superintendent.

This work shall be paid for at the contract unit price per square yard of HOT-MIX ASPHALT SURFACE REMOVAL, VARIABLE DEPTH. Price shall be payment in full for performing this work, regardless of the number of passes required.

**MANHOLES, TYPE A, 6'-DIAMETER, WITH 2 TYPE 1 FRAME, CLOSED LID, RESTRICTOR PLATE**

This work shall consist of constructing a manhole in accordance with Section 602 of the Standard Specifications and District Detail BD-12 "Manhole with Restrictor Plate".

This work shall be paid for at the Contract unit price per each for MANHOLES, TYPE A, 6'-DIAMETER, WITH 2 TYPE 1 FRAME, CLOSED LID, RESTRICTOR PLATE, which shall include the labor, equipment, and materials required to perform the work described herein.

**BIKE PATH REMOVAL**

This work shall consist of the removal of the existing hot-mix asphalt multi-use path and aggregate base under the paths at the locations indicated in the plans or as directed by the Engineer. This work shall conform to this special provision and Articles 440.03 and 440.06 of the Standard Specifications.

Method of Measurement. Removal of the existing hot-mix asphalt multi-use path will be measured for payment in place and the area computed in square yards.

This work will be paid for at the contract unit price per square yard for BIKE PATH REMOVAL.

**STORM SEWER ADJACENT TO OR CROSSING WATER MAIN**

Effective: February 1, 1996

Revised: January 1, 2007

This work consists of constructing storm sewer adjacent to or crossing a water main, at the locations shown on the plans. The material and installation requirements shall be according to the latest edition of the "Standard Specifications for Water and Sewer Main Construction in Illinois", and the applicable portions of Section 550 of the Standard Specifications; which may include concrete collars and encasing pipe with seals if required.

Pipe materials shall meet the requirements of Sections 40 and 41-2.01 of the "Standard Specifications for Water and Sewer Main Construction in Illinois", except PVC pipe will not be allowed. Ductile-Iron pipe shall meet the minimum requirements for Thickness Class 50.

Encasing of standard type storm sewer, according to the details for "Water and Sewer Separation Requirements (Vertical Separation)" in the "STANDARD DRAWINGS" Division of the "Standard Specifications for Water and Sewer Main Construction in Illinois", may be used for storm sewers crossing water mains.

Basis of Payment: This work will be paid according to Article 550.10 of the Standard Specifications, except the pay item shall be STORM SEWER (WATER MAIN REQUIREMENTS), of the diameter specified.

### **STORM SEWER, RUBBER GASKET**

This work shall consist of furnishing and installing storm sewer with rubber gaskets in accordance with the applicable portions of Section 550 of the Standard Specifications.

All lengths of reinforced concrete pipe shall be constructed with the bell and spigot or tongue and groove ends of concrete formed on machine rings to ensure accurate joint surfaces. The contact surfaces shall be recessed or stepped to accommodate a round compression type rubber gasket for the entire diameter of the pipe.

Rubber gaskets shall be extruded or molded in a manner that any cross sections will be dense, homogeneous, and free of porosity, blisters, pitting and other imperfections. The gaskets shall be fabricated from a high-grade rubber compound containing no reclaimed rubber. The basic polymer shall be natural rubber, synthetic rubber or a blend of both.

The gaskets shall be seated on the pipe in accordance with the manufacturer's specifications. Where adhesive is required to properly seat the gasket, the gaskets shall be applied no less than 24 hours before installing the pipe.

When the pipe is lowered into the trench, installers shall make certain that no dirt is clinging to the joining surface or lodged under the gasket. The gasket and inside surface of the groove shall be thoroughly lubricated as specified by the gasket manufacturer. The tongue end shall be carefully centered in the groove so as to avoid displacement of the gasket, and the pipe shall be driven home, fully deforming the gasket, by use of a cable and winch set inside the pipeline, at least two pipe lengths back, or by other methods approved by the Engineer. Adjustment to line and grade shall be made in such a manner as not to disturb the deformed gasket.

This work shall be paid for at the contract unit price per foot for STORM SEWER, RUBBER GASKET, of the type and size specified, STORM SEWERS, CLASS A, TYPE 3 78", OR STORM SEWERS, CLASS A, TYPE 2 EQUIVALENT ROUND-SIZE 36". This price shall be payment in full for all equipment, labor, and materials necessary to complete this work as specified.

### **RETAINING WALL REMOVAL**

This work shall consist of removing the existing concrete wall and footing(s) at locations shown on the plans. The concrete wall, footings and any steel reinforcement shall be disposed of off-site at an approved location and shall be disposed of the day that it is removed.

This work shall be paid for at the contract unit price foot for RETAINING WALL REMOVAL which price shall be payment in full for furnishing all labor and equipment necessary to remove and dispose of the retaining wall off-site at an approved location.

### **TELESCOPING STEEL SIGN SUPPORT (SPECIAL)**

This work shall consist of furnishing and installing telescoping steel sign supports for ground-mounted signs utilizing a telescoping base section in accordance with applicable articles of Section 728 of the IDOT Standard Specifications and as detailed in the plans and the following.

Posts as specified in article 1093.01 (c) of the IDOT Standard Specifications shall be formed of 14 gage steel, except that the base shall be formed of 12 gage steel. Holes 7/16+or-1/64 inch diameter will be spaced one inch on centers on all sides for the entire length of the posts. Holes shall be on the centerline of each side in true alignment and opposite of each other to accept a 3/8 inch bolt through the post at any location. The post shall have a smooth galvanized finish applied either before or after forming.

The base shall be constructed with 12 gage steel winged anchors by using standard tubular steel and welding metal triangular fins on each corner of the tubular steel. The four triangular fins shall be 10" long by 4" wide mounted 9" from the top of the base pointing in a downward direction. The base shall be 3 feet in length. The base shall have a smooth galvanized finish applied after fabrication.

Splicing of the top section will not be permitted.

The base shall be driven according to Article 728.04 (b) of the IDOT Standard Specifications except that leaving top 9" above the adjacent finished ground surface.

Method of Measurement: This work will be measured for payment in feet. The length measured will be the total length of all sections installed, except for any telescoping of a top section more than 12 inches into a base section.

Basis of Payment: This work will be paid for at the contract unit price per lineal foot for TELESCOPING STEEL SIGN SUPPORT (SPECIAL).

### **HOT-MIX ASPHALT DRIVEWAY PAVEMENT, 10"**

This work shall consist of furnishing, placing and compacting hot-mix asphalt driveway pavement at locations shown on the plans and as directed by the Engineer.

This work shall conform to the applicable Sections of Articles 355 and 406 of the IDOT Standard Specifications and IDOT District Details BD-01 and BD-02.

Commercial driveways shall be constructed to a nominal thickness of 10 inches which shall consist of a minimum 2" thick surface course (HMA Surface Course, Mix "D", N50) with the balance constructed using hot mix asphalt binder course (HMA Base Course, 8"). Aggregate and bituminous material prime coats shall be applied according to Article 406 and as directed by the Engineer.

Method of Measurement: Hot-mix asphalt driveway pavement will be measured in place and the area computed in square yards. The pavement materials and aggregate and bituminous material prime coats will not be measured for payment separately but shall be considered included in payment for Hot-Mix Asphalt Driveway Pavement.

Basis of Payment: The work will be paid at the contract unit price per square yard for HOT-MIX ASPHALT DRIVEWAY PAVEMENT, 10", which price shall be full payment for all materials, labor, and equipment necessary to construct the driveways.

#### **SANITARY MANHOLES TO BE ADJUSTED**

This item of work shall consist of the adjustment of the sanitary sewer manholes in accordance with the applicable portions of Section 602 of the Standard Specification, except as herein modified.

The manhole rims shall be adjusted to meet the proposed elevations. The manholes shall be thoroughly cleaned and all cracks and joints shall be sealed with mortar approved by the Engineer. Two rows of extrudible preformed mastic gasket shall be installed under the manhole frame.

Chimney seals shall be provided.

This work shall be paid for at the contract unit price each for SANITARY MANHOLES TO BE ADJUSTED which price shall be payment in full for furnishing all materials, labor and equipment necessary to adjust the sanitary manhole complete in place.

#### **ADJUSTING WATER MAIN**

This work consists of adjustments of existing water mains as necessary to eliminate conflicts with proposed utilities and shall conform to the Standard Specifications for Water and Sewer Main Construction in Illinois and applicable portions of Section 561 of the Standard Specifications.

Ductile iron pipe shall conform to ANSI Specification A21.51 or AWWA C151. Class 52 minimum thickness is required.

This work shall be paid for at the contract unit price per foot for ADJUSTING WATER MAIN, of the diameter specified, which price shall include excavation, existing pipe removal and disposal, pipe installation, fittings, mega lugs, thrust blocks, coordination with the City of Crystal Lake personnel for operation of water valves, and all other labor, equipment and materials necessary to complete the work.

TRENCH BACKFILL shall be paid for separately.

### **SHREDDED BARK MULCH 3"**

This item shall consist of furnishing, transporting and placing of SHREDDED BARK MULCH 3" in the landscaped median shown in the construction documents.

General Requirements:

1. The Contractor must supply and install Mulch as required to mulch around shrubs and herbaceous plants in landscaped areas.
2. The Contractor must remove all litter and plant debris before mulching. Care must be taken not to bury leaves, stems, or vines under mulch material.
3. The Contractor must place a 12" lift of topsoil in the area to be mulched before installing the mulch. The topsoil will be paid for separately as TOPSOIL FURNISH AND PLACE, 12".
4. All finished mulch areas must be left smooth and level to maintain a uniform surface and appearance. All planting areas or work areas must be clean of debris and mulch, prior to leaving the site.

Materials:

1. Mulch must be clean, finely shredded mixed-hardwood bark, not to exceed 2" in its largest dimension, free of foreign matter, sticks, stones, and clods.
2. All Mulch must be processed through a hammermill. Hardwood bark not processed through a hammermill must not be accepted.
3. A sample and request for material inspection form must be supplied to the Architect for approval prior to performing any work.

Installation:

1. Place mulch layer around all plants as follows:
  - A. Perennials, including perennials, bulbs, ground cover, vines, grasses: 3" deep - keep mulch away from crowns of plants.

- B. Shrubs, including shrubs and roses: 3” deep - keep mulch away from stem, crown, or neck of shrub.

Method of Measurement:

1. SHREDDED BARK MULCH 3” will be measured for payment in place and the area computed per SQUARE YARD of mulch installed. This item will not be paid by Load Tickets.

Basis of Payment:

1. The work under this item must be paid for at the contract unit price per SQUARE YARD as shown in the Schedule of Unit Prices for SHREDDED BARK MULCH 3” including all labor, material, equipment, and Traffic Control and Protection necessary to complete the work.

**FLASHING BEACON, POST MOUNTED, SOLAR POWERED INSTALLATION**

This item shall consist of relocating the existing solar panel, controller, pedestrian push button and rectangular rapid flashing beacon from the existing supports onto a new steel mast arm assembly and pole as shown on the plans and as described herein. The new concrete foundation and steel mast arm assembly and pole will be paid for separately.

Basis of Payment. This work shall be paid for at the contract unit price each for FLASHING BEACON, POST MOUNTED, SOLAR POWERED INSTALLATION. The price shall be payment in full for all labor and material necessary to complete the work described above.

**REMOVE EXISTING SIGN SUPPORT**

This work shall consist of removing the existing sign supports which support the existing solar panel and RRFB. The supports are the property of the City of Crystal Lake and shall be returned to the maintenance facility of the City of Crystal Lake located just east of 111 S. Main Street immediately after the removal. If the supports are damaged by the contractor during the removal process, then the contractor shall replace the supports at their own expense.

Basis of Payment:

The work under this item must be paid for at the contract unit price per EACH as shown in the Schedule of Unit Prices for REMOVE EXISTING SIGN SUPPORT including all labor, material, and equipment, necessary to complete the work.



**REMOVE EXISTING SIGN POST**

This work shall consist of removing existing sign posts as shown on the plans. The sign posts shall be returned to the maintenance facility of the City of Crystal Lake located just east of 111 S. Main Street City upon removal.

**Basis of Payment:**

The work under this item must be paid for at the contract unit price per EACH as shown in the Schedule of Unit Prices for REMOVE EXISTING SIGN POST including all labor, material, and equipment, necessary to complete the work.

**SPLIT RAIL FENCE**

This work shall consist of furnishing and installing wood split rail fence at locations shown on the plans. The split rail fence shall be inspected and approved by the Resident Engineer before it is installed. The fence shall be 4 feet high and be installed per the direction of the Resident Engineer. The posts shall be a minimum of 4 feet into the ground.

**Basis of Payment:**

The work under this item must be paid for at the contract unit price per FOOT as shown in the Schedule of Unit Prices for SPLIT RAIL FENCE including all labor, material, and equipment, necessary to complete the work.

**AGGREGATE SURFACE COURSE FOR TEMPORARY ACCESS**

Revise Article 402.10 of the Standard Specifications to read:

**“402.10 For Temporary Access.** The contractor shall construct and maintain aggregate surface course for temporary access to private entrances, commercial entrances and roads according to Article 402.07 and as directed by the Engineer.

The aggregate surface course shall be constructed to the dimensions and grades specified below, except as modified by the plans or as directed by the Engineer.

- (a) Private Entrance. The minimum width shall be 12 ft (3.6 m). The minimum compacted thickness shall be 6 in. (150 mm). The maximum grade shall be eight percent, except as required to match the existing grade.

- (b) Commercial Entrance. The minimum width shall be 24 ft (7.2 m). The minimum compacted thickness shall be 9 in. (230 mm). The maximum grade shall be six percent, except as required to match the existing grade.
- (c) Road. The minimum width shall be 24 ft (7.2 m). The minimum compacted thickness shall be 9 in. (230 mm). The grade and elevation shall be the same as the removed pavement, except as required to meet the grade of any new pavement constructed.
- (d) Sidewalk. The minimum width shall be four feet. The minimum compacted thickness shall be 4 inches. The grade and elevation shall be the same as the removed sidewalk, except as required to meet the grade of any new sidewalk constructed.

Maintaining the temporary access shall include relocating and/or regrading the aggregate surface course for any operation that may disturb or remove the temporary access. The same type and gradation of material used to construct the temporary access shall be used to maintain it.

When use of the temporary access is discontinued, the aggregate shall be removed and utilized in the permanent construction or disposed of according to Article 202.03.”

Add the following to Article 402.12 of the Standard Specifications:

“Aggregate surface course for temporary access will be measured for payment as each for every private entrance, commercial entrance or road constructed for the purpose of temporary access. If a residential drive, commercial entrance, or road is to be constructed under multiple stages, the aggregate needed to construct the second or subsequent stages will not be measured for payment but shall be included in the cost per each of the type specified.”

Revise the second paragraph of Article 402.13 of the Standard Specifications to read:

“Aggregate surface course for temporary access will be paid for at the contract unit price per each for TEMPORARY ACCESS (PRIVATE ENTRANCE), TEMPORARY ACCESS (COMMERCIAL ENTRANCE), TEMPORARY ACCESS (ROAD), or TEMPORARY ACCESS WALK.

Partial payment of the each amount bid for temporary access, of the type specified, will be paid according to the following schedule:

Upon construction of the temporary access, sixty percent of the contract unit price per each, of the type constructed, will be paid.

Subject to the approval of the Engineer for the adequate maintenance and removal of the temporary access, the remaining forty percent of the pay item will be paid upon the permanent removal of the temporary access.”

## **EMBANKMENT II**

Effective: March 1, 2011

Revised: November 1, 2013

Description. This work shall be according to Section 205 of the Standard Specifications except for the following.

Material. Reclaimed asphalt shall not be used within the ground water table or as a fill if ground water is present. The RAP used shall be according to the current Bureau of Materials and Physical Research Policy Memorandum, "Reclaimed Asphalt Pavement (RAP) for Aggregate Applications". Gradation deleterious count shall not exceed 10% of total RAP and 5% of other by total weight.

### CONSTRUCTION REQUIREMENTS

Samples. Embankment material shall be sampled and tested before use. The contractor shall identify embankment sources, and provide equipment as the Engineer requires, for the collection of samples from those sources. Samples will be furnished to the Geotechnical Engineer a minimum of three weeks prior to use in order that laboratory tests for compaction can be performed. Embankment material placement cannot begin until tests are completed.

Placing Material. In addition to Article 202.03, broken concrete, reclaimed asphalt with no expansive aggregate, or uncontaminated dirt and sand generated from construction or demolition activities shall be placed in 6 inches (150 mm) lifts and disked with the underlying lift until a uniform homogenous material is formed. This process also applies to the overlaying lifts. The disk must have a minimum blade diameter of 24 inches (600 mm).

When embankments are to be constructed on hillsides or existing slopes that are steeper than 3H:1V, steps shall be keyed into the existing slope by stepping and benching as shown in the plans or as directed by the Engineer.

Compaction. Soils classification for moisture content control will be determined by the Soils Inspector using visual field examination techniques and the IDH Textural Classification Chart.

When tested for density in place each lift shall have a maximum moisture content as follows.

- a) A maximum of 110 percent of the optimum moisture for all forms of clay soils.
- b) A maximum of 105 percent of the optimum moisture for all forms of clay loam soils.

Stability. The requirement for embankment stability in article 205.04 will be measured with a Dynamic Cone Penetrometer (DCP) according to the test method in the IDOT Geotechnical Manual. The penetration rate must be equal or less than 1.5 inches (38 mm) per blow.

Basis of Payment. This work will not be paid separately but will be considered as included in the various items of excavation.

### **FIRE HYDRANT WITH AUXILIARY VALVE AND VALVE BOX**

Description. This work shall consist of constructing fire hydrants with auxiliary valves and valve boxes at the locations shown on the plans, as shown in the plan details and as directed by the Engineer.

Materials. Materials shall be as shown in the contract. Cast iron valve boxes shall have the word "WATER" cast into the lid.

Construction Requirements. The construction of fire hydrants with auxiliary valves and valve boxes shall be done in accordance with the requirements of Section 561 of the Standard Specifications, the details shown on the plans and as directed by the Engineer.

Basis of Payment. This work shall be paid for at the contract unit price per each for FIRE HYDRANT WITH AUXILIARY VALVE AND VALVE BOX to include all costs of installation, labor and materials required to complete the work shown on the plans, details, and specified herein.

The cost to furnish and install the six (6) inch diameter ductile iron pipe between the mainline tee and the hydrant auxiliary valve and between the hydrant auxiliary valve and the fire hydrant shall be paid for separately as WATER MAIN 6".

### **PORTLAND CEMENT CONCRETE BASE COURSE WIDENING, 10 ½"**

This work shall be completed in accordance with Section 354 of the Standard Specifications for Road and Bridge Construction and the detail shown in the proposed typical sections of the plans.

This work shall be paid for at the contract unit price square yard for PORTLAND CEMENT CONCRETE BASE COURSE WIDENING, 10 ½" which shall include all labor, equipment and materials to complete the work shown on the plans, details, and specified herein.

### **SANITARY SEWER SERVICE REMOVAL AND REPLACEMENT:**

Description: The work of this Pay Item shall be completed in accordance with the applicable portions of the Special Provision for "SANITARY SEWER SYSTEM" and the latest edition of

the “Standard Specifications for Water and Sewer Main Construction in Illinois”, and shall consist of installation of a 6” PVC sanitary sewer building service line complete in place from the main to the right-of-way, a 8” ductile iron sleeve to protect the 6” PVC line within the proposed storm sewer manhole limits; removal of existing 6” service line; protecting, repair or replacement of utilities; plugs or connections to existing building service lines at the property line and at the sanitary sewer; excavation; bracing, bedding and covering of pipe; trench dewatering; trench backfilling with excavated materials or trench backfill materials; testing; and finish grading.

Method of Measurement: This work will be measured in lineal feet along the centerline of the service pipe from the centerline of the main line sewer to the point of connection with the existing service pipe, including all riser pipes.

Basis of Payment: This work will be paid for at the Contract Unit Price per each for SANITARY SEWER SERVICE REMOVAL AND REPLACEMENT, of the diameter specified, regardless of depth. Where the sanitary sewer service pipe is outside the water main trench, the cost of granular backfill material where required will be included in this pay item.

**ADJUSTING SANITARY SEWER CLEANOUT**

Description: The work of this Pay Item consists of the adjustment of the existing sanitary sewer cleanouts to the finished grade elevations at locations shown on the plans.

Basis of Payment: The work will be paid for a the Contract Unit Price for each ADJUST SANITARY SEWER CLEANOUT.

**WEED CONTROL, BROADLEAF IN TURF**

Description: This work shall consist of the application of a broadleaf herbicide (2,4-D or equal) along highway roadsides for control of broadleaf plants in turf.

Materials: The broadleaf herbicide (2,4-D or equal) shall have the following formulation:

A. Active Ingredient	
Dimethylamine salt of 2,4-D-Dichlorophenoxyacetic acid .....	46.3%
B. Inert Ingredients	<u>53.7%</u>
	TOTAL      100.00%

The Contractor shall submit a certificate, including the following, prior to starting work:

1. The chemical names of the compound and the percentage by weight of the ingredients which must match the above specified formulation.
2. A statement that the material is in a solution which will form a satisfactory emulsion for use when diluted with water for normal spraying conditions.
3. A statement that the 2,4-D or equal, when mixed with water, will be completely soluble and dispersible and remain in suspension with continuous agitation.
4. A statement describing the products proposed for use when the manufacturer of 2,4-D or equal requires that surfactants, drift control agents, or other additives be used with the product. These tank mix additives shall be used as specified by the manufacturer. Required additives will not be paid for separately.  
**All material shall be brought to the spray area in the original, unopened containers supplied by the manufacturer.**

Schedule: Spraying will not be allowed when temperatures exceed 90° F or under 45° F, when wind velocities exceed fifteen (15) miles per hour, when foliage is wet or rain is eminent, when visibility is poor or during legal holiday periods.

Application Rate: The 2,4-D or equal broadleaf herbicide shall be applied at the rate of four (4) pints per acre. 2,4-D or equal formulation shall be diluted with a minimum of one-hundred (100) gallons of water and applied as a mixture. Water for dilution of the mixture will not be paid for separately.

Method of Measurement: Weed Control, Broadleaf in Turf will be measured for payment in gallons (liters) of undiluted 2,4-D or equal applied as specified.

Basis of Payment: Weed Control, Broadleaf in Turf will be paid for at the contract unit price per gallon (liters). Water for dilution of the mixture and additives required for application will not be paid for as separate items, but the costs shall be considered as included in the contract unit price for Weed Control, Broadleaf in Turf and no additional compensation will be allowed.

#### **EXPLORATION TRENCH (SPECIAL)**

Description: This work will be performed where directed by the Engineer to locate utility service lines and other subsurface improvements.

Use of this item will not absolve the Contractor of any responsibilities under Article 105.07. This work will otherwise be performed in accordance with Section 213.

Where required by Article 208.01, trench backfill will be paid for according to Article 208.04.

When an existing sewer or service is encountered, another trench shall be excavated on the opposite side of the proposed improvement to establish the line and grade of the existing sewer or service. Broken tile shall be repaired immediately and no surface runoff shall be allowed to enter any tile.

After the trench has been inspected by the engineer, the excavated material shall be used to backfill the trench in a manner satisfactory to the engineer. Any excess material shall be disposed of according to Article 202.03, and the area shall be shaped and trimmed according to Section 212.

Method of Measurement: Exploration trench will be measured for payment to the lines of the excavated trench and the volume computed in cubic yards.

Basis of Payment: This work shall be paid for at the contract unit price per cubic yard for EXPLORATION TRENCH (SPECIAL).

**FLY ASH RESTRICTION**  
Effective: May 8, 2012  
Revised: December 10, 2013

The use of fly ash in any PCC mixtures will not be allowed. All references to fly ash in the Standard Specifications or contract special provisions shall not apply.

**HOT-MIX ASPHALT – PRIME COAT (D-1)**

Effective: February 19, 2013  
Revised: April 1, 2014

Revise Note 1 of Article 406.02 of the Standard Specifications to read:

“Note 1. The bituminous material used for prime coat shall be one of the types listed in the following table.

shall be performed by the emulsion producer. The emulsified asphalt shall be thoroughly agitated within 24 hours of application and show no separation of water and emulsion.

Application	Bituminous Material Types
-------------	---------------------------

Prime Coat on Brick, Concrete, or HMA Bases	SS-1, SS-1h, SS-1hP, SS-1vh, CSS-1, CSS-1h, CSS-1hP, HFE-90, RC-70
Prime Coat on Aggregate Bases	MC-30, PEP”

Add the following to Article 406.03 of the Standard Specifications:

“(i) Regenerative Air Vacuum Sweeper.....1101.19”

Revise Article 406.05(b) of the Standard Specifications to read:

“(b) Prime Coat. The bituminous material shall be prepared according to Article 403.05 and applied according to Article 403.10. The use of RC-70 shall be limited to air temperatures less than 60 °F (15 °C).”

(1) Brick, Concrete or HMA Bases. The base shall be cleaned of all dust, debris and any substance that will prevent the prime coat from adhering to the base. Cleaning shall be accomplished by sweeping to remove all large particles and air blasting to remove dust. As an alternate to air blasting, vacuum sweeping may be used to accomplish the dust removal. Vacuum sweeping shall be accomplished with a regenerative air vacuum sweeper. The base shall be free of standing water at the time of application. The prime coat shall be applied uniformly and at a rate that will provide a residual asphalt rate on the prepared surface as specified in the following table.

Type of Surface to be Primed	Residual Asphalt Rate lb/sq ft (kg/sq m)
Milled HMA, Aged Non-Milled HMA, Milled Concrete, Non-Milled Concrete & Tined Concrete	0.05 (0.244)
Fog Coat between HMA Lifts, IL-4.75 & Brick	0.025 (0.122)

The bituminous material for the prime coat shall be placed one lane at a time. The primed lane shall remain closed until the prime coat is fully cured and does not pickup under traffic. When placing prime coat through an intersection where it is not possible to keep the lane closed, the prime coat may be covered immediately following its application with fine aggregate mechanically spread at a uniform rate of 2 to 4 lb/sq yd (1 to 2 kg/sq m).

(2) Aggregate Bases. The prime coat shall be applied uniformly and at a rate that will provide a residual asphalt rate on the prepared surface of 0.25 lb/sq ft ± 0.01 (1.21 kg/sq m ± 0.05).

The prime coat shall be permitted to cure until the penetration has been approved by the Engineer, but at no time shall the curing period be less than 24 hours for MC-30 or four hours for



PEP. Pools of prime occurring in the depressions shall be broomed or squeegeed over the surrounding surface the same day the prime coat is applied.

The base shall be primed 1/2 width at a time. The prime coat on the second half/width shall not be applied until the prime coat on the first half/width has cured so that it will not pick up under traffic.

The residual asphalt binder rate will be verified a minimum of once per type of surface to be primed as specified herein for which at least 2,000 tons of HMA will be placed. The test will be according to the "Determination of Residual Asphalt in Prime and Tack Coat Materials" test procedure.

Prime coat shall be fully cured prior to placement of HMA to prevent pickup by haul trucks or paving equipment. If pickup occurs, paving shall cease in order to provide additional cure time.

Prime coat shall be placed no more than five days in advance of the placement of HMA. If after five days loss of prime coat is evident prior to covering with HMA, additional prime coat shall be placed as determined by the Engineer at no additional cost to the Department."

Revise the last sentence of the first paragraph of 406.13(b) to read:

"Water added to emulsified asphalt at the source as allowed in article 406.02 will not be included in the quantities measured for payment."

Revise the second paragraph of Article 406.13(b) of the Standard Specifications to read:

"Aggregate for covering prime coat will not be measured for payment."

Revise the first paragraph of Article 406.14 and the second paragraph of Article 407.12 of the Standard Specifications to read:

"Prime Coat will be paid for at the contract unit price per pound (kilogram) of residual asphalt applied for BITUMINOUS MATERIALS (PRIME COAT), POLYMERIZED BITUMINOUS MATERIALS (PRIME COAT) or NON-TRACKING BITUMINOUS MATERIALS (PRIME COAT)."

Revise Article 407.06(b) of the Standard Specifications to read:

"A bituminous prime coat shall be applied between each lift of HMA according to Article 406.05(b)."

Revise Article 1032.02 of the Standard Specifications to read:

“1032.02 Measurement. Asphalt binders, emulsified asphalts, rapid curing liquid asphalt, medium curing liquid asphalts, slow curing liquid asphalts, asphalt fillers, and road oils will be measured by weight.

A weight ticket for each truck load shall be furnished to the inspector. The truck shall be weighed at a location approved by the Engineer. The ticket shall show the weight of the empty truck (the truck being weighed each time before it is loaded), the weight of the loaded truck, and the net weight of the bituminous material.

When an emulsion or cutback is used for prime coat, the percentage of asphalt residue of the actual certified product shall be shown on the producer’s bill of lading or attached certificate of analysis. If the producer adds extra water to an emulsion at the request of the purchaser, the amount of water shall also be shown on the bill of lading.

Payment will not be made for bituminous materials in excess of 105 percent of the amount specified by the Engineer.”

Add the following to the table in article 1032.04 of the Standard Specifications:

“SS-1vh	160 - 180	70 – 80”
---------	-----------	----------

Add the following to Article 1032.06 of the Standard Specifications:

“(g) Non Tracking Emulsified Asphalt SS-1vh:

Requirements for SS-1vh			
Test		SPEC	AASHTO Test Method
Saybolt Viscosity @ 25C,	SFS	20-200	T 72
Storage Stability, 24hr.,	%	1 max.	T 59
Residue by Evaporation,	%	50 min.	T 59
Sieve Test,	%	0.3 max.	T 59
Tests on Residue from Evaporation			
Penetration @25°C, 100g., 5 sec.,	dmm	20 max.	T 49
Softening Point,	°C	65 min.	T 53
Solubility,	%	97.5 min.	T 44
Orig. DSR @ 82°C,	kPa	1.00 min.	T 315”

Revise the last table of Article 1032.06 to read:

“Grade	Use
--------	-----

SS-1, SS-1h, CSS-1, CSS-1h, HFE-90, SS-1hP, CSS-1hP, SS-1vh	Prime or fog seal
PEP	Bituminous surface treatment prime
RS-2, HFE-90, HFE-150, HFE-300, CRSP, HFP, CRS-2, HFRS-2	Bituminous surface treatment
CSS-1h Latex Modified	Microsurfacing"

Add the following to Article 1101 of the Standard Specifications:

“1101.19 Regenerative Air Vacuum Sweeper. The regenerative air vacuum sweeper shall blast re-circulated, filtered air through a vacuum head having a minimum width of 6.0 feet at a minimum rate of 20,000 cubic feet per minute.”

**RECLAIMED WATER (D-1)**

Effective: December 1, 2013

General. This specification covers the blending, testing, storing, use of and requirements for reclaimed water in Portland cement concrete.

Material. Reclaimed water shall consist of wash out, runoff, and/or storm water that has been combined with water conforming to Article 1002.01. Reclaimed water meeting the quality requirements of this specification shall be evaluated for acceptance by the Department.

Use. Reclaimed water will only be allowed in Class PV and SI concrete mix designs at a maximum of 20.0% total by weight. Reclaimed water is prohibited in all other concrete class mix designs. This material will only be allowed in work without reinforcing steel only. Dowel bars and tie bars are not considered reinforcing steel.

Reclaimed water shall be weighed or metered separately from water conforming to Article 1002.01 and shall be detailed separately on batch sheets used to document concrete batch weights.

Quality. The reclaimed water shall be clean, clear, and free from sugar. Reclaimed water shall be combined at a 1:4 ratio with water conforming to Article 1002.01 and the combination shall be according to Article 1002.02 except for the following:

“(2) Alkalinity -- 0.1 Normal HCl..... 60 ml max.\*

\*To neutralize 200 ml sample.”

Water Intake. Reclaimed water shall enter a settling pond before being filtered to remove the necessary amount of solids to meet specifications in Article 1002.02. The intake of the pipeline shall be at a minimum height of 2 ft (600 m) above the bottom of the reclaimed water settling pond. A properly labeled tank shall be provided for storage of the reclaimed water. The tank is to be separate from water which has been approved by the Illinois Department of Public Health for drinking or household use. The tank may be heated, however the maximum water temperature of the reclaimed water shall not exceed 150 °F (65 °C).

#### Quality Control and Quality Assurance (QC/QA).

- (a) Quality Control by Contractor. The Contractor shall provide evidence to assure conformance to the standards stated in Article 1002.02 (a) and (b). The Engineer shall be immediately notified of any failing tests and subsequent remedial action. Inability to maintain the reclaimed water within specifications is cause for the Engineer to suspend the use of reclaimed water in concrete until adjustments have been made and the water is within the specifications.

Water samples will be taken on the same date and sampled as follows: three liters from the tank containing water that conforms to Art. 1002.01 and three liters from the filtered tank. Both samples must be submitted to the Department for testing every 4 months and when requested by the Engineer. A state representative must witness the sampling. The results from these samples shall serve as a check to the data provided by the contractor.

One Trial Batch per proposed mix design is required to verify minimum strengths can be achieved as defined in Article 1020.04 of the Standard Provision.

- (b) Quality Assurance by the Engineer. The Engineer will conduct independent assurance tests on split samples taken by the Contractor for quality control testing.
- (c) Documentation. The Contractor shall be responsible for documenting all test results. Records of testing shall be kept for a minimum of three years. The Contractor shall provide the Engineer full access to all documents.

**WATER MAIN LINE STOP 8”**

Description. This work shall consist of furnishing and installing a temporary line stop in an existing water main.

This work includes locating the existing water main, excavation and removal and disposal of excavated material, sheeting as required, temporary fencing of the work site as required and removal of the temporary line stop, capping of the tapping sleeve, and backfilling of the excavation to the existing subgrade.

This work shall be done in accordance with the manufacturer’s recommendations and shall meet the approval of the Engineer.

Materials. Materials shall be as shown on the plans and as approved by the Engineer.

Construction Requirements. This work shall be done in accordance with the requirements of Section 561 of the Standard Specifications, the details shown on the plans and as directed by the Engineer.

The Contractor shall schedule a meeting with the City of Crystal Lake Engineering Division Inspection Services Coordinator (815-356-3615) a minimum of 2 weeks prior to the anticipated start of work for the line stop.

Basis of Payment. This work will be paid for at the contract unit price per each for WATER MAIN LINE STOP 8”.

Trench backfill will be paid according to Article 208.04 of the Standard Specifications.

**REMOVE EXISTING HANDHOLE**

This work shall be done in accordance with Section 895 of the Standard Specifications, except as modified herein:

895.07 Method of Measurement. Add the following to the end of the Article:

“This work will be measured for payment in place for each handhole removed.”

**REMOVE EXISTING DOUBLE HANDHOLE**

This work shall be done in accordance with Section 895 of the Standard Specifications, except as modified herein:

895.07 Method of Measurement. Add the following to the end of the Article:

“This work will be measured for payment in place for each double handhole removed.”

**REMOVE EXISTING CONCRETE FOUNDATION**

This work shall be done in accordance with Section 895 of the Standard Specifications, except as modified herein:

895.07 Method of Measurement. Add the following to the end of the Article:

“This work will be measured for payment in place for each concrete foundation removed.”

**TRAFFIC SIGNAL SPECIFICATIONS (MCDOT)**

**Effective: January 1, 2010**  
**Revised: March 1, 2013**

These Traffic Signal Special Provisions and the "District 1 Standard Traffic Signal Design Details" supplement the requirements of the State of Illinois "Standard Specifications for Road and Bridge Construction." The intent of these Special Provisions is to prescribe the materials and construction methods commonly used for traffic signal installations. All material furnished shall be new. The locations and the details of all installations shall be as indicated on the Plans or as directed by the Engineer. Traffic signal construction and maintenance work shall be performed by personnel holding IMSA Traffic Signal Technician Level II certification. The work to be done under this contract consists of furnishing and installing all traffic signal work as specified in the Plans and as specified herein in a manner acceptable and approved by the Engineer.

## **SECTION 720 SIGNING**

### **MAST ARM SIGN PANELS.**

Add the following to Section 720.02 of the Standard Specifications:

Signs attached to poles or posts (such as mast arm signs) shall have mounting brackets and sign channels which are equal to and completely interchangeable with those used by the McHenry County Sign Shop. Signfix Aluminum Channel Framing System is currently recommended, but other brands of mounting hardware are acceptable based upon the Department's approval. All signs shall have a white reflectorized legend and border on a green reflectorized background, and shall meet ASTM Type XI and IDOT Type ZZ reflective sheeting. The sign face shall not have any holes. 3M Scotch Joining Systems bonding tape shall be used in place of screws or rivets.

## **DIVISION 800 ELECTRICAL**

### **SUBMITTALS.**

Revise Section 801.05 of the Standard Specifications to read:

All material approval requests shall be submitted in accordance with the District's current Electrical Product Data and Documentation Submittal Guidelines. General requirements include:

1. Material approval requests shall be submitted at the preconstruction meeting, including major traffic signal items listed in the table in Article 801.05. All material or equipment which are similar or identical shall be the product of the same manufacturer, unless necessary for system continuity. Traffic signal materials and equipment shall bear the U.L. label whenever such labeling is available.

2. Product data and shop drawings shall be assembled by pay item and separated from other pay item submittals. Only the top sheet of each pay item submittal will be stamped by the Department with the review status, except shop drawings for mast arm pole assemblies and the like will be stamped with the review status on each sheet.
3. Four complete copies of the manufacturer's descriptive literatures and technical data for the traffic signal materials. The descriptive literatures and technical data shall be adequate for determining whether the materials meet the requirements of the plans and specifications. If the literature contains more than one item, the Contractor shall indicate which item or items will be furnished.
4. Seven complete copies of the shop drawings for the mast arm assemblies and poles, and the combination mast arm assemblies and poles showing, in detail, the fabrication thereof and the certified mill analyses of the materials used in the fabrication, anchor rods, and reinforcing materials.
5. Partial or incomplete submittals will be returned without review.
6. Certain non-standard mast arm poles and structures will require additional review from IDOT's Central Office. Examples include ornamental/decorative and non-standard length mast arm pole assemblies. The Contractor shall account for the additional review time in his schedule.
7. The contract number or permit number, project location/limits and corresponding pay code number must be on each sheet of the letter, material catalog cuts and mast arm poles and assemblies drawings.
8. Where certifications and/or warranties are specified, the information submitted for approval shall include certifications and warranties. Certifications involving inspections, and/or tests of material shall be complete with all test data, dates, and times.
9. After the Engineer reviews the submittals for conformance with the design concept of the project, the Engineer will stamp the drawings indicating their status as 'Approved', 'Approved As Corrected', 'Not Approved', or 'Please Resubmit'. Since the Engineer's review is for conformance with the design concept only, it is the Contractor's responsibility to coordinate the various items into a working system as specified. The Contractor shall not be relieved from responsibility for errors or omissions in the shop, working, layout drawings, or other documents by the Department's approval thereof. The Contractor must still be in full compliance with contract and specification requirements.
10. All submitted items reviewed and marked 'APPROVED AS CORRECTED', or 'NOT APPROVED' or 'PLEASE RESUBMIT' are to be resubmitted in their entirety, unless otherwise indicated within the submittal comments, with a disposition of previous comments to verify contract compliance at no additional cost to the contract.
11. Exceptions, Deviations and Substitutions. In general, exceptions to and deviations from the requirements of the Contract Documents will not be allowed. It is the Contractor's responsibility to note any deviations from Contract requirements at the



time of submittal and to make any requests for deviations in writing to the Engineer. In general, substitutions will not be acceptable. Requests for substitutions must demonstrate that the proposed substitution is superior to the material or equipment required by the Contract Documents. No exceptions, deviations or substitutions will be permitted without the approval of the Engineer.

### **MARKING PROPOSED LOCATIONS**

Revise “Marking Proposed Locations for Highway Lighting System” of Article 801.09 to read “Marking Proposed Locations for Highway Lighting System and Traffic Signals.”

### **INSPECTION OF ELECTRICAL SYSTEMS.**

Add the following to Section 801.10 of the Standard Specifications:

All cabinets including temporary traffic signal cabinets shall be assembled by an approved equipment supplier in District One. The Department reserves the right to request any controller and cabinet to be tested at the equipment supplier facilities prior to field installation, at no extra cost to this contract.

### **MAINTENANCE AND RESPONSIBILITY.**

Revise Section 801.11 of the Standard Specifications to read:

- a) Existing traffic signal installations and/or any electrical facilities at all or various locations may be altered or reconstructed totally or partially as part of the work on this Contract. The Contractor is hereby advised that all traffic control equipment, presently installed at these locations, may be the property of the State of Illinois, Department of Transportation, Division of Highways, County, Private Developer, or the Municipality in which they are located. Once the Contractor has begun any work on any portion of the project, all traffic signals within the limits of this contract or those which have the item "Maintenance of Existing Traffic Signal Installation," "Temporary Traffic Signal Installation(s)" and/or "Maintenance of Existing Flashing Beacon Installation," shall become the full responsibility of the Contractor. Automatic Traffic Enforcement equipment is not owned by the State and the Contractor shall not be responsible for maintaining it during construction. The Contractor shall supply the Engineer, Area Traffic Signal Maintenance and Operations Engineer, Department's Electrical Maintenance Contractor with two 24-hour emergency contact names and telephone numbers.

- b) When the project has a pay item for "Maintenance of Existing Traffic Signal Installation", "Temporary Traffic Signal Installation(s)" and/or "Maintenance of Existing Flashing Beacon Installation", the Contractor must notify both the Area Traffic Signal Maintenance and Operations Engineer at (815) 334-4960 and the Department's Electrical Maintenance Contractor, of their intent to begin any physical construction work on the Contract or any portion thereof. This notification must be made a minimum of seven (7) working days prior to the start of construction to allow sufficient time for inspection of the existing traffic signal installation(s) and transfer of maintenance to the Contractor. If work is started prior to an inspection, maintenance of the traffic signal installation(s) will be transferred to the Contractor without an inspection. The Contractor will become responsible for repairing or replacing all equipment that is not operating properly or is damaged at no cost to the owner of the traffic signal. Final repairs or replacement of damaged equipment must meet the approval of the Engineer prior to or at the time of final inspection otherwise the traffic signal installation will not be accepted.
- c) Contracts such as pavement grinding or patching which result in the destruction of traffic signal loops do not require maintenance transfer, but require a notification of intent to work and an inspection. A minimum of seven (7) working days prior to the loop removal, the Contractor shall notify the Area Traffic Signal Maintenance and Operations Engineer at (815) 334-4960 and the Department's Electrical Maintenance Contractor, at which time arrangements will be made to adjust the traffic controller timing to compensate for the absence of detection. See additional requirements in these specifications under Inductive Loop Detector.
- d) The Contractor is advised that the existing and/or temporary traffic signal installation must remain in operation during all construction stages, except for the most essential down time. Any shutdown of the traffic signal installation, which exceeds fifteen (15) minutes, must have prior approval of the Engineer. Approval to shutdown the traffic signal installation will only be granted during the period extending from 10:00 a.m. to 3:00 p.m. on weekdays. Shutdowns shall not be allowed during inclement weather or holiday periods.
- e) The Contractor shall be fully responsible for the safe and efficient operation of the traffic signals. Any inquiry, complaint or request by the Department, the Department's Electrical Maintenance Contractor or the public, shall be investigated and repairs begun within one hour. Failure to provide this service will result in liquidated damages of \$500 per day per occurrence. In addition, the Department reserves the right to assign any work not completed within this timeframe to the Electrical Maintenance Contractor. All costs associated to repair this uncompleted work shall be the responsibility of the Contractor. Failure to pay these costs to the Electrical Maintenance Contractor within one month after the incident will result in additional liquidated damages of \$500 per month per occurrence. Unpaid bills will be deducted from the cost of the Contract. The

Department's Electrical Maintenance Contractor may inspect any signaling device on the Department's highway system at any time without notification.

- f) Any proposed activity in the vicinity of a highway-rail grade crossing must adhere to the guidelines set forth in the current edition of the Manual on Uniform Traffic Control Devices (MUTCD) regarding work in temporary traffic control zones in the vicinity of highway-rail grade crossings which states that lane restrictions, flagging, or other operations shall not create conditions where vehicles can be queued across the railroad tracks. If the queuing of vehicles across the tracks cannot be avoided, a uniformed law enforcement officer or flagger shall be provided at the crossing to prevent vehicles from stopping on the tracks, even if automatic warning devices are in place.

#### **DAMAGE TO TRAFFIC SIGNAL SYSTEM.**

Revise Section 801.12(b) of the Standard Specifications to read:

Any damaged equipment or equipment not operating properly from any cause whatsoever shall be repaired with new equipment meeting current MCDOT traffic signal specifications provided by the Contractor at no additional cost to the Contract and or owner of the traffic signal system, all as approved by the Engineer. Final repairs or replacement of damaged equipment must meet the approval of the Engineer prior to or at the time of final inspection otherwise the traffic signal installation will not be accepted. Cable splices outside the controller cabinet shall not be allowed.

Automatic Traffic Enforcement equipment, such as Red Light Enforcement cameras, detectors, and peripheral equipment, damaged or not operating properly from any cause whatsoever, shall be the responsibility of the municipality or the Automatic Traffic Enforcement company per Permit agreement.

#### **TRAFFIC SIGNAL INSPECTION (TURN-ON).**

Revise Section 801.15(b) of the Standard Specifications to read:

It is the intent to have all electric work completed and equipment field tested by the vendor prior to the Department's "turn-on" field inspection. If in the event the Engineer determines work is not complete and the inspection will require more than two (2) hours to complete, the inspection shall be canceled and the Contractor will be required to reschedule at another date. The maintenance of the traffic signals will not be accepted until all punch list work is corrected and re-inspected.

When the road is open to traffic, except as otherwise provided in Section 850 of the Standard Specifications, the Contractor may request a turn-on and inspection of the completed traffic signal installation at each separate location. This request must be made to the Area Traffic Signal Maintenance and Operations Engineer at (815) 334-4960 a minimum of seven (7) working days prior to the time of the requested inspection. The Department will not grant a field inspection until notification is provided from the Contractor that the equipment has been field tested and the intersection is operating according to Contract requirements. There shall be no Friday traffic signal turn-ons allow by the MCDOT. The Department's facsimile number is (815) 334-4989. The Contractor must invite local fire department personnel to the turn-on when Emergency Vehicle Preemption (EVP) is included in the project. When the contract includes the item RE-OPTIMIZE TRAFFIC SIGNAL SYSTEM, OPTIMIZE TRAFFIC SIGNAL SYSTEM, or TEMPORARY TRAFFIC SIGNAL TIMINGS, the Contractor must notify the SCAT Consultant of the turn-on/detour implementation schedule, as well as stage changes and phase changes during construction.

The Contractor must have all traffic signal work completed and the electrical service installation connected by the utility company prior to requesting an inspection and turn-on of the traffic signal installation. The Contractor shall be responsible to provide a police officer to direct traffic at the time of testing.

The Contractor shall provide a representative from the control equipment vendor's office to attend the traffic signal inspection for both permanent and temporary traffic signal turn-ons. Upon demonstration that the signals are operating and all work is completed in accordance with the Contract and to the satisfaction of the Engineer, the Engineer will then allow the signals to be placed in continuous operation. The Agency that is responsible for the maintenance of each traffic signal installation will assume the maintenance upon successful completion of this inspection.

The Department requires the following from the Contractor at traffic signal turn-ons.

1. One set of signal plans of record with field revisions marked in red ink.
2. Notification from the Contractor and the equipment vendor of satisfactory field testing.
3. A knowledgeable representative of the controller equipment supplier shall be required at the traffic signal turn-on. The representative shall be knowledgeable of the cabinet design and controller functions.
4. A copy of the approved material letter.
5. One (1) copy of the operation and service manuals of the signal controller and associated control equipment.
6. Five (5) copies (280 mm X 430 mm) 11" x 17" of the cabinet wiring diagrams.
7. Five (5) copies of the traffic signal installation cable log.
8. The controller manufacturer shall provide a printer at the turn-on to supply a printed form, not to exceed (280 mm X 430 mm) 11" x 17" for recording the traffic signal

controller's timings; backup timings; coordination splits, offsets, and cycles; TBC Time of Day, Week and Year Programs; Traffic Responsive Program, Detector Phase Assignment, Type and Detector Switching; and any other functions programmable from the keyboard. The form shall include a location, date, manufacturer's name, controller model and software version. The form shall be approved by the Engineer and a minimum of three (3) copies must be furnished at each turn-on. The manufacturer must provide all programming information used within the controller at the time of turn-on.

9. All manufacturer and contractor warranties and guarantees required by Article 801.14

Acceptance of the traffic signal equipment by the Department shall be based upon inspection results at the traffic signal "turn on." If approved, traffic signal acceptance shall be verbal at the "turn on" inspection followed by written correspondence from the Engineer. The Contractor shall be responsible for all traffic signal equipment and associated maintenance thereof until Departmental acceptance is granted.

All equipment and/or parts to keep the traffic signal installation operating shall be furnished by the Contractor. No spare traffic signal equipment is available from the Department.

All punch list work shall be completed within two (2) weeks after the final inspection. The Contractor shall notify the Electrical Maintenance Contractor to inspect all punch list work. Failure to meet these time constraints shall result in liquidated damage charges of \$500 per month per incident.

All cost of work and materials required to comply with the above requirements shall be included in the pay item bid prices, under which the subject materials and signal equipment are paid, and no additional compensation will be allowed. Materials and signal equipment not complying with the above requirements shall be subject to removal and disposal at the Contractor's expense.

## RECORD DRAWINGS

The requirements listed for Electrical Installation shall apply for Traffic Signal Installations in Article 801.16. Revise the 2<sup>nd</sup> paragraph of Article 801.16 of the Standard Specifications to read:

- a. "When the work is complete, and seven days before the request for a final inspection, the full-size set of contract drawings. Stamped "RECORD DRAWINGS", shall be submitted to the Engineer for review and approval and shall be stamped with the date and the signature of the Contractor's supervising Engineer or electrician. The record drawings shall be submitted in PDF format on CDROM as well as hardcopy for review and approval.

- b. In addition to the record drawings, copies of the final catalog cuts which have been Approved or Approved as Noted shall be submitted in PDF format along with the record drawings. The PDF files shall clearly indicate the pay item either by filename or PDF Table of Contents referencing the respective pay item number for multi-item PDF files. Specific part or model numbers of items which have been selected shall be clearly visible.”
  
- c. Additional requirements are listed in the District’s Electrical Product Data and Documentation Guidelines.

Add the following to Article 801.16 of the Standard Specifications:

“In addition to the specified record drawings, the Contactor shall record GPS coordinates of the following traffic signal components being installed, modified or being affected in other ways by this contract:

- All Mast Arm Poles and Posts
- Handholes
- Conduit roadway crossings
- Controller Cabinets
- Communication Cabinets
- Electric Service Disconnect locations
- CCTV Camera installations
- Fiber Optic Splice Locations

Datum to be used shall be North American 1983.

Data shall be provided electronically and in print form. The electronic format shall be compatible with MS Excel. Latitude and Longitude shall be in decimal degrees with a minimum of 6 decimal places. Each coordinate shall have the following information:

1. Description of item
2. Designation or approximate station if the item is undesignated
3. Latitude
4. Longitude

Examples:

Description	Designation	Latitude	Longitude
Mast Arm Pole	MP (SW, NW, SE or	41.580493	-

Assembly (dual, combo, etc)	NE corner)		87.793378
FO mainline splice handhole	HHL-ST31	41.558532	- 87.792571
Handhole	HH	41.765532	- 87.543571
Electric Service	Elec Srv	41.602248	- 87.794053
Conduit crossing	SB IL83 to EB I290 ramp SIDE A	41.584593	- 87.793378
PTZ Camera	PTZ	41.584600	- 87.793432
Signal Post	Post	41.558532	- 87.792571
Controller Cabinet	CC	41.651848	- 87.762053
Master Controller Cabinet	MCC	41.580493	- 87.793378
Communication Cabinet	ComC	41.558532	- 87.789771
Fiber splice connection	Toll Plaza34	41.606928	- 87.794053

Prior to the collection of data, the contractor shall provide a sample data collection of at least six data points of known locations to be reviewed and verified by the Engineer to be accurate within 100 feet. Upon verification, data collection can begin. Data collection can be made as construction progresses, or can be collected after all items are installed. If the data is unacceptable the contractor shall make corrections to the data collection equipment and or process and submit the data for review and approval as specified.

Accuracy. Data collected is to be mapping grade. A handheld mapping grade GPS device shall be used for the data collection. The receiver shall support differential correction and data shall have a minimum 5 meter accuracy after post processing.

GPS receivers integrated into cellular communication devices, recreational and automotive GPS devices are not acceptable.

The GPS shall be the product of an established major GPS manufacturer having been in the business for a minimum of 6 years.”

Delete the last sentence of the 3<sup>rd</sup> paragraph of Article 801.16.

### **LOCATING UNDERGROUND FACILITIES.**

Revise Section 803.00 to the Standard Specifications to read:

If this Contract requires the services of an Electrical Contractor, the Contractor shall be responsible at his/her own expense for locating existing MCDOT electrical facilities prior to performing any work. If this Contract does not require the services of an Electrical Contractor, the Contractor may request one free locate for existing MCDOT electrical facilities from the Department's Electrical Maintenance Contractor prior to the start of any work. Additional requests may be at the expense of the Contractor. The location of underground traffic facilities does not relieve the Contractor of their responsibility to repair any facilities damaged during construction at their expense.

The exact location of all utilities shall be field verified by the Contractor before the installation of any components of the traffic signal system. For locations of utilities the local Counties or Municipalities may need to be contacted, in the City of Chicago contact D.I.G.G.E.R. at (312) 744-7000 and for all other locations contact J.U.L.I.E. at 1-800-892-0123 or 811.

### **RESTORATION OF WORK AREA.**

Add the following article to Section 801 of the Standard Specifications:

801.17 Restoration of work area. Restoration of the traffic signal work area shall be included in the related pay items such as foundation, conduit, handhole, underground raceways, etc. All roadway surfaces such as shoulders, medians, sidewalks, pavement, etc. shall be replaced in kind. All damage to mowed lawns shall be replaced with an approved sod, and all damage to unmowed fields shall be seeded. All brick pavers disturbed in the work area shall be restored to their original configuration or as directed by the Engineer. All damaged brick pavers shall be replaced with a comparable material approved by the Engineer. Restoration of the work area shall be included in the contract without any extra compensation allowed to the Contractor.

### **ELECTRIC SERVICE INSTALLATION.**

Revise Section 805 of the Standard Specifications to read:

Description. This work shall consist of all materials and labor required to install, modify, or extend the electric service installation. All installations shall meet the requirements of the details



in the “District 1 Standard Traffic Signal Design Details” and applicable portions of the Specifications.

General. The electric service installation shall be the electric service disconnecting means and it shall be identified as suitable for use as service equipment.

The electric utility contact information is noted on the plans and represents the current information at the time of contract preparation. The Contractor must request in writing for service and/or service modification within 10 days of contract award and must follow-up with the electric utility to assure all necessary documents and payment are received by the utility. The Contractor shall forward copies of all correspondence between the contractor and utility company. The service agreement and sketch shall be submitted for signature to the Traffic Program’s engineer.

#### Materials.

- a. General. The completed control panel shall be constructed in accordance with UL Std. 508A, Industrial Control Panel, and carry the UL label. Wire terminations shall be UL listed.
- b. Enclosures.
  1. Pole Mounted Cabinet. The cabinet shall be UL 50, NEMA Type 4X, unfinished single door design, fabricated from minimum 2.03 mm (0.080-inch) thick Type 5052 H-32 aluminum. Seams shall be continuous welded and ground smooth. Stainless steel screws and clamps shall secure the cover and assure a watertight seal. The cover shall be removable by pulling the continuous stainless steel hinge pin. The cabinet shall have an oil-resistant gasket and a lock kit shall be provided with an internal O-ring in the locking mechanism assuring a watertight and dust-tight seal. The cabinet shall be sized to adequately house all required components with extra space for arrangement and termination of wiring. A minimum size of 350 mm (14-inches) high, 225 mm (9-inches) wide and 200 mm (8-inches) in depth is required. The cabinet shall be channel mounted to a wooden utility pole using assemblies recommended by the manufacturer.
  2. Ground Mounted Cabinet. The cabinet shall be UL 50, NEMA Type 3R unfinished single door design with back panel. The cabinet shall be fabricated from Type 5052 H-32 aluminum with the frame and door 3.175 mm (0.125-inch) thick, the top 6.350 mm (0.250-inch) thick and the bottom 12.70 mm (0.500-inch) thick. Seams shall be continuous welded and ground smooth. The door and door opening shall be double flanged. The door shall be approximately 80% of the front surface, with a full length tamperproof stainless steel 1.91 mm (.075-inch) thick hinge bolted to the cabinet with stainless steel carriage bolts and nylocks nuts. The locking mechanism shall

- be slam-latch type with a keyhole cover. The cabinet shall be sized to adequately house all required components with extra space for arrangement and termination of wiring. A minimum size of 1000 mm (40-inches high), 400 mm (16-inches) wide and 375 mm (15-inches) in depth is required. The cabinet shall be mounted upon a square Type A concrete foundation as indicated on the plans. The foundation is paid for separately.
- c. Surge Protector. Overvoltage protection, with LED indicator, shall be provided for the 120 volt load circuit by the means MOV and thermal fusing technology. The response time shall be <5n seconds and operate within a range of -40C to +85C. The surge protector shall be UL 1449 Listed.
  - d. Circuit Breakers. Circuit breakers shall be standard UL listed molded case, thermal-magnetic bolt-on type circuit breakers with trip free indicating handles. 120 volt circuit breakers shall have an interrupting rating of not less than 65,000 rms symmetrical amperes. Unless otherwise indicated, the main disconnect circuit breaker for the traffic signal controller shall be rated 60 amperes, otherwise noted on the plans, 120 V and the auxiliary circuit breakers shall be rated 10 amperes, 120 V.
  - e. Fuses, Fuseholders and Power Indicating Light. Fuses shall be small-dimensional cylindrical fuses of the dual element time-delay type. The fuses shall be rated for 600 V AC and shall have a UL listed interrupting rating of not less than 10,000 rms symmetrical amperes at rated voltage. The power indicating light shall be LED type with a green colored lens and shall be energized when electric utility power is present.
  - f. Ground and Neutral Bus Bars. A single copper ground and neutral bus bar, mounted on the equipment panel shall be provided. Ground and neutral conductors shall be separated on the bus bar. Compression lugs, plus 2 spare lugs, shall be sized to accommodate the cables with the heads of the connector screws painted green for ground connections and white for neutral connections.
  - g. Utility Services Connection. The Contractor shall notify the Utility Company marketing representative a minimum of 30 working days prior to the anticipated date of hook-up. This 30 day advance notification will begin only after the Utility Company marketing representative has received service charge payments from the Contractor. Prior to contacting the Utility Company marketing representative for service connection, the service installation controller cabinet and cable must be installed for inspection by the Utility Company.
  - h. Ground Rod. Ground rods shall be copper-clad steel, a minimum of 3.0 meters (10') in length, and 20mm (3/4") in diameter. Ground rod resistance measurements to

ground shall be 25 ohms or less. If necessary additional rods shall be installed to meet resistance requirements at no additional cost to the contract.

#### Installation

- a. General. The Contractor shall confirm the orientation of the traffic service installation and its door side with the engineer, prior to installation. All conduit entrances into the service installation shall be sealed with a pliable waterproof material.
- b. Pole Mounted. Brackets designed for pole mounting shall be used. All mounting hardware shall be stainless steel. Mounting height shall be as noted on the plans or as directed by the Engineer.
- c. Ground Mounted. The service installation shall be mounted plumb and level on the foundation and fastened to the anchor bolts with hot-dipped galvanized or stainless steel nuts and washers. The space between the bottom of the enclosure and the top of the foundation shall be caulked at the base with silicone.

Basis of Payment. The service installation shall be paid for at the contract unit price each for SERVICE INSTALLATION of the type specified which shall be payment in full for furnishing and installing the service installation complete. The CONCRETE FOUNDATION, TYPE A, which includes the ground rod shall be paid for separately. SERVICE INSTALLATION, POLE MOUNTED shall include the 20mm (3/4") grounding conduit, ground rod, and pole mount assembly. Any changes by the utility companies shall be approved by the engineer and paid for as an addition to the contract according to Article 109.05 of the Standard Specifications.

#### **GROUNDING OF TRAFFIC SIGNAL SYSTEMS.**

Revise Section 806 of the Standard Specifications to read:

General. All traffic signal systems, equipment and appurtenances shall be properly grounded in strict conformance with the NEC. See IDOT District 1 Traffic Signal detail plan sheet for additional information.

The grounding electrode system shall include a ground rod installed with each traffic signal controller concrete foundation and all mast arm and post concrete foundations. An additional ground rod will be required at locations where measured resistance exceeds 25 ohms. Ground rods are included in the applicable foundation paid item and will not be paid for separately.

Testing shall be according to Section 801.13(a) (4) and (5).

- a) The grounded conductor (neutral conductor) shall be white color coded. This conductor shall be bonded to the equipment grounding conductor only at the Electric Service Installation. All power cables shall include one neutral conductor of the same size.
- b) The equipment grounding conductor shall be green color coded. The following is in addition to Section 801.04 of the Standard Specifications.
  - 1) Equipment grounding conductors shall be bonded to the grounded conductor (neutral conductor) only at the Electric Service Installation. The equipment grounding conductor is paid for separately and shall be continuous. The Earth shall not be used as the equipment grounding conductor.
  - 2) Equipment grounding conductors shall be bonded, using a Listed grounding connector, to all traffic signal mast arm poles, traffic signal posts, pedestrian posts, pull boxes, handhole frames and covers and other metallic enclosures throughout the traffic signal wiring system, except where noted herein. A Listed electrical joint compound shall be applied to all conductors terminations, connector threads and contact points.
  - 3) All metallic and non-metallic raceways containing traffic signal circuit runs shall have a continuous equipment grounding conductor, except raceways containing only detector loop lead-in circuits, circuits under 50 volts and/or fiber optic cable will not be required to include an equipment grounding conductor.
  - 4) Individual conductor splices in handholes shall be soldered and sealed with heat shrink. When necessary to maintain effective equipment grounding, a full cable heat shrink shall be provided over individual conductor heat shrinks.
- c) The grounding electrode conductor shall be similar to the equipment grounding conductor in color coding (green) and size. The grounding electrode conductor is used to connect the ground rod to the equipment grounding conductor and is bonded to ground rods via exothermic welding, listed pressure connectors, listed clamps or other approved listed means.

**GROUNDING EXISTING HANDHOLE FRAME AND COVER.**

Description.

This work shall consist of all materials and labor required to bond the equipment grounding conductor to the existing handhole frame and handhole cover. All installations shall meet the requirements of the details in the "District One Standard Traffic Signal Design Details" and applicable portions of the Specifications.

The equipment grounding conductor shall be bonded to the handhole frame and to the handhole cover. Two (2) ½-inch diameter x 1 ¼-inch long hex-head stainless steel bolts, spaced 1.75-inches apart center-to-center shall be fully welded to the frame and to the cover to accommodate a heavy duty Listed grounding compression terminal (Burdny type YGHA). The grounding compression terminal shall be secured to the bolts with stainless steel split-lock washers and nylon-insert locknuts.

Welding preparation for the stainless steel bolt hex-head to the frame and to the cover shall include thoroughly cleaning the contact and weldment area of all rust, dirt and contaminates. The Contractor shall assure a solid strong weld. The welds shall be smooth and thoroughly cleaned of flux and spatter. The grounding installation shall not affect the proper seating of the cover when closed.

The grounding cable shall be paid for separately.

Method of Measurement.

Units measured for payment will be counted on a per handhole basis, regardless of the type of handhole and its location.

Basis of Payment.

This work shall be paid for at the contract unit price each for GROUNDING EXISTING HANDHOLE FRAME AND COVER which shall be payment in full for grounding the handhole complete.

**COILABLE NON-METALLIC CONDUIT.**

Description.

This work shall consist of furnishing and installing empty coilable non-metallic conduit (CNC) for detector loop raceways.

General.

The CNC installation shall be in accordance with Sections 810 and 811 of the Standard Specifications except for the following:

Add the following to Article 810.03 of the Standard Specifications:

CNC meeting the requirements of NEC Article 353 shall be used for detector loop raceways to the handholes.

Add the following to Article 811.03 of the Standard Specifications:

On temporary traffic signal installations with detector loops, CNC meeting the requirements of NEC Article 353 shall be used for detector loop raceways from the saw-cut to 10 feet (3m) up the wood pole, unless otherwise shown on the plans.

Basis of Payment.

All installations of CNC for loop detection shall be included in the contract and not paid for separately.

**UNDERGROUND RACEWAYS.**

Revise Article 810.04 - Installation of the Standard Specifications to read:

All underground conduit shall have a minimum depth of 2 ½ ft (750 mm) below the finished grade and shall be installed to avoid existing and proposed utilities within the project limits.

**HANDHOLES.**

Add the following to Section 814.00 of the Standard Specifications:

All handholes shall be concrete, poured in place, with inside dimensions of 21-1/2" (549 mm) minimum. Frames and lid openings shall match this dimension. The cover of the handhole frame shall be labeled "Traffic Signals" with legible raised letters.

For grounding purposes the handhole frame shall have provisions for a 7/16" (15.875 mm) diameter stainless bolt cast into one corner of the frame. The covers shall have a stainless steel threaded stint extended from the eye hook assembly for the purpose of attaching the grounding conductor to the handhole frame.

The minimum wall thickness for heavy duty hand holes shall be 12" (300 mm).

All conduits shall enter the handhole at a depth of 30" (760 mm) except for the conduits for detector loops when the handhole is less than 5' (1.52 m) from the detector loop. All conduit

ends should be sealed with a waterproof sealant to prevent the entrance of contaminants into the handhole.

Steel cable hooks shall be coated with hot-dipped galvanization in accordance with AASHTO Specification M111. Hooks shall be a minimum of 1/2 inch (12.7 mm) diameter with two 90 degree bends and extend into the handhole at least 6 inches (150 mm). Hooks shall be placed a minimum of 12 inches (300 mm) below the lid or lower if additional space is required.

### **GROUNDING CABLE.**

The cable shall meet the requirements of Section 817 of the "Standard Specifications," except for the following:

Add to Section 817.02 (b) of the Standard Specifications:

Unless otherwise noted on the Plans, traffic signal grounding conductor shall be one conductor, #6 gauge copper, with a XLP jacket.

The traffic signal grounding conductor shall be bonded, using a Listed grounding connector (Burndy type KC/K2C, as applicable), to all proposed and existing traffic signal mast arm poles and traffic/pedestrian signal posts, including push button posts. The grounding conductor shall be bonded to all proposed and existing pull boxes, handhole frames and covers and other metallic enclosures throughout the traffic signal wiring system and noted herein and detailed on the plans. Bonding to existing handhole frames and covers shall be paid for separately.

Revise Section 817.05 of the Standard Specifications to read:

Basis of Payment. Grounding cable shall be measured in place for payment in (meter) foot. Payment shall be at the contract unit price for EQUIPMENT GROUNDING CONDUCTOR, NO. 6, 1C, which price includes all associated labor and material including grounding clamps, splicing, exothermic welds/other Listed connectors and hardware.

### **RAILROAD INTERCONNECT CABLE.**

The cable shall meet the requirements of Section 873 of the Standard Specifications, except for the following:

Add to Article 873.02 of the Standard Specifications:

The railroad interconnect cable shall be three conductor stranded #14 copper cable in a clear polyester binder, shielded with #36 AWG tinned copper braid with 85% coverage, and insulated with .016" polyethylene (black, blue, red). The jacket shall be black 0.045 PVC or polyethylene.

Add the following to Article 873.05 of the Standard Specifications:

Basis of Payment.

This work shall be paid for at the contract unit price per foot (meter) for ELECTRIC CABLE IN CONDUIT, RAILROAD, NO. 14 3C, which price shall be payment in full for furnishing, installing, and making all electrical connections in the traffic signal controller cabinet. Connections in the railroad controller cabinet shall be performed by railroad personnel.

**FIBER OPTIC TRACER CABLE.**

The cable shall meet the requirements of Section 817 of the "Standard Specifications," except for the following:

Add to Section 817.03 of the Standard Specifications:

In order to trace the fiber optic cable after installation, the tracer cable shall be installed in the same conduit as the fiber optic cable. The tracer cable shall be continuous, extended into the controller cabinet and terminated on a terminal strip mounted on the side wall of the controller cabinet. The terminal strip and tracer cable shall be clearly marked and identified. The tracer cable will be allowed to be spliced at the handholes only. All tracer cable splices shall be kept to a minimum and shall incorporate maximum lengths of cable supplied by the manufacturer. The tracer cable splice shall use a Western Union Splice soldered with resin core flux. All exposed surfaces of the solder shall be smooth. Splices shall be soldered using a soldering iron. Blow torches or other devices which oxidize copper cable shall not be allowed for soldering operations. The splice shall be covered with WCSMW 30/100 heat shrink tube, minimum length (100 mm) 4" and with a minimum (25 mm) 1" coverage over the XLP insulation, underwater grade.

Revise Section 817.05 of the Standard Specifications to read:

Basis of Payment. The tracer cable shall be paid for separately as ELECTRIC CABLE IN CONDUIT, TRACER, NO. 14 1C per (meter) foot, which price shall include all associated labor and material for installation.

**MAINTENANCE OF EXISTING TRAFFIC SIGNAL INSTALLATION.**

Revise Articles 850.02 and 850.03 of the Standard Specification to read:

Procedure.

The energy charges for the operation of the traffic signal installation shall be paid for by others.



Full maintenance responsibility shall start as soon as the Contractor begins any physical work on the Contract or any portion thereof.

The Contractor shall have electricians with IMSA Level II certification on staff to provide signal maintenance.

This item shall include maintenance of all traffic signal equipment at the intersection, including emergency vehicle pre-emption equipment, master controllers, uninterruptible power supply (UPS and batteries), telephone service installations, communication cables, conduits to adjacent intersections, and other traffic signal equipment, but shall not include Automatic Traffic Enforcement equipment, such as Red Light Enforcement cameras, detectors, or peripheral equipment, not owned by the State.

Maintenance.

The maintenance shall be according to MAINTENANCE AND RESPONSIBILITY in Division 800 of these specifications and the following:

The Contractor shall check all controllers every two (2) weeks, which will include visually inspecting all timing intervals, relays, detectors, and pre-emption equipment to ensure that they are functioning properly. This item includes, as routine maintenance, all portions of emergency vehicle pre-emption equipment. The Contractor shall maintain in stock at all times a sufficient amount of materials and equipment to provide effective temporary and permanent repairs.

The Contractor shall assume all locating duties of the traffic signal during the extent of the project. These locating duties shall include existing underground traffic signal utilities and all newly installed traffic signal utilities not yet transferred to/or accepted by the MCDOT. The Contractor shall not be required to locate any abandoned traffic signal utilities.

The Contractor shall provide immediate corrective action when any part or parts of the system fail to function properly. Two far side heads facing each approach shall be considered the minimum acceptable signal operation pending permanent repairs. When repairs at a signalized intersection require that the controller be disconnected or otherwise removed from normal operation, and power is available, the Contractor shall place the traffic signal installation on flashing operation. The signals shall flash RED for all directions unless a different indication has been specified by the Engineer. The Contractor shall be required to place stop signs (R1-1-36) at each approach of the intersection as a temporary means of regulating traffic. When the signals operate in flash, the Contractor shall furnish and equip all their vehicles assigned to the maintenance of traffic signal installations with a sufficient number of stop signs as specified herein. The Contractor shall maintain a sufficient number of spare stop signs in stock at all times to replace stop signs which may be damaged or stolen.

The Contractor shall provide the Engineer with a 24 hour telephone number for the maintenance of the traffic signal installation and for emergency calls by the Engineer.

Traffic signal equipment which is lost or not returned to the Department for any reason shall be replaced with new equipment meeting the requirements of the Standard Specifications and these special provisions.

The Contractor shall respond to all emergency calls from the Department or others within one hour after notification and provide immediate corrective action. When equipment has been damaged or becomes faulty beyond repair, the Contractor shall replace it with new and identical equipment. The cost of furnishing and installing the replaced equipment shall be borne by the Contractor at no additional charge to the contract. The Contractor may institute action to recover damages from a responsible third party. If at any time the Contractor fails to perform all work as specified herein to keep the traffic signal installation in proper operating condition or if the Engineer cannot contact the Contractor's designated personnel, the Engineer shall have the County's Electrical Maintenance Contractor perform the maintenance work required. The County's Electrical Maintenance Contractor shall bill the Contractor for the total cost of the work. The Contractor shall pay this bill within thirty (30) days of the date of receipt of the invoice or the cost of such work will be deducted from the amount due the Contractor. The Contractor shall allow the Electrical Maintenance Contractor to make reviews of the Existing Traffic Signal Installation that has been transferred to the Contractor for Maintenance.

#### **TRAFFIC ACTUATED CONTROLLER.**

Add the following to Section 857.02 of the Standard Specifications:

Controllers shall be NEMA TS2 Type 1 compatible, Econolite ASC3-1000 or ASC3-2100 as shown on the plans unless specified otherwise on the plans or elsewhere on these specifications. Only controllers supplied by one of the District 1 approved closed loop equipment manufacturers will be allowed. The controller shall be the most recent model and software version supplied by the manufacturer at the time of the approval. The traffic signal controller shall provide features to inhibit simultaneous display of a circular yellow ball and a yellow arrow display. Individual load switches shall be provided for each vehicle, pedestrian, and right turn over lap phase. The controller shall prevent phases from being skipped during program changes and after all preemption events. The controller shall be equipped with an Ethernet port and removable data key to save the controller database.

Add the following to Article 857.03 of the Standard Specifications:

The Contractor shall arrange to install a standard voice-grade dial-up telephone line to the RAILROAD, FULL-ACTUATED CONTROLLER AND CABINET as called for on the traffic signal installation plans. If the traffic signal installation is part of a traffic signal system, a telephone line is usually not required, unless a telephone line is called for on the traffic signal

plans. The Contractor shall follow the requirements for the telephone service installation as contained in the current District One Traffic Signal Special Provisions under Master Controller.

### **MASTER CONTROLLER.**

Revise Sections 860.02 - Materials and 860.03 - Installation of the Standard Specifications to read:

Only controllers supplied by one of the District approved closed loop equipment manufacturers will be allowed. Only NEMA TS 2 Type 1 Econolite closed loop systems shall be supplied. The latest model and software version of master controller shall be supplied.

Functional requirements in addition to those in section 863 of the Standard Specification include:

The system commands shall consist of, as a minimum, six (6) cycle lengths, five (5) offsets, three (3) splits, and four (4) special functions. The system commands shall also include commands for free or coordinated operation.

Traffic Responsive operation shall consist of the real time acquisition of system detector data, data validation, and the scaling of acquired volumes and occupancies in a deterministic fashion so as to cause the selection and implementation of the most suitable traffic plan.

Upon request by the Engineer, each master shall be delivered with up to three (3) complete sets of the latest edition of registered remote monitoring software with full manufacture's support. Each set shall consist of software on CD, DVD, or other suitable media approved by the Engineer, and a bound set of manuals containing loading and operating instruction. One copy of the software and support data shall be delivered to the Agency in charge of system operation, if other than IDOT. One of these two sets will be provided to the Agency Signal Maintenance Contractor for use in monitoring the system.

The Contractor shall be required to setup graphic displays and all software parameters for every intersection to be interconnected under this Contract, including complete viewing and control capabilities from IDOT remote monitor.

The approved manufacturer of equipment shall loan the District one master controller and two intersection controllers of the most recent models and the newest software version to be used for instructional purposes in addition to the equipment to be supplied for the Contract.

The Contractor shall arrange to install a standard voice-grade dial-up telephone line to the master controller. This shall be accomplished through the following process utilizing District One staff. This telephone line may be coupled with a DSL line and a phone filter to isolate the dial-up line. An E911 address is required.

The cabinet shall be provided with an Outdoor Network Interface for termination of the telephone service. It shall be mounted to the inside of the cabinet in a location suitable to provide access for termination of the telephone service at a later date.

Full duplex communication between the master and its local controllers is recommended, but at this time not required. The data rate shall be 1200 baud minimum and shall be capable of speeds to 38,400 or above as technology allows. The controller, when installed in an Ethernet topology, may operate non-serial communications.

The master controller shall be furnished with a NEMA rated Econolite 56K industrial modem.

The Contractor shall arrange to install a standard voice-grade dial-up telephone line to the master controller. This shall be accomplished through the following process utilizing Department staff.

As soon as practical or within one week after the contract has been awarded, the Contractor shall contact (via phone) the Traffic Engineer at the McHenry County Division of Transportation at (815) 334-4960 to request a phone line installation.

A follow-up fax transmittal to the Traffic Engineer (815-334-4989) with all required information pertaining to the phone installation is required from the Contractor as soon as possible or within one week after the initial request has been made. The required information to be supplied on the fax shall include (but not limited to): A street address for the new traffic signal controller (or nearby address); a nearby existing telephone number; what type of telephone service is needed; the name and number of the Contractor's employee for the telephone company to contact regarding site work and questions.

The usual time frame for the activation of the phone line is 4-6 weeks after the MCDOT has received the Contractor supplied fax. It is, therefore, imperative that the phone line conduit and pull-string be installed by the Contractor in anticipation of this time frame. On jobs which include roadway widening in which the conduit cannot be installed until this widening is completed, the Contractor will be allowed to delay the phone line installation request to the Business Services Section until a point in time that is 4-6 weeks prior to the anticipated completion of the traffic signal work. The contractor shall provide the Administrative Support Manager with an expected installation date considering the 4-6 week processing time.

The telephone line shall be installed and activated one month before the system final inspection.

All costs associated with the telephone line installation and activation (not including the Contract specified conduit installation between the point of telephone service and the traffic signal controller cabinet) shall be paid for by the McHenry County Division of Transportation (i.e., this will be an MCDOT phone number not a Contractor phone number).

**UNINTERRUPTIBLE POWER SUPPLY.**

Add the following to Article 862.01 of the Standard Specifications:

The UPS shall have the power capacity to provide normal operation of a signalized intersection that utilizes all LED type signal head optics, for a minimum of six hours.

Add the following to Article 862.02 of the Standard Specifications:

Materials shall be according to Article 1074.04 as modified in UNINTERRUPTIBLE POWER SUPPLY in Division 1000 of these specifications.

Add the following to Article 862.03 of the Standard Specifications:

The UPS shall additionally include, but not be limited to, a battery cabinet. The UPS shall provide reliable emergency power to the traffic signals in the event of a power failure or interruption.

Revise Article 862.04 of the Standard Specifications to read:

**Installation.**

When a UPS is installed at an existing traffic signal cabinet, the UPS cabinet shall partially rest on the lip of the existing controller cabinet foundation and be secured to the existing controller cabinet by means of at least four (4) stainless steel bolts. The UPS cabinet shall be completely enclosed with the bottom and back constructed of the same material as the cabinet.

When a UPS is installed at a new signal cabinet and foundation, it shall be mounted as shown on the plans.

At locations where UPS is installed and Emergency Vehicle Priority System is in use, any existing incandescent confirmation beacons shall be replaced with LED lamps in accordance with the District One Emergency Vehicle Priority System specification at no additional cost to the contract. When LED lamps are installed resistors shall be required to be placed on the load switches to eliminate any voltage leaking to the LED lamps. The resistor type shall be that recommended by the vendor of the preemption equipment. A concrete apron 67 in. x 50 in. x 5 in. (1702mm x 1270mm x 130mm) shall be provided on the side of the existing Type D Foundation, where the UPS cabinet is located. The concrete apron shall follow the District 1 Standard Traffic Signal Design Detail, Type D for Ground Mounted Controller Cabinet and UPS Battery Cabinet. The concrete apron shall follow Articles 424 and 202 of the Standard Specifications.

Revise Article 862.05 of the Standard Specifications to read:

**Basis of Payment.**

This work will be paid for at the contract unit price per each for UNINTERRUPTIBLE POWER SUPPLY. Replacement of Emergency Vehicle Priority System confirmation beacons and installation of load switch resistors shall be included in the cost of the UNINTERRUPTIBLE POWER SUPPLY item.

**FIBER OPTIC CABLE.**

Add the following to Article 871.01 of the Standard Specifications:

The Fiber Optic cable shall be installed in conduit or as specified on the plans.

Add the following to Article 872.02 of the Standard Specifications:

The control cabinet distribution enclosure shall be CSC FTWO12KST-W/O 12 Port Fiber Wall Enclosure. The fiber optic cable shall provide six fibers per tube for the amount of fibers called for in the Fiber Optic Cable pay item in the Contract. Fiber Optic cable may be gel filled or have an approved water blocking tape.

Add the following to Article 871.04 of the Standard Specifications:

A minimum of six multimode fibers from each cable shall be terminated with approved mechanical connectors at the distribution enclosure. Fibers not being used shall be labeled "spare." Fibers not attached to the distribution enclosure shall be capped and sealed. A minimum of 13.0 feet (4m) of extra cable length shall be provided for controller cabinets. The controller cabinet extra cable length shall be stored as directed by the Engineer.

Add the following to Article 871.06 of the Standard Specifications:

The distribution enclosure and all connectors will be included in the cost of the fiber optic cable.

**Basis of Payment.** The work shall be paid for at the contract unit price for FIBER OPTIC CABLE IN CONDUIT, NO. 62.5/125, MM12F SM12F, per (meter) foot for the cable in place, including distribution enclosure and all connectors.

**MAST ARM ASSEMBLY AND POLE.**

Revise Article 877.01 of the Standard Specifications to read:

**Description.**

This work shall consist of furnishing and installing a steel mast arm and assembly and a galvanized steel or extruded aluminum shroud for protection of the base plate.

Revise Article 877.03 of the Standard Specifications:

Mast arm assembly and pole shall be as follows.

- (a) Steel Mast Arm Assembly and Pole and Steel Combination Mast Arm Assembly and Pole. The steel mast arm assembly and pole and steel combination mast arm assembly and pole shall consist of a traffic signal mast arm, a luminaire mast arm or davit (for combination pole only), a pole, and a base, together with anchor rods and other appurtenances. The configuration of the mast arm assembly, pole, and base shall be according to the details shown on the plans.
  - (1) Loading. The mast arm assembly and pole, and combination mast arm assembly and pole shall be designed for the loading shown on the Highway Standards or elsewhere on the plans, whichever is greater. The design shall be according to AASHTO "Standard Specification for Structural Supports for Highway Signs, Luminaries and Traffic Signals" 1994 Edition for 80 mph (130 km/hr) wind velocity. However, the arm-to-pole connection for tapered signal and luminaire arms shall be according to the "ring plate" detail as shown in Figure 11-1(f) of the 2002 Interim, to the AASHTO "Standard Specification for Structural Supports for Highway Signs, Luminaries and Traffic Signals" 2001 4th Edition.
  - (2) Structural Steel Grade. The mast arm and pole shall be fabricated according to ASTM A 595, Grade A or B, ASTM A 572 Grade 55, or ASTM A 1011 Grade 55 HSLAS Class 2. The base and flange plates shall be of structural steel according to AASHTO M 270 Grade 50 (M 270M Grade 345). Luminaire arms and trussed arms 15 ft (4.5 m) or less shall be fabricated from one steel pipe or tube size according to ASTM A 53 Grade B or ASTM A 500 Grade B or C. All mast arm assemblies, poles, and bases shall be galvanized according to AASHTO M 111.
  - (3) Fabrication. The design and fabrication of the mast arm assembly, pole, and base shall be according to the requirements of the Standard Specifications for Structural Supports for Highway Signs, Luminaires, and Traffic Signals published by AASHTO. The mast arm and pole may be of single length or sectional design. If section design is used, the overlap shall be at least 150 percent of the maximum diameter of the overlapping section and shall be assembled in the factory.

The manufacturer will be allowed to slot the base plate in which other bolt circles may fit, providing that these slots do not offset the integrity of the pole. Circumferential welds of tapered arms and poles to base plates shall be full penetration welds.

- (4) Shop Drawing Approval. The Contractor shall submit detailed drawings showing design materials, thickness of sections, weld sizes, and anchor rods to the Engineer for approval prior to fabrication. These drawings shall be at least 11 x 17 in. (275 x 425 mm) in size and of adequate quality for microfilming.
- (b) Anchor Rods. The anchor rods shall be ASTM F 1554 Grade 105, coated by the hot-dip galvanizing process according to AASHTO M 232, and shall be threaded a minimum of 7 1/2 in. (185 mm) at one end and have a bend at the other end. The first 12 in. (300 mm) at the threaded end shall be galvanized. Two nuts, one lock washer, and one flat washer shall be furnished with each anchor rod. All nuts and washers shall be galvanized.
- (c) The galvanized steel or extruded aluminum shroud shall have dimensions similar to those detailed in the "District One Standard Traffic Signal Design Details." The shroud shall be installed such that it allow air to circulate throughout the mast arm but not allow infestation of insects or other animals, and such that it is not hazardous to probing fingers and feet.

Add the following to Article 877.04 of the Standard Specifications:

The shroud shall not be paid for separately but shall be included in the cost of the mast arm assembly and pole.

### **CONCRETE FOUNDATIONS.**

Add the following to Section 878.03 of the Standard Specifications:

All anchor bolts shall be according to Section 1006.09, except all anchor bolts shall be hot dipped galvanized the full length of the anchor bolt including the hook.

Concrete Foundations, Type "A" for Traffic Signal Posts shall provide anchor bolts with the bolt pattern specified within the "District 1 Standard Traffic Signal Design Details." All Type "A" foundations shall be a minimum depth of 1.22 m (48").

Concrete Foundations, Type "C" for Traffic Signal Cabinets with Uninterruptible Power Supply (UPS) cabinet installations shall be a combined concrete foundation with the UPS portion of the foundation located on the signal power panel side of the controller foundation. The dimensions of the Type C foundation shall be a minimum of 72 inches long and 36 inches wide. All Type "C" foundations shall be a minimum depth of 48 inches. The concrete apron in front Type IV or V cabinet shall be 36 in. x 72 in. x 4 in. The concrete apron in front of the UPS cabinet shall be 36 in. x 72 in. x 4 in. Anchor bolts shall provide bolt spacing as required by the manufacturer.



Concrete Foundations, Type "D" for Traffic Signal Cabinets shall be a minimum of 48 inches (1.22 m) long and 31 inches (790 mm) wide. All Type "D" foundations shall be a minimum depth of 48 inches (1.22 m). The concrete apron shall be 36 in. x 48 in. x 5 in. (910 mm X 1220 mm X 130 mm). Anchor bolts shall provide bolt spacing as required by the manufacturer.

Concrete Foundations, Type "E" for Mast Arm and Combination Mast Arm Poles shall meet the current requirements listed in the Highway Standards.

Foundations used for Combination Mast Arm Poles shall provide an extra 2-1/2 inch (65 mm) raceway.

No foundation is to be poured until the Resident Engineer gives his/her approval as to the depth of the foundation.

**LIGHT EMITTING DIODE (LED) SIGNAL HEAD AND OPTICALLY PROGRAMMED LED SIGNAL HEAD.**

Add the following to the first paragraph of Article 880.04 of the Standard Specifications:

**Basis of Payment.**

The price shall include furnishing the equipment described above, all mounting hardware and installing them in satisfactory operating condition.

**LIGHT EMITTING DIODE (LED), SIGNAL HEAD, RETROFIT**

**Description.**

This work shall consist of retrofitting an existing polycarbonate traffic signal head with a traffic signal module, pedestrian signal module, and pedestrian countdown signal module, with light emitting diodes (LEDs) as specified in the plans.

**Materials.**

Materials shall be according to LIGHT EMITTING DIODE (LED) AND OPTICALLY PROGRAMMED LED SIGNAL HEAD, AND LIGHT EMITTING DIODE (LED) PEDESTRIAN SIGNAL HEAD in Divisions 880, 881 and 1000 of these specifications.

Add the following to Article 880.04 of the Standard Specifications:

**Basis of Payment.**

This item shall be paid for at the contract unit price each for SIGNAL HEAD, LED, RETROFIT, or PEDESTRIAN SIGNAL HEAD, LED, RETROFIT, for the type and number of polycarbonate signal heads, faces, and sections specified, which price shall be payment in full for furnishing the equipment described above including LED modules, all mounting hardware, and installing them

in satisfactory operating condition. The type specified will indicate the number of faces and the method of mounting.

### **LIGHT EMITTING DIODE (LED) PEDESTRIAN SIGNAL HEAD**

Add the following to the third paragraph of Article 881.03 of the Standard Specifications:

No mixing of different types of pedestrian traffic signals or displays will be permitted.

Add the following to Article 881.03 of the Standard Specifications:

(a) Pedestrian Countdown Signal Heads.

- (1) Pedestrian Countdown Signal Heads shall not be installed at signalized intersections where traffic signals and railroad warning devices are interconnected.
- (2) Pedestrian Countdown Signal Heads shall be 16 inch (406mm) x 18 inch (457mm), for single units with the housings glossy black polycarbonate. Connecting hardware and mounting brackets shall be polycarbonate (black). A corrosion resistant anti-seize lubricant shall be applied to all metallic mounting bracket joints, and shall be visible to the inspector at the signal turn-on.
- (3) Each pedestrian signal LED module shall be fully MUTCD compliant and shall consist of double overlay message combining full LED symbols of an Upraised Hand and a Walking Person. "Egg Crate" type sun shields are not permitted. Numerals shall measure 9 inches (229mm) in height and easily identified from a distance of 120 feet (36.6m).

Add the following to Article 881.04 of the Standard Specifications:

#### **Basis of Payment.**

The price shall include furnishing the equipment described above, all mounting hardware and installing them in satisfactory operating condition.

#### **DETECTOR LOOP.**

Revise Section 886 of the Standard Specifications to read:

#### **Description.**

This work shall consist of furnishing and installing a detector loop in the pavement.

Procedure.

A minimum of seven (7) working days prior to the Contractor cutting loops, the Contractor shall have the proposed loop locations marked and contact the Area Traffic Signal Maintenance and Operations Engineer (815) 334-4960 to inspect and approve the layout. When preformed detector loops are installed, the Contractor shall have them inspected and approved prior to the pouring of the Portland cement concrete surface, using the same notification process as above.

Installation.

Loop detectors shall be installed according to the requirements of the "District One Standard Traffic Signal Design Details." Saw-cuts (homeruns on preformed detector loops) from the loop to the edge of pavement shall be made perpendicular to the edge of pavement when possible in order to minimize the length of the saw-cut (homerun on preformed detector loops) unless directed otherwise by the Engineer or as shown on the plan.

The detector loop cable insulation shall be labeled with the cable specifications.

Each loop detector lead-in wire shall be labeled in the handhole using a Panduit PLFIM water proof tag, secured to each wire with nylon ties.

Resistance to ground shall be a minimum of 100 mega-ohms under any conditions of weather or moisture. Inductance shall be more than 50 and less than 700 microhenries. Quality readings shall be more than 5.

- (a) Type I. All loops installed in new asphalt pavement shall be installed in the binder course and not in the surface course. The edge of pavement, curb and handhole shall be cut with a 1/4 inch (6.3 mm) deep x 4 inches (100 mm) saw cut to mark location of each loop lead-in.
- (b) Loop sealant shall be a two-component thixotropic chemically cured polyurethane either Chemque Q-Seal 295, Percol Elastic Cement AC Grade. The sealant shall be installed 1/8 inch (3 mm) below the pavement surface, if installed above the surface the overlap shall be removed immediately.
- (c) Detector loop measurements shall include the saw cut and the length of the loop lead-in to the edge of pavement. The lead-in wire, including all necessary connections for proper operations, from the edge of pavement to the handhole, shall be included in the price of the detector loop. Unit duct, trench and backfill, and drilling of pavement or handholes shall be included in detector loop quantities.
- (d) Preformed. This work shall consist of furnishing and installing a rubberized or crosslinked polyethylene heat resistant preformed traffic signal loop in accordance with the Standard Specifications, except for the following:

- (e) Preformed detector loops shall be installed in new pavement constructed of Portland cement concrete using mounting chairs or tied to re-bar or the preformed detector loops may be placed in the sub-base. Loop lead-ins shall be extended to a temporary protective enclosure near the proposed handhole location. The protective enclosure shall provide sufficient protection from other construction activities and may be buried for additional protection.
- (f) Handholes shall be placed next to the shoulder or back of curb when preformed detector loops enter the handhole. Non-metallic coilable duct, included in this pay item, shall be used to protect the preformed lead-ins from back of curb to the handhole.
- (g) Preformed detector loops shall be factory assembled with ends capped and sealed against moisture and other contaminants. Homeruns and interconnects shall be pre-wired and shall be an integral part of the loop assembly. The loop configurations and homerun lengths shall be assembled for the specific application. The loop and homerun shall be constructed using 11/16 inch (17.2 mm) outside diameter (minimum), 3/8 inch (9.5 mm) inside diameter (minimum) Class A oil resistant synthetic cord reinforced hydraulic hose with 250 psi (1,720 kPa) internal pressure rating or a similarly sized XLPE cable jacket. Hose for the loop and homerun assembly shall be one continuous piece. No joints or splices shall be allowed in the hose except where necessary to connect homeruns or interconnects to the loops. This will provide maximum wire protection and loop system strength. Hose tee connections shall be heavy duty high temperature synthetic rubber. The tee shall be of proper size to attach directly to the hose, minimizing glue joints. The tee shall have the same flexible properties as the hose to insure that the whole assembly can conform to pavement movement and shifting without cracking or breaking. For XLPE jacketed preformed loops, all splice connections shall be soldered, sealed, and tested before being sealed in a high impact glass impregnated plastic splice enclosure. The wire used shall be #16 THWN stranded copper. The number of turns in the loop shall be application specific. Homerun wire pairs shall be twisted a minimum of four turns per foot. No wire splices will be allowed in the preformed loop assembly. The loop and homeruns shall be filled and sealed with a flexible sealant to insure complete moisture blockage and further protect the wire. The preformed loops shall be constructed to allow a minimum of 6.5 feet of extra cable in the handhole.

#### Method of Measurement.

This work will be measured for payment in feet (meters) in place. Type I detector loop will be measured along the sawed slot in the pavement containing the loop and lead-in, rather than the actual length of the wire. Preformed detector loops will be measured along the detector loop and lead-in embedded in the pavement, rather than the actual length of the wire.

#### Basis of Payment.

This work shall be paid for at the contract unit price per foot (meter) for DETECTOR LOOP, TYPE I or PREFORMED DETECTOR LOOP as specified in the plans, which price shall be payment in full for furnishing and installing the detector loop and all related connections for proper operation.

**EMERGENCY VEHICLE PRIORITY SYSTEM.**

Revise Section 887.00 of the Standard Specifications to read:

It shall be the Contractor's responsibility to contact the municipality or fire district to verify the brand of emergency vehicle pre-emption equipment to be installed prior to the contract bidding. The equipment must be completely compatible with all components of the equipment currently in use by the Agency.

All new installations shall be equipped with Confirmation Beacons as shown on the "District One Standard Traffic Signal Design Details." The Confirmation Beacon shall consist of a 6 watt Par 38 LED flood lamp with a 30 degree light spread, maximum 6 watt energy consumption at 120V, and a 2,000 hour warranty for each direction of pre-emption. The lamp shall have an adjustable mount with a weatherproof enclosure for cable splicing. All hardware shall be cast aluminum or stainless steel. Holes drilled into signal poles, mast arms, or posts shall require rubber grommets. In order to maintain uniformity between communities, the confirmation beacons shall indicate when the control equipment receives the pre-emption signal. The pre-emption movement shall be signaled by a flashing indication at the rate specified by Section 4D-11 of the "Manual on Uniform Traffic Control Devices." The stopped pre-empted movements shall be signaled by a continuous indication.

Due to electric voltage leakage of the load switches in the cabinet, a resistor shall be installed on each load switch used for preemption to eliminate this occurrence.

All light operated systems shall operate at a uniform rate of 14.035 Hz  $\pm$ 0.002, or as otherwise required by the Engineer, and provide compatible operation with other light systems currently being operated in the District.

Basis of Payment. The work shall be paid for at the contract unit price each for furnishing and installing LIGHT DETECTOR and LIGHT DETECTOR AMPLIFIER. Furnishing and installing the confirmation beacon shall be incidental to the cost of the Light Detector. The preemption detector amplifier shall be paid for on a basis of (1) one each per intersection controller and shall provide operation for all movements required in the pre-emption phase sequence.

**EMERGENCY VEHICLE PRIORITY SYSTEM LINE SENSOR CABLE, NO. 20 3/C**

This work shall consist of furnishing and installing lead-in cable for light detectors installed at existing and/or proposed traffic signal installations as part of an emergency vehicle priority system. The work includes installation of the lead-in cables in existing and/or new conduit. The electric cable shall be shielded and have (3) stranded conductors colored blue, orange, and

yellow with a stranded tinned copper drain wire. The cable shall meet the requirements of the manufacturer of the Emergency Vehicle Priority System Equipment.

Basis of Payment. This work will be paid for at the contract unit price per foot for EMERGENCY VEHICLE PRIORITY SYSTEM LINE SENSOR CABLE, NO. 20 3/C, which price shall be payment in full for furnishing, installing and making all electrical connections necessary for proper operations.

**TEMPORARY TRAFFIC SIGNAL INSTALLATION.**

Revise Section 890 of the Standard Specifications to read:

Description.

This work shall consist of furnishing, installing, maintaining, and removing a temporary traffic signal installation as shown on the plans, including but not limited to temporary signal heads, emergency vehicle priority systems, interconnect, vehicle detectors, uninterruptible power supply, and signing. Temporary traffic signal controllers and cabinets interconnected to railroad traffic control devices shall be new. When temporary traffic signals will be operating within a county or local agency Traffic Management System, the equipment must be NTCIP compliant and compatible with the current operating requirements of the Traffic Management System.

General.

Only an approved equipment vendor will be allowed to assemble the temporary traffic signal cabinet. Also, an approved equipment vendor shall assemble and test a temporary railroad traffic signal cabinet. (Refer to the "Inspection of Controller and Cabinet" specification). A representative of the approved control equipment vendor shall be present at the temporary traffic signal turn-on inspection.

Construction Requirements.

(a) Controllers.

1. Only controllers supplied by one of the District approved closed loop equipment manufacturers will be approved for use at temporary signal locations. All controllers used for temporary traffic signals shall be fully actuated NEMA microprocessor based with RS232 data entry ports compatible with existing monitoring software approved by IDOT District 1, installed in TS2 cabinets with 8 phase back panels, capable of supplying 255 seconds of cycle length and individual phase length settings up to 99 seconds. On projects with one lane open and two way traffic flow, such as bridge deck repairs, the temporary signal controller shall be capable of providing an adjustable all red clearance setting of up to 30 seconds in length. All controllers used for temporary traffic signals shall meet or exceed the requirements of Section 857 of the Standard Specifications with regards to internal time base coordination and preemption. All railroad interconnected temporary controllers and cabinets shall be new and shall satisfy the requirements of Article 857.02 of the Standard Specifications as modified herein.
  2. Only control equipment, including controller cabinet and peripheral equipment, supplied by one of the District approved closed loop equipment manufacturers will be approved for use at temporary traffic signal locations. All control equipment for the temporary traffic signal(s) shall be furnished by the Contractor unless otherwise stated in the plans. On projects with multiple temporary traffic signal installations, all controllers shall be the same manufacturer brand and model number with current software installed.
- (b) Cabinets. All temporary traffic signal cabinets shall have a closed bottom made of aluminum alloy. The bottom shall be sealed along the entire perimeter of the cabinet base to ensure a water, dust and insect-proof seal. The bottom shall provide a minimum of two (2) 4 inch (100 mm) diameter holes to run the electric cables through. The 4 inch (100 mm) diameter holes shall have a bushing installed to protect the electric cables and shall be sealed after the electric cables are installed.
- (c) Grounding. Grounding shall be provided for the temporary traffic signal cabinet meeting or exceeding the applicable portions of the National Electrical Code, Section 807 of the Standard Specifications and shall meet the requirements of the District 1 Traffic Signal Specifications for "Grounding of Traffic Signal Systems".
- (d) Traffic Signal Heads. All traffic signal sections and pedestrian signal sections shall be 12 inches (300 mm). Traffic signal sections shall be LED with expandable view, unless otherwise approved by the Engineer. Pedestrian signal heads shall be Light Emitting Diode (LED) Pedestrian Countdown Signal Heads except when a

temporary traffic signal is installed at an intersection interconnected with a railroad grade crossing. When a temporary traffic signal is installed at an intersection interconnected with a railroad grade crossing, Light Emitting Diode (LED) Pedestrian Signal Heads shall be furnished. The temporary traffic signal heads shall be placed as indicated on the temporary traffic signal plan or as directed by the Engineer. The Contractor shall furnish enough extra cable length to relocate heads to any position on the span wire or at locations illustrated on the plans for construction staging. The temporary traffic signal shall remain in operation during all signal head relocations. Each temporary traffic signal head shall have its own cable from the controller cabinet to the signal head.

(e) Interconnect.

1. Temporary traffic signal interconnect shall be provided using fiber optic cable or wireless interconnect technology as specified in the plans. The Contractor may request, in writing, to substitute the fiber optic temporary interconnect indicated in the contract documents with a wireless interconnect. The Contractor must provide assurances that the radio device will operate properly at all times and during all construction staging. If approved for use by the Engineer, the Contractor shall submit marked-up traffic signal plans indicating locations of radios and antennas and installation details. If wireless interconnect is used, and in the opinion of the engineer, it is not viable, or if it fails during testing or operations, the Contractor shall be responsible for installing all necessary poles, fiber optic cable, and other infrastructure for providing temporary fiber optic interconnect at no cost to the contract.
2. The existing system interconnect and phone lines are to be maintained as part of the Temporary Traffic Signal Installation specified for on the plan. The interconnect shall be installed into the temporary controller cabinet as per the notes or details on the plans. All labor and equipment required to install and maintain the existing interconnect as part of the Temporary Traffic Signal Installation shall be included in the item Temporary Traffic Signal Installation. When shown in the plans, temporary traffic signal interconnect equipment shall be furnished and installed. The temporary traffic signal interconnect shall maintain interconnect communications throughout the entire signal system for the duration of the project.
3. Temporary wireless interconnect, complete. The radio interconnect system shall be compatible with Eagle or Econolite controller closed loop systems. This item shall include all materials, labor and testing to provide the completely operational closed loop system as shown on the plans. The radio interconnect system shall include the following components:



- a. Rack or Shelf Mounted RS-232 Frequency Hopping Spread Spectrum (FHSS) Radio
- b. Software for Radio Configuration (Configure Frequency and Hopping Patterns)
- c. Antennas (Omni Directional or Yagi Directional)
- d. Antenna Cables, LMR400, Low Loss. Max. 100-ft from controller cabinet to antenna
- e. Brackets, Mounting Hardware, and Accessories Required for Installation
- f. RS232 Data Cable for Connection from the radio to the local or master controller
- g. All other components required for a fully functional radio interconnect system

All controller cabinet modifications and other modifications to existing equipment that are required for the installation of the radio interconnect system components shall be included in this item.

The radio interconnect system may operate at 900Mhz (902-928) or 2.4 Ghz depending on the results of a site survey. The telemetry shall have an acceptable rate of transmission errors, time outs, etc. comparable to that of a hardwire system.

The proposed master controller and telemetry module shall be configured for use with the radio interconnect at a minimum rate of 9600 baud.

The radio interconnect system shall include all other components required for a complete and fully functional telemetry system and shall be installed in accordance to the manufacturers recommendations.

The following radio equipment is currently approved for use in Region One/District One: Encon Model 5100 and Intuicom Communicator II.

- (f) Emergency Vehicle Pre-Emption. All emergency vehicle preemption equipment (light detectors, light detector amplifiers, confirmation beacons, etc.) as shown on the temporary traffic signal plans shall be provided by the Contractor. It shall be the Contractor's responsibility to contact the municipality or fire district to verify the brand of emergency vehicle preemption equipment to be installed prior to the contract bidding. The equipment must be completely compatible with all components of the equipment currently in use by the Agency. All light operated systems shall operate at a uniform rate of 14.035 hz  $\pm$ 0.002, or as otherwise required by the Engineer, and provide compatible operation with other light systems currently being operated in the District. All labor and material required to install and maintain the Emergency

Vehicle Preemption installation shall be included in the item Temporary Traffic Signal Installation.

- (g) Vehicle Detection. All temporary traffic signal installations shall have vehicular detection installed as shown on the plans or as directed by the Engineer. Pedestrian push buttons shall be provided for all pedestrian signal heads/phases as shown on the plans or as directed by the Engineer. All approaches shall have vehicular detection provided by Video Vehicle Detection System as shown on the plans or as directed by the Engineer. The microwave vehicle sensor or video vehicle detection system shall be approved by IDOT before furnishing and installing. The Contractor shall install, wire, and adjust the alignment of the microwave vehicle sensor or video vehicle detection system in accordance to the manufacturer's recommendations and requirements. The Contractor shall be responsible for adjusting the alignment of the microwave vehicle sensor or video vehicle detection system for all construction staging changes and for maintaining proper alignment throughout the project. A representative of the approved control equipment vendor shall be present and assist the contractor in setting up and maintaining the microwave vehicle sensor or video vehicle detection system. An in-cabinet video monitor shall be provided with all video vehicle detection systems and shall be included in the item Temporary Traffic Signal Installation.
- (h) Uninterruptible Power Supply. All temporary traffic signal installations shall have Uninterruptible Power Supply (UPS). The UPS cabinet shall be mounted to the temporary traffic signal cabinet and meet the requirements of Uninterruptible Power Supply in Divisions 800 and 1000 of these specifications.
- (i) Signs. All existing street name and intersection regulatory signs shall be removed from existing poles and relocated to the temporary signal span wire. If new mast arm assembly and pole(s) and posts are specified for the permanent signals, the signs shall be relocated to the new equipment at no extra cost.
- (j) Energy Charges. The electrical utility energy charges for the operation of the traffic signal installation shall be paid for by others if the installation replaces an existing signal. Otherwise charges shall be paid for under 109.05 of the Standard Specifications.
- (k) Maintenance. Maintenance shall meet the requirements of the Standard Specifications and MAINTENANCE OF EXISTING TRAFFIC SIGNAL INSTALLATION in Division 800 of these specifications. Maintenance of temporary signals and of the existing signals shall be included in the cost of the TEMPORARY TRAFFIC SIGNAL INSTALLATION pay item. When temporary traffic signals are to be installed at locations where existing signals are presently operating, the Contractor shall be fully responsible for the maintenance of the existing signal

installation as soon as he begins any physical work on the Contract or any portion thereof. In addition, a minimum of seven (7) days prior to assuming maintenance of the existing traffic signal installation(s) under this Contract, the Contractor shall request that the Resident Engineer contact the County's Traffic Operations Engineer (815) 334-4960 for an inspection of the installation(s).

- (l) Temporary Traffic Signals for Bridge Projects. Temporary Traffic Signals for bridge projects shall follow the State Standards, Standard Specifications, District 1 Traffic Signal Specifications and any plans for Bridge Temporary Traffic Signals included in the plans. The installation shall meet the above requirements for "Temporary Traffic Signal Installation". In addition all electric cable shall be aerially suspended, at a minimum height of 18 feet (5.5m), on temporary wood poles (Class 5 or better) of 45 feet (13.7 m), minimum height. The signal heads shall be span wire mounted or bracket mounted to the wood pole or as directed by the Engineer. The Controller cabinet shall be mounted to the wood pole or as directed by the Engineer. Microwave vehicle sensors or video vehicle detection may be used in place of the detector loops as approved by the Engineer.
- (m) Temporary Portable Traffic Signal for Bridge Projects.
  1. Unless otherwise directed by the Engineer, temporary portable traffic signals shall be restricted to use on roadways of less than 8000 ADT that have limited access to electric utility service, shall not be installed on projects where the estimated need exceeds ten (10) weeks, and shall not be in operation during the period of November through March. The Contractor shall replace the temporary portable traffic signals with temporary span wire traffic signals noted herein at no cost to the contract if the bridge project or Engineer requires temporary traffic signals to remain in operation into any part of period of November through March. If, in the opinion of the engineer, the reliability and safety of the temporary portable traffic signal is not similar to that of a temporary span wire traffic signal installation, the Contractor shall replace the temporary portable traffic signals with temporary span wire traffic signals noted herein at no cost to the contract.
  2. The controller and LED signal displays shall meet the Standard Specifications and all other requirements in this TEMPORARY TRAFFIC SIGNAL INSTALLATION specification.
  3. Work shall be according to Article 701.18(b) of the Standard Specifications except as noted herein.
  4. General.

- a. The temporary portable bridge traffic signals shall be trailer-mounted units. The trailer-mounted units shall be set up securely and level. Each unit shall be self-contained and consist of two signal heads. The left signal head shall be mounted on a mast arm capable of extending over the travel lane. Each unit shall contain a solar cell system to facilitate battery charging. There shall be a minimum of 12 days backup reserve battery supply and the units shall be capable of operating with a 120 V power supply from a generator or electrical service.
- b. All signal heads located over the travel lane shall be mounted at a minimum height of 17 feet (5m) from the bottom of the signal back plate to the top of the road surface. All far right signal heads located outside the travel lane shall be mounted at a minimum height of 8 feet (2.5m) from the bottom of the signal back plate to the top of the adjacent travel lane surface.
- c. The long all red intervals for the traffic signal controller shall be adjustable up to 250 seconds in one-second increments.
- d. As an alternative to detector loops, temporary portable bridge traffic signals may be equipped with microwave sensors or other approved methods of vehicle detection and traffic actuation.
- e. All portable traffic signal units shall be interconnected using hardwire communication cable. Radio communication equipment may be used only with the approval of the Engineer. If radio communication is used, a site analysis shall be completed to ensure that there is no interference present that would affect the traffic signal operation. The radio equipment shall meet all applicable FCC requirements.
- f. The temporary portable bridge traffic signal system shall meet the physical display and operational requirements of conventional traffic signals as specified in Part IV of the Manual on Uniform Traffic Control Devices (MUTCD). The signal system shall be designed to continuously operate over an ambient temperature range between -30 °F (-34 °C) and 120 °F (48 °C). When not being utilized to inform and direct traffic, portable signals shall be treated as nonoperating equipment according to Article 701.11.
- g. Basis of Payment. This work will be paid for according to Article 701.20(c).

Basis of Payment.

This work shall be paid for at the contract unit price each for TEMPORARY TRAFFIC SIGNAL INSTALLATION, TEMPORARY BRIDGE TRAFFIC SIGNAL INSTALLATION, or TEMPORARY PORTABLE BRIDGE TRAFFIC SIGNAL INSTALLATION. The price of which shall include all costs for the modifications required for traffic staging, changes in signal phasing as required in the Contract plans, microwave vehicle sensors, video vehicle detection system, any maintenance or adjustment to the microwave vehicle sensors/video vehicle detection system, all material required, the installation and complete removal of the temporary traffic signal.

**REMOVE EXISTING TRAFFIC SIGNAL EQUIPMENT.**

Add the following to Section 895.05 of the Standard Specifications:

The traffic signal equipment, which is to be removed and is to become the property of the Contractor shall be disposed of by them outside the right-of-way at their expense.

All equipment to be returned to the County shall be delivered by the Contractor to the County's Traffic Signal Maintenance Contractor's main facility. The Contractor shall contact the County's Electrical Maintenance Contractor to schedule an appointment to deliver the equipment. No equipment will be accepted without a prior appointment. All equipment shall be delivered within 30 days of removing it from the traffic signal installation. The Contractor shall provide 5 copies of a list of equipment that is to remain the property of the State, including model and serial numbers, where applicable. He shall also provide a copy of the Contract plan or special provision showing the quantities and type of equipment. Controllers and peripheral equipment from the same location shall be boxed together (equipment from different locations may not be mixed) and all boxes and controller cabinets shall be clearly marked or labeled with the location from which they were removed. If equipment is not returned with these requirements, it will be rejected by the County's Electrical Maintenance Contractor. The Contractor shall be responsible for the condition of the traffic signal equipment from the time he takes maintenance of the signal installation until the acceptance of a receipt drawn by the County's Electrical Maintenance Contractor indicating the items have been returned in good condition.

The Contractor shall safely store and arrange for pick up of all equipment to be returned to agencies other than the State. The Contractor shall package the equipment and provide all necessary documentation as stated above.

Traffic signal equipment, which is lost or not returned to the Department for any reason shall be replaced with new equipment meeting the requirements of these Specifications.

**TRAFFIC SIGNAL PAINTING.**

Description.

This work shall include surface preparation, powder type painted finish application and packaging of new galvanized steel traffic signal mast arm poles and posts assemblies. All work associated with applying the painted finish shall be performed at the manufacturing facility for the pole assembly or post or at a painting facility approved by the Engineer. Traffic signal mast arm shrouds and post bases shall also be painted the same color as the pole assemblies and posts.

Surface Preparation.

All weld flux and other contaminates shall be mechanically removed. The traffic mast arms and post assemblies shall be degreased, cleaned, and air dried to assure all moisture is removed.

Painted Finish.

All galvanized exterior surfaces shall be coated with a urethane or triglycidyl isocyanurate (TGIC) polyester powder to a dry film thickness of 2.0 mils. Prior to application, the surface shall be mechanically etched by brush blasting (Ref. SSPC-SP7) and the zinc coated substrate preheated to 450 degrees F for a minimum one (1) hour. The coating shall be electrostatically applied and cured by elevating the zinc-coated substrate temperature to a minimum of 400 degrees F.

The finish paint color shall be one of the manufacturer's standard colors and shall be as selected by the local agency responsible for paint costs. The Contractor shall confirm, in writing, the color selection with the local responsible agency and provide a copy of the approval to the Engineer and a copy of the approval shall be included in the material catalog submittal.

Traffic signal heads, pedestrian signal heads and controller cabinets are not included in this pay item.

Any damage to the finish after leaving the manufacturer's facility shall be repaired to the satisfaction of the Engineer using a method approvable by the Engineer and manufacturer. If while at the manufacturer's facility the finish is damaged, the finish shall be re-applied.

Warranty.

The Contractor shall furnish in writing to the Engineer, the paint manufacturer's standard warranty and certification that the paint system has been properly applied.

Packaging.

Prior to shipping, the poles and posts shall be wrapped in ultraviolet-inhibiting plastic foam or rubberized foam.

Basis of Payment.

This work shall be paid for at the contract unit price each for PAINT NEW MAST ARM POLE, UNDER 40 FEET (12.19 METER); PAINT NEW MAST ARM POLE, 40 FEET (12.19 METER) AND OVER; PAINT NEW COMBINATION MAST ARM POLE, UNDER 40 FEET

(12.19 METER); PAINT NEW COMBINATION MAST ARM POLE, 40 FEET (12.19 METER) AND OVER; or TRAFFIC SIGNAL POST of any height, which shall be payment in full for painting and packaging the traffic signal mast arm poles and posts described above including all shrouds, bases and appurtenances.

## **ILLUMINATED STREET NAME SIGN**

### **Description.**

This work shall consist of furnishing and installing a LED internally illuminated street name sign.

### **Materials.**

Materials shall be in accordance with ILLUMINATED STREET NAME SIGN in Division 1000 of these specifications.

### **Installation.**

The sign can be mounted on most steel mast arm poles. Mounting on aluminum mast arm pole requires supporting structural calculations. Some older or special designed steel mast arm poles may require structural evaluation to assure that construction of the mast arm pole is adequate for the proposed additional loading. Structural calculations and other supporting documentation as determined by the Engineer shall be provided by the contractor for review by the Department.

The sign shall be located on a steel traffic signal mast arm no further than 8-feet from the center of the pole to the center of the sign at a height of between 16 to 18-feet above traveled pavement. Mounting hardware shall be Pelco model SE-5015, utilizing stainless steel components.

Signs shall be installed such that they are not energized when traffic signals are powered by an alternate energy source such as a generator or uninterruptible power supply (UPS). The signs shall be connected to the generator or UPS bypass circuitry.

### **Basis of Payment.**

This work will be paid for at the contract unit price each for LED INTERNALLY ILLUMINATED STREET NAME SIGN, which shall be payment in full for furnishing and installing the LED internally illuminated street sign, complete with circuitry and mounting hardware including photo cell, circuit breaker, fusing, relay, connections and cabling as shown on the plans for proper operation and installation.

## **RE-OPTIMIZE TRAFFIC SIGNAL SYSTEM**

### **Description.**

This work shall consist of re-optimizing a closed loop traffic signal system according to the following Levels of work.

LEVEL I applies when improvements are made to an existing signalized intersection within an existing closed loop traffic signal system. The purpose of this work is to integrate the improvements to the subject intersection into the signal system while minimizing the impacts to the existing system operation. This type of work would be commonly associated with the addition of signal phases, pedestrian phases, or improvements that do not affect the capacity at an intersection.

LEVEL II applies when improvements are made to an existing signalized intersection within an existing closed loop traffic signal system and detailed analysis of the intersection operation is desired by the engineer, or when a new signalized or existing signalized intersection is being added to an existing system, but optimization of the entire system is not required. The purpose of this work is to optimize the subject intersection, while integrating it into the existing signal system with limited impact to the system operations. This item also includes an evaluation of the overall system operation, including the traffic responsive program.

For the purposes of re-optimization work, an intersection shall include all traffic movements operated by the subject controller and cabinet.

After the signal improvements are completed, the signal shall be re-optimized as specified by an approved Consultant who has previous experience in optimizing Closed Loop Traffic Signal Systems for District One of the Illinois Department of Transportation. The Contractor shall contact the Traffic Signal Engineer at (815) 334-4960 for a listing of approved Consultants. Traffic signal system optimization work, including fine-tuning adjustments of the optimized system, shall follow the requirements stated in the most recent IDOT District 1 SCAT Guidelines, except as note herein.

A listing of existing signal equipment, interconnect information, phasing data, and timing patterns may be obtained from the Department, if available and as appropriate. The existing SCAT Report is available for review at the District One office and if the Consultant provides blank computer disks, copies of computer simulation files for the existing optimized system and a timing database that includes intersection displays will be made for the Consultant. The Consultant shall confer with the Traffic Signal Engineer prior to optimizing the system to determine if any extraordinary conditions exist that would affect traffic flows in the vicinity of the system, in which case, the Consultant may be instructed to wait until the conditions return to normal or to follow specific instructions regarding the optimization.

(a) LEVEL I Re-Optimization

1. The following tasks are associated with LEVEL I Re-Optimization.



- a. Appropriate signal timings shall be developed for the subject intersection and existing timings shall be utilized for the rest of the intersections in the system.
  - b. Proposed signal timing plan for the new or modified intersection(s) shall be forwarded to IDOT for review prior to implementation.
  - c. Consultant shall conduct on-site implementation of the timings at the turn-on and make fine-tuning adjustments to the timings of the subject intersection in the field to alleviate observed adverse operating conditions and to enhance operations.
2. The following deliverables shall be provided for LEVEL I Re-Optimization.
- a. Consultant shall furnish to IDOT a cover letter describing the extent of the re-optimization work performed.
  - b. Consultant shall furnish an updated intersection graphic display for the subject intersection to IDOT and to IDOT's Traffic Signal Maintenance Contractor.
- (b) LEVEL II Re-Optimization
1. In addition to the requirements described in the LEVEL I Re-Optimization above, the following tasks are associated with LEVEL II Re-Optimization.
- a. Traffic counts shall be taken at the subject intersection after the traffic signals are approved for operation by the Area Traffic Signal Operations Engineer. Manual turning movement counts shall be conducted from 6:30 a.m. to 9:30 a.m., 11:00 a.m. to 1:00 p.m., and 3:30 p.m. to 6:30 p.m. on a typical weekday from midday Monday to midday Friday. The turning movement counts shall identify cars, and single-unit, multi-unit heavy vehicles, and transit buses.
  - b. As necessary, the intersections shall be re-addressed and all system detectors reassigned in the master controller according to the current standard of District One.
  - c. Traffic responsive program operation shall be evaluated to verify proper pattern selection and lack of oscillation and a report of the operation shall be provided to IDOT.
2. The following deliverables shall be provided for LEVEL II Re-Optimization.
- a. Consultant shall furnish to IDOT one (1) copy of a technical memorandum for the optimized system. The technical memorandum shall include the following elements:
    - (1) Brief description of the project
    - (2) Printed copies of the analysis output from Synchro (or other appropriate, approved optimization software file)
    - (3) Printed copies of the traffic counts conducted at the subject intersection
  - b. Consultant shall furnish to IDOT two (2) CDs for the optimized system. The CDs shall include the following elements:
    - (1) Electronic copy of the technical memorandum in PDF format
    - (2) Revised Synchro files (or other appropriate, approved optimization software file) including the new signal and the rest of the signals in the closed loop system

- (3) Traffic counts conducted at the subject intersection
- (4) New or updated intersection graphic display file for the subject intersection
- (5) The CD shall be labeled with the IDOT system number and master location, as well as the submittal date and the consultant logo. The CD case shall include a clearly readable label displaying the same information securely affixed to the side and front.

**Basis of Payment.**

This work shall be paid for at the contract unit price each for RE-OPTIMIZE TRAFFIC SIGNAL SYSTEM – LEVEL I or RE-OPTIMIZE TRAFFIC SIGNAL SYSTEM – LEVEL II, which price shall be payment in full for performing all work described herein per intersection. Following completion of the timings and submittal of specified deliverables, 100 percent of the bid price will be paid.

**OPTIMIZE TRAFFIC SIGNAL SYSTEM**

**Description.**

This work shall consist of optimizing a closed loop traffic signal system.

OPTIMIZE TRAFFIC SIGNAL SYSTEM applies when a new or existing closed loop traffic signal system is to be optimized and a formal Signal Coordination and Timing (SCAT) Report is to be prepared. The purpose of this work is to improve system performance by optimizing traffic signal timings, developing a time of day program and a traffic responsive program.

After the signal improvements are completed, the signal system shall be optimized as specified by an approved Consultant who has previous experience in optimizing Closed Loop Traffic Signal Systems for District One of the Illinois Department of Transportation. The Contractor shall contact the Traffic Signal Engineer at (815) 334-4960 for a listing of approved Consultants. Traffic signal system optimization work, including fine-tuning adjustments of the optimized system, shall follow the requirements stated in the most recent IDOT District 1 SCAT Guidelines, except as note herein.

A listing of existing signal equipment, interconnect information, phasing data, and timing patterns may be obtained from the Department, if available and as appropriate. The existing SCAT Report is available for review at the District One office and if the Consultant provides blank computer disks, copies of computer simulation files for the existing optimized system and a timing database that includes intersection displays will be made for the Consultant. The Consultant shall confer with the Traffic Signal Engineer prior to optimizing the system to determine if any extraordinary conditions exist that would affect traffic flows in the vicinity of the system, in which case, the Consultant may be instructed to wait until the conditions return to normal or to follow specific instructions regarding the optimization.

- (a) The following tasks are associated with OPTIMIZE TRAFFIC SIGNAL SYSTEM.
1. Appropriate signal timings and offsets shall be developed for each intersection and appropriate cycle lengths shall be developed for the closed loop signal system.
  2. Traffic counts shall be taken at all intersections after the permanent traffic signals are approved for operation by the Area Traffic Signal Engineer. Manual turning movement counts shall be conducted from 6:30 a.m. to 9:30 a.m., 11:00 a.m. to 1:00 p.m., and 3:30 p.m. to 6:30 p.m. on a typical weekday from midday Monday to midday Friday. The turning movement counts shall identify cars, and single-unit and multi-unit heavy vehicles.
  3. As necessary, the intersections shall be re-addressed and all system detectors reassigned in the master controller according to the current standard of District One.
  4. A traffic responsive program shall be developed, which considers both volume and occupancy. A time-of-day program shall be developed for used as a back-up system.
  5. Proposed signal timing plan for the new or modified intersection shall be forwarded to MCDOT for review prior to implementation.
  6. Consultant shall conduct on-site implementation of the timings and make fine-tuning adjustments to the timings in the field to alleviate observed adverse operating conditions and to enhance operations.
  7. Speed and delay studies shall be conducted during each of the count periods along the system corridor in the field before and after implementation of the proposed timing plans for comparative evaluations. These studies should utilize specialized electronic timing and measuring devices.
- (b) The following deliverables shall be provided for OPTIMIZE TRAFFIC SIGNAL SYSTEM.
1. Consultant shall furnish to MCDOT one (1) copy of a SCAT Report for the optimized system. The SCAT Report shall include the following elements:

<b>Cover Page in color showing a System Map</b>
<b>Figures</b> <ol style="list-style-type: none"> <li>1. System overview map – showing system number, system schematic map with numbered system detectors, oversaturated movements, master location, system phone number, cycle lengths, and date of completion.</li> <li>2. General location map in color – showing signal system location in the metropolitan area.</li> <li>3. Detail system location map in color – showing cross street names and local controller addresses.</li> <li>4. Controller sequence – showing controller phase sequence diagrams.</li> </ol>
<b>Table of Contents</b>
<b>Tab 1: Final Report</b> <ol style="list-style-type: none"> <li>1. Project Overview</li> <li>2. System and Location Description (Project specific)</li> <li>3. Methodology</li> <li>4. Data Collection</li> <li>5. Data Analysis and Timing Plan Development</li> <li>6. Implementation           <ol style="list-style-type: none"> <li>a. Traffic Responsive Programming (Table of TRP vs. TOD Operation)</li> </ol> </li> <li>7. Evaluation           <ol style="list-style-type: none"> <li>a. Speed and Delay runs</li> </ol> </li> </ol>
<b>Tab 2. Turning Movement Counts</b> <ol style="list-style-type: none"> <li>1. Turning Movement Counts (Showing turning movement counts in the intersection diagram for each period, including truck percentage)</li> </ol>
<b>Tab 3. Synchro Analysis</b> <ol style="list-style-type: none"> <li>1. AM: Time-Space diagram in color, followed by intersection Synchro report (Timing report) summarizing the implemented timings.</li> <li>2. Midday: same as AM</li> <li>3. PM: same as AM</li> </ol>
<b>Tab 4: Speed, Delay Studies</b> <ol style="list-style-type: none"> <li>1. Summary of before and after runs results in two (2) tables showing travel time and delay time.</li> <li>2. Plot of the before and after runs diagram for each direction and time period.</li> </ol>
<b>Tab 5: Environmental Report</b> <ol style="list-style-type: none"> <li>1. Environmental impact report including gas consumption, NO2, HCCO, improvements.</li> </ol>
<b>Tab 6: Electronic Files</b> <ol style="list-style-type: none"> <li>1. Two (2) CDs for the optimized system. The CDs shall include the following elements:           <ol style="list-style-type: none"> <li>a. Electronic copy of the SCAT Report in PDF format</li> <li>b. Copies of the Synchro files for the optimized system</li> <li>c. Traffic counts for the optimized system</li> </ol> </li> </ol>

- d. New or updated intersection graphic display files for each of the system intersections and the system graphic display file including system detector locations and addresses.

Basis of Payment.

The work shall be paid for at the contract unit each for OPTIMIZE TRAFFIC SIGNAL SYSTEM, which price shall be payment in full for performing all work described herein for the entire traffic signal system. Following the completion of traffic counts, 25 percent of the bid price will be paid. Following the completion of the Synchro analysis, 25 percent of the bid price will be paid. Following the setup and fine tuning of the timings, the speed-delay study, and the TRP programming, 25 percent of the bid price will be paid. The remaining 25 percent will be paid when the system is working to the satisfaction of the engineer and the report and CD have been submitted.

**TEMPORARY TRAFFIC SIGNAL TIMING**

Description.

This work shall consist of developing and maintaining appropriate traffic signal timings for the specified intersection for the duration of the temporary signalized condition.

All timings and adjustments necessary for this work shall be performed by an approved Consultant who has previous experience in optimizing Closed Loop Traffic signal Systems for District One of the Illinois Department of Transportation. The Contractor shall contact the Traffic Signal Engineer at (815) 334-4960 for a listing of approved Consultants.

The following tasks are associated with TEMPORARY TRAFFIC SIGNAL TIMING.

- (a) Consultant shall attend temporary traffic signal inspection (turn-on) and conduct on-site implementation of the traffic signal timings. Make fine-tuning adjustments to the timings in the field to alleviate observed adverse operating conditions and to enhance operations.
- (b) Consultant shall provide monthly observation of traffic signal operations in the field.
- (c) Consultant shall provide on-site consultation and adjust timings as necessary for construction stage changes, temporary traffic signal phase changes, and any other conditions affecting timing and phasing, including lane closures, detours, and other construction activities.
- (d) Consultant shall make timing adjustments and prepare comment responses as directed by the Area Traffic Signal Engineer.

Basis of Payment.

The work shall be paid for at the contract unit price each for TEMPORARY TRAFFIC SIGNAL TIMING, which price shall be payment in full for performing all work described herein per intersection. When the temporary traffic signal installation is turned on, 50 percent of the bid price will be paid. The remaining 50 percent of the bid price will be paid following the removal of the temporary traffic signal installation.

**MODIFYING EXISTING CONTROLLER CABINET.**

The work shall consist of modifying an existing controller cabinet as follows:

- (a) Uninterruptible Power Supply (UPS). The addition of uninterruptible power supply (UPS) to an existing controller cabinet could require the relocation of the existing controller cabinet items to allow for the installation of the uninterruptible power supply (UPS) components inside the existing controller cabinet as outlined under Sections 862 and 1074.04 of the Standard Specifications.
- (b) Light Emitting Diode (LED) Signal Heads, Light Emitting Diode (LED) Optically Programmed Signal Heads and Light Emitting Diode (LED) Pedestrian Signal Heads. The contractor shall verify that the existing load switches meet the requirements of Section 1074.03(5)(b)(2) of the Standard Specifications and the recommended load requirements of the light emitting diode (LED) signal heads that are being installed at the existing traffic signal. If any of the existing load switches do not meet these requirements, they shall be replaced, as directed by the Engineer.
- (c) Light Emitting Diode (LED), Signal Head, Retrofit. The contractor shall verify that the existing load switches meet the requirements of Section 1074.03(2) of the Standard Specifications and the recommended load requirements of light emitting diode (LED) traffic signal modules, pedestrian signal modules, and pedestrian countdown signal modules as specified in the plans. If any of the existing load switches do not meet these requirements, they shall be replaced, as directed by the Engineer.

Basis of Payment.

Modifying an existing controller cabinet will be paid for at the contract unit price per each for MODIFY EXISTING CONTROLLER CABINET. This shall include all material and labor required to complete the work as described above, the removal and disposal of all items removed from the controller cabinet, as directed by the Engineer. The equipment for the Uninterruptible Power Supply (UPS) and labor to install it in the existing controller cabinet shall be included in the pay item Uninterruptible Power Supply. Modifying an existing controller will be paid for at the contract unit price per each for MODIFY EXISTING CONTROLLER, per Sections 895.04 and 895.08 of the Standard Specifications.

## **DIVISION 1000 MATERIALS**

### **PEDESTRIAN PUSH-BUTTON.**

Revise Article 1074.02(a) of the Standard Specifications to read:

The pedestrian push-button housing shall be constructed of aluminum alloy according to ASTM B 308 6061-T6 and shall be unfinished (not painted), unless otherwise noted on the plans. The housing shall be furnished with suitable mounting hardware.

All push buttons shall be mechanical buttons. Latching buttons with LED indicators are not accepted by the Department.

Revise Article 1074-02(e) of the Standard Specifications to read:

Stations shall be designed to be mounted directly to a post, mast arm pole or wood pole. The station shall be aluminum and shall accept a 3 inch (75mm) round push-button assembly and a regulatory pedestrian instruction sign according to MUTCD, sign series R10-3 9 x 12 inch sign with arrow(s) for a count-down pedestrian signal. The pedestrian station size without count-down pedestrian signals shall accommodate a MUTCD sign series R10-3 9 x 12 inch sign with arrow(s).

Add the following to Article 1074.02(a) of the Standard Specifications:

- (f) Location. Pedestrian push-buttons and stations shall be mounted directly to a post, mast arm pole or wood pole as shown on the plans and shall be fully accessible from a paved or concrete surface. See the District's Detail sheets for orientation and mounting details.

### **CONTROLLER CABINET AND PERIPHERAL EQUIPMENT.**

Revise Section 1074.03 of the Standard Specifications to read:

Add the following to Article 1074.03 of the Standard Specifications:

- (a) Cabinets shall be designed for NEMA TS2 Type 1 operation. All cabinets shall be pre-wired for a minimum of eight (8) phases of vehicular, four (4) phases of pedestrian and four (4) phases of overlap operation.
- (b)(5) Cabinets – Provide 1/8" (3.2 mm) thick unpainted aluminum alloy 5052-H32. The surface shall be smooth, free of marks and scratches. All external hardware shall be stainless steel. All seams/corners on the cabinet shall be welded.

- (b) (6) Controller Harness – Provide a TS2 Type 2 “A” wired harness in addition to the TS2 Type 1 harness.
- (b) (7) Surge Protection – ASC Zone IT (50 kA rating) with LED status indicators. Model 91391 Zone IT base station and Model 91375 Zone IT ASC model.
- (b) (8) BIU – Containment screw required.
- (b) (9) Transfer Relays – Solid state or mechanical flash relays are acceptable.
- (b) (10) Switch Guards – All switches shall be guarded.
- (b) (11) Heating – Electric heaters (2 total), Hoffman model DAH2001A located in upper left and lower right corners of cabinet, controlled by a thermostat on the heater itself.
- (b) (12) Lighting – One (1) LED Panel shall be placed inside the cabinet top panel and one (1) LED Panel shall be placed on each side of the pull-out drawer/shelf assembly located beneath the controller support shelf. The LED Panels shall be controlled by a wall switch. Relume Traffic Control Box LED Panels and power supply.
- (b) (13) The cabinet shall be equipped with a pull-out drawer/shelf assembly. A 1 ½ inch (38mm) deep drawer shall be provided in the cabinet, mounted directly beneath the controller support shelf. The drawer shall have a hinged top cover and shall be capable of accommodating one (1) complete set of cabinet prints and manuals. This drawer shall support 50 lbs. (23 kg) in weight when fully extended. The drawer shall open and close smoothly. Drawer dimensions shall make maximum use of available depth offered by the controller shelf and be a minimum of 24 inches (610mm) wide.
- (b) (14) Plan & Wiring Diagrams – 12” x 16” (3.05mm x 4.06mm) moisture sealed container attached to door.
- (b) (15) Detector Racks – Fully wired and labeled for four (4) channels of emergency vehicle pre-emption and sixteen channels (16) of vehicular operation.
- (b) (16) Field Wiring Labels – All field wiring shall be labeled.
- (b) (17) Field Wiring Termination – Approved channel lugs required.
- (b) (18) Power Panel – Provide a nonconductive shield.
- (b) (19) Circuit Breaker – The circuit breaker shall be sized for the proposed load but shall not be rated less than 30 amps.
- (b) (20) Police Door – Provide wiring and termination for plug in manual phase advance switch.
- (b) (21) Railroad Pre-Emption Test Switch – Eaton 8830K13 SHA 1250.
- (b) (22) Malfunction Management Unit (MMU) – The MMU supplied shall have a Liquid Crystal Display (LCD) and also have an Ethernet communications port.
- (b) (23) Load Switch – All load switches shall have both input and output LED controller status indicators.



**RAILROAD, FULL-ACTUATED CONTROLLER AND CABINET.**

Controller shall comply with Article 1073.01 as amended in these Traffic Signal Special Provisions.

Controller Cabinet and Peripheral Equipment shall comply with Article 1074.03 as amended in these Traffic Signal Special Provisions.

Add the following to Articles 1073.01 (c) (2) and 1074.03 (a) (5) (e) of the Standard Specifications:

Controllers and cabinets shall be new and NEMA TS2 Type 1 design.

A method of monitoring and/or providing redundancy to the railroad preemptor input to the controller shall be included as a component of the Railroad, Full Actuated Controller and Cabinet installation and be verified by the traffic signal equipment supplier prior to installation.

Railroad interconnected controllers and cabinets shall be assembled only by an approved traffic signal equipment supplier. The equipment shall be tested and approved in the equipment supplier's District One facility prior to field installation.

**UNINTERRUPTIBLE POWER SUPPLY (UPS)**

Revise Article 1074.04(a)(1) of the Standard Specifications to read:

The UPS shall be an on-line, double conversion system only and provide voltage regulation and power conditioning when utilizing utility power. The UPS shall be sized appropriately for the intersection's normal traffic signal operating connected load, plus 20 percent (20%). The total connected traffic signal load shall not exceed the published ratings for the UPS. The UPS shall provide a minimum of six (3) hours of normal operation run-time for signalized intersections with LED type signal head optics at 77 °F (25 °C) (minimum 700 W/1000 VA active output capacity, with 90 percent minimum inverter efficiency).

Revise the first paragraph of Article 1074.04(a)(3) of the Standard Specifications to read:

The UPS shall have a minimum of four (4) sets of normally open (NO) and normally closed (NC) single-pole double-throw (SPDT) relay contact closures, available on a panel mounted terminal block or locking circular connectors, rated at a minimum 120 V/1 A, and labeled so as to identify each contact according to the plans.

Revise Article 1074.04(a)(10) of the Standard Specifications to read:

The UPS shall be compatible with the District's approved traffic controller assemblies utilizing NEMA TS 1 or NEMA TS 2 controllers and cabinet components for full time operation.

Revise Article 1074.04(a)(17) of the Standard Specifications to read:

When the intersection is in battery backup mode, the UPS shall bypass all internal cabinet lights, ventilation fans, cabinet heaters, service receptacles, any lighted street name signs, any automated enforcement equipment and any other devices directed by the Engineer.

Revise Article 1074.04(b)(2)b of the Standard Specifications to read:

Batteries, inverter/charger and power transfer relay shall be housed in a separate NEMA Type 3R cabinet. The cabinet shall be Aluminum alloy, 5052-H32, 0.125-inch thick and have a natural mill finish.

Revise Article 1074.04(b)(2)c of the Standard Specifications to read:

No more than three batteries shall be mounted on individual shelves for a cabinet housing six batteries and no more than four batteries per shelf for a cabinet housing eight batteries.

Revise Article 1074.04(b)(2)e of the Standard Specifications to read:

The cabinet shall be a California Chassis aluminum cabinet, Part Number FCU104013, with a natural aluminum mill finish.

The external cabinet dimensions shall be 41 inches tall by 25 inches wide by 16 inches deep, excluding the door. Shelf clearance shall be a minimum of 10 inches. The cabinet shall house all batteries, the UPS, the Bypass Switch, and the wiring harnesses.

When installed, the cabinet for the UPS shall rest on the traffic signal cabinet foundation and shall also be secured to the right side of the traffic signal cabinet.

A blue LED indicator light shall be mounted on the side of the UPS cabinet facing traffic and shall turn on to indicate when cabinet power has been disrupted and the UPS is in operation. The light shall be a minimum of 1" in diameter, be viewable from the driving lanes, and shall be large enough and visible enough to be seen from 200 feet away.

The cabinet shall provide an external connection for an AC generator to power the signals, if necessary, during an extended utility power outage. The external connection shall be a NEMA Style 5-15 male flanged receptacle. A police door shall provided in the upper half of the main door end encompasses the full area of the outlet panel. This shall be location of the outlet to supply an external connection for an AC generator listed above. The standard dimensions of the panel are 7½" high, 12" wide and 2½" deep and are located directly behind the police door. A skeleton lock by Corbin is furnished for the police door unless otherwise specified.

## UPS

End of paragraph 1074.04(b) (2)e

The door shall be equipped with a two position doorstop, one a 90 degree and one at 120 degree.

Revise Article 1074.04(b)(2)g of the Standard Specifications to read:

The door shall open to the entire cabinet, have a neoprene gasket, an Aluminum continuous piano hinge with stainless steel pin, and a three point locking system. The cabinet shall be provided with a main door lock which shall operate with a traffic industry conventional No. 2 key. Provisions for padlocking the door shall be provided.

Add the following to Article 1074.04(b)(2) of the Standard Specifications:

- j. The battery cabinet shall have provisions for an external generator connection.

Add the following to Article 1074.04(c) of the Standard Specifications:

- (8) The UPS shall include a tip or kill switch installed in the battery cabinet, which shall completely disconnect power from the UPS when the switch is manually activated.
- (9) The UPS shall incorporate a flanged electric generator inlet for charging the batteries and operating the UPS. The generator connector shall be male type, twist-lock, rated as 15A, 125VAC with a NEMA L5-15P configuration and weatherproof lift cover plate (Hubbell model HBL4716C). Access to the generator inlet shall be from a secured weatherproof lift cover plate or behind a locked battery cabinet police panel.

## Battery System.

Revise Article 1074.04(d)(3) of the Standard Specifications to read:

All batteries supplied in the UPS shall be either gel cell or AGM type, deep cycle, completely sealed, prismatic leadcalcium based, silver alloy, valve regulated lead acid (VRLA) requiring no maintenance. All batteries in a UPS installation shall be the same type; mixing of gel cell and AGM types within a UPS installation is not permitted.

Revise Article 1074.04(d)(4) of the Standard Specifications to read:

Batteries shall be certified by the manufacturer to operate over a temperature range of -13 to 160 °F (-25 to + 71 °C) for gel cell batteries and -40 to 140 °F (-40 to + 60 °C) for AGM type batteries.

Add the following to Article 1074.04(d) of the Standard Specifications:

- (9) The UPS shall consist of a number of batteries that match the voltage requirements of the entire string of batteries per manufacturer, (i.e. 36 volt/3 batteries, 72 volt/6 batteries) that are capable of maintaining normal operation of the signalized intersection for a minimum of three hours. Calculations shall be provided showing the number of batteries of the type supplied that are needed to satisfy this requirement. A minimum of three batteries shall be provided.

Add the following to the Article 1074.04 of the Standard Specifications:

- (e) Warranty. The warranty for an uninterruptible power supply (UPS) shall cover a minimum of two years from date the equipment is placed in operation; however, the batteries of the UPS shall be warranted for full replacement for a minimum of five years from the date the traffic signal and UPS are placed into service.

#### **ELECTRIC CABLE.**

Delete “or stranded, and No. 12 or” from the last sentence of Section 1076.04 (a) of the Standard Specifications.

Add the following to the Article 1076.04(d) of the Standard Specifications:

Service cable may be single or multiple conductor cable.

#### **TRAFFIC SIGNAL POST.**

Add the following to Section 1077.03 (b) of the Standard Specifications:

All posts and bases shall be steel and hot dipped galvanized. If the Department approves painting, powder coating by the manufacturer will be required over the galvanization in accordance with TRAFFIC SIGNAL PAINTING in Division 800 of these specifications.

#### **PEDESTRIAN PUSH-BUTTON POST.**

Add the following to Article 1077.02(b) of the Standard Specifications:

All posts and bases shall be steel and hot-dipped galvanized. If the Department approves painting, powder coating by the manufacturer will be required over the galvanization in accordance with Traffic Signal Painting in Division 800 of these specifications.

### **MAST ARM ASSEMBLY AND POLE.**

Add the following to Section 1077.03 (a) of the Standard Specifications:

Traffic signal mast arms shall be one piece construction, unless otherwise approved by the Engineer. All poles shall be galvanized. If the Department approves painting, powder coating by the manufacturer will be required over the galvanization in accordance with with TRAFFIC SIGNAL PAINTING in Division 800 of these specifications.

The shroud shall be of sufficient strength to deter pedestrian and vehicular damage. The shroud shall be constructed and designed to allow air to circulate throughout the mast arm but not allow infestation of insects or other animals, and such that it is not hazardous to probing fingers and feet. All mounting hardware shall be stainless steel.

### **LIGHT EMITTING DIODE (LED) TRAFFIC SIGNAL HEAD.**

Add the following to Section 1078 of the Standard Specifications to read:

1. All signal and pedestrian heads shall provide 12" (300 mm) displays with glossy **yellow** polycarbonate housings. All head housings shall be the same color (**yellow**) at the intersection. For new signalized intersections and existing signalized intersections where all signal and/or pedestrian heads are being replaced, the proposed head housings shall be **yellow**. Where only selected heads are being replaced, the proposed head housing color (**yellow**) shall match existing head housings. Connecting hardware and mounting brackets shall be polycarbonate (black). A corrosive resistant anti-seize lubricant shall be applied to all metallic mounting bracket joints, and shall be visible to the inspector at the signal turn-on. Post top mounting collars are required on all posts, and shall be constructed of the same material as the brackets.
2. All signal heads shall have a "baseball" cap visor for each section. Tunnel visors shall not be accepted. All cap visors shall be black polycarbonate.
3. Pedestrian signal heads shall be furnished with the international symbolic "Walking Person" and "Upraised Palm" lenses. Egg crate sun shields are not permitted.
4. Signal heads shall be positioned according to the "McHenry County Signal Design Guidelines."
5. LED signal heads (All Face and Section Quantities), (All Mounting Types) shall conform fully to the requirements of Articles 1078.01 and 1078.02 of the Standard Specifications amended herein.

6. The LED signal modules shall be replaced or repaired if an LED signal module fails to function as intended due to workmanship or material defects within the first **72 months** from the date of delivery. LED signal modules which exhibit luminous intensities less than the minimum values specified in Table 1 of the ITE Vehicle Traffic Control Signal Heads: Light Emitting Diode (LED) Circular Signal Supplement (June 27, 2005) [VTSCH] or show signs of entrance of moisture or contaminants within the first **72 months** of the date of delivery shall be replaced or repaired. The manufacturer's written warranty for the LED signal modules shall be dated, signed by an Officer of the company and included in the product submittal to the Department.

(a) Physical and Mechanical Requirements

1. Modules can be manufactured under this specification for the following faces:
  - a. 12 inch (300 mm) circular, multi-section
  - b. 12 inch (300 mm) arrow, multi-section
  - c. 12 inch (300 mm) pedestrian, 2 sections
2. The maximum weight of a module shall be 4 lbs. (1.8 kg).
3. Each module shall be a sealed unit to include all parts necessary for operation (a printed circuit board, power supply, a lens and gasket, etc.), and shall be weather proof after installation and connection.
4. Material used for the lens and signal module construction shall conform to ASTM specifications for the materials.
5. The lens of the module shall be tinted with a wavelength-matched color to reduce sun phantom effect and enhance on/off contrast. The tinting shall be uniform across the lens face. Polymeric lens shall provide a surface coating or chemical surface treatment applied to provide abrasion resistance. The lens of the module shall be integral to the unit, convex with a smooth outer surface and made of plastic. The lens shall have a textured surface to reduce glare.
6. The use of tinting or other materials to enhance ON/OFF contrasts shall not affect chromaticity and shall be uniform across the face of the lens.
7. Each module shall have a symbol of the type of module (i.e. circle, arrow, etc.) in the color of the module. The symbol shall be 1 inch (25.4 mm) in diameter. Additionally, the color shall be written out in 1/2 inch (12.7mm) letters next to the symbol.

(b) Photometric Requirements

1. The minimum initial luminous intensity values for the modules shall conform to the values in Table 1 of the VTCSH (2005) for circular signal indications, and as stated in Table 3 of these specifications for arrow and pedestrian indications at 25°C.
2. The modules shall meet or exceed the illumination values stated in Article 1078.01(3)c of the "Standard Specifications for Road and Bridge Construction," Adopted January 1, 2007 for circular signal indications, and Table 3 of these specifications for arrow and pedestrian indications, throughout the useful life based on normal use in a traffic signal operation over the operating temperature range.
3. The measured chromaticity coordinates of the modules shall conform to the chromaticity requirements of Section 4.2 of the VTCSH (2005).
4. The LEDs utilized in the modules shall be AlInGaP technology for red and Portland orange (pedestrian) and InGaN for green, amber and white (pedestrian) indications, and shall be the ultra bright type rated for 100,000 hours of continuous operation from -40°C to +74°C.

(c) Electrical

1. Maximum power consumption for LED modules is per Table 2.
2. Operating voltage of the modules shall be 120 VAC. All parameters shall be measured at this voltage.
3. The modules shall be operationally compatible with currently used controller assemblies (solid state load switches, flashers, and conflict monitors).
4. When a current of 20 mA AC (or less) is applied to the unit, the voltage read across the two leads shall be 15 VAC or less.
5. The LED modules shall provide constant light output under power. Modules with dimming capabilities shall have the option disabled or set on a non-dimming operation.
6. LED arrows shall be wired such that a catastrophic loss or the failure of one or more LED will not result in the loss of the entire module.

(d) Retrofit Traffic Signal Module

1. The following specification requirements apply to the Retrofit module only. All general specifications apply unless specifically superseded in this section.

2. Retrofit modules can be manufactured under this specification for the following faces:
    - a. 12 inch (300 mm) circular, multi-section
    - b. 12 inch (300 mm) arrow, multi-section
    - c. 12 inch (300 mm) pedestrian, 2 sections
  3. Each Retrofit module shall be designed to be installed in the doorframe of a standard traffic signal housing. The Retrofit module shall be sealed in the doorframe with a one-piece EPDM (ethylene propylene rubber) gasket.
  4. The maximum weight of a Retrofit module shall be 4 lbs. (1.8 kg).
  5. Each Retrofit module shall be a sealed unit to include all parts necessary for operation (a printed circuit board, power supply, a lens and gasket, etc.), and shall be weather proof after installation and connection.
  6. Electrical conductors for modules, including Retrofit modules, shall be 39.4 inches (1m) in length, with quick disconnect terminals attached.
  7. The lens of the Retrofit module shall be integral to the unit, shall be convex with a smooth outer surface and made of plastic or of glass.
- (e) The following specification requirements apply to the 12 inch (300 mm) arrow module only. All general specifications apply unless specifically superseded in this section.
1. The arrow module shall meet specifications stated in VTCSH-ITE 2004 or applicable successor.
  2. The LEDs arrow indication shall be a solid display with a minimum of three (3) outlining rows of LEDs and at least one (1) fill row of LEDs.
- (f) The following specification requirement applies to the 12 inch (300 mm) programmed visibility (PV) module only. All general specifications apply unless specifically superseded in this section.
1. The LED module shall be a module designed and constructed to be installed in a programmed visibility (PV) signal housing without modification to the housing.
- (g) The following specification requirements apply to the 12 inch (300 mm) Pedestrian module only. All general specifications apply unless specifically superseded in this section.
1. Each pedestrian signal LED module shall provide the ability to actuate the solid upraised hand and the solid walking person on one 12 inch (300mm) section.



2. Two (2) pedestrian sections shall be installed. The top section shall be wired to illuminate only the upraised hand and the bottom section shall be the walking man.
3. "Egg Crate" type sun shields are not permitted. All figures must be a minimum of 9 inches (225mm) in height and easily identified from a distance of 120-feet (36.6m).

### **LIGHT EMITTING DIODE (LED) PEDESTRIAN COUNTDOWN SIGNAL HEAD.**

Add the following to Article 1078.02 of the Standard Specifications:

#### General.

1. The module shall operate in one mode: Clearance Cycle Countdown Mode Only. The countdown module shall display actual controller programmed clearance cycle and shall start counting when the flashing clearance signal turns on and shall countdown to "0" and turn off when the steady Upraised Hand (symbolizing Don't Walk) signal turns on. Module shall not have user accessible switches or controls for modification of cycle.
2. At power on, the module shall enter a single automatic learning cycle. During the automatic learning cycle, the countdown display shall remain dark.
3. The module shall re-program itself if it detects any increase or decrease of Pedestrian Timing. The counting unit will go blank once a change is detected and then take one complete pedestrian cycle (with no counter during this cycle) to adjust its buffer timer.
4. The module shall allow for consecutive cycles without displaying the steady Upraised Hand.
5. The module shall recognize preemption events and temporarily modify the crossing cycle accordingly.
6. If the controller preempts during the Walking Person (symbolizing Walk), the countdown will follow the controller's directions and will adjust from Walking Person to flashing Upraised Hand. It will start to count down during the flashing Upraised Hand.
7. If the controller preempts during the flashing Upraised Hand, the countdown will continue to count down without interruption.
8. The next cycle, following the preemption event, shall use the correct, initially programmed values.

9. If the controller output displays Upraised Hand steady condition and the unit has not arrived to zero or if both the Upraised Hand and Walking Person are dark for some reason, the unit suspends any timing and the digits will go dark.
10. The digits will go dark for one pedestrian cycle after loss of power of more than 1.5 seconds.
11. The countdown numerals shall be two (2) “7 segment” digits forming the time display utilizing two rows of LEDs.
12. The LED module shall meet the requirements of the Institute of Transportation Engineers (ITE) LED purchase specification, “Pedestrian Traffic Control Signal Indications - Part 2: LED Pedestrian Traffic Signal Modules,” or applicable successor ITE specifications, except as modified herein.
13. The LED modules shall provide constant light output under power. Modules with dimming capabilities shall have the option disabled or set on a non-dimming operation.
14. In the event of a power outage, light output from the LED modules shall cease instantaneously.
15. The LEDs utilized in the modules shall be AlInGaP technology for Portland Orange (Countdown Numerals and Upraised Hand) and InGaN technology for Lunar White (Walking Person) indications.
16. The individual LEDs shall be wired such that a catastrophic loss or the failure of one or more LED will not result in the loss of the entire module.

#### Electrical.

1. Maximum power consumption for LED modules is 29 watts.
2. The measured chromaticity shall remain unchanged over the input line voltage range listed of 80 VAC to 135 VAC.

#### **TRAFFIC SIGNAL BACKPLATE.**

Delete second sentence of the fourth paragraph of Article 1078.03 f the Standard Specifications.

Add the following to the fourth paragraph of Article 1078.03 of the Standard Specifications:

When retro reflective sheeting is specified, it shall be Type ZZ sheeting according to Article 1091.03 and applied in preferred orientation for the maximum angularity according to the manufacturer's recommendations. The retro reflective sheeting shall be installed under a controlled environment at the manufacturer/supplier before shipment to the contractor. The aluminum backplate shall be prepared and cleaned, following recommendations of the retro reflective sheeting manufacturer.

### **INDUCTIVE LOOP DETECTOR.**

Add the following to Section 1079.01 of the Standard Specifications:

Contracts requiring new cabinets shall provide for card mounted detector amplifiers. Loop amplifiers shall provide LCD displays with loop frequency, inductance, and change of inductance readings.

### **ILLUMINATED SIGN, LIGHT EMITTING DIODE.**

Delete last sentence of Article 1084.01(a) and add "Mounting hardware shall be black polycarbonate or galvanized steel and similar to mounting Signal Head hardware and brackets specified herein and shall provide tool free access to the interior.

Add the following to Article 1084.01 (b) of the Standard Specifications:

The message shall be formed by rows of LEDs. The sign face shall be 24 inches (600 mm) by 24 inches (600 mm).

Add the following to Article 1084.01 of the Standard Specifications:

(e) The light emitting diode (LED) blank out signs shall be manufactured by National Sign & Signal Company, and consist of a weatherproof housing and door, LEDs and transformers.

### **ILLUMINATED STREET NAME SIGN.**

The illuminate street name sign shall be as follows.

(a) Description.

The LEDs shall be white in color and utilize InGaN or UV thermally efficient technology. The LED Light Engines shall be designed to fit inside a standard fluorescent illuminated street sign housing in lieu of fluorescent lamps and ballasts or a slim line type housing. The LED internally-illuminated street name sign shall display the designated street name clearly

and legibly in the daylight hours without being energized and at night when energized. The sign assemblies are generally available in four-, six-, or eight-foot lengths but are also available in 6 inch increments. White translucent 3M DG<sup>3</sup> reflective sheeting sign faces with the street name applied in 3M/Scotchlite Series 1177 transparent green shall be installed in hinged doors on the side of the sign for easy access to perform general cleaning and maintenance operations. Illumination shall occur with LED Light Engine as specified.

(b) Environmental Requirements.

The LED lamp shall be rated for use in the ambient operating temperature range of -40 to +50°C (-40 to +122°F) for storage in the ambient temperature range of -40 to +75°C (-40 to +167°F).

(c) General Construction.

1. The LED Light Engine shall be a single, self-contained device, for installation in an existing street sign housing. The power supply must be designed to fit and mounted on the inside wall at one end of the street sign housing. The LED Light Engine shall be mounted within the inner top portion of the housing and no components of the light source shall sit between the sign faces.
2. The assembly and manufacturing processes of the LED Light Engine shall be designed to ensure that all LED and electronic components are adequately supported to withstand mechanical shocks and vibrations in compliance with the specifications of the ANSI, C136.31-2001 standards.
3. The Manufacturer/Vendor shall supply shop drawings of the fixtures, sign, sign message and mounting hardware for approval. All hardware used to install the sign shall be in accordance with the manufacturer's recommendations.

(d) Mechanical Construction.

1. The sign shall be constructed using a weatherproof, aluminum housing consisting of an extruded aluminum top with a minimum thickness of .140" x 10 3/4" deep (including the drip edge). The extruded aluminum bottom is .094" thick x 5 7/8" deep. The ends of the housing shall be cast aluminum with a minimum thickness of .250". A six-foot sign shall be 72 5/8" long and 22 5/16" tall and not weigh more than 77 pounds. An eight-foot sign shall be 96 5/8" long and 22 5/16" tall and not weigh more than 92 pounds. All corners are continuous TIG (Tungsten Inert Gas) welded to provide a weatherproof seal around the entire housing.
2. The door shall be constructed of extruded aluminum. Two corners are continuous TIG welded with the other two screwed together to make one side of the door removable for installation of the sign face. The door is fastened to the housing on the bottom by a full length, .040" x 1 1/8" open stainless steel hinge. The door shall be held secure onto a 1" wide by 5/32" thick neoprene gasket by three (six total for two-way sign) quarter-turn fasteners to form a watertight seal between the door and the housing.

3. The sign face shall be constructed of .125" white translucent polycarbonate. The letters shall be 8" upper case and 6" lower case. The sign face legend background shall consist of 3M/Scotchlite Series 4090T 3M translucent diamond grade DG<sup>3</sup> white and 3M/Scotchlite Series 1177 transparent green acrylic EC (electronic cut-able) film applied to the front of the sign face. The legend shall be framed by a white polycarbonate border.
4. All fasteners and hardware shall be corrosion resistant stainless steel. No tools are required for routine maintenance.
5. All wiring shall be secured by insulated wire compression nuts.
6. A wire entrance junction box shall be supplied with the sign assembly. The box may be supplied mounted to the exterior or interior of the sign and provide a weather tight seal.
7. Each sign shall be activated by the same photocell/power panel mounted/installed inside the traffic signal cabinet on the left side of the cabinet when facing into the cabinet. All signs shall be wired to the same power panel with lighting contactor sized for the power consumption of the LED signs. The photo-cell shall be mounted above the door and under the lip of the signal cabinet on the left side of the cabinet.
8. Brackets and Mounting: LED internally-illuminated street name signs will be factory drilled to accommodate mast arm two-point support assembly mounting brackets.

(e) Electrical.

1. Photocell shall be rated 105-305V, turn on at 1.5 fcs. with a 3-5 second delay. A manufacturer's warranty of six (6) years shall be provided. Power consumption shall be no greater than 1 watt at 120V.
2. The LED Light Engine shall operate from a 60 +/- 3 cycle AC line power over a voltage range of 80 to 135 Vac rms. Fluctuations in line voltage over the range of 80 to 135 Vac shall not affect luminous intensity by more than +/- 10%.
3. Total harmonic distortion induced into the AC power line by the LED Light Engine, operated at a nominal operating voltage, and at a temperature of +25°C (+77°F), shall not exceed 20%.
4. The LED Light Engine shall cycled ON and OFF with a photocell as shown on the detail sheet and shall not exceed the following maximum power values:

4-Foot Sign	60 W max
6-Foot Sign or less	90 W max
8-Foot Sign or less	120 W

	max
--	-----

The signs shall not be energized when traffic signals are powered by an alternate energy source such as a generator or uninterruptable power source (UPS). The signs shall be connected to the generator or UPS bypass circuitry.

(f) Photometric Requirements.

1. The entire surface of the sign panel shall be evenly illuminated. The average maintained luminous intensity measured across the letters, operating under the conditions defined in Environmental Requirements and Wattage Sections shall be of a minimum value of 100 cd/m<sup>2</sup>.
2. The manufacturer shall make available independent laboratory test results to verify compliance to Voltage Range and Luminous Intensity Distribution Sections.
3. Twelve (12) 1.25 watt LED units shall be mounted on 1-inch x 22-inch metal cone printed circuit boards (MCPCB). The viewing angle shall be 120 degrees. LED shall have a color temperature of 5200k nominal, CRI of 80 with a life expectancy of 75,000 hrs.

(g) Quality Assurance.

The LED Light Engine shall be manufactured in accordance with a vendor quality assurance (QA) program. The production QA shall include statistically controlled routine tests to ensure minimum performance levels of the LED Light Engine build to meet this specification. QA process and test result documentations shall be kept on file for a minimum period of seven (7) years. The LED Light Engine that does not satisfy the production QA testing performance requirements shall not be labeled, advertised, or sold as conforming to these specifications. Each LED Light Engine shall be identified by a manufacturer's serial number for warranty purposes. LED Light Engines shall be replaced or repaired if they fail to function as intended due to workmanship or material defects within the first sixty (60) months from the date of acceptance. LED Light Engines that exhibit luminous intensities less than the minimum value specified in Photometric Section within the first thirty-six (36) months from the date of acceptance shall be replaced or repaired.

**FULL-ACTUATED CONTROLLER AND TYPE IV CABINET, SPECIAL.**

This work shall consist of furnishing and installing an "Econolite" brand traffic actuated solid state digital controller ASC3-1000 or ASC3-2100 as specified in the plans in a NEMA TS2 Type 1 controller cabinet, meeting the requirements of the Standard Specifications Section 857 and the included Traffic Signal Specifications.

Basis of Payment: This work shall be paid for at the contract unit price each for FULL-ACTUATED CONTROLLER AND CABINET (SPECIAL) of the type specified, which shall be payment in full for furnishing and installing the controller complete including conflict monitor, load switches and flasher relays, with necessary connections for proper operation.

The type specified will indicate the type of cabinet. For example, FULL-ACTUATED CONTROLLER AND TYPE IV CABINET (SPECIAL).

### **ELECTRIC CABLE IN CONDUIT, SIGNAL, NO. 18, 3/C**

This work shall consist of furnishing and installing a Belden YR52311 electric cable, in existing and/or new conduit. The cable shall consist of 18 AWG stranded bare copper, three (3) conductors, with HDPE insulation, and HDPE jacket and shall be capable of broadband over power communication. The nominal outside diameter shall be 0.341-inch.

The signal cable, No. 18, 3/C shall be run directly from the Autoscope Terra Interface Panel (TIP) to the Autoscope Terra MVP on the mast arm with no splicing of the cable allowed.

Basis of Payment: This work will be paid for at the contract unit price per foot for ELECTRIC CABLE IN CONDUIT, SIGNAL NO. 18, 3/C, which price shall be payment in full for furnishing, installing and making all electrical connections necessary for proper operation.

### **VIDEO DETECTION SYSTEM, (COMPLETE INTERSECTION).**

#### **1. Video Detection – General**

This specification sets forth the minimum requirements for a system that monitors vehicles on a roadway via processing of video images. The detection of vehicles passing through the field-of-view of an image sensor shall be made available to a large variety of end user applications as simple contact closure outputs that reflect the current real-time detector or alarm states (on/off) or as summary traffic statistics that are reported locally or remotely. The contact closure outputs shall be provided to a traffic signal controller and comply with the National Electrical Manufacturers Association (NEMA) type C or D detector rack or 170 input file rack standards.

The system architecture shall fully support Ethernet networking of system components through a variety of industry standard and commercially available infrastructures that are used in the traffic industry. The data communications shall support direct connect, [modem,] and multi-drop interconnects. Simple, standard Ethernet wiring shall be supported to minimize overall system cost and improve reliability, utilizing existing infrastructure and ease of system installation and maintenance. Both streaming video and data communications shall optionally be interconnected

over long distances through fiber optic, microwave, or other commonly used digital communications transport configurations.

On the software application side of the network, the system shall be integrated through a client-server relationship. A communications server application shall provide the data communications interface between as few as one to as many as hundreds of Machine Vision Processor (MVP) sensors and a number of client applications. The client applications shall either be hosted on the same PC as the communications server or may be distributed over a local area network of PC's using the industry standard TCP/IP network protocol. Multiple client applications shall execute simultaneously on the same host or multiple hosts, depending on the network configuration. Additionally, a web-browser interface shall allow use of industry standard Internet web browsers to connect to MVP sensors for setup, maintenance, and playing digital streaming video.

### **1.1. System Hardware**

The machine vision system hardware shall consist of three components: 1) a color, 22x zoom, MVP sensor 2) a modular cabinet interface unit 3) a communication interface panel. Additionally, an optional personal computer (PC) shall host the server and client applications that are used to program and monitor the system components. The real-time performance shall be observed by viewing the video output from the sensor with overlaid flashing detectors to indicate the current detection state (on/off). The MVP sensor shall optionally store cumulative traffic statistics internally in non-volatile memory for later retrieval and analysis.

The MVP shall communicate to the modular cabinet interface unit via the communications interface panel and the software applications using the industry standard TCP/IP network protocol. The MVP shall have a built-in, Ethernet-ready, Internet Protocol (IP) address and shall be addressable with no plug in devices or converters required. The MVP shall provide standard MPEG-4 streaming digital video. Achievable frame rates shall vary from 5 to 30 frames/sec as a function of video quality and available bandwidth.

The modular cabinet interface unit shall communicate directly with up to eight (8) MVP sensors and shall comply with the form factor and electrical characteristics to plug directly into a NEMA type C or D detector rack providing up to thirty-two (32) inputs and sixty-four (64) outputs or a 170 input file rack providing up to sixteen (16) contact closure inputs and twenty-four (24) contact closure outputs to a traffic signal controller.

The communication interface panel shall provide four (4) sets of three (3) electrical terminations for three-wire power cables for up to eight (8) MVP sensors that may be mounted on a pole or mast arm with a traffic signal cabinet or junction box. The communication interface panel shall provide high-energy transient protection to electrically protect the modular cabinet interface unit and connected MVP sensors. The communications interface panel shall provide single-point



Ethernet connectivity via RJ45 connector for communication to and between the modular cabinet interface module and the MVP sensors.

## **1.2. System Software**

The MVP sensor embedded software shall incorporate multiple applications that perform a variety of diagnostic, installation, fault tolerant operations, data communications, digital video streaming, and vehicle detection processing. The detection shall be reliable, consistent, and perform under all weather, lighting, and traffic congestion levels. An embedded web server shall permit standard internet browsers to connect and perform basic configuration, maintenance, and video streaming services.

There shall be a suite of client applications that reside on the host client / server PC. The applications shall execute under Microsoft Windows XP or Vista. Available client applications shall include:

- Master network browser: Learn a network of connected modular cabinet interface units and MVP sensors, display basic information, and launch applications software to perform operations within that system of sensors.
- Configuration setup: Create and modify detector configurations to be executed on the MVP sensor and the modular cabinet interface unit.
- Operation log: Retrieve, display, and save field hardware run-time operation logs of special events that have occurred.
- Software install: Reconfigure one or more MVP sensors with a newer release of embedded system software.
- Streaming video player: Play and record streaming video with flashing detector overlay.
- Data retrieval: Fetch once or poll for traffic data and alarms and store on PC storage media.
- Communications server: Provide fault-tolerant, real-time TCP/IP communications to / from all devices and client applications with full logging capability for systems integration.

## **2. Functional Capabilities**

### **2.1. MVP Sensor**

The MVP sensor shall be an integrated imaging color CCD array with zoom lens optics, high-speed, dual-core image processing hardware bundled into a sealed enclosure. The CCD array shall be directly controlled by the dual-core processor, thus providing high-quality video for detection that has virtually no noise to degrade detection performance. It shall be possible to zoom the lens as required for setup and operation. It shall provide JPEG video compression as well as standard MPEG-4 digital streaming video with flashing detector overlay. The MVP shall provide direct real-time iris and shutter speed control. The MVP image sensor shall be equipped

with an integrated 22x zoom lens that can be changed using either configuration computer software. The digital streaming video output and all data communications shall be transmitted over the three-wire power cable.

#### **2.1.1. Power**

The MVP sensor shall operate on 110/220 VAC, 50/60Hz at a maximum of 25 watts. The camera and processor electronics shall consume a maximum of 10 watts and the remaining 15 watts shall support an enclosure heater.

#### **2.1.2. Detection Zone Programming**

Placement of detection zones shall be by means of a PC with a Windows XP or Vista operating system, a keyboard, and a mouse. The PC monitor shall be able to show the detection zones superimposed on images of traffic scenes.

The detection zones shall be created by using a mouse to draw detection zones on the PC monitor. Using the mouse and keyboard it shall be possible to place, size, and orient detection zones to provide optimal road coverage for vehicle detection. It shall be possible to download detector configurations from the PC to the MVP sensor and cabinet interface module, to retrieve the detector configuration that is currently running in the MVP sensor, and to back up detector configurations by saving them to the PC fixed disks or other removable storage media.

The supervisor computer's mouse and keyboard shall be used to edit previously defined detector configurations to permit adjustment of the detection zone size and placement, to add detectors for additional traffic applications, or to reprogram the MVP sensor for different traffic applications or changes in installation site geometry or traffic rerouting.

#### **2.1.3. Optimal Detection**

The video detection system shall optimally detect vehicle passage and presence when the MVP sensor is mounted 30 feet (10 m) or higher above the roadway, when the image sensor is adjacent to the desired coverage area, and when the distance to the farthest detection zone locations are not greater than ten (10) times the mounting height of the MVP. The recommended deployment geometry for optimal detection also requires that there be an unobstructed view of each traveled lane where detection is required. Although optimal detection may be obtained when the MVP is mounted directly above the traveled lanes, the MVP shall not be required to be directly over the roadway. The MVP shall be able to view either approaching or receding traffic or both in the same field of view. The preferred MVP sensor orientation shall be to view approaching traffic since there are more high contrast features on vehicles as viewed from the front rather than the rear. The MVP sensor placed at a mounting height that minimizes vehicle image occlusion shall be able to simultaneously monitor a maximum of six (6) traffic lanes when

mounted at the road-side or up to eight (8) traffic lanes when mounted in the center with four lanes on each side.

## **2.2. Modular Cabinet Interface Unit**

The modular cabinet interface unit shall provide the hardware and software means for up to eight (8) MVP sensors to communicate real-time detection states and alarms to a local traffic signal controller. It shall comply with the electrical and protocol specifications of the detector rack standards. The card shall have 1500 Vrms isolation between rack logic ground and street wiring.

The modular cabinet interface unit shall be a simple interface card that plugs directly into a 170 input file rack or a NEMA type C or D detector rack. The modular cabinet interface unit shall occupy only 2 slots of the detector rack. The modular cabinet interface unit shall accept up to sixteen (16) phase inputs and shall provide up to twenty-four (24) detector outputs.

## **2.3. Communications Interface Panel**

The communications interface panel shall support up to eight MVPs. The communications interface panel shall accept 110/220 VAC, 50/60 Hz power and provide predefined wire termination blocks for MVP power connections, a Broadband-over-Power-Line (BPL) transceiver to support up to 10MB/s interdevice communications, electrical surge protectors to isolate the modular cabinet interface unit and MVP sensors, and an interface connector to cable directly to the modular cabinet interface unit.

The interface panel shall provide power for up to eight (8) MVP sensors, taking local line voltage 110/220 VAC, 50/60 Hz and producing 110/220 VAC, 50/60 Hz, at about 30 watts to each MVP sensor. Two ½-amp SLO-BLO fuses shall protect the communications interface panel.

## **3. System Installation & Training**

The supplier of the video detection system may supervise the installation and testing of the video detection system and computer equipment as required by the contracting agency.

Training is available to personnel of the contracting agency in the operation, set up, and maintenance of the video detection system. The MVP sensor and its support hardware / software is a sophisticated leading-edge technology system. Proper instruction from certified instructors is recommended to ensure that the end user has complete competency in system operation. The User's Guide is not an adequate substitute for practical classroom training and formal certification by an approved agency.

## **4. Warranty, Service, & Support**

For a minimum of two (2) years, the supplier shall warrant the video detection system. An option for additional year(s) warranty for up to 5 years shall be available. Ongoing software support by the supplier shall include software updates of the MVP sensor, modular cabinet interface unit, and supervisor computer applications. These updates shall be provided free of charge during the warranty period. The supplier shall maintain a program for technical support and software updates following expiration of the warranty period. This program shall be available to the contracting agency in the form of a separate agreement for continuing support.

## **CITY OF CRYSTAL LAKE TRAFFIC SIGNAL SPECIFICATIONS**

These Traffic Signal Special Provisions and the "District One Standard Traffic Signal Design Details" supplement the requirements of the State of Illinois "Standard Specifications for Road and Bridge Construction." The intent of these Special Provisions is to prescribe the materials and construction methods commonly used for traffic signal installations. All material furnished shall be new. The locations and the details of all installations shall be as indicated on the Plans or as directed by the Engineer. Traffic signal construction and maintenance work shall be performed by personnel holding IMSA Traffic Signal Technician Level II certification. The work to be done under this contract consists of furnishing and installing all traffic signal work as specified in the Plans and as specified herein in a manner acceptable and approved by the Engineer.

### **SECTION 720 SIGNING**

#### **MAST ARM SIGN PANELS**

Add the following to Article 720.02 of the Standard Specifications:

Signs attached to poles or posts (such as mast arm signs) shall have mounting brackets and sign channels which are equal to and completely interchangeable with those used by the District Sign

Shops. Signfix Aluminum Channel Framing System is currently recommended, but other brands of mounting hardware are acceptable based upon the Department's approval.

## **DIVISION 800 ELECTRICAL**

### **SUBMITTALS.**

Revise Article 801.05 of the Standard Specifications to read:

All material approval requests shall be submitted in accordance with the District's current Electrical Product Data and Documentation Submittal Guidelines. General requirements include:

1. Material approval requests shall be made at the preconstruction meeting, including major traffic signal items listed in the table in Article 801.05. Material or equipment which is similar or identical shall be the product of the same manufacturer, unless necessary for system continuity. Traffic signal materials and equipment shall bear the U.L. label whenever such labeling is available.
2. Product data and shop drawings shall be assembled by pay item and separated from of other pay item submittals. Only the top sheet of each pay item submittal will be stamped by the Department with the review status, except shop drawings for mast arm pole assemblies and the like will be stamped with the review status on each sheet.
3. Partial or incomplete submittals will be returned without review.
4. Certain non-standard mast arm poles and structures will require additional review from IDOT's Central Office. Examples include ornamental/decorative and non-standard length mast arm pole assemblies. The Contractor shall account for the additional review time in his schedule.
5. The contract number or permit number, project location/limits and corresponding pay code number must be on each sheet of correspondence,, catalog cuts and mast arm poles and assemblies drawings.
6. Where certifications and/or warranties are specified, the information submitted for approval shall include certifications and warranties. Certifications involving inspections, and/or tests of material shall be complete with all test data, dates, and times.
7. After the Engineer reviews the submittals for conformance with the design concept of the project, the Engineer will stamp the drawings indicating their status as 'Approved', 'Approved-As-Noted', 'Disapproved', or 'Incomplete'. Since the Engineer's review is for conformance with the design concept only, it is the Contractor's responsibility to coordinate the various items into a working system as specified. The Contractor shall not be relieved from responsibility for errors or omissions in the shop, working, layout drawings,

or other documents by the Department's approval thereof. The Contractor must still be in full compliance with contract and specification requirements.

8. All submitted items reviewed and marked 'APPROVED AS NOTED', 'DISAPPROVED', or 'INCOMPLETE' are to be resubmitted in their entirety, unless otherwise indicated within the submittal comments, with a disposition of previous comments to verify contract compliance at no additional cost to the contract.
9. Exceptions to and deviations from the requirements of the Contract Documents will not be allowed. It is the Contractor's responsibility to note any deviations from Contract requirements at the time of submittal and to make any requests for deviations in writing to the Engineer. In general, substitutions will not be acceptable. Requests for substitutions must demonstrate that the proposed substitution is superior to the material or equipment required by the Contract Documents. No exceptions, deviations or substitutions will be permitted without the approval of the Engineer.

#### **INSPECTION OF ELECTRICAL SYSTEMS.**

Add the following to Article 801.10 of the Standard Specifications:

- (c) All cabinets including temporary traffic signal cabinets shall be assembled by an approved equipment supplier in District One. The Department reserves the right to request any controller and cabinet to be tested at the equipment supplier facilities prior to field installation, at no extra cost to this contract.

#### **MAINTENANCE AND RESPONSIBILITY.**

Revise Article 801.11 of the Standard Specifications to read:

- a. Existing traffic signal installations and/or any electrical facilities at all or various locations may be altered or reconstructed totally or partially as part of the work on this Contract. The Contractor is hereby advised that all traffic control equipment, presently installed at these locations, may be the property of the State of Illinois, Department of Transportation, Division of Highways, County, Private Developer, or the Municipality in which they are located. Once the Contractor has begun any work on any portion of the project, all traffic signals within the limits of this contract or those which have the item "Maintenance of Existing Traffic Signal Installation," "Temporary Traffic Signal Installation(s)" and/or "Maintenance of Existing Flashing Beacon Installation," shall become the full responsibility of the Contractor. Automatic Traffic Enforcement equipment is not owned by the State and the Contractor shall not be responsible for maintaining it during construction.

The Contractor shall supply the Engineer, Area Traffic Signal Maintenance and Operations Engineer, IDOT ComCenter and the Department's Electrical Maintenance Contractor with two 24-hour emergency contact names and telephone numbers.

- b. When the project has a pay item for "Maintenance of Existing Traffic Signal Installation," "Temporary Traffic Signal Installation(s)" and/or "Maintenance of Existing Flashing Beacon Installation," the Contractor must notify both the Area Traffic Signal Maintenance and Operations Engineer at (847) 705-4424 and the Department's Electrical Maintenance Contractor, of their intent to begin any physical construction work on the Contract or any portion thereof. This notification must be made a minimum of seven (7) working days prior to the start of construction to allow sufficient time for inspection of the existing traffic signal installation(s) and transfer of maintenance to the Contractor. If work is started prior to an inspection, maintenance of the traffic signal installation(s) will be transferred to the Contractor without an inspection. The Contractor will become responsible for repairing or replacing all equipment that is not operating properly or is damaged at no cost to the owner of the traffic signal. Final repairs or replacement of damaged equipment must meet the approval of the Engineer prior to or at the time of final inspection otherwise the traffic signal installation will not be accepted.
- c. Contracts such as pavement grinding or patching which result in the destruction of traffic signal loops do not require maintenance transfer, but require a notification of intent to work and an inspection. A minimum of seven (7) working days prior to the loop removal, the Contractor shall notify the Area Traffic Signal Maintenance and Operations Engineer at (847) 705-4424 and the Department's Electrical Maintenance Contractor, at which time arrangements will be made to adjust the traffic controller timing to compensate for the absence of detection. Damaged Automatic Traffic Enforcement equipment, including cameras, detectors, or other peripheral equipment, shall be replaced by others, per Permit agreement, at no cost to the contract. See additional requirements in these specifications under Inductive Loop Detector.
- d. The Contractor is advised that the existing and/or temporary traffic signal installation must remain in operation during all construction stages, except for the most essential down time. Any shutdown of the traffic signal installation, which exceeds fifteen (15) minutes, must have prior approval of the Engineer. Approval to shutdown the traffic signal installation will only be granted during the period extending from 10:00 a.m. to 3:00 p.m. on weekdays. Shutdowns shall not be allowed during inclement weather or holiday periods.

- e. The Contractor shall be fully responsible for the safe and efficient operation of the traffic signals. Any inquiry, complaint or request by the Department, the Department's Electrical Maintenance Contractor or the public, shall be investigated and repairs begun within one hour. Failure to provide this service will result in liquidated damages of \$500 per day per occurrence. In addition, the Department reserves the right to assign any work not completed within this timeframe to the Electrical Maintenance Contractor. All costs associated to repair this uncompleted work shall be the responsibility of the Contractor. Failure to pay these costs to the Electrical Maintenance Contractor within one month after the incident will result in additional liquidated damages of \$500 per month per occurrence. Unpaid bills will be deducted from the cost of the Contract. The District's Electrical Maintenance Contractor may inspect any signaling device on the Department's highway system at any time without notification.
  
- f. Any proposed activity in the vicinity of a highway-rail grade crossing must adhere to the guidelines set forth in the current edition of the Manual on Uniform Traffic Control Devices (MUTCD) regarding work in temporary traffic control zones in the vicinity of highway-rail grade crossings which states that lane restrictions, flagging, or other operations shall not create conditions where vehicles can be queued across the railroad tracks. If the queuing of vehicles across the tracks cannot be avoided, a uniformed law enforcement officer or flagger shall be provided at the crossing to prevent vehicles from stopping on the tracks, even if automatic warning devices are in place.

#### **DAMAGE TO TRAFFIC SIGNAL SYSTEM.**

Add the following to Article 801.12(b) of the Standard Specifications to read:

Any traffic signal control equipment damaged or not operating properly from any cause whatsoever shall be replaced with new equipment meeting current District One traffic signal specifications and provided by the Contractor at no additional cost to the Contract and/or owner of the traffic signal system, all as approved by the Engineer. Final replacement of damaged equipment must meet the approval of the Engineer prior to or at the time of final inspection otherwise the traffic signal installation will not be accepted. Cable splices outside the controller cabinet shall not be allowed.

Automatic Traffic Enforcement equipment, such as Red Light Enforcement cameras, detectors, and peripheral equipment, damaged or not operating properly from any cause whatsoever, shall be the responsibility of the municipality or the Automatic Traffic Enforcement company per Permit agreement.



**TRAFFIC SIGNAL INSPECTION (TURN-ON).**

Revise Article 801.15(b) of the Standard Specifications to read:

It is the intent to have all electric work completed and equipment field tested by the vendor prior to the Department's "turn-on" field inspection. If in the event the Engineer determines work is not complete and the inspection will require more than two (2) hours to complete, the inspection shall be canceled and the Contractor will be required to reschedule at another date. The maintenance of the traffic signals will not be accepted until all punch list work is corrected and re-inspected.

When the road is open to traffic, except as otherwise provided in Section 850 of the Standard Specifications, the Contractor may request a turn-on and inspection of the completed traffic signal installation at each separate location. This request must be made to the Area Traffic Signal Maintenance and Operations Engineer at (847) 705-4424 a minimum of seven (7) working days prior to the time of the requested inspection. The Department will not grant a field inspection until notification is provided from the Contractor that the equipment has been field tested and the intersection is operating according to Contract requirements. The Department's facsimile number is (847) 705-4089. The Contractor must invite local fire department personnel to the turn-on when Emergency Vehicle Preemption (EVP) is included in the project. When the contract includes the item RE-OPTIMIZE TRAFFIC SIGNAL SYSTEM, OPTIMIZE TRAFFIC SIGNAL SYSTEM, or TEMPORARY TRAFFIC SIGNAL TIMINGS, the Contractor must notify the SCAT Consultant of the turn-on/detour implementation schedule, as well as stage changes and phase changes during construction.

The Contractor must have all traffic signal work completed and the electrical service installation connected by the utility company prior to requesting an inspection and turn-on of the traffic signal installation. The Contractor shall be responsible to provide a police officer to direct traffic at the time of testing.

The Contractor shall provide a representative from the control equipment vendor's office to attend the traffic signal inspection for both permanent and temporary traffic signal turn-ons. Upon demonstration that the signals are operating and all work is completed in accordance with the Contract and to the satisfaction of the Engineer, the Engineer will then allow the signals to be placed in continuous operation. The Agency that is responsible for the maintenance of each traffic signal installation will assume the maintenance upon successful completion of this inspection.

The District requires the following from the Contractor at traffic signal turn-ons.

1. One set of signal plans of record with field revisions marked in red ink.
2. Written notification from the Contractor and the equipment vendor of satisfactory field testing.

3. A knowledgeable representative of the controller equipment supplier shall be required at the traffic signal turn-on. The representative shall be knowledgeable of the cabinet design and controller functions.
4. A copy of the approved material letter.
5. One (1) copy of the operation and service manuals of the signal controller and associated control equipment.
6. Five (5) copies 11" x 17" (280 mm X 430 mm) of the cabinet wiring diagrams.
7. The controller manufacturer shall supply a printed form, not to exceed 11" x 17" (280 mm X 430 mm) for recording the traffic signal controller's timings; backup timings; coordination splits, offsets, and cycles; TBC Time of Day, Week and Year Programs; Traffic Responsive Program, Detector Phase Assignment, Type and Detector Switching; and any other functions programmable from the keyboard. The form shall include a location, date, manufacturer's name, controller model and software version. The form shall be approved by the Engineer and a minimum of three (3) copies must be furnished at each turn-on. The manufacturer must provide all programming information used within the controller at the time of turn-on.
8. All manufacturer and contractor warranties and guarantees required by Article 801.14.

Acceptance of the traffic signal equipment by the Department shall be based upon inspection results at the traffic signal "turn on." If approved, traffic signal acceptance shall be verbal at the "turn on" inspection followed by written correspondence from the Engineer. The Contractor shall be responsible for all traffic signal equipment and associated maintenance thereof until Departmental acceptance is granted.

All equipment and/or parts to keep the traffic signal installation operating shall be furnished by the Contractor. No spare traffic signal equipment is available from the Department.

All punch list work shall be completed within two (2) weeks after the final inspection. The Contractor shall notify the Electrical Maintenance Contractor to inspect all punch list work. Failure to meet these time constraints shall result in liquidated damage charges of \$500 per month per incident.

All cost of work and materials required to comply with the above requirements shall be included in the pay item bid prices, under which the subject materials and signal equipment are paid, and no additional compensation will be allowed. Materials and signal equipment not complying with the above requirements shall be subject to removal and disposal at the Contractor's expense.

## RECORD DRAWINGS

The requirements listed for Electrical Installation shall apply for Traffic Signal Installations in Article 801.16. Revise the 2<sup>nd</sup> paragraph of Article 801.16 of the Standard Specifications to read:

- a. “When the work is complete, and seven days before the request for a final inspection, the full-size set of contract drawings. Stamped “RECORD DRAWINGS”, shall be submitted to the Engineer for review and approval and shall be stamped with the date and the signature of the Contractor’s supervising Engineer or electrician. The record drawings shall be submitted in PDF format on CDROM as well as hardcopy for review and approval.
- b. In addition to the record drawings, copies of the final catalog cuts which have been Approved or Approved as Noted shall be submitted in PDF format along with the record drawings. The PDF files shall clearly indicate the pay item either by filename or PDF Table of Contents referencing the respective pay item number for multi-item PDF files. Specific part or model numbers of items which have been selected shall be clearly visible.”
- c. Additional requirements are listed in the District’s Electrical Product Data and Documentation Guidelines.

Add the following to Article 801.16 of the Standard Specifications:

“In addition to the specified record drawings, the Contactor shall record GPS coordinates of the following traffic signal components being installed, modified or being affected in other ways by this contract:

- All Mast Arm Poles and Posts
- Handholes
- Conduit roadway crossings
- Controller Cabinets
- Communication Cabinets
- Electric Service Disconnect locations
- CCTV Camera installations
- Fiber Optic Splice Locations

Datum to be used shall be North American 1983.

Data shall be provided electronically and in print form. The electronic format shall be compatible with MS Excel. Latitude and Longitude shall be in decimal degrees with a minimum of 6 decimal places. Each coordinate shall have the following information:

- 1. Description of item

2. Designation or approximate station if the item is undesignated
3. Latitude
4. Longitude

Examples:

Description	Designation	Latitude	Longitude
Mast Arm Pole Assembly (dual, combo, etc)	MP (SW, NW, SE or NE corner)	41.580493	-87.793378
FO mainline splice handhole	HHL-ST31	41.558532	-87.792571
Handhole	HH	41.765532	-87.543571
Electric Service	Elec Srv	41.602248	-87.794053
Conduit crossing	SB IL83 to EB I290 ramp SIDE A	41.584593	-87.793378
PTZ Camera	PTZ	41.584600	-87.793432
Signal Post	Post	41.558532	-87.792571
Controller Cabinet	CC	41.651848	-87.762053
Master Controller Cabinet	MCC	41.580493	-87.793378
Communication Cabinet	ComC	41.558532	-87.789771
Fiber splice connection	Toll Plaza34	41.606928	-87.794053

Prior to the collection of data, the contractor shall provide a sample data collection of at least six data points of known locations to be reviewed and verified by the Engineer to be accurate within 100 feet. Upon verification, data collection can begin. Data collection can be made as construction progresses, or can be collected after all items are installed. If the data is unacceptable the contractor shall make corrections to the data collection equipment and or process and submit the data for review and approval as specified.

Accuracy. Data collected is to be mapping grade. A handheld mapping grade GPS device shall be used for the data collection. The receiver shall support differential correction and data shall have a minimum 5 meter accuracy after post processing.

GPS receivers integrated into cellular communication devices, recreational and automotive GPS devices are not acceptable.

The GPS shall be the product of an established major GPS manufacturer having been in the business for a minimum of 6 years.”

Delete the last sentence of the 3<sup>rd</sup> paragraph of Article 801.16.

**LOCATING UNDERGROUND FACILITIES.**

Revise Section 803 to the Standard Specifications to read:

If this Contract requires the services of an Electrical Contractor, the Contractor shall be responsible at his/her own expense for locating existing IDOT electrical facilities prior to performing any work. If this Contract does not require the services of an Electrical Contractor, the Contractor may request one free locate for existing IDOT electrical facilities from the District One Electrical Maintenance Contractor prior to the start of any work. Additional requests may be at the expense of the Contractor. The location of underground traffic facilities does not relieve the Contractor of their responsibility to repair any facilities damaged during construction at their expense.

The exact location of all utilities shall be field verified by the Contractor before the installation of any components of the traffic signal system. For locations of utilities, locally owned equipment, and leased enforcement camera system facilities, the local Counties or Municipalities may need to be contacted: in the City of Chicago contact Digger at (312) 744-7000 and for all other locations contact J.U.L.I.E. at 1-800-892-0123 or 811.

#### **RESTORATION OF WORK AREA.**

Add the following article to Section 801 of the Standard Specifications:

801.17 Restoration of work area. Restoration of the traffic signal work area shall be included in the related pay items such as foundation, conduit, handhole, trench and backfill, underground raceways, etc. All roadway surfaces such as shoulders, medians, sidewalks, pavement, etc. shall be replaced in kind. All damage to mowed lawns shall be replaced with an approved sod, and all damage to unmowed fields shall be seeded. All brick pavers disturbed in the work area shall be restored to their original configuration as directed by the Engineer. All damaged brick pavers shall be replaced with a comparable material approved by the Engineer. Restoration of the work area shall be included in the contract without any extra compensation allowed to the Contractor.

#### **ELECTRIC SERVICE INSTALLATION.**

Revise Section 805 of the Standard Specifications to read:

##### Description.

This work shall consist of all materials and labor required to install, modify, or extend the electric service installation. All installations shall meet the requirements of the details in the "District One Standard Traffic Signal Design Details" and applicable portions of the Specifications.

##### General.

The electric service installation shall be the electric service disconnecting means and it shall be identified as suitable for use as service equipment.

The electric utility contact information is noted on the plans and represents the current information at the time of contract preparation. The Contractor must request in writing for service and/or service modification within 10 days of contract award and must follow-up with the electric utility to assure all necessary documents and payment are received by the utility. The Contractor shall forward copies of all correspondence between the contractor and utility company to the Engineer and Area Traffic Signal Maintenance and Operations Engineer. The service agreement and sketch shall be submitted for signature to the IDOT's Traffic Operations Programs Engineer.

Materials.

- a. General. The completed control panel shall be constructed in accordance with UL Std. 508A, Industrial Control Panel, and carry the UL label. Wire terminations shall be UL listed.
- b. Enclosures.
  1. Pole Mounted Cabinet. The cabinet shall be UL 50, NEMA Type 4X, unfinished single door design, fabricated from minimum 0.080-inch (2.03 mm) thick Type 5052 H-32 aluminum. Seams shall be continuous welded and ground smooth. Stainless steel screws and clamps shall secure the cover and assure a watertight seal. The cover shall be removable by pulling the continuous stainless steel hinge pin. The cabinet shall have an oil-resistant gasket and a lock kit shall be provided with an internal O-ring in the locking mechanism assuring a watertight and dust-tight seal. The cabinet shall be sized to adequately house all required components with extra space for arrangement and termination of wiring. A minimum size of 14-inches (350 mm) high, 9-inches (225 mm) wide and 8-inches (200 mm) in depth is required. The cabinet shall be channel mounted to a wooden utility pole using assemblies recommended by the manufacturer.
  2. Ground Mounted Cabinet. The cabinet shall be UL 50, NEMA Type 3R unfinished single door design with back panel. The cabinet shall be fabricated from Type 5052 H-32 aluminum with the frame and door 0.125-inch (3.175 mm) thick, the top 0.250-inch (6.350 mm) thick and the bottom 0.500-inch (12.70 mm) thick. Seams shall be continuous welded and ground smooth. The door and door opening shall be double flanged. The door shall be approximately 80% of the front surface, with a full length tamperproof stainless steel .075-inch (1.91 mm) thick hinge bolted to the cabinet with stainless steel carriage bolts and nylocks nuts. The locking mechanism shall be slam-latch type with a keyhole cover. The cabinet shall be sized to adequately house all required components with extra space for arrangement and termination of wiring. A minimum size of 40-inches (1000 mm) high, 16-inches (400 mm) wide and 15-inches (375 mm) in depth is required. The

cabinet shall be mounted upon a square Type A concrete foundation as indicated on the plans. The foundation is paid for separately.

- c. Surge Protector. Overvoltage protection, with LED indicator, shall be provided for the 120 volt load circuit by the means MOV and thermal fusing technology. The response time shall be <5n seconds and operate within a range of -40C to +85C. The surge protector shall be UL 1449 Listed.
- d. Circuit Breakers. Circuit breakers shall be standard UL listed molded case, thermal-magnetic bolt-on type circuit breakers with trip free indicating handles. 120 volt circuit breakers shall have an interrupting rating of not less than 65,000 rms symmetrical amperes. Unless otherwise indicated, the main disconnect circuit breaker for the traffic signal controller shall be rated 60 amperes, 120 V and the auxiliary circuit breakers shall be rated 10 amperes, 120 V.
- e. Fuses, Fuseholders and Power Indicating Light. Fuses shall be small-dimensional cylindrical fuses of the dual element time-delay type. The fuses shall be rated for 600 V AC and shall have a UL listed interrupting rating of not less than 10,000 rms symmetrical amperes at rated voltage. The power indicating light shall be LED type with a green colored lens and shall be energized when electric utility power is present.
- f. Ground and Neutral Bus Bars. A single copper ground and neutral bus bar, mounted on the equipment panel shall be provided. Ground and neutral conductors shall be separated on the bus bar. Compression lugs, plus 2 spare lugs, shall be sized to accommodate the cables with the heads of the connector screws painted green for ground connections and white for neutral connections.
- g. Utility Services Connection. The Contractor shall notify the Utility Company marketing representative a minimum of 30 working days prior to the anticipated date of hook-up. This 30 day advance notification will begin only after the Utility Company marketing representative has received service charge payments from the Contractor. Prior to contacting the Utility Company marketing representative for service connection, the service installation controller cabinet and cable must be installed for inspection by the Utility Company.
- h. Ground Rod. Ground rods shall be copper-clad steel, a minimum of 10 feet (3.0m) in length, and 3/4 inch (20mm) in diameter. Ground rod resistance measurements to ground shall be 25 ohms or less. If necessary additional rods shall be installed to meet resistance requirements at no additional cost to the contract.

Installation.

- a. General. The Contractor shall confirm the orientation of the traffic service installation and its door side with the engineer, prior to installation. All conduit entrances into the service installation shall be sealed with a pliable waterproof material.
- b. Pole Mounted. Brackets designed for pole mounting shall be used. All mounting hardware shall be stainless steel. Mounting height shall be as noted on the plans or as directed by the Engineer.
- c. Ground Mounted. The service installation shall be mounted plumb and level on the foundation and fastened to the anchor bolts with hot-dipped galvanized or stainless steel nuts and washers. The space between the bottom of the enclosure and the top of the foundation shall be caulked at the base with silicone.

#### Basis of Payment.

The service installation shall be paid for at the contract unit price each for SERVICE INSTALLATION of the type specified which shall be payment in full for furnishing and installing the service installation complete. The CONCRETE FOUNDATION, TYPE A, which includes the ground rod, shall be paid for separately. SERVICE INSTALLATION, POLE MOUNTED shall include the 3/4 inch (20mm) grounding conduit, ground rod, and pole mount assembly. Any charges by the utility companies shall be approved by the engineer and paid for as an addition to the contract according to Article 109.05 of the Standard Specifications.

#### **GROUNDING OF TRAFFIC SIGNAL SYSTEMS.**

Revise Section 806 of the Standard Specifications to read:

##### General.

All traffic signal systems, equipment and appurtenances shall be properly grounded in strict conformance with the NEC. See IDOT District One Traffic Signal detail plan sheets for additional information.

The grounding electrode system shall include a ground rod installed with each traffic signal controller concrete foundation and all mast arm and post concrete foundations. An additional ground rod will be required at locations where measured resistance exceeds 25 ohms. Ground rods are included in the applicable concrete foundation or service installation pay item and will not be paid for separately.

Testing shall be according to Article 801.13 (a) (4) and (5).



- a) The grounded conductor (neutral conductor) shall be white color coded. This conductor shall be bonded to the equipment grounding conductor only at the Electric Service Installation. All power cables shall include one neutral conductor of the same size.
- b) The equipment grounding conductor shall be green color coded. The following is in addition to Article 801.04 of the Standard Specifications.
  - 1) Equipment grounding conductors shall be bonded to the grounded conductor (neutral conductor) only at the Electric Service Installation. The equipment grounding conductor is paid for separately and shall be continuous. The Earth shall not be used as the equipment grounding conductor.
  - 2) Equipment grounding conductors shall be bonded, using a Listed grounding connector, to all traffic signal mast arm poles, traffic signal posts, pedestrian posts, pull boxes, handhole frames and covers, conduits, and other metallic enclosures throughout the traffic signal wiring system, except where noted herein. Bonding shall be made with a splice and pigtail connection, using a sized compression type copper sleeve, sealant tape, and heat-shrinkable cap. A Listed electrical joint compound shall be applied to all conductors' terminations, connector threads and contact points. Conduit grounding bushings shall be installed at all conduit terminations.
  - 3) All metallic and non-metallic raceways containing traffic signal circuit runs shall have a continuous equipment grounding conductor, except raceways containing only detector loop lead-in circuits, circuits under 50 volts and/or fiber optic cable will not be required to include an equipment grounding conductor.
  4. Individual conductor splices in handholes shall be soldered and sealed with heat shrink. When necessary to maintain effective equipment grounding, a full cable heat shrink shall be provided over individual conductor heat shrinks.
- c) The grounding electrode conductor shall be similar to the equipment grounding conductor in color coding (green) and size. The grounding electrode conductor is used to connect the ground rod to the equipment grounding conductor and is bonded to ground rods via exothermic welding, listed pressure connectors, listed clamps or other approved listed means.

### **GROUNDING EXISTING HANDHOLE FRAME AND COVER.**

#### **Description.**

This work shall consist of all materials and labor required to bond the equipment grounding conductor to the existing handhole frame and handhole cover. All installations shall meet the requirements of the details in the "District One Standard Traffic Signal Design Details," and applicable portions of the Standard Specifications and these specifications.

The equipment grounding conductor shall be bonded to the handhole frame and to the handhole cover. Two (2) ½-inch diameter x 1 ¼-inch long hex-head stainless steel bolts, spaced 1.75-inches apart center-to-center shall be fully welded to the frame and to the cover to accommodate a heavy duty Listed grounding compression terminal (Burdny type YGHA). The grounding compression terminal shall be secured to the bolts with stainless steel split-lock washers and nylon-insert locknuts.

Welding preparation for the stainless steel bolt hex-head to the frame and to the cover shall include thoroughly cleaning the contact and weldment area of all rust, dirt and contaminates. The Contractor shall assure a solid strong weld. The welds shall be smooth and thoroughly cleaned of flux and spatter. The grounding installation shall not affect the proper seating of the cover when closed.

The grounding cable shall be paid for separately.

Method of Measurement.

Units measured for payment will be counted on a per handhole basis, regardless of the type of handhole and its location.

Basis of Payment.

This work shall be paid for at the contract unit price each for GROUNDING EXISTING HANDHOLE FRAME AND COVER which shall be payment in full for grounding the handhole complete.

**COILABLE NON-METALLIC CONDUIT.**

Description.

This work shall consist of furnishing and installing empty coilable non-metallic conduit (CNC) for detector loop raceways.

General.

The CNC installation shall be in accordance with Sections 810 and 811 of the Standard Specifications except for the following:

Add the following to Article 810.03 of the Standard Specifications:

CNC meeting the requirements of NEC Article 353 shall be used for detector loop raceways to the handholes.

Add the following to Article 811.03 of the Standard Specifications:

On temporary traffic signal installations with detector loops, CNC meeting the requirements of NEC Article 353 shall be used for detector loop raceways from the saw-cut to 10 feet (3m) up the wood pole, unless otherwise shown on the plans

Basis of Payment.

All installations of CNC for loop detection shall be included in the contract and not paid for separately.

**HANDHOLES.**

Add the following to Section 814 of the Standard Specifications:

All handholes shall be concrete, poured in place, with inside dimensions of 21-1/2 inches (549mm) minimum. Frames and lid openings shall match this dimension. The cover of the handhole frame shall be labeled "Traffic Signals" with legible raised letters.

For grounding purposes the handhole frame shall have provisions for a 7/16 inch (15.875mm) diameter stainless bolt cast into the frame. The covers shall have a stainless steel threaded stint extended from the eye hook assembly for the purpose of attaching the grounding conductor to the handhole cover.

The minimum wall thickness for heavy duty hand holes shall be 12 inches (300mm).

All conduits shall enter the handhole at a depth of 30 inches (760mm) except for the conduits for detector loops when the handhole is less than 5 feet (1.52 m) from the detector loop. All conduit ends should be sealed with a waterproof sealant to prevent the entrance of contaminants into the handhole.

Steel cable hooks shall be coated with hot-dipped galvanization in accordance with AASHTO Specification M111. Hooks shall be a minimum of 1/2 inch (12.7 mm) diameter with two 90 degree bends and extend into the handhole at least 6 inches (150 mm). Hooks shall be placed a minimum of 12 inches (300 mm) below the lid or lower if additional space is required.

**GROUNDING CABLE.**

The cable shall meet the requirements of Section 817 of the "Standard Specifications," except for the following:

Add the following to Article 817.02 (b) of the Standard Specifications:

Unless otherwise noted on the Plans, traffic signal grounding conductor shall be one conductor, #6 gauge copper, with a green color coded XLP jacket.

The traffic signal grounding conductor shall be bonded, using a Listed grounding connector (Burdny type KC/K2C, as applicable), to all proposed and existing traffic signal mast arm poles and traffic/pedestrian signal posts, including push button posts. The grounding conductor shall be bonded to all proposed and existing pull boxes, handhole frames and covers and other metallic enclosures throughout the traffic signal wiring system and noted herein and detailed on the plans. The grounding conductor shall be bonded to conduit terminations using rated grounding bushings. Bonding to existing handhole frames and covers shall be paid for separately.

Add the following to Article 817.05 of the Standard Specifications:

Basis of Payment.

Grounding cable shall be measured in place for payment in foot (meter). Payment shall be at the contract unit price for ELECTRIC CABLE IN CONDUIT, GROUNDING, NO. 6, 1C, which price includes all associated labor and material including grounding clamps, splicing, exothermic welds, grounding connectors, conduit grounding bushings, and other hardware.

**RAILROAD INTERCONNECT CABLE.**

The cable shall meet the requirements of Section 873 of the Standard Specifications, except for the following:

Add to Article 873.02 of the Standard Specifications:

The railroad interconnect cable shall be three conductor stranded #14 copper cable in a clear polyester binder, shielded with #36 AWG tinned copper braid with 85% coverage, and insulated with .016" polyethylene (black, blue, red). The jacket shall be black 0.045 PVC or polyethylene.

Add the following to Article 873.05 of the Standard Specifications:

Basis of Payment.

This work shall be paid for at the contract unit price per foot (meter) for ELECTRIC CABLE IN CONDUIT, RAILROAD, NO. 14 3C, which price shall be payment in full for furnishing, installing, and making all electrical connections in the traffic signal controller cabinet. Connections in the railroad controller cabinet shall be performed by railroad personnel.

**FIBER OPTIC TRACER CABLE.**

The cable shall meet the requirements of Section 817 of the "Standard Specifications," except for the following:

Add the following to Article 817.03 of the Standard Specifications:

In order to trace the fiber optic cable after installation, the tracer cable shall be installed in the same conduit as the fiber optic cable in locations shown on the plans. The tracer cable shall be continuous, extended into the controller cabinet and terminated on a barrier type terminal strip mounted on the side wall of the controller cabinet. The barrier type terminal strip and tracer cable shall be clearly marked and identified. All tracer cable splices shall be kept to a minimum and shall incorporate maximum lengths of cable supplied by the manufacturer. The tracer cable will be allowed to be spliced at handholes only. The tracer cable splice shall use a Western Union Splice soldered with resin core flux and shall be soldered using a soldering iron. Blow torches or other devices which oxidize copper cable shall not be allowed for soldering operations. All exposed surfaces of the solder shall be smooth. The splice shall be covered with a black shrink tube meeting UL 224 guidelines, Type V and rated 600v, minimum length 4 inches (100 mm) and with a minimum 1 inch (25 mm) coverage over the XLP insulation, underwater grade.

Add the following to Article 817.05 of the Standard Specifications:

Basis of Payment.

The tracer cable shall be paid for separately as ELECTRIC CABLE IN CONDUIT, TRACER, NO. 14 1C per foot (meter), which price shall include all associated labor and material for installation.

**MAINTENANCE OF EXISTING TRAFFIC SIGNAL INSTALLATION.**

Revise Articles 850.02 and 850.03 of the Standard Specifications to read:

Procedure.

The energy charges for the operation of the traffic signal installation shall be paid for by others. Full maintenance responsibility shall start as soon as the Contractor begins any physical work on the Contract or any portion thereof.

The Contractor shall have electricians with IMSA Level II certification on staff to provide signal maintenance.

This item shall include maintenance of all traffic signal equipment at the intersection, including emergency vehicle pre-emption equipment, master controllers, uninterruptible power supply (UPS and batteries), telephone service installations, communication cables, conduits to adjacent intersections, and other traffic signal equipment, but shall not include Automatic Traffic

Enforcement equipment, such as Red Light Enforcement cameras, detectors, or peripheral equipment, not owned by the State.

Maintenance.

The maintenance shall be according to MAINTENANCE AND RESPONSIBILITY in Division 800 of these specifications and the following:.

The Contractor shall check all controllers every two (2) weeks, which will include visually inspecting all timing intervals, relays, detectors, and pre-emption equipment to ensure that they are functioning properly. This item includes, as routine maintenance, all portions of emergency vehicle pre-emption equipment. The Contractor shall maintain in stock at all times a sufficient amount of materials and equipment to provide effective temporary and permanent repairs. The Contractor shall provide immediate corrective action when any part or parts of the system fail to function properly. Two far side heads facing each approach shall be considered the minimum acceptable signal operation pending permanent repairs. When repairs at a signalized intersection require that the controller be disconnected or otherwise removed from normal operation, and power is available, the Contractor shall place the traffic signal installation on flashing operation. The signals shall flash RED for all directions unless a different indication has been specified by the Engineer. The Contractor shall be required to place stop signs (R1-1-36) at each approach of the intersection as a temporary means of regulating traffic. When the signals operate in flash, the Contractor shall furnish and equip all their vehicles assigned to the maintenance of traffic signal installations with a sufficient number of stop signs as specified herein. The Contractor shall maintain a sufficient number of spare stop signs in stock at all times to replace stop signs which may be damaged or stolen.

The Contractor shall provide the Engineer with a 24 hour telephone number for the maintenance of the traffic signal installation and for emergency calls by the Engineer.

Traffic signal equipment which is lost or not returned to the Department for any reason shall be replaced with new equipment meeting the requirements of the Standard Specifications and these special provisions.

The Contractor shall respond to all emergency calls from the Department or others within one hour after notification and provide immediate corrective action. When equipment has been damaged or becomes faulty beyond repair, the Contractor shall replace it with new and identical equipment. The cost of furnishing and installing the replaced equipment shall be borne by the Contractor at no additional charge to the contract. The Contractor may institute action to recover damages from a responsible third party. If at any time the Contractor fails to perform all work as specified herein to keep the traffic signal installation in proper operating condition or if the Engineer cannot contact the Contractor's designated personnel, the Engineer shall have the State's Electrical Maintenance Contractor perform the maintenance work required. The State's Electrical Maintenance Contractor shall bill the Contractor for the total cost of the work. The Contractor shall pay this bill within thirty (30) days of the date of receipt of the invoice or the

cost of such work will be deducted from the amount due the Contractor. The Contractor shall allow the Electrical Maintenance Contractor to make reviews of the Existing Traffic Signal Installation that has been transferred to the Contractor for Maintenance.

### **TRAFFIC ACTUATED CONTROLLER.**

Add the following to Article 857.02 of the Standard Specifications:

Controllers shall be NTCIP compliant NEMA TS2 Type 1, Econolite ASC/3S-1000 or Eagle/Siemens M50 unless specified otherwise on the plans or elsewhere on these specifications. Only controllers supplied by one of the District One approved closed loop equipment manufacturers will be allowed. The controller shall be the most recent model and software version supplied by the manufacturer at the time of the approval and include the standard data key. The traffic signal controller shall provide features to inhibit simultaneous display of a circular yellow ball and a yellow arrow display. Individual load switches shall be provided for each vehicle, pedestrian, and right turn over lap phase. The controller shall prevent phases from being skipped during program changes and after all preemption events.

Add the following to Article 857.03 of the Standard Specifications:

The Contractor shall arrange to install a standard voice-grade dial-up telephone line to the RAILROAD, FULL-ACTUATED CONTROLLER AND CABINET as called for on the traffic signal installation plans. If the traffic signal installation is part of a traffic signal system, a telephone line is usually not required, unless a telephone line is called for on the traffic signal plans. The Contractor shall follow the requirements for the telephone service installation as contained in the current District One Traffic Signal Special Provisions under Master Controller.

### **MASTER CONTROLLER.**

Revise Articles 860.02 - Materials and 860.03 - Installation of the Standard Specifications to read:

Only controllers supplied by one of the District approved closed loop equipment manufacturers will be allowed. Only NEMA TS 2 Type 1 Eagle/Siemens and Econolite closed loop systems shall be supplied. The latest model and software version of master controller shall be supplied.

Functional requirements in addition to those in Section 863 of the Standard Specifications include:

The system commands shall consist of, as a minimum, six (6) cycle lengths, five (5) offsets, three (3) splits, and four (4) special functions. The system commands shall also include commands for free or coordinated operation.

Traffic Responsive operation shall consist of the real time acquisition of system detector data, data validation, and the scaling of acquired volumes and occupancies in a deterministic fashion so as to cause the selection and implementation of the most suitable traffic plan.

Upon request by the Engineer, each master shall be delivered with up to three (3) complete sets of the latest edition of registered remote monitoring software with full manufacture's support. Each set shall consist of software on CD, DVD, or other suitable media approved by the Engineer, and a bound set of manuals containing loading and operating instruction. One copy of the software and support data shall be delivered to the Agency in charge of system operation, if other than IDOT. One of these two sets will be provided to the Agency Signal Maintenance Contractor for use in monitoring the system.

The approved manufacturer of equipment shall loan the District one master controller and two intersection controllers of the most recent models and the newest software version to be used for instructional purposes in addition to the equipment to be supplied for the Contract.

The Contractor shall arrange to install a standard voice-grade dial-up telephone line to the master controller. This shall be accomplished through the following process utilizing District One staff. This telephone line may be coupled with a DSL line and a phone filter to isolate the dial-up line. An E911 address is required.

The cabinet shall be provided with an Outdoor Network Interface for termination of the telephone service. It shall be mounted to the inside of the cabinet in a location suitable to provide access for termination of the telephone service at a later date.

Full duplex communication between the master and its local controllers is recommended, but at this time not required. The data rate shall be 1200 baud minimum and shall be capable of speeds to 38,400 or above as technology allows. The controller, when installed in an Ethernet topology, may operate non-serial communications.

The cabinet shall be equipped with a 9600 baud, auto dial/auto answer modem. It shall be a US robotics 33.6K baud rate.

As soon as practical or within one week after the contract has been awarded, the Contractor shall contact (via phone) the Administrative Support Manager in the District One Business Services Section at (847) 705-4011 to request a phone line installation.

A follow-up fax transmittal to the Administrative Support Manager (847-705-4712) with all required information pertaining to the phone installation is required from the Contractor as soon as possible or within one week after the initial request has been made. A copy of this fax transmittal must also be faxed by the Contractor to the Traffic Signal Systems Engineer at (847) 705-4089. The required information to be supplied on the fax shall include (but not limited to):



A street address for the new traffic signal controller (or nearby address); a nearby existing telephone number; what type of telephone service is needed; the name and number of the Contractor's employee for the telephone company to contact regarding site work and questions.

The usual time frame for the activation of the phone line is 4-6 weeks after the Business Services Section has received the Contractor supplied fax. It is, therefore, imperative that the phone line conduit and pull-string be installed by the Contractor in anticipation of this time frame. On jobs which include roadway widening in which the conduit cannot be installed until this widening is completed, the Contractor will be allowed to delay the phone line installation request to the Business Services Section until a point in time that is 4-6 weeks prior to the anticipated completion of the traffic signal work. The contractor shall provide the Administrative Support Manager with an expected installation date considering the 4-6 week processing time.

The telephone line shall be installed and activated one month before the system final inspection.

All costs associated with the telephone line installation and activation (not including the Contract specified conduit installation between the point of telephone service and the traffic signal controller cabinet) shall be paid for by the District One Business Services Section (i.e., this will be an IDOT phone number not a Contractor phone number).

#### **UNINTERRUPTIBLE POWER SUPPLY.**

Add the following to Article 862.01 of the Standard Specifications:

The UPS shall have the power capacity to provide normal operation of a signalized intersection that utilizes all LED type signal head optics, for a minimum of six hours.

Add the following to Article 862.02 of the Standard Specifications:

Materials shall be according to Article 1074.04 as modified in UNINTERRUPTIBLE POWER SUPPLY in Division 1000 of these specifications.

Add the following to Article 862.03 of the Standard Specifications:

The UPS shall additionally include, but not be limited to, a battery cabinet. The UPS shall provide reliable emergency power to the traffic signals in the event of a power failure or interruption.

Revise Article 862.04 of the Standard Specifications to read:

Installation.

When a UPS is installed at an existing traffic signal cabinet, the UPS cabinet shall partially rest on the lip of the existing controller cabinet foundation and be secured to the existing controller cabinet by means of at least four (4) stainless steel bolts. The UPS cabinet shall be completely enclosed with the bottom and back constructed of the same material as the cabinet.

When a UPS is installed at a new signal cabinet and foundation, it shall be mounted as shown on the plans.

At locations where UPS is installed and Emergency Vehicle Priority System is in use, any existing incandescent confirmation beacons shall be replaced with LED lamps in accordance with the District One Emergency Vehicle Priority System specification at no additional cost to the contract. A concrete apron 67 in. x 50 in. x 5 in. (1702mm x 1270mm x 130mm) shall be provided on the side of the existing Type D Foundation, where the UPS cabinet is located. The concrete apron shall follow the District 1 Standard Traffic Signal Design Detail, Type D for Ground Mounted Controller Cabinet and UPS Battery Cabinet. The concrete apron shall follow Articles 424 and 202 of the Standard Specifications.

This item shall include any required modifications to an existing traffic signal controller as a result of the addition of the UPS.

Revise Article 862.05 of the Standard Specifications to read:

Basis of Payment.

This work will be paid for at the contract unit price per each for UNINTERRUPTIBLE POWER SUPPLY SPECIAL. Replacement of Emergency Vehicle Priority System confirmation beacons and any required modifications to the traffic signal controller shall be included in the cost of the UNINTERRUPTIBLE POWER SUPPLY SPECIAL item. The concrete apron and earth excavation required shall be included in the cost of the UNINTERRUPTIBLE POWER SUPPLY SPECIAL item.

**FIBER OPTIC CABLE.**

Add the following to Article 871.01 of the Standard Specifications:

The Fiber Optic cable shall be installed in conduit or as specified on the plans.

Add the following to Article 872.02 of the Standard Specifications:

The control cabinet distribution enclosure shall be CSC FTWO12KST-W/O 12 Port Fiber Wall Enclosure. The fiber optic cable shall provide six fibers per tube for the amount of fibers called for in the Fiber Optic Cable pay item in the Contract. Fiber Optic cable may be gel filled or have an approved water blocking tape.

Add the following to Article 871.04 of the Standard Specifications:

A minimum of six multimode fibers from each cable shall be terminated with approved mechanical connectors at the distribution enclosure. Fibers not being used shall be labeled "spare." Fibers not attached to the distribution enclosure shall be capped and sealed. A minimum of 13.0 feet (4m) of extra cable length shall be provided for controller cabinets. The controller cabinet extra cable length shall be stored as directed by the Engineer.

Add the following to Article 871.06 of the Standard Specifications:

The distribution enclosure and all connectors will be included in the cost of the fiber optic cable.

### **MAST ARM ASSEMBLY AND POLE.**

Revise Article 877.01 of the Standard Specifications to read:

#### Description.

This work shall consist of furnishing and installing a steel mast arm assembly and pole and a galvanized steel or extruded aluminum shroud for protection of the base plate.

Revise Article 877.03 of the Standard Specifications:

Mast arm assembly and pole shall be as follows.

- (a) Steel Mast Arm Assembly and Pole and Steel Combination Mast Arm Assembly and Pole. The steel mast arm assembly and pole and steel combination mast arm assembly and pole shall consist of a traffic signal mast arm, a luminaire mast arm or davit (for combination pole only), a pole, and a base, together with anchor rods and other appurtenances. The configuration of the mast arm assembly, pole, and base shall be according to the details shown on the plans.
  - (1) Loading. The mast arm assembly and pole, and combination mast arm assembly and pole shall be designed for the loading shown on the Highway Standards or elsewhere on the plans, whichever is greater. The design shall be according to AASHTO "Standard Specification for Structural Supports for Highway Signs, Luminaries and Traffic Signals" 1994 Edition for 80 mph (130 km/hr) wind velocity. However, the arm-to-pole connection for tapered signal and luminaire arms shall be according to the "ring plate" detail as shown in Figure 11-1(f) of the 2002 Interim, to the AASHTO "Standard Specification for Structural Supports for Highway Signs, Luminaries and Traffic Signals" 2001 4th Edition.

- (2) Structural Steel Grade. The mast arm and pole shall be fabricated according to ASTM A 595, Grade A or B, ASTM A 572 Grade 55, or ASTM A 1011 Grade 55 HSLAS Class 2. The base and flange plates shall be of structural steel according to AASHTO M 270 Grade 50 (M 270M Grade 345). Luminaire arms and trussed arms 15 ft (4.5 m) or less shall be fabricated from one steel pipe or tube size according to ASTM A 53 Grade B or ASTM A 500 Grade B or C. All mast arm assemblies, poles, and bases shall be galvanized according to AASHTO M 111.
- (3) Fabrication. The design and fabrication of the mast arm assembly, pole, and base shall be according to the requirements of the Standard Specifications for Structural Supports for Highway Signs, Luminaires, and Traffic Signals published by AASHTO. The mast arm and pole may be of single length or sectional design. If section design is used, the overlap shall be at least 150 percent of the maximum diameter of the overlapping section and shall be assembled in the factory.

The manufacturer will be allowed to slot the base plate in which other bolt circles may fit, providing that these slots do not offset the integrity of the pole. Circumferential welds of tapered arms and poles to base plates shall be full penetration welds.

- (4) Shop Drawing Approval. The Contractor shall submit detailed drawings showing design materials, thickness of sections, weld sizes, and anchor rods to the Engineer for approval prior to fabrication. These drawings shall be at least 11 x 17 in. (275 x 425 mm) in size and of adequate quality for microfilming. All product data and shop drawings shall be submitted in electronic form on CD-ROM
- (b) Anchor Rods. The anchor rods shall be ASTM F 1554 Grade 105, coated by the hot-dip galvanizing process according to AASHTO M 232, and shall be threaded a minimum of 7 1/2 in. (185 mm) at one end and have a bend at the other end. The first 12 in. (300 mm) at the threaded end shall be galvanized. Two nuts, one lock washer, and one flat washer shall be furnished with each anchor rod. All nuts and washers shall be galvanized.
- (c) The galvanized steel or extruded aluminum shroud shall have dimensions similar to those detailed in the "District One Standard Traffic Signal Design Details." The shroud shall be installed such that it allow air to circulate throughout the mast arm but not allow infestation of insects or other animals, and such that it is not hazardous to probing fingers and feet.

Add the following to Article 877.04 of the Standard Specifications:

The shroud shall not be paid for separately but shall be included in the cost of the mast arm assembly and pole.

## **CONCRETE FOUNDATIONS.**

Add the following to Article 878.03 of the Standard Specifications:

All anchor bolts shall be according to Article 1006.09, with all anchor bolts hot dipped galvanized a minimum of 12 in. (300 mm) from the threaded end.

Concrete Foundations, Type “A” for Traffic Signal Posts shall provide anchor bolts with the bolt pattern specified within the “District One Standard Traffic Signal Design Details.” All Type “A” foundations shall be a minimum depth of 48 inches (1220 mm).

Concrete Foundations, Type “C” for Traffic Signal Cabinets with Uninterruptible Power Supply (UPS) cabinet installations shall be a minimum of 72 inches (1830 mm) long and 31 inches (790 mm) wide. All Type “C” foundations shall be a minimum depth of 48 inches (1220 mm). The concrete apron in front of the Type IV or V cabinet shall be 36 in. x 48 in. x 5 in. (915 mm X 1220 mm X 130 mm). The concrete apron in front of the UPS cabinet shall be 36 in. x 67 in. x 5 in. (915 mm X 1700 mm X 130 mm). Anchor bolts shall provide bolt spacing as required by the manufacturer.

Concrete Foundations, Type “D” for Traffic Signal Cabinets shall be a minimum of 48 inches (1220 mm) long and 31 inches (790 mm) wide. All Type “D” foundations shall be a minimum depth of 48 inches (1220 mm). The concrete apron shall be 36 in. x 48 in. x 5 in. (910 mm X 1220 mm X 130 mm). Anchor bolts shall provide bolt spacing as required by the manufacturer.

Concrete Foundations, Type “E” for Mast Arm and Combination Mast Arm Poles shall meet the current requirements listed in the Highway Standards.

Foundations used for Combination Mast Arm Poles shall provide an extra 2-1/2 inch (65 mm) raceway.

No foundation is to be poured until the Resident Engineer gives his/her approval as to the depth of the foundation.

## **LIGHT EMITTING DIODE (LED) SIGNAL HEAD AND OPTICALLY PROGRAMMED LED SIGNAL HEAD.**

Add the following to the first paragraph of Article 880.04 of the Standard Specifications:

Basis of Payment.

The price shall include furnishing the equipment described above, all mounting hardware and installing them in satisfactory operating condition.

**LIGHT EMITTING DIODE (LED), SIGNAL HEAD, RETROFIT**

Description.

This work shall consist of retrofitting an existing polycarbonate traffic signal head with a traffic signal module, pedestrian signal module, and pedestrian countdown signal module, with light emitting diodes (LEDs) as specified in the plans.

Materials.

Materials shall be according to LIGHT EMITTING DIODE (LED) AND OPTICALLY PROGRAMMED LED SIGNAL HEAD, AND LIGHT EMITTING DIODE (LED) PEDESTRIAN SIGNAL HEAD in Divisions 880, 881 and 1000 of these specifications.

Add the following to Article 880.04 of the Standard Specifications:

Basis of Payment.

This item shall be paid for at the contract unit price each for SIGNAL HEAD, LED, RETROFIT, or PEDESTRIAN SIGNAL HEAD, LED, RETROFIT, for the type and number of polycarbonate signal heads, faces, and sections specified, which price shall be payment in full for furnishing the equipment described above including LED modules, all mounting hardware, and installing them in satisfactory operating condition. The type specified will indicate the number of faces and the method of mounting.

**LIGHT EMITTING DIODE (LED) PEDESTRIAN SIGNAL HEAD**

Add the following to the third paragraph of Article 881.03 of the Standard Specifications:

No mixing of different types of pedestrian traffic signals or displays will be permitted.

Add the following to Article 881.03 of the Standard Specifications:

(a) Pedestrian Countdown Signal Heads.

- (1) Pedestrian Countdown Signal Heads shall not be installed at signalized intersections where traffic signals and railroad warning devices are interconnected.

- (2) Pedestrian Countdown Signal Heads shall be 16 inch (406mm) x 18 inch (457mm), for single units with the housings glossy black polycarbonate. Connecting hardware and mounting brackets shall be polycarbonate (black). A corrosion resistant anti-seize lubricant shall be applied to all metallic mounting bracket joints, and shall be visible to the inspector at the signal turn-on.
- (3) Each pedestrian signal LED module shall be fully MUTCD compliant and shall consist of double overlay message combining full LED symbols of an Upraised Hand and a Walking Person. "Egg Crate" type sun shields are not permitted. Numerals shall measure 9 inches (229mm) in height and easily identified from a distance of 120 feet (36.6m).

Add the following to Article 881.04 of the Standard Specifications:

Basis of Payment.

The price shall include furnishing the equipment described above, all mounting hardware and installing them in satisfactory operating condition.

**DETECTOR LOOP.**

Revise Section 886 of the Standard Specifications to read:

Description.

This work shall consist of furnishing and installing a detector loop in the pavement.

Procedure.

A minimum of seven (7) working days prior to the Contractor cutting loops, the Contractor shall have the proposed loop locations marked and contact the Area Traffic Signal Maintenance and Operations Engineer (847) 705-4424 to inspect and approve the layout. When preformed detector loops are installed, the Contractor shall have them inspected and approved prior to the pouring of the Portland cement concrete surface, using the same notification process as above.

Installation.

Loop detectors shall be installed according to the requirements of the "District One Standard Traffic Signal Design Details." Saw-cuts (homeruns on preformed detector loops) from the loop to the edge of pavement shall be made perpendicular to the edge of pavement when possible in order to minimize the length of the saw-cut (homerun on preformed detector loops) unless directed otherwise by the Engineer or as shown on the plan.

The detector loop cable insulation shall be labeled with the cable specifications.

Each loop detector lead-in wire shall be labeled in the handhole using a Panduit PLFIM water proof tag, secured to each wire with nylon ties.

Resistance to ground shall be a minimum of 100 mega-ohms under any conditions of weather or moisture. Inductance shall be more than 50 and less than 700 microhenries. Quality readings shall be more than 5.

- (a) Type I. All loops installed in new asphalt pavement shall be installed in the binder course and not in the surface course. The edge of pavement, curb and handhole shall be cut with a 1/4 inch (6.3 mm) deep x 4 inches (100 mm) saw cut to mark location of each loop lead-in.
- (b) Loop sealant shall be a two-component thixotropic chemically cured polyurethane either Chemque Q-Seal 295, Percol Elastic Cement AC Grade. The sealant shall be installed 1/8 inch (3 mm) below the pavement surface, if installed above the surface the overlap shall be removed immediately.
- (c) Detector loop measurements shall include the saw cut and the length of the loop lead-in to the edge of pavement. The lead-in wire, including all necessary connections for proper operations, from the edge of pavement to the handhole, shall be included in the price of the detector loop. Unit duct, trench and backfill, and drilling of pavement or handholes shall be included in detector loop quantities.
- (d) Preformed. This work shall consist of furnishing and installing a rubberized or crosslinked polyethylene heat resistant preformed traffic signal loop in accordance with the Standard Specifications, except for the following:
- (e) Preformed detector loops shall be installed in new pavement constructed of Portland cement concrete using mounting chairs or tied to re-bar or the preformed detector loops may be placed in the sub-base. Loop lead-ins shall be extended to a temporary protective enclosure near the proposed handhole location. The protective enclosure shall provide sufficient protection from other construction activities and may be buried for additional protection.
- (f) Handholes shall be placed next to the shoulder or back of curb when preformed detector loops enter the handhole. Non-metallic coilable duct, included in this pay item, shall be used to protect the preformed lead-ins from back of curb to the handhole.
- (g) Preformed detector loops shall be factory assembled with ends capped and sealed against moisture and other contaminants. Homeruns and interconnects shall be pre-wired and shall be an integral part of the loop assembly. The loop configurations and homerun lengths shall be assembled for the specific application. The loop and homerun shall be constructed using 11/16 inch (17.2 mm) outside diameter (minimum), 3/8 inch (9.5 mm) inside diameter (minimum) Class A oil resistant synthetic cord reinforced hydraulic hose with 250 psi (1,720 kPa) internal pressure rating or a similarly sized XLPE cable jacket. Hose for the loop and



homerun assembly shall be one continuous piece. No joints or splices shall be allowed in the hose except where necessary to connect homeruns or interconnects to the loops. This will provide maximum wire protection and loop system strength. Hose tee connections shall be heavy duty high temperature synthetic rubber. The tee shall be of proper size to attach directly to the hose, minimizing glue joints. The tee shall have the same flexible properties as the hose to insure that the whole assembly can conform to pavement movement and shifting without cracking or breaking. For XLPE jacketed preformed loops, all splice connections shall be soldered, sealed, and tested before being sealed in a high impact glass impregnated plastic splice enclosure. The wire used shall be #16 THWN stranded copper. The number of turns in the loop shall be application specific. Homerun wire pairs shall be twisted a minimum of four turns per foot. No wire splices will be allowed in the preformed loop assembly. The loop and homeruns shall be filled and sealed with a flexible sealant to insure complete moisture blockage and further protect the wire. The preformed loops shall be constructed to allow a minimum of 6.5 feet of extra cable in the handhole.

Method of Measurement.

This work will be measured for payment in feet (meters) in place. Type I detector loop will be measured along the sawed slot in the pavement containing the loop and lead-in, rather than the actual length of the wire. Preformed detector loops will be measured along the detector loop and lead-in embedded in the pavement, rather than the actual length of the wire.

Basis of Payment.

This work shall be paid for at the contract unit price per foot (meter) for DETECTOR LOOP, TYPE I or PREFORMED DETECTOR LOOP as specified in the plans, which price shall be payment in full for furnishing and installing the detector loop and all related connections for proper operation.

**EMERGENCY VEHICLE PRIORITY SYSTEM.**

Revise Section 887 of the Standard Specifications to read:

It shall be the Contractor's responsibility to contact the municipality or fire district to verify the brand of emergency vehicle pre-emption equipment to be installed prior to the contract bidding. The equipment must be completely compatible with all components of the equipment currently in use by the Agency. Due to Electric Voltage Leakage of the Load Switches in the cabinet, a resistor shall be installed on each load switch used for pre-emption to eliminate this occurrence.

All new installations shall be equipped with Confirmation Beacons as shown on the "District One Standard Traffic Signal Design Details." The Confirmation Beacon shall consist of a 6 watt Par 38 LED flood lamp with a 30 degree light spread, maximum 6 watt energy consumption at 120V, and a 2,000 hour warranty for each direction of pre-emption. The lamp shall have an adjustable mount with a weatherproof enclosure for cable splicing. All hardware shall be cast

aluminum or stainless steel. Holes drilled into signal poles, mast arms, or posts shall require rubber grommets. In order to maintain uniformity between communities, the confirmation beacons shall indicate when the control equipment receives the pre-emption signal. The pre-emption movement shall be signalized by a flashing indication at the rate specified by Section 4L.01 of the "Manual on Uniform Traffic Control Devices," and other applicable sections of future editions. The stopped pre-empted movements shall be signalized by a continuous indication.

All light operated systems shall include security and transit preemption software and operate at a uniform rate of 14.035 Hz  $\pm$ 0.002, or as otherwise required by the Engineer, and provide compatible operation with other light systems currently being operated in the District.

This item shall include any required modifications to an existing traffic signal controller as a result of the addition of the EMERGENCY VEHICLE PRIORITY SYSTEM.

Basis of Payment.

The work shall be paid for at the contract unit price each for furnishing and installing LIGHT DETECTOR and LIGHT DETECTOR AMPLIFIER. Furnishing and installing the confirmation beacon shall be included in the cost of the Light Detector. Any required modifications to the traffic signal controller shall be included in the cost of the LIGHT DETECTOR AMPLIFIER. The preemption detector amplifier shall be paid for on a basis of (1) one each per intersection controller and shall provide operation for all movements required in the pre-emption phase sequence.

**TEMPORARY TRAFFIC SIGNAL INSTALLATION.**

Revise Section 890 of the Standard Specifications to read:

Description.

This work shall consist of furnishing, installing, maintaining, and removing a temporary traffic signal installation as shown on the plans, including but not limited to temporary signal heads, emergency vehicle priority systems, interconnect, vehicle detectors, uninterruptible power supply, and signing. Temporary traffic signal controllers and cabinets interconnected to railroad traffic control devices shall be new. When temporary traffic signals will be operating within a county or local agency Traffic Management System, the equipment must be NTCIP compliant and compatible with the current operating requirements of the Traffic Management System.

General.

Only an approved equipment vendor will be allowed to assemble the temporary traffic signal cabinet. Also, an approved equipment vendor shall assemble and test a temporary railroad traffic signal cabinet. (Refer to the "Inspection of Controller and Cabinet" specification). A

representative of the approved control equipment vendor shall be present at the temporary traffic signal turn-on inspection.

Construction Requirements.

(a) Controllers.

1. Only controllers supplied by one of the District approved closed loop equipment manufacturers will be approved for use at temporary signal locations. All controllers used for temporary traffic signals shall be fully actuated NEMA microprocessor based with RS232 data entry ports compatible with existing monitoring software approved by IDOT District 1, installed in NEMA TS2 cabinets with 8 phase back panels, capable of supplying 255 seconds of cycle length and individual phase length settings up to 99 seconds. On projects with one lane open and two way traffic flow, such as bridge deck repairs, the temporary signal controller shall be capable of providing an adjustable all red clearance setting of up to 30 seconds in length. All controllers used for temporary traffic signals shall meet or exceed the requirements of Section 857 of the Standard Specifications with regards to internal time base coordination and preemption. All railroad interconnected temporary controllers and cabinets shall be new and shall satisfy the requirements of Article 857.02 of the Standard Specifications as modified herein.
  2. Only control equipment, including controller cabinet and peripheral equipment, supplied by one of the District approved closed loop equipment manufacturers will be approved for use at temporary traffic signal locations. All control equipment for the temporary traffic signal(s) shall be furnished by the Contractor unless otherwise stated in the plans. On projects with multiple temporary traffic signal installations, all controllers shall be the same manufacturer brand and model number with current software installed.
- (b) Cabinets. All temporary traffic signal cabinets shall have a closed bottom made of aluminum alloy. The bottom shall be sealed along the entire perimeter of the cabinet base to ensure a water, dust and insect-proof seal. The bottom shall provide a minimum of two (2) 4 inch (100 mm) diameter holes to run the electric cables through. The 4 inch (100 mm) diameter holes shall have a bushing installed to protect the electric cables and shall be sealed after the electric cables are installed.
- (c) Grounding. Grounding shall be provided for the temporary traffic signal cabinet meeting or exceeding the applicable portions of the National Electrical Code, Section 806 of the Standard Specifications and shall meet the requirements of the District 1 Traffic Signal Specifications for "Grounding of Traffic Signal Systems."
- (d) Traffic Signal Heads. All traffic signal sections and pedestrian signal sections shall be 12 inches (300 mm). Traffic signal sections shall be LED with expandable

view, unless otherwise approved by the Engineer. Pedestrian signal heads shall be Light Emitting Diode (LED) Pedestrian Countdown Signal Heads except when a temporary traffic signal is installed at an intersection interconnected with a railroad grade crossing. When a temporary traffic signal is installed at an intersection interconnected with a railroad grade crossing, Light Emitting Diode (LED) Pedestrian Signal Heads shall be furnished. The temporary traffic signal heads shall be placed as indicated on the temporary traffic signal plan or as directed by the Engineer. The Contractor shall furnish enough extra cable length to relocate heads to any position on the span wire or at locations illustrated on the plans for construction staging. The temporary traffic signal shall remain in operation during all signal head relocations. Each temporary traffic signal head shall have its own cable from the controller cabinet to the signal head.

(e) Interconnect.

1. Temporary traffic signal interconnect shall be provided using fiber optic cable or wireless interconnect technology as specified in the plans. The Contractor may request, in writing, to substitute the fiber optic temporary interconnect indicated in the contract documents with a wireless interconnect. The Contractor must provide assurances that the radio device will operate properly at all times and during all construction staging. If approved for use by the Engineer, the Contractor shall submit marked-up traffic signal plans indicating locations of radios and antennas and installation details. If wireless interconnect is used, and in the opinion of the engineer, it is not viable, or if it fails during testing or operations, the Contractor shall be responsible for installing all necessary poles, fiber optic cable, and other infrastructure for providing temporary fiber optic interconnect at no cost to the contract.
2. The existing system interconnect and phone lines are to be maintained as part of the Temporary Traffic Signal Installation specified for on the plan. The interconnect shall be installed into the temporary controller cabinet as per the notes or details on the plans. All labor and equipment required to install and maintain the existing interconnect as part of the Temporary Traffic Signal Installation shall be included in the item Temporary Traffic Signal Installation. When shown in the plans, temporary traffic signal interconnect equipment shall be furnished and installed. The temporary traffic signal interconnect shall maintain interconnect communications throughout the entire signal system for the duration of the project.
3. Temporary wireless interconnect, complete. The radio interconnect system shall be compatible with Eagle or Econolite controller closed loop systems. This item shall include all temporary wireless interconnect components, complete, at the adjacent existing traffic signal(s) to provide a completely operational closed loop

system. This item shall include all materials, labor and testing to provide the completely operational closed loop system as shown on the plans. The radio interconnect system shall include the following components:

- a. Rack or Shelf Mounted RS-232 Frequency Hopping Spread Spectrum (FHSS) Radio
- b. Software for Radio Configuration (Configure Frequency and Hopping Patterns)
- c. Antennas (Omni Directional or Yagi Directional)
- d. Antenna Cables, LMR400, Low Loss. Max. 100-ft from controller cabinet to antenna
- e. Brackets, Mounting Hardware, and Accessories Required for Installation
- f. RS232 Data Cable for Connection from the radio to the local or master controller
- g. All other components required for a fully functional radio interconnect system

All controller cabinet modifications and other modifications to existing equipment that are required for the installation of the radio interconnect system components shall be included in this item.

The radio interconnect system may operate at 900Mhz (902-928) or 2.4 Ghz depending on the results of a site survey. The telemetry shall have an acceptable rate of transmission errors, time outs, etc. comparable to that of a hardwire system.

The proposed master controller and telemetry module shall be configured for use with the radio interconnect at a minimum rate of 9600 baud.

The radio interconnect system shall include all other components required for a complete and fully functional telemetry system and shall be installed in accordance to the manufacturers recommendations.

The following radio equipment is currently approved for use in Region One/District One: Encom Model 5100 and Intuicom Communicator II.

- (f) Emergency Vehicle Pre-Emption. All emergency vehicle preemption equipment (light detectors, light detector amplifiers, confirmation beacons, etc.) as shown on the temporary traffic signal plans shall be provided by the Contractor. It shall be the Contractor's responsibility to contact the municipality or fire district to verify the brand of emergency vehicle preemption equipment to be installed prior to the contract bidding. The equipment must be completely compatible with all components of the equipment currently in use by the Agency. All light operated systems shall operate at

a uniform rate of 14.035 hz  $\pm$ 0.002, or as otherwise required by the Engineer, and provide compatible operation with other light systems currently being operated in the District. All labor and material required to install and maintain the Emergency Vehicle Preemption installation shall be included in the item Temporary Traffic Signal Installation.

- (g) Vehicle Detection. All temporary traffic signal installations shall have vehicular detection installed as shown on the plans or as directed by the Engineer. Pedestrian push buttons shall be provided for all pedestrian signal heads/phases as shown on the plans or as directed by the Engineer. All approaches shall have vehicular detection provided by vehicle detection system as shown on the plans or as directed by the Engineer. Microwave vehicle sensors or video vehicle detection system shall be approved by IDOT prior to Contractor furnishing and installing. The Contractor shall install, wire, and adjust the alignment of the microwave vehicle sensor or video vehicle detection system in accordance to the manufacturer's recommendations and requirements. The Contractor shall be responsible for adjusting the alignment of the microwave vehicle sensor or video vehicle detection system for all construction staging changes and for maintaining proper alignment throughout the project. A representative of the approved control equipment vendor shall be present and assist the contractor in setting up and maintaining the microwave vehicle sensor or video vehicle detection system. An in-cabinet video monitor shall be provided with all video vehicle detection systems and shall be included in the item Temporary Traffic Signal Installation.
- (h) Uninterruptible Power Supply. All temporary traffic signal installations shall have Uninterruptible Power Supply (UPS). The UPS cabinet shall be mounted to the temporary traffic signal cabinet and meet the requirements of Uninterruptible Power Supply in Divisions 800 and 1000 of these specifications.
- (i) Signs. All existing street name and intersection regulatory signs shall be removed from existing poles and relocated to the temporary signal span wire. If new mast arm assembly and pole(s) and posts are specified for the permanent signals, the signs shall be relocated to the new equipment at no extra cost. Any intersection regulatory signs that are required for the temporary traffic signal shall be provided as shown on the plans or as directed by the Engineer. Relocation, removing, bagging and installing the regulatory signs for the various construction stages shall be provided as shown on the plans or as directed by the Engineer.
- (j) Energy Charges. The electrical utility energy charges for the operation of the temporary traffic signal installation shall be paid for by others if the installation replaces an existing signal. Otherwise charges shall be paid for under 109.05 of the Standard Specifications.

- (k) Maintenance. Maintenance shall meet the requirements of the Standard Specifications and MAINTENANCE OF EXISTING TRAFFIC SIGNAL INSTALLATION in Division 800 of these specifications. Maintenance of temporary signals and of the existing signals shall be included in the cost of the TEMPORARY TRAFFIC SIGNAL INSTALLATION pay item. When temporary traffic signals are to be installed at locations where existing signals are presently operating, the Contractor shall be fully responsible for the maintenance of the existing signal installation as soon as he begins any physical work on the Contract or any portion thereof. In addition, a minimum of seven (7) days prior to assuming maintenance of the existing traffic signal installation(s) under this Contract, the Contractor shall request that the Resident Engineer contact the Bureau of Traffic Operations (847) 705-4424 for an inspection of the installation(s).
- (l) Temporary Traffic Signals for Bridge Projects. Temporary Traffic Signals for bridge projects shall follow the State Standards, Standard Specifications, District One Traffic Signal Specifications and any plans for Bridge Temporary Traffic Signals included in the plans. The installation shall meet the Standard Specifications and all other requirements in this TEMPORARY TRAFFIC SIGNAL INSTALLATION specification. In addition all electric cable shall be aurally suspended, at a minimum height of 18 feet (5.5m) on temporary wood poles (Class 5 or better) of 45 feet (13.7 m) minimum height. The signal heads shall be span wire mounted or bracket mounted to the wood pole or as directed by the Engineer. The Controller cabinet shall be mounted to the wood pole as shown in the plans, or as directed by the Engineer. Microwave vehicle sensors or video vehicle detection system may be used in place of detector loops as approved by the Engineer.
- (m) Temporary Portable Traffic Signal for Bridge Projects.
1. Unless otherwise directed by the Engineer, temporary portable traffic signals shall be restricted to use on roadways of less than 8000 ADT that have limited access to electric utility service, shall not be installed on projects where the estimated need exceeds ten (10) weeks, and shall not be in operation during the period of November through March. The Contractor shall replace the temporary portable traffic signals with temporary span wire traffic signals noted herein at no cost to the contract if the bridge project or Engineer requires temporary traffic signals to remain in operation into any part of period of November through March. If, in the opinion of the engineer, the reliability and safety of the temporary portable traffic signal is not similar to that of a temporary span wire traffic signal installation, the Contractor shall replace the temporary portable traffic signals with temporary span wire traffic signals noted herein at no cost to the contract.

2. The controller and LED signal displays shall meet the Standard Specifications and all other requirements in this TEMPORARY TRAFFIC SIGNAL INSTALLATION specification.
3. Work shall be according to Article 701.18(b) of the Standard Specifications except as noted herein.
4. General.
  - a. The temporary portable bridge traffic signals shall be trailer-mounted units. The trailer-mounted units shall be set up securely and level. Each unit shall be self-contained and consist of two signal heads. The left signal head shall be mounted on a mast arm capable of extending over the travel lane. Each unit shall contain a solar cell system to facilitate battery charging. There shall be a minimum of 12 days backup reserve battery supply and the units shall be capable of operating with a 120 V power supply from a generator or electrical service.
  - b. All signal heads located over the travel lane shall be mounted at a minimum height of 17 feet (5m) from the bottom of the signal back plate to the top of the road surface. All far right signal heads located outside the travel lane shall be mounted at a minimum height of 8 feet (2.5m) from the bottom of the signal back plate to the top of the adjacent travel lane surface.
  - c. The long all red intervals for the traffic signal controller shall be adjustable up to 250 seconds in one-second increments.
  - d. As an alternative to detector loops, temporary portable bridge traffic signals may be equipped with microwave sensors or other approved methods of vehicle detection and traffic actuation.
  - e. All portable traffic signal units shall be interconnected using hardwire communication cable. Radio communication equipment may be used only with the approval of the Engineer. If radio communication is used, a site analysis shall be completed to ensure that there is no interference present that would affect the traffic signal operation. The radio equipment shall meet all applicable FCC requirements.
  - f. The temporary portable bridge traffic signal system shall meet the physical display and operational requirements of conventional traffic signals as specified in Part IV and other applicable portions of the currently adopted version of the Manual on Uniform Traffic Control Devices (MUTCD) and the Illinois MUTCD. The signal system shall be



designed to continuously operate over an ambient temperature range between -30 °F (-34 °C) and 120 °F (48 °C). When not being utilized to inform and direct traffic, portable signals shall be treated as nonoperating equipment according to Article 701.11.

- g. Basis of Payment. This work will be paid for according to Article 701.20(c).

Basis of Payment.

This work shall be paid for at the contract unit price each for TEMPORARY TRAFFIC SIGNAL INSTALLATION, TEMPORARY BRIDGE TRAFFIC SIGNAL INSTALLATION, or TEMPORARY PORTABLE BRIDGE TRAFFIC SIGNAL INSTALLATION, the price of which shall include all costs for the modifications required for traffic staging, changes in signal phasing as required in the Contract plans, microwave vehicle sensors, video vehicle detection system, any maintenance or adjustment to the microwave vehicle sensors/video vehicle detection system, the temporary wireless interconnect system complete, temporary fiber optic interconnect system complete, all material required, the installation and complete removal of the temporary traffic signal. Each intersection will be paid for separately.

**REMOVE EXISTING TRAFFIC SIGNAL EQUIPMENT.**

Add the following to Article 895.05 of the Standard Specifications:

The traffic signal equipment which is to be removed and is to become the property of the Contractor shall be disposed of outside the right-of-way at the Contractor's expense.

All equipment to be returned to the State shall be delivered by the Contractor to the State's Traffic Signal Maintenance Contractor's main facility. The Contractor shall contact the State's Electrical Maintenance Contractor to schedule an appointment to deliver the equipment. No equipment will be accepted without a prior appointment. All equipment shall be delivered within 30 days of removing it from the traffic signal installation. The Contractor shall provide 5 copies of a list of equipment that is to remain the property of the State, including model and serial numbers, where applicable. The Contractor shall also provide a copy of the Contract plan or special provision showing the quantities and type of equipment. Controllers and peripheral equipment from the same location shall be boxed together (equipment from different locations may not be mixed) and all boxes and controller cabinets shall be clearly marked or labeled with the location from which they were removed. If equipment is not returned with these requirements, it will be rejected by the State's Electrical Maintenance Contractor. The Contractor shall be responsible for the condition of the traffic signal equipment from the time Contractor takes maintenance of the signal installation until the acceptance of a receipt drawn by the State's Electrical Maintenance Contractor indicating the items have been returned in good condition.

The Contractor shall safely store and arrange for pick up or delivery of all equipment to be returned to agencies other than the State. The Contractor shall package the equipment and provide all necessary documentation as stated above.

Traffic signal equipment which is lost or not returned to the Department for any reason shall be replaced with new equipment meeting the requirements of these Specifications at no cost to the contract.

### **TRAFFIC SIGNAL PAINTING.**

#### Description.

This work shall include surface preparation, powder type painted finish application and packaging of new galvanized steel traffic signal mast arm poles and posts assemblies. All work associated with applying the painted finish shall be performed at the manufacturing facility for the pole assembly or post or at a painting facility approved by the Engineer. Traffic signal mast arm shrouds and post bases shall also be painted the same color as the pole assemblies and posts.

#### Surface Preparation.

All weld flux and other contaminants shall be mechanically removed. The traffic mast arms and post assemblies shall be degreased, cleaned, and air dried to assure all moisture is removed.

#### Painted Finish.

All galvanized exterior surfaces shall be coated with a urethane or triglycidyl isocyanurate (TGIC) polyester powder to a dry film thickness of 2.0 mils. Prior to application, the surface shall be mechanically etched by brush blasting (Ref. SSPC-SP7) and the zinc coated substrate preheated to 450 °F for a minimum one (1) hour. The coating shall be electrostatically applied and cured by elevating the zinc-coated substrate temperature to a minimum of 400 °F.

The finish paint color shall be one of the manufacturer's standard colors and shall be as selected by the local agency responsible for paint costs. The Contractor shall confirm, in writing, the color selection with the local responsible agency and provide a copy of the approval to the Engineer and a copy of the approval shall be included in the material catalog submittal.

Painting of traffic signal heads, pedestrian signal heads and controller cabinets is not included in this pay item.

Any damage to the finish after leaving the manufacturer's facility shall be repaired to the satisfaction of the Engineer using a method recommended by the manufacturer and approved by the Engineer. If while at the manufacturer's facility the finish is damaged, the finish shall be re-applied at no cost to the contract.

#### Warranty.

The Contractor shall furnish in writing to the Engineer, the paint manufacturer's standard warranty and certification that the paint system has been properly applied.

Packaging.

Prior to shipping, the poles and posts shall be wrapped in ultraviolet-inhibiting plastic foam or rubberized foam.

Basis of Payment.

This work shall be paid for at the contract unit price each for PAINT NEW MAST ARM AND POLE, UNDER 40 FEET (12.19 METER), PAINT NEW MAST ARM AND POLE, 40 FEET (12.19 METER) AND OVER, PAINT NEW COMBINATION MAST ARM AND POLE, UNDER 40 FEET (12.19 METER), PAINT NEW COMBINATION MAST ARM AND POLE, 40 FEET (12.19 METER) AND OVER, or PAINT NEW TRAFFIC SIGNAL POST of the length specified, which shall be payment in full for painting and packaging the traffic signal mast arm poles and posts described above including all shrouds, bases and appurtenances.

**ILLUMINATED STREET NAME SIGN**

Description.

This work shall consist of furnishing and installing a LED internally illuminated street name sign.

Materials.

Materials shall be in accordance with ILLUMINATED STREET NAME SIGN in Division 1000 of these specifications.

Installation.

The sign can be mounted on most steel mast arm poles. Mounting on aluminum mast arm pole requires supporting structural calculations. Some older or special designed steel mast arm poles may require structural evaluation to assure that construction of the mast arm pole is adequate for the proposed additional loading. Structural calculations and other supporting documentation as determined by the Engineer shall be provided by the contractor for review by the Department.

The sign shall be located on a steel traffic signal mast arm no further than 8-feet from the center of the pole to the center of the sign at a height of between 16 to 18-feet above traveled pavement. Mounting hardware shall be Pelco model SE-5015, utilizing stainless steel components.

Signs shall be installed such that they are not energized when traffic signals are powered by an alternate energy source such as a generator or uninterruptible power supply (UPS). The signs shall be connected to the generator or UPS bypass circuitry.

Basis of Payment.

This work will be paid for at the contract unit price each for ILLUMINATED STREET NAME SIGN, of the length specified which shall be payment in full for furnishing and installing the LED internally illuminated street sign, complete with circuitry and mounting hardware including photo cell, circuit breaker, fusing, relay, connections and cabling as shown on the plans for proper operation and installation.

## **RE-OPTIMIZE TRAFFIC SIGNAL SYSTEM.**

### Description.

This work shall consist of re-optimizing a closed loop traffic signal system according to the following Levels of work.

LEVEL I applies when improvements are made to an existing signalized intersection within an existing closed loop traffic signal system. The purpose of this work is to integrate the improvements to the subject intersection into the signal system while minimizing the impacts to the existing system operation. This type of work would be commonly associated with the addition of signal phases, pedestrian phases, or improvements that do not affect the capacity at an intersection.

LEVEL II applies when improvements are made to an existing signalized intersection within an existing closed loop traffic signal system and detailed analysis of the intersection operation is desired by the engineer, or when a new signalized or existing signalized intersection is being added to an existing system, but optimization of the entire system is not required. The purpose of this work is to optimize the subject intersection, while integrating it into the existing signal system with limited impact to the system operations. This item also includes an evaluation of the overall system operation, including the traffic responsive program.

For the purposes of re-optimization work, an intersection shall include all traffic movements operated by the subject controller and cabinet.

After the signal improvements are completed, the signal shall be re-optimized as specified by an approved Consultant who has previous experience in optimizing Closed Loop Traffic Signal Systems for District One of the Illinois Department of Transportation. The Contractor shall contact the Traffic Signal Engineer at (847) 705-4424 for a listing of approved Consultants. Traffic signal system optimization work, including fine-tuning adjustments of the optimized system, shall follow the requirements stated in the most recent IDOT District 1 SCAT Guidelines, except as note herein.

A listing of existing signal equipment, interconnect information, phasing data, and timing patterns may be obtained from the Department, if available and as appropriate. The existing SCAT Report is available for review at the District One office and if the Consultant provides blank computer disks, copies of computer simulation files for the existing optimized system and

a timing database that includes intersection displays will be made for the Consultant. The Consultant shall confer with the Traffic Signal Engineer prior to optimizing the system to determine if any extraordinary conditions exist that would affect traffic flows in the vicinity of the system, in which case, the Consultant may be instructed to wait until the conditions return to normal or to follow specific instructions regarding the optimization.

(a) LEVEL I Re-Optimization

1. The following tasks are associated with LEVEL I Re-Optimization.
  - a. Appropriate signal timings shall be developed for the subject intersection and existing timings shall be utilized for the rest of the intersections in the system.
  - b. Proposed signal timing plan for the new or modified intersection(s) shall be forwarded to IDOT for review prior to implementation.
  - c. Consultant shall conduct on-site implementation of the timings at the turn-on and make fine-tuning adjustments to the timings of the subject intersection in the field to alleviate observed adverse operating conditions and to enhance operations.
2. The following deliverables shall be provided for LEVEL I Re-Optimization.
  - a. Consultant shall furnish to IDOT a cover letter describing the extent of the re-optimization work performed.
  - b. Consultant shall furnish an updated intersection graphic display for the subject intersection to IDOT and to IDOT's Traffic Signal Maintenance Contractor.

(b) LEVEL II Re-Optimization

1. In addition to the requirements described in the LEVEL I Re-Optimization above, the following tasks are associated with LEVEL II Re-Optimization.
  - a. Traffic counts shall be taken at the subject intersection after the traffic signals are approved for operation by the Area Traffic Signal Operations Engineer. Manual turning movement counts shall be conducted from 6:30 a.m. to 9:30 a.m., 11:00 a.m. to 1:00 p.m., and 3:30 p.m. to 6:30 p.m. on a typical weekday from midday Monday to midday Friday. The turning movement counts shall identify cars, and single-unit, multi-unit heavy vehicles, and transit buses.
  - b. As necessary, the intersections shall be re-addressed and all system detectors reassigned in the master controller according to the current standard of District One.
  - c. Traffic responsive program operation shall be evaluated to verify proper pattern selection and lack of oscillation and a report of the operation shall be provided to IDOT.
2. The following deliverables shall be provided for LEVEL II Re-Optimization.
  - a. Consultant shall furnish to IDOT one (1) copy of a technical memorandum for the optimized system. The technical memorandum shall include the following elements:
    - (1) Brief description of the project

- (2) Printed copies of the analysis output from Synchro (or other appropriate, approved optimization software file)
  - (3) Printed copies of the traffic counts conducted at the subject intersection
- b. Consultant shall furnish to IDOT two (2) CDs for the optimized system. The CDs shall include the following elements:
- (1) Electronic copy of the technical memorandum in PDF format
  - (2) Revised Synchro files (or other appropriate, approved optimization software file) including the new signal and the rest of the signals in the closed loop system
  - (3) Traffic counts conducted at the subject intersection
  - (4) New or updated intersection graphic display file for the subject intersection
  - (5) The CD shall be labeled with the IDOT system number and master location, as well as the submittal date and the consultant logo. The CD case shall include a clearly readable label displaying the same information securely affixed to the side and front.

#### Basis of Payment.

This work shall be paid for at the contract unit price each for RE-OPTIMIZE TRAFFIC SIGNAL SYSTEM – LEVEL I or RE-OPTIMIZE TRAFFIC SIGNAL SYSTEM – LEVEL II, which price shall be payment in full for performing all work described herein per intersection. Following completion of the timings and submittal of specified deliverables, 100 percent of the bid price will be paid. Each intersection will be paid for separately.

#### **OPTIMIZE TRAFFIC SIGNAL SYSTEM.**

##### Description.

This work shall consist of optimizing a closed loop traffic signal system.

OPTIMIZE TRAFFIC SIGNAL SYSTEM applies when a new or existing closed loop traffic signal system is to be optimized and a formal Signal Coordination and Timing (SCAT) Report is to be prepared. The purpose of this work is to improve system performance by optimizing traffic signal timings, developing a time of day program and a traffic responsive program.

After the signal improvements are completed, the signal system shall be optimized as specified by an approved Consultant who has previous experience in optimizing Closed Loop Traffic Signal Systems for District One of the Illinois Department of Transportation. The Contractor shall contact the Traffic Signal Engineer at (847) 705-4424 for a listing of approved Consultants. Traffic signal system optimization work, including fine-tuning adjustments of the optimized system, shall follow the requirements stated in the most recent IDOT District 1 SCAT Guidelines, except as note herein.

A listing of existing signal equipment, interconnect information, phasing data, and timing patterns may be obtained from the Department, if available and as appropriate. The existing SCAT Report is available for review at the District One office and if the Consultant provides blank computer disks, copies of computer simulation files for the existing optimized system and a timing database that includes intersection displays will be made for the Consultant. The Consultant shall confer with the Traffic Signal Engineer prior to optimizing the system to determine if any extraordinary conditions exist that would affect traffic flows in the vicinity of the system, in which case, the Consultant may be instructed to wait until the conditions return to normal or to follow specific instructions regarding the optimization.

- (a) The following tasks are associated with OPTIMIZE TRAFFIC SIGNAL SYSTEM.
1. Appropriate signal timings and offsets shall be developed for each intersection and appropriate cycle lengths shall be developed for the closed loop signal system.
  2. Traffic counts shall be taken at all intersections after the permanent traffic signals are approved for operation by the Area Traffic Signal Operations Engineer. Manual turning movement counts shall be conducted from 6:30 a.m. to 9:30 a.m., 11:00 a.m. to 1:00 p.m., and 3:30 p.m. to 6:30 p.m. on a typical weekday from midday Monday to midday Friday. The turning movement counts shall identify cars, and single-unit and multi-unit heavy vehicles.
  3. As necessary, the intersections shall be re-addressed and all system detectors reassigned in the master controller according to the current standard of District One.
  4. A traffic responsive program shall be developed, which considers both volume and occupancy. A time-of-day program shall be developed for used as a back-up system.
  5. Proposed signal timing plan for the new or modified intersection shall be forwarded to IDOT for review prior to implementation.
  6. Consultant shall conduct on-site implementation of the timings and make fine-tuning adjustments to the timings in the field to alleviate observed adverse operating conditions and to enhance operations.
  7. Speed and delay studies shall be conducted during each of the count periods along the system corridor in the field before and after implementation of the proposed timing plans for comparative evaluations. These studies should utilize specialized electronic timing and measuring devices.
- (b) The following deliverables shall be provided for OPTIMIZE TRAFFIC SIGNAL SYSTEM.
1. Consultant shall furnish to IDOT one (1) copy of a SCAT Report for the optimized system. The SCAT Report shall include the following elements:

<b>Cover Page in color showing a System Map</b>	
<b>Figures</b>	
1.	System overview map – showing system number, system schematic map with numbered system detectors, oversaturated movements, master location, system phone number, cycle lengths, and date of completion.
2.	General location map in color – showing signal system location in the metropolitan area.
3.	Detail system location map in color – showing cross street names and local controller addresses.
4.	Controller sequence – showing controller phase sequence diagrams.
<b>Table of Contents</b>	
<b>Tab 1: Final Report</b>	
1.	Project Overview
2.	System and Location Description (Project specific)
3.	Methodology
4.	Data Collection
5.	Data Analysis and Timing Plan Development
6.	Implementation
a.	Traffic Responsive Programming (Table of TRP vs. TOD Operation)
7.	Evaluation
a.	Speed and Delay runs
<b>Tab 2. Turning Movement Counts</b>	
1.	Turning Movement Counts (Showing turning movement counts in the intersection diagram for each period, including truck percentage)
<b>Tab 3. Synchro Analysis</b>	
1.	AM: Time-Space diagram in color, followed by intersection Synchro report (Timing report) summarizing the implemented timings.
2.	Midday: same as AM
3.	PM: same as AM
<b>Tab 4: Speed, Delay Studies</b>	
1.	Summary of before and after runs results in two (2) tables showing travel time and delay time.
2.	Plot of the before and after runs diagram for each direction and time period.



**Tab 5: Environmental Report**

1. Environmental impact report including gas consumption, NO<sub>2</sub>, HCCO, improvements.

**Tab 6: Electronic Files**

1. Two (2) CDs for the optimized system. The CDs shall include the following elements:
  - a. Electronic copy of the SCAT Report in PDF format
  - b. Copies of the Synchro files for the optimized system
  - c. Traffic counts for the optimized system
  - d. New or updated intersection graphic display files for each of the system intersections and the system graphic display file including system detector locations and addresses.

Basis of Payment.

The work shall be paid for at the contract unit each for OPTIMIZE TRAFFIC SIGNAL SYSTEM, which price shall be payment in full for performing all work described herein for the entire traffic signal system. Following the completion of traffic counts, 25 percent of the bid price will be paid. Following the completion of the Synchro analysis, 25 percent of the bid price will be paid. Following the setup and fine tuning of the timings, the speed-delay study, and the TRP programming, 25 percent of the bid price will be paid. The remaining 25 percent will be paid when the system is working to the satisfaction of the engineer and the report and CD have been submitted.

**TEMPORARY TRAFFIC SIGNAL TIMINGS**

Description.

This work shall consist of developing and maintaining appropriate traffic signal timings for the specified intersection for the duration of the temporary signalized condition, as well as impact to existing traffic signal timings caused by detours or other temporary conditions.

All timings and adjustments necessary for this work shall be performed by an approved Consultant who has previous experience in optimizing Closed Loop Traffic signal Systems for District One of the Illinois Department of Transportation. The Contractor shall contact the Traffic Signal Engineer at (847) 705-4424 for a listing of approved Consultants.

The following tasks are associated with TEMPORARY TRAFFIC SIGNAL TIMINGS.

- (a) Consultant shall attend temporary traffic signal inspection (turn-on) and/or detour meeting and conduct on-site implementation of the traffic signal timings. Make fine-tuning adjustments to the timings in the field to alleviate observed adverse operating conditions and to enhance operations.

- (b) Consultant shall provide monthly observation of traffic signal operations in the field.
- (c) Consultant shall provide on-site consultation and adjust timings as necessary for construction stage changes, temporary traffic signal phase changes, and any other conditions affecting timing and phasing, including lane closures, detours, and other construction activities.
- (d) Consultant shall make timing adjustments and prepare comment responses as directed by the Area Traffic Signal Operations Engineer.

Basis of Payment.

The work shall be paid for at the contract unit price each for TEMPORARY TRAFFIC SIGNAL TIMINGS, which price shall be payment in full for performing all work described herein per intersection. When the temporary traffic signal installation is turned on and/or detour implemented, 50 percent of the bid price will be paid. The remaining 50 percent of the bid price will be paid following the removal of the temporary traffic signal installation and/or detour.

**MODIFYING EXISTING CONTROLLER CABINET.**

The work shall consist of modifying an existing controller cabinet as follows:

- (a) Uninterruptible Power Supply (UPS). The addition of uninterruptible power supply (UPS) to an existing controller cabinet could require the relocation of the existing controller cabinet items to allow for the installation of the uninterruptible power supply (UPS) components inside the existing controller cabinet as outlined under Sections 862 and 1074.04 of the Standard Specifications.
- (b) Light Emitting Diode (LED) Signal Heads, Light Emitting Diode (LED) Optically Programmed Signal Heads and Light Emitting Diode (LED) Pedestrian Signal Heads. The contractor shall verify that the existing load switches meet the requirements of Section 1074.03(5)(b)(2) of the Standard Specifications and the recommended load requirements of the light emitting diode (LED) signal heads that are being installed at the existing traffic signal. If any of the existing load switches do not meet these requirements, they shall be replaced, as directed by the Engineer.
- (c) Light Emitting Diode (LED), Signal Head, Retrofit. The contractor shall verify that the existing load switches meet the requirements of Section 1074.03(2) of the Standard Specifications and the recommended load requirements of light emitting diode (LED) traffic signal modules, pedestrian signal modules, and pedestrian countdown signal modules as specified in the plans. If any of the existing load switches do not meet these requirements, they shall be replaced, as directed by the Engineer.

Basis of Payment.

Modifying an existing controller cabinet will be paid for at the contract unit price per each for MODIFY EXISTING CONTROLLER CABINET. This shall include all material and labor required to complete the work as described above, the removal and disposal of all items removed from the controller cabinet, as directed by the Engineer. The equipment for the Uninterruptible Power Supply (UPS) and labor to install it in the existing controller cabinet shall be included in the pay item Uninterruptible Power Supply. Modifying an existing controller will be paid for at the contract unit price per each for MODIFY EXISTING CONTROLLER, per Sections 895.04 and 895.08 of the Standard Specifications.

**DIVISION 1000 MATERIALS**

**PEDESTRIAN PUSH-BUTTON.**

Revise Article 1074.02(a) of the Standard Specifications to read:

The pedestrian push-button housing shall be constructed of aluminum alloy according to ASTM B 308 6061-T6 and powder coated yellow, unless otherwise noted on the plans. The housing shall be furnished with suitable mounting hardware.

Revise Article 1074-02(e) of the Standard Specifications to read:

Stations shall be designed to be mounted directly to a post, mast arm pole or wood pole. The station shall be aluminum and shall accept a 3 inch (75mm) round push-button assembly and a regulatory pedestrian instruction sign according to MUTCD, sign series R10-3e 9 x 15 inch sign with arrow(s) for a count-down pedestrian signal. The pedestrian station size without count-down pedestrian signals shall accommodate a MUTCD sign series R10-3b or R10-3d 9 x 12 inch sign with arrow(s).

Add the following to Article 1074.02(a) of the Standard Specifications:

- (f) Location. Pedestrian push-buttons and stations shall be mounted directly to a post, mast arm pole or wood pole as shown on the plans and shall be fully accessible from a paved or concrete surface. See the District's Detail sheets for orientation and mounting details.

**CONTROLLER CABINET AND PERIPHERAL EQUIPMENT.**

Add the following to Article 1074.03 of the Standard Specifications:

- (a) (6) Cabinets shall be designed for NEMA TS2 Type 1 operation. All cabinets shall be pre-wired for a minimum of eight (8) phases of vehicular, four (4) phases of pedestrian and four (4) phases of overlap operation.
- (b) (5) Cabinets – Provide 1/8" (3.2 mm) thick unpainted aluminum alloy 5052-H32. The surface shall be smooth, free of marks and scratches. All external hardware shall be stainless steel.
- (b) (6) Controller Harness – Provide a TS2 Type 2 “A” wired harness in addition to the TS2 Type 1 harness.
- (b) (7) Surge Protection – Plug-in type EDCO SHA-1250.
- (b) (8) BIU – Containment screw required.
- (b) (9) Transfer Relays – Solid state or mechanical flash relays are acceptable.
- (b) (10) Switch Guards – All switches shall be guarded.
- (b) (11) Heating – One (1) 200 watt, thermostatically-controlled, Hoffman electric heater.
- (b) (12) Lighting – One (1) LED Panel shall be placed inside the cabinet top panel and one (1) LED Panel shall be placed on each side of the pull-out drawer/shelf assembly located beneath the controller support shelf. The LED Panels shall be controlled by a wall switch. Relume Traffic Control Box LED Panels and power supply.
- (b) (13) The cabinet shall be equipped with a pull-out drawer/shelf assembly. A 1 ½ inch (38mm) deep drawer shall be provided in the cabinet, mounted directly beneath the controller support shelf. The drawer shall have a hinged top cover and shall be capable of accommodating one (1) complete set of cabinet prints and manuals. This drawer shall support 50 lbs. (23 kg) in weight when fully extended. The drawer shall open and close smoothly. Drawer dimensions shall make maximum use of available depth offered by the controller shelf and be a minimum of 24 inches (610mm) wide.
- (b) (14) Plan & Wiring Diagrams – 12” x 16” (3.05mm x 4.06mm) moisture sealed container attached to door.
- (b) (15) Detector Racks – Fully wired and labeled for four (4) channels of emergency vehicle pre-emption and sixteen channels (16) of vehicular operation.
- (b) (16) Field Wiring Labels – All field wiring shall be labeled.
- (b) (17) Field Wiring Termination – Approved channel lugs required.
- (b) (18) Power Panel – Provide a nonconductive shield.
- (b) (19) Circuit Breaker – The circuit breaker shall be sized for the proposed load but shall not be rated less than 30 amps.
- (b) (20) Police Door – Provide wiring and termination for plug in manual phase advance switch.
- (b) (21) Railroad Pre-Emption Test Switch – Eaton 8830K13 SHA 1250.

**RAILROAD, FULL-ACTUATED CONTROLLER AND CABINET.**

Controller shall comply with Article 1073.01 as amended in these Traffic Signal Special Provisions.

Controller Cabinet and Peripheral Equipment shall comply with Article 1074.03 as amended in these Traffic Signal Special Provisions.

Add the following to Articles 1073.01 (c) (2) and 1074.03 (a) (5) (e) of the Standard Specifications:

Controllers and cabinets shall be new and NEMA TS2 Type 1 design.

A method of monitoring and/or providing redundancy to the railroad preemptor input to the controller shall be included as a component of the Railroad, Full Actuated Controller and Cabinet installation and be verified by the traffic signal equipment supplier prior to installation.

Railroad interconnected controllers and cabinets shall be assembled only by an approved traffic signal equipment supplier. All railroad interconnected (including temporary railroad interconnect) controllers and cabinets shall be new, built, tested and approved by the controller equipment vendor, in the vendor's District One facility, prior to field installation. The vendor shall provide the technical equipment and assistance as required by the Engineer to fully test this equipment.

**UNINTERRUPTIBLE POWER SUPPLY (UPS).**

Revise Article 1074.04(a)(1) of the Standard Specifications to read:

The UPS shall be line interactive and provide voltage regulation and power conditioning when utilizing utility power. The UPS shall be sized appropriately for the intersection's normal traffic signal operating connected load, plus 20 percent (20%). The total connected traffic signal load shall not exceed the published ratings for the UPS. The UPS shall provide a minimum of six (6) hours of normal operation run-time for signalized intersections with LED type signal head optics at 77 °F (25 °C) (minimum 700 W/1000 VA active output capacity, with 90 percent minimum inverter efficiency).

Revise the first paragraph of Article 1074.04(a)(3) of the Standard Specifications to read:

The UPS shall have a minimum of four (4) sets of normally open (NO) and normally closed (NC) single-pole double-throw (SPDT) relay contact closures, available on a panel mounted terminal block or locking circular connectors, rated at a minimum 120 V/1 A, and labeled so as to identify each contact according to the plans.

Revise Article 1074.04(a)(10) of the Standard Specifications to read:

The UPS shall be compatible with the District's approved traffic controller assemblies utilizing NEMA TS 1 or NEMA TS 2 controllers and cabinet components for full time operation.

Revise Article 1074.04(a)(17) of the Standard Specifications to read:

When the intersection is in battery backup mode, the UPS shall bypass all internal cabinet lights, ventilation fans, cabinet heaters, service receptacles, any lighted street name signs, any automated enforcement equipment and any other devices directed by the Engineer.

Revise Article 1074.04(b)(2)b of the Standard Specifications to read:

Batteries, inverter/charger and power transfer relay shall be housed in a separate NEMA Type 3R cabinet. The cabinet shall be Aluminum alloy, 5052-H32, 0.125-inch thick and have a natural mill finish.

Revise Article 1074.04(b)(2)c of the Standard Specifications to read:

No more than three batteries shall be mounted on individual shelves for a cabinet housing six batteries and no more than four batteries per shelf for a cabinet housing eight batteries.

Revise Article 1074.04(b)(2)e of the Standard Specifications to read:

The battery cabinet housing shall have the following nominal outside dimensions: a width of 25 in. (785 mm), a depth of 16 in. (440 mm), and a height of 41 to 48 in. (1.1 to 1.3 m). Clearance between shelves shall be a minimum of 10 in. (250 mm).

UPS

End of paragraph 1074.04(b) (2)e

The door shall be equipped with a two position doorstop, one a 90° and one at 120°.

Revise Article 1074.04(b)(2)g of the Standard Specifications to read:

The door shall open to the entire cabinet, have a neoprene gasket, an Aluminum continuous piano hinge with stainless steel pin, and a three point locking system. The cabinet shall be provided with a main door lock which shall operate with a traffic industry conventional No. 2 key. Provisions for padlocking the door shall be provided.

Add the following to Article 1074.04(b)(2) of the Standard Specifications:

j. The battery cabinet shall have provisions for an external generator connection.

Add the following to Article 1074.04(c) of the Standard Specifications:

- (8) The UPS shall include a tip or kill switch installed in the battery cabinet, which shall completely disconnect power from the UPS when the switch is manually activated.
- (9) The UPS shall incorporate a flanged electric generator inlet for charging the batteries and operating the UPS. The generator connector shall be male type, twist-lock, rated as 15A, 125VAC with a NEMA L5-15P configuration and weatherproof lift cover plate (Hubbell model HBL4716C). Access to the generator inlet shall be from a secured weatherproof lift cover plate or behind a locked battery cabinet police panel.

Battery System.

Revise Article 1074.04(d)(3) of the Standard Specifications to read:

All batteries supplied in the UPS shall be either gel cell or AGM type, deep cycle, completely sealed, prismatic leadcalcium based, silver alloy, valve regulated lead acid (VRLA) requiring no maintenance. All batteries in a UPS installation shall be the same type; mixing of gel cell and AGM types within a UPS installation is not permitted.

Revise Article 1074.04(d)(4) of the Standard Specifications to read:

Batteries shall be certified by the manufacturer to operate over a temperature range of -13 to 160 °F (-25 to + 71 °C) for gel cell batteries and -40 to 140 °F (-40 to + 60 °C) for AGM type batteries.

Add the following to Article 1074.04(d) of the Standard Specifications:

- (9) The UPS shall consist of an even number of batteries that are capable of maintaining normal operation of the signalized intersection for a minimum of six hours. Calculations shall be provided showing the number of batteries of the type supplied that are needed to satisfy this requirement. A minimum of four batteries shall be provided.

Add the following to the Article 1074.04 of the Standard Specifications:

- (e) Warranty\_ The warranty for an uninterruptible power supply (UPS) shall cover a minimum of two years from date the equipment is placed in operation; however, the batteries of the UPS shall be warranted for full replacement for a minimum of five years from the date the traffic signal and UPS are placed into service.

**ELECTRIC CABLE.**

Delete “or stranded, and No. 12 or” from the last sentence of Article 1076.04 (a) of the Standard Specifications.

Add the following to the Article 1076.04(d) of the Standard Specifications:

Service cable may be single or multiple conductor cable.

#### **TRAFFIC SIGNAL POST.**

Add the following to Article 1077.01 (d) of the Standard Specifications:

All posts and bases shall be steel and hot dipped galvanized. If the Department approves painting, powder coating by the manufacturer will be required over the galvanization in accordance with TRAFFIC SIGNAL PAINTING in Division 800 of these specifications.

#### **PEDESTRIAN PUSH-BUTTON POST.**

Add the following to Article 1077.02(b) of the Standard Specifications:

All posts and bases shall be steel and hot-dipped galvanized. If the Department approves painting, powder coating by the manufacturer will be required over the galvanization in accordance with Traffic Signal Painting in Division 800 of these specifications.

#### **MAST ARM ASSEMBLY AND POLE.**

Add the following to Article 1077.03 (a) of the Standard Specifications:

Traffic signal mast arms shall be one piece construction, unless otherwise approved by the Engineer. All poles shall be galvanized. If the Department approves painting, powder coating by the manufacturer will be required over the galvanization in accordance with with TRAFFIC SIGNAL PAINTING in Division 800 of these specifications.

The shroud shall be of sufficient strength to deter pedestrian and vehicular damage. The shroud shall be constructed and designed to allow air to circulate throughout the mast arm but not allow infestation of insects or other animals, and such that it is not hazardous to probing fingers and feet. All mounting hardware shall be stainless steel.

#### **LIGHT EMITTING DIODE (LED) TRAFFIC SIGNAL HEAD.**

Add the following to Section 1078 of the Standard Specifications:



General.

All signal and pedestrian heads shall provide 12" (300 mm) displays with glossy black polycarbonate housings. All signal heads shall have a "Tunnel" visor for each section. "Baseball" cap visors shall not be accepted. All tunnel visors shall be black polycarbonate.

All head housings shall be the same color black at the intersection. For new signalized intersections and existing signalized intersections where all signal and/or pedestrian heads are being replaced, the proposed head housings shall be black. Where only selected heads are being replaced, the proposed head housing color (yellow or black) shall match existing head housings.

Connecting hardware and mounting brackets shall be polycarbonate (black). A corrosion resistant anti-seize lubricant shall be applied to all metallic mounting bracket joints, and shall be visible to the inspector at the signal turn-on. Post top mounting collars are required on all posts, and shall be constructed of the same material as the brackets.

Pedestrian signal heads shall be furnished with the international symbolic "Walking Person" and "Upraised Palm" displays. Egg crate sun shields are not permitted.

Signal heads shall be positioned according to the "District One Standard Traffic Signal Design Details."

LED signal heads (All Face and Section Quantities), (All Mounting Types) shall conform fully to the requirements of Articles 1078.01 and 1078.02 of the Standard Specifications amended herein.

1. The LED signal modules shall be replaced or repaired if an LED signal module fails to function as intended due to workmanship or material defects within the first 60 months from the date of delivery. LED signal modules which exhibit luminous intensities less than the minimum values specified in Table 1 of the ITE Vehicle Traffic Control Signal Heads: Light Emitting Diode (LED) Circular Signal Supplement (June 27, 2005) [VTSCH], or applicable successor ITE specifications, or show signs of entrance of moisture or contaminants within the first 60 months of the date of delivery shall be replaced or repaired. The manufacturer's written warranty for the LED signal modules shall be dated, signed by an Officer of the company and included in the product submittal to the State.

(a) Physical and Mechanical Requirements

1. Modules can be manufactured under this specification for the following faces:
  - a. 12 inch (300 mm) circular, multi-section
  - b. 12 inch (300 mm) arrow, multi-section
  - c. 12 inch (300 mm) pedestrian, 2 sections
2. The maximum weight of a module shall be 4 lbs. (1.8 kg).

3. Each module shall be a sealed unit to include all parts necessary for operation (a printed circuit board, power supply, a lens and gasket, etc.), and shall be weather proof after installation and connection.
4. Material used for the lens and signal module construction shall conform to ASTM specifications for the materials.
5. The lens of the module shall be tinted with a wavelength-matched color to reduce sun phantom effect and enhance on/off contrast. The tinting shall be uniform across the lens face. Polymeric lens shall provide a surface coating or chemical surface treatment applied to provide abrasion resistance. The lens of the module shall be integral to the unit, convex with a smooth outer surface and made of plastic. The lens shall have a textured surface to reduce glare.
6. The use of tinting or other materials to enhance ON/OFF contrasts shall not affect chromaticity and shall be uniform across the face of the lens.
7. Each module shall have a symbol of the type of module (i.e. circle, arrow, etc.) in the color of the module. The symbol shall be 1 inch (25.4 mm) in diameter. Additionally, the color shall be written out in 1/2 inch (12.7mm) letters next to the symbol.

(b) Photometric Requirements

1. The minimum initial luminous intensity values for the modules shall conform to the values in Table 1 of the VTCSH (2005) for circular signal indications, and as stated in Table 3 of these specifications for arrow and pedestrian indications at 25 °C.
2. The modules shall meet or exceed the illumination values stated in Articles 1078.01 and 1078.02 the Standard Specifications for circular signal indications, and Table 3 of these specifications for arrow and pedestrian indications, throughout the useful life based on normal use in a traffic signal operation over the operating temperature range.
3. The measured chromaticity coordinates of the modules shall conform to the chromaticity requirements of Section 4.2 of the VTCSH (2005) or applicable successor ITE specifications.
4. The LEDs utilized in the modules shall be AlInGaP technology for red, yellow, Portland orange (pedestrian) and white (pedestrian) indications, and GaN for green indications, and shall be the ultra bright type rated for 100,000 hours of continuous operation from -40 °C to +74 °C.

(c) Electrical

1. Maximum power consumption for LED modules is per Table 2.
2. Operating voltage of the modules shall be 120 VAC. All parameters shall be measured at this voltage.
3. The modules shall be operationally compatible with currently used controller assemblies (solid state load switches, flashers, and conflict monitors).
4. When a current of 20 mA AC (or less) is applied to the unit, the voltage read across the two leads shall be 15 VAC or less.
5. The LED modules shall provide constant light output under power. Modules with dimming capabilities shall have the option disabled or set on a non-dimming operation.
6. The individual LEDs shall be wired such that a catastrophic loss or the failure of one or more LED will not result in the loss of the entire module.

(d) Retrofit Traffic Signal Module

1. The following specification requirements apply to the Retrofit module only. All general specifications apply unless specifically superseded in this section.
2. Retrofit modules can be manufactured under this specification for the following faces:
  - a. 12 inch (300 mm) circular, multi-section
  - b. 12 inch (300 mm) arrow, multi-section
  - c. 12 inch (300 mm) pedestrian, 2 sections
3. Each Retrofit module shall be designed to be installed in the doorframe of a standard traffic signal housing. The Retrofit module shall be sealed in the doorframe with a one-piece EPDM (ethylene propylene rubber) gasket.
4. The maximum weight of a Retrofit module shall be 4 lbs. (1.8 kg).
5. Each Retrofit module shall be a sealed unit to include all parts necessary for operation (a printed circuit board, power supply, a lens and gasket, etc.), and shall be weather proof after installation and connection.
6. Electrical conductors for modules, including Retrofit modules, shall be 39.4 inches (1m) in length, with quick disconnect terminals attached.

7. The lens of the Retrofit module shall be integral to the unit, shall be convex with a smooth outer surface and made of plastic or of glass.
- (e) The following specification requirements apply to the 12 inch (300 mm) arrow module only. All general specifications apply unless specifically superseded in this section.
1. The arrow module shall meet specifications stated in Section 9.01 of the Equipment and Material Standards of the Institute of Transportation Engineers (November 1998) [ITE Standards], Chapter 2 (Vehicle Traffic Control Signal Heads) or applicable successor ITE specifications for arrow indications.
  2. The LEDs arrow indication shall be a solid display with a minimum of three (3) outlining rows of LEDs and at least one (1) fill row of LEDs.
- (f) The following specification requirement applies to the 12 inch (300 mm) programmed visibility (PV) module only. All general specifications apply unless specifically superseded in this section.
1. The LED module shall be a module designed and constructed to be installed in a programmed visibility (PV) signal housing without modification to the housing.
- (g) The following specification requirements apply to the 12 inch (300 mm) Pedestrian module only. All general specifications apply unless specifically superseded in this section.
1. Each pedestrian signal LED module shall provide the ability to actuate the solid upraised hand and the solid walking person on one 12 inch (300mm) section.
  2. Two (2) pedestrian sections shall be installed. The top section shall be wired to illuminate only the upraised hand and the bottom section shall be the walking man.
  3. "Egg Crate" type sun shields are not permitted. All figures must be a minimum of 9 inches (225mm) in height and easily identified from a distance of 120-feet (36.6m).

**LIGHT EMITTING DIODE (LED) PEDESTRIAN COUNTDOWN SIGNAL HEAD.**

Add the following to Article 1078.02 of the Standard Specifications:

General.

1. The module shall operate in one mode: Clearance Cycle Countdown Mode Only. The countdown module shall display actual controller programmed clearance cycle and shall start counting when the flashing clearance signal turns on and shall countdown to "0" and

turn off when the steady Upraised Hand (symbolizing Don't Walk) signal turns on. Module shall not have user accessible switches or controls for modification of cycle.

2. At power on, the module shall enter a single automatic learning cycle. During the automatic learning cycle, the countdown display shall remain dark.
3. The module shall re-program itself if it detects any increase or decrease of Pedestrian Timing. The counting unit will go blank once a change is detected and then take one complete pedestrian cycle (with no counter during this cycle) to adjust its buffer timer.
4. The module shall allow for consecutive cycles without displaying the steady Upraised Hand.
5. The module shall recognize preemption events and temporarily modify the crossing cycle accordingly.
6. If the controller preempts during the Walking Person (symbolizing Walk), the countdown will follow the controller's directions and will adjust from Walking Person to flashing Upraised Hand. It will start to count down during the flashing Upraised Hand.
7. If the controller preempts during the flashing Upraised Hand, the countdown will continue to count down without interruption.
8. The next cycle, following the preemption event, shall use the correct, initially programmed values.
9. If the controller output displays Upraised Hand steady condition and the unit has not arrived to zero or if both the Upraised Hand and Walking Person are dark for some reason, the unit suspends any timing and the digits will go dark.
10. The digits will go dark for one pedestrian cycle after loss of power of more than 1.5 seconds.
11. The countdown numerals shall be two (2) "7 segment" digits forming the time display utilizing two rows of LEDs.
12. The LED module shall meet the requirements of the Institute of Transportation Engineers (ITE) LED purchase specification, "Pedestrian Traffic Control Signal Indications - Part 2: LED Pedestrian Traffic Signal Modules," or applicable successor ITE specifications, except as modified herein.
13. The LED modules shall provide constant light output under power. Modules with dimming capabilities shall have the option disabled or set on a non-dimming operation.

14. In the event of a power outage, light output from the LED modules shall cease instantaneously.
15. The LEDs utilized in the modules shall be AlInGaP technology for Portland Orange (Countdown Numerals and Upraised Hand) and GaN technology for Lunar White (Walking Person) indications.
16. The individual LEDs shall be wired such that a catastrophic loss or the failure of one or more LED will not result in the loss of the entire module.

#### Electrical.

1. Maximum power consumption for LED modules is 29 watts.
2. The measured chromaticity shall remain unchanged over the input line voltage range listed of 80 VAC to 135 VAC.

#### **TRAFFIC SIGNAL BACKPLATE.**

Delete 1<sup>st</sup> sentence of Article 1078.03 of the Standard Specifications and add “All backplates shall be aluminum and louvered”.

Add the following to the third paragraph of Article 1078.03 of the Standard Specifications. The reflective backplate shall not contain louvers.

Delete second sentence of the fourth paragraph of Article 1078.03 of the Standard Specifications.

Add the following to the fourth paragraph of Article 1078.03 of the Standard Specifications:

When retro reflective sheeting is specified, it shall be Type ZZ sheeting according to Article 1091.03 and applied in preferred orientation for the maximum angularity according to the manufacturer’s recommendations. The retro reflective sheeting shall be installed under a controlled environment at the manufacturer/supplier before shipment to the contractor. The aluminum backplate shall be prepared and cleaned, following recommendations of the retro reflective sheeting manufacturer.

#### **INDUCTIVE LOOP DETECTOR.**

Add the following to Article 1079.01 of the Standard Specifications:

Contracts requiring new cabinets shall provide for rack mounted detector amplifier cards. Detector amplifiers shall provide LCD displays with loop frequency, inductance, and change of inductance readings.

### **ILLUMINATED SIGN, LIGHT EMITTING DIODE.**

Delete last sentence of Article 1084.01(a) and add “Mounting hardware shall be black polycarbonate or galvanized steel and similar to mounting Signal Head hardware and bracket specified herein and shall provide tool free access to the interior.”

Revise the second paragraph of Article 1084.01(a) to read:

The exterior surface of the housing shall be powder coated black and shop painted with one coat of zinc-chromate primer and two coats of exterior enamel. The housing shall be the same color (yellow or black) to match the existing or proposed signal heads. The painting shall be according to Section 851.

Add the following to Article 1084.01 (b) of the Standard Specifications:

The message shall be formed by rows of LEDs. The sign face shall be 24 inches (600 mm) by 24 inches (600 mm).

Add the following to Article 1084.01 of the Standard Specifications:

- (e) The light emitting diode (LED) blank out signs shall be manufactured by National Sign & Signal Company, and consist of a weatherproof housing and door, LEDs and transformers.

### **ILLUMINATED STREET NAME SIGN**

The illuminate street name sign shall be as follows.

- (a) Description.  
The LEDs shall be white in color and utilize InGaN or UV thermally efficient technology. The LED Light Engines shall be designed to fit inside a standard fluorescent illuminated street sign housing in lieu of fluorescent lamps and ballasts or a slim line type housing. The LED internally-illuminated street name sign shall display the designated street name clearly and legibly in the daylight hours without being energized and at night when energized. The sign assembly shall consist of a four-, six-, or eight-foot aluminum housing. White translucent 3M DG<sup>3</sup> reflective sheeting sign faces with the street name applied in 3M/Scotchlite Series 1177 transparent green shall be installed in hinged doors on the side of

the sign for easy access to perform general cleaning and maintenance operations.  
Illumination shall occur with LED Light Engine as specified.

(b) Environmental Requirements.

The LED lamp shall be rated for use in the ambient operating temperature range of -40 to +50°C (-40 to +122°F) for storage in the ambient temperature range of -40 to +75°C (-40 to +167°F).

(c) General Construction.

1. The LED Light Engine shall be a single, self-contained device, for installation in an existing street sign housing. The power supply must be designed to fit and mounted on the inside wall at one end of the street sign housing. The LED Light Engine shall be mounted within the inner top portion of the housing and no components of the light source shall sit between the sign faces.
2. The assembly and manufacturing processes of the LED Light Engine shall be designed to ensure that all LED and electronic components are adequately supported to withstand mechanical shocks and vibrations in compliance with the specifications of the ANSI, C136.31-2001 standards.

(d) Mechanical Construction.

1. The sign shall be constructed using a weatherproof, aluminum housing consisting of an extruded aluminum top with a minimum thickness of .140" x 10 3/4" deep (including the drip edge). The extruded aluminum bottom is .094" thick x 5 7/8" deep. The ends of the housing shall be cast aluminum with a minimum thickness of .250". A six-foot sign shall be 72 5/8" long and 22 5/16" tall and not weigh more than 77 pounds. An eight-foot sign shall be 96 5/8" long and 22 5/16" tall and not weigh more than 92 pounds. All corners are continuous TIG (Tungsten Inert Gas) welded to provide a weatherproof seal around the entire housing.
2. The door shall be constructed of extruded aluminum. Two corners are continuous TIG welded with the other two screwed together to make one side of the door removable for installation of the sign face. The door is fastened to the housing on the bottom by a full length, .040" x 1 1/8" open stainless steel hinge. The door shall be held secure onto a 1" wide by 5/32" thick neoprene gasket by three (six total for two-way sign) quarter-turn fasteners to form a watertight seal between the door and the housing.
3. The sign face shall be constructed of .125" white translucent polycarbonate. The letters shall be 8" upper case and 6" lower case. The sign face legend background shall consist of 3M/Scotchlite Series 4090T 3M translucent DG<sup>3</sup> white VIP (Visual Impact Performance) diamond grade sheeting (ATSM Type 9) and 3M/Scotchlite Series 1177 transparent green acrylic EC (electronic cut-able) film applied to the front of the sign



face. The legend shall be framed by a white polycarbonate border. A logo symbol and/or name of the community may be included with approval of the Engineer.

4. All surfaces of the sign shall powder coated black and primed in accordance to industry standards before receiving appropriate color coats of industrial enamel.
5. All fasteners and hardware shall be corrosion resistant stainless steel. No tools are required for routine maintenance.
6. All wiring shall be secured by insulated wire compression nuts.
7. A wire entrance junction box shall be supplied with the sign assembly. The box may be supplied mounted to the exterior or interior of the sign and provide a weather tight seal.
8. A photoelectric switch shall be mounted in the control cabinet to control lighting functions for day and night display. Each sign shall be individually fused.
9. Brackets and Mounting: LED internally-illuminated street name signs will be factory drilled to accommodate mast arm two-point support assembly mounting brackets.

(e) Electrical.

1. Photocell shall be rated 105-305V, turn on at 1.5 fcs. with a 3-5 second delay. A manufacturer's warranty of six (6) years shall be provided. Power consumption shall be no greater than 1 watt at 120V.
2. The LED Light Engine shall operate from a 60 +/- 3 cycle AC line power over a voltage range of 80 to 135 Vac rms. Fluctuations in line voltage over the range of 80 to 135 Vac shall not affect luminous intensity by more than +/- 10%.
3. Total harmonic distortion induced into the AC power line by the LED Light Engine, operated at a nominal operating voltage, and at a temperature of +25°C (+77°F), shall not exceed 20%.
4. The LED Light Engine shall cycled ON and OFF with a photocell as shown on the detail sheet and shall not exceed the following maximum power values:

4-Foot Sign	60 W
6-Foot Sign	90 W
8-Foot Sign	120 W

The signs shall not be energized when traffic signals are powered by an alternate energy source such as a generator or uninterruptable power source (UPS). The signs shall be connected to the generator or UPS bypass circuitry.

(f) Photometric Requirements.

1. The entire surface of the sign panel shall be evenly illuminated. The average maintained luminous intensity measured across the letters, operating under the conditions defined in Environmental Requirements and Wattage Sections shall be of a minimum value of 100 cd/m<sup>2</sup>.
2. The manufacturer shall make available independent laboratory test results to verify compliance to Voltage Range and Luminous Intensity Distribution Sections.
3. Twelve (12) 1.25 watt LED units shall be mounted on 1-inch x 22-inch metal cone printed circuit boards (MCPCB). The viewing angle shall be 120 degrees. LED shall have a color temperature of 5200k nominal, CRI of 80 with a life expectancy of 75,000 hrs.

(g) Quality Assurance.

The LED Light Engine shall be manufactured in accordance with a vendor quality assurance (QA) program. The production QA shall include statistically controlled routine tests to ensure minimum performance levels of the LED Light Engine build to meet this specification. QA process and test result documentations shall be kept on file for a minimum period of seven (7) years. The LED Light Engine that does not satisfy the production QA testing performance requirements shall not be labeled, advertised, or sold as conforming to these specifications. Each LED Light Engine shall be identified by a manufacturer's serial number for warranty purposes. LED Light Engines shall be replaced or repaired if they fail to function as intended due to workmanship or material defects within the first sixty (60) months from the date of acceptance. LED Light Engines that exhibit luminous intensities less than the minimum value specified in Photometric Section within the first thirty-six (36) months from the date of acceptance shall be replaced or repaired.

**ELECTRIC CABLE IN CONDUIT NO. 20 3/C, TWISTED, SHIELDED**

This work shall consist of furnishing and installing electric cable in conduit of the type, size, and number of conductors specified. The construction performed and materials used shall be in conformance with applicable parts of Sections 873 and 1076 of the Standard Specifications. Physical specifications are as follows:

Conductors: 3-20 awg (7/28) tinned copper .037"

Dielectric: 25 mil wall of color coded polyethylene to a nominal diameter of .191"

Cabling: Cable together three insulated conductors with an overall aluminum/polyester tape, the foil out, and a 20 awg (7/28) tinned copper drain, in a 3" left hand lay to a nominal diameter of .191"

Jacket: 45 mil wall of black moisture resistant sunlight resistant polyvinyl chloride to a nominal diameter of .281" +/- .010"

Basis of Payment. This work will be paid for at the contract unit price foot for ELECTRIC CABLE IN CONDUIT NO. 20 3/C, TWISTED SHIELDED, which price shall include all labor, equipment and materials necessary to complete the work.

**LED INTERNALLY ILLUMINATED STREET NAME SIGN**

This work shall consist of furnishing and installing LED illuminated street name signs as shown in the plan detail sheets and meeting the requirements of the current District One Traffic Signal Special Provision for Illuminated Street Name Signs.

Basis of Payment. This work will be paid for at the contract unit price each for LED INTERNALLY ILLUMINATED STREET NAME SIGN, which price shall include all labor, equipment and materials necessary to complete the work.

## **ROADWAY LIGHTING SPECIFICATIONS**

### **GENERAL ELECTRICAL REQUIREMENTS**

Effective: January 1, 2012

Add the following to Article 801 of the Standard Specifications:

“Maintenance transfer and Preconstruction Inspection:

General. Before performing any excavation, removal, or installation work (electrical or otherwise) at the site, the Contractor shall request a maintenance transfer and preconstruction site inspection, to be held in the presence of the Engineer and a representative of the party or parties responsible for maintenance of any lighting and/or traffic control systems which may be affected by the work. The request for the maintenance transfer and preconstruction inspection shall be made no less than seven (7) calendar days prior to the desired inspection date. The maintenance transfer and preconstruction inspection shall:

Establish the procedures for formal transfer of maintenance responsibility required for the construction period.

Establish the approximate location and operating condition of lighting and/or traffic control systems which may be affected by the work

Marking of Existing Cable Systems. The party responsible for maintenance of any existing lighting and/or traffic control systems at the project site will, at the Contractor's request, mark and/or stake, once per location, all underground cable routes owned or maintained by the State. A project may involve multiple "locations" where separated electrical systems are involved (i.e. different controllers). The markings shall be taken to have a horizontal tolerance of at least 304.8 mm (one (1) foot) to either side.. The request for the cable locations and marking shall be made at the same time the request for the maintenance transfer and preconstruction inspection is made. The Contractor shall exercise extreme caution

where existing buried cable runs are involved. The markings of existing systems are made strictly for assistance to the Contractor and this does not relieve the Contractor of responsibility for the repair or replacement of any cable run damaged in the course of his work, as specified elsewhere herein. Note that the contractor shall be entitled to only one request for location marking of existing systems and that multiple requests may only be honored at the contractor's expense. No locates will be made after maintenance is transferred, unless it is at the contractor's expense.

Condition of Existing Systems. The Contractor shall conduct an inventory of all existing electrical system equipment within the project limits, which may be affected by the work, making note of any parts which are found broken or missing, defective or malfunctioning. Megger and load readings shall be taken for all existing circuits which will remain in place or be modified. If a circuit is to be taken out in its entirety, then readings do not have to be taken. The inventory and test data shall be reviewed with and approved by the Engineer and a record of the inventory shall be submitted to the Engineer for the record. Without such a record, all systems transferred to the Contractor for maintenance during construction shall be returned at the end of construction in complete, fully operating condition.”

Add the following to the 1<sup>st</sup> paragraph of Article 801.05(a) of the Standard Specifications:

“Items from multiple disciplines shall not be combined on a single submittal and transmittal. Items for lighting, signals, surveillance and CCTV must be in separate submittals since they may be reviewed by various personnel in various locations.”

Revise the second sentence of the 5<sup>th</sup> paragraph of Article 801.05(a) of the Standard Specifications to read:

“The Engineer will stamp the submittals indicating their status as ‘Approved’, ‘Approved as Noted’, ‘Disapproved’, or ‘Information Only’.

Revise the 6<sup>th</sup> paragraph of Article 801.05(a) of the Standard Specifications to read:

Resubmittals. All submitted items reviewed and marked ‘Approved as Noted’, or ‘Disapproved’ are to be resubmitted in their entirety with a disposition of previous comments to verify contract compliance at no additional cost to the state unless otherwise indicated within the submittal comments.”

Revise Article 801.11(a) of the Standard Specifications to read:

“Lighting Operation and Maintenance Responsibility. The scope of work shall include the assumption of responsibility for the continuing operation and maintenance the of existing, proposed, temporary, sign and navigation lighting, or other lighting systems and all appurtenances affected by the work as specified elsewhere herein. Maintenance of lighting systems is specified elsewhere and will be paid for separately

Energy and Demand Charges. The payment of basic energy and demand charges by the electric utility for existing lighting which remains in service will continue as a responsibility of the Owner, unless otherwise indicated. Unless otherwise indicated or required by the Engineer duplicate lighting systems (such as temporary lighting and proposed new lighting) shall not be operated simultaneously at the Owner's expense and lighting systems shall not be kept in operation during long daytime periods at the Owner's expense. Upon written authorization from the Engineer to place a proposed new lighting system in service, whether the system has passed final acceptance or not, (such as to allow temporary lighting to be removed), the Owner will accept responsibility for energy and demand charges for such lighting, effective the date of authorization. All other energy and demand payments to the utility shall be the responsibility of the Contractor until final acceptance.”

Add the following to Section 801 of the Standard Specifications:

“Lighting Cable Identification. Each wire installed shall be identified with its complete circuit number at each termination, splice, junction box or other location where the wire is accessible.”

“Lighting Cable Fuse Installation. Standard fuse holders shall be used on non-frangible (non-breakaway) light pole installations and quick-disconnect fuse holders shall be used on frangible (breakaway) light pole installations. Wires shall be carefully stripped only as far as needed for connection to the device. Over-stripping shall be avoided. An oxide inhibiting lubricant shall be applied to the wire for minimum connection resistance before the terminals are crimped-on. Crimping shall be performed in accordance with the fuse holder manufacturer's recommendations. The exposed metal connecting portion of the assembly shall be taped with two half-lapped wraps of electrical tape and then covered by the specified insulating boot. The fuse holder shall be installed such that the fuse side is connected to the pole wire (load side) and the receptacle side of the holder is connected to the line side.”

Revise the 2<sup>nd</sup> paragraph of Article 801.16 of the Standard Specifications to read:

“When the work is complete, and seven days before the request for a final inspection, the full-size set of contract drawings. Stamped “RECORD DRAWINGS”, shall be submitted to the Engineer for review and approval and shall be stamped with the date and the signature of the Contractor’s supervising Engineer or electrician. The record drawings shall be submitted in PDF format on CDROM as well as hardcopy for review and approval. In addition to the record drawings, copies of the final catalog cuts which have been Approved or Approved as Noted shall be submitted in PDF format along with the record drawings. The PDF files shall clearly indicate either by filename or PDF table of contents the respective pay item number. Specific part or model numbers of items which have been selected shall be clearly visible.”

Add the following to Article 801.16 of the Standard Specifications:

“In addition to the specified record drawings, the Contactor shall record GPS coordinates of the following electrical components being installed, modified or being affected in other ways by this contract:

- Last light pole on each circuit
- Handholes
- Conduit roadway crossings
- Controllers
- Control Buildings
- Structures with electrical connections, i.e. DMS, lighted signs.
- Electric Service locations
- CCTV Camera installations
- Fiber Optic Splice Locations

Datum to be used shall be North American 1983.

Data shall be provided electronically and in print form. The electronic format shall be compatible with MS Excel. Latitude and Longitude shall be in decimal degrees with a minimum of 6 decimal places. Each coordinate shall have the following information:

5. Description of item
6. Designation or approximate station if the item is undesignated
7. Latitude
8. Longitude

Examples:

<b>Equipment Description</b>	<b>Equipment Designation</b>	<b>Latitude</b>	<b>Longitude</b>
CCTV Camera pole	ST42	41.580 493	- 87.793378
FO mainline splice handhole	HHL-ST31	41.558 532	- 87.792571
Handhole	HH at STA 234+35	41.765 532	- 87.543571
Electric Service	Elec Srv	41.602 248	- 87.794053
Conduit crossing	SB IL83 to EB I290 ramp SIDE A	41.584 593	- 87.793378
Conduit crossing	SB IL83 to EB I290 ramp SIDE B	41.584 600	- 87.793432
Light Pole	DA03	41.558 532	- 87.792571
Lighting Controller	X	41.651 848	- 87.762053
Sign Structure	FGD	41.580 493	- 87.793378
Video Collection Point	VCP-IK	41.558 532	- 87.789771
Fiber splice connection	Toll Plaza34	41.606 928	- 87.794053

Prior to the collection of data, the contractor shall provide a sample data collection of at least six data points of known locations to be reviewed and verified by the Engineer to be accurate within 100 feet. Upon verification, data collection can begin. Data collection can be made as construction progresses, or can be collected after all items are installed. If the data is unacceptable the contractor shall make corrections to the data collection equipment and or process and submit the data for review and approval as specified.

Accuracy. Data collected is to be mapping grade. A handheld mapping grade GPS device shall be used for the data collection. The receiver shall support differential correction and data shall have a minimum 5 meter accuracy after post processing.

GPS receivers integrated into cellular communication devices, recreational and automotive GPS devices are not acceptable.



The GPS shall be the product of an established major GPS manufacturer having been in the business for a minimum of 6 years.”

**UNIT DUCT**

Effective: January 1, 2012

Revise the first paragraph of Article 810.04 to read:

“The unit duct shall be installed at a minimum depth of 30-inches (760 mm) unless otherwise directed by the Engineer.”

Revise Article 1088.01(c) to read:

“(c) Coilable Nonmetallic Conduit.

General:

The duct shall be a plastic duct which is intended for underground use and which can be manufactured and coiled or reeled in continuous transportable lengths and uncoiled for further processing and/or installation without adversely affecting its properties of performance. The duct shall be a plastic duct which is intended for underground use and can be manufactured and coiled or reeled in continuous transportable lengths and uncoiled for further processing and/or installation without adversely affecting its properties of performance.

The duct shall be made of high density polyethylene which shall meet the requirements of ASTM D 2447, for schedule 40. The duct shall be composed of black high density polyethylene meeting the requirements of ASTM D 3350, Class C, Grade P33. The wall thickness shall be in accordance with Table 2 for ASTM D 2447.

The duct shall be UL Listed per 651-B for continuous length HDPE coiled conduit. The duct shall also comply with NEC Article 354.100 and 354.120.

Submittal information shall demonstrate compliance with the details of these requirements.

Dimensions:

Duct dimensions shall conform to the standards listed in ASTM D2447. Submittal information shall demonstrate compliance with these requirements.

Nominal Size		Nominal I.D.		Nominal O.D.		Minimum Wall	
mm	in	mm	in	mm	in	mm	in
31.75	1.25	35.05	1.380	42.16	1.660	3.556 +0.51	0.140 +0.020
38.1	1.50	40.89	1.610	48.26	1.900	3.683 +0.51	0.145 +0.020

Nominal Size		Pulled Tensile	
mm	in	N	lbs
31.75	1.25	3322	747
38.1	1.50	3972	893

**Marking:**

As specified in NEMA Standard Publication No. TC-7, the duct shall be clearly and durably marked at least every 3.05 meters (10 feet) with the material designation (HDPE for high density polyethylene), nominal size of the duct and the name and/or trademark of the manufacturer.

**Performance Tests:**

Polyethylene Duct testing procedures and test results shall meet the requirements of UL 651. Certified copies of the test report shall be submitted to the Engineer prior to the installation of the duct. Duct crush test results shall meet or exceed the following requirements:

Duct Diameter		Min. force required to deform sample 50%	
mm	in	N	lbs
35	1.25	4937	1110
41	1.5	4559	1025

**TEMPORARY WOOD POLE, INSTALL ONLY**

Effective: January 1, 2012

**Description.** This item shall consist of retrieving from storage, transporting, and installing a temporary wood pole, and mast as applicable, as specified herein and as indicated on the plans.

**Materials.** Materials shall be according to the following Articles of Section 1000 - Materials

Item	Article/Section
(a) Light Pole Identification.....	1069.06

### CONSTRUCTION REQUIREMENTS

**Inspection And Acceptance.** The Contractor shall examine the wood pole, and mast as applicable, in the presence of the Engineer and after accepting the pole(s) shall be held responsible for preservation of the condition of each pole, as it was at the time of acceptance, until the Final Acceptance Inspection.

**Transportation.** The Contractor shall transport, handle the wood pole in complete conformance with industry standard recommendations. The Contractor shall make arrangements to transfer the light poles from the State's storage facility located within District 1 on weekdays between the hours of 8:00 a.m. and 4:00 p.m., excluding State holidays applicable to the Department.

**Installation.** Installation shall be as described in Article 830.03(c). Unless otherwise indicated, the Contractor shall provide all hardware to install the pole and mast arm as specified herein and indicated on the plans.

Unless otherwise indicated, the wood pole and mast arm, as applicable, shall remain the property of the owner and shall be removed as specified elsewhere herein.

**Method Of Measurement.** Wood poles shall be counted as, each installed.

**Basis Of Payment.** This item shall be paid at the contract unit price each for **TEMPORARY WOOD POLE**, of the mounting height, mast arm quantity and length indicated, (**INSTALL ONLY**).

### ELECTRIC SERVICE INSTALLATION

Effective: January 1, 2012

**Description.** This item shall consist of all material and labor required to extend, connect or modify the electric services, as indicated or specified, which is over and above the work performed by the utility. Unless otherwise indicated, the cost for the utility work, if any, will be reimbursed to the Contractor separately under **ELECTRIC UTILITY SERVICE CONNECTION**. This item may apply to the work at more than one service location and each will be paid separately.

**Materials.** Materials shall be in accordance with the Standard Specifications.

## CONSTRUCTION REQUIREMENTS

**General.** The Contractor shall ascertain the work being provided by the electric utility and shall provide all additional material and work not included by other contract pay items required to complete the electric service work in complete compliance with the requirements of the utility.

No additional compensation will be allowed for work required for the electric service, even though not explicitly shown on the Drawings or specified herein

**Method Of Measurement.** Electric Service Installation shall be counted, each.

**Basis Of Payment.** This work will be paid for at the contract unit price each for **ELECTRIC SERVICE INSTALLATION** which shall be payment in full for the work specified herein.

### **ELECTRIC UTILITY SERVICE CONNECTION (COMED)**

Effective: January 1, 2012

**Description.** This item shall consist of payment for work performed by ComEd in providing or modifying electric service as indicated. **THIS MAY INVOLVE WORK AT MORE THAN ONE ELECTRIC SERVICE.** For summary of the Electrical Service Drop Locations see the schedule contained elsewhere herein.

## CONSTRUCTION REQUIREMENTS

**General.** It shall be the Contractor's responsibility to contact ComEd. The Contractor shall coordinate his work fully with the ComEd both as to the work required and the timing of the installation. No additional compensation will be granted under this or any other item for extra work caused by failure to meet this requirement. **Please contact ComEd, New Business Center Call Center, at 866 NEW ELECTRIC (1-866-639-3532) to begin the service connection process. The Call Center Representatives will create a work order for the service connection. The representative will ask the requestor for information specific to the request. The representative will assign the request based upon the location of project.**

The Contractor should make particular note of the need for the earliest attention to arrangements with ComEd for service. In the event of delay by ComEd, no extension of time will be considered applicable for the delay unless the Contractor can produce written evidence of a request for electric service within 30 days of execution.

**Method Of Payment.** The Contractor will be reimbursed to the exact amount of money as billed by ComEd for its services. Work provided by the Contractor for electric service will be paid separately as described under ELECTRIC SERVICE INSTALLATION. No extra compensation shall be paid to the Contractor for any incidental materials and labor required to fulfill the requirements as shown on the plans and specified herein.

For bidding purposes, this item shall be estimated as \$ 2,500

**Basis Of Payment.** This work will be paid for at the contract lump sum price for **ELECTRIC UTILITY SERVICE CONNECTION** which shall be reimbursement in full for electric utility service charges.

**Designers Note:** The estimate of cost of service connections for bidding purposes shall be provided by the Designer or Design Consultant.

### **UNDERGROUND RACEWAYS**

Effective: January 1, 2012

Revise Article 810.04 of the Standard Specifications to read:

“Installation. All underground conduit shall have a minimum depth of 30-inches (700 mm) below the finished grade.”

Add the following to Article 810.04 of the Standard Specifications:

“All metal conduit installed underground shall be Rigid Steel Conduit unless otherwise indicated on the plans.”

Add the following to Article 810.04 of the Standard Specifications:

“All raceways which extend outside of a structure or duct bank but are not terminated in a cabinet, junction box, pull box, handhole, post, pole, or pedestal shall extend a minimum of 300 mm (12”) or the length shown on the plans beyond the structure or duct bank. The end of this extension shall be capped and sealed with a cap designed for the conduit to be capped. The ends of rigid metal conduit to be capped shall be threaded, the threads protected with full galvanizing, and capped with a threaded galvanized steel cap. The ends of rigid nonmetallic conduit and coilable nonmetallic conduit shall be capped with a rigid PVC cap of not less than 3 mm (0.125”) thick. The cap shall be sealed to the

conduit using a room-temperature-vulcanizing (RTV) sealant compatible with the material of both the cap and the conduit. A washer or similar metal ring shall be glued to the inside center of the cap with epoxy, and the pull cord shall be tied to this ring.”

Add the following to Article 810.04(c) of the Standard Specifications:

“Coilable non-metallic conduit shall be machine straightened to remove the longitudinal curvature caused by coiling the conduit onto reels prior to installing in trench, encasing in concrete or embedding in structure. The straightening shall not deform the cross-section of the conduit such that any two measured outside diameters, each from any location and at any orientation around the longitudinal axis along the conduit differ by more than 6 mm (0.25”).” The longitudinal axis of the straightened conduit shall not deviate by more than 20 mm per meter (0.25” per foot” from a straight line. The HDPE and straightening mechanism manufacturer operating temperatures shall be followed.

#### **LUMINAIRE SAFETY CABLE ASSEMBLY**

Effective: January 1, 2012

**Description:** This item shall consist of providing a luminaire safety cable assembly as specified herein and as indicated in the plans.

**Materials.** Materials shall be according to the following:

**Wire Rope.** Cables (wire rope) shall be manufactured from Type 304 or Type 316 stainless steel having a maximum carbon content of 0.08 % and shall be a stranded assembly. Cables shall be 3.18 mm (0.125”) diameter, 7x19 Class strand core and shall have no strand joints or strand splices.

Cables shall be manufactured and listed for compliance with Federal Specification RR-W-410 and Mil-DTL-83420.

Cable terminals shall be stainless steel compatible with the cable and as recommended by the cable manufacturer. Terminations and clips shall be the same stainless steel grade as the wire rope they are connected to.

**U-Bolts.** U-Bolts and associated nuts, lock washers, and mounting plates shall be manufactured from Type 304 or Type 316 stainless steel.

## CONSTRUCTION REQUIREMENTS

**General.** The safety cable assembly shall be installed as indicated in the plan details. One end of the cable assembly shall have a loop fabricated from a stainless steel compression sleeve. The other end of the cable assembly shall be connected with stainless steel wire rope clips as indicated. Slack shall be kept to a minimum to prevent the luminaire from creeping off the end of the mast arm. Unless otherwise indicated in the plans, the luminaire safety cable shall only be used in conjunction with luminaires which are directly above the traveled pavement.

**Basis of Payment:** This work shall be paid for at the contract price each for **LUMINAIRE SAFETY CABLE ASSEMBLY**, which shall be payment for the work as described herein and as indicated in the plans.

### LUMINAIRE

Effective: January 1, 2012

Add the following to first paragraph of Article 1067(c) of the Standard Specifications:

“The reflector shall not be altered by paint or other opaque coatings which would cover or coat the reflecting surface. Control of the light distribution by any method other than the reflecting material and the aforementioned clear protective coating that will alter the reflective properties of the reflecting surface is unacceptable”

Add the following to Article 1067(f) of the Standard Specifications:

“The ballast shall be a High Pressure Sodium, high power factor, constant wattage auto-regulator, lead type (CWA) for operation on a nominal 240 volt system.”

Revise Article 1067(f)(1) of the Standard Specifications to read:

“The high pressure sodium, auto-regulator, lead type (CWA) ballast shall be designed to ANSI Standards and shall be designed and rated for operation on a nominal 240 volt system. The ballast shall provide positive lamp ignition at the input voltage of 216 volts. It shall operate the lamp over a range of input voltages from 216 to 264 volts without damage to the ballast. It shall provide lamp operation within lamp specifications for rated lamp life at input design voltage range. Operating characteristics shall produce output regulation not exceeding the following values:

Nominal Ballast Wattage	Maximum Ballast Regulation
750	25%
400	26%
310	26%
250	26%
150	24%
70	18%

For this measure, regulation shall be defined as the ratio of the lamp watt difference between the upper and lower operating curves to the nominal lamp watts; with the lamp watt difference taken within the ANSI trapezoid at the nominal lamp operating voltage point parallel to the minimum lamp volt line:

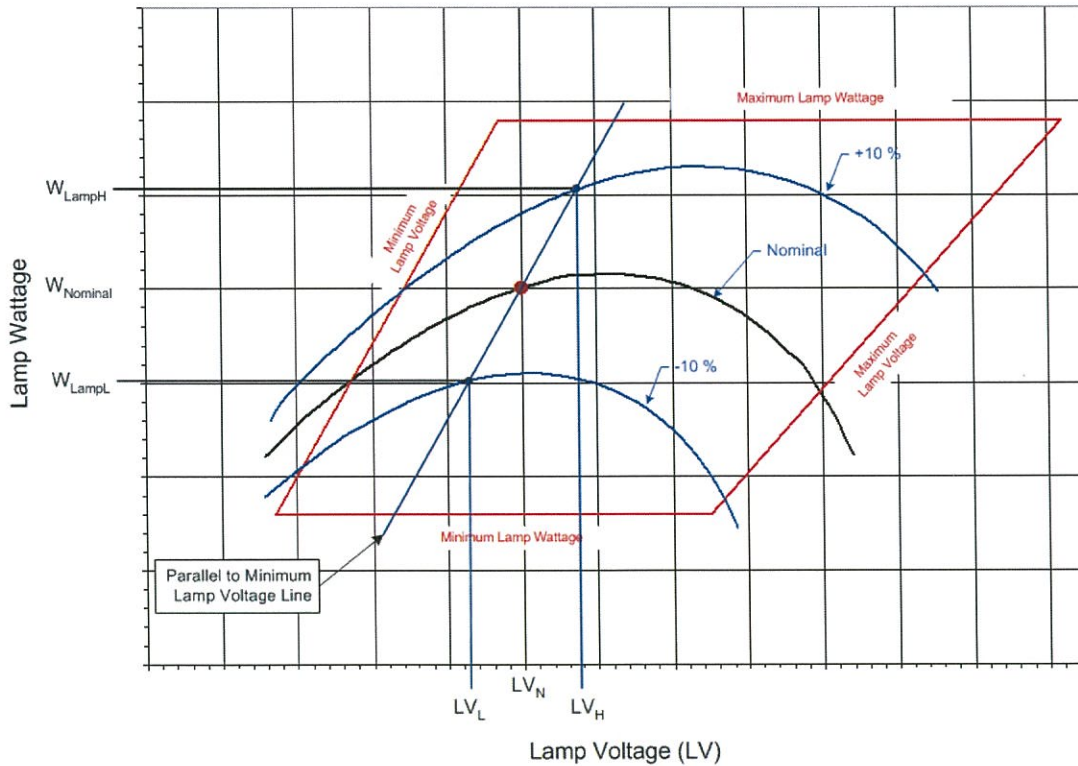



$$\text{Ballast Regulation} = \frac{W_{LampH} - W_{LampL}}{W_{LampN}} \times 100$$

where:

$W_{LampH}$  = lamp watts at +10% line voltage when Lamp voltage =  $LV_H$

$W_{LampL}$  = lamp watts at - 10% line voltage when lamp voltage =  $LV_L$

$W_{lampN}$  = lamp watts at nominal lamp operating voltage =  $LV_N$

Wattage	Nominal Lamp Voltage, $LV_N$	$LV_L$	$LV_H$
750	120v	115v	125v
400	100v	95v	105v
310	100v	95v	105v
250	100v	95v	105v
150	55v	50v	60v
70	52v	47v	57v

Ballast losses, based on cold bench tests, shall not exceed the following values:

Nominal Ballast Wattage	Maximum Ballast Losses
750	15%
400	20%
310	21%
250	24%
150	26%
70	34%

Ballast losses shall be calculated based on input watts and lamp watts at nominal system voltage as indicated in the following equation:

$$\text{Ballast Losses} = \frac{W_{Line} - W_{Lamp}}{W_{Lamp}} \times 100$$

where:

$W_{line}$  = line watts at nominal system voltage

$W_{lamp}$  = lamp watts at nominal system voltage

Ballast output to lamp. At nominal system voltage and nominal lamp voltage, the ballast shall deliver lamp wattage with the variation specified in the following table.

Nominal Ballast Wattage	Output to lamp variation
750	± 7.5%
400	± 7.5%
310	± 7.5%
250	± 7.5%
150	± 7.5%
70	± 7.5%

Example: For a 400w luminaire, the ballast shall deliver 400 watts ±7.5% at a lamp voltage of 100v for the nominal system voltage of 240v which is the range of 370w to 430w.

Ballast output over lamp life. Over the life of the lamp the ballast shall produce average output wattage of the nominal lamp rating as specified in the following table. Lamp wattage readings shall be taken at 5-volt increments throughout the ballast trapezoid. Reading shall begin at the lamp voltage (L<sub>v</sub>) specified in the table and continue at 5 volt increments until the right side of the trapezoid is reached. The lamp wattage values shall then be averaged and shall be within the specified value of the nominal ballast rating. Submittal documents shall include a tabulation of the lamp wattage vs. lamp voltage readings.

Nominal Ballast Wattage	LV Readings begin at	Maximum Wattage Variation
750	110v	± 7.5%
400	90v	± 7.5%
310	90v	± 7.5%
250	90v	± 7.5%
150	50v	± 7.5%
70	45v	± 7.5%

*Example: For a 400w luminaire, the averaged lamp wattage reading shall not exceed the range of  $\pm 7.5\%$  which is 370w to 430w*

Add the following to Article 1067(h) of the Standard Specifications:

“Independent Testing. Independent testing of luminaires shall be required whenever the pay item quantity of luminaires of a given pay item, as indicated on the plans, is 50 or more. For each luminaire type to be so tested, one luminaire plus one luminaire for each 50 luminaires shall be tested. Example: *A plan pay item quantity of 75 luminaires for a specific pay item would dictate that 2 be tested; 135 luminaires would dictate that three be tested.*” If the luminaire performance table is missing from the contract documents, the luminaire(s) shall be tested and the test results shall be evaluated against the manufacturer’s data as provided in the approved material submittal. The test luminaire(s) results shall be equal to or better than the published data. If the test results indicated performance not meeting the published data, the test luminaire will be designated as failed and corrective action as described herein shall be performed.

The Contractor shall be responsible for all costs associated with the specified testing, including but not limited to shipping, travel and lodging costs as well as the costs of the tests themselves, all as part of the bid unit price for this item. Travel, lodging and other associated costs for travel by the Engineer shall be direct-billed to or shall be pre-paid by the Contractor, requiring no direct reimbursement to the Engineer or the independent witness, as applicable”

The Contractor shall select one of the following options for the required testing with the Engineer's approval:

- a. Engineer Factory Selection for Independent Lab: The Contractor may select this option if the luminaire manufacturing facility is within the state of Illinois. The Contractor shall propose an independent test laboratory for approval by the Engineer. The selected luminaires shall be marked by the Engineer and shipped to the independent laboratory for tests.
- b. Engineer Witness of Independent Lab Test: The Contractor may select this option if the independent testing laboratory is within the state of Illinois. The Engineer shall select, from the project luminaires at the manufacturer’s facility or at the Contractor's storage facility, luminaires for testing by the independent laboratory.
- c. Independent Witness of Manufacturer Testing: The independent witness shall select from the project luminaires at the manufacturers facility or at

the Contractor's storage facility, the luminaires for testing. The Contractor shall propose a qualified independent agent, familiar with the luminaire requirements and test procedures, for approval by the Engineer, to witness the required tests as performed by the luminaire manufacturer.

The independent witness shall as a minimum meet the following requirements:

- ▶ Have been involved with roadway lighting design for at least 15 years.
- ▶ Not have been the employee of a luminaire or ballast manufacturer within the last 5 years.
- ▶ Not associated in any way (plan preparation, construction or supply) with the particular project being tested.
- ▶ Be a member of IESNA in good standing.
- ▶ Provide a list of professional references.

This list is not an all inclusive list and the Engineer will make the final determination as to the acceptability of the proposed independent witness.

- d. Engineer Factory Selection and Witness of Manufacturer Testing: The Contractor may select this option if the luminaire manufacturing facility is within the state of Illinois. At the Manufacturer's facility, the Engineer shall select the luminaires to be tested and shall be present during the testing process. The Contractor shall schedule travel by the Engineer to and from the Manufacturer's laboratory to witness the performance of the required tests.

Should any of the tested luminaires fail to satisfy the specifications and perform according to approved submittal information, the luminaire shall be unacceptable and be replaced by alternate equipment meeting the specifications with the submittal and testing process repeated in their entirety; or corrections made to achieve required performance. In the case of corrections, the Contractor shall advise the Engineer of corrections made and shall request a repeat of the specified testing and, if the corrections are deemed reasonable by the Engineer, the testing process shall be repeated. The number of luminaires to be tested shall be the same quantity as originally tested; i.e. if three luminaires were tested originally, one, two or three failed, another three must be tested after corrective action is taken.

Revise Article 1067.06(a)(1) of the Standard Specifications to read:

"The lamps shall be of the clear type and shall have a color of 1900° to 2200° Kelvin."

Add the following table(s) to Article 1067 of the Standard Specifications:

**IDOT DISTRICT 1 LUMINAIRE PERFORMANCE TABLE**

<b>GIVEN CONDITIONS</b>		
<b>ROADWAY DATA</b>	Pavement Width	55 (ft)
	Number of Lanes	5
	I.E.S. Surface Classification	R3
	Q-Zero Value	.07
<b>LIGHT POLE DATA</b>	Mounting Height	40 (ft)
	Mast Arm Length	15 (ft)
	Pole Set-Back From Edge of Pavement	5.1 (ft) – East Side, 5 (ft) – West Side S. Main St.
		5 (ft) – Pyott Rd.
		5 (ft) North Side, 10.5 (ft) South Side West Leg Virginia Rd.
7 (ft) North Side, 5 (ft) South Side East Leg Virginia Rd.		
<b>LUMINAIRE DATA</b>	Lamp Type	HPS
	Lamp Lumens	28,000
	I.E.S. Vertical Distribution	Medium
	I.E.S. Control Of Distribution	Cutoff
	I.E.S. Lateral Distribution	Type III
	Total Light Loss Factor	0.700
	<b>LAYOUT DATA</b>	Spacing
160 (ft), 235 (ft) South Leg Pyott Rd.		
Configuration		175 (ft) West Leg Virginia Rd.
	245 (ft) East Leg Virginia Rd.	
	Luminaire Overhang over edge of pavement	Opposite Varies 4.5 (ft) to 10 (ft)

**NOTE:** Variations from the above specified I.E.S. distribution pattern may be requested and acceptance of variations will be subject to review by the Engineer based on how well the performance requirements are met.

<b>PERFORMANCE REQUIREMENTS</b>
---------------------------------

**NOTE:** These performance requirements shall be the minimum acceptable standards of photometric performance for the luminaire, based on the given conditions listed above.

<b>LUMINANCE</b>	Average Luminance, $L_{AVE}$	<u>0.6 Cd/m<sup>2</sup></u>
	Uniformity Ratio, $L_{AVE}/L_{MIN}$	<u>3.5 (Max)</u>
	Uniformity Ratio, $L_{MAX}/L_{MIN}$	<u>6.0 (Max)</u>
	Veiling Luminance Ratio, $L_v/L_{AVE}$	<u>0.4 (Max)</u>

**MAINTENANCE OF LIGHTING SYSTEMS**

Effective: January 1, 2012

Replace Article 801.11 and 801.12 of the Standard Specifications with the following:

Effective the date the Contractor's activities (electrical or otherwise) at the job site begin, the Contractor shall be responsible for the proper operation and maintenance of all existing and proposed lighting systems which are part of, or which may be affected by the work until final acceptance or as otherwise determined by the Engineer.

Before performing any excavation, removal, or installation work (electrical or otherwise) at the site, the Contractor shall initiate a request for a maintenance transfer and preconstruction inspection, as specified elsewhere herein, to be held in the presence of the Engineer and a representative of the party or parties responsible for maintenance of any lighting systems which may be affected by the work. The request for the maintenance preconstruction inspection shall be made no less than seven (7) calendar days prior to the desired inspection date.

Existing lighting systems, when depicted on the plans, are intended only to indicate the general equipment installation of the systems involved and shall not be construed as an exact representation of the field conditions. It remains the Contractor's responsibility to visit the site to confirm and ascertain the exact condition of the electrical equipment and systems to be maintained.

### **Maintenance of Existing Lighting Systems**

**Existing lighting systems.** Existing lighting systems shall be defined as any lighting system or part of a lighting system in service at the time of contract Letting. The contract drawings indicate the general extent of any existing lighting, but whether indicated or not, it remains the Contractor's responsibility to ascertain the extent of effort required for compliance with these specifications and failure to do so will not be justification for extra payment or reduced responsibilities.

#### **Extent of Maintenance.**

**Partial Maintenance.** Unless otherwise indicated, if the number of circuits affected by the contract is equal to or less than 40% of the total number of circuits in a given controller and the controller is not part of the contract work, the Contractor needs only to maintain the affected circuits. The affected circuits shall be isolated by means of in-line waterproof fuse holders as specified elsewhere and as approved by the Engineer.

**Full Maintenance.** If the number of circuits affected by the contract is greater than 40% of the total number of circuits in a given controller, or if the controller is modified in any way under the contract work, the Contractor shall maintain the entire controller and all associated circuits.

### **Maintenance of Proposed Lighting Systems**

**Proposed Lighting Systems.** Proposed lighting systems shall be defined as any lighting system or part of a lighting system, temporary or permanent, which is to be constructed under this contract.

The Contractor shall be fully responsible for maintenance of all items installed under this contract. Maintenance shall include, but not be limited to, any equipment failures or malfunctions as well as equipment damage either by the motoring public, Contractor operations, vandalism, or other means. The potential cost of replacing or repairing any malfunctioning, damaged, or vandalized equipment shall be included in the bid price of this item and will not be paid for separately.

### **Lighting System Maintenance Operations**

The Contractor's responsibility shall include all applicable responsibilities of the Electrical Maintenance Contract, State of Illinois, Department of Transportation, Division of Highways, District One. These responsibilities shall include the maintenance of lighting units (including sign lighting), cable runs and lighting controls. In the case of a pole knockdown or sign light damage, the Contractor shall promptly clear the lighting unit and circuit discontinuity and restore the system

to service. The equipment shall then be re-set by the contractor within the time limits specified herein.

If the equipment damaged by normal vehicular traffic, not contractor operations, is beyond repair and cannot be re-set, the contractor shall replace the equipment in kind with payment made for such equipment under Article 109.04. If the equipment damaged by any construction operations, not normal vehicular traffic, is beyond repair and cannot be re-set, the contractor shall replace the equipment in kind and the cost of the equipment shall be included in the cost of this pay item and shall not be paid for separately.

Responsibilities shall also include weekly night-time patrol of the lighting system, with patrol reports filed immediately with the Engineer and with deficiencies corrected within 24 hours of the patrol. Patrol reports shall be presented on standard forms as designated by the Engineer. Uncorrected deficiencies may be designated by the Engineer as necessitating emergency repairs as described elsewhere herein.

The following chart lists the maximum response, service restoration, and permanent repair time the Contractor will be allowed to perform corrective action on specific lighting system equipment.

<b>INCIDENT OR PROBLEM</b>	<b>SERVICE RESPONSE TIME</b>	<b>SERVICE RESTORATION TIME</b>	<b>PERMANENT REPAIR TIME</b>
Control cabinet out	1 hour	4 hours	7 Calendar days
Hanging mast arm	1 hour to clear	na	7 Calendar days
Radio problem	1 hour	4 hours	7 Calendar days
Motorist caused damage or leaning light pole 10 degrees or more	1 hour to clear	4 hours	7 Calendar days
Circuit out – Needs to reset breaker	1 hour	4 hours	na
Circuit out – Cable trouble	1 hour	24 hours	21 Calendar days



Outage of 3 or more successive lights	1 hour	4 hours	na
Outage of 75% of lights on one tower	1 hour	4 hours	na
Outage of light nearest RR crossing approach, Islands and gores	1 hour	4 hours	na
Outage (single or multiple) found on night outage survey or reported to EMC	na	na	7 Calendar days
Navigation light outage	na	na	24 hours

- **Service Response Time** -- amount of time from the initial notification to the Contractor until a patrolman physically arrives at the location.
- **Service Restoration Time** – amount of time from the initial notification to the Contractor until the time the system is fully operational again (In cases of motorist caused damage the undamaged portions of the system are operational.)
- **Permanent Repair Time** – amount of time from initial notification to the Contractor until the time permanent repairs are made if the Contractor was required to make temporary repairs to meet the service restoration requirement.

Failure to provide this service will result in liquidated damages of \$500 per day per occurrence. In addition, the Department reserves the right to assign any work not completed within this timeframe to the Electrical Maintenance Contractor. All costs associated to repair this uncompleted work shall be the responsibility of the Contractor. Failure to pay these costs to the Electrical Maintenance Contractor within one month after the incident will result in additional liquidated damages of \$500 per month per occurrence. Unpaid bills will be deducted from any monies owed to the Contractor. Repeated failures and/or a gross failure of maintenance shall result in the State’s Electrical Maintenance Contractor being directed to correct all deficiencies and the resulting costs deducted from any monies owed the contractor.

Damage caused by the Contractor’s operations shall be repaired at no additional cost to the Contract.

**Operation of Lighting**

The lighting shall be operational every night, dusk to dawn. Duplicate lighting systems (such as temporary lighting and proposed new lighting) shall not be operated simultaneously. Lighting systems shall not be kept in operation during long daytime periods.

**Method of Measurement**

The contractor shall demonstrate to the satisfaction of the Engineer that the lighting system is fully operational prior to submitting a pay request. Failure to do so will be grounds for denying the pay request. Months in which the lighting systems are not maintained and not operational will not be paid for. Payment shall not be made retroactively for months in which lighting systems were not operational.

**Basis of Payment.** Maintenance of lighting systems shall be paid for at the contract unit price per calendar month for **MAINTENANCE OF LIGHTING SYSTEM**, which shall include all work as described herein.

**WIRE AND CABLE**

Effective: January 1, 2012

Add the following to the first paragraph of Article 1066.02(a):

“The cable shall be rated at a minimum of 90°C dry and 75°C wet and shall be suitable for installation in wet and dry locations, and shall be resistant to oils and chemicals.”

Revise the Aerial Electric Cable Properties table of Article 1066.03(a)(3) to read:

Aerial Electric Cable Properties

Phase Conductor		Messenger wire			
Size AWG	Stranding	Average Insulation Thickness		Minimum Size AWG	Stranding
		mm	mils		
6	7	1.1	(45)	6	6/1
4	7	1.1	(45)	4	6/1

2	7	1.1	(45)	2	6/1
1/0	19	1.5	(60)	1/0	6/1
2/0	19	1.5	(60)	2/0	6/1
3/0	19	1.5	(60)	3/0	6/1
4/0	19	1.5	(60)	4/0	6/1

Add the following to Article 1066.03(b) of the Standard Specifications:

“Cable sized No. 2 AWG and smaller shall be U.L. listed Type RHH/RHW and may be Type RHH/RHW/USE. Cable sized larger than No. 2 AWG shall be U.L. listed Type RHH/RHW/USE.”

Revise Article 1066.04 to read:

“Aerial Cable Assembly. The aerial cable shall be an assembly of insulated aluminum conductors according to Section 1066.02 and 1066.03. Unless otherwise indicated, the cable assembly shall be composed of three insulated conductors and a steel reinforced bare aluminum conductor (ACSR) to be used as the ground conductor. Unless otherwise indicated, the code word designation of this cable assembly is “Palomino”. The steel reinforced aluminum conductor shall conform to ASTM B-232. The cable shall be assembled according to ANSI/ICEA S-76-474.”

Revise the second paragraph of Article 1066.05 to read:

“The tape shall have reinforced metallic detection capabilities consisting of a woven reinforced polyethylene tape with a metallic core or backing.”

**ELECTRIC SERVICE DISCONNECT, LIGHTING AND TRAFFIC SIGNAL**

Effective: January 1, 2012

**Description:**

This item shall consist of furnishing and installing for the Lighting and Traffic Signal System a service disconnect box, 2 or 3 wire mounted on a wood pole as specified below, and as shown on the detail drawings and as directed by the Engineer.

**Materials:**

The disconnect box shall be NEMA 4X stainless steel, nominally 12" W x 16" H x 8" D with piano hinged door, steel back panel, fast acting stainless steel enclosure clamps, padlock provisions and door stop kit (Hoffman catalog #A-16H1208SS6LP/A-16P12/A-DSTOPK/C-PMK12).

Circuit Breakers shall be thermal magnetic bolt-on type with a minimum interrupt capacity of 25,000 symmetrical amperes at 240 volts. Breakers shall be lockable in the off position for lockout/tag-out compliance.

Bus bars, connectors, and lugs shall be copper, insulated and isolated, and configured to prevent shorted conditions from tightening terminations. Lugs and connectors shall be rated for 75°C. Overall bus sections shall be configured behind an insulating barrier shield which is removable for access to connections. The circuit breakers and bus may be part of an approved panelboard assembly.

Disconnect surge protector shall be suitable for 240/120 volt single phase 60Hz, AC electrical service. Protector shall have a surge energy capability of 2160 joules or better at 8/20 microseconds, rate -40 to 60°C., with LED operating indicators and shall be UL listed per UL 1449. The surge protector shall be a Cutler Hammer CMOV230L065XST.

Conduit, wire, and ground rods to complete the installation of the disconnect box shall be included as part of this item, as required and as indicated.

Combination ground and neutral bar shall be configured with separate ground and neutral sections and spare terminals as indicated. The heads of grounding screws shall be painted green. The heads of neutral screws shall be painted white.

A plastic laminated layout and circuit diagram shall be affixed to the interior side of the enclosure door.

A 2-color engraved plastic nameplate, attached with screws and engraved as indicated, shall be provided for each main breaker.

The exact mounting height for the Electric Service Disconnect shall be field determined and marked by the Engineer.

Electrical service shall be of the voltage indicated. Where 120 volt service is indicated, service drop cable shall be installed accordingly and lighting main breaker and all other service appurtenances shall be included regardless of the service voltage applied to the installation.

The electric service equipment assembly shall be UL labeled, suitable for use as service equipment.

Steel strut channel shall be provided for proper installation of the disconnect, as shown on the disconnect mounting detail.

Electric Utility charges will be paid separately and are not part of this item.

**Installation:**

The Electric Service Disconnect shall be installed as indicated in the Electric Service Disconnect detail. All work shall be fully coordinated with the electric utility company by the Contractor.

**Method Of Measurement:**

Each Electric Service Disconnect, installed complete as specified and as indicated on the plans, shall be counted each for payment.

**Basis Of Payment:**

This item shall be paid for at the contract unit price, each, for **ELECTRIC SERVICE DISCONNECT, LIGHTING AND TRAFFIC SIGNAL**, which shall be payment in full for the work.

**UNDERPASS LUMINAIRE, HPS, STAINLESS STEEL HOUSING**

Effective: January 1, 2012

1. **Description.** This item shall consist of furnishing, testing as required, and installing a luminaire suitable for roadway underpasses as specified herein.
  
2. **General.**
  - 2.1 The luminaire shall be optically sealed, mechanically strong and easy to maintain.
  - 2.2 All wiring within the fixture shall have a minimum temperature rating of 125° C. In addition, the unit shall be designed to allow for a maximum supply wire rating of 90° C.
  - 2.3 All hardware of the housing, reflector, and ballast assembly shall be captive
  - 2.4 The luminaire shall be UL Listed for Wet Locations.
  - 2.5 The underpass luminaire shall be suitable for lighting a roadway underpass at approximate mounting height of 16 feet from a position suspended directly above the roadway.

2.6 The luminaire shall be certified by the U.L. testing laboratory to meet the IP66 criteria of the International Electro technical Commission Standard 529.

### **3. Housing.**

3.1 The housing shall be stainless steel and be made of 16 gauge minimum thickness stainless steel, Type 304, #2B finish.

3.2 Since the installed location of the luminaires has severe space limitations that prohibit servicing the luminaire from the top or side of the fixture, the luminaire must be serviceable from the bottom of the housing when in the installed position. Both ballast and optical compartments must be serviceable from the bottom of the fixture. Fixtures which open from the top or sides are not acceptable.

3.3 The housing shall have a maximum width of 13"

3.4 All internal and external hardware, unless specifically specified otherwise, shall be made of stainless steel.

#### **3.5 Stainless Steel Housing**

3.5.1 The stainless steel housing, and lens frame shall be made of 16 gauge minimum thickness stainless steel, Type 304 #2B.

3.5.2 All housing and frame components shall be cut within with a laser with a positioning accuracy of +/- .004" for assembly accuracy and machine welded to minimize irregularities in the weld joint.

3.5.3 All seams in the housing enclosure shall be welded by continuous welding. Stainless steel weld wire shall be used for all welds. A sample weld shall be submitted for review and approval.

3.5.4 The luminaire lens shall be flush, within 3.1 mm (0.122"), of the lens frame.

3.5.5 The lens frame shall be flat and the frame and luminaire housing shall not have any protruding flanges.

3.5.6 The lens frame assembly shall consist of a one-piece 16 gauge 304 stainless steel external frame with the lens facing toward the housing and a 16 gauge 304 stainless internal frame with the legs facing away from the housing. The internal frame shall have seam welded corners for added strength. The two panels will sandwich the glass lens and be fastened together with the use of no less than 10 #10 stainless steel fasteners.

3.5.7 The lens frame and the door frame shall each be secured through the use of two stainless steel draw latches secured to the fixture housing.

3.5.8 When in open position, it shall be possible to un-hinge and remove the lens frame for maintenance. The lens frame hinge shall be stainless steel and designed so that there must be a conscious action of the maintenance personnel to remove the lens frame. The frame hinging method shall not be designed so that bumping the frame accidentally could allow the frame to fall to the roadway surface. The removal method must be accomplished without the use of tools or hardware. The hinge pin shall be a minimum of 6.35 mm (0.250") in diameter. The pin shall be spring loaded and retractable with a safety catch to hold the pin in the retracted position for ease of maintenance.

3.5.9 The suspended housing shall be divided into two compartments, one for the ballast and optical assembly, the other for wire connections. The optical chamber shall be sealed from the environment. The wire portal between compartments shall be sealed so as to prevent air exchange through the portal. There shall be an internally mounted breather mechanism to allow internal and external air pressure to equalize without permitting dust or water into the unit.

3.5.10 The ballast and all electrical equipment shall be mounted to a removable aluminum chassis with a minimum thickness of 3.175, (0.125"). The chassis shall be held in place with captive stainless steel hardware. The hardware shall include a bracket that can be loosened and shifted to allow the chassis to pivot away from fastened position for removal. The splice box shall include a heavy-duty 3 pole terminal block to accommodate #6 conductors and a KTK 2 amp fuse with HPC fuse holder. Quick-connect power distribution terminal blocks shall be a molded thermoset plastic, rated 70A, 600V and have 3 poles, each with (4) .250 quick connect terminals. Operating temperature rating to be 150° C. Input wire size shall accommodate #2-#14 AWG. Torque rating shall be 45 in./lb. Maximum. Agency approvals shall be UL E62622; CSA LR15364.

3.5.11 Ballast compartment surfaces shall be deburred and free of sharp edges, points or corners that may come in contact with installers or service personnel.

#### **4. Gasketing:**

4.1 The junction between the lens frame and the ballast housing door and the housing shall be sealed with a one-piece vulcanized or molded high temperature solid silicone rubber gasket with the equivalent of a 60 Shore A durometer rating. The gasket between the lens frame and the luminaire housing shall be securely attached by mechanical means, such a retaining lip to prevent the movement of the gasket. The gasket may not be secured by adhesive means exclusively. The lens and ballast housing doors shall be designed and constructed so they seal to the gasket on a flat surface. The frame shall not seal to the gasket using the edge of leg on a doorframe. The lens shall be sealed inside of the lens frame with the use of a one-piece solid silicone rubber gasket with ribbed flanges and a rating of 60 Shore A Durometer

4.2 The junction between conduit connections to the luminaire and the lens frame junction to the housing shall withstand entry of water when subjected to a water jet pressure of 207 kPa (30 lbs. Per sq. inch), tested under laboratory conditions. Submittal information shall include data relative to gasket thickness and density and the means of securing it in place.

## **5. Mounting Brackets**

5.1 The brackets shall be properly sized to accommodate the weight of the luminaire with calculations or other suitable reference documentation submitted to support the material choice.

5.2 The luminaire shall have an opening in the housing for installation (by others) of a 28.1 mm (3/4 inch) diameter flexible conduit. The location of the opening will be determined by the Engineer during the shop drawing review.

## **6. Lamp Socket:**

6.1 The lamp socket shall be a 4KV pulse rated mogul type, porcelain glazed enclosed, and be provided with grips, or other suitable means to hold the lamp against vibration. The rating of the socket shall exceed the lamp starting voltage, or starting pulse voltage rating.

6.2 If the lamp socket is of the sealed removable type, proper alignment of the socket shall be provided and molded into the socket assembly and indicated in a contrasting color.

6.3 If the lamp socket is adjustable, the factory setting must be indicated legibly in the luminaire housing.

## **7. ANSI Identification Decal:**

A decal, complying to ANSI standard C136-15 for luminaire wattage and distribution type, shall be factory attached permanently to the luminaire. The information contained in the decal shall enable a viewer, from the ground level, to identify the lamp wattage and type of luminaire distribution.

## **8. Optical Assembly:**

8.1 Lens and Lens Frame. The lens shall be made of crystal clear, impact and heat resistant tempered glass a minimum of 6.35 mm (0.25") thick. The lens shall be held in such a manner as to allow for its expansion and contraction, due to temperature variation. The lens shall be a flat glass design.

8.2 Reflector:



8.2.1 The reflector shall be hydro formed aluminum, 0.063" thick, bright-dip and clear anodized finish.

8.2.2 The reflector shall be secured with a stainless steel aircraft cable during maintenance operations.

8.2.3 If the reflector has multiple light distribution positions, each position must have positive stop/mounting with the original factory distribution identified.

8.2.4 The luminaire shall be photometrically efficient. Luminaire efficiency, defined by the I.E.S. as "the ratio of luminous flux (lumens) emitted by a luminaire to that emitted by the lamp or lamps used within", shall not be less than 67%. Submittal information shall include published efficiency data.

8.2.5 The reflector, the refractor or lens, and the entire optical assembly shall not develop any discoloration over the normal life span of the luminaire.

8.2.6 The reflector shall not be altered by paint or other opaque coatings which would cover or coat the reflecting surface. Control of the light distribution by any method other than the reflecting material and the aforementioned clear protective coating that will alter the reflective properties of the reflecting surface is unacceptable

## **9. Ballast:**

9.1 The ballast shall be a High Pressure Sodium, high power factor, lead type, Isolated Regulator Ballast (CWI) or a Constant Wattage Auto-regulator (CWA), for operation on a nominal 240 volt system.

9.2 The ballast shall be designed to furnish proper electrical characteristics for starting and operating a high pressure sodium vapor lamp of the specified rating at ambient temperatures of -29 degrees to +40 degrees C. The ballast windings shall be adequately impregnated and treated for protection against the entrance of moisture, insulated with Class H insulation, and able to withstand the NEMA standard dielectric test.

9.3 The ballast shall include an electronic starting assembly. The starter assembly shall be comprised of solid state devices capable of withstanding ambient temperatures of 85 degrees C. The starter shall provide timed pulsing with sufficient follow-through current to completely ionize and start all lamps. Minimum amplitude of the pulse shall be 2,500 volts, with a width of one (1) microsecond at 2,250 volts, and shall be applied within 20 electrical degrees of the peak of the open circuit voltage wave with a repetition rate as recommended by the lamp manufacturer for the 60 cycle wave. The lamp peak pulse current shall be a minimum of 0.2 amperes. Proper ignition shall be provided over a range of input voltage from 216 to 264 volts. The starter component shall be field replaceable and completely interchangeable with no adjustment necessary for proper operation. The starter component shall have push-on type electrical terminations to provide good

electrical and mechanical integrity and ease of replacement. Terminal configuration shall preclude improper insertion of plug-in components. The starter circuit board shall be treated in an approved manner to provide a water and contaminant-resistant coating.

9.4 The ballast shall have an overall power factor of at least 0.9 when operated under rated lamp load.

9.5 The ballast shall withstand a 2,500 volt dielectric test between the core and windings without damage to the insulation.

9.6 The ballast shall not subject the lamp to a crest factor exceeding 1.8 and shall operate the lamp without affecting adversely the lamp life and performance.

9.7 The ballast shall be designed to ANSI Standards and shall be designed and rated for operation on a nominal 240 volt system. The ballast shall provide positive lamp ignition at the input voltage of 216 volts. It shall operate the lamp over a range of input voltages from 216 to 264 volts without damage to the ballast. It shall provide lamp operation within lamp specifications for rated lamp life at input design voltage range. Operating characteristics shall produce output regulation not exceeding the following values:

<b>Nominal Ballast Wattage</b>	<b>Maximum Ballast Regulation</b>
400	25%
310	26%
250	22%
150	22%
70	17%

For this measure, regulation shall be defined as the ratio of the lamp watt difference between the upper and lower operating curves to the nominal lamp watts; with the lamp watt difference taken within the ANSI trapezoid at the nominal lamp operating voltage point parallel to the minimum lamp volt line:

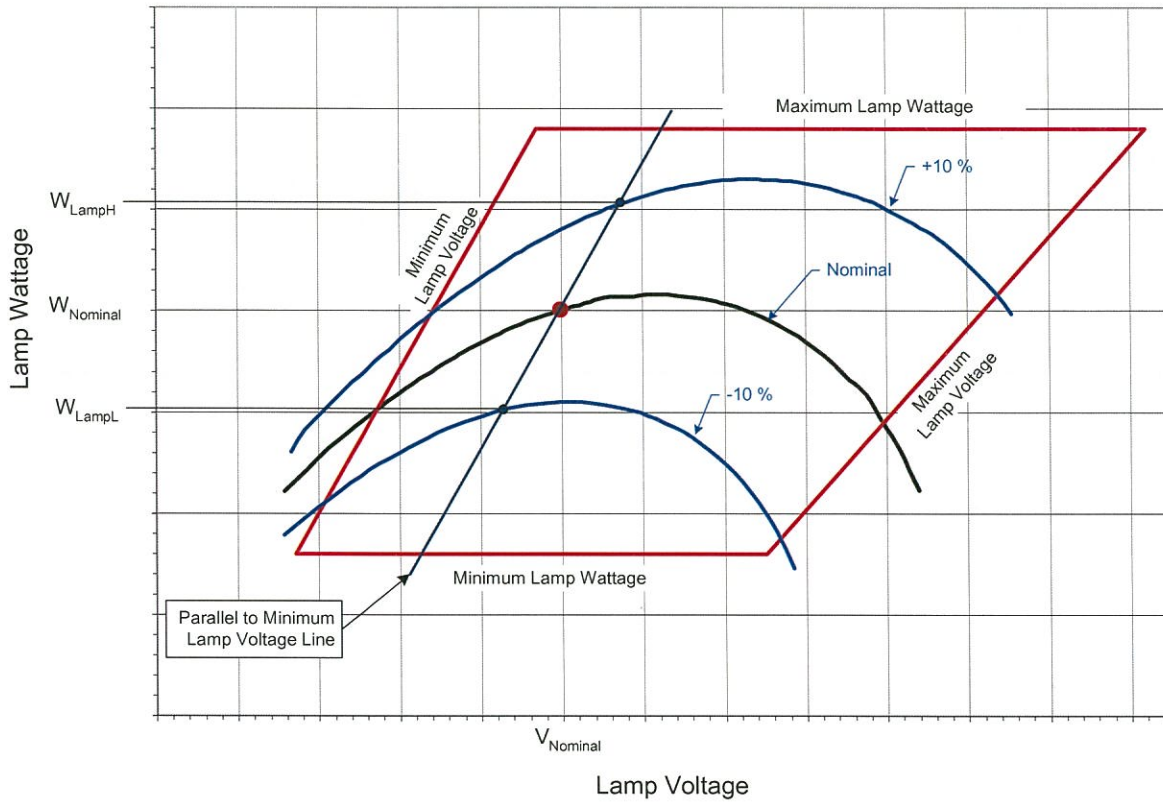

$$\text{Ballast Regulation} = \frac{W_{LampH} - W_{LampL}}{W_{LampN}} \times 100$$

where:

$W_{LampH}$  = lamp watts at +10% line voltage (264v)

$W_{LampL}$  = lamp watts at - 10% line voltage (216v)

$W_{lampN}$  = lamp watts at 240v”

9.8 Ballast losses, based on cold bench tests, shall not exceed the following values:

Nominal Ballast Wattage	Maximum Ballast Losses
400	16.0%
310	19.0%
250	17.5%

150	26.0%
70	34.0%

Ballast losses shall be calculated based on input watts and lamp watts at nominal system voltage as indicated in the following equation:

$$\text{Ballast Losses} = \frac{W_{Line} - W_{Lamp}}{W_{Lamp}} \times 100$$

where:

$W_{line}$  = line watts at 240v

$W_{lamp}$  = lamp watts at 240v

9.9 Ballast output to lamp. At nominal system voltage and a lamp voltage of 52v, the ballast shall deliver a lamp wattage within  $\pm 4\%$  of the nominal lamp wattage. For a 70w luminaire, the ballast shall deliver 70 watts  $\pm 4\%$  at a lamp voltage of 52v for the nominal system voltage of 240v.

9.10 Ballast output over lamp life. Over the life of the lamp the ballast shall produce an average of the nominal lamp rating  $\pm 5\%$ . Lamp wattage readings shall be taken at 5-volt increments throughout the ballast trapezoid. The lamp wattage values shall then be averaged within the trapezoid and shall be within  $\pm 5\%$  of the nominal ballast rating. Submittal documents shall include a tabulation of the lamp wattage vs. lamp voltage readings.

9.11 The ballast shall be integral to the luminaire. The ballast components shall be mounted on a removable door or on a removable mounting tray. The ballast tray or mounting door shall be manufactured with dissimilar metal conflicts kept to a minimum.

9.12 Ballast wiring and lamp socket wiring shall be connected by means of keyed plugs. Upon unplugging the ballast wiring the entire ballast assembly shall be removable for maintenance. The plugs shall not be interchangeable to avoid improper connection of the assemblies.

9.13 The mounting adjustments and wiring terminals shall be readily accessible. The removable door or pad shall be secure when fastened in place and all individual components shall be secure upon the removable element. Upon ballast assembly removal, each component shall be readily removable for replacement.

9.14 The luminaire shall be completely wired. All wiring connections within the luminaire shall be made with insulated compression connectors or insulated terminal blocks. An insulated terminal block shall be provided to terminate the incoming supply wires. The terminal block shall be rated for 600 volts and shall accommodate wire sizes from #10 to #6 AWG. The use of "wire nuts" is unacceptable. A ground terminal shall be provided for the connection of a ground wire.

9.15 Ballast and lamp Leads shall not be smaller than #16 AWG conductors rated at a minimum temperature rating of 90° C.

9.16 All wires shall be coded by tagging and/or color coding for proper identification. A complete legible permanently attached wiring diagram (no smaller than 3" x 4" with a min. font size of 8 pts.) coordinated with the wire identifications shall be displayed at the convenient location on the interior of the luminaire. The wiring diagram shall be oriented so that it is right side up and readable when the luminaire is in the installed position.

9.17 The ballast shall not be excessively noisy. Noticeable noisy ballasts, as determined by the Engineer, shall be replaced at no additional cost to the State.

9.18 The ballast shall provide lamp operation within lamp specifications for the rated lamp life at the input design voltage range. It shall have a 6 month operation capability with a cycling lamp.

9.19 Submittal information shall include manufacturer's literature and data to confirm compliance with all specified requirements including an ANSI Standard Ballast Characteristic Graph (Trapezoid) diagram, with all items clearly identified.

**10. Photometric Performance:**

10.1 The luminaire photometric performance shall produce results equal to or better than those listed in the included Luminaire Performance Table. Submittal information shall include computer calculations based on the controlling given conditions which demonstrate achievement of all listed performance requirements. The computer calculations shall be done according to I.E.S. recommendations and the submitted calculations shall include point-by-point illuminance, luminance and veiling luminance as well as listings of all indicated averages and ratios as applicable. Calculations shall be performed with AGI32. The program used to perform the calculations shall be identified on the submittal. The submittal data shall also include all photometric calculations files with the proposed photometric data on a CD ROM. The performance requirements shall define the minimum number of decimal places used in the calculations. Rounding of calculations shall not be allowed.

10.2 In addition to computer printouts of photometric performance, submittal information shall include: Descriptive literature; an Isofootcandle chart of horizontal lux (footcandles); Utilization curve; Isocandela diagram; Luminaire classification per ANSI designation; Candlepower values at every 2.5 degree intervals; Candlepower tables are to be provided on CD ROM in the IES format as specified in IES publication LM-63.

**IDOT DISTRICT 1 LUMINAIRE PERFORMANCE TABLE #1  
5 Lane Cross Section**

<b>GIVEN CONDITIONS</b>
-------------------------

<b>ROADWAY DATA</b>	Pavement Width	60 ft
	Number of Lanes	5
	I.E.S. Surface Classification	R3
	Q-Zero Value	.07
<b>LIGHT POLE DATA</b>	Mounting Height	16 ft
	Mast Arm Length	0 ft
	Pole Set-Back From Edge of Pavement	2 ft
<b>LUMINAIRE DATA</b>	Lamp Type	HPS
	Lamp Lumens	9,500
	I.E.S. Vertical Distribution	Medium
	I.E.S. Control Of Distribution	Cutoff
	I.E.S. Lateral Distribution	IV
	Total Light Loss Factor	0.65
<b>LAYOUT DATA</b>	Spacing	35 ft
	Configuration	Opposite Side
	Luminaire Overhang over edge of pavement	-2 ft

**NOTE:** Variations from the above specified I.E.S. distribution pattern may be requested and acceptance of variations will be subject to review by the Engineer based on how well the performance requirements are met.

<b>PERFORMANCE REQUIREMENTS</b>
---------------------------------

**NOTE:** These performance requirements shall be the minimum acceptable standards of photometric performance for the luminaire, based on the given conditions listed above.

<b>ILLUMINATION</b>	Ave. Horizontal Illumination, $E_{AVE}$	18 Lux
	Uniformity Ratio, $E_{AVE}/E_{MIN}$	:1
<b>LUMINANCE</b>	Average Luminance, $L_{AVE}$	1.2 Cd/m <sup>2</sup>
	Uniformity Ratio, $L_{AVE}/L_{MIN}$	2.5:1 (Max)
	Uniformity Ratio, $L_{MAX}/L_{MIN}$	4:1 (Max)
	Veiling Luminance Ratio, $L_V/L_{AVE}$	0.25:1 (Max)

**IDOT DISTRICT 1 LUMINAIRE PERFORMANCE TABLE #2**  
**4 Lane Cross Section**

**GIVEN CONDITIONS**

<b>ROADWAY DATA</b>	Pavement Width	48 ft
	Number of Lanes	4
	I.E.S. Surface Classification	R3
	Q-Zero Value	.07
<b>LIGHT POLE DATA</b>	Mounting Height	16 ft
	Mast Arm Length	0 ft
	Pole Set-Back From Edge of Pavement	2 ft
<b>LUMINAIRE DATA</b>	Lamp Type	HPS
	Lamp Lumens	9,500
	I.E.S. Vertical Distribution	Medium
	I.E.S. Control Of Distribution	Cutoff
	I.E.S. Lateral Distribution	IV
	Total Light Loss Factor	0.65
<b>LAYOUT DATA</b>	Spacing	35 ft
	Configuration	Opposite Side
	Luminaire Overhang over edge of pavement	-2 ft

**NOTE:** Variations from the above specified I.E.S. distribution pattern may be requested and acceptance of variations will be subject to review by the Engineer based on how well the performance requirements are met.

**PERFORMANCE REQUIREMENTS**

**NOTE:** These performance requirements shall be the minimum acceptable standards of photometric performance for the luminaire, based on the given conditions listed above.

<b>ILLUMINATION</b>	Ave. Horizontal Illumination, $E_{AVE}$	18 Lux
	Uniformity Ratio, $E_{AVE}/E_{MIN}$	2.5:1
<b>LUMINANCE</b>	Average Luminance, $L_{AVE}$	1.2 Cd/m <sup>2</sup>
	Uniformity Ratio, $L_{AVE}/L_{MIN}$	2.5:1

Uniformity Ratio, $L_{MAX}/L_{MIN}$	4:1
Veiling Luminance Ratio, $L_V/L_{AVE}$	0.25:1

**IDOT DISTRICT 1 LUMINAIRE PERFORMANCE TABLE #3  
 3 Lane Cross Section**

**GIVEN CONDITIONS**

<b>ROADWAY DATA</b>	Pavement Width	36 ft
	Number of Lanes	3
	I.E.S. Surface Classification	R3
	Q-Zero Value	.07
<b>LIGHT POLE DATA</b>	Mounting Height	16 ft
	Mast Arm Length	0 ft
	Pole Set-Back From Edge of Pavement	2 ft
<b>LUMINAIRE DATA</b>	Lamp Type	HPS
	Lamp Lumens	6,300
	I.E.S. Vertical Distribution	Medium
	I.E.S. Control Of Distribution	Cutoff
	I.E.S. Lateral Distribution	III
	Total Light Loss Factor	0.65
<b>LAYOUT DATA</b>	Spacing	45 ft
	Configuration	Opposite Side
	Luminaire Overhang over edge of pavement	-2 ft

**NOTE:** Variations from the above specified I.E.S. distribution pattern may be requested and acceptance of variations will be subject to review by the Engineer based on how well the performance requirements are met.

**PERFORMANCE REQUIREMENTS**

**NOTE:** These performance requirements shall be the minimum acceptable standards of photometric performance for the luminaire, based on the given conditions listed above.

<b>ILLUMINATION</b>	Ave. Horizontal Illumination, $E_{AVE}$	18 Lux
---------------------	--	--------



	Uniformity Ratio, $E_{AVE}/E_{MIN}$	2.5:1
<b>LUMINANCE</b>	Average Luminance, $L_{AVE}$	1.2 Cd/m <sup>2</sup>
	Uniformity Ratio, $L_{AVE}/L_{MIN}$	2.5:1
	Uniformity Ratio, $L_{MAX}/L_{MIN}$	4:1
	Veiling Luminance Ratio, $L_v/L_{AVE}$	0.30:1

**IDOT DISTRICT 1 LUMINAIRE PERFORMANCE TABLE #4**  
**2 Lane Cross Section**

GIVEN CONDITIONS		
<b>ROADWAY DATA</b>	Pavement Width	24 ft
	Number of Lanes	2
	I.E.S. Surface Classification	R3
	Q-Zero Value	.07
<b>LIGHT POLE DATA</b>	Mounting Height	16 ft
	Mast Arm Length	0 ft
	Pole Set-Back From Edge of Pavement	2 ft
<b>LUMINAIRE DATA</b>	Lamp Type	HPS
	Lamp Lumens	6,300
	I.E.S. Vertical Distribution	Medium
	I.E.S. Control Of Distribution	Cutoff
	I.E.S. Lateral Distribution	III
	Total Light Loss Factor	0.65
<b>LAYOUT DATA</b>	Spacing	30 ft
	Configuration	Single Side
	Luminaire Overhang over edge of pavement	-2 ft

**NOTE:** Variations from the above specified I.E.S. distribution pattern may be requested and acceptance of variations will be subject to review by the Engineer based on how well the performance requirements are met.

PERFORMANCE REQUIREMENTS
--------------------------

**NOTE:** These performance requirements shall be the minimum acceptable standards of

photometric performance for the luminaire, based on the given conditions listed above.

<b>ILLUMINATION</b>	Ave. Horizontal Illumination, $E_{AVE}$	18 Lux
	Uniformity Ratio, $E_{AVE}/E_{MIN}$	3:1
<b>LUMINANCE</b>	Average Luminance, $L_{AVE}$	1.2 Cd/m <sup>2</sup>
	Uniformity Ratio, $L_{AVE}/L_{MIN}$	3:1
	Uniformity Ratio, $L_{MAX}/L_{MIN}$	5:1
	Veiling Luminance Ratio, $L_V/L_{AVE}$	0.30:1

**IDOT DISTRICT 1 LUMINAIRE PERFORMANCE TABLE #5**  
**1 Lane Cross Section**

GIVEN CONDITIONS		
<b>ROADWAY DATA</b>	Pavement Width	16 ft
	Number of Lanes	1
	I.E.S. Surface Classification	R3
	Q-Zero Value	.07
<b>LIGHT POLE DATA</b>	Mounting Height	16 ft
	Mast Arm Length	0 ft
	Pole Set-Back From Edge of Pavement	5 ft
<b>LUMINAIRE DATA</b>	Lamp Type	HPS
	Lamp Lumens	6,300
	I.E.S. Vertical Distribution	Medium
	I.E.S. Control Of Distribution	Cutoff
	I.E.S. Lateral Distribution	III
	Total Light Loss Factor	0.65
<b>LAYOUT DATA</b>	Spacing	35 ft
	Configuration	Single Side
	Luminaire Overhang over edge of pavement	-5 ft

**NOTE:** Variations from the above specified I.E.S. distribution pattern may be requested and acceptance of variations will be subject to review by the Engineer based on how well the performance requirements are met.

<b>PERFORMANCE REQUIREMENTS</b>
---------------------------------

**NOTE:** These performance requirements shall be the minimum acceptable standards of photometric performance for the luminaire, based on the given conditions listed above.

<b>ILLUMINATION</b>	Ave. Horizontal Illumination, $E_{AVE}$	18 Lux
	Uniformity Ratio, $E_{AVE}/E_{MIN}$	2.5:1
<b>LUMINANCE</b>	Average Luminance, $L_{AVE}$	1.2 Cd/m <sup>2</sup>
	Uniformity Ratio, $L_{AVE}/L_{MIN}$	2.5:1
	Uniformity Ratio, $L_{MAX}/L_{MIN}$	4:1
	Veiling Luminance Ratio, $L_V/L_{AVE}$	0.30:1

**11. Independent Testing:**

11.1 Independent testing of luminaires shall be required whenever the quantity of luminaires of a given wattage and distribution, as indicated on the plans, is 50 or more. For each luminaire type to be so tested, one luminaire plus one luminaire for each 50 luminaires shall be tested. Example: *A plan quantity of 75 luminaires would dictate that 2 to be tested; 135 luminaires would dictate that three be tested.*

11.2 The Contractor shall be responsible for all costs associated with the specified testing, including but not limited to shipping, travel and lodging costs as well as the costs of the tests themselves, all as part of the bid unit price for this item. Travel, lodging and other associated costs for travel by the Engineer shall be direct-billed to or shall be pre-paid by the Contractor, requiring no direct reimbursement to the Engineer or the independent witness, as applicable.

11.3 Commitment to test. The Vendor shall select one of the following options for the required testing with the Engineer's approval:

a. Engineer Factory Selection for Independent Lab: The Contractor may select this option if the luminaire manufacturing facility is within the state of Illinois. The Contractor shall propose an independent test laboratory for approval by the Engineer. The selected luminaires shall be marked by the Engineer and shipped to the independent laboratory for tests.

b. Engineer Witness of Independent Lab Test: The Contractor may select this option if the independent testing laboratory is within the state of Illinois. The Engineer shall select, from the project luminaires at the manufacturer's facility or at the Contractor's storage facility, luminaires for testing by the independent laboratory.

c. Independent Witness of Manufacturer Testing: The independent witness shall select from the project luminaires at the manufacturer's facility or at the Contractor's storage facility, the luminaires for testing. The Contractor shall propose a qualified independent agent, familiar with the luminaire requirements and test procedures, for approval by the Engineer, to witness the required tests as performed by the luminaire manufacturer. The independent witness shall:

- ▶ Have been involved with roadway lighting design for at least 15 years.
- ▶ Not have been the employee of a luminaire or ballast manufacturer within the last 5 years.
- ▶ Be a member of IESNA in good standing.
- ▶ Provide a list of professional references.

d. Engineer Factory Selection and Witness of Manufacturer Testing: The Contractor may select this option if the manufacturing facility is within the state of Illinois. At the manufacturer's facility, the Engineer shall select the luminaires to be tested and shall be present during the testing process. The Contractor shall schedule travel by the Engineer to and from the Manufacturer's laboratory to witness the performance of the required tests.

In all cases, the selection of luminaires shall be a random selection from the entire completed lot of luminaires required for the contract. Selections from partial lots will not be allowed. The selection of the testing option shall be presented with the information submitted for approval. The proposed independent laboratory or independent witness shall be included with that information. The selection of the testing option shall be presented with the information submitted for approval. The proposed independent laboratory or independent witness shall be included with that information.

11.4 The testing performed shall include photometric, electrical, heat and water jet testing.

11.5 Photometric testing shall be in accordance with IES recommendations except that the selected luminaire(s) shall be tested as manufactured without any disassembly or modification and, as a minimum shall yield an isofootcandle chart, with max candela point and half candela trace indicated, an isocandela diagram, maximum plane and cone plots of candela, a candlepower table (house and street side), a coefficient of utilization chart, a luminous flux distribution table, and complete calculations based on specified requirements and tests.

11.6 Electrical testing shall conform to NEMA and ANSI standards and as a minimum, shall yield a complete check of wiring connections, a ballast dielectric test, total ballast losses in watts and percent of input, a lamp volt-watt trace, regulation data, a starter test, lamp current crest factor, power factor (minimum over the design range of input voltage at nominal lamp voltage) and, a table of ballast characteristics showing input amperes, watts and power factor, output volts, amperes, watts and lamp crest factor as well as ballast losses over the range of values required to

produce the lamp volt-watt trace. Ballast test data shall also be provided in an electronic format acceptable to the Engineer to demonstrate compliance with sections 9.7, 9.8, 9.9 and 9.10.

11.7 Heat Testing. Heat testing shall be conducted to ensure that the luminaire complies with UL 1572. An ambient temperature of 40 degrees centigrade (104 degrees F) shall be used for the test.

11.8 Water spray test. The luminaires must pass the following water spray test.:

A spray apparatus consisting of four spray nozzles set at an angle of 30 degrees from the vertical plane space 30 inches apart on a 2 inch pipe, each delivering 12 gallons of water per minute at a minimum of 100 psi at each nozzle in a 90 degree cone. A water pressure gauge shall be installed at the first nozzle.

The luminaires shall be mounted in a ceiling configuration and with each nozzle set a distance of 18 inches below the fixture in the vertical plane and 18 inches away in the horizontal plane from the fixture lens, apply spray for a duration of 3 minutes at a minimum of 100 psi. When opened, the fixture shall not show any signs of leakage.

The above test shall be repeated in the opposite horizontal plane from the fixture lens with no signs of leakage.

The summary report and the test results shall be certified by the independent test laboratory or the independent witness, as applicable, and shall be sent by certified mail directly to the Engineer. A copy of this material shall be sent to the Contractor and luminaire manufacturer at the same time.

11.9 Should any of the tested luminaires of a given distribution type and wattage fail to satisfy the specifications and perform according to approved submittal information, the luminaire of that distribution type and wattage shall be unacceptable and be replaced by alternate equipment meeting the specifications with the submittal and testing process repeated in their entirety; or corrections made to achieve required performance. In the case of corrections, the Vendor shall advise the Engineer of corrections made and shall request a repeat of the specified testing and, if the corrections are deemed reasonable by the Engineer, the testing process shall be repeated. The number of luminaires to be tested shall be the same quantity as originally tested. Luminaires which are not modified or corrected shall not be re-tested without prior approval from the Engineer.

Coordination shall be the Vendor's responsibility. Failure to coordinate arrangements and notice shall not be grounds for additional compensation or extension of time.

Submittal information shall include a statement of intent to provide the testing as well as a request for approval of the chosen laboratory.

## **12. Installation.**

12.1 Underpass luminaires shall be either attached to structures (such as piers, etc.) or suspended from structures (such as bridge decks) as indicated or implied by the configuration on the Plans. Mounting, including all hardware and appurent items, shall be included as part of this item.

12.2 Unless otherwise indicated, suspended underpass luminaires shall be installed one-inch above the lowest underpass beam and shall be mounted using vibration dampening assemblies. All mounting hardware shall be corrosion resistant and shall be stainless steel unless otherwise indicated.

12.3 The Engineer reserves the right to select the final light distribution pattern, luminaire aiming angle and change it as deemed necessary to produce the proper pavement luminance.

12.4 Surface mounted luminaires, all luminaires not mounted on suspension rods, shall have one-inch thick stainless steel spacers installed between the luminaire and the deck or wall.

### **13. Guarantee.**

The Vendor shall provide a written guarantee for materials, and workmanship for a period of 6 months after final acceptable of the lighting system.

### **14. Documentation.**

All instruction sheets required to be furnished by the manufacturer for materials and supplies and for operation of the equipment shall be delivered to the Engineer.

The manufacturer shall have been incorporated for at least five years and shall have at least five years in the design and manufacturing of roadway underpass lighting. The manufacturer shall provide evidence of financial strength to finance the production of the project by submitting the name of at least three projects completed in the previous calendar year of greater than \$250,000 each. All steel used in the project shall be certified to be provided domestically, and all fixture components used shall be manufactured domestically.

**15. Method of Measurement.** Luminaires shall be counted, each.

**16. Basis of Payment.** This item shall be paid at the contract unit price each for **UNDERPASS LUMINAIRE**, of the wattage specified, **HIGH PRESSURE SODIUM VAPOR**, which shall be payment in full for the material and work describ

**JUNCTION BOX EMBEDDED IN STRUCTURE**

Effective: January 1, 2012

Description. This work shall consist of furnishing and installing an embedded Composite Concrete Junction Box in concrete.

Materials. The box and cover shall be constructed of a polymer concrete and reinforced with a heavy-weave fiberglass cloth. The material shall have the following properties:

Mechanical Property	Value	Physical Property	Value
Compressive strength	9,000 – 15,000 psi	Density	85-150 lbs/ft <sup>2</sup>
flexural strength	3,000 – 6,000 psi	Barcol Hardness	45
Impact Energy	30 – 72 ft.-lbs	Water Absorption	Less Than 1%
tensile strength	800 – 1,100 psi		

The resulting enclosure shall have a Tier 8 Load Rating in accordance with ANSI/SCTE 77 2002. The material shall have light gray color to match the surrounding concrete. The cover shall be made of the same material. The junction box and cover shall be arranged to fit flush with the structure surface. The cover shall be gasketed and attached with a minimum of four stainless steel hex-head bolts factory coated with anti-seize compound. The enclosure shall be UL Listed.

Installation. The embedded junction box shall be set flush with the adjoining surface and shall be properly supported during concrete placement. Concrete cover shall not be less than 3 in. (75 mm) all around the embedded junction box. The junction box shall not be installed in areas where vehicular traffic may drive over the junction box.

Field cut conduit openings shall be uniform and smooth. All burrs and rough edges shall be filed smooth to the satisfaction of the Engineer prior to the installation of conduit(s) into the junction box. Field cut conduit openings shall be fitted with the appropriate conduit fittings and accessories. Conduit fittings and accessories shall be provided according to Article 1088.01 and as shown on the plans.

Conduit openings may be factory cut and pre-assembled with conduit fittings. Conduit fittings and accessories shall be manufactured from polyvinyl chloride complying with ASTM D 1784 and shall comply with all the applicable requirements of NEMA Publication No. TC2, U.L. Standard 651 for EPC-40-PVC and NEC Article 347.

Slight deviations to a larger size than the specified sizes may be allowed to conform to a standard manufacturer's production size with the approval of the Engineer.

Basis of Payment. This work will be paid for at the contract unit price each for **JUNCTION BOX, EMBEDDED IN STRUCTURE**, of the type and size when specified. The Contractor

may, with the approval of the Engineer, use box sizes larger than indicated, at no additional cost to the Department.

**LIGHTING CONTROLLER, RADIO CONTROL, DUPLEX CONSOLE TYPE, WITH SCADA**

Effective: January 1, 2012

Description: This work shall consist of furnishing and installing a roadway lighting electrical control cabinet with radio control complete with foundation and wiring for the control of highway lighting.

General. The completed controller shall be an Industrial Control Panel under UL 508, and shall be suitable for use as service equipment

Double Door Enclosure.

Cabinet. The cabinet shall be of the dimensions shown on the plans and fabricated from 1/8 in. (3 mm) thick aluminum alloy No. 3003-H14. The cabinet shall comply with ANSI C 33.71 and UL 50 and be reinforced with aluminum angles.

Doors. The doors shall have stainless steel hinges. The door handle shall be stainless steel, a minimum diameter of 1/2 in. (13 mm) and be furnished with a rain and ice resistant lock. The doors shall be gasketed to exclude the entry of moisture, dirt, and insects. A linkage-arm system, of simple construction, shall be attached to the cabinet doors to allow securing in a wide open position during field operations.

Insulation. When specified, the interior compartment shall be insulated on the inside of the sides, back, top, bottom, and inside of the doors with 1 in. (25 mm) thick polyisocyanurate rigid foam insulation board. The foam board shall have foil facers on each side. The side facing the interior of the cabinet shall have a white tinted foil facer with a satin finish. The insulation shall have a minimum aged thermal resistance (R-value) of 8 at a 40°F (4°C) mean temperature. The insulation shall comply with Federal Specification HH-I-1972/1, Class 2.

Mounting. The cabinet shall be mounted as indicated on the plans.

Work Pad. Except where the cabinet is facing a sidewalk, a poured, 4 in. (100 mm) thick concrete pad, not less than 48 in. (1.2 m) square shall be provided in front of the cabinet.

Finish. All aluminum enclosures shall be finished.



Surface Preparation: The cabinet, doors and all other parts to be painted will be submerged in each tank of a 3 step iron phosphate conversion technique. After phosphatizing the parts shall be passed through an oven and baked to eliminate any moisture.

Finish coat: Shall be polyester powder paint applied electrostatically to a minimum thickness of 2 mils and baked at 375°F for 20 minutes.

The color of the finish paint shall be ANSI Standard No. 70 Sky Gray or as specified by the Engineer.

The finish shall be applied according to the paint manufacturer's recommendations and the manufacturer shall certify, in writing, to the Department, that the finish has been applied properly.

Submittal data submitted for approval shall address the requirement for the paint manufacturer's certification and shall include a standard, single source paint warranty by the paint manufacturer of the controller manufacturer to the Department.

Identification. The cabinet door shall have a stainless steel name plate of the dimensions and engraving indicated on the plans. An identification decal shall also be installed on the back of the cabinet as specified elsewhere herein.

### Control Components.

Time Switch. When specified, each controller shall have an electric time switch for automatic control of highway lighting circuits operating on a daily schedule having a fixed relation to sunrise and sunset. Turn-on and Turn-off times shall be adjustable  $\pm$  45 minutes from sunrise and sunset. All settings shall be field adjustable without special tools. Complete installation instructions, details on wiring connections, and information on time setting, manual operation, and necessary adjustments shall be furnished with each time switch.

The time switch shall be a microprocessor-based two channel controller with astronomic functions on both channels. The latitude shall be adjustable from ten to 60 degrees in the Northern hemisphere. Latitude changes shall be user ettable without the use of special tools.

The time switch shall be programmable in an AM/PM format, with a resolution of one minute or better. The time switch shall automatically adjust for daylight saving time and have automatic leap year correction and operate on 240 V AC without the use of an additional transformer.

A battery backup shall be integral with the controller and shall use a nickel-cadmium battery. The battery backup shall provide power to the controller memory for a minimum of 72 hours in the event of power failures.

The published operating temperature range of the time switch shall be from 86 to 158°F (-30 to 70°C).

The time switch output relay contacts shall be rated sufficiently to handle the inrush current of two 200 A contactors. The time switch shall have a NEMA Type 1 enclosure as a minimum. The time switch programming instructions shall be moisture proof and permanently affixed to the time switch or as otherwise approved by the Engineer.

### Circuit Breakers.

All feeders, branch circuits, and auxiliary and control circuits shall have overcurrent protection. The overcurrent protection shall be by means of circuit breakers.

Circuit breakers shall be standard UL listed molded case, thermal-magnetic bolt-on type circuit breakers with trip free indicating handles.

240 V circuit breakers shall have a UL listed interrupting rating of not less than 10,000 rms symmetrical amperes at rated circuit voltage for which the breaker is applied. 480 V applications shall have a UL listed interrupting rating of not less than 14,000 rms symmetrical amperes at rated circuit voltage.

Multi-pole circuit breakers larger than 100 A size shall have adjustable magnetic trip settings.

The number of branch circuit breakers shall be as indicated on the Control Cabinet detail drawing or as indicated in the lighting system wiring diagram which ever is greater plus two spare circuit breakers.

### Contactors.

Contactors shall be electrically operated, mechanically held as specified, with the number of poles required for the service and with operating coil voltage as indicated. The contactor shall have an in-line drive operating mechanism. Ampere rating of contactors shall be not less than required for the duty shown and shall otherwise be rated as indicated.

Contactors shall be complete with a non-conducting inorganic, non-asbestos subpanel for mounting.

Mechanically held contactors shall be complete with coil clearing contacts to interrupt current through the coil once the contactor is held in position.

The main contactor contacts shall be the double break, silver to silver type. They shall be spring loaded and provide a wiping action when opening and closing. The contacts shall be renewable from the front panel, self aligning, and protected by auxiliary arcing contacts.

The line and load terminals shall be pressure type terminals of copper construction and of the proper size for the ampere rating of the contactor.

A lever for manual operation shall be incorporated in the mechanically held contactor. Protection from accidental contact with current carrying parts when operating the contactor manually shall be provided.

The contactor operating coil shall operate at phase to neutral voltage. Single phase contactors shall be two pole devices with continuous rating for the amperage selected per pole.

Open and closed positions for mechanically held contactors shall be clearly indicated and labeled in permanent manner as approved by the Engineer.

Auto/Manual Switches. The cabinet shall be equipped with automatic and manual operating controls via two, single pole double throw switches, one being a maintained-contact manual-automatic selector switch and one being a momentary-contact manual on-off switch with a center rest position. Both switches shall be premium specification grade, rated for the applied duty but not less than 20 A at 240 V and each shall be mounted in a 4 in. (100 mm) square box with cover.

The control circuit shall have overcurrent protection as indicated and as required by NEC requirements.

#### Ground & Neutral Bus Bars.

Separate ground and neutral bus bars shall be provided. The ground bus bar shall be copper, mounted on the equipment panel, fitted with 22 connectors of the type shown on the plans, as a minimum. The neutral bar shall be similar. The heads of connector screws shall be painted white for neutral bar connectors and green for ground bar connectors.

#### Interior Lighting, Receptacle and CCTV power.

The cabinet shall have an auxiliary device circuit at 120 V single phase to supply a convenience receptacle, cabinet light and a dedicated 120v circuit for CCTV camera power indicated in the plans. Where 120 V is not available directly from the service voltage, an outdoor dry type step-down transformer not less than 2 KVA shall be provided as described elsewhere herein.

The auxiliary circuit, including transformer primary and secondary, shall have overcurrent protection according to NEC requirements.

The interior, 60 W incandescent lighting fixture of the enclosed-and-gasketed type, shall be switched from a single pole, single throw, 20 A switch. The switch shall be premium specification grade in a suitable 4 in. (100 mm) box with a cover.

A 20 A duplex receptacle, ground fault interrupting, premium specification grade shall be furnished in a 4 in. (100 mm) square box with cover, for 120 V auxiliary use.

#### Surge Arrester.

The control circuit in the cabinet shall be protected by a surge arrester meeting the requirements of Article 1065.02.

#### Wiring and Identification.

Power wiring within the cabinet shall be of the size specified for the corresponding service conductors and branch circuits and shall be rated RHH/RHW, 600 V.

Control and auxiliary circuit wiring shall be rated RHH/RHW or MTW with jacket, 600 V.

All power and control wiring shall be stranded copper. When specified all wiring shall be tagged with self-sticking cable markers. When the contract drawings do not specifically indicate assigned wire designations, the manufacturer shall assign wire designations and indicate them on the shop drawings.

All switches, controls and the like shall be identified both as to function and position (as applicable) by means of engraved two color nameplates attached with screws, or where nameplate are not possible in the judgement of the Engineer, by the use of cloth-backed adhesive labels as approved by the Engineer.

The cabinet with all of its electrical components and parts shall be assembled in a neat orderly fashion. All of the electrical cables shall be installed in a trim, neat, professional

manner. The cables shall be trained in straight horizontal and vertical directions and be parallel, next to, and adjacent to other cables whenever possible.

Transformer, General Purpose.

The transformer shall be dry type and weatherproof so that it may be installed indoors or outdoors without additional housing. It shall have an enclosure for splices with provisions for weather tight conduit connections.

The transformer shall have four taps on the primary side, one at 2 1/2 percent, one at 5 percent, one at 7 1/2 percent and one at ten percent below rated voltage.

Insulation shall be Class F or Class H. The transformer shall meet the applicable ASA and IEEE standards.

Mounting and back plates shall be of Aluminum Alloy 2024, 3003 or 6061. Bolts, nuts and washers shall be of Series 300 stainless steel. Bolts shall have hexheads. Nuts shall be hexagon and self locking. Washers shall be of the flat type.

Radio Control Equipment.

Receiver - Decoder: The radio control module consists of a radio receiver, digital decoder, and an output interface which allows centralized remote radio control of the lighting controller turn-on and turn-off functions. The radio control module must be capable of operation consistent with the existing radio control system, a Motorola SCADA Central Station.

The existing control system currently operates over 250 discrete lighting controllers via a securely coded proprietary data scheme. For this reason, the control module must consist of a Motorola ACE 3600 Modular Remote Unit, model F 7563, (small housing), with no less than the following options:

<b>Motorola Designation</b>	<b>Description</b>
F 7563 (VHF), F 7564 (UHF)	ACE 3600 CPU *
V 245	Mixed I/O
V 261	240 VAC Power Supply

Motorola Designation	Description
	w/charger
Z 857AA	Surge Protection

\* Includes (1) three slot frame, (1) ACE 3600 CPU plus firmware, (1) mixed I/O Module, (1) VHF or UHF (as directed by the Engineer) CDM 750 Radio with FSK Radio Interface, port 3 (1) AC Power Supply with Charger, (1) 6.5 Ah battery, installed in a 15" X 15" X 8.26" NEMA 4X/IP 56 painted metal enclosure with instruction manual.

The manufacturer's designation by no means relieves the Contractor of providing a fully functional radio system as described herein.

A 120/240 to 24VAC step down transformer shall be included for the SCADA system.

The Radio Control Module shall be programmed for the following operational parameters:

- Transceiver Frequency: To be specified by the Engineer
- Receive Frequency: To be specified by the Engineer
- Communications Failure Preset: Normally Open
- Individual Station address: To be specified by the Engineer

Antenna. The antenna shall be thick mount up to ½" mounting surface mounted by screw adapter (no magnet mounts). The low profile antenna mount shall be equivalent to Antenex – MABT8XNSI antenna Mount Low Profile. Accompanying antenna shall be equivalent to Antenex – B132 (Broad Band – VHF/UHF ¼ wave 150-928 MHz. Accompanying cable shall be equivalent to Antenex-RG8X and conductor equivalent to Antenex – CN8X from Radio to Antenna and shall be of appropriate length and not longer than 8 ft.

Installation. I/O Module. All motherboard cards shall be configured and installed as per manufacturer's specifications and IDOT specification Ltg SCADA 397. Modules include but are not limited to; CPU, Mixed I/O. All digital inputs terminated on the Mixed I/O card shall be dry. Termination points for all digital input points will be reflected on power center wiring diagram or additional wiring schematic provided by the engineer. All digital outputs received from the Mixed I/O card shall be rated at 24 VAC 2A. All digital outputs shall be connected to interposing relays prior to being integrated into the power center wiring logic. The digital outputs shall maintain a momentary closure for approximately 2 seconds.

All wiring termination points shall be tagged using the nomenclature given on the wiring diagram. The alarms acknowledge button shall be implemented with a placard stating

“Alarm Acknowledge”. Site configuration, map implementation, screens tagging and other related software configurations shall be specified elsewhere herein.

The antenna shall be centered on the top of the control cabinet. The antenna cable shall be dressed and trimmed for minimal length, allowing sufficient slack of removal of the radio connection for replacement or testing without disruption to the installation. The antenna connector shall be properly soldered to the cable assembly. Great care shall be exercised in the assembly of the antenna connector, excessive heat will destroy the inner insulation, and insufficient heat will produce a cold solder connection on the outer shield.

Intra-module wiring shall be 18 AWG stranded wire, color coded (American) consistent with battery polarity, and signal. The wire connection from terminal block (TB2) to the interpose relays shall be 14AWG stranded. All wires connected to the radio modules shall be dressed and tinned prior to insertion, (crimp on connectors will not be allowed for use in the radio system). Cost of all wire is inclusive within the scope of this work.

A terminal strip separate from the integral radio module and power supply shall be provided to interface power and signal conductors to the lighting controller. Terminals and wiring shall be labeled in accordance with the drawings, and dressed to allow service. The radio module shall be provided with constant 240 VAC power. The control power breaker shall provide power for the SCADA system. This is to allow the system to be energized at all times.

The SCADA system shall be tested in conjunction with the controller inspection, prior to field installation. The turn-on and turn-off function shall be tested ten (10) consecutive times utilizing actual signals originating from District 1 Headquarters. Any failures must be cleared before the controller is delivered to the job site.

Null covers shall be provided for the slots not used. All analog inputs shall be 4-20 mA. All I-O wiring including analog and digital shall be wired as per the enclosed table.

SCADA System Control Relay Assembly. The Contractor shall mount and wire four (4) relays in a box as shown in the wiring diagram. Two relays shall be 240 volts sealed type and two relays shall be 24 volts sealed type, unless otherwise indicated, shall have contacts rated at not less than 20 amperes at 240 volts. The power relay for activating the lighting contactors shall have contacts rated to handle the contactor inrush. The relays shall be wired to a marked terminal strip.

Testing. As part of final acceptance testing, all individual I/O points and internal status alarms shall be tested for proper operation and transmission. The transmission shall be confirmed at IDOT District 1 HQ, and the contractors dispatch facility. This full SCADA system start-up shall be completed with the Engineer present.

The SCADA radio system shall have the following items tested: VSWR, cable impedance, RSSI to the power center and confirmation that data sent from power center is received by the IDOT lighting system computers.

Analog Inputs And Transducers. The panel shall include one voltage transducer for monitoring the line voltage and one current transducer for monitoring the neutral current. Their outputs shall be 4-20 mA DC each and shall be wired to channels 1 and 2 of the Mixed I/O module as shown. The voltage transducer shall be Scientific Columbus Model # VT110 – PAN7 – A4-2 for 480/240 volt single phase systems. The current transducers shall be Mel Kirchner Technologies Model # AT2-420-24L-FT, with power supply, PS-240-24P-1A. Both analog inputs shall be wired using shielded cable. Both transducers shall also be calibrated so that the SCADA system reads the correct value.

Testing Of The Assembled Cabinet. Prior to shipment of the completed control cabinet, the control cabinet shall be tested for load, short circuits and complete operation of the cabinet as specified herein and as shown on the plans. The test shall be made at the manufacturer’s shop, by the manufacturer and shall be witnessed by the Engineer. The Contractor shall arrange the test date with the Engineer and so allow not less than seven (7) days advance notice. The cabinet shall not be delivered to the job site until inspected, tested and approved for delivery by the Engineer.

Staging. All Central Configuration programming be completed prior to the initial check out/PM of the SCADA unit in the field. This is to assure/confirm 2 way radio communications from the field RTU the Central. Lighting controller information submitted for approval shall include any recommendations of the Manufacturer for storage as provided under this contract.

The packaging of the lighting controller shall incorporate the provisions recommended by the Manufacturer to accommodate storage.

<b>TER M</b>	<b>MOSCAD DESTINATION</b>	<b>WIRE #</b>	<b>DESCRIPTION OF INPUT</b>
32	Analog Input 1 (+)	TB2 B11	CABINET NEUTRAL CURRENT
33	Analog Input 1 (-)	TB2 B1	CABINET NEUTRAL CURRENT
34	Analog Input 2 (+)	TB2 A2	CABINET SERVICE VOLTAGE
35	Analog Input 2 (-)	TB2 B2	CABINET SERVICE VOLTAGE
40	P. Ground	TB2 A3	GROUND
1	Digital Input 1	TB2 B3	ALARM ACKNOWLEDGE



2	Digital Input 2	TB2 A4	DOOR OPEN
3	Digital input 3	TB2 A5	MAIN(S) BREAKER OPEN
4	Digital input 4	TB2 A7	CONTACTOR 1 OPEN
5	Digital Input 5	TB2 A8	CONTACTOR 2 OPEN
6	Digital input 6	TB2 A9	CABINET IN NON-AUTO
7	Digital input 7	TB2 A10	BACK-UP CLOCK OFF CALL
8	Digital Input 8	TB2 A11	BACK-UP CLOCK ON CALL
18	DI Common	*	COMMON
20	K1 NO	TB2 A12	LIGHTS ON CALL
21	K1 Com	TB2 B17	K1 COMMON
23	K2 NO	TB2 A13	LIGHTS OFF CALL
24	K2 Com	TB2 B17	K2 COMMON
17	24 V+	TB2 B13	24+ VDC

All analog inputs will be 4-20 mA only. Digital output relays will be electrically energized and momentarily held.

Mixed I/O module model number V 245

Lighting SCADA RTU terminal Configuration.

Description. This work shall consist of having the SCADA system manufacturer design, implement and test a new RTU on the Lighting SCADA System on all system terminals.

Materials. All software work shall be completed by the manufacturer or approved factory licensed sales and service company for the SCADA equipment. All licensing shall be provided by the entity completing the work. Licenses are to be held by IDOT.

SCADA RTU Configuration And Programming:

1. Setup of CPU and accompanying modules.
2. Setup of RTU site number, octal address, group call and All Call.
3. Configure application alarm parameters (download config./application).
4. Development and implementation of control and alarm application from IDOT submitted telemetry requirements.

NOTE: IDOT shall supply checklist listing I/O, telemetry, all call, group call and individual call data.

#### SCADA Service/Client Wonderware Programming:

1. Add RTU to Wonderware.
2. Configure Wonderware to poll SCADA CPU for data on that specific RTU.
3. Setup servers and clients for alarm notification and database I/O, for that specific RTU.
4. Configure RTU polling.
5. Activate RTU on FIU polling.

#### SCADA FIU CPU Programming:

If RTU exists as an Intrac site, it will have to be setup as a MOSCAD site (MOSCAD CPU). If RTU is a new site, it will have to be configured as a MOSCAD site (MOSCAD CPU).

Submittals. The Motorola VAR shall submit ladder programming, quiescent telemetry and SCADA configuration files for approval by the IDOT Engineer. Submittal will be reviewed by the Engineer and returned noting changes and/or comments.

Testing and Documentation. As part of final acceptance testing, all individual I/O points and internal status (COS) alarms shall be tested for proper operation and transmission. The transmission shall be confirmed at IDOT Dist. HQ. And the contractors dispatch facility. This full SCADA system start-up shall be completed with the Engineer present.

The control cabinet shall be tested for complete operation and the electrical load on each circuit shall be measured and documented on the Log form L-3. The ground resistance test shall be performed by the Contractor using the fall-of-potential method, with results recorded by the Contractor and witnessed by the Engineer. Ground continuity shall be tested using an approved low-impedance ohmmeter, to the farthest point of each circuit extension from the controller cabinet. Results shall be recorded by the Contractor and witnessed by the Engineer.

#### Installation.

The lighting controller installation shall be according to the details, location, and orientation shown on the plans.

Work Pad. A 4 in. (100 mm) thick portland cement concrete work pad, not less than 48 x 48 in. (1.2 x 1.2 m) shall be provided in front of the cabinet, except where the cabinet faces an adjacent sidewalk.

All conduit entrances into the lighting controller shall be sealed with a pliable waterproof material.

Concrete Foundation. The Contractor shall confirm the orientation of the lighting controller, and its door side, with the Engineer, prior to installing the foundation. A portland cement concrete foundation shall be constructed to the details shown on the plans and is included as a part of this pay items and shall not be paid for separately. The top of the foundation shall be 12-inches above grade.

The lighting controller enclosure shall be set plumb and level on the foundation. It shall be fastened to the anchor rods with hot-dipped galvanized or stainless steel nuts and washers. Foundation mounted lighting controllers shall be caulked at the base with silicone.

Where the controller has a metal bottom plate, the plate shall be sealed with a rodent and dust/moisture barrier.

#### Grounding.

Grounding shall be as shown on the lighting controller detail drawings. Ground rods, ground wells, connections, ground wire and other associated items shall be included in the cost the lighting controller and shall not be paid for separately.”

**Method Of Measurement.** Each lighting controller shall be counted each for payment.

**Basis Of Payment.** This item shall be paid for at the contract unit price each for **LIGHTING CONTROLLER, RADIO CONTROL, DUPLEX CONSOLE TYPE WITH SCADA**, which shall be payment in full for the work, complete, as specified herein.

#### **LIGHT TOWER**

Effective: January 1, 2012

1. Description. This work shall consist of furnishing and delivering a light tower complete with lowering device, and all appurtenances required for a complete operating unit.
2. Definitions.

**Light Tower:** The complete light tower shaft and lowering device as one integral working system.

**Shaft:** The light tower shaft.

**Lowering Device:** The components involved with the mounting, operation, and raising and lowering of the luminaire ring, luminaires, and CCTV camera if so equipped.

**Tower Height:** The height of the tower shall be measured from the bottom of the base plate to the center-line of the luminaire tenon arm. This dimension is also referred to as Mounting Height.

3. Materials. Materials shall be as specified elsewhere herein.
4. Submittals and Certifications. Shop drawings, product data and certifications shall be submitted. The submitted information shall be complete and shall include information relative to all specified requirements suitable for verification of compliance.

**THE SUBMITTALS SHALL BE ARRANGED AND CROSS-REFERENCED TO THE SPECIAL PROVISIONS. FAILURE TO CROSS-REFERENCE THE SUBMITTAL INFORMATION WITH THE SPECIAL PROVISIONS WILL RESULT IN THE SUBMITTAL BEING RETURNED WITHOUT REVIEW.**

The submittal information shall be dated, current, project specific, identified as to the project, and shall also include the following calculations and certifications:

- Shaft design calculations, including Registered Engineer Certification.
- Lowering device seating force calculations.
- Certification of intent to provide domestic steel in accordance with Article 106.01 of the Standard Specifications.
- Welding details and procedures.
- Letter of intent to provide specified weld inspection reports.
- Confirmation of coordination between anchor rod supplier and tower manufacturer for adequacy of anchor rod assembly.
- Manufacturer's recommended installation procedures.
- Letter of intent to provide manufacturer's representative during installation and to provide specified installation certification.

All certifications shall be notarized.

5. Deleted
6. Light Tower

6.1 General. Light towers (high mast poles) shall consist of any poles 24 m (80 ft) or more in length.

Each light tower shall be complete with internal, integral motorized lowering mechanism, luminaire ring, pole top hood, internal electric power cables, luminaire counter-weight (when applicable), and all appurtenances required for a complete operating unit.

The design shall be based upon AASHTO “Standard Specifications for Structural Supports for Highway Signs, Luminaires and Traffic Signals” current at the time the project is advertised. The calculated loading shall incorporate a total combined luminaire weight of 720 lbs and a total projected area of 7.3 m<sup>2</sup> (24 ft<sup>2</sup>). The towers shall also comply with AASHTO fatigue Category I.

Light towers shall be designed and constructed so no structural member or other component is applied in excess of the manufacturer’s recommended rating (when applicable) or the published rating, whichever is lower.

The light towers shall be of a height and luminaire capacity as indicated and shall be of the non-latching ring support design. A latching-type ring support will not be acceptable.

The tower shall be provided as a single coordinated assembly, with one entity responsible as manufacturer of the whole. One entity must be the manufacturer of the lowering device or the tower shaft, or both, shall warrant the entire coordinated assembly.

6.2 Deflection. The design of the tower shaft shall achieve a maximum, fully loaded deflection at the top of the pole, which is not greater than the following percentage of the tower height:

<b>Light Tower Maximum Deflection</b>		
Tower Height		Maximum Deflection as % of Tower Height
Meters	Feet	
49	160	13.70
46	150	10.04
43	140	7.80
40	130	6.02
36	120	10.75
33	110	7.80
30	100	5.30

<b>Light Tower Maximum Deflection</b>		
Tower Height		Maximum Deflection as
27	90	4.50
24	80	3.50

6.3 Shaft.

- 6.3.1 The tower shaft shall be a low deflection tapered shaft having polysided, circular, or elliptical cross sections. The shaft cross section at the top shall be not less than 190 mm (7.5 in.) in length across the major axis. The shaft cross section at the bottom shall not be greater than that which is compatible with the base plate bolt circle specified, and shall not be less than 600 mm (24 in.) in length across the minor axis for new installations.
- 6.3.2 All tower shaft components, including, but not limited to the shaft sections, tower sections, base plates, handhole door, handhole reinforcing, rain gutter, and base plate shall be fabricated from high strength, low alloy steel with minimum yield strength of 345,000 kPa (50,000 psi) according to AASHTO M 223 (ASTM A 572 GR 50).
- 6.3.3 Each tower shaft shall be constructed of not more than the following welded or slip fitted sections:

<b>Maximum Light Tower Sections</b>		
Tower Height		Maximum Number of Sections
Meters	Feet	
49	160	4
46	150	4
43	140	4
40	130	4
36	120	3
33	110	3
30	100	3
27	90	3
24	80	2

- 6.3.4 Sections which are slip fitted shall have slip joints with a minimum overlap of 1.5 times the diameter of the bottom of the upper section at the slip joint. Towers having slip joint construction shall be pre-fitted and match marked at the factory and shall be shipped disassembled for

assembly at the job site. Slip joints shall be marked with a scribe to allow verification that 1.5 times diameter insertion is provided. A copper bonding jumper, included with the tower, shall bond slip fit pole sections together with a flat copper mesh and UL Listed ground lugs.

#### 6.4 Handhole.

- 6.4.1 Each tower shaft shall be constructed with a handhole/access door for access to power connections and lowering mechanism equipment. The handhole shall be large enough to make the following items visible from an extended operating position and accessible for maintenance: cable drum, transition plate, and the drive train oil level indicator. The handhole shall be sized and arranged to permit removal of the lowering mechanism without excessive dismantling of the equipment. The handhole may be a reinforced opening in the pole shaft as detailed on the plans or may be a part of a flared shaft base assembly as approved by the Engineer. The flared base shall not be considered a separate section of the tower shaft. Minimum opening dimension for the handhole shall be 300 mm x 900 mm (12 in. x 36 in.) and it shall have a lockable door. The handhole shall be located so as to not interfere with the operation of the door clamps, and it shall be positioned on the tower shaft to align on center with one of the anchor bolt (rod) positions and at a minimum height, as detailed on the plans, to facilitate access to mounting nuts with tools required for installation.
- 6.4.2 The handholes in the pole shafts shall have rounded corners and shall be reinforced to maintain the original strength of the tower shaft. Flared base assemblies shall maintain the strength of the shaft and have no nonround protrusions.
- 6.4.3 Handhole Door. The handhole shall have a door with a full-height stainless steel piano hinge, or with not less than two stainless steel hinges. A bolt through a door and frame eyelet shall not constitute an acceptable hinge. Hinges shall be heavy duty, suitable for the weight of the handhole door. The handhole door shall not be warped in any direction. The door hinge shall be attached with stainless steel nuts and bolts.
- 6.4.4 Handhole door gasket. The door/opening shall be gasketed in a manner which will prevent the entry of water into the tower and the door shall have a tight compressive seal employing a tubular gasket to assure compressibility. The gasket shall be a one piece design and shall be jointed by chemical fusion at the bottom of the opening.

- 6.4.5 Handhole door clamps. The door shall be held closed with a 12 gauge captive adjustable, spring loaded, stainless steel clamp assembly. The clamps shall have a depth stop feature to insure uniform sealing pressure at all clamp points. A minimum of four clamps shall be used around the nonhinged sides of the door assembly. The door clamp locations and handhole shall be coordinated with the tower so that the clamps can operate over their full range of movement without any interference from other tower components including anchor bolts which may protrude up to 6" above the top surface of the base plate. The door clamps shall be attached with stainless steel nuts and bolts.
- 6.4.6 Padlock provision. A stainless steel padlock hasp and staple shall be provided for locking the door. Door hardware shall be stainless steel. The door shall be equipped with an integral door stop/hold-open mechanism.
- 6.4.7 Rain Shield. A rain shield shall be placed above the handhole to direct water away from the handhole. The shield shall be fabricated of the same material as the pole shaft, shall have rounded corners, and shall be permanently welded to the shaft. The rain shield cannot interfere with operation of the handhole door or door clamps. Details of the configuration and welding shall be submitted for the Engineer's approval.
- 6.4.8 Cable Hook. A cable hook/cradle, readily accessible from the front of the tower, shall be provided to hang the control operator cable assembly when not in use. The hook or cradle shall be made from steel rod no less than ½-inch in diameter and shall be painted as the pole is. This hook or cradle shall be large enough to hold 25 ft. (7.5m) of power cable and positioned for practical in-field use. The hook shall not have sharp edges or protrusions that could damage the cable, and it shall not interfere with the operation of the lowering mechanism.
- 6.4.9 Ground Lug. Each tower shaft shall have a handhole accessible ground lug welded to the shaft for connection of ground conductors. The lug shall be UL Listed and accessible with the lowering device installed.
- 6.4.10 Interior Bolt Exposure. Bolts attaching the various components to the tower, handhole, and handhole door shall be properly sized and coordinated with the matching nuts so that no more than 0.25" of thread is exposed past the nut when properly tightened.
- 6.5 CCTV component box mounting provision. The tower shaft shall include four (4) mounting standoffs welded to the tower shaft prior to finishing. The standoffs shall be configured as indicated on the drawings and shall be arranged to facilitate



the installation of a standard 20" x 16" x 10" NEMA 4X stainless steel junction box as manufactured by Hoffman Enclosures (A-20H1610SSLP) or Electromate Enclosures (E-20H1610SS). The standoffs shall be drilled and tapped to accept a 7/16" diameter bolt.

Two 1" diameter holes shall be drilled and tapped at the upper third of the mounting area to facilitate the installation of conduits from the back of the box to the tower. The locations of these holes may be modified during the submittal process and must be approved by the Engineer. The holes shall be sealed with threaded steel plugs. The junction box mounting holes shall be sealed with threaded stainless steel bolts. The bolt and plug threads shall be coated with a generous amount of anti-seize compound prior to installation.

The manufacturer shall demonstrate that the specified junction box will fit by test fitting an actual junction box and documenting the results with photographs submitted to the Engineer for approval.

6.6 Base Plate.

6.6.1 The base plate shall be factory predrilled (slotted) for the number and configuration of anchor rods as provided in the following table:

<b>Base Plate Configuration</b>				
Tower Height		Min, number anchor rods	Rod Circle	
Meters	Feet		mm	inches
49	160	8	914	36
46	150	8	914	36
43	140	8	914	36
40	130	8	914	36
36	120	8	762	30
33	110	8	762	30
30	100	8	762	30
27	90	8	762	30
24	80	6	762	30

The base plate shall have a round (disk) shape of the specified outer diameter or as otherwise approved by the Engineer. The minimum thickness of the base plate shall be 50 mm (2.0 in.). The base plate shall be circumferentially welded to the tower shaft and, as noted above, the plate shall be oriented such that one anchor rod is aligned with the vertical center line of the handhole.

## 7. Welding.

### 7.1 Manufacturer Welding Requirements.

7.1.1 Circumferential welds. Circumferential welds, including top flange welds, shall be full penetration welds.

7.1.2 Longitudinal welds. Longitudinal welds shall have a minimum of 60 percent penetration, except the longitudinal welds on both the male and female shaft sections shall be full penetration welds within a distance of two diameters of overlap joints.

Minimum preheats for welds shall be 40° C (100° F) for fillets, 65° C (150° F) for seams, and 110° C (225° F) for circumferential welds.

Weld procedure specifications for seams and circumferential welds must be qualified according to Section 4, Part B of AWS D1.1. Charpy V-Notch (CVN) impact specimens shall be tested according to Table III-1 (note 2) of Appendix III for minimum values of 34 J (25 ft lb) at 4° C (40° F). Fillet weld procedures shall be tested according to Table 4.4 of AWS D1.1.

The welds shall be smooth and thoroughly cleaned of flux and spatter and be according to the AWS.

All full penetration welds shall be inspected for soundness by the ultrasonic method and all partial penetration welds shall be inspected by the magnetic particle method. Welding inspection reports shall be submitted to the Engineer for approval. The welding symbols and complete information regarding location, type, size, welding sequence, and WPSs shall be shown on all shop drawings. The Contractor shall submit the manufacturer's welding procedures, including inspection procedures, to the Engineer for approval.

7.2 Independent Welding Inspection. In addition to manufacturer's own welding inspection, the Contractor shall have welding inspected by an independent Certified Welding Inspector (CWI). The selected inspector shall be approved by the Engineer before any inspecting is performed. The NDE inspector(s) shall be independent nondestructive testing inspector(s), certified as level II in RT, UT, and/or MT as applicable. The methods for testing full penetration and partial penetration welds by the independent welding inspector(s) shall be the same as specified above in section 7.1

The independent welding inspector shall send the test results directly to the Engineers, as follows: Illinois Department of Transportation, Attn: Engineer of Structural Services, 2300 S. Dirksen Parkway, Bureau of Bridges & Structures, Springfield, Illinois 62764 and to: Illinois Department of Transportation, District 1, Attn: Electrical Design Section Chief, Bureau of Traffic Operations, 201 West Center Court, Schaumburg, Illinois 60196. All welds must pass inspection. Any deficient welds must be brought to the attention of the Engineer and corrective measures must be outlined.

## 8. Light Tower Finish.

### 8.1 General.

The light tower shall be finished with a duplex finishing system. Towers shall be hot dipped galvanized and then the exterior of the tower shall be painted with an intermediate coat of polyamide epoxy paint and a finish coat of aliphatic polyurethane paint.

Components receiving this duplex coating are the tower shaft, handhole, handhole door, base plate, mounting plate and all other elements attached to the exterior of the shaft.

The luminaire ring shall be painted with a three part paint system consisting of a organic zinc rich aromatic urethane primer, a polyamidoamine epoxy intermediate coat, and an aliphatic acrylic polyurethane finish coat.

The color of the finish coat shall be according to Federal Standard Color Number 6307, Hanford Gray. A color sample shall be included in the submittal information for review and approval.

All cleaning, preparation for painting, and painting shall be done in the same shop to ensure single source responsibility of the entire coating system. Also, all paint materials shall be from a single source to ensure compatibility.

In addition, sequence of operation shall be submitted describing the procedure used in preparing the galvanized surface, the brand names of the paint to be used, and certification that the paint that is used is compatible with galvanized surfaces.

The paint manufacturer shall also submit a detailed field touch-up procedure for the paint system. The procedure shall be specific to the various degrees of damage and shall include, but not limited to, the specific type of touch paint to be

used, surface preparation, and application requirements including temperature and humidity ranges.

- 8.2 Galvanizing. Hot-Dip galvanizing shall be in accordance with the applicable portions of ASTM A 123/123M or A 153/A 153M. Water quenching or chromate conversion coating of the galvanized steel is not allowed.
- 8.3 Shop conditions, General. The surfaces to be painted after surface preparation must remain free of moisture and other contaminants. The Contractor shall control the operations to insure that dust, dirt, or moisture does not come in contact with surfaces prepared or painted that day. In addition to the manufacturer's written instructions for surface preparation and painting, the following conditions shall apply (when in conflict, the most restrictive conditions shall govern):

The minimum steel and air temperatures shall be 40° F (4° C). Painting shall not be applied to steel that is at a temperature that will cause blistering, porosity, or be otherwise detrimental to the life of the painted surfaces. Painting shall not be applied when the steel surface temperature is less than 5° F (3° C) above the dew point. Painting shall not be applied to wet, damp, or frosted surfaces. Paint shall not be applied when the relative humidity is above 85%. Work accomplished under unfavorable weather conditions will be considered unacceptable and complete re-cleaning and painting of these areas will be required at no additional cost to the State.

All material must be applied under conditions within the following tolerances and permanent records must be kept of the processing conditions during the complete finishing process:

- Air temperature 50° F (10° C) minimum and 90° F (32° C) maximum.
- Steel surface temperature 50° F (10° C) minimum and 100° F (37° C) maximum.
- Humidity 85% maximum.
- Steel temperature at least 5° F (3° C) above the dew point.

- 8.4 Galvanized Steel Preparation.

The galvanized steel surfaces shall be prepared and primed as soon after galvanizing as possible but the surfaces shall be primed within 24 hours of the galvanizing operations. There should be no visible signs of zinc oxide or zinc hydroxide, which first appear as a fine white powder.

- 8.4.1 Surface smoothing. Zinc high spots shall be removed by cleaning with hand or power tools as describe in SSPC SP2 or SP3. The zinc should be removed until it is level with the surrounding area, taking care that the basecoating is not removed by the cleaning methods. After cleaning, the surface shall be inspected for conformance to the required zinc thickness in accordance with ASTM A 123 utilizing a magnetic or eddy current type thickness instrument in accordance with ASTM E 376. Any item falling below the required zinc thickness, before or after removal of any high spots, shall be repaired in accordance with practice ASTM A 780.
- 8.4.2 Surface cleaning. Hot dip galvanized surfaces must be clean and free of oil and grease before they are painted. Absolutely no water quenching or chromate conversion coating is allowed of the galvanized surface that is to be painted, as they will interfere with the adhesion of the paint coatings to the zinc surface. Any of the following methods as deemed necessary by the paint manufacturer shall be used for surface cleaning of the galvanized surfaces. The paint submittal shall indicate the proposed method of surface cleaning.
- Aqueous Alkaline Cleaning. An alkaline solution, with a pH of 11 to 13 may be used to remove traces of oil, grease, or dirt. Alkaline cleaner may not be used for removal of heavy build-up of zinc oxide or wet storage stain. The solution can be applied through immersion in a tank filled with the solution, sprayed, or brushed with a soft bristle brush. After cleaning, rinse thoroughly in hot water or water under pressure. Heated drying to accelerate the complete removal of water from the surface should be used.
  - Solvent Cleaning. Typical cleaning solvents, such as mineral spirits or high-flash naphtha, can be used to remove oil and grease. The procedure to be used is as specified in SSPC SP1. Proper rags or brushes should be used to wipe the galvanized parts. These rags or brushes should be cleaned or recycled often since oil can accumulate on their surfaces and be transferred back to the galvanized part. After cleaning, rinse thoroughly in hot water or water under pressure. Allow to dry completely before proceeding.
- 8.4.3 Surface preparation. Any of the following methods as per the written recommendation of the paint manufacturer may be used to prepare the galvanized surface for painting. The paint submittal shall indicate the proposed method of surface preparation.

- Sweep Blasting. Abrasive sweep or brush blasting which uses a rapid nozzle movement will roughen the galvanized surface profile. The abrasive material shall provide a stripping action without removing excess zinc layers. Particle size should be in the 8 mils to 20 mils (200  $\mu\text{m}$  to 500  $\mu\text{m}$ ) range. Materials that can be used are aluminum/magnesium silicate, soft mineral sands with a mohs hardness of 5 or less, corundum, limestone, and organic media such as corncobs or walnut shells. Nozzle pressure shall not exceed 50 psi (350 kPa). The blasting angle to surface shall be 45° at a distance of 16" – 18" (406 – 457 mm). The purpose of the sweep blasting is to deform not to remove the galvanized metal. Any area falling below the required zinc thickness, before or after the sweep blasting should be repaired in accordance with ASTM A 780. The procedure for this process can be found in SSPC SP7. Sweep blasting of zinc shall not be less than 130 yds<sup>2</sup>/h (110 m<sup>2</sup> /h) using these types of abrasives. Substrate should be maintained at a temperature greater than 5° F (3° C) above the dew point temperature. Following abrasive blast cleaning, surfaces should be blown down with clean, compressed air. The formation of zinc oxide on the blasted surface will begin very quickly so the paint coating should be applied immediately, within 60 minutes, after sweep blasting.
- Wash Primer Treatment. This process involves the use of a metal conditioner to neutralize surface oxides and hydroxides along with etching the surface. One example of a wash primer is SSPC-Paint Specification No. 27. The process is based on three primary components: a hydroxyl-containing resin; a pigment capable of reacting with resin and acid; and an acid capable of making the resin insoluble by reacting with the resin, the pigment, and the zinc surface. The result is a film of approximately 0.3 mils to 0.5 mils (8  $\mu\text{m}$  to 13  $\mu\text{m}$ ). Failures can occur if the film exceeds 0.5 mils (13  $\mu\text{m}$ ). The film is usually applied by spray, but may be applied by soft bristle brush, dip, or roller coater. For drying time prior to top coating, follow the manufacturer's instructions.
- Acrylic Passivation/Pretreatment. The passivation/pretreatment process consists of applying an acidic acrylic solution to the newly galvanized surface and then allowing it to dry, forming a thin film coating. The application methods for these water-based treatments are dipping, flow coating, spraying, or other appropriate means. Following application the coating is dried in an oven or in air. In some instances the coating is applied to hot galvanized articles in which case

separate drying is not necessary. Rinsing is not required. The coating is approximately 0.04 mils (1 µm) thick. Painting is possible any time during a period of four months after application as long as the surface is free of visible zinc oxides or zinc hydroxides. However, if harmful contaminants such as dust, dirt, oils, grease, or deposits are present, they must be removed with a mild alkaline degreasing solution, pH 11.5 maximum, followed by a thorough rinse with hot water (140° F (60° C) maximum temperature) or a pressure wash, and then, thoroughly dried. This treatment applied in the galvanizing plant or later in the paint shop. When applied in the paint shop, the surface must first be appropriately cleaned as described above to remove contaminants picked up after galvanizing.

8.5 Bare Metal Preparation.

Bare metal shall be prepared in accordance with SSPC-SP6 (Commercial Blast Cleaning) with a 1.0 – 3.0 mil (25 –75 micron) surface profile.

8.6 General Paint Requirements.

8.6.1 Compatibility. Each coating in the system shall be supplied by the same paint manufacturer.

8.6.2 Toxicity. Each coating shall contain less than 0.01 percent lead in the dry film and no more than trace amounts of hexavalent chromium, cadmium, mercury or other toxic heavy metals.

8.6.3 Volatile Organics. The volatile organic compounds of each coating shall not exceed 420 g/L (3.5 lb/gal) as applied.

8.6.4 The paint system shall be manufactured by the following paint manufacturers as determined by the Engineer.

<b>Manufacturer</b>	<b>Primer Coat</b>	<b>Intermediate Coat</b>	<b>Finish Coat</b>
Carboline	Carbozinc 859	Cabogaurd 888	Carboline 133 HB
Sherwin Williams	Zinc Clad III HS	Macropoxy 646	Acrolon 218

8.7 Zinc-Rich Primer Requirements.

- 8.7.1 Generic Type. This material shall be an organic zinc-rich epoxy or urethane primer. It shall be suitable for topcoating with epoxies, urethanes, and acrylics.
  - 8.7.2 Zinc Dust. The zinc dust pigment shall comply with ASTM D 520, Type II.
  - 8.7.3 Slip Coefficient. The organic zinc coating shall meet a Class B AASHTO slip coefficient (0.50 or greater) for structural steel joints using ASTM A 325M (A 325) or A 490M (A 490) bolts.
  - 8.7.4 Salt Fog. There shall be no delamination, blistering, rust creepage at the scribe, or rusting at the scribe edges after 5,000 hours of salt fog exposure when tested according to ASTM B 117 and evaluated according to AASHTO R 31.
  - 8.7.5 Cyclic Exposure. There shall be no delamination, blistering, rust creepage at the scribe, or rusting at the scribe edges after 5,000 hours of cyclic exposure when tested according to ASTM D 5894 and evaluated according to AASHTO R 31.
  - 8.7.6 Humidity Exposure. There shall be no delamination, blistering, rust creepage at the scribe, or rusting at the scribe edges after 4,000 hours of humidity exposure when tested according to ASTM D 2247 and evaluated according to AASHTO R 31.
  - 8.7.7 Adhesion. The adhesion to an abrasively blasted steel substrate shall not be less than 6200 kPa (900 psi) when tested according to ASTM D 4541 Annex A4.
  - 8.7.8 Freeze Thaw Stability. There shall be no reduction of adhesion, which exceeds the test precision, after 30 days of freeze/thaw/immersion testing. One 24-hour cycle shall consist of 16 hours of approximately  $-30^{\circ}\text{C}$  ( $-22^{\circ}\text{F}$ ) followed by 4 hours of thawing at  $50^{\circ}\text{C}$  ( $122^{\circ}\text{F}$ ) and 4 hours tap water immersion at  $25^{\circ}\text{C}$  ( $77^{\circ}\text{F}$ ). The test panels shall remain in the freezer on weekends and holidays.
  - 8.7.9 Application. The primer shall be applied in accordance with manufacturer's instructions to a dry film thickness of 2.5 – 3.5 mils.
- 8.8 Intermediate Coat Requirements.



8.8.1 Generic Type. This material shall be an epoxy or urethane. It shall be suitable as an intermediate coat over inorganic and organic zinc primers and compatible with acrylic, epoxy, and polyurethane topcoats.

8.8.2 Color. The color of the intermediate coat shall be white or off-white.

8.8.3 Application. The primer shall be applied in accordance with manufacturer's instructions to a dry fill thickness of 3.0 – 4.0 mils.

8.9 Urethane Finish Coat Requirements.

8.9.1 Generic Type. This material shall be an aliphatic urethane. It shall be suitable as a topcoat over epoxies and urethanes. The finish shall be semi-gloss

8.9.2 Color. The color of the finish coat shall be according to Federal Standard Color Number 6307, Hanford Gray. A color sample shall be included in the submittal information for review and approval.

8.9.4 Application. The finish coat shall be applied in accordance with manufacturer's instructions to a dry fill thickness of 2.5 – 3.5 mils.

8.10 Three Coat System Requirements.

The paint manufacturer shall certify that the paint system complies with the following requirements. The certification shall be signed by an officer of the manufacturer and shall be notarized.

8.10.1 Finish Coat Color. For testing purposes, the color of the finish coat shall be according to Federal Standard Color Number 6307, Hanford Gray.

8.10.2 Salt Fog. When tested according to ASTM B 117 and evaluated according to AASHTO R 31, the paint system shall exhibit no spontaneous delamination and not exceed the following acceptance levels after 5,000 hours of salt fog exposure:

<b>Salt Fog Acceptance Criteria (max)</b>			
<b>Blister Criteria</b>	<b>Rust Criteria</b>		
<b>Size/Frequency</b>	<b>Maximum Creep</b>	<b>Average Creep</b>	<b>% Rusting at Scribed Edges</b>
#8 Few	4mm	1mm	1

8.10.3 Cyclic Exposure. When tested according to ASTM D 5894 and evaluated according to AASHTO R 31, the paint system shall exhibit no spontaneous delamination and not exceed the following acceptance levels after 5,000 hours of cyclic exposure:

<b>Cyclic Exposure Acceptance Criteria (max)</b>			
<b>Blister Criteria</b>	<b>Rust Criteria</b>		
<b>Size/Frequency</b>	<b>Maximum Creep</b>	<b>Average Creep</b>	<b>% Rusting at Scribed Edges</b>
#8 Few	2mm	1mm	1

8.10.4 Humidity Exposure. There shall be no delamination, blistering, rust creepage at the scribe, or rusting at the scribe edges after 4,000 hours of humidity exposure when tested according to ASTM D 2247 and evaluated according to AASHTO R 31.

8.10.5 Adhesion. The adhesion to an abrasively blasted steel substrate shall not be less than 6200 kPa (900 psi) when tested according to ASTM D 4541 Annex A4.

8.10.6 Freeze Thaw Stability. There shall be no reduction of adhesion, which exceeds the test precision, after 30 days of freeze/thaw/immersion testing. One 24 hour cycle shall consist of 16 hours of approximately -30° C (-22° F) followed by 4 hours of thawing at 50° C (122° F) and 4 hours tap water immersion at 25° C (77° F).

#### 8.11 Quality Control.

The Contractor shall conduct a quality control program that ensures that the work accomplished complies with these specifications. The quality control program shall consist of:

- Qualified personnel to manage the program and conduct quality control tests.
- Proper quality measuring instruments.
- Quality Control Plan.
- Condition and quality recording procedures.

The personnel managing the quality control program shall have experience and knowledge of industrial coatings and the measurements needed to assure quality work. The personnel performing the quality control tests shall be trained in the use of the quality control instruments. These personnel shall not perform surface preparation and painting. Painters shall perform wet film thickness measurements. The Contractor shall supply all necessary equipment to perform quality control

testing of shop conditions, equipment, surface preparation, and profile and paint film thickness. The Contractor's personnel in accordance with the equipment manufacturer's recommendations shall calibrate these instruments.

The Contractor shall implement a Quality Control Plan approved by the Engineer including a schedule of required measurements and tests as outlined herein, procedures for correcting unacceptable work, and procedures for improving surface preparation and painting quality as a result of quality control findings. The Contractor shall supply and use forms approved by the Engineer to record the results of quality control tests. These reports shall be available at the work site for review by the Engineer. The purpose of the quality control program is to assist the Contractor in the proper performance of the work. Quality control tests performed by the Contractor will not be used as the sole basis for acceptance of the work.

8.12 Warranty. Before the painted surfaces, described herein, are accepted as a finished product, the light tower manufacturer shall have the paint manufacturer certify that the paint system was applied correctly in accordance with the paint manufacturer's procedures and these special provisions. The Contractor shall then furnish to the State, the tower manufacturer's, or paint manufacturer's normal paint warranty for a minimum of six months after final tower installation under a separate contract. It is anticipated that the towers will be installed by the end of 2005.

8.13 The paint thickness will be checked at the time of tower installation. If it is determined that the paint dry film thicknesses does not comply with the specified values, the Contractor shall apply another coat of finish paint, at no additional cost to the State, on the installed tower with surface preparation as required by the paint manufacturer. The dry film thickness will then be re-measured and if the thickness is not compliant, the procedure will be repeated again until the dry film thickness complies with all requirements at no additional cost to the State.

## 9. Head Frame.

9.1 Each tower shall be equipped with a head frame assembly to support and guide the luminaire ring assembly.

9.2 The head frame and luminaire ring shall have a positive mating/alignment interface at which the seating force is applied at each support cable. The interface shall be designed to operate with not less than 1.3 kN (300 lbs.) of total seating force distributed among the interface points. Manufacturer calculations shall be submitted to confirm this requirement. The stop used at the top of the tower shall not deform with the full force applied.

- 9.3 All head frame members and components, including support arms, shall be fabricated of steel of the same type as specified for the tower shafts or stainless steel of appropriate strength. The head frame shall have a head plate, a support, and 2 pulleys for each support cable. All openings in the head frame assembly shall be machined smooth and free from any burrs and sharp edges which could damage the support cables and power cable.
  - 9.4 The head frame shall have a power cable pulley placed between and roughly equidistant from 2 support arms, with a pulley diameter around the groove of not less than 350 mm (14 inches).
  - 9.5 The power cable shall pass through the head frame assembly utilizing a four-way roller guide assembly sized to accommodate the outside diameter of the power cable.
  - 9.6 Pulleys shall be constructed to allow associated cables to ride freely within pulley grooves and cable guides shall be incorporated to prevent cables from riding out of pulleys.
  - 9.7 Pulleys, attachment hardware, latches, hinges and the like shall be stainless steel. Pulleys shall be made of Unified Numbering System type 300 stainless steel and have permanently lubricated sealed bearings except the power cable pulleys may be cast aluminum or high-strength nylon.
  - 9.8 The head frame assembly shall be equipped with a metal hood. The hood shall protect the operating head frame components from damage or deterioration from weather but shall permit pole ventilation while preventing the entry of birds. The hood shall have a strong secure mechanical means to open/raise the hood for the future maintenance of the head frame such as a spin screw mount, and shall have a double-secured latching system to assure closure. The Design shall be such as to minimize the risk that the hood will be displaced from gusts of wind. The head frame assembly shall be match-marked to its tower shaft and shall be attached to the shaft by stainless steel hardware.
10. Luminaire Ring.
- 10.1 Each tower shall be provided with a luminaire ring suitable for twelve (12) luminaires of the type, and orientation specified. The ring shall mate/align with the head frame and shall be coordinated relative to seating force.
  - 10.2 The ring shall be designed for lowering to a position with the center line of luminaire arms 1.4 m (54 inches) or less above the top of the tower base plate.

The exact fully-lowered position shall be adjustable in the field. Wiring shall be fully enclosed in a metal raceway.

- 10.3 The ring shall be equipped with spring loaded bumpers, spring loaded rollers, spring-loaded outriggers or other shock-absorbing mechanism to guide the ring during the raising/lowering operations. The guide mechanism shall be spring loaded and shall be designed to minimize shock to the luminaire during raising and lowering. These devices shall be attached in a secure manner. The mechanism does not have to maintain constant contact with the tower shaft.
- 10.4 Arms for the attachment of luminaires shall be standard 50 mm (2-inch) diameter tenon arms. The arms shall be attached to the ring in a secure manner either by welding or by means of stainless steel bolts, nuts, lock washers and hardware such that a permanent rigid attachment is achieved. Arms shall be approximately 325 mm (13 inches) in length, coordinated with luminaire size and configuration and shall be arranged so that the overall diameter of the ring, including the luminaire, does not exceed 3.4 m (11 ft.). A "T" arm configuration shall be used as indicated in the plans and described elsewhere herein. Tenon arm ends shall be threaded to accept a PVC pipe cap. All tenon arms shall be capped. The tenon arms shall be level when the ring is in the raised position.
- 10.5 The ring raceway shall be arranged with screened weep holes of not less than 1/2-inch diameter at no less than 90 degree intervals around the ring.
- 10.6 The ring shall be equipped with an enclosed wire raceway and a stainless steel NEMA 4X terminal box for wiring of the luminaires and CCTV camera.
  - 10.6.1 Junction Box. The box shall be made of Type 304 stainless steel, not less than 2.03 mm (14 gauge), with all seams continuously welded with stainless steel weld wire and ground smooth. Exterior surfaces shall have a smooth polished finish. The box shall be UL 50 "Junction and Pull Box", "Junction Box", or "Pull Box".

A grounding lug shall be provided for the connection of the equipment grounding conductors as required by NEC Article 250-114.

The box shall have an overlapping stainless steel cover and shall be secured to the box with a continuous stainless steel hinge and a minimum of 4 captive stainless steel clamps utilizing captive stainless steel hex-head bolts or deep slotted stainless steel screws.

Be suitable for surface mounting, complete with external stainless steel mounting lugs or brackets welded to the enclosure.

The box cover shall have a continuous formed, seamless, urethane, oil-resistant gasket. The gasket shall be extruded directly onto the junction box cover. The gasket shall adhere to the cover without the use of adhesives. A neoprene strip gasket, or urethane strip gasket cut out of a larger sheet and glued to the junction box will not be acceptable.

10.6.2 The box shall be arranged and connected to the top of the ring from the top of the box in a manner that precludes moisture draining from the ring into the box. All fittings penetrating the box shall be watertight hubs with an integral O-ring. The hubs shall be watertight and corrosion resistant NEMA 4X and have an insulated polycarbonate throat. The insulated throat shall be rated up to 105° C. The hubs shall be UL Listed and comply with UL Standard 514B.

10.6.3 The box shall be equipped with a hinged door and a latch or with captive stainless steel closure hardware acceptable to the Engineer and an external special fixed-mount plug with a retained cap as specified elsewhere herein to accept a test power connection when the ring is in the lowered position.

10.6.4 The box shall be divided into two (2) compartments by a non-conductive barrier, minimum thickness of 0.04". One side of the box shall, on the top, have the main tower cable entry and the entry for the luminaire wires; it shall also contain a terminal strip with identified terminals for connection of the main power cord, luminaires, and the test power receptacle. The terminal strip shall have terminals sized to accommodate the cables to be connected and shall have luminaire connection terminals to accommodate the usage of all luminaire positions. The other side of the box shall, have on the top, a 3/4" inch conduit entry, capped, for extension of CCTV wiring, as applicable and shall contain an appropriate terminal strip for CCTV camera power and control connections as well as provisions for video output connections.

10.7 The ring shall facilitate ease of wiring to the arms by the use of removable gasketed covers, physical arrangement, or other means acceptable to the Engineer. Arms shall be factory or field wired according to NEC Article 410-31 using No. 10 wire having ethylene propylene rubber (EPR) insulation or bonded composite EPR insulation with a chlorosulfanated polyethylene jacket, rated 600 V not less than 90° C (194 ° F.), RHH-RHW, U.L. listed with solid color coding.

<b>Luminaire wire</b>		
<b>Insulation Type</b>	<b>Average EPR Insulation Thickness</b>	<b>Average Jacket Thickness</b>

Single Material EPR	1.1 mm (45 mils)	n/a
Bonded Composite Insulation Thickness	0.8 mm (30 mils)	0.4 mm (15 mils)

Wiring shall be color coded (black, red, white, and green, as applicable) with coloring via outer material color or by painting with a process approved by the Engineer. Wire rating information shall be visible in a contrasting color. Wires shall be installed to all luminaire arms. Luminaire wires shall extend 600 mm (24 inches) longer than their respective tenon arm and shall be trained back into the arm which shall then be closed with a protective cap for shipment of the jobsite. All wires shall be capped and crimped with sealant and heat-shrink insulating sleeves (wire nuts, tape, crimps, etc. will not be acceptable.). All ring wires shall be tagged with wire markers at both ends. The tenon arms shall also be tagged corresponding to the wiring contained within.

- 10.8 The luminaire ring shall be factory checked and marked for proper positioning and luminaire orientation. Catalog cuts and shop drawings shall indicate the orientation of the luminaire ring, handhole, and bolt circle in relation to each other on a single drawing.
  - 10.9 The ring shall be complete with a counterweight for each unused luminaire position plus one additional counterweight. Counterweights shall be based upon the luminaires to be installed on each respective tower.
  - 10.10 All luminaire rings shall be arranged to accommodate the complete indicated compliment of luminaires, regardless of the number actually to be installed, to facilitate luminaire positioning and orientation. For rings of 6 positions or less, each position shall have a tenon arm. For rings of more than 6 luminaire positions, the arrangement shall be accomplished by a "T" type of tenon arm to produce two luminaire mounting positions from a single extension arm, or by other means approved by the Engineer.
11. Lowering and Support Mechanism.
- 11.1 The support shall be of the non-latching design.
  - 11.2 The mechanism shall operate to raise the luminaire ring to its fully raised position and to lower the ring to a position with the centerline of the luminaire tenon arms 1.4 m (54 inches) or less above the top of the tower base plate. The exact fully-lowered position shall be adjustable in the field.
  - 11.3 The lowering and support mechanism shall include, but not be limited to the support cables, power cable, pulleys, winch, gear reducer, mechanical clutch,

electric motor, control and all accessories and appurtenances for a coordinated operating system.

- 11.4 The lowering and support scheme shall be of the 2-cable or 3-cable type as specified.
- 11.5 Three-cable mechanisms shall incorporate 3 support cables joined via an appropriate proven transition design to a single hoist cable wound around a single hoist winch. The transition design shall be such to prevent twisting of the support cables, to assure smooth winding of the cables on the winch and to prevent binding on the inside of the tower shaft.
- 11.6 Two-cable mechanisms shall incorporate 2 support/hoist cables wound around a dual winch assembly. The design shall be such to prevent twisting of the cables and to assure smooth winding of the cables on their respective winches and to prevent binding on the inside of the tower shaft.
- 11.7 The hoisting system shall be securely mounted and the lower assembly, i.e. motor, winch, mechanical clutch, gear reducer, etc., shall be designed to allow ease in removal of the equipment via the tower handhole without dismantling the system. Individual components shall be accessible and removable without the removal of other components. Mounting plates and other mounting templates and provisions shall have standardized dimensions to facilitate removal and interchangeability from unit to unit. Mounting hardware shall have an abundant strength safety factor and shall be positioned for even distribution of load.
- 11.8 The lowering device shall tightly position the luminaire mounting ring against the head assembly frame by applying a holding force evenly distributed among the seating/interfacepoints. The total force required by the system must not be less than 1.3 kN (300 lbs.) greater than the weight of the luminaire mounting ring with all luminaire positions occupied by luminaires. There shall be a positive indication at the handhole that the required force has been applied, visible from the extended operating position away from the handhole and not under the ring. Submittal information shall include load and seating force calculations to demonstrate compliance with specified requirements.
- 11.9 The mechanism shall be equipped with a multi-point safety chain and hook assembly to maintain the tension on the support system, allowing the motorized winch assembly to be disengaged. Chain and all hardware shall be stainless steel.
- 11.10 The system shall be designed so that unbroken power cable, suspension and/or hoist cable can be replaced from ground level.



## 11.11 Support and Hoist Cables.

- 11.11.1 Cables (wire rope) shall be manufactured from Type 302 stainless steel having a carbon content of 0.09 to 0.15 and shall be a stranded assembly coated with a friction-limiting non-corrosive lubricant.
- 11.11.2 Cables shall be 7x19 wire strand and have no strand joints or strand splices.
- 11.11.3 Cables shall be manufactured and listed for compliance with military specification MIL-W-83420B, Type 1, Composition B.
- 11.11.4 Cable terminals shall be stainless steel compatible with the cable and as recommended by the cable manufacturer. The terminals, swaging, etc. shall meet the requirements of military specification MIL-T-781 and shall be so listed. Care shall be exercised to assure a match of connector sizes to the wire rope size(s), and, to the extent possible, connectors shall have visible size markings.
- 11.11.5 For 3-cable systems, the support cables shall each be not less than 5 mm (3/16 inch) in diameter and the hoist cable shall not be less than 8 mm (5/16 inch) in diameter.
- 11.11.6 For 2-cable systems, the support/hoist cables shall each be not less than 6 mm (1/4 inch) in diameter.
- 11.11.7 As part of the tower shop drawings and product data submitted for approval, support and hoist cable information shall be provided. Submittals without such information will be incomplete and will be rejected. The information shall include, but not limited to:
- Catalog information to confirm sizing, stranding and other specified requirements.
  - Evidence of listing as military specification cable as specified.
  - Certification of compliance with all specification requirements made by the cable manufacturer.

Documentation of arrangement to provide a sample of the support cable to an independent laboratory as selected by the Engineer for testing to the military specifications listed herein, with results to be sent directly to the Engineer, all included incidental to this item. Copies of recent test reports made on identical cable indicating compliance with military specification requirements shall be submitted. The test reports shall include as a minimum, the following:

- Breaking Strength test.
- Endurance test.
- Stretch test.
- Test load.
- Chemical Composition.

## 11.12 Winch.

11.12.1 Drum. The winch/gear reducer assembly shall have a drum suitable for the hoist of support/hoist cables, arranged to provide smooth winding of the cable and to prevent slippage. The drum shall be stainless steel or cast/ductile iron and shall have a diameter not less than 18 times the diameter of its respective cable (wire rope). The winch drum shall be designed with cable guides for a smooth cable take-up of level lays and to prevent the cable from riding over the drum flange. The drum shall have the end of the cable attached by means of a swaged connection and one full layer of cable shall be wound on the drum even when the ring is in the fully lowered position. The drum flange axle shall be supported at both ends.

11.12.2 Gear Reducer. Each assembly shall incorporate a gear reducer having a reduction ratio which will prevent free fall of the luminaire ring upon failure or disengagement of the drive unit and which will produce a travel rate of 3 m (10 ft.) to 4.6 m (15 ft.) per minute under normal operation.

11.12.3 The unit shall have a worm gear which is totally enclosed in a lubricating reservoir. The lubricant shall have a viscosity range suitable for proper operation in ambient temperatures from -40° C to 49° C (-40° F. to 120° F.)

11.12.4 The worm shall be manufactured of case hardened ground alloy steel or cast iron.

11.12.5 The gear shall be of bronze alloy or of a proven alternate material and design acceptable to the Engineer with and the gear shall be keyed to the output shaft. The output shaft shall be high quality medium carbon steel ground to close tolerances. The worm and output shaft shall be mounted on anti-friction bearings. All shaft extensions shall be equipped with a lip-type synthetic element and oil seals.

- 11.12.6 The unit shall have provisions to verify oil levels in all gear boxes, and oil level indication shall be visible from the handhole when the unit is installed.
- 11.13 Clutch. The mechanism shall incorporate a mechanical clutch, installed between the winch/gear reducer and the cable winch assembly. The clutch shall be of mechanical type, in a sealed cast metal housing. The clutch torque shall be factory calibrated and coordinated with the electric motor. The clutch shall act to limit the seating force of the raised ring to a pre-established value. The clutch shall be suitable for the application and torque limitation and shall not deteriorate with use.
- 11.14 Motor.
- 11.14.1 The electric motor shall be matched to the load and torque characteristics required for a fully loaded luminaire ring and shall not be less than 746 watts (1 horsepower).
- 11.14.2 The motor shall be capable of producing torque in excess of the clutch maximum torque rating. The motor shall be totally enclosed fan cooled (TEFC), shall be reversible to operate the lowering mechanism in both directions, and shall be suitable for operation on the power supply characteristics shown on the drawings. Submittal information shall include complete motor data, including, but not limited to:
- Manufacturer
  - Nameplate Rated Watts (Horsepower)
  - Rated Voltage
  - Full Load RPM
  - Full Load Current
  - Locked Rotor Current
  - NEMA Design Letter
  - Insulation Class
  - Torque Data
  - Dimensional Data
- 11.15 Lowering Device Control.
- 11.15.1 The lowering device control shall consist of motor short circuit and motor running overcurrent protection and motor control complete with all appurtenances and interconnecting wiring. The control may

incorporate a reversing motor starter or a suitably-rated reversing control station.

- 11.15.2 The lowering device control may be provided in a separate NEMA 4X stainless steel enclosure or in the enclosure with the tower main Electrical breaker, provided the remote control station is a separate remote device.
- 11.15.3 The lowering device motor shall have a motor disconnecting means circuit and running overload protection according to N.E.C. requirements. The motor disconnect and short circuit protection shall be achieved by a molded case thermal magnetic bolt-on circuit breaker rated at 600 volts, of an ampere rating suitable for the motor and having a UL-listed interrupting rating of not less than 14,000 rms symmetrical amperes at 480 volts and 10,000 rms symmetrical amperes at 240 volts.
- 11.15.4 Running overcurrent protection shall be according to N.E.C. requirements. Motor overload protection shall be achieved by an appropriate dual element fuse in a spring-loaded screw-in type small-dimension fuse holder mounted within the enclosure in a suitable box or other arrangement approved by the Engineer.
- 11.15.5 The motor starter, if incorporated, shall not be smaller than NEMA size 1, shall be rated 600 volts and shall be full voltage, reversing type, with arc-extinguishing characteristics and renewable silver-to-silver contacts. A reversing control switch, if incorporated, shall be rated well in excess of the duty required and in no case less than 2,240 watts (3 horsepower) at 230 volts single phase. The control shall be momentary contact, raise-stop-lower with a neutral stop condition, requiring positive action by the person operating the device to keep the motor energized. The control shall have auxiliary contacts as indicated and as required for the control.
- 11.15.6 The enclosure shall have an exterior position-indicating trip-free operating handle for the motor circuit breaker. The enclosure(s) shall have exterior nameplates to read "LOWERING DEVICE CONTROL" and "MOTOR CIRCUIT BREAKER" as well as an interior nameplate "MOTOR OVERLOAD FUSE" which shall also be inscribed with the applicable fuse type and ratings. Nameplates shall be engraved, 2-color, attached with screws.

11.15.7 The line side power to the lowering device control shall be obtained via a plug extended connection to the power distribution cord/receptacle.

11.15.8 The control shall be complete with a cable-connected remote control station. The control station shall incorporate heavy duty control devices in a non-metallic impact-resistant NEMA 4X enclosure. The control shall be "dead man" type with "RAISE" and "LOWER" controls, requiring the operator to hold the respective control depressed in position for movement of the ring in either direction and with release of the control to stop the mechanism. The cord shall incorporate a No. 12 ground wire and the number of conductors required for a control, with control conductors not less than No. 14. The cord shall be weatherproof with watertight connections at either end and it shall be long enough to allow the operator to stand 7.5 m (25 ft.) away from the lowered luminaire ring. Provisions for storage of the control station and cord such as a suitable hanger cradle, shall be provided in a manner easily accessible at the handhole and in a location which precludes interference with the internal components of the lowering mechanism.

11.15.9 Cables extended from the enclosure shall be passed through a watertight sealing bushing and the cable shall be supported and arranged to preclude interference with the lowering mechanism. Wiring shall be in compliance with NEC requirements. Motor wires shall not be less than No. 12 and motor wiring shall be extended in UL-listed extra-flexible, weatherproof cord or other cord approved by the Engineer with suitable fittings, bushings and supports. All equipment shall be grounded and bonded via an appropriately sized equipment ground wire.

#### 11.16 Electric Power Distribution.

11.16.1 Electric power for motorized operation of the lowering mechanism and for the power supply to the lighting shall be taken from the lighting circuitry feeding the tower. The distribution shall provide termination of the supply feeder, extension to a tower main breaker and distribution to lighting and the lowering device.

11.16.2 The tower shall be equipped with a main circuit breaker. The circuit breaker shall be molded case, 2-pole, 40-ampere thermal magnetic, bolt-on type having a UL-listed interrupting rating of not less than 14,000 rms symmetrical amperes at 480 volts. The breaker shall

indicate "ON", "OFF" and "TRIPPED" conditions and the handle shall be trip-free.

11.16.3 The main breaker shall be housed in NEMA 4X stainless steel enclosure with an external, position-indicating operating handle with padlock provisions. The enclosure shall have a 2-color engraved nameplate to read "MAIN BREAKER", attached with screws. The box shall have openings and suitable bushings for cable extensions.

11.16.4 The main breaker shall be arranged for line-side connection to incoming feeder conductors entering the base of the tower via an extension of multi-conductor cable. The load side of the main breaker shall be connected to a cord and receptacle which shall be arranged for connection to either the luminaire ring main power, the lowered luminaire ring test power or the lowering device control.

11.16.5 Each connection to the main breaker shall be made with the specified electric power cable, extended from the enclosure through a watertight sealing/support bushing. The cables shall be arranged and secured to preclude any interference with the lowering device operation.

#### 11.17 Electric Power Cable.

11.17.1 The electric power cable shall consist of a 4-conductor jacketed extra flexible cable, (2 phase conductors, neutral conductor and a ground conductor) Type W industrial grade portable power cable, as listed in NEC Table 400-4. The cable shall meet ICEA S-68-516, WC-3 and shall be approved by the Pennsylvania Bureau of Mines.

11.17.2 Each conductor shall be stranded assembly of 133 flexible annealed copper wires according to ASTM B 33. Each of the 4 conductors shall be sized No. 6. Each conductor shall be individually insulated with ethylene propylene rubber insulation, all in compliance with ICEA S-68-516. Insulation shall be rated not less than 600/2000 volts, 90° C (194° F.) and insulation thickness shall not be less than 1.5 mm (60 mils).

11.17.3 Each individual conductor's insulation shall be color coded; one black, one red, one white and one green.

11.17.4 The individual conductors shall be assembled in a cable, with non-hydroscopic reinforced rubber fillers to maintain a smooth round outer

surface, with a jacket applied overall. The jacket shall be a heavy duty jacket manufactured according to ASTM D 752 and shall be imprinted with the manufacturer, conductor size number of conductors, type of cable, voltage rating, and Pennsylvania Bureau of Mines designation P-XXX-MSHA.

12. Ground Continuity.

12.1 A flexible copper braid connector of #2 copper equivalent shall be attached with studs and exothermic welds at tower shaft sections or the shafts shall be electrically joined by other means approved by the Engineer. Towers shall include all materials to achieve this bond.

13. Power Receptacles and Plugs.

13.1 Power receptacles and plugs shall be circuit-breaking devices which shall mate with each other. The plugs and receptacles shall be 4-wire 4-pole, 600 volt, 60 ampere weatherproof devices according to UL Standard 498 and International Electrical Commission Standard 309. The devices shall be listed by the manufacturer as suitable for make and break operation at rated current.

13.2 Components and insert assemblies shall be interchangeable to accept either pin or socket inserts to allow either plug or receptacle to be configured in an energized or de-energized condition, i.e. reverse-contact configurations shall be available. Locations of reverse-contact devices shall be as indicated.

13.3 Each plug or receptacle connection to a power cord shall be complete with a suitable non-metallic sealing connector body with a wire mesh strain relief. Other plugs and receptacles shall be complete with suitable sealing angle-adaptor panel of box mounting bodies, as applicable and shall be complete with back-boxes if so dictated by the power distribution configuration.

13.4 Each plug and each receptacle shall be complete with a retained flap-type or retained screw-on cover.

13.5 Plugs and receptacles shall be water-tight, dust-tight, and chemical resistant and be suitable for use when exposed to the weather and shall be applicable for safe use in harsh, wet weather conditions. The Engineer shall be the judge of applicability.

14. Shipment and Installation.

14.1 The light tower, luminaire ring, etc., and hardware shall be packaged during shipment to protect all surfaces from being scratched, marred, chipped, or

- damaged in any way. Prior to installation, the tower and all its components will be inspected by the Engineer and any parts found to be damaged or defective shall be replaced. Any minor damage to a completely painted light tower surface shall be touched up in a professional manner as approved by the paint manufacturer.
- 14.2 The tower shall be set plumb on the foundation and fastened to the anchor rods with double nuts and washers. Flat washers shall be installed below and above the base plate of the pole. Locknuts with nylon or steel inserts shall be installed on top of the top nut. The nuts shall be tightened in compliance with torque specifications recommended by the manufacturer of the lighting unit.
- 14.3 The space between the finished top of the foundation and the bottom of the base plate of the pole shall be enclosed with an expanded metal screen made of stainless steel. The size of the mesh of the screen shall be 1/4 in. (6 mm) or less and #18 gauge (1.22 mm) thick, or heavier as approved by the Engineer. The screen shall be held in place with a stainless steel band installed around the tower base plate. The band shall be held tight by a ratchet-type device. Grouting shall not be used to enclose the above described space.
- 14.4 The light tower shall be straight and centered on its longitudinal axis, under no-wind conditions, so, when examined with a transit from any direction, the deviation from the normal shall not exceed 1/8 in. in 3 ft (3 mm in 1 m) within any 5 ft (1.5 m) of height, with total deviation not to exceed 3 in. (75 mm) from the vertical axis through the center of the pole base.
15. Method of Measurement. Each light tower which is delivered and installed shall be counted as a unit for payment.
16. Basis of Payment. This work will be paid for at the contract unit price each for **LIGHT TOWER** of the mounting height, luminaire mounting positions specified.

#### **PROTECTION AND MAINTENANCE OF EXISTING UNDERPASS LUMINAIRES**

Effective: July 1, 2012

**Description:** This item shall consist of providing protection, temporary support, removal and reattachment as required, of the existing underpass lighting system. The system consists of, but not limited to, luminaires, junction boxes, raceways, support equipment and conductors. Any wiring required to maintain the operation of the underpass or other circuits feed through the underpass lighting system shall be included in this item.

**Materials.** Materials shall be according to the following Articles of Section 1000 - Materials



Item	Article/Section
(a) Electric Raceway Material.....	1088
(b) Conductors.....	1066.02
(c) Insulation.....	1066.03

**CONSTRUCTION REQUIREMENTS**

**General.** Before performing any work, an inventory of all missing hardware of the existing lighting system shall be taken jointly by the Contractor and the Engineer.

**Protection During Deck Reconstruction:** Luminaires, junction boxes, and conduit hangers attached to the bridge deck shall be removed prior to the removal of the existing bridge deck. The luminaires, junction boxes and the conduits shall be temporarily supported during bridge deck reconstruction. The method of support shall be structurally equivalent to the existing system and shall be approved by the Engineer. Existing vertical clearances shall be maintained at all times.

The underpass luminaires and hardware shall be protected from overhead debris during the removal and reconstruction of the bridge deck. The underpass luminaire protection shall be coordinated with the protective shield as described elsewhere in these Special Provisions.

The underpass lighting system shall be protected from spills and over-spray during any painting operations. Spills and over-spray shall be removed by the Contractor at no additional expense to the State. If spills or over-spray occur on the luminaire lens, the luminaire lens shall be replaced with new lens from the luminaire manufacturer at no additional cost to the State.

Prior to bridge deck removal the Contractor shall measure and log the location of all existing conduit and luminaire hangers for reattachment purposes. Upon completion of the bridge deck reconstruction, the existing underpass lighting system shall be permanently reattached at these locations. New heavy duty expansion anchors, as approved by the Engineer, shall be used. New hangers may be installed at the option of the Contractor. The new hangers shall be equivalent to the existing hangers or as approved by the Engineer. The cost of the new expansion anchors and hangers shall be included in this pay item.

**Protection During concrete repair:** Luminaires, junction boxes, and conduit attached to any structural concrete walls and or bridge deck shall be temporarily supported during the concrete repair. The method of support shall be structurally equivalent to the existing system and shall be approved by the Engineer. Existing clearances shall be maintained at all times.

Prior to any equipment or raceway removal the Contractor shall measure and log the location of all existing equipment for reattachment purposes. Upon completion of the concrete repair, the existing equipment shall be permanently reattached at these locations. New heavy duty expansion anchors, as approved by the Engineer, shall be used. The new hangers shall be equivalent to the existing

hangers or as approved by the Engineer. The cost of the new expansion anchors and hangers shall be included in this pay item.

**Damage to Underpass Lighting System:** Should the lighting system be damaged through the Contractor's operations, repairs shall be made by the Contractor at no additional cost to the State.

All repairs shall be performed expeditiously and shall be approved by the Engineer. The Contractor shall conduct his work in a manner as not to keep out of service any of the lighting between 4:00 PM and 8:00 AM. All lights shall be tested daily and any necessary repairs shall be made immediately without delay.

Damaged cable shall be replaced in complete spans, no underground splices will be allowed. Temporary aerial quadruplex cable may be used to maintain luminaires operational provided it does not interfere with traffic or other operations as determined by the Engineer.

**Grounding of Existing Lighting System:** As indicated on the plans, the Contractor shall furnish and install a grounding conductor for the underpass lighting system in all existing conduits, junction boxes and luminaires. The ground conductor shall be a 1/C #10 AWG EPR (Type-RHW) green insulated conductor. The new ground conductor shall be connected to the existing ground conductor in the main junction box. The cost of this work shall be included in this pay item.

The continuity and continued operation of the adjacent lighting system shall be the responsibility of the Contractor. Any temporary wiring required to comply with this requirement shall be included in this item.

**Basis of Payment:** This work shall be paid for at the contract lump sum price for **PROTECT AND MAINTAIN EXISTING UNDERPASS LUMINAIRE**, which shall be payment for the work as described herein and as indicated in the plans.

### **EXPOSED RACEWAYS**

Effective: January 1, 2012

Revise the first paragraph of Article 811.03(a) of the Standard Specifications to read:

“General. Rigid metal conduit installation shall be according to Article 810.05(a). Conduits terminating in junction and pull boxes shall be terminated with insulated and gasketed watertight threaded NEMA 4X conduit hubs. The hubs shall be Listed under UL 514B. The insulated throat shall be rated up to 105° C. When PVC coated conduit is utilized, the aforementioned hubs shall also be PVC coated.”

Add the following to Article 811.03(b) of the Standard Specifications:

“Where PVC coated conduit is utilized, all conduit fittings, couplings and clamps shall be PVC coated. All other mounting hardware and appurtenances shall be stainless steel.”

“The personnel installing the PVC coated conduit must be trained and certified by the PVC coated conduit Manufacturer or Manufacturer’s representative to install PVC coated conduit. Documentation demonstrating this requirement must be submitted for review and approval.”

Add the following to Article 1088.01(a) of the Standard Specifications:

All iron and steel products, which are to be incorporated into the work, including conduit and all conduit fittings, shall be domestically manufactured or produced and fabricated as specified in Article 106.”

Revise Article 1088.01(a)(3) of the Standard Specifications to read:

- “a. PVC Coated Steel Conduit. The PVC coated rigid metal conduit shall be UL Listed (UL 6). The PVC coating must have been investigated by UL as providing the primary corrosion protection for the rigid metal conduit. Ferrous fittings for general service locations shall be UL Listed with PVC as the primary corrosion protection. Hazardous location fittings, prior to plastic coating shall be UL listed.
- b. The PVC coating shall have the following characteristics:

Hardness:	85+ Shore A Durometer
Dielectric Strength:	400V/mil @ 60 Hz
Aging:	1,000 Hours Atlas Weatherometer
Temperature	The PVC compound shall conform at 0° F. to Federal Specifications PL-406b, Method 2051, Amendment 1 of 25 September 1952 (ASTM D 746)
Elongation:	200%

- c. The exterior and interior galvanized conduit surface shall be chemically treated to enhance PVC coating adhesion and shall also be coated with a primer before the PVC coating to ensure a bond between the zinc substrate

and the PVC coating. The bond strength created shall be greater than the tensile strength of the plastic coating.

- d. The nominal thickness of the PVC coating shall be 1 mm (40 mils). The PVC exterior and urethane interior coatings applied to the conduit shall afford sufficient flexibility to permit field bending without cracking or flaking at temperatures above -1°C (30°F).
- e. An interior urethane coating shall be uniformly and consistently applied to the interior of all conduit and fittings. This internal coating shall be a nominal 2 mil thickness. The interior coating shall be applied in a manner so there are no runs, drips, or pinholes at any point. The coating shall not peel, flake, or chip off after a cut is made in the conduit or a scratch is made in the coating.
- f. Conduit bodies shall have a tongue-in-groove gasket for maximum sealing capability. The design shall incorporate a positive placement feature to assure proper installation. Certified test results confirming seal performance at 15 psig (positive) and 25 in. of mercury (vacuum) for 72 hours shall be submitted for review when requested by the Engineer.
- g. The PVC conduit shall pass the following tests:

Exterior PVC Bond test RN1:

Two parallel cuts 13 mm (1/2 inch) apart and 40 mm (1 1/2 inches) in length shall be made with a sharp knife along the longitudinal axis. A third cut shall be made perpendicular to and crossing the longitudinal cuts at one end. The knife shall then be worked under the PVC coating for 13 mm (1/2 inch) to free the coating from the metal.

Using pliers, the freed PVC tab shall be pulled with a force applied vertically and away from the conduit. The PVC tab shall tear rather than cause any additional PVC coating to separate from the substrate.

Boil Test:

Acceptable conduit coating bonds (exterior and interior) shall be confirmed if there is no disbondment after a minimum average of 200 hours in boiling water or exposure to steam vapor at one atmosphere. Certified test results from a national recognized

independent testing laboratory shall be submitted for review and approval. The RN1 Bond Test and the Standard Method for Measuring Adhesion by Tape Test shall be utilized.

Exterior Adhesion. In accordance with ASTM D870, a 6" length of conduit test specimen shall be placed in boiling water. The specimen shall be periodically removed, cooled to ambient temperature and immediately tested according to the bond test (RN1). When the PVC coating separates from the substrate, the boil time to failure in hours shall be recorded.

Interior Adhesion. In accordance with ASTM D3359, a 6" conduit test specimen shall be cut in half longitudinally and placed in boiling water or directly above boiling water with the urethane surface facing down. The specimen shall be periodically removed, cooled to ambient temperature and tested in accordance with the Standard Method of Adhesion by Tape Test (ASTM D3359). When the coating disbonds, the time to failure in hours shall be recorded.

#### Heat/Humidity Test:

Acceptable conduit coating bonds shall be confirmed by a minimum average of 30 days in the Heat and Humidity Test. The RN1 Bond Test and the Standard Method for Measuring Adhesion by Tape Test shall be utilized.

Exterior Adhesion. In accordance with ASTM D1151, D1735, D2247 and D4585, conduit specimens shall be placed in a heat and humidity environment where the temperature is maintained at 150°F (66°C) and 95% relative humidity. The specimens shall be periodically removed and a bond test (RN1) performed. When the PVC coating separates from the substrate, the exposure time to failure in days shall be recorded.

Interior Adhesion. In accordance with ASTM D3359, conduit specimens shall be placed in a heat and humidity environment where the temperature is maintained at 150°F (66°C) and 95% relative humidity. When the coating disbonds, the time to failure in hours shall be recorded.

Add the following to Article 1088.01(a)(4) of the Standard Specifications:

“All liquid tight flexible metal conduit fittings shall have an insulated throat to prevent abrasion of the conductors and shall have a captive sealing O-ring gasket. The fittings shall be Listed under UL 514B. The insulated throat shall be rated up to 105° C.”

Revise the second paragraph of Article 811.04 of the Standard Specifications to read:

“Expansion fittings and LFNC will not be measured for payment.”

Revise Article 811.05 of the Standard Specifications to read:

**“811.05 Basis of Payment.** This work will be paid for at the contract unit price per meter (foot) for **CONDUIT ATTACHED TO STRUCTURE**, of the diameter specified, **RIGID GALVANIZED STEEL** or **CONDUIT ATTACHED TO STRUCTURE**, of the diameter specified, **RIGID GALVANIZED STEEL, PVC COATED.**”

### **TEMPORARY LIGHTING FOR SINGLE LANE STAGING**

Effective: January 1, 2012

#### **Description:**

This item shall consist of furnishing, installing, operating, maintaining and removing all the components necessary for the complete and safe Temporary Lighting in construction zone where traffic is staged in a single lane.

#### **Materials:**

The materials used for the installation of the Temporary Lighting for Single Lane Staging can be new or used and shall remain the property of the Contractor after the removal.

The material shall be according to the Standard Specifications, the special provisions or as directed by the Engineer. The contractor shall submit to the Engineer, prior to installation, suitable and complete information for the proposed material documenting conformance to requirements herein.

The Temporary Lighting for Single Lane Staging plan sheets show typical materials to be installed. The Contractor shall provide the materials shown in the plans and any additional materials required to install Temporary Lighting for Single Lane Staging. All materials required for the complete and safe installation of the Temporary Lighting for Single Lane Staging shall be included as part of this pay item.

Wood poles, luminaires, mast arms, electric service box, conduit, wire, ground rods and any additional materials required to install a complete Temporary Lighting for Single Lane Staging shall be included as part of this item as indicated and as required.

The electric service installation, the electric utility service connection, electric utility charges, and any associated labor or materials are included in the lump sum payment and will not be paid separately.

The maintenance of the Temporary Lighting for Single Lane Staging is part of this item and will not be paid separately.

The equipment used for the Temporary Lighting shall be UL listed or as otherwise approved by the Engineer.

**Installation:**

The Temporary Lighting for Single Lane Staging layout as shown in the contract plans shows spacing, setback, and placement of the equipment required for a typical installation. The layout of the temporary equipment will vary based on field conditions, staging, utility impacts, and electric service location as coordinated with the electric utility. The contractor shall submit a plan or sketch indicating the setting of poles, traffic signals, and the combined service including dimensions between poles, setback, and pole locations by stationing or dimensioning from some existing fixed objects as well as any revisions required for staging. This submittal must be approved by the engineer before any poles are placed.

The contractor is responsible for advance coordination with the electric utility company required to attain electric service for the Temporary Lighting for Single Lane Staging. The contractor shall contact the electric utility company prior to the pre-construction meeting and document the status of the coordination at the meeting.

Contractor shall coordinate his work fully with the ComEd both as to the work required and the timing of the installation. No additional compensation will be granted under this or any other item for extra work caused by failure to meet this requirement. **Please contact ComEd, New Business Center Call Center, at 866 NEW ELECTRIC (1-866-639-3532) to begin the service connection process. The Call Center Representatives will create a work order for the service connection. The representative will ask the requestor for information specific to the request. The representative will assign the request based upon the location of project.**

The Contractor should make particular note of the need for the earliest attention to arrangements with ComEd for service. In the event of delay by ComEd, no extension of time will be considered applicable for the delay unless the Contractor can produce written evidence of a request for electric service within 30 days of execution.

Electrical service shall be 240/120V 1 Phase 3 Wire. Where 240V service is not available, the contractor may submit a proposal for 120V service. Where 120 volt source is indicated, service drop cable shall be installed accordingly and lighting main breaker and all other service appurtenances shall be appropriately rated and included regardless of the service voltage applied to the installation.

Temporary lighting and temporary traffic signals shall be powered by one shared electric service 120/240V 3 wire one phase and shall be metered or as otherwise approved by the Engineer. Electric service costs shall be paid as specified in the special provision for temporary traffic signals. The contractor shall be responsible for discontinuing electric service when so approved by the Engineer.

The disconnect box shall be NEMA 4X stainless steel, nominally 12" W x 16" H x 8" D with piano hinged door, steel back panel, fast acting stainless steel enclosure clamps, padlock provisions and door stop kit (Hoffman catalog #A-16H1208SS6LP/A-16P12/A-DSTOPK/C-PMK12).

Circuit Breakers shall be thermal magnetic bolt-on type with a minimum interrupt capacity of 25,000 symmetrical amperes at 240 volts. Breakers shall be lockable in the off position for lockout/tag-out compliance.

Bus bars, connectors, and lugs shall be copper, insulated and isolated, and configured to prevent shorted conditions from tightening terminations. Lugs and connectors shall be rated for 75°C. Overall bus sections shall be configured behind an insulating barrier shield which is removable for access to connections. The circuit breakers and bus may be part of an approved panelboard assembly.

Disconnect surge protector shall be suitable for 240/120 volt single phase 60Hz, AC electrical service. Protector shall have a surge energy capability of 2160 joules or better at 8/20 microseconds, rate -40 to 60°C., with LED operating indicators and shall be UL listed per UL 1449. The surge protector shall be a Cutler Hammer CMOV230L065XST.

Steel strut channel, conduit, wire, and ground rods to complete the installation of the disconnect box shall be included as part of this item, as required and as indicated.

Combination ground and neutral bar shall be configured with separate ground and neutral sections and spare terminals as indicated. The heads of grounding screws shall be painted green. The heads of neutral screws shall be painted white.

A plastic laminated layout and circuit diagram shall be affixed to the interior side of the enclosure door.

A 2-color engraved plastic nameplate, attached with screws and engraved as indicated, shall be provided for each main breaker.



The exact mounting height for the Electric Service Disconnect shall be field determined and marked by the Engineer.

The contractor is responsible for contacting IDOT Electrical Maintenance Contractor for locates of any buried State electrical facilities. The contractor shall contact JULIE for locates of any other utilities in the construction zone.

When the temporary traffic signal and lighting installation are to share any common elements such as wood poles, electrical service, disconnect box, cable, etc., the contractor shall coordinate the temporary signals and the lighting installation.

The contractor shall install the equipment in accordance with the Standard Specifications for Road and Bridge Construction, the special provisions or as directed by the Engineer. The Temporary Lighting and any other associated provisional installation, including Traffic Signals, shall be inspected and approved by the Engineer prior to placing in operation.

When the contract work is complete and all the lanes are open to the traffic, the contractor shall remove and salvage all the temporary lighting equipment within 30 days.

The contractor is responsible for restoring, including any grading or seeding, of all areas disturbed under this contract to the satisfaction of the Engineer.

**Method Of Measurement:**

Temporary Lighting for Single Lane Staging installed complete as specified and as indicated on the plans, shall be counted as lump sum for payment.

The contractor shall receive and accept the compensation as herein described; 50 percent of the total cost of this pay item shall be paid after the installation and approval by the Engineer of the complete Temporary Lighting, and the remaining 50 percent shall be paid after the removal once the project is completed.

All equipment and work provided by the Contractor including coordination, revisions, relocations, installation, maintenance, removal and restoration required to provide complete and operational Temporary Lighting for Single Lane Staging are included in the lump sum payment. The electric service installation, the electric utility service connection, and any associated material, labor, or charges to the utility company are included in the lump sum payment and will not be paid separately.

No extra compensation shall be paid to the Contractor for any incidental materials and labor required to fulfill the requirements as shown on the plans and specified herein.

**Basis Of Payment:**

This work will be paid for at the contract lump sum price for **TEMPORARY LIGHTING FOR SINGLE LANE STAGING**.

### **LIGHTING CONTROLLER, SPECIAL**

Description. This item shall consist of furnishing and installing a Control Center complete with all circuit breakers and appurtenances by Excel Ltd., Inc., as shown on the plans, Section 825 of the SSRBC and as modified herein.

Materials. The Control Center, complete, shall consist of the following:

1. Controller foundation and pad.
2. Ground Mounted Aluminum Cabinet, 50" x 36" x 17" minimum size.
3. Enclosure to house mechanically held contactor of proper size for system with 120 volt coil. Also to contain thermal magnetic main circuit breaker of adequate size. Wiring for the number of circuit breakers to be provided. Provide the number of circuit breakers indicated on the plans. Breakers shall be provided for roadway lighting circuits and festoon circuits as indicated on the plans.
4. GFI Duplex Convenience outlet and porcelain lampholder with pull chain.
5. Hand-Off-Auto Switch for lighting and festoon circuits.
6. Photo-electric cell

The concrete foundation and pad for the cabinet shall be of the dimensions shown on the plans. The concrete shall conform to specifications for Class "SI" concrete as outlined in the Standard Specifications.

Rigid Steel Conduit and elbows, of the diameter indicated, shall be placed in the foundation and extended into the cabinet as shown on the plans. Insulating bushings shall be neoprene and shall be of a creditable manufacturer's make, anchor bolts shall be provided as shown on the plans.

The cabinet shall have a smooth and even texture and shall be free from marks and imperfections. After fabrication and painting, the outside surface of the control cabinet shall be covered with a tough nonstaining gummed paper. Such protective covering shall remain in place until such time as the Engineer will order its removal. After the protective covering has been removed, the entire cabinet shall be thoroughly cleaned to the satisfaction of the Engineer.

Equipment mounting panels shall be of the dimensions and shape indicated on the plans and shall be fabricated from non-conducting inorganic, non-asbestos subpanel. Equipment to be mounted on the panels will be as shown on the plans.

Each panel shall be easily mounted or removed from the front of the cabinet. All equipment mounted on panels shall be easily installed or removed from the front. All wiring of equipment shall be in the front of the panels and wire sizes shall be as designated on the Control Cabinet Wiring Diagram.

A suggested arrangement of equipment on the control equipment panels is shown on the plans. This arrangement has been carefully planned and any deviation from same shall be submitted to the Engineer for approval.

The control cabinet door shall face away from the roadway. All panel and equipment shall be front mounted necessitating no back entry to the cabinet. All cable and connections shall be in front of the panels as shown. All wire or cable sizes shall be as shown on the plans. Bus bar and wire or cable sizes shall be in conformity with the National Electrical code. Bus bars for the equipment shall be insulated, where exposed, except at terminal points.

The main breakers shall be standard UL listed molded case, which are sufficient to trip the branch circuit breakers. The Main Breakers shall be of the size indicated on the plans. The electrically operated mechanically held automatic switch shall be 200 Amp, 2P, 600v, with 120v coil. The contactor shall be complete with coil clearing contacts to interrupt current through the coil once the contactor is held in position. The main contacts for the automatic switch shall be double breaksilver type protected by arcing contacts. Contacts shall be self-aligning and renewable from the front of the panel.

A three position switch as indicated on the plans shall be provided for lighting and festoon circuits. The switch shall provide for automatic operation, manual and off.

The photocell shall be mounted on top of the light pole with pole top adaptor at the locations indicated in the plans. It shall be located on pole closest to the controller. The photo-electric cell shall be connected with 3-1/C #10 AWG standard, color coded control wiring from pole location shown on the plans to the control cabinet.

It is called to the attention of the Contractor that all branch circuits shall be identified by numbers as indicated on the control cabinet wiring diagram. The exact color and number sequence, shown on the plans, must be followed in order to maintain the designed load across each pole of the main switch.

All ends of conduit terminating in the control cabinet shall be blocked with a neoprene plug, and sealed with an approved sealing compound.

#### Submittal of Drawings:

The Contractor shall furnish, prior to any shop work or fabrication, complete and detailed drawings as to dimensions, type of material and method of fabrication for the control cabinet, equipment

mounting panel, arrangement of equipment of panels, bus bar sizes, wire or cable sizes for connections between main breaker, automatic switches, photo electric cell, circuit breakers, H-O-A switch, all appurtenances as shown on the plans, and any other equipment as may be necessary for proper operation and control of the lighting system.

**Basis of Payment.** This work will be paid for at the contract unit price each for LIGHTING CONTROLLER, SPECIAL, which price shall be payment in full for furnishing and placing Class "SI" concrete foundation with rigid steel conduit for cable entrance and grounding of equipment; Class "SI" concrete pad; furnishing and placing ground rod, furnishing and placing fabricated cabinet complete with equipment panels and all necessary circuit breakers, appurtenances and wiring of same as indicated on the plans; furnishing, installing and connecting the photo-electric cells, and shall include all labor, materials, tools and incidentals necessary to complete and test the operation of the control cabinet as herein specified and as shown on the plans.

#### **STORM SEWERS TO BE CLEANED**

All existing storm sewers, pipe culverts, manholes, catch basins and inlets shall be considered as storm sewers insofar as the interpretation of this Special Provision is concerned. When specified for payment, the location of storm sewers to be cleaned will be shown on the plans.

All existing storm sewers which are specified to be cleaned on the plans will be cleaned according to Article 602.15 of the Standard Specifications. The cleaning of existing drainage structures between the existing storm sewers shall be included in this pay item.

**Basis of Payment.** This work will be paid for at the contract unit price foot (meter) for STORM SEWERS TO BE CLEANED, of the diameter specified.

**IDOT TRAINING PROGRAM GRADUATE ON-THE-JOB TRAINING SPECIAL PROVISION (TPG)**

Effective: August 1, 2012

Revised: February 1, 2014

In addition to the Contractor's equal employment opportunity affirmative action efforts undertaken as elsewhere required by this Contract, the Contractor is encouraged to participate in the incentive program to provide additional on-the-job training to certified graduates of IDOT funded pre-apprenticeship training programs outlined by this Special Provision.

It is the policy of IDOT to fund IDOT pre-apprenticeship training programs throughout Illinois to provide training and skill-improvement opportunities to assure the increased participation of minority groups, disadvantaged persons and women in all phases of the highway construction industry. The intent of this IDOT Training Program Graduate (TPG) Special Provision is to place certified graduates of these IDOT funded pre-apprentice training programs on IDOT project sites when feasible, and provide the graduates with meaningful on-the-job training intended to lead to journey-level employment. IDOT and its sub-recipients, in carrying out the responsibilities of a state contract, shall determine which construction contracts shall include "Training Program Graduate Special Provisions." To benefit from the incentives to encourage the participation in the additional on-the-job training under this Training Program Graduate Special Provision, the Contractor shall make every reasonable effort to employ certified graduates of IDOT funded Pre-apprenticeship Training Programs to the extent such persons are available within a reasonable recruitment area.

Participation pursuant to IDOT's requirements by the Contractor or subcontractor in this Training Program Graduate (TPG) Special Provision entitles the Contractor or subcontractor to be reimbursed at \$15.00 per hour for training given a certified TPG on this contract. As approved by the Department, reimbursement will be made for training persons as specified herein. This reimbursement will be made even though the Contractor or subcontractor may receive additional training program funds from other sources for other trainees, provided such other source does not specifically prohibit the Contractor or subcontractor from receiving other reimbursement. For purposes of this Special Provision the Contractor is not relieved of requirements under applicable federal law, the Illinois Prevailing Wage Act, and is not eligible for other training fund reimbursements in addition to the Training Program Graduate (TPG) Special Provision reimbursement.

No payment shall be made to the Contractor if the Contractor or subcontractor fails to provide the required training. It is normally expected that a TPG will begin training on the project as soon as feasible after start of work utilizing the skill involved and remain on the project through completion of the contract, so long as training opportunities exist in his work classification or until he has completed his training program. Should the TPG's employment end in advance of the completion of the contract, the Contractor shall promptly notify the designated IDOT staff member under this Special Provision that the TPG's involvement in the contract has ended and supply a written report of the reason for the end of the involvement, the hours completed by the

TPG under the Contract and the number of hours for which the incentive payment provided under this Special Provision will be or has been claimed for the TPG.

The Contractor will provide for the maintenance of records and furnish periodic reports documenting its performance under this Special Provision.

METHOD OF MEASUREMENT: The unit of measurement is in hours.

BASIS OF PAYMENT: This work will be paid for at the contract unit price of \$15.00 per hour for certified TRAINEES TRAINING PROGRAM GRADUATE. The estimated total number of hours, unit price and total price have been included in the schedule of prices.

The Contractor shall provide training opportunities aimed at developing full journeyworker in the type of trade or job classification involved. The initial number of TPGs for which the incentive is available under this contract is 3. During the course of performance of the Contract the Contractor may seek approval from the Department for additional incentive eligible TPGs. In the event the Contractor subcontracts a portion of the contract work, it shall determine how many, if any, of the TPGs are to be trained by the subcontractor, provided however, that the Contractor shall retain the primary responsibility for meeting the training requirements imposed by this Special Provision. The Contractor shall also insure that this Training Program Graduate Special Provision is made applicable to such subcontract if the TPGs are to be trained by a subcontractor and that the incentive payment is passed on to each subcontractor.

For the Contractor to meet the obligations for participation in this TPG incentive program under this Special Provision, the Department has contracted with several entities to provide screening, tutoring and pre-training to individuals interested in working in the applicable construction classification and has certified those students who have successfully completed the program and are eligible to be TPGs. A designated IDOT staff member, the Director of the Office of Business and Workforce Diversity (OBWD), will be responsible for providing assistance and referrals to the Contractor for the applicable TPGs. For this contract, the Director of OBWD is designated as the responsible IDOT staff member to provide the assistance and referral services related to the placement for this Special Provision. For purposes of this Contract, contacting the Director of OBWD and interviewing each candidate he/she recommends constitutes reasonable recruitment.

Prior to commencing construction, the Contractor shall submit to the Department for approval the TPGs to be trained in each selected classification. Furthermore, the Contractor shall specify the starting time for training in each of the classifications. No employee shall be employed as a TPG in any classification in which he/she has successfully completed a training course leading to journeyman status or in which he/she has been employed as a journeyman. Notwithstanding the on-the-job training purpose of this TPG Special Provision, some offsite training is permissible as long as the offsite training is an integral part of the work of the contract and does not comprise a significant part of the overall training.

Training and upgrading of TPGs of IDOT pre-apprentice training programs is intended to move said TPGs toward journeyman status and is the primary objective of this Training Program Graduate Special Provision. Accordingly, the Contractor shall make every effort to enroll TPGs by recruitment through the IDOT funded TPG programs to the extent such persons are available within a reasonable area of recruitment. The Contractor will be responsible for demonstrating the steps that it has taken in pursuance thereof, prior to a determination as to whether the Contractor is in compliance and entitled to the Training Program Graduate Special Provision \$15.00 an hour incentive.

The Contractor or subcontractor shall provide each TPG with a certificate showing the type and length of training satisfactorily completed.

**MEMORANDUM  
PRELIMINARY  
SITE INVESTIGATION  
for  
The City of Crystal Lake**

**South Main Street  
North of Rakow Road to South of US Route 14  
Crystal Lake, McHenry County, Illinois**

**Prepared for  
TranSystems**

**Prepared by  
Huff & Huff, Inc.**

**September 2012**



#### 4. SOIL MANAGEMENT

As the scope of this PSI focuses on further delineating the area identified in the *previous* Report as special waste, it is important to review the current regulatory oversight concerning “clean fill” determination. On July 30, 2010, Public Act 96-1416 became effective, which significantly broadened the regulatory oversight on the use of CCDD and uncontaminated soil used as fill. The law includes interim standards for CCDD fill facilities and uncontaminated soil fill operations. The Illinois Pollution Control Board published what is called *Second Notice* of implementing regulations, and the final regulations, by statute, are to be final by July 30, 2012. These regulations include proposed MACs of chemical constituents in uncontaminated soil for CCDD disposal.

On-site handling and off-site disposal were alternatives considered for management of impacted soil. CCDD determination is based upon the following two criteria:

- 1) Achievement of the MACs for CCDD disposal
- 2) Physical characteristics compatible with “clean fill” definition

Excavated soil is considered “clean fill” only if it achieves all of the MACs. Excavated soil that has any contaminant level above any MAC must be disposed of in a landfill. However, soil that achieves the MACs but contains glass or other debris and has the appearance of “fill” material is generally not accepted by CCDD facilities.

An area has been delineated within project limits which will require special waste handling and is not eligible for CCDD disposal; however, soil in the remainder of the project area qualifies as CCDD. Figure 4-1 depicts the area of special waste.

The regulations require completion of Uncontaminated Soil Certification by Licensed Professional Engineer (LPC663) prior to placement of soils at either a CCDD or soil-only facility. Based on the findings of this investigation, H&H has included a LPC-663 form for the areas without special waste designation in Appendix C. The Illinois EPA webpage further discusses acceptable materials at CCDD facilities (<http://www.epa.state.il.us/land/ccdd/index.html>). Should soils be encountered that are not representative of those encountered during the PSI boring activities (odors or debris), those soils would need to be reassessed prior to disposal at a “clean fill” facility.



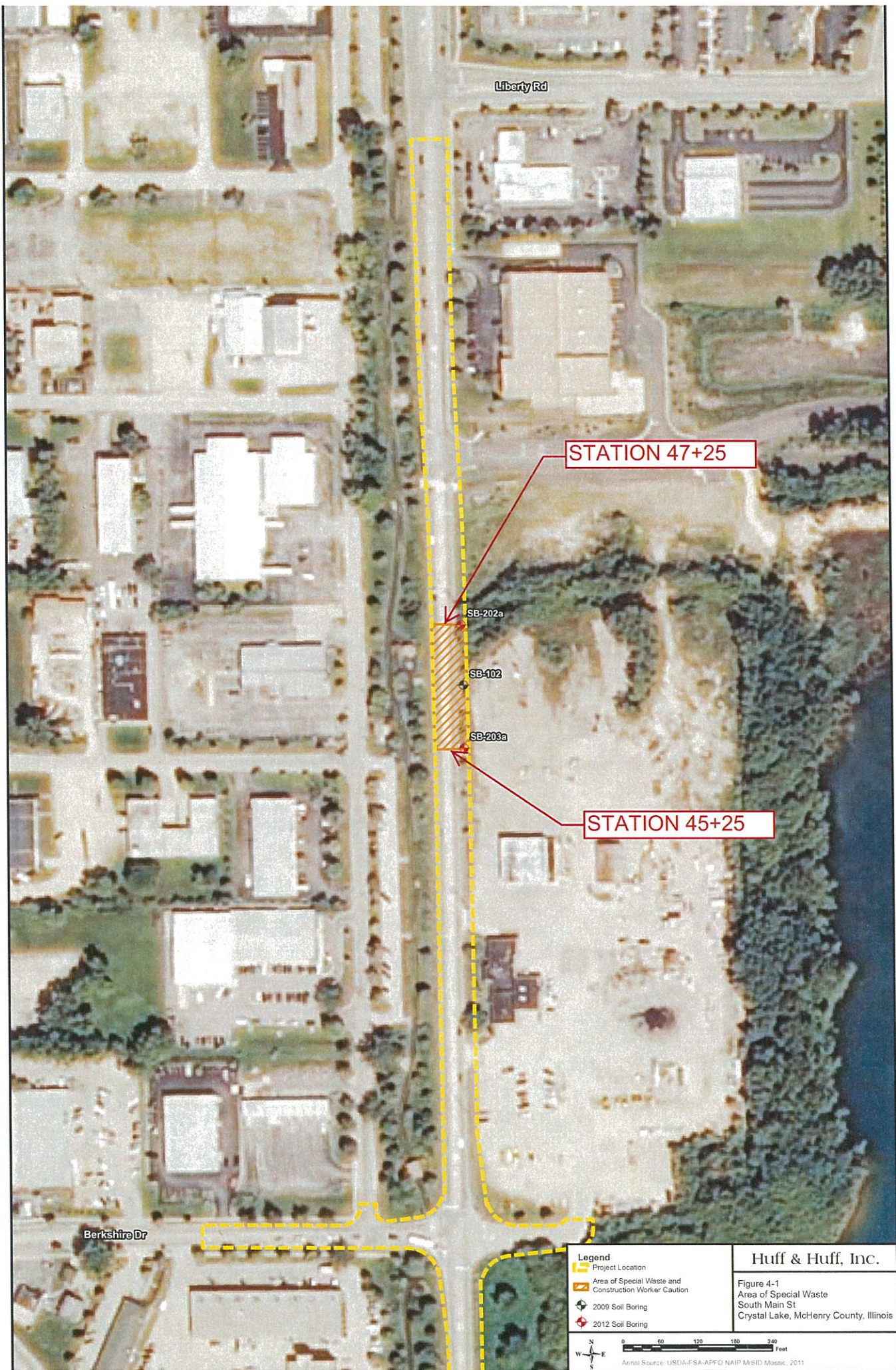

STATION 47+25

SB-202a

SB-102

SB-203a

STATION 45+25

Berkshire Dr

Liberty Rd

- Legend**
- Project Location
  - Area of Special Waste and Construction Worker Caution
  - 2009 Soil Boring
  - 2012 Soil Boring



Huff & Huff, Inc.

Figure 4-1  
Area of Special Waste  
South Main St  
Crystal Lake, McHenry County, Illinois



## 5. CONCLUSIONS

H&H performed a PSI to assess the potential for natural and man-made hazards that may be encountered in the right-of-way within the vicinity of proposed construction activities along South Main Street and Pyott Road in Crystal Lake, IL. The *Preliminary Environmental Site Assessment* report from December 2009 had originally identified an area of special waste due to elevated concentrations of arsenic at SB-102. This area was further investigated by advancing two step-out soil borings from SB-102 and by duplicating the soil borings SB-101 and SB-104 with the 2012 SB-201 and SB-204 borings respectively.

For VOCs and PNAs: all samples achieved the Tier 1 ROs for construction worker inhalation and ingestion as well as the MACs.

The metals results indicate that a portion of the project area will be continue to be designated as special waste, due to elevated concentrations of arsenic; however, the results of the stepout borings were successful in further delineating the area of special waste from the delineation presented in the *previous* Report.

The area of special waste depicted on Figure 4-1 also represents the area of construction worker caution. The construction worker caution is associated with the elevated arsenic concentrations above the Tier 1 Remedial Objective for construction worker ingestion. Excavated soils from this area are not eligible for CCDD disposal.

Based on sampling, the soils in the project area can be reused as fill on-site during construction. Soils from excavation, with the exception of the soils in the area designated as special waste, may also disposed of in a CCDD facility. Should soils be encountered that are not representative of those encountered during the PSI boring activities (odors or debris), those soils would need to be reassessed prior to disposal at a "clean fill" facility. Based on the *previous* Report and the analyses conducted for this PSI, soils outside of the special waste area may be disposed of in a CCDD facility. Huff & Huff has completed the LPC663 form for the areas with a clean soil determination.

STATION 45+25  
TO 47+25

## 6. RECOMMENDATIONS

Soils generated as part of this project can be reused on site as fill material. If engineering constraints do not allow for material reuse, soils (except those excavated from the designated area of special waste) will be able to be transported to a local CCDD facility. Glass, debris, and fill material were not encountered during field activities; however, caution should be taken to ensure that these materials are not included in any soil transported to the CCDD facility.

The CCDD-required LPC663 form is included in Appendix C, which is necessary for soils that will be transported to a CCDD facility. Soils encountered that are not representative of those encountered during the boring activities (odors or staining) would need to be reassessed prior to disposal at a CCDD facility. Only the soils in the vicinity of SB-101 have been identified as special waste.

A construction worker safety plan which limits construction worker exposure to the area of special waste with elevated arsenic concentrations above the construction worker RO is recommended.

A NOMINAL QUANTITY OF NON-SPECIAL WASTE OF 100 CY HAS BEEN INCLUDED IN THE PLANS ASSUMING NON-SPECIAL WASTE IS ENCOUNTERED BETWEEN STATION 45+25 AND 47+25.

---

James E. Huff

---

Emily Sturnfield

**SITE HEALTH & SAFETY SUPPLEMENT**

**FOR THE EXCAVATION OF  
ARSENIC-IMPACTED SOILS**

**SOUTH MAIN STREET RECONSTRUCTION  
CRYSTAL LAKE, ILLINOIS**

**Prepared by:**

**Huff & Huff, Inc.  
Oak Brook, Illinois**

**September 2012**

## GLOSSARY OF ACRONYMS

H&S	Health and Safety
mg/kg	Milligrams per Kilogram
mg/m <sup>3</sup>	Milligrams per cubic meter
OSHA	Occupational Safety and Health Administration
PEL	Permissible Exposure Limit
TWA	Time-weighted Average
µg/m <sup>3</sup>	Microgram per cubic meter
CFR	Code of Federal Regulations

**TABLE OF CONTENTS**

1. INTRODUCTION .....1

2. BACKGROUND .....4

3. ACTION LEVELS.....6

4. SITE SAFETY PROCEDURES .....8

    4.1 Worker Practices.....8

    4.2 Construction Site Safety Practices.....8

**LIST OF FIGURES**

Figure 1-1 Site Location Map.....2

Figure 1-2 Area of Special Waste Requiring Construction Worker Caution.....3

**APPENDICES**

Appendix A Approval Sign-off Sheet  
Example Log Sheet

Appendix B Material Safety Data Sheets

Appendix C Gilian Dust-Sampling Procedures and Operating Manual

## 1. INTRODUCTION

The purpose of this Site Health and Safety (H&S) Supplement is to define health and safety protocols to be followed by construction workers during proposed excavation activities within the area of arsenic contaminated soils, hereafter referred to as the “Area of Special Waste” and/or “Area of Construction Worker Caution”, along South Main Street in Crystal Lake, IL. The improvements include widening and resurfacing of the roadway and sewer improvements. The Project Corridor is generally occupied by commercial development (See Figure 1-1).

Specifically, the area of construction worker caution is a 200-foot stretch along Main Street, between Station # 45+25 feet and Station # 47+25 feet. Figure 1-2 depicts the Area of Special Waste/Construction Worker Caution. This H&S Supplement specifically addresses construction worker exposure to arsenic during the excavation of soils within this portion of the project area.

This is a supplement, **not** a substitute, for a full, all-inclusive Health & Safety Plan for the project. The sole intent of this Health & Safety Supplement is to provide guidance for the protection of workers in the zone of construction worker caution for arsenic exposure within the project area.

Appendix A contains a sign-off sheet for documenting that site personnel have read this site H&S Supplement. It is the responsibility of the project manager to ensure that site personnel are provided with the information contained in this H&S Supplement in addressing the arsenic levels at the site.



## 2. BACKGROUND

Based on previous investigation and site reconnaissance, the project area is located in an area with commercial development. A former railroad spur is the likely source of the arsenic in soils in the Area of Special Waste/Construction Worker Caution. Wind-blown soil is the primary source of exposure. The Material Safety Data Sheets for Arsenic are included in Appendix B.

The arsenic present at the site is in a particulate form, and the potential exposure route is through the ingestion of arsenic in the airborne dust. The key to protecting construction workers is minimizing airborne dust generation that is often associated with construction activities.

Inhalation of arsenic compounds in dust is the most common cause of arsenic poisoning in the industrial work environment. This medical condition is divided into three phases:

- The worker complains of weakness, loss of appetite, nausea, occasional vomiting, and some diarrhea.
- The worker complains of an inflammation of the eyelids and mucous membranes of the nose and respiratory passages. Hoarseness and a cough may also occur. In addition, skin lesions are common.
- The worker complains of pains in the hands and feet. In more severe cases, paralysis may occur.

Airborne arsenic compounds are a skin irritant causing skin rashes or dermatitis, burning, itching, and changes in the color of the skin. The moist mucous membranes of the body are most sensitive to the irritant action. In addition, the skin, eyelids, angles of the ears, nose, mouth, and respiratory membranes are susceptible to the irritant effects of exposure. Of particular concern, research has shown that arsenic exposure can cause lung and skin cancer.

Health symptoms associated with ingestion of arsenic include weight loss, nausea and diarrhea alternating with constipation, eruption of skin, loss of hair, neuritis, and horizontal white lines on

the fingernails and toenails. In addition, arsenic poisoning can cause stomach or gastrointestinal damage.

### 3. ACTION LEVELS

If assistance is needed in establishing a monitoring program and training workers, it is recommended that the Consultant be contacted prior to initiating any activities requiring the excavation of soil at this location.

Consultant: Mr. James E. Huff, P.E.  
Huff & Huff, Inc.  
915 Harger Road, Suite 330  
Oak Brook, Illinois 60523  
  
630-684-9100  
630-684-9120 (Fax)

Ingestion exposure is based on airborne particulates and thus worker safety precautions are based on measurement of particulate levels. Particulate levels can be monitored using an aerosol dust monitor. Appendix C includes information on real-time dust monitoring equipment and sampling.

OSHA has established a comprehensive Arsenic Standard, CFR 1910.1018. This standard sets a permissible exposure limit (PEL) for inorganic arsenic compounds of 0.01 milligrams per cubic meter of air, ( $0.01 \text{ mg/m}^3$ ) averaged over any eight-hour period (time-weighted average or TWA). In addition, the OSHA standard has established an "Action Level" of  $0.005 \text{ mg/m}^3$  averaged over any eight hour period.

The maximum recorded arsenic soil concentration at this site reported was 263 mg/kg. The 8-hour nuisance dust standard is  $5 \text{ mg/m}^3$ , or 500-fold higher than the arsenic standard (PEL). Assuming a maximum arsenic concentration of 300 mg/kg, or 0.03%, and that the arsenic in the airborne dust will also represent 0.03% of the total dust, then at  $5 \text{ mg/m}^3$  total dust, the airborne arsenic dust concentration will result in airborne arsenic levels of  $0.0015 \text{ mg/m}^3$ , or 15% of the arsenic PEL.

Therefore, as long as total dust levels remain below the OSHA nuisance dust standard, arsenic exposure will remain well below the OSHA arsenic limit. Total dust monitoring is recommended with the following action levels:

**ABATEMENT ACTIONS  
ASSOCIATED ACTION LEVEL UPGRADES**

<b>ACTION LEVEL</b>	<b>PARTICULATE LEVEL</b>	<b>ABATEMENT</b>
Level 1	Visible dust	<ul style="list-style-type: none"> <li>• Cover exposed material</li> <li>• Monitor particulate level – upwind and downwind</li> </ul>
Level 2	2.5 mg/m <sup>3</sup>	<ul style="list-style-type: none"> <li>• Application of water to area of activity to minimize dust emissions or other dust control measure</li> <li>• Slow the pace of the construction traffic and any other activity that generates dust</li> <li>• Street sweep area</li> <li>• Retest</li> </ul>
Level 3	5 mg/m <sup>3</sup>	<ul style="list-style-type: none"> <li>• Cease all site work until safe levels achieved</li> <li>• Continue to monitor until dust level drops between 2.5 mg/m<sup>3</sup> and 5 mg/m<sup>3</sup></li> <li>• Increase application of water to area of activity to minimize dust emissions</li> <li>• Cover exposed sources</li> <li>• Clean all impacted streets with street sweeper</li> </ul>

The sampling location should be near to equipment operators or other workers nearest to the construction activity generating dust. Care should be taken that the location represents the likely inhalation by personnel (e.g. meter is placed at worker’s head level, smoking is not permitted near meter, etc.). Once the measuring location has been determined for the particular sampling event, the meter should be started and a maximum reading recorded after a 5-minute period. This result and ambient conditions should be recorded on a log sheet. An example log sheet for recording measurements is included in Appendix A. The result should be compared to action levels noted above. If abatement action is required, another 5-minute maximum should be sampled after abatement to ensure adequate corrective action.

## 4. SITE SAFETY PRACTICES

### 4.1 Worker Practices

Construction workers are to follow the protocols listed below while working on the site in the identified area:

- Eating, drinking, chewing gum, etc. should be avoided in the work area.
- Wash hands and face before eating or smoking.
- Smoking and eating are to be outside the area identified in Figure 2.
- Avoid skin contact with the soil by wearing work gloves, long pants and long sleeved shirts. Wash exposed skin with soap and water after handling soil.
- Avoid tracking mud and dirt off-site. This may necessitate changing work shoes and possibly clothing at the end of each work day, prior to leaving the site.

### 4.2 Construction Site Safety Practices

- Minimize dust generation during excavation by wetting dried surfaces, carefully moving soil, and minimizing speed of haul trucks on the site.
- Secure any excavations at the end of the day to assure unauthorized persons cannot come into contact with soil in excavations or stockpiles, and to prevent accidents from persons falling into any excavations.
- Cover all soil stockpiled from the excavation nightly

- Non-essential workers should maintain a distance from any open excavation in the construction worker caution area.
- If visible dust is being generated from excavation piles, cover the piles with visqueen or water frequently.
- Total dust levels should be monitored a minimum of 4 times per day when excavation activities in the worker caution area are occurring.
- Trucks of excavated soil shall be covered to minimize airborne dust during transit
- During all excavation activities, daily street sweeping of active areas is required.



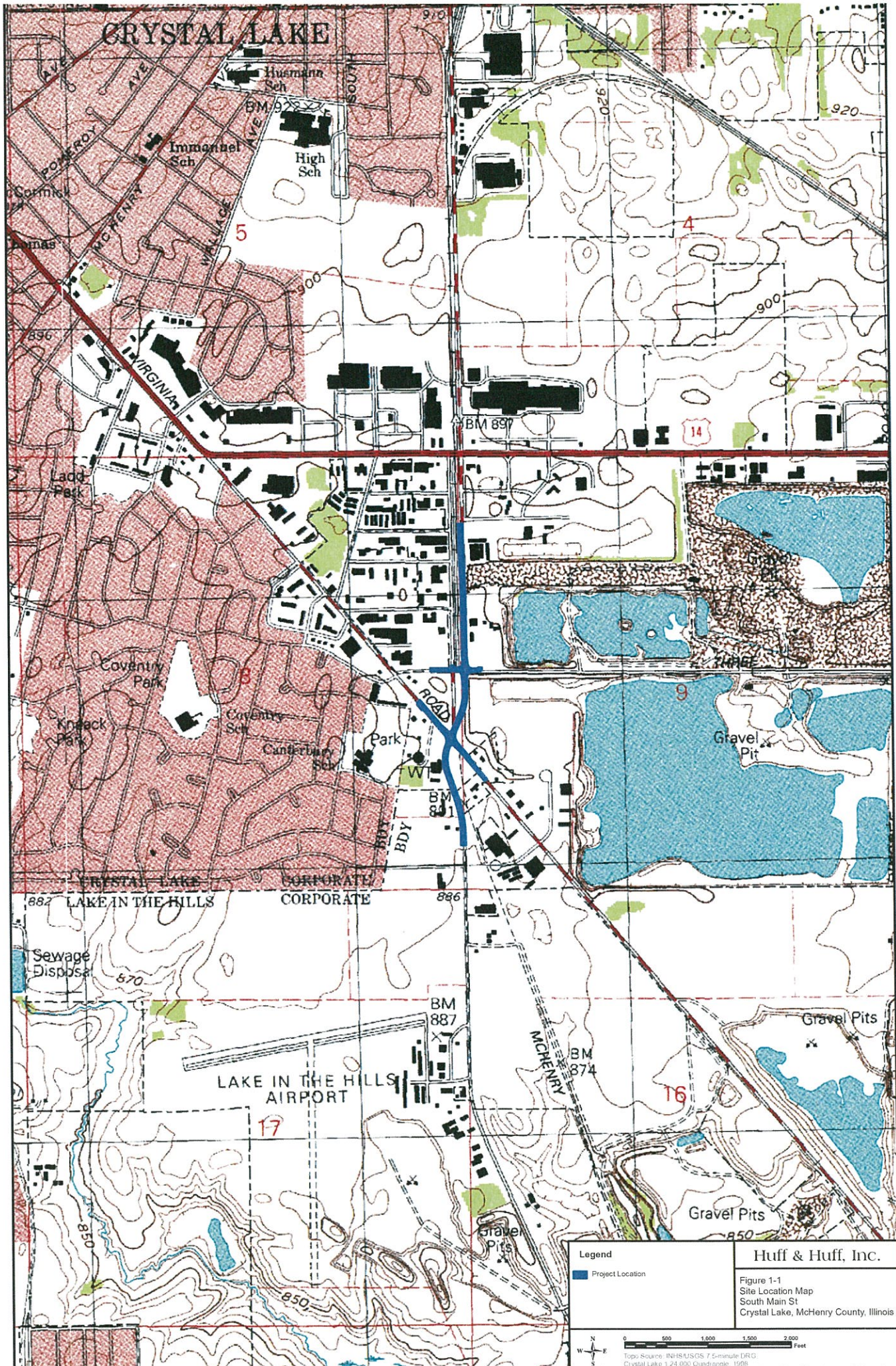





Liberty Rd

Berkshire Dr

SB-202a

SB-102

SB-203a

- Legend**
- Project Location
  - Area of Special Waste and Construction Worker Caution
  - 2009 Soil Boring
  - 2012 Soil Boring

Huff & Huff, Inc.

Figure 4-1  
 Area of Special Waste  
 South Main St  
 Crystal Lake, McHenry County, Illinois



Aerial Source: USDA-FSA-APFO NAIP MDSID Mosaic, 2011



## **APPENDIX A**

**SIGNATURE PAGE**  
**HEALTH AND SAFETY SUPPLEMENT**  
**APPROVAL SIGN-OFF**

I have read, understood, and agreed with the information set forth in this Health and Safety Supplement (and attachments) and discussed in the Personnel Health and Safety briefing.

Name	Signature	Date

### EXAMPLE DUST MONITORING LOG SHEET

**Project:** \_\_\_\_\_ **Location:** \_\_\_\_\_

**Project Manager On-Site:** \_\_\_\_\_

**Date:** \_\_\_\_\_ **Time Start:** \_\_\_\_\_ **Time End:** \_\_\_\_\_

**Weather Conditions:** \_\_\_\_\_  
*(include wind direction and speed, air temperature, rain, degree of cloud cover)*

**Description of work being conducted:** \_\_\_\_\_  
\_\_\_\_\_  
\_\_\_\_\_  
\_\_\_\_\_

---

---

#### DAILY LOG

---

---

Time	Particulate Measurement (mg/m <sup>3</sup> )	Comments

*A new daily log sheet is required for each area of soil disturbance within the area of construction worker caution.*

**APPENDIX B**  
**THE MATERIAL SAFETY DATA SHEETS**



Health	3
Fire	1
Reactivity	2
Personal Protection	E

# Material Safety Data Sheet

## Arsenic MSDS

### Section 1: Chemical Product and Company Identification

**Product Name:** Arsenic

**Catalog Codes:** SLA1006

**CAS#:** 7440-38-2

**RTECS:** CG0525000

**TSCA:** TSCA 8(b) inventory: Arsenic

**CI#:** Not applicable.

**Synonym:**

**Chemical Name:** Arsenic

**Chemical Formula:** As

**Contact Information:**

**Sciencelab.com, Inc.**

14025 Smith Rd.

Houston, Texas 77396

US Sales: **1-800-901-7247**

International Sales: **1-281-441-4400**

Order Online: [ScienceLab.com](http://ScienceLab.com)

**CHEMTREC (24HR Emergency Telephone), call:**

1-800-424-9300

**International CHEMTREC, call:** 1-703-527-3887

**For non-emergency assistance, call:** 1-281-441-4400

### Section 2: Composition and Information on Ingredients

**Composition:**

Name	CAS #	% by Weight
Arsenic	7440-38-2	100

**Toxicological Data on Ingredients:** Arsenic: ORAL (LD50): Acute: 763 mg/kg [Rat]. 145 mg/kg [Mouse].

### Section 3: Hazards Identification

**Potential Acute Health Effects:**

Very hazardous in case of ingestion, of inhalation. Slightly hazardous in case of skin contact (irritant), of eye contact (irritant).

**Potential Chronic Health Effects:**

**CARCINOGENIC EFFECTS:** Classified A1 (Confirmed for human.) by ACGIH. **MUTAGENIC EFFECTS:** Not available.

**TERATOGENIC EFFECTS:** Not available. **DEVELOPMENTAL TOXICITY:** Not available. The substance is toxic to kidneys, lungs, the nervous system, mucous membranes. Repeated or prolonged exposure to the substance can produce target organs damage.

### Section 4: First Aid Measures

**Eye Contact:**

Check for and remove any contact lenses. In case of contact, immediately flush eyes with plenty of water for at least 15 minutes. Get medical attention if irritation occurs.

**Skin Contact:** Wash with soap and water. Cover the irritated skin with an emollient. Get medical attention if irritation develops.

**Serious Skin Contact:** Not available.

**Inhalation:**

If inhaled, remove to fresh air. If not breathing, give artificial respiration. If breathing is difficult, give oxygen. Get medical attention.

**Serious Inhalation:**

Evacuate the victim to a safe area as soon as possible. Loosen tight clothing such as a collar, tie, belt or waistband. If breathing is difficult, administer oxygen. If the victim is not breathing, perform mouth-to-mouth resuscitation. Seek medical attention.

**Ingestion:**

Do NOT induce vomiting unless directed to do so by medical personnel. Never give anything by mouth to an unconscious person. If large quantities of this material are swallowed, call a physician immediately. Loosen tight clothing such as a collar, tie, belt or waistband.

**Serious Ingestion:** Not available.

---

---

## Section 5: Fire and Explosion Data

---

**Flammability of the Product:** May be combustible at high temperature.

**Auto-Ignition Temperature:** Not available.

**Flash Points:** Not available.

**Flammable Limits:** Not available.

**Products of Combustion:** Some metallic oxides.

**Fire Hazards in Presence of Various Substances:** Flammable in presence of open flames and sparks, of heat, of oxidizing materials.

**Explosion Hazards in Presence of Various Substances:**

Risks of explosion of the product in presence of mechanical impact: Not available. Risks of explosion of the product in presence of static discharge: Not available.

**Fire Fighting Media and Instructions:**

SMALL FIRE: Use DRY chemical powder. LARGE FIRE: Use water spray, fog or foam. Do not use water jet.

**Special Remarks on Fire Hazards:**

Material in powder form, capable of creating a dust explosion. When heated to decomposition it emits highly toxic fumes.

**Special Remarks on Explosion Hazards:** Not available.

---

---

## Section 6: Accidental Release Measures

---

**Small Spill:** Use appropriate tools to put the spilled solid in a convenient waste disposal container.

**Large Spill:**

Use a shovel to put the material into a convenient waste disposal container. Be careful that the product is not present at a concentration level above TLV. Check TLV on the MSDS and with local authorities.

---

---

## Section 7: Handling and Storage

---

**Precautions:**

Keep locked up.. Keep away from heat. Keep away from sources of ignition. Empty containers pose a fire risk, evaporate the residue under a fume hood. Ground all equipment containing material. Do not ingest. Do not breathe dust. Wear suitable

protective clothing. In case of insufficient ventilation, wear suitable respiratory equipment. If ingested, seek medical advice immediately and show the container or the label. Keep away from incompatibles such as oxidizing agents, acids, moisture.

**Storage:** Keep container tightly closed. Keep container in a cool, well-ventilated area.

---

---

## Section 8: Exposure Controls/Personal Protection

---

### **Engineering Controls:**

Use process enclosures, local exhaust ventilation, or other engineering controls to keep airborne levels below recommended exposure limits. If user operations generate dust, fume or mist, use ventilation to keep exposure to airborne contaminants below the exposure limit.

**Personal Protection:** Safety glasses. Lab coat. Dust respirator. Be sure to use an approved/certified respirator or equivalent. Gloves.

### **Personal Protection in Case of a Large Spill:**

Splash goggles. Full suit. Dust respirator. Boots. Gloves. A self contained breathing apparatus should be used to avoid inhalation of the product. Suggested protective clothing might not be sufficient; consult a specialist BEFORE handling this product.

### **Exposure Limits:**

TWA: 0.01 from ACGIH (TLV) [United States] [1995] Consult local authorities for acceptable exposure limits.

---

---

## Section 9: Physical and Chemical Properties

---

**Physical state and appearance:** Solid. (Lustrous solid.)

**Odor:** Not available.

**Taste:** Not available.

**Molecular Weight:** 74.92 g/mole

**Color:** Silvery.

**pH (1% soln/water):** Not applicable.

**Boiling Point:** Not available.

**Melting Point:** Sublimation temperature: 615°C (1139°F)

**Critical Temperature:** Not available.

**Specific Gravity:** 5.72 (Water = 1)

**Vapor Pressure:** Not applicable.

**Vapor Density:** Not available.

**Volatility:** Not available.

**Odor Threshold:** Not available.

**Water/Oil Dist. Coeff.:** Not available.

**Ionicity (in Water):** Not available.

**Dispersion Properties:** Not available.

**Solubility:** Insoluble in cold water, hot water.

---

---

## Section 10: Stability and Reactivity Data

---

**Stability:** The product is stable.

**Instability Temperature:** Not available.

**Conditions of Instability:** Not available.

**Incompatibility with various substances:** Reactive with oxidizing agents, acids, moisture.

**Corrosivity:** Non-corrosive in presence of glass.

**Special Remarks on Reactivity:** Not available.

**Special Remarks on Corrosivity:** Not available.

**Polymerization:** Will not occur.

---

## Section 11: Toxicological Information

---

**Routes of Entry:** Inhalation. Ingestion.

**Toxicity to Animals:** Acute oral toxicity (LD50): 145 mg/kg [Mouse].

**Chronic Effects on Humans:**

**CARCINOGENIC EFFECTS:** Classified A1 (Confirmed for human.) by ACGIH. Causes damage to the following organs: kidneys, lungs, the nervous system, mucous membranes.

**Other Toxic Effects on Humans:**

Very hazardous in case of ingestion, of inhalation. Slightly hazardous in case of skin contact (irritant).

**Special Remarks on Toxicity to Animals:** Not available.

**Special Remarks on Chronic Effects on Humans:** Not available.

**Special Remarks on other Toxic Effects on Humans:** Not available.

---

## Section 12: Ecological Information

---

**Ecotoxicity:** Not available.

**BOD5 and COD:** Not available.

**Products of Biodegradation:**

Possibly hazardous short term degradation products are not likely. However, long term degradation products may arise.

**Toxicity of the Products of Biodegradation:** The products of degradation are as toxic as the original product.

**Special Remarks on the Products of Biodegradation:** Not available.

---

## Section 13: Disposal Considerations

---

**Waste Disposal:**

---

## Section 14: Transport Information

---

**DOT Classification:** CLASS 6.1: Poisonous material.

**Identification:** : Arsenic UNNA: UN1558 PG: II

**Special Provisions for Transport:** Not available.

---

## Section 15: Other Regulatory Information

---



**Federal and State Regulations:**

California prop. 65: This product contains the following ingredients for which the State of California has found to cause cancer, birth defects or other reproductive harm, which would require a warning under the statute: Arsenic California prop. 65: This product contains the following ingredients for which the State of California has found to cause cancer which would require a warning under the statute: Arsenic Pennsylvania RTK: Arsenic Massachusetts RTK: Arsenic TSCA 8(b) inventory: Arsenic

**Other Regulations:** OSHA: Hazardous by definition of Hazard Communication Standard (29 CFR 1910.1200).

**Other Classifications:****WHMIS (Canada):**

CLASS D-1A: Material causing immediate and serious toxic effects (VERY TOXIC). CLASS D-2A: Material causing other toxic effects (VERY TOXIC).

**DSCL (EEC):**

R22- Harmful if swallowed. R45- May cause cancer.

**HMIS (U.S.A.):**

Health Hazard: 3

Fire Hazard: 1

Reactivity: 2

Personal Protection: E

**National Fire Protection Association (U.S.A.):**

Health: 3

Flammability: 1

Reactivity: 2

Specific hazard:

**Protective Equipment:**

Gloves. Lab coat. Dust respirator. Be sure to use an approved/certified respirator or equivalent. Wear appropriate respirator when ventilation is inadequate. Safety glasses.

---

**Section 16: Other Information**

---

**References:**

-Hawley, G.G.. The Condensed Chemical Dictionary, 11e ed., New York N.Y., Van Nostrand Reinold, 1987. -Liste des produits purs tératogènes, mutagènes, cancérigènes. Répertoire toxicologique de la Commission de la Santé et de la Sécurité du Travail du Québec. -Material safety data sheet emitted by: la Commission de la Santé et de la Sécurité du Travail du Québec. -SAX, N.I. Dangerous Properties of Industrial Materials. Toronto, Van Nostrand Reinold, 6e ed. 1984. -The Sigma-Aldrich Library of Chemical Safety Data, Edition II. -Guide de la loi et du règlement sur le transport des marchandises dangereuses au Canada. Centre de conformité international Ltée. 1986.

**Other Special Considerations:** Not available.

**Created:** 10/09/2005 04:16 PM

**Last Updated:** 11/01/2010 12:00 PM

*The information above is believed to be accurate and represents the best information currently available to us. However, we make no warranty of merchantability or any other warranty, express or implied, with respect to such information, and we assume no liability resulting from its use. Users should make their own investigations to determine the suitability of the information for their particular purposes. In no event shall ScienceLab.com be liable for any claims, losses, or damages of any third party or for lost profits or any special, indirect, incidental, consequential or exemplary damages, howsoever arising, even if ScienceLab.com has been advised of the possibility of such damages.*

**APPENDIX C**  
**GILIAN DUST-SAMPLING PROCEDURES AND**  
**OPERATING MANUAL**

# Gilian® HFS-513 Air Sampling System

Operating Manual for Models:

HFS-513A  
HFS-513AT  
HFS-513AC  
HFS-513AP  
HFS-513AU  
HFS-513AUT  
HFS-513AUC  
HFS-513AUP

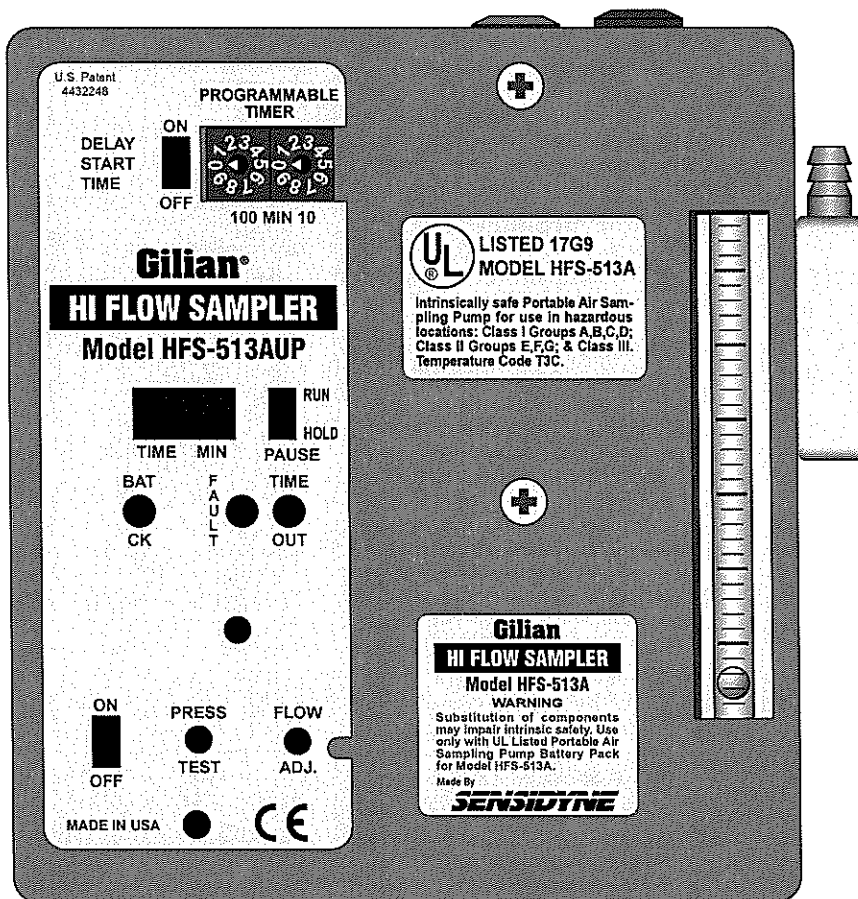

Revision C • Document No. F-PRO-2105

## LETTER FROM THE PRESIDENT

Thank you for purchasing your new Sensidyne air monitoring product. We stand behind all of the products we sell . . . each Sensidyne product has been designed and manufactured to provide unparalleled service, day after day. Our professional staff has tested each unit under the strictest conditions possible to ensure successful, accurate results every time. With the minimal care and maintenance described in this *Operation & Service Manual*, the Sensidyne product you have purchased will give you many years of reliable service.

**Our only goal is that you are pleased with the quality, performance, and accuracy of your Sensidyne product.** Be assured of our complete and prompt answers to any questions you may have about this product, since we are totally committed to providing you with fast, responsive customer service and technical support.

If you ever have difficulty solving a problem with any Sensidyne product, or if you are not 100% satisfied with the service you receive from any level of our organization, please let me know about it. Call me at either of the numbers listed below, and I will personally research your problem to ensure that it is resolved in a manner that is satisfactory to you. Your satisfaction with our products and service is of the utmost importance to me.

Sincerely,

*Carl Mazzuca*

Carl Mazzuca  
President, Sensidyne, Inc.

800-451-9444  
727-530-3602  
Fax: 727-539-0550

# Operating Manual For The HFS-513 Air Sampling System

## 1.0 INTRODUCTION

The HFS Air Sampling System is the first system truly designed with the user in mind. Many of its features have been incorporated after evaluation of current sampler technology and extensive contact with its users. It is the intent of the HFS system to provide a versatile, rugged, reliable, compact sampler employing modular design concepts and to allow the unit to be upgraded to the needs of the user. The modular stack construction concept reduces repairs and maintenance, resulting in minimum down time and maximum flexibility.

This manual contains operation, maintenance and spare parts information for the Gilian HFS Constant Flow air Sampling System. Model designations are as follows:

TIMING AND PROGRAMMABILITY OPTIONS						
MODELS & # DESIGNATION		FLOW		TIMING		
		LOW	HIGH	TIME DISPLAY FAULT	PROGRAMMABLE	
					STOP	START/STOP
HIGH FLOW	HFS-513A		X			
	HFS-513AC		X	X		
	HFS-513AT		X	X	X	
	HFS-513AP		X	X	X	X
HIGH & LOW FLOW	HFS-513AU	X	X			
	HFS-513AUC	X	X	X		
	HFS-513AUT	X	X	X	X	
	HFS-513AUP	X	X	X	X	X
Consult "Flow" section to select high and/or low flow capabilities Consult "Timing" section to select optional time display and/or programmable start/stop features.						

All HFS series pumps are UL approved intrinsically safe for use in hazardous locations Class I, Division 1, Groups A, B, C, D; Class II Division 1, E, F, G; and Class III (UL Listed 17G9). Temperature code T3C.

## **2.0 GENERAL DESCRIPTION**

The sampler is composed of the Pneumatic System, Control System, and Rechargeable Battery Pack, all housed in a sturdy 1/8" Lexan case.

### **2.1 PNEUMATIC SYSTEM**

This assembly consists of the pump, damper assemblies (2) and regulator assembly, all stacked and held together by two retaining screws. This stacking construction technique allows easy removal and replacement of any defective assembly. The Pneumatic System also includes the filter assembly, flowmeter and interconnect tubing assembled to allow the entire Pneumatic System to be tested as a complete subassembly (refer to Figures 3 and 3A).

#### **2.1.1 Pump**

The Pump is a DC motor driven dual piston unit that utilizes the patented Gilian pre-loaded valving system. The pump mechanism is sealed to prevent dirt and debris from entering.

#### **2.1.2 Damper Assembly**

The Damper Assembly consists of a compression spring sandwiched between 2 silicon diaphragms within a plastic housing which stacks directly above the pump to provide pulsation free flow for close coupling with the flowmeter. An air intake port connects the damper to the pump intake and a through hole passage is provided in the damper body to allow communicating the pump discharge to the pressure regulator stacked above.

#### **2.1.3 Regulator**

The Regulator used for low flow sampling, from 1 to 750 cc/min, includes a sensing diaphragm, spring and a valve enclosed in a plastic housing which mounts directly to the top of the damper assembly and communicates the inlet and outlet of the regulator to the suction and discharge of the pump, respectively. Provisions for shutting off the suction side of the regulator are provided. The regulator allows the pump to maintain either suction or discharge at a nominal 25" of water.

#### **2.1.4 Filter Assembly**

This assembly includes a see-through housing with an air intake boss mounted to the outside of the case for easy monitoring. The front housing secures the filter membrane and sealing "O"-Ring to the rear housing (mounted within the case) by means of 4 screws that provide an airtight seal for the air passage. The rear housing employs a vertical standpipe for conducting air into the pneumatic system. The transparent housing allows monitoring of the filter condition as well as prevention of water carry-over into the filter housing. The see-through housing allows the user to view the pump filter to determine when changing is necessary. The standpipe within the rear housing prevents water from directly entering the pump (a benefit for those doing impinger or wet sampling work).

#### **2.1.5 Flow Indicator**

The Flow Indicator is a rotameter ( $\pm 20\%$  accuracy) mounted vertically and visible from the outside of the case which is used to set and monitor pump flows over the operating range of 500 cc to 5 LPM.

### **2.2.0 Control System**

The Control System consists of a control board and 3 optional timer boards of "T", "C", and "P" models.

#### **2.2.1 Control Board**

The Control Board incorporates the on-off switch, press-to-test button, flow control system, battery charge indicator, low flow fault indicator, and time out indicator (activated only for "T", "C", "P" models).

### **2.2.1.1 Flow Compensation Control**

This control provides for constant air flow from the pump at any preset flow within the performance envelope. The compensation control includes a sensing resistor mounted in the motor leg which provides a voltage signal proportional to the motor load current which is fed to a comparator which in turn adjusts the motor voltage proportionally to the pump load line curves thereby maintaining constant flow over the operating range.

### **2.2.1.2 Flow Fault Indication**

The flow fault indicator is activated by either an under voltage, over current, or over pressure condition which occurs when the pump is operated beyond its performance envelope. A suitable time delay is incorporated in the system to prevent unnecessary shutdown. Activation of the fault system stops the pump and an LED fault indicator will light. On "C", "T" and "P" models, in addition to the pump shutting off, if a fault condition occurs, elapsed time to shut down is visible on a digital clock display. This feature allows the user to always achieve a valid sample.

### **2.2.1.3 Visual Battery Charge Indicator**

The visual battery charge indicator, activated by the press-to-test button, confirms sufficient battery capacity to run a minimum eight hour sample under any conditions with the instrument's capability.

### **2.2.1.4 Time Out Indicator**

The time out indicator, activated only for timing models "C", "T", "P", indicates that the sampling sequence has ended.

### **2.2.2.0 Timer Board (Timing Models Only)**

The timer board incorporates the timer set switches and the time readout display.

#### **2.2.2.1 Timer Set Switches**

Timer set switches are used to stop the pump at a preset time. Two switches provide 10 or 100 minute increments up to 990 minutes (16.5 hours) maximum. The clock which controls the timer automatically stops after approximately 15-30 seconds if the unit is operated beyond its performance capabilities. An illuminated time display reads out directly in minutes, indicating the amount of time of operation prior to pump shutdown. This feature allows the user to always achieve a valid sample even if the total sampling period is not realized.

## **3.0 OPERATION**

### **3.1.0 HIGH FLOW UNITS (750 CC TO 5 LPM)**

#### **3.1.1 (Refer to Figure 1 & Table 1)**

- A) Prior to use, charge the unit for a maximum of 16 hours through the Charging Jack (18), located on the case front.
- B) For "U" Models (HFS-513AU, HFS-513AUC, HFS-513AUT, HFS-513AUP) make sure the regulator shut-off valve is completely closed. This is accomplished by removing the Protective Cap (23), inserting the small blade end of the Regulator Adjust Screwdriver through the opening, and engaging the slot of the regulator shut-off valve. Turn clockwise until closed — **DO NOT OVERTIGHTEN**. The user will learn to recognize when the regulator is open since the regulator adjust screw is in the upward position (Protective Cap removed).

- C) Connect the sampling head (cyclone, impinger, filter holder, etc.) to the air intake boss of the filter housing (15).
- D) Use the small screwdriver to remove the Anti-Tamper Cover (7) to expose the control panel. (IF UNIT IS NOT A TIMER MODEL, SKIP TO STEP "F").
- E) Set the programmable timer (1) with the small screwdriver. The Left dial sets in 100 minute increments. The Right dial sets in 10 minute increments. (WHEN USING TIMER MODELS "T", "C", OR "P", PLEASE REFER TO SECTION 3.3.0 FOR DETAILED INSTRUCTION IN THE OPERATION OF INDIVIDUAL TIMER BOARDS.) Reinstall the Anti-Tamper Cover.
- F) Turn on the unit by pushing the ON/OFF Switch (5) upward to the "ON" position with the small screwdriver.
- G) Adjust the Flow Control Pot (9) with the small screwdriver to the desired flow rate on the built-in flowmeter (11). If the flow rate is adjusted below 1 LPM (**WITH NO BACK PRESSURE FROM FILTER, SAMPLING TUBE, ETC.**) oscillation of the flowmeter float will be noted. This is perfectly normal and will stop, or decrease, once an external load (filter, cassette, etc.) is applied to the pump. In order to facilitate setting the flow rate below 1 LPM, a small restrictor (supplied with the sampler) will provide the necessary back pressure. The restrictor may be left in place, but will reduce the maximum back pressure of the sampler. **CAUTION: BE SURE THE RESTRICTOR IS REMOVED WHEN SAMPLING ABOVE 1 LPM.**
- H) Push the Press-to-Test button (6) to determine the battery charge state through illumination of the battery check LED (3B). The LED should light indicating a full charge.
- I) The unit must be turned off manually when the full sampling period is realized. If you are using a Timer model, the unit will stop when the time set on the Programmable timer (1) is read and the Time Out LED (3C) will light. Pushing the Press-to-Test Button (6) will indicate the set programmed time. Should the air supply to the sampler be interrupted for a period of 15–30 seconds, the unit will stop and the Fault Indicator (3A) will light. Actuating the Press-to-Test Button will indicate the time at which the fault occurred.

### 3.2.0 LOW FLOW UNITS (1 CC TO 750 CC/MIN) ["U" MODELS ONLY]

Refer to Figure 1 & Table 1. The Gilian Low flow Regulator Models are designed to permit either single or multiple low flow sampling by using the appropriate Variable flow Controller found in the Universal Tube Holder System. The pump flow is controlled by means of a built-in constant pressure regulator and is adjusted by means of the Variable Flow Controller incorporated into the tube holder assembly.

#### 3.2.1 Preparation for Low Flow Sampling — Single

Turn on the pump and adjust the Flow Control (9) to approximately 1 LPM. Remove the Protective Cap (23) using the Regulator Adjusting Screwdriver supplied with the sampler. Open the regulator Shut-off Valve by turning it counterclockwise approximately 5 turns. Replace the cap. Attach the tube holder containing the Variable Flow Controller to the pump inlet boss (15), using the special adaptor tubing provided (800159). Using a calibrated rotameter, bubble tube, adjust the Variable flow Controller to the desired flow rate. The flow controller adjustment screw is located under the knurled knob protective cover at the end of the unit.



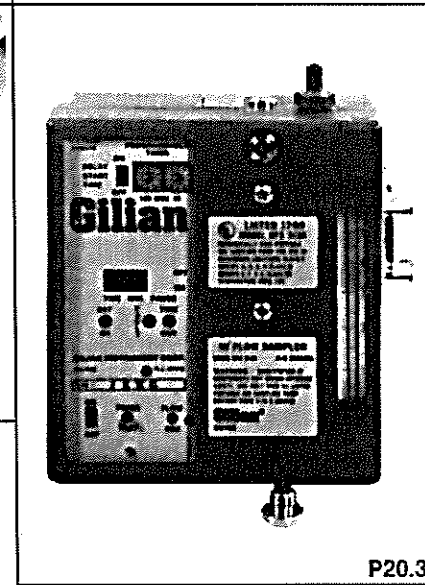
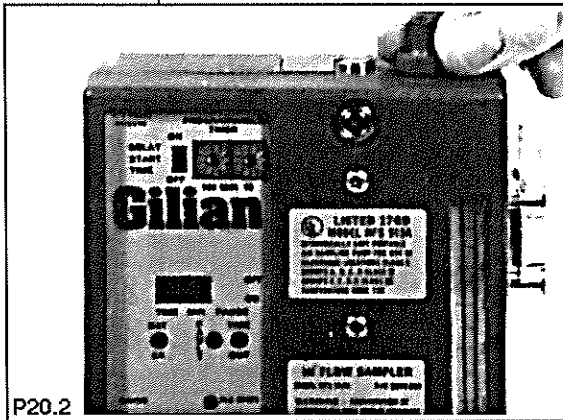
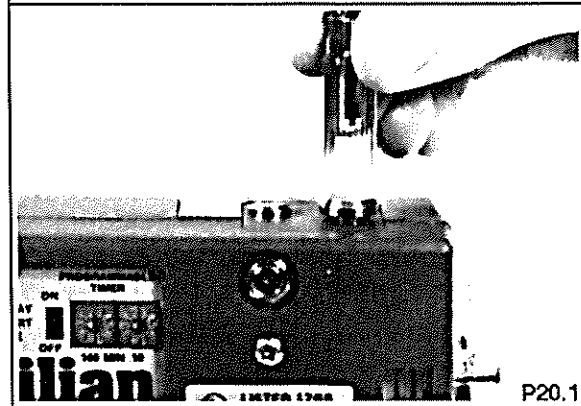
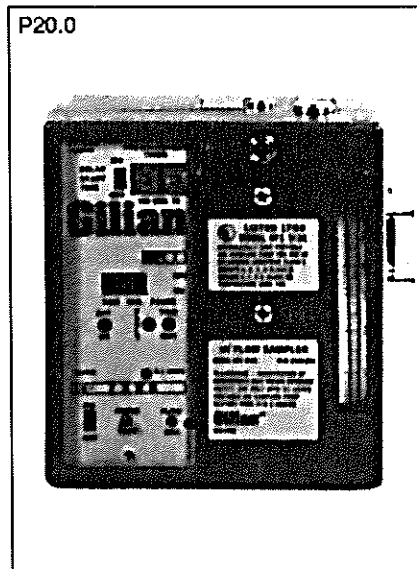

**P20.0 INSTALLING THE DISCHARGE AIR BOSS**

The Discharge Air Boss is used for Bag Sampling media or where a discharge sample is required.

P20.1 Remove the air discharge cover (22).

P20.2 Screw the Discharge Air Boss into the sampler.

P20.3 The Discharge Air Boss is now inserted into the sampler.

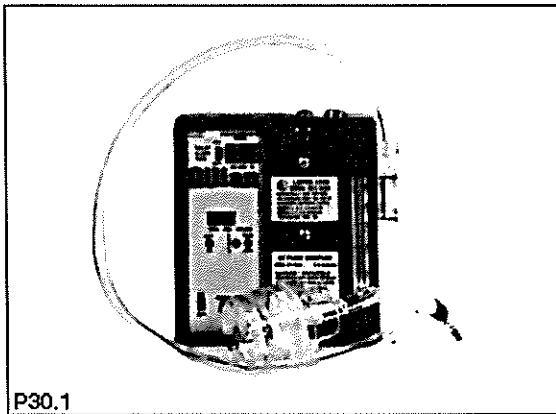

P30.1

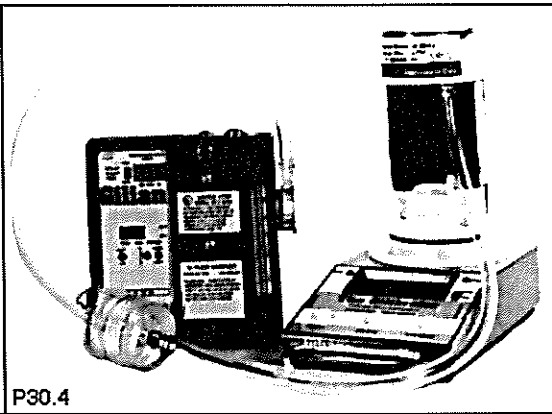

P30.4

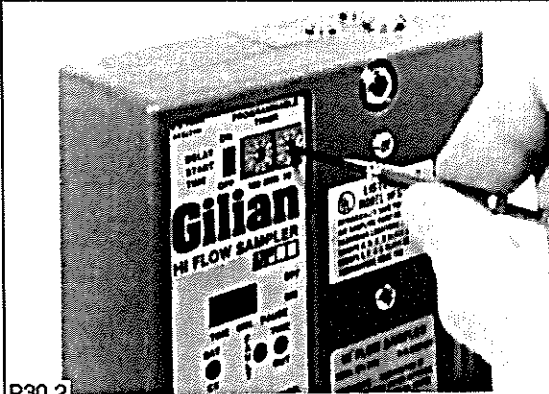

P30.2

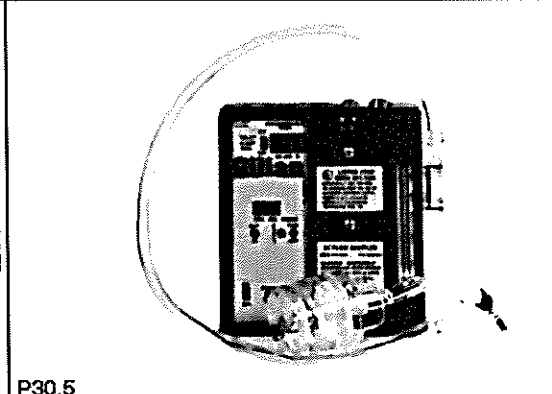

P30.5

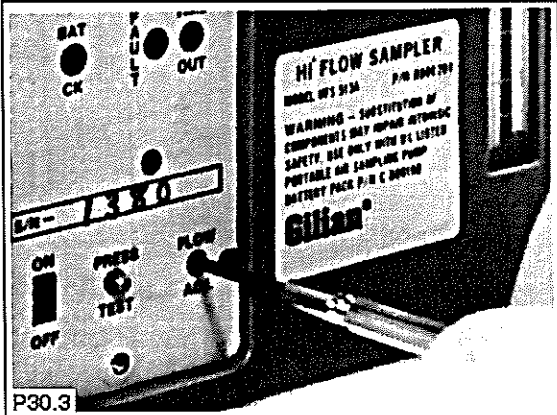

P30.3

## P30.0 HIGH FLOW OPERATIONS

P30.1 Typical High Flow system.

P30.2 Set the Timing Functions (see Section 3.3.0 for specific timing instructions).

P30.3 Set the flow (.5 to 3.5 LPM) and turn on the pump. Refer to Section 3 for specific instructions for setting the flow.

P30.4 Verify the flow with sampling media on line using a Primary Standard.

**NOTE:** Always be sure to use an impinger trap when doing this procedure. This will prevent liquid from entering the sampling line or sampling pump.

P30.5 Remove the calibrator and sampler is now ready for High Flow Sampling.

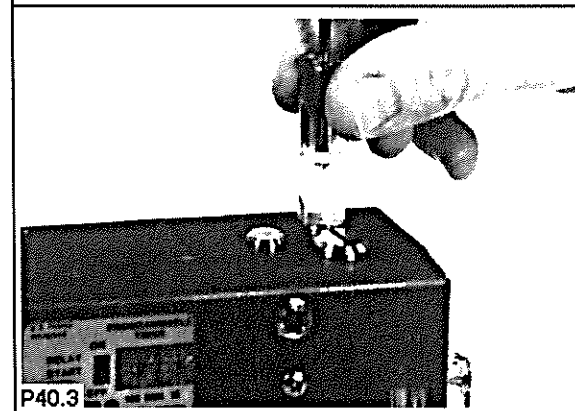
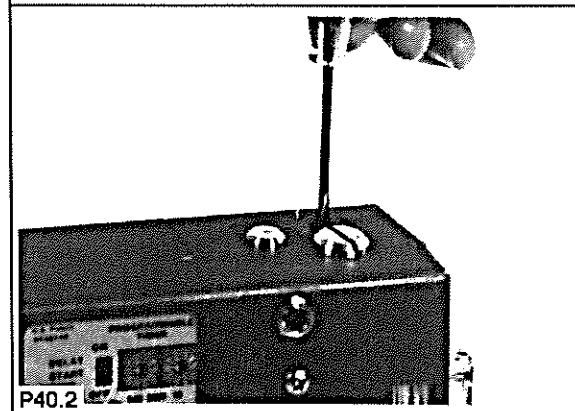
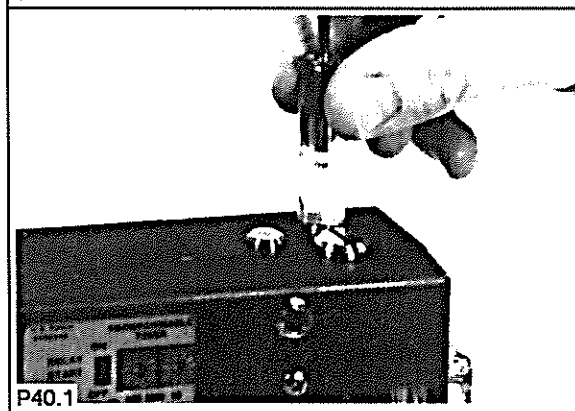
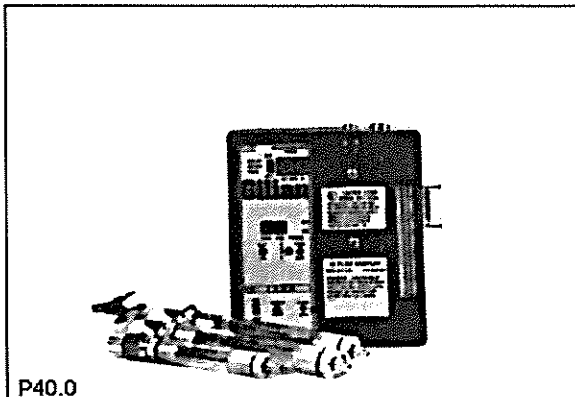

**LOW FLOW OPERATIONS**

P40.0 Typical High Flow System.

**CONVERTING TO LOW FLOW MODE**

P40.1 To convert to Lowflow, remove the regulator's protective cap screw with the screwdriver supplied with the sampler.

P40.2 Place the end of the regulator screwdriver into the recess and engage the slot of regulator shut-off valve.

To open the valve, turn shut-off valve 4 or 5 turns counterclockwise.

**NOTE: DO NOT OVERTURN THE VALVE. IT WILL HAVE NO EFFECT.**

To close the valve, turn the shut-off valve 4 or 5 times clockwise. **DO NOT OVERTIGHTEN!**

P40.3 Replace the cap.

# Multiple Low Flow Sampling



P40.1.1

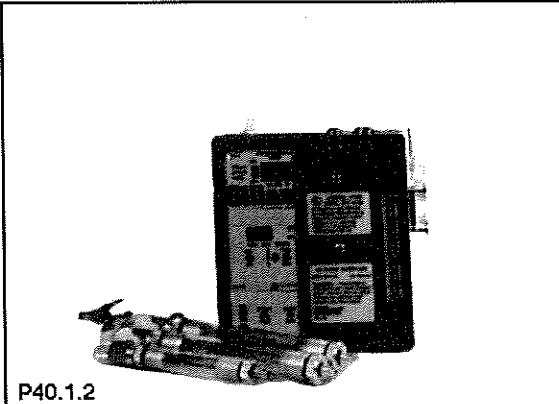

P40.1.2

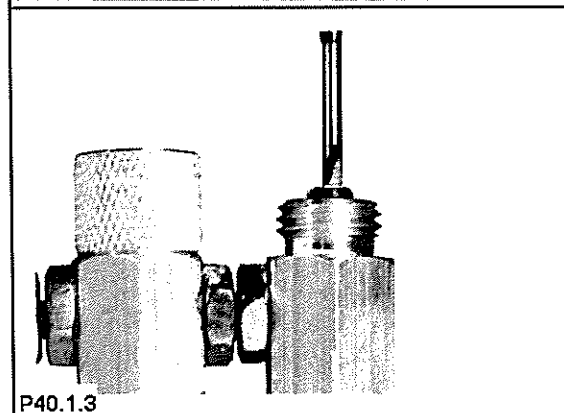

P40.1.3

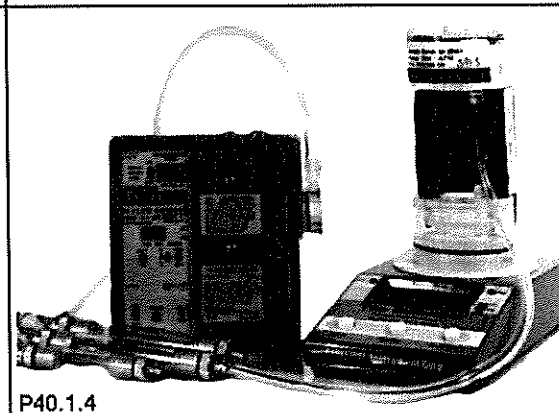

P40.1.4

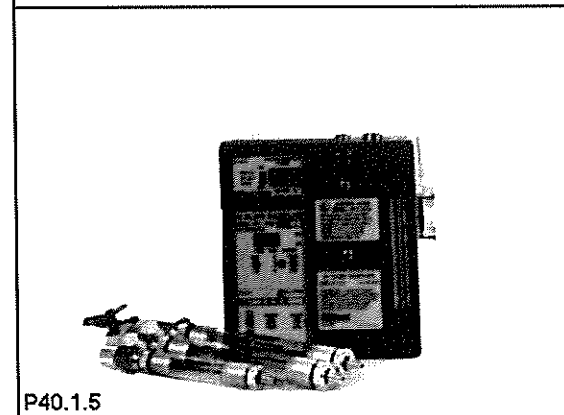

P40.1.5

## P40.1.0 LOW FLOW FUNCTIONS

- P40.1.1 Set Timing (see Section 3.3.0 for specific timing instructions).
- P40.1.2 Attach Multiple Flow Controller Manifold Tube Holder for replicate Low Flow sampling and turn on pump.
- P40.1.3 Remove Cap Ends on flow Controller Manifold. To adjust flow turn the Needle Valve with a small screwdriver (counterclockwise for increase, clockwise for decrease).
- P40.1.4 Verify the flow of each tube flow rate using a Primary Standard.
- P40.1.5 Remove the Primary Standard and the sampler is now ready for Low Flow Sampling.

### 3.2.2 Multiple Low Flow Sampling

Proceed as in 3.2.1, except in place of the single Variable Flow Controller, connect the sampling manifold to the adaptor tubing. Continue as in 3.2.1 until all stations of the manifold are set to the flow rate that you require. **NOTE: TOTAL COMBINED FLOW THROUGH A FLOW CONTROLLER MANIFOLD MAY NOT EXCEED 750 cc/min.**

## TIMING

### 3.3.0 GENERAL DESCRIPTION

The timer boards described in this section provide the following additional features not available in the HFS-513AT series boards.

1. Programmable start up to 990 minutes prior to desired sampling time.
2. Option to run pump for unlimited time increments.
3. Display clock readout of up to 9999 minutes.
4. Optional remote start/stop with cumulative time available on special order.

#### 3.3.1 Operation of "C" Board

1. This is the board provided with the HFS-513AC and HFS-513AUC.
2. This board is a continuous running board only and has no programming options. Should the pump fault under load or due to low batteries, the timer will latch and maintain the time up to 12 hours or until the pump is reset.

#### 3.3.2 Operation of "P" Board

1. This is the board provided with the HFS-513AP and HFS-513AUP.
2. The programmable run features of this board are functionally identical to the HFS-513AT series board, with the following exceptions:
  - a. When set to 0.0, the pump will run for an indefinite period of time (i.e. until the batteries run out).
  - b. The timer display will read up to 9999 minutes.

### 3.4.0 USE OF PROGRAMMABLE START TIME

Refer to Figure 1.

1. Switch the delay start time switch (1a) to the "ON" position.
2. Calculate start time delay in minutes and enter on switches (1) (i.e., 2 hours [120 minutes], 4 hours [240 minutes]).
3. Turn on pump (5).
4. Confirm delay time by pressing test button (6). Time remaining to start will be displayed on LED (2). A flashing decimal point in the lower right-hand corner indicates operational timer.
5. Proceed to set run time in a normal manner (i.e., 2 hours [120 minutes], 4 hours [240 minutes]). If run time is uncertain, it is recommended that you set time to 990 minutes.

### 3.4.1 USE OF PROGRAMMABLE RUN TIME

Refer to Figure 1.

**WARNING: IF YOU DO NOT WISH TO USE PUMP IN PRESET START MODE, MAKE SURE THAT THE DELAY START TIME SWITCH IS IN THE “OFF” POSITION.**

1. Switch the Delay Start time Switch (1a) to the “OFF” position.
2. Calculate the run time day in minutes and enter on the switches (1).
3. Turn on the pump.
4. To read the accumulated time, press the Test button (6) and the activity indicator will be at the lower right hand side of the LED display.
5. Please note that the programmable timer will not operate for longer than 990 minutes (16.5 hours). Should it be necessary to operate the pump for longer than 990 minutes, the time switch dials should be set to 0/0.

**NOTE: These controls do not affect the standard high and/or low flow setting procedures. If review of the flow procedures is necessary, please see Section 3.**

## 4.0 MAINTENANCE

### 4.1 HFS-513 BATTERY PACK — CHARGING AND MAINTENANCE

The HFS-513 sampler operates using a rechargeable Nickel-Cadmium 6-volt UL listed battery pack system. (UL rated intrinsically safe with highest UL rating available.)

#### HFS-513 BATTERY PACK REPLACEMENT

**TO REMOVE:** First, place the pump face down on a soft level surface. Remove the 2 screws which secure the Battery Pack to the case front. Carefully slide the battery pack to the right, out from under the belt clip. Be careful not to damage the wire connection. Stand the battery pack up vertically and gently disconnect the battery pack from the sampler connection. Remove the battery pack completely.

**TO REPLACE:** Reconnect the plug from the battery pack to the sampler connection. Reposition the battery pack on the sampler and slip the front edge under the belt clip. Be careful not to crimp the wiring in any way. Move the battery pack so the rails engage with the slots on the front case. Push the battery pack to the left until it is located in place. Reinstall the holding screws.

#### CHARGING & MAINTENANCE

The HFS-513 battery pack may be charged internally through the sampler’s built-in charging jack using either a single or multiple station charging unit. It can also be recharged with the use of an external charging adapter (800312). The adapter will be necessary for charging the battery pack when it is not installed in the sampler.

A proper battery maintenance program is essential to insure maximum battery life and performance. Specific charging and discharging procedures will vary with your particular needs and applications. The following is a list of general recommendations that should help to provide efficient battery life and serviceability.

1. Do not short the battery connectors. This will result in irreversible damage to the battery pack.

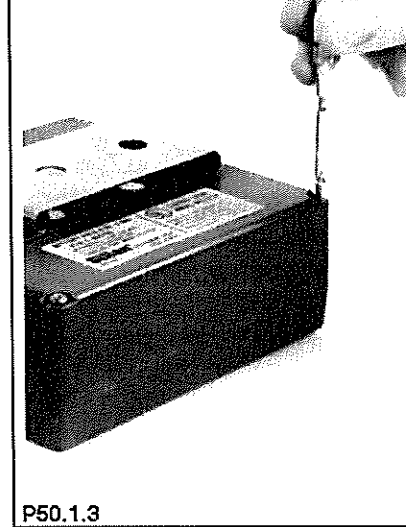
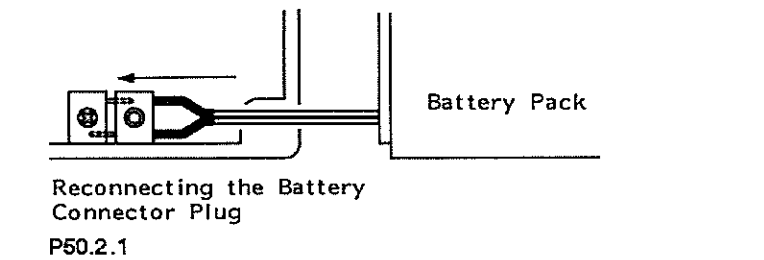
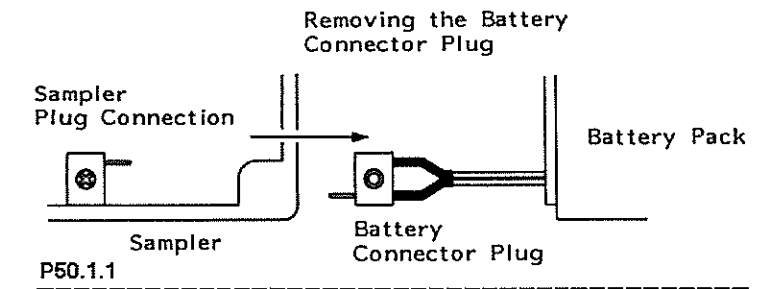
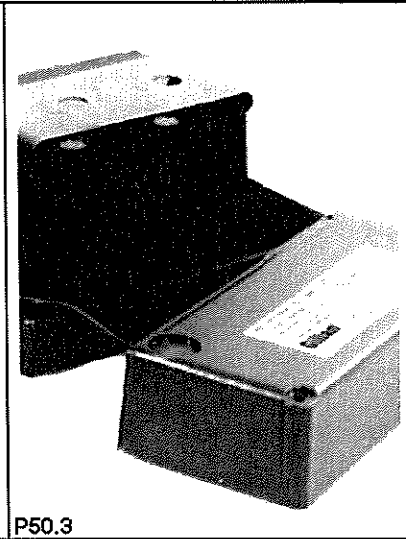
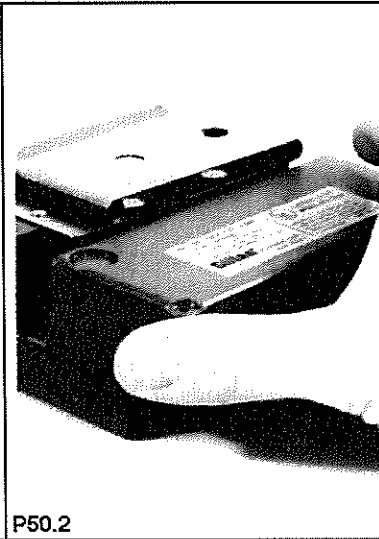
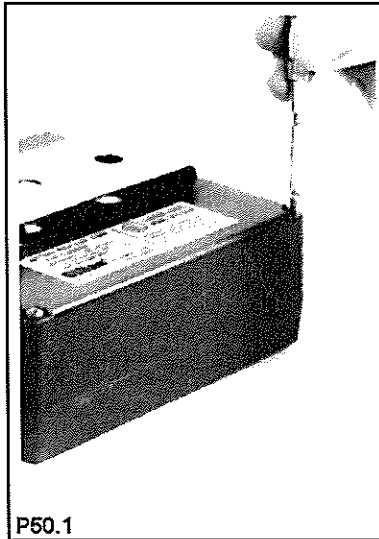

**REMOVAL/INSTALLATION & MAINTENANCE**

**P50.0** This section is to provide the user with a basic knowledge of battery upkeep and installation. When disassembling your sampler, it is recommended that you work on a clean, level surface with a soft cloth underneath.

**REINSTALLING THE BATTERY PACK**

- P50.1** Remove the (2) long screws from the Battery Pack rear.
- P50.2** Slide the Battery Pack out slowly from under the Belt Clip. Be careful of the wire connection.
- P50.3** Battery Pack removed.

**P50.1.1** Gently remove the battery pack plug from the lead connection on the sampler. It is now disconnected and ready for recharging or replacement.

**REINSTALLING THE BATTERY PACK.**

- P50.2.1** Reconnect the Battery Pack plug to the lead connection on the sampler.
- P50.2** Engage the rails of the Battery Pack and slide under the belt clip. The battery will lock into place.
- P50.1.3** Reinstall the (2) long screws into the Battery Pack rear. Battery Pack installation is now complete.

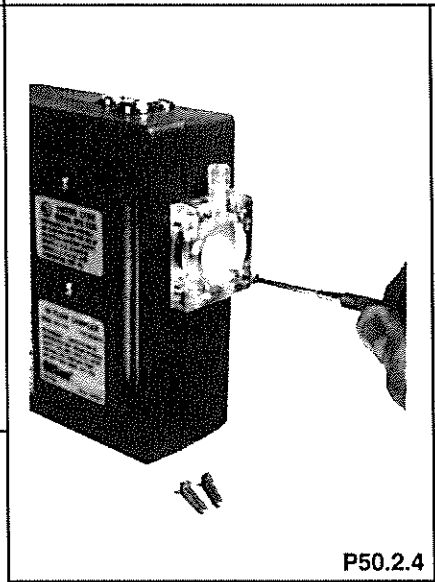
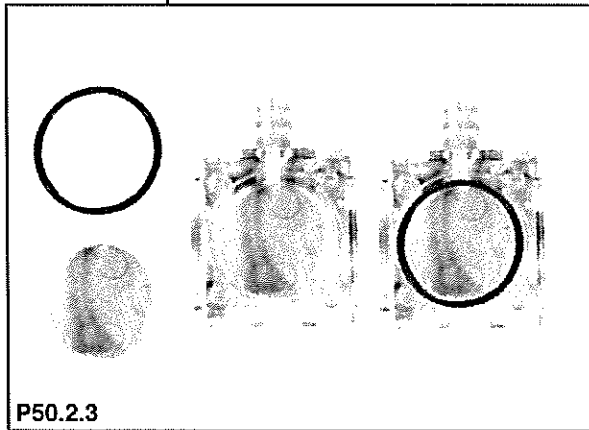
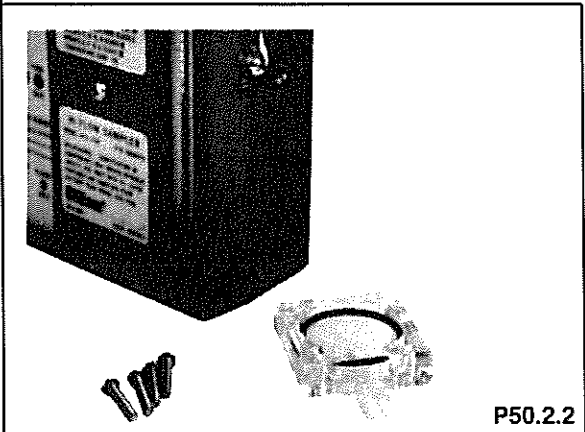
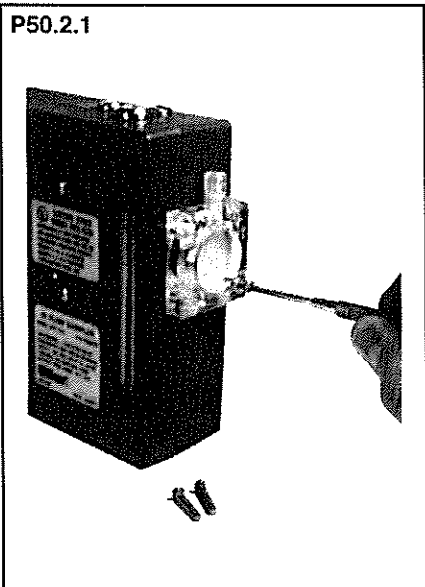

**P50.2 FILTER REPLACEMENT** — the filter and o-ring should be replaced when you see discoloration of the filter or a buildup of unknown particulate. Keeping up with this will insure accurate flows and samples as well as keeping the sampler operating efficiently.

**P50.2.1** Remove (4) screws from the Filter Housing Front located at the right side of the pump.

**P50.2.2** Remove the Filter Housing Front.

**P50.2.3** Remove the old filter and o-ring and replace with a new filter and o-ring using a Gilian Pump Filter Kit (800053).

**P50.2.4** Replace the Filter Housing Front and reinstall (4) screws. Tighten screws until they stop turning. **DO NOT OVERTIGHTEN.** Filter replacement is now complete.



2. Do not overcharge the batteries. You should not charge battery packs at the high (standard) rate for more than 24 hours. Continuous charging will eventually lead to deterioration in the performance and life of the battery pack. If you must have the batteries on charge for extended periods of time, switch the charger to a low (trickle) rate.
3. Use only HFS-513 single or multi-station chargers. Use of any other charger (including HFS-113 chargers) will result in an improper charge or permanent damage to the battery systems.

## **DAY TO DAY CHARGING**

1. Using a single or multi-station charger, connect the charging connector to the sampler's charging jack and charge the battery for 16 hours prior to operation.
2. Remove the sampler from the charger and operate pump until it shuts down from a low battery.
3. Recharge the batteries for 16 hours or overnight for the next use.

## **LONG TERM CHARGING & STORAGE**

The long term storage of pumps will require some special handling. If pumps are not scheduled to be used for long periods of time (over 2 months), it is recommended that the following procedure be followed on a periodic basis.

1. Charge the battery for 16 hours for a full charge.
2. Run the pump until it shuts down from a low battery.
3. Recharge the batteries only for 16 hours (or overnight) and return to storage. Note: Continuous charging will eventually lead to a deterioration in the performance level of the batter pack. If you must have the batteries on charge for more than 24 hours, switch the charger to a low (trickle) rate.

## **4.2 CHANGING THE PUMP FILTER**

Refer to Figure 3. Under the normal operating conditions, the pump filter should be changed after approximately 250 hours of operation (or sooner). Failure to change the filter as it becomes dirty will decrease the pump back pressure capability and performance envelope. Blow all dust and debris from around the filter housing. Remove the 4 screws (8) and the front filter housing (5). Remove and discard the filter membrane (6) and the O-ring (7). Wash the filter housing in a mild soap and warm water solution, then blow it dry. Insert a new filter membrane and O-ring. Insert the 4 screws (8) and cross tighten until the front filter housing is secured to the rear housing within the case.

## **LEAK TESTING**

Refer to Figure 1. Leakage test the system by removing the screw (22) and installing the discharge air boss. Block the pump inlet boss and apply 20" of suction to the pressure fitting. No leakage should be observed. An alternate procedure to pick up severe leakage is to turn on the pump, block the inlet boss, and then observe that the pump cuts out on a flow fault.

## **4.4 CALIBRATION**

### **4.4.1 High Flow Calibration**

Refer to Figure 1 and Table 1. The constant flow feature of the sampler utilizes load sensing of the pump motor which, through a feedback loop, readjusts the motor speed to maintain constant flow. High Flow Calibration is accomplished by checking and adjusting the flow and Back Pressure Compensation System (BCS) at two points: 1.5 LPM and 4 LPM. This insures that the calibration is accurate at all ranges in the high flow mode.

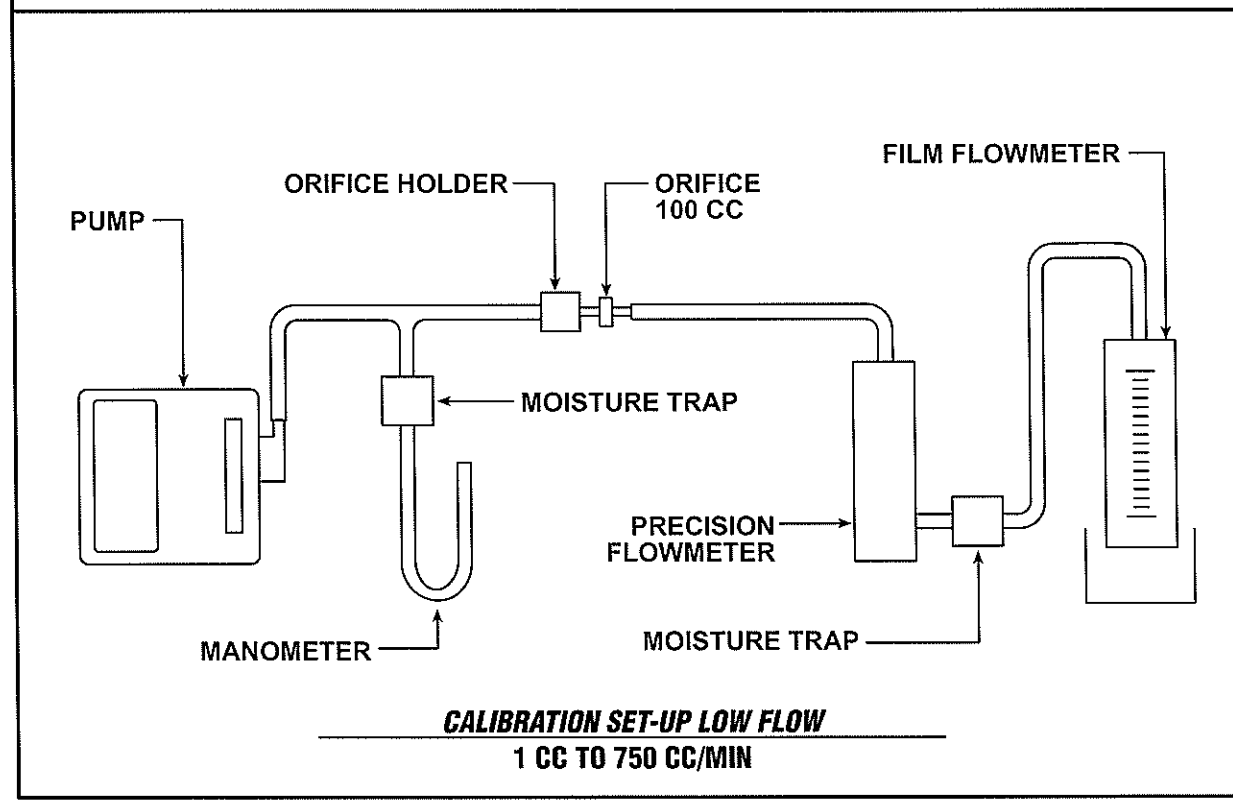
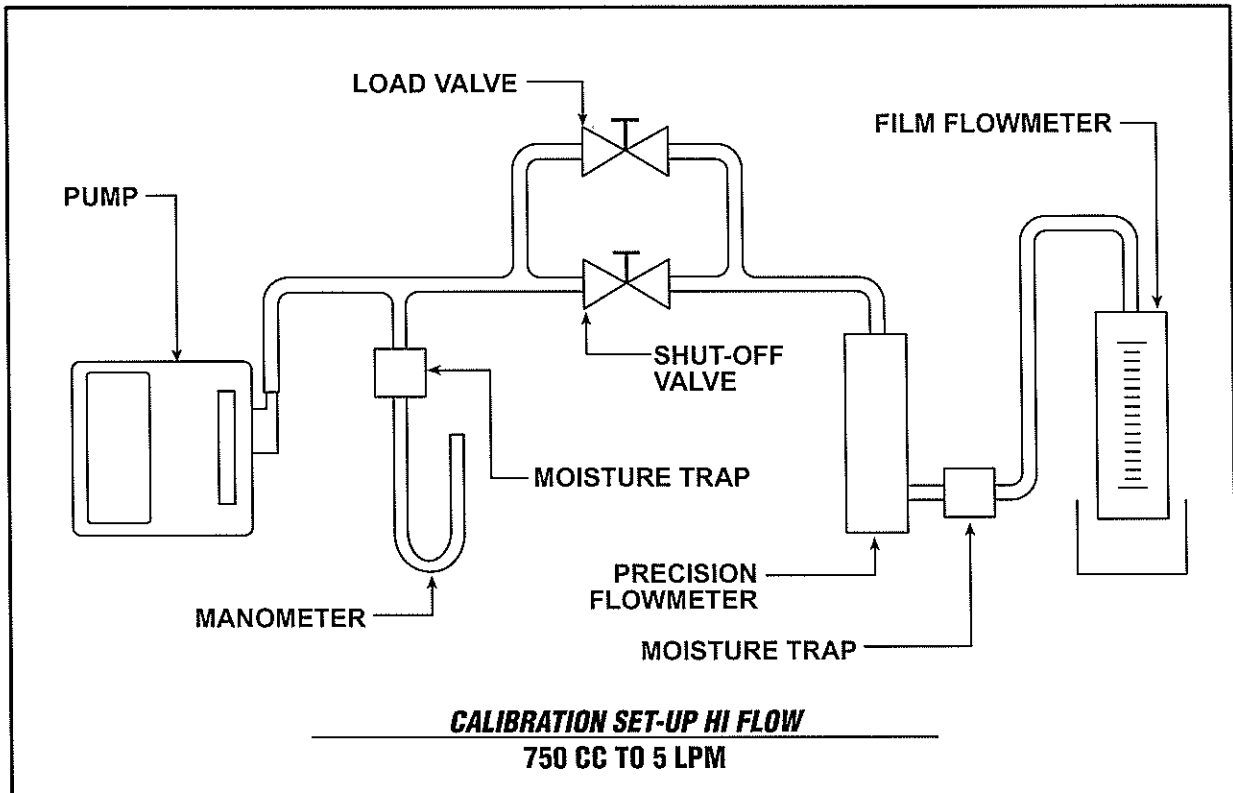

Figure 7  
Calibration Set-Up

#### 4.4.2 High Flow Calibration at 1.5 LPM

Set the pump to 1.5 LPM using the Flow Adjust Pot (9). Allow approximately 15 seconds to stabilize. Apply approximately 25" of back pressure by partially restricting the inlet to the pump and note the change in flow on the flowmeter or external flow calibrator. (The pump flowmeter is in the suction side of the pump. Consequently, the flowmeter will read higher as the pressure within the system decreases. An external flow calibrator is not affected by this.)

If the flow decreases (at 25" of back pressure) turn the Flow Calibration Pot (10) slightly counterclockwise to increase the speed of the motor and increase the flow until it is back at 1.5 LPM.

If the flow increases (at 25" of back pressure) turn the Flow Calibration Pot (10) slightly clockwise to decrease the speed of the motor and decrease the flow until it is back to 1.5 LPM. Remove the back pressure. Reset the flow to approximately 1.5 LPM, if necessary. **NOTE:** It is not necessary to set the flow exactly for it is the change in flow which is of importance. Repeat this procedure until the change is within  $\pm 5\%$

#### 4.4.3 High Flow Calibration at 4 LPM

Set the pump to 4 LPM using the Flow Adjust Pot (9). Allow approximately 15 seconds to stabilize. Apply approximately 15" of back pressure by partially restricting the inlet to the pump and note the change in flow on the flowmeter or external flow calibrator. (The pump flowmeter is in the suction side of the pump. Consequently, the flowmeter will read higher as the pressure within the system decreases. An external flow calibrator is not affected by this.)

If the flow changes with load (increases or decreases) note the AMOUNT OF CHANGE (differential). Remove the back pressure. Adjust the 4 LPM Flow Calibration Pot (4) to increase or decrease the flow ten times (10x) the differential noted.

Example:

##### **FLOW INCREASES:**

Flow at Set Point .....	4000 cc/min
Flow at 10" Back Pressure .....	4050 cc/min
Flow at Differential .....	+50 cc/min
10x.....	+500 cc/min
Calibration Set Point .....	4500 cc/min

Example:

##### **FLOW DECREASES:**

Flow at Set Point .....	4000 cc/min
Flow at 10" Back Pressure .....	3950 cc/min
Flow at Differential .....	-50 cc/min
10x.....	-500 cc/min
Calibration Set Point .....	3500 cc/min

Adjust the Flow Control Pot (9) to bring the flow back to 4 LPM. Reapply the back pressure and note any change in the flow. Repeat this procedure until the change is within  $\pm 5\%$ .

#### 4.4.4 Low Flow Calibration (1 cc to 750 cc/min)

(HFS-513AU, HFS-513AUC, HFS-513AUT, HFS-513AUP, timing Model only)

Refer to Figure 1 and Table 1.

Low flow calibration consists of simply setting the differential pressure drop of the Low Flow Pressure Regulator. Once set, the regulator should not require frequent readjustment. Turn on the pump and adjust the Flow control Pot (9) to 1,5 LPM.

Remove the Protective Cap (23). With the Regulator Adjust Screwdriver, open the pressure regulator shut-off valve located under the cap (23). By turning it counterclockwise approximately 5 turns (additional turns will have no effect).

Connect a manometer or pressure gauge capable of reading up to 40" H<sub>2</sub>O to the pump as shown in Figure 7.

**NOTE:**

**IF A MANOMETER IS USED, MAKE SURE THAT A WATER TRAP IS INSERTED BETWEEN THE MANOMETER AND THE PUMP INLET. THIS WILL PREVENT POTENTIAL DAMAGE CAUSED BY LIQUID ACCIDENTALLY ENTERING THE PUMP.**

Attach a Variable Flow Controller tube holder as shown in Figure 7. Remove the Protective Cap (21) and completely block the air entering the tube holder.

Adjust the pump suction pressure to 25" H<sub>2</sub>O by turning the pressure regulator adjust screw (located under the Protective Cap [21]) clockwise to increase the pressure. Turn the screw counterclockwise to decrease the pressure.

With the flow between 0 and 200 cc/min, the pressure should not change more than 1 1/4". Replace the protective caps.

This completes Low Flow Calibration.

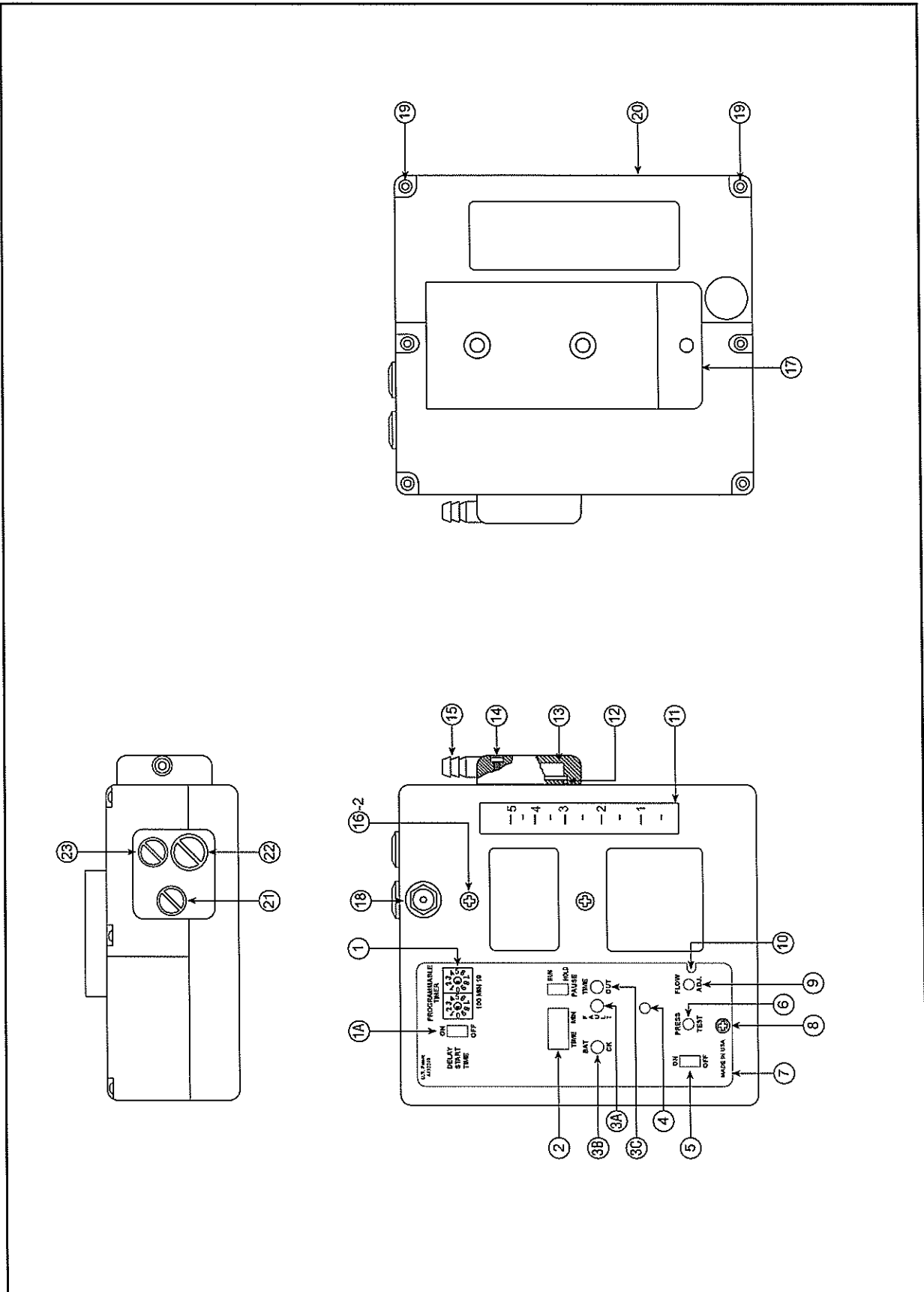

Figure 1  
HFS-513 Air Sampling Pump

**TABLE 1**

**HFS 513 FUNCTIONS**

ITEM NO.	NOMENCLATURE	DESCRIPTION	ITEM NO.	NOMENCLATURE	DESCRIPTION
1	PROGRAMMABLE TIMER	Allows user to set sample time from 10 minutes to 990 minutes in ten minute increments.	10	1 LPM CALIBRATION ADJUST	Calibrates low flow tracking.
1A	PROGRAMMABLE DELAY START SWITCH	Allows user to delay start of pump.	11	FLOW METER	Show flow; read center of meter ball.
2	TIME DISPLAY	Recorded run time and/or fault time.	12	"O" RING SEAL	Seals Filter (13) into inlet housing (15).
3	TEST AND FAULT DISPLAY		13	FILTER	10 micron nylon.
	A) FAULT	Indicates insufficient battery voltage to continue running flow set point, or indicates pump could not maintain flow performance parameters.	14	SCREWS (4)	Secures filter housing to pump.
	B) BATTERY CHECK	Insures sufficient battery capacity to run performance profile when Press-To-Test Switch is pressed.	15	FILTER HOUSING (AIR INLET)	Provides air inlet boss and visual monitoring of pump inlet filter.
	C) TIME OUT	Indicates programmed time has been completed.	16-2	ACCESSORY MOUNTING SCREWS (2)	Provides means of securing pump accessories.
4	4 LPM CALIBRATION ADJUST	Calibrates hi flow tracking.	17	BELT CLIP	Secures pump to worker.
5	ON-OFF SWITCH	Provides power to unit.	18	CHARGING JACK	Provides means of recharging battery.
6	PRESS-TO-TEST SWITCH	Checks test, fault, and time displays.	19	BATTERY PACK SCREWS (2)	Secures battery pack to pump.
7	ANTI-TAMPER COVER PLATE	Prevents inadvertent adjustment or tampering with pump settings.	20	BATTERY PACK ASSEMBLY	Provides power for sampler.
8	ANTI-TAMPER COVER PLATE SCREW	Secures plate.	21	REGULATOR ADJUST	Removing screw provides access to regulator pressure adjust.
9	FLOW ADJUST	Turned clockwise, increases flow; counterclockwise, decreases flow.	22	DISCHARGE AIR CAP SCREW	Removing provides access to discharge port, for installing air boss.
			23	REGULATOR SHUT-OFF CAP SCREW	Removing screw provides access to the regulator shut-off valve.

Case Assembly (complete) (PN° 800336)  
 consists of items 3, 4, 5, 7, 8, 11, 12, 13, 14, 15

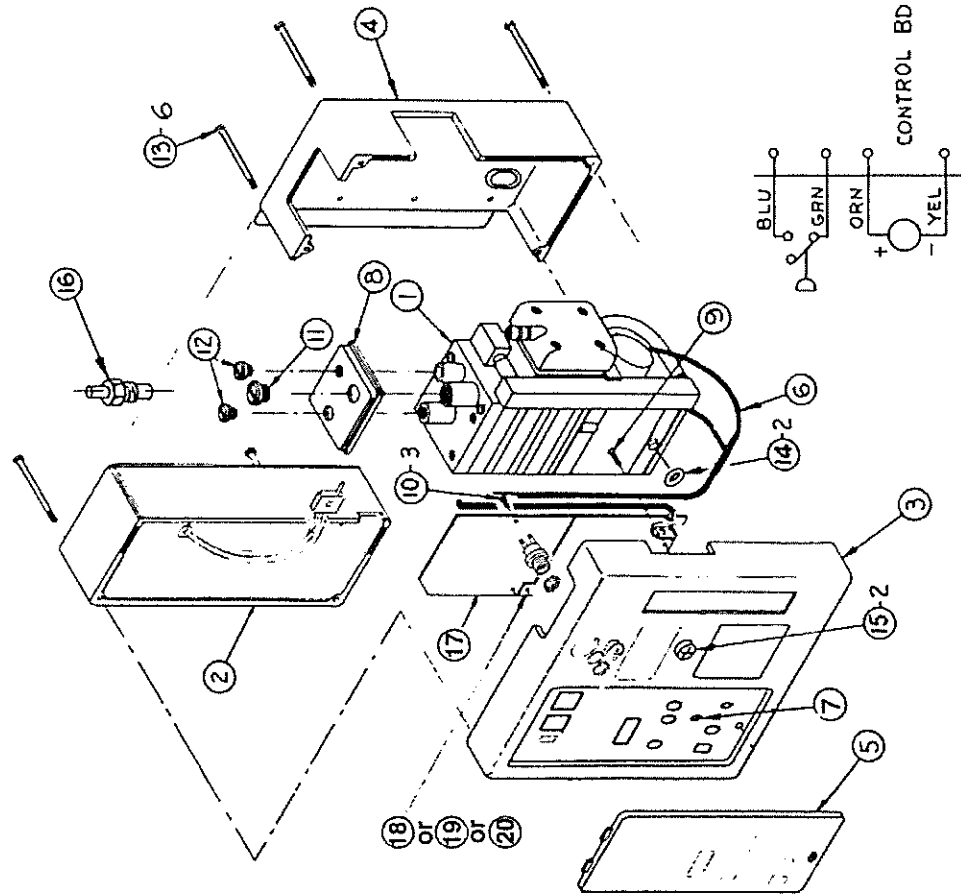

WIRING DIAGRAM

20	1	400256	Timing Board, "P" Mod
19	1	400255	Timing Board, "T" Mod
18	1	400254	Timing Board, "C" Mod
17	1	400606	Control Board
16	1	200042	Fitting, Outlet
15	2	800052	Screw, Pan Head, #6-32 x 3/16" LG
14	2	800052	"O" Ring
13	6	800052	Screw, #4-40 x 1 3/8" LG
12	2	800109	Screw, Sealing 1/4-28
11	1	800109	Screw, Sealing 3/8-20
10	3	—	Screw, #2-56 x 3/16" LG
9	1	—	Screw, #2-56 x 7/16" LG
8	1	200050	Insert, Case
7	1	200045	Button, Push-to-Test
6	1	200703	Wiring Harness
5	1	800034	Cover Plate Assembly
4	1	800202	Case Assembly, Rear
3	1	800201	Case Assembly, Front
2	1	800198	Battery Pack
1	1	800199	Pneumatic Assembly
Item No.	Qty Req	Part No.	Description
CONSTANT FLOW SAMPLER			
		SKA 1615	REV B

Pneumatic Assembly Overhaul Kit (PN° 800054) consists of items 9, 10, 12, & 13  
 Pump Filter Kit (PN° 800053 consists of items 6 (Qty 3), 7 (Qty 3), & 8 (Qty 1)

14	1	800048	Regulator Dummy Assembly
13	1	—	Tubing, Inlet, 3/16" ID x 1/16" Wall x 1/2" LG
12	1	—	Tubing, Inlet, 3/16" ID x 1/16" Wall x 2.4" LG
11	1	400410	Flowmeter
10	2	—	Screw, Pan Head, #4-40 x 2 1/4" LG
9	6	—	"O" Ring
8	4	—	Screw, Pan Head #4-40 x 5/8" LG
7	1	—	"O" Ring
6	1	—	Filter
5	1	200023	Housing, Filter Front
4	1	800045	Housing, Filter Rear
3	1	800009	Regulator Assembly
2	2	800008	Damper Assembly
1	1	800302	Pump Assembly
Item No.	Qty Req	Part No.	Description
PNEUMATIC ASSEMBLY			
		SKA 1616	REV B

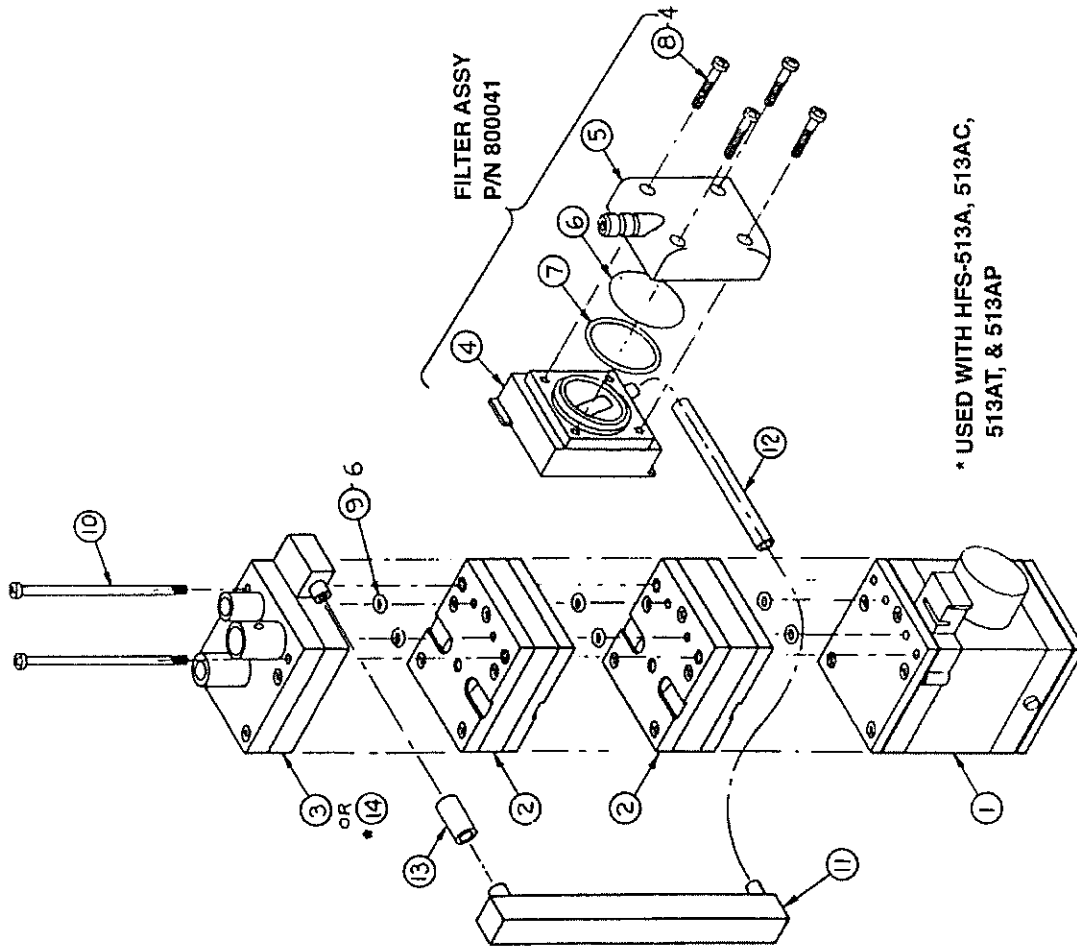
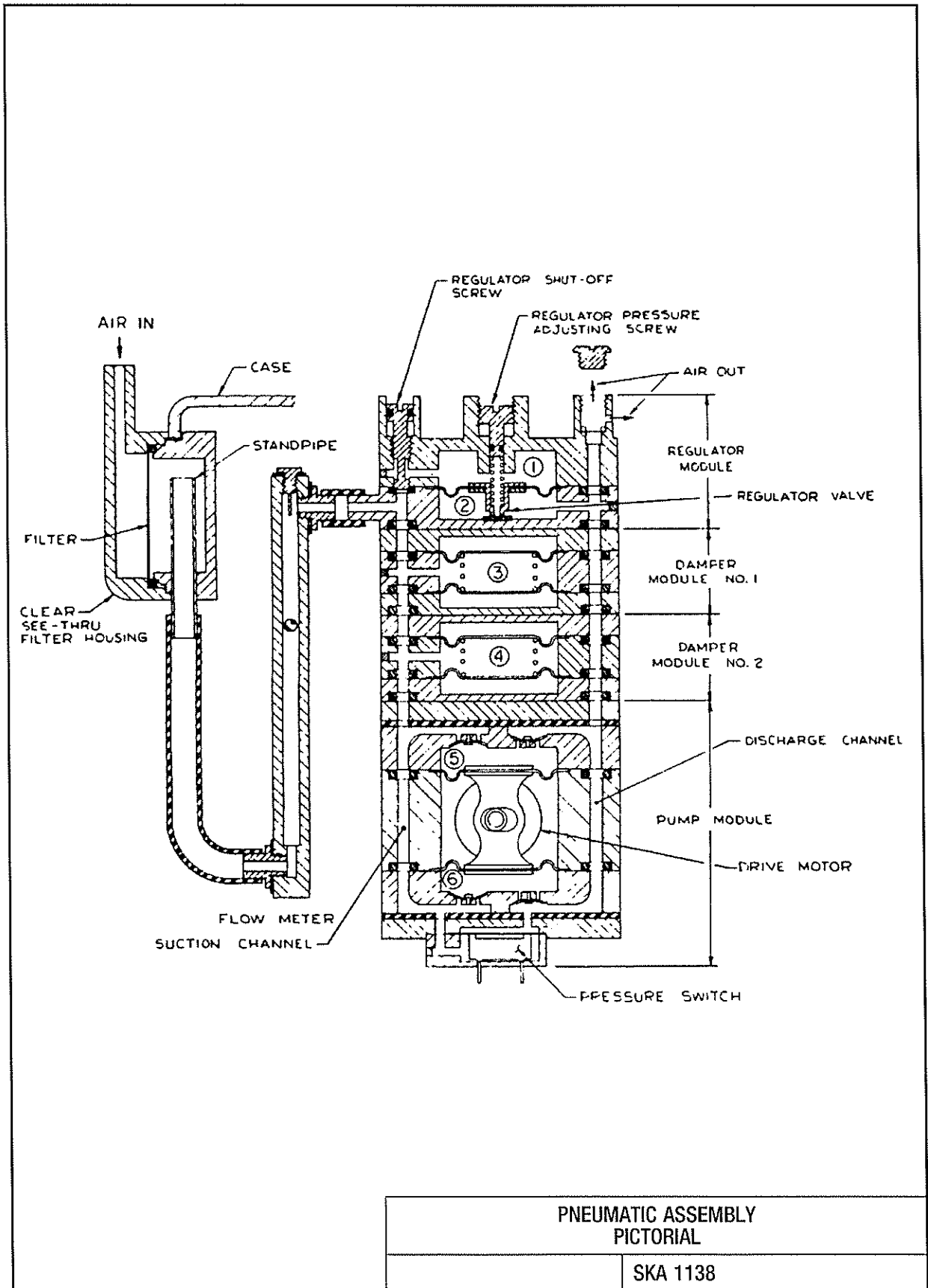

Figure 3  
 Pneumatic Assembly





PNEUMATIC ASSEMBLY PICTORIAL	
SKA 1138	

Figure 3A  
Pneumatic Assembly Pictorial

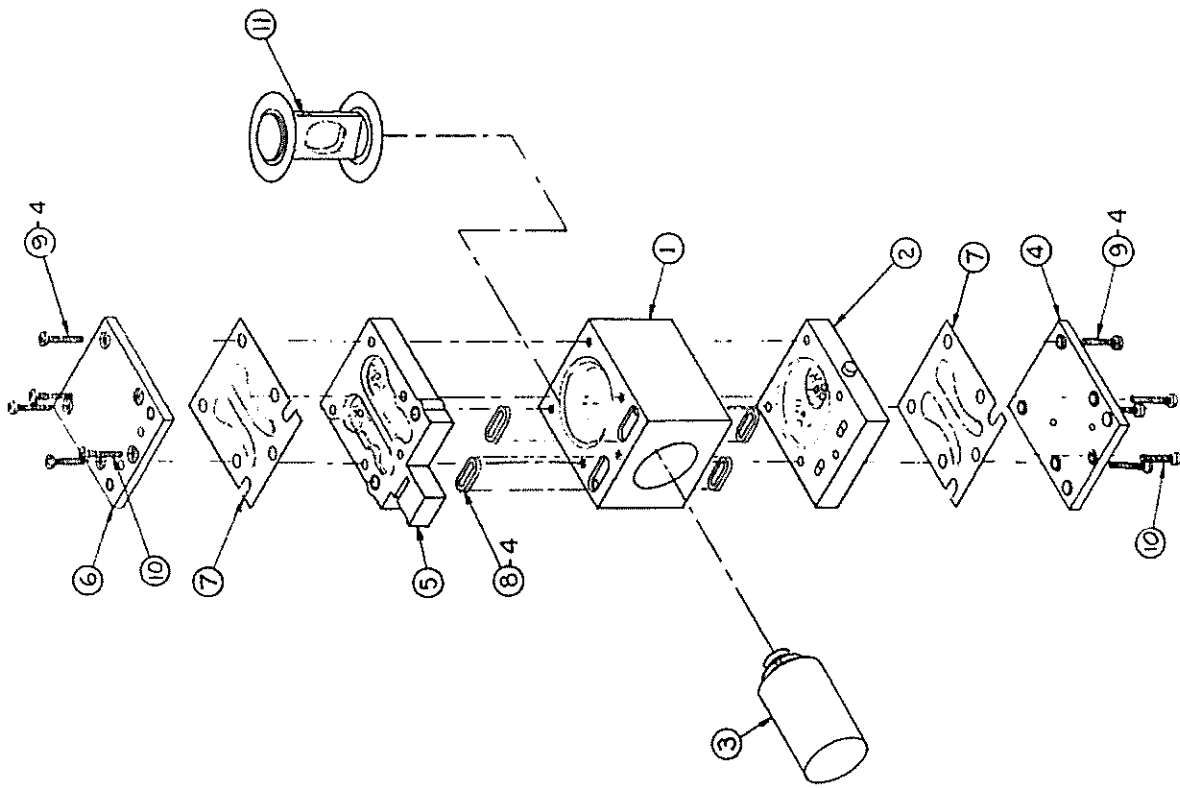

11	1	800305	Yoke Assembly
10	2	800362 800362 800362 800362	Screw, Pan Head, #4-40 x 9/16" LG
	8		Screw, Pan Head, #4-40 x 3/4" LG
	4		Quad Ring
	2		Gasket, Pump
6	1	200015	Plate, Top
5	1	800304	Valve Plate, Top Assembly
4	1	800014	Pressure Switch Assembly
3	1	800307	Drive Assembly
2	1	800303	Valve Plate, Bot. Assembly
1	1	800301	Body, Pump Assembly
Item No.	Qty Req	Part No.	Description
PUMP ASSEMBLY			
SKA 1617 REV B			

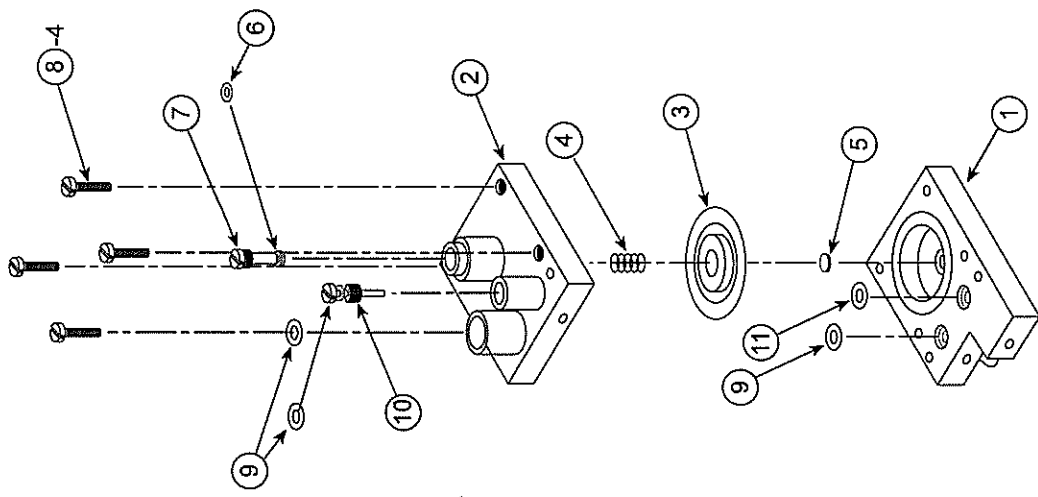

11	1	"O" Ring	
10	1	Screw, Shut-Off	
9	3	"O" Ring	
8	4	Screw, Pan Head #4-40 x 7/16" LG	
7	1	Screw, Adjusting	
6	1	"O" Ring	
5	1	Seat, Regulator	
4	1	Spring, Regulator	
3	1	Regulator Valve Assembly	
2	1	Regulator Top Assembly	
1	1	Regulator Bottom Assembly	
Item No.	Qty Req	Part No.	Description
<b>REGULATOR ASSEMBLY</b>			
		SKA 1162	REV A

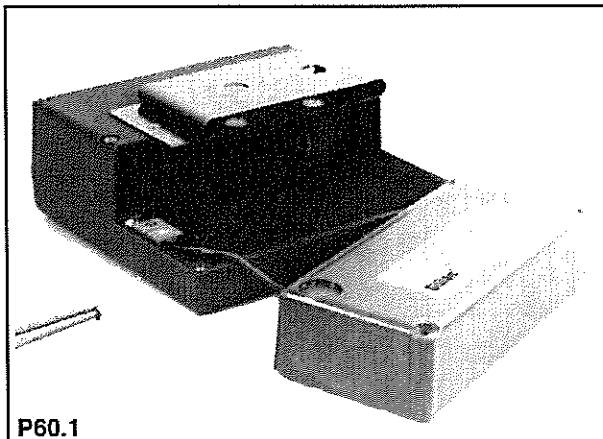

P60.1

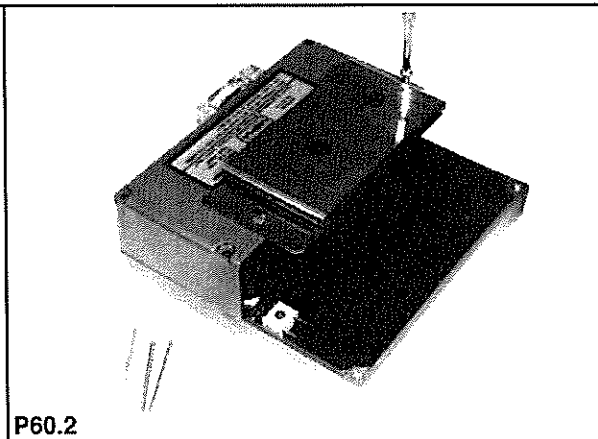

P60.2

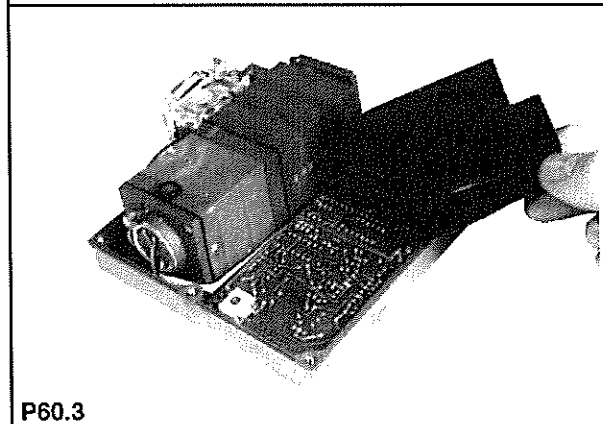

P60.3

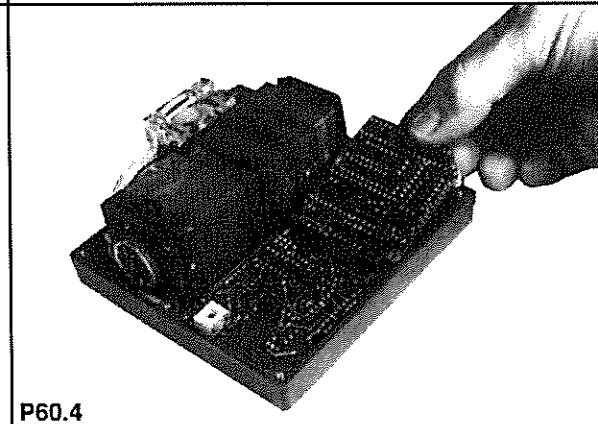

P60.4

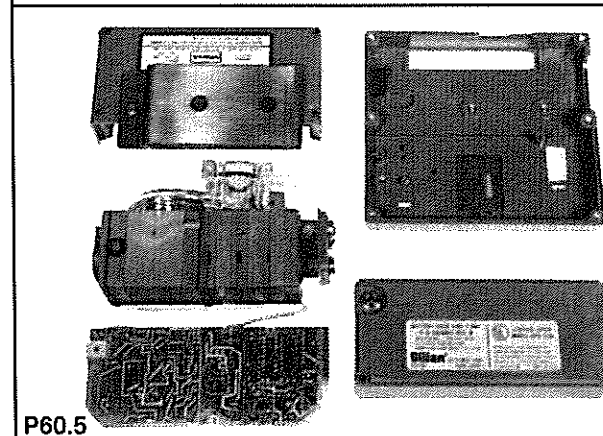

P60.5

**P60.0 GENERAL DISASSEMBLY**

**P60.1** Remove Battery Pack (See Removal of Battery pack Section P50.0). (Photos)

**P60.2** Remove (4) long screws from Case Rear. While holding the filter assembly, gently and slowly wiggle the cover upward.

**P60.3** Remove protective foam from the electronic system and remove the (4) hold down screws from the Timer/Control Board **NOTE:** The fourth screw is located in the electrical jack.

**P60.4** After hold down screws have been removed, lift gently and slide the Timer Board out of the Control Board.  
**NOTE:** Handle these components gently and place on a soft surface.

**P60.5** These are your basic HFS assemblies.

**NOTE:** If you have problems with the Pneumatic Assembly or have damaged it with water or in a corrosive atmosphere, send the unit to the Sensidyne Service Department. (Please refer to the Return Material Authorization on page 31).

**Pump Diagrams and Part Number**  
(see Figures for revision information)

**HFS-513 Air Sampler Parts List**

**Case Components (Refer to SKA 1615 Rev B, page 21)**

	Description	Part#	Qty	Remarks
—	Pneumatic Assy. (basic)	800309	1	
1	Pneumatic Assy. (U)	800199	1	
2	Battery Pack	800198	1	Inc. 2 screws
3	Case Assy. Front	800201	1	Inc. Nameplates
4	Case Assy. Rear	800202	1	Inc. Beltclip
5	Cover Plate Assy.	800034	1	
—	Anti-Tamper Cover Plate	800144	1	
7	Press to Test Button	200045	1	
8	Insert Case	200050	1	
16	Fitting Outlet	200042	1	
—	Screws, Sealing Kit	800109	1	Inc. Items 11, 12
—	Screws & O-ring Kit	800052	1	Inc. Items 13, 14, 15
—	Case Assy. (complete)	800051	1	Inc. Items 3, 4, 5, 7, 8, 11, 12, 13, 14, 15

**Electronic Components (Refer to SKA 1615 Rev B, page 21)**

6	Wiring Harness	200703		
17	Control Board	400146	1	Inc. Mount Screws
18	Timing Board (C)	400254	1	Inc. Mount Screws
19	Timing Board (T)	400255	1	Inc. Mount Screws
20	Timing Board (P)	200256	1	Inc. Mount Screws

**Pneumatic Assembly (Refer to SKA 1616 Rev B, page 22)**

—	Pneumatic Assy. (basic)	800309	1	
—	Pneumatic Assy. (U)	800199	1	
1	Pump Assembly	800302	1	
2	Damper Assembly	800008	1	Inc. Mount O-ring
3	Regulator Assembly	800009	1	Inc. Mount O-ring
4	Housing, Filter Rear	800045	1	
5	Housing, Filter Front	200023	1	
—	Pump Filter Assy. (comp)	800041	1	Inc. 4, 5, 6, 7, 8
—	Pump Filter Kit	800053	1	Inc. Items 6, 7, 8
11	Flowmeter	400410	1	
14	Regulator Dummy Assy.	800048	1	
—	Pneumatic Assy. Ovrhaul Kit	800054	1	Inc. 9, 10, 12, 13

**HFS-513 Air Sampler Parts List (Cont'd)****Pump Assembly (Refer to SKA 1617 Rev B, page 24)**

	<b>Description</b>	<b>Part#</b>	<b>Qty</b>	<b>Remarks</b>
—	Pump Assy. (complete)	800302	1	
1	Body Assy.	800301	1	
2	Valve Plate (bottom)	800303	1	Assembled/Tested
5	Valve Plate (top)	800304	1	Assembled/Tested
4	Pressure Switch Assy.	800014	1	Assembled/Tested
6	Plate, Top	200015	1	
3	Drive Assy.	800307	1	Bearing, Eccentric
11	Yoke Assy.	800305	1	Diaphragm, retainer
—	Pump Overhaul Kit	800308	1	Inc. Items 7, 8, 9, 10

**Damper Assembly**

	Damper Assy. (complete)	800008	1	Inc. mount O-rings
	Body, Damper	800047	1	
	Plate, Damper (top)	200019	1	
	Plate, Damper (bottom)	200018	1	
	Damper Overhaul Kit	800055	1	Inc. 4, 5, 6, 7, 8

**Regulator Assembly (Refer to SKA 1162 Rev B, page 25)**

—	Regulator Assy. (complete)	800009	1	Inc. mount O-rings
1	Regulator Assy. (bottom)	800050	1	Inc. Items 1, 5
2	Regulator Assy. (top)	800049	1	
3	Regulator Valve Assy.	800040	1	Diaphragm, Valve, Ret.
—	Damper Overhaul Kit	800056	1	4, 5, 6, 7, 8, 9, 10, 11
—	Regulator, Dummy	800048	1	Spacer for Non-Reg Models HFS-512A, -513AC, -513AT, -513AP

## HFS-513 Air Sampling System Specifications

Operation Range .....	High Flow: 750–5000 cc/min constant flow sampling. Low Flow: 1–750 cc/min achieved through use with variable flow controller. This unique feature allows very low flows as well as two or more simultaneous, independently set samples.
Pressure Range .....	750 cc/35" H <sub>2</sub> O 1000 cc/35" H <sub>2</sub> O 2000 cc/35" H <sub>2</sub> O 3000 cc/30" H <sub>2</sub> O 4000 cc/20" H <sub>2</sub> O 5000 cc/15" H <sub>2</sub> O
Flow Control .....	± 5% of set point
Flow Indicator .....	Built-in flowmeter, range 0–5 LPM with 500 cc/div. scale marked at 1, 2, 3, 4, & 5 LPM.
Flow Fault Indicator .....	LED fault indicator will light immediately if the unit is operated out of its performance envelope. The pump will run for another 15–30 seconds before shutting down, and the LED will remain illuminated.
Battery Test .....	When the Push-to-Test button is pressed, the Battery LED will illuminate, indicating that battery will provide a minimum of 8 hours of operation over the operating range.
Battery .....	Plug-in battery pack, rechargeable NiCad, 1.8 Ah, 6.0V, UL listed. Can be charge internally or externally with use of an adaptor.
Intrinsic Safety Ratings .....	UL listed for Classes 1, 2 & 3, Groups A, B, C, D, E, F and G, for explosive gas and dust atmospheres. SCS (SIRA Certification Service) listed Certificate No. Ex91C2018X, Coding: EEx iB IICT4.
Compact Size .....	1.87" x 4.62" x 5.12" (44.7 in <sup>3</sup> ) 4.76 cm x 11.74 cm x 13.02 mm [732 cm <sup>3</sup> ]

## HFS-513 Air Sampling System Specifications (continued)

Weight .....	2.25 lbs (1.02 kg) • HFS-513A, HFS-513AU, 2.31 lbs (1.05 kg) • HFS Timer Models
Temperature.....	Operating: -20 to 45 C° (-4 to 113 F°) Storage: -40 to 45 C° (-40 to 113 F°) Charging: +5 to 45 C° (41 to 113 F°)
Additional Features .....	See-through external filter housing, built-in moisture trap, anti-tamper cover, accessory mounting provisions.
Timer Modules .....	"C" module provides fault shut down function with elapsed-time clock display. "T" module provides fault shut down, clock display, and programmable stop time. "P" module provides fault shut down, clock display, and programmable start and stop times.
Low Flow Regulator Module ...	Provides low flow capability from 1 to 750 cc/min by using an active pressure regulator which is set to 20" W.C. across variable flow controllers as described above, this allows very low flows as well as multiple, simultaneous samples with independently adjusted samples.
Warranty .....	The HFS-513 constant flow sampler is guaranteed for one year against any defects in parts and/or workmanship.



**RETURNED MATERIAL AUTHORIZATION (RMA)**

Sensidyne maintains a factory facility to provide its customers with both warranty and non-warranty repair service. Our policy is to perform all needed repairs to restore the instrument to its full operating condition. *Sensidyne assumes no liability for service performed by personnel other than qualified Sensidyne personnel.* Please contact Sensidyne Service *in advance* if you have a problem which cannot be remedied and/or requires a Returned Material Authorization (RMA). (You need an RMA No. to return the product to the factory). You can reach Sensidyne Service at 727-530-3602 [voice], 727-539-0550 [FAX], or at address below.

There is a minimum fee for all non-warranty repairs (for handling and inspection costs, and for cost of providing an estimate). However, fee is waived, if repair is authorized. State "Not To Exceed \$(dollar amt)" on P.O. if you want to keep repair costs below a certain amount. If you need a price quote before authorizing a repair, state so on the purchase order (this costs more and could delay your repair). Repairs are handled on a "first come--first serve" basis. You can speed up your repair by authorizing an expediting fee. This places your order next in line behind orders currently in process. First time service orders require prepayment or COD shipment. Prices subject to change without notice.

Ship instrument and accessories in original packing (if possible). Enclose your return address, purchase order, shipping & billing information, RMA No., description of problem, and any special instructions. Send to:

**Sensidyne, Inc.**  
**ATTN: Service (RMA # \_\_\_\_\_)**  
**16333 Bay Vista Drive**  
**Clearwater, FL 33760**



Certificate No. 970084

***SENSIDYNE***<sup>®</sup>

Sensidyne, Inc.

16333 Bay Vista Drive • Clearwater, FL 33760

(800) 451-9444 • (727) 530-3602

FAX 727-539-0550

© 1997, Sensidyne, Inc.

Document No. F-PRO-2105, Rev C

# FIELD Environmental Instruments, Inc.

Equipment Rental and Field Supplies

99 Miller Avenue  
Braddock, Pa 15104  
1-800-393-4009  
Fax (412) 271-5083

*"Your Needs Are Our Business"*

## AIR SAMPLING PUMP CALIBRATION DATA

Date: \_\_\_\_/\_\_\_\_/\_\_\_\_

Calibration Unit: \_\_\_\_\_

Serial # \_\_\_\_\_

Cell # \_\_\_\_\_

Certified Calibration Date: \_\_\_\_/\_\_\_\_/\_\_\_\_

Next Calibration Due: \_\_\_\_/\_\_\_\_/\_\_\_\_

**Calibration:**

Instrument: \_\_\_\_\_

Serial #: \_\_\_\_\_

**Response:**

Flow Rate: \_\_\_\_\_ L/Min

**Calibration:**

Instrument: \_\_\_\_\_

Serial #: \_\_\_\_\_

**Response:**

Flow Rate: \_\_\_\_\_ L/Min

OTHER: \_\_\_\_\_  
\_\_\_\_\_  
\_\_\_\_\_  
\_\_\_\_\_  
\_\_\_\_\_  
\_\_\_\_\_

TECHNICIAN: \_\_\_\_\_

**ELEMENTS by ICP  
(Nitric/Perchloric Acid Ashing)**

**7300**

MW: Table 1

CAS: Table 2

RTECS: Table 2

**METHOD: 7300, Issue 3**

**EVALUATION: PARTIAL**

**Issue 1: 15 August 1990**

**Issue 3: 15 March 2003**

**OSHA: Table 2**

**NIOSH: Table 2**

**ACGIH: Table 2**

**PROPERTIES: Table 1**

<b>ELEMENTS:</b> aluminum*	calcium	lanthanum	nickel	strontium	tungsten*
antimony*	chromium*	lithium*	potassium	tellurium	vanadium*
arsenic	cobalt*	magnesium	phosphorus	tin	yttrium
barium	copper	manganese*	selenium	thallium	zinc
beryllium*	iron	molybdenum*	silver	titanium	zirconium*
cadmium	lead*				

\*Some compounds of these elements require special sample treatment.

SAMPLING		MEASUREMENT	
<b>SAMPLER:</b>	FILTER (0.8- $\mu$ m, cellulose ester membrane, or 5.0- $\mu$ m, polyvinyl chloride membrane)	<b>TECHNIQUE:</b>	INDUCTIVELY COUPLED ARGON PLASMA, ATOMIC EMISSION SPECTROSCOPY (ICP-AES)
<b>FLOWRATE:</b>	1 to 4 L/min	<b>ANALYTE:</b>	elements above
<b>VOL-MIN:</b>	Table 1	<b>ASHING</b>	
<b>-MAX:</b>	Table 1	<b>REAGENTS:</b>	conc. HNO <sub>3</sub> / conc. HClO <sub>4</sub> (4:1), 5 mL; 2mL increments added as needed
<b>SHIPMENT:</b>	routine	<b>CONDITIONS:</b>	room temperature, 30 min; 150 °C to near dryness
<b>SAMPLE STABILITY:</b>	stable	<b>FINAL SOLUTION:</b>	4% HNO <sub>3</sub> , 1% HClO <sub>4</sub> , 25 mL
<b>BLANKS:</b>	2 to 10 field blanks per set	<b>WAVELENGTH:</b>	depends upon element; Table 3
<b>ACCURACY</b>		<b>BACKGROUND CORRECTION:</b>	spectral wavelength shift
<b>RANGE STUDIED:</b>	not determined	<b>CALIBRATION:</b>	elements in 4% HNO <sub>3</sub> , 1% HClO <sub>4</sub>
<b>BIAS:</b>	not determined	<b>RANGE:</b>	varies with element [1]
<b>OVERALL PRECISION (<math>\hat{S}_{r,r}</math>):</b>	not determined	<b>ESTIMATED LOD:</b>	Tables 3 and 4
<b>ACCURACY:</b>	not determined	<b>PRECISION (<math>\hat{S}</math>):</b>	Tables 3 and 4

**APPLICABILITY:** The working range of this method is 0.005 to 2.0 mg/m<sup>3</sup> for each element in a 500-L air sample. This is simultaneous elemental analysis, not compound specific. Verify that the types of compounds in the samples are soluble with the ashing procedure selected.

**INTERFERENCES:** Spectral interferences are the primary interferences encountered in ICP-AES analysis. These are minimized by judicious wavelength selection, interelement correction factors and background correction [1-4].

**OTHER METHODS:** This issue updates issues 1 and 2 of Method 7300, which replaced P&CAM 351 [3] for trace elements. Flame atomic absorption spectroscopy (e.g., Methods 70XX) is an alternate analytical technique for many of these elements. Graphite furnace AAS (e.g., 7102 for Be, 7105 for Pb) is more sensitive.

**REAGENTS:**

1. Nitric acid (HNO<sub>3</sub>), conc., ultra pure.
2. Perchloric acid (HClO<sub>4</sub>), conc., ultra pure.\*
3. Ashing acid: 4:1 (v/v) HNO<sub>3</sub>:HClO<sub>4</sub>. Mix 4 volumes conc. HNO<sub>3</sub> with 1 volume conc. HClO<sub>4</sub>.
4. Calibration stock solutions, 1000 µg/mL. Commercially available, or prepared per instrument manufacturer's recommendation (see step 12).
5. Dilution acid, 4% HNO<sub>3</sub>, 1% HClO<sub>4</sub>. Add 50 mL ashing acid to 600 mL water; dilute to 1 L.
6. Argon.
7. Distilled, deionized water.

\* See SPECIAL PRECAUTIONS.

**EQUIPMENT:**

1. Sampler: cellulose ester membrane filter, 0.8-µm pore size; or polyvinyl chloride membrane, 5.0-µm pore size; 37-mm diameter, in cassette filter holder.
2. Personal sampling pump, 1 to 4 L/min, with flexible connecting tubing.
3. Inductively coupled plasma-atomic emission spectrometer, equipped as specified by the manufacturer for analysis of elements of interest.
4. Regulator, two-stage, for argon.
5. Beakers, Phillips, 125-mL, or Griffin, 50-mL, with watchglass covers.\*\*
6. Volumetric flasks, 10-, 25-, 100-mL, and 1-L\*\*
7. Assorted volumetric pipets as needed.\*\*
8. Hotplate, surface temperature 150 °C.

\*\* Clean all glassware with conc. nitric acid and rinse thoroughly in distilled water before use.

---

**SPECIAL PRECAUTIONS:** All perchloric acid digestions are required to be done in a perchloric acid hood. When working with concentrated acids, wear protective clothing and gloves.

---

**SAMPLING:**

1. Calibrate each personal sampling pump with a representative sampler in line.
2. Sample at an accurately known flow rate between 1 and 4 L/min for a total sample size of 200 to 2000 L (see Table 1) for TWA measurements. Do not exceed a filter loading of approximately 2 mg total dust.

**SAMPLE PREPARATION:**

3. Open the cassette filter holders and transfer the samples and blanks to clean beakers.
4. Add 5 mL ashing acid. Cover with a watchglass. Let stand 30 min at room temperature.  
NOTE: Start a reagent blank at this step.
5. Heat on hotplate (120 °C) until ca. 0.5 mL remains.  
NOTE 1: Recovery of lead from some paint matrices may require other digestion techniques. See Method 7082 (Lead by Flame AAS) for an alternative hotplate digestion procedure or Method 7302 for a microwave digestion procedure.  
NOTE 2: Some species of Al, Be, Co, Cr, Li, Mn, Mo, V, and Zr will not be completely solubilized by this procedure. Alternative solubilization techniques for most of these elements can be found elsewhere [5-10]. For example, aqua regia may be needed for Mn [6,12].
6. Add 2 mL ashing acid and repeat step 5. Repeat this step until the solution is clear.
7. Remove watchglass and rinse into the beaker with distilled water.
8. Increase the temperature to 150 °C and take the sample to near dryness (ca. 0.5 mL).
9. Dissolve the residue in 2 to 3 mL dilution acid.
10. Transfer the solutions quantitatively to 25-mL volumetric flasks.
11. Dilute to volume with dilution acid.  
NOTE: If more sensitivity is required, the final sample volume may be held to 10 mL.

**CALIBRATION AND QUALITY CONTROL:**

12. Calibrate the spectrometer according to the manufacturers recommendations.

NOTE: Typically, an acid blank and 1.0 µg/mL multielement working standards are used. The following multielement combinations are chemically compatible in 4% HNO<sub>3</sub>/1% HClO<sub>4</sub>:

- a. Al, As, Ba, Be, Ca, Cd, Co, Cr, Cu, Fe, La, In, Na
  - b. Ag, K, Li, Mg, Mn, Ni, P, Pb, Se, Sr, Tl, V, Y, Zn, Sc
  - c. Mo, Sb, Sn, Te, Ti, W, Zr
  - d. Acid blank
13. Analyze a standard for every ten samples.
14. Check recoveries with at least two spiked blank filters per ten samples.

**MEASUREMENT:**

15. Set spectrometer to conditions specified by manufacturer.
16. Analyze standards and samples.

NOTE: If the values for the samples are above the range of the standards, dilute the solutions with dilution acid, reanalyze and apply the appropriate dilution factor in the calculations.

**CALCULATIONS:**

17. Obtain the solution concentrations for the sample, C<sub>s</sub> (µg/mL), and the average media blank, C<sub>b</sub> (µg/mL), from the instrument.
18. Using the solution volumes of sample, V<sub>s</sub> (mL), and media blank, V<sub>b</sub> (mL), calculate the concentration, C (mg/m<sup>3</sup>), of each element in the air volume sampled, V (L):

$$C = \frac{C_s V_s - C_b V_b}{V}, \text{mg} / \text{m}^3$$

NOTE: µg/L = mg/m<sup>3</sup>

**EVALUATION OF METHOD:****Issues 1 and 2**

Method, 7300 was originally evaluated in 1981 [2,3]. The precision and recovery data were determined at 2.5 and 1000 µg of each element per sample on spiked filters. The measurements used for the method evaluation in Issues 1 and 2 were determined with a Jarrell-Ash Model 1160 Inductively Coupled Plasma Spectrometer operated according to manufacturer's instructions.

**Issue 3**

In this update of NIOSH Method 7300, the precision and recovery data were determined at approximately 3x and 10x the instrumental detection limits on commercially prepared spiked filters [12] using 25.0 mL as the final sample volume. Tables 3 and 4 list the precision and recovery data, instrumental detection limits, and analytical wavelengths for mixed cellulose ester (MCE) and polyvinyl chloride (PVC) filters. PVC Filters which can be used for total dust measurements and then digested for metals measurements were tested and found to give good results. The values in Tables 3 and 4 were determined with a Spectro Analytical Instruments Model End On Plasma (EOP)(axial) operated according to manufacturer's instructions.

**REFERENCES:**

- [1] Millson M, Andrews R [2002]. Backup data report, Method 7300, unpublished report, NIOSH/DART.
- [2] Hull RD [1981]. Multielement Analysis of Industrial Hygiene Samples, NIOSH Internal Report, presented at the American Industrial Hygiene Conference, Portland, Oregon.
- [3] NIOSH [1982]. NIOSH Manual of Analytical Methods, 2nd ed., V. 7, P&CAM 351 (Elements by ICP), U.S. Department of Health and Human Services, Publ. (NIOSH) 82-100.
- [4] NIOSH [1994]. Elements by ICP: Method 7300, Issue 2. In: Eller PM, Cassinelli ME, eds., NIOSH Manual of Analytical Methods, 4<sup>th</sup> ed. Cincinnati, OH: U.S. Department of Health and Human Services, Centers for Disease Control and Prevention, National Institute for Occupational Safety and Health, DHHS (NIOSH) Publication No. 94-113.
- [5] NIOSH [1994]. Lead by FAAS: Method 7082. In: Eller PM, Cassinelli ME, eds., NIOSH Manual of Analytical Methods, 4<sup>th</sup> ed. Cincinnati, OH: U.S. Department of Health and Human Services, Centers for Disease Control and Prevention, National Institute for Occupational Safety and Health, DHHS (NIOSH) Publication No. 94-113.
- [6] NIOSH [1977]. NIOSH Manual of Analytical Methods, 2nd ed., V. 2, S5 (Manganese), U.S. Department of Health, Education, and Welfare, Publ. (NIOSH) 77-157-B.
- [7] NIOSH [1994]. Tungsten, soluble/insoluble: Method 7074. In: Eller PM, Cassinelli ME, eds., NIOSH Manual of Analytical Methods, 4<sup>th</sup> ed. Cincinnati, OH: U.S. Department of Health and Human Services, Centers for Disease Control and Prevention, National Institute for Occupational Safety and Health, DHHS (NIOSH) Publication No. 94-113.
- [8] NIOSH [1979]. NIOSH Manual of Analytical Methods, 2nd ed., V. 5, P&CAM 173 (Metals by Atomic Absorption), U.S. Department of Health, Education, and Welfare, Publ. (NIOSH) 79-141.
- [9] NIOSH [1977]. NIOSH Manual of Analytical Methods, 2nd ed., V. 3, S183 (Tin), S185 (Zirconium), and S376 (Molybdenum), U.S. Department of Health, Education, and Welfare, Publ. (NIOSH) 77-157-C.
- [10] ISO [2001]. Workplace air - Determination of metals and metalloids in airborne particulate matter by inductively coupled plasma atomic emission spectrometry - Part 2: Sample preparation. International Organization for Standardization. ISO 15202-2:2001(E).
- [11] ASTM [1985]. 1985 Annual Book of ASTM Standards, Vol. 11.01; Standard Specification for Reagent Water; ASTM, Philadelphia, PA, D1193-77 (1985).
- [12] Certification Inorganic Ventures for spikes.

**METHOD REVISED BY:**

Mark Millson and Ronnee Andrews, NIOSH/DART.

Method originally written by Mark Millson, NIOSH/DART, and R. DeLon Hull, Ph.D., NIOSH/DSHEFS, James B. Perkins, David L. Wheeler, and Keith Nicholson, DataChem Laboratories, Salt Lake City, UT.

TABLE 1. PROPERTIES AND SAMPLING VOLUMES

Element (Symbol)	Properties		Air Volume, L @ OSHA PEL	
	Atomic Weight	MP, °C	MIN	MAX
Silver (Ag)	107.87	961	250	2000
Aluminum (Al)	26.98	660	5	100
Arsenic (As)	74.92	817	5	2000
Barium (Ba)	137.34	710	50	2000
Beryllium (Be)	9.01	1278	1250	2000
Calcium (Ca)	40.08	842	5	200
Cadmium (Cd)	112.40	321	13	2000
Cobalt (Co)	58.93	1495	25	2000
Chromium (Cr)	52.00	1890	5	1000
Copper (Cu)	63.54	1083	5	1000
Iron (Fe)	55.85	1535	5	100
Potassium (K)	39.10	63.65	5	1000
Lanthanum	138.91	920	5	1000
Lithium (Li)	6.94	179	100	2000
Magnesium (Mg)	24.31	651	5	67
Manganese (Mn)	54.94	1244	5	200
Molybdenum (Mo)	95.94	651	5	67
Nickel (Ni)	58.71	1453	5	1000
Phosphorus (P)	30.97	44	25	2000
Lead (Pb)	207.19	328	50	2000
Antimony (Sb)	121.75	630.5	50	2000
Selenium (Se)	78.96	217	13	2000
Tin (Sn)	118.69	231.9	5	1000
Strontium (Sr)	87.62	769	10	1000
Tellurium (Te)	127.60	450	25	2000
Titanium (Ti)	47.90	1675	5	100
Thallium (Tl)	204.37	304	25	2000
Vanadium (V)	50.94	1890	5	2000
Tungsten (W)	183.85	3410	5	1000
Yttrium (Y)	88.91	1495	5	1000
Zinc (Zn)	65.37	419	5	200
Zirconium (Zr)	91.22	1852	5	200



TABLE 2. EXPOSURE LIMITS, CAS #, RTECS

Element (Symbol)	CAS #	RTECS	Exposure Limits, mg/m <sup>3</sup> (Ca = carcinogen)		
			OSHA	NIOSH	ACGIH
Silver (Ag)	7440-22-4	VW3500000	0.01 (dust, fume, metal)	0.01 (metal, soluble)	0.1 (metal) 0.01 (soluble)
Aluminum (Al)	7429-90-5	BD0330000	15 (total dust) 5 (respirable)	10 (total dust) 5 (respirable fume) 2 (salts, alkyls)	10 (dust) 5 (powders, fume) 2 (salts, alkyls)
Arsenic (As)	7440-38-2	CG0525000	varies	C 0.002, Ca	0.01, Ca
Barium (Ba)	7440-39-3	CQ8370000	0.5	0.5	0.5
Beryllium (Be)	7440-41-7	DS1750000	0.002, C 0.005	0.0005, Ca	0.002, Ca
Calcium (Ca)	7440-70-2	--	varies	varies	varies
Cadmium (Cd)	7440-43-9	EU9800000	0.005	lowest feasible, Ca	0.01 (total), Ca 0.002 (respir.), Ca
Cobalt (Co)	7440-48-4	GF8750000	0.1	0.05 (dust, fume)	0.02 (dust, fume)
Chromium (Cr)	7440-47-3	GB4200000	0.5	0.5	0.5
Copper (Cu)	7440-50-8	GL5325000	1 (dust, mists) 0.1 (fume)	1 (dust) 0.1 (fume)	1 (dust, mists) 0.2 (fume)
Iron (Fe)	7439-89-6	NO4565500	10 (dust, fume)	5 (dust, fume)	5 (fume)
Potassium (K)	7440-09-7	TS6460000	--	--	--
Lanthanum	7439-91-0	--	--	--	--
Lithium (Li)	7439-93-2	--	--	--	--
Magnesium (Mg)	7439-95-4	OM2100000	15 (dust) as oxide 5 (respirable)	10 (fume) as oxide	10 (fume) as oxide
Manganese (Mn)	7439-96-5	OO9275000	C 5	1; STEL 3	5 (dust) 1; STEL 3 (fume)
Molybdenum (Mo)	7439-98-7	QA4680000	5 (soluble) 15 (total insoluble)	5 (soluble) 10 (insoluble)	5 (soluble) 10 (insoluble)
Nickel (Ni)	7440-02-0	QR5950000	1	0.015, Ca	0.1 (soluble) 1 (insoluble, metal)
Phosphorus (P)	7723-14-0	TH3500000	0.1	0.1	0.1
Lead (Pb)	7439-92-1	OF7525000	0.05	0.05	0.05
Antimony (Sb)	7440-36-0	CC4025000	0.5	0.5	0.5
Selenium (Se)	7782-49-2	VS7700000	0.2	0.2	0.2
Tin (Sn)	7440-31-5	XP7320000	2	2	2
Strontium (Sr)	7440-24-6				--
Tellurium (Te)	13494-80-9	WY2625000	0.1	0.1	0.1
Titanium (Ti)	7440-32-6	XR1700000	--	--	--
Thallium (Tl)	7440-28-0	XG3425000	0.1 (skin) (soluble)	0.1 (skin) (soluble)	0.1 (skin)
Vanadium (V)	7440-62-2	YW2400000	--	C 0.05	--
Tungsten	7440-33-7		5	5 10 (STEL)	5 10 (STEL)
Yttrium (Y)	7440-65-5	ZG2980000	1	N/A	1
Zinc (Zn)	7440-66-6	ZG8600000		--	--
Zirconium (Zr)	7440-67-7	ZH7070000	5	5, STEL 10	5, STEL 10

**TABLE 3. MEASUREMENT PROCEDURES AND DATA [1].**  
**Mixed Cellulose Ester Filters (0.45 µm)**

Element (a)	wavelength nm	Est. LOD µg/ Filter	LOD ng/mL	Certified 3x LOD (b)	% Recovery (c)	Percent RSD (N=25)	Certified 10x LOD (b)	% Recovery (c)	Percent RSD (N=25)
Ag	328	0.042	1.7	0.77	102.9	2.64	3.21	98.3	1.53
Al	167	0.115	4.6	1.54	105.4	11.5	6.40	101.5	1.98
As	189	0.140	5.6	3.08	94.9	2.28	12.9	93.9	1.30
Ba	455	0.005	0.2	0.31	101.8	1.72	1.29	97.7	0.69
Be	313	0.005	0.2	0.31	100.0	1.44	1.29	98.4	0.75
Ca	317	0.908	36.3	15.4	98.7	6.65	64.0	100.2	1.30
Cd	226	0.0075	0.3	0.31	99.8	1.99	1.29	97.5	0.88
Co	228	0.012	0.5	0.31	100.8	1.97	1.29	98.4	0.90
Cr	267	0.020	0.8	0.31	93.4	16.3	1.29	101.2	2.79
Cu	324	0.068	2.7	1.54	102.8	1.47	6.40	100.6	0.92
Fe	259	0.095	3.8	1.54	103.3	5.46	6.40	98.0	0.95
K	766	1.73	69.3	23.0	90.8	1.51	96.4	97.6	0.80
La	408	0.048	1.9	0.77	102.8	2.23	3.21	100.1	0.92
Li	670	0.010	0.4	0.31	110.0	1.91	1.29	97.7	0.81
Mg	279	0.098	3.9	1.54	101.1	8.35	6.40	98.0	1.53
Mn	257	0.005	0.2	0.31	101.0	1.77	1.29	94.7	0.73
Mo	202	0.020	0.8	0.31	105.3	2.47	1.29	98.6	1.09
Ni	231	0.020	0.8	0.31	109.6	3.54	1.29	101.2	1.38
P	178	0.092	3.7	1.54	84.4	6.19	6.40	82.5	4.75
Pb	168	0.062	2.5	1.54	109.4	2.41	6.40	101.7	0.88
<b>Sb</b>	206	0.192	7.7	3.08	90.2	11.4	12.9	<b>41.3</b>	32.58
Se	196	0.135	5.4	2.3	87.6	11.6	9.64	84.9	4.78
<b>Sn</b>	189	0.040	1.6	0.77	90.2	18.0	3.21	<b>49</b>	21.79
Sr	407	0.005	0.2	0.31	101.0	1.55	1.29	97.3	0.65
Te	214	0.078	3.1	1.54	102.0	2.67	6.40	97.4	1.24
Ti	334	0.050	2.0	0.77	98.4	2.04	3.21	93.4	1.08
Tl	190	0.092	3.7	1.54	100.9	2.48	6.40	99.1	0.80
V	292	0.028	1.1	0.77	103.2	1.92	3.21	98.3	0.84
<b>W</b>	207	0.075	3.0	1.54	<b>72.2</b>	10.1	6.40	<b>57.6</b>	14.72
Y	371	0.012	0.5	0.31	100.5	1.80	1.29	97.4	0.75
Zn	213	0.310	12.4	4.60	102.2	1.87	19.3	95.3	0.90
Zr	339	0.022	0.9	0.31	88.0	19.4	1.29	<b>25</b>	57.87

(a) Bold values are qualitative only because of low recovery.

(b) Values are certified by Inorganic Ventures INC. at 3x and 10x the approximate instrumental LOD

(c) Values reported were obtained with a Spectro Analytical Instruments EOP ICP; performance may vary with instrument and should be independently verified.

**TABLE 4. MEASUREMENT PROCEDURES AND DATA [1].**  
**Polyvinyl Chloride Filter (5.0 µm)**

Element (c)	wavelength nm	Est. LOD µg per filter	LOD ng/mL	Certified 3x LOD (b)	% Recovery (a)	Percent RSD (N=25)	Certified <sup>17</sup> 10x LOD (b)	% Recovery (a)	Percent RSD (N=25)
Ag	328	0.042	1.7	0.78	104.2	8.20	3.18	81.8	18.9
Al	167	0.115	4.6	1.56	77.4	115.24	6.40	92.9	20.9
As	189	0.140	5.6	3.10	100.7	5.13	12.70	96.9	3.2
Ba	455	0.005	0.2	0.31	102.4	3.89	1.270	99.8	2.0
Be	313	0.005	0.2	0.31	106.8	3.53	1.270	102.8	2.1
<b>Ca</b>	317	0.908	36.3	15.6	<b>68.1</b>	12.66	64.00	96.8	5.3
Cd	226	0.0075	0.3	0.31	105.2	5.57	1.27	101.9	2.8
Co	228	0.012	0.5	0.31	109.3	4.67	1.27	102.8	2.8
Cr	267	0.020	0.8	0.31	109.4	5.31	1.27	103.4	4.1
Cu	324	0.068	2.7	1.56	104.9	5.18	6.40	101.8	2.4
Fe	259	0.095	3.8	1.56	88.7	46.82	6.40	99.1	9.7
K	766	1.73	69.3	23.4	96.4	4.70	95.00	99.2	2.2
<b>La</b>	408	0.048	1.9	0.78	<b>45.5</b>	4.19	3.18	98.8	2.6
Li	670	0.010	0.4	0.31	107.7	4.80	1.27	110.4	2.7
<b>Mg</b>	279	0.098	3.9	1.56	<b>54.8</b>	20.59	6.40	<b>64.5</b>	5.7
Mn	257	0.005	0.2	0.31	101.9	4.18	1.27	99.3	2.4
Mo	202	0.020	0.8	0.31	106.6	5.82	1.27	98.1	3.8
Ni	231	0.020	0.8	0.31	111.0	5.89	1.27	103.6	3.2
P	178	0.092	3.7	1.56	101.9	17.82	6.40	86.5	10.4
Pb	168	0.062	2.5	1.56	109.6	6.12	6.40	103.2	2.9
<b>Sb</b>	206	0.192	7.7	3.10	<b>64.6</b>	22.54	12.70	<b>38.1</b>	30.5
Se	196	0.135	5.4	2.30	83.1	26.23	9.50	76.0	17.2
<b>Sn</b>	189	0.040	1.6	0.78	85.7	27.29	3.18	<b>52.0</b>	29.4
<b>Sr</b>	407	0.005	0.2	0.31	<b>71.8</b>	4.09	1.27	81.2	2.7
Te	214	0.078	3.1	1.56	109.6	7.49	6.40	97.3	3.8
Ti	334	0.050	2.0	0.78	101.0	9.46	3.18	92.4	5.5
Tl	190	0.092	3.7	1.56	110.3	4.04	6.40	101.9	2.0
V	292	0.028	1.1	0.78	108.3	3.94	3.18	102.5	2.6
<b>W</b>	207	0.075	3.0	1.56	<b>74.9</b>	15.79	6.40	<b>44.7</b>	19.6
Y	371	0.012	0.5	0.31	101.5	3.63	1.27	101.4	2.5
Zn	213	0.310	12.4	4.70	91.0	68.69	19.1	101.0	9.6
<b>Zr</b>	339	0.022	0.9	0.31	<b>70.7</b>	54.20	1.27	<b>40.4</b>	42.1

- (a) Values reported were obtained with a Spectro Analytical Instruments EOP ICP; performance may vary with instrument and should be independently verified.
- (b) Values are certified by Inorganic Ventures INC. at 3x and 10x the approximate instrumental LOD [12].
- (c) Bold values are qualitative only because of low recovery. Other digestion techniques may be more appropriate for these elements and their compounds.

Test Code: A\_7300\_IH

Test Number: N7300

Test Name: Metals in Air

Matrix: Air Units: µg, Total

**METHOD DETECTION /  
REPORTING LIMITS**

Updated: 17-Dec-03

Type	Analyte	MDL	PQL
A	Aluminum	2.5	2.5
A	Antimony	2.5	2.5
A	Arsenic	2.5	2.5
A	Barium	0.5	0.5
A	Barium Carbonate, as BaCO3 (N7056 prep)	0.72	0.72
A	Beryllium	0.05	0.05
A	Boron	2.5	2.5
A	Cadmium	0.05	0.05
A	Calcium	20	20
A	Chromium	2.5	2.5
A	Cobalt	0.5	0.5
A	Copper	0.5	0.5
A	Iron	2.5	2.5
A	Lead	0.5	0.5
A	Lithium	2.5	2.5
A	Magnesium	20	20
A	Manganese	0.5	0.5
A	Molybdenum	0.5	0.5
A	Nickel	0.5	0.5
A	Potassium	20	20
A	Selenium	5	5
A	Silver	0.5	0.5
A	Sodium	50	50
A	Soluble Barium, (N7056 prep)	0.5	0.5
A	Strontium	0.5	0.5
A	Thallium	2.5	2.5
A	Tin	5	5
A	Titanium	2.5	2.5
A	Titanium Dioxide, as TiO2	4.2	4.2
A	Tungsten	2.5	2.5
A	Vanadium	0.5	0.5
A	Zinc	2.5	2.5
X	Barium I	0	0
X	Bismuth	0	0
X	Gallium (See Qualifier T 2)	2.5	2.5
X	Gold	0	0
X	Hardness, Calcium (As CaCO3)	0	0
X	Hardness, Calcium/Magnesium (As CaCO3)	0	0
X	Phosphorus	0	0
X	Phosphorus, Total (As P)	0	0
X	Scandium	0	0
X	Silicon	0	0

Test Code: A\_7300\_IH

Test Number: N7300

Test Name: Metals in Air

Matrix: Air Units:  $\mu\text{g}$ , Total

**METHOD DETECTION /  
REPORTING LIMITS**

Updated: 01-May-03

Type	Analyte	MDL	PQL
X	Tellurium	0	0
X	Yttrium	0	0
X	Zirconium	0	0

### **III Air Sampling Instructions**

#### 37-mm, 0.8- $\mu$ m MCE Filter Cassette for Toxaphene, Metals, and Welding Fumes

1. Remove both plastic caps of the cassette immediately before sampling.
2. Attach the cassette to a personal sampling pump with the flexible tubing and cassette holder provided. Make sure the cassette is facing the correct way, which is for the air to be pulled in through the inlet and out the outlet of the cassette.
3. Sample the air for the appropriate amount of time, which depends on the chemical(s) of interest and the method(s) being referenced. If a pump that has been provided by Aerotech is being used, then the pump has been pre-calibrated based on the specifications provided by the client at the time of the pump request.
4. Once sampling is complete, the cassette sample must have the plastic caps placed on each end of the cassette. Make sure the sample is appropriately labeled.
5. Samples should be shipped or delivered to the laboratory, and should be accompanied by a completed chain of custody.
6. The client should submit at least one field blank with each set of samples.



Route South Main Street  
 Section 08-00106-00-FP  
 County McHenry

Marked Rte. FAU 0124  
 Project No. M-9003(685)  
 Contract No. 63843

This plan has been prepared to comply with the provisions of the National Pollutant Discharge Elimination System (NPDES) Permit No. ILR10 (Permit ILR10), issued by the Illinois Environmental Protection Agency (IEPA) for storm water discharges from construction site activities.

I certify under penalty of law that this document and all attachments were prepared under my direction or supervision in accordance with a system designed to assure that qualified personnel properly gathered and evaluated the information submitted. Based on my inquiry of the person or persons who manage the system, or those persons directly responsible for gathering the information, the information submitted is, to the best of my knowledge and belief, true, accurate and complete. I am aware that there are significant penalties for submitting false information, including the possibility of fine and imprisonment for knowing violations.

Erik Morimoto, P.E.  
 Print Name  
City Engineer  
 Title  
City of Crystal Lake  
 Agency

Erik D. Morimoto  
 Signature  
10-1-2013  
 Date

**I. Site Description:**

A. Provide a description of the project location (include latitude and longitude):

South Main Street (FAU 0124) is a north-south arterial. The project is located in the City of Crystal Lake. The project limits are along Pyott Road/South Main Street from 1,000 feet north of Rakow Road on the south to just south of Liberty Road on the north, a distance of 0.67 miles.

B. Provide a description of the construction activity which is the subject of this plan:

The proposed improvements will include HMA base course widening, HMA milling and resurfacing, earth excavation, drainage, signals, landscaping, signing, and striping.

C. Provide the estimated duration of this project:

8.5 months

D. The total area of the construction site is estimated to be 9.7 acres.

The total area of the site estimated to be disturbed by excavation, grading or other activities is 5.4 acres.

E. The following is a weighted average of the runoff coefficient for this project after construction activities are completed:

C=0.54

F. List all soils found within project boundaries. Include map unit name, slope information, and erosivity:

The most predominant soil types in the region according to the USDA Soil Survey are Warsaw Loam and Vama Silt Loam. The erosion potential of these soils is low.

G. Provide an aerial extent of wetland acreage at the site:

0.0 acres

H. Provide a description of potentially erosive areas associated with this project:

Stripping the existing topsoil for re-grading is potentially erosive.

I. The following is a description of soil disturbing activities by stages, their locations, and their erosive factors (e.g. steepness of slopes, length of slopes, etc):

Slope regrading and topsoil stripping.

J. See the erosion control plans and/or drainage plans for this contract for information regarding drainage patterns, approximate slopes anticipated before and after major grading activities, locations where vehicles enter or exit the site and controls to prevent offsite sediment tracking (to be added after contractor identifies locations), areas of soil disturbance, the location of major structural and non-structural controls identified in the plan, the location of areas where stabilization practices are expected to occur, surface waters (including wetlands) and locations where storm water is discharged to surface water including wetlands.

K. Identify who owns the drainage system (municipality or agency) this project will drain into:

City of Crystal Lake

L. The following is a list of receiving water(s) and the ultimate receiving water(s) for this site. The location of the receiving waters can be found on the erosion and sediment control plans:

The project flows into Vulcan Lakes.

M. Describe areas of the site that are to be protected or remain undisturbed. These areas may include steep slopes, highly erodible soils, streams, stream buffers, specimen trees, natural vegetation, nature preserves, etc.

The entire construction limits on both east and west side of roadway will be enclosed in perimeter erosion barrier to protect the areas outside these limits.

N. The following sensitive environmental resources are associated with this project, and may have the potential to be impacted by the proposed development:

- Floodplain
- Wetland Riparian
- Threatened and Endangered Species
- Historic Preservation
- 303(d) Listed receiving waters for suspended solids, turbidity, or siltation
- Receiving waters with Total Maximum Daily Load (TMDL) for sediment, total suspended solids, turbidity or siltation
- Applicable Federal, Tribal, State or Local Programs
- Other

1. 303(d) Listed receiving waters (fill out this section if checked above):

a. The name(s) of the listed water body, and identification of all pollutants causing impairment:

b. Provide a description of how erosion and sediment control practices will prevent a discharge of sediment resulting from a storm event equal to or greater than a twenty-five (25) year, twenty-four (24) hour rainfall event:

c. Provide a description of the location(s) of direct discharge from the project site to the 303(d) water body:

d. Provide a description of the location(s) of any dewatering discharges to the MS4 and/or water body:

2. TMDL (fill out this section if checked above)

a. The name(s) of the listed water body:



- b. Provide a description of the erosion and sediment control strategy that will be incorporated into the site design that is consistent with the assumptions and requirements of the TMDL:
- c. If a specific numeric waste load allocation has been established that would apply to the project's discharges, provide a description of the necessary steps to meet that allocation:

O. The following pollutants of concern will be associated with this construction project:

- |   |  |
|---|--|
| <input checked="" type="checkbox"/> Soil Sediment             | <input checked="" type="checkbox"/> Petroleum (gas, diesel, oil, kerosene, hydraulic oil / fluids) |
| <input checked="" type="checkbox"/> Concrete                  | <input checked="" type="checkbox"/> Antifreeze / Coolants  |
| <input checked="" type="checkbox"/> Concrete Truck Waste      | <input checked="" type="checkbox"/> Waste water from cleaning construction equipment               |
| <input checked="" type="checkbox"/> Concrete Curing Compounds | <input type="checkbox"/> Other (specify)   |
| <input type="checkbox"/> Solid Waste Debris                   | <input type="checkbox"/> Other (specify)   |
| <input type="checkbox"/> Paints                               | <input type="checkbox"/> Other (specify)   |
| <input type="checkbox"/> Solvents                             | <input type="checkbox"/> Other (specify)   |
| <input checked="" type="checkbox"/> Fertilizers / Pesticides  | <input type="checkbox"/> Other (specify)   |

**II. Controls:**

This section of the plan addresses the controls that will be implemented for each of the major construction activities described in I.C. above and for all use areas, borrow sites, and waste sites. For each measure discussed, the Contractor will be responsible for its implementation as indicated. The Contractor shall provide to the Resident Engineer a plan for the implementation of the measures indicated. The Contractor, and subcontractors, will notify the Resident Engineer of any proposed changes, maintenance, or modifications to keep construction activities compliant with the Permit ILR10. Each such Contractor has signed the required certification on forms which are attached to, and are a part of, this plan:

**A. Erosion and Sediment Controls**

1. **Stabilized Practices:** Provided below is a description of interim and permanent stabilization practices, including site specific scheduling of the implementation of the practices. Site plans will ensure that existing vegetation is preserved where attainable and disturbed portions of the site will be stabilized. Stabilization practices may include but are not limited to: temporary seeding, permanent seeding, mulching, geotextiles, sodding, vegetative buffer strips, protection of trees, preservation of mature vegetation, and other appropriate measures. Except as provided below in II(A)(1)(a) and II(A)(3), stabilization measures shall be initiated as soon as practicable in portions of the site where construction activities have temporarily or permanently ceased, but in no case more than seven (7) days after the construction activity in that portion of the site has temporarily or permanently ceases on all disturbed portions of the site where construction will not occur for a period of fourteen (14) or more calendar days.

Where the initiation of stabilization measures by the seventh day after construction activity temporarily or permanently ceases is precluded by snow cover, stabilization measures shall be initiated as soon as practicable thereafter.

The following stabilization practices will be used for this project:

- |   |  |
|---|--|
| <input checked="" type="checkbox"/> Preservation of Mature Vegetation | <input checked="" type="checkbox"/> Erosion Control Blanket / Mulching |
| <input type="checkbox"/> Vegetated Buffer Strips                      | <input checked="" type="checkbox"/> Sodding                            |
| <input checked="" type="checkbox"/> Protection of Trees               | <input type="checkbox"/> Geotextiles                                   |
| <input checked="" type="checkbox"/> Temporary Erosion Control Seeding | <input type="checkbox"/> Other (specify)                               |
| <input type="checkbox"/> Temporary Turf (Seeding, Class 7)            | <input type="checkbox"/> Other (specify)                               |
| <input type="checkbox"/> Temporary Mulching                           | <input type="checkbox"/> Other (specify)                               |
| <input type="checkbox"/> Permanent Seeding                            | <input type="checkbox"/> Other (specify)                               |

Describe how the stabilization practices listed above will be utilized during construction:

1. Preservation of Mature Vegetation - Areas of existing vegetation on and adjacent to the right-of-way shall be protected from disturbance and accidental intrusions of construction equipment and personnel.
2. Protection of Trees - Trees with a diameter of more than 6 inches will be protected with boards branded continuously around the trunk or with temporary fencing in the case of multistem trees.

3. Temporary Erosion Control Seeding - Utilized on all temporary seeding areas. Applied to all bare areas every seven days to minimize the amount of exposed surface area.
4. Erosion Control Blanket - Used in conjunction with temporary erosion control seeding.
5. Sodding - All disturbed soils within the construction zone will be permanently stabilized with sodding as soon as the area is at final grade.

Describe how the stabilization practices listed above will be utilized after construction activities have been completed:

Topsoil and sodding will be the permanent restoration.

2. **Structural Practices:** Provided below is a description of structural practices that will be implemented, to the degree attainable, to divert flows from exposed soils, store flows or otherwise limit runoff and the discharge of pollutants from exposed areas of the site. Such practices may include but are not limited to: perimeter erosion barrier, earth dikes, drainage swales, sediment traps, ditch checks, subsurface drains, pipe slope drains, level spreaders, storm drain inlet protection, rock outlet protection, reinforced soil retaining systems, gabions, and temporary or permanent sediment basins. The installation of these devices may be subject to Section 404 of the Clean Water Act.

The following structural practices will be used for this project:

- |  |   |
|--|---|
| <input checked="" type="checkbox"/> Perimeter Erosion Barrier    | <input type="checkbox"/> Rock Outlet Protection                         |
| <input type="checkbox"/> Temporary Ditch Check                   | <input type="checkbox"/> Riprap   |
| <input checked="" type="checkbox"/> Storm Drain Inlet Protection | <input type="checkbox"/> Gabions  |
| <input type="checkbox"/> Sediment Trap                           | <input type="checkbox"/> Slope Mattress                                 |
| <input type="checkbox"/> Temporary Pipe Slope Drain              | <input type="checkbox"/> Retaining Walls                                |
| <input type="checkbox"/> Temporary Sediment Basin                | <input type="checkbox"/> Slope Walls                                    |
| <input type="checkbox"/> Temporary Stream Crossing               | <input type="checkbox"/> Concrete Revetment Mats                        |
| <input type="checkbox"/> Stabilized Construction Exits           | <input type="checkbox"/> Level Spreaders                                |
| <input type="checkbox"/> Turf Reinforcement Mats                 | <input checked="" type="checkbox"/> Other (specify) Treatment Structure |
| <input type="checkbox"/> Permanent Check Dams                    | <input type="checkbox"/> Other (specify)                                |
| <input type="checkbox"/> Permanent Sediment Basin                | <input type="checkbox"/> Other (specify)                                |
| <input type="checkbox"/> Aggregate Ditch                         | <input type="checkbox"/> Other (specify)                                |
| <input type="checkbox"/> Paved Ditch                             | <input type="checkbox"/> Other (specify)                                |

Describe how the structural practices listed above will be utilized during construction:

1. Perimeter Erosion Barrier - A silt filter fence will be placed on the perimeter of the construction area to intercept waterborne silt and prevent it from leaving the site.
2. Storm Drain Inlet Protection - Inlet Sediment Filters will be placed in all open grate drainage structures during construction and will be cleaned on a regular basis.
3. Treatment Structure - One treatment structure will be used to treat stormwater runoff that has been collected in storm sewers.

Describe how the structural practices listed above will be utilized after construction activities have been completed:

The perimeter erosion barrier will be removed upon completion of construction. The inlet sediment filters and treatment structure will remain upon completion of construction.

3. **Storm Water Management:** Provided below is a description of measures that will be installed during the construction process to control pollutants in storm water discharges that will occur after construction operations have been completed. The installation of these devices may be subject to Section 404 of the Clean Water Act.
- a. Such practices may include but are not limited to: storm water detention structures (including wet ponds), storm water retention structures, flow attenuation by use of open vegetated swales and natural depressions, infiltration of runoff on site, and sequential systems (which combine several practices).

The practices selected for implementation were determined on the basis of the technical guidance in Chapter 41 (Construction Site Storm Water Pollution Control) of the IDOT Bureau of Design and Environment Manual. If practices other than those discussed in Chapter 41 are selected for implementation or if practices are applied to situations different from those covered in Chapter 41, the

technical basis for such decisions will be explained below.

- b. Velocity dissipation devices will be placed at discharge locations and along the length of any outfall channel as necessary to provide a non-erosive velocity flow from the structure to a water course so that the natural physical and biological characteristics and functions are maintained and protected (e.g. maintenance of hydrologic conditions such as the hydroperiod and hydrodynamics present prior to the initiation of construction activities).

Description of storm water management controls:

A treatment structure will be used to treat stormwater before exiting the proposed storm sewer system.

4. **Approved State or Local Laws:** The management practices, controls and provisions contained in this plan will be in accordance with IDOT specifications, which are at least as protective as the requirements contained in the Illinois Environmental Protection Agency's Illinois Urban Manual. Procedures and requirements specified in applicable sediment and erosion site plans or storm water management plans approved by local officials shall be described or incorporated by reference in the space provided below. Requirements specified in sediment and erosion site plans, site permits, storm water management site plans or site permits approved by local officials that are applicable to protecting surface water resources are, upon submittal of an NOI, to be authorized to discharge under the Permit ILR10 incorporated by reference and are enforceable under this permit even if they are not specifically included in the plan.

Description of procedures and requirements specified in applicable sediment and erosion site plans or storm water management plans approved by local officials:

Temporary Erosion Control Notes on Erosion Control Notes Plan Sheet. All management practices, controls, and other provisions provided in this plan are in accordance with the IDOT Standard Specifications for Road and Bridge Construction adopted January 1, 2012, and the Illinois Urban Manual revised 2012.

5. **Contractor Required Submittals:** Prior to conducting any professional services at the site covered by this plan, the Contractor and each subcontractor responsible for compliance with the permit shall submit to the Resident Engineer a Contractor Certification Statement, BDE 2342a.
  - a. The Contractor shall provide a construction schedule containing an adequate level of detail to show major activities with implementation of pollution prevention BMPs, including the following items:
    - Approximate duration of the project, including each stage of the project
    - Rainy season, dry season, and winter shutdown dates
    - Temporary stabilization measures to be employed by contract phases
    - Mobilization timeframe
    - Mass clearing and grubbing/roadside clearing dates
    - Deployment of Erosion Control Practices
    - Deployment of Sediment Control Practices (including stabilized construction entrances/exits)
    - Deployment of Construction Site Management Practices (including concrete washout facilities, chemical storage, refueling locations, etc.)
    - Paving, saw-cutting, and any other pavement related operations
    - Major planned stockpiling operations
    - Timeframe for other significant long-term operations or activities that may plan non-storm water discharges such as dewatering, grinding, etc.
    - Permanent stabilization activities for each area of the project
  - b. The Contractor and each subcontractor shall provide, as an attachment to their signed Contractor Certification Statement, a discussion of how they will comply with the requirements of the permit in regard to the following items and provide a graphical representation showing location and type of BMPs to be used when applicable:
    - Vehicle Entrances and Exits – Identify type and location of stabilized construction entrances and exits to be used and how they will be maintained.
    - Material Delivery, Storage and Use – Discuss where and how materials including chemicals, concrete curing compounds, petroleum products, etc. will be stored for this project.
    - Stockpile Management – Discuss what BMPs will be used to prevent pollution of storm water from stockpiles.
    - Waste Disposal – Discuss methods of waste disposal that will be used for this project.
    - Spill Prevention and Control – Discuss steps that will be taken in the event of a material spill (chemicals, concrete curing compounds, petroleum, etc.)
    - Concrete Residuals and Washout Wastes – Discuss the location and type of concrete washout facilities to be used on this project and how they will be signed and maintained.
    - Litter Management – Discuss how litter will be maintained for this project (education of employees, number of

- dumpsters, frequency of dumpster pick-up, etc.).
- Vehicle and Equipment Fueling – Identify equipment fueling locations for this project and what BMPs will be used to ensure containment and spill prevention.
- Vehicle and Equipment Cleaning and Maintenance – Identify where equipment cleaning and maintenance locations for this project and what BMPs will be used to ensure containment and spill prevention.
- Additional measures indicated in the plan.

### III. Maintenance:

When requested by the Contractor, the Resident Engineer will provide general maintenance guides to the Contractor for the practices associated with this project. The following additional procedures will be used to maintain, in good and effective operating conditions, the vegetation, erosion and sediment control measures and other protective measures identified in this plan. It will be the Contractor's responsibility to attain maintenance guidelines for any manufactured BMPs which are to be installed and maintained per manufacture's specifications.

The following erosion and sediment control measures will be checked weekly and after each significant rainfall (0.5 inches or greater in a 24 hour period):

1. Seeding - all erodible bare earth areas will be temporarily seeded on a weekly basis.
2. Perimeter Erosion Barrier - Sediment will be removed when the integrity of the fence is compromised and any fence that collapses will be replaced immediately.
3. Erosion Control - Any areas which fail will be repaired immediately.

All maintenance of erosion control systems will be the responsibility of the contractor. All locations where vehicles enter or exit the construction site and all other areas subject to erosion should also be inspected periodically.

### IV. Inspections:

Qualified personnel shall inspect disturbed areas of the construction site which have not yet been finally stabilized, structural control measures, and locations where vehicles and equipment enter and exit the site using IDOT Storm Water Pollution Prevention Plan Erosion Control Inspection Report (BC 2259). Such inspections shall be conducted at least once every seven (7) calendar days and within twenty-four (24) hours of the end of a storm that is 0.5 inch or greater or equivalent snowfall.

If any violation of the provisions of this plan is identified during the conduct of the construction work covered by this plan, the Resident Engineer shall notify the appropriate IEPA Field Operations Section office by email at: [epa.swnoncomp@illinois.gov](mailto:epa.swnoncomp@illinois.gov), telephone or fax within twenty-four (24) hours of the incident. The Resident Engineer shall then complete and submit an "Incidence of Non-Compliance" (ION) report for the identified violation within five (5) days of the incident. The Resident Engineer shall use forms provided by IEPA and shall include specific information on the cause of noncompliance, actions which were taken to prevent any further causes of noncompliance, and a statement detailing any environmental impact which may have resulted from the noncompliance. All reports of non-compliance shall be signed by a responsible authority in accordance with Part VI. G of the Permit ILR10.

The Incidence of Non-Compliance shall be mailed to the following address:

Illinois Environmental Protection Agency  
 Division of Water Pollution Control  
 Attn: Compliance Assurance Section  
 1021 North Grand East  
 Post Office Box 19276  
 Springfield, Illinois 62794-9276

### V. Failure to Comply:

Failure to comply with any provisions of this Storm Water Pollution Prevention Plan will result in the implementation of a National Pollutant Discharge Elimination System/Erosion and Sediment Control Deficiency Deduction against the Contractor and/or penalties under the Permit ILR10 which could be passed on to the Contractor.



Prior to conducting any professional services at the site covered by this contract, the Contractor and every subcontractor must complete and return to the Resident Engineer the following certification. A separate certification must be submitted by each firm. Attach to this certification all items required by Section II.5 of the Storm Water Pollution Prevention Plan (SWPPP) which will be handled by the Contractor/subcontractor completing this form.

Route	<u>South Main Street</u>	Marked Rte.	<u>FAU 0124</u>
Section	<u>08-00106-00-FP</u>	Project No.	<u>M-9003(685)</u>
County	<u>McHenry</u>	Contract No.	<u>63843</u>

This certification statement is a part of the SWPPP for the project described above, in accordance with the General NPDES Permit No. ILR10 issued by the Illinois Environmental Protection Agency.

I certify under penalty of law that I understand the terms of the Permit No. ILR 10 that authorizes the storm water discharges associated with industrial activity from the construction site identified as part of this certification.

In addition, I have read and understand all of the information and requirements stated in the SWPPP for the above mentioned project; I have received copies of all appropriate maintenance procedures; and, I have provided all documentation required to be in compliance with the Permit ILR10 and SWPPP and will provide timely updates to these documents as necessary.

Contractor

Sub-Contractor

\_\_\_\_\_  
Print Name

\_\_\_\_\_  
Title

\_\_\_\_\_  
Name of Firm

\_\_\_\_\_  
Street Address

\_\_\_\_\_  
Signature

\_\_\_\_\_  
Date

\_\_\_\_\_  
Telephone

\_\_\_\_\_  
City/State/ZIP

Items which this Contractor/subcontractor will be responsible for as required in Section II.5. of the SWPPP:

\_\_\_\_\_

\_\_\_\_\_

\_\_\_\_\_

\_\_\_\_\_

**ILLINOIS ENVIRONMENTAL PROTECTION AGENCY**  
**NOTICE OF INTENT (NOI)**  
**GENERAL PERMIT TO DISCHARGE STORM WATER**  
**CONSTRUCTION SITE ACTIVITIES**

**OWNER INFORMATION**

COMPANY/ OWNER NAME:	City of Crystal Lake	OWNER TYPE: <b>SELECT ONE</b> City MS4 Community <input checked="" type="checkbox"/> Yes <input type="checkbox"/> No			
MAILING ADDRESS:	100 W. Woodstock Street	PHONE:		Area Code ( 815 ) Number 356-3615 ext.	
CITY:	Crystal Lake	STATE: <b>IL</b>	ZIP CODE: 60014	FAX: Area Code ( 815 ) Number 479-1647	
CONTACT PERSON:	Abigail Wilgreen, P.E.		EMAIL: awilgreen@crystallake.org		

**CONTRACTOR INFORMATION**

CONTRACTOR NAME:					
MAILING ADDRESS:			PHONE:		
CITY:			Area Code ( )	Number	ext.
			STATE:	ZIP CODE:	

**CONSTRUCTION SITE INFORMATION**

SELECT ONE:	<input checked="" type="checkbox"/> NEW SITE <input type="checkbox"/> CHANGE OF INFORMATION FOR: <b>ILR10</b>									
PROJECT NAME:	South Main Street (FAU 0124)							COUNTY: McHenry		
STREET ADDRESS/ LOCATION	Rakow Road to US Route 14					CITY: Crystal Lake			IL	ZIP CODE: 60014
LATITUDE:	DEG. 42	MIN. 13	SEC. 00	LONGITUDE:	DEG. 88	MIN. 18	SEC. 59	SECTION: 8.9	TOWNSHIP: 43N	RANGE: 8E
APPROX CONST START DATE 08 / 15 / 2013	APPROX CONST END DATE 10 / 15 / 2013		TOTAL SIZE OF CONSTRUCTION SITE IN ACRES: <u>6.0</u> If less than 1 acre, is site part of larger common plan of development? <input type="checkbox"/> YES <input type="checkbox"/> NO							

**STORM WATER POLLUTION PREVENTION PLAN INFORMATION**

HAS STORM WATER POLLUTION PREVENTION PLAN BEEN SUBMITTED TO AGENCY? <input checked="" type="checkbox"/> YES <input type="checkbox"/> NO (SUBMIT SWPPP ELECTRONICALLY TO: <a href="mailto:epa.constilr10swppp@illinois.gov">epa.constilr10swppp@illinois.gov</a> )	
WILL STORM WATER POLLUTION PREVENTION PLAN BE AVAILABLE AT SITE? <input checked="" type="checkbox"/> YES <input type="checkbox"/> NO	
LOCATION OF SWPPP FOR VIEWING: ADDRESS: Crystal Lake - 100 W. Woodstock Street	CITY: Crystal Lake
SWPPP CONTACT INFORMATION: NAME: Abigail Wilgreen, P.E.	INSPECTOR QUALIFICATIONS: <b>SELECT ONE</b> P.E.
PHONE: ( 815 ) 356-3615	FAX: ( 815 ) 479-1647
EMAIL: awilgreen@crystallake.org	
PROJECT INSPECTOR, IF DIFFERENT THAN ABOVE: NAME:	INSPECTOR QUALIFICATIONS: <b>SELECT ONE</b> P.E.
PHONE: ( )	FAX: ( )
EMAIL:	



**ILLINOIS ENVIRONMENTAL PROTECTION AGENCY  
NOTICE OF INTENT (NOI)  
GENERAL PERMIT TO DISCHARGE STORM WATER  
CONSTRUCTION SITE ACTIVITIES**

**TYPE OF CONSTRUCTION (SELECT ALL THAT APPLY)**

<b>SELECT ONE</b> Transportation	SIC Code:
<p><b>TYPE DETAILED DESCRIPTION OF PROJECT:</b></p> <p>This improvement consists of roadway widening and resurfacing including earth excavation, landscaping, drainage, signing, striping, and all incidental and collateral work as necessary to complete the improvement.</p>	

**HISTORIC PRESERVATION AND ENDANGERED SPECIES COMPLIANCE**

HAS THIS PROJECT BEEN SUBMITTED TO THE FOLLOWING STATE AGENCIES TO SATISFY APPLICABLE REQUIREMENTS FOR COMPLIANCE WITH ILLINOIS LAW ON:			
HISTORIC PRESERVATION	<input checked="" type="checkbox"/> YES	<input type="checkbox"/> NO	<a href="http://www.illinoishistory.gov/PS/rcdocument.htm">http://www.illinoishistory.gov/PS/rcdocument.htm</a>
ENDANGERED SPECIES	<input checked="" type="checkbox"/> YES	<input type="checkbox"/> NO	<a href="http://dnrecocat.state.il.us/ecopublic/">http://dnrecocat.state.il.us/ecopublic/</a>

**RECEIVING WATER INFORMATION**

DOES YOUR STORM WATER DISCHARGE DIRECTLY TO:	<input type="checkbox"/> WATERS OF THE STATE	OR	<input checked="" type="checkbox"/> STORM SEWER
<b>OWNER</b> TO STORM SEWER SYSTEMS: Crystal Lake			
NAME OF CLOSEST RECEIVING WATERBODY TO WHICH YOU DISCHARGE:			

I certify under penalty of law that this document and all attachments were prepared under my direction and supervision in accordance with a system designed to assure that qualified personnel properly gather and evaluate the information submitted. Based on my inquiry of the person or persons who manage this system, or those persons directly responsible for gathering the information, the information submitted is, to the best of my knowledge and belief, true, accurate, and complete. I am aware that there are significant penalties for submitting false information, including the possibility of fine and imprisonment. In addition, I certify that the provisions of the permit, including the development and implementation of a storm water pollution prevention plan and a monitoring program plan, will be complied with.

OWNER SIGNATURE: \_\_\_\_\_

DATE: \_\_\_\_\_

SUBMIT ELECTRONICALLY TO:  
[epa.constilr10swppp@illinois.gov](mailto:epa.constilr10swppp@illinois.gov)

OR MAIL COMPLETED FROM TO:

ILLINOIS ENVIRONMENTAL PROTECTION AGENCY  
DIVISION OF WATER POLLUTION CONTROL  
ATTN: PERMIT SECTION  
POST OFFICE BOX 19276  
SPRINGFIELD, ILLINOIS 62794-9276  
[www.epa.state.il.us](http://www.epa.state.il.us)

FOR OFFICE USE ONLY

LOG:
PERMIT NO. ILR10 _____
DATE:

Information required by this form must be provided to comply with 415 ILCS 5/39 (1996). Failure to do so may prevent this form from being processed and could result in your application being denied. This form has been approved by the Forms Management Center.

IL 532 2104  
WPC 623 Rev. 8/08

# INSTRUCTIONS FOR COMPLETION OF CONSTRUCTION ACTIVITY NOTICE OF INTENT (NOI) FORM

Please adhere to the following instructions:

Submit original, electronic or facsimile copies. Facsimile and/or electronic copies should be followed-up with an original signature copy as soon as possible. Please write "copy" under the "For Office Use Only" box in the lower right hand corner.

< **Submit completed forms to:**

Illinois Environmental Protection Agency  
Division of Water Pollution Control  
Permit Section  
Post Office Box 19276  
Springfield, Illinois 62794-9276  
or call (217)782-0610  
[www.epa.state.il.us](http://www.epa.state.il.us)

< **Reports must be typed or printed legibly and signed.**

< Any facility that is not presently covered by the General NPDES Permit for Storm Water Discharges From Construction Site Activities is considered a new facility.

< **If this is a change in your facility information, renewal, etc., please fill in your permit number on the appropriate line, changes of information or permit renewal notifications do not require a fee.**

< **NOTE: FACILITY LOCATION IS NOT NECESSARILY THE FACILITY MAILING ADDRESS, BUT SHOULD DESCRIBE WHERE THE FACILITY IS LOCATED.**

< **Use the formats given in the following examples for correct form completion.**

	<u>Example</u>	<u>Format</u>
SECTION	12	1 or 2 numerical digits
TOWNSHIP	12N	1 or 2 numerical digits followed by "N" or "S"
RANGE	12W	1 or 2 numerical digits followed by "E" or "W"

< **For the Name of Closest Receiving Waters, do not use terms such as ditch or channel. For unnamed tributaries, use terms which include at least a named main tributary such as "Unnamed Tributary to Sugar Creek to Sangamon River."**

< **Submit a fee of \$500 and the Storm Water Pollution Plan (SWPPP) for initial permit prior to the Notice of Intent being considered complete for coverage by the ILR10 General Permits. Please make checks payable to: Illinois EPA.**

< **SWPPP should be submitted electronically to: [epa.constilr10swppp@illinois.gov](mailto:epa.constilr10swppp@illinois.gov) When submitting electronically, use Project Name and City as indicated on NOI form.**



**ILLINOIS ENVIRONMENTAL PROTECTION AGENCY  
CONSTRUCTION SITE STORM WATER DISCHARGE  
INCIDENCE OF NON-COMPLIANCE (ION)**

PERMITTEE NAME:	LAST	FIRST	MIDDLE INITIAL	AREA CODE + PHONE NUMBER:					
STREET:				CITY: Crystal Lake	ST:	ZIP:			
CONSTRUCTION SITE NAME:	South Main Street (FAU 0124)								
COUNTY:	McHenry			SECTION: 8	TOWNSHIP: 43	RANGE: 8			
NPDES PERMIT NUMBER:	I	L	R	1	0				
				LATITUDE: DEG. 42	MIN. 13	SEC. 00	LONGITUDE: DEG. 88	MIN. 18	SEC. 59

**CAUSE OF NON-COMPLIANCE:**

**ACTIONS TAKEN TO PREVENT ANY FURTHER NON-COMPLIANCE:**

**ENVIRONMENTAL IMPACT RESULTING FROM THE NON-COMPLIANCE:**

**ACTIONS TAKEN TO REDUCE THE ENVIRONMENTAL IMPACT RESULTING FROM THE NON-COMPLIANCE:**

SIGNATURE: \_\_\_\_\_ TITLE: \_\_\_\_\_ DATE: \_\_\_\_\_

MAIL COMPLETED FORM TO:  
(DO NOT SUBMIT ADDITIONAL DOCUMENTATION UNLESS REQUESTED)

ILLINOIS ENVIRONMENTAL PROTECTION AGENCY  
DIVISION OF WATER POLLUTION CONTROL  
COMPLIANCE ASSURANCE SECTION #19  
POST OFFICE BOX 19276  
SPRINGFIELD, ILLINOIS 62794-9276

FOR OFFICE USE ONLY	
LOG:	
PERMIT NO. ILR10	_____
DATE:	

Information required by this form must be provided to comply with 415 ILCS 5/39(1996). Failure to do so may prevent this form from being processed and could result in your application being denied. This form has been approved by the Forms Management Center.

**GUIDELINES FOR COMPLETION OF INCIDENCE OF NON-COMPLIANCE (ION)  
FORM**

Complete and submit this form for any violation of the Storm Water Pollution Prevention Plan observed during any inspection conducted, including those not required by the Plan. Please adhere to the following guidelines.

- Submit original, photocopy or facsimile copies. Facsimile and/or photo copies should be followed-up with an original signature copy as soon as possible. Please write "copy" under the "For Office Use Only" box in the lower right hand corner.
- Submit completed forms to:

Illinois Environmental Protection Agency  
Division of Water Pollution Control  
Permit Section  
Post Office Box 19276  
Springfield, Illinois 62794-9276

- Reports must be typed or printed legibly and signed.
- Use the formats given in the following examples for correct form completion.

<u>Example</u>		<u>Format</u>
SECTION	12	1 or 2 numerical digits
TOWNSHIP	12N	1 or 2 numerical digits followed by "N" or "S"
RANGE	12W	1 or 2 numerical digits followed by "E" or "W"

**ILLINOIS ENVIRONMENTAL PROTECTION AGENCY**  
**NOTICE OF TERMINATION (NOT)**  
**OF COVERAGE UNDER THE GENERAL PERMIT**  
**FOR STORM WATER DISCHARGES**  
**ASSOCIATED WITH CONSTRUCTION SITE ACTIVITIES**

Please use the tab or arrow keys

**OWNER INFORMATION**

NAME:	LAST City of Crystal Lake	FIRST	MIDDLE	OWNER TYPE:	City
MAILING ADDRESS:	100 W. Woodstock Street				
CITY:	Crystal Lake	STATE:	IL	ZIP:	60014
CONTACT PERSON:	Abigail Wilgreen, P.E.			TELEPHONE NUMBER:	AREA CODE 815 NUMBER 356-3615

**CONTRACTOR INFORMATION**

NAME:	LAST	FIRST	MIDDLE	TELEPHONE NUMBER:	AREA CODE	NUMBER
MAILING ADDRESS:				CITY:	STATE:	ZIP:

**CONSTRUCTION SITE INFORMATION**

FACILITY NAME:	South Main Street	OTHER NPDES PERMIT NOS.:	I	L	R	1	0						
FACILITY LOCATION:	Rakow Road to U.S. Route 14												
CITY:	Crystal Lake	STATE:	IL	ZIP:	60014	LATITUDE:	42	13	00	LONGITUDE:	88	18	59
COUNTY:	McHenry County	SECTION:	8,9	TOWNSHIP:	43N	RANGE:	8E						

DATE PROJECT HAS BEEN COMPLETED AND STABILIZED:
---

I certify under penalty of law that disturbed soils at the identified facility have been finally stabilized or that all storm water discharges associated with industrial activity from the identified facility that are authorized by an NPDES general permit have otherwise been eliminated. I understand that by submitting this notice of termination, that I am no longer authorized to discharge storm water associated with industrial activity by the general permit, and that discharging pollutants in storm water associated with industrial activity to Waters of the State is unlawful under the Environmental Protection Act and the Clean Water Act where the discharge is not authorized by an NPDES permit.

OWNER SIGNATURE: \_\_\_\_\_ DATE: \_\_\_\_\_

MAIL COMPLETED FORM TO:  
 (DO NOT SUBMIT ADDITIONAL DOCUMENTATION UNLESS REQUESTED)

ILLINOIS ENVIRONMENTAL PROTECTION AGENCY  
 DIVISION OF WATER POLLUTION CONTROL  
 ATTN: PERMIT SECTION  
 POST OFFICE BOX 19276  
 SPRINGFIELD, ILLINOIS 62794-9276

FOR OFFICE USE ONLY	
LOG:	
PERMIT NO. ILR10 _____	
DATE:	

Information required by this form must be provided to comply with 415 ILCS 5/39 (1996). Failure to do so may prevent this form from being processed and could result in your application being denied. This form has been approved by the Forms Management Center.

## GUIDELINES FOR COMPLETION OF NOTICE OF TERMINATION (NOT) FORM

Please adhere to the following guidelines:

Submit original, photocopy or facsimile copies. Facsimile and/or photo copies should be followed-up with an original signature copy as soon as possible. Please write "copy" under the "For Office Use Only" box in the lower right hand corner.

•••• Submit completed forms to:

Illinois Environmental Protection Agency  
Division of Water Pollution Control  
Permit Section  
Post Office Box 19276  
Springfield, Illinois 62794-9276  
217/782-0610

•••• Reports must be typed or printed legibly and signed.

•••• NOTE: FACILITY LOCATION IS NOT NECESSARILY THE FACILITY MAILING ADDRESS, BUT SHOULD DESCRIBE WHERE THE FACILITY IS LOCATED.

•••• Use the formats given in the following examples for correct form completion.

	<u>Example</u>	<u>Format</u>
SECTION	12	1 or 2 numerical digits
TOWNSHIP	12N	1 or 2 numerical digits followed by "N" or "S"
RANGE	12W	1 or 2 numerical digits followed by "E" or "W"

•••• Final stabilization has occurred when:

- (a) all soil disturbing activities at the site have been completed
- (b) a uniform perennial vegetative cover with a density of 70% of the native background vegetative cover for the area has been established on all unpaved areas and areas not covered by permanent structures,
- (c) or equivalent permanent stabilization measures have been employed.

State of Illinois  
Department of Transportation  
Bureau of Local Roads and Streets

SPECIAL PROVISION  
FOR  
COOPERATION WITH UTILITIES

Effective: January 1, 1999  
Revised: January 1, 2007

All references to Sections or Articles in this specification shall be construed to mean specific Section or Article of the Standard Specifications for Road and Bridge Construction, adopted by the Department of Transportation.

Replace Article 105.07 of the Standard Specifications with the following:

**“105.07 Cooperation with Utilities.** The adjustment of utilities consists of the relocation, removal, replacement, rearrangements, reconstruction, improvement, disconnection, connection, shifting, new installation or altering of an existing utility facility in any manner.

When the plans or special provisions include information pertaining to the location of underground utility facilities, such information represents only the opinion of the Department as to the location of such utilities and is only included for the convenience of the bidder. The Department assumes no responsibility in respect to the sufficiency or the accuracy of the information shown on the plans relative to the location of the underground utility facilities.

Utilities which are to be adjusted shall be adjusted by the utility owner or the owner's representative or by the Contractor as a contract item. Generally, arrangements for adjusting existing utilities will be made by the Department prior to project construction; however, utilities will not necessarily be adjusted in advance of project construction and, in some cases, utilities will not be removed from the proposed construction limits. When utility adjustments must be performed in conjunction with construction, the utility adjustment work will be shown on the plans and/or covered by Special Provisions.

When the Contractor discovers a utility has not been adjusted by the owner or the owner's representative as indicated in the contract documents, or the utility is not shown on the plans or described in the Special Provisions as to be adjusted in conjunction with construction, the Contractor shall not interfere with said utility, and shall take proper precautions to prevent damage or interruption of the utility and shall promptly notify the Engineer of the nature and location of said utility.

All necessary adjustments, as determined by the Engineer, of utilities not shown on the plans or not identified by markers, will be made at no cost to the Contractor except traffic structures, light poles, etc., that are normally located within the proposed construction limits as hereinafter defined will not be adjusted unless required by the proposed improvement.

(a) Limits of Proposed Construction for Utilities Paralleling the Roadway. For the purpose of this Article, limits of proposed construction for utilities extending in the same longitudinal direction as the roadway, shall be defined as follows:

(1) The horizontal limits shall be a vertical plane, outside of, parallel to, and 600 mm (2 ft) distant at right angles from the plan or revised slope limits.

In cases where the limits of excavation for structures are not shown on the plans, the horizontal limits shall be a vertical plane 1.2 m (4 ft) outside the edges of structure footings or the structure where no footings are required.

(2) The upper vertical limits shall be the regulations governing the roadbed clearance for the specific utility involved.

(3) The lower vertical limits shall be the top of the utility at the depth below the proposed grade as prescribed by the governing agency or the limits of excavation, whichever is less.

(b) Limits of Proposed Construction for Utilities Crossing the Roadway. For the purpose of this Article, limits of proposed construction for utilities crossing the roadway in a generally transverse direction shall be defined as follows:

(1) Utilities crossing excavations for structures that are normally made by trenching such as sewers, underdrains, etc. and all minor structures such as manholes, inlets, foundations for signs, foundations for traffic signals, etc., the limits shall be the space to be occupied by the proposed permanent construction unless otherwise required by the regulations governing the specific utility involved.

(2) For utilities crossing the proposed site of major structures such as bridges, sign trusses, etc., the limits shall be as defined above for utilities extending in the same general direction as the roadway.

The Contractor may make arrangements for adjustment of utilities outside of the limits of proposed construction provided the Contractor furnishes the Department with a signed agreement with the utility owner covering the adjustments to be made. The cost of any adjustments made outside the limits of proposed construction shall be the responsibility of the Contractor unless otherwise provided.

The Contractor shall request all utility owners to field locate their facilities according to Article 107.31. The Engineer may make the request for location from the utility after receipt of notice from the Contractor. On request, the Engineer will make an inspection to verify that the utility company has field located its facilities, but will not assume responsibility for the accuracy of such work. The Contractor shall be responsible for maintaining the excavations or markers provided by the utility owners. This field location procedure may be waived if the utility owner has stated in writing to the Department it is satisfied the construction plans are sufficiently accurate. If the utility owner does not submit such statement to the Department, and they do not field locate their facilities in both horizontal and vertical alignment, the Engineer will authorize the Contractor in writing to proceed to locate the facilities in the most economical and reasonable manner, subject to the approval of the Engineer, and be paid according to Article 109.04.

The Contractor shall coordinate with any planned utility adjustment or new installation and the Contractor shall take all precautions to prevent disturbance or damage to utility facilities. Any failure on the part of the utility owner, or their representative, to proceed with any planned utility adjustment or new installation shall be reported promptly by the Contractor to the Engineer orally and in writing.

The Contractor shall take all necessary precautions for the protection of the utility facilities. The Contractor shall be responsible for any damage or destruction of utility facilities resulting from neglect, misconduct, or omission in the Contractor's manner or method of execution or nonexecution of the work, or caused by defective work or the use of unsatisfactory materials. Whenever any damage or destruction of a utility facility occurs as a result of work performed by the Contractor, the utility company will be immediately notified. The utility company will make arrangements to restore such facility to a condition equal to that existing before any such damage or destruction was done.

It is understood and agreed that the Contractor has considered in the bid all of the permanent and temporary utilities in their present and/or adjusted positions.

No additional compensation will be allowed for any delays, inconvenience, or damage sustained by the Contractor due to any interference from the said utility facilities or the operation of relocating the said utility facilities.

State of Illinois  
Department of Transportation  
Bureau of Local Roads and Streets

SPECIAL PROVISION  
FOR  
INSURANCE

Effective: February 1, 2007  
Revised: August 1, 2007

All references to Sections or Articles in this specification shall be construed to mean specific Section or Article of the Standard Specifications for Road and Bridge Construction, adopted by the Department of Transportation.

The Contractor shall name the following entities as additional insured under the Contractor's general liability insurance policy in accordance with Article 107.27:

City of Crystal Lake

---

---

---

---

---

---

---

---

The entities listed above and their officers, employees, and agents shall be indemnified and held harmless in accordance with Article 107.26.



## BITUMINOUS MATERIALS COST ADJUSTMENTS (BDE) (RETURN FORM WITH BID)

Effective: November 2, 2006

Revised: August 1, 2013

Description. Bituminous material cost adjustments will be made to provide additional compensation to the Contractor, or credit to the Department, for fluctuations in the cost of bituminous materials when optioned by the Contractor. The adjustments shall apply to permanent and temporary hot-mix asphalt (HMA) mixtures, bituminous surface treatments (cover and seal coats), and preventative maintenance type surface treatments. The adjustments shall not apply to bituminous prime coats, tack coats, crack filling/sealing, or joint filling/sealing.

The bidder shall indicate on the attached form whether or not this special provision will be part of the contract and submit the completed form with his/her bid. Failure to submit the form, or failure to fill out the form completely, shall make this contract exempt of bituminous materials cost adjustments.

Method of Adjustment. Bituminous materials cost adjustments will be computed as follows.

$$CA = (BPI_P - BPI_L) \times (\%AC_V / 100) \times Q$$

Where: CA = Cost Adjustment, \$.  
BPI<sub>P</sub> = Bituminous Price Index, as published by the Department for the month the work is performed, \$/ton (\$/metric ton).  
BPI<sub>L</sub> = Bituminous Price Index, as published by the Department for the month prior to the letting, \$/ton (\$/metric ton).  
%AC<sub>V</sub> = Percent of virgin Asphalt Cement in the Quantity being adjusted. For HMA mixtures, the % AC<sub>V</sub> will be determined from the adjusted job mix formula. For bituminous materials applied, a performance graded or cutback asphalt will be considered to be 100% AC<sub>V</sub> and undiluted emulsified asphalt will be considered to be 65% AC<sub>V</sub>.  
Q = Authorized construction Quantity, tons (metric tons) (see below).

For HMA mixtures measured in square yards:  $Q, \text{ tons} = A \times D \times (G_{mb} \times 46.8) / 2000$ . For HMA mixtures measured in square meters:  $Q, \text{ metric tons} = A \times D \times (G_{mb} \times 1) / 1000$ . When computing adjustments for full-depth HMA pavement, separate calculations will be made for the binder and surface courses to account for their different  $G_{mb}$  and % AC<sub>V</sub>.

For bituminous materials measured in gallons:  $Q, \text{ tons} = V \times 8.33 \text{ lb/gal} \times SG / 2000$   
For bituminous materials measured in liters:  $Q, \text{ metric tons} = V \times 1.0 \text{ kg/L} \times SG / 1000$

Where: A = Area of the HMA mixture, sq yd (sq m).  
D = Depth of the HMA mixture, in. (mm).  
G<sub>mb</sub> = Average bulk specific gravity of the mixture, from the approved mix design.  
V = Volume of the bituminous material, gal (L).

SG = Specific Gravity of bituminous material as shown on the bill of lading.

Basis of Payment. Bituminous materials cost adjustments may be positive or negative but will only be made when there is a difference between the  $BPI_L$  and  $BPI_P$  in excess of five percent, as calculated by:

$$\text{Percent Difference} = \{(BPI_L - BPI_P) \div BPI_L\} \times 100$$

Bituminous materials cost adjustments will be calculated for each calendar month in which applicable bituminous material is placed; and will be paid or deducted when all other contract requirements for the work placed during the month are satisfied. The adjustments shall not apply during contract time subject to liquidated damages for completion of the entire contract.

Return With Bid

**ILLINOIS DEPARTMENT  
OF TRANSPORTATION**

**OPTION FOR  
BITUMINOUS MATERIALS COST ADJUSTMENTS**

The bidder shall submit this completed form with his/her bid. Failure to submit the form, or failure to fill out the form completely, shall make this contract exempt of bituminous materials cost adjustments. After award, this form, when submitted, shall become part of the contract.

**Contract No.:** \_\_\_\_\_

**Company Name:** \_\_\_\_\_

**Contractor's Option:**

Is your company opting to include this special provision as part of the contract?

Yes  No

**Signature:** \_\_\_\_\_ **Date:** \_\_\_\_\_

80173

## COATED GALVANIZED STEEL CONDUIT (BDE)

Effective: January 1, 2013

Revised: August 1, 2014

Revise Article 811.03(b) of the Standard Specifications to read:

“(b) Coated Galvanized Steel Conduit. In addition to the methods described in Article 810.05(a) the following methods shall be observed when installing coated conduit.

Coated conduit pipe vise jaw adapters shall be used when the conduit is being clamped to avoid damaging the coating.

Coated conduit shall be cut with a roller cutter or by other means approved by the conduit manufacturer.

After any cutting or threading operations are completed, the bare steel shall be touched up with the conduit manufacturer’s touch up compound.”

Revise Article 1088.01(a)(3) of the Standard Specifications to read:

“(3) Coated Galvanized Steel Conduit. The conduit prior to coating shall meet the requirements for rigid metal conduit and be manufactured according to NEMA Standard No. RN1.

The coating shall have the following characteristics.

Hardness	85+ Shore A Durometer
Dielectric Strength	400 V/mil @ 60 Hz
Aging	1,000 Hours Atlas Weatherometer
Brittleness Temperature	0 °F (-18 °C) when tested according to ASTM D 746
Elongation	200 percent

The exterior galvanized surfaces shall be coated with a primer before the coating to ensure a bond between the zinc substrate and the coating. The bond strength created shall be greater than the tensile strength of the plastic coating. The nominal thickness of the coating shall be 40 mils (1 mm). The coating shall pass the following bonding test.

Two parallel cuts 1/2 in. (13 mm) apart and 1 1/2 in. (38 mm) in length shall be made with a sharp knife along the longitudinal axis. A third cut shall be made perpendicular to and crossing the longitudinal cuts at one end. The knife shall then be worked under the coating for 1/2 in. (13 mm) to free the coating from the metal.

Using pliers, the freed tab shall be pulled with a force applied vertically and away from the conduit. The tab shall tear rather than cause any additional coating to separate from the substrate.

A two part urethane coating shall be applied to the interior of the conduit. The internal coating shall have a nominal thickness of 2 mils (50  $\mu\text{m}$ ). The interior coating shall be applied in a manner so there are no runs, drips, or pinholes at any point. The coating shall not peel, flake, or chip off after a cut is made in the conduit or a scratch is made in the coating. The urethane interior coating applied shall afford sufficient flexibility to permit field bending without cracking or flaking of the interior coating.

All conduit fittings and couplings shall be as specified and recommended by the conduit manufacturer. All conduit fitting covers shall be furnished with stainless steel screws which have been encapsulated with a polyester material on the head to ensure maximum corrosion protection.”

80310

## **COLIABLE NONMETALLIC CONDUIT (BDE)**

Effective: August 1, 2014

Revise Article 1088.01(c) of the Standard Specifications to read:

“(c) Coilable Nonmetallic Conduit. The conduit shall be a high density polyethylene duct which is intended for underground use can be manufactured and coiled or reeled in continuous transportable lengths and uncoiled for further processing and/or installation without adversely affecting its properties or performance. The conduit and its manufacture shall be according to UL Standard 651A.

Performance Tests. Testing procedures and test results shall meet the requirements of UL Standard 651A. Certified copies of the test report shall be submitted to the Engineer prior to the installation of the conduit.”

80341

**CONCRETE GUTTER, CURB, MEDIAN, AND PAVED DITCH (BDE)**

Effective: April 1, 2014  
| Revised: August 1, 2014

Add the following to Article 606.02 of the Standard Specifications:

“(i) Polyurethane Joint Sealant ..... 1050.04”

Revise the fifth paragraph of Article 606.07 of the Standard Specifications to read:

“Transverse contraction and longitudinal construction joints shall be sealed according to Article 420.12, except transverse joints in concrete curb and gutter shall be sealed with polysulfide or polyurethane joint sealant.”

Add the following to Section 1050 of the Standard Specifications:

“**1050.04 Polyurethane Joint Sealant.** The joint sealant shall be a polyurethane sealant, | Type S, Grade NS, Class 25 or better, Use T (T<sub>1</sub> or T<sub>2</sub>), according to ASTM C 920.”

80334

## CONSTRUCTION AIR QUALITY – DIESEL RETROFIT (BDE)

Effective: June 1, 2010

Revised: January 1, 2014

The reduction of emissions of particulate matter (PM) for off-road equipment shall be accomplished by installing retrofit emission control devices. The term "equipment" refers to diesel fuel powered devices rated at 50 hp and above, to be used on the jobsite in excess of seven calendar days over the course of the construction period on the jobsite (including rental equipment).

Contractor and subcontractor diesel powered off-road equipment assigned to the contract shall be retrofitted using the phased in approach shown below. Equipment that is of a model year older than the year given for that equipment's respective horsepower range shall be retrofitted:

Effective Dates	Horsepower Range	Model Year
June 1, 2010 <sup>1/</sup>	600-749	2002
	750 and up	2006
June 1, 2011 <sup>2/</sup>	100-299	2003
	300-599	2001
	600-749	2002
	750 and up	2006
June 1, 2012 <sup>2/</sup>	50-99	2004
	100-299	2003
	300-599	2001
	600-749	2002
	750 and up	2006

1/ Effective dates apply to Contractor diesel powered off-road equipment assigned to the contract.

2/ Effective dates apply to Contractor and subcontractor diesel powered off-road equipment assigned to the contract.

The retrofit emission control devices shall achieve a minimum PM emission reduction of 50 percent and shall be:

- a) Included on the U.S. Environmental Protection Agency (USEPA) *Verified Retrofit Technology List* (<http://www.epa.gov/cleandiesel/verification/verif-list.htm>), or verified by the California Air Resources Board (CARB) (<http://www.arb.ca.gov/diesel/verdev/vt/cvt.htm>); or
- b) Retrofitted with a non-verified diesel retrofit emission control device if verified retrofit emission control devices are not available for equipment proposed to be used on the project, and if the Contractor has obtained a performance certification from the retrofit



device manufacturer that the emission control device provides a minimum PM emission reduction of 50 percent.

Note: Large cranes (Crawler mounted cranes) which are responsible for critical lift operations are exempt from installing retrofit emission control devices if such devices adversely affect equipment operation.

Diesel powered off-road equipment with engine ratings of 50 hp and above, which are unable to be retrofitted with verified emission control devices or if performance certifications are not available which will achieve a minimum 50 percent PM reduction, may be granted a waiver by the Department if documentation is provided showing good faith efforts were made by the Contractor to retrofit the equipment.

Construction shall not proceed until the Contractor submits a certified list of the diesel powered off-road equipment that will be used, and as necessary, retrofitted with emission control devices. The list(s) shall include (1) the equipment number, type, make, Contractor/rental company name; and (2) the emission control devices make, model, USEPA or CARB verification number, or performance certification from the retrofit device manufacturer. Equipment reported as fitted with emissions control devices shall be made available to the Engineer for visual inspection of the device installation, prior to being used on the jobsite.

The Contractor shall submit an updated list of retrofitted off-road construction equipment as retrofitted equipment changes or comes on to the jobsite. The addition or deletion of any diesel powered equipment shall be included on the updated list.

If any diesel powered off-road equipment is found to be in non-compliance with any portion of this special provision, the Engineer will issue the Contractor a diesel retrofit deficiency deduction.

Any costs associated with retrofitting any diesel powered off-road equipment with emission control devices shall be considered as included in the contract unit prices bid for the various items of work involved and no additional compensation will be allowed. The Contractor's compliance with this notice and any associated regulations shall not be grounds for a claim.

### **Diesel Retrofit Deficiency Deduction**

When the Engineer determines that a diesel retrofit deficiency exists, a daily monetary deduction will be imposed for each calendar day or fraction thereof the deficiency continues to exist. The calendar day(s) will begin when the time period for correction is exceeded and end with the Engineer's written acceptance of the correction. The daily monetary deduction will be \$1,000.00 for each deficiency identified.

The deficiency will be based on lack of diesel retrofit emissions control.

If a Contractor accumulates three diesel retrofit deficiency deductions for the same piece of equipment in a contract period, the Contractor will be shutdown until the deficiency is corrected.

Such a shutdown will not be grounds for any extension of the contract time, waiver of penalties, or be grounds for any claim.

80261

## CONTRACT CLAIMS (BDE)

Effective: April 1, 2014

Revise the first paragraph of Article 109.09(a) of the Standard Specifications to read:

“(a) Submission of Claim. All claims filed by the Contractor shall be in writing and in sufficient detail to enable the Department to ascertain the basis and amount of the claim. As a minimum, the following information must accompany each claim submitted.”

Revise Article 109.09(e) of the Standard Specifications to read:

“(e) Procedure. The Department provides two administrative levels for claims review.

Level I Engineer of Construction

Level II Chief Engineer/Director of Highways or Designee

- (1) Level I. All claims shall first be submitted at Level I. Two copies each of the claim and supporting documentation shall be submitted simultaneously to the District and the Engineer of Construction. The Engineer of Construction, in consultation with the District, will consider all information submitted with the claim and render a decision on the claim within 90 days after receipt by the Engineer of Construction. Claims not conforming to this Article will be returned without consideration. The Engineer of Construction may schedule a claim presentation meeting if in the Engineer of Construction’s judgment such a meeting would aid in resolution of the claim, otherwise a decision will be made based on the claim documentation submitted. If a Level I decision is not rendered within 90 days of receipt of the claim, or if the Contractor disputes the decision, an appeal to Level II may be made by the Contractor.
- (2) Level II. An appeal to Level II shall be made in writing to the Engineer of Construction within 45 days after the date of the Level I decision. Review of the claim at Level II shall be conducted as a full evaluation of the claim. A claim presentation meeting may be scheduled if the Chief Engineer/Director of Highways determines that such a meeting would aid in resolution of the claim, otherwise a decision will be made based on the claim documentation submitted. A Level II final decision will be rendered within 90 days of receipt of the written request for appeal.

Full compliance by the Contractor with the provisions specified in this Article is a contractual condition precedent to the Contractor’s right to seek relief in the Court of Claims. The Director’s written decision shall be the final administrative action of the Department. Unless the Contractor files a claim for adjudication by the Court of Claims within 60 days after the date of the written decision, the failure to file shall constitute a release and waiver of the claim.”

80335

## **DISADVANTAGED BUSINESS ENTERPRISE PARTICIPATION (BDE)**

Effective: September 1, 2000

Revised: August 2, 2011

FEDERAL OBLIGATION. The Department of Transportation, as a recipient of federal financial assistance, is required to take all necessary and reasonable steps to ensure nondiscrimination in the award and administration of contracts. Consequently, the federal regulatory provisions of 49 CFR Part 26 apply to this contract concerning the utilization of disadvantaged business enterprises. For the purposes of this Special Provision, a disadvantaged business enterprise (DBE) means a business certified by the Department in accordance with the requirements of 49 CFR Part 26 and listed in the Illinois Unified Certification Program (IL UCP) DBE Directory.

STATE OBLIGATION. This Special Provision will also be used by the Department to satisfy the requirements of the Business Enterprise for Minorities, Females, and Persons with Disabilities Act, 30 ILCS 575. When this Special Provision is used to satisfy state law requirements on 100 percent state-funded contracts, the federal government has no involvement in such contracts (not a federal-aid contract) and no responsibility to oversee the implementation of this Special Provision by the Department on those contracts. DBE participation on 100 percent state-funded contracts will not be credited toward fulfilling the Department's annual overall DBE goal required by the US Department of Transportation to comply with the federal DBE program requirements.

CONTRACTOR ASSURANCE. The Contractor makes the following assurance and agrees to include the assurance in each subcontract that the Contractor signs with a subcontractor.

The Contractor, subrecipient, or subcontractor shall not discriminate on the basis of race, color, national origin, or sex in the performance of this contract. The Contractor shall carry out applicable requirements of 49 CFR Part 26 in the award and administration of contracts funded in whole or in part with federal or state funds. Failure by the Contractor to carry out these requirements is a material breach of this contract, which may result in the termination of this contract or such other remedy as the recipient deems appropriate.

OVERALL GOAL SET FOR THE DEPARTMENT. As a requirement of compliance with 49 CFR Part 26, the Department has set an overall goal for DBE participation in its federally assisted contracts. That goal applies to all federal-aid funds the Department will expend in its federally assisted contracts for the subject reporting fiscal year. The Department is required to make a good faith effort to achieve the overall goal. The dollar amount paid to all approved DBE companies performing work called for in this contract is eligible to be credited toward fulfillment of the Department's overall goal.

CONTRACT GOAL TO BE ACHIEVED BY THE CONTRACTOR. This contract includes a specific DBE utilization goal established by the Department. The goal has been included because the Department has determined that the work of this contract has subcontracting opportunities that may be suitable for performance by DBE companies. The determination is

based on an assessment of the type of work, the location of the work, and the availability of DBE companies to do a part of the work. The assessment indicates that, in the absence of unlawful discrimination, and in an arena of fair and open competition, DBE companies can be expected to perform 21.00% of the work. This percentage is set as the DBE participation goal for this contract. Consequently, in addition to the other award criteria established for this contract, the Department will only award this contract to a bidder who makes a good faith effort to meet this goal of DBE participation in the performance of the work. A bidder makes a good faith effort for award consideration if either of the following is done in accordance with the procedures set for in this Special Provision:

- (a) The bidder documents that enough DBE participation has been obtained to meet the goal: or
- (b) The bidder documents that a good faith effort has been made to meet the goal, even though the effort did not succeed in obtaining enough DBE participation to meet the goal.

DBE LOCATOR REFERENCES. Bidders shall consult the IL UCP DBE Directory as a reference source for DBE-certified companies. In addition, the Department maintains a letting and item specific DBE locator information system whereby DBE companies can register their interest in providing quotes on particular bid items advertised for letting. Information concerning DBE companies willing to quote work for particular contracts may be obtained by contacting the Department's Bureau of Small Business Enterprises at telephone number (217)785-4611, or by visiting the Department's website at [www.dot.il.gov](http://www.dot.il.gov).

BIDDING PROCEDURES. Compliance with this Special Provision is a material bidding requirement. The failure of the bidder to comply will render the bid not responsive.

- (a) The bidder shall submit a Disadvantaged Business Utilization Plan on Department forms SBE 2025 and 2026 with the bid.
- (b) The Utilization Plan shall indicate that the bidder either has obtained sufficient DBE participation commitments to meet the contract goal or has not obtained enough DBE participation commitments in spite of a good faith effort to meet the goal. The Utilization Plan shall further provide the name, telephone number, and telefax number of a responsible official of the bidder designated for purposes of notification of plan approval or disapproval under the procedures of this Special Provision.
- (c) The Utilization Plan shall include a DBE Participation Commitment Statement, Department form SBE 2025, for each DBE proposed for the performance of work to achieve the contract goal. For bidding purposes, submission of the completed SBE 2025 forms, signed by the DBEs and faxed to the bidder will be acceptable as long as the original is available and provided upon request. All elements of information indicated on the said form shall be provided, including but not limited to the following:
  - (1) The names and addresses of DBE firms that will participate in the contract;

- (2) A description, including pay item numbers, of the work each DBE will perform;
- (3) The dollar amount of the participation of each DBE firm participating. The dollar amount of participation for identified work shall specifically state the quantity, unit price, and total subcontract price for the work to be completed by the DBE. If partial pay items are to be performed by the DBE, indicate the portion of each item, a unit price where appropriate and the subcontract price amount;
- (4) DBE Participation Commitment Statements, form SBE 2025, signed by the bidder and each participating DBE firm documenting the commitment to use the DBE subcontractors whose participation is submitted to meet the contract goal;
- (5) if the bidder is a joint venture comprised of DBE companies and non-DBE companies, the plan must also include a clear identification of the portion of the work to be performed by the DBE partner(s); and,
- (6) If the contract goal is not met, evidence of good faith efforts.

GOOD FAITH EFFORT PROCEDURES. The contract will not be awarded until the Utilization Plan submitted by the apparent successful bidder is approved. All information submitted by the bidder must be complete, accurate and adequately document that enough DBE participation has been obtained or document that good faith efforts of the bidder, in the event enough DBE participation has not been obtained, before the Department will commit to the performance of the contract by the bidder. The Utilization Plan will be approved by the Department if the Utilization Plan documents sufficient commercially useful DBE work performance to meet the contract goal or the bidder submits sufficient documentation of a good faith effort to meet the contract goal pursuant to 49 CFR Part 26, Appendix A. The Utilization Plan will not be approved by the Department if the Utilization Plan does not document sufficient DBE participation to meet the contract goal unless the apparent successful bidder documented in the Utilization Plan that it made a good faith effort to meet the goal. This means that the bidder must show that all necessary and reasonable steps were taken to achieve the contract goal. Necessary and reasonable steps are those which, by their scope, intensity and appropriateness to the objective, could reasonably be expected to obtain sufficient DBE participation, even if they were not successful. The Department will consider the quality, quantity, and intensity of the kinds of efforts that the bidder has made. Mere *pro forma* efforts, in other words, efforts done as a matter of form, are not good faith efforts; rather, the bidder is expected to have taken genuine efforts that would be reasonably expected of a bidder actively and aggressively trying to obtain DBE participation sufficient to meet the contract goal.

- (a) The following is a list of types of action that the Department will consider as part of the evaluation of the bidder's good faith efforts to obtain participation. These listed factors are not intended to be a mandatory checklist and are not intended to be exhaustive. Other factors or efforts brought to the attention of the Department may be relevant in appropriate cases, and will be considered by the Department.

- (1) Soliciting through all reasonable and available means (e.g. attendance at pre-bid meetings, advertising and/or written notices) the interest of all certified DBE companies that have the capability to perform the work of the contract. The bidder must solicit this interest within sufficient time to allow the DBE companies to respond to the solicitation. The bidder must determine with certainty if the DBE companies are interested by taking appropriate steps to follow up initial solicitations.
- (2) Selecting portions of the work to be performed by DBE companies in order to increase the likelihood that the DBE goals will be achieved. This includes, where appropriate, breaking out contract work items into economically feasible units to facilitate DBE participation, even when the prime Contractor might otherwise prefer to perform these work items with its own forces.
- (3) Providing interested DBE companies with adequate information about the plans, specifications, and requirements of the contract in a timely manner to assist them in responding to a solicitation.
- (4) a. Negotiating in good faith with interested DBE companies. It is the bidder's responsibility to make a portion of the work available to DBE subcontractors and suppliers and to select those portions of the work or material needs consistent with the available DBE subcontractors and suppliers, so as to facilitate DBE participation. Evidence of such negotiation includes the names, addresses, and telephone numbers of DBE companies that were considered; a description of the information provided regarding the plans and specifications for the work selected for subcontracting; and evidence as to why additional agreements could not be reached for DBE companies to perform the work.  
  
b. A bidder using good business judgment would consider a number of factors in negotiating with subcontractors, including DBE subcontractors, and would take a firm's price and capabilities as well as contract goals into consideration. However, the fact that there may be some additional costs involved in finding and using DBE companies is not in itself sufficient reason for a bidder's failure to meet the contract DBE goal, as long as such costs are reasonable. Also the ability or desire of a bidder to perform the work of a contract with its own organization does not relieve the bidder of the responsibility to make good faith efforts. Bidders are not, however, required to accept higher quotes from DBE companies if the price difference is excessive or unreasonable.
- (5) Not rejecting DBE companies as being unqualified without sound reasons based on a thorough investigation of their capabilities. The bidder's standing within its industry, membership in specific groups, organizations, or associations and political or social affiliations (for example union vs. non-union employee status) are not legitimate causes for the rejection or non-solicitation of bids in the bidder's efforts to meet the project goal.

- (6) Making efforts to assist interested DBE companies in obtaining bonding, lines of credit, or insurance as required by the recipient or Contractor.
  - (7) Making efforts to assist interested DBE companies in obtaining necessary equipment, supplies, materials, or related assistance or services.
  - (8) Effectively using the services of available minority/women community organizations; minority/women contractors' groups; local, state, and federal minority/women business assistance offices; and other organizations as allowed on a case-by-case basis to provide assistance in the recruitment and placement of DBE companies.
- (b) If the Department determines that the apparent successful bidder has made a good faith effort to secure the work commitment of DBE companies to meet the contract goal, the Department will award the contract provided that it is otherwise eligible for award. If the Department determines that the bidder has failed to meet the requirements of this Special Provision or that a good faith effort has not been made, the Department will notify the responsible company official designated in the Utilization Plan that the bid is not responsive. The notification shall include a statement of reasons for the determination.
- (c) The bidder may request administrative reconsideration of a determination adverse to the bidder within the five working days after the receipt of the notification date of the determination by delivering the request to the Department of Transportation, Bureau of Small Business Enterprises, Contract Compliance Section, 2300 South Dirksen Parkway, Room 319, Springfield, Illinois 62764 (Telefax: (217)785-1524). Deposit of the request in the United States mail on or before the fifth business day shall not be deemed delivery. The determination shall become final if a request is not made and delivered. A request may provide additional written documentation and/or argument concerning the issues raised in the determination statement of reasons, provided the documentation and arguments address efforts made prior to submitting the bid. The request will be forwarded to the Department's Reconsideration Officer. The Reconsideration Officer will extend an opportunity to the bidder to meet in person in order to consider all issues of documentation and whether the bidder made a good faith effort to meet the goal. After the review by the Reconsideration Officer, the bidder will be sent a written decision within ten working days after receipt of the request for consideration, explaining the basis for finding that the bidder did or did not meet the goal or make adequate good faith efforts to do so. A final decision by the Reconsideration Officer that a good faith effort was made shall approve the Utilization Plan submitted by the bidder and shall clear the contract for award. A final decision that a good faith effort was not made shall render the bid not responsive.

CALCULATING DBE PARTICIPATION. The Utilization Plan values represent work anticipated to be performed and paid for upon satisfactory completion. The Department is only able to count toward the achievement of the overall goal and the contract goal the value of payments made for the work actually performed by DBE companies. In addition, a DBE must perform a commercially useful function on the contract to be counted. A commercially useful function is



generally performed when the DBE is responsible for the work and is carrying out its responsibilities by actually performing, managing, and supervising the work involved. The Department and Contractor are governed by the provisions of 49 CFR Part 26.55(c) on questions of commercially useful functions as it affects the work. Specific counting guidelines are provided in 49 CFR Part 26.55, the provisions of which govern over the summary contained herein.

- (a) DBE as the Contractor: 100 percent goal credit for that portion of the work performed by the DBE's own forces, including the cost of materials and supplies. Work that a DBE subcontracts to a non-DBE does not count toward the DBE goals.
- (b) DBE as a joint venture Contractor: 100 percent goal credit for that portion of the total dollar value of the contract equal to the distinct, clearly defined portion of the work performed by the DBE's own forces.
- (c) DBE as a subcontractor: 100 percent goal credit for the work of the subcontract performed by the DBE's own forces, including the cost of materials and supplies, excluding the purchase of materials and supplies or the lease of equipment by the DBE subcontractor from the prime Contractor or its affiliates. Work that a DBE subcontractor in turn subcontracts to a non-DBE does not count toward the DBE goal.
- (d) DBE as a trucker: 100 percent goal credit for trucking participation provided the DBE is responsible for the management and supervision of the entire trucking operation for which it is responsible. At least one truck owned, operated, licensed, and insured by the DBE must be used on the contract. Credit will be given for the following:
  - (1) The DBE may lease trucks from another DBE firm, including an owner-operator who is certified as a DBE. The DBE who leases trucks from another DBE receives credit for the total value of the transportation services the lessee DBE provides on the contract.
  - (2) The DBE may also lease trucks from a non-DBE firm, including from an owner-operator. The DBE who leases trucks from a non-DBE is entitled to credit only for the fee or commission it receives as a result of the lease arrangement.
- (e) DBE as a material supplier:
  - (1) 60 percent goal credit for the cost of the materials or supplies purchased from a DBE regular dealer.
  - (2) 100 percent goal credit for the cost of materials or supplies obtained from a DBE manufacturer.
  - (3) 100 percent credit for the value of reasonable fees and commissions for the procurement of materials and supplies if not a regular dealer or manufacturer.

CONTRACT COMPLIANCE. Compliance with this Special Provision is an essential part of the contract. The Department is prohibited by federal regulations from crediting the participation of a DBE included in the Utilization Plan toward either the contract goal or the Department's overall goal until the amount to be applied toward the goals has been paid to the DBE. The following administrative procedures and remedies govern the compliance by the Contractor with the contractual obligations established by the Utilization Plan. After approval of the Utilization Plan and award of the contract, the Utilization Plan and individual DBE Participation Statements become part of the contract. If the Contractor did not succeed in obtaining enough DBE participation to achieve the advertised contract goal, and the Utilization Plan was approved and contract awarded based upon a determination of good faith, the total dollar value of DBE work calculated in the approved Utilization Plan as a percentage of the awarded contract value shall become the amended contract goal. All work indicated for performance by an approved DBE shall be performed, managed, and supervised by the DBE executing the Participation Statement.

- (a) NO AMENDMENT. No amendment to the Utilization Plan may be made without prior written approval from the Department's Bureau of Small Business Enterprises. All requests for amendment to the Utilization Plan shall be submitted to the Department of Transportation, Bureau of Small Business Enterprises, Contract Compliance Section, 2300 South Dirksen Parkway, Room 319, Springfield, Illinois 62764. Telephone number (217)785-4611. Telefax number (217)785-1524.
- (b) TERMINATION OR REPLACEMENT. The Contractor shall not terminate or replace a DBE listed on the approved Utilization Plan, or perform with other forces work designated for a listed DBE except as provided in the Special Provision.
- (c) CHANGES TO WORK. Any deviation from the DBE condition-of-award or contract plans, specifications, or special provisions must be approved, in writing, by the Department as provided elsewhere in the Contract. The Contractor shall notify affected DBEs in writing of any changes in the scope of work which result in a reduction in the dollar amount condition-of-award to the contract. Where the revision includes work committed to a new DBE subcontractor, not previously involved in the project, then a Request for Approval of Subcontractor, Department form BC 260A, must be signed and submitted. If the commitment of work is in the form of additional tasks assigned to an existing subcontract, then a new Request for Approval of Subcontractor shall not be required. However, the Contractor must document efforts to assure that the existing DBE subcontractor is capable of performing the additional work and has agreed in writing to the change.
- (d) ALTERNATIVE WORK METHODS. In addition to the above requirements for reductions in the condition of award, additional requirements apply to the two cases of Contractor-initiated work substitution proposals. Where the contract allows alternate work methods which serve to delete or create underruns in condition of award DBE work, and the Contractor selects that alternate method or, where the Contractor proposes a substitute work method or material that serves to diminish or delete work committed to a DBE and replace it with other work, then the Contractor must demonstrate one of the following:

- (1) That the replacement work will be performed by the same DBE (as long as the DBE is certified in the respective item of work) in a modification of the condition of award; or
- (2) That the DBE is aware that its work will be deleted or will experience underruns and has agreed in writing to the change. If this occurs, the Contractor shall substitute other work of equivalent value to a certified DBE or provide documentation of good faith efforts to do so; or
- (3) That the DBE is not capable of performing the replacement work or has declined to perform the work at a reasonable competitive price. If this occurs, the Contractor shall substitute other work of equivalent value to a certified DBE or provide documentation of good faith efforts to do so.

(e) TERMINATION AND REPLACEMENT PROCEDURES. The Contractor shall not terminate or replace a DBE subcontractor listed in the approved Utilization Plan without prior written consent. This includes, but is not limited to, instances in which the Contractor seeks to perform work originally designated for a DBE subcontractor with its own forces or those of an affiliate, a non-DBE firm, or with another DBE firm. Written consent will be granted only if the Bureau of Small Business Enterprises agrees, for reasons stated in its concurrence document, that the Contractor has good cause to terminate or replace the DBE firm. Before transmitting to the Bureau of Small Business Enterprises any request to terminate and/or substitute a DBE subcontractor, the Contractor shall give notice in writing to the DBE subcontractor, with a copy to the Bureau, of its intent to request to terminate and/or substitute, and the reason for the request. The Contractor shall give the DBE five days to respond to the Contractor's notice. The DBE so notified shall advise the Bureau and the Contractor of the reasons, if any, why it objects to the proposed termination of its subcontract and why the Bureau should not approve the Contractor's action. If required in a particular case as a matter of public necessity, the Bureau may provide a response period shorter than five days.

For purposes of this paragraph, good cause includes the following circumstances:

- (1) The listed DBE subcontractor fails or refuses to execute a written contract;
- (2) The listed DBE subcontractor fails or refuses to perform the work of its subcontract in a way consistent with normal industry standards. Provided, however, that good cause does not exist if the failure or refusal of the DBE subcontractor to perform its work on the subcontract results from the bad faith or discriminatory action of the prime contractor;
- (3) The listed DBE subcontractor fails or refuses to meet the prime Contractor's reasonable, nondiscriminatory bond requirements;

- (4) The listed DBE subcontractor becomes bankrupt, insolvent, or exhibits credit unworthiness;
- (5) The listed DBE subcontractor is ineligible to work on public works projects because of suspension and debarment proceedings pursuant 2 CFR Parts 180, 215 and 1,200 or applicable state law.
- (6) You have determined that the listed DBE subcontractor is not a responsible contractor;
- (7) The listed DBE subcontractor voluntarily withdraws from the projects and provides to you written notice of its withdrawal;
- (8) The listed DBE is ineligible to receive DBE credit for the type of work required;
- (9) A DBE owner dies or becomes disabled with the result that the listed DBE contractor is unable to complete its work on the contract;
- (10) Other documented good cause that compels the termination of the DBE subcontractor. Provided, that good cause does not exist if the prime Contractor seeks to terminate a DBE it relied upon to obtain the contract so that the prime Contractor can self-perform the work for which the DBE contractor was engaged or so that the prime Contractor can substitute another DBE or non-DBE contractor after contract award.

When a DBE is terminated, or fails to complete its work on the Contract for any reason the Contractor shall make a good faith effort to find another DBE to substitute for the original DBE to perform at least the same amount of work under the contract as the terminated DBE to the extent needed to meet the established Contract goal.

- (f) PAYMENT RECORDS. The Contractor shall maintain a record of payments for work performed to the DBE participants. The records shall be made available to the Department for inspection upon request. After the performance of the final item of work or delivery of material by a DBE and final payment therefore to the DBE by the Contractor, but not later than thirty calendar days after payment has been made by the Department to the Contractor for such work or material, the Contractor shall submit a DBE Payment Agreement on Department form SBE 2115 to the Regional Engineer. If full and final payment has not been made to the DBE, the DBE Payment Agreement shall indicate whether a disagreement as to the payment required exists between the Contractor and the DBE or if the Contractor believes that the work has not been satisfactorily completed. If the Contractor does not have the full amount of work indicated in the Utilization Plan performed by the BDE companies indicated in the Utilization Plan and after good faith efforts are reviewed, the Department may deduct from contract payments to the Contractor the amount of the goal not achieved as liquidated and ascertained damages. The Contractor may request an administrative

| reconsideration of any amount deducted as damages pursuant to subsection (h) of this part.

| (g) ENFORCEMENT. The Department reserves the right to withhold payment to the Contractor to enforce the provisions of this Special Provision. Final payment shall not be made on the contract until such time as the Contractor submits sufficient documentation demonstrating achievement of the goal in accordance with this Special Provision or after liquidated damages have been determined and collected.

| (h) RECONSIDERATION. Notwithstanding any other provision of the contract, including but not limited to Article 109.09 of the Standard Specifications, the Contractor may request administrative reconsideration of a decision to deduct the amount of the goal not achieved as liquidated damages. A request to reconsider shall be delivered to the Contract Compliance Section and shall be handled and considered in the same manner as set forth in paragraph (c) of "Good Faith Effort Procedures" of this Special Provision, except a final decision that a good faith effort was not made during contract performance to achieve the goal agreed to in the Utilization Plan shall be the final administrative decision of the Department.

80029

**GRANULAR MATERIALS (BDE)**

Effective: November 1, 2012

Revise the title of Article 1003.04 of the Standard Specifications to read:

**“1003.04 Fine Aggregate for Bedding, Trench Backfill, Embankment, Porous Granular Backfill, Sand Backfill for Underdrains, and French Drains.”**

Revise Article 1003.04(c) of the Standard Specifications to read:

“(c) Gradation. The fine aggregate gradations for granular embankment, granular backfill, bedding, and trench backfill for pipe culverts and storm sewers shall be FA 1, FA 2, or FA 6 through FA 21.

The fine aggregate gradation for porous granular embankment, porous granular backfill, french drains, and sand backfill for underdrains shall be FA 1, FA 2, or FA 20, except the percent passing the No. 200 (75 μm) sieve shall be 2±2.”

Revise Article 1004.05(c) of the Standard Specifications to read:

“(c) Gradation. The coarse aggregate gradations shall be as follows.

Application	Gradation
Blotter	CA 15
Granular Embankment, Granular Backfill, Bedding, and Trench Backfill for Pipe Culverts and Storm Sewers	CA 6, CA 9, CA 10, CA 12, CA17, CA18, and CA 19
Porous Granular Embankment, Porous Granular Backfill, and French Drains	CA 7, CA 8, CA 11, CA 15, CA 16 and CA 18”

80303

**HOT-MIX ASPHALT - DENSITY TESTING OF LONGITUDINAL JOINTS (BDE)**

Effective: January 1, 2010

Revised: April 1, 2012

Description. This work shall consist of testing the density of longitudinal joints as part of the quality control/quality assurance (QC/QA) of hot-mix asphalt (HMA). Work shall be according to Section 1030 of the Standard Specifications except as follows.

Quality Control/Quality Assurance (QC/QA). Delete the second and third sentence of the third paragraph of Article 1030.05(d)(3) of the Standard Specifications.

Add the following paragraphs to the end of Article 1030.05(d)(3) of the Standard Specifications:

“Longitudinal joint density testing shall be performed at each random density test location. Longitudinal joint testing shall be located at a distance equal to the lift thickness or a minimum of 4 in. (100 mm), from each pavement edge. (i.e. for a 5 in. (125 mm) lift the near edge of the density gauge or core barrel shall be within 5 in. (125 mm) from the edge of pavement.) Longitudinal joint density testing shall be performed using either a correlated nuclear gauge or cores.

- a. Confined Edge. Each confined edge density shall be represented by a one-minute nuclear density reading or a core density and shall be included in the average of density readings or core densities taken across the mat which represents the Individual Test.
- b. Unconfined Edge. Each unconfined edge joint density shall be represented by an average of three one-minute density readings or a single core density at the given density test location and shall meet the density requirements specified herein. The three one-minute readings shall be spaced ten feet apart longitudinally along the unconfined pavement edge and centered at the random density test location.”

Revise the Density Control Limits table in Article 1030.05(d)(4) of the Standard Specifications to read:

“Mixture Composition	Parameter	Individual Test (includes confined edges)	Unconfined Edge Joint Density Minimum
IL-4.75	Ndesign = 50	93.0 – 97.4%	91.0%
IL-9.5, IL-12.5	Ndesign ≥ 90	92.0 – 96.0%	90.0%
IL-9.5, IL-9.5L, IL-12.5	Ndesign < 90	92.5 – 97.4%	90.0%
IL-19.0, IL-25.0	Ndesign ≥ 90	93.0 – 96.0%	90.0%
IL-19.0, IL-19.0L, IL-25.0	Ndesign < 90	93.0 – 97.4%	90.0%

SMA	Ndesign = 50 & 80	93.5 – 97.4%	91.0%
All Other	Ndesign = 30	93.0 - 97.4%	90.0%"

80246



## LRFD STORM SEWER BURIAL TABLES (BDE)

Effective: November 1, 2013

Revise Article 550.02 of the Standard Specifications to read as follows:

"Item	Article Section
(a) Clay Sewer Pipe .....	1040.02
(b) Extra Strength Clay Pipe .....	1040.02
(c) Concrete Sewer, Storm Drain, and Culvert Pipe .....	1042
(d) Reinforced Concrete Culvert, Storm Drain, and Sewer Pipe .....	1042
(e) Reinforced Concrete Elliptical Culvert, Storm Drain, and Sewer Pipe (Note 1) .....	1042
(f) Reinforced Concrete Arch Culvert, Storm Drain, and Sewer Pipe (Note 1) .....	1042
(g) Polyvinyl Chloride (PVC) Pipe .....	1040.03
(h) Corrugated Polyvinyl Chloride (PVC) Pipe with a Smooth Interior .....	1040.03
(i) Corrugated Polypropylene (CPP) Pipe with Smooth Interior .....	1040.07
(j) Rubber Gaskets and Preformed Flexible Joint Sealants for Concrete Pipe .....	1056
(k) Mastic Joint Sealer for Pipe .....	1055
(l) External Sealing Band .....	1057
(m) Fine Aggregate (Note 2) .....	1003.04
(n) Coarse Aggregate (Note 3) .....	1004.05
(o) Reinforcement Bars and Welded Wire Fabric .....	1006.10
(p) Handling Hole Plugs .....	1042.16
(q) Polyethylene (PE) Pipe with a Smooth Interior .....	1040.04
(r) Corrugated Polyethylene (PE) Pipe with a Smooth Interior .....	1040.04

Note 1. The class of elliptical and arch pipe used for various storm sewer sizes and heights of fill shall conform to the requirements for circular pipe.

Note 2. The fine aggregate shall be moist.

Note 3. The coarse aggregate shall be wet."

Revise the table for permitted materials in Article 550.03 of the Standard Specifications as follows:

"Class	Materials
A	Rigid Pipes: Clay Sewer Pipe Extra Strength Clay Pipe Concrete Sewer, Storm Drain, and Culvert Pipe Reinforced Concrete Culvert, Storm Drain, and Sewer Pipe Reinforced Concrete Elliptical Culvert, Storm Drain, and Sewer Pipe Reinforced Concrete Arch Culvert, Storm Drain, and Sewer Pipe
B	Rigid Pipes: Clay Sewer Pipe Extra Strength Clay Pipe Concrete Sewer, Storm Drain, and Culvert Pipe Reinforced Concrete Culvert, Storm Drain, and Sewer Pipe Reinforced Concrete Elliptical Culvert, Storm Drain, and Sewer Pipe Reinforced Concrete Arch Culvert, Storm Drain, and Sewer Pipe Flexible Pipes: Polyvinyl Chloride (PVC) Pipe Corrugated Polyvinyl Chloride Pipe (PVC) with a Smooth Interior Polyethylene (PE) Pipe with a Smooth Interior Corrugated Polyethylene (PE) Pipe with a Smooth Interior Corrugated Polypropylene (CPP) Pipe with a Smooth Interior"

Replace the storm sewers tables in Article 550.03 of the Standard Specifications with the following:

STORM SEWERS																
KIND OF MATERIAL PERMITTED AND STRENGTH REQUIRED FOR A GIVEN PIPE DIAMETERS AND FILL HEIGHTS OVER THE TOP OF THE PIPE																
Nominal Diameter in.	Type 2															
	Fill Height: Greater than 3' not exceeding 10'															
	RCCP	CSP	ESCP	PVC	CPVC	PE	CPE	CPP	RCCP	CSP	ESCP	PVC	CPVC	PE	CPE	CPP
10	NA	3	X	X	X	X	NA	NA	1	*X	X	X	X	X	X	NA
12	IV	NA	X	X	X	X	X	II	1	*X	X	X	X	X	X	X
15	IV	NA	X	X	X	X	X	II	1	*X	X	X	X	NA	X	X
18	IV	NA	X	X	X	X	X	II	2	X	X	X	X	X	X	X
21	III	NA	X	X	X	X	NA	II	2	X	X	X	X	NA	NA	NA
24	III	NA	X	X	X	X	X	II	2	X	X	X	X	X	X	X
27	III	NA	NA	NA	NA	NA	NA	II	3	X	NA	NA	NA	NA	NA	NA
30	IV	NA	X	X	X	X	X	II	3	X	X	X	X	X	X	X
33	III	NA	NA	NA	NA	NA	NA	II	NA	X	NA	NA	NA	NA	NA	NA
36	III	NA	NA	NA	X	X	X	II	NA	X	X	X	X	X	X	X
42	II	NA	X	X	X	X	NA	II	NA	X	X	NA	NA	NA	NA	NA
48	II	NA	X	X	X	X	X	II	NA	X	X	NA	NA	NA	NA	NA
54	II	NA	NA	NA	NA	NA	NA	II	NA	NA	NA	NA	NA	NA	NA	NA
60	II	NA	NA	NA	NA	NA	X	II	NA	NA	NA	NA	NA	NA	NA	X
66	II	NA	NA	NA	NA	NA	NA	II	NA	NA	NA	NA	NA	NA	NA	NA
72	II	NA	NA	NA	NA	NA	NA	II	NA	NA	NA	NA	NA	NA	NA	NA
78	II	NA	NA	NA	NA	NA	NA	II	NA	NA	NA	NA	NA	NA	NA	NA
84	II	NA	NA	NA	NA	NA	NA	II	NA	NA	NA	NA	NA	NA	NA	NA
90	II	NA	NA	NA	NA	NA	NA	II	NA	NA	NA	NA	NA	NA	NA	NA
96	II	NA	NA	NA	NA	NA	NA	II	NA	NA	NA	NA	NA	NA	NA	NA
102	II	NA	NA	NA	NA	NA	NA	II	NA	NA	NA	NA	NA	NA	NA	NA
108	II	NA	NA	NA	NA	NA	NA	II	NA	NA	NA	NA	NA	NA	NA	NA
RCCP	Reinforced Concrete Culvert, Storm Drain, and Sewer Pipe															
CSP	Concrete Sewer, Storm drain, and Culvert Pipe															
PVC	Polyvinyl Chloride Pipe															
CPVC	Corrugated Polyvinyl Chloride Pipe															
ESCP	Extra Strength Clay Pipe															
PE	Polyethylene Pipe with a Smooth Interior															
CPE	Corrugated Polyethylene Pipe with a Smooth Interior															
CPP	Corrugated Polypropylene pipe with a Smooth Interior															
X	This material may be used for the given pipe diameter and fill height.															
NA	This material is Not Acceptable for the given pipe diameter and fill height.															
*	May also use Standard Strength Clay Pipe															

STORM SEWERS (Metric)																
KIND OF MATERIAL PERMITTED AND STRENGTH REQUIRED FOR A GIVEN PIPE DIAMETERS AND FILL HEIGHTS OVER THE TOP OF THE PIPE																
Type 2																
Nominal Diameter In.	Type 1							Type 2								
	Fill Height: 1 m' and less With 300 mm minimum cover							Fill Height: Greater than 1 m not exceeding 3 m								
	RCCP	CSP	ESCP	PVC	CPVC	PE	CPE	CPP	RCCP	CSP	ESCP	PVC	CPVC	PE	CPE	CPP
250	NA	3	X	X	X	X	X	NA	NA	1	*X	X	X	X	X	NA
300	IV	NA	X	X	X	X	X	X	II	1	*X	X	X	X	X	X
375	IV	NA	NA	X	X	NA	X	X	II	1	*X	X	X	NA	X	X
450	IV	NA	NA	X	X	X	X	X	II	2	X	X	X	X	X	X
525	III	NA	NA	X	X	NA	NA	NA	II	2	X	X	X	NA	NA	NA
600	III	NA	NA	X	X	X	X	X	II	2	X	X	X	X	X	X
675	III	NA	NA	NA	NA	NA	NA	NA	II	3	X	NA	NA	NA	NA	NA
750	IV	NA	NA	NA	X	X	X	X	II	3	X	X	X	X	X	X
825	III	NA	NA	NA	NA	NA	NA	NA	II	NA	X	NA	NA	NA	NA	NA
900	III	NA	NA	NA	X	X	X	X	II	NA	X	X	X	X	NA	X
1050	II	NA	X	X	NA	X	X	NA	II	NA	X	X	NA	X	NA	NA
1200	II	NA	X	X	NA	X	X	NA	II	NA	X	X	NA	X	NA	NA
1350	II	NA	NA	NA	NA	NA	NA	NA	II	NA	NA	NA	NA	NA	NA	NA
1500	II	NA	NA	NA	NA	NA	NA	NA	II	NA	NA	NA	NA	NA	NA	X
1650	II	NA	NA	NA	NA	NA	NA	NA	II	NA	NA	NA	NA	NA	NA	NA
1800	II	NA	NA	NA	NA	NA	NA	NA	II	NA	NA	NA	NA	NA	NA	NA
1950	II	NA	NA	NA	NA	NA	NA	NA	II	NA	NA	NA	NA	NA	NA	NA
2100	II	NA	NA	NA	NA	NA	NA	NA	II	NA	NA	NA	NA	NA	NA	NA
2250	II	NA	NA	NA	NA	NA	NA	NA	III	NA	NA	NA	NA	NA	NA	NA
2400	II	NA	NA	NA	NA	NA	NA	NA	III	NA	NA	NA	NA	NA	NA	NA
2550	II	NA	NA	NA	NA	NA	NA	NA	III	NA	NA	NA	NA	NA	NA	NA
2700	II	NA	NA	NA	NA	NA	NA	NA	III	NA	NA	NA	NA	NA	NA	NA

RCCP Reinforced Concrete Culvert, Storm Drain, and Sewer Pipe  
CSP Concrete Sewer, Storm drain, and Culvert Pipe  
PVC Polyvinyl Chloride Pipe  
CPVC Corrugated Polyvinyl Chloride Pipe  
ESCP Extra Strength Clay Pipe  
PE Polyethylene Pipe with a Smooth Interior  
CPE Corrugated Polyethylene Pipe with a Smooth Interior  
CPP Corrugated Polypropylene pipe with a Smooth Interior  
X This material may be used for the given pipe diameter and fill height.  
NA This material is Not Acceptable for the given pipe diameter and fill height.  
\* May also use Standard Strength Clay Pipe

**STORM SEWERS**  
**KIND OF MATERIAL PERMITTED AND STRENGTH REQUIRED**  
**FOR A GIVEN PIPE DIAMETERS AND FILL HEIGHTS OVER THE TOP OF THE PIPE**

Nominal Diameter in.	Type 3											Type 4					
	Fill Height: Greater than 10' not exceeding 15'											Fill Height: Greater than 15' not exceeding 20'					
	RCCP	CSP	ESCP	PVC	CPVC	PE	CPE	CPP	RCCP	CSP	ESCP	PVC	CPVC	PE	CPP		
10	NA	2	X	X	X	X	NA	NA	3	X	X	X	X	X	NA		
12	III	2	X	X	X	NA	X	IV	NA	NA	X	X	X	X	NA		
15	III	3	X	X	NA	NA	X	IV	NA	NA	X	X	NA	X	NA		
18	III	NA	X	X	X	NA	X	IV	NA	NA	X	X	X	X	NA		
21	III	NA	NA	X	NA	NA	NA	IV	NA	NA	X	X	X	NA	NA		
24	III	NA	NA	X	X	NA	NA	IV	NA	NA	X	X	X	NA	NA		
27	III	NA	NA	NA	NA	NA	NA	IV	NA	NA	NA	NA	NA	NA	NA		
30	III	NA	NA	X	X	NA	X	IV	NA	NA	X	X	X	NA	NA		
33	III	NA	NA	NA	NA	NA	NA	IV	NA	NA	NA	NA	NA	NA	NA		
36	III	NA	NA	NA	X	X	NA	IV	NA	NA	X	X	X	NA	NA		
42	III	NA	NA	NA	NA	X	NA	IV	NA	NA	X	NA	NA	NA	NA		
48	III	NA	NA	NA	NA	X	NA	IV	NA	NA	X	NA	NA	NA	NA		
54	III	NA	NA	NA	NA	NA	NA	IV	NA	NA	NA	NA	NA	NA	NA		
60	III	NA	NA	NA	NA	NA	NA	IV	NA	NA	NA	NA	NA	NA	NA		
66	III	NA	NA	NA	NA	NA	NA	IV	NA	NA	NA	NA	NA	NA	NA		
72	III	NA	NA	NA	NA	NA	NA	IV	NA	NA	NA	NA	NA	NA	NA		
78	III	NA	NA	NA	NA	NA	NA	IV	NA	NA	NA	NA	NA	NA	NA		
84	III	NA	NA	NA	NA	NA	NA	IV	NA	NA	NA	NA	NA	NA	NA		
90	III	NA	NA	NA	NA	NA	NA	IV	NA	NA	NA	NA	NA	NA	NA		
96	III	NA	NA	NA	NA	NA	NA	IV	NA	NA	NA	NA	NA	NA	NA		
102	IV	NA	NA	NA	NA	NA	NA	IV	NA	NA	NA	NA	NA	NA	NA		
108	1360	NA	NA	NA	NA	NA	NA	1710	NA	NA	NA	NA	NA	NA	NA		

RCCP Reinforced Concrete Culvert, Storm Drain, and Sewer Pipe  
 CSP Concrete Sewer, Storm drain, and Culvert Pipe  
 PVC Polyvinyl Chloride Pipe  
 CPVC Corrugated Polyvinyl Chloride Pipe  
 ESCP Extra Strength Clay Pipe  
 PE Polyethylene Pipe with a Smooth Interior  
 CPE Corrugated Polyethylene Pipe with a Smooth Interior  
 CPP Corrugated Polypropylene pipe with a Smooth Interior  
 X This material may be used for the given pipe diameter and fill height.  
 NA This material is Not Acceptable for the given pipe diameter and fill height.  
 \* May also use Standard Strength Clay Pipe  
 Note RCCP with a number instead of a Roman numeral shall be furnished according to AASHTO M170 Section 6. This number represents the D-load to produce a 0.01 in crack.

STORM SEWERS (metric)															
KIND OF MATERIAL PERMITTED AND STRENGTH REQUIRED FOR A GIVEN PIPE DIAMETERS AND FILL HEIGHTS OVER THE TOP OF THE PIPE															
Nominal Diameter in.	Type 3							Type 4							
	Fill Height: Greater than 3 m not exceeding 4.5 m							Fill Height: Greater than 4.5 m not exceeding 6 m							
	RCCP	CSP	ESCP	PVC	CPVC	PE	CPE	CPP	RCCP	CSP	ESCP	PVC	CPVC	PE	CPP
250	NA	2	X	X	X	X	X	NA	3	X	X	X	X	X	NA
300	III	2	X	X	X	NA	NA	X	NA	NA	X	X	X	X	NA
375	III	3	X	X	X	NA	NA	X	NA	NA	X	X	X	NA	X
450	III	NA	X	X	X	X	NA	X	NA	NA	X	X	X	X	NA
525	III	NA	X	X	X	NA	NA	NA	NA	NA	X	X	X	NA	NA
600	III	NA	X	X	X	X	NA	NA	NA	NA	X	X	X	X	NA
675	III	NA	NA	NA	NA	NA	NA	NA	NA	NA	NA	NA	NA	NA	NA
750	III	NA	NA	NA	X	X	NA	X	NA	NA	X	X	X	X	NA
825	III	NA	NA	NA	NA	NA	NA	NA	NA	NA	NA	NA	NA	NA	NA
900	III	NA	NA	NA	X	X	NA	NA	NA	NA	X	X	X	X	NA
1050	III	NA	NA	NA	X	X	NA	NA	NA	NA	X	X	X	X	NA
1200	III	NA	NA	NA	NA	X	NA	NA	NA	NA	NA	NA	NA	X	NA
1350	III	NA	NA	NA	NA	NA	NA	NA	NA	NA	NA	NA	NA	NA	NA
1500	III	NA	NA	NA	NA	NA	NA	NA	NA	NA	NA	NA	NA	NA	NA
1650	III	NA	NA	NA	NA	NA	NA	NA	NA	NA	NA	NA	NA	NA	NA
1800	III	NA	NA	NA	NA	NA	NA	NA	NA	NA	NA	NA	NA	NA	NA
1950	III	NA	NA	NA	NA	NA	NA	NA	NA	NA	NA	NA	NA	NA	NA
2100	III	NA	NA	NA	NA	NA	NA	NA	NA	NA	NA	NA	NA	NA	NA
2250	III	NA	NA	NA	NA	NA	NA	NA	NA	NA	NA	NA	NA	NA	NA
2400	III	NA	NA	NA	NA	NA	NA	NA	NA	NA	NA	NA	NA	NA	NA
2550	IV	NA	NA	NA	NA	NA	NA	NA	NA	NA	NA	NA	NA	NA	NA
2700	70	NA	NA	NA	NA	NA	NA	NA	NA	NA	NA	NA	NA	NA	NA

RCCP Reinforced Concrete Culvert, Storm Drain, and Sewer Pipe  
CSP Concrete Sewer, Storm drain, and Culvert Pipe  
PVC Polyvinyl Chloride Pipe  
CPVC Corrugated Polyvinyl Chloride Pipe  
ESCP Extra Strength Clay Pipe  
PE Polyethylene Pipe with a Smooth Interior  
CPE Corrugated Polyethylene Pipe with a Smooth Interior  
CPP Corrugated Polypropylene pipe with a Smooth Interior  
X This material is Not Acceptable for the given pipe diameter and fill height.  
\* This material is Not Acceptable for the given pipe diameter and fill height.  
Note May also use Standard Strength Clay Pipe  
RCCP with a number instead of a Roman numeral shall be furnished according to AASHTO M170 Section 6. This number represents the metric D-load to produce a 25.4 micro-meter crack.

STORM SEWERS KIND OF MATERIAL PERMITTED AND STRENGTH REQUIRED FOR A GIVEN PIPE DIAMETERS AND FILL HEIGHTS OVER THE TOP OF THE PIPE									
Nominal Diameter in.	Type 5 Fill Height: Greater than 20' not exceeding 25'			Type 6 Fill Height: Greater than 25' not exceeding 30'			Type 7 Fill Height: Greater than 30' not exceeding 35'		
	RCCP	PVC	CPVC	RCCP	PVC	CPVC	RCCP	CPVC	CPVC
	10	NA	X	X	NA	X	X	NA	X
12	IV	X	X	V	X	X	V	V	X
15	IV	X	X	V	X	X	V	V	X
18	IV	X	X	V	X	X	V	V	X
21	IV	X	X	V	X	X	V	V	X
24	IV	X	X	V	X	X	V	V	X
27	IV	NA	NA	V	NA	NA	V	NA	NA
30	IV	X	X	V	X	X	V	X	X
33	IV	NA	NA	V	NA	NA	V	NA	NA
36	IV	X	X	V	X	X	V	X	X
42	IV	X	NA	V	X	NA	V	NA	NA
48	IV	X	NA	V	X	NA	V	NA	NA
54	IV	NA	NA	V	NA	NA	V	NA	NA
60	IV	NA	NA	V	NA	NA	V	NA	NA
66	IV	NA	NA	V	NA	NA	V	NA	NA
72	V	NA	NA	V	NA	NA	V	NA	NA
78	2020	NA	NA	2370	NA	NA	2730	NA	NA
84	2020	NA	NA	2380	NA	NA	2740	NA	NA
90	2030	NA	NA	2390	NA	NA	2750	NA	NA
96	2040	NA	NA	2400	NA	NA	2750	NA	NA
102	2050	NA	NA	2410	NA	NA	2760	NA	NA
108	2060	NA	NA	2410	NA	NA	2770	NA	NA

RCCP Reinforced Concrete Culvert, Storm Drain, and Sewer Pipe

PVC Polyvinyl Chloride Pipe

CPVC Corrugated Polyvinyl Chloride Pipe

ESCP Extra Strength Clay Pipe

X This material may be used for the given pipe diameter and fill height.

NA This material is Not Acceptable for the given pipe diameter and fill height.

Note RCCP with a number instead of a Roman numeral shall be furnished according to AASHTO M170 Section 6. This number represents the D-load to produce a 0.01 in crack.

STORM SEWERS (metric)									
KIND OF MATERIAL PERMITTED AND STRENGTH REQUIRED FOR A GIVEN PIPE DIAMETERS AND FILL HEIGHTS OVER THE TOP OF THE PIPE									
Nominal Diameter in.	Type 5			Type 6			Type 7		
	Fill Height: Greater than 20' not exceeding 25'			Fill Height: Greater than 25' not exceeding 30'			Fill Height: Greater than 30' not exceeding 35'		
	RCCP	PVC	CPVC	RCCP	PVC	CPVC	RCCP	PVC	CPVC
250	NA	X	X	NA	X	X	NA	X	X
300	IV	X	X	V	X	X	V	V	X
375	IV	X	X	V	X	X	V	V	X
450	IV	X	X	V	X	X	V	V	X
525	IV	X	X	V	X	X	V	V	X
600	IV	X	X	V	X	X	V	V	X
675	IV	NA	NA	V	NA	NA	V	NA	NA
750	IV	X	X	V	X	X	V	V	X
825	IV	NA	NA	V	NA	NA	V	V	NA
900	IV	X	X	V	X	X	V	V	X
1050	IV	X	NA	V	X	NA	V	V	NA
1200	IV	X	NA	V	X	NA	V	V	NA
1350	IV	NA	NA	V	NA	NA	V	V	NA
1500	IV	NA	NA	V	NA	NA	V	V	NA
1650	IV	NA	NA	V	NA	NA	V	V	NA
1800	V	NA	NA	V	NA	NA	V	V	NA
1950	100	NA	NA	110	NA	NA	130	NA	NA
2100	100	NA	NA	110	NA	NA	130	NA	NA
2250	100	NA	NA	110	NA	NA	130	NA	NA
2400	100	NA	NA	120	NA	NA	130	NA	NA
2550	100	NA	NA	120	NA	NA	130	NA	NA
2700	100	NA	NA	120	NA	NA	130	NA	NA

RCCP Reinforced Concrete Culvert, Storm Drain, and Sewer Pipe

PVC Polyvinyl Chloride Pipe

CPVC Corrugated Polyvinyl Chloride Pipe

ESCP Extra Strength Clay Pipe

X This material may be used for the given pipe diameter and fill height.

NA This material is Not Acceptable for the given pipe diameter and fill height.

Note RCCP with a number instead of a Roman numeral shall be furnished according to AASHTO M170 Section 6. This number represents the metric D-load to produce a 25.4 micro-meter crack.



Revise the sixth paragraph of Article 550.06 of the Standard Specifications to read:

“PVC, PE and CPP pipes shall be joined according to the manufacturer’s specifications.”

Revise the first and second paragraphs of Article 550.08 of the Standard Specifications to read:

“**550.08 Deflection Testing for Storm Sewers.** All PVC, PE, and CPP storm sewers shall be tested for deflection not less than 30 days after the pipe is installed and the backfill compacted. The testing shall be performed in the presence of the Engineer.

For PVC, PE, and CPP storm sewers with diameters 24 in. (600 mm) or smaller, a mandrel drag shall be used for deflection testing. For PVC, PE, and CPP storm sewers with diameters over 24 in. (600 mm), deflection measurements other than by a mandrel shall be used.”

Revise the fifth paragraph of Article 550.08 to read as follows.

“The outside diameter of the mandrel shall be 95 percent of the base inside diameter. For all PVC pipe the base inside diameter shall be defined using ASTM D 3034 methodology. For all PE and CPP pipe, the base inside diameter shall be defined as the average inside diameter based on the minimum and maximum tolerances specified in the corresponding ASTM or AASHTO material specifications.”

Revise the first paragraph of Article 1040.03 of the Standard Specifications to read:

“**1040.03 Polyvinyl Chloride (PVC) Pipe.** Acceptance testing of PVC pipe and fittings shall be accomplished during the same construction season in which they are installed. The section properties shall be according to the manufacturer pre-submitted geometric properties on file with the Department. The manufacturer shall submit written certification that the material meets those properties. The pipe shall meet the following additional requirements.”

Delete Articles 1040.03(e) and (f) of the Standard Specifications.

Revise Articles 1040.04(c) and (d) of the Standard Specifications to read:

“(c) PE Profile Wall Pipe for Insertion Lining. The pipe shall be according to ASTM F 894. When used for insertion lining of pipe culverts, the pipe liner shall have a minimum pipe stiffness of 46 psi (317 kPa) at five percent deflection for nominal inside diameters of 42 in. (1050 mm) or less. For nominal inside diameters of greater than 42 in. (1050 mm), the pipe liner shall have a minimum pipe stiffness of 32.5 psi (225 kPa) at five percent deflection. All sizes shall have wall construction that presents essentially smooth internal and external surfaces.

(d) PE Pipe with a Smooth Interior. The pipe shall be according to ASTM F 714 (DR 32.5) with a minimum cell classification of PE 335434 as defined in ASTM D 3350. The section properties shall be according to the manufacturer pre-submitted geometric properties on file with the Department. The manufacturer shall submit written

certification that the material meets those properties and the resin used to manufacture the pipe meets or exceeds the minimum cell classification requirements.”

Add the following to Section 1040 of the Standard Specifications:

“**1040.08 Polypropylene (PP) Pipe.** Storage and handling shall be according to the manufacturer's recommendations, except in no case shall the pipe be exposed to direct sunlight for more than six months. Acceptance testing of the pipe shall be accomplished during the same construction season in which it is installed. The section properties shall be according to the manufacturer pre-submitted geometric properties on file with the Department. The manufacturer shall submit written certification that the material meets those properties. The pipe shall meet the following additional requirements.

- (a) Corrugated PP Pipe with a Smooth Interior. The pipe shall be according to AAHSTO M 330 (nominal size – 12 to 60 in. (300 to 1500 mm)). The pipe shall be Type S or D.
- (b) Perforated Corrugated PP Pipe with A Smooth Interior. The pipe shall be according to AASHTO M 330 (nominal size – 12 to 60 in. (300 to 1500 mm)). The pipe shall be Type SP. In addition, the top centerline of the pipe shall be marked so that it is readily visible from the top of the trench before backfilling, and the upper ends of the slot perforations shall be a minimum of ten degrees below the horizontal.”

80325

**PAVED SHOULDER REMOVAL (BDE)**

Effective: April 1, 2014

Revise the first paragraph of Article 440.07(b) of the Standard Specifications to read:

“(b) Measured Quantities. Pavement removal, driveway pavement removal, and paved shoulder removal will be measured for payment in place and the area computed in square yards (square meters).”

Revise Article 440.07(c) of the Standard Specifications to read:

“(c) Adjustment of Quantities. The quantity of pavement removal and paved shoulder removal will be adjusted if their respective thickness varies more than 15 percent from that shown on the plans. The quantity will be either increased or decreased according to the following table.

% change of thickness	% change of quantity
0 to less than 15	0
15 to less than 20	10
20 to less than 30	15
30 to less than 50	20

If the thickness of the existing pavement varies by 50 percent or more from that shown on the plans, the character of the work will be considered significantly changed and an adjustment to the contract will be made according to Article 104.02.

When an adjustment is made for variations in pavement or shoulder thickness a resulting adjustment will also be made in the earthwork quantities when applicable.

No adjustment will be made for variations in the amount of reinforcement.”

80337

**PAVEMENT MARKING FOR BIKE SYMBOL (BDE)**

Effective: January 1, 2014

Add the following to the SYMBOLS table in Article 780.14 of the Standard Specifications:

"Symbol	Large Size sq ft (sq m)	Small Size Sq ft (sq m)
Bike Symbol	6.0 (0.56)	---

80330

## **PAVEMENT PATCHING (BDE)**

Effective: January 1, 2010

Revise the first sentence of the second paragraph of Article 701.17(e)(1) of the Standard Specifications to read:

“In addition to the traffic control and protection shown elsewhere in the contract for pavement, two devices shall be placed immediately in front of each open patch, open hole, and broken pavement where temporary concrete barriers are not used to separate traffic from the work area.”

80254

## **PAYROLLS AND PAYROLL RECORDS (BDE)**

Effective: January 1, 2014

FEDERAL AID CONTRACTS. Revise the following section of Check Sheet #1 of the Recurring Special Provisions to read:

### **“STATEMENTS AND PAYROLLS**

The payroll records shall include the worker's name, the worker's address, the worker's telephone number when available, the worker's social security number, the worker's classification or classifications, the worker's gross and net wages paid in each pay period, the worker's number of hours worked each day, the worker's starting and ending times of work each day. However, any Contractor or subcontractor who remits contributions to a fringe benefit fund that is not jointly maintained and jointly governed by one or more employers and one or more labor organization must additionally submit the worker's hourly wage rate, the worker's hourly overtime wage rate, the worker's hourly fringe benefit rates, the name and address of each fringe benefit fund, the plan sponsor of each fringe benefit, if applicable, and the plan administrator of each fringe benefit, if applicable.

The Contractor and each subcontractor shall submit payroll records to the Engineer each week from the start to the completion of their respective work, except that full social security numbers and home addresses shall not be included on weekly transmittals. Instead, the payrolls shall include an identification number for each employee (e.g., the last four digits of the employee's social security number). In addition, starting and ending times of work each day may be omitted from the payroll records submitted to the Engineer. The submittals shall be on the Department's form SBE 48, or an approved facsimile. When there has been no activity during a work week, a payroll record shall still be submitted with the appropriate box (“No Work”, “Suspended”, or “Complete”) checked on the form.”

STATE CONTRACTS. Revise Section IV of Check Sheet #5 of the Recurring Special Provisions to read:

### **“IV.COMPLIANCE WITH THE PREVAILING WAGE ACT**

1. Prevailing Wages. All wages paid by the Contractor and each subcontractor shall be in compliance with The Prevailing Wage Act (820 ILCS 130), as amended, except where a prevailing wage violates a federal law, order, or ruling, the rate conforming to the federal law, order, or ruling shall govern. The Contractor shall be responsible to notify each subcontractor of the wage rates set forth in this contract and any revisions thereto. If the Department of Labor revises the wage rates, the Contractor will not be allowed additional compensation on account of said revisions.
2. Payroll Records. The Contractor and each subcontractor shall make and keep, for a period of five years from the later of the date of final payment under the contract or completion of the contract, records of the wages paid to his/her workers. The payroll

records shall include the worker's name, the worker's address, the worker's telephone number when available, the worker's social security number, the worker's classification or classifications, the worker's gross and net wages paid in each pay period, the worker's number of hours worked each day, the worker's starting and ending times of work each day. However, any contractor or subcontractor who remits contributions to a fringe benefit fund that is not jointly maintained and jointly governed by one or more employers and one or more labor organization must additionally submit the worker's hourly wage rate, the worker's hourly overtime wage rate, the worker's hourly fringe benefit rates, the name and address of each fringe benefit fund, the plan sponsor of each fringe benefit, if applicable, and the plan administrator of each fringe benefit, if applicable. Upon seven business days' notice, these records shall be available at a location within the State, during reasonable hours, for inspection by the Department or the Department of Labor; and Federal, State, or local law enforcement agencies and prosecutors.

3. Submission of Payroll Records. The Contractor and each subcontractor shall submit payroll records to the Engineer each week from the start to the completion of their respective work, except that full social security numbers and home addresses shall not be included on weekly transmittals. Instead the payrolls shall include an identification number for each employee (e.g., the last four digits of the employee's social security number). In addition, starting and ending times of work each day may be omitted from the payroll records submitted to the Engineer. The submittals shall be on the Department's form SBE 48, or an approved facsimile. When there has been no activity during a work week, a payroll record shall still be submitted with the appropriate box ("No Work", "Suspended", or "Complete") checked on the form.

Each submittal shall be accompanied by a statement signed by the Contractor or subcontractor, or an officer, employee, or officer thereof, which avers that: (i) he or she has examined the records and such records are true and accurate; (ii) the hourly rate paid to each worker is not less than the general prevailing rate of hourly wages required by the Act; and (iii) the Contractor or subcontractor is aware that filing a payroll record that he/she knows to be false is a Class A misdemeanor.

4. Employee Interviews. The Contractor and each subcontractor shall permit his/her employees to be interviewed on the job, during working hours, by compliance investigators of the Department or the Department of Labor."

80331

## **PORTLAND CEMENT CONCRETE EQUIPMENT (BDE)**

Effective: November 1, 2013

Add the following to the first paragraph of Article 1103.03(a)(5) of the Standard Specifications to read:

“As an alternative to a locking key, the start and finish time for mixing may be automatically printed on the batch ticket. The start and finish time shall be reported to the nearest second.”

80326



## **PRECAST CONCRETE HANDHOLE (BDE)**

Effective: August 1, 2014

Revise the third paragraph of Article 814.03 of the Standard Specifications to read:

“Handholes shall be constructed as shown on the plans and shall be cast-in-place, composite concrete, or precast units. Heavy duty handholes shall be either cast-in-place or precast units.”

Add the following to Article 814.03 of the Standard Specifications:

“(c) Precast Concrete. Precast concrete handholes shall be fabricated according to Article 1042.17. Where a handhole is contiguous to a sidewalk, preformed joint filler of 1/2 inch (13 mm) thickness shall be placed between the handhole and the sidewalk.”

Add the following to Section 1042 of the Standard Specifications:

“**1042.17 Precast Concrete Handholes.** Precast concrete handholes shall be according to Articles 1042.03(a)(c)(d)(e).”

80343

## **PROGRESS PAYMENTS (BDE)**

Effective: November 2, 2013

Revise Article 109.07(a) of the Standard Specifications to read:

“(a) Progress Payments. At least once each month, the Engineer will make a written estimate of the quantity of work performed in accordance with the contract, and the value thereof at the contract unit prices. The amount of the estimate approved as due for payment will be vouchered by the Department and presented to the State Comptroller for payment. No amount less than \$1000.00 will be approved for payment other than the final payment.

Progress payments may be reduced by liens filed pursuant to Section 23(c) of the Mechanics' Lien Act, 770 ILCS 60/23(c).

If a Contractor or subcontractor has defaulted on a loan issued under the Department's Disadvantaged Business Revolving Loan Program (20 ILCS 2705/2705-610), progress payments may be reduced pursuant to the terms of that loan agreement. In such cases, the amount of the estimate related to the work performed by the Contractor or subcontractor, in default of the loan agreement, will be offset, in whole or in part, and vouchered by the Department to the Working Capital Revolving Fund or designated escrow account. Payment for the work shall be considered as issued and received by the Contractor or subcontractor on the date of the offset voucher. Further, the amount of the offset voucher shall be a credit against the Department's obligation to pay the Contractor, the Contractor's obligation to pay the subcontractor, and the Contractor's or subcontractor's total loan indebtedness to the Department. The offset shall continue until such time as the entire loan indebtedness is satisfied. The Department will notify the Contractor and Fund Control Agent in a timely manner of such offset. The Contractor or subcontractor shall not be entitled to additional payment in consideration of the offset.

The failure to perform any requirement, obligation, or term of the contract by the Contractor shall be reason for withholding any progress payments until the Department determines that compliance has been achieved.”

80328

## QUALITY CONTROL/QUALITY ASSURANCE OF CONCRETE MIXTURES (BDE)

Effective: January 1, 2012

Revised: January 1, 2014

Revise Note 7/ of Schedule B of Recurring Special Provision Check Sheet #31 of the Standard Specifications to read:

7/ The test of record for strength shall be the day indicated in Article 1020.04. For cement aggregate mixture II, a strength requirement is not specified and testing is not required. Additional strength testing to determine early falsework and form removal, early pavement or bridge opening to traffic, or to monitor strengths is at the discretion of the Contractor. Strength shall be defined as the average of two 6 x 12 in. (150 x 300 mm) cylinder breaks, three 4 x 8 in. (100 x 200 mm) cylinder breaks, or two beam breaks for field tests. Per Illinois Modified AASHTO T 23, cylinders shall be 6 x 12 in. (150 x 300 mm) when the nominal maximum size of the coarse aggregate exceeds 1 in. (25 mm).

80281

## REMOVAL AND DISPOSAL OF REGULATED SUBSTANCES (BDE)

Effective: January 1, 2012

Revised: November 2, 2012

Revise Article 669.01 of the Standard Specifications to read:

**“669.01 Description.** This work shall consist of the transportation and proper disposal of contaminated soil and water. This work shall also consist of the removal, transportation, and proper disposal of underground storage tanks (UST), their content and associated underground piping to the point where the piping is above the ground, including determining the content types and estimated quantities.”

Revise Article 669.08 of the Standard Specifications to read:

**“669.08 Contaminated Soil and/or Groundwater Monitoring.** The Contractor shall hire a qualified environmental firm to monitor the area containing the regulated substances. The affected area shall be monitored with a photoionization detector (PID) utilizing a lamp of 10.6eV or greater or a flame ionization detector (FID). Any field screen reading on the PID or FID in excess of background levels indicates the potential presence of contaminated material requiring handling as a non-special waste, special waste, or hazardous waste. No excavated soils can be taken to a clean construction and demolition debris (CCDD) facility or an uncontaminated soil fill operation with detectable PID or FID meter readings that are above background. The PID or FID meter shall be calibrated on-site and background level readings taken and recorded daily. All testing shall be done by a qualified engineer/technician. Such testing and monitoring shall be included in the work. The Contractor shall identify the exact limits of removal of non-special waste, special waste, or hazardous waste. All limits shall be approved by the Engineer prior to excavation. The Contractor shall take all necessary precautions.

Based upon the land use history of the subject property and/or PID or FID readings indicating contamination, a soil or groundwater sample shall be taken from the same location and submitted to an approved laboratory. Soil or groundwater samples shall be analyzed for the contaminants of concern, including pH, based on the property's land use history or the parameters listed in the maximum allowable concentration (MAC) for chemical constituents in uncontaminated soil established pursuant to Subpart F of 35 Illinois Administrative Code 1100.605. The analytical results shall serve to document the level of soil contamination. Soil and groundwater samples may be required at the discretion of the Engineer to verify the level of soil and groundwater contamination.

Samples shall be grab samples (not combined with other locations). The samples shall be taken with decontaminated or disposable instruments. The samples shall be placed in sealed containers and transported in an insulated container to the laboratory. The container shall maintain a temperature of 39 °F (4 °C). All samples shall be clearly labeled. The labels shall indicate the sample number, date sampled, location and elevation, and any other observations.

The laboratory shall use analytical methods which are able to meet the lowest appropriate practical quantitation limits (PQL) or estimated quantitation limit (EQL) specified in "Test Methods for Evaluating Solid Wastes, Physical/Chemical Methods", EPA Publication No. SW-846 and "Methods for the Determination of Organic Compounds in Drinking Water", EPA, EMSL, EPA-600/4-88/039. For parameters where the specified cleanup objective is below the acceptable detection limit (ADL), the ADL shall serve as the cleanup objective. For other parameters the ADL shall be equal to or below the specified cleanup objective."

Replace the first two paragraphs of Article 669.09 of the Standard Specifications with the following:

**"669.09 Contaminated Soil and/or Groundwater Management and Disposal.** The management and disposal of contaminated soil and/or groundwater shall be according to the following:

- (a) Soil Analytical Results Exceed Most Stringent MAC. When the soil analytical results indicate that detected levels exceed the most stringent maximum allowable concentration (MAC) for chemical constituents in uncontaminated soil established pursuant to Subpart F of 35 Illinois Administrative Code 1100.605, the soil shall be managed as follows:
  - (1) When analytical results indicate inorganic chemical constituents exceed the most stringent MAC but they are still considered within area background levels by the Engineer, the excavated soil can be utilized within the construction limits as fill, when suitable. Such soil excavated for storm sewers can be placed back into the excavated trench as backfill, when suitable, unless trench backfill is specified. If the soils cannot be utilized within the construction limits, they shall be managed and disposed of off-site as a non-special waste, special waste, or hazardous waste as applicable.
  - (2) When analytical results indicate chemical constituents exceed the most stringent MAC but do not exceed the MAC for a Metropolitan Statistical Area (MSA) County, the excavated soil can be utilized within the construction limits as fill, when suitable, or managed and disposed of off-site as "uncontaminated soil" at a CCDD facility or an uncontaminated soil fill operation within an MSA County provided the pH of the soil is within the range of 6.25 - 9.0, inclusive.
  - (3) When analytical results indicate chemical constituents exceed the most stringent MAC but do not exceed the MAC for an MSA County excluding Chicago, or the MAC within the Chicago corporate limits, the excavated soil can be utilized within the construction limits as fill, when suitable, or managed and disposed of off-site as "uncontaminated soil" at a CCDD facility or an uncontaminated soil fill operation within an MSA County excluding Chicago or within the Chicago corporate limits provided the pH of the soil is within the range of 6.25 - 9.0, inclusive.

- (4) When analytical results indicate chemical constituents exceed the most stringent MAC but do not exceed the MAC for an MSA County excluding Chicago, the excavated soil can be utilized within the construction limits as fill, when suitable, or managed and disposed of off-site as "uncontaminated soil" at a CCDD facility or an uncontaminated soil fill operation within an MSA County excluding Chicago provided the pH of the soil is within the range of 6.25 - 9.0, inclusive.
- (5) When the Engineer determines soil cannot be managed according to Articles 669.09(a)(1) through (a)(4) above, the soil shall be managed and disposed of off-site as a non-special waste, special waste, or hazardous waste as applicable.
- (b) Soil Analytical Results Do Not Exceed Most Stringent MAC. When the soil analytical results indicate that detected levels do not exceed the most stringent MAC but the pH of the soil is less than 6.25 or greater than 9.0, the excavated soil can be utilized within the construction limits or managed and disposed of off-site as "uncontaminated soil" according to Article 202.03. However the excavated soil cannot be taken to a CCDD facility or an uncontaminated soil fill operation.
- (c) Groundwater. When groundwater analytical results indicate the detected levels are above Appendix B, Table E of 35 Illinois Administrative Code 742, the most stringent Tier 1 Groundwater Remediation Objectives for Groundwater Component of the Groundwater Ingestion Route for Class 1 groundwater, the groundwater shall be managed off-site as a special waste.

All groundwater encountered within lateral trenches may be managed within the trench and allowed to infiltrate back into the ground. If the groundwater cannot be managed within the trench it must be removed as a special or hazardous waste. The Contractor is prohibited from managing groundwater within the trench by discharging it through any existing or new storm sewer. The Contractor shall install backfill plugs within the area of groundwater contamination.

One backfill plug shall be placed down gradient to the area of groundwater contamination. Backfill plugs shall be installed at intervals not to exceed 50 ft (15 m). Backfill plugs are to be 4 ft (1.2 m) long, measured parallel to the trench, full trench width and depth. Backfill plugs shall not have any fine aggregate bedding or backfill, but shall be entirely cohesive soil or any class of concrete. The Contractor shall provide test data that the material has a permeability of less than  $10^{-7}$  cm/sec according to ASTM D 5084, Method A or per another test method approved by the Engineer."

Revise Article 669.14 of the Standard Specifications to read:

**"669.14 Final Environmental Construction Report.** At the end of the project, the Contractor will prepare and submit three copies of the Environmental Construction Report on the activities conducted during the life of the project, one copy shall be submitted to the Resident Engineer, one copy shall be submitted to the District's Environmental Studies Unit, and one copy shall be submitted with an electronic copy in Adode.pdf format to the Geologic

and Waste Assessment Unit, Bureau of Design and Environment, IDOT, 2300 South Dirksen Parkway, Springfield, Illinois 62764. The technical report shall include all pertinent information regarding the project including, but not limited to:

- (a) Measures taken to identify, monitor, handle, and dispose of soil or groundwater containing regulated substances, to prevent further migration of regulated substances, and to protect workers,
- (b) Cost of identifying, monitoring, handling, and disposing of soil or groundwater containing regulated substances, the cost of preventing further migration of regulated substances, and the cost for worker protection from the regulated substances. All cost should be in the format of the contract pay items listed in the contract plans (identified by the preliminary environmental site investigation (PESA) site number),
- (c) Plan sheets showing the areas containing the regulated substances,
- (d) Field sampling and testing results used to identify the nature and extent of the regulated substances,
- (e) Waste manifests (identified by the preliminary environmental site investigation (PESA) site number) for special or hazardous waste disposal, and
- (f) Landfill tickets (identified by the preliminary environmental site investigation (PESA) site number) for non-special waste disposal."

Revise the second paragraph of Article 669.16 of the Standard Specifications to read:

"The transportation and disposal of soil and other materials from an excavation determined to be contaminated will be paid for at the contract unit price per cubic yard (cubic meter) for NON-SPECIAL WASTE DISPOSAL, SPECIAL WASTE DISPOSAL, or HAZARDOUS WASTE DISPOSAL."

80283

## REMOVAL AND DISPOSAL OF SURPLUS MATERIALS (BDE)

Effective: November 2, 2012

Revise the first four paragraphs of Article 202.03 of the Standard Specifications to read:

**“202.03 Removal and Disposal of Surplus, Unstable, Unsuitable, and Organic Materials.** Suitable excavated materials shall not be wasted without permission of the Engineer. The Contractor shall dispose of all surplus, unstable, unsuitable, and organic materials, in such a manner that public or private property will not be damaged or endangered.

Suitable earth, stones and boulders naturally occurring within the right-of-way may be placed in fills or embankments in lifts and compacted according to Section 205. Broken concrete without protruding metal bars, bricks, rock, stone, reclaimed asphalt pavement with no expansive aggregate, or uncontaminated dirt and sand generated from construction or demolition activities may be used in embankment or in fill. If used in fills or embankments, these materials shall be placed and compacted to the satisfaction of the Engineer; shall be buried under a minimum of 2 ft (600 mm) of earth cover (except when the materials include only uncontaminated dirt); and shall not create an unsightly appearance or detract from the natural topographic features of an area. Broken concrete without protruding metal bars, bricks, rock, or stone may be used as riprap as approved by the Engineer. If the materials are used for fill in locations within the right-of-way but outside project construction limits, the Contractor must specify to the Engineer, in writing, how the landscape restoration of the fill areas will be accomplished. Placement of fill in such areas shall not commence until the Contractor's landscape restoration plan is approved by the Engineer.

Aside from the materials listed above, all other construction and demolition debris or waste shall be disposed of in a licensed landfill, recycled, reused, or otherwise disposed of as allowed by State or Federal laws and regulations. When the Contractor chooses to dispose of uncontaminated soil at a clean construction and demolition debris (CCDD) facility or at an uncontaminated soil fill operation, it shall be the Contractor's responsibility to have the pH of the material tested to ensure the value is between 6.25 and 9.0, inclusive. A copy of the pH test results shall be provided to the Engineer.

A permit shall be obtained from IEPA and made available to the Engineer prior to open burning of organic materials (i.e., plant refuse resulting from pruning or removal of trees or shrubs) or other construction or demolition debris. Organic materials originating within the right-of-way limits may be chipped or shredded and placed as mulch around landscape plantings within the right-of-way when approved by the Engineer. Chipped or shredded material to be placed as mulch shall not exceed a depth of 6 in. (150 mm).”

80319



## **RIGID METAL CONDUIT (BDE)**

Effective: August 1, 2014

Add the following to Article 1088.01(a) of the Standard Specifications:

“(6) Stainless Steel Conduit. The conduit shall be Type 304 or Type 316 stainless steel, shall be manufactured according to UL Standard 6A, and shall meet ANSI Standard C80.1. Conduit fittings shall be Type 304 or Type 316 stainless steel and shall be manufactured according to UL Standard 514B.

All conduit supports, straps, clamps. And other attachments shall be Type 304 or Type 316 stainless steel. Attachment hardware shall be stainless steel according to Article 1006.31.”

80344

## **TRACKING THE USE OF PESTICIDES (BDE)**

Effective: August 1, 2012

Add the following paragraph after the first paragraph of Article 107.23 of the Standard Specifications:

"Within 48 hours of the application of pesticides, including but not limited to herbicides, insecticides, algaecides, and fungicides, the Contractor shall complete and return to the Engineer, Operations form "OPER 2720"."

80301

**TRAINING SPECIAL PROVISIONS (BDE)** This Training Special Provision supersedes Section 7b of the Special Provision entitled "Specific Equal Employment Opportunity Responsibilities," and is in implementation of 23 U.S.C. 140(a).

As part of the contractor's equal employment opportunity affirmative action program, training shall be provided as follows:

The contractor shall provide on-the-job training aimed at developing full journeyman in the type of trade or job classification involved. The number of trainees to be trained under this contract will be 3. In the event the contractor subcontracts a portion of the contract work, he shall determine how many, if any, of the trainees are to be trained by the subcontractor, provided however, that the contractor shall retain the primary responsibility for meeting the training requirements imposed by this special provision. The contractor shall also insure that this Training Special Provision is made applicable to such subcontract. Where feasible, 25 percent of apprentices or trainees in each occupation shall be in their first year of apprenticeship or training.

The number of trainees shall be distributed among the work classifications on the basis of the contractor's needs and the availability of journeymen in the various classifications within the reasonable area of recruitment. Prior to commencing construction, the contractor shall submit to the Illinois Department of Transportation for approval the number of trainees to be trained in each selected classification and training program to be used. Furthermore, the contractor shall specify the starting time for training in each of the classifications. The contractor will be credited for each trainee employed by him on the contract work who is currently enrolled or becomes enrolled in an approved program and will be reimbursed for such trainees as provided hereinafter.

Training and upgrading of minorities and women toward journeyman status is a primary objective of this Training Special Provision. Accordingly, the contractor shall make every effort to enroll minority trainees and women (e.g. by conducting systematic and direct recruitment through public and private sources likely to yield minority and women trainees) to the extent such persons are available within a reasonable area of recruitment. The contractor will be responsible for demonstrating the steps that he has taken in pursuance thereof, prior to a determination as to whether the contractor is in compliance with this Training Special Provision. This training commitment is not intended, and shall not be used, to discriminate against any applicant for training, whether a member of a minority group or not.

No employee shall be employed as a trainee in any classification in which he has successfully completed a training course leading to journeyman status or in which he has been employed as a journeyman. The contractor should satisfy this requirement by including appropriate questions in the employee application or by other suitable means. Regardless of the method used the contractor's records should document the findings in each case.

The minimum length and type of training for each classification will be as established in the training program selected by the contractor and approved by the Illinois Department of Transportation and the Federal Highway Administration. The Illinois Department of Transportation and the Federal Highway Administration shall approve a program, if it is reasonably calculated to meet the equal employment opportunity obligations of the contractor and to qualify the average trainee for journeyman status in the classification concerned by the end of the training period. Furthermore, apprenticeship programs registered with the U.S. Department of Labor, Bureau of Apprenticeship and Training, or with a State apprenticeship agency recognized by the Bureau and training programs approved by not necessarily sponsored by the U.S. Department of Labor, Manpower Administration, Bureau of Apprenticeship and Training shall also be considered acceptable provided it is being administered in a manner consistent with the equal employment obligations of Federal-aid highway construction contracts. Approval or acceptance of a training program shall be obtained from the State prior to commencing work on the classification covered by the program. It is the intention of these provisions that training is to be provided in the construction crafts rather than clerk-typists or secretarial-type positions. Training is permissible in lower level management positions such as office engineers, estimators, timekeepers, etc., where the training is oriented toward construction applications. Training in the laborer classification may be permitted provided that significant and meaningful training is provided and approved by the Illinois Department of Transportation and the Federal Highway Administration. Some offsite training is permissible as long as the training is an integral part of an approved training program and does not comprise a significant part of the overall training.

Except as otherwise noted below, the contractor will be reimbursed 80 cents per hour of training given an employee on this contract in accordance with an approved training program. As approved by the Engineer, reimbursement will be made for training of persons in excess of the number specified herein. This reimbursement will be made even though the contractor receives additional training program funds from other sources, provided such other source does not specifically prohibit the contractor from receiving other reimbursement. Reimbursement for offsite training indicated above may only be made to the contractor where he does one or more of the following and the trainees are concurrently employed on a Federal-aid project; contributes to the cost of the training, provides the instruction to the trainee or pays the trainee's wages during the offsite training period.

No payment shall be made to the contractor if either the failure to provide the required training, or the failure to hire the trainee as a journeyman, is caused by the contractor and evidences a lack of good faith on the part of the contractor in meeting the requirement of this Training Special Provision. It is normally expected that a trainee will begin his training on the project as soon as feasible after start of work utilizing the skill involved and remain on the project as long as training opportunities exist in his work classification or until he has completed his training program.

It is not required that all trainees be on board for the entire length of the contract. A contractor will have fulfilled his responsibilities under this Training Special Provision if he has provided acceptable training to the number of trainees specified. The number trained shall be determined on the basis of the total number enrolled on the contract for a significant period.

Trainees will be paid at least 60 percent of the appropriate minimum journeyman's rate specified in the contract for the first half of the training period, 75 percent for the third quarter of the training period, and 90 percent for the last quarter of the training period, unless apprentices or trainees in an approved existing program are enrolled as trainees on this project. In that case, the appropriate rates approved by the Departments of Labor or Transportation in connection with the existing program shall apply to all trainees being trained for the same classification who are covered by this Training Special Provision.

The contractor shall furnish the trainee a copy of the program he will follow in providing the training. The contractor shall provide each trainee with a certification showing the type and length of training satisfactorily complete.

The contractor will provide for the maintenance of records and furnish periodic reports documenting his performance under this Training Special Provision.

METHOD OF MEASUREMENT The unit of measurement is in hours.

BASIS OF PAYMENT This work will be paid for at the contract unit price of 80 cents per hour for TRAINEES. The estimated total number of hours, unit price and total price have been included in the schedule of prices.

20338

## WARM MIX ASPHALT (BDE)

Effective: January 1, 2012

Revised: November 1, 2013

Description. This work shall consist of designing, producing and constructing Warm Mix Asphalt (WMA) in lieu of Hot Mix Asphalt (HMA) at the Contractor's option. Work shall be according to Sections 406, 407, 408, 1030, and 1102 of the Standard Specifications, except as modified herein. In addition, any references to HMA in the Standard Specifications, or the special provisions shall be construed to include WMA.

WMA is an asphalt mixture which can be produced at temperatures lower than allowed for HMA utilizing approved WMA technologies. WMA technologies are defined as the use of additives or processes which allow a reduction in the temperatures at which HMA mixes are produced and placed. WMA is produced by the use of additives, a water foaming process, or combination of both. Additives include minerals, chemicals or organics incorporated into the asphalt binder stream in a dedicated delivery system. The process of foaming injects water into the asphalt binder stream, just prior to incorporation of the asphalt binder with the aggregate.

Approved WMA technologies may also be used in HMA provided all the requirements specified herein, with the exception of temperature, are met. However, asphalt mixtures produced at temperatures in excess of 275 °F (135 °C) will not be considered WMA when determining the grade reduction of the virgin asphalt binder grade.

### Materials.

Add the following to Article 1030.02 of the Standard Specifications.

"(h) Warm Mix Asphalt (WMA) Technologies (Note 3)"

Add the following note to Article 1030.02 of the Standard Specifications.

"Note 3. Warm mix additives or foaming processes shall be selected from the current Bureau of Materials and Physical Research Approved List, "Warm-Mix Asphalt Technologies"."

### Equipment.

Revise the first paragraph of Article 1102.01 of the Standard Specifications to read:

**"1102.01 Hot-Mix Asphalt Plant.** The hot-mix asphalt (HMA) plant shall be the batch-type, continuous-type, or dryer drum plant. The plants shall be evaluated for prequalification rating and approval to produce HMA according to the current Bureau of Materials and Physical Research Policy Memorandum, "Approval of Hot-Mix Asphalt Plants and Equipment". Once approved, the Contractor shall notify the Bureau of Materials and Physical Research to obtain approval of all plant modifications. The plants shall not be used to produce mixtures concurrently for more than one project or for private work unless permission is granted in writing

by the Engineer. The plant units shall be so designed, coordinated and operated that they will function properly and produce HMA having uniform temperatures and compositions within the tolerances specified. The plant units shall meet the following requirements.”

Add the following to Article 1102.01(a) of the Standard Specifications.

“(13) Equipment for Warm Mix Technologies.

- a. Foaming. Metering equipment for foamed asphalt shall have an accuracy of  $\pm 2$  percent of the actual water metered. The foaming control system shall be electronically interfaced with the asphalt binder meter.
- b. Additives. Additives shall be introduced into the plant according to the supplier’s recommendations and shall be approved by the Engineer. The system for introducing the WMA additive shall be interlocked with the aggregate feed or weigh system to maintain correct proportions for all rates of production and batch sizes.”

Mix Design Verification.

Add the following to Article 1030.04 of the Standard Specifications.

“(e) Warm Mix Technologies.

- (1) Foaming. WMA mix design verification will not be required when foaming technology is used alone (without WMA additives). However, the foaming technology shall only be used on HMA designs previously approved by the Department.
- (2) Additives. WMA mix designs utilizing additives shall be submitted to the Engineer for mix design verification.

Production.

Revise the second paragraph of Article 1030.06(a) of the Standard Specifications to read:

“At the start of mix production for HMA, WMA, and HMA using WMA technologies, QC/QA mixture start-up will be required for the following situations; at the beginning of production of a new mixture design, at the beginning of each production season, and at every plant utilized to produce mixtures, regardless of the mix.”

Quality Control/Quality Assurance Testing.

Revise the table in Article 1030.05(d)(2)a. of the Standard Specifications to read:

Parameter	Frequency of Tests		Test Method See Manual of Test Procedures for Materials
	High ESAL Mixture Low ESAL Mixture	All Other Mixtures	
Aggregate Gradation  % passing sieves: 1/2 in. (12.5 mm), No. 4 (4.75 mm), No. 8 (2.36 mm), No. 30 (600 μm) No. 200 (75 μm)  Note 1.	1 washed ignition oven test on the mix per half day of production  Note 4.	1 washed ignition oven test on the mix per day of production  Note 4.	Illinois Procedure
Asphalt Binder Content by Ignition Oven  Note 2.	1 per half day of production	1 per day	Illinois-Modified AASHTO T 308
VMA  Note 3.	Day's production ≥ 1200 tons:  1 per half day of production  Day's production < 1200 tons:  1 per half day of production for first 2 days and 1 per day thereafter (first sample of the day)	N/A	Illinois-Modified AASHTO R 35
Air Voids  Bulk Specific Gravity of Gyrotory Sample  Note 5.	Day's production ≥ 1200 tons:  1 per half day of production  Day's production < 1200 tons:  1 per half day of production for first 2 days and 1 per day thereafter (first sample of the day)	1 per day	Illinois-Modified AASHTO T 312
Maximum Specific Gravity of Mixture	Day's production ≥ 1200 tons:  1 per half day of production  Day's production < 1200 tons:  1 per half day of production for first 2 days and 1 per	1 per day	Illinois-Modified AASHTO T 209



Parameter	Frequency of Tests	Frequency of Tests	Test Method See Manual of Test Procedures for Materials
	High ESAL Mixture Low ESAL Mixture	All Other Mixtures	
	day thereafter (first sample of the day)		

Note 1. The No. 8 (2.36 mm) and No. 30 (600 µm) sieves are not required for All Other Mixtures.

Note 2. The Engineer may waive the ignition oven requirement for asphalt binder content if the aggregates to be used are known to have ignition asphalt binder content calibration factors which exceed 1.5 percent. If the ignition oven requirement is waived, other Department approved methods shall be used to determine the asphalt binder content.

Note 3. The  $G_{sb}$  used in the voids in the mineral aggregate (VMA) calculation shall be the same average  $G_{sb}$  value listed in the mix design.

Note 4. The Engineer reserves the right to require additional hot bin gradations for batch

Note 5. The WMA compaction temperature for mixture volumetric testing shall be  $270 \pm 5$  °F ( $132 \pm 3$  °C) for quality control testing. The WMA compaction temperature for quality assurance testing will be  $270 \pm 5$  °F ( $132 \pm 3$  °C) if the mixture is not allowed to cool to room temperature. If the mixture is allowed to cool to room temperature it shall be reheated to standard HMA compaction temperatures.”

#### Construction Requirements.

Revise the second paragraph of Article 406.06(b)(1) of the Standard Specifications to read:

“The HMA shall be delivered at a temperature of 250 to 350 °F (120 to 175 °C). WMA shall be delivered at a minimum temperature of 215 °F (102 °C).”

#### Basis of Payment.

This work will be paid at the contract unit price bid for the HMA pay items involved. Anti-strip will not be paid for separately, but shall be considered as included in the cost of the work.

80288

## **WEEKLY DBE TRUCKING REPORTS (BDE)**

Effective: June 2, 2012

The Contractor shall provide a weekly report of Disadvantaged Business Enterprise (DBE) trucks hired by the Contractor or subcontractors (i.e. not owned by the Contractor or subcontractors) that are used on the jobsite; or used for the delivery and/or removal of equipment/material to and from the jobsite. The jobsite shall also include offsite locations, such as plant sites or storage sites, when those locations are used solely for this contract.

The report shall be submitted on the form provided by the Department within ten business days following the reporting period. The reporting period shall be Monday through Sunday for each week reportable trucking activities occur. The report shall be submitted to the Engineer and a copy shall be provided to the district EEO Officer.

Any costs associated with providing weekly DBE trucking reports shall be considered as included in the contract unit prices bid for the various items of work involved and no additional compensation will be allowed.

80302

## **SEGMENTAL CONCRETE BLOCK WALL**

Effective: January 7, 1999

Revised: October 30, 2012

**Description.** This work shall consist of furnishing the design computations, shop plans, materials, equipment and labor to construct a Segmental Concrete Block Retaining Wall to the limits shown on the plans.

**General.** The wall shall consist of a leveling pad, precast concrete blocks (either dry-cast or wet cast), select fill and, if required by the design, soil reinforcement. The wall shall be designed and constructed according to the lines, grades, and dimensions shown on the contract plans and approved shop plans.

**Submittals.** The wall supplier shall submit design computations and shop plans to the Engineer according to Article 1042.03(b) of the Standard Specifications. No work or ordering of materials for the structure shall be done by the Contractor until the submittal has been approved in writing by the Engineer. The shop plans shall be sealed by an Illinois Licensed Structural Engineer and shall include all details, dimensions, quantities, and cross sections necessary to construct the wall and shall include, but not be limited to, the following items:

- (a) Plan, elevation, and cross section sheet(s) for each wall showing the following:
  - (1) A plan view of the wall indicating the offsets from the construction centerline to the first course of blocks at all changes in horizontal alignment. These shall be calculated using the offsets to the front face of the block shown on the contract plans and the suppliers proposed wall batter. The plan view shall indicate bottom (and top course of block when battered), the excavation and select fill limits as well as any soil reinforcing required by the design. The centerline of any drainage structure or pipe behind or passing through/under the wall shall also be shown.
  - (2) An elevation view of the wall, indicating the elevation and all steps in the top course of blocks along the length of the wall. The top of these blocks shall be at or above the theoretical top of block line shown on the contract plans. This view shall also show the steps and proposed top of leveling pad elevations as well as the finished grade line at the wall face specified on the contract plans. These leveling pad elevations shall be located at or below the theoretical top of leveling line shown on the contract plans. The location, size, and length of any soil reinforcing connected to the blocks shall be indicated.
  - (3) Typical cross section(s) showing the limits of the select fill, soil reinforcement if used in the design. The right-of-way limits shall be indicated as well as the proposed excavation, cut slopes, and the elevation relationship between existing ground conditions and proposed grades.
  - (4) All general notes required for constructing the wall.

- (b) All details for the leveling pads, including the steps, shall be shown. The theoretical top of the leveling pad shall either be below the anticipated frost depth or 1.5 ft. (450 mm) below the finished grade line at the wall face, whichever is greater; unless otherwise shown on the plans. The minimum leveling pad thickness shall be 6 in. (152 mm)
- (c) Cap blocks shall be used to cover the top of the standard block units. The top course of blocks and cap blocks shall be stepped to satisfy the top of block line shown on the contract plans.
- (d) All details of the block and/or soil reinforcement placement around all appurtenances located behind, on top of, or passing through the wall shall be clearly indicated. Any modifications to the design of these appurtenances to accommodate a particular design arrangement shall also be submitted.
- (e) All details of the blocks, including color and texture shall be shown. The exterior face shall preferably be straight, textured with a "split rock face" pattern, and dark gray in color unless otherwise stated on the plans.
- (f) All block types (standard, cap, corner, and radius turning blocks) shall be detailed showing all dimensions.
- (g) All blocks shall have alignment/connection devices such as shear keys, leading/trailing lips, or pins. The details for the connection devices between adjacent blocks and the block to soil reinforcement shall be shown. The block set back or face batter shall be limited to 20 degrees from vertical, unless otherwise shown by the plans.

**Materials.** The materials shall meet the following requirements:

- (a) Dry-Cast Concrete Block: Dry-cast concrete block proposed for use shall be pre-cast and produced according Article 1042.02 and the requirements of ASTM C1372 except as follows:
  - 1. Fly ash shall be according to Articles 1010.01 and 1010.02(b).
  - 2. Ground granulated blast-furnace slag shall be according to Articles 1010.01 and 1010.05.
  - 3. Aggregate shall be according to Articles 1003.02 and 1004.02, with the exception of gradation.
  - 4. Water shall be according to Section 1002.
  - 5. Testing for freeze-thaw durability will not be required. However, unsatisfactory field performance as determined by the Department will be cause to prohibit the use of the block on Department projects.

- (b) Wet-cast Concrete Block: Wet-cast concrete block proposed for use shall be pre-cast and produced according to Section 1020 and Article 1042.02. The concrete shall be Class PC with a minimum compressive strength of at least 3000 psi (31 MPa) at 28 days.
- (c) Select fill: The select fill, defined as the material placed in the reinforced volume behind the wall, shall be according to Sections 1003 and 1004 of the Standard Specifications and the following:
- (1) Select Fill Gradation. Either a coarse aggregate or a fine aggregate may be used. For coarse aggregate, gradations CA 6 thru CA 16 may be used. For fine aggregate, gradations FA 1, FA 2, or FA 20 may be used.
  - (2) Select Fill Quality. The coarse or fine aggregate shall have a maximum sodium sulfate ( $\text{Na}_2\text{SO}_4$ ) loss of 15 percent according to Illinois Modified AASHTO T 104.
  - (3) Select Fill Internal Friction Angle. The effective internal friction angle for the coarse or fine aggregate shall be a minimum 34 degrees according to AASHTO T 236 on samples compacted to 95 percent density according to Illinois Modified AASHTO T 99. The AASHTO T 296 test with pore pressure measurement may be used in lieu of AASHTO T 236. If the vendor's design uses a friction angle higher than 34 degrees, as indicated on the approved shop drawings, this higher value shall be taken as the minimum required.
  - (4) Select Fill and Geosynthetic Reinforcing. When geosynthetic reinforcing is used, the select fill pH shall be 4.5 to 9.0 according to Illinois Modified AASHTO T 289.
  - (5) Test Frequency. Prior to start of construction, the Contractor shall provide internal friction angle and pH test results to show the select fill material meets the specification requirements. However, the pH will be required only when geosynthetic reinforcing is used. All test results shall not be older than 12 months. In addition, a sample of select fill material will be obtained for testing and approval by the Department. Thereafter, the minimum frequency of sampling and testing at the jobsite will be one per 40,000 tons (36,300 metric tons) of select fill material. Testing to verify the internal friction angle will only be required when the wall design utilizes a minimum effective internal friction angle greater than 34 degrees, or when crushed coarse aggregate is not used.

When a fine aggregate is selected, the rear of all block joints shall be covered by a non-woven needle punch geotextile filter material according to Article 1080.05 of the Standard Specifications and shall have a minimum permeability according to ASTM D4491 of 0.008 cm/sec. All fabric overlaps shall be 6 in. (150 mm) and non-sewn. As an alternative to the geotextile, a coarse aggregate shall be placed against the back face of the blocks to create a minimum 12 in. (300 mm) wide continuous gradation filter to prevent the select fill material from passing through the block joints.

- (d) Leveling pad: The material shall be either Class SI concrete according to Article 1020.04 or compacted coarse aggregate according to Articles 1004.04, (a) and (b). The compacted coarse aggregate gradation shall be CA 6 or CA 10.

(e) Soil Reinforcement: If soil reinforcement is required by the approved design, the Contractor shall submit a manufacturer's certification for the soil reinforcement properties which equals or exceeds those required in the design computations. The soil reinforcement shall be manufactured from high density polyethylene (HDPE) uniaxial or polypropylene biaxial resins or high tenacity polyester fibers with a PVC coating, stored between -20 and 140° F (-29 and 60° C). The following standards shall be used in determining and demonstrating the soil reinforcement capacities:

- ASTM D638 Test Method for Tensile Properties of Plastic
- ASTM D1248 Specification for Polyethylene Plastics Molding and Extrusion Materials
- ASTM D4218 Test Method for Carbon Black Content in Polyethylene Compounds
- ASTM D5262 Test Method for Evaluating the Unconfined Tension Creep Behavior of Geosynthetics
- GG1-Standard Test Method for Geogrid Rib Tensile Strength
- GG2-Standard Test Method for Geogrid Junction Strength
- GG4-Standard Practice for Determination of the Long Term Design Strength of Geogrid
- GG5-Standard Practice for Evaluating Geogrid Pullout Behavior

**Design Criteria.** The design shall be according to AASHTO Specifications and commentaries for Earth Retaining Walls or FHWA Publication No. HI-95-038, SA-96-071 and SA-96-072. The wall supplier shall be responsible for all internal stability aspects of the wall design.

Internal stability design shall insure that adequate factors of safety against overturning and sliding are present at each level of block. If required by design, soil reinforcement shall be utilized and the loading at the block/soil reinforcement connection as well as the failure surface must be indicated. The calculations to determine the allowable load of the soil reinforcement and the factor of safety against pullout shall also be included. The analysis of settlement, bearing capacity, and overall slope stability are the responsibility of the Department.

External loads such as those applied through structure foundations, from traffic or railroads, slope surcharge etc., shall be accounted for in the internal stability design. The presence of all appurtenances behind, in front of, mounted upon, or passing through the wall volume such as drainage structures, utilities, structure foundation elements, or other items shall be accounted for in the internal stability design of the wall.

**Construction Requirements.** The Contractor shall obtain technical assistance from the supplier during wall erection to demonstrate proper construction procedures and shall include all costs related to this technical assistance in the unit price bid for this item.

The foundation material for the leveling pad and select fill volume shall be graded to the design elevation and compacted according to Article 205.05, except the minimum required compaction shall be 95 percent of the standard laboratory density. The Engineer will perform one density test per 1500 ft (450 m) of the entire length of foundation material through both cut and fill areas. Any foundation soils found to be unsuitable shall be removed and replaced as directed by the Engineer and shall be paid for according to Article 109.04.

The select fill lift placement shall closely follow the erection of each course of blocks. All aggregate shall be swept from the top of the block prior to placing the next block lift. If soil reinforcement is used, the select fill material shall be leveled and compacted before placing and attaching the soil reinforcement to the blocks. The soil reinforcement shall be pulled taut, staked in place, and select fill placed from the rear face of the blocks outward. The lift thickness shall be the lesser of 10 in. (255 mm) loose measurement or the proposed block height.

The select fill shall be compacted according to Article 205.05, except the minimum required compaction shall be 95 percent of the standard laboratory density. Compaction shall be achieved using a minimum of 3 passes of a lightweight mechanical tamper, roller, or vibratory system. The Engineer will perform one density test per 5000 cu yd (3800 cu m) and not less than one test per 2 ft (0.6m) of lift. The top 12 in. (300 mm) of backfill shall be a cohesive, impervious material capable of supporting vegetation, unless other details are specified on the plans.

The blocks shall be maintained in position as successive lifts are compacted along the rear face of the block. Vertical, horizontal, and rotational alignment tolerances shall not exceed 0.5 in. (12 mm) when measured along a 10 ft. (3 m) straight edge.

**Method of Measurement.** Segmental Concrete Block Wall will be measured by the square foot (square meter) of wall face from the top of block line to the theoretical top of the leveling pad for the length of the wall in a vertical plane, as shown on the contract plans.

**Basis of Payment.** This work will be paid for at the contract unit price per square foot (square meter) for SEGMENTAL CONCRETE BLOCK WALL.

## REQUIRED CONTRACT PROVISIONS FEDERAL-AID CONSTRUCTION CONTRACTS

- I. General
- II. Nondiscrimination
- III. Nonsegregated Facilities
- IV. Davis-Bacon and Related Act Provisions
- V. Contract Work Hours and Safety Standards Act Provisions
- VI. Subletting or Assigning the Contract
- VII. Safety: Accident Prevention
- VIII. False Statements Concerning Highway Projects
- IX. Implementation of Clean Air Act and Federal Water Pollution Control Act
- X. Compliance with Governmentwide Suspension and Debarment Requirements
- XI. Certification Regarding Use of Contract Funds for Lobbying

### ATTACHMENTS

A. Employment and Materials Preference for Appalachian Development Highway System or Appalachian Local Access Road Contracts (included in Appalachian contracts only)

#### I. GENERAL

1. Form FHWA-1273 must be physically incorporated in each construction contract funded under Title 23 (excluding emergency contracts solely intended for debris removal). The contractor (or subcontractor) must insert this form in each subcontract and further require its inclusion in all lower tier subcontracts (excluding purchase orders, rental agreements and other agreements for supplies or services).

The applicable requirements of Form FHWA-1273 are incorporated by reference for work done under any purchase order, rental agreement or agreement for other services. The prime contractor shall be responsible for compliance by any subcontractor, lower-tier subcontractor or service provider.

Form FHWA-1273 must be included in all Federal-aid design-build contracts, in all subcontracts and in lower tier subcontracts (excluding subcontracts for design services, purchase orders, rental agreements and other agreements for supplies or services). The design-builder shall be responsible for compliance by any subcontractor, lower-tier subcontractor or service provider.

Contracting agencies may reference Form FHWA-1273 in bid proposal or request for proposal documents, however, the Form FHWA-1273 must be physically incorporated (not referenced) in all contracts, subcontracts and lower-tier subcontracts (excluding purchase orders, rental agreements and other agreements for supplies or services related to a construction contract).

2. Subject to the applicability criteria noted in the following sections, these contract provisions shall apply to all work performed on the contract by the contractor's own organization and with the assistance of workers under the contractor's immediate superintendence and to all work performed on the contract by piecework, station work, or by subcontract.

3. A breach of any of the stipulations contained in these Required Contract Provisions may be sufficient grounds for withholding of progress payments, withholding of final payment, termination of the contract, suspension / debarment or any other action determined to be appropriate by the contracting agency and FHWA.

4. Selection of Labor: During the performance of this contract, the contractor shall not use convict labor for any purpose within the limits of a construction project on a Federal-aid highway unless it is labor performed by convicts who are on parole, supervised release, or probation. The term Federal-aid highway does not include roadways functionally classified as local roads or rural minor collectors.

#### II. NONDISCRIMINATION

The provisions of this section related to 23 CFR Part 230 are applicable to all Federal-aid construction contracts and to all related construction subcontracts of \$10,000 or more. The provisions of 23 CFR Part 230 are not applicable to material supply, engineering, or architectural service contracts.

In addition, the contractor and all subcontractors must comply with the following policies: Executive Order 11246, 41 CFR 60, 29 CFR 1625-1627, Title 23 USC Section 140, the Rehabilitation Act of 1973, as amended (29 USC 794), Title VI of the Civil Rights Act of 1964, as amended, and related regulations including 49 CFR Parts 21, 26 and 27; and 23 CFR Parts 200, 230, and 633.

The contractor and all subcontractors must comply with: the requirements of the Equal Opportunity Clause in 41 CFR 60-1.4(b) and, for all construction contracts exceeding \$10,000, the Standard Federal Equal Employment Opportunity Construction Contract Specifications in 41 CFR 60-4.3.

Note: The U.S. Department of Labor has exclusive authority to determine compliance with Executive Order 11246 and the policies of the Secretary of Labor including 41 CFR 60, and 29 CFR 1625-1627. The contracting agency and the FHWA have the authority and the responsibility to ensure compliance with Title 23 USC Section 140, the Rehabilitation Act of 1973, as amended (29 USC 794), and Title VI of the Civil Rights Act of 1964, as amended, and related regulations including 49 CFR Parts 21, 26 and 27; and 23 CFR Parts 200, 230, and 633.

The following provision is adopted from 23 CFR 230, Appendix A, with appropriate revisions to conform to the U.S. Department of Labor (US DOL) and FHWA requirements.

**1. Equal Employment Opportunity:** Equal employment opportunity (EEO) requirements not to discriminate and to take affirmative action to assure equal opportunity as set forth under laws, executive orders, rules, regulations (28 CFR 35, 29 CFR 1630, 29 CFR 1625-1627, 41 CFR 60 and 49 CFR 27) and orders of the Secretary of Labor as modified by the provisions prescribed herein, and imposed pursuant to 23 U.S.C. 140 shall constitute the EEO and specific affirmative action standards for the contractor's project activities under this contract. The provisions of the Americans with Disabilities Act of 1990 (42 U.S.C. 12101 et seq.) set forth under 28 CFR 35 and 29 CFR 1630 are incorporated by reference in this contract. In the execution of this contract, the contractor agrees to comply with the following minimum specific requirement activities of EEO:

a. The contractor will work with the contracting agency and the Federal Government to ensure that it has made every good faith effort to provide equal opportunity with respect to all of its terms and conditions of employment and in their review of activities under the contract.

b. The contractor will accept as its operating policy the following statement:

"It is the policy of this Company to assure that applicants are employed, and that employees are treated during employment, without regard to their race, religion, sex, color, national origin, age or disability. Such action shall include: employment, upgrading, demotion, or transfer; recruitment or recruitment advertising; layoff or termination; rates of pay or other forms of compensation; and selection for training, including apprenticeship, pre-apprenticeship, and/or on-the-job training."

**2. EEO Officer:** The contractor will designate and make known to the contracting officers an EEO Officer who will have the responsibility for and must be capable of effectively administering and promoting an active EEO program and who must be assigned adequate authority and responsibility to do so.



**3. Dissemination of Policy:** All members of the contractor's staff who are authorized to hire, supervise, promote, and discharge employees, or who recommend such action, or who are substantially involved in such action, will be made fully cognizant of, and will implement, the contractor's EEO policy and contractual responsibilities to provide EEO in each grade and classification of employment. To ensure that the above agreement will be met, the following actions will be taken as a minimum:

a. Periodic meetings of supervisory and personnel office employees will be conducted before the start of work and then not less often than once every six months, at which time the contractor's EEO policy and its implementation will be reviewed and explained. The meetings will be conducted by the EEO Officer.

b. All new supervisory or personnel office employees will be given a thorough indoctrination by the EEO Officer, covering all major aspects of the contractor's EEO obligations within thirty days following their reporting for duty with the contractor.

c. All personnel who are engaged in direct recruitment for the project will be instructed by the EEO Officer in the contractor's procedures for locating and hiring minorities and women.

d. Notices and posters setting forth the contractor's EEO policy will be placed in areas readily accessible to employees, applicants for employment and potential employees.

e. The contractor's EEO policy and the procedures to implement such policy will be brought to the attention of employees by means of meetings, employee handbooks, or other appropriate means.

**4. Recruitment:** When advertising for employees, the contractor will include in all advertisements for employees the notation: "An Equal Opportunity Employer." All such advertisements will be placed in publications having a large circulation among minorities and women in the area from which the project work force would normally be derived.

a. The contractor will, unless precluded by a valid bargaining agreement, conduct systematic and direct recruitment through public and private employee referral sources likely to yield qualified minorities and women. To meet this requirement, the contractor will identify sources of potential minority group employees, and establish with such identified sources procedures whereby minority and women applicants may be referred to the contractor for employment consideration.

b. In the event the contractor has a valid bargaining agreement providing for exclusive hiring hall referrals, the contractor is expected to observe the provisions of that agreement to the extent that the system meets the contractor's compliance with EEO contract provisions. Where implementation of such an agreement has the effect of discriminating against minorities or women, or obligates the contractor to do the same, such implementation violates Federal nondiscrimination provisions.

c. The contractor will encourage its present employees to refer minorities and women as applicants for employment. Information and procedures with regard to referring such applicants will be discussed with employees.

**5. Personnel Actions:** Wages, working conditions, and employee benefits shall be established and administered, and personnel actions of every type, including hiring, upgrading, promotion, transfer, demotion, layoff, and termination, shall be taken without regard to race, color, religion, sex, national origin, age or disability. The following procedures shall be followed:

a. The contractor will conduct periodic inspections of project sites to insure that working conditions and employee facilities do not indicate discriminatory treatment of project site personnel.

b. The contractor will periodically evaluate the spread of wages paid within each classification to determine any evidence of discriminatory wage practices.

c. The contractor will periodically review selected personnel actions in depth to determine whether there is evidence of discrimination. Where evidence is found, the contractor will promptly take corrective action. If

the review indicates that the discrimination may extend beyond the actions reviewed, such corrective action shall include all affected persons.

d. The contractor will promptly investigate all complaints of alleged discrimination made to the contractor in connection with its obligations under this contract, will attempt to resolve such complaints, and will take appropriate corrective action within a reasonable time. If the investigation indicates that the discrimination may affect persons other than the complainant, such corrective action shall include such other persons. Upon completion of each investigation, the contractor will inform every complainant of all of their avenues of appeal.

## **6. Training and Promotion:**

a. The contractor will assist in locating, qualifying, and increasing the skills of minorities and women who are applicants for employment or current employees. Such efforts should be aimed at developing full journey level status employees in the type of trade or job classification involved.

b. Consistent with the contractor's work force requirements and as permissible under Federal and State regulations, the contractor shall make full use of training programs, i.e., apprenticeship, and on-the-job training programs for the geographical area of contract performance. In the event a special provision for training is provided under this contract, this subparagraph will be superseded as indicated in the special provision. The contracting agency may reserve training positions for persons who receive welfare assistance in accordance with 23 U.S.C. 140(a).

c. The contractor will advise employees and applicants for employment of available training programs and entrance requirements for each.

d. The contractor will periodically review the training and promotion potential of employees who are minorities and women and will encourage eligible employees to apply for such training and promotion.

**7. Unions:** If the contractor relies in whole or in part upon unions as a source of employees, the contractor will use good faith efforts to obtain the cooperation of such unions to increase opportunities for minorities and women. Actions by the contractor, either directly or through a contractor's association acting as agent, will include the procedures set forth below:

a. The contractor will use good faith efforts to develop, in cooperation with the unions, joint training programs aimed toward qualifying more minorities and women for membership in the unions and increasing the skills of minorities and women so that they may qualify for higher paying employment.

b. The contractor will use good faith efforts to incorporate an EEO clause into each union agreement to the end that such union will be contractually bound to refer applicants without regard to their race, color, religion, sex, national origin, age or disability.

c. The contractor is to obtain information as to the referral practices and policies of the labor union except that to the extent such information is within the exclusive possession of the labor union and such labor union refuses to furnish such information to the contractor, the contractor shall so certify to the contracting agency and shall set forth what efforts have been made to obtain such information.

d. In the event the union is unable to provide the contractor with a reasonable flow of referrals within the time limit set forth in the collective bargaining agreement, the contractor will, through independent recruitment efforts, fill the employment vacancies without regard to race, color, religion, sex, national origin, age or disability; making full efforts to obtain qualified and/or qualifiable minorities and women. The failure of a union to provide sufficient referrals (even though it is obligated to provide exclusive referrals under the terms of a collective bargaining agreement) does not relieve the contractor from the requirements of this paragraph. In the event the union referral practice prevents the contractor from meeting the obligations pursuant to Executive Order 11246, as amended, and these special provisions, such contractor shall immediately notify the contracting agency.

**8. Reasonable Accommodation for Applicants / Employees with Disabilities:** The contractor must be familiar with the requirements for and comply with the Americans with Disabilities Act and all rules and regulations established there under. Employers must provide reasonable accommodation in all employment activities unless to do so would cause an undue hardship.

**9. Selection of Subcontractors, Procurement of Materials and Leasing of Equipment:** The contractor shall not discriminate on the grounds of race, color, religion, sex, national origin, age or disability in the selection and retention of subcontractors, including procurement of materials and leases of equipment. The contractor shall take all necessary and reasonable steps to ensure nondiscrimination in the administration of this contract.

a. The contractor shall notify all potential subcontractors and suppliers and lessors of their EEO obligations under this contract.

b. The contractor will use good faith efforts to ensure subcontractor compliance with their EEO obligations.

**10. Assurance Required by 49 CFR 26.13(b):**

a. The requirements of 49 CFR Part 26 and the State DOT's U.S. DOT-approved DBE program are incorporated by reference.

b. The contractor or subcontractor shall not discriminate on the basis of race, color, national origin, or sex in the performance of this contract. The contractor shall carry out applicable requirements of 49 CFR Part 26 in the award and administration of DOT-assisted contracts. Failure by the contractor to carry out these requirements is a material breach of this contract, which may result in the termination of this contract or such other remedy as the contracting agency deems appropriate.

**11. Records and Reports:** The contractor shall keep such records as necessary to document compliance with the EEO requirements. Such records shall be retained for a period of three years following the date of the final payment to the contractor for all contract work and shall be available at reasonable times and places for inspection by authorized representatives of the contracting agency and the FHWA.

a. The records kept by the contractor shall document the following:

(1) The number and work hours of minority and non-minority group members and women employed in each work classification on the project;

(2) The progress and efforts being made in cooperation with unions, when applicable, to increase employment opportunities for minorities and women; and

(3) The progress and efforts being made in locating, hiring, training, qualifying, and upgrading minorities and women;

b. The contractors and subcontractors will submit an annual report to the contracting agency each July for the duration of the project, indicating the number of minority, women, and non-minority group employees currently engaged in each work classification required by the contract work. This information is to be reported on [Form FHWA-1391](#). The staffing data should represent the project work force on board in all or any part of the last payroll period preceding the end of July. If on-the-job training is being required by special provision, the contractor will be required to collect and report training data. The employment data should reflect the work force on board during all or any part of the last payroll period preceding the end of July.

**III. NONSEGREGATED FACILITIES**

This provision is applicable to all Federal-aid construction contracts and to all related construction subcontracts of \$10,000 or more.

The contractor must ensure that facilities provided for employees are provided in such a manner that segregation on the basis of race, color,

religion, sex, or national origin cannot result. The contractor may neither require such segregated use by written or oral policies nor tolerate such use by employee custom. The contractor's obligation extends further to ensure that its employees are not assigned to perform their services at any location, under the contractor's control, where the facilities are segregated. The term "facilities" includes waiting rooms, work areas, restaurants and other eating areas, time clocks, restrooms, washrooms, locker rooms, and other storage or dressing areas, parking lots, drinking fountains, recreation or entertainment areas, transportation, and housing provided for employees. The contractor shall provide separate or single-user restrooms and necessary dressing or sleeping areas to assure privacy between sexes.

**IV. Davis-Bacon and Related Act Provisions**

This section is applicable to all Federal-aid construction projects exceeding \$2,000 and to all related subcontracts and lower-tier subcontracts (regardless of subcontract size). The requirements apply to all projects located within the right-of-way of a roadway that is functionally classified as Federal-aid highway. This excludes roadways functionally classified as local roads or rural minor collectors, which are exempt. Contracting agencies may elect to apply these requirements to other projects.

The following provisions are from the U.S. Department of Labor regulations in 29 CFR 5.5 "Contract provisions and related matters" with minor revisions to conform to the FHWA-1273 format and FHWA program requirements.

**1. Minimum wages**

a. All laborers and mechanics employed or working upon the site of the work, will be paid unconditionally and not less often than once a week, and without subsequent deduction or rebate on any account (except such payroll deductions as are permitted by regulations issued by the Secretary of Labor under the Copeland Act (29 CFR part 3)), the full amount of wages and bona fide fringe benefits (or cash equivalents thereof) due at time of payment computed at rates not less than those contained in the wage determination of the Secretary of Labor which is attached hereto and made a part hereof, regardless of any contractual relationship which may be alleged to exist between the contractor and such laborers and mechanics.

Contributions made or costs reasonably anticipated for bona fide fringe benefits under section 1(b)(2) of the Davis-Bacon Act on behalf of laborers or mechanics are considered wages paid to such laborers or mechanics, subject to the provisions of paragraph 1.d. of this section; also, regular contributions made or costs incurred for more than a weekly period (but not less often than quarterly) under plans, funds, or programs which cover the particular weekly period, are deemed to be constructively made or incurred during such weekly period. Such laborers and mechanics shall be paid the appropriate wage rate and fringe benefits on the wage determination for the classification of work actually performed, without regard to skill, except as provided in 29 CFR 5.5(a)(4). Laborers or mechanics performing work in more than one classification may be compensated at the rate specified for each classification for the time actually worked therein: Provided, That the employer's payroll records accurately set forth the time spent in each classification in which work is performed. The wage determination (including any additional classification and wage rates conformed under paragraph 1.b. of this section) and the Davis-Bacon poster (WH-1321) shall be posted at all times by the contractor and its subcontractors at the site of the work in a prominent and accessible place where it can be easily seen by the workers.

b.(1) The contracting officer shall require that any class of laborers or mechanics, including helpers, which is not listed in the wage determination and which is to be employed under the contract shall be classified in conformance with the wage determination. The contracting officer shall approve an additional classification and wage rate and fringe benefits therefore only when the following criteria have been met:

(i) The work to be performed by the classification requested is not performed by a classification in the wage determination; and

(ii) The classification is utilized in the area by the construction industry; and

(iii) The proposed wage rate, including any bona fide fringe benefits, bears a reasonable relationship to the wage rates contained in the wage determination.

(2) If the contractor and the laborers and mechanics to be employed in the classification (if known), or their representatives, and the contracting officer agree on the classification and wage rate (including the amount designated for fringe benefits where appropriate), a report of the action taken shall be sent by the contracting officer to the Administrator of the Wage and Hour Division, Employment Standards Administration, U.S. Department of Labor, Washington, DC 20210. The Administrator, or an authorized representative, will approve, modify, or disapprove every additional classification action within 30 days of receipt and so advise the contracting officer or will notify the contracting officer within the 30-day period that additional time is necessary.

(3) In the event the contractor, the laborers or mechanics to be employed in the classification or their representatives, and the contracting officer do not agree on the proposed classification and wage rate (including the amount designated for fringe benefits, where appropriate), the contracting officer shall refer the questions, including the views of all interested parties and the recommendation of the contracting officer, to the Wage and Hour Administrator for determination. The Wage and Hour Administrator, or an authorized representative, will issue a determination within 30 days of receipt and so advise the contracting officer or will notify the contracting officer within the 30-day period that additional time is necessary.

(4) The wage rate (including fringe benefits where appropriate) determined pursuant to paragraphs 1.b.(2) or 1.b.(3) of this section, shall be paid to all workers performing work in the classification under this contract from the first day on which work is performed in the classification.

c. Whenever the minimum wage rate prescribed in the contract for a class of laborers or mechanics includes a fringe benefit which is not expressed as an hourly rate, the contractor shall either pay the benefit as stated in the wage determination or shall pay another bona fide fringe benefit or an hourly cash equivalent thereof.

d. If the contractor does not make payments to a trustee or other third person, the contractor may consider as part of the wages of any laborer or mechanic the amount of any costs reasonably anticipated in providing bona fide fringe benefits under a plan or program, Provided, That the Secretary of Labor has found, upon the written request of the contractor, that the applicable standards of the Davis-Bacon Act have been met. The Secretary of Labor may require the contractor to set aside in a separate account assets for the meeting of obligations under the plan or program.

## 2. Withholding

The contracting agency shall upon its own action or upon written request of an authorized representative of the Department of Labor, withhold or cause to be withheld from the contractor under this contract, or any other Federal contract with the same prime contractor, or any other federally-assisted contract subject to Davis-Bacon prevailing wage requirements, which is held by the same prime contractor, so much of the accrued payments or advances as may be considered necessary to pay laborers and mechanics, including apprentices, trainees, and helpers, employed by the contractor or any subcontractor the full amount of wages required by the contract. In the event of failure to pay any laborer or mechanic, including any apprentice, trainee, or helper, employed or working on the site of the work, all or part of the wages required by the contract, the contracting agency may, after written notice to the contractor, take such

action as may be necessary to cause the suspension of any further payment, advance, or guarantee of funds until such violations have ceased.

## 3. Payrolls and basic records

a. Payrolls and basic records relating thereto shall be maintained by the contractor during the course of the work and preserved for a period of three years thereafter for all laborers and mechanics working at the site of the work. Such records shall contain the name, address, and social security number of each such worker, his or her correct classification, hourly rates of wages paid (including rates of contributions or costs anticipated for bona fide fringe benefits or cash equivalents thereof of the types described in section 1(b)(2)(B) of the Davis-Bacon Act), daily and weekly number of hours worked, deductions made and actual wages paid. Whenever the Secretary of Labor has found under 29 CFR 5.5(a)(1)(iv) that the wages of any laborer or mechanic include the amount of any costs reasonably anticipated in providing benefits under a plan or program described in section 1(b)(2)(B) of the Davis-Bacon Act, the contractor shall maintain records which show that the commitment to provide such benefits is enforceable, that the plan or program is financially responsible, and that the plan or program has been communicated in writing to the laborers or mechanics affected, and records which show the costs anticipated or the actual cost incurred in providing such benefits. Contractors employing apprentices or trainees under approved programs shall maintain written evidence of the registration of apprenticeship programs and certification of trainee programs, the registration of the apprentices and trainees, and the ratios and wage rates prescribed in the applicable programs.

b. (1) The contractor shall submit weekly for each week in which any contract work is performed a copy of all payrolls to the contracting agency. The payrolls submitted shall set out accurately and completely all of the information required to be maintained under 29 CFR 5.5(a)(3)(i), except that full social security numbers and home addresses shall not be included on weekly transmittals. Instead the payrolls shall only need to include an individually identifying number for each employee ( e.g. , the last four digits of the employee's social security number). The required weekly payroll information may be submitted in any form desired. Optional Form WH-347 is available for this purpose from the Wage and Hour Division Web site at <http://www.dol.gov/esa/whd/forms/wh347instr.htm> or its successor site. The prime contractor is responsible for the submission of copies of payrolls by all subcontractors. Contractors and subcontractors shall maintain the full social security number and current address of each covered worker, and shall provide them upon request to the contracting agency for transmission to the State DOT, the FHWA or the Wage and Hour Division of the Department of Labor for purposes of an investigation or audit of compliance with prevailing wage requirements. It is not a violation of this section for a prime contractor to require a subcontractor to provide addresses and social security numbers to the prime contractor for its own records, without weekly submission to the contracting agency..

(2) Each payroll submitted shall be accompanied by a "Statement of Compliance," signed by the contractor or subcontractor or his or her agent who pays or supervises the payment of the persons employed under the contract and shall certify the following:

(i) That the payroll for the payroll period contains the information required to be provided under §5.5 (a)(3)(ii) of Regulations, 29 CFR part 5, the appropriate information is being maintained under §5.5 (a)(3)(i) of Regulations, 29 CFR part 5, and that such information is correct and complete;

(ii) That each laborer or mechanic (including each helper, apprentice, and trainee) employed on the contract during the payroll period has been paid the full weekly wages earned, without rebate, either directly or indirectly, and that no deductions have been made either directly or indirectly from the full wages earned, other than permissible deductions as set forth in Regulations, 29 CFR part 3;

(iii) That each laborer or mechanic has been paid not less than the applicable wage rates and fringe benefits or cash equivalents for the classification of work performed, as specified in the applicable wage determination incorporated into the contract.

(3) The weekly submission of a properly executed certification set forth on the reverse side of Optional Form WH-347 shall satisfy the requirement for submission of the "Statement of Compliance" required by paragraph 3.b.(2) of this section.

(4) The falsification of any of the above certifications may subject the contractor or subcontractor to civil or criminal prosecution under section 1001 of title 18 and section 231 of title 31 of the United States Code.

c. The contractor or subcontractor shall make the records required under paragraph 3.a. of this section available for inspection, copying, or transcription by authorized representatives of the contracting agency, the State DOT, the FHWA, or the Department of Labor, and shall permit such representatives to interview employees during working hours on the job. If the contractor or subcontractor fails to submit the required records or to make them available, the FHWA may, after written notice to the contractor, the contracting agency or the State DOT, take such action as may be necessary to cause the suspension of any further payment, advance, or guarantee of funds. Furthermore, failure to submit the required records upon request or to make such records available may be grounds for debarment action pursuant to 29 CFR 5.12.

#### 4. Apprentices and trainees

##### a. Apprentices (programs of the USDOL).

Apprentices will be permitted to work at less than the predetermined rate for the work they performed when they are employed pursuant to and individually registered in a bona fide apprenticeship program registered with the U.S. Department of Labor, Employment and Training Administration, Office of Apprenticeship Training, Employer and Labor Services, or with a State Apprenticeship Agency recognized by the Office, or if a person is employed in his or her first 90 days of probationary employment as an apprentice in such an apprenticeship program, who is not individually registered in the program, but who has been certified by the Office of Apprenticeship Training, Employer and Labor Services or a State Apprenticeship Agency (where appropriate) to be eligible for probationary employment as an apprentice.

The allowable ratio of apprentices to journeymen on the job site in any craft classification shall not be greater than the ratio permitted to the contractor as to the entire work force under the registered program. Any worker listed on a payroll at an apprentice wage rate, who is not registered or otherwise employed as stated above, shall be paid not less than the applicable wage rate on the wage determination for the classification of work actually performed. In addition, any apprentice performing work on the job site in excess of the ratio permitted under the registered program shall be paid not less than the applicable wage rate on the wage determination for the work actually performed. Where a contractor is performing construction on a project in a locality other than that in which its program is registered, the ratios and wage rates (expressed in percentages of the journeyman's hourly rate) specified in the contractor's or subcontractor's registered program shall be observed.

Every apprentice must be paid at not less than the rate specified in the registered program for the apprentice's level of progress, expressed as a percentage of the journeymen hourly rate specified in the applicable wage determination. Apprentices shall be paid fringe benefits in accordance with the provisions of the apprenticeship program. If the apprenticeship program does not specify fringe benefits, apprentices must be paid the full amount of fringe benefits listed on the wage determination for the applicable classification. If the Administrator determines that a different practice prevails for the applicable apprentice classification, fringes shall be paid in accordance with that determination.

In the event the Office of Apprenticeship Training, Employer and Labor Services, or a State Apprenticeship Agency recognized by the Office, withdraws approval of an apprenticeship program, the contractor will no longer be permitted to utilize apprentices at less than the applicable predetermined rate for the work performed until an acceptable program is approved.

##### b. Trainees (programs of the USDOL).

Except as provided in 29 CFR 5.16, trainees will not be permitted to work at less than the predetermined rate for the work performed unless they are employed pursuant to and individually registered in a program which has received prior approval, evidenced by formal certification by the U.S. Department of Labor, Employment and Training Administration.

The ratio of trainees to journeymen on the job site shall not be greater than permitted under the plan approved by the Employment and Training Administration.

Every trainee must be paid at not less than the rate specified in the approved program for the trainee's level of progress, expressed as a percentage of the journeyman hourly rate specified in the applicable wage determination. Trainees shall be paid fringe benefits in accordance with the provisions of the trainee program. If the trainee program does not mention fringe benefits, trainees shall be paid the full amount of fringe benefits listed on the wage determination unless the Administrator of the Wage and Hour Division determines that there is an apprenticeship program associated with the corresponding journeyman wage rate on the wage determination which provides for less than full fringe benefits for apprentices. Any employee listed on the payroll at a trainee rate who is not registered and participating in a training plan approved by the Employment and Training Administration shall be paid not less than the applicable wage rate on the wage determination for the classification of work actually performed. In addition, any trainee performing work on the job site in excess of the ratio permitted under the registered program shall be paid not less than the applicable wage rate on the wage determination for the work actually performed.

In the event the Employment and Training Administration withdraws approval of a training program, the contractor will no longer be permitted to utilize trainees at less than the applicable predetermined rate for the work performed until an acceptable program is approved.

c. Equal employment opportunity. The utilization of apprentices, trainees and journeymen under this part shall be in conformity with the equal employment opportunity requirements of Executive Order 11246, as amended, and 29 CFR part 30.

##### d. Apprentices and Trainees (programs of the U.S. DOT).

Apprentices and trainees working under apprenticeship and skill training programs which have been certified by the Secretary of Transportation as promoting EEO in connection with Federal-aid highway construction programs are not subject to the requirements of paragraph 4 of this Section IV. The straight time hourly wage rates for apprentices and trainees under such programs will be established by the particular programs. The ratio of apprentices and trainees to journeymen shall not be greater than permitted by the terms of the particular program.

**5. Compliance with Copeland Act requirements.** The contractor shall comply with the requirements of 29 CFR part 3, which are incorporated by reference in this contract.

**6. Subcontracts.** The contractor or subcontractor shall insert Form FHWA-1273 in any subcontracts and also require the subcontractors to include Form FHWA-1273 in any lower tier subcontracts. The prime contractor shall be responsible for the compliance by any subcontractor or lower tier subcontractor with all the contract clauses in 29 CFR 5.5.

**7. Contract termination: debarment.** A breach of the contract clauses in 29 CFR 5.5 may be grounds for termination of the contract, and for

debarment as a contractor and a subcontractor as provided in 29 CFR 5.12.

**8. Compliance with Davis-Bacon and Related Act requirements.** All rulings and interpretations of the Davis-Bacon and Related Acts contained in 29 CFR parts 1, 3, and 5 are herein incorporated by reference in this contract.

**9. Disputes concerning labor standards.** Disputes arising out of the labor standards provisions of this contract shall not be subject to the general disputes clause of this contract. Such disputes shall be resolved in accordance with the procedures of the Department of Labor set forth in 29 CFR parts 5, 6, and 7. Disputes within the meaning of this clause include disputes between the contractor (or any of its subcontractors) and the contracting agency, the U.S. Department of Labor, or the employees or their representatives.

#### **10. Certification of eligibility.**

a. By entering into this contract, the contractor certifies that neither it (nor he or she) nor any person or firm who has an interest in the contractor's firm is a person or firm ineligible to be awarded Government contracts by virtue of section 3(a) of the Davis-Bacon Act or 29 CFR 5.12(a)(1).

b. No part of this contract shall be subcontracted to any person or firm ineligible for award of a Government contract by virtue of section 3(a) of the Davis-Bacon Act or 29 CFR 5.12(a)(1).

c. The penalty for making false statements is prescribed in the U.S. Criminal Code, 18 U.S.C. 1001.

#### **V. CONTRACT WORK HOURS AND SAFETY STANDARDS ACT**

The following clauses apply to any Federal-aid construction contract in an amount in excess of \$100,000 and subject to the overtime provisions of the Contract Work Hours and Safety Standards Act. These clauses shall be inserted in addition to the clauses required by 29 CFR 5.5(a) or 29 CFR 4.6. As used in this paragraph, the terms laborers and mechanics include watchmen and guards.

**1. Overtime requirements.** No contractor or subcontractor contracting for any part of the contract work which may require or involve the employment of laborers or mechanics shall require or permit any such laborer or mechanic in any workweek in which he or she is employed on such work to work in excess of forty hours in such workweek unless such laborer or mechanic receives compensation at a rate not less than one and one-half times the basic rate of pay for all hours worked in excess of forty hours in such workweek.

**2. Violation; liability for unpaid wages; liquidated damages.** In the event of any violation of the clause set forth in paragraph (1.) of this section, the contractor and any subcontractor responsible therefor shall be liable for the unpaid wages. In addition, such contractor and subcontractor shall be liable to the United States (in the case of work done under contract for the District of Columbia or a territory, to such District or to such territory), for liquidated damages. Such liquidated damages shall be computed with respect to each individual laborer or mechanic, including watchmen and guards, employed in violation of the clause set forth in paragraph (1.) of this section, in the sum of \$10 for each calendar day on which such individual was required or permitted to work in excess of the standard workweek of forty hours without payment of the overtime wages required by the clause set forth in paragraph (1.) of this section.

**3. Withholding for unpaid wages and liquidated damages.** The FHWA or the contacting agency shall upon its own action or upon written request of an authorized representative of the Department of Labor withhold or cause to be withheld, from any moneys payable on account of work performed by the contractor or subcontractor under any such

contract or any other Federal contract with the same prime contractor, or any other federally-assisted contract subject to the Contract Work Hours and Safety Standards Act, which is held by the same prime contractor, such sums as may be determined to be necessary to satisfy any liabilities of such contractor or subcontractor for unpaid wages and liquidated damages as provided in the clause set forth in paragraph (2.) of this section.

**4. Subcontracts.** The contractor or subcontractor shall insert in any subcontracts the clauses set forth in paragraph (1.) through (4.) of this section and also a clause requiring the subcontractors to include these clauses in any lower tier subcontracts. The prime contractor shall be responsible for compliance by any subcontractor or lower tier subcontractor with the clauses set forth in paragraphs (1.) through (4.) of this section.

#### **VI. SUBLETTING OR ASSIGNING THE CONTRACT**

This provision is applicable to all Federal-aid construction contracts on the National Highway System.

1. The contractor shall perform with its own organization contract work amounting to not less than 30 percent (or a greater percentage if specified elsewhere in the contract) of the total original contract price, excluding any specialty items designated by the contracting agency. Specialty items may be performed by subcontract and the amount of any such specialty items performed may be deducted from the total original contract price before computing the amount of work required to be performed by the contractor's own organization (23 CFR 635.116).

a. The term "perform work with its own organization" refers to workers employed or leased by the prime contractor, and equipment owned or rented by the prime contractor, with or without operators. Such term does not include employees or equipment of a subcontractor or lower tier subcontractor, agents of the prime contractor, or any other assignees. The term may include payments for the costs of hiring leased employees from an employee leasing firm meeting all relevant Federal and State regulatory requirements. Leased employees may only be included in this term if the prime contractor meets all of the following conditions:

(1) the prime contractor maintains control over the supervision of the day-to-day activities of the leased employees;

(2) the prime contractor remains responsible for the quality of the work of the leased employees;

(3) the prime contractor retains all power to accept or exclude individual employees from work on the project; and

(4) the prime contractor remains ultimately responsible for the payment of predetermined minimum wages, the submission of payrolls, statements of compliance and all other Federal regulatory requirements.

b. "Specialty Items" shall be construed to be limited to work that requires highly specialized knowledge, abilities, or equipment not ordinarily available in the type of contracting organizations qualified and expected to bid or propose on the contract as a whole and in general are to be limited to minor components of the overall contract.

2. The contract amount upon which the requirements set forth in paragraph (1) of Section VI is computed includes the cost of material and manufactured products which are to be purchased or produced by the contractor under the contract provisions.

3. The contractor shall furnish (a) a competent superintendent or supervisor who is employed by the firm, has full authority to direct performance of the work in accordance with the contract requirements, and is in charge of all construction operations (regardless of who performs the work) and (b) such other of its own organizational resources (supervision, management, and engineering services) as the contracting officer determines is necessary to assure the performance of the contract.

4. No portion of the contract shall be sublet, assigned or otherwise disposed of except with the written consent of the contracting officer, or authorized representative, and such consent when given shall not be construed to relieve the contractor of any responsibility for the fulfillment of the contract. Written consent will be given only after the contracting agency has assured that each subcontract is evidenced in writing and that it contains all pertinent provisions and requirements of the prime contract.

5. The 30% self-performance requirement of paragraph (1) is not applicable to design-build contracts; however, contracting agencies may establish their own self-performance requirements.

## **VII. SAFETY: ACCIDENT PREVENTION**

This provision is applicable to all Federal-aid construction contracts and to all related subcontracts.

1. In the performance of this contract the contractor shall comply with all applicable Federal, State, and local laws governing safety, health, and sanitation (23 CFR 635). The contractor shall provide all safeguards, safety devices and protective equipment and take any other needed actions as it determines, or as the contracting officer may determine, to be reasonably necessary to protect the life and health of employees on the job and the safety of the public and to protect property in connection with the performance of the work covered by the contract.

2. It is a condition of this contract, and shall be made a condition of each subcontract, which the contractor enters into pursuant to this contract, that the contractor and any subcontractor shall not permit any employee, in performance of the contract, to work in surroundings or under conditions which are unsanitary, hazardous or dangerous to his/her health or safety, as determined under construction safety and health standards (29 CFR 1926) promulgated by the Secretary of Labor, in accordance with Section 107 of the Contract Work Hours and Safety Standards Act (40 U.S.C. 3704).

3. Pursuant to 29 CFR 1926.3, it is a condition of this contract that the Secretary of Labor or authorized representative thereof, shall have right of entry to any site of contract performance to inspect or investigate the matter of compliance with the construction safety and health standards and to carry out the duties of the Secretary under Section 107 of the Contract Work Hours and Safety Standards Act (40 U.S.C.3704).

## **VIII. FALSE STATEMENTS CONCERNING HIGHWAY PROJECTS**

This provision is applicable to all Federal-aid construction contracts and to all related subcontracts.

In order to assure high quality and durable construction in conformity with approved plans and specifications and a high degree of reliability on statements and representations made by engineers, contractors, suppliers, and workers on Federal-aid highway projects, it is essential that all persons concerned with the project perform their functions as carefully, thoroughly, and honestly as possible. Willful falsification, distortion, or misrepresentation with respect to any facts related to the project is a violation of Federal law. To prevent any misunderstanding regarding the seriousness of these and similar acts, Form FHWA-1022 shall be posted on each Federal-aid highway project (23 CFR 635) in one or more places where it is readily available to all persons concerned with the project:

18 U.S.C. 1020 reads as follows:

"Whoever, being an officer, agent, or employee of the United States, or of any State or Territory, or whoever, whether a person, association, firm, or corporation, knowingly makes any false statement, false representation, or false report as to the character, quality, quantity, or cost of the material used or to be used, or the quantity or quality of the work performed or to be performed, or the cost thereof in connection with the submission of plans, maps, specifications, contracts, or costs of construction on any highway or related project submitted for approval to the Secretary of Transportation; or

Whoever knowingly makes any false statement, false representation, false report or false claim with respect to the character, quality, quantity, or cost of any work performed or to be performed, or materials furnished or to be furnished, in connection with the construction of any highway or related project approved by the Secretary of Transportation; or

Whoever knowingly makes any false statement or false representation as to material fact in any statement, certificate, or report submitted pursuant to provisions of the Federal-aid Roads Act approved July 1, 1916, (39 Stat. 355), as amended and supplemented;

Shall be fined under this title or imprisoned not more than 5 years or both."

## **IX. IMPLEMENTATION OF CLEAN AIR ACT AND FEDERAL WATER POLLUTION CONTROL ACT**

This provision is applicable to all Federal-aid construction contracts and to all related subcontracts.

By submission of this bid/proposal or the execution of this contract, or subcontract, as appropriate, the bidder, proposer, Federal-aid construction contractor, or subcontractor, as appropriate, will be deemed to have stipulated as follows:

1. That any person who is or will be utilized in the performance of this contract is not prohibited from receiving an award due to a violation of Section 508 of the Clean Water Act or Section 306 of the Clean Air Act.

2. That the contractor agrees to include or cause to be included the requirements of paragraph (1) of this Section X in every subcontract, and further agrees to take such action as the contracting agency may direct as a means of enforcing such requirements.

## **X. CERTIFICATION REGARDING DEBARMENT, SUSPENSION, INELIGIBILITY AND VOLUNTARY EXCLUSION**

This provision is applicable to all Federal-aid construction contracts, design-build contracts, subcontracts, lower-tier subcontracts, purchase orders, lease agreements, consultant contracts or any other covered transaction requiring FHWA approval or that is estimated to cost \$25,000 or more – as defined in 2 CFR Parts 180 and 1200.

### **1. Instructions for Certification – First Tier Participants:**

a. By signing and submitting this proposal, the prospective first tier participant is providing the certification set out below.

b. The inability of a person to provide the certification set out below will not necessarily result in denial of participation in this covered transaction. The prospective first tier participant shall submit an explanation of why it cannot provide the certification set out below. The certification or explanation will be considered in connection with the department or agency's determination whether to enter into this transaction. However, failure of the prospective first tier participant to furnish a certification or an explanation shall disqualify such a person from participation in this transaction.

c. The certification in this clause is a material representation of fact upon which reliance was placed when the contracting agency determined to enter into this transaction. If it is later determined that the prospective participant knowingly rendered an erroneous certification, in addition to other remedies available to the Federal Government, the contracting agency may terminate this transaction for cause of default.

d. The prospective first tier participant shall provide immediate written notice to the contracting agency to whom this proposal is submitted if any time the prospective first tier participant learns that its certification was erroneous when submitted or has become erroneous by reason of changed circumstances.

e. The terms "covered transaction," "debarred," "suspended," "ineligible," "participant," "person," "principal," and "voluntarily excluded,"



as used in this clause, are defined in 2 CFR Parts 180 and 1200. "First Tier Covered Transactions" refers to any covered transaction between a grantee or subgrantee of Federal funds and a participant (such as the prime or general contract). "Lower Tier Covered Transactions" refers to any covered transaction under a First Tier Covered Transaction (such as subcontracts). "First Tier Participant" refers to the participant who has entered into a covered transaction with a grantee or subgrantee of Federal funds (such as the prime or general contractor). "Lower Tier Participant" refers any participant who has entered into a covered transaction with a First Tier Participant or other Lower Tier Participants (such as subcontractors and suppliers).

f. The prospective first tier participant agrees by submitting this proposal that, should the proposed covered transaction be entered into, it shall not knowingly enter into any lower tier covered transaction with a person who is debarred, suspended, declared ineligible, or voluntarily excluded from participation in this covered transaction, unless authorized by the department or agency entering into this transaction.

g. The prospective first tier participant further agrees by submitting this proposal that it will include the clause titled "Certification Regarding Debarment, Suspension, Ineligibility and Voluntary Exclusion-Lower Tier Covered Transactions," provided by the department or contracting agency, entering into this covered transaction, without modification, in all lower tier covered transactions and in all solicitations for lower tier covered transactions exceeding the \$25,000 threshold.

h. A participant in a covered transaction may rely upon a certification of a prospective participant in a lower tier covered transaction that is not debarred, suspended, ineligible, or voluntarily excluded from the covered transaction, unless it knows that the certification is erroneous. A participant is responsible for ensuring that its principals are not suspended, debarred, or otherwise ineligible to participate in covered transactions. To verify the eligibility of its principals, as well as the eligibility of any lower tier prospective participants, each participant may, but is not required to, check the Excluded Parties List System website (<https://www.epls.gov/>), which is compiled by the General Services Administration.

i. Nothing contained in the foregoing shall be construed to require the establishment of a system of records in order to render in good faith the certification required by this clause. The knowledge and information of the prospective participant is not required to exceed that which is normally possessed by a prudent person in the ordinary course of business dealings.

j. Except for transactions authorized under paragraph (f) of these instructions, if a participant in a covered transaction knowingly enters into a lower tier covered transaction with a person who is suspended, debarred, ineligible, or voluntarily excluded from participation in this transaction, in addition to other remedies available to the Federal Government, the department or agency may terminate this transaction for cause or default.

\* \* \* \* \*

## **2. Certification Regarding Debarment, Suspension, Ineligibility and Voluntary Exclusion – First Tier Participants:**

a. The prospective first tier participant certifies to the best of its knowledge and belief, that it and its principals:

(1) Are not presently debarred, suspended, proposed for debarment, declared ineligible, or voluntarily excluded from participating in covered transactions by any Federal department or agency;

(2) Have not within a three-year period preceding this proposal been convicted of or had a civil judgment rendered against them for commission of fraud or a criminal offense in connection with obtaining, attempting to obtain, or performing a public (Federal, State or local) transaction or contract under a public transaction; violation of Federal or State antitrust statutes or commission of embezzlement, theft, forgery, bribery, falsification or destruction of records, making false statements, or receiving stolen property;

(3) Are not presently indicted for or otherwise criminally or civilly charged by a governmental entity (Federal, State or local) with

commission of any of the offenses enumerated in paragraph (a)(2) of this certification; and

(4) Have not within a three-year period preceding this application/proposal had one or more public transactions (Federal, State or local) terminated for cause or default.

b. Where the prospective participant is unable to certify to any of the statements in this certification, such prospective participant shall attach an explanation to this proposal.

### **2. Instructions for Certification - Lower Tier Participants:**

(Applicable to all subcontracts, purchase orders and other lower tier transactions requiring prior FHWA approval or estimated to cost \$25,000 or more - 2 CFR Parts 180 and 1200)

a. By signing and submitting this proposal, the prospective lower tier is providing the certification set out below.

b. The certification in this clause is a material representation of fact upon which reliance was placed when this transaction was entered into. If it is later determined that the prospective lower tier participant knowingly rendered an erroneous certification, in addition to other remedies available to the Federal Government, the department, or agency with which this transaction originated may pursue available remedies, including suspension and/or debarment.

c. The prospective lower tier participant shall provide immediate written notice to the person to which this proposal is submitted if at any time the prospective lower tier participant learns that its certification was erroneous by reason of changed circumstances.

d. The terms "covered transaction," "debarred," "suspended," "ineligible," "participant," "person," "principal," and "voluntarily excluded," as used in this clause, are defined in 2 CFR Parts 180 and 1200. You may contact the person to which this proposal is submitted for assistance in obtaining a copy of those regulations. "First Tier Covered Transactions" refers to any covered transaction between a grantee or subgrantee of Federal funds and a participant (such as the prime or general contract). "Lower Tier Covered Transactions" refers to any covered transaction under a First Tier Covered Transaction (such as subcontracts). "First Tier Participant" refers to the participant who has entered into a covered transaction with a grantee or subgrantee of Federal funds (such as the prime or general contractor). "Lower Tier Participant" refers any participant who has entered into a covered transaction with a First Tier Participant or other Lower Tier Participants (such as subcontractors and suppliers).

e. The prospective lower tier participant agrees by submitting this proposal that, should the proposed covered transaction be entered into, it shall not knowingly enter into any lower tier covered transaction with a person who is debarred, suspended, declared ineligible, or voluntarily excluded from participation in this covered transaction, unless authorized by the department or agency with which this transaction originated.

f. The prospective lower tier participant further agrees by submitting this proposal that it will include this clause titled "Certification Regarding Debarment, Suspension, Ineligibility and Voluntary Exclusion-Lower Tier Covered Transaction," without modification, in all lower tier covered transactions and in all solicitations for lower tier covered transactions exceeding the \$25,000 threshold.

g. A participant in a covered transaction may rely upon a certification of a prospective participant in a lower tier covered transaction that is not debarred, suspended, ineligible, or voluntarily excluded from the covered transaction, unless it knows that the certification is erroneous. A participant is responsible for ensuring that its principals are not suspended, debarred, or otherwise ineligible to participate in covered transactions. To verify the eligibility of its principals, as well as the eligibility of any lower tier prospective participants, each participant may, but is not required to, check the Excluded Parties List System website (<https://www.epls.gov/>), which is compiled by the General Services Administration.

h. Nothing contained in the foregoing shall be construed to require establishment of a system of records in order to render in good faith the

certification required by this clause. The knowledge and information of participant is not required to exceed that which is normally possessed by a prudent person in the ordinary course of business dealings.

i. Except for transactions authorized under paragraph e of these instructions, if a participant in a covered transaction knowingly enters into a lower tier covered transaction with a person who is suspended, debarred, ineligible, or voluntarily excluded from participation in this transaction, in addition to other remedies available to the Federal Government, the department or agency with which this transaction originated may pursue available remedies, including suspension and/or debarment.

\* \* \* \* \*

**Certification Regarding Debarment, Suspension, Ineligibility and Voluntary Exclusion--Lower Tier Participants:**

1. The prospective lower tier participant certifies, by submission of this proposal, that neither it nor its principals is presently debarred, suspended, proposed for debarment, declared ineligible, or voluntarily excluded from participating in covered transactions by any Federal department or agency.

2. Where the prospective lower tier participant is unable to certify to any of the statements in this certification, such prospective participant shall attach an explanation to this proposal.

\* \* \* \* \*

**XI. CERTIFICATION REGARDING USE OF CONTRACT FUNDS FOR LOBBYING**

This provision is applicable to all Federal-aid construction contracts and to all related subcontracts which exceed \$100,000 (49 CFR 20).

1. The prospective participant certifies, by signing and submitting this bid or proposal, to the best of his or her knowledge and belief, that:

a. No Federal appropriated funds have been paid or will be paid, by or on behalf of the undersigned, to any person for influencing or attempting to influence an officer or employee of any Federal agency, a Member of Congress, an officer or employee of Congress, or an employee of a Member of Congress in connection with the awarding of any Federal contract, the making of any Federal grant, the making of any Federal loan, the entering into of any cooperative agreement, and the extension, continuation, renewal, amendment, or modification of any Federal contract, grant, loan, or cooperative agreement.

b. If any funds other than Federal appropriated funds have been paid or will be paid to any person for influencing or attempting to influence an officer or employee of any Federal agency, a Member of Congress, an officer or employee of Congress, or an employee of a Member of Congress in connection with this Federal contract, grant, loan, or cooperative agreement, the undersigned shall complete and submit Standard Form-LLL, "Disclosure Form to Report Lobbying," in accordance with its instructions.

2. This certification is a material representation of fact upon which reliance was placed when this transaction was made or entered into. Submission of this certification is a prerequisite for making or entering into this transaction imposed by 31 U.S.C. 1352. Any person who fails to file the required certification shall be subject to a civil penalty of not less than \$10,000 and not more than \$100,000 for each such failure.

3. The prospective participant also agrees by submitting its bid or proposal that the participant shall require that the language of this certification be included in all lower tier subcontracts, which exceed \$100,000 and that all such recipients shall certify and disclose accordingly.



**MINIMUM WAGES FOR FEDERAL AND FEDERALLY  
ASSISTED CONSTRUCTION CONTRACTS**

This project is funded, in part, with Federal-aid funds and, as such, is subject to the provisions of the Davis-Bacon Act of March 3, 1931, as amended (46 Sta. 1494, as amended, 40 U.S.C. 276a) and of other Federal statutes referred to in a 29 CFR Part 1, Appendix A, as well as such additional statutes as may from time to time be enacted containing provisions for the payment of wages determined to be prevailing by the Secretary of Labor in accordance with the Davis-Bacon Act and pursuant to the provisions of 29 CFR Part 1. The prevailing rates and fringe benefits shown in the General Wage Determination Decisions issued by the U.S. Department of Labor shall, in accordance with the provisions of the foregoing statutes, constitute the minimum wages payable on Federal and federally assisted construction projects to laborers and mechanics of the specified classes engaged on contract work of the character and in the localities described therein.

General Wage Determination Decisions, modifications and supersedes decisions thereto are to be used in accordance with the provisions of 29 CFR Parts 1 and 5. Accordingly, the applicable decision, together with any modifications issued, must be made a part of every contract for performance of the described work within the geographic area indicated as required by an applicable DBRA Federal prevailing wage law and 29 CFR Part 5. The wage rates and fringe benefits contained in the General Wage Determination Decision shall be the minimum paid by contractors and subcontractors to laborers and mechanics.

**NOTICE**

The most current **General Wage Determination Decisions** (wage rates) are available on the IDOT web site. They are located on the Letting and Bidding page at <http://www.dot.state.il.us/desenv/delett.html>.

In addition, ten (10) days prior to the letting, the applicable Federal wage rates will be e-mailed to subscribers. It is recommended that all contractors subscribe to the Federal Wage Rates List or the Contractor's Packet through IDOT's subscription service.

PLEASE NOTE: if you have already subscribed to the Contractor's Packet you will automatically receive the Federal Wage Rates.

The instructions for subscribing are at <http://www.dot.state.il.us/desenv/subsc.html>.

If you have any questions concerning the wage rates, please contact IDOT's Chief Contract Official at 217-782-7806.