

HANDICAPPED SYMBOL LAYOUT DETAIL
NOT TO SCALE

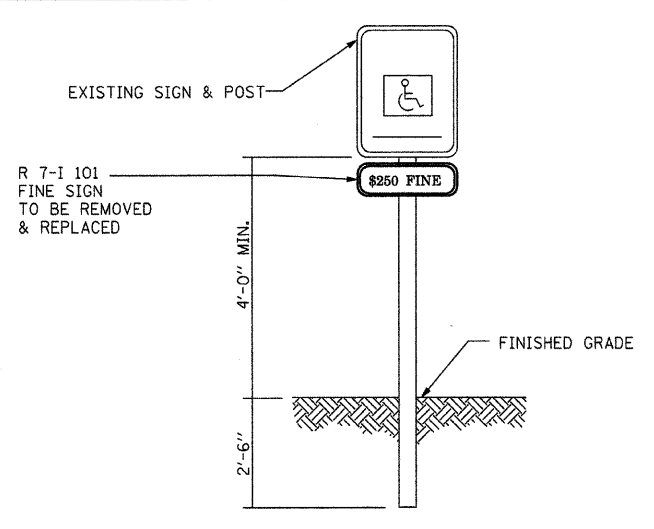

HANDICAPPED PARKING SIGNS
NOT TO SCALE

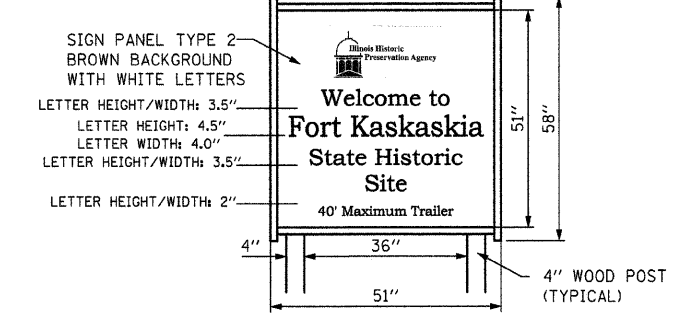
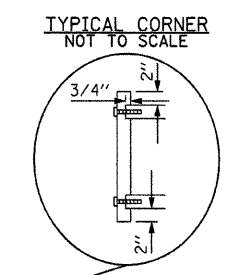

ALL TIMBER POSTS AND FRAMES SHALL BE TREATED IN ACCORDANCE WITH SECTION 1007 OF THE STANDARD SPECIFICATIONS.

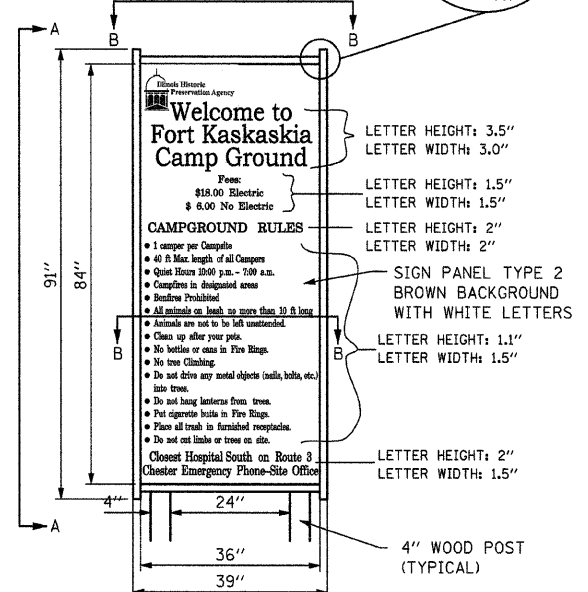

SHOW LAYOUT OF SIGN FOR APPROVAL FROM SITE ADMINISTRATOR PRIOR TO FABRICATION

FORT KASKASKIA SIGN DETAILS
NOT TO SCALE

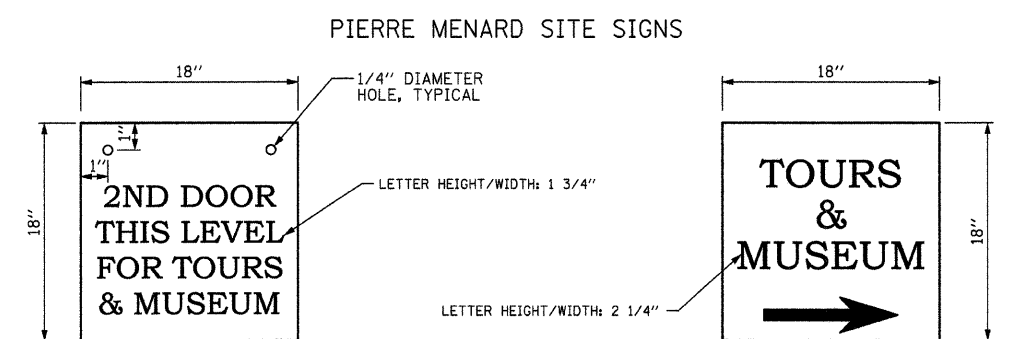
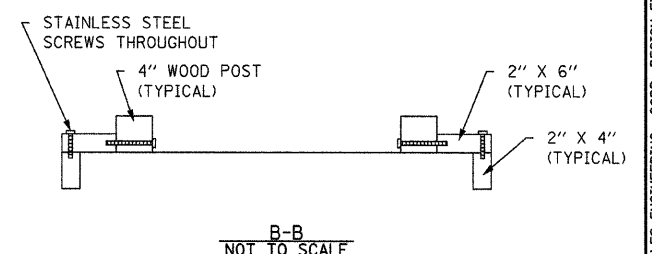
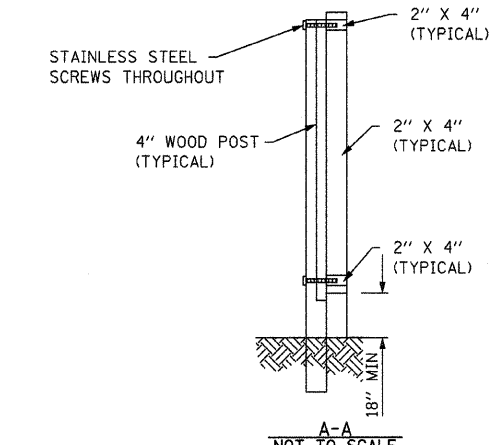

PIERRE MENARD HOME SIGN
NOT TO SCALE

SIGN - STATION 49+39
NOT TO SCALE

SIGN COLORING TO MATCH EXISTING SIGNS AT SITE.
SHOW LAYOUT OF SIGN FOR APPROVAL FROM SITE ADMINISTRATOR PRIOR TO FABRICATION

FILE NAME =	USER NAME = #USER#	DESIGNED - T.T.P.	REVISED - 8/24/09
#FILE#		DRAWN - S.D.K.	REVISED -
	PLOT SCALE = #SCALE#	CHECKED - R.H.D.	REVISED -
	PLOT DATE = #DATE#	DATE - 8/1/08	REVISED -

STATE OF ILLINOIS
DEPARTMENT OF TRANSPORTATION

DETAILS
PIERRE MENARD/FORT KASKASKIA STATE HISTORIC SITES

SCALE: SHEET NO. 11 OF 16 SHEETS STA. TO STA.

F.A.R.T.E.	SECTION	COUNTY	TOTAL SHEETS	SHEET NO.
		RANDOLPH	16	11
CONTRACT NO. 46003				
FED. ROAD DIST. NO.		ILLINOIS FED. AID PROJECT		

JOB NO. 250-061-H VASCONCELLES ENGINEERING CORP. DESIGN FIRM REGISTRATION NUMBER 184-00210