

If you plan to submit a bid directly to the Department of Transportation

PREQUALIFICATION

Any contractor who desires to become pre-qualified to bid on work advertised by IDOT must submit the properly completed pre-qualification forms to the Bureau of Construction no later than 4:30 p.m. prevailing time twenty-one days prior to the letting of interest. This pre-qualification requirement applies to first time contractors, contractors renewing expired ratings, contractors maintaining continuous pre-qualification or contractors requesting revised ratings. To be eligible to bid, existing pre-qualification ratings must be effective through the date of letting.

REQUESTS FOR AUTHORIZATION TO BID

Contractors downloading and/or ordering CD-ROM's and are wanting to bid on items included in a particular letting must submit the properly completed "Request for Authorization to Bid/or Not For Bid Status" (BDE 124INT) and the ORIGINAL, signed and notarized, "Affidavit of Availability" (BC 57) to the proper office no later than 4:30 p.m. prevailing time, three (3) days prior to the letting date.

WHO CAN BID ?

Bids will be accepted from only those companies that request and receive written **Authorization to Bid** from IDOT's Central Bureau of Construction.

WHAT CONSTITUTES WRITTEN AUTHORIZATION TO BID? When a prospective prime bidder submits a "Request for Authorization to Bid/or Not For Bid Status" (BDE 124INT) he/she must indicate at that time which items are being requested For Bidding purposes. Only those items requested For Bidding will be analyzed. After the request has been analyzed, the bidder will be issued a **Proposal Denial and/or Authorization Form**, approved by the Central Bureau of Construction, that indicates which items have been approved For Bidding. If **Authorization to Bid** cannot be approved, the **Proposal Denial and/or Authorization Form** will indicate the reason for denial.

ABOUT AUTHORIZATION TO BID: Firms that have not received an authorization form within a reasonable time of complete and correct original document submittal should contact the department as to status. This is critical in the week before the letting. These documents must be received three days before the letting date. Firms unsure as to authorization status should call the Prequalification Section of the Bureau of Construction at the number listed at the end of these instructions.

ADDENDA AND REVISIONS: It is the contractor's responsibility to determine which, if any, addenda or revisions pertain to any project they may be bidding. Failure to incorporate all relevant addenda or revisions may cause the bid to be declared unacceptable.

Each addendum will be placed with the contract number. Addenda and revisions will also be placed on the Addendum/Revision Checklist and each subscription service subscriber will be notified by e-mail of each addendum and revision issued.

The Internet is the Department's primary way of doing business. The subscription server e-mails are an added courtesy the Department provides. It is suggested that bidder check IDOT's website <http://www.dot.il.gov/desenv/delett.html> before submitting final bid information.

IDOT is not responsible for any e-mail related failures.

Addenda Questions may be directed to the Contracts Office at (217)782-7806 or D&Econtracts@dot.il.gov

Technical Questions about downloading these files may be directed to Tim Garman (217)524-1642 or garmantr@dot.il.gov.

WHAT MUST BE INCLUDED WHEN BIDS ARE SUBMITTED?: Bidders need not return the entire proposal when bids are submitted. That portion of the proposal that must be returned includes the following:

1. All documents from the Proposal Cover Sheet through the Proposal Bid Bond
2. Other special documentation and/or information that may be required by the contract special provisions

All proposal documents, including Proposal Guaranty Checks or Proposal Bid Bonds, should be stapled together to prevent loss when bids are processed by IDOT personnel.

ABOUT SUBMITTING BIDS: It is recommended that bidders deliver bids in person to insure they arrive at the proper location prior to the time specified for the receipt of bids. Any bid received at the place of letting after the time specified will not be accepted.

WHO SHOULD BE CALLED IF ASSISTANCE IS NEEDED?

Questions Regarding	Call
Prequalification and/or Authorization to Bid	(217)782-3413
Preparation and submittal of bids	(217)782-7806
Mailing of plans and proposals	(217)782-7806
Electronic plans and proposals	(217)524-1642

ADDENDUMS AND REVISIONS TO THE PROPOSAL FORMS

Planholders should verify that they have received and incorporated the addendum and/or revision prior to submitting their bid. Failure by the bidder to include an addendum could result in a bid being rejected as irregular.

35

RETURN WITH BID

Proposal Submitted By
Name
Address
City

Letting August 5, 2005

BIDDERS NEED NOT RETURN THE ENTIRE PROPOSAL
(See instructions inside front cover)

NOTICE TO PROSPECTIVE BIDDERS

This proposal can be used for bidding purposes by only those companies that request and receive written AUTHORIZATION TO BID from IDOT's Central Bureau of Construction.

(SEE INSTRUCTIONS ON THE INSIDE OF COVER)

Notice To Bidders, Specifications, Proposal, Contract and Contract Bond



Illinois Department
of Transportation

Springfield, Illinois 62764

Contract No. 99231
SALINE County
Section 05-00136-00-RS
Route FAS 901 (Ch 9)
Project RS-901(103)
District 9 Construction Funds

PLEASE MARK THE APPROPRIATE BOX BELOW:

- A Bid Bond is included.
- A Cashier's Check or a Certified Check is included

Plans Included
Herein

Prepared by

F

Checked by

(Printed by authority of the State of Illinois)

INSTRUCTIONS

ABOUT IDOT PROPOSALS: All proposals issued by IDOT are potential bidding proposals. Each proposal contains all Certifications and Affidavits, a Proposal Signature Sheet and a Proposal Bid Bond required for Prime Contractors to submit a bid after written **Authorization to Bid** has been issued by IDOT's Central Bureau of Construction.

WHO CAN BID?: Bids will be accepted from only those companies that request and receive written **Authorization to Bid** from IDOT's Central Bureau of Construction. To request authorization, a potential bidder must complete and submit Part B of the Request for Authorization to Bid/or Not For Bid Status form (BDE 124 INT) and submit an original Affidavit of Availability (BC 57).

WHAT CONSTITUTES WRITTEN AUTHORIZATION TO BID?: When a prospective prime bidder submits a "Request for Proposal Forms and Plans" he/she must indicate at that time which items are being requested For Bidding purposes. Only those items requested For Bidding will be analyzed. After the request has been analyzed, the bidder will be issued a **Proposal Denial and/or Authorization Form**, approved by the Central Bureau of Construction, that indicates which items have been approved For Bidding. If **Authorization to Bid** cannot be approved, the **Proposal Denial and/or Authorization Form** will indicate the reason for denial. If a contractor has requested to bid but has not received a **Proposal Denial and/or Authorization Form**, they should contact the Central Bureau of Construction in advance of the letting date.

WHAT MUST BE INCLUDED WHEN BIDS ARE SUBMITTED?: Bidders need not return the entire proposal when bids are submitted. That portion of the proposal that must be returned includes the following:

1. All documents from the Proposal Cover Sheet through the Proposal Bid Bond
2. Other special documentation and/or information that may be required by the contract special provisions

All proposal documents, including Proposal Guaranty Checks or Proposal Bid Bonds, should be stapled together to prevent loss when bids are processed by IDOT personnel.

ABOUT SUBMITTING BIDS: It is recommended that bidders deliver bids in person to insure they arrive at the proper location prior to the time specified for the receipt of bids. Any bid received at the place of letting after the time specified will not be accepted.

WHO SHOULD BE CALLED IF ASSISTANCE IS NEEDED?

Questions Regarding	Call
Prequalification and/or Authorization to Bid	217/782-3413
Preparation and submittal of bids	217/782-7806
Mailing of CD-ROMS	217/782-7806

RETURN WITH BID



PROPOSAL

TO THE DEPARTMENT OF TRANSPORTATION

1. Proposal of _____

for the improvement identified and advertised for bids in the Invitation for Bids as:

**Contract No. 99231
SALINE County
Section 05-00136-00-RS
Project RS-901(103)
Route FAS 901 (Ch 9)
District 9 Construction Funds**

Construction consists of 3.29 miles resurfacing with aggregate shoulders along FAS Route 901, CH 9 from Oak Street in Carrier Mills extending northerly to SN 083-0033.

2. The undersigned bidder will furnish all labor, material and equipment to complete the above described project in a good and workmanlike manner as provided in the contract documents provided by the Department of Transportation. This proposal will become part of the contract and the terms and conditions contained in the contract documents shall govern performance and payments.

RETURN WITH BID

3. **ASSURANCE OF EXAMINATION AND INSPECTION/WAIVER.** The undersigned further declares that he/she has carefully examined the proposal, plans, specifications, form of contract and contract bond, and special provisions, and that he/she has inspected in detail the site of the proposed work, and that he/she has familiarized themselves with all of the local conditions affecting the contract and the detailed requirements of construction, and understands that in making this proposal he/she waives all right to plead any misunderstanding regarding the same.

4. **EXECUTION OF CONTRACT AND CONTRACT BOND.** The undersigned further agrees to execute a contract for this work and present the same to the department within fifteen (15) days after the contract has been mailed to him/her. The undersigned further agrees that he/she and his/her surety will execute and present within fifteen (15) days after the contract has been mailed to him/her contract bond satisfactory to and in the form prescribed by the Department of Transportation, in the penal sum of the full amount of the contract, guaranteeing the faithful performance of the work in accordance with the terms of the contract.

5. **PROPOSAL GUARANTY.** Accompanying this proposal is either a bid bond on the department form, executed by a corporate surety company satisfactory to the department, or a proposal guaranty check consisting of a bank cashier's check or a properly certified check for not less than 5 per cent of the amount bid or for the amount specified in the following schedule:

<u>Amount of Bid</u>		<u>Proposal Guaranty</u>	<u>Amount of Bid</u>		<u>Proposal Guaranty</u>	
Up to	\$5,000	\$150	\$2,000,000	to	\$3,000,000	\$100,000
\$5,000	to \$10,000	\$300	\$3,000,000	to	\$5,000,000	\$150,000
\$10,000	to \$50,000	\$1,000	\$5,000,000	to	\$7,500,000	\$250,000
\$50,000	to \$100,000	\$3,000	\$7,500,000	to	\$10,000,000	\$400,000
\$100,000	to \$150,000	\$5,000	\$10,000,000	to	\$15,000,000	\$500,000
\$150,000	to \$250,000	\$7,500	\$15,000,000	to	\$20,000,000	\$600,000
\$250,000	to \$500,000	\$12,500	\$20,000,000	to	\$25,000,000	\$700,000
\$500,000	to \$1,000,000	\$25,000	\$25,000,000	to	\$30,000,000	\$800,000
\$1,000,000	to \$1,500,000	\$50,000	\$30,000,000	to	\$35,000,000	\$900,000
\$1,500,000	to \$2,000,000	\$75,000	over		\$35,000,000	\$1,000,000

Bank cashier's checks or properly certified checks accompanying proposals shall be made payable to the Treasurer, State of Illinois, when the state is awarding authority; the county treasurer, when a county is the awarding authority; or the city, village, or town treasurer, when a city, village, or town is the awarding authority.

If a combination bid is submitted, the proposal guaranties which accompany the individual proposals making up the combination will be considered as also covering the combination bid.

The amount of the proposal guaranty check is _____ \$(_____). If this proposal is accepted and the undersigned shall fail to execute a contract bond as required herein, it is hereby agreed that the amount of the proposal guaranty shall become the property of the State of Illinois, and shall be considered as payment of damages due to delay and other causes suffered by the State because of the failure to execute said contract and contract bond; otherwise, the bid bond shall become void or the proposal guaranty check shall be returned to the undersigned.

Attach Cashier's Check or Certified Check Here

In the event that one proposal guaranty check is intended to cover two or more proposals, the amount must be equal to the sum of the proposal guaranties which would be required for each individual proposal. If the guaranty check is placed in another proposal, state below where it may be found.

The proposal guaranty check will be found in the proposal for:

Item _____

Section No. _____

County _____

Mark the proposal cover sheet as to the type of proposal guaranty submitted.

BD 354 (Rev. 11/2001)

RETURN WITH BID

6. **COMBINATION BIDS.** The undersigned further agrees that if awarded the contract for the sections contained in the following combination, he/she will perform the work in accordance with the requirements of each individual proposal comprising the combination bid specified in the schedule below, and that the combination bid shall be prorated against each section in proportion to the bid submitted for the same. If an error is found to exist in the gross sum bid for one or more of the individual sections included in a combination, the combination bid shall be corrected as provided in the specifications.

When a combination bid is submitted, the schedule below must be completed in each proposal comprising the combination.

If alternate bids are submitted for one or more of the sections comprising the combination, a combination bid must be submitted for each alternate.

Schedule of Combination Bids

Combination No.	Sections Included in Combination	Combination Bid	
		Dollars	Cents

7. **SCHEDULE OF PRICES.** The undersigned bidder submits herewith, in accordance with the rules and instructions, a schedule of prices for the items of work for which bids are sought. The unit prices bid are in U.S. dollars and cents, and all extensions and summations have been made. The bidder understands that the quantities appearing in the bid schedule are approximate and are provided for the purpose of obtaining a gross sum for the comparison of bids. If there is an error in the extension of the unit prices, the unit prices shall govern. Payment to the contractor awarded the contract will be made only for actual quantities of work performed and accepted or materials furnished according to the contract. The scheduled quantities of work to be done and materials to be furnished may be increased, decreased or omitted as provided elsewhere in the contract.
8. **CERTIFICATE OF AUTHORITY.** The undersigned bidder, if a business organized under the laws of another State, assures the Department that it will furnish a copy of its certificate of authority to do business in the State of Illinois with the return of the executed contract and bond. Failure to furnish the certificate within the time provided for execution of an awarded contract may be cause for cancellation of the award and forfeiture of the proposal guaranty to the State.

STATE JOB # - C-99-516-05
 PPS NBR - 9-10072-0000

ILLINOIS DEPARTMENT OF TRANSPORTATION
 SCHEDULE OF PRICES
 CONTRACT NUMBER - 99231

ECMS002 DTGECM03 ECRM003 PAGE 1
 RUN DATE - 06/14/05
 RUN TIME - 223518

COUNTY NAME	CODE	DIST	SECTION NUMBER	PROJECT NUMBER	ROUTE		
					FAS	901	
SALINE	165	09	05-00136-00-RS	RS-0901/103/000			
ITEM NUMBER	PAY ITEM DESCRIPTION	UNIT OF MEASURE	QUANTITY	UNIT PRICE DOLLARS	CENTS	TOTAL PRICE DOLLARS	CTS
X4066416	BC SC SUPER "C" N70	TON	3,665.000		=		
X4066770	LEV BIND MM SUPER N70	TON	2,250.000		=		
40200800	AGG SURF CSE B	TON	40.000		=		
40600100	BIT MATLS PR CT	GALLON	2,510.000		=		
40600300	AGG PR CT	TON	38.000		=		
44000004	BIT SURF REM 1	SQ YD	16,200.000		=		
44000006	BIT SURF REM 1 1/2	SQ YD	715.000		=		
44000030	BIT SURF REM VAR DP	SQ YD	742.000		=		
44001700	COMB C C&G REM & REPL	FOOT	93.000		=		
44300100	AREA REF CR CON TREAT	SQ YD	16,200.000		=		
48101200	AGGREGATE SHLDS B	TON	670.000		=		
60300305	FR & LIDS ADJUST	EACH	4.000		=		
67100100	MOBILIZATION	L SUM	1.000		=		
70300100	SHORT-TERM PAVT MKING	FOOT	1,740.000		=		
70300220	TEMP PVT MK LINE 4	FOOT	28,420.000		=		

FAS 901
05-00136-00-RS
SALINE

ILLINOIS DEPARTMENT OF TRANSPORTATION
SCHEDULE OF PRICES
CONTRACT NUMBER - 99231

ECMS002 DTGECM03 ECMR003 PAGE 2
RUN DATE - 06/14/05
RUN TIME - 223518

ITEM NUMBER	PAY ITEM DESCRIPTION	UNIT OF MEASURE	QUANTITY	UNIT PRICE		TOTAL PRICE	
				DOLLARS	CENTS	DOLLARS	CTS
78001110	PAINT PVT MK LINE 4	FOOT	28,420.000	X	=	=	=
78100100	RAISED REFL PAVT MKR	EACH	152.000	X	=	=	=
TOTAL				\$			

NOTE:

1. EACH PAY ITEM SHOULD HAVE A UNIT PRICE AND A TOTAL PRICE.
2. THE UNIT PRICE SHALL GOVERN IF NO TOTAL PRICE IS SHOWN OR IF THERE IS A DISCREPANCY BETWEEN THE PRODUCT OF THE UNIT PRICE MULTIPLIED BY THE QUANTITY.
3. IF A UNIT PRICE IS OMITTED, THE TOTAL PRICE WILL BE DIVIDED BY THE QUANTITY IN ORDER TO ESTABLISH A UNIT PRICE.
4. A BID MAY BE DECLARED UNACCEPTABLE IF NEITHER A UNIT PRICE NOR A TOTAL PRICE IS SHOWN.

RETURN WITH BID

STATE REQUIRED ETHICAL STANDARDS GOVERNING CONTRACT PROCUREMENT: ASSURANCES, CERTIFICATIONS AND DISCLOSURES

I. GENERAL

A. Article 50 of the Illinois Procurement Code establishes the duty of all State chief procurement officers, State purchasing officers, and their designees to maximize the value of the expenditure of public moneys in procuring goods, services, and contracts for the State of Illinois and to act in a manner that maintains the integrity and public trust of State government. In discharging this duty, they are charged by law to use all available information, reasonable efforts, and reasonable actions to protect, safeguard, and maintain the procurement process of the State of Illinois.

B. In order to comply with the provisions of Article 50 and to carry out the duty established therein, all bidders are to adhere to ethical standards established for the procurement process, and to make such assurances, disclosures and certifications required by law. By execution of the Proposal Signature Sheet, the bidder indicates that each of the mandated assurances has been read and understood, that each certification is made and understood, and that each disclosure requirement has been understood and completed.

C. In addition to all other remedies provided by law, failure to comply with any assurance, failure to make any disclosure or the making of a false certification shall be grounds for termination of the contract and the suspension or debarment of the bidder.

II. ASSURANCES

A. The assurances hereinafter made by the bidder are each a material representation of fact upon which reliance is placed should the Department enter into the contract with the bidder. The Department may terminate the contract if it is later determined that the bidder rendered a false or erroneous assurance, and the surety providing the performance bond shall be responsible for the completion of the contract.

B. Felons

1. The Illinois Procurement Code provides:

Section 50-10. Felons. Unless otherwise provided, no person or business convicted of a felony shall do business with the State of Illinois or any state agency from the date of conviction until 5 years after the date of completion of the sentence for that felony, unless no person held responsible by a prosecutorial office for the facts upon which the conviction was based continues to have any involvement with the business.

2. The bidder assures the Department that the award and execution of the contract would not cause a violation of Section 50-10.

C. Conflicts of Interest

1. The Illinois Procurement Code provides in pertinent part:

Section 50-13. Conflicts of Interest.

(a) Prohibition. It is unlawful for any person holding an elective office in this State, holding a seat in the General Assembly, or appointed to or employed in any of the offices or agencies of state government and who receives compensation for such employment in excess of 60% of the salary of the Governor of the State of Illinois, or who is an officer or employee of the Capital Development Board or the Illinois Toll Highway Authority, or who is the spouse or minor child of any such person to have or acquire any contract, or any direct pecuniary interest in any contract therein, whether for stationery, printing, paper, or any services, materials, or supplies, that will be wholly or partially satisfied by the payment of funds appropriated by the General Assembly of the State of Illinois or in any contract of the Capital Development Board or the Illinois Toll Highway authority.

(b) Interests. It is unlawful for any firm, partnership, association or corporation, in which any person listed in subsection (a) is entitled to receive (i) more than 7 1/2% of the total distributable income or (ii) an amount in excess of the salary of the Governor, to have or acquire any such contract or direct pecuniary interest therein.

(c) Combined interests. It is unlawful for any firm, partnership, association, or corporation, in which any person listed in subsection (a) together with his or her spouse or minor children is entitled to receive (i) more than 15%, in the aggregate, of the total distributable income or (ii) an amount in excess of 2 times the salary of the Governor, to have or acquire any such contract or direct pecuniary interest therein.

(d) Securities. Nothing in this Section invalidates the provisions of any bond or other security previously offered or to be offered for sale or sold by or for the State of Illinois.

(e) Prior interests. This Section does not affect the validity of any contract made between the State and an officer or employee of the State or member of the General Assembly, his or her spouse, minor child or any combination of those persons if that contract was in existence before his or her election or employment as an officer, member, or employee. The contract is voidable, however, if it cannot be completed within 365 days after the officer, member, or employee takes office or is employed.

The current salary of the Governor is \$150,700.00. Sixty percent of the salary is \$90,420.00.

RETURN WITH BID

2. The bidder assures the Department that the award and execution of the contract would not cause a violation of Section 50-13, or that an effective exemption has been issued by the Board of Ethics to any individual subject to the Section 50-13 prohibitions pursuant to the provisions of Section 50-20 of the Code and Executive Order Number 3 (1998). Information concerning the exemption process is available from the Department upon request.

D. Negotiations

1. The Illinois Procurement Code provides in pertinent part:

Section 50-15. Negotiations.

(a) It is unlawful for any person employed in or on a continual contractual relationship with any of the offices or agencies of State government to participate in contract negotiations on behalf of that office or agency with any firm, partnership, association, or corporation with whom that person has a contract for future employment or is negotiating concerning possible future employment.

2. The bidder assures the Department that the award and execution of the contract would not cause a violation of Section 50-15, and that the bidder has no knowledge of any facts relevant to the kinds of acts prohibited therein.

E. Inducements

1. The Illinois Procurement Code provides:

Section 50-25. Inducement. Any person who offers or pays any money or other valuable thing to any person to induce him or her not to bid for a State contract or as recompense for not having bid on a State contract is guilty of a Class 4 felony. Any person who accepts any money or other valuable thing for not bidding for a State contract or who withholds a bid in consideration of the promise for the payment of money or other valuable thing is guilty of a Class 4 felony.

2. The bidder assures the Department that the award and execution of the contract would not cause a violation of Section 50-25, and that the bidder has no knowledge of any facts relevant to the kinds of acts prohibited therein.

F. Revolving Door Prohibition

1. The Illinois Procurement Code provides:

Section 50-30. Revolving door prohibition. Chief procurement officers, associate procurement officers, State purchasing officers, their designees whose principal duties are directly related to State procurement, and executive officers confirmed by the Senate are expressly prohibited for a period of 2 years after terminating an affected position from engaging in any procurement activity relating to the State agency most recently employing them in an affected position for a period of at least 6 months. The prohibition includes, but is not limited to: lobbying the procurement process; specifying; bidding; proposing bid, proposal, or contract documents; on their own behalf or on behalf of any firm, partnership, association, or corporation. This Section applies only to persons who terminate an affected position on or after January 15, 1999.

2. The bidder assures the Department that the award and execution of the contract would not cause a violation of Section 50-30, and that the bidder has no knowledge of any facts relevant to the kinds of acts prohibited therein.

G. Reporting Anticompetitive Practices

1. The Illinois Procurement Code provides:

Section 50-40. Reporting anticompetitive practices. When, for any reason, any vendor, bidder, contractor, chief procurement officer, State purchasing officer, designee, elected official, or State employee suspects collusion or other anticompetitive practice among any bidders, offerors, contractors, proposers, or employees of the State, a notice of the relevant facts shall be transmitted to the Attorney General and the chief procurement officer.

2. The bidder assures the Department that it has not failed to report any relevant facts concerning the practices addressed in Section 50-40 which may involve the contract for which the bid is submitted.

H. Confidentiality

1. The Illinois Procurement Code provides:

Section 50-45. Confidentiality. Any chief procurement officer, State purchasing officer, designee, or executive officer who willfully uses or allows the use of specifications, competitive bid documents, proprietary competitive information, proposals, contracts, or selection information to compromise the fairness or integrity of the procurement, bidding, or contract process shall be subject to immediate dismissal, regardless of the Personnel code, any contract, or any collective bargaining agreement, and may in addition be subject to criminal prosecution.

2. The bidder assures the Department that it has no knowledge of any fact relevant to the practices addressed in Section 50-45 which may involve the contract for which the bid is submitted.

RETURN WITH BID

I. Insider Information

1. The Illinois Procurement Act provides:

Section 50-50. Insider information. It is unlawful for any current or former elected or appointed State official or State employee to knowingly use confidential information available only by virtue of that office or employment for actual or anticipated gain for themselves or another person.

2. The bidder assures the Department that it has no knowledge of any facts relevant to the practices addressed in Section 50-50 which may involve the contract for which the bid is submitted.

III. CERTIFICATIONS

A. The certifications hereinafter made by the bidder are each a material representation of fact upon which reliance is placed should the Department enter into the contract with the bidder. The Department may terminate the contract if it is later determined that the bidder rendered a false or erroneous certification, and the surety providing the performance bond shall be responsible for completion of the contract.

B. Bribery

1. The Illinois Procurement Code provides:

Section 50-5. Bribery.

(a) Prohibition. No person or business shall be awarded a contract or subcontract under this Code who:

(1) has been convicted under the laws of Illinois or any other state of bribery or attempting to bribe an officer or employee of the State of Illinois or any other state in that officer's or employee's official capacity; or

(2) has made an admission of guilt of that conduct that is a matter of record but has not been prosecuted for that conduct.

(b) Businesses. No business shall be barred from contracting with any unit of State or local government as a result of a conviction under this Section of any employee or agent of the business if the employee or agent is no longer employed by the business and:

(1) the business has been finally adjudicated not guilty; or

(2) the business demonstrates to the governmental entity with which it seeks to contract, and that entity finds that the commission of the offense was not authorized, requested, commanded, or performed by a director, officer, or high managerial agent on behalf of the business as provided in paragraph (2) of subsection (a) of Section 5-4 of the Criminal Code of 1961.

(c) Conduct on behalf of business. For purposes of this Section, when an official, agent, or employee of a business committed the bribery or attempted bribery on behalf of the business and in accordance with the direction or authorization of a responsible official of the business, the business shall be chargeable with the conduct.

(d) Certification. Every bid submitted to and contract executed by the State shall contain a certification by the contractor that the contractor is not barred from being awarded a contract or subcontract under this Section. A contractor who makes a false statement, material to the certification, commits a Class 3 felony.

2. The bidder certifies that it is not barred from being awarded a contract under Section 50.5.

C. Educational Loan

1. Section 3 of the Educational Loan Default Act provides:

§ 3. No State agency shall contract with an individual for goods or services if that individual is in default, as defined in Section 2 of this Act, on an educational loan. Any contract used by any State agency shall include a statement certifying that the individual is not in default on an educational loan as provided in this Section.

2. The bidder, if an individual as opposed to a corporation, partnership or other form of business organization, certifies that the bidder is not in default on an educational loan as provided in Section 3 of the Act.

D. Bid-Rigging/Bid Rotating

1. Section 33E-11 of the Criminal Code of 1961 provides:

§ 33E-11. (a) Every bid submitted to and public contract executed pursuant to such bid by the State or a unit of local government shall contain a certification by the prime contractor that the prime contractor is not barred from contracting with any unit of State or local government as a result of a violation of either Section 33E-3 or 33E-4 of this Article. The State and units of local government shall provide the appropriate forms for such certification.

RETURN WITH BID

(b) A contractor who makes a false statement, material to the certification, commits a Class 3 felony.

A violation of Section 33E-3 would be represented by a conviction of the crime of bid-rigging which, in addition to Class 3 felony sentencing, provides that any person convicted of this offense or any similar offense of any state or the United States which contains the same elements as this offense shall be barred for 5 years from the date of conviction from contracting with any unit of State or local government. No corporation shall be barred from contracting with any unit of State or local government as a result of a conviction under this Section of any employee or agent of such corporation if the employee so convicted is no longer employed by the corporation and: (1) it has been finally adjudicated not guilty or (2) if it demonstrates to the governmental entity with which it seeks to contract and that entity finds that the commission of the offense was neither authorized, requested, commanded, nor performed by a director, officer or a high managerial agent in behalf of the corporation.

A violation of Section 33E-4 would be represented by a conviction of the crime of bid-rotating which, in addition to Class 2 felony sentencing, provides that any person convicted of this offense or any similar offense of any state or the United States which contains the same elements as this offense shall be permanently barred from contracting with any unit of State or local government. No corporation shall be barred from contracting with any unit of State or local government as a result of a conviction under this Section of any employee or agent of such corporation if the employee so convicted is no longer employed by the corporation and: (1) it has been finally adjudicated not guilty or (2) if it demonstrates to the governmental entity with which it seeks to contract and that entity finds that the commission of the offense was neither authorized, requested, commanded, nor performed by a director, officer or a high managerial agent in behalf of the corporation.

2. The bidder certifies that it is not barred from contracting with the Department by reason of a violation of either Section 33E-3 or Section 33E-4.

E. International Anti-Boycott

1. Section 5 of the International Anti-Boycott Certification Act provides:

§ 5. State contracts. Every contract entered into by the State of Illinois for the manufacture, furnishing, or purchasing of supplies, material, or equipment or for the furnishing of work, labor, or services, in an amount exceeding the threshold for small purchases according to the purchasing laws of this State or \$10,000.00, whichever is less, shall contain certification, as a material condition of the contract, by which the contractor agrees that neither the contractor nor any substantially-owned affiliated company is participating or shall participate in an international boycott in violation of the provisions of the U.S. Export Administration Act of 1979 or the regulations of the U.S. Department of Commerce promulgated under that Act.

2. The bidder makes the certification set forth in Section 5 of the Act.

F. Drug Free Workplace

1. The Illinois "Drug Free Workplace Act" applies to this contract and it is necessary to comply with the provisions of the "Act" if the contractor is a corporation, partnership, or other entity (including a sole proprietorship) which has 25 or more employees.

2. The bidder certifies that if awarded a contract in excess of \$5,000 it will provide a drug free workplace by:

(a) Publishing a statement notifying employees that the unlawful manufacture, distribution, dispensation, possession or use of a controlled substance, including cannabis, is prohibited in the contractor's workplace; specifying the actions that will be taken against employees for violations of such prohibition; and notifying the employee that, as a condition of employment on such contract, the employee shall abide by the terms of the statement, and notify the employer of any criminal drug statute conviction for a violation occurring in the workplace no later than five (5) days after such conviction.

(b) Establishing a drug free awareness program to inform employees about the dangers of drug abuse in the workplace; the contractor's policy of maintaining a drug free workplace; any available drug counseling, rehabilitation, and employee assistance programs; and the penalties that may be imposed upon employees for drug violations.

(c) Providing a copy of the statement required by subparagraph (1) to each employee engaged in the performance of the contract and to post the statement in a prominent place in the workplace.

(d) Notifying the Department within ten (10) days after receiving notice from an employee or otherwise receiving actual notice of the conviction of an employee for a violation of any criminal drug statute occurring in the workplace.

(e) Imposing or requiring, within 30 days after receiving notice from an employee of a conviction or actual notice of such a conviction, an appropriate personnel action, up to and including termination, or the satisfactory participation in a drug abuse assistance or rehabilitation program approved by a federal, state or local health, law enforcement or other appropriate agency.

(f) Assisting employees in selecting a course of action in the event drug counseling, treatment, and rehabilitation is required and indicating that a trained referral team is in place.

(g) Making a good faith effort to continue to maintain a drug free workplace through implementation of the actions and efforts stated in this certification.

G. Debt Delinquency

1. The Illinois Procurement Code provides:

Section 50-11 and 50-12. Debt Delinquency.

The contractor or bidder certifies that it, or any affiliate, is not barred from being awarded a contract under 30 ILCS 500. Section 50-11 prohibits a person from entering into a contract with a State agency if it knows or should know that it, or any affiliate, is delinquent in the payment of any debt to the State as defined by the Debt Collection Board. Section 50-12 prohibits a person from entering into a contract with a State agency if it, or any affiliate, has failed to collect and remit Illinois Use Tax on all sales of tangible personal property into the State of Illinois in accordance with the provisions of the Illinois Use Tax Act. The contractor further acknowledges that the contracting State agency may declare the contract void if this certification is false or if the contractor, or any affiliate, is determined to be delinquent in the payment of any debt to the State during the term of the contract.

H. Sarbanes-Oxley Act of 2002

1. The Illinois Procurement Code provides:

Section 50-60(c).

The contractor certifies in accordance with 30 ILCS 500/50-10.5 that no officer, director, partner or other managerial agent of the contracting business has been convicted of a felony under the Sarbanes-Oxley Act of 2002 or a Class 3 or Class 2 felony under the Illinois Securities Law of 1953 for a period of five years prior to the date of the bid or contract. The contractor acknowledges that the contracting agency shall declare the contract void if this certification is false.

I. ADDENDA

The contractor or bidder certifies that all relevant addenda have been incorporated in to this contract. Failure to do so may cause the bid to be declared unacceptable.

J. Section 42 of the Environmental Protection Act

The contractor certifies in accordance with 30 ILCS 500/50-12 that the bidder or contractor is not barred from being awarded a contract under this Section which prohibits the bidding on or entering into contracts with the State of Illinois or a State agency by a person or business found by a court or the Pollution Control Board to have committed a willful or knowing violation of Section 42 of the Environmental Protection Act for a period of five years from the date of the order. The contractor acknowledges that the contracting agency may declare the contract void if this certification is false.

K. Apprenticeship and Training Certification (Does not apply to federal aid projects)

In accordance with the provisions of Section 30-22 (6) of the Illinois Procurement Code, the bidder certifies that it is a participant, either as an individual or as part of a group program, in the approved apprenticeship and training programs applicable to each type of work or craft that the bidder will perform with its own forces. The bidder further certifies for work that will be performed by subcontract that each of its subcontractors submitted for approval either (a) is, at the time of such bid, participating in an approved, applicable apprenticeship and training program; or (b) will, prior to commencement of performance of work pursuant to this contract, begin participation in an approved apprenticeship and training program applicable to the work of the subcontract. The Department, at any time before or after award, may require the production of a copy of each applicable Certificate of Registration issued by the United States Department of Labor evidencing such participation by the contractor and any or all of its subcontractors. Applicable apprenticeship and training programs are those that have been approved and registered with the United States Department of Labor. The bidder shall list in the space below, the official name of the program sponsor holding the Certificate of Registration for all of the types of work or crafts in which the bidder is a participant and that will be performed with the bidder's forces. Types of work or craft work that will be subcontracted shall be included and listed as subcontract work. The list shall also indicate any type of work or craft job category that does not have an applicable apprenticeship or training program. **The bidder is responsible for making a complete report and shall make certain that each type of work or craft job category that will be utilized on the project as reported on the Construction Employee Workforce Projection (Form BC-1256) and returned with the bid is accounted for and listed.**

NA - FEDERAL

The requirements of this certification and disclosure are a material part of the contract, and the contractor shall require this certification provision to be included in all approved subcontracts. In order to fulfill this requirement, it shall not be necessary that an applicable program sponsor be currently taking or that it will take applications for apprenticeship, training or employment during the performance of the work of this contract.

TO BE RETURNED WITH BID

IV. DISCLOSURES

A. The disclosures hereinafter made by the bidder are each a material representation of fact upon which reliance is placed should the Department enter into the contract with the bidder. The Department may terminate the contract if it is later determined that the bidder rendered a false or erroneous disclosure, and the surety providing the performance bond shall be responsible for completion of the contract.

B. Financial Interests and Conflicts of Interest

1. Section 50-35 of the Illinois Procurement Code provides that all bids of more than \$10,000 shall be accompanied by disclosure of the financial interests of the bidder. This disclosed information for the successful bidder, will be maintained as public information subject to release by request pursuant to the Freedom of Information Act.

The financial interests to be disclosed shall include ownership or distributive income share that is in excess of 5%, or an amount greater than 60% of the annual salary of the Governor, of the bidding entity or its parent entity, whichever is less, unless the contractor or bidder is a publicly traded entity subject to Federal 10K reporting, in which case it may submit its 10K disclosure in place of the prescribed disclosure. If a bidder is a privately held entity that is exempt from Federal 10K reporting, but has more than 400 shareholders, it may submit the information that Federal 10K companies are required to report, and list the names of any person or entity holding any ownership share that is in excess of 5%. The disclosure shall include the names, addresses, and dollar or proportionate share of ownership of each person making the disclosure, their instrument of ownership or beneficial relationship, and notice of any potential conflict of interest resulting from the current ownership or beneficial interest of each person making the disclosure having any of the relationships identified in Section 50-35 and on the disclosure form.

In addition, all disclosures shall indicate any other current or pending contracts, proposals, leases, or other ongoing procurement relationships the bidding entity has with any other unit of state government and shall clearly identify the unit and the contract, proposal, lease, or other relationship.

2. Disclosure Forms. Disclosure Form A is attached for use concerning the individuals meeting the above ownership or distributive share requirements. Subject individuals should be covered each by one form. In addition, a second form (Disclosure Form B) provides for the disclosure of current or pending procurement relationships with other (non-IDOT) state agencies. **The forms must be included with each bid or incorporated by reference.**

C. Disclosure Form Instructions

Form A: For bidders that have previously submitted the information requested in Form A

The Department has retained the Form A disclosures submitted by all bidders responding to these requirements for the April 24, 1998 or any subsequent letting conducted by the Department. The bidder has the option of submitting the information again or the bidder may sign the following certification statement indicating that the information previously submitted by the bidder is, as of the date of signature, current and accurate. The Certification must be signed and dated by a person who is authorized to execute contracts for the bidding company. Before signing this certification, the bidder should carefully review its prior submissions to ensure the Certification is correct. If the Bidder signs the Certification, the Bidder should proceed to Form B instructions.

CERTIFICATION STATEMENT

I have determined that the Form A disclosure information previously submitted is current and accurate, and all forms are hereby incorporated by reference in this bid. Any necessary additional forms or amendments to previously submitted forms are attached to this bid.

(Bidding Company)

Name of Authorized Representative (type or print)

Title of Authorized Representative (type or print)

Signature of Authorized Representative

Date

Form A: For bidders who have NOT previously submitted the information requested in Form A

If the bidder is a publicly traded entity subject to Federal 10K reporting, the 10K Report may be submitted to meet the requirements of Form A. If a bidder is a privately held entity that is exempt from Federal 10K reporting, but has more than 400 shareholders, it may submit the information that Federal 10K companies are required to report, and list the names of any person or entity holding any ownership share that is in excess of 5%. If a bidder is not subject to Federal 10K reporting, the bidder must determine if any individuals are required by law to complete a financial disclosure form. To do this, the bidder should answer each of the following questions. A "YES" answer indicates Form A must be completed. If the answer to each of the following questions is "NO", then the NOT APPLICABLE STATEMENT on the second page of Form A must be signed and dated by a person that is authorized to execute contracts for the bidding company. Note: These questions are for assistance only and are not required to be completed.

1. Does anyone in your organization have a direct or beneficial ownership share of greater than 5% of the bidding entity or parent entity? YES ___ NO ___
2. Does anyone in your organization have a direct or beneficial ownership share of less than 5%, but which has a value greater than \$90,420.00? YES ___ NO ___
3. Does anyone in your organization receive more than \$90,420.00 of the bidding entity's or parent entity's distributive income? (Note: Distributive income is, for these purposes, any type of distribution of profits. An annual salary is not distributive income.) YES ___ NO ___
4. Does anyone in your organization receive greater than 5% of the bidding entity's or parent entity's total distributive income, but which is less than \$90,420.00? YES ___ NO ___
(Note: Only one set of forms needs to be completed per person per bid even if a specific individual would require a yes answer to more than one question.)

A "YES" answer to any of these questions requires the completion of Form A. The bidder must determine each individual in the bidding entity or the bidding entity's parent company that would cause the questions to be answered "Yes". Each form must be signed and dated by a person that is authorized to execute contracts for your organization. **Photocopied or stamped signatures are not acceptable.** The person signing can be, but does not have to be, the person for which the form is being completed. The bidder is responsible for the accuracy of any information provided.

If the answer to each of the above questions is "NO", then the NOT APPLICABLE STATEMENT on page 2 of Form A must be signed and dated by a person that is authorized to execute contracts for your company.

Form B: Identifying Other Contracts & Procurement Related Information Disclosure Form B must be completed for each bid submitted by the bidding entity. It must be signed by an individual who is authorized to execute contracts for the bidding entity. *Note: Signing the NOT APPLICABLE STATEMENT on Form A does not allow the bidder to ignore Form B. Form B must be completed, signed and dated or the bidder may be considered nonresponsive and the bid will not be accepted.*

The Bidder shall identify, by checking Yes or No on Form B, whether it has any pending contracts (including leases), bids, proposals, or other ongoing procurement relationship with any other (non-IDOT) State of Illinois agency. If "No" is checked, the bidder only needs to complete the signature box on the bottom of Form B. If "Yes" is checked, the bidder must do one of the following:

Option I: If the bidder did not submit an Affidavit of Availability to obtain authorization to bid, the bidder must list all non-IDOT State of Illinois agency pending contracts, leases, bids, proposals, and other ongoing procurement relationships. These items may be listed on Form B or on an attached sheet(s). Do not include IDOT contracts. Contracts with cities, counties, villages, etc. are not considered State of Illinois agency contracts and are not to be included. Contracts with other State of Illinois agencies such as the Department of Natural Resources or the Capital Development Board must be included. Bidders who submit Affidavits of Availability are suggested to use Option II.

Option II: If the bidder is required and has submitted an Affidavit of Availability in order to obtain authorization to bid, the bidder may write or type "See Affidavit of Availability" which indicates that the Affidavit of Availability is incorporated by reference and includes all non-IDOT State of Illinois agency pending contracts, leases, bids, proposals, and other ongoing procurement relationships. For any contracts that are not covered by the Affidavit of Availability, the bidder must identify them on Form B or on an attached sheet(s). These might be such things as leases.

D. Bidders Submitting More Than One Bid

Bidders submitting multiple bids may submit one set of forms consisting of all required Form A disclosures and one Form B for use with all bids. Please indicate in the space provided below the bid item that contains the original disclosure forms and the bid items which incorporate the forms by reference.

- The bid submitted for letting item _____ contains the Form A disclosures or Certification Statement and the Form B disclosures. The following letting items incorporate the said forms by reference:

RETURN WITH BID/OFFER

ILLINOIS DEPARTMENT OF TRANSPORTATION

Form A Financial Information & Potential Conflicts of Interest Disclosure

Contractor Name
Legal Address
City, State, Zip
Telephone Number Email Address Fax Number (if available)

Disclosure of the information contained in this Form is required by the Section 50-35 of the Illinois Procurement Code (30 ILCS 500). Vendors desiring to enter into a contract with the State of Illinois must disclose the financial information and potential conflict of interest information as specified in this Disclosure Form. This information shall become part of the publicly available contract file. This Form A must be completed for bids in excess of \$10,000, and for all open-ended contracts. A publicly traded company may submit a 10K disclosure (or equivalent if applicable) in satisfaction of the requirements set forth in Form A. See Disclosure Form Instructions.

DISCLOSURE OF FINANCIAL INFORMATION

1. Disclosure of Financial Information. The individual named below has an interest in the BIDDER (or its parent) in terms of ownership or distributive income share in excess of 5%, or an interest which has a value of more than \$90,420.00 (60% of the Governor's salary as of 7/1/01). (Make copies of this form as necessary and attach a separate Disclosure Form A for each individual meeting these requirements)

FOR INDIVIDUAL (type or print information)

NAME:

ADDRESS

Type of ownership/distributable income share:

stock sole proprietorship Partnership other: (explain on separate sheet):
% or \$ value of ownership/distributable income share:

2. Disclosure of Potential Conflicts of Interest. Check "Yes" or "No" to indicate which, if any, of the following potential conflict of interest relationships apply. If the answer to any question is "Yes", please attach additional pages and describe.

(a) State employment, currently or in the previous 3 years, including contractual employment of services. Yes ___ No ___

If your answer is yes, please answer each of the following questions.

- 1. Are you currently an officer or employee of either the Capitol Development Board or the Illinois Toll Highway Authority? Yes ___ No ___
2. Are you currently appointed to or employed by any agency of the State of Illinois? If you are currently appointed to or employed by any agency of the State of Illinois, and your annual salary exceeds \$90,420.00, (60% of the Governor's salary as of 7/1/01) provide the name the State agency for which you are employed and your annual salary.

RETURN WITH BID/OFFER

- 3. If you are currently appointed to or employed by any agency of the State of Illinois, and your annual salary exceeds \$90,420.00, (60% of the Governor's salary as of 7/1/01) are you entitled to receive (i) more than 7 1/2% of the total distributable income of your firm, partnership, association or corporation, or (ii) an amount in excess of the salary of the Governor? Yes ___ No ___

- 4. If you are currently appointed to or employed by any agency of the State of Illinois, and your annual salary exceeds \$90,420.00, (60% of the Governor's salary as of 7/1/01) are you and your spouse or minor children entitled to receive (i) more than 15% in aggregate of the total distributable income of your firm, partnership, association or corporation, or (ii) an amount in excess of 2 times the salary of the Governor? Yes ___ No ___

(b) State employment of spouse, father, mother, son, or daughter, including contractual employment for services in the previous 2 years.

Yes ___ No ___

If your answer is yes, please answer each of the following questions.

- 1. Is your spouse or any minor children currently an officer or employee of the Capitol Development Board or the Illinois Toll Highway Authority? Yes ___ No ___

- 2. Is your spouse or any minor children currently appointed to or employed by any agency of the State of Illinois? If your spouse or minor children is/are currently appointed to or employed by any agency of the State of Illinois, and his/her annual salary exceeds \$90,420.00, (60% of the Governor's salary as of 7/1/01) provide the name of the spouse and/or minor children, the name of the State agency for which he/she is employed and his/her annual salary. _____

3. If your spouse or any minor children is/are currently appointed to or employed by any agency of the State of Illinois, and his/her annual salary exceeds \$90,420.00, (60% of the salary of the Governor as of 7/1/01) are you entitled to receive (i) more than 7 1/2% of the total distributable income of your firm, partnership, association or corporation, or (ii) an amount in excess of the salary of the Governor? Yes ___ No ___

4. If your spouse or any minor children are currently appointed to or employed by any agency of the State of Illinois, and his/her annual salary exceeds \$90,420.00, (60% of the Governor's salary as of 7/1/01) are you and your spouse or any minor children entitled to receive (i) more than 15% in the aggregate of the total distributable income from your firm, partnership, association or corporation, or (ii) an amount in excess of 2 times the salary of the Governor? Yes ___ No ___

(c) Elective status; the holding of elective office of the State of Illinois, the government of the United States, any unit of local government authorized by the Constitution of the State of Illinois or the statutes of the State of Illinois currently or in the previous 3 years. Yes ___ No ___

(d) Relationship to anyone holding elective office currently or in the previous 2 years; spouse, father, mother, son, or daughter. Yes ___ No ___

(e) Appointive office; the holding of any appointive government office of the State of Illinois, the United State of America, or any unit of local government authorized by the Constitution of the State of Illinois or the statutes of the State of Illinois, which office entitles the holder to compensation in excess of the expenses incurred in the discharge of that office currently or in the previous 3 years. Yes ___ No ___

(f) Relationship to anyone holding appointive office currently or in the previous 2 years; spouse, father, mother, son, or daughter. Yes ___ No ___

(g) Employment, currently or in the previous 3 years, as or by any registered lobbyist of the State government. Yes ___ No ___

RETURN WITH BID/OFFER

(h) Relationship to anyone who is or was a registered lobbyist in the previous 2 years; spouse, father, mother, son, or daughter. Yes ___ No ___

(i) Compensated employment, currently or in the previous 3 years, by any registered election or reelection committee registered with the Secretary of State or any county clerk of the State of Illinois, or any political action committee registered with either the Secretary of State or the Federal Board of Elections. Yes ___ No ___

(j) Relationship to anyone; spouse, father, mother, son, or daughter; who was a compensated employee in the last 2 years by any registered election or re-election committee registered with the Secretary of State or any county clerk of the State of Illinois, or any political action committee registered with either the Secretary of State or the Federal Board of Elections. Yes ___ No ___

APPLICABLE STATEMENT

This Disclosure Form A is submitted on behalf of the INDIVIDUAL named on previous page.

Completed by: _____
Name of Authorized Representative (type or print)

Completed by: _____
Title of Authorized Representative (type or print)

Completed by: _____ Date _____
Signature of Individual or Authorized Representative

NOT APPLICABLE STATEMENT

I have determined that no individuals associated with this organization meet the criteria that would require the completion of this Form A.

This Disclosure Form A is submitted on behalf of the CONTRACTOR listed on the previous page.

Name of Authorized Representative (type or print)

Title of Authorized Representative (type or print)

Signature of Authorized Representative Date _____

RETURN WITH BID/OFFER

**ILLINOIS DEPARTMENT
OF TRANSPORTATION**

**Form B
Other Contracts &
Procurement Related Information
Disclosure**

Contractor Name		
Legal Address		
City, State, Zip		
Telephone Number	Email Address	Fax Number (if available)

Disclosure of the information contained in this Form is required by the Section 50-35 of the Illinois Procurement Act (30 ILCS 500). This information shall become part of the publicly available contract file. This Form B must be completed for bids in excess of \$10,000, and for all open-ended contracts.

DISCLOSURE OF OTHER CONTRACTS AND PROCUREMENT RELATED INFORMATION

1. Identifying Other Contracts & Procurement Related Information. The BIDDER shall identify whether it has any pending contracts (including leases), bids, proposals, or other ongoing procurement relationship with any other State of Illinois agency: Yes ___ No ___

If "No" is checked, the bidder only needs to complete the signature box on the bottom of this page.

2. If "Yes" is checked. Identify each such relationship by showing State of Illinois agency name and other descriptive information such as bid or project number (attach additional pages as necessary). SEE DISCLOSURE FORM INSTRUCTIONS:

THE FOLLOWING STATEMENT MUST BE SIGNED

Name of Authorized Representative (type or print)	

Title of Authorized Representative (type or print)	
_____	_____
Signature of Authorized Representative	Date

RETURN WITH BID

SPECIAL NOTICE TO CONTRACTORS

The following requirements of the Illinois Department of Human Rights' Rules and Regulations are applicable to bidders on all construction contracts advertised by the Illinois Department of Transportation:

CONSTRUCTION EMPLOYEE UTILIZATION PROJECTION

- (a) All bidders on construction contracts shall complete and submit, along with and as part of their bids, a Bidder's Employee Utilization Form (Form BC-1256) setting forth a projection and breakdown of the total workforce intended to be hired and/or allocated to such contract work by the bidder including a projection of minority and female employee utilization in all job classifications on the contract project.
- (b) The Department of Transportation shall review the Employee Utilization Form, and workforce projections contained therein, of the contract awardee to determine if such projections reflect an underutilization of minority persons and/or women in any job classification in accordance with the Equal Employment Opportunity Clause and Section 7.2 of the Illinois Department of Human Rights' Rules and Regulations for Public Contracts adopted as amended on September 17, 1980. If it is determined that the contract awardee's projections reflect an underutilization of minority persons and/or women in any job classification, it shall be advised in writing of the manner in which it is underutilizing and such awardee shall be considered to be in breach of the contract unless, prior to commencement of work on the contract project, it submits revised satisfactory projections or an acceptable written affirmative action plan to correct such underutilization including a specific timetable geared to the completion stages of the contract.
- (c) The Department of Transportation shall provide to the Department of Human Rights a copy of the contract awardee's Employee Utilization Form, a copy of any required written affirmative action plan, and any written correspondence related thereto. The Department of Human Rights may review and revise any action taken by the Department of Transportation with respect to these requirements.



RETURN WITH BID

**Contract No. 99231
 SALINE County
 Section 05-00136-00-RS
 Project RS-901(103)
 Route FAS 901 (Ch 9)
 District 9 Construction Funds**

PART I. IDENTIFICATION

Dept. Human Rights # _____ Duration of Project: _____

Name of Bidder: _____

PART II. WORKFORCE PROJECTION

A. The undersigned bidder has analyzed minority group and female populations, unemployment rates and availability of workers for the location in which this contract work is to be performed, and for the locations from which the bidder recruits employees, and hereby submits the following workforce projection including a projection for minority and female employee utilization in all job categories in the workforce to be allocated to this contract:

TABLE A TOTAL Workforce Projection for Contract												TABLE B CURRENT EMPLOYEES TO BE ASSIGNED TO CONTRACT					
JOB CATEGORIES	TOTAL EMPLOYEES		MINORITY EMPLOYEES					TRAINEES				TOTAL EMPLOYEES		MINORITY EMPLOYEES			
	M	F	BLACK		HISPANIC		*OTHER MINOR.		APPRENTICES		ON THE JOB TRAINEES		M	F	M	F	
			M	F	M	F	M	F	M	F	M	F					
OFFICIALS (MANAGERS)																	
SUPERVISORS																	
FOREMEN																	
CLERICAL EQUIPMENT OPERATORS																	
MECHANICS																	
TRUCK DRIVERS																	
IRONWORKERS																	
CARPENTERS																	
CEMENT MASONS																	
ELECTRICIANS																	
PIPEFITTERS, PLUMBERS																	
PAINTERS																	
LABORERS, SEMI-SKILLED																	
LABORERS, UNSKILLED																	
TOTAL																	

TABLE C TOTAL Training Projection for Contract								
EMPLOYEES IN TRAINING	TOTAL EMPLOYEES		BLACK		HISPANIC		*OTHER MINOR.	
	M	F	M	F	M	F	M	F
APPRENTICES								
ON THE JOB TRAINEES								

FOR DEPARTMENT USE ONLY

*Other minorities are defined as Asians (A) or Native Americans (N).

Please specify race of each employee shown in Other Minorities column.

Note: See instructions on the next page

RETURN WITH BID

**Contract No. 99231
SALINE County
Section 05-00136-00-RS
Project RS-901(103)
Route FAS 901 (Ch 9)
District 9 Construction Funds**

PART II. WORKFORCE PROJECTION - continued

- B. Included in "Total Employees" under Table A is the total number of **new hires** that would be employed in the event the undersigned bidder is awarded this contract.

The undersigned bidder projects that: (number) _____ new hires would be recruited from the area in which the contract project is located; and/or (number) _____ new hires would be recruited from the area in which the bidder's principal office or base of operation is located.

- C. Included in "Total Employees" under Table A is a projection of numbers of persons to be employed directly by the undersigned bidder as well as a projection of numbers of persons to be employed by subcontractors.

The undersigned bidder estimates that (number) _____ persons will be directly employed by the prime contractor and that (number) _____ persons will be employed by subcontractors.

PART III. AFFIRMATIVE ACTION PLAN

- A. The undersigned bidder understands and agrees that in the event the foregoing minority and female employee utilization projection included under **PART II** is determined to be an underutilization of minority persons or women in any job category, and in the event that the undersigned bidder is awarded this contract, he/she will, prior to commencement of work, develop and submit a written Affirmative Action Plan including a specific timetable (geared to the completion stages of the contract) whereby deficiencies in minority and/or female employee utilization are corrected. Such Affirmative Action Plan will be subject to approval by the contracting agency and the **Department of Human Rights**.
- B. The undersigned bidder understands and agrees that the minority and female employee utilization projection submitted herein, and the goals and timetable included under an Affirmative Action Plan if required, are deemed to be part of the contract specifications.

Company _____ Telephone Number _____

Address _____

NOTICE REGARDING SIGNATURE

The Bidder's signature on the Proposal Signature Sheet will constitute the signing of this form. The following signature block needs to be completed only if revisions are required.

Signature: _____ Title: _____ Date: _____

Instructions: All tables must include subcontractor personnel in addition to prime contractor personnel.

Table A - Include both the number of employees that would be hired to perform the contract work and the total number currently employed (Table B) that will be allocated to contract work, and include all apprentices and on-the-job trainees. The "Total Employees" column should include all employees including all minorities, apprentices and on-the-job trainees to be employed on the contract work.

Table B - Include all employees currently employed that will be allocated to the contract work including any apprentices and on-the-job trainees currently employed.

Table C - Indicate the racial breakdown of the total apprentices and on-the-job trainees shown in Table A.

RETURN WITH BID

ADDITIONAL FEDERAL REQUIREMENTS

In addition to the Required Contract Provisions for Federal-Aid Construction Contracts (FHWA 1273), all bidders make the following certifications.

- A. By the execution of this proposal, the signing bidder certifies that the bidding entity has not, either directly or indirectly, entered into any agreement, participated in any collusion, or otherwise taken any action, in restraint of free competitive bidding in connection with the submitted bid. This statement made by the undersigned bidder is true and correct under penalty of perjury under the laws of the United States.
- B. CERTIFICATION, EQUAL EMPLOYMENT OPPORTUNITY:
1. Have you participated in any previous contracts or subcontracts subject to the equal opportunity clause. YES _____ NO _____
 2. If answer to #1 is yes, have you filed with the Joint Reporting Committee, the Director of OFCC, any Federal agency, or the former President's Committee on Equal Employment Opportunity, all reports due under the applicable filing requirements of those organizations? YES _____ NO _____

RETURN WITH BID

**Contract No. 99231
SALINE County
Section 05-00136-00-RS
Project RS-901(103)
Route FAS 901 (Ch 9)
District 9 Construction Funds**

PROPOSAL SIGNATURE SHEET

The undersigned bidder hereby makes and submits this bid on the subject Proposal, thereby assuring the Department that all requirements of the Invitation for Bids and rules of the Department have been met, that there is no misunderstanding of the requirements of paragraph 3 of this Proposal, and that the contract will be executed in accordance with the rules of the Department if an award is made on this bid.

(IF AN INDIVIDUAL)

Firm Name _____

Signature of Owner _____

Business Address _____

(IF A CO-PARTNERSHIP)

Firm Name _____

By _____

Business Address _____

Name and Address of All Members of the Firm: _____

(IF A CORPORATION)

Corporate Name _____

By _____

Signature of Authorized Representative _____

Typed or printed name and title of Authorized Representative _____

(IF A JOINT VENTURE, USE THIS SECTION FOR THE MANAGING PARTY AND THE SECOND PARTY SHOULD SIGN BELOW)

Attest _____

Signature _____

Business Address _____

(IF A JOINT VENTURE)

Corporate Name _____

By _____

Signature of Authorized Representative _____

Typed or printed name and title of Authorized Representative _____

Attest _____

Signature _____

Business Address _____

If more than two parties are in the joint venture, please attach an additional signature sheet.

RETURN WITH BID



Division of Highways
Proposal Bid Bond
(Effective November 1, 1992)

Item No.
Letting Date

KNOW ALL MEN BY THESE PRESENTS, That We

as PRINCIPAL, and

held jointly, severally and firmly bound unto the STATE OF ILLINOIS in the penal sum of 5 percent of the total bid price, or for the amount specified in Article 102.09 of the "Standard Specifications for Road and Bridge Construction" in effect on the date of invitation for bids, whichever is the lesser sum, well and truly to be paid unto said STATE OF ILLINOIS, for the payment of which we bind ourselves, our heirs, executors, administrators, successors and assigns.

THE CONDITION OF THE FOREGOING OBLIGATION IS SUCH, That Whereas, the PRINCIPAL has submitted a bid proposal to the STATE OF ILLINOIS, acting through the Department of Transportation, for the improvement designated by the Transportation Bulletin Item Number and Letting Date indicated above.

NOW, THEREFORE, if the Department shall accept the bid proposal of the PRINCIPAL; and if the PRINCIPAL shall, within the time and as specified in the bidding and contract documents, submit a DBE Utilization Plan that is accepted and approved by the Department; and if, after award by the Department, the PRINCIPAL shall enter into a contract in accordance with the terms of the bidding and contract documents including evidence of the required insurance coverages and providing such bond as specified with good and sufficient surety for the faithful performance of such contract and for the prompt payment of labor and material furnished in the prosecution thereof; or if, in the event of the failure of the PRINCIPAL to make the required DBE submission or to enter into such contract and to give the specified bond, the PRINCIPAL pays to the Department the difference not to exceed the penalty hereof between the amount specified in the bid proposal and such larger amount for which the Department may contract with another party to perform the work covered by said bid proposal, then this obligation shall be null and void, otherwise, it shall remain in full force and effect.

IN THE EVENT the Department determines the PRINCIPAL has failed to comply with any requirement as set forth in the preceding paragraph, then Surety shall pay the penal sum to the Department within fifteen (15) days of written demand therefor. If Surety does not make full payment within such period of time, the Department may bring an action to collect the amount owed. Surety is liable to the Department for all its expenses, including attorney's fees, incurred in any litigation in which it prevails either in whole or in part.

In TESTIMONY WHEREOF, the said PRINCIPAL and the said SURETY have caused this instrument to be signed by their respective officers this day of A.D.,

PRINCIPAL SURETY
(Company Name)
By: (Signature & Title) By: (Signature of Attorney-in-Fact)

Notary Certification for Principal and Surety

STATE OF ILLINOIS,
COUNTY OF

I, a Notary Public in and for said County, do hereby certify that and

(Insert names of individuals signing on behalf of PRINCIPAL & SURETY)

who are each personally known to me to be the same persons whose names are subscribed to the foregoing instrument on behalf of PRINCIPAL and SURETY, appeared before me this day in person and acknowledged respectively, that they signed and delivered said instrument as their free and voluntary act for the uses and purposes therein set forth.

Given under my hand and notarial seal this day of, A.D.

My commission expires Notary Public

In lieu of completing the above section of the Proposal Bid Form, the Principal may file an Electronic Bid Bond. By signing below the Principal is ensuring the identified electronic bid bond has been executed and the Principal and Surety are firmly bound unto the State of Illinois under the conditions of the bid bond as shown above.

Electronic Bid Bond ID# Company/Bidder Name Signature and Title

PROPOSAL ENVELOPE



PROPOSALS

for construction work advertised for bids by the
Illinois Department of Transportation

Item No.	Item No.	Item No.

Submitted By:

Name:
Address:
Phone No.

Bidders should use an IDOT proposal envelope or affix this form to the front of a 10" x 13" envelope for the submittal of bids. If proposals are mailed, they should be enclosed in a second or outer envelope addressed to:

Engineer of Design and Environment - Room 326
Illinois Department of Transportation
2300 South Dirksen Parkway
Springfield, Illinois 62764

NOTICE

Individual bids, including Bid Bond and/or supplemental information if required, should be securely stapled.

CONTRACTOR OFFICE COPY OF CONTRACT SPECIFICATIONS

NOTICE

None of the following material needs to be returned with the bid package unless the special provisions require documentation and/or other information to be submitted.

**Contract No. 99231
SALINE County
Section 05-00136-00-RS
Project RS-901(103)
Route FAS 901 (Ch 9)
District 9 Construction Funds**



Illinois Department of Transportation



NOTICE TO BIDDERS

- 1. TIME AND PLACE OF OPENING BIDS.** Sealed proposals for the improvement described herein will be received by the Department of Transportation at the Harry R. Hanley Building, 2300 South Dirksen Parkway, in Springfield, Illinois until 10:00 o'clock a.m., August 5, 2005. All bids will be gathered, sorted, publicly opened and read in the auditorium at the Department of Transportation's Harry R. Hanley Building shortly after the 10:00 a.m. cut off time.
- 2. DESCRIPTION OF WORK.** The proposed improvement is identified and advertised for bids in the Invitation for Bids as:

**Contract No. 99231
SALINE County
Section 05-00136-00-RS
Project RS-901(103)
Route FAS 901 (Ch 9)
District 9 Construction Funds**

Construction consists of 3.29 miles resurfacing with aggregate shoulders along FAS Route 901, CH 9 from Oak Street in Carrier Mills extending northerly to SN 083-0033.

- 3. INSTRUCTIONS TO BIDDERS.** (a) This Notice, the invitation for bids, proposal and letter of award shall, together with all other documents in accordance with Article 101.09 of the Standard Specifications for Road and Bridge Construction, become part of the contract. Bidders are cautioned to read and examine carefully all documents, to make all required inspections, and to inquire or seek explanation of the same prior to submission of a bid.

(b) State law, and, if the work is to be paid wholly or in part with Federal-aid funds, Federal law requires the bidder to make various certifications as a part of the proposal and contract. By execution and submission of the proposal, the bidder makes the certification contained therein. A false or fraudulent certification shall, in addition to all other remedies provided by law, be a breach of contract and may result in termination of the contract.
- 4. AWARD CRITERIA AND REJECTION OF BIDS.** This contract will be awarded to the lowest responsive and responsible bidder considering conformity with the terms and conditions established by the Department in the rules, Invitation for Bids and contract documents. The issuance of plans and proposal forms for bidding based upon a prequalification rating shall not be the sole determinant of responsibility. The Department reserves the right to determine responsibility at the time of award, to reject any or all proposals, to readvertise the proposed improvement, and to waive technicalities.

By Order of the
Illinois Department of Transportation

Timothy W. Martin, Secretary

BD 351 (Rev. 01/2003)

INDEX
FOR
SUPPLEMENTAL SPECIFICATIONS
AND RECURRING SPECIAL PROVISIONS
Adopted March 1, 2005

This index contains a listing of SUPPLEMENTAL SPECIFICATIONS and frequently used RECURRING SPECIAL PROVISIONS and LOCAL ROADS AND STREETS RECURRING SPECIAL PROVISIONS.

ERRATA Standard Specifications for Road and Bridge Construction (Adopted 1-1-02) (Revised 3-1-05)

SUPPLEMENTAL SPECIFICATIONS

<u>Std. Spec. Sec.</u>	<u>Page No.</u>
101 Definition of Terms	1
105 Control of Work	2
205 Embankment	3
251 Mulch	4
281 Riprap	5
282 Filter Fabric for Use With Riprap	8
285 Concrete Revetment Mats	10
311 Granular Subbase	14
351 Aggregate Base Course	15
440 Removal of Existing Pavement and Appurtenances	16
442 Pavement Patching	17
449 Removal and Replacement of Preformed Elastomeric Compression Joint Seal	18
481 Aggregate Shoulders	19
501 Removal of Existing Structures	20
503 Concrete Structures	21
505 Steel Structures	22
506 Cleaning and Painting Metal Structures	25
508 Reinforcement Bars	26
512 Piling	27
540 Box Culverts	28
589 Elastic Joint Sealer	30
602 Catch Basin, Manhole, Inlet, Drainage Structures and Valve Vault Construction, Adjustment and Reconstruction	31
603 Adjusting Frames and Grates of Drainage and Utility Structures	32
610 Shoulder Inlets with Curb	33
665 Woven Wire Fence	34
669 Removal and Disposal of Regulated Substances	35
671 Mobilization	36
702 Work Zone Traffic Control Devices	37
1003 Fine Aggregates	38
1004 Coarse Aggregate	39
1005 Stone, Concrete Blocks and Broken Concrete for Erosion Protection, Sediment Control and Rockfill	42
1006 Metals	46
1007 Timber and Preservative Treatment	49
1012 Hydrated Lime	50
1020 Portland Cement Concrete	51
1021 Concrete Admixtures	58
1022 Concrete Curing Materials	59
1024 Nonshrink Grout	61
1041 Brick	63
1043 Precast Reinforced Concrete Manhole Sections and Adjusting Rings	64
1056 Preformed Flexible Gaskets and Mastic Joint Sealer for Sewer and Culvert Pipe	66
1059 Elastic Joint Sealers	67
1060 Waterproofing Materials	68
1069 Pole and Tower	69
1070 Foundation and Breakaway Devices	70
1077 Post and Foundation	72
1080 Fabric Materials	73
1081 Materials For Planting	76
1083 Elastomeric Bearings	77
1094 Overhead Sign Structures	78
1103 Portland Cement Concrete Equipment	79

RECURRING SPECIAL PROVISIONS

The following RECURRING SPECIAL PROVISIONS and RECURRING LOCAL ROADS AND STREETS SPECIAL PROVISIONS indicated by an "X" are applicable to this contract and are included by reference:

<u>CHECK SHEET #</u>	<u>PAGE NO.</u>
1 X State Required Contract Provisions All Federal-aid Construction Contracts (Eff. 2-1-69) (Rev. 10-1-83)....	80
2 X Subletting of Contracts (Federal-aid Contracts) (Eff. 1-1-88) (Rev. 5-1-93)	82
3 X EEO (Eff. 7-21-78) (Rev. 11-18-80)	83
4 Specific Equal Employment Opportunity Responsibilities NonFederal-aid Contracts (Eff. 3-20-69) (Rev. 1-1-94)	94
5 Required Provisions - State Contracts (Eff. 4-1-65) (Rev. 4-1-93)	100
6 Reserved	105
7 Asphalt Quantities and Cost Reviews (Eff. 7-1-88).....	106
8 National Pollutant Discharge Elimination System Permit (Eff. 7-1-94) (Rev. 1-1-03)	107
9 Haul Road Stream Crossings, Other Temporary Stream Crossings and In-Stream Work Pads (Eff. 1-2-92) (Rev. 1-1-98)	108
10 Construction Layout Stakes Except for Bridges (Eff. 1-1-99) (Rev. 1-1-02)	109
11 Construction Layout Stakes (Eff. 5-1-93) (Rev. 1-1-02).....	112
12 Use of Geotextile Fabric for Railroad Crossing (Eff. 1-1-95) (Rev. 1-1-97)	115
13 Asphaltic Emulsion Slurry Seal and Fibrated Asphaltic Emulsion Slurry Seal (Eff. 8-1-89) (Rev. 2-1-97) ...	117
14 Bituminous Surface Treatments Half-Smart (Eff. 7-1-93) (Rev. 1-1-97).....	123
15 X Quality Control/Quality Assurance of Bituminous Concrete Mixtures (Eff. 1-1-00) (Rev. 3-1-05).....	129
16 Subsealing of Concrete Pavements (Eff. 11-1-84) (Rev. 2-1-95)	148
17 Bituminous Surface Removal (Cold Milling) (Eff. 11-1-87) (Rev. 10-15-97)	152
18 X Resurfacing of Milled Surfaces (Eff. 10-1-95).....	154
19 PCC Partial Depth Bituminous Patching (Eff. 1-1-98)	155
20 Patching with Bituminous Overlay Removal (Eff. 10-1-95) (Rev. 7-1-99).....	157
21 Reserved	159
22 Protective Shield System (Eff. 4-1-95) (Rev. 1-1-03).....	160
23 Polymer Concrete (Eff. 8-1-95) (Rev. 3-1-05).....	162
24 Controlled Low-Strength Material (CLSM) (Eff. 1-1-90) (Rev. 3-1-05).....	164
25 Pipe Underdrains (Eff. 9-9-87) (Rev. 1-1-98).....	169
26 Guardrail and Barrier Wall Delineation (Eff. 12-15-93) (Rev. 1-1-97).....	170
27 Bicycle Racks (Eff. 4-1-94) (Rev. 1-1-97)	175
28 Reserved	177
29 Reserved	178
30 Reserved	179
31 Night Time Inspection of Roadway Lighting (Eff. 5-1-96)	180
32 Reserved	181
33 English Substitution of Metric Bolts (Eff. 7-1-96)	182
34 English Substitution of Metric Reinforcement Bars (Eff. 4-1-96) (Rev. 1-1-03)	183
35 Polymer Modified Emulsified Asphalt (Eff. 5-15-89) (Rev. 1-1-04)	185
36 Corrosion Inhibitor (Eff. 3-1-80) (Rev. 7-1-99)	187
37 Quality Control of Concrete Mixtures at the Plant-Single A (Eff. 8-1-00) (Rev. 1-1-04).....	188
38 Quality Control of Concrete Mixtures at the Plant-Double A (Eff. 8-1-00) (Rev. 1-1-04).....	194
39 Quality Control/Quality Assurance of Concrete Mixtures (Eff. 4-1-92) (Rev. 3-1-05).....	202
40 Traffic Barrier Terminal Type 1, Special (Eff. 8-1-94) (Rev. 1-1-03)	215
41 Reserved	216
42 X Segregation Control of Bituminous Concrete (Eff. 7-15-97)	217
43 Reserved	220

LOCAL ROADS AND STREETS RECURRING SPECIAL PROVISIONS

<u>LRS #</u>	<u>PAGE NO.</u>
LRS 1 <input checked="" type="checkbox"/> Cooperation With Utilities (Eff. 1-1-99) (Rev. 1-1-02)	222
LRS 2 <input type="checkbox"/> Furnished Excavation (Eff. 1-1-99) (Rev. 1-1-02)	224
LRS 3 <input checked="" type="checkbox"/> Construction Zone Traffic Control (Eff. 1-1-99)	225
LRS 4 <input checked="" type="checkbox"/> Flaggers in Work Zones (Eff. 1-1-99)	226
LRS 5 <input type="checkbox"/> Reserved	227
LRS 6 <input type="checkbox"/> Bidding Requirements and Conditions for Contract Proposals (Eff. 1-1-02)	228
LRS 7 <input type="checkbox"/> Bidding Requirements and Conditions for Material Proposals (Eff. 1-1-03)	234
LRS 8 <input type="checkbox"/> Failure to Complete the Work on Time (Eff. 1-1-99)	240
LRS 9 <input type="checkbox"/> Bituminous Surface Treatments (Eff. 1-1-99)	241
LRS 10 <input type="checkbox"/> Reflective Sheeting Type C (Eff. 1-1-99) (Rev. 1-1-02)	242
LRS 11 <input type="checkbox"/> Employment Practices (Eff. 1-1-99)	243
LRS 12 <input type="checkbox"/> Wages of Employees on Public Works (Eff. 1-1-99)	245
LRS 13 <input type="checkbox"/> Selection of Labor (Eff. 1-1-99)	246

TABLE OF CONTENTS

<u>ITEM</u>	<u>PAGE NUMBER</u>
REFERENCES	1
DESCRIPTION OF WORK	1
TRAFFIC CONTROL	1
UTILITIES	1
AGGREGATE SURFACE COURSE, TYPE B.....	1
BITUMINOUS CONCRETE SURFACE COURSE AND LEVELING BINDER.....	2
EXISTING TRAFFIC SIGNS	2
MAILBOX TURNOUTS.....	2
BITUMINOUS SURFACE REMOVAL (VARIABLE DEPTH)	2
FRAMES AND LIDS TO BE ADJUSTED.....	3
RAISED REFLECTIVE PAVEMENT MARKERS	3

INDEX LOCAL ROADS AND STREETS SPECIAL PROVISIONS

<u>LR#</u>	<u>TITLE</u>	<u>PAGE</u>
SD 16	"Slab Movement Detection Device" (Eff. 11-1-84).....	
SD 17	"Required Cold Milled Surface Texture" (Eff. 11-1-87).....	
107-1	"Nationwide Permit No. 14" (Eff. 2-1-04) (Rev. 3-1-05). Developed by the Bureau of Local Roads and Streets..... to outline the necessary requirements to comply with No. 14 permits.	
107-2	"Railroad Protective Liability Insurance for Local Lettings" (Eff. 3-1-05). Developed by the Bureau of Local Roads & Streets to require insurance policies to be submitted to the letting agency rather than the department.	
108	"Combination Bids (Eff. 1-1-94)(Rev. 3-1-05). Developed by the Bureau of Local Roads & Streets to allow the revision of working days and calendar days. Revised to incorporate applicable portions of deleted Sections 102 & 103	
109	"Contract Claims" (Eff. 1-1-02) (Rev. 5-1-02). Developed by the Bureau of Local Roads..... and Streets to assist local agencies in handling contract claims.	
212	"Shaping Roadway" (Eff. 8-1-69) (Rev. 1-1-02).....	
302	Rescinded	
355-1	"Asphalt Stabilized Base Course, Road Mix or Traveling Plant Mix" (Eff. 10-1-73)(Rev. 1-1-02).....	
355-2	"Asphalt Stabilized Base Course, Plant Mix" (Eff. 2-20-63)(Rev. 1-1-02)	
355-3	"Bituminous Aggregate Mixture Base Course" (6-27-66)(Rev. 1-1-02). Developed by the..... Bureau of Materials and Physical Research and the Bureau of Local Roads and Streets to construct a stabilized base course with paving grade asphalt.	
400	"Penetrating Emulsified Prime" (Eff. 4-1-84)(Rev. 1-1-02).....	
402	"Salt Stabilized Surface Course" (Eff. 2-20-63)(Rev. 1-1-02).....	
403-1	"Penetrating Emulsified Asphalt" (Eff. 1-1-94)(Rev. 1-1-02). Developed for bituminous..... surface treatments on roads that require flexibility and penetration due to low traffic volume.	
403-2	Bituminous Hot Mix Sand Seal Coat" (Eff. 8-1-69)(Rev. 1-1-02).....	
420	"PCC Pavement (Special)" (Eff. 5-12-64)(Rev. 1-1-02). Developed by the Bureau of Local Roads & Streets to allow local agencies to construct quality PCC pavements for low volume roads.	
430	"Paving Brick and Concrete Paver Pavements and Sidewalks" (Eff 1-1-04) Developed by the Bureau of Local Roads & Streets and the Bureau of Materials & Physical Research to provide statewide requirements for paving brick and concrete paver pavements and sidewalks.	
442	"Bituminous Patching Mixtures for Maintenance Use" (Eff 1-1-04). Developed by the Bureau of Local Roads & Streets to reference approved bituminous patching mixtures.	
451	"Crack Filling Bituminous Pavement with Fiber-Asphalt" (Eff. 10-1-91)(Rev. 1-1-02).....	
503-1	"Furnishing Class SI Concrete" (Eff. 10-1-73)(Rev. 1-1-02).....	
503-2	"Furnishing Class SI Concrete (Short Load)" (Eff. 1-1-89) (Rev. 1-1-02). Developed by the Bureau of Local Roads and Streets to allow a load charge to be added when short loads are expected during the contract.	
542	"Pipe Culverts, Type (Furnished)" (Eff. 9-1-64) (Rev. 1-1-02).....	
663	"Calcium Chloride Applied" (Eff. 6-1-58) (Rev. 1-1-02).....	
671	Rescinded	
701	"Flagger Certification" (Eff. 1-1-93) (Rev. 1-1-02).....	
702	"Construction and Maintenance Signs" (Eff 1-1-04) Developed by the Bureau of Local Roads & Streets to require florescent orange sheeting and a minimum sign size of 48" X 48" on construction and maintenance signs.	
1004	"Coarse Aggregate for Bituminous Surface Treatment" (Eff. 1-1-02). Developed by the Bureau of Materials & Physical Research, the Bureau of Local Roads & Streets, and Local Agencies to provide a coarser mix when aggregate producers have adjusted the CA-16 gradation according to the Aggregate Gradation Control System (AGCS) to a finer mix for Hot-Mix Asphalt.	
1013	"Rock Salt (Sodium Chloride)" (Eff. 8-1-69) (Rev. 1-1-02).....	

BDE SPECIAL PROVISIONS
For The August 5, 2005 Letting

The following special provisions indicated by an "X" are applicable to this contract and will be included by the Project Development and Implementation Section of the BD&E. An * indicates a new or revised special provision for the letting.

<u>File Name</u>	<u>Pg.#</u>	<u>Special Provision Title</u>	<u>Effective</u>	<u>Revised</u>
80099		Accessible Pedestrian Signals (APS)	April 1, 2003	
80141		Additional Award Criteria	June 1, 2004	
80108		Asbestos Bearing Pad Removal	Nov. 1, 2003	
72541		Asbestos Waterproofing Membrane and Asbestos Bituminous Concrete Surface Removal	June 1, 1989	June 30, 1994
80128		Authority of Railroad Engineer	July 1, 2004	
* 80065		Bituminous Base Course/Widening Superpave	April 1, 2002	Aug. 1, 2005
80050	4	X Bituminous Concrete Surface Course	April 1, 2001	April 1, 2003
80142	5	X Bituminous Equipment, Spreading and Finishing Machine	Jan. 1, 2005	
80066		Bridge Deck Construction	April 1, 2002	April 1, 2004
50261		Building Removal-Case I (Non-Friable and Friable Asbestos)	Sept. 1, 1990	Aug. 1, 2001
50481		Building Removal-Case II (Non-Friable Asbestos)	Sept. 1, 1990	Aug. 1, 2001
50491		Building Removal-Case III (Friable Asbestos)	Sept. 1, 1990	Aug. 1, 2001
50531		Building Removal-Case IV (No Asbestos)	Sept. 1, 1990	Aug. 1, 2001
80118	6	X Butt Joints	April 1, 2004	April 1, 2005
80031		Calcium Chloride Accelerator for Portland Cement Concrete Patching	Jan. 1, 2001	
80077		Chair Supports	Nov. 1, 2002	Nov. 2, 2002
80051		Coarse Aggregate for Trench Backfill, Backfill and Bedding	April 1, 2001	Nov. 1, 2003
80094	7	X Concrete Admixtures	Jan. 1, 2003	July 1, 2004
80112		Concrete Barrier	Jan. 1, 2004	April 2, 2004
80102		Corrugated Metal Pipe Culverts	Aug. 1, 2003	July 1, 2004
80114	12	X Curing and Protection of Concrete Construction	Jan. 1, 2004	
* 80146		Detectable Warnings	Aug. 1, 2005	
80029	20	X Disadvantaged Business Enterprise Participation	Sept. 1, 2000	June 1, 2004
80144		Elastomeric Bearings	April 1, 2005	
31578		Epoxy Coating on Reinforcement	April 1, 1997	Jan. 1, 2003
80041		Epoxy Pavement Marking	Jan. 1, 2001	Aug. 1, 2003
80055		Erosion and Sediment Control Deficiency Deduction	Aug. 1, 2001	Nov. 1, 2001
80103		Expansion Joints	Aug. 1, 2003	
* 80101	27	X Flagger Vests	April 1, 2003	Aug. 1, 2005
80079		Freeze-Thaw Rating	Nov. 1, 2002	
80072		Furnished Excavation	Aug. 1, 2002	Nov. 1, 2004
80054		Hand Vibrator	Nov. 1, 2003	
* 80147		Illuminated Sign	Aug. 1, 2005	
80109		Impact Attenuators	Nov. 1, 2003	
80110		Impact Attenuators, Temporary	Nov. 1, 2003	April 1, 2004
80104		Inlet Filters	Aug. 1, 2003	
80080		Insertion Lining of Pipe Culverts	Nov. 1, 2002	Aug. 1, 2003
80067		Light Emitting Diode (LED) Signal Head	April 1, 2002	Aug. 1, 2003
80081		Lime Gradation Requirements	Nov. 1, 2002	
80133		Lime Stabilized Soil Mixture	Nov. 1, 2004	April 1, 2005
80045		Material Transfer Device	June 15, 1999	March 1, 2001
80137		Minimum Lane Width with Lane Closure	Jan. 1, 2005	
80138		Mulching Seeded Areas	Jan. 1, 2005	
80082		Multilane Pavement Patching	Nov. 1, 2002	
80129		Notched Wedge Longitudinal Joint	July 1, 2004	
80069		Organic Zinc-Rich Paint System	Nov. 1, 2001	Aug. 1, 2003
80116	28	X Partial Payments	Sept. 1, 2003	
80013		Pavement and Shoulder Resurfacing	Feb. 1, 2000	July 1, 2004
53600		Pavement Thickness Determination for Payment	April 1, 1999	Jan. 1, 2004

File Name	Pg.#		Special Provision Title	Effective	Revised
80022	29	X	Payment to Subcontractors	June 1, 2000	Sept. 1, 2003
80130	30	X	Personal Protective Equipment	July 1, 2004	
80134			Plastic Blockouts for Guardrail	Nov. 1, 2004	
80073			Polymer Modified Emulsified Asphalt	Nov. 1, 2002	
80119			Polyurea Pavement Marking	April 1, 2004	
80124			Portable Changeable Message Signs	Nov. 1, 1993	April 2, 2004
80139	31	X	Portland Cement	Jan. 1, 2005	
80083	32	X	Portland Cement Concrete	Nov. 1, 2002	
80036			Portland Cement Concrete Patching	Jan. 1, 2001	Jan. 1, 2004
419			Precast Concrete Products	July 1, 1999	Nov. 1, 2004
80120			Precast, Prestressed Concrete Members	April 1, 2004	
80084			Preformed Recycled Rubber Joint Filler	Nov. 1, 2002	
80015			Public Convenience and Safety	Jan. 1, 2000	
80121			PVC Pipeliner	April 1, 2004	April 1, 2005
80122			Railroad, Full-Actuated Controller	April 1, 2004	
34261			Railroad Protective Liability Insurance	Dec. 1, 1986	May 1, 1988
80105	33	X	Raised Reflective Pavement Markers (Bridge)	Aug. 1, 2003	
80011			RAP for Use in Bituminous Concrete Mixtures	Jan. 1, 2000	April 1, 2002
80032			Remove and Re-Erect Steel Plate Beam Guardrail and Traffic Barrier Terminals	Jan. 1, 2001	Jan. 1, 2005
80085			Sealing Abandoned Water Wells	Nov. 1, 2002	
* 80131			Seeding and Sodding	July 1, 2004	Aug. 1, 2005
80132			Self-Consolidating Concrete for Precast Products	July 1, 2004	
80096			Shoulder Rumble Strips	Jan. 1, 2003	
80140			Shoulder Stabilization at Guardrail	Jan. 1, 2005	
80135			Soil Modification	Nov. 1, 2004	April 1, 2005
* 80070			Stabilized Subbase and Bituminous Shoulders Superpave	April 1, 2002	Aug. 1, 2005
80127			Steel Cost Adjustment	April 2, 2004	July 1, 2004
* 80143	34	X	Subcontractor Mobilization Payments	April 2, 2005	
80086			Subgrade Preparation	Nov. 1, 2002	
80136			Superpave Bituminous Concrete Mixture IL-4.75	Nov. 1, 2004	
80010	35	X	Superpave Bituminous Concrete Mixtures	Jan. 1, 2000	April 1, 2004
80039			Superpave Bituminous Concrete Mixtures (Low ESAL)	Jan. 1, 2001	April 1, 2004
* 80075			Surface Testing of Pavements	April 1, 2002	Aug. 1, 2005
80145			Suspension of Slipformed Parapets	June 11, 2004	
80092			Temporary Concrete Barrier	Oct. 1, 2002	Nov. 1, 2003
80087			Temporary Erosion Control	Nov. 1, 2002	
80008			Temporary Module Glare Screen System	Jan. 1, 2000	
80106			Temporary Portable Bridge Traffic Signals	Aug. 1, 2003	
80098			Traffic Barrier Terminals	Jan. 1, 2003	
57291	42	X	Traffic Control Deficiency Deduction	April 1, 1992	Jan. 1, 2005
20338			Training Special Provisions	Oct. 15, 1975	
80107			Transient Voltage Surge Suppression	Aug. 1, 2003	
80123	43	X	Truck Bed Release Agent	April 1, 2004	
* 80149			Variable Spaced Tining	Aug. 1, 2005	
80048	44	X	Weight Control Deficiency Deduction	April 1, 2001	Aug. 1, 2002
80090			Work Zone Public Information Signs	Sept. 1, 2002	Jan. 1, 2005
80125			Work Zone Speed Limit Signs	April 2, 2004	April 15, 2004
80126			Work Zone Traffic Control	April 2, 2004	Jan. 2, 2005
80097			Work Zone Traffic Control Devices	Jan. 1, 2003	Nov. 1, 2004
80071	46	X	Working Days	Jan. 1, 2002	
	47	X	Plans		

The following special provisions have been **deleted** from use:

80113 Curb Ramps for Sidewalk This special provision has been replaced by the BDE Special Provision, "Detectable Warnings".

43761 Driving Guardrail Posts This special provision has been made obsolete by revising Standard 630201 and issuing the BDE Special Provision, "Shoulder Stabilization at Guardrail".

80091 Underdrain Operations This special provision is no longer required and has been deleted.

The following special provisions are in the 2005 Supplemental Specifications and Recurring Special Provisions:

<u>File Name</u>	<u>Special Provision Title</u>	<u>New Location</u>	<u>Effective</u>	<u>Revised</u>
80052	Adjusting Frames and Grates	Sections 602, 603, and 1043	Aug. 1, 2001	Nov. 1, 2001
80093	Articulated Block Revetment Mat	Sections 285 and 1005	Jan. 1, 2003	
80078	Controlled Aggregate Mixing System	Sections 311, 351, and 481	Nov. 1, 2002	
80100	Epoxy Coatings for Steel Reinforcement	Section 1006	April 1, 2003	
80095	Precast Block Revetment Mat	Sections 285 and 1005	Jan. 1, 2003	
80074	Shoulder Inlets with Curb	Section 610	Aug. 1, 2002	
80117	Stone for Erosion Protection, Sediment Control, and Rockfill	Sections 281 and 1005	Jan. 1, 2004	
80088	Traffic Structures	Sections 1069 and 1077	Nov. 1, 2002	

The following special provisions require additional information from the designer. The additional information needs to be included in a separate document attached to this check sheet. The Project Development and Implementation section will then include the information in the applicable special provision. The Special Provisions are:

- Building Removal-Case I
- Building Removal-Case II
- Building Removal-Case III
- Building Removal-Case IV
- DBE Participation
- Material Transfer Device
- Railroad Protective Liability Insurance
- Training Special Provisions
- Working Days

SPECIAL PROVISIONS

The following Special Provisions supplement the "Standard Specifications for Road and Bridge Construction" adopted January 1, 2002, the latest edition of the "Illinois Manual on Uniform Traffic Control Devices for Streets and Highways" and the "Manual of Test Procedures for Materials" in effect on the date of invitation for bids, and the Supplemental Specifications and Recurring Special Provisions indicated on the Check Sheet included herein which apply to and govern the construction of FAS Route 901, Section 05-00136-00-RS, Project RS-901 (103), in Saline County, and in case of conflict with any part, or parts, of said Specifications, the said Special Provisions shall take precedence and shall govern.

DESCRIPTION OF WORK

The proposed improvement consists of milling the existing surface, placement of a bituminous overlay, crushed stone shoulders, and miscellaneous items necessary to complete the improvement.

TRAFFIC CONTROL

The Contractor will be required to keep the road open to through traffic during construction of the proposed improvement.

Traffic control shall be in accordance with the applicable section of the Standard Specifications, the applicable guidelines contained in the Illinois Manual on Uniform Traffic Control Devices, these Special Provisions, and any special details and Highways Standards contained herein and in the plans.

Special attention is called to Articles 107.09 and 107.14 of the Standard Specifications and the following Highway Standards: 701001, 701006, 701011, 701301, 701306, 701311, 702001 and 701501.

The cost of the materials, labor, and equipment necessary for Traffic Control in accordance with the above-mentioned standards shall be included in the total cost of the contract, and no additional compensation will be allowed.

UTILITIES

There are no known utilities within the limits of this improvement requiring adjustment. It shall be the Contractor's responsibility to determine the actual location of all such facilities, known or unknown.

AGGREGATE SURFACE COURSE, TYPE B

The placement of the Aggregate Surface Course, Type B, shall be in accordance with Article 402.07 except a spreader box will not be required.

BITUMINOUS CONCRETE SURFACE COURSE AND LEVELING BINDER

The Bituminous Concrete Surface Course and Leveling Binder used shall meet the following Superpave mixture requirements:

Mixture Use:	Bituminous Concrete Surface Course, Superpave, Mix C, N70
AC/PG:	PG64-22
RAP% (Max.):	10
Design Air Voids:	4.0 %, 70 Gyration Superpave Design
Mixture Composition: (Gradation Mixture)	IL-9.5 mm or IL-12.5 mm
Friction Aggregate:	C Surface

EXISTING TRAFFIC SIGNS

Existing traffic signs, which interfere with construction operations, shall be relocated at a temporary location as directed by the Engineer. Upon completion of the work the signs shall be re-erected at their permanent location. This work shall be included in the total cost of the contract, and no extra compensation will be allowed.

MAILBOX TURNOUTS

Mailbox turnouts (Est. 12 Ea.) shall be constructed of Leveling Binder and Bituminous Concrete Surface Course, with thicknesses equal to the adjacent overlay, in accordance with Standard BLR-24. The exact number and location of turnouts shall be determined in the field by the Engineer. The existing surface shall be primed with Bituminous Materials (Prime Coat) at 0.1 gal./s.y. and Aggregate (Prime Coat) at 3 lbs./s.y..

This work will not be paid for separately but shall be included in the contract unit price for the various items involved.

BITUMINOUS SURFACE REMOVAL (VARIABLE DEPTH)

This work shall be done in accordance with Section 440 of the Standard Specifications and as shown in the plans.

FRAMES AND LIDS TO BE ADJUSTED

This work shall be performed in accordance with Section 603 of the Standard Specifications. Adjusting rings shall be connected to the existing frame with a continuous weld. Tack welding will not be permitted.

RAISED REFLECTIVE PAVEMENT MARKERS

Raised Reflective Pavement Markers shall be installed from Station 70+05 to 192+00 only.

COMBINATION CONCRETE CURB AND GUTTER REMOVAL AND REPLACEMENT

This work shall consist of removing and replacing the existing concrete curb and gutter Type M6.24. The subgrade shall be repaired to match the original grade. All work shall be performed in accordance with Section 440 and 606 of the Standard Specifications and Highway Standard 606001

BITUMINOUS CONCRETE SURFACE COURSE (BDE)

Effective: April 1, 2001

Revised: April 1, 2003

Replace the fourth paragraph of Article 406.23(b) of the Standard Specifications with the following:

"Mixture for cracks, joints, flangeways, leveling binder (machine method), leveling binder (hand method) and binder course in excess of 103 percent of the quantity specified by the Engineer will not be measured for payment.

Surface course mixture in excess of 103 percent of adjusted plan quantity will not be measured for payment. The adjusted plan quantity for surface course mixtures will be calculated as follows:

Adjusted Plan Quantity = C x quantity shown on the plans or as specified by the Engineer.

where C = metric: $C = \frac{G_{mb} \times 24.99}{U}$ English: $C = \frac{G_{mb} \times 46.8}{U}$

and where:

G_{mb} = average bulk specific gravity from approved mix design.

U = Unit weight of surface course shown on the plans in kg/sq m/25 mm (lb/sq yd/in.), used to estimate plan quantity.

24.99 = metric constant.

46.8 = English constant.

If project circumstances warrant a new surface course mix design, the above equations shall be used to calculate the adjusted plan quantity for each mix design using its respective average bulk specific gravity."

80050

BITUMINOUS EQUIPMENT, SPREADING AND FINISHING MACHINE (BDE)

Effective: January 1, 2005

Revise the fourth paragraph of Article 1102.03 of the Standard Specifications to read:

"The paver shall be equipped with a receiving hopper having sufficient capacity for a uniform spreading operation. The hopper shall be equipped with a distribution system to uniformly place a non-segregated mixture in front of the screed. The distribution system shall have chain curtains, deflector plates, and /or other devices designed and built by the paver manufacturer to prevent segregation during distribution of the mixture from the hopper to the paver screed. The Contractor shall submit a written certification that the devices recommended by the paver manufacturer to prevent segregation have been installed and are operational. Prior to paving, the Contractor, in the presence of the Engineer, shall visually inspect paver parts specifically identified by the manufacturer for excessive wear and the need for replacement. The Contractor shall supply a completed check list to the Engineer noting the condition of the parts. Worn parts shall be replaced. The Engineer may require an additional inspection prior to placement of the surface course or at other times throughout the work."

80142

BUTT JOINTS (BDE)

Effective: April 1, 2004

Revised: April 1, 2005

Revise Article 406.18 of the Standard Specifications to read:

406.18 Butt Joints. Butt joints shall be constructed according to the details shown on the plans. The surface removal shall be performed according to Section 440. Construction of butt joints shall not begin prior to beginning general operations on the project.

When butt joints are to be constructed under traffic, temporary ramps shall be constructed and maintained at both the upstream and downstream ends of the surface removal areas immediately upon completion of the surface removal operation. The temporary ramps shall be constructed by the following methods.

- (a) **Temporary Bituminous Ramps.** Temporary bituminous ramps shall have a minimum taper rate of 1:40 (V:H). The bituminous material used shall meet the approval of the Engineer. Cold-milled bituminous tailings will not be acceptable.
- (b) **Temporary Rubber Ramps.** Temporary rubber ramps shall only be used on roadways with permanent posted speeds of 55 mph or less. The ramps shall have a minimum taper rate of 1:30 (V:H). The leading edge of the rubber ramp shall have a maximum thickness of 6 mm (1/4 in.) and the trailing edge shall match the height of the adjacent pavement \pm 6 mm (1/4 in.).

The rubber material shall conform to the following.

Property	Test Method	Requirement
Durometer Hardness, Shore A	ASTM D 2240	80 \pm 10
Tensile Strength	ASTM D 412	5500 kPa (800 psi) min.
Elongation, percent	ASTM D 412	100 min.
Specific Gravity	ASTM D 297	1.1-1.3
Brittleness	ASTM D 746	-40 °C (-40 °F)

The rubber ramps shall be installed according to the manufacturer's specifications and fastened with the anchors provided. Rubber ramps that fail to stay in place or create a traffic hazard shall be replaced immediately with temporary bituminous ramps at the Contractor's expense.

The temporary ramps shall be removed just prior to placing the proposed surface course. If work is suspended for the winter season prior to completion of surface course construction, precut butt joints shall be filled to the elevation of the existing pavement surface with compacted bituminous concrete surface course or binder course."

80118

CONCRETE ADMIXTURES (BDE)

Effective: January 1, 2003

Revised: July 1, 2004

Revise Article 1020.05(b) of the Standard Specifications to read:

"(b) Admixtures. Except as specified, the use of admixtures to increase the workability or to accelerate the hardening of the concrete will be permitted only when approved in writing by the Engineer. The Department will maintain an Approved List of Concrete Admixtures. When the Department permits the use of a calcium chloride accelerator, it shall be according to Article 442.02, Note 5.

When the atmosphere or concrete temperature is 18 °C (65 °F) or higher, a retarding admixture meeting the requirements of Article 1021.03 shall be used in the Class BD Concrete and portland cement concrete bridge deck overlays. The amount of retarding admixture to be used will be determined by the Engineer. The proportions of the ingredients of the concrete shall be the same as without the retarding admixture except that the amount of mixing water shall be reduced, as may be necessary, in order to maintain the consistency of the concrete as required. In addition, a high range water-reducing admixture shall be used in Class BD Concrete. The amount of high range water-reducing admixture will be determined by the Engineer. At the option of the Contractor, a water-reducing admixture may be used. Type I cement shall be used.

For Class PC and PS Concrete, a retarding admixture may be added to the concrete mixture when the concrete temperature is 18 °C (65 °F) or higher. Other admixtures may be used when approved by the Engineer, or if specified by the contract. If an accelerating admixture is permitted by the Engineer, it shall be the non-chloride type.

At the Contractor's option, admixtures in addition to an air-entraining admixture may be used for Class PP-1 concrete. The accelerator shall be the non-chloride type. If a water-reducing or retarding admixture is used, the cement factor may be reduced a maximum 18 kg/cu m (0.30 hundredweight/cu yd). If a high range water-reducing admixture is used, the cement factor may be reduced a maximum 36 kg/cu m (0.60 hundredweight/cu yd). Cement factor reductions shall not be cumulative when using multiple admixtures. An accelerator shall always be added prior to a high range water-reducing admixture, if both are used.

If Class C fly ash or ground granulated blast-furnace slag is used in Class PP-1 concrete, a water-reducing or high range water-reducing admixture shall be used. However, the cement factor shall not be reduced if a water-reducing, retarding, or high range water-reducing admixture is used. In addition, an accelerator shall not be used.

For Class PP-2 or PP-3 concrete, a non-chloride accelerator followed by a high range water-reducing admixture shall be used, in addition to the air-entraining admixture. For Class PP-3 concrete, the non-chloride accelerator shall be calcium nitrite.

For Class PP-2 or PP-3 concrete, the Contractor has the option to use a water-reducing admixture. A retarding admixture shall not be used unless approved by the Engineer. A water-reducing, retarding, or high range water-reducing admixture shall not be used to reduce the cement factor.

When the air temperature is less than 13 °C (55 °F) for Class PP-1 or PP-2 concrete, the non-chloride accelerator shall be calcium nitrite.

For Class PP-4 concrete, a high range water-reducing admixture shall be used in addition to the air-entraining admixture. The Contractor has the option to use a water-reducing admixture. An accelerator shall not be used. For stationary or truck mixed concrete, a retarding admixture shall be used to allow for haul time. The Contractor has the option to use a mobile portland cement concrete plant according to Article 1103.04, but a retarding admixture shall not be used unless approved by the Engineer. A water-reducing, retarding, or high range water-reducing admixture shall not be used to reduce the cement factor.

If the Department specifies a calcium chloride accelerator for Class PP-1 concrete, the maximum chloride dosage shall be 1.0 L (1.0 quart) of solution per 45 kg (100 lb) of cement. The dosage may be increased to a maximum 2.0 L (2.0 quarts) per 45 kg (100 lb) of cement if approved by the Engineer. If the Department specifies a calcium chloride accelerator for Class PP-2 concrete, the maximum chloride dosage shall be 1.3 L (1.3 quarts) of solution per 45 kg (100 lb) of cement. The dosage may be increased to a maximum 2.6 L (2.6 quarts) per 45 kg (100 lb) of cement if approved by the Engineer.

For Class PV, MS, SI, RR, SC and SH concrete, at the option of the Contractor, or when specified by the Engineer, a water-reducing admixture or a retarding admixture may be used. The amount of water-reducing admixture or retarding admixture permitted will be determined by the Engineer. The air-entraining admixture and other admixtures shall be added to the concrete separately, and shall be permitted to intermingle only after they have separately entered the concrete batch. The sequence, method and equipment for adding the admixtures shall be approved by the Engineer. The water-reducing admixture shall not delay the initial set of the concrete by more than one hour. Type I cement shall be used.

When a water-reducing admixture is added, a cement factor reduction of up to 18 kg/cu m (0.30 hundredweight/cu yd), from the concrete designed for a specific slump without the admixture, will be permitted for Class PV, MS, SI, RR, SC and SH concrete. When an approved high range water-reducing admixture is used, a cement factor reduction of up to 36 kg/cu m (0.60 hundredweight/cu yd), from a specific water cement/ratio without the admixture, will be permitted based on a 14 percent minimum water reduction. This is applicable to Class PV, MS, SI, RR, SC and SH concrete. A cement factor below 320 kg/cu m (5.35 hundredweight/cu yd) will not be permitted for Class PV, MS, SI, RR, SC and SH concrete. A cement factor reduction will not be

allowed for concrete placed underwater. Cement factor reductions shall not be cumulative when using multiple admixtures.

For use of admixtures to control concrete temperature, refer to Articles 1020.14(a) and 1020.14(b).

The maximum slumps given in Table 1 may be increased to 175 mm (7 in.) when a high range water-reducing admixture is used for all classes of concrete except Class PV and PP."

Revise Section 1021 of the Standard Specifications to read:

"SECTION 1021. CONCRETE ADMIXTURES

1021.01 General. Admixtures shall be furnished in liquid form ready for use. The admixtures may be delivered in the manufacturer's original containers, bulk tank trucks or such containers or tanks as are acceptable to the Engineer. Delivery shall be accompanied by a ticket which clearly identifies the manufacturer and trade name of the material. Containers shall be readily identifiable to the satisfaction of the Engineer as to manufacturer and trade name of the material they contain.

Prior to inclusion of a product on the Department's Approved List of Concrete Admixtures, the manufacturer shall submit a report prepared by an independent laboratory accredited by the AASHTO Accreditation Program. The report shall show the results of physical tests conducted no more than five years prior to the time of submittal, according to applicable specifications.

Tests shall be conducted using materials and methods specified on a "test" concrete and a "reference" concrete, together with a certification that no changes have been made in the formulation of the material since the performance of the tests. Per the manufacturer's option, the cement content for all required tests shall either be according to applicable specifications or 335 kg/cu m (5.65 cwt/cu yd). Compressive strength test results for six months and one year will not be required.

In addition to the report, the manufacturer shall submit AASHTO T 197 water content and set time test results on the standard cement used by the Department. The test and reference concrete mixture shall contain a cement content of 335 kg/cu m (5.65 cwt/cu yd). The manufacturer may select their lab or an independent lab to perform this testing. The laboratory is not required to be accredited by the AASHTO Accreditation Program.

Prior to the approval of an admixture, the Engineer may conduct all or part of the applicable tests on a sample that is representative of the material to be furnished. The test and reference concrete mixtures tested by the Engineer will contain a cement content of 335 kg/cu m (5.65 cwt/cu yd). For freeze-thaw testing, the Department will perform the test according to Illinois Modified AASHTO T 161, Procedure B.

The manufacturer shall include in the submittal the following information according to ASTM C 494; the average and manufacturing range of specific gravity, the average and manufacturing range of solids in the solution, and the average and manufacturing range of pH. The submittal shall also include an infrared spectrophotometer trace no more than five years old.

When test results are more than seven years old, the manufacturer shall re-submit the infrared spectrophotometer trace and the report prepared by an independent laboratory accredited by the AASHTO Accreditation Program.

All admixtures, except chloride-based accelerators, shall contain no more than 0.3 percent chloride by mass (weight).

1021.02 Air-Entraining Admixtures. Air-entraining admixtures shall conform to the requirements of AASHTO M 154.

If the manufacturer certifies that the air-entraining admixture is an aqueous solution of Vinsol resin that has been neutralized with sodium hydroxide (caustic soda), testing for compliance with the requirements may be waived by the Engineer. In the certification, the manufacturer shall show complete information with respect to the formulation of the solution, including the number of parts of Vinsol resin to each part of sodium hydroxide. Before the approval of its use is granted, the Engineer will test the solution for its air-entraining quality in comparison with a solution prepared and kept for that purpose.

1021.03 Retarding and Water-Reducing Admixtures. The admixture shall comply with the following requirements:

- (a) The retarding admixture shall comply with the requirements of AASHTO M 194, Type B (retarding) or Type D (water-reducing and retarding).
- (b) The water-reducing admixture shall comply with the requirements of AASHTO M 194, Type A.
- (c) The high range water-reducing admixture shall comply with the requirements of AASHTO M 194, Type F (high range water-reducing) or Type G (high range water-reducing and retarding).

When a Type F or Type G high range water-reducing admixture is used, water-cement ratios shall be a minimum of 0.32.

Type F or Type G admixtures may be used, subject to the following restrictions:

For Class MS, SI, RR, SC and SH concrete, the water-cement ratio shall be a maximum of 0.44.

The Type F or Type G admixture shall be added at the jobsite unless otherwise directed by the Engineer. The initial slump shall be a minimum of 40 mm (1 1/2 in.)

prior to addition of the Type F or Type G admixture, except as approved by the Engineer.

When a Type F or Type G admixture is used, retempering with water or with a Type G admixture will not be allowed. An additional dosage of a Type F admixture, not to exceed 40 percent of the original dosage, may be used to retemper concrete once, provided set time is not unduly affected. A second retempering with a Type F admixture may be used for all classes of concrete except Class PP and SC, provided that the dosage does not exceed the dosage used for the first retempering, and provided that the set time is not unduly affected. No further retempering will be allowed.

Air tests shall be performed after the addition of the Type F or Type G admixture.

1021.04 Set Accelerating Admixtures. The admixture shall comply with the requirements of AASHTO M 194, Type C (accelerating) or Type E (water reducing and accelerating)"

80094

CURING AND PROTECTION OF CONCRETE CONSTRUCTION (BDE)

Effective: January 1, 2004

Revise the second and third sentences of the eleventh paragraph of Article 503.06 of the Standard Specifications to read:

"Forms on substructure units shall remain in place at least 24 hours. The method of form removal shall not result in damage to the concrete."

Delete the twentieth paragraph of Article 503.22 of the Standard Specifications.

Revise the "Unit Price Adjustments" table of Article 503.22 of the Standard Specifications to read:

"UNIT PRICE ADJUSTMENTS"	
Type of Construction	Percent Adjustment in Unit Price
For concrete in substructures, culverts (having a waterway opening of more than 1 sq m (10 sq ft)), pump houses, and retaining walls (except concrete pilings, footings and foundation seals): When protected by: Protection Method II Protection Method I	 115% 110%
For concrete in superstructures: When protected by: Protection Method II Protection Method I	 123% 115%
For concrete in footings: When protected by: Protection Method I, II or III	 107%
For concrete in slope walls: When protected by: Protection Method I	 107%

Delete the fourth paragraph of Article 504.05(a) of the Standard Specifications.

Revise the second and third sentences of the fifth paragraph of Article 504.05(a) of the Standard Specifications to read:

"All test specimens shall be cured with the units according to Article 1020.13."

Revise the first paragraph of Article 504.06(c)(6) of the Standard Specifications to read:

"Curing and Low Air Temperature Protection. The curing and protection for precast, prestressed concrete members shall be according to Article 1020.13 and this Article."

Revise the first sentence of the second paragraph of Article 504.06(c)(6) of the Standard Specifications to read:

"For curing, air vents shall be in place, and shall be so arranged that no water can enter the void tubes during the curing of the members."

Revise the first sentence of the third paragraph of Article 504.06(c)(6) of the Standard Specifications to read:

"As soon as each member is finished, the concrete shall be covered with curing material according to Article 1020.13."

Revise the eighth paragraph of Article 504.06(c)(6) of the Standard Specifications to read:

"The prestressing force shall not be transferred to any member before the concrete has attained the compressive strength of 28,000 kPa (4000 psi) or other higher compressive release strength specified on the plans, as determined from tests of 150 mm (6 in.) by 300 mm (12 in.) cylinders cured with the member according to Article 1020.13. Members shall not be shipped until 28-day strengths have been attained and members have a yard age of at least 4 days."

Delete the third paragraph of Article 512.03(a) of the Standard Specifications.

Delete the last sentence of the second paragraph of Article 512.04(d) of the Standard Specifications.

Revise the "Index Table of Curing and Protection of Concrete Construction" table of Article 1020.13 of the Standard Specifications to read:

"INDEX TABLE OF CURING AND PROTECTION OF CONCRETE CONSTRUCTION"			
TYPE OF CONSTRUCTION	CURING METHODS	CURING PERIOD DAYS	LOW AIR TEMPERATURE PROTECTION METHODS
Cast-in-Place Concrete: ^{11/}			
Pavement			
Shoulder	1020.13(a)(1)(2)(3)(4)(5) ^{3/5/}	3	1020.13(c)
Base Course			
Base Course Widening	1020.13(a)(1)(2)(3)(4)(5) ^{1/2/}	3	1020.13(c)
Driveway			
Median			
Curb			
Gutter	1020.13(a)(1)(2)(3)(4)(5) ^{4/5/}	3	1020.13(c) ^{16/}
Curb and Gutter			
Sidewalk			
Slope Wall			
Paved Ditch			
Catch Basin			
Manhole	1020.13(a)(1)(2)(3)(4)(5) ^{4/}	3	1020.13(c)
Inlet			
Valve Vault			
Pavement Patching	1020.13(a)(1)(2)(3)(4)(5) ^{2/}	3 ^{12/}	1020.13(c)
Pavement Replacement	1020.13(a)(1)(2)(3)(4)(5) ^{1/2/}	3	442.06(h) and 1020.13(c)
Railroad Crossing	1020.13(a)(3)(5)	1	1020.13(c)
Piles	1020.13(a)(3)(5)	7	1020.13(e)(1)(2)(3)
Footings			
Foundation Seals	1020.13(a)(1)(2)(3)(4)(5) ^{4/6/}	7	1020.13(e)(1)(2)(3)
Substructure	1020.13(a)(1)(2)(3)(4)(5) ^{17/}	7	1020.13(e)(1)(2)(3)
Superstructure (except deck)	1020.13(a)(1)(2)(3)(5) ^{8/}	7	1020.13(e)(1)(2)
Deck	1020.13(a)(5)	7	1020.13(e)(1)(2) ^{17/}
Retaining Walls	1020.13(a)(1)(2)(3)(4)(5) ^{17/}	7	1020.13(e)(1)(2)
Pump Houses	1020.13(a)(1)(2)(3)(4)(5) ^{1/}	7	1020.13(e)(1)(2)
Culverts	1020.13(a)(1)(2)(3)(4)(5) ^{4/6/}	7	1020.13(e)(1)(2) ^{18/}
Other incidental Concrete	1020.13(a)(1)(2)(3)(5)	3	1020.13(c)
Precast Concrete: ^{11/}			
Bridge Beams			
Piles			
Bridge Slabs	1020.13(a)(3)(5) ^{9/10/}	As required.	^{13/} 504.06(c)(6), 1020.13(e)(2) ^{18/}
Nelson Type Structural Member			
All Other Precast Items	1020.13(a)(3)(4)(5) ^{2/9/10/}	As required.	^{14/} 504.06(c)(6), 1020.13(e)(2) ^{19/}
Precast, Prestressed Concrete: ^{11/}			
All Items	1020.13(a)(3)(5) ^{9/10/}	Until strand tensioning is released. ^{15/}	504.06(c)(6), 1020.13(e)(2) ^{19/}

Notes-General:

- 1/ Type I, membrane curing only
- 2/ Type II, membrane curing only
- 3/ Type III, membrane curing only
- 4/ Type I, II and III membrane curing.
- 5/ Membrane curing will not be permitted between November 1 and April 15.
- 6/ The use of water to inundate footings, foundation seals or the bottom slab of culverts is permissible when approved by the Engineer, provided the water temperature can be maintained at 7 °C (45 °F) or higher.
- 7/ Asphalt Emulsion for Waterproofing may be used in lieu of other curing methods when specified and permitted according to Article 503.18.
- 8/ On non-traffic surfaces which receive protective coat according to Article 503.19, a linseed oil emulsion curing compound may be used as a substitute for protective coat and other curing methods. The linseed emulsion curing compound will be permitted between April 16 and October 31 of the same year, provided it is applied with a mechanical sprayer according to Article 1101.09 (b), and meets the material requirements of Article 1022.07.
- 9/ Steam curing (heat and moisture) is acceptable and shall be accomplished by the method specified in Article 504.06(c)(6).
- 10/ A moist room according to AASHTO M 201 is acceptable for curing.
- 11/ If curing is required and interrupted because of form removal for cast-in-place concrete items, precast concrete products, or precast prestressed concrete products, the curing shall be resumed within two hours from the start of the form removal.
- 12/ Curing maintained only until opening strength is attained, with a maximum curing period of three days.
- 13/ The curing period shall end when the concrete has attained the mix design strength. The producer has the option to discontinue curing when the concrete has attained 80 percent of the mix design strength or after seven days. All strength test specimens shall remain with the units and shall be subjected to the same curing method and environmental condition as the units, until the time of testing.
- 14/ The producer shall determine the curing period or may elect to not cure the product. All strength test specimens shall remain with the units and shall be subjected to the same curing method and environmental condition as the units, until the time of testing.
- 15/ The producer has the option to continue curing after strand release.
- 16/ When structural steel or structural concrete is in place above slope wall, Article 1020.13(c) shall not apply. The protection method shall be according to Article 1020.13(e)(1).
- 17/ When Article 1020.13(e)(2) is used to protect the deck, the housing may enclose only the bottom and sides. The top surface shall be protected according to Article 1020.13(e)(1).
- 18/ For culverts having a waterway opening of 1 sq m (10 sq ft) or less, the culverts may be protected according to Article 1020.13(e)(3).
- 19/ The seven day protection period in the first paragraph of Article 1020.13(e)(2) shall not apply. The protection period shall end when curing is finished. For the third paragraph of Article 1020.13(e)(2), the decrease in temperature shall be according to Article 504.06(c)(6)."

Add the following to Article 1020.13(a) of the Standard Specifications:

"(5) Wetted Cotton Mat Method. After the surface of concrete has been textured or finished, it shall be covered immediately with dry cotton mats. The cotton mats shall be placed in a manner which will not mar the concrete surface. A texture resulting from the cotton mat material is acceptable. The cotton mats shall then be wetted immediately and thoroughly soaked with a gentle spray of water. For bridge decks, a foot bridge shall be used to place and wet the cotton mats.

The cotton mats shall be maintained in a wetted condition until the concrete has hardened sufficiently to place soaker hoses without marring the concrete surface. The soaker hoses shall be placed on top of the cotton mats at a maximum 1.2 m (4 ft) spacing. The cotton mats shall be kept wet with a continuous supply of water for the remainder of the curing period. Other continuous wetting systems may be used if approved by the Engineer.

After placement of the soaker hoses, the cotton mats shall be covered with white polyethylene sheeting or burlap-polyethylene blankets.

For construction items other than bridge decks, soaker hoses or a continuous wetting system will not be required if the alternative method keeps the cotton mats wet. Periodic wetting of the cotton mats is acceptable.

For areas inaccessible to the cotton mats on bridge decks, curing shall be according to Article 1020.13(a)(3)."

Revise the first paragraph of Article 1020.13(c) of the Standard Specifications to read:

"Protection of Portland Cement Concrete, Other Than Structures, From Low Air Temperatures. When the official National Weather Service forecast for the construction area predicts a low of 0 °C (32 °F), or lower, or if the actual temperature drops to 0 °C (32 °F), or lower, concrete less than 72 hours old shall be provided at least the following protection:"

Delete Article 1020.13(d) and Articles 1020.13(d)(1),(2),(3),(4) of the Standard Specifications.

Revise the first five paragraphs of Article 1020.13(e) of the Standard Specifications to read:

"Protection of Portland Cement Concrete Structures From Low Air Temperatures. When the official National Weather Service Forecast for the construction area predicts a low below 7 °C (45 °F), or if the actual temperature drops below 7 °C (45 °F), concrete less than 72 hours old shall be provided protection. Concrete shall also be provided protection when placed during the winter period of December 1 through March 15. Concrete shall not be placed until the materials, facilities and equipment for protection are approved by the Engineer.

When directed by the Engineer, the Contractor may be required to place concrete during the winter period. If winter construction is specified, the Contractor shall proceed with the construction, including concrete, excavation, pile driving, steel erection and all appurtenant work required for the complete construction of the item, except at times when weather conditions make such operations impracticable.

Regardless of the precautions taken, the Contractor shall be responsible for protection of the concrete placed and any concrete damaged by cold temperatures shall be removed and replaced by the Contractor at his/her own expense."

Add the following at the end of the third paragraph of Article 1020.13(e)(1) of the Standard Specifications:

"The Contractor shall provide means for checking the temperature of the surface of the concrete during the protection period."

Revise the second sentence of the first paragraph of Article 1020.13(e)(2) of the Standard Specifications to read:

"The Contractor shall provide means for checking the temperature of the surface of the concrete or air temperature within the housing during the protection period."

Delete the last sentence of the first paragraph of Article 1020.13(e)(3) of the Standard Specifications.

Add the following Article to Section 1022 of the Standard Specifications:

"1022.06 Cotton Mats. Cotton mats shall consist of a cotton fill material, minimum 400 g/sq m (11.8 oz/sq yd), covered with unsized cloth or burlap, minimum 200 g/sq m (5.9 oz/sq yd), and be tufted or stitched to maintain stability.

Cotton mats shall be in a condition satisfactory to the Engineer. Any tears or holes in the mats shall be repaired.

Add the following Article to Section 1022 of the Standard Specifications:

"1022.07 Linseed Oil Emulsion Curing Compound. Linseed oil emulsion curing compound shall be composed of a blend of boiled linseed oil and high viscosity, heavy bodied linseed oil emulsified in a water solution. The curing compound shall meet the requirements of a Type I, II, or III according to Article 1022.01, except the drying time requirement will be waived. The oil phase shall be 50 ± 4 percent by volume. The oil phase shall consist of 80 percent by mass (weight) boiled linseed oil and 20 percent by mass (weight) Z-8 viscosity linseed oil. The water phase shall be 50 ± 4 percent by volume."

Revise Article 1020.14 of the Standard Specifications to read:

1020.14 Temperature Control for Placement. Temperature control for concrete placement shall conform to the following requirements:

- (a) Temperature Control other than Structures. The temperature of concrete immediately before placing, shall be not less than 10 °C (50 °F) nor more than 32 °C (90 °F). Aggregates and/or water shall be heated or cooled as necessary to produce concrete within these temperature limits.

When the temperature of the plastic concrete reaches 30 °C (85 °F), an approved retarding admixture shall be used or the approved water reducing admixture in use shall have its dosage increased by 50 percent over the dosage recommended on the Department's Approved List of Concrete Admixtures for the temperature experienced. The amount of retarding admixture to be used will be determined by the Engineer. This requirement may be waived by the Engineer when fly ash compensated mixtures are used.

Plastic concrete temperatures up to 35 °C (96 °F), as placed, may be permitted provided job site conditions permit placement and finishing without excessive use of water on and/or overworking of the surface. The occurrence within 24 hours of unusual surface distress shall be cause to revert to a maximum 32 °C (90 °F) plastic concrete temperature.

Concrete shall not be placed when the air temperature is below 5 °C (40 °F) and falling or below 2 °C (35 °F), without permission of the Engineer. When placing of concrete is authorized during cold weather, the Engineer may require the water and/or the aggregates to be heated to not less than 20 °C (70 °F) nor more than 65 °C (150 °F). The aggregates may be heated by either steam or dry heat prior to being placed in the mixer. The apparatus used shall heat the mass uniformly and shall be so arranged as to preclude the possible occurrence of overheated areas which might damage the materials. No frozen aggregates shall be used in the concrete.

For pavement patching, refer to Article 442.06(e) for additional information on temperature control for placement.

- (b) Temperature Control for Structures. The temperature of concrete as placed in the forms shall be not less than 10 °C (50 °F) nor more than 32 °C (90 °F). Aggregates and/or water shall be heated or cooled as necessary to produce concrete within these temperature limits. When insulated forms are used, the temperature of the concrete mixture shall not exceed 25 °C (80 °F). If the Engineer determines that heat of hydration might cause excessive temperatures in the concrete, the concrete shall be placed at a temperature between 10 °C (50 °F) and 15 °C (60 °F), per the Engineer's instructions. When concrete is placed in contact with previously placed concrete, the temperature of the concrete may be increased as required to offset anticipated heat loss.

Concrete shall not be placed when the air temperature is below 7 °C (45 °F) and falling or below 4 °C (40 °F), without permission of the Engineer. When placing of concrete is

authorized during cold weather, the Engineer may require the water and/or the aggregates to be heated to not less than 20 °C (70 °F) nor more than 65 °C (150 °F). The aggregates may be heated by either steam or dry heat prior to being placed in the mixer. The apparatus used shall heat the mass uniformly and shall be so arranged as to preclude the possible occurrence of overheated areas which might damage the materials. No frozen aggregates shall be used in the concrete.

When the temperature of the plastic concrete reaches 30 °C (85 °F), an approved retarding admixture shall be used or the approved water reducing admixture in use shall have its dosage increased by 50 percent over the dosage recommended on the Department's Approved List of Concrete Admixtures for the temperature experienced. The amount of retarding admixture to be used will be determined by the Engineer. This requirement may be waived by the Engineer when fly ash compensated mixtures are used.

- (c) Temperature. The concrete temperature shall be determined according to ASTM C 1064."

80114

DISADVANTAGED BUSINESS ENTERPRISE PARTICIPATION (BDE)

Effective: September 1, 2000

Revised: June 1, 2004

FEDERAL OBLIGATION. The Department of Transportation, as a recipient of federal financial assistance, is required to take all necessary and reasonable steps to ensure nondiscrimination in the award and administration of contracts. Consequently, the federal regulatory provisions of 49 CFR part 26 apply to this contract concerning the utilization of disadvantaged business enterprises. This Special Provision will also be used by the Department to satisfy the requirements of the Business Enterprise for Minorities, Females, and Persons with Disabilities Act, 30 ILCS 575. For the purposes of this Special Provision, a disadvantaged business enterprise (DBE) means a business certified by the Department in accordance with the requirements of 49 CFR part 26 and listed in the DBE Directory or most recent addendum.

CONTRACTOR ASSURANCE. The Contractor makes the following assurance and agrees to include the assurance in each subcontract that the Contractor signs with a subcontractor:

The contractor, subrecipient or subcontractor shall not discriminate on the basis of race, color, national origin, or sex in the performance of this contract. The contractor shall carry out applicable requirements of 49 CFR part 26 in the award and administration of federally-assisted contracts. Failure by the contractor to carry out these requirements is a material breach of this contract, which may result in the termination of this contract or such other remedy as the recipient deems appropriate.

OVERALL GOAL SET FOR THE DEPARTMENT. As a requirement of compliance with 49 CFR part 26, the Department has set an overall goal for DBE participation in its federally assisted contracts. That goal applies to all federal-aid funds the Department will expend in its federally assisted contracts for the subject reporting fiscal year. The Department is required to make a good faith effort to achieve the overall goal. The dollar amount paid to all approved DBE firms performing work called for in this contract is eligible to be credited toward fulfillment of the Department's overall goal.

CONTRACT GOAL TO BE ACHIEVED BY THE CONTRACTOR. This contract includes a specific DBE utilization goal established by the Department. The goal has been included because the Department has determined that the work of this contract has subcontracting opportunities that may be suitable for performance by DBE companies. This determination is based on an assessment of the type of work, the location of the work, and the availability of DBE companies to do a part of the work. The assessment indicates that, in the absence of unlawful discrimination, and in an arena of fair and open competition, DBE companies can be expected to perform 3 % of the work. This percentage is set as the DBE participation goal for this contract. Consequently, in addition to the other award criteria established for this contract, the Department will award this contract to a bidder who makes a good faith effort to meet this goal of DBE participation in the performance of the work. A bidder makes a good faith effort for award consideration if either of the following is done in accordance with the procedures set forth in this Special Provision:

- (a) The bidder documents that firmly committed DBE participation has been obtained to meet the goal; or
- (b) The bidder documents that a good faith effort has been made to meet the goal, even though the effort did not succeed in obtaining enough DBE participation to meet the goal.

DBE LOCATOR REFERENCES. Bidders may consult the DBE Directory as a reference source for DBE companies certified by the Department. In addition, the Department maintains a letting and item specific DBE locator information system whereby DBE companies can register their interest in providing quotes on particular bid items advertised for letting. Information concerning DBE companies willing to quote work for particular contracts may be obtained by contacting the Department's Bureau of Small Business Enterprises at telephone number (217)785-4611, or by visiting the Department's web site at www.dot.state.il.us.

BIDDING PROCEDURES. Compliance with the bidding procedures of this Special Provision is required prior to the award of the contract and the failure of the as-read low bidder to comply will render the bid nonresponsive.

- (a) In order to assure the timely award of the contract, the as-read low bidder must submit a Disadvantaged Business Utilization Plan on Department form SBE 2026 within seven (7) working days after the date of letting. To meet the seven (7) day requirement, the bidder may send the Plan by certified mail or delivery service within the seven (7) working day period. If a question arises concerning the mailing date of a Plan, the mailing date will be established by the U.S. Postal Service postmark on the original certified mail receipt from the U.S. Postal Service or the receipt issued by a delivery service. It is the responsibility of the as-read low bidder to ensure that the postmark or receipt date is affixed within the seven (7) working days if the bidder intends to rely upon mailing or delivery to satisfy the submission day requirement. The Plan is to be submitted to the Department of Transportation, Bureau of Small Business Enterprises, Contract Compliance Section, 2300 South Dirksen Parkway, Room 319, Springfield, Illinois 62764 (Telefax: (217)785-1524). It is the responsibility of the bidder to obtain confirmation of telefax delivery. The Department will not accept a Utilization Plan if it does not meet the seven (7) day submittal requirement, and the bid will be declared nonresponsive. In the event the bid is declared nonresponsive due to a failure to submit a Plan or failure to comply with the bidding procedures set forth herein, the Department may elect to cause the forfeiture of the penal sum of the bidder's proposal guaranty, and may deny authorization to bid the project if re-advertised for bids. The Department reserves the right to invite any other bidder to submit a Utilization Plan at any time for award consideration or to extend the time for award.
- (b) The Utilization Plan shall indicate that the bidder either has obtained sufficient DBE participation commitments to meet the contract goal or has not obtained enough DBE participation commitments in spite of a good faith effort to meet the goal. The Utilization Plan shall further provide the name, telephone number and telefax number of a

responsible official of the bidder designated for purposes of notification of plan approval or disapproval under the procedures of this Special Provision.

- (c) The Utilization Plan shall include a DBE Participation Commitment Statement, Department form SBE 2025, for each DBE proposed for the performance of work to achieve the contract goal. The signatures on these forms must be original signatures. All elements of information indicated on the said form shall be provided, including but not limited to the following:
- (1) The name and address of each DBE to be used;
 - (2) A description, including pay item numbers, of the commercially useful work to be done by each DBE;
 - (3) The price to be paid to each DBE for the identified work specifically stating the quantity, unit price and total subcontract price for the work to be completed by the DBE. If partial pay items are to be performed by the DBE, indicate the portion of each item, a unit price where appropriate and the subcontract price amount;
 - (4) A commitment statement signed by the bidder and each DBE evidencing availability and intent to perform commercially useful work on the project; and
 - (5) If the bidder is a joint venture comprised of DBE firms and non-DBE firms, the plan must also include a clear identification of the portion of the work to be performed by the DBE partner(s).
- (d) The contract will not be awarded until the Utilization Plan submitted by the bidder is approved. The Utilization Plan will be approved by the Department if the Plan commits sufficient commercially useful DBE work performance to meet the contract goal. The Utilization Plan will not be approved by the Department if the Plan does not commit sufficient DBE performance to meet the contract goal unless the bidder documents that it made a good faith effort to meet the goal. The good faith procedures of Section VIII of this special provision apply. If the Utilization Plan is not approved because it is deficient in a technical matter, unless waived by the Department, the bidder will be notified and will be allowed no less than a five (5) working day period in order to cure the deficiency.

CALCULATING DBE PARTICIPATION. The Utilization Plan values represent work anticipated to be performed and paid for upon satisfactory completion. The Department is only able to count toward the achievement of the overall goal and the contract goal the value of payments made for the work actually performed by DBE companies. In addition, a DBE must perform a commercially useful function on the contract to be counted. A commercially useful function is generally performed when the DBE is responsible for the work and is carrying out its responsibilities by actually performing, managing, and supervising the work involved. The Department and Contractor are governed by the provisions of 49 CFR part 26.55(c) on questions of commercially useful functions as it affects the work. Specific counting guidelines

are provided in 49 CFR part 26.55, the provisions of which govern over the summary contained herein.

- (a) DBE as the Contractor: 100% goal credit for that portion of the work performed by the DBE's own forces, including the cost of materials and supplies. Work that a DBE subcontracts to a non-DBE firm does not count toward the DBE goals.
- (b) DBE as a joint venture Contractor: 100% goal credit for that portion of the total dollar value of the contract equal to the distinct, clearly defined portion of the work performed by the DBE's own forces.
- (c) DBE as a subcontractor: 100% goal credit for the work of the subcontract performed by the DBE's own forces, including the cost of materials and supplies, excluding the purchase of materials and supplies or the lease of equipment by the DBE subcontractor from the prime contractor or its affiliates. Work that a DBE subcontractor in turn subcontracts to a non-DBE firm does not count toward the DBE goal.
- (d) DBE as a trucker: 100% goal credit for trucking participation provided the DBE is responsible for the management and supervision of the entire trucking operation for which it is responsible. At least one truck owned, operated, licensed and insured by the DBE must be used on the contract. Credit will be given for the full value of all such DBE trucks operated using DBE employed drivers. Goal credit will be limited to the value of the reasonable fee or commission received by the DBE if trucks are leased from a non-DBE company.
- (e) DBE as a material supplier:
 - (1) 60% goal credit for the cost of the materials or supplies purchased from a DBE regular dealer.
 - (2) 100% goal credit for the cost of materials or supplies obtained from a DBE manufacturer.
 - (3) 100% credit for the value of reasonable fees and commissions for the procurement of materials and supplies if not a regular dealer or manufacturer.

GOOD FAITH EFFORT PROCEDURES. If the bidder cannot obtain sufficient DBE commitments to meet the contract goal, the bidder must document in the Utilization Plan the good faith efforts made in the attempt to meet the goal. This means that the bidder must show that all necessary and reasonable steps were taken to achieve the contract goal. Necessary and reasonable steps are those which could reasonably be expected to obtain sufficient DBE participation. The Department will consider the quality, quantity and intensity of the kinds of efforts that the bidder has made. Mere *pro forma* efforts are not good faith efforts; rather, the bidder is expected to have taken those efforts that would be reasonably expected of a bidder actively and aggressively trying to obtain DBE participation sufficient to meet the contract goal.

- (a) The following is a list of types of action that the Department will consider as part of the evaluation of the bidder's good faith efforts to obtain participation. These listed factors are not intended to be a mandatory checklist and are not intended to be exhaustive. Other factors or efforts brought to the attention of the Department may be relevant in appropriate cases, and will be considered by the Department.
- (1) Soliciting through all reasonable and available means (e.g. attendance at pre-bid meetings, advertising and/or written notices) the interest of all certified DBE companies that have the capability to perform the work of the contract. The bidder must solicit this interest within sufficient time to allow the DBE companies to respond to the solicitation. The bidder must determine with certainty if the DBE companies are interested by taking appropriate steps to follow up initial solicitations.
 - (2) Selecting portions of the work to be performed by DBE companies in order to increase the likelihood that the DBE goals will be achieved. This includes, where appropriate, breaking out contract work items into economically feasible units to facilitate DBE participation, even when the prime contractor might otherwise prefer to perform these work items with its own forces.
 - (3) Providing interested DBE companies with adequate information about the plans, specifications, and requirements of the contract in a timely manner to assist them in responding to a solicitation.
 - (4) a. Negotiating in good faith with interested DBE companies. It is the bidder's responsibility to make a portion of the work available to DBE subcontractors and suppliers and to select those portions of the work or material needs consistent with the available DBE subcontractors and suppliers, so as to facilitate DBE participation. Evidence of such negotiation includes the names, addresses, and telephone numbers of DBE companies that were considered; a description of the information provided regarding the plans and specifications for the work selected for subcontracting; and evidence as to why additional agreements could not be reached for DBE companies to perform the work.

b. A bidder using good business judgment would consider a number of factors in negotiating with subcontractors, including DBE subcontractors, and would take a firm's price and capabilities as well as contract goals into consideration. However, the fact that there may be some additional costs involved in finding and using DBE companies is not in itself sufficient reason for a bidder's failure to meet the contract DBE goal, as long as such costs are reasonable. Also, the ability or desire of a prime contractor to perform the work of a contract with its own organization does not relieve the bidder of the responsibility to make good faith efforts. Prime contractors are not, however, required to accept higher quotes from DBE companies if the price difference is excessive or unreasonable.
 - (5) Not rejecting DBE companies as being unqualified without sound reasons based on a thorough investigation of their capabilities. The contractor's standing within its

extend the time for award. The request will be forwarded to the Department's Reconsideration Officer. The Reconsideration Officer will extend an opportunity to the bidder to meet in person in order to consider all issues of whether the bidder made a good faith effort to meet the goal. After the review by the Reconsideration Officer, the bidder will be sent a written decision within ten (10) working days after receipt of the request for reconsideration, explaining the basis for finding that the bidder did or did not meet the goal or make adequate good faith efforts to do so. A final decision by the Reconsideration Officer that a good faith effort was made shall approve the Utilization Plan submitted by the bidder and shall clear the contract for award. A final decision that a good faith effort was not made shall render the bid nonresponsive.

CONTRACT COMPLIANCE. Compliance with this Special Provision is an essential part of the contract. The Department is prohibited by federal regulations from crediting the participation of a DBE included in the Utilization Plan toward either the contract goal or the Department's overall goal until the amount to be applied toward the goals has been paid to the DBE. The following administrative procedures and remedies govern the compliance by the Contractor with the contractual obligations established by the Utilization Plan. After approval of the Plan and award of the contract, the Utilization Plan and individual DBE Participation Statements become part of the contract. If the contractor did not succeed in obtaining enough DBE participation to achieve the advertised contract goal, and the Utilization Plan was approved and contract awarded based upon a determination of good faith, the total dollar value of DBE work calculated in the approved Utilization Plan as a percentage of the awarded contract value shall become the amended contract goal.

- (a) No amendment to the Utilization Plan may be made without prior written approval from the Department's Bureau of Small Business Enterprises. All requests for amendment to the Utilization Plan shall be submitted to the Department of Transportation, Bureau of Small Business Enterprises, Contract Compliance Section, 2300 South Dirksen Parkway, Room 319, Springfield, Illinois 62764. Telephone number (217) 785-4611. Telefax number (217) 785-1524.
- (b) All work indicated for performance by an approved DBE shall be performed, managed and supervised by the DBE executing the Participation Statement. The Contractor shall not terminate for convenience a DBE listed in the Utilization Plan and then perform the work of the terminated DBE with its own forces, those of an affiliate or those of another subcontractor, whether DBE or not, without first obtaining the written consent of the Bureau of Small Business Enterprises to amend the Utilization Plan. If a DBE listed in the Utilization Plan is terminated for reasons other than convenience, or fails to complete its work on the contract for any reason, the Contractor shall make good faith efforts to find another DBE to substitute for the terminated DBE. The good faith efforts shall be directed at finding another DBE to perform at least the same amount of work under the contract as the DBE that was terminated, but only to the extent needed to meet the contract goal or the amended contract goal. The Contractor shall notify the Bureau of Small Business Enterprises of any termination for reasons other than convenience, and shall obtain approval for inclusion of the substitute DBE in the Utilization Plan. If good faith efforts following a termination of a DBE for cause are not successful, the Contractor

shall contact the Bureau and provide a full accounting of the efforts undertaken to obtain substitute DBE participation. The Bureau will evaluate the good faith efforts in light of all circumstances surrounding the performance status of the contract, and determine whether the contract goal should be amended.

- (c) The Contractor shall maintain a record of payments for work performed to the DBE participants. The records shall be made available to the Department for inspection upon request. After the performance of the final item of work or delivery of material by a DBE and final payment therefor to the DBE by the Contractor, but not later than thirty (30) calendar days after payment has been made by the Department to the Contractor for such work or material, the Contractor shall submit a DBE Payment Report on Department form SBE 2115 to the District Engineer. If full and final payment has not been made to the DBE, the Report shall indicate whether a disagreement as to the payment required exists between the Contractor and the DBE or if the Contractor believes that the work has not been satisfactorily completed. If the Contractor does not have the full amount of work indicated in the Utilization Plan performed by the DBE companies indicated in the Plan, the Department will deduct from contract payments to the Contractor the amount of the goal not achieved as liquidated and ascertained damages.
- (d) The Department reserves the right to withhold payment to the Contractor to enforce the provisions of this Special Provision. Final payment shall not be made on the contract until such time as the Contractor submits sufficient documentation demonstrating achievement of the goal in accordance with this Special Provision or after liquidated damages have been determined and collected.

80029

FLAGGER VESTS (BDE)

Effective: April 1, 2003

Revised: August 1, 2005

Revise the first sentence of Article 701.04(c)(1) of the Standard Specifications to read:

"The flagger shall be stationed to the satisfaction of the Engineer and be equipped with a fluorescent orange, fluorescent yellow/green or a combination of fluorescent orange and fluorescent yellow/green vest meeting the requirements of the American National Standards Institute specification ANSI/ISEA 107-1999 for Conspicuity Class 2 garments and approved flagger traffic control signs conforming to Standard 702001 and Article 702.05(e)."

Revise Article 701.04(c)(6) of the Standard Specifications to read:

"(6) Nighttime Flagging. Flaggers shall be illuminated by an overhead light source providing a minimum vertical illuminance of 108 lux (10 fc) measured 300 mm (1 ft) out from the flagger's chest. The bottom of any luminaire shall be a minimum of 3 m (10 ft) above the pavement. Luminaire(s) shall be shielded to minimize glare to approaching traffic and trespass light to adjoining properties.

The flagger vest shall be a fluorescent orange or fluorescent orange and fluorescent yellow/green vest meeting the requirements of the American National Standards Institute specification ANSI/ISEA 107-1999 for Conspicuity Class 3 garments."

80101

PARTIAL PAYMENTS (BDE)

Effective: September 1, 2003

Revise Article 109.07 of the Standard Specifications to read:

"109.07 Partial Payments. Partial payments will be made as follows:

- (a) **Progress Payments.** At least once each month, the Engineer will make a written estimate of the amount of work performed in accordance with the contract, and the value thereof at the contract unit prices. The amount of the estimate approved as due for payment will be vouchered by the Department and presented to the State Comptroller for payment. No amount less than \$1000.00 will be approved for payment other than the final payment.

The failure to perform any requirement, obligation, or term of the contract by the Contractor shall be reason for withholding any progress payments until the Department determines that compliance has been achieved. Furthermore, progress payments may be reduced by liens filed pursuant to Section 23(c) of the Mechanics Lien Act, 770 ILCS 60/23(c).

- (b) **Material Allowances.** At the discretion of the Department, payment may be made for materials, prior to their use in the work, when satisfactory evidence is presented by the Contractor. Satisfactory evidence includes justification for the allowance (to expedite the work, meet project schedules, regional or national material shortages, etc.), documentation of material and transportation costs, and evidence that such material is properly stored on the project or at a secure location acceptable and accessible to the Department.

Material allowances will be considered only for nonperishable materials when the cost, including transportation, exceeds \$10,000 and such materials are not expected to be utilized within 60 days of the request for the allowance. For contracts valued under \$500,000, the minimum \$10,000 requirement may be met by combining the principal (material) product of no more than two contract items. An exception to this two item limitation may be considered for any contract regardless of value for items in which material (products) are similar except for type and/or size.

Material allowances shall not exceed the value of the contract items in which used and shall not include the cost of installation or related markups. Amounts paid by the Department for material allowances will be deducted from estimates due the Contractor as the material is used. Two-sided copies of the Contractor's cancelled checks for materials and transportation must be furnished to the Department within 60 days of payment of the allowances or the amounts will be reclaimed by the Department."

80116

PAYMENTS TO SUBCONTRACTORS (BDE)

Effective: June 1, 2000

Revised: September 1, 2003

Federal regulations found at 49 CFR §26.29 mandate the Department to establish a contract clause to require Contractors to pay subcontractors for satisfactory performance of their subcontracts no later than 30 days from the receipt of each payment made to the Contractor.

State law addresses the timing of payments to be made to subcontractors. Section 7 of the Prompt Payment Act, 30 ILCS 540/7, generally requires that when a Contractor receives any payment from the Department, the Contractor is required to make corresponding, proportional payments to each subcontractor performing work within 15 calendar days after receipt of the state payment. Section 7 of the State Prompt Payment Act further provides that interest in the amount of 2% per month, in addition to the payment due, shall be paid to any subcontractor by the Contractor if the payment required by the Act is withheld or delayed without reasonable cause. The Act also provides that the time for payment required and the calculation of any interest due applies to transactions between subcontractors and lower-tier subcontractors throughout the contracting chain.

This Special Provision establishes the required federal contract clause, and adopts the 15 calendar day requirement of the Act for purposes of compliance with the federal regulation regarding payments to subcontractors. This contract is subject to the following payment obligations.

As progress payments are made to the Contractor in accordance with Article 109.07 of the Standard Specifications for Road and Bridge Construction, the Contractor shall make a corresponding partial payment within 15 calendar days to each subcontractor in proportion to the work satisfactorily completed by each subcontractor. The proportionate amount of partial payment due to each subcontractor shall be determined by the quantities measured or otherwise determined as eligible for payment by the Department and included in the progress payment to the Contractor. Subcontractors shall be paid in full within 15 calendar days after the subcontractor's work has been satisfactorily completed. The Contractor shall hold no retainage from the subcontractors.

This Special Provision does not create any rights in favor of any subcontractor against the State of Illinois or authorize any cause of action against the State of Illinois on account of any payment, nonpayment, delayed payment or interest claimed by application of the State Prompt Payment Act. The Department will neither determine the reasonableness of any cause for delay of payment nor enforce any claim to payment, including interest. Moreover, the Department will not approve any delay or postponement of the 15 day requirement. State law creates remedies available to any subcontractor or material supplier, regardless of tier, who has not been paid for work properly performed or material furnished. These remedies are a lien against public funds set forth in Section 23(c) of the Mechanics Lien Act, 770 ILCS 60/23(c), and a recovery on the Contractor's payment bond in accordance with the Public Construction Bond Act, 30 ILCS 550.

80022

PERSONAL PROTECTIVE EQUIPMENT (PPE)

Effective: July 1, 2004

All personnel, excluding flaggers, working outside of a vehicle (car or truck) within 7.6 m (25 ft) of pavement open to traffic shall wear a fluorescent orange, fluorescent yellow/green or a combination of fluorescent orange and fluorescent yellow/green vest meeting the requirements of the American National Standards Institute specification ANSI/ISEA 107-1999 for Conspicuity Class 2 garments. Other types of garments may be substituted for the vest as long as the garments have manufacturers tags identifying them as meeting the ANSI Class 2 requirement.

80130

PORTLAND CEMENT (BDE)

Effective: January 1, 2005

Replace the first sentence of the second paragraph of Article 1001.01 of the Standard Specifications with the following:

“For portland cement according to ASTM C 150, the addition of up to 5.0 percent limestone by mass (weight) to the cement will not be permitted. Also, the total of all organic processing additions shall not exceed 1.0 percent by mass (weight) of the cement and the total of all inorganic processing additions shall not exceed 4.0 percent by mass (weight) of the cement.”

80139

PORTLAND CEMENT CONCRETE (BDE)

Effective: November 1, 2002

Add the following paragraph after the fourth paragraph of Article 1103.01(b) of the Standard Specifications:

"The truck mixer shall be approved before use according to the Bureau of Materials and Physical Research's Policy Memorandum, "Approval of Concrete Plants and Delivery Trucks"."

Add the following paragraph after the first paragraph of Article 1103.01(c) of the Standard Specifications:

"The truck agitator shall be approved before use according to the Bureau of Materials and Physical Research's Policy Memorandum, "Approval of Concrete Plants and Delivery Trucks"."

Add the following paragraph after the first paragraph of Article 1103.01(d) of the Standard Specifications:

"The nonagitator truck shall be approved before use according to the Bureau of Materials and Physical Research's Policy Memorandum, "Approval of Concrete Plants and Delivery Trucks"."

Revise the first sentence of the first paragraph of Article 1103.02 of the Standard Specifications to read:

"The plant shall be approved before production begins according to the Bureau of Materials and Physical Research's Policy Memorandum, "Approval of Concrete Plants and Delivery Trucks"."

80083

RAISED REFLECTIVE PAVEMENT MARKERS (BRIDGE) (BDE)

Effective: August 1, 2003

Add the following sentence to the end of the second paragraph of Article 781.03(a) of the Standard Specifications:

"The installed height for the reflective pavement markers shall be approximately 7.5 mm (0.3 in.) above the road surface."

Revise Article 781.05 of the Standard Specifications to read:

"781.05 Basis of Payment. This work will be paid for at the contract unit price per each for RAISED REFLECTIVE PAVEMENT MARKER, RAISED REFLECTIVE PAVEMENT MARKER (BRIDGE), TEMPORARY RAISED REFLECTIVE PAVEMENT MARKER, and REPLACEMENT REFLECTOR."

Revise the first paragraph of Article 1096.01(b) of the Standard Specifications to read:

"(b) The overall dimensions for raised reflective pavement markers shall be approximately 254 mm (10 in.) long by 140 mm (5.5 in.) wide and a maximum of 45 mm (1.76 in.) high. The overall dimensions for bridge raised reflective pavement markers shall be approximately 235 mm (9.25 in.) long by 149 mm (5.86 in.) wide and a maximum of 32 mm (1.25 in.) high. The surface of the keel and web shall be free of scale, dirt, rust, oil, grease, or any other contaminant which may reduce the bond."

80105

SUBCONTRACTOR MOBILIZATION PAYMENTS (BDE)

Effective: April 2, 2005

To account for the preparatory work and operations necessary for the movement of subcontractor personnel, equipment, supplies, and incidentals to the project site and for all other work or operations that must be performed or costs incurred when beginning work approved for subcontracting in accordance with Article 108.01 of the Standard Specifications, the Contractor shall make a mobilization payment to each subcontractor.

This mobilization payment shall be made at least 14 days prior to the subcontractor starting work. The amount paid shall be equal to 3 percent of the amount of the subcontract reported on form BC 260A submitted for the approval of the subcontractor's work.

This provision shall be incorporated directly or by reference into each subcontract approved by the Department.

80143

SUPERPAVE BITUMINOUS CONCRETE MIXTURES (BDE)

Effective: January 1, 2000

Revised: April 1, 2004

Description. This work shall consist of designing, producing and constructing Superpave bituminous concrete mixtures using Illinois Modified Strategic Highway Research Program (SHRP) Superpave criteria. This work shall be according to Sections 406 and 407 of the Standard Specifications and the special provision, "Quality Control/Quality Assurance of Bituminous Concrete Mixtures", except as follows.

Materials.

- (a) **Fine Aggregate Blend Requirement.** The Contractor may be required to provide FA 20 manufactured sand to meet the design requirements. For mixtures with $N_{design} \geq 90$, at least 50 percent of the required fine aggregate fraction shall consist of either stone sand, slag sand, or steel slag sand meeting the FA/FM 20 gradation.
- (b) **Reclaimed Asphalt Pavement (RAP).** If the Contractor is allowed to use more than 15 percent RAP, as specified in the plans, a softer performance-graded binder may be required as determined by the Engineer.

RAP shall meet the requirements of the special provision, "RAP for Use in Bituminous Concrete Mixtures".

RAP will not be permitted in mixtures containing polymer modifiers.

RAP containing steel slag will be permitted for use in top-lift surface mixtures only.

- (c) **Bituminous Material.** The asphalt cement (AC) shall be performance-graded (PG) or polymer modified performance-graded (SBS-PG or SBR-PG) meeting the requirements of Article 1009.05 of the Standard Specifications for the grade specified on the plans.

The following additional guidelines shall be used if a polymer modified asphalt is specified:

- (1) The polymer modified asphalt cement shall be shipped, maintained, and stored at the mix plant according to the manufacturer's requirements. Polymer modified asphalt cement shall be placed in an empty tank and shall not be blended with other asphalt cements.
- (2) The mixture shall be designed using a mixing temperature of 163 ± 3 °C (325 ± 5 °F) and a gyratory compaction temperature of 152 ± 3 °C (305 ± 5 °F).
- (3) Pneumatic-tired rollers will not be allowed unless otherwise specified by the Engineer. A vibratory roller meeting the requirements of Article 406.16 of the

Standard Specifications shall be required in the absence of the pneumatic-tired roller.

Laboratory Equipment.

- (a) Superpave Gyratory Compactor. The superpave gyratory compactor (SGC) shall be used for all QC/QA testing.
- (b) Ignition Oven. The ignition oven shall be used to determine the AC content. The ignition oven shall also be used to recover aggregates for all required washed gradations.

The Engineer may waive the ignition oven requirement for AC content if the aggregates to be used are known to have ignition AC content calibration factors which exceed 1.5 percent. If the ignition oven requirement is waived, other Department approved methods shall be used to determine the AC content.

Mixture Design. The Contractor shall submit mix designs, for approval, for each required mixture. Mix designs shall be developed by Level III personnel who have successfully completed the course, "Superpave Mix Design Upgrade". Articles 406.10 and 406.13 of the Standard Specifications shall not apply. The mixtures shall be designed according to the respective Illinois Modified AASHTO references listed below.

AASHTO MP 2	Standard Specification for Superpave Volumetric Mix Design
AASHTO R 30	Standard Practice for Mixture Conditioning of Hot-Mix Asphalt (HMA)
AASHTO PP 28	Standard Practice for Designing Superpave HMA
AASHTO T 209	Theoretical Maximum Specific Gravity and Density of Bituminous Paving Mixtures
AASHTO T 312	Preparing and Determining the Density of Hot Mix Asphalt (HMA) Specimens by Means of the Superpave Gyratory Compactor
AASHTO T 308	Determining the Asphalt Content of Hot Mix Asphalt (HMA) by the Ignition Method

- (a) Mixture Composition. The ingredients of the bituminous mixture shall be combined in such proportions as to produce a mixture conforming to the composition limits by weight. The gradation mixture specified on the plans shall produce a mixture falling within the limits specified in Table 1.

TABLE 1. MIXTURE COMPOSITION (% PASSING) ^{1/}								
Sieve Size	IL-25.0 mm		IL-19.0 mm		IL-12.5 mm ^{4/}		IL-9.5 mm ^{4/}	
	min	max	min	max	min	max	min	max
37.5 mm (1 1/2 in.)		100						
25 mm (1 in.)	90	100		100				
19 mm (3/4 in.)		90	82	100		100		
12.5 mm (1/2 in.)	45	75	50	85	90	100		100
9.5 mm (3/8 in.)						89	90	100
4.75 mm (#4)	24	42 ^{2/}	24	50 ^{2/}	28	65	28	65
2.36 mm (#8)	16	31	20	36	28	48 ^{3/}	28	48 ^{3/}
1.18 mm (#16)	10	22	10	25	10	32	10	32
600 μm (#30)								
300 μm (#50)	4	12	4	12	4	15	4	15
150 μm (#100)	3	9	3	9	3	10	3	10
75 μm (#200)	3	6	3	6	4	6	4	6

- 1/ Based on percent of total aggregate weight.
- 2/ The mixture composition shall not exceed 40 percent passing the 4.75 mm (#4) sieve for binder courses with Ndesign ≥ 90.
- 3/ The mixture composition shall not exceed 40 percent passing the 2.36 mm (#8) sieve for surface courses with Ndesign ≥ 90.
- 4/ The mixture composition for surface courses shall be according to IL-12.5 mm or IL-9.5 mm, unless otherwise specified by the Engineer.

One of the above gradations shall be used for leveling binder as specified in the plans and according to Article 406.04 of the Standard Specifications.

It is recommended that the selected combined aggregate gradation not pass through the restricted zones specified in Illinois Modified AASHTO MP 2.

- (b) **Dust/AC Ratio for Superpave.** The ratio of material passing the 75 μm (#200) sieve to total asphalt cement shall not exceed 1.0 for mixture design (based on total weight of mixture).
- (c) **Volumetric Requirements.** The target value for the air voids of the hot mix asphalt (HMA) shall be 4.0 percent at the design number of gyrations. The VMA and VFA of the HMA design shall be based on the nominal maximum size of the aggregate in the mix and shall conform to the requirements listed in Table 2.

TABLE 2. VOLUMETRIC REQUIREMENTS					
Ndesign	Voids in the Mineral Aggregate (VMA), % minimum				Voids Filled with Asphalt (VFA), %
	IL-25.0	IL-19.0	IL-12.5	IL-9.5	
50	12.0	13.0	14.0	15	65 - 78
70					65 - 75
90					
105					

- (d) **Determination of Need for Anti-Stripping Additive.** The mixture designer shall determine if an additive is needed in the mix to prevent stripping. The determination will be made on the basis of tests performed according to Illinois Modified T 283 using 4 in. Marshall bricks. To be considered acceptable by the Department as a mixture not susceptible to stripping, the ratio of conditioned to unconditioned split tensile strengths (TSRs) shall be equal to or greater than 0.75. Mixtures, either with or without an additive, with TSRs less than 0.75 will be considered unacceptable.

If it is determined that an additive is required, the additive may be hydrated lime, slaked quicklime, or a liquid additive, at the Contractor's option. The liquid additive shall be selected from the Department's list of approved additives and may be limited to those which have exhibited satisfactory performance in similar mixes.

Dry hydrated lime shall be added at a rate of 1.0 to 1.5 percent by weight of total dry aggregate. Slurry shall be added in such quantity as to provide the required amount of hydrated lime solids by weight of total dry aggregate. The exact rate of application for all anti-stripping additives will be determined by the Department. The method of application shall be according to Article 406.12 of the Standard Specifications.

Personnel. The QC Manager and Level I Technician shall have successfully completed the Department's "Superpave Field Control Course".

Required Plant Tests. Testing shall be conducted to control the production of the bituminous mixture. The Contractor shall use the test methods identified to perform the following mixture tests at a frequency not less than that indicated in Table 3.

TABLE 3. REQUIRED PLANT TESTS for SUPERPAVE		
Parameter	Frequency of Tests	Test Method
Aggregate Gradation Hot bins for batch and continuous plants Individual cold-feeds or combined belt-feed for drier drum plants. (% passing sieves: 12.5 mm (1/2 in.), 4.75 mm (No. 4), 2.36 mm (No. 8), 600 µm (No. 30), 75 µm (No. 200))	1 dry gradation per day of production (either morning or afternoon sample). and 1 washed ignition oven test on the mix per day of production (conduct in afternoon if dry gradation is conducted in the morning or vice versa). NOTE. The order in which the above tests are conducted shall alternate from the previous production day (example: a dry gradation conducted in the morning will be conducted in the afternoon on the next production day and so forth). The dry gradation and washed ignition oven test results shall be plotted on the same control chart.	Illinois Procedure (See Manual of Test Procedures for Materials).
Asphalt Content by Ignition Oven (Note 1.)	1 per half day of production	Illinois Modified AASHTO T 308
Air Voids	1 per half day of production for first 2 days and 1 per day thereafter (first sample of the day)	Illinois Modified AASHTO T 312
Bulk Specific Gravity of Gyratory Sample		Illinois Modified AASHTO T 209
Maximum Specific Gravity of Mixture		

Note 1. The Engineer may waive the ignition oven requirement for AC content if the aggregates to be used are known to have ignition AC content calibration factors which exceed 1.5 percent. If the ignition oven requirement is waived, other Department approved methods shall be used to determine the AC content.

During production, the ratio of minus 75 µm (#200) sieve material to total asphalt cement shall be not less than 0.6 nor more than 1.2 and the moisture content of the mixture at discharge from the mixer shall not exceed 0.5 percent. If at any time the ratio of minus 75 µm (#200) material to asphalt or moisture content of the mixture falls outside the stated limits, production of the mix shall cease. The cause shall be determined and corrective action satisfactory to the Engineer shall be initiated prior to resuming production.

During production, mixtures containing an anti-stripping additive will be tested by the Department for stripping according to Illinois Modified T 283. If the mixture fails to meet the TSR

criteria for acceptance, no further mixture will be accepted until the Contractor takes such action as is necessary to furnish a mixture meeting the criteria.

Construction Requirements

Lift Thickness.

- (a) Binder and Surface Courses. The minimum compacted lift thickness for constructing bituminous concrete binder and surface courses shall be according to Table 4:

Mixture	Thickness, mm (in.)
IL-9.5	32 (1 1/4)
IL-12.5	38 (1 1/2)
IL-19.0	57 (2 1/4)
IL-25.0	76 (3)

- (b) Leveling Binder. Mixtures used for leveling binder shall be as follows:

Nominal, Compacted, Leveling Binder Thickness, mm (in.)	Mixture
≤ 32 (1 1/4)	IL-9.5
32 (1 1/4) to 50 (2)	IL 9.5 or IL-12.5

Density requirements shall apply for leveling binder when the nominal, compacted thickness is 32 mm (1 1/4 in.) or greater for IL-9.5 mixtures and 38 mm (1 1/2 in.) or greater for IL-12.5 mixtures.

- (c) Full-Depth Pavement. The compacted thickness of the initial lift of binder course shall be 100 mm (4 in.). The compacted thickness of succeeding lifts shall meet the minimums specified in Table 4 but not exceed 100 mm (4 in.).

If a vibratory roller is used for breakdown, the compacted thickness of the binder lifts, excluding the top lift, may be increased to 150 mm (6 in.) provided the required density is obtained.

- (d) Bituminous Patching. The minimum compacted lift thickness for constructing bituminous patches shall be according to Table 4.

Control Charts/Limits. Control charts/limits shall be according to QC/QA Class I requirements, except density shall be plotted on the control charts within the following control limits:

TABLE 6. DENSITY CONTROL LIMITS		
Mixture	Parameter	Individual Test
12.5 mm / 9.5 mm	Ndesign \geq 90	92.0 – 96.0%
12.5 mm / 9.5 mm	Ndesign < 90	92.5 – 97.4%
19.0 mm / 25.0 mm	Ndesign \geq 90	93.0 – 96.0%
19.0 mm / 25.0 mm	Ndesign < 90	93.0 – 97.4%

Basis of Payment. On resurfacing projects, this work will be paid for at the contract unit price per metric ton (ton) for BITUMINOUS CONCRETE SURFACE COURSE, SUPERPAVE, of the friction aggregate mixture and Ndesign specified, LEVELING BINDER (HAND METHOD), SUPERPAVE, of the Ndesign specified, LEVELING BINDER (MACHINE METHOD), SUPERPAVE, of the Ndesign specified, and BITUMINOUS CONCRETE BINDER COURSE, SUPERPAVE, of the mixture composition and Ndesign specified.

On resurfacing projects in which polymer modifiers are required, this work will be paid for at the contract unit price per metric ton (ton) for POLYMERIZED BITUMINOUS CONCRETE SURFACE COURSE, SUPERPAVE, of the friction aggregate mixture and Ndesign specified, POLYMERIZED LEVELING BINDER (HAND METHOD), SUPERPAVE, of the Ndesign specified, POLYMERIZED LEVELING BINDER (MACHINE METHOD), SUPERPAVE, of the Ndesign specified, and POLYMERIZED BITUMINOUS CONCRETE BINDER COURSE, SUPERPAVE, of the mixture composition and Ndesign specified.

On full-depth pavement projects, this work will be paid for at the contract unit price per square meter (square yard) for BITUMINOUS CONCRETE PAVEMENT, (FULL-DEPTH), SUPERPAVE, of the thickness specified.

On projects where widening is constructed and the entire pavement is then resurfaced, the binder for the widening will be paid for at the contract unit price per square meter (square yard) for BITUMINOUS CONCRETE BINDER COURSE, SUPERPAVE, of the mixture composition, Ndesign, and thickness specified. The surface and binder used to resurface the entire pavement will be paid for according to the paragraphs above for resurfacing projects.

80010

TRAFFIC CONTROL DEFICIENCY DEDUCTION (BDE)

Effective: April 1, 1992

Revised: January 1, 2005

To ensure a prompt response to incidents involving the integrity of work zone traffic control, the Contractor shall provide a telephone number where a responsible individual can be contacted 24 hours-a-day.

When the Engineer is notified, or determines a traffic control deficiency exists, he/she will notify and direct the Contractor to correct the deficiency within a specified time. The specified time, which begins upon notification to the Contractor, will be from 1/2 hour to 12 hours based upon the urgency of the situation and the nature of the deficiency. The Engineer shall be the sole judge.

A deficiency may be any lack of repair, maintenance, or non-compliance with the traffic control plan. A deficiency may also be applied to situations where corrective action is not an option such as the use of non-certified flaggers for short term operations; working with lane closures beyond the time allowed in the contract; or failure to perform required contract obligations such as traffic control surveillance.

If the Contractor fails to correct a deficiency within the specified time, a daily monetary deduction will be imposed for each calendar day or fraction thereof the deficiency exists. The calendar day(s) will begin with notification to the Contractor and end with the Engineer's acceptance of the correction. The daily monetary deduction will be either \$1,000 or 0.05 percent of the awarded contract value, whichever is greater. For those deficiencies where corrective action was not an option this monetary deduction will be immediate.

In addition, if the Contractor fails to respond, the Engineer may correct the deficiency and the cost thereof will be deducted from monies due or which may become due the Contractor. This corrective action will in no way relieve the Contractor of his/her contractual requirements or responsibilities.

5729I

TRUCK BED RELEASE AGENT (BDE)

Effective: April 1, 2004

Add the following sentence after the third sentence of the first paragraph of Article 406.14 of the Standard Specifications.

"In addition to the release agent, the Contractor may use a light scatter of manufactured sand (FA 20 or FA 21) evenly distributed over the bed of the vehicle."

80123

WEIGHT CONTROL DEFICIENCY DEDUCTION (BDE)

Effective: April 1, 2001

Revised: August 1, 2002

The Contractor shall provide accurate weights of materials delivered to the contract for incorporation into the work (whether temporary or permanent) and for which the basis of payment is by weight. These weights shall be documented on delivery tickets which shall identify the source of the material, type of material, the date and time the material was loaded, the contract number, the net weight, the tare weight when applicable and the identification of the transporting vehicle. For aggregates, the Contractor shall have the driver of the vehicle furnish or establish an acceptable alternative to provide the contract number and a copy of the material order to the source for each load. The source is defined as that facility that produces the final material product that is to be incorporated into the contract pay items.

The Department will conduct random, independent vehicle weight checks for material sources according to the procedures outlined in the Documentation Section Policy Statement of the Department's Construction Manual and hereby incorporated by reference. The results of the independent weight checks shall be applicable to all contracts containing this Special Provision. Should the vehicle weight check for a source result in the net weight of material on the vehicle exceeding the net weight of material shown on the delivery ticket by 0.50% (0.70% for aggregates) or more, the Engineer will document the independent vehicle weight check and immediately furnish a copy of the results to the Contractor. No adjustment in pay quantity will be made. Should the vehicle weight check for a source result in the net weight of material shown on the delivery ticket exceeding the net weight of material on the vehicle by 0.50% (0.70% for aggregates) or more, the Engineer will document the independent vehicle weight check and immediately furnish a copy of the results to the Contractor. The Engineer will adjust the net weight shown on the delivery ticket to the checked delivered net weight as determined by the independent vehicle weight check.

The Engineer will also adjust the method of measurement for all contracts for subsequent deliveries of all materials from the source based on the independent weight check. The net weight of all materials delivered to all contracts containing this Special Provision from this source, for which the basis of payment is by weight, will be adjusted by applying a correction factor "A" as determined by the following formula:

$$A = 1.0 - \left(\frac{B-C}{B} \right); \text{ Where } A \leq 1.0; \left(\frac{B-C}{C} \right) > 0.50\% \text{ (0.70\% for aggregates)}$$

Where A = Adjustment factor

B = Net weight shown on delivery ticket

C = Net weight determined from independent weight check

The adjustment factor will be applied as follows:

$$\text{Adjusted Net Weight} = A \times \text{Delivery Ticket Net Weight}$$

The adjustment factor will be imposed until the cause of the deficient weight is identified and corrected by the Contractor to the satisfaction of the Engineer. If the cause of the deficient weight is not identified and corrected within seven (7) calendar days, the source shall cease delivery of all materials to all contracts containing this Special Provision for which the basis of payment is by weight.

Should the Contractor elect to challenge the results of the independent weight check, the Engineer will continue to document the weight of material for which the adjustment factor would be applied. However, provided the Contractor furnishes the Engineer with written documentation that the source scale has been calibrated within seven (7) calendar days after the date of the independent weight check, adjustments in the weight of material paid for will not be applied unless the scale calibration demonstrates that the source scale was not within the specified Department of Agriculture tolerance.

At the Contractor's option, the vehicle may be weighed on a second independent Department of Agriculture certified scale to verify the accuracy of the scale used for the independent weight check.

80048

WORKING DAYS (BDE)

Effective: January 1, 2002

The Contractor shall complete the work within 35 working days.

80071

STATE OF ILLINOIS
DEPARTMENT OF TRANSPORTATION
PLANS FOR PROPOSED

SURFACE TRANSPORTATION PROGRAM

FAS ROUTE 901
SECTION 05-00136-00-RS
PROJECT NO. RS-901 (103)
JOB NO. C-99-516-05

SALINE COUNTY



06/03/05

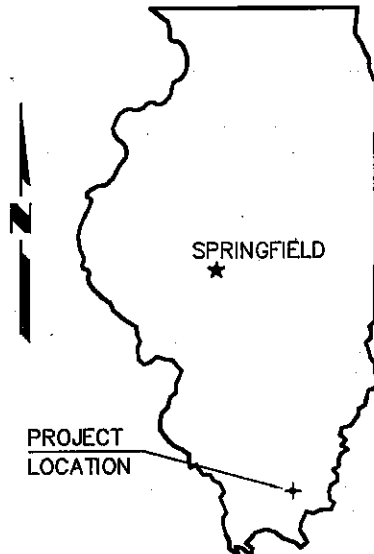

FOR INDEX OF SHEETS AND SUMMARY
OF QUANTITIES, SEE SHEET NO. 3

CLASSIFICATION : COLLECTOR
ADT : 2,150
DESIGN SPEED : 50 MPH

Edward W. Miller
PROFESSIONAL ENGINEER
#062-025277
EXPIRES NOV. 30, 2005

CONTRACT NO. 99231

J.U.L.I.E. 1-800-892-0123

E. MILLER ENGINEERING, INC.
CONSULTING ENGINEERS
HARRISBURG, ILLINOIS

STATE OF ILLINOIS DEPARTMENT OF TRANSPORTATION	
APPROVED	<u>06-02</u> , 20 <u>05</u>
LOCAL AGENCY REPRESENTATIVE	
PASSED	<u>JUNE 6</u> , 20 <u>05</u> <u>Dani W. Hillel</u>
DISTRICT ENGINEER OF LOCAL ROADS & STREETS	
APPROVED	<u>June 7</u> , 20 <u>05</u> <u>Mary C. Lamie</u>
MARY C. LAMIE, P.E. DEPUTY DIRECTOR OF HIGHWAYS, REGION FIVE ENGINEER	

CONTRACT NO. 99231

LOCATION MAP

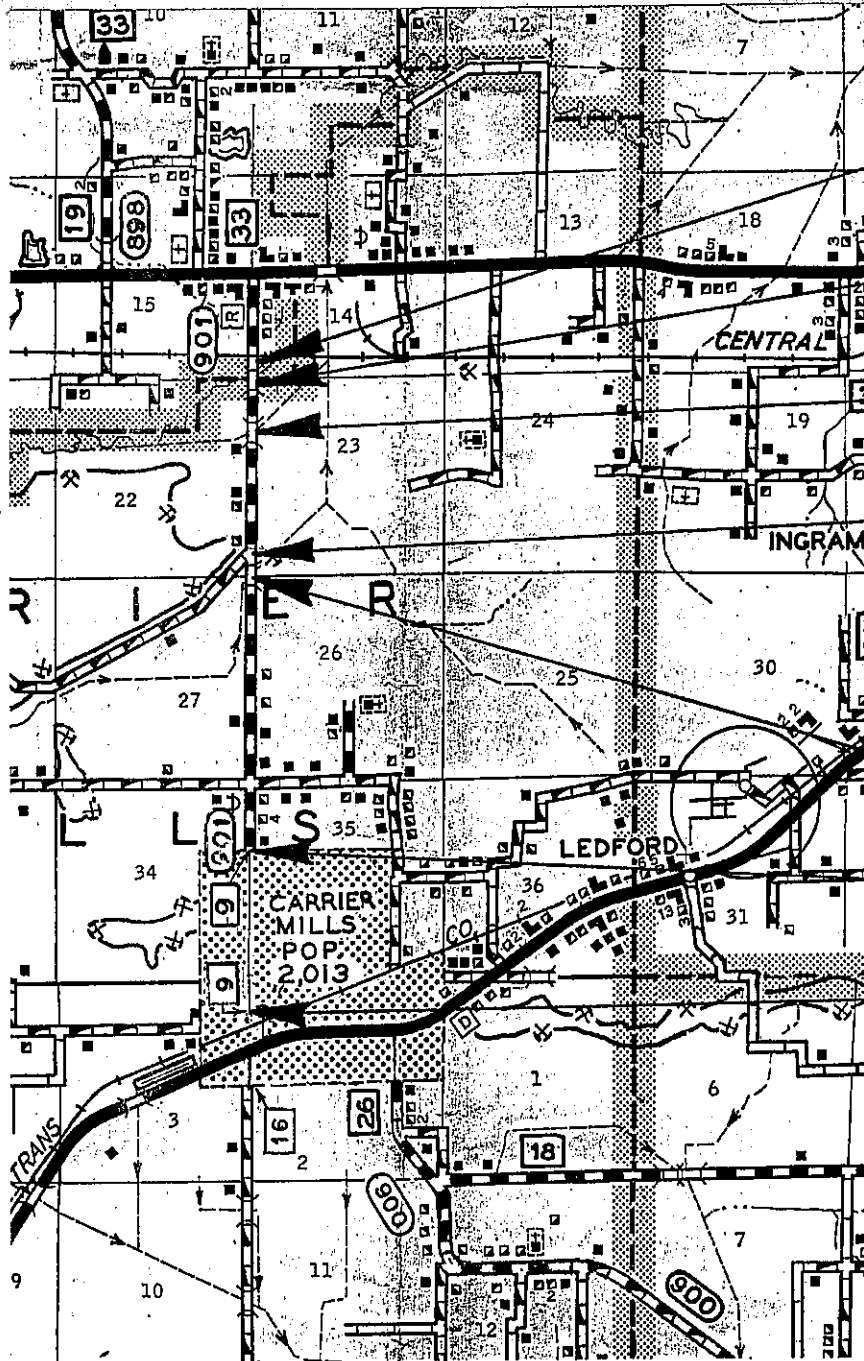
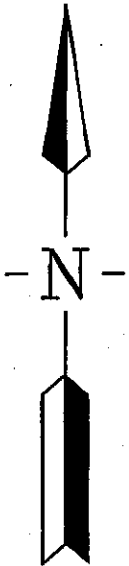

END IMPROVEMENT
STATION 192+00

BRIDGE (RESURFACE)
STA. 190+89.0 - STA. 191+52.2

BRIDGE (RESURFACE)
STA. 177+12.0 - STA. 178+16.0

MINE CROSSING (RESURFACE)
STA. 143+18.0 - STA. 143+78.0

BRIDGE (RESURFACE)
STA. 139+63.5 - STA. 140+12.0

EQ. STA. 51+95.00 BACK
= STA. 70+05.00 AHEAD

BEGIN IMPROVEMENT
STATION 0+01

SCALE: 1" = 1 MILE

NET LENGTH OF IMPROVEMENT = 17,389.00 FT. = 3.2934 MILES

INDEX OF SHEETS

1. COVER SHEET
2. LOCATION MAP
3. INDEX OF SHEETS & SUMMARY OF QUANTITIES
- 4.-5. TYPICAL SECTIONS
6. TYPICAL ENTRANCE DETAILS
7. TYPICAL SIDE ROAD DETAILS
- 8.-9. MISCELLANEOUS DETAILS
 - STANDARDS 606001-02 COMB. CONCRETE CURB & GUTTER
 - 701001-01 TRAFFIC CONTROL
 - 701006-02 TRAFFIC CONTROL
 - 701011-01 TRAFFIC CONTROL
 - 701301-02 TRAFFIC CONTROL
 - 701306-01 TRAFFIC CONTROL
 - 701311-02 TRAFFIC CONTROL
 - 701501-03 TRAFFIC CONTROL
 - 702001-05 TRAFFIC CONTROL DEVICES
 - 780001-01 TYPICAL PAVEMENT MARKINGS
 - 781001-02 RAISED REFLECTIVE PAVEMENT MARKERS
 - BLR 24-1 MAILBOX TURNOUTS

SUMMARY OF QUANTITIES

<u>CODE NO.</u>	<u>PAY ITEM</u>	<u>UNIT</u>	<u>TOTAL</u>
X4066416*	BITUMINOUS CONCRETE SURFACE COURSE, SUPERPAVE, MIX "C", N70	TON	3,665
X4066770*	LEVELING BINDER (MACHINE METHOD), SUPERPAVE N70	TON	2,250
40200800*	AGGREGATE SURFACE COURSE, TYPE B	TON	40
40600100	BITUMINOUS MATERIALS (PRIME COAT)	GALLON	2,510
40600300	AGGREGATE (PRIME COAT)	TON	38
44000004	BITUMINOUS SURFACE REMOVAL 1"	SQ YD	16,200
44000006	BITUMINOUS SURFACE REMOVAL 1 1/2"	SQ YD	715
44000030*	BITUMINOUS SURFACE REMOVAL (VARIABLE DEPTH)	SQ YD	742
44001700*	COMBINATION CONCRETE CURB AND GUTTER REMOVAL AND REPLACEMENT	FOOT	93
44300100	AREA REFLECTIVE CRACK CONTROL TREATMENT	SQ YD	16,200
48101200	AGGREGATE SHOULDERS, TYPE B	TON	670
60300305*	FRAMES AND LIDS TO BE ADJUSTED	EACH	4
70300100	SHORT-TERM PAVEMENT MARKING	FOOT	1,740
70300220	TEMPORARY PAVEMENT MARKING - LINE 4"	FOOT	28,420
78001110*	PAINT PAVEMENT MARKING - LINE 4"	FOOT	28,420
78100100*	RAISED REFLECTIVE PAVEMENT MARKER	EACH	152
67100100	MOBILIZATION * SEE SPECIAL PROVISIONS	LSUM	1
	* SPECIALITY ITEMS		

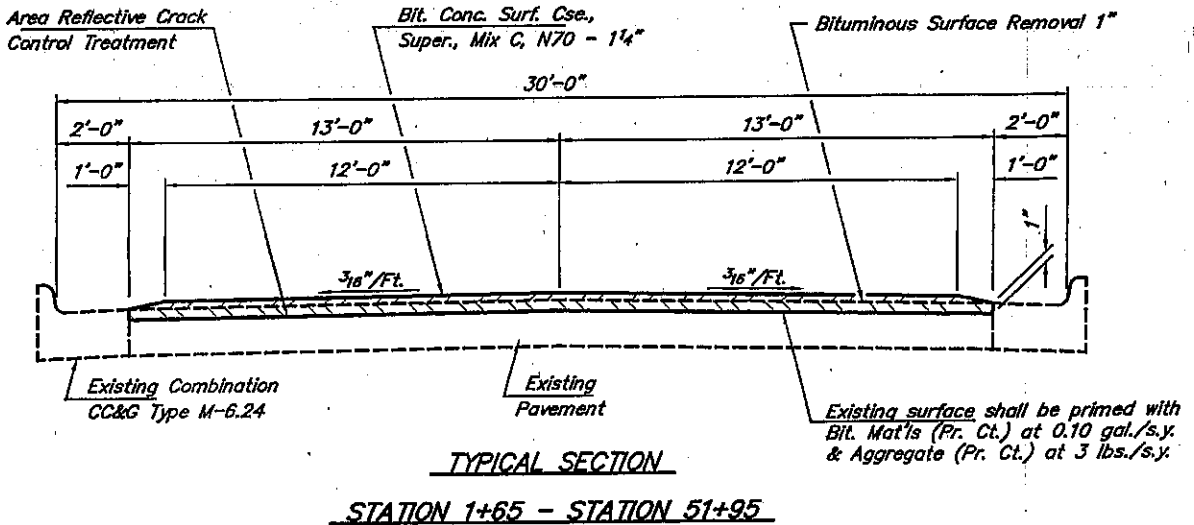
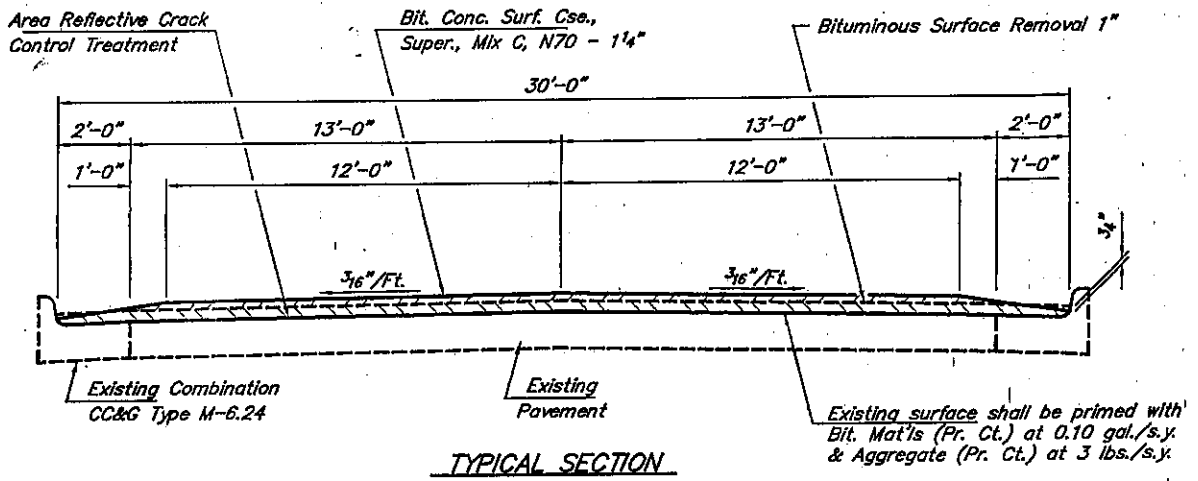

MATERIAL COEFFICIENT

Existing Agg. Base Course	- 0.11
Existing Oil & Chip Surface	- 0.13
Exist. Water Bound Macadam	- 0.14
Existing BAM/BMC	- 0.25
Existing Class I Surface	- 0.30
Leveling Binder	- 0.33
Bit. Conc. Surface Course	- 0.40

STRUCTURAL DESIGN DATA

STA. 0+01 - STA. 3+20

Class II Roadway			
Design Period - 8 Years			
PC	3215	IBR	3.8
SU	75	TF	0.0536
MU	20	DT	2.491

STRUCTURAL DESIGN DATA

STA. 3+20 - STA. 51+95

Class III Roadway			
Design Period - 8 Years			
PC	1715	IBR	3.8
SU	45	TF	0.0294
MU	10	DT	2.273

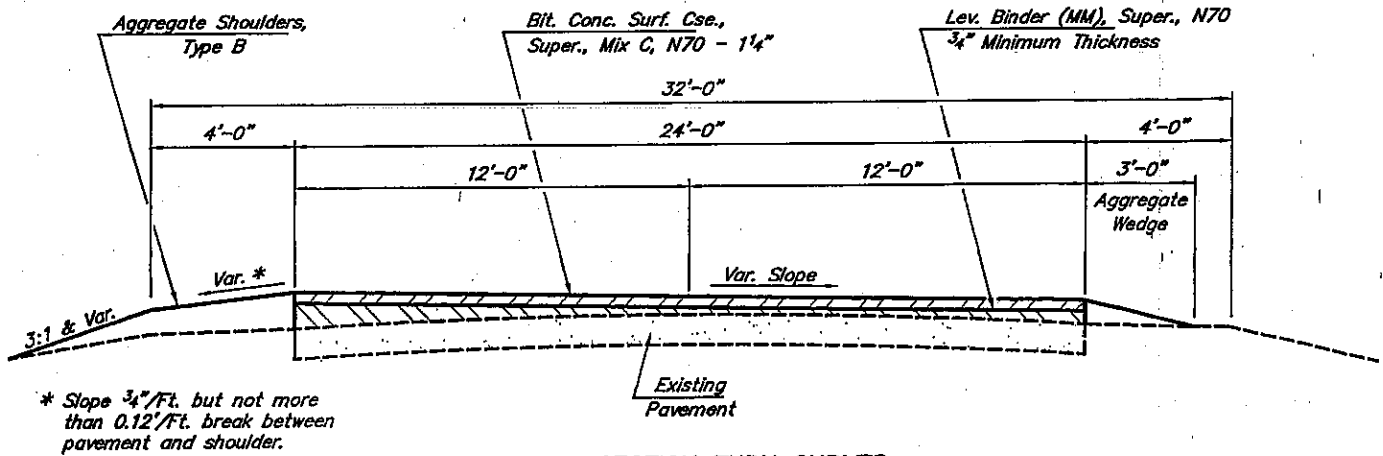
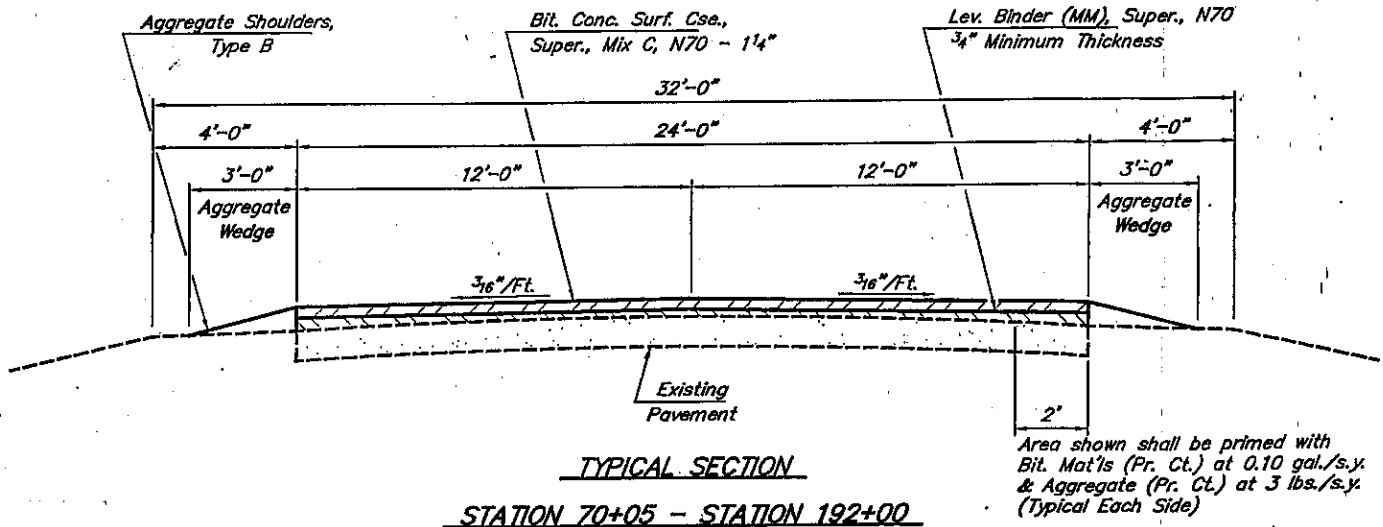

MATERIAL COEFFICIENT

Existing Agg. Base Course	- 0.11
Existing Oil & Chip Surface	- 0.13
Exist. Water Bound Macadam	- 0.14
Existing BAM/BMC	- 0.25
Existing Class I Surface	- 0.30
Leveling Binder	- 0.33
Bit. Conc. Surface Course	- 0.40

STRUCTURAL DESIGN DATA

STA. 70+05 - STA. 192+00

Class III Roadway	
Design Period - 8 Years	
PC 2085 IBR	3.8
SU 55 TF	0.0333
MU 10 DT	2.315

SUPERELEVATIONS

S.E. = 0.025'/Ft.	55 MPH
Attain Sta. 117+68 - Sta. 119+30	
Remove Sta. 122+36 - Sta. 123+99	
S.E. = 0.025'/Ft.	55 MPH
Attain Sta. 123+99 - Sta. 125+61	
Remove Sta. 128+63 - Sta. 130+25	

Angle of Intersection	Private Entrance	
	Acute L.	Obtuse L.
90° - 80°	15'	15'
79° - 70°	15'	25'
69° - 60°	15'	35'
59° - 50°	10'	40'
49° - 40°	10'	60'
39° - 30°	10'	100'

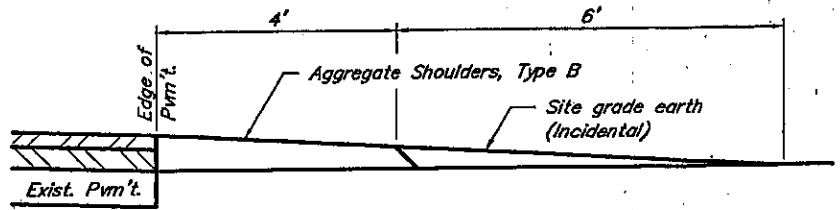

SECTION A-A FIELD ENTRANCE (Est. No. = 2)

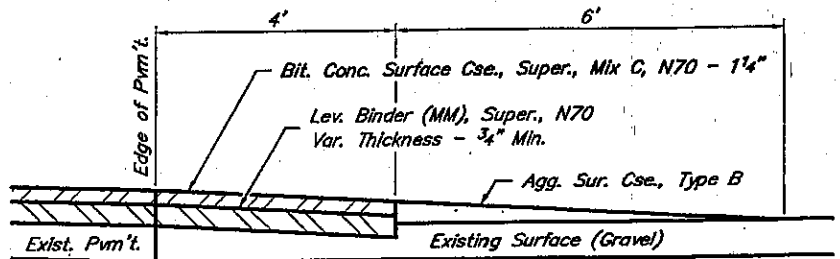

SECTION A-A PRIVATE ENTRANCE - GRAVEL (Est. No. = 16)

NOTE: Actual number and locations of side roads to be determined in the field by the Engineer.

NOTE: Areas to receive bituminous material shall be primed with Bituminous Mat's (Pr. Ct.) at 0.10 gal./s.y. and Aggregate (Pr. Ct.) at 3 lbs./s.y.

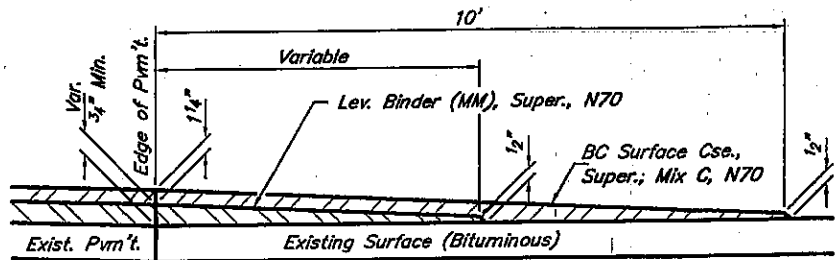

SECTION A-A PRIVATE ENTRANCE - BITUMINOUS (Est. No. = 8)

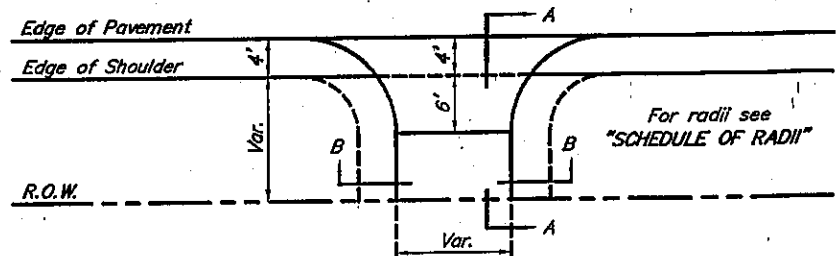

TYPICAL ENTRANCE DETAILS

Angle of Intersection	Side Road	
	Acute L.	Obtuse L.
90° - 80°	25'	25'
79° - 70°	25'	40'
69° - 60°	25'	60'
59° - 50°	20'	75'
49° - 40°	20'	100'
39° - 30°	15'	150'

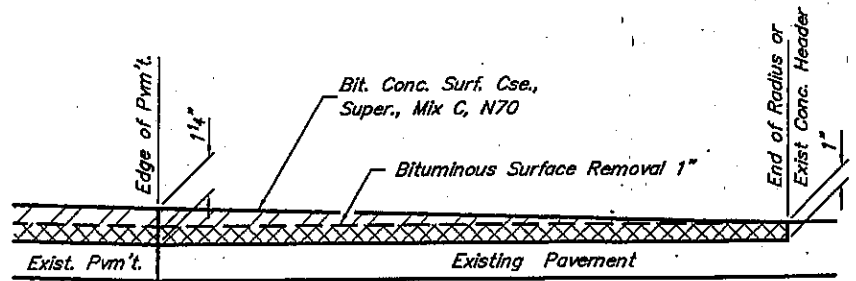

SECTION A-A SIDE ROAD (Est. No. = 20)
STATION 0+01 - STATION 51+95

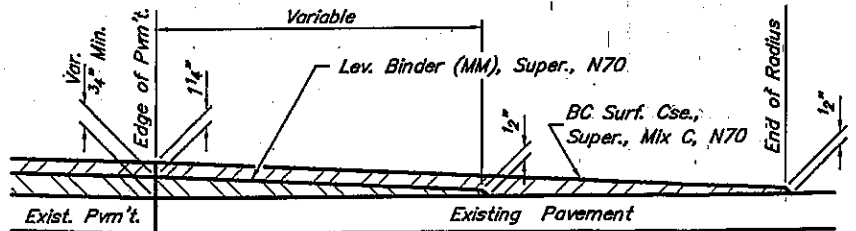

SECTION A-A SIDE ROAD (Est. No. = 4)
STATION 70+05 - STATION 192+00

NOTE: Actual number and locations of entrances to be determined in the field by the Engineer.

NOTE: Where bituminous material is to be placed, the existing surface shall be primed with Bituminous Mat'ls (Pr. Ct.) at 0.10 gal./s.y. and Aggregate (Pr. Ct.) at 3 lbs./s.y.

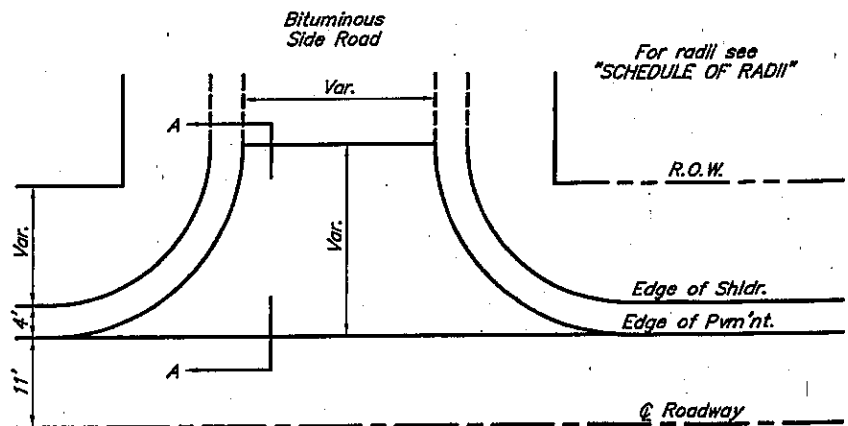

TYPICAL SIDE ROAD DETAILS

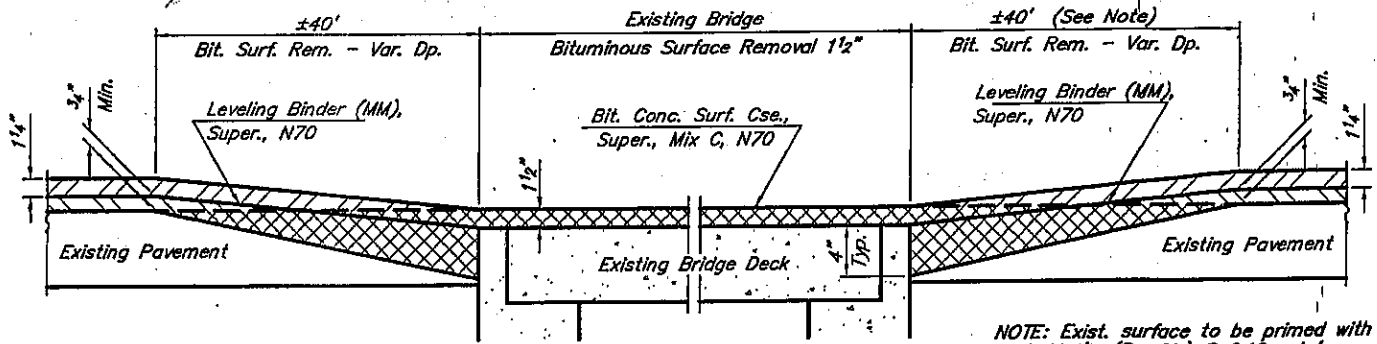

NOTE: Exist. surface to be primed with
 Bit. Mat'ls (Pr. Ct.) @ 0.10 gal./s.y.
 & Aggregate (Pr. Ct.) @ 3 lbs./s.y.

BRIDGE PAVING DETAIL - (TYPICAL)

NOTE: See "ENDING TAPER DETAIL" for
 end of northernmost bridge.

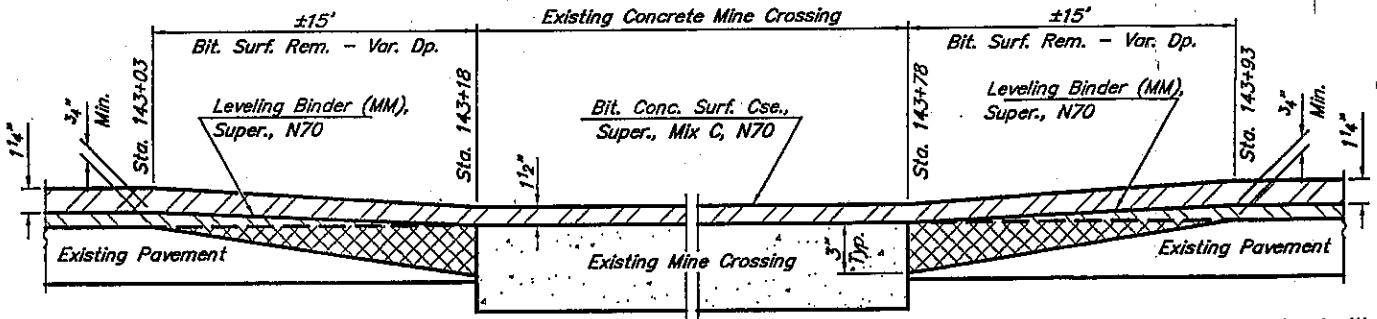

NOTE: Exist. surface to be primed with
 Bit. Mat'ls (Pr. Ct.) @ 0.10 gal./s.y.
 & Aggregate (Pr. Ct.) @ 3 lbs./s.y.

MINE CROSSING DETAIL - STATION 143+48

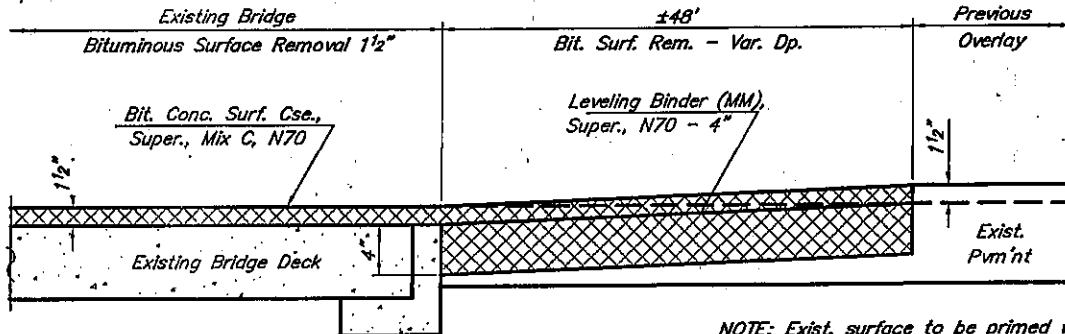

NOTE: Exist. surface to be primed with
Bit. Mat's (Pr. Ct.) @ 0.10 gal./s.y.
& Aggregate (Pr. Ct.) @ 3 lbs./s.y.

ENDING TAPER DETAIL

SCHEDULE OF PAVEMENT MARKING LINE 4" (LIN. FT.)

Location	Centerline (Yellow Dashed)	Edge Line (White Solid)	No Passing (Yellow Solid)
Sta. 0+01 to Sta. 192+00	4,350	24,070	NA

**COMBINATION CONCRETE CURB AND GUTTER
REMOVAL AND REPLACEMENT**

Location	Length
Sta. 8+00 - Sta. 8+22 Rt.	22 Ft.
Sta. 22+22 - Sta. 22+43 Rt.	21 Ft.
Sta. 26+21 - Sta. 26+44 Lt.	23 Ft.
Sta. 26+41 - Sta. 26+68 Rt.	27 Ft.

FRAMES AND LIDS TO BE ADJUSTED

Location	Type
Sta. 1+58 - 9.5' Rt.	Manhole
Sta. 2+76 - 31.0' Lt.	Meter Vault
Sta. 4+68 - 10.0' Rt.	Manhole
Sta. 14+36 - 7.5' Rt.	Meter Vault

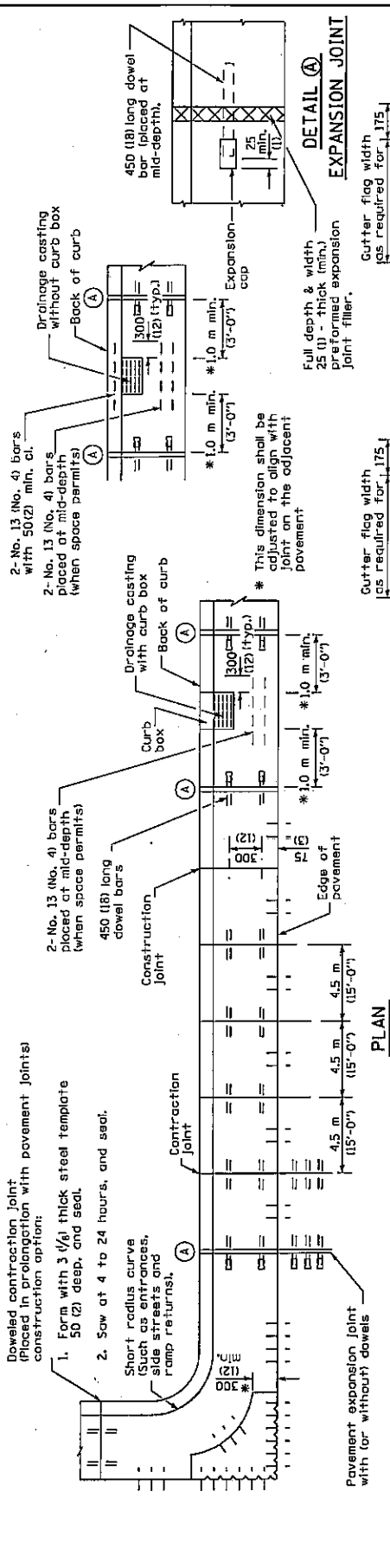

ADJACENT TO PCC PAVEMENT OR PCC BASE COURSE

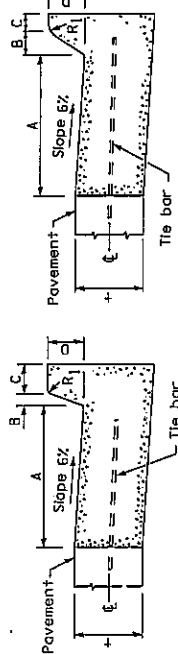

DEPRESSED CURB (TYPICAL)

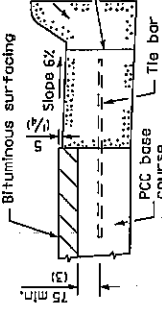

ADJACENT TO PCC BASE COURSE AND BITUMINOUS SURFACING

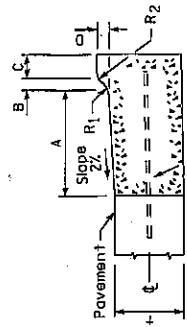

TABLE OF DIMENSIONS BARRIER CURB

TYPE	A	B	C	D	R1	R2
B-15.30	300	25	150	150	25	25
(B-6.12)	(12)	(1)	(6)	(6)	(1)	(1)
B-15.45	450	25	150	150	25	25
(B-6.18)	(18)	(1)	(6)	(6)	(1)	(1)
B-15.60	600	25	150	150	25	25
(B-6.24)	(24)	(1)	(6)	(6)	(1)	(1)
B-22.30	300	50	125	225	25	25
(B-9.12)	(12)	(2)	(5)	(9)	(1)	(1)
B-22.45	450	50	125	225	25	25
(B-9.18)	(18)	(2)	(5)	(9)	(1)	(1)
B-22.60	600	50	125	225	25	25
(B-9.24)	(24)	(2)	(5)	(9)	(1)	(1)

TABLE OF DIMENSIONS MOUNTABLE CURB

TYPE	A	B	C	D	R1	R2
M-5.15	150	50	100	50	75	50
(M-2.06)	(6)	(2)	(4)	(2)	(3)	(2)
M-5.30	300	50	100	50	75	50
(M-2.12)	(12)	(2)	(4)	(2)	(3)	(2)
M-10.15	150	100	75	100	75	NA
(M-4.06)	(6)	(4)	(3)	(4)	(3)	NA
M-10.30	300	100	75	100	75	NA
(M-4.12)	(12)	(4)	(3)	(4)	(3)	NA
M-10.45	450	100	75	100	75	NA
(M-4.18)	(18)	(4)	(3)	(4)	(3)	NA
M-10.60	600	100	75	100	75	NA
(M-4.24)	(24)	(4)	(3)	(4)	(3)	NA
M-15.15	150	150	50	150	50	NA
(M-6.06)	(6)	(6)	(2)	(6)	(2)	NA
M-15.30	300	150	50	150	50	NA
(M-6.12)	(12)	(6)	(2)	(6)	(2)	NA
M-15.45	450	150	50	150	50	NA
(M-6.18)	(18)	(6)	(2)	(6)	(2)	NA
M-15.60	600	150	50	150	50	NA
(M-6.24)	(24)	(6)	(2)	(6)	(2)	NA

Illinois Department of Transportation
 PASSED January 1, 2004
 ENGINEER OF PUBLIC WORKS
 APPROVED January 1, 2004
 ENGINEER OF DESIGN AND ENVIRONMENT

GENERAL NOTES

The bottom slope of combination curb and gutter constructed adjacent to concrete pavement shall be the same slope as the subbase or 6% when subbase is omitted.

t = Thickness of pavement.

Longitudinal joint tie bars shall be No. 19 (No. 6) at 600 mm (24") centers in accordance with details for longitudinal construction joint shown on Standard 420001.

A minimum clearance of 50 mm (2") between the end of the tie bar and the back of the curb shall be maintained.

All dimensions are in millimeters (inches) unless otherwise shown.

DEPRESSED CURB ADJACENT TO CURB RAMP ACCESSIBLE TO THE DISABLED

Gutter flag width as required for curb type, Slope 5% max.

Tie bar

Pavement

REVISIONS

DATE	REVISIONS
1-1-04	Revised expansion cap and soft converted metric reinforcement.
1-1-98	Rev. slope on M-5 (M-2) curbs. Del. "Hinge Joint"

From plan view.

CONCRETE CURB TYPE B AND COMBINATION CONCRETE CURB AND GUTTER

STANDARD 606001-02

(Sheet 1 of 2)

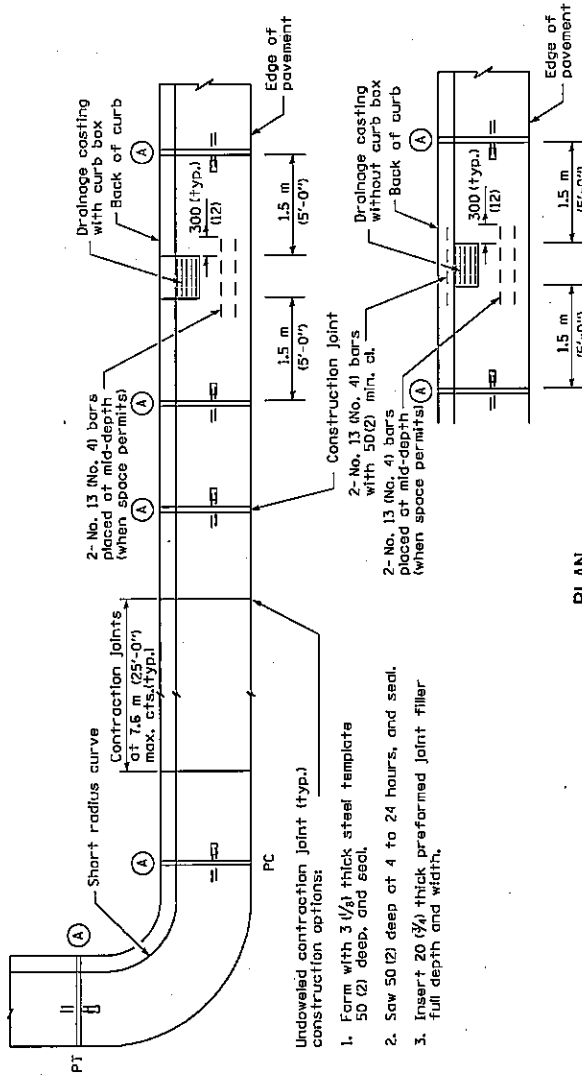

- Undowled contraction joint (typ.) construction options:
1. Form with $3 \frac{1}{4}$ thick steel template 50 (2) deep, and seal.
 2. Saw 50 (2) deep at 4 to 24 hours, and seal.
 3. Insert 20 (3/4) thick preformed joint filler full depth and width.

PLAN

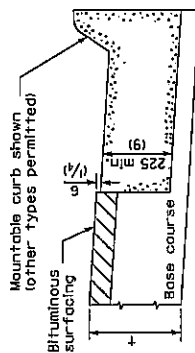

ON DISTURBED SUBGRADE

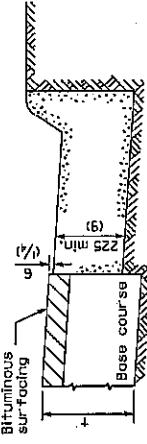

ON UNDISTURBED SUBGRADE

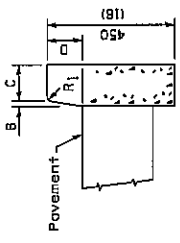

BARRIER CURB

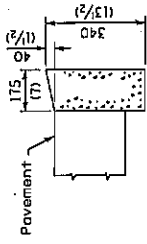

DEPRESSED CURB

ADJACENT TO FLEXIBLE PAVEMENT

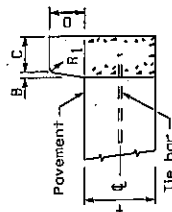

BARRIER CURB

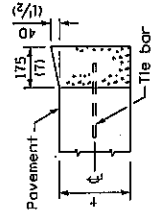

DEPRESSED CURB

ADJACENT TO PCC PAVEMENT OR PCC BASE COURSE

CONCRETE CURB TYPE B

All dimensions are in millimeters (inches) unless otherwise shown.

CONCRETE CURB TYPE B AND COMBINATION CONCRETE CURB AND GUTTER
(Sheet 2 of 2)

STANDARD 606001-02

	ISSUED 1-1-97
	PASSED JANUARY 1, 2004
	APPROVED BY <i>[Signature]</i>
	ENGINEER OF DESIGN AND ENVIRONMENT

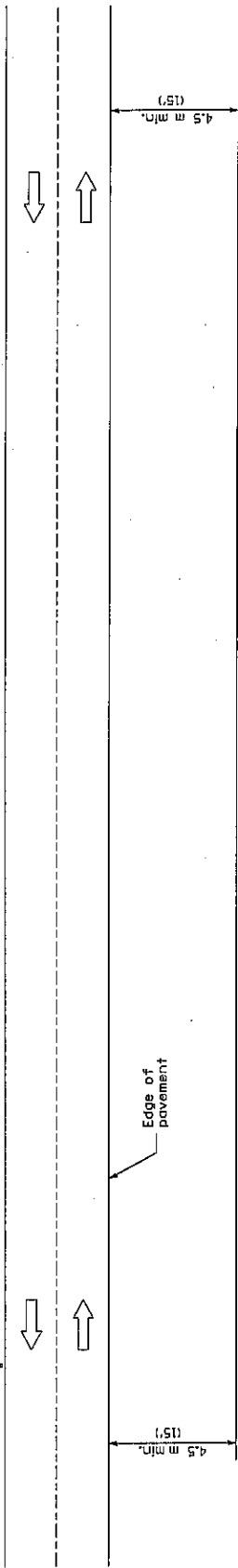

TYPICAL APPLICATIONS

- Landscaping work
- Utility work
- Fencing contracts and maintenance
- Cleaning culverts

GENERAL NOTES

This Standard is used where at all times all vehicles, equipment, workers or their activities are more than 4.5 m (15') from the edge of pavement.

When the work operation requires that two or more work vehicles cross the 4.5 m (15') clear zone in any one hour, traffic control shall be according to Standard 701005.

All dimensions are in millimeters (inches) unless otherwise shown.

DATE	REVISIONS
1-1-05	Revised title and notes.
1-1-97	Renum. Standard 2301-6.

**OFF-RD OPERATIONS,
2L, 2W, MORE THAN
4.5 m (15') AWAY**

STANDARD 701001-01

Illinois Department of Transportation
 APPROVED *[Signature]* JANUARY 1, 2005
 ENGINEER OF OPERATIONS
 APPROVED *[Signature]* JANUARY 1, 2005
 ENGINEER OF DESIGN AND ENVIRONMENT

ISSUED 1-1-97

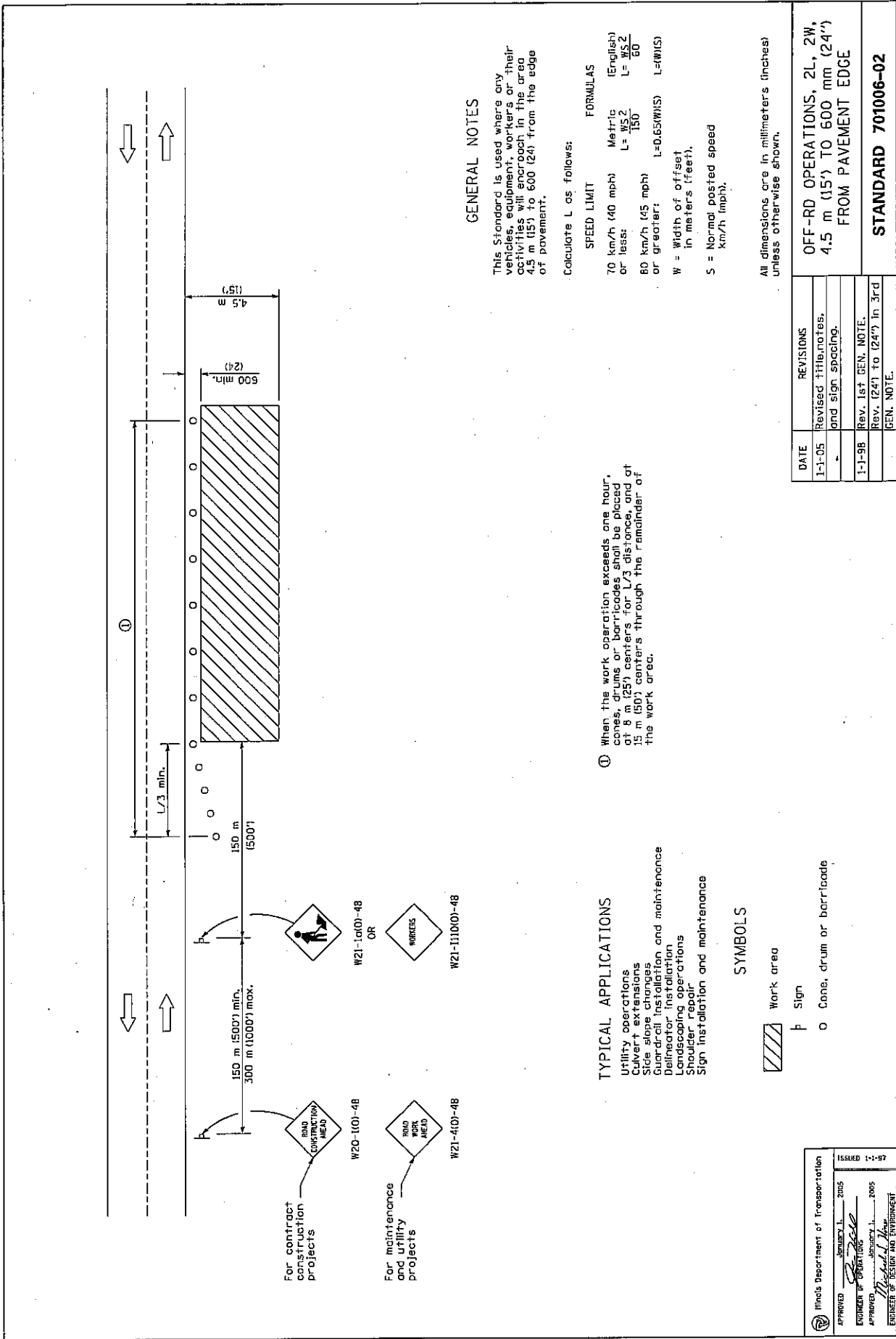

For contract construction projects

For maintenance and utility projects

TYPICAL APPLICATIONS

- Utility operations
- Street extensions
- Shoulder installation
- Super-elevation and maintenance
- Queue-jam installation
- Delineator installation
- Landscaping operations
- Shoulder repair
- Sign installation and maintenance

SYMBOLS

- Work area
- Sign
- Cone, drum or barricade

GENERAL NOTES

This Standard is used where any vehicles, equipment, workers or their activities will encroach in the area 4.5 m (15') to 600 (24') from the edge of pavement.

Calculate L as follows:

SPEED LIMIT	FORMULAS
70 km/h (40 mph) or less:	Metric (English) $L = \frac{WS}{2}$ $L = \frac{WS}{2}$ 80 150 80
80 km/h (45 mph) or greater:	$L = 0.65(W/S)$ $L = (W/S)$
	W = Width of offset in meters (feet), S = Normal posted speed in km/h (mph).

① When the work operation exceeds one hour, cones, drums or barricades shall be placed at 8 m (25') centers for L/3 distance, and at 15 m (50') centers through the remainder of the work area.

All dimensions are in millimeters (inches) unless otherwise shown.

DATE	REVISIONS
1-1-05	Revised title, notes, and sign spacing.
1-1-98	Rev. 1st GEN. NOTE.
	Rev. (24") to (24") in 3rd GEN. NOTE.

OFF-RD OPERATIONS, 2L, 2W,
4.5 m (15') TO 600 mm (24")
FROM PAVEMENT EDGE

STANDARD 701006-02

Illinois Department of Transportation
 APPROVED January 1, 2005
 APPROVED January 1, 2005
 ILLINOIS DEPARTMENT OF TRANSPORTATION
 DIVISION OF DESIGN AND ENVIRONMENT

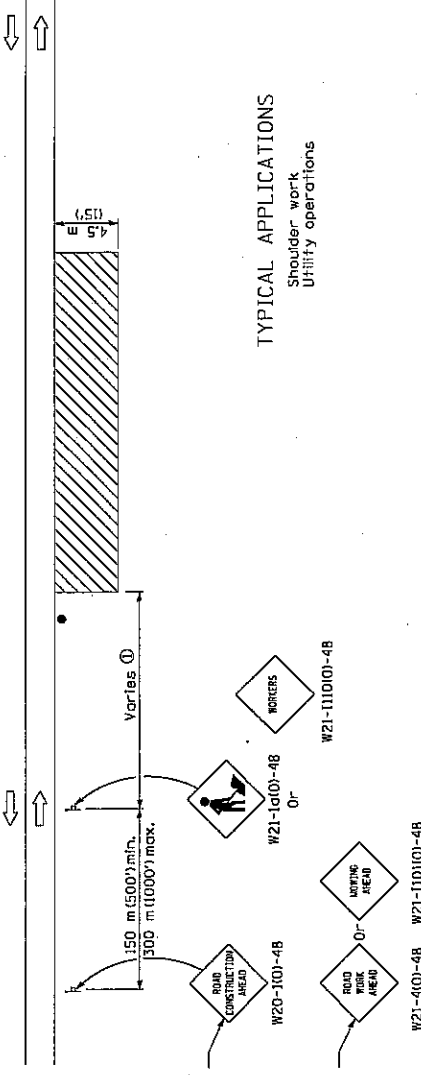
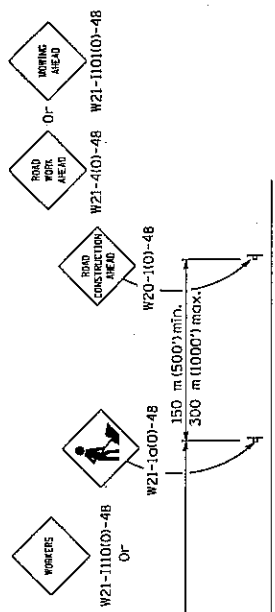

For contract construction projects

For maintenance and utility projects

TYPICAL APPLICATIONS
Shoulder work
Utility operations

GENERAL NOTES

This Standard is used where at any time, any vehicle, equipment, workers or their activities require an intermittent or continuous moving operation on the shoulder, where the average speed is 2 km/h (11 mph) or less.

When the work operation does not exceed 60 minutes, traffic control may be according to Standard 701301.

① Minimum distance is 60 m (200'). Maximum distance to be determined by the Engineer but should not exceed 1/2 the length required for one normal working day's operation, or 6.4 km (4 miles) which ever is less.

SYMBOLS

- Work area
- Flagger with traffic control sign when required

All dimensions are in millimeters (inches) unless otherwise shown.

DATE	REVISIONS
1-1-05	Revised title, notes, and sign spacing.
1-1-97	Renum. Standard 2305-9.
	Deleted orange flags.

**OFF-RD MOVING OPERATIONS,
2L, 2W, DAY ONLY**

STANDARD 701011-01

Illinois Department of Transportation
 Approved: _____ January 1, 2005
 ENGINEER OF OPERATIONS
 Approved: _____ January 1, 2005
 ENGINEER OF RECORD AND SUPERVISOR

ISSUED 1-1-97

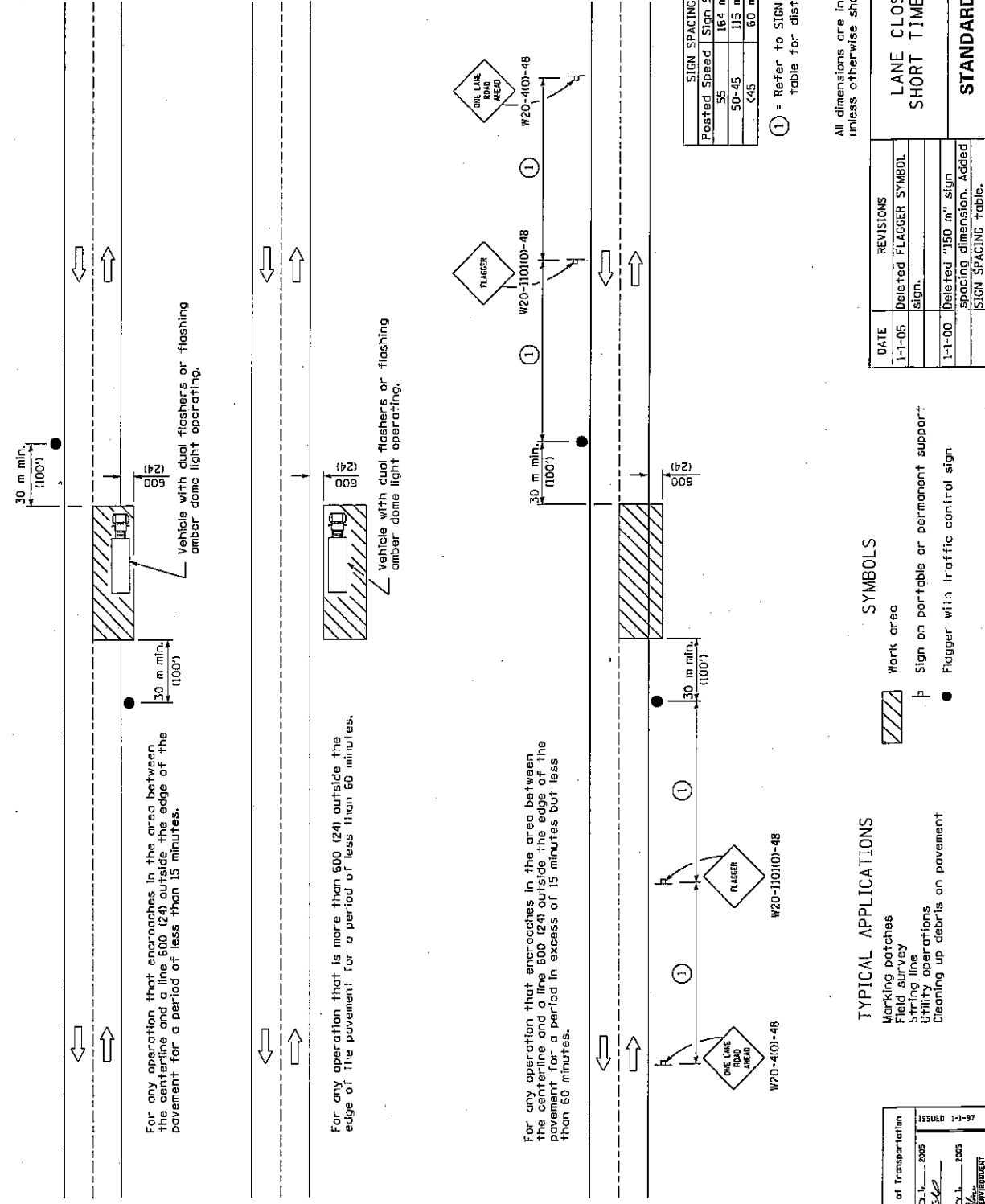

For any operation that encroaches in the area between the centerline and a line 600 (24) outside the edge of the pavement for a period of less than 15 minutes.

For any operation that is more than 600 (24) outside the edge of the pavement for a period of less than 60 minutes.

For any operation that encroaches in the area between the centerline and a line 600 (24) outside the edge of the pavement for a period in excess of 15 minutes but less than 60 minutes.

Posted Speed	Sign Spacing
55	164 m (500')
50-45	115 m (350')
<45	60 m (200')

① = Refer to SIGN SPACING table for distances.

All dimensions are in millimeters (inches) unless otherwise shown.

TYPICAL APPLICATIONS

- Marking patches
- Field survey
- String line
- Utility operations
- Cleaning up debris on pavement

SYMBOLS

- Work area
- Sign on portable or permanent support
- Flagger with traffic control sign

DATE	REVISIONS
1-1-05	Deleted FLAGGER SYMBOL sign.
1-1-00	Deleted "150 m" sign spacing dimension. Added SIGN SPACING table.

LANE CLOSURE, 2L, 2W, SHORT TIME OPERATIONS

STANDARD 701301-02

APPROVED: [Signature] 2005
 ENGINEER OF OPERATIONS
 APPROVED: [Signature] 2005
 ENGINEER OF DESIGN AND ENVIRONMENT

ISSUED 1-1-97

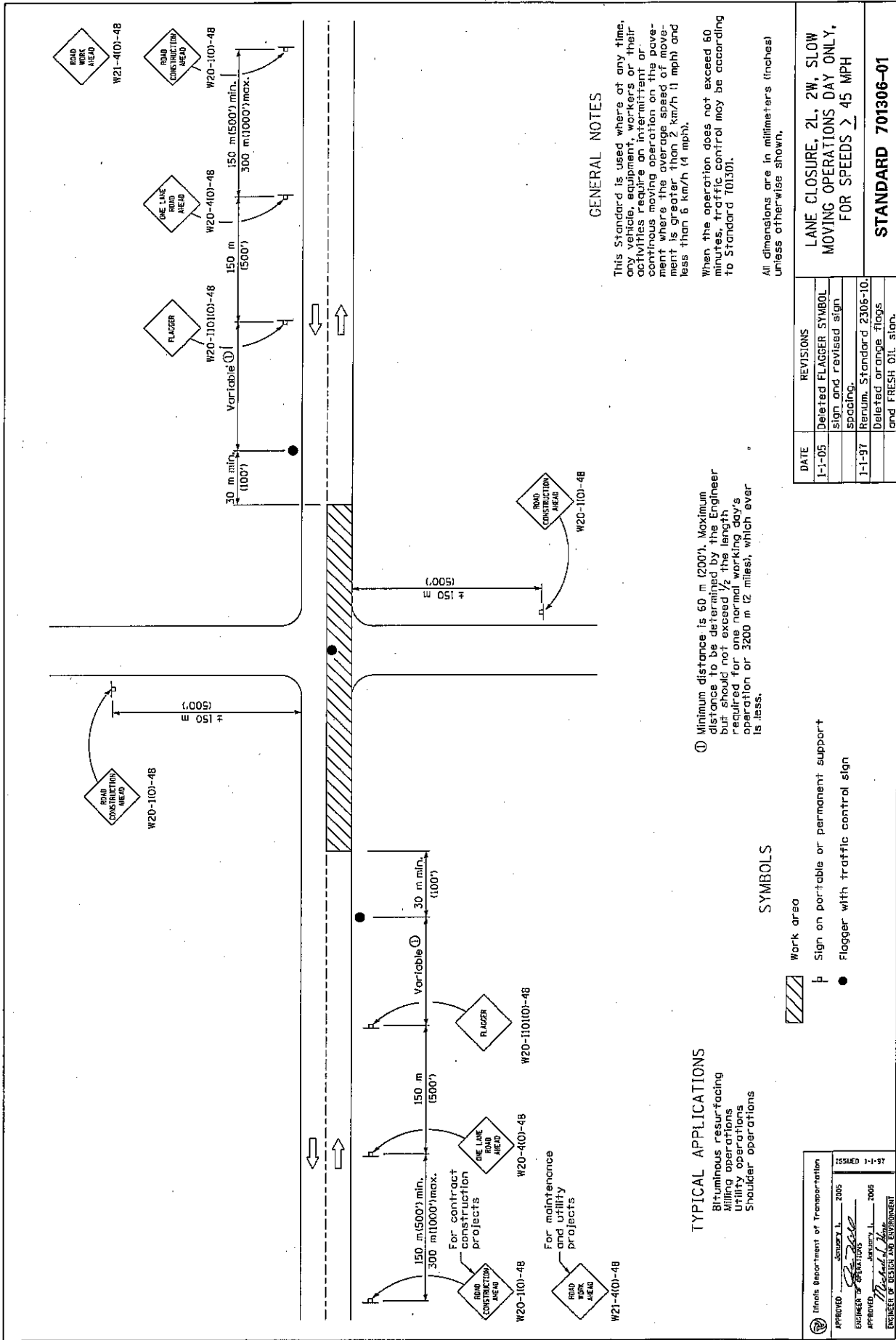

GENERAL NOTES

This Standard is used where, at any time, any vehicle, equipment, workers or their activities require an intermittent or continuing operation on the pavement where the speed of movement is greater than 2 km/h (1 mph) and less than 5 km/h (4 mph).

When the operation does not exceed 60 minutes, traffic control may be according to Standard 701301.

All dimensions are in millimeters (inches) unless otherwise shown.

① Minimum distance is 60 m (200'). Maximum distance to be determined by the Engineer but should not exceed 1/2 the length required for one normal working day's operation or 3200 m (2 miles), which ever is less.

TYPICAL APPLICATIONS

- Bituminous resurfacing
- Milling operations
- Utility operations
- Shoulder operations

SYMBOLS

- Work area
- Sign on portable or permanent support
- Flagger with traffic control sign

DATE	REVISIONS
1-1-05	Deleted FLAGGER SYMBOL sign and revised sign spacing.
1-1-97	Renum. Standard 2306-10. Deleted orange flags and FRESH OIL sign.

LANE CLOSURE, 2L, 2W, SLOW MOVING OPERATIONS DAY ONLY, FOR SPEEDS ≥ 45 MPH

STANDARD 701306-01

Illinois Department of Transportation
 APPROVED: [Signature] 2005
 ENGINEER OF OPERATIONS
 APPROVED: [Signature] 2005
 ENGINEER OF DESIGN AND ENVIRONMENT
 ISSUED 1-1-97

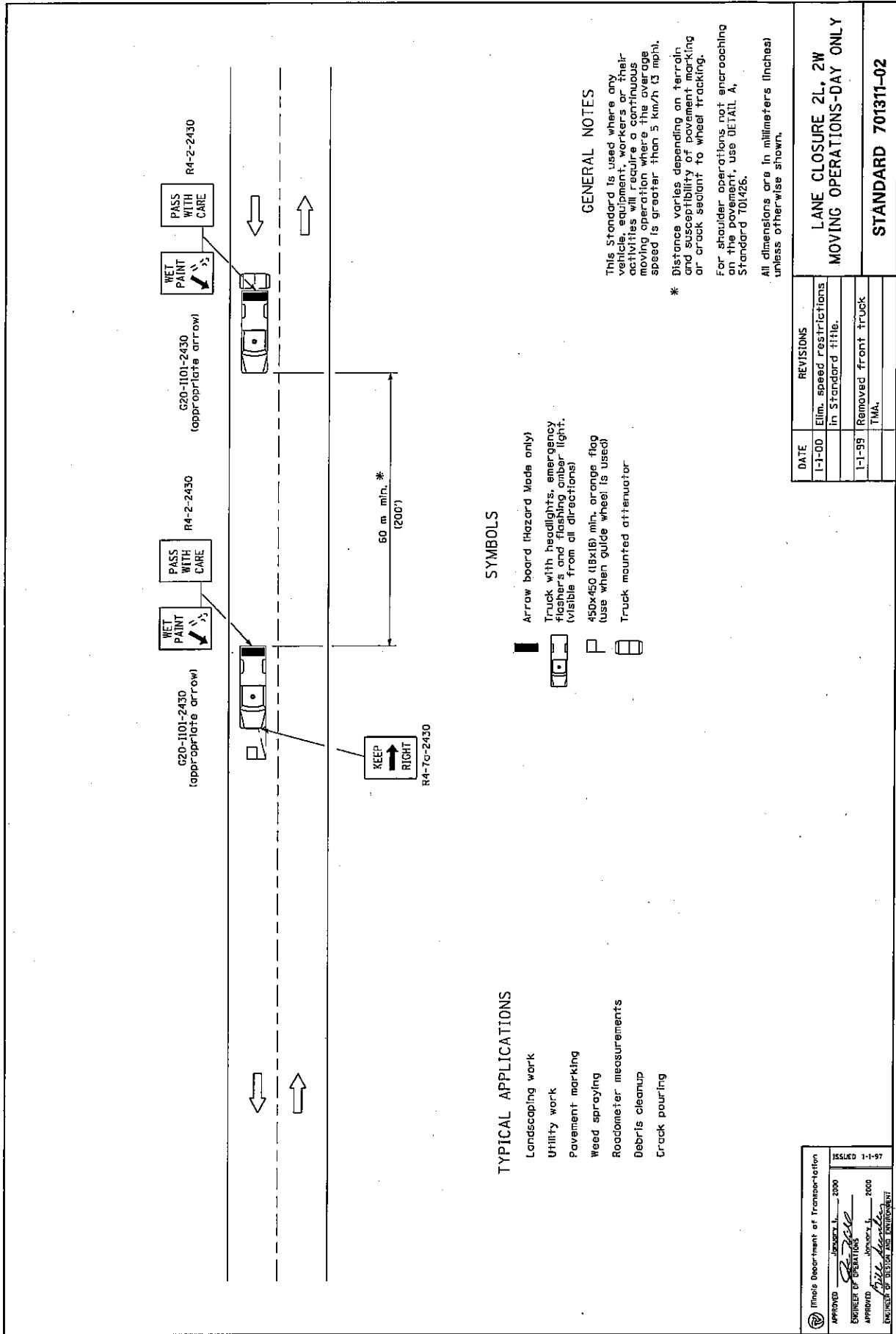

- TYPICAL APPLICATIONS**
- Landscaping work
 - Utility work
 - Pavement marking
 - Weed spraying
 - Roadometer measurements
 - Debris cleanup
 - Crack pouring

SYMBOLS

- Arrow board (Hazard Mode only)
- Truck with headlights, emergency flashers and flashing amber light. (visible from all directions)
- 450x450 (18x18) min. orange flag (use when guide wheel is used)
- Truck mounted attenuator

GENERAL NOTES

This Standard is used where any vehicle, equipment, workers or their activities will require a continuous moving operation where the average speed is greater than 5 km/h (3 mph).

* Distance varies depending on terrain and susceptibility of pavement marking or crack sealant to wheel tracking.

For shoulder operations not encroaching on the pavement, use DETAIL A.

All dimensions are in millimeters (inches) unless otherwise shown.

DATE	REVISIONS
1-1-00	Elim. speed restrictions in Standard title.
1-1-99	Removed front truck TMA.

**LANE CLOSURE 2L, 2W
MOVING OPERATIONS-DAY ONLY**

STANDARD 701311-02

Illinois Department of Transportation APPROVED: <i>[Signature]</i> January 1, 2000 ENGINEER OF OPERATIONS APPROVED: <i>[Signature]</i> January 1, 2000 ENGINEER OF DESIGN AND ENVIRONMENT	ISSUED 1-1-97
---	---------------

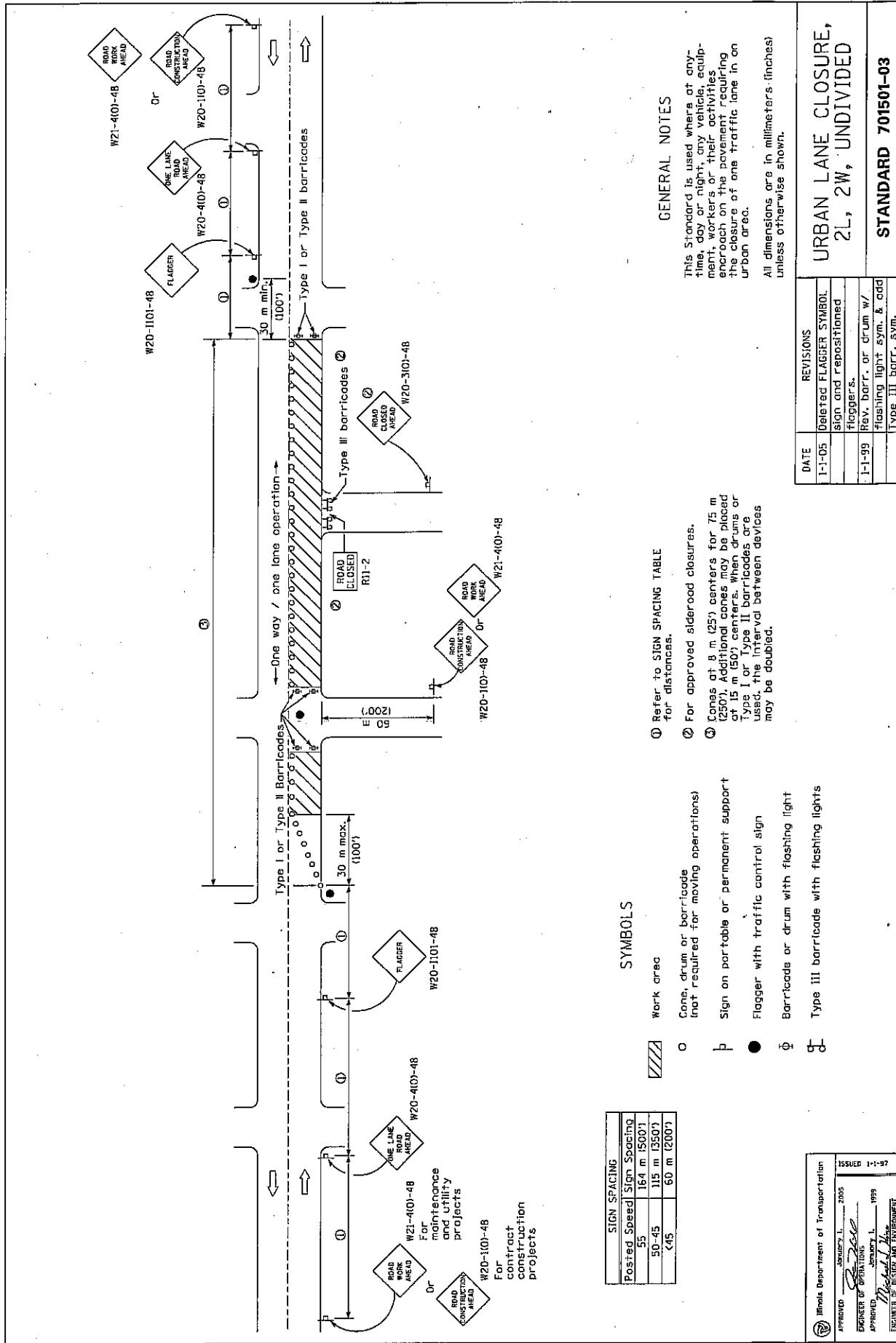

GENERAL NOTES

This Standard is used where at any time, day or night, any vehicle, equipment, workers or their activities encroach on the pavement requiring the closure of one traffic lane in an urban area.

All dimensions are in millimeters (inches) unless otherwise shown.

- ① Refer to SIGN SPACING TABLE for distances.
- ② For approved sideroad closures.
- ③ Cones at 8 m (25') centers for 75 m (250'). Additional cones may be placed at 15 m (50') centers. When drums or Type I or Type II barricades are used, the interval between devices may be doubled.

SYMBOLS

- Work area
- Cone, drum or barricade that required for moving operations)
- ▬ Sign on portable or permanent support
- Flagger with traffic control sign
- ⊕ Barricade or drum with flashing light
- ⊕ Type III barricade with flashing lights

SIGN SPACING	
Posted Speed	Sign Spacing
55	164 m (500')
50-45	115 m (350')
<45	60 m (200')

**URBAN LANE CLOSURE,
2L, 2W, UNDIVIDED**

STANDARD 701501-03

DATE	REVISIONS
1-1-05	Deleted FLAGGER SYMBOL sign and repositioned flaggers.
1-1-99	Rev. barr. or drum w/ flashing light sym. & add Type III barr. sym.

APPROVED: *[Signature]* January 1, 2005
 ENGINEER OF OPERATIONS
 APPROVED: *[Signature]* January 1, 1999
 ENGINEER OF DESIGN AND ENVIRONMENT

ISSUED 1-1-97

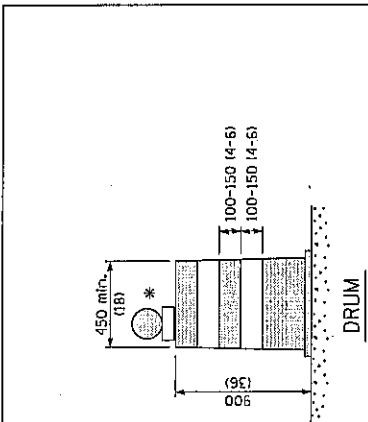

CONE

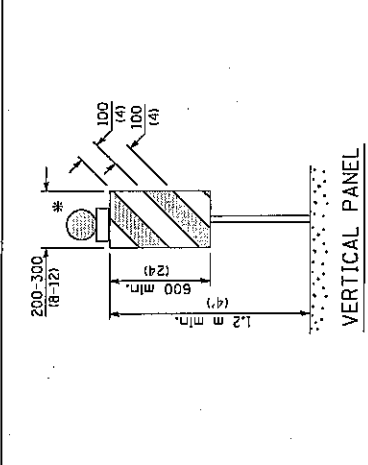

REFLECTORIZED CONE

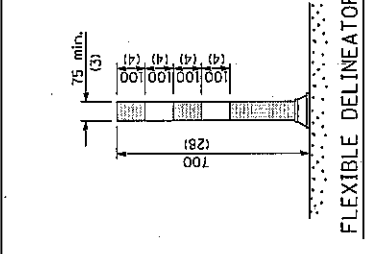

FLEXIBLE DELINEATOR

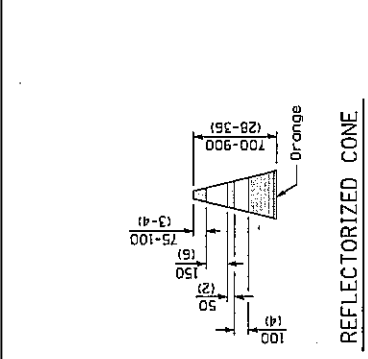

POST MOUNTED
VERTICAL PANEL

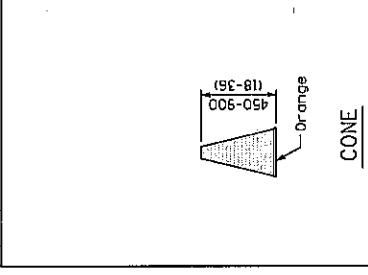

DRUM

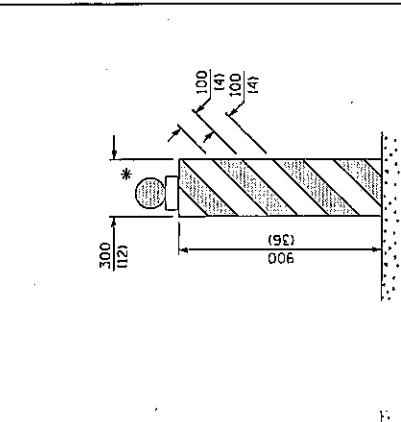

TYPE I BARRICADE

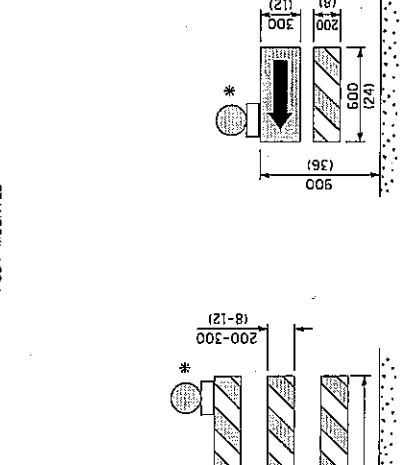

TYPE II BARRICADE

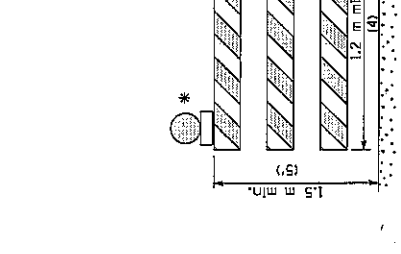

TYPE III BARRICADE

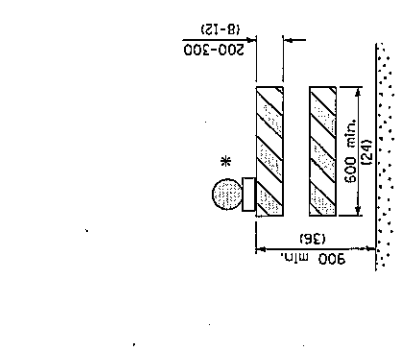

DIRECTION INDICATOR
BARRICADE

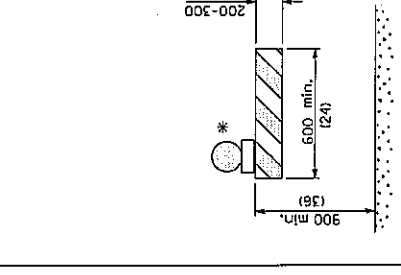

VERTICAL BARRICADE

* Warning lights (if required)

GENERAL NOTES

All heights shown shall be measured above the pavement surface.
All dimensions are in millimeters (inches) unless otherwise shown.

Illinois Department of Transportation	
APPROVED	JANUARY 1, 2005
ENGINEER OF OPERATIONS	
APPROVED	JANUARY 1, 2005
ENGINEER OF DESIGN AND ENVIRONMENT	

DATE	REVISIONS
1-1-05	Added note to work limit signing and re-added Type I barricade.
4-1-04	Removed Type I barricade and const'r. speed limit sign.

TRAFFIC CONTROL DEVICES
(Sheet 1 of 3)
STANDARD 702001-05

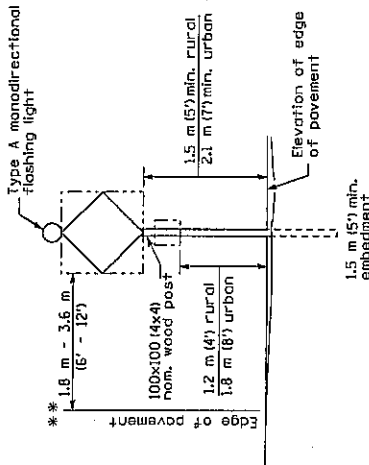

POST MOUNTED SIGNS

** When curb or paved shoulder are present this dimension shall be 600 (24) to the face of curb or 1.8 m (6') to the outside edge of the paved shoulder.

SIGNS ON TEMPORARY SUPPORTS

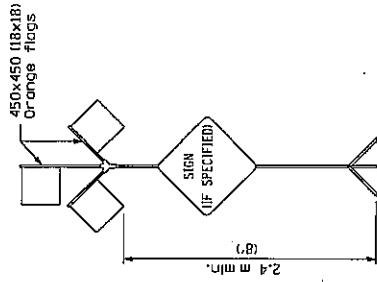
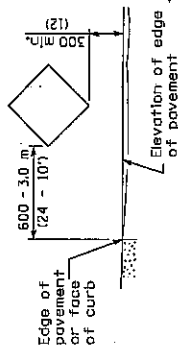

HIGH LEVEL WARNING DEVICE

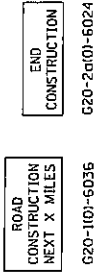

This signing is required for all projects 3200 m (12 miles) or more in length.
 ROAD CONSTRUCTION NEXT X MILES sign shall be placed 150 m (500') in advance of project limits.
 END CONSTRUCTION sign shall be erected at the end of the job unless another job is within 3200 m (2 miles).
 Dual sign displays shall be utilized on multi-lane highways.

WORK LIMIT SIGNING

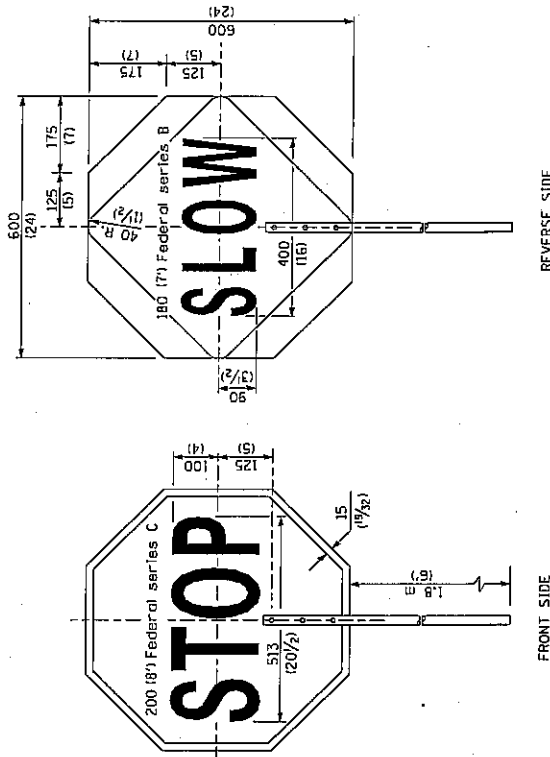

FLAGGER TRAFFIC CONTROL SIGN

Missouri Department of Transportation		ISSUED	1-1-97
APPROVED	JANUARY 1, 2005		
ENGINEER OF OPERATIONS	<i>[Signature]</i>		
APPROVED	JANUARY 1, 2005		
ENGINEER OF DESIGN AND ENVIRONMENT	<i>[Signature]</i>		

All dimensions are in millimeters (inches) unless otherwise shown.

TRAFFIC CONTROL DEVICES

(Sheet 2 of 3)

STANDARD 702001-05

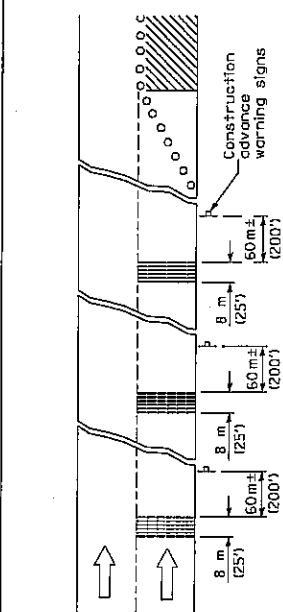

TYPICAL INSTALLATION

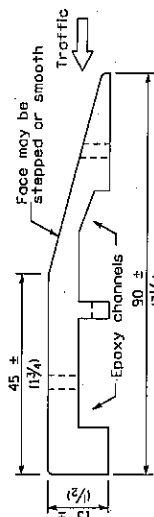
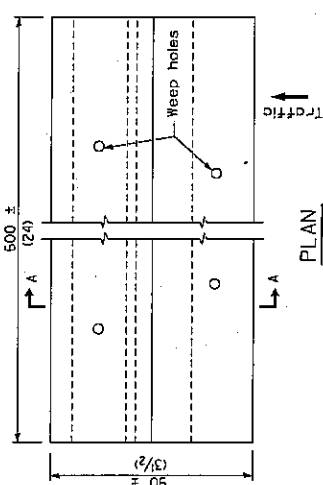

SECTION A-A

TEMPORARY RUMBLE STRIPS

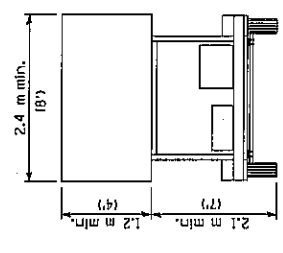

TYPE C
TRAILER
MOUNTED

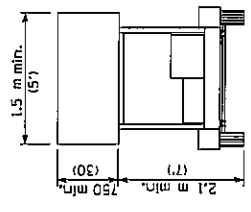

TYPE B
ROOF OR TRAILER
MOUNTED

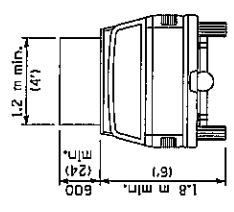

TYPE A
ROOF
MOUNTED

ARROW BOARDS

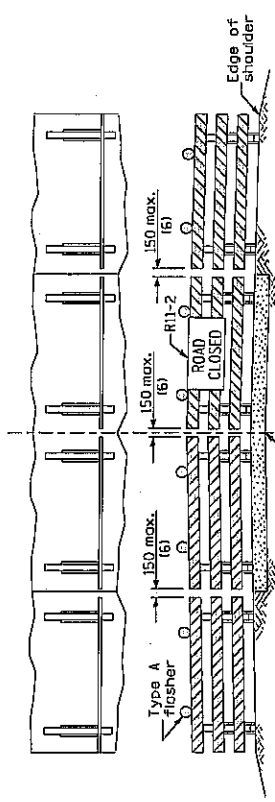

ROAD CLOSED TO ALL TRAFFIC
 ReflectORIZED striping may be omitted on the back side of the barricades. If a Type III barricade with an attached sign panel which meets NCHRP 350 is available, the sign may be mounted on an NCHRP 350 temporary sign support directly in front of the barricade.

TYPICAL APPLICATIONS OF
TYPE III BARRICADES CLOSING A ROAD

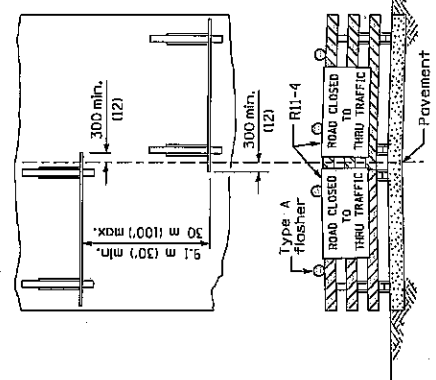

ROAD CLOSED TO THRU TRAFFIC
 ReflectORIZED striping shall appear on both sides of the barricades. If a Type III barricade with an attached sign panel which meets NCHRP 350 is not available, the signs may be mounted on NCHRP 350 temporary sign supports directly in front of the barricade.

All dimensions are in millimeters (inches) unless otherwise shown.

TRAFFIC CONTROL DEVICES

(Sheet 3 of 3)

STANDARD 702001-05

Illinois Department of Transportation	ISSUED	1-1-97
	APPROVED	JANUARY 1, 2005
ENGINEER IN CHARGE	[Signature]	
APPROVED	[Signature]	
ENGINEER OF DESIGN AND ENVIRONMENT	[Signature]	

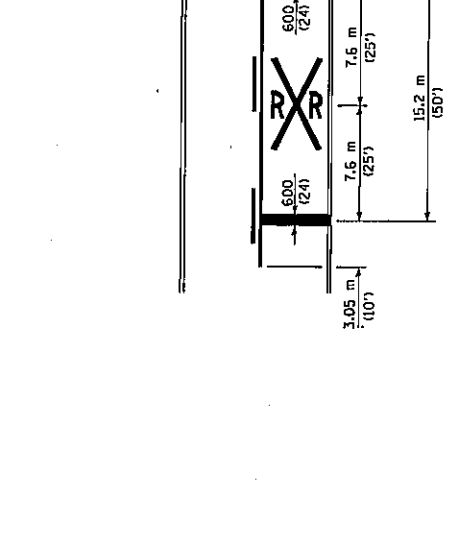
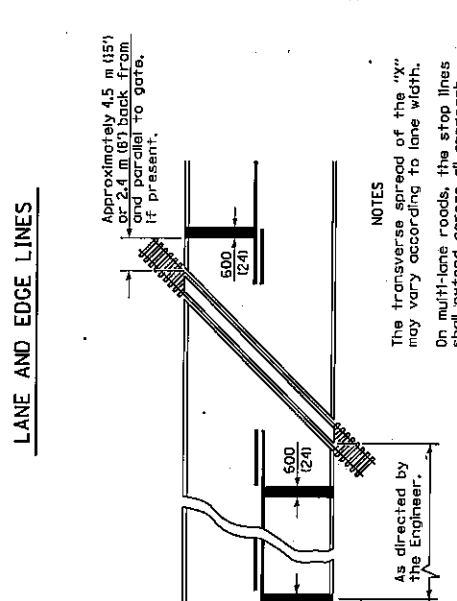
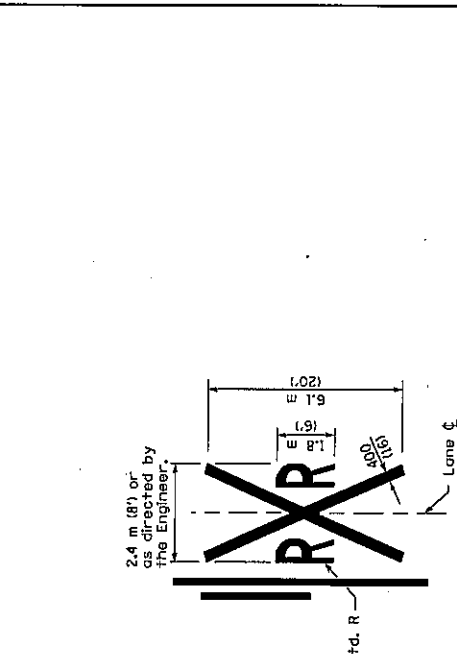
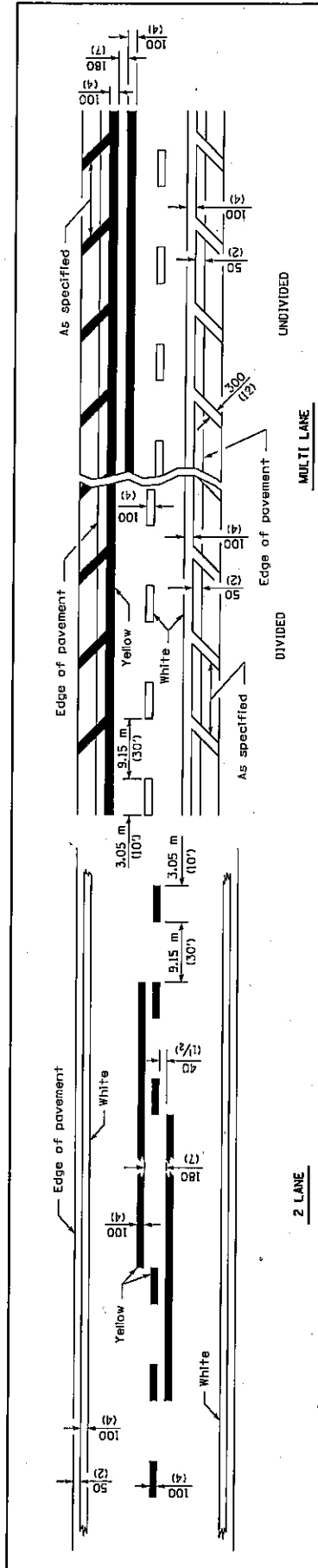

LANE AND EDGE LINES

NOTES

The transverse spread of the "RR" may vary according to lane width.

On multi-lane roads, the stop lines shall extend across all approach lanes and separate RR symbols shall be placed adjacent to each other in each lane.

When the pavement marking symbol is used, a portion of the symbol should be located directly adjacent to the Advance Warning Sign (W10-1) or placed in accordance with condition B of the MUTCD.

TYPICAL PAVEMENT MARKINGS

STANDARD 780001-01

(Sheet 1 of 2)

DATE	REVISIONS
1-1-99	Rev. dimen. & added 3rd note to pav't markings @ RR-Hwy grade Xing.
1-1-97	Renum. Standard 7396-1.
	Revised metric values.

All dimensions are in millimeters (inches) unless otherwise shown.

PAVEMENT MARKINGS AT RAILROAD-HIGHWAY GRADE CROSSING

Illinois Department of Transportation

APPROVED: [Signature] 1999

ENGINEER OF OPERATIONS

APPROVED: [Signature] 1999

ENGINEER OF DESIGN AND CONSTRUCTION

ISSUED: 1-1-97

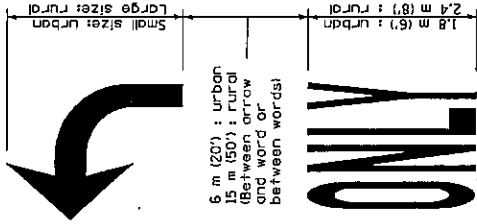
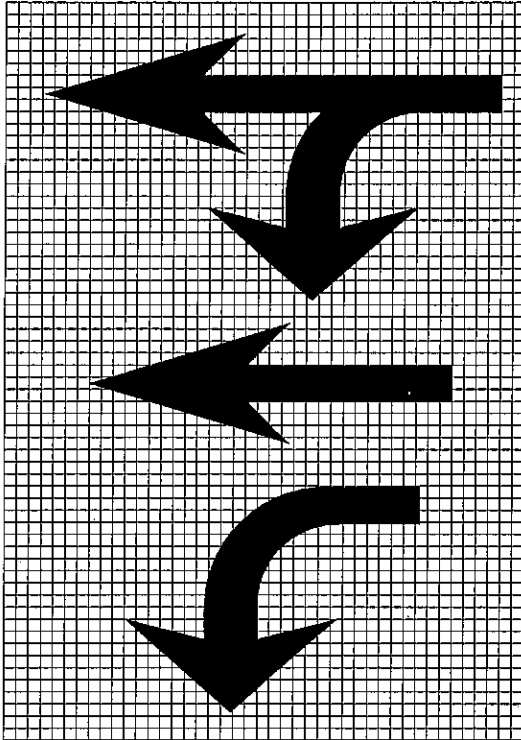
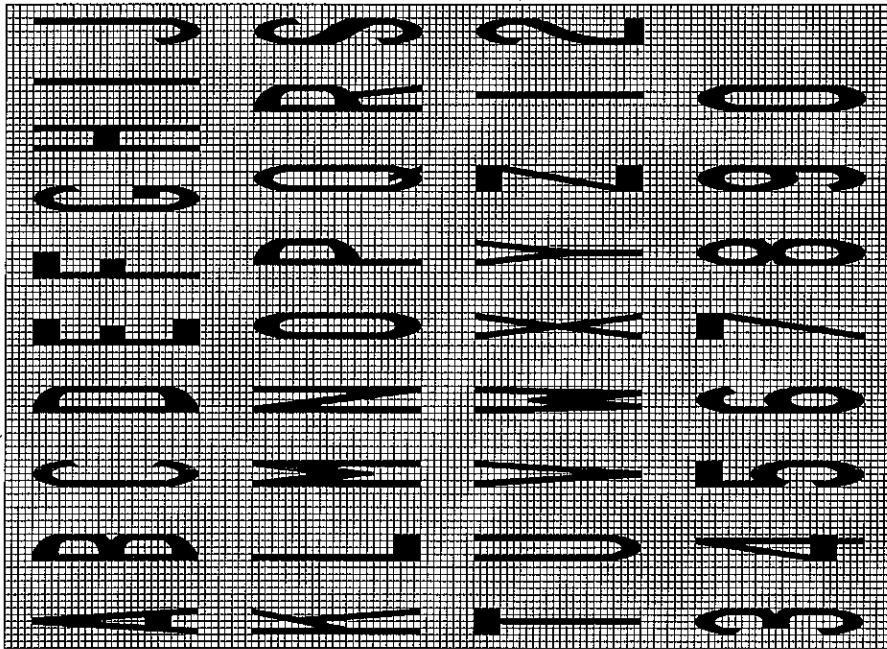

WORD AND ARROW LAYOUT

Legend Height	Arrow Size	a
1.8 m (6')	Small	74 (2.9)
2.4 m (8')	Large	96 (3.8)

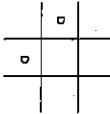

The space between adjacent letters or numerals should be approximately 75 (3) for 1.8 m (6') legend and 100 (4) for 2.4 m (8') legend.

LETTER AND ARROW GRID SCALE

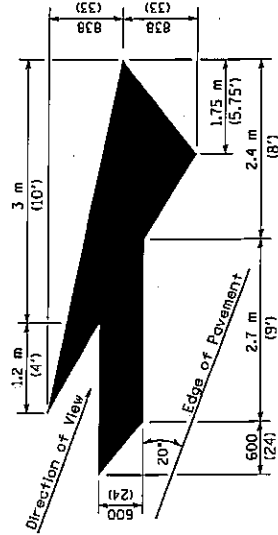

LANE DROP ARROW

Right lane drop arrow shown. Use mirror image for left lane.

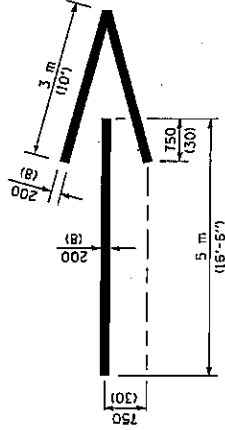

WRONG WAY ARROW

All dimensions are in millimeters (inches) unless otherwise shown.

TYPICAL PAVEMENT MARKINGS

(Sheet 2 of 2)

STANDARD 780001-01

Illinois Department of Transportation
 APPROVED: [Signature] 1979
 ENGINEER OF TRANSPORTATION
 APPROVED: [Signature] 1979
 ENGINEER OF TRAFFIC AND ENVIRONMENT
 ISSUED 1-1-97

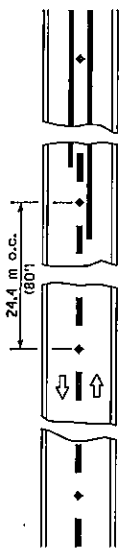

Reduce to 12.2 m (40') o.c. on curves with posted or advisory speeds of 70 km/h (45 mph) or less.

TWO-LANE / TWO-WAY

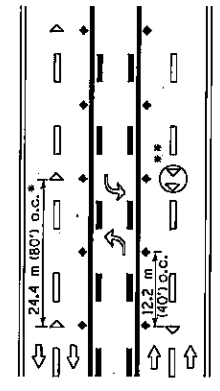

*** See MULTI LANE DIVIDED detail for lane marker notes.

TWO-WAY LEFT TURN

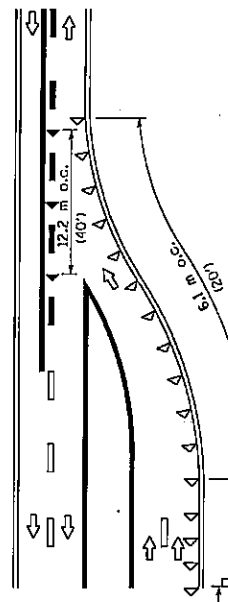

LANE REDUCTION TRANSITION

4-2

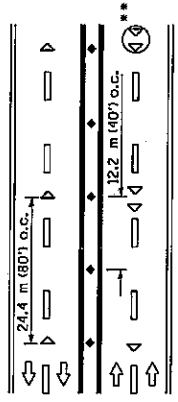

*** See MULTI LANE DIVIDED detail for lane marker notes.

MULTI-LANE UNDIVIDED

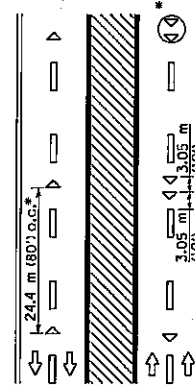

* Reduce to 12.2 m (40') o.c. on curves where advisory speeds are 15 km/h (10 mph) lower than posted speeds.

** Where double lane line markers are specified, they shall be spaced as shown.

MULTI-LANE DIVIDED

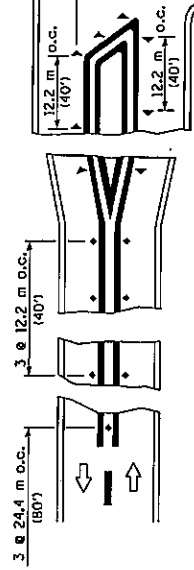

RURAL LEFT TURN

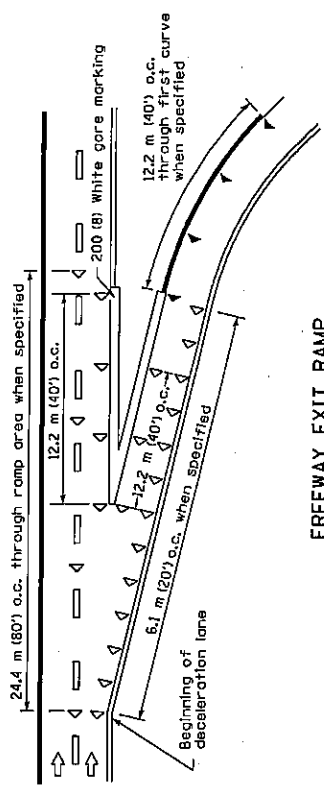

FREEWAY EXIT RAMP

SYMBOLS

- Yellow stripe
- White stripe
- One-way amber marker
- One-way crystal marker
- Two-way amber marker

All dimensions are in millimeters (inches) unless otherwise shown.

APPROVED	ILLINOIS	1999
ENGINEER	DESIGN	
APPROVED	ILLINOIS	1999
ENGINEER	DESIGN	

Illinois Department of Transportation
ISSUED 1-1-97

DATE	REVISIONS
1-1-99	Extended double line to show different scenario in RURAL LEFT TURN.
1-1-98	Added "o.c." to 12.2 m dim. in RURAL LEFT TURN.

**TYPICAL APPLICATIONS
RAISED REFLECTIVE
PAVEMENT MARKERS**

STANDARD 781001-02

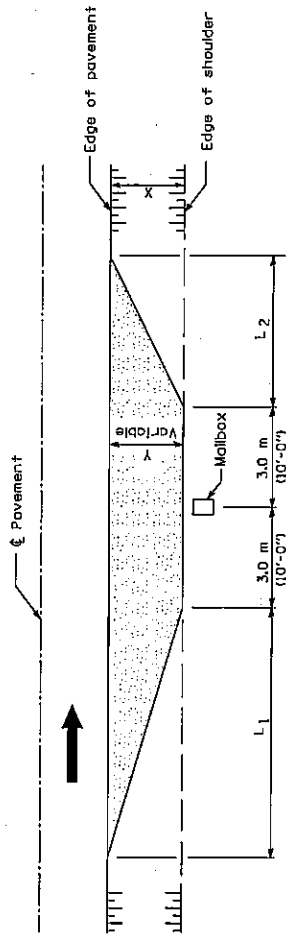

TYPICAL APPLICATION

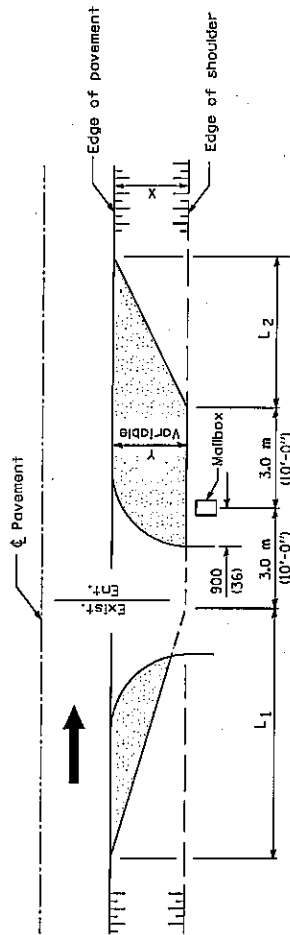

MAILBOX ON FAR SIDE OF ENTRANCE

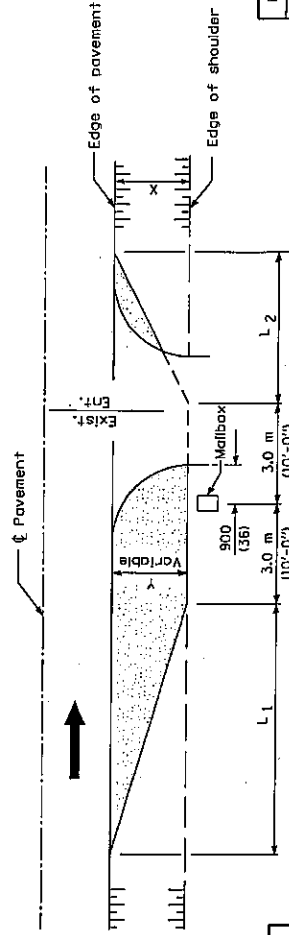

MAILBOX ON NEAR SIDE OF ENTRANCE

DIMENSIONS - m		DIMENSIONS - (ft.)	
Width of Shoulder (X)	3.6 (12)	2.4 (8)	1.8 (6)
Width of Turnout (Y)	2.4 (8)	1.8 (6)	1.2 (4)
L1	9.0 (30)	6.9 (23)	4.5 (15)
L2	6.0 (20)	4.5 (15)	3.0 (10)

Note: Dimensions for Township and District Roads may vary from the above dimensions.

GENERAL NOTES

Mailboxes shall be mounted such that the face of the mailbox is 150 mm (6") to 300 mm (12") and not post a maximum of 600 mm (24") from the edge of the turnout surfacing.

All dimensions are in millimeters (inches) unless otherwise shown.

DATE	REVISIONS
1-1-99	Add width of shoulder X.
1-1-97	New BLR Standard.

Illinois Department of Transportation
 APPROVED: JUNE 11, 1999
 ENGINEER OF LOCAL ROADS AND STREETS
 APPROVED: JUNE 7, 1999
 MEMBER OF ILLINOIS AND ENVIRONMENT

MAILBOX TURNOUT FOR LOCAL ROADS
 STANDARD B.L.R. 24-1

**REQUIRED CONTRACT PROVISIONS
FEDERAL-AID CONSTRUCTION CONTRACTS**

	Page
I. General	1
II. Nondiscrimination	1
III. Nonsegregated Facilities	3
IV. Payment of Predetermined Minimum Wage.....	3
V. Statements and Payrolls	6
VI. Record of Materials, Supplies, and Labor.....	7
VIII. Safety: Accident Prevention	7
IX. False Statements Concerning Highway Projects.....	7
X. Implementation of Clean Air Act and Federal Water Pollution Control Act	8
XI. Certification Regarding Debarment, Suspension, Ineligibility, and Voluntary Exclusion	8
XII. Certification Regarding Use of Contract Funds for Lobbying	9

ATTACHMENTS

- A. Employment Preference for Appalachian Contracts
(included in Appalachian contracts only)

I. GENERAL

1. These contract provisions shall apply to all work performed on the contract by the contractor's own organization and with the assistance of workers under the contractor's immediate superintendence and to all work performed on the contract by piecework, station work, or by subcontract.

2. Except as otherwise provided for in each section, the contractor shall insert in each subcontract all of the stipulations contained in these Required Contract Provisions, and further require their inclusion in any lower tier subcontract or purchase order that may in turn be made. The Required Contract Provisions shall not be incorporated by reference in any case. The prime contractor shall be responsible for compliance by any subcontractor or lower tier subcontractor with these Required Contract Provisions.

3. A breach of any of the stipulations contained in these Required Contract Provisions shall be sufficient grounds for termination of the contract.

4. A breach of the following clauses of the Required Contract Provisions may also be grounds for debarment as provided in 29 CFR 5.12:

- Section I, paragraph 2;
- Section IV, paragraphs 1, 2, 3, 4 and 7;
- Section V, paragraphs 1 and 2a through 2g.

5. Disputes arising out of the labor standards provisions of Section IV (except paragraph 5) and Section V of these Required Contract Provisions shall not be subject to the general disputes clause of this contract. Such disputes shall be resolved in accordance with the procedures of the U.S. Department of Labor (DOL) as set forth in 29 CFR 5, 6 and 7. Disputes within the meaning of this clause include disputes between the contractor (or any of its subcontractors) and the contracting agency, the DOL, or the contractor's employees or their representatives.

6. Selection of Labor: During the performance of this contract, the contractor shall not:

- a. Discriminate against labor from any other State, possession, or territory of the United States (except for employment preference for Appalachian contracts, when applicable, as specified in Attachment A), or
- b. Employ convict labor for any purpose within the limits of the project unless it is labor performed by convicts who are on parole, supervised release, or probation.

II. NONDISCRIMINATION

1. Equal Employment Opportunity: Equal employment opportunity (EEO) requirements not to discriminate and to take affirmative action to assure equal opportunity as set forth under laws, executive orders, rules, regulations (28 CFR 35, 29 CFR 1630 and 41 CFR 60 (and orders of the Secretary of Labor as modified by the provisions prescribed herein, and imposed pursuant to 23 U.S.C. 140 shall constitute the EEO and specific affirmative action standards for the contractor's project activities under this contract. The Equal Opportunity Construction Contract Specifications set forth under 41 CFR 60-4.3 and the provisions of the American Disabilities Act of 1990 (42 U.S.C. 12101 et seq.) set forth under 28 CFR 35 and 29 CFR 1630 are incorporated by reference in this contract. In the execution of this contract, the contractor agrees to comply with the following minimum specific requirement activities of EEO:

a. The contractor will work with the State highway agency (SHA) and the Federal Government in carrying out EEO obligations and in their review of his/her activities under the contract.

b. The contractor will accept as his operating policy the following statement:

"It is the policy of this Company to assure that applicants are employed, and that employees are treated during employment, without regard to their race, religion, sex, color, national origin, age or disability. Such action shall include: employment, upgrading, demotion, or transfer; recruitment or recruitment advertising; layoff or termination; rates of pay or other forms of compensation; and selection for training, including apprenticeship, preapprenticeship, and/or on-the-job-training."

2. EEO Officer: The contractor will designate and make known to the SHA contracting officers an EEO Officer who will have the responsibility for an must be capable of effectively administering and promoting an active contractor program of EEO and who must be assigned adequate authority and responsibility to do so.

3. Dissemination of Policy: All members of the contractor's staff who are authorized to hire, supervise, promote, and discharge employees, or who recommend such action, or who are substantially involved in such action, will be made fully cognizant of, and will implement, the contractor's EEO policy and contractual responsibilities to provide EEO in each grade and classification of employment. To ensure that the above

agreement will be met, the following actions will be taken as a minimum:

a. Periodic meetings of supervisory and personnel office employees will be conducted before the start of work and then not less often than once every six months, at which time the contractor's EEO policy and its implementation will be reviewed and explained. The meetings will be conducted by the EEO Officer.

b. All new supervisory or personnel office employees will be given a thorough indoctrination by the EEO Officer, covering all major aspects of the contractor's EEO obligations within thirty days following their reporting for duty with the contractor.

c. All personnel who are engaged in direct recruitment for the project will be instructed by the EEO Officer in the contractor's procedures for locating and hiring minority group employees.

d. Notices and posters setting forth the contractor's EEO policy will be placed in areas readily accessible to employees, applicants for employment and potential employees.

e. The contractor's EEO policy and the procedures to implement such policy will be brought to the attention of employees by means of meetings, employee handbooks, or other appropriate means.

4. Recruitment: When advertising for employees, the contractor will include in all advertisements for employees the notation: "An Equal Opportunity Employer." All such advertisements will be placed in publications having a large circulation among minority groups in the area from which the project work force would normally be derived.

a. The contractor will, unless precluded by a valid bargaining agreement, conduct systematic and direct recruitment through public and private employees referral sources likely to yield qualified minority group applicants. To meet this requirement, the contractor will identify sources of potential minority group employees, and establish which such identified sources procedures whereby minority group applicants may be referred to the contractor for employment consideration.

b. In the event the contractor has a valid bargaining agreement providing for exclusive hiring hall referrals, he is expected to observe the provisions of that agreement to the extent that the system permits the contractor's compliance with EEO contract provisions. (The DOL has held that where implementation of such agreements have the effect of discriminating against minorities or women, or obligates the contractor to do the same, such implementation violates Executive Order 11246, as amended.)

c. The contractor will encourage his present employees to refer minority group applicants for employment. Information and procedures with regard to referring minority group applicants will be discussed with employees.

5. Personnel Actions: Wages, working conditions, and employee benefits shall be established and administered, and personnel actions of every type, including hiring, upgrading, promotion, transfer, demotion, layoff, and termination, shall be taken without regard to race, color, religion, sex, national origin, age or disability. The following procedures shall be followed:

a. The contractor will conduct periodic inspections of project sites to insure that working conditions and employee facilities do not indicate discriminatory treatment of project site personnel.

b. The contractor will periodically evaluate the spread of wages paid within each classification to determine any

evidence of discriminatory wage practices.

c. The contractor will periodically review selected personnel actions in depth to determine whether there is evidence of discrimination. Where evidence is found, the contractor will promptly take corrective action. If the review indicates that the discrimination may extend beyond the actions reviewed, such corrective action shall include all affected persons.

d. The contractor will promptly investigate all complaints of alleged discrimination made to the contractor in connection with his obligations under this contract, will attempt to resolve such complaints, and will take appropriate corrective action within a reasonable time. If the investigation indicates that the discrimination may affect persons other than the complainant, such corrective action shall include such other persons. Upon completion of each investigation, the contractor will inform every complainant of all of his avenues of appeal.

6. Training and Promotion:

a. The contractor will assist in locating, qualifying, and increasing the skills of minority group and women employees, and applicants for employment.

b. Consistent with the contractor's work force requirements and as permissible under Federal and State regulations, the contractor shall make full use of training programs, i.e., apprenticeship, and on-the-job training programs for the geographical area of contract performance. Where feasible, 25 percent of apprentices or trainees in each occupation shall be in their first year of apprenticeship or training. In the event a special provision for training is provided under this contract, this subparagraph will be superseded as indicated in the special provision.

c. The contractor will advise employees and applicants for employment of available training programs and entrance requirements for each.

d. The contractor will periodically review the training and promotion potential of minority group and women employees and will encourage eligible employees to apply for such training and promotion.

7. Unions: If the contractor relies in whole or in part upon unions as a source of employees, the contractor will use his/her best efforts to obtain the cooperation of such unions to increase opportunities for minority groups and women within the unions, and to effect referrals by such unions of minority and female employees. Actions by the contractor either directly or through a contractor's association acting as agent will include the procedures set forth below:

a. The contractor will use best efforts to develop, in cooperation with the unions, joint training programs aimed toward qualifying more minority group members and women for membership in the unions and increasing the skills of minority group employees and women so that they may qualify for higher paying employment.

b. The contractor will use best efforts to incorporate an EEO clause into each union agreement to the end that such union will be contractually bound to refer applicants without regard to their race, color, religion, sex, national origin, age or disability.

c. The contractor is to obtain information as to the referral practices and policies of the labor union except that to the extent such information is within the exclusive possession of the labor union and such labor union refuses to furnish such information to the contractor, the contractor shall so certify to

the SHA and shall set forth what efforts have been made to obtain such information.

d. In the event the union is unable to provide the contractor with a reasonable flow of minority and women referrals within the time limit set forth in the collective bargaining agreement, the contractor will, through independent recruitment efforts, fill the employment vacancies without regard to race, color, religion, sex, national origin, age or disability; making full efforts to obtain qualified and/or quailifiable minority group persons and women. (The DOL has held that it shall be no excuse that the union with which the contractor has a collective bargaining agreement providing for exclusive referral failed to refer minority employees.) In the event the union referral practice prevents the contractor from meeting the obligations pursuant to Executive Order 11246, as amended, and these special provisions, such contractor shall immediately notify the SHA.

8. Selection of Subcontractors, Procurement of Materials and Leasing of Equipment: The contractor shall not discriminate on the grounds of race, color, religion, sex, national origin, age or disability in the selection and retention of subcontractors, including procurement of materials and leases of equipment.

a. The contractor shall notify all potential subcontractors and suppliers of his/her EEO obligations under this contract.

b. Disadvantaged business enterprises (DBE), as defined in 49 CFR 23, shall have equal opportunity to compete for and perform subcontracts which the contractor enters into pursuant to this contract. The contractor will use his best efforts to solicit bids from and to utilize DBE subcontractors or subcontractors with meaningful minority group and female representation among their employees. Contractors shall obtain lists of DBE construction firms from SHA personnel.

c. The contractor will use his best efforts to ensure subcontractor compliance with their EEO obligations.

9. Records and Reports: The contractor shall keep such records as necessary to document compliance with the EEO requirements. Such records shall be retained for a period of three years following completion of the contract work and shall be available at reasonable times and places for inspection by authorized representatives of the SHA and the FHWA.

a. The records kept by the contractor shall document the following:

(1) The number of minority and non-minority group members and women employed in each work classification on the project;

(2) The progress and efforts being made in cooperation with unions, when applicable, to increase employment opportunities for minorities and women;

(3) The progress and efforts being made in locating, hiring, training, qualifying, and upgrading minority and female employees; and

(4) The progress and efforts being made in securing the services of DBE subcontractors or subcontractors with meaningful minority and female representation among their employees.

b. The contractors will submit an annual report to the SHA each July for the duration of the project, indicating the number of minority, women, and non-minority group employees currently engaged in each work classification required by the contract work. This information is to be reported on Form FHWA-1391. If on-the-job training is being required by special provision, the contractor will be required to collect and report training data.

III. NONSEGREGATED FACILITIES

(Applicable to all Federal-aid construction contracts and to all related subcontracts of \$10,000 or more.)

a. By submission of this bid, the execution of this contract or subcontract, or the consummation of this material supply agreement or purchase order, as appropriate, the bidder, Federal-aid construction contractor, subcontractor, material supplier, or vendor, as appropriate, certifies that the firm does not maintain or provide for its employees any segregated facilities at any of its establishments, and that the firm does not permit its employees to perform their services at any location, under its control, where segregated facilities are maintained. The firm agrees that a breach of this certification is a violation of the EEO provisions of this contract. The firm further certifies that no employee will be denied access to adequate facilities on the basis of sex or disability.

b. As used in this certification, the term "segregated facilities" means any waiting rooms, work areas, restrooms and washrooms, restaurants and other eating areas, timeclocks, locker rooms, and other storage or dressing areas, parking lots, drinking fountains, recreation or entertainment areas, transportation, and housing facilities provided for employees which are segregated by explicit directive, or are, in fact, segregated on the basis of race, color, religion, national origin, age or disability, because of habit, local custom, or otherwise. The only exception will be for the disabled when the demands for accessibility override (e.g. disabled parking).

c. The contractor agrees that it has obtained or will obtain identical certification from proposed subcontractors or material suppliers prior to award of subcontracts or consummation of material supply agreements of \$10,000 or more and that it will retain such certifications in its files.

IV. PAYMENT OF PREDETERMINED MINIMUM WAGE

(Applicable to all Federal-aid construction contracts exceeding \$2,000 and to all related subcontracts, except for projects located on roadways classified as local roads or rural minor collectors, which are exempt.)

1. General:

a. All mechanics and laborers employed or working upon the site of the work will be paid unconditionally and not less often than once a week and without subsequent deduction or rebate on any account [except such payroll deductions as are permitted by regulations (29 CFR 3) issued by the Secretary of Labor under the Copeland Act (40 U.S.C. 276c)] the full amounts of wages and bona fide fringe benefits (or cash equivalents thereof) due at time of payment. The payment shall be computed at wage rates not less than those contained in the wage determination of the Secretary of Labor (hereinafter "the wage determination") which is attached hereto and made a part hereof, regardless of any contractual relationship which may be alleged to exist between the

contractor or its subcontractors and such laborers and mechanics. The wage determination (including any additional classifications and wage rates conformed under paragraph 2 of this Section IV and the DOL poster (WH-1321) or Form FHWA-1495) shall be posted at all times by the contractor and its subcontractors at the site of the work in a prominent and accessible place where it can be easily seen by the workers. For the purpose of this Section, contributions made or costs reasonably anticipated for bona fide fringe benefits under Section 1(b)(2) of the Davis-Bacon Act (40 U.S.C. 276a) on behalf of laborers or mechanics are considered wages paid to such laborers or mechanics, subject to the provisions of Section IV, paragraph 3b, hereof. Also, for the purpose of this Section, regular contributions made or costs incurred for more than a weekly period (but not less often than quarterly) under plans, funds, or programs, which cover the particular weekly period, are deemed to be constructively made or incurred during such weekly period. Such laborers and mechanics shall be paid the appropriate wage rate and fringe benefits on the wage determination for the classification of work actually performed, without regard to skill, except as provided in paragraphs 4 and 5 of this Section IV.

b. Laborers or mechanics performing work in more than one classification may be compensated at the rate specified for each classification for the time actually worked therein, provided, that the employer's payroll records accurately set forth the time spent in each classification in which work is performed.

c. All rulings and interpretations of the Davis-Bacon Act and related acts contained in 29 CFR 1, 3, and 5 are herein incorporated by reference in this contract.

2. Classification:

a. The SHA contracting officer shall require that any class of laborers or mechanics employed under the contract, which is not listed in the wage determination, shall be classified in conformance with the wage determination.

b. The contracting officer shall approve an additional classification, wage rate and fringe benefits only when the following criteria have been met:

(1) the work to be performed by the additional classification requested is not performed by a classification in the wage determination;

(2) the additional classification is utilized in the area by the construction industry;

(3) the proposed wage rate, including any bona fide fringe benefits, bears a reasonable relationship to the wage rates contained in the wage determination; and

(4) with respect to helpers, when such a classification prevails in the area in which the work is performed.

c. If the contractor or subcontractors, as appropriate, the laborers and mechanics (if known) to be employed in the additional classification or their representatives, and the contracting officer agree on the classification and wage rate (including the amount designated for fringe benefits where appropriate), a report of the action taken shall be sent by the contracting officer to the DOL, Administrator of the Wage and Hour Division, Employment Standards Administration, Washington, D.C. 20210. The Wage and Hour Administrator, or an authorized representative, will approve, modify, or

disapprove every additional classification action within 30 days of receipt and so advise the contracting officer or will notify the contracting officer within the 30-day period that additional time is necessary.

d. In the event the contractor or subcontractors, as appropriate, the laborers or mechanics to be employed in the additional classification or their representatives, and the contracting officer do not agree on the proposed classification and wage rate (including the amount designated for fringe benefits, where appropriate), the contracting officer shall refer the question, including the views of all interested parties and the recommendation of the contracting officer, to the Wage and Hour Administrator for determination. Said Administrator, or an authorized representative, will issue a determination within 30 days of receipt and so advised the contracting officer or will notify the contracting officer within the 30-day period that additional time is necessary.

e. The wage rate (including fringe benefits where appropriate) determined pursuant to paragraph 2c or 2d of this Section IV shall be paid to all workers performing work in the additional classification from the first day on which work is performed in the classification.

3. Payment of Fringe Benefits:

a. Whenever the minimum wage rate prescribed in the contract for a class of laborers or mechanics includes a fringe benefit which is not expressed as an hourly rate, the contractor or subcontractors, as appropriate, shall either pay the benefit as stated in the wage determination or shall pay another bona fide fringe benefit or an hourly case equivalent thereof.

b. If the contractor or subcontractor, as appropriate, does not make payments to a trustee or other third person, he/she may consider as a part of the wages of any laborer or mechanic the amount of any cost reasonably anticipated in providing bona fide fringe benefits under a plan or program, provided that the Secretary of Labor has found, upon the written request of the contractor, that the applicable standards of the Davis-Bacon Act have been met. The Secretary of Labor may require the contractor to set aside in a separate account assets for the meeting of obligations under the plan or program.

4. Apprentices and Trainees (Programs of the U.S. DOL) and Helpers:

a. Apprentices:

(1) Apprentices will be permitted to work at less than the predetermined rate for the work they performed when they are employed pursuant to and individually registered in a bona fide apprenticeship program registered with the DOL, Employment and Training Administration, Bureau of Apprenticeship and Training, or with a State apprenticeship agency recognized by the Bureau, or if a person is employed in his/her first 90 days of probationary employment as an apprentice in such an apprenticeship program, who is not individually registered in the program, but who has been certified by the Bureau of Apprenticeship and Training or a State apprenticeship agency (where appropriate) to be eligible for probationary employment as an apprentice.

(2) The allowable ratio of apprentices to journeyman-level employees on the job site in any craft classification shall not

listed on the wage determination unless the Administrator of the

be greater than the ratio permitted to the contractor as to the entire work force under the registered program. Any employee listed on a payroll at an apprentice wage rate, who is not registered or otherwise employed as stated above, shall be paid not less than the applicable wage rate listed in the wage determination for the classification of work actually performed. In addition, any apprentice performing work on the job site in excess of the ratio permitted under the registered program shall be paid not less than the applicable wage rate on the wage determination for the work actually performed. Where a contractor or subcontractor is performing construction on a project in a locality other than that in which its program is registered, the ratios and wage rates (expressed in percentages of the journeyman-level hourly rate) specified in the contractor's or subcontractor's registered program shall be observed.

(3) Every apprentice must be paid at not less than the rate specified in the registered program for the apprentice's level of progress, expressed as a percentage of the journeyman-level hourly rate specified in the applicable wage determination. Apprentices shall be paid fringe benefits in accordance with the provisions of the apprenticeship program. If the apprenticeship program does not specify fringe benefits, apprentices must be paid the full amount of fringe benefits listed on the wage determination for the applicable classification. If the Administrator for the Wage and Hour Division determines that a different practice prevails for the applicable apprentice classification, fringes shall be paid in accordance with that determination.

(4) In the event the Bureau of Apprenticeship and Training, or a State apprenticeship agency recognized by the Bureau, withdraws approval of an apprenticeship program, the contractor or subcontractor will no longer be permitted to utilize apprentices at less than the applicable predetermined rate for the comparable work performed by regular employees until an acceptable program is approved.

b. Trainees:

(1) Except as provided in 29 CFR 5.16, trainees will not be permitted to work at less than the predetermined rate for the work performed unless they are employed pursuant to and individually registered in a program which has received prior approval, evidenced by formal certification by the DOL, Employment and Training Administration.

(2) The ratio of trainees to journeyman-level employees on the job site shall not be greater than permitted under the plan approved by the Employment and Training Administration. Any employee listed on the payroll at a trainee rate who is not registered and participating in a training plan approved by the Employment and Training Administration shall be paid not less than the applicable wage rate on the wage determination for the classification of work actually performed. In addition, any trainee performing work on the job site in excess of the ratio permitted under the registered program shall be paid not less than the applicable wage rate on the wage determination for the work actually performed.

(3) Every trainee must be paid at not less than the rate specified in the approved program for his/her level of progress, expressed as a percentage of the journeyman-level hourly rate specified in the applicable wage determination. Trainees shall be paid fringe benefits in accordance with the provisions of the trainee program. If the trainee program does not mention fringe benefits, trainees shall be paid the full amount of fringe benefits

Wage and Hour Division determines that there is an apprenticeship program associated with the corresponding journeyman-level wage rate on the wage determination which provides for less than full fringe benefits for apprentices, in which cases such trainees shall receive the same fringe benefits as apprentices.

(4) In the event the Employment and Training Administration withdraws approval of a training program, the contractor or subcontractor will no longer be permitted to utilize trainees at less than the applicable predetermined rate for the work performed until an acceptable program is approved.

c. Helpers:

Helpers will be permitted to work on a project if the helper classification is specified and defined on the applicable wage determination or is approved pursuant to the conformance procedure set forth in Section IV. 2. Any worker listed on a payroll at a helper wage rate, who is not a helper under a approved definition, shall be paid not less than the applicable wage rate on the wage determination for the classification of work actually performed.

5. Apprentices and Trainees (Programs of the U.S. DOT):

Apprentices and trainees working under apprenticeship and skill training programs which have been certified by the Secretary of Transportation as promoting EEO in connection with Federal-aid highway construction programs are not subject to the requirements of paragraph 4 of this Section IV. The straight time hourly wage rates for apprentices and trainees under such programs will be established by the particular programs. The ratio of apprentices and trainees to journeymen shall not be greater than permitted by the terms of the particular program.

6. Withholding:

The SHA shall upon its own action or upon written request of an authorized representative of the DOL withhold, or cause to be withheld, from the contractor or subcontractor under this contract or any other Federal contract with the same prime contractor or any other Federally-assisted contract subject to Davis-Bacon prevailing wage requirements which is held by the same prime contractor, as much of the accrued payments or advances as may be considered necessary to pay laborers and mechanics, including apprentices, trainee's and helpers, employed by the contractor or any subcontractor the full amount of wages required by the contract. In the event of failure to pay any laborer or mechanic, including any apprentice, trainee, or helper, employed or working on the site of the work, all or part of the wages required by the contract, the SHA contracting officer may, after written notice to the contractor, take such action as may be necessary to cause the suspension of any further payment, advance, or guarantee of funds until such violations have ceased.

7. Overtime Requirements:

No contractor or subcontractor contracting for any part of the contract work which may require or involve the employment of laborers, mechanics, watchmen, or guards (including apprentices, trainees, and helpers described in paragraphs 4 and 5 above) shall require or permit any laborer, mechanic, watchman, or guard in any workweek in which he/she is employed on such work, to work in excess of 40 hours in such workweek unless such laborer, mechanic, watchman, or guard receives compensation at a rate not less than one-and-one-half times his/her basic rate of pay for all hours worked in excess of 40 hours in such workweek.

8. Violation:

Liability for Unpaid Wages; Liquidated Damages: In the event of any violation of the clause set forth in paragraph 7 above, the contractor and any subcontractor responsible thereof shall be liable to the affected employee for his/her unpaid wages. In addition, such contractor and subcontractor shall be liable to the United States (in the case of work done under contract for the District of Columbia or a territory, to such District or to such territory) for liquidated damages. Such liquidated damages shall be computed with respect to each individual laborer, mechanic, watchman, or guard employed in violation of the clause set forth in paragraph 7, in the sum of \$10 for each calendar day on which such employee was required or permitted to work in excess of the standard work week of 40 hours without payment of the overtime wages required by the clause set forth in paragraph 7.

9. Withholding for Unpaid Wages and Liquidated Damages:

The SHA shall, upon its own action or upon written request of any authorized representative of the DOL withhold, or cause to be withheld, from any monies payable on account of work performed by the contractor or subcontractor under any such contract or any other Federal contract with the same prime contractor, or any other Federally-assisted contract subject to the Contract Work Hours and Safety Standards Act, which is held by the same prime contractor, such sums as may be determined to be necessary to satisfy any liabilities of such contractor or subcontractor for unpaid wages and liquidated damages as provided in the clause set forth in paragraph 8 above.

V. STATEMENTS AND PAYROLLS

(Applicable to all Federal-aid construction contracts exceeding \$2,000 and to all related subcontracts, except for projects located on roadways classified as local roads or rural collectors, which are exempt.)

1. Compliance with Copeland Regulations (29 CFR 3):

The contractor shall comply with the Copeland Regulations of the Secretary of Labor which are herein incorporated by reference.

2. Payrolls and Payroll Records:

a. Payrolls and basic records relating thereto shall be maintained by the contractor and each subcontractor during the course of the work and preserved for a period of 3 years from the date of completion of the contract for all laborers, mechanics, apprentices, trainees, watchmen, helpers, and guards working at the site of the work.

b. The payroll records shall contain the name, social security number, and address of each such employee; his or her correct classification; hourly rates of wages paid (including rates of contributions or costs anticipated for bona fide fringe benefits or cash equivalent thereof the types described in Section 1(b)(2)(B) of the Davis Bacon Act); daily and weekly number of hours worked; deductions made; and actual wages paid. In addition, for Appalachian contracts, the payroll records shall contain a notation indicating whether the employee does, or does not, normally reside in the labor area as defined in Attachment A, paragraph 1. Whenever the Secretary of Labor, pursuant to Section IV, paragraph 3b, has found that the wages of any laborer or mechanic include the amount of any costs reasonably anticipated in providing benefits under a plan

or program described in Section 1(b)(2)(B) of the Davis Bacon Act, the contractor and each subcontractor shall maintain records which show that the commitment to provide such benefits is enforceable, that the plan or program is financially responsible, that the plan or program has been communicated in writing to the laborers or mechanics affected, and show the cost anticipated or the actual cost incurred in providing benefits. Contractors or subcontractors employing apprentices or trainees under approved programs shall maintain written evidence of the registration of apprentices and trainees, and ratios and wage rates prescribed in the applicable programs.

c. Each contractor and subcontractor shall furnish, each week in which any contract work is performed, to the SHA resident engineer a payroll of wages paid each of its employees (including apprentices trainees, and helpers, described in Section IV, paragraphs 4 and 5, and watchmen and guards engaged on work during the preceding weekly payroll period).

The payroll submitted shall set out accurately and completely all of the information required to be maintained under paragraph 2b of this Section V.

This information may be submitted in any form desired. Optional Form WH-347 is available for this purpose and may be purchased from the Superintendent of Documents (Federal stock number 029-005-0014-1), U.S. Government Printing Office, Washington, D.C. 20402. The prime contractor is responsible for the submission of copies of payrolls by all subcontractors.

d. Each payroll submitted shall be accompanied by a "Statement of Compliance," signed by the Contractor or subcontractor or his/her agent who pays or supervises the payment of the persons employed under the contract and shall certify the following:

(1) that the payroll for the payroll period contains the information required to be maintained under paragraph 2b of this Section V and that such information is correct and complete;

(2) that such laborer or mechanic (including each helper, apprentice, and trainee) employed on the contract during the payroll period has been paid the full weekly wages earned, without rebate, either directly or indirectly, and that no deductions have been made either directly or indirectly from the full wages earned, other than permissible deductions as set forth in the Regulations, 29 CFR 3;

(3) that each laborer or mechanic has been paid not less than the applicable wage rate and fringe benefits or cash equivalent for the classification of work performed, as specified in the applicable wage determination incorporated into the contract.

e. The weekly submission of a properly executed certification set forth on the reverse side of Optional Form WH-347 shall satisfy the requirement for submission of the "Statement of Compliance" required by paragraph 2d of this Section V.

f. The falsification of any of the above certifications may subject the contractor to civil or criminal prosecution under 18 U.S. C. 1001 and 31 U.S.C. 231.

g. The contractor or subcontractor shall make the records required under paragraph 2b of this Section V available for

inspection, copying, or transcription by authorized representatives of the SHA, the FHWA, or the DOL, and shall permit such representatives to interview employees during working hours on the job. If the contractor or subcontractor fails to submit the required records or to make them available, the SHA, the FHWA, the DOL, or all may, after written notice to the contractor, sponsor, applicant, or owner, take such actions as may be necessary to cause the suspension of any further payment, advance, or guarantee of funds. Furthermore, failure to submit the required records upon request or to make such records available may be grounds for debarment action pursuant to 29 CFR 5.12.

VI. RECORD OF MATERIALS, SUPPLIES, AND LABOR

1. On all federal-aid contracts on the national highway system, except those which provide solely for the installation of protective devices at railroad grade crossings, those which are constructed on a force account or direct labor basis, highway beautification contracts, and contracts for which the total final construction cost for roadway and bridge is less than \$1,000,000 (23 CFR 635) the contractor shall:

a. Become familiar with the list of specific materials and supplies contained in Form FHWA-47, "Statement of Materials and Labor Used by Contractor of Highway Construction Involving Federal Funds," prior to the commencement of work under this contract.

b. Maintain a record of the total cost of all materials and supplies purchased for and incorporated in the work, and also of the quantities of those specific materials and supplies listed on Form FHWA-47, and in the units shown on Form FHWA-47.

c. Furnish, upon the completion of the contract, to the SHA resident engineer on Form FHWA-47 together with the data required in paragraph 1b relative to materials and supplies, a final labor summary of all contract work indicating the total hours worked and the total amount earned.

2. At the prime contractor's option, either a single report covering all contract work or separate reports for the contractor and for each subcontract shall be submitted.

VII. SUBLETTING OR ASSIGNING THE CONTRACT

1. The contractor shall perform with its own organization contract work amounting to not less than 30 percent (or a greater percentage if specified elsewhere in the contract) of the total original contract price, excluding any specialty items designated by the State. Specialty items may be performed by subcontract and the amount of any such specialty items performed may be deducted from the total original contract price before computing the amount of work required to be performed by the contractor's own organization (23 CFR 635).

a. "Its own organization" shall be construed to include only workers employed and paid directly by the prime contractor and equipment owned or rented by the prime contractor, with or without operators. Such term does not include employees or equipment of a subcontractor, assignee, or agent of the prime contractor.

b. "Specialty Items" shall be construed to be limited to work that requires highly specialized knowledge, abilities, or equipment not ordinarily available in the type of contracting organizations qualified and expected to bid on the contract as a

whole and in general are to be limited to minor components of the overall contract.

2. The contract amount upon which the requirements set forth in paragraph 1 of Section VII is computed includes the cost of material and manufactured products which are to be purchased or produced by the contractor under the contract provisions.

3. The contractor shall furnish (a) a competent superintendent or supervisor who is employed by the firm, has full authority to direct performance of the work in accordance with the contract requirements, and is in charge of all construction operations (regardless of who performs the work) and (b) such other of its own organizational resources (supervision, management, and engineering services) as the SHA contracting officer determines is necessary to assure the performance of the contract.

4. No portion of the contract shall be sublet, assigned or otherwise disposed of except with the written consent of the SHA contracting officer, or authorized representative, and such consent when given shall not be construed to relieve the contractor of any responsibility for the fulfillment of the contract.

Written consent will be given only after the SHA has assured that each subcontract is evidenced in writing and that it contains all pertinent provisions and requirements of the prime contract.

VIII. SAFETY: ACCIDENT PREVENTION

1. In the performance of this contract the contractor shall comply with all applicable Federal, State, and local laws governing safety, health, and sanitation (23 CFR 635). The contractor shall provide all safeguards, safety devices and protective equipment and take any other needed actions as it determines, or as the SHA contracting officer may determine, to be reasonably necessary to protect the life and health of employees on the job and the safety of the public and to protect property in connection with the performance of the work covered by the contract.

2. It is a condition of this contract, and shall be made a condition of each subcontract, which the contractor enters into pursuant to this contract, that the contractor and any subcontractor shall not permit any employee, in performance of the contract, to work in surroundings or under conditions which are unsanitary, hazardous or dangerous to his/her health or safety, as determined under construction safety and health standards (29 CFR 1926) promulgated by the Secretary of Labor, in accordance with Section 107 of the Contract Work Hours and Safety Standards Act (40 U.S.C. 333).

3. Pursuant to 29 CFR 1926.3, it is a condition of this contract that the Secretary of Labor or authorized representative thereof, shall have right of entry to any site of contract performance to inspect or investigate the matter of compliance with the construction safety and health standards and to carry out the duties of the Secretary under Section 107 of the Contract Work Hours and Safety Standards Act (40 U.S.C. 333).

IX. FALSE STATEMENTS CONCERNING HIGHWAY PROJECTS

In order to assure high quality and durable construction in conformity with approved plans and specifications and a high degree of reliability on statements and representations made by engineers, contractors, suppliers, and workers on Federal-aid highway projects, it is essential that all persons concerned with the project perform their functions as carefully, thoroughly, and honestly as possible. Willful falsification,

distortion, or misrepresentation with respect to any facts related to the project is a violation of Federal law. To prevent any misunderstanding regarding the seriousness of these and similar acts, the following notice shall be posted on each Federal-aid highway project (23 CFR 635) in one or more places where it is readily available to all persons concerned with the project:

NOTICE TO ALL PERSONNEL ENGAGED ON FEDERAL-AID HIGHWAY PROJECTS

18 U.S.C. 1020 reads as follows:

"Whoever, being an officer, agent or employee of the United States, or of any State or Territory, or whoever, whether a person, association, firm, or corporation, knowingly makes any false statement, false representation, or false report as to the character, quality, quantity, or cost of the material used or to be used, or the quantity or quality of the work performed or to be performed, or the cost thereof in connection with the submission of plans, maps, specifications, contracts, or costs of construction on any highway or related project submitted for approval to the Secretary of Transportation; or

Whoever knowingly makes any false statement, false representation, false report or false claim with respect to the character, quality, quantity, or cost of any work performed or to be performed, or materials furnished or to be furnished, in connection with the construction of any highway or related project approved by the Secretary of Transportation; or

Whoever knowingly makes any false statement or false representation as to material fact in any statement, certificate, or report submitted pursuant to provisions of the Federal-aid Roads Act approved July 1, 1916, (39 Stat. 355), as amended and supplemented;

Shall be fined not more than \$10,000 or imprisoned not more than 5 years or both."

X. IMPLEMENTATION OF CLEAN AIR ACT AND FEDERAL WATER POLLUTION CONTROL ACT

(Applicable to all Federal-aid construction contracts and to all related subcontracts of \$100,000 or more).

By submission of this bid or the execution of this contract, or subcontract, as appropriate, the bidder, Federal-aid construction contractor, or subcontractor, as appropriate, will be deemed to have stipulated as follows:

1. That any facility that is or will be utilized in the performance of this contract, unless such contract is exempt under the Clean Air Act, as amended (42 U.S.C. 1857 et seq., as amended by Pub.L. 91-604), and under the Federal Water Pollution Control Act, as amended (33 U.S.C. 1251 et seq., as amended by Pub.L. 92-500), Executive Order 11738, and regulations in implementation thereof (40 CFR 15) is not listed, on the date of contract award, on the U.S. Environmental Protection Agency (EPA) List of Violating Facilities pursuant to 40 CFR 15.20.

2. That the firm agrees to comply and remain in compliance with all the requirements of Section 114 of the Clean Air Act and Section 308 of the Federal Water Pollution Control Act and all regulations and guidelines listed thereunder.

3. That the firm shall promptly notify the SHA of the receipt of

any communication from the Director, Office of Federal Activities, EPA indicating that a facility that is or will be utilized for the contract is under consideration to be listed on the EPA List of Violating Facilities.

4. That the firm agrees to include or cause to be included the requirements of paragraph 1 through 4 of this Section X in every nonexempt subcontract, and further agrees to take such action as the government may direct as a means of enforcing such requirements.

XI. CERTIFICATION REGARDING DEBARMENT, SUSPENSION, INELIGIBILITY AND VOLUNTARY EXCLUSION

1. Instructions for Certification - Primary Covered Transactions:

(Applicable to all Federal-aid contracts - 49 CFR 29)

a. By signing and submitting this proposal, the prospective primary participant is providing the certification set out below.

b. The inability of a person to provide the certification set out below will not necessarily result in denial of participation in this covered transaction. The prospective participant shall submit an explanation of why it cannot provide the certification set out below. The certification or explanation will be considered in connection with the department or agency's determination whether to enter into this transaction. However, failure of the prospective primary participant to furnish a certification or an explanation shall disqualify such a person from participation in this transaction.

c. The certification in this clause is a material representation of fact upon which reliance was placed when the department or agency determined to enter into this transaction. If it is later determined that the prospective primary participant knowingly rendered an erroneous certification, in addition to other remedies available to the Federal Government, the department or agency may terminate this transaction for cause of default.

d. The prospective primary participant shall provide immediate written notice to the department or agency to whom this proposal is submitted if any time the prospective primary participant learns that its certification was erroneous when submitted or has become erroneous by reason of changed circumstances.

e. The terms "covered transaction," "debarred," "suspended," "ineligible," "lower tier covered transaction," "participant," "person," "primary covered transaction," "principal," "proposal," and "voluntarily excluded," as used in this clause, have the meanings set out in the Definitions and Coverage sections of rules implementing Executive Order 12549. You may contact the department or agency to which this proposal is submitted for assistance in obtaining a copy of those regulations.

f. The prospective primary participant agrees by submitting this proposal that, should the proposed covered transaction be entered into, it shall not knowingly enter into any lower tier covered transaction with a person who is debarred, suspended, declared ineligible, or voluntarily excluded from participation in this covered transaction, unless authorized by the department or agency entering into this transaction.

g. The prospective primary participant further agrees by submitting this proposal that it will include the clause titled

“Certification Regarding Debarment, Suspension, Ineligibility and Voluntary Exclusion-Lower Tier Covered Transaction,” provided by the department or agency entering into this covered transaction, without modification in all lower tier covered transactions and in all solicitations for lower tier covered transactions.

h. A participant in a covered transaction may rely upon a certification of a prospective participant in a lower tier covered transaction that is not debarred, suspended, ineligible, or voluntarily excluded from the covered transaction, unless it knows that the certification is erroneous. A participant may decide the method and frequency by which it determines the eligibility of its principals. Each participant may, but is not required to, check the nonprocurement portion of the “Lists of Parties Excluded from Federal Procurement or Nonprocurement Programs” (Nonprocurement List) which is compiled by the General Services Administration.

i. Nothing contained in the foregoing shall be construed to require establishment of a system of records in order to render in good faith the certification required by this clause. The knowledge and information of participant is not required to exceed that which is normally possessed by a prudent person in the ordinary course of business dealings.

j. Except for transactions authorized under paragraph f of these instructions, if a participant in a covered transaction knowingly enters into a lower tier covered transaction with a person who is suspended, debarred, ineligible, or voluntarily excluded from participation in this transaction, in addition to other remedies available to the Federal Government, the department or agency may terminate this transaction for cause or default.

Certification Regarding Debarment, Suspension, Ineligibility and Voluntary Exclusion-Primary Covered Transactions

1. The prospective primary participant certifies to the best of its knowledge and belief, that it and its principals:

- a. Are not presently debarred, suspended, proposed for debarment, declared ineligible, or voluntarily excluded from covered transactions by any Federal department or agency;
- b. Have not within a 3-year period preceding this proposal been convicted of or had a civil judgment rendered against them for commission of fraud or a criminal offense in connection with obtaining, attempting to obtain, or performing a public (Federal, State or local) transaction or contract under a public transaction; violation of Federal or State antitrust statutes or commission of embezzlement, theft, forgery, bribery, falsification or destruction of records, making false statements, or receiving stolen property;
- c. Are not presently indicted for or otherwise criminally or civilly charged by a governmental entity (Federal, State or local) with commission of any of the offenses enumerated in paragraph 1b of this certification; and
- d. Have not within a 3-year period preceding this application/proposal had one or more public transactions (Federal, State or local) terminated for cause or default.

2. Where the prospective primary participant is unable to certify to any of the statements in this certification, such prospective participant shall attach an explanation to this proposal.

2. Instructions for Certification - Lower Tier Covered Transactions:

(Applicable to all subcontracts, purchase orders and other lower tier transactions of \$25,000 or more - 49 CFR 29)

- a. By signing and submitting this proposal, the prospective lower tier is providing the certification set out below.
- b. The certification in this clause is a material representation of fact upon which reliance was placed when this transaction was entered into. If it is later determined that the prospective lower tier participant knowingly rendered an erroneous certification, in addition to other remedies available to the Federal Government, the department, or agency with which this transaction originated may pursue available remedies, including suspension and/or debarment.
- c. The prospective lower tier participant shall provide immediate written notice to the person to which this proposal is submitted if at any time the prospective lower tier participant learns that its certification was erroneous by reason of changed circumstances.
- d. The terms “covered transaction,” “debarred,” “suspended,” “ineligible,” “primary covered transaction,” “participant,” “person,” “principal,” “proposal,” and “voluntarily excluded,” as used in this clause, have the meanings set out in the Definitions and Coverage sections of rules implementing Executive Order 12549. You may contact the person to which this proposal is submitted for assistance in obtaining a copy of those regulations.
- e. The prospective lower tier participant agrees by submitting this proposal that, should the proposed covered transaction be entered into, it shall not knowingly enter into any lower tier covered transaction with a person who is debarred, suspended, declared ineligible, or voluntarily excluded from participation in this covered transaction, unless authorized by the department or agency with which this transaction originated.
- f. The prospective lower tier participant further agrees by submitting this proposal that it will include this clause titled “Certification Regarding Debarment, Suspension, Ineligibility and Voluntary Exclusion-Lower Tier Covered Transaction,” without modification, in all lower tier covered transactions and in all solicitations for lower tier covered transactions.
- g. A participant in a covered transaction may rely upon a certification of a prospective participant in a lower tier covered transaction that is not debarred, suspended, ineligible, or voluntarily excluded from the covered transaction, unless it knows that the certification is erroneous. A participant may decide the method and frequency by which it determines the eligibility of its principals. Each participant may, but is not required to, check the Nonprocurement List.
- h. Nothing contained in the foregoing shall be construed to require establishment of a system of records in order to render in good faith the certification required by this clause. The knowledge and information of participant is not required to exceed that which is normally possessed by a prudent person in the ordinary course of business dealing.
- i. Except for transactions authorized under paragraph e of these instructions, if a participant in a covered transaction knowingly enters into a lower tier covered transaction with a person who is suspended, debarred, ineligible, or voluntarily

excluded from participation in this transaction, in addition to other remedies available to the Federal Government, the department or agency with which this transaction originated may pursue available remedies, including suspension and/or debarment.

Certification Regarding Debarment, Suspension, Ineligibility And Voluntary Exclusion-Lower Tier Covered Transactions:

1. The prospective lower tier participant certifies, by submission of this proposal, that neither it nor its principals is presently debarred, suspended, proposed for debarment, declared ineligible, or voluntarily excluded from participation in this transaction by any Federal department or agency.

2. Where the prospective lower tier participant is unable to certify to any of the statements in this certification, such prospective participant shall attach an explanation to this proposal.

XII. CERTIFICATION REGARDING USE OF CONTRACT FUNDS FOR LOBBYING

(Applicable to all Federal-aid construction contracts and to all related subcontracts which exceed \$100,000 - 49 CFR 20)

1. The prospective participant certifies, by signing and submitting this bid or proposal, to the best of his or her knowledge and belief, that:

a. No Federal appropriated funds have been paid or will be paid, by or on behalf of the undersigned, to any person for influencing or attempting to influence an officer or employee of any Federal agency, a Member of Congress, an officer or employee of Congress, or an employee of a Member of Congress in connection with the awarding of any Federal contract, the making of any Federal grant, the making of any Federal loan, the entering into of any cooperative agreement, and the extension, continuation, renewal, amendment, or modification of any Federal contract, grant, loan, or cooperative agreement.

b. If any funds other than Federal appropriated funds have been paid or will be paid to any person for influencing or attempting to influence an officer or employee of any Federal agency, a Member of Congress, an officer or employee of Congress, or an employee of a Member of Congress in connection with this Federal contract, grant, loan, or cooperative agreement, the undersigned shall complete and submit Standard Form-LLL, "Disclosure Form to Report Lobbying," in accordance with its instructions.

2. This certification is a material representation of fact upon which reliance was placed when this transaction was made or entered into. Submission of this certification is a prerequisite for making or entering into this transaction imposed by 31 U.S.C. 1352. Any person who fails to file the required certification shall be subject to a civil penalty of not less than \$10,000 and not more than \$100,000 for each such failure.

3. The prospective participant also agrees by submitting his or her bid or proposal that he or she shall require that the language of this certification be included in all lower tier subcontracts, which exceed \$100,000 and that all such recipients shall certify and disclose accordingly.

MINIMUM WAGES FOR FEDERAL AND FEDERALLY ASSISTED CONSTRUCTION CONTRACTS

This project is funded, in part, with Federal-aid funds and, as such, is subject to the provisions of the Davis-Bacon Act of March 3, 1931, as amended (46 Sta. 1494, as amended, 40 U.S.C. 276a) and of other Federal statutes referred to in a 29 CFR Part 1, Appendix A, as well as such additional statutes as may from time to time be enacted containing provisions for the payment of wages determined to be prevailing by the Secretary of Labor in accordance with the Davis-Bacon Act and pursuant to the provisions of 29 CFR Part 1. The prevailing rates and fringe benefits shown in the General Wage Determination Decisions issued by the U.S. Department of Labor shall, in accordance with the provisions of the foregoing statutes, constitute the minimum wages payable on Federal and federally assisted construction projects to laborers and mechanics of the specified classes engaged on contract work of the character and in the localities described therein.

General Wage Determination Decisions, modifications and supersedes decisions thereto are to be used in accordance with the provisions of 29 CFR Parts 1 and 5. Accordingly, the applicable decision, together with any modifications issued, must be made a part of every contract for performance of the described work within the geographic area indicated as required by an applicable DBRA Federal prevailing wage law and 29 CFR Part 5. The wage rates and fringe benefits contained in the General Wage Determination Decision

NOTICE

The most current **General Wage Determination Decisions** (wage rates) are available on the IDOT web site. They are located on the Letting and Bidding page at <http://www.dot.il.gov/desenv/delett.html>.

In addition, ten (10) days prior to the letting, the applicable Federal wage rates will be e-mailed to subscribers. It is recommended that all contractors subscribe to the Federal Wage Rates List or the Contractor's Packet through IDOT's subscription service.

PLEASE NOTE: if you have already subscribed to the Contractor's Packet you will automatically receive the Federal Wage Rates.

The instructions for subscribing are at <http://www.dot.il.gov/desenv/subsc.html>.

If you have any questions concerning the wage rates, please contact IDOT's Chief Contract Official at 217-782-7806.