

If you plan to submit a bid directly to the Department of Transportation

PREQUALIFICATION

Any contractor who desires to become pre-qualified to bid on work advertised by IDOT must submit the properly completed pre-qualification forms to the Bureau of Construction no later than 4:30 p.m. prevailing time twenty-one days prior to the letting of interest. This pre-qualification requirement applies to first time contractors, contractors renewing expired ratings, contractors maintaining continuous pre-qualification or contractors requesting revised ratings. To be eligible to bid, existing pre-qualification ratings must be effective through the date of letting.

REQUESTS FOR AUTHORIZATION TO BID

Contractors downloading and/or ordering CD-ROM's and are wanting to bid on items included in a particular letting must submit the properly completed "Request for Authorization to Bid/or Not For Bid Status" (BDE 124INT) and the ORIGINAL, signed and notarized, "Affidavit of Availability" (BC 57) to the proper office no later than 4:30 p.m. prevailing time, three (3) days prior to the letting date.

WHO CAN BID ?

Bids will be accepted from only those companies that request and receive written **Authorization to Bid** from IDOT's Central Bureau of Construction.

WHAT CONSTITUTES WRITTEN AUTHORIZATION TO BID? When a prospective prime bidder submits a "Request for Authorization to Bid/or Not For Bid Status" (BDE 124INT) he/she must indicate at that time which items are being requested For Bidding purposes. Only those items requested For Bidding will be analyzed. After the request has been analyzed, the bidder will be issued a **Proposal Denial and/or Authorization Form**, approved by the Central Bureau of Construction, that indicates which items have been approved For Bidding. If **Authorization to Bid** cannot be approved, the **Proposal Denial and/or Authorization Form** will indicate the reason for denial.

ABOUT AUTHORIZATION TO BID: Firms that have not received an authorization form within a reasonable time of complete and correct original document submittal should contact the department as to status. This is critical in the week before the letting. These documents must be received three days before the letting date. Firms unsure as to authorization status should call the Prequalification Section of the Bureau of Construction at the number listed at the end of these instructions.

ADDENDA AND REVISIONS: It is the contractor's responsibility to determine which, if any, addenda or revisions pertain to any project they may be bidding. Failure to incorporate all relevant addenda or revisions may cause the bid to be declared unacceptable.

Each addendum will be placed with the contract number. Addenda and revisions will also be placed on the Addendum/Revision Checklist and each subscription service subscriber will be notified by e-mail of each addendum and revision issued.

The Internet is the Department's primary way of doing business. The subscription server e-mails are an added courtesy the Department provides. It is suggested that bidder check IDOT's website <http://www.dot.il.gov/desenv/delett.html> before submitting final bid information.

IDOT is not responsible for any e-mail related failures.

Addenda Questions may be directed to the Contracts Office at (217)782-7806 or D&Econtracts@dot.il.gov

Technical Questions about downloading these files may be directed to Tim Garman (217)524-1642 or garmantr@dot.il.gov.

WHAT MUST BE INCLUDED WHEN BIDS ARE SUBMITTED?: Bidders need not return the entire proposal when bids are submitted. That portion of the proposal that must be returned includes the following:

1. All documents from the Proposal Cover Sheet through the Proposal Bid Bond
2. Other special documentation and/or information that may be required by the contract special provisions

All proposal documents, including Proposal Guaranty Checks or Proposal Bid Bonds, should be stapled together to prevent loss when bids are processed by IDOT personnel.

ABOUT SUBMITTING BIDS: It is recommended that bidders deliver bids in person to insure they arrive at the proper location prior to the time specified for the receipt of bids. Any bid received at the place of letting after the time specified will not be accepted.

WHO SHOULD BE CALLED IF ASSISTANCE IS NEEDED?

Questions Regarding	Call
Prequalification and/or Authorization to Bid	(217)782-3413
Preparation and submittal of bids	(217)782-7806
Mailing of plans and proposals	(217)782-7806
Electronic plans and proposals	(217)524-1642

ADDENDUMS AND REVISIONS TO THE PROPOSAL FORMS

Planholders should verify that they have received and incorporated the addendum and/or revision prior to submitting their bid. Failure by the bidder to include an addendum could result in a bid being rejected as irregular.

78

RETURN WITH BID

Proposal Submitted By
Name
Address
City

Letting August 5, 2005

BIDDERS NEED NOT RETURN THE ENTIRE PROPOSAL
(See instructions inside front cover)

NOTICE TO PROSPECTIVE BIDDERS
 This proposal can be used for bidding purposes by only those companies that request and receive written AUTHORIZATION TO BID from IDOT's Central Bureau of Construction.
 (SEE INSTRUCTIONS ON THE INSIDE OF COVER)

Notice To Bidders, Specifications, Proposal, Contract and Contract Bond



**Illinois Department
of Transportation**

Springfield, Illinois 62764

**Contract No. 64B02
BUREAU County
Section D2 MRS 2005-14
District 2 Construction Funds
Routes FAP 698 & FAU 5601**

PLEASE MARK THE APPROPRIATE BOX BELOW:

A Bid Bond is included.

A Cashier's Check or a Certified Check is included.

Plans Included
Herein

Prepared by	
Checked by	S

(Printed by authority of the State of Illinois)

INSTRUCTIONS

ABOUT IDOT PROPOSALS: All proposals issued by IDOT are potential bidding proposals. Each proposal contains all Certifications and Affidavits, a Proposal Signature Sheet and a Proposal Bid Bond required for Prime Contractors to submit a bid after written **Authorization to Bid** has been issued by IDOT's Central Bureau of Construction.

WHO CAN BID?: Bids will be accepted from only those companies that request and receive written **Authorization to Bid** from IDOT's Central Bureau of Construction. To request authorization, a potential bidder must complete and submit Part B of the Request for Authorization to Bid/or Not For Bid Status form (BDE 124 INT) and submit an original Affidavit of Availability (BC 57).

WHAT CONSTITUTES WRITTEN AUTHORIZATION TO BID?: When a prospective prime bidder submits a "Request for Proposal Forms and Plans" he/she must indicate at that time which items are being requested For Bidding purposes. Only those items requested For Bidding will be analyzed. After the request has been analyzed, the bidder will be issued a **Proposal Denial and/or Authorization Form**, approved by the Central Bureau of Construction, that indicates which items have been approved For Bidding. If **Authorization to Bid** cannot be approved, the **Proposal Denial and/or Authorization Form** will indicate the reason for denial. If a contractor has requested to bid but has not received a **Proposal Denial and/or Authorization Form**, they should contact the Central Bureau of Construction in advance of the letting date.

WHAT MUST BE INCLUDED WHEN BIDS ARE SUBMITTED?: Bidders need not return the entire proposal when bids are submitted. That portion of the proposal that must be returned includes the following:

1. All documents from the Proposal Cover Sheet through the Proposal Bid Bond
2. Other special documentation and/or information that may be required by the contract special provisions

All proposal documents, including Proposal Guaranty Checks or Proposal Bid Bonds, should be stapled together to prevent loss when bids are processed by IDOT personnel.

ABOUT SUBMITTING BIDS: It is recommended that bidders deliver bids in person to insure they arrive at the proper location prior to the time specified for the receipt of bids. Any bid received at the place of letting after the time specified will not be accepted.

WHO SHOULD BE CALLED IF ASSISTANCE IS NEEDED?

Questions Regarding	Call
Prequalification and/or Authorization to Bid	217/782-3413
Preparation and submittal of bids	217/782-7806
Mailing of CD-ROMS	217/782-7806

RETURN WITH BID



PROPOSAL

TO THE DEPARTMENT OF TRANSPORTATION

1. Proposal of _____

for the improvement identified and advertised for bids in the Invitation for Bids as:

Contract No. 64B02
BUREAU County
Section D2 MRS 2005-14
Routes FAP 698 & FAU 5601
District 2 Construction Funds

1.12 miles of 2 @ 18 feet and various widths bituminous surface removal and bituminous resurfacing on IL Route 89/U.S. Route 6 and IL Route 89 between Ladd and Spring Valley at the interchange with Interstate 80.

2. The undersigned bidder will furnish all labor, material and equipment to complete the above described project in a good and workmanlike manner as provided in the contract documents provided by the Department of Transportation. This proposal will become part of the contract and the terms and conditions contained in the contract documents shall govern performance and payments.

RETURN WITH BID

6. **COMBINATION BIDS.** The undersigned further agrees that if awarded the contract for the sections contained in the following combination, he/she will perform the work in accordance with the requirements of each individual proposal comprising the combination bid specified in the schedule below, and that the combination bid shall be prorated against each section in proportion to the bid submitted for the same. If an error is found to exist in the gross sum bid for one or more of the individual sections included in a combination, the combination bid shall be corrected as provided in the specifications.

When a combination bid is submitted, the schedule below must be completed in each proposal comprising the combination.

If alternate bids are submitted for one or more of the sections comprising the combination, a combination bid must be submitted for each alternate.

Schedule of Combination Bids

Combination No.	Sections Included in Combination	Combination Bid	
		Dollars	Cents

7. **SCHEDULE OF PRICES.** The undersigned bidder submits herewith, in accordance with the rules and instructions, a schedule of prices for the items of work for which bids are sought. The unit prices bid are in U.S. dollars and cents, and all extensions and summations have been made. The bidder understands that the quantities appearing in the bid schedule are approximate and are provided for the purpose of obtaining a gross sum for the comparison of bids. If there is an error in the extension of the unit prices, the unit prices shall govern. Payment to the contractor awarded the contract will be made only for actual quantities of work performed and accepted or materials furnished according to the contract. The scheduled quantities of work to be done and materials to be furnished may be increased, decreased or omitted as provided elsewhere in the contract.

8. **CERTIFICATE OF AUTHORITY.** The undersigned bidder, if a business organized under the laws of another State, assures the Department that it will furnish a copy of its certificate of authority to do business in the State of Illinois with the return of the executed contract and bond. Failure to furnish the certificate within the time provided for execution of an awarded contract may be cause for cancellation of the award and forfeiture of the proposal guaranty to the State.

ILLINOIS DEPARTMENT OF TRANSPORTATION
 SCHEDULE OF PRICES
 CONTRACT
 NUMBER -

64B02

State Job # - C-92-087-05
 PPS NBR - 0-00845-2043
 County Name - BUREAU- -
 Code - 11 - -
 District - 2 - -
 Section Number - D2 MRS 2005-14

Project Number

Route
 FAP 698
 FAU 5601

Item Number	Pay Item Description	Unit of Measure	Quantity	x	Unit Price	=	Total Price
X4066414	BC SC SUPER "C" N50	TON	217.000				
X4066526	P BCSC SUPER "D" N70	TON	1,624.000				
X4066810	POL LB HM SUPER N70	TON	12.000				
X4066910	POL LB MM SUPER N70	TON	1,321.000				
40600200	BIT MATLS PR CT	TON	7.300				
40600300	AGG PR CT	TON	39.000				
40600990	TEMPORARY RAMP	SQ YD	374.000				
40800040	INCIDENTAL BIT SURF	TON	180.000				
44000007	BIT SURF REM 2	SQ YD	20,755.000				
67100100	MOBILIZATION	L SUM	1.000				
70100460	TRAF CONT-PROT 701306	L SUM	1.000				
70300100	SHORT-TERM PAVT MKING	FOOT	2,538.000				
70301000	WORK ZONE PAVT MK REM	SQ FT	281.000				
78000100	THPL PVT MK LTR & SYM	SQ FT	62.400				
78000200	THPL PVT MK LINE 4	FOOT	17,186.000				

ILLINOIS DEPARTMENT OF TRANSPORTATION
 SCHEDULE OF PRICES
 CONTRACT
 NUMBER - 64B02

State Job # - C-92-087-05
 PPS NBR - 0-00845-2043
 County Name - BUREAU- -
 Code - 11 - -
 District - 2 - -
 Section Number - D2 MRS 2005-14

Project Number

Route
 FAP 698
 FAU 5601

Item Number	Pay Item Description	Unit of Measure	Quantity	x	Unit Price	=	Total Price
78000500	THPL PVT MK LINE 8	FOOT	682.000				
78000600	THPL PVT MK LINE 12	FOOT	295.000				
78000650	THPL PVT MK LINE 24	FOOT	163.000				
78100100	RAISED REFL PAVT MKR	EACH	4.000				
78300200	RAISED REF PVT MK REM	EACH	2.000				

CONTRACT NUMBER **64B02**

THIS IS THE TOTAL BID **\$** _____

NOTES:

1. Each PAY ITEM should have a UNIT PRICE and a TOTAL PRICE.
2. The UNIT PRICE shall govern if no TOTAL PRICE is shown or if there is a discrepancy between the product of the UNIT PRICE multiplied by the QUANTITY.
3. If a UNIT PRICE is omitted, the TOTAL PRICE will be divided by the QUANTITY in order to establish a UNIT PRICE.
4. A bid may be declared UNACCEPTABLE if neither a unit price nor a total price is shown.

RETURN WITH BID

STATE REQUIRED ETHICAL STANDARDS GOVERNING CONTRACT PROCUREMENT: ASSURANCES, CERTIFICATIONS AND DISCLOSURES

I. GENERAL

A. Article 50 of the Illinois Procurement Code establishes the duty of all State chief procurement officers, State purchasing officers, and their designees to maximize the value of the expenditure of public moneys in procuring goods, services, and contracts for the State of Illinois and to act in a manner that maintains the integrity and public trust of State government. In discharging this duty, they are charged by law to use all available information, reasonable efforts, and reasonable actions to protect, safeguard, and maintain the procurement process of the State of Illinois.

B. In order to comply with the provisions of Article 50 and to carry out the duty established therein, all bidders are to adhere to ethical standards established for the procurement process, and to make such assurances, disclosures and certifications required by law. By execution of the Proposal Signature Sheet, the bidder indicates that each of the mandated assurances has been read and understood, that each certification is made and understood, and that each disclosure requirement has been understood and completed.

C. In addition to all other remedies provided by law, failure to comply with any assurance, failure to make any disclosure or the making of a false certification shall be grounds for termination of the contract and the suspension or debarment of the bidder.

II. ASSURANCES

A. The assurances hereinafter made by the bidder are each a material representation of fact upon which reliance is placed should the Department enter into the contract with the bidder. The Department may terminate the contract if it is later determined that the bidder rendered a false or erroneous assurance, and the surety providing the performance bond shall be responsible for the completion of the contract.

B. Felons

1. The Illinois Procurement Code provides:

Section 50-10. Felons. Unless otherwise provided, no person or business convicted of a felony shall do business with the State of Illinois or any state agency from the date of conviction until 5 years after the date of completion of the sentence for that felony, unless no person held responsible by a prosecutorial office for the facts upon which the conviction was based continues to have any involvement with the business.

2. The bidder assures the Department that the award and execution of the contract would not cause a violation of Section 50-10.

C. Conflicts of Interest

1. The Illinois Procurement Code provides in pertinent part:

Section 50-13. Conflicts of Interest.

(a) Prohibition. It is unlawful for any person holding an elective office in this State, holding a seat in the General Assembly, or appointed to or employed in any of the offices or agencies of state government and who receives compensation for such employment in excess of 60% of the salary of the Governor of the State of Illinois, or who is an officer or employee of the Capital Development Board or the Illinois Toll Highway Authority, or who is the spouse or minor child of any such person to have or acquire any contract, or any direct pecuniary interest in any contract therein, whether for stationery, printing, paper, or any services, materials, or supplies, that will be wholly or partially satisfied by the payment of funds appropriated by the General Assembly of the State of Illinois or in any contract of the Capital Development Board or the Illinois Toll Highway authority.

(b) Interests. It is unlawful for any firm, partnership, association or corporation, in which any person listed in subsection (a) is entitled to receive (i) more than 7 1/2% of the total distributable income or (ii) an amount in excess of the salary of the Governor, to have or acquire any such contract or direct pecuniary interest therein.

(c) Combined interests. It is unlawful for any firm, partnership, association, or corporation, in which any person listed in subsection (a) together with his or her spouse or minor children is entitled to receive (i) more than 15%, in the aggregate, of the total distributable income or (ii) an amount in excess of 2 times the salary of the Governor, to have or acquire any such contract or direct pecuniary interest therein.

(d) Securities. Nothing in this Section invalidates the provisions of any bond or other security previously offered or to be offered for sale or sold by or for the State of Illinois.

(e) Prior interests. This Section does not affect the validity of any contract made between the State and an officer or employee of the State or member of the General Assembly, his or her spouse, minor child or any combination of those persons if that contract was in existence before his or her election or employment as an officer, member, or employee. The contract is voidable, however, if it cannot be completed within 365 days after the officer, member, or employee takes office or is employed.

The current salary of the Governor is \$150,700.00. Sixty percent of the salary is \$90,420.00.

RETURN WITH BID

2. The bidder assures the Department that the award and execution of the contract would not cause a violation of Section 50-13, or that an effective exemption has been issued by the Board of Ethics to any individual subject to the Section 50-13 prohibitions pursuant to the provisions of Section 50-20 of the Code and Executive Order Number 3 (1998). Information concerning the exemption process is available from the Department upon request.

D. Negotiations

1. The Illinois Procurement Code provides in pertinent part:

Section 50-15. Negotiations.

(a) It is unlawful for any person employed in or on a continual contractual relationship with any of the offices or agencies of State government to participate in contract negotiations on behalf of that office or agency with any firm, partnership, association, or corporation with whom that person has a contract for future employment or is negotiating concerning possible future employment.

2. The bidder assures the Department that the award and execution of the contract would not cause a violation of Section 50-15, and that the bidder has no knowledge of any facts relevant to the kinds of acts prohibited therein.

E. Inducements

1. The Illinois Procurement Code provides:

Section 50-25. Inducement. Any person who offers or pays any money or other valuable thing to any person to induce him or her not to bid for a State contract or as recompense for not having bid on a State contract is guilty of a Class 4 felony. Any person who accepts any money or other valuable thing for not bidding for a State contract or who withholds a bid in consideration of the promise for the payment of money or other valuable thing is guilty of a Class 4 felony.

2. The bidder assures the Department that the award and execution of the contract would not cause a violation of Section 50-25, and that the bidder has no knowledge of any facts relevant to the kinds of acts prohibited therein.

F. Revolving Door Prohibition

1. The Illinois Procurement Code provides:

Section 50-30. Revolving door prohibition. Chief procurement officers, associate procurement officers, State purchasing officers, their designees whose principal duties are directly related to State procurement, and executive officers confirmed by the Senate are expressly prohibited for a period of 2 years after terminating an affected position from engaging in any procurement activity relating to the State agency most recently employing them in an affected position for a period of at least 6 months. The prohibition includes, but is not limited to: lobbying the procurement process; specifying; bidding; proposing bid, proposal, or contract documents; on their own behalf or on behalf of any firm, partnership, association, or corporation. This Section applies only to persons who terminate an affected position on or after January 15, 1999.

2. The bidder assures the Department that the award and execution of the contract would not cause a violation of Section 50-30, and that the bidder has no knowledge of any facts relevant to the kinds of acts prohibited therein.

G. Reporting Anticompetitive Practices

1. The Illinois Procurement Code provides:

Section 50-40. Reporting anticompetitive practices. When, for any reason, any vendor, bidder, contractor, chief procurement officer, State purchasing officer, designee, elected official, or State employee suspects collusion or other anticompetitive practice among any bidders, offerors, contractors, proposers, or employees of the State, a notice of the relevant facts shall be transmitted to the Attorney General and the chief procurement officer.

2. The bidder assures the Department that it has not failed to report any relevant facts concerning the practices addressed in Section 50-40 which may involve the contract for which the bid is submitted.

H. Confidentiality

1. The Illinois Procurement Code provides:

Section 50-45. Confidentiality. Any chief procurement officer, State purchasing officer, designee, or executive officer who willfully uses or allows the use of specifications, competitive bid documents, proprietary competitive information, proposals, contracts, or selection information to compromise the fairness or integrity of the procurement, bidding, or contract process shall be subject to immediate dismissal, regardless of the Personnel code, any contract, or any collective bargaining agreement, and may in addition be subject to criminal prosecution.

2. The bidder assures the Department that it has no knowledge of any fact relevant to the practices addressed in Section 50-45 which may involve the contract for which the bid is submitted.

RETURN WITH BID

I. Insider Information

1. The Illinois Procurement Act provides:

Section 50-50. Insider information. It is unlawful for any current or former elected or appointed State official or State employee to knowingly use confidential information available only by virtue of that office or employment for actual or anticipated gain for themselves or another person.

2. The bidder assures the Department that it has no knowledge of any facts relevant to the practices addressed in Section 50-50 which may involve the contract for which the bid is submitted.

III. CERTIFICATIONS

A. The certifications hereinafter made by the bidder are each a material representation of fact upon which reliance is placed should the Department enter into the contract with the bidder. The Department may terminate the contract if it is later determined that the bidder rendered a false or erroneous certification, and the surety providing the performance bond shall be responsible for completion of the contract.

B. Bribery

1. The Illinois Procurement Code provides:

Section 50-5. Bribery.

(a) Prohibition. No person or business shall be awarded a contract or subcontract under this Code who:

(1) has been convicted under the laws of Illinois or any other state of bribery or attempting to bribe an officer or employee of the State of Illinois or any other state in that officer's or employee's official capacity; or

(2) has made an admission of guilt of that conduct that is a matter of record but has not been prosecuted for that conduct.

(b) Businesses. No business shall be barred from contracting with any unit of State or local government as a result of a conviction under this Section of any employee or agent of the business if the employee or agent is no longer employed by the business and:

(1) the business has been finally adjudicated not guilty; or

(2) the business demonstrates to the governmental entity with which it seeks to contract, and that entity finds that the commission of the offense was not authorized, requested, commanded, or performed by a director, officer, or high managerial agent on behalf of the business as provided in paragraph (2) of subsection (a) of Section 5-4 of the Criminal Code of 1961.

(c) Conduct on behalf of business. For purposes of this Section, when an official, agent, or employee of a business committed the bribery or attempted bribery on behalf of the business and in accordance with the direction or authorization of a responsible official of the business, the business shall be chargeable with the conduct.

(d) Certification. Every bid submitted to and contract executed by the State shall contain a certification by the contractor that the contractor is not barred from being awarded a contract or subcontract under this Section. A contractor who makes a false statement, material to the certification, commits a Class 3 felony.

2. The bidder certifies that it is not barred from being awarded a contract under Section 50.5.

C. Educational Loan

1. Section 3 of the Educational Loan Default Act provides:

§ 3. No State agency shall contract with an individual for goods or services if that individual is in default, as defined in Section 2 of this Act, on an educational loan. Any contract used by any State agency shall include a statement certifying that the individual is not in default on an educational loan as provided in this Section.

2. The bidder, if an individual as opposed to a corporation, partnership or other form of business organization, certifies that the bidder is not in default on an educational loan as provided in Section 3 of the Act.

D. Bid-Rigging/Bid Rotating

1. Section 33E-11 of the Criminal Code of 1961 provides:

§ 33E-11. (a) Every bid submitted to and public contract executed pursuant to such bid by the State or a unit of local government shall contain a certification by the prime contractor that the prime contractor is not barred from contracting with any unit of State or local government as a result of a violation of either Section 33E-3 or 33E-4 of this Article. The State and units of local government shall provide the appropriate forms for such certification.

RETURN WITH BID

(b) A contractor who makes a false statement, material to the certification, commits a Class 3 felony.

A violation of Section 33E-3 would be represented by a conviction of the crime of bid-rigging which, in addition to Class 3 felony sentencing, provides that any person convicted of this offense or any similar offense of any state or the United States which contains the same elements as this offense shall be barred for 5 years from the date of conviction from contracting with any unit of State or local government. No corporation shall be barred from contracting with any unit of State or local government as a result of a conviction under this Section of any employee or agent of such corporation if the employee so convicted is no longer employed by the corporation and: (1) it has been finally adjudicated not guilty or (2) if it demonstrates to the governmental entity with which it seeks to contract and that entity finds that the commission of the offense was neither authorized, requested, commanded, nor performed by a director, officer or a high managerial agent in behalf of the corporation.

A violation of Section 33E-4 would be represented by a conviction of the crime of bid-rotating which, in addition to Class 2 felony sentencing, provides that any person convicted of this offense or any similar offense of any state or the United States which contains the same elements as this offense shall be permanently barred from contracting with any unit of State or local government. No corporation shall be barred from contracting with any unit of State or local government as a result of a conviction under this Section of any employee or agent of such corporation if the employee so convicted is no longer employed by the corporation and: (1) it has been finally adjudicated not guilty or (2) if it demonstrates to the governmental entity with which it seeks to contract and that entity finds that the commission of the offense was neither authorized, requested, commanded, nor performed by a director, officer or a high managerial agent in behalf of the corporation.

2. The bidder certifies that it is not barred from contracting with the Department by reason of a violation of either Section 33E-3 or Section 33E-4.

E. International Anti-Boycott

1. Section 5 of the International Anti-Boycott Certification Act provides:

§ 5. State contracts. Every contract entered into by the State of Illinois for the manufacture, furnishing, or purchasing of supplies, material, or equipment or for the furnishing of work, labor, or services, in an amount exceeding the threshold for small purchases according to the purchasing laws of this State or \$10,000.00, whichever is less, shall contain certification, as a material condition of the contract, by which the contractor agrees that neither the contractor nor any substantially-owned affiliated company is participating or shall participate in an international boycott in violation of the provisions of the U.S. Export Administration Act of 1979 or the regulations of the U.S. Department of Commerce promulgated under that Act.

2. The bidder makes the certification set forth in Section 5 of the Act.

F. Drug Free Workplace

1. The Illinois "Drug Free Workplace Act" applies to this contract and it is necessary to comply with the provisions of the "Act" if the contractor is a corporation, partnership, or other entity (including a sole proprietorship) which has 25 or more employees.

2. The bidder certifies that if awarded a contract in excess of \$5,000 it will provide a drug free workplace by:

(a) Publishing a statement notifying employees that the unlawful manufacture, distribution, dispensation, possession or use of a controlled substance, including cannabis, is prohibited in the contractor's workplace; specifying the actions that will be taken against employees for violations of such prohibition; and notifying the employee that, as a condition of employment on such contract, the employee shall abide by the terms of the statement, and notify the employer of any criminal drug statute conviction for a violation occurring in the workplace no later than five (5) days after such conviction.

(b) Establishing a drug free awareness program to inform employees about the dangers of drug abuse in the workplace; the contractor's policy of maintaining a drug free workplace; any available drug counseling, rehabilitation, and employee assistance programs; and the penalties that may be imposed upon employees for drug violations.

(c) Providing a copy of the statement required by subparagraph (1) to each employee engaged in the performance of the contract and to post the statement in a prominent place in the workplace.

(d) Notifying the Department within ten (10) days after receiving notice from an employee or otherwise receiving actual notice of the conviction of an employee for a violation of any criminal drug statute occurring in the workplace.

(e) Imposing or requiring, within 30 days after receiving notice from an employee of a conviction or actual notice of such a conviction, an appropriate personnel action, up to and including termination, or the satisfactory participation in a drug abuse assistance or rehabilitation program approved by a federal, state or local health, law enforcement or other appropriate agency.

(f) Assisting employees in selecting a course of action in the event drug counseling, treatment, and rehabilitation is required and indicating that a trained referral team is in place.

(g) Making a good faith effort to continue to maintain a drug free workplace through implementation of the actions and efforts stated in this certification.

G. Debt Delinquency

1. The Illinois Procurement Code provides:

Section 50-11 and 50-12. Debt Delinquency.

The contractor or bidder certifies that it, or any affiliate, is not barred from being awarded a contract under 30 ILCS 500. Section 50-11 prohibits a person from entering into a contract with a State agency if it knows or should know that it, or any affiliate, is delinquent in the payment of any debt to the State as defined by the Debt Collection Board. Section 50-12 prohibits a person from entering into a contract with a State agency if it, or any affiliate, has failed to collect and remit Illinois Use Tax on all sales of tangible personal property into the State of Illinois in accordance with the provisions of the Illinois Use Tax Act. The contractor further acknowledges that the contracting State agency may declare the contract void if this certification is false or if the contractor, or any affiliate, is determined to be delinquent in the payment of any debt to the State during the term of the contract.

H. Sarbanes-Oxley Act of 2002

1. The Illinois Procurement Code provides:

Section 50-60(c).

The contractor certifies in accordance with 30 ILCS 500/50-10.5 that no officer, director, partner or other managerial agent of the contracting business has been convicted of a felony under the Sarbanes-Oxley Act of 2002 or a Class 3 or Class 2 felony under the Illinois Securities Law of 1953 for a period of five years prior to the date of the bid or contract. The contractor acknowledges that the contracting agency shall declare the contract void if this certification is false.

I. ADDENDA

The contractor or bidder certifies that all relevant addenda have been incorporated in to this contract. Failure to do so may cause the bid to be declared unacceptable.

J. Section 42 of the Environmental Protection Act

The contractor certifies in accordance with 30 ILCS 500/50-12 that the bidder or contractor is not barred from being awarded a contract under this Section which prohibits the bidding on or entering into contracts with the State of Illinois or a State agency by a person or business found by a court or the Pollution Control Board to have committed a willful or knowing violation of Section 42 of the Environmental Protection Act for a period of five years from the date of the order. The contractor acknowledges that the contracting agency may declare the contract void if this certification is false.

K. Apprenticeship and Training Certification (Does not apply to federal aid projects)

In accordance with the provisions of Section 30-22 (6) of the Illinois Procurement Code, the bidder certifies that it is a participant, either as an individual or as part of a group program, in the approved apprenticeship and training programs applicable to each type of work or craft that the bidder will perform with its own forces. The bidder further certifies for work that will be performed by subcontract that each of its subcontractors submitted for approval either (a) is, at the time of such bid, participating in an approved, applicable apprenticeship and training program; or (b) will, prior to commencement of performance of work pursuant to this contract, begin participation in an approved apprenticeship and training program applicable to the work of the subcontract. The Department, at any time before or after award, may require the production of a copy of each applicable Certificate of Registration issued by the United States Department of Labor evidencing such participation by the contractor and any or all of its subcontractors. Applicable apprenticeship and training programs are those that have been approved and registered with the United States Department of Labor. The bidder shall list in the space below, the official name of the program sponsor holding the Certificate of Registration for all of the types of work or crafts in which the bidder is a participant and that will be performed with the bidder's forces. Types of work or craft work that will be subcontracted shall be included and listed as subcontract work. The list shall also indicate any type of work or craft job category that does not have an applicable apprenticeship or training program. **The bidder is responsible for making a complete report and shall make certain that each type of work or craft job category that will be utilized on the project as reported on the Construction Employee Workforce Projection (Form BC-1256) and returned with the bid is accounted for and listed.**

The requirements of this certification and disclosure are a material part of the contract, and the contractor shall require this certification provision to be included in all approved subcontracts. In order to fulfill this requirement, it shall not be necessary that an applicable program sponsor be currently taking or that it will take applications for apprenticeship, training or employment during the performance of the work of this contract.

TO BE RETURNED WITH BID

IV. DISCLOSURES

A. The disclosures hereinafter made by the bidder are each a material representation of fact upon which reliance is placed should the Department enter into the contract with the bidder. The Department may terminate the contract if it is later determined that the bidder rendered a false or erroneous disclosure, and the surety providing the performance bond shall be responsible for completion of the contract.

B. Financial Interests and Conflicts of Interest

1. Section 50-35 of the Illinois Procurement Code provides that all bids of more than \$10,000 shall be accompanied by disclosure of the financial interests of the bidder. This disclosed information for the successful bidder, will be maintained as public information subject to release by request pursuant to the Freedom of Information Act.

The financial interests to be disclosed shall include ownership or distributive income share that is in excess of 5%, or an amount greater than 60% of the annual salary of the Governor, of the bidding entity or its parent entity, whichever is less, unless the contractor or bidder is a publicly traded entity subject to Federal 10K reporting, in which case it may submit its 10K disclosure in place of the prescribed disclosure. If a bidder is a privately held entity that is exempt from Federal 10K reporting, but has more than 400 shareholders, it may submit the information that Federal 10K companies are required to report, and list the names of any person or entity holding any ownership share that is in excess of 5%. The disclosure shall include the names, addresses, and dollar or proportionate share of ownership of each person making the disclosure, their instrument of ownership or beneficial relationship, and notice of any potential conflict of interest resulting from the current ownership or beneficial interest of each person making the disclosure having any of the relationships identified in Section 50-35 and on the disclosure form.

In addition, all disclosures shall indicate any other current or pending contracts, proposals, leases, or other ongoing procurement relationships the bidding entity has with any other unit of state government and shall clearly identify the unit and the contract, proposal, lease, or other relationship.

2. Disclosure Forms. Disclosure Form A is attached for use concerning the individuals meeting the above ownership or distributive share requirements. Subject individuals should be covered each by one form. In addition, a second form (Disclosure Form B) provides for the disclosure of current or pending procurement relationships with other (non-IDOT) state agencies. **The forms must be included with each bid or incorporated by reference.**

C. Disclosure Form Instructions

Form A: For bidders that have previously submitted the information requested in Form A

The Department has retained the Form A disclosures submitted by all bidders responding to these requirements for the April 24, 1998 or any subsequent letting conducted by the Department. The bidder has the option of submitting the information again or the bidder may sign the following certification statement indicating that the information previously submitted by the bidder is, as of the date of signature, current and accurate. The Certification must be signed and dated by a person who is authorized to execute contracts for the bidding company. Before signing this certification, the bidder should carefully review its prior submissions to ensure the Certification is correct. If the Bidder signs the Certification, the Bidder should proceed to Form B instructions.

CERTIFICATION STATEMENT

I have determined that the Form A disclosure information previously submitted is current and accurate, and all forms are hereby incorporated by reference in this bid. Any necessary additional forms or amendments to previously submitted forms are attached to this bid.

(Bidding Company)

Name of Authorized Representative (type or print)

Title of Authorized Representative (type or print)

Signature of Authorized Representative

Date

Form A: For bidders who have NOT previously submitted the information requested in Form A

If the bidder is a publicly traded entity subject to Federal 10K reporting, the 10K Report may be submitted to meet the requirements of Form A. If a bidder is a privately held entity that is exempt from Federal 10K reporting, but has more than 400 shareholders, it may submit the information that Federal 10K companies are required to report, and list the names of any person or entity holding any ownership share that is in excess of 5%. If a bidder is not subject to Federal 10K reporting, the bidder must determine if any individuals are required by law to complete a financial disclosure form. To do this, the bidder should answer each of the following questions. A "YES" answer indicates Form A must be completed. If the answer to each of the following questions is "NO", then the NOT APPLICABLE STATEMENT on the second page of Form A must be signed and dated by a person that is authorized to execute contracts for the bidding company. Note: These questions are for assistance only and are not required to be completed.

1. Does anyone in your organization have a direct or beneficial ownership share of greater than 5% of the bidding entity or parent entity? YES ___ NO ___
2. Does anyone in your organization have a direct or beneficial ownership share of less than 5%, but which has a value greater than \$90,420.00? YES ___ NO ___
3. Does anyone in your organization receive more than \$90,420.00 of the bidding entity's or parent entity's distributive income? (Note: Distributive income is, for these purposes, any type of distribution of profits. An annual salary is not distributive income.) YES ___ NO ___
4. Does anyone in your organization receive greater than 5% of the bidding entity's or parent entity's total distributive income, but which is less than \$90,420.00? YES ___ NO ___

(Note: Only one set of forms needs to be completed per person per bid even if a specific individual would require a yes answer to more than one question.)

A "YES" answer to any of these questions requires the completion of Form A. The bidder must determine each individual in the bidding entity or the bidding entity's parent company that would cause the questions to be answered "Yes". Each form must be signed and dated by a person that is authorized to execute contracts for your organization. **Photocopied or stamped signatures are not acceptable.** The person signing can be, but does not have to be, the person for which the form is being completed. The bidder is responsible for the accuracy of any information provided.

If the answer to each of the above questions is "NO", then the NOT APPLICABLE STATEMENT on page 2 of Form A must be signed and dated by a person that is authorized to execute contracts for your company.

Form B: Identifying Other Contracts & Procurement Related Information Disclosure Form B must be completed for each bid submitted by the bidding entity. It must be signed by an individual who is authorized to execute contracts for the bidding entity. *Note: Signing the NOT APPLICABLE STATEMENT on Form A does not allow the bidder to ignore Form B. Form B must be completed, signed and dated or the bidder may be considered nonresponsive and the bid will not be accepted.*

The Bidder shall identify, by checking Yes or No on Form B, whether it has any pending contracts (including leases), bids, proposals, or other ongoing procurement relationship with any other (non-IDOT) State of Illinois agency. If "No" is checked, the bidder only needs to complete the signature box on the bottom of Form B. If "Yes" is checked, the bidder must do one of the following:

Option I: If the bidder did not submit an Affidavit of Availability to obtain authorization to bid, the bidder must list all non-IDOT State of Illinois agency pending contracts, leases, bids, proposals, and other ongoing procurement relationships. These items may be listed on Form B or on an attached sheet(s). Do not include IDOT contracts. Contracts with cities, counties, villages, etc. are not considered State of Illinois agency contracts and are not to be included. Contracts with other State of Illinois agencies such as the Department of Natural Resources or the Capital Development Board must be included. Bidders who submit Affidavits of Availability are suggested to use Option II.

Option II: If the bidder is required and has submitted an Affidavit of Availability in order to obtain authorization to bid, the bidder may write or type "See Affidavit of Availability" which indicates that the Affidavit of Availability is incorporated by reference and includes all non-IDOT State of Illinois agency pending contracts, leases, bids, proposals, and other ongoing procurement relationships. For any contracts that are not covered by the Affidavit of Availability, the bidder must identify them on Form B or on an attached sheet(s). These might be such things as leases.

D. Bidders Submitting More Than One Bid

Bidders submitting multiple bids may submit one set of forms consisting of all required Form A disclosures and one Form B for use with all bids. Please indicate in the space provided below the bid item that contains the original disclosure forms and the bid items which incorporate the forms by reference.

- The bid submitted for letting item _____ contains the Form A disclosures or Certification Statement and the Form B disclosures. The following letting items incorporate the said forms by reference:

**ILLINOIS DEPARTMENT
OF TRANSPORTATION**

**Form A
Financial Information &
Potential Conflicts of Interest
Disclosure**

Contractor Name		
Legal Address		
City, State, Zip		
Telephone Number	Email Address	Fax Number (if available)

Disclosure of the information contained in this Form is required by the Section 50-35 of the Illinois Procurement Code (30 ILCS 500). Vendors desiring to enter into a contract with the State of Illinois must disclose the financial information and potential conflict of interest information as specified in this Disclosure Form. This information shall become part of the publicly available contract file. This Form A must be completed for bids in excess of \$10,000, and for all open-ended contracts. **A publicly traded company may submit a 10K disclosure (or equivalent if applicable) in satisfaction of the requirements set forth in Form A. See Disclosure Form Instructions.**

DISCLOSURE OF FINANCIAL INFORMATION

1. Disclosure of Financial Information. The individual named below has an interest in the BIDDER (or its parent) in terms of ownership or distributive income share in excess of 5%, or an interest which has a value of more than \$90,420.00 (60% of the Governor's salary as of 7/1/01). **(Make copies of this form as necessary and attach a separate Disclosure Form A for each individual meeting these requirements)**

FOR INDIVIDUAL (type or print information)

NAME: _____

ADDRESS _____

Type of ownership/distributable income share:

stock _____ sole proprietorship _____ Partnership _____ other: (explain on separate sheet):
% or \$ value of ownership/distributable income share: _____

2. Disclosure of Potential Conflicts of Interest. Check "Yes" or "No" to indicate which, if any, of the following potential conflict of interest relationships apply. If the answer to any question is "Yes", please attach additional pages and describe.

(a) State employment, currently or in the previous 3 years, including contractual employment of services. Yes ___ No ___

If your answer is yes, please answer each of the following questions.

1. Are you currently an officer or employee of either the Capitol Development Board or the Illinois Toll Highway Authority? Yes ___ No ___

2. Are you currently appointed to or employed by any agency of the State of Illinois? If you are currently appointed to or employed by any agency of the State of Illinois, and your annual salary exceeds \$90,420.00, (60% of the Governor's salary as of 7/1/01) provide the name the State agency for which you are employed and your annual salary. _____

RETURN WITH BID/OFFER

- 3. If you are currently appointed to or employed by any agency of the State of Illinois, and your annual salary exceeds \$90,420.00, (60% of the Governor's salary as of 7/1/01) are you entitled to receive (i) more than 7 1/2% of the total distributable income of your firm, partnership, association or corporation, or (ii) an amount in excess of the salary of the Governor? Yes ___ No ___
- 4. If you are currently appointed to or employed by any agency of the State of Illinois, and your annual salary exceeds \$90,420.00, (60% of the Governor's salary as of 7/1/01) are you and your spouse or minor children entitled to receive (i) more than 15 % in the aggregate of the total distributable income of your firm, partnership, association or corporation, or (ii) an amount in excess of 2 times the salary of the Governor? Yes ___ No ___

(b) State employment of spouse, father, mother, son, or daughter, including contractual employment services in the previous 2 years.

Yes ___ No ___

If your answer is yes, please answer each of the following questions.

- 1. Is your spouse or any minor children currently an officer or employee of the Capitol Development Board or the Illinois Toll Highway Authority? Yes ___ No ___
- 2. Is your spouse or any minor children currently appointed to or employed by any agency of the State of Illinois? If your spouse or minor children is/are currently appointed to or employed by any agency of the State of Illinois, and his/her annual salary exceeds \$90,420.00, (60 % of the Governor's salary as of 7/1/01) provide the name of your spouse and/or minor children, the name of the State agency for which he/she is employed and his/her annual salary. _____

- 3. If your spouse or any minor children is/are currently appointed to or employed by any agency of the State of Illinois, and his/her annual salary exceeds \$90,420.00, (60% of the salary of the Governor as of 7/1/01) are you entitled to receive (i) more then 71/2% of the total distributable income of your firm, partnership, association or corporation, or (ii) an amount in excess of the salary of the Governor? Yes ___ No ___
- 4. If your spouse or any minor children are currently appointed to or employed by any agency of the State of Illinois, and his/her annual salary exceeds \$90,420.00, (60% of the Governor's salary as of 7/1/01) are you and your spouse or minor children entitled to receive (i) more than 15 % in the aggregate of the total distributable income of your firm, partnership, association or corporation, or (ii) an amount in excess of 2 times the salary of the Governor? Yes ___ No ___

(c) Elective status; the holding of elective office of the State of Illinois, the government of the United States, any unit of local government authorized by the Constitution of the State of Illinois or the statutes of the State of Illinois currently or in the previous 3 years.

Yes ___ No ___

(d) Relationship to anyone holding elective office currently or in the previous 2 years; spouse, father, mother, son, or daughter.

Yes ___ No ___

(e) Appointive office; the holding of any appointive government office of the State of Illinois, the United States of America, or any unit of local government authorized by the Constitution of the State of Illinois or the statutes of the State of Illinois, which office entitles the holder to compensation in excess of the expenses incurred in the discharge of that office currently or in the previous 3 years.

Yes ___ No ___

(f) Relationship to anyone holding appointive office currently or in the previous 2 years; spouse, father, mother, son, or daughter.

Yes ___ No ___

(g) Employment, currently or in the previous 3 years, as or by any registered lobbyist of the State government.

Yes ___ No ___

RETURN WITH BID/OFFER

(h) Relationship to anyone who is or was a registered lobbyist in the previous 2 years; spouse, father, mother, son, or daughter. Yes ___ No ___

(i) Compensated employment, currently or in the previous 3 years, by any registered election or reelection committee registered with the Secretary of State or any county clerk of the State of Illinois, or any political action committee registered with either the Secretary of State or the Federal Board of Elections. Yes ___ No ___

(j) Relationship to anyone; spouse, father, mother, son, or daughter; who was a compensated employee in the last 2 years by any registered election or re-election committee registered with the Secretary of State or any county clerk of the State of Illinois, or any political action committee registered with either the Secretary of State or the Federal Board of Elections. Yes ___ No ___

APPLICABLE STATEMENT

This Disclosure Form A is submitted on behalf of the INDIVIDUAL named on previous page.

Completed by: _____
Name of Authorized Representative (type or print)

Completed by: _____
Title of Authorized Representative (type or print)

Completed by: _____ Date _____
Signature of Individual or Authorized Representative

NOT APPLICABLE STATEMENT

I have determined that no individuals associated with this organization meet the criteria that would require the completion of this Form A.

This Disclosure Form A is submitted on behalf of the CONTRACTOR listed on the previous page.

Name of Authorized Representative (type or print)

Title of Authorized Representative (type or print)

Signature of Authorized Representative Date _____

RETURN WITH BID/OFFER

ILLINOIS DEPARTMENT
OF TRANSPORTATION

Form B
Other Contracts &
Procurement Related Information
Disclosure

Contractor Name		
Legal Address		
City, State, Zip		
Telephone Number	Email Address	Fax Number (if available)

Disclosure of the information contained in this Form is required by the Section 50-35 of the Illinois Procurement Act (30 ILCS 500). This information shall become part of the publicly available contract file. This Form B must be completed for bids in excess of \$10,000, and for all open-ended contracts.

DISCLOSURE OF OTHER CONTRACTS AND PROCUREMENT RELATED INFORMATION

1. Identifying Other Contracts & Procurement Related Information. The BIDDER shall identify whether it has any pending contracts (including leases), bids, proposals, or other ongoing procurement relationship with any other State of Illinois agency: Yes ___ No ___

If **“No” is checked**, the bidder only needs to complete the signature box on the bottom of this page.

2. If “Yes” is checked. Identify each such relationship by showing State of Illinois agency name and other descriptive information such as bid or project number (attach additional pages as necessary). SEE DISCLOSURE FORM INSTRUCTIONS:

THE FOLLOWING STATEMENT MUST BE SIGNED

Name of Authorized Representative (type or print)	

Title of Authorized Representative (type or print)	
_____	_____
Signature of Authorized Representative	Date

RETURN WITH BID

SPECIAL NOTICE TO CONTRACTORS

The following requirements of the Illinois Department of Human Rights' Rules and Regulations are applicable to bidders on all construction contracts advertised by the Illinois Department of Transportation:

CONSTRUCTION EMPLOYEE UTILIZATION PROJECTION

- (a) All bidders on construction contracts shall complete and submit, along with and as part of their bids, a Bidder's Employee Utilization Form (Form BC-1256) setting forth a projection and breakdown of the total workforce intended to be hired and/or allocated to such contract work by the bidder including a projection of minority and female employee utilization in all job classifications on the contract project.
- (b) The Department of Transportation shall review the Employee Utilization Form, and workforce projections contained therein, of the contract awardee to determine if such projections reflect an underutilization of minority persons and/or women in any job classification in accordance with the Equal Employment Opportunity Clause and Section 7.2 of the Illinois Department of Human Rights' Rules and Regulations for Public Contracts adopted as amended on September 17, 1980. If it is determined that the contract awardee's projections reflect an underutilization of minority persons and/or women in any job classification, it shall be advised in writing of the manner in which it is underutilizing and such awardee shall be considered to be in breach of the contract unless, prior to commencement of work on the contract project, it submits revised satisfactory projections or an acceptable written affirmative action plan to correct such underutilization including a specific timetable geared to the completion stages of the contract.
- (c) The Department of Transportation shall provide to the Department of Human Rights a copy of the contract awardee's Employee Utilization Form, a copy of any required written affirmative action plan, and any written correspondence related thereto. The Department of Human Rights may review and revise any action taken by the Department of Transportation with respect to these requirements.

RETURN WITH BID

**Contract No. 64B02
BUREAU County
Section D2 MRS 2005-14
Routes FAP 698 & FAU 5601
District 2 Construction Funds**

PART II. WORKFORCE PROJECTION - continued

B. Included in "Total Employees" under Table A is the total number of **new hires** that would be employed in the event the undersigned bidder is awarded this contract.

The undersigned bidder projects that: (number) _____ new hires would be recruited from the area in which the contract project is located; and/or (number) _____ new hires would be recruited from the area in which the bidder's principal office or base of operation is located.

C. Included in "Total Employees" under Table A is a projection of numbers of persons to be employed directly by the undersigned bidder as well as a projection of numbers of persons to be employed by subcontractors.

The undersigned bidder estimates that (number) _____ persons will be directly employed by the prime contractor and that (number) _____ persons will be employed by subcontractors.

PART III. AFFIRMATIVE ACTION PLAN

A. The undersigned bidder understands and agrees that in the event the foregoing minority and female employee utilization projection included under **PART II** is determined to be an underutilization of minority persons or women in any job category, and in the event that the undersigned bidder is awarded this contract, he/she will, prior to commencement of work, develop and submit a written Affirmative Action Plan including a specific timetable (geared to the completion stages of the contract) whereby deficiencies in minority and/or female employee utilization are corrected. Such Affirmative Action Plan will be subject to approval by the contracting agency and the **Department of Human Rights**.

B. The undersigned bidder understands and agrees that the minority and female employee utilization projection submitted herein, and the goals and timetable included under an Affirmative Action Plan if required, are deemed to be part of the contract specifications.

Company _____ Telephone Number _____

Address _____

NOTICE REGARDING SIGNATURE

The Bidder's signature on the Proposal Signature Sheet will constitute the signing of this form. The following signature block needs to be completed only if revisions are required.

Signature: _____ Title: _____ Date: _____

- Instructions: All tables must include subcontractor personnel in addition to prime contractor personnel.
- Table A - Include both the number of employees that would be hired to perform the contract work and the total number currently employed (Table B) that will be allocated to contract work, and include all apprentices and on-the-job trainees. The "Total Employees" column should include all employees including all minorities, apprentices and on-the-job trainees to be employed on the contract work.
- Table B - Include all employees currently employed that will be allocated to the contract work including any apprentices and on-the-job trainees currently employed.
- Table C - Indicate the racial breakdown of the total apprentices and on-the-job trainees shown in Table A.

RETURN WITH BID

**Contract No. 64B02
BUREAU County
Section D2 MRS 2005-14
Routes FAP 698 & FAU 5601
District 2 Construction Funds**

PROPOSAL SIGNATURE SHEET

The undersigned bidder hereby makes and submits this bid on the subject Proposal, thereby assuring the Department that all requirements of the Invitation for Bids and rules of the Department have been met, that there is no misunderstanding of the requirements of paragraph 3 of this Proposal, and that the contract will be executed in accordance with the rules of the Department if an award is made on this bid.

Firm Name _____
(IF AN INDIVIDUAL) Signature of Owner _____
Business Address _____

Firm Name _____
By _____
(IF A CO-PARTNERSHIP) Business Address _____

Name and Address of All Members of the Firm:

Corporate Name _____
By _____
Signature of Authorized Representative _____
Typed or printed name and title of Authorized Representative _____

(IF A CORPORATION)
(IF A JOINT VENTURE, USE THIS SECTION FOR THE MANAGING PARTY AND THE SECOND PARTY SHOULD SIGN BELOW) Attest _____
Signature _____
Business Address _____

Corporate Name _____
By _____
Signature of Authorized Representative _____
Typed or printed name and title of Authorized Representative _____

(IF A JOINT VENTURE)
Attest _____
Signature _____
Business Address _____

If more than two parties are in the joint venture, please attach an additional signature sheet.



RETURN WITH BID

Division of Highways
Proposal Bid Bond
(Effective November 1, 1992)

Item No.
Letting Date

KNOW ALL MEN BY THESE PRESENTS, That We
as PRINCIPAL, and

held jointly, severally and firmly bound unto the STATE OF ILLINOIS in the penal sum of 5 percent of the total bid price, or for the amount specified in Article 102.09 of the "Standard Specifications for Road and Bridge Construction" in effect on the date of invitation for bids, whichever is the lesser sum, well and truly to be paid unto said STATE OF ILLINOIS, for the payment of which we bind ourselves, our heirs, executors, administrators, successors and assigns.

THE CONDITION OF THE FOREGOING OBLIGATION IS SUCH, That Whereas, the PRINCIPAL has submitted a bid proposal to the STATE OF ILLINOIS, acting through the Department of Transportation, for the improvement designated by the Transportation Bulletin Item Number and Letting Date indicated above.

NOW, THEREFORE, if the Department shall accept the bid proposal of the PRINCIPAL; and if the PRINCIPAL shall, within the time and as specified in the bidding and contract documents, submit a DBE Utilization Plan that is accepted and approved by the Department; and if, after award by the Department, the PRINCIPAL shall enter into a contract in accordance with the terms of the bidding and contract documents including evidence of the required insurance coverages and providing such bond as specified with good and sufficient surety for the faithful performance of such contract and for the prompt payment of labor and material furnished in the prosecution thereof; or if, in the event of the failure of the PRINCIPAL to make the required DBE submission or to enter into such contract and to give the specified bond, the PRINCIPAL pays to the Department the difference not to exceed the penalty hereof between the amount specified in the bid proposal and such larger amount for which the Department may contract with another party to perform the work covered by said bid proposal, then this obligation shall be null and void, otherwise, it shall remain in full force and effect.

IN THE EVENT the Department determines the PRINCIPAL has failed to comply with any requirement as set forth in the preceding paragraph, then Surety shall pay the penal sum to the Department within fifteen (15) days of written demand therefor. If Surety does not make full payment within such period of time, the Department may bring an action to collect the amount owed. Surety is liable to the Department for all its expenses, including attorney's fees, incurred in any litigation in which it prevails either in whole or in part.

In TESTIMONY WHEREOF, the said PRINCIPAL and the said SURETY have caused this instrument to be signed by their respective officers this day of A.D.,

PRINCIPAL SURETY
(Company Name) (Company Name)
By: (Signature & Title) By: (Signature of Attorney-in-Fact)

Notary Certification for Principal and Surety

STATE OF ILLINOIS,
COUNTY OF

I, a Notary Public in and for said County, do hereby certify that
and

(Insert names of individuals signing on behalf of PRINCIPAL & SURETY)

who are each personally known to me to be the same persons whose names are subscribed to the foregoing instrument on behalf of PRINCIPAL and SURETY, appeared before me this day in person and acknowledged respectively, that they signed and delivered said instrument as their free and voluntary act for the uses and purposes therein set forth.

Given under my hand and notarial seal this day of, A.D.

My commission expires
Notary Public

In lieu of completing the above section of the Proposal Bid Form, the Principal may file an Electronic Bid Bond. By signing below the Principal is ensuring the identified electronic bid bond has been executed and the Principal and Surety are firmly bound unto the State of Illinois under the conditions of the bid bond as shown above.

Electronic Bid Bond ID# Company/Bidder Name Signature and Title

PROPOSAL ENVELOPE



PROPOSALS

for construction work advertised for bids by the
Illinois Department of Transportation

Item No.	Item No.	Item No.

Submitted By:

Name:
Address:
Phone No.

Bidders should use an IDOT proposal envelope or affix this form to the front of a 10" x 13" envelope for the submittal of bids. If proposals are mailed, they should be enclosed in a second or outer envelope addressed to:

Engineer of Design and Environment - Room 326
Illinois Department of Transportation
2300 South Dirksen Parkway
Springfield, Illinois 62764

NOTICE

Individual bids, including Bid Bond and/or supplemental information if required, should be securely stapled.

CONTRACTOR OFFICE COPY OF CONTRACT SPECIFICATIONS

NOTICE

None of the following material needs to be returned with the bid package unless the special provisions require documentation and/or other information to be submitted.

**Contract No. 64B02
BUREAU County
Section D2 MRS 2005-14
Routes FAP 698 & FAU 5601
District 2 Construction Funds**



Illinois Department of Transportation



NOTICE TO BIDDERS

1. TIME AND PLACE OF OPENING BIDS. Sealed proposals for the improvement described herein will be received by the Department of Transportation at the Harry R. Hanley Building, 2300 South Dirksen Parkway, in Springfield, Illinois until 10:00 o'clock a.m., August 5, 2005. All bids will be gathered, sorted, publicly opened and read in the auditorium at the Department of Transportation's Harry R. Hanley Building shortly after the 10:00 a.m. cut off time.

2. DESCRIPTION OF WORK. The proposed improvement is identified and advertised for bids in the Invitation for Bids as:

**Contract No. 64B02
BUREAU County
Section D2 MRS 2005-14
Routes FAP 698 & FAU 5601
District 2 Construction Funds**

1.12 miles of 2 @ 18 feet and various widths bituminous surface removal and bituminous resurfacing on IL Route 89/U.S. Route 6 and IL Route 89 between Ladd and Spring Valley at the interchange with Interstate 80.

3. INSTRUCTIONS TO BIDDERS. (a) This Notice, the invitation for bids, proposal and letter of award shall, together with all other documents in accordance with Article 101.09 of the Standard Specifications for Road and Bridge Construction, become part of the contract. Bidders are cautioned to read and examine carefully all documents, to make all required inspections, and to inquire or seek explanation of the same prior to submission of a bid.

(b) State law, and, if the work is to be paid wholly or in part with Federal-aid funds, Federal law requires the bidder to make various certifications as a part of the proposal and contract. By execution and submission of the proposal, the bidder makes the certification contained therein. A false or fraudulent certification shall, in addition to all other remedies provided by law, be a breach of contract and may result in termination of the contract.

4. AWARD CRITERIA AND REJECTION OF BIDS. This contract will be awarded to the lowest responsive and responsible bidder considering conformity with the terms and conditions established by the Department in the rules, Invitation for Bids and contract documents. The issuance of plans and proposal forms for bidding based upon a prequalification rating shall not be the sole determinant of responsibility. The Department reserves the right to determine responsibility at the time of award, to reject any or all proposals, to readvertise the proposed improvement, and to waive technicalities.

By Order of the
Illinois Department of Transportation

Timothy W. Martin, Secretary

BD 351 (Rev. 01/2003)

INDEX FOR SUPPLEMENTAL SPECIFICATIONS AND RECURRING SPECIAL PROVISIONS

Adopted March 1, 2005

This index contains a listing of SUPPLEMENTAL SPECIFICATIONS and frequently used RECURRING SPECIAL PROVISIONS.

ERRATA Standard Specifications for Road and Bridge Construction (Adopted 1-1-02) (Revised 3-1-05)

SUPPLEMENTAL SPECIFICATIONS

<u>Std. Spec. Sec.</u>	<u>Page No.</u>
101 Definition of Terms	1
105 Control of Work	2
205 Embankment	3
251 Mulch	4
281 Riprap.....	5
282 Filter Fabric for Use With Riprap	8
285 Concrete Revetment Mats.....	10
311 Granular Subbase	14
351 Aggregate Base Course.....	15
440 Removal of Existing Pavement and Appurtenances	16
442 Pavement Patching	17
449 Removal and Replacement of Preformed Elastomeric Compression Joint Seal	18
481 Aggregate Shoulders	19
501 Removal of Existing Structures	20
503 Concrete Structures	21
505 Steel Structures	22
506 Cleaning and Painting Metal Structures	25
508 Reinforcement Bars	26
512 Piling	27
540 Box Culverts.....	28
589 Elastic Joint Sealer	30
602 Catch Basin, Manhole, Inlet, Drainage Structures and Valve Vault Construction, Adjustment and Reconstruction	31
603 Adjusting Frames and Grates of Drainage and Utility Structures	32
610 Shoulder Inlets with Curb	33
665 Woven Wire Fence	34
669 Removal and Disposal of Regulated Substances	35
671 Mobilization	36
702 Work Zone Traffic Control Devices	37
1003 Fine Aggregates	38
1004 Coarse Aggregate	39
1005 Stone, Concrete Blocks and Broken Concrete for Erosion Protection, Sediment Control and Rockfill	42
1006 Metals	46
1007 Timber and Preservative Treatment	49
1012 Hydrated Lime	50
1020 Portland Cement Concrete	51
1021 Concrete Admixtures	58
1022 Concrete Curing Materials	59
1024 Nonshrink Grout	61
1041 Brick	63
1043 Precast Reinforced Concrete Manhole Sections and Adjusting Rings	64
1056 Preformed Flexible Gaskets and Mastic Joint Sealer for Sewer and Culvert Pipe	66
1059 Elastic Joint Sealers	67
1060 Waterproofing Materials	68
1069 Pole and Tower	69
1070 Foundation and Breakaway Devices	70
1077 Post and Foundation	72
1080 Fabric Materials	73
1081 Materials For Planting	76
1083 Elastomeric Bearings	77
1094 Overhead Sign Structures	78
1103 Portland Cement Concrete Equipment	79

RECURRING SPECIAL PROVISIONS

The following RECURRING SPECIAL PROVISIONS indicated by an "X" are applicable to this contract and are included by reference:

<u>CHECK SHEET #</u>	<u>PAGE NO.</u>
1 State Required Contract Provisions All Federal-aid Construction Contracts (Eff. 2-1-69) (Rev. 10-1-83)	80
2 Subletting of Contracts (Federal-aid Contracts) (Eff. 1-1-88) (Rev. 5-1-93).....	82
3 X EEO (Eff. 7-21-78) (Rev. 11-18-80)	83
4 X Specific Equal Employment Opportunity Responsibilities NonFederal-aid Contracts (Eff. 3-20-69) (Rev. 1-1-94)	94
5 X Required Provisions - State Contracts (Eff. 4-1-65) (Rev. 4-1-93).....	100
6 Reserved	105
7 X Asphalt Quantities and Cost Reviews (Eff. 7-1-88).....	106
8 National Pollutant Discharge Elimination System Permit (Eff. 7-1-94) (Rev. 1-1-03).....	107
9 Haul Road Stream Crossings, Other Temporary Stream Crossings and In-Stream Work Pads (Eff. 1-2-92) (Rev. 1-1-98)	108
10 Construction Layout Stakes Except for Bridges (Eff. 1-1-99) (Rev. 1-1-02).....	109
11 Construction Layout Stakes (Eff. 5-1-93) (Rev. 1-1-02).....	112
12 Use of Geotextile Fabric for Railroad Crossing (Eff. 1-1-95) (Rev. 1-1-97).....	115
13 Asphaltic Emulsion Slurry Seal and Fibrated Asphaltic Emulsion Slurry Seal (Eff. 8-1-89) (Rev. 2-1-97)	117
14 Bituminous Surface Treatments Half-Smart (Eff. 7-1-93) (Rev. 1-1-97)	123
15 X Quality Control/Quality Assurance of Bituminous Concrete Mixtures (Eff. 1-1-00) (Rev. 3-1-05)	129
16 Subsealing of Concrete Pavements (Eff. 11-1-84) (Rev. 2-1-95).....	148
17 Bituminous Surface Removal (Cold Milling) (Eff. 11-1-87) (Rev. 10-15-97).....	152
18 Resurfacing of Milled Surfaces (Eff. 10-1-95)	154
19 PCC Partial Depth Bituminous Patching (Eff. 1-1-98).....	155
20 Patching with Bituminous Overlay Removal (Eff. 10-1-95) (Rev. 7-1-99)	157
21 Reserved	159
22 Protective Shield System (Eff. 4-1-95) (Rev. 1-1-03).....	160
23 Polymer Concrete (Eff. 8-1-95) (Rev. 3-1-05).....	162
24 Controlled Low-Strength Material (CLSM) (Eff. 1-1-90) (Rev. 3-1-05).....	164
25 Pipe Underdrains (Eff. 9-9-87) (Rev. 1-1-98).....	169
26 Guardrail and Barrier Wall Delineation (Eff. 12-15-93) (Rev. 1-1-97)	170
27 Bicycle Racks (Eff. 4-1-94) (Rev. 1-1-97)	175
28 Reserved	177
29 Reserved	178
30 Reserved	179
31 Night Time Inspection of Roadway Lighting (Eff. 5-1-96).....	180
32 Reserved	181
33 English Substitution of Metric Bolts (Eff. 7-1-96).....	182
34 English Substitution of Metric Reinforcement Bars (Eff. 4-1-96) (Rev. 1-1-03)	183
35 Polymer Modified Emulsified Asphalt (Eff. 5-15-89) (Rev. 1-1-04).....	185
36 Corrosion Inhibitor (Eff. 3-1-80) (Rev. 7-1-99)	187
37 Quality Control of Concrete Mixtures at the Plant-Single A (Eff. 8-1-00) (Rev. 1-1-04)	188
38 Quality Control of Concrete Mixtures at the Plant-Double A (Eff. 8-1-00) (Rev. 1-1-04)	194
39 Quality Control/Quality Assurance of Concrete Mixtures (Eff. 4-1-92) (Rev. 3-1-05)	202
40 Traffic Barrier Terminal Type 1, Special (Eff. 8-1-94) (Rev. 1-1-03)	215
41 Reserved	216
42 X Segregation Control of Bituminous Concrete (Eff. 7-15-97).....	217
43 Reserved	220

TABLE OF CONTENTS

LOCATION OF PROJECT 1
DESCRIPTION OF PROJECT 1
TRAFFIC CONTROL PLAN 1
MAINTENANCE OF TRAFFIC 2
ADDITIONAL FLAGGERS 2
BITUMINOUS CONCRETE SURFACE COURSE (BDE)..... 2
BITUMINOUS EQUIPMENT, SPREADING AND FINISHING MACHINE (BDE)..... 3
FLAGGER VESTS (BDE)..... 4
PARTIAL PAYMENTS (BDE)..... 4
PAYMENTS TO SUBCONTRACTORS (BDE)..... 5
PERSONAL PROTECTIVE EQUIPMENT (BDE)..... 6
RAP FOR USE IN BITUMINOUS CONCRETE MIXTURES (BDE)..... 6
SUPERPAVE BITUMINOUS CONCRETE MIXTURES (BDE)..... 10
TRAFFIC CONTROL DEFICIENCY DEDUCTION (BDE) 16
TRUCK BED RELEASE AGENT (BDE) 17
WEIGHT CONTROL DEFICIENCY DEDUCTION 17
WORK ZONE TRAFFIC CONTROL DEVICES (BDE) 18
WORKING DAYS (BDE) 20
SUBCONTRACTOR MOBILIZATION PAYMENTS (BDE) 20

STATE OF ILLINOIS

SPECIAL PROVISIONS

The following Special Provisions supplement the "Standard Specifications for Road and Bridge Construction," adopted January 1, 2002, the latest edition of the "Manual on Uniform Traffic Control Devices for Streets and Highways," and the "Manual of Test Procedures for Materials" in effect on the date of invitation for bids, and the Supplemental Specifications and Recurring Special Provisions indicated on the Check Sheet included herein which apply to and govern the construction of FAP Route 698 and FAU Route 6501, Section: D2 MRS 2005-14, Bureau County, Contract: 64B02, and in case of conflict with any part or parts of said Specifications, the said Special Provisions shall take precedence and shall govern.

LOCATION OF PROJECT

This work is on IL 89/US 6 & IL 89 between Ladd and Spring Valley at the interchange with Interstate 80.

DESCRIPTION OF PROJECT

Work includes 2 inch bituminous surface removal, bituminous resurfacing, and placing thermoplastic pavement markings.

TRAFFIC CONTROL PLAN

Effective January 14, 1999

Traffic Control shall be according to the applicable sections of the Standard Specifications for Road and Bridge Construction, the applicable guidelines contained in the National Manual on Uniform Traffic Control Devices for Streets and Highways, Illinois Supplement to the National Manual on Uniform Traffic Control Devices, these special provisions, and any special details and Highway Standards contained herein and in the plans.

Special attention is called to Articles 107.09 and 107.14 of the Standard Specifications for Road and Bridge Construction and the following Highway Standards relating to traffic control.

Standards:

701301

701306

701311

702001

Details:

District Standard 91.2

District Standard 94.2

A minimum of 3 drums spaced at 4 feet shall be placed at each return when the sideroad is open.

BUMP (W8-1(O)48) signs shall be installed as directed by the Engineer.

The cost of furnishing, erecting, maintaining, covering, and removing the signs shall be included in the cost of specified traffic control standards or items.

Low Shoulder Signs: “LOW SHOULDER” W8-9(O)48 signs shall be installed as directed by the Engineer.

Uneven Pavement Signs: “UNEVEN LANES” W8-11(O)48 signs shall be installed as directed by the Engineer.

The cost of furnishing, erecting, maintaining, covering and removing these signs shall be included in the cost of TRAFFIC CONTROL AND PROTECTION STANDARD 701306.

The bituminous grinding, resurfacing, and shoulder work shall be completed using Traffic Control and Protection Standard 701306.

MAINTENANCE OF TRAFFIC

Traffic Control and Protection Standards needed at all locations are 701301, 701306, 701311, and 702001.

The mainline shall remain open to one-way traffic during working hours and two-way traffic during non-working hours.

The pavement markings shall be completed using Traffic Control and Protection Standard 701311.

ADDITIONAL FLAGGERS

Additional flaggers will be required at the ramp terminals. They will be required regardless of what the daily work limits are. These additional flaggers shall be considered included in the contract unit price per Lump Sum for TRAFFIC CONTROL AND PROTECTION STANDARD 701306.

BITUMINOUS CONCRETE SURFACE COURSE (BDE)

Effective: April 1, 2001

Revised: April 1, 2003

Replace the fourth paragraph of Article 406.23(b) of the Standard Specifications with the following:

“Mixture for cracks, joints, flangeways, leveling binder (machine method), leveling binder (hand method) and binder course in excess of 103 percent of the quantity specified by the Engineer will not be measured for payment.

Surface course mixture in excess of 103 percent of adjusted plan quantity will not be measured for payment. The adjusted plan quantity for surface course mixtures will be calculated as follows:

Adjusted Plan Quantity = C x quantity shown on the plans or as specified by the Engineer.

where C = metric: $C = \frac{G_{mb} \times 24.99}{U}$ English: $C = \frac{G_{mb} \times 46.8}{U}$

and where:

G_{mb} = average bulk specific gravity from approved mix design.

U = Unit weight of surface course shown on the plans in kg/sq m/25 mm (lb/sq yd/in.), used to estimate plan quantity.

24.99 = metric constant.

46.8 = English constant.

If project circumstances warrant a new surface course mix design, the above equations shall be used to calculate the adjusted plan quantity for each mix design using its respective average bulk specific gravity.”

80050

BITUMINOUS EQUIPMENT, SPREADING AND FINISHING MACHINE (BDE)

Effective: January 1, 2005

Revise the fourth paragraph of Article 1102.03 of the Standard Specifications to read:

“The paver shall be equipped with a receiving hopper having sufficient capacity for a uniform spreading operation. The hopper shall be equipped with a distribution system to uniformly place a non-segregated mixture in front of the screed. The distribution system shall have chain curtains, deflector plates, and/or other devices designed and built by the paver manufacturer to prevent segregation during distribution of the mixture from the hopper to the paver screed. The Contractor shall submit a written certification that the devices recommended by the paver manufacturer to prevent segregation have been installed and are operational. Prior to paving, the Contractor, in the presence of the Engineer, shall visually inspect paver parts specifically identified by the manufacturer for excessive wear and the need for replacement. The Contractor shall supply a completed check list to the Engineer noting the condition of the parts. Worn parts shall be replaced. The Engineer may require an additional inspection prior to the placement of a surface course or at other times throughout the work.”

80142

FLAGGER VESTS (BDE)

Effective: April 1, 2003

Revised: August 1, 2005

Revise the first sentence of Article 701.04(c)(1) of the Standard Specifications to read:

“The flagger shall be stationed to the satisfaction of the Engineer and be equipped with a fluorescent orange, fluorescent yellow/green or a combination of fluorescent orange and fluorescent yellow/green vest meeting the requirements of the American National Standards Institute specification ANSI/ISEA 107-1999 for Conspicuity Class 2 garments and approved flagger traffic control signs conforming to Standard 702001 and Article 702.05(e).”

Revise Article 701.04(c)(6) of the Standard Specifications to read:

“(6) Nighttime Flagging. Flaggers shall be illuminated by an overhead light source providing a minimum vertical illuminance of 108 lux (10 fc) measured 300 mm (1 ft) out from the flagger’s chest. The bottom of any luminaire shall be a minimum of 3 m (10 ft) above the pavement. Luminaire(s) shall be shielded to minimize glare to approaching traffic and trespass light to adjoining properties.

The flagger vest shall be a fluorescent orange or fluorescent orange and fluorescent yellow/green vest meeting the requirements of the American National Standards Institute specification ANSI/ISEA 107-1999 for Conspicuity Class 3 garments.”

80101

PARTIAL PAYMENTS (BDE)

Effective: September 1, 2003

Revise Article 109.07 of the Standard Specifications to read:

“**109.07 Partial Payments.** Partial payments will be made as follows:

(a) Progress Payments. At least once each month, the Engineer will make a written estimate of the amount of work performed in accordance with the contract, and the value thereof at the contract unit prices. The amount of the estimate approved as due for payment will be vouchered by the Department and presented to the State Comptroller for payment. No amount less than \$1000.00 will be approved for payment other than the final payment.

The failure to perform any requirement, obligation, or term of the contract by the Contractor shall be reason for withholding any progress payments until the Department determines that compliance has been achieved. Furthermore, progress payments may be reduced by liens filed pursuant to Section 23(c) of the Mechanics Lien Act, 770 ILCS 60/23(c).

- (b) Material Allowances. At the discretion of the Department, payment may be made for materials, prior to their use in the work, when satisfactory evidence is presented by the Contractor. Satisfactory evidence includes justification for the allowance (to expedite the work, meet project schedules, regional or national material shortages, etc.), documentation of material and transportation costs, and evidence that such material is properly stored on the project or at a secure location acceptable and accessible to the Department.

Material allowances will be considered only for nonperishable materials when the cost, including transportation, exceeds \$10,000 and such materials are not expected to be utilized within 60 days of the request for the allowance. For contracts valued under \$500,000, the minimum \$10,000 requirement may be met by combining the principal (material) product of no more than two contract items. An exception to this two item limitation may be considered for any contract regardless of value for items in which material (products) are similar except for type and/or size.

Material allowances shall not exceed the value of the contract items in which used and shall not include the cost of installation or related markups. Amounts paid by the Department for material allowances will be deducted from estimates due the Contractor as the material is used. Two-sided copies of the Contractor's cancelled checks for materials and transportation must be furnished to the Department within 60 days of payment of the allowances or the amounts will be reclaimed by the Department."

80116

PAYMENTS TO SUBCONTRACTORS (BDE)

Effective: June 1, 2000

Revised: September 1, 2003

Federal regulations found at 49 CFR §26.29 mandate the Department to establish a contract clause to require Contractors to pay subcontractors for satisfactory performance of their subcontracts no later than 30 days from the receipt of each payment made to the Contractor.

State law addresses the timing of payments to be made to subcontractors. Section 7 of the Prompt Payment Act, 30 ILCS 540/7, generally requires that when a Contractor receives any payment from the Department, the Contractor is required to make corresponding, proportional payments to each subcontractor performing work within 15 calendar days after receipt of the state payment. Section 7 of the State Prompt Payment Act further provides that interest in the amount of 2% per month, in addition to the payment due, shall be paid to any subcontractor by the Contractor if the payment required by the Act is withheld or delayed without reasonable cause. The Act also provides that the time for payment required and the calculation of any interest due applies to transactions between subcontractors and lower-tier subcontractors throughout the contracting chain.

This Special Provision establishes the required federal contract clause, and adopts the 15 calendar day requirement of the Act for purposes of compliance with the federal regulation regarding payments to subcontractors. This contract is subject to the following payment obligations.

As progress payments are made to the Contractor in accordance with Article 109.07 of the Standard Specifications for Road and Bridge Construction, the Contractor shall make a corresponding partial payment within 15 calendar days to each subcontractor in proportion to the work satisfactorily completed by each subcontractor. The proportionate amount of partial payment due to each subcontractor shall be determined by the quantities measured or otherwise determined as eligible for payment by the Department and included in the progress payment to the Contractor. Subcontractors shall be paid in full within 15 calendar days after the subcontractor's work has been satisfactorily completed. The Contractor shall hold no retainage from the subcontractors.

This Special Provision does not create any rights in favor of any subcontractor against the State of Illinois or authorize any cause of action against the State of Illinois on account of any payment, nonpayment, delayed payment or interest claimed by application of the State Prompt Payment Act. The Department will neither determine the reasonableness of any cause for delay of payment nor enforce any claim to payment, including interest. Moreover, the Department will not approve any delay or postponement of the 15 day requirement. State law creates remedies available to any subcontractor or material supplier, regardless of tier, who has not been paid for work properly performed or material furnished. These remedies are a lien against public funds set forth in Section 23(c) of the Mechanics Lien Act, 770 ILCS 60/23(c), and a recovery on the Contractor's payment bond in accordance with the Public Construction Bond Act, 30 ILCS 550. 80022

PERSONAL PROTECTIVE EQUIPMENT (BDE)

Effective: July 1, 2004

All personnel, excluding flaggers, working outside of a vehicle (car or truck) within 7.6 m (25 ft) of pavement open to traffic shall wear a fluorescent orange, fluorescent yellow/green or a combination of fluorescent orange and fluorescent yellow/green vest meeting the requirements of the American National Standards Institute specification ANSI/ISEA 107-1999 for Conspicuity Class 2 garments. Other types of garments may be substituted for the vest as long as the garments have manufacturers tags identifying them as meeting the ANSI Class 2 requirement. 80130

RAP FOR USE IN BITUMINOUS CONCRETE MIXTURES (BDE)

Effective: January 1, 2000

Revised: April 1, 2002

Revise Article 1004.07 to read:

"1004.07 RAP Materials. RAP is reclaimed asphalt pavement resulting from cold milling or crushing of an existing dense graded hot-mix asphalt pavement. RAP must originate from routes or airfields under federal, state or local agency jurisdiction. The Contractor shall supply documentation that the RAP meets these requirements.

- (a) Stockpiles. The Contractor shall construct individual, sealed RAP stockpiles meeting one of the following definitions. No additional RAP will be allowed on top of the pile after the pile has been sealed.

- (1) Homogeneous. Homogeneous RAP stockpiles shall consist of RAP from Class I/ Superpave, or equivalent mixtures only and represent the same aggregate quality, but shall be at least C quality or better, the same type of crushed aggregate (either crushed natural aggregate, ACBF slag, or steel slag), similar gradation and similar AC content. If approved by the Engineer, combined single pass surface/binder millings may be considered "homogenous", with a quality rating dictated by the lowest coarse aggregate quality present in the mixture. Homogenous stockpiles shall meet the requirements of Article 1004.07(d). Homogeneous RAP stockpiles not meeting these requirements may be processed (crushing and screening) and retested.
- (2) Conglomerate. Conglomerate RAP stockpiles shall consist of RAP from Class I/ Superpave, or equivalent mixtures only. The coarse aggregate in this RAP shall be crushed aggregate only and may represent more than one aggregate type and/or quality but shall be at least C quality or better. This RAP may have an inconsistent gradation and/or asphalt cement content prior to processing. All conglomerate RAP shall be processed prior to testing by crushing to where all RAP shall pass the 16 mm (5/8 in.) or smaller screen. Conglomerate RAP stockpiles shall not contain steel slag or other expansive material as determined by the Department. Conglomerate RAP stockpiles shall meet the requirements of Article 1004.07(d).
- (3) Conglomerate "D" Quality (DQ). Conglomerate DQ RAP stockpiles shall consist of RAP containing coarse aggregate (crushed or round) that is at least D quality or better. This RAP may have an inconsistent gradation and/or asphalt content. Conglomerate DQ RAP stockpiles shall not contain steel slag or other expansive material as determined by the Department. Conglomerate DQ RAP shall meet the requirements of Article 1004.07(d).

Reclaimed Superpave Low ESAL IL-9.5L surface mixtures shall only be placed in conglomerate DQ RAP stockpiles due to the potential for rounded aggregate.

- (4) Other. RAP stockpiles that do not meet the requirements of the stockpile categories listed above shall be classified as "Other". "Other" RAP stockpiles shall not be used in any of the Department's bituminous mixtures.
- (b) Use. The allowable use of a RAP stockpile shall be set by the lowest quality of coarse aggregate in the RAP stockpile. Class I/Superpave surface mixtures are designated as containing Class B quality coarse aggregate only. Superpave Low ESAL IL-19.0L binder and IL-9.5L surface mixtures are designated as Class C quality coarse aggregate only. Class I/Superpave binder mixtures, bituminous base course mixtures, and bituminous base course widening mixtures are designated as containing Class C quality coarse aggregate only. Bituminous stabilized subbase and BAM shoulders are designated as containing Class D quality coarse aggregate only. Any mixture not listed above shall have the designated quality determined by the Department.

RAP containing steel slag or other expansive material, as determined by the Department, shall be homogeneous and will be approved for use in Class I/Superpave (including Low ESAL) surface mixtures only. RAP stockpiles for use in Class I/Superpave mixtures (including Low ESAL), base course, base course widening and Class B mixtures shall be either homogeneous or conglomerate RAP stockpiles except conglomerate RAP stockpiles shall not be used in Superpave surface mixture Ndesign 50 or greater. RAP for use in bituminous aggregate mixtures (BAM) shoulders and BAM stabilized subbase shall be from homogeneous, conglomerate, or conglomerate DQ stockpiles.

Additionally, RAP used in Class I/Superpave surface mixtures shall originate from milled or crushed mixtures only, in which the coarse aggregate is of Class B quality or better. RAP stockpiles for use in Class I/Superpave (including Low ESAL) binder mixes as well as base course, base course widening and Class B mixtures shall originate from milled or processed surface mixture, binder mixture, or a combination of both mixtures uniformly blended to the satisfaction of the Engineer, in which the coarse aggregate is of Class C quality or better.

(c) Contaminants. RAP containing contaminants, such as earth, brick, sand, concrete, sheet asphalt, bituminous surface treatment (i.e. chip seal), pavement fabric, etc., will be unacceptable unless the contaminants are removed to the satisfaction of the Engineer. Sheet asphalt shall be stockpiled separately.

(d) Testing. All RAP shall be sampled and tested either during or after stockpiling.

For testing during stockpiling, washed extraction samples shall be run at the minimum frequency of one sample per 450 metric tons (500 tons) for the first 1800 metric tons (2,000 tons) and one sample per 1800 metric tons (2,000 tons) thereafter. A minimum of five tests shall be required for stockpiles less than 3600 metric tons (4,000 tons).

For testing existing stockpiles, the Contractor shall submit a plan for approval to the District proposing a satisfactory method of sampling and testing the RAP pile either in-situ or by restocking. The sampling plan shall meet the minimum frequency required above and detail the procedure used to extract representative samples throughout the pile for testing.

Before extraction, each field sample shall be split to test sample size. One of the two test samples from the final split shall be labeled and stored for Department use. The Contractor shall extract the other test sample according to Department procedure. The Engineer reserves the right to test any sample (split or Department-taken) to verify Contractor test results.

All of the extraction results shall be compiled and averaged for asphalt content and gradation. Individual extraction test results, when compared to the averages, will be accepted if within the tolerances listed below.

Parameter	Homogeneous / Conglomerate	Conglomerate "D" Quality
25 mm (1 in.)		± 5%
12.5 mm (1/2 in.)	± 8%	± 15%
4.75 mm (No. 4)	± 6%	± 13%
2.36 mm (No. 8)	± 5%	
1.18 mm (No. 16)		± 15%
600 μm (No. 30)	± 5%	
75 μm (No. 200)	± 2.0%	± 4.0%
AC	± 0.4%	± 0.5%

If more than 20 percent of the individual sieves are out of the gradation tolerances, or if more than 20 percent of the asphalt content test results fall outside the appropriate tolerances, the RAP will not be allowed to be used in the Department's bituminous concrete mixtures unless the RAP representing the failing tests is removed from the stockpile to the satisfaction of the Engineer. All test data and acceptance ranges shall be sent to the District for evaluation.

With the approval of the Engineer, the ignition oven may be substituted for extractions according to the Illinois Test Procedure, "Calibration of the Ignition Oven for the Purpose of Characterizing Reclaimed Asphalt Pavement (RAP)".

- (e) Designs. At the Contractor's option, bituminous concrete mixtures may be constructed utilizing RAP material meeting the above detailed requirements. The amount of RAP included in the mixture shall not exceed the percentages specified in the plans.

RAP designs shall be submitted for volumetric verification. If additional RAP stockpiles are tested and found that no more than 20 percent of the results, as defined under "Testing" herein, are outside of the control tolerances set for the original RAP stockpile and design, and meets all of the requirements herein, the additional RAP stockpiles may be used in the original mix design at the percent previously verified.

- (f) Production. The coarse aggregate in all RAP used shall be equal to or less than the nominal maximum size requirement for the bituminous mixture being produced.

To remove or reduce agglomerated material, a scalping screen, crushing unit or comparable sizing device approved by the Engineer shall be used in the RAP feed system to remove or reduce oversized material. If material passing the sizing device adversely affects the mix production or quality of the mix, the sizing device shall be set at a size specified by the Engineer.

If the RAP control tolerances or QC/QA test results require corrective action, the Contractor shall cease production of the mixture containing RAP and either switch to the virgin aggregate design or submit a new RAP design.

80011

SUPERPAVE BITUMINOUS CONCRETE MIXTURES (BDE)

Effective: January 1, 2000

Revised: April 1, 2004

Description. This work shall consist of designing, producing and constructing Superpave bituminous concrete mixtures using Illinois Modified Strategic Highway Research Program (SHRP) Superpave criteria. This work shall be according to Sections 406 and 407 of the Standard Specifications and the special provision, "Quality Control/Quality Assurance of Bituminous Concrete Mixtures", except as follows.

Materials.

- (a) Fine Aggregate Blend Requirement. The Contractor may be required to provide FA 20 manufactured sand to meet the design requirements. For mixtures with $N_{design} \geq 90$, at least 50 percent of the required fine aggregate fraction shall consist of either stone sand, slag sand, or steel slag sand meeting the FA/FM 20 gradation.
- (b) Reclaimed Asphalt Pavement (RAP). If the Contractor is allowed to use more than 15 percent RAP, as specified in the plans, a softer performance-graded binder may be required as determined by the Engineer.

RAP shall meet the requirements of the special provision, "RAP for Use in Bituminous Concrete Mixtures".

RAP will not be permitted in mixtures containing polymer modifiers.

RAP containing steel slag will be permitted for use in top-lift surface mixtures only.

- (c) Bituminous Material. The asphalt cement (AC) shall be performance-graded (PG) or polymer modified performance-graded (SBS-PG or SBR-PG) meeting the requirements of Article 1009.05 of the Standard Specifications for the grade specified on the plans.

The following additional guidelines shall be used if a polymer modified asphalt is specified:

- (1) The polymer modified asphalt cement shall be shipped, maintained, and stored at the mix plant according to the manufacturer's requirements. Polymer modified asphalt cement shall be placed in an empty tank and shall not be blended with other asphalt cements.
- (2) The mixture shall be designed using a mixing temperature of 163 ± 3 °C (325 ± 5 °F) and a gyratory compaction temperature of 152 ± 3 °C (305 ± 5 °F).
- (3) Pneumatic-tired rollers will not be allowed unless otherwise specified by the Engineer. A vibratory roller meeting the requirements of Article 406.16 of the Standard Specifications shall be required in the absence of the pneumatic-tired roller.

Laboratory Equipment.

- (a) Superpave Gyratory Compactor. The superpave gyratory compactor (SGC) shall be used for all QC/QA testing.
- (b) Ignition Oven. The ignition oven shall be used to determine the AC content. The ignition oven shall also be used to recover aggregates for all required washed gradations.

The Engineer may waive the ignition oven requirement for AC content if the aggregates to be used are known to have ignition AC content calibration factors which exceed 1.5 percent. If the ignition oven requirement is waived, other Department approved methods shall be used to determine the AC content.

Mixture Design. The Contractor shall submit mix designs, for approval, for each required mixture. Mix designs shall be developed by Level III personnel who have successfully completed the course, "Superpave Mix Design Upgrade". Articles 406.10 and 406.13 of the Standard Specifications shall not apply. The mixtures shall be designed according to the respective Illinois Modified AASHTO references listed below.

AASHTO MP 2	Standard Specification for Superpave Volumetric Mix Design
AASHTO R 30	Standard Practice for Mixture Conditioning of Hot-Mix Asphalt (HMA)
AASHTO PP 28	Standard Practice for Designing Superpave HMA
AASHTO T 209	Theoretical Maximum Specific Gravity and Density of Bituminous Paving Mixtures
AASHTO T 312	Preparing and Determining the Density of Hot Mix Asphalt (HMA) Specimens by Means of the Superpave Gyratory Compactor
AASHTO T 308	Determining the Asphalt Content of Hot Mix Asphalt (HMA) by the Ignition Method

- (a) Mixture Composition. The ingredients of the bituminous mixture shall be combined in such proportions as to produce a mixture conforming to the composition limits by weight. The gradation mixture specified on the plans shall produce a mixture falling within the limits specified in Table 1.

TABLE 1. MIXTURE COMPOSITION (% PASSING) ^{1/}								
Sieve Size	IL-25.0 mm		IL-19.0 mm		IL-12.5 mm ^{4/}		IL-9.5 mm ^{4/}	
	min	max	min	max	Min	max	min	max
37.5 mm (1 1/2 in.)		100						
25 mm (1 in.)	90	100		100				
19 mm (3/4 in.)		90	82	100		100		
12.5 mm (1/2 in.)	45	75	50	85	90	100		100
9.5 mm (3/8 in.)						89	90	100
4.75 mm (#4)	24	42 ^{2/}	24	50 ^{2/}	28	65	28	65
2.36 mm (#8)	16	31	20	36	28	48 ^{3/}	28	48 ^{3/}
1.18 mm (#16)	10	22	10	25	10	32	10	32
600 µm (#30)								
300 µm (#50)	4	12	4	12	4	15	4	15
150 µm (#100)	3	9	3	9	3	10	3	10
75 µm (#200)	3	6	3	6	4	6	4	6

- 1/ Based on percent of total aggregate weight.
- 2/ The mixture composition shall not exceed 40 percent passing the 4.75 mm (#4) sieve for binder courses with Ndesign ≥ 90.
- 3/ The mixture composition shall not exceed 40 percent passing the 2.36 mm (#8) sieve for surface courses with Ndesign ≥ 90.
- 4/ The mixture composition for surface courses shall be according to IL-12.5 mm or IL-9.5 mm, unless otherwise specified by the Engineer.

One of the above gradations shall be used for leveling binder as specified in the plans and according to Article 406.04 of the Standard Specifications.

It is recommended that the selected combined aggregate gradation not pass through the restricted zones specified in Illinois Modified AASHTO MP 2.

- (b) Dust/AC Ratio for Superpave. The ratio of material passing the 75 μm (#200) sieve to total asphalt cement shall not exceed 1.0 for mixture design (based on total weight of mixture).
- (c) Volumetric Requirements. The target value for the air voids of the hot mix asphalt (HMA) shall be 4.0 percent at the design number of gyrations. The VMA and VFA of the HMA design shall be based on the nominal maximum size of the aggregate in the mix and shall conform to the requirements listed in Table 2.

TABLE 2. VOLUMETRIC REQUIREMENTS					
Ndesign	Voids in the Mineral Aggregate (VMA), % minimum				Voids Filled with Asphalt (VFA), %
	IL-25.0	IL-19.0	IL-12.5	IL-9.5	
50	12.0	13.0	14.0	15	65 - 78
70					65 - 75
90					
105					

- (d) Determination of Need for Anti-Stripping Additive. The mixture designer shall determine if an additive is needed in the mix to prevent stripping. The determination will be made on the basis of tests performed according to Illinois Modified T 283 using 4 in. Marshall bricks. To be considered acceptable by the Department as a mixture not susceptible to stripping, the ratio of conditioned to unconditioned split tensile strengths (TSRs) shall be equal to or greater than 0.75. Mixtures, either with or without an additive, with TSRs less than 0.75 will be considered unacceptable.

If it is determined that an additive is required, the additive may be hydrated lime, slaked quicklime, or a liquid additive, at the Contractor's option. The liquid additive shall be selected from the Department's list of approved additives and may be limited to those which have exhibited satisfactory performance in similar mixes.

Dry hydrated lime shall be added at a rate of 1.0 to 1.5 percent by weight of total dry aggregate. Slurry shall be added in such quantity as to provide the required amount of hydrated lime solids by weight of total dry aggregate. The exact rate of application for all anti-stripping additives will be determined by the Department. The method of application shall be according to Article 406.12 of the Standard Specifications.

Personnel. The QC Manager and Level I Technician shall have successfully completed the Department's "Superpave Field Control Course".

Required Plant Tests. Testing shall be conducted to control the production of the bituminous mixture. The Contractor shall use the test methods identified to perform the following mixture tests at a frequency not less than that indicated in Table 3.

TABLE 3. REQUIRED PLANT TESTS for SUPERPAVE		
Parameter	Frequency of Tests	Test Method
Aggregate Gradation Hot bins for batch and continuous plants Individual cold-feeds or combined belt-feed for drier drum plants. (% passing sieves: 12.5 mm (1/2 in.), 4.75 mm (No. 4), 2.36 mm (No. 8), 600 µm (No. 30), 75 µm (No. 200))	1 dry gradation per day of production (either morning or afternoon sample). And 1 washed ignition oven test on the mix per day of production (conduct in afternoon if dry gradation is conducted in the morning or vice versa). NOTE. The order in which the above tests are conducted shall alternate from the previous production day (example: a dry gradation conducted in the morning will be conducted in the afternoon on the next production day and so forth). The dry gradation and washed ignition oven test results shall be plotted on the same control chart.	Illinois Procedure (See Manual of Test Procedures for Materials).
Asphalt Content by Ignition Oven (Note 1.)	1 per half day of production	Illinois Modified AASHTO T 308
Air Voids	Bulk Specific Gravity of Gyratory Sample	1 per half day of production for first 2 days and 1 per day thereafter (first sample of the day)
	Maximum Specific Gravity of Mixture	Illinois Modified AASHTO T 209

Note 1. The Engineer may waive the ignition oven requirement for AC content if the aggregates to be used are known to have ignition AC content calibration factors which exceed 1.5 percent. If the ignition oven requirement is waived, other Department approved methods shall be used to determine the AC content.

During production, the ratio of minus 75 µm (#200) sieve material to total asphalt cement shall be not less than 0.6 nor more than 1.2 and the moisture content of the mixture at discharge from the mixer shall not exceed 0.5 percent. If at any time the ratio of minus 75 µm (#200) material to asphalt or moisture content of the mixture falls outside the stated limits, production of the mix shall cease. The cause shall be determined and corrective action satisfactory to the Engineer shall be initiated prior to resuming production.

During production, mixtures containing an anti-stripping additive will be tested by the Department for stripping according to Illinois Modified T 283. If the mixture fails to meet the TSR criteria for acceptance, no further mixture will be accepted until the Contractor takes such action as is necessary to furnish a mixture meeting the criteria.

Construction Requirements

Lift Thickness.

- (a) Binder and Surface Courses. The minimum compacted lift thickness for constructing bituminous concrete binder and surface courses shall be according to Table 4:

TABLE 4 – MINIMUM COMPACTED LIFT THICKNESS	
Mixture	Thickness, mm (in.)
IL-9.5	32 (1 1/4)
IL-12.5	38 (1 1/2)
IL-19.0	57 (2 1/4)
IL-25.0	76 (3)

- (b) Leveling Binder. Mixtures used for leveling binder shall be as follows:

TABLE 5 – LEVELING BINDER	
Nominal, Compacted, Leveling Binder Thickness, mm (in.)	Mixture
≤ 32 (1 1/4)	IL-9.5
32 (1 1/4) to 50 (2)	IL 9.5 or IL-12.5

Density requirements shall apply for leveling binder when the nominal, compacted thickness is 32 mm (1 1/4 in.) or greater for IL-9.5 mixtures and 38 mm (1 1/2 in.) or greater for IL-12.5 mixtures.

- (c) Full-Depth Pavement. The compacted thickness of the initial lift of binder course shall be 100 mm (4 in.). The compacted thickness of succeeding lifts shall meet the minimums specified in Table 4 but not exceed 100 mm (4 in.).

If a vibratory roller is used for breakdown, the compacted thickness of the binder lifts, excluding the top lift, may be increased to 150 mm (6 in.) provided the required density is obtained.

- (d) Bituminous Patching. The minimum compacted lift thickness for constructing bituminous patches shall be according to Table 4.

Control Charts/Limits. Control charts/limits shall be according to QC/QA Class I requirements, except density shall be plotted on the control charts within the following control limits:

TABLE 6. DENSITY CONTROL LIMITS		
Mixture	Parameter	Individual Test
12.5 mm / 9.5 mm	N _{design} ≥ 90	92.0 – 96.0%
12.5 mm / 9.5 mm	N _{design} < 90	92.5 – 97.4%
19.0 mm / 25.0 mm	N _{design} ≥ 90	93.0 – 96.0%
19.0 mm / 25.0 mm	N _{design} < 90	93.0 – 97.4%

Basis of Payment. On resurfacing projects, this work will be paid for at the contract unit price per metric ton (ton) for BITUMINOUS CONCRETE SURFACE COURSE, SUPERPAVE, of the friction aggregate mixture and Ndesign specified, LEVELING BINDER (HAND METHOD), SUPERPAVE, of the Ndesign specified, LEVELING BINDER (MACHINE METHOD), SUPERPAVE, of the Ndesign specified, and BITUMINOUS CONCRETE BINDER COURSE, SUPERPAVE, of the mixture composition and Ndesign specified.

On resurfacing projects in which polymer modifiers are required, this work will be paid for at the contract unit price per metric ton (ton) for POLYMERIZED BITUMINOUS CONCRETE SURFACE COURSE, SUPERPAVE, of the friction aggregate mixture and Ndesign specified, POLYMERIZED LEVELING BINDER (HAND METHOD), SUPERPAVE, of the Ndesign specified, POLYMERIZED LEVELING BINDER (MACHINE METHOD), SUPERPAVE, of the Ndesign specified, and POLYMERIZED BITUMINOUS CONCRETE BINDER COURSE, SUPERPAVE, of the mixture composition and Ndesign specified.

On full-depth pavement projects, this work will be paid for at the contract unit price per square meter (square yard) for BITUMINOUS CONCRETE PAVEMENT, (FULL-DEPTH), SUPERPAVE, of the thickness specified.

On projects where widening is constructed and the entire pavement is then resurfaced, the binder for the widening will be paid for at the contract unit price per square meter (square yard) for BITUMINOUS CONCRETE BINDER COURSE, SUPERPAVE, of the mixture composition, Ndesign, and thickness specified. The surface and binder used to resurface the entire pavement will be paid for according to the paragraphs above for resurfacing projects.

80010

TRAFFIC CONTROL DEFICIENCY DEDUCTION (BDE)

Effective: April 1, 1992

Revised: January 1, 2005

To ensure a prompt response to incidents involving the integrity of work zone traffic control, the Contractor shall provide a telephone number where a responsible individual can be contacted 24 hours-a-day.

When the Engineer is notified, or determines a traffic control deficiency exists, he/she will notify and direct the Contractor to correct the deficiency within a specified time. The specified time, which begins upon notification to the Contractor, will be from 1/2 hour to 12 hours based upon the urgency of the situation and the nature of the deficiency. The Engineer shall be the sole judge.

A deficiency may be any lack of repair, maintenance, or non-compliance with the traffic control plan. A deficiency may also be applied to situations where corrective action is not an option such as the use of non-certified flaggers for short term operations; working with lane closures beyond the time allowed in the contract; or failure to perform required contract obligations such as traffic control surveillance.

If the Contractor fails to correct a deficiency within the specified time, a daily monetary deduction will be imposed for each calendar day or fraction thereof the deficiency exists. The calendar day(s) will begin with notification to the Contractor and end with the Engineer's acceptance of the correction. The daily monetary deduction will be either \$1,000 or 0.05 percent of the awarded contract value, whichever is greater. For those deficiencies where corrective action was not an option this monetary deduction will be immediate.

In addition, if the Contractor fails to respond, the Engineer may correct the deficiency and the cost thereof will be deducted from monies due or which may become due the Contractor. This corrective action will in no way relieve the Contractor of his/her contractual requirements or responsibilities.

5729I

TRUCK BED RELEASE AGENT (BDE)

Effective: April 1, 2004

Add the following sentence after the third sentence of the first paragraph of Article 406.14 of the Standard Specifications.

"In addition to the release agent, the Contractor may use a light scatter of manufactured sand (FA 20 or FA 21) evenly distributed over the bed of the vehicle."

80123

WEIGHT CONTROL DEFICIENCY DEDUCTION

Effective: April 1, 2001

Revised: August 1, 2002

The Contractor shall provide accurate weights of materials delivered to the contract for incorporation into the work (whether temporary or permanent) and for which the basis of payment is by weight. These weights shall be documented on delivery tickets which shall identify the source of the material, type of material, the date and time the material was loaded, the contract number, the net weight, the tare weight when applicable and the identification of the transporting vehicle. For aggregates, the Contractor shall have the driver of the vehicle furnish or establish an acceptable alternative to provide the contract number and a copy of the material order to the source for each load. The source is defined as that facility that produces the final material product that is to be incorporated into the contract pay items.

The Department will conduct random, independent vehicle weight checks for material sources according to the procedures outlined in the Documentation Section Policy Statement of the Department's Construction Manual and hereby incorporated by reference. The results of the independent weight checks shall be applicable to all contracts containing this Special Provision. Should the vehicle weight check for a source result in the net weight of material on the vehicle exceeding the net weight of material shown on the delivery ticket by 0.50% (0.70% for aggregates) or more, the Engineer will document the independent vehicle weight check and immediately furnish a copy of the results to the Contractor. No adjustment in pay quantity will be made. Should the vehicle weight check for a source result in the net weight of material shown on the delivery ticket exceeding the net weight of material on the vehicle by 0.50% (0.70% for aggregates) or more, the Engineer will document the independent vehicle weight check and immediately furnish a copy of the results to the Contractor. The Engineer will adjust the net weight shown on the delivery ticket to the checked delivered net weight as determined by the independent vehicle weight check.

The Engineer will also adjust the method of measurement for all contracts for subsequent deliveries of all materials from the source based on the independent weight check. The net weight of all materials delivered to all contracts containing this Special Provision from this source, for which the basis of payment is by weight, will be adjusted by applying a correction factor "A" as determined by the following formula:

$$A = 1.0 - \left(\frac{B - C}{B} \right); \text{ Where } A \leq 1.0; \left(\frac{B - C}{C} \right) > 0.50\% \text{ (0.70\% for aggregates)}$$

Where A = Adjustment factor
B = Net weight shown on delivery ticket
C = Net weight determined from independent weight check

The adjustment factor will be applied as follows:

$$\text{Adjusted Net Weight} = A \times \text{Delivery Ticket Net Weight}$$

The adjustment factor will be imposed until the cause of the deficient weight is identified and corrected by the Contractor to the satisfaction of the Engineer. If the cause of the deficient weight is not identified and corrected within seven (7) calendar days, the source shall cease delivery of all materials to all contracts containing this Special Provision for which the basis of payment is by weight.

Should the Contractor elect to challenge the results of the independent weight check, the Engineer will continue to document the weight of material for which the adjustment factor would be applied. However, provided the Contractor furnishes the Engineer with written documentation that the source scale has been calibrated within seven (7) calendar days after the date of the independent weight check, adjustments in the weight of material paid for will not be applied unless the scale calibration demonstrates that the source scale was not within the specified Department of Agriculture tolerance.

At the Contractor's option, the vehicle may be weighed on a second independent Department of Agriculture certified scale to verify the accuracy of the scale used for the independent weight check.

80048

WORK ZONE TRAFFIC CONTROL DEVICES (BDE)

Effective: January 1, 2003

Revised: November 1, 2004

Add the following to Article 702.01 of the Standard Specifications:

"All devices and combinations of devices shall meet the requirements of the National Cooperative Highway Research Program (NCHRP) Report 350 for their respective categories. The categories are as follows:

Category 1 includes small, lightweight, channelizing and delineating devices that have been in common use for many years and are known to be crashworthy by crash testing of similar devices or years of demonstrable safe performance. These include cones, tubular markers, flexible delineators and plastic drums with no attachments. Category 1 devices shall be crash tested and accepted or may be self-certified by the manufacturer.

Category 2 includes devices that are not expected to produce significant vehicular velocity change but may otherwise be hazardous. These include drums and vertical panels with lights, barricades and portable sign supports. Category 2 devices shall be crash tested and accepted for Test Level 3.

Category 3 includes devices that are expected to cause significant velocity changes or other potentially harmful reactions to impacting vehicles. These include crash cushions, truck mounted attenuators and other devices not meeting the definitions of Category 1 or 2. Category 3 devices shall be crash tested and accepted for either Test Level 3 or the test level specified.

Category 4 includes portable or trailer-mounted devices such as arrow boards, changeable message signs, temporary traffic signals and area lighting supports. Currently, there is no implementation date set for this category and it is exempt from the NCHRP 350 compliance requirement.

The Contractor shall provide a manufacturer's self-certification letter for each Category 1 device and an FHWA acceptance letter for each Category 2 and Category 3 device used on the contract. The letters shall state the device meets the NCHRP 350 requirements for its respective category and test level, and shall include a detail drawing of the device."

Delete the third, fourth and fifth paragraphs of Article 702.03(b) of the Standard Specifications.

Delete the third sentence of the first paragraph of Article 702.03(c) of the Standard Specifications.

Revise the first sentence of the first paragraph of Article 702.03(e) of the Standard Specifications to read:

"Drums shall be nonmetallic and have alternating reflectorized Type AA or Type AP fluorescent orange and reflectorized white horizontal, circumferential stripes."

Add the following to Article 702.03 of the Standard Specifications:

"(h) Vertical Barricades. Vertical barricades may be used in lieu of cones, drums or Type II barricades to channelize traffic."

Delete the fourth paragraph of Article 702.05(a) of the Standard Specifications.

Revise the sixth paragraph of Article 702.05(a) of the Standard Specifications to read:

“When the work operations exceed four days, all signs shall be post mounted unless the signs are located on the pavement or define a moving or intermittent operation. When approved by the Engineer, a temporary sign stand may be used to support a sign at 1.2 m (5 ft) minimum where posts are impractical. Longitudinal dimensions shown on the plans for the placement of signs may be increased up to 30 m (100 ft) to avoid obstacles, hazards or to improve sight distance, when approved by the Engineer. “ROAD CONSTRUCTION AHEAD” signs will also be required on side roads located within the limits of the mainline “ROAD CONSTRUCTION AHEAD” signs.”

Delete all references to “Type 1A barricades” and “wing barricades” throughout Section 702 of the Standard Specifications.

80097

WORKING DAYS (BDE)

Effective: January 1, 2002

The Contractor shall complete the work within 15 working days.

80071

SUBCONTRACTOR MOBILIZATION PAYMENTS (BDE)

Effective: April 2, 2005

To account for the preparatory work and operations necessary for the movement of subcontractor personnel, equipment, supplies, and incidentals to the project site and for all other work or operations that must be performed or costs incurred when beginning work approved for subcontracting in accordance with Article 108.01 of the Standard Specifications, the Contractor shall make a mobilization payment to each subcontractor.

This mobilization payment shall be made at least 14 days prior to the subcontractor starting work. The amount paid shall be equal to 3 percent of the amount of the subcontract reported on form BC 260A submitted for the approval of the subcontractor’s work.

This provision shall be incorporated directly or by reference into each subcontract approved by the Department.

80143

STATE OF ILLINOIS
DEPARTMENT OF TRANSPORTATION
PLANS FOR PROPOSED ROADWORK

FAP 698 & FAU5601 (IL 89 & US 6)
D2 MRS 2005-14
Bureau County

R 11 E

Begin Work
Sta. 95+90

EQ. 100+00Bk.
= 0+00Ah.

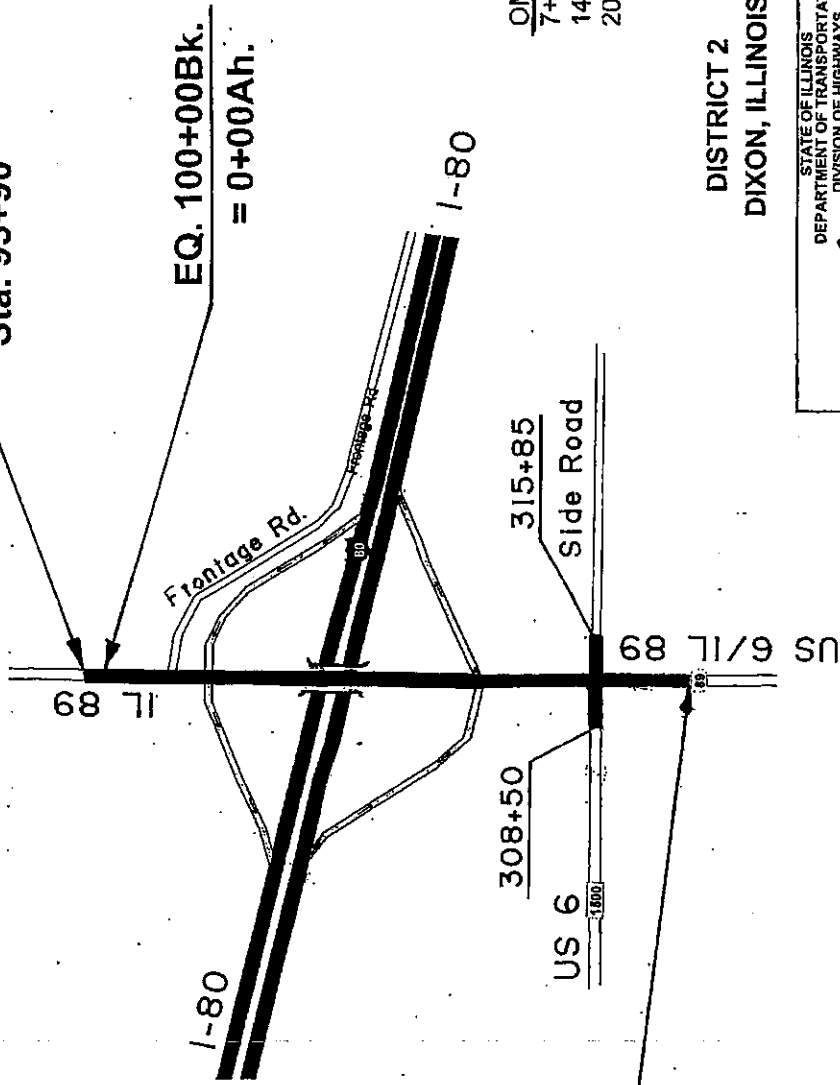

OMISSIONS
7+93 - 10+80
14+87 - 17+12
20+70 - 24+20

DISTRICT 2
DIXON, ILLINOIS

STATE OF ILLINOIS
DEPARTMENT OF TRANSPORTATION
DIVISION OF HIGHWAYS

SUBMITTED April 5, 2005

Gregory L. Mouton
DISTRICT ENGINEER

HALL TWP. - Sec. 15, 16, 21, 22
Gross Length of Project = 6,754' = 1,279 Miles.
Net Length of Project = 5,892' = 1,116 Miles.

INDEX OF SHEETS

- 1. Cover Sheet
- Index of Sheets
- 2-3 Summary of Quantities
- 4. General Notes
- 5-8 Typical Sections
- 9-15 Schedule of Work
- 16-20 Plan Sheet
- 21-25 District Standards
(41.1, 91.2, 94.2, 43.4)

STANDARDS

- 701301-02
- 701306-01
- 701311-02
- 702001-05
- 780001-01
- 781001-02

End Work
Sta. 47+47

CONTRACT NUMBER 64B02
CALL J.U.I.E. BEFORE YOU DIG
800-892-0123
mrs2005-14

FAP 698 & FAU 5601
D2 MRS 2005-14
Bureau County
Sheet 2 of 25
Contract Number 64B02

SUMMARY OF QUANTITIES

100% STATE
I000

CODE NUMBER	ITEM	UNIT	QUANTITY	FAP 698		FAU 5601 (US 6) Urban
				IL 89 Rural	US 6/IL 89 Urban	
40600200	BITUMINOUS MATERIALS (PRIME COAT)	TON	7.3	2.9	2.0	2.4
40600300	AGGREGATE (PRIME COAT)	TON	39	15	11	13
40600990	TEMPORARY RAMP	SQ. YD.	374	256	31	87
40800040	INCIDENTAL BITUMINOUS SURFACING	TON	180	84	29	67
44000007	BITUMINOUS SURFACE REMOVAL - 2 INCH	SQ. YD.	20,755	10,214	7,087	3,454
67100100	MOBILIZATION	L. SUM	1	0.4	0.3	0.3
70100460	TRAFFIC CONTROL & PROTECTION, STANDARD 701306	L. SUM	1	0.4	0.3	0.3
70300100	SHORT TERM PAVEMENT MARKING	FOOT	2,538	1,464	702	372
70301000	WORK ZONE PAVEMENT MARKING REMOVAL	SQ. FT.	281	162	78	41
78000100	THERMOPLASTIC PAVEMENT MARKING - LETTERS & SYMBOLS	SQ.FT	62.4	62.4	--	--
78000200	THERMOPLASTIC PAVEMENT MARKING - LINE 4 INCH	FOOT	17,186	7,824	6,267	3,095
78000500	THERMOPLASTIC PAVEMENT MARKING - LINE 8 INCH	FOOT	682	682	--	--
78000600	THERMOPLASTIC PAVEMENT MARKING - LINE 12 INCH	FOOT	295	255	--	40

FAP 698 & FAU 5601
 D2 MRS 2005-14
 Bureau County
 Sheet 3 of 25
 Contract Number 64B02

SUMMARY OF QUANTITIES

100% STATE
 1000

CODE NUMBER	ITEM	UNIT	QUANTITY	FAP 698		FAU 5601 (US 6) Urban
				IL 89 Rural	US 6/IL 89 Urban	
78000650	THERMOPLASTIC PAVEMENT MARKING - LINE 24 INCH	FOOT	163	18	18	127
78100100*	RAISED REFLECTIVE PAVEMENT MARKER	EACH	4	4	--	--
78300200*	RAISED REFLECTIVE PAVEMENT MARKER REMOVAL	EACH	2	2	--	--
X4066414	BITUMINOUS CONCRETE SURFACE COURSE, SUPERPAVE, "C" N50	TON	217	171	--	46
X4066526	POLYMERIZED BITUMINOUS CONCRETE SURFACE COURSE, SUPERPAVE, "D" N70	TON	1,624	627	480	517
X4066810	POLYMERIZED LEVELING BINDER, (HAND METHOD), SUPERPAVE, N70	TON	12	5	5	2
X4066910	POLYMERIZED LEVELING BINDER, (MACHINE METHOD), SUPERPAVE, N70	TON	1,321	501	384	436

GENERAL NOTES

The millings from Bituminous Surface Removal – 2 Inch shall be used to build up the existing shoulders, as shown on the typical sections and/or as directed by the Engineer. The shoulder shall be rolled and compacted as directed by the Engineer. Excess grindings or large chunks shall be properly disposed of by the Contractor. No grindings will be allowed on the foreslopes. In the areas where the corrugated concrete median has been surfaced over, remove only the bituminous material. If the Contractor chooses to remove part of the corrugated concrete with his operations, no additional compensation will be allowed. This work shall be included in the contract unit price per SQ. YD. for BITUMINOUS SURFACE REMOVAL – 2 INCH.

If, during the grinding or resurfacing operations, the existing mailboxes become a hindrance, the Contractor shall be required to carefully remove and reinstall the mailboxes as directed by the Engineer. This work shall be included in the contract unit price per ton for INCIDENTAL BITUMINOUS SURFACING.

The Contractor will be required to furnish 5-1/2" high brass stencils as approved by the Engineer and install stationing at 250' intervals. Stationing shall be placed on both lanes of two lane highways and on the outside lanes in both directions on four lane highways. The stations shall be placed 6 inches inside the pavement marking edge so they can be read from the shoulder. This work will be included in the cost of the final pavement surface.

Pavement Markings shall be done according to Standard 780001, except as follows:

1. All words, such as ONLY, shall be 8 feet high.
2. All non-freeway arrows shall be the large size.
3. The distance between yellow no-passing lines shall be 8", not 7" as shown in the detail of Typical Lane and Edge Lines.

The following Mixture Requirements are applicable for all locations in this project.

Mixture Uses	Level Binder	Surface	Shoulder
AC/PG:	SBS PG 70-22	SBS PG 70-22	PG 58-22
RAP % (Max)	0%	0%	30
Design Air Voids:	4.2 @ N70	4.2 @ N70	3 @ N50
Mixture Composition (Gradation Mixture)	IL 9.5	IL 9.5 or 12.5	IL 9.5 or 12.5
Friction Aggregate	N/A	D	C

Estimated Quantities

Type	Yellow	White
Thermoplastic Pavement Marking – Line 4 Inch	7,819	9,367
Thermoplastic Pavement Marking – Line 8 Inch	--	682
Thermoplastic Pavement Marking – Line 12 Inch	40	255
Thermoplastic Pavement Marking – Line 24 Inch	--	163

TYPICAL SECTIONS

FAP 698 & FAU 6501
D2 MRS 2005-14
Bureau County
Sheet 5 of 25
Contract Number: 64B02

Sta. 95+90 - 100+00
EQ. 100+00Bk. = 0+00Ah
Sta. 0+00 - 2+80
Sta. 33+33 - 47+47
Sta. 313+78 - 315+85

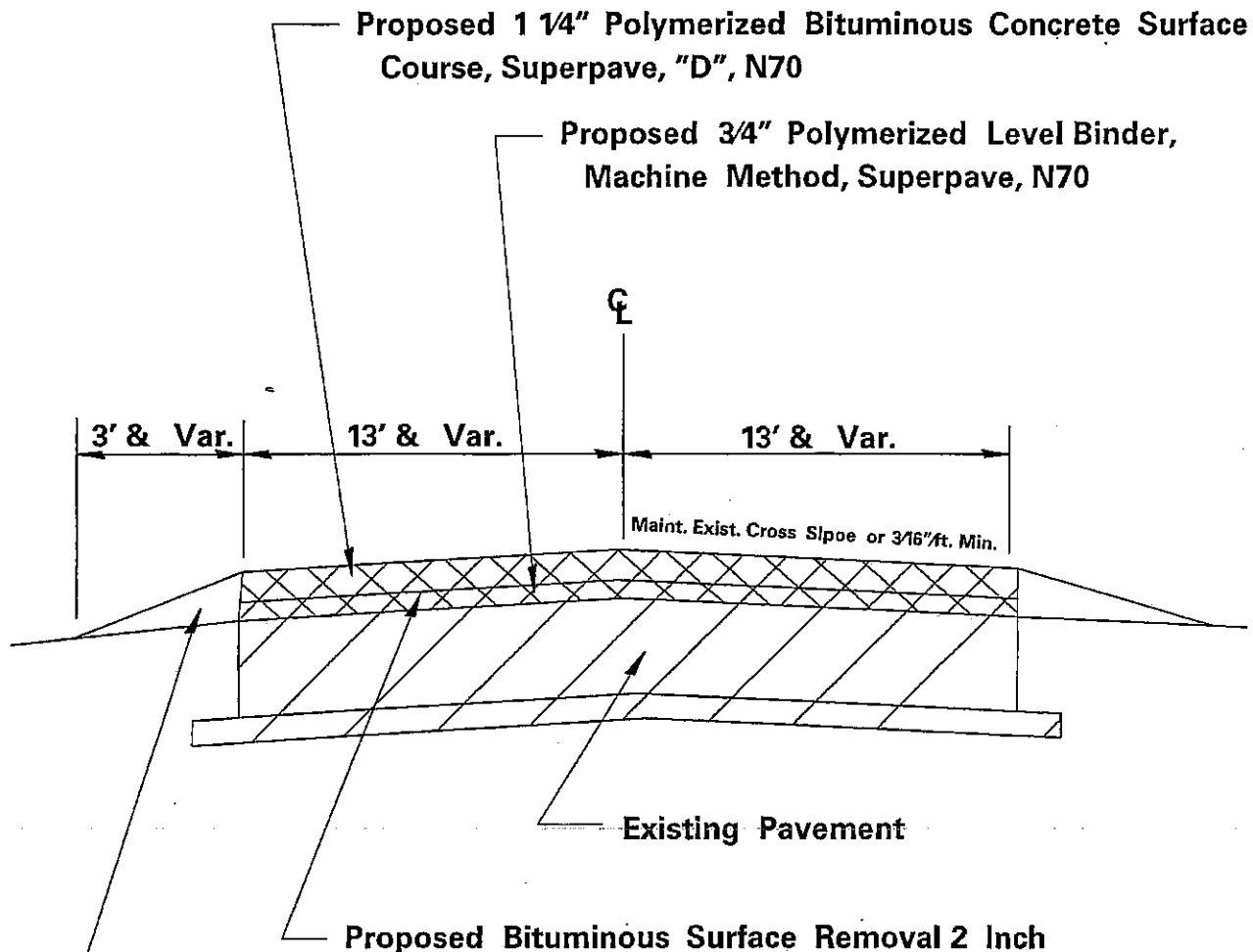

BITUMINOUS APPLICATION RATES:
All Bituminous Mixtures: 112lb/sq. yd/inch
Bituminous Materials (Prime Coat) = 0.000286 Ton/Sq. Yd.
Aggregate (Prime Coat) = 0.0015 Ton/Sq. Yd.

TYPICAL SECTION

Sta. 10 + 80 - 14 + 87
 Sta. 17 + 12 - 20 + 70

FAP 698 & FAU 5601
 D2 MRS 2005-14
 Bureau County
 Sheet 6 of 25
 Contract Number: 64B02

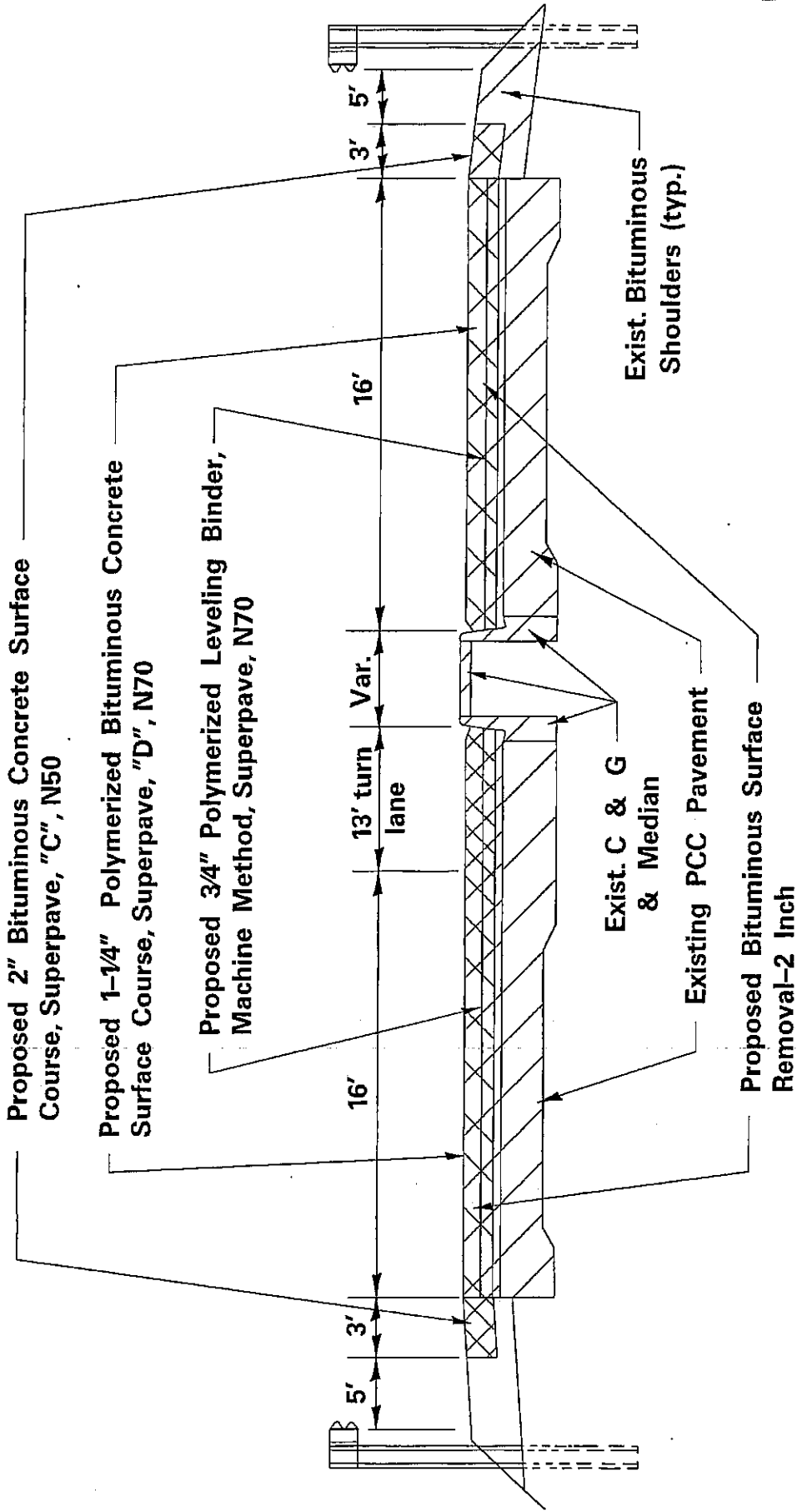

BITUMINOUS APPLICATION RATES:
 All Bituminous Mixtures: 112lb/sq.yd./inch
 Bituminous Materials (Prime Coat) = 0.000286 Ton/Sq. Yd.
 Aggregate (Prime Coat) = 0.0015 Ton/Sq. Yd.

TYPICAL SECTION

Sta. 2+80 - 7+93
 Rt. Sta. 24+20 - 27+85 *
 Sta. 28+99 - 33+33
 Sta. 308+50 - 313+22

FAP 698 & FAU 5601
 D2 MRS 2005-14
 Bureau County
 Sheet 7 of 25
 Contract Number: 64B02

* Has 8' Bituminous Shoulder

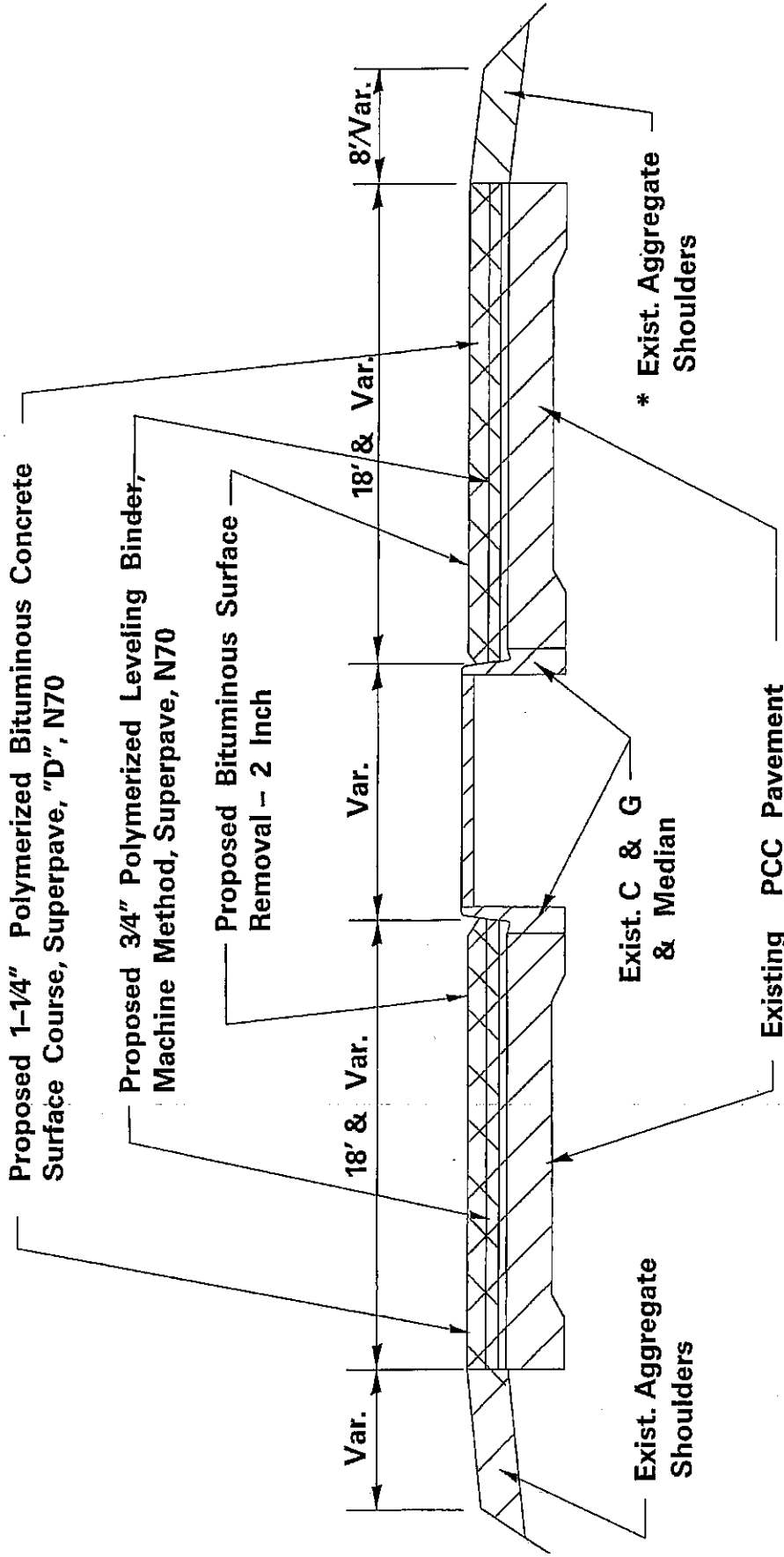

BITUMINOUS APPLICATION RATES:
 All Bituminous Mixtures: 112lb/sq.yd./inch
 Bituminous Materials (Prime Coat) = 0.000286 Ton/Sq.Yd.
 Aggregate (Prime Coat) = 0.0015 Ton/Sq.Yd.

TYPICAL SECTIONS

Side Roads, P.E., C.E.

FAP 698 & FAU 5601
D2 MRS 2005-14
Bureau County
Sheet 8 of 25
Contract Number: 64B02

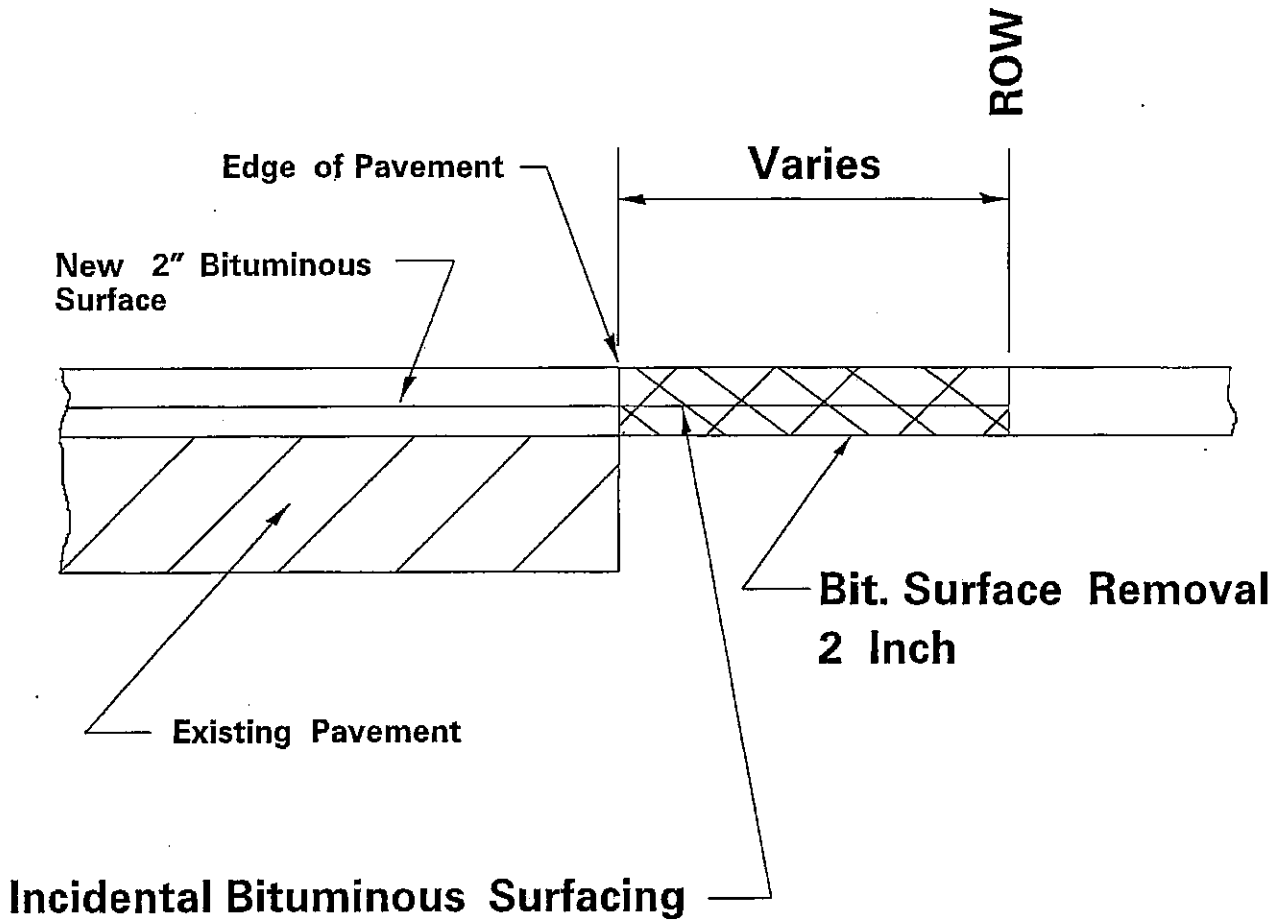

BITUMINOUS APPLICATION RATES:
All Bituminous Mixtures: 112lb/sq. yd/inch
Bituminous Materials (Prime Coat) = 0.000286 Ton/Sq. Yd.
Aggregate (Prime Coat) = 0.0015 Ton/Sq. Yd.

SCHEDULE OF BITUMINOUS WORK
FAP 698 (RURAL) (ILLINOIS 89)

excel: bitsscdmrs2005-14

Location	Length (Feet)	Width (Feet)	Square Yards	Blt. Mat'l Prime (ton)	Agg. Prime (ton)	Bituminous Surf. Rem. 2 Inch (Sq. Yd.)	Incidental Bit. Surf. (Ton)	Poly. Level Bind. HM Super N70 (Ton)	Poly Level Binder MM Super N70 (Ton)	Short-term Pavement Marking (Feet)	Poly BC Surf Cse. Super "D" N70 (Ton)	BC Surf Cse Super "C" N50 (Shoulders) (Ton)
Start Sta. 95+90 - Going South	410	27	1,230	0.35	1.8	1,230			0	0	0	0
Lt. & Rt. 95+90 - 100+00			0	0.00	0.0	0			69	123	86	0
EQ. 100+00Bk =0+00Ah									0	0	0	0
Lt. & Rt. 0+00 - 2+80	280	34	1,058	0.30	1.6	1,058			59	84	74	0
Lt. 2+80 - 6+86	406	18	812	0.23	1.2	812		1	45	122	57	0
Rt. 2+80 - 6+86	406	18	812	0.23	1.2	812		1	45	122	57	0
Lt. & Rt. 6+86 - 7+47	61	50	339	0.10	0.5	339			19	24	24	0
Lt. 7+47 - 7+93	46	18	92	0.03	0.1	92			5	19	6	0
Rt. 7+47 - 7+93	46	18	92	0.03	0.1	92			5	19	6	0
Lt. 10+80 - 14+87	407	16	724	0.21	1.1	724			41	122	51	0
Lt. 10+80 - 11+61 (turn ln)	81	13	117	0.03	0.2	117			7	24	8	0
Lt. 11+61 - 14+50 (turn ln)	289	6.5	209	0.06	0.3	209			12	87	15	0
Rt. 10+80 - 14+87	407	16	724	0.21	1.1	724		3	41	122	51	0
Lt. 17+12 - 20+70	358	16	636	0.18	1.0	636			36	107	45	0
Rt. 17+12 - 20+70	358	16	636	0.18	1.0	636			36	107	45	0
Rt. 17+50 - 19+90 (turn ln)	240	6.5	173	0.05	0.3	173			10	72	12	0
Rt. 19+90 - 20+70 (turn ln)	80	13	116	0.03	0.2	116			6	24	8	0
Lt. 27+10 - 27+85	75	18	150	0.04	0.2	150			8	23	11	0
Rt. 24+20 - 27+85	365	18	730	0.21	1.1	730			41	110	51	0
Lt. & Rt. 27+85 - 28+42	57	48	304	0.09	0.5	304			17	17	21	0
Shoulders												
Rt. 10+80 - 14+87	407	3	136	0.04	0.2	136			0	36	0	46
Lt. 10+80 - 14+87	407	3	136	0.04	0.2	136			0	36	0	46
Rt. 17+12 - 20+70	358	3	119	0.03	0.2	119			0	32	0	40
Lt. 17+12 - 20+70	358	3	119	0.03	0.2	119			0	32	0	40
Side Roads (1)			334	0.10	0.5	334	37		0	0	0	
C.E. (1)			417	0.12	0.6	417	47		0	0	0	
Totals:	5,902		10,214	2.9	15	10,214	84	5	501	1,464	627	171

SCHEDULE OF BITUMINOUS WORK
FAU 5601 (URBAN) (US 6)

excel: bitscd\fa5601\mrs2005-14

Location	Length (Feet)	Width (Feet)	Square Yards	Bit. Matl Prime (ton)	Agg. Prime (ton)	Bituminous Surf. Rem. 2 Inch (Sq. Yd.)	Incidental Bit. Surf. (Ton)	Poly. Level Blind, HM Super N70 (Ton)	Poly Level Binder MM Super N70 (Ton)	Short-term Pavement Marking (Feet)	BC Surf Cse. Super "C" N50 (Shoulders) (Ton)	Poly BC Surf Cse. Super "D" N70 (Ton)
Station Location												
Start Sta. 308+50 - Going East				0.0	0.0					0	0	0
Main Line				0	0.00	0				0	0	0
Lt. 308+50 - 309+50	100	16	178	0.05	0.3	178				30	0	0
Rt. 308+50 - 309+50	100	22	244	0.07	0.4	244				30	0	12
Lt. & Rt. 309+50 - 309+93	43	45	215	0.06	0.3	215				13	0	17
Lt. 309+93 - 313+02	309	16	549	0.16	0.8	549				93	0	15
Rt. 309+93 - 313+02	309	16	549	0.16	0.8	549		2		93	0	38
Lt. & Rt. 313+02 - 313+30	28	50	156	0.04	0.2	156				8	0	11
Lt. & Rt. 313+78 - 315+85	207	24	562	0.16	0.8	552				62	0	39
Returns & Around Islands				0	0.00	0				0	0	0
Lt. 312+02 - 27+10 (NW)			1,488	0.43	2.2	0				83	0	104
Rt. 312+02 - 29+91 (SW)			982	0.28	1.5	0				55	0	69
Lt. 27+10 - 315+46 (NE)			1,488	0.43	2.2	0				83	0	104
Rt. 29+84 - 315+46 (SE)			982	0.28	1.5	0				55	0	69
			0	0.00	0.0	0				0	0	0
			0	0.00	0.0	0				0	0	0
			0	0.00	0.0	0				0	0	0
			0	0.00	0.0	0				0	0	0
Shoulders				0	0.00	0				0	0	0
Lt. 312+02 - 27+10 (NW)	200	8	178	0.05	0.3	178				18	20	0
Lt. 27+10 - 315+46 (NE)	262	8	233	0.07	0.3	233				25	26	0
			0	0.00	0.0	0				0	0	0
			0	0.00	0.0	0				0	0	0
			0	0.00	0.0	0				0	0	0
			0	0.00	0.0	0				0	0	0
Side Roads (0)				0	0.00	0				0	0	0
Mailbox Turn Outs (0)				0	0.00	0				0	0	0
P.E. (0)				0	0.00	0				0	0	0
C.E. (3)			600	0.17	0.9	600	67			0	0	0
			0	0.00	0.0					0	0	0
Totals:	1,558		8,394	2.4	13	3,454	67	2	436	372	46	517

FAP 698 & FAU 5601
 D2 MRS 2005-14
 Bureau County
 Sheet 11 of 25
 Contract Number: 64B02

SCHEDULE OF BITUMINOUS WORK
FAP 698 (URBAN) (US 6/ILLINOIS 89)

Location	Length (Feet)	Width (Feet)	Square Yards	Bit. Mat'l Prime (ton)	Agg. Prime (ton)	Bituminous Surf. Rem. 2 Inch (Sq. Yd.)	Incidental Bit. Surf. (Ton)	Poly. Level Bind. HM Super. N70 (Ton)	Poly Level Binder MM Super N70 (Ton)	Short-term Pavement Marking (Feet)	Poly BC Surf Cse. Super "D" N70 (Ton)
Station Location											
Start Sta. 28+42 - Going South				0.0					0	0	0
Lt. & Rt. 28+42 - 28+99	57	48	304	0.09	0.5	304			17	17	21
Rt. 28+99 - 33+33	434	18	868	0.25	1.3	868		1	49	130	61
Lt. 28+99 - 33+33	434	18	868	0.25	1.3	868		1	49	130	61
Lt. & Rt. 33+33 - 34+83	150	36.5	608	0.17	0.9	608			34	45	43
Lt. & Rt. 34+83 - 47+47	1,264	30	4,213	1.21	6.3	4,213		3	236	379	295
				0.0	0.0	0			0	0	0
				0.0	0.0	0			0	0	0
				0.0	0.0	0			0	0	0
				0.0	0.0	0			0	0	0
				0.0	0.0	0			0	0	0
				0.0	0.0	0			0	0	0
				0.0	0.0	0			0	0	0
				0.0	0.0	0			0	0	0
				0.0	0.0	0			0	0	0
				0.0	0.0	0			0	0	0
				0.0	0.0	0			0	0	0
				0.0	0.0	0			0	0	0
				0.0	0.0	0			0	0	0
				0.0	0.0	0			0	0	0
				0.0	0.0	0			0	0	0
				0.0	0.0	0			0	0	0
				0.0	0.0	0			0	0	0
				0.0	0.0	0			0	0	0
				0.0	0.0	0			0	0	0
				0.0	0.0	0			0	0	0
				0.0	0.0	0			0	0	0
Side Roads ()				0.0	0.0	0			0	0	0
Mailbox Turn Outs (1)				0.0	0.0	0			0	0	0
P.E. (1)			35	0.01	0.1		4		0	0	0
C.E. ()			225	0.06	0.3	225	25		0	0	0
				0.0	0.0		0		0	0	0
				0.0	0.0				0	0	0
Totals:	2,339		7,122	2.0	11	7,087	29	5	384	702	480

Schedule of Work

Temporary Ramp

Location	Sq. Yd.
FAP 698 – (Rural)	
Sta. 95+90 (26' x 6.7')	19.4
Lt. at CE (30' x 6.7')	22.3
Lt. Sta. 7+00 (at Service Road) (30' X 6.7')	22.3
Lt. Sta. 7+93 (18' x 6.7')	13.4
Rt. Sta. 7+93 (18' x 6.7')	13.4
Lt. Sta. 10+80 (32' x 6.7')	23.8
Rt. Sta. 10+80 (19' x 6.7')	14.1
Lt. Sta. 14+87 (21' x 6.7') (At Bridge)	15.6
Rt. Sta. 14+87 (21' x 6.7') (At Bridge)	15.6
Lt. Sta. 17+12 (21' x 6.7') (At Bridge)	15.6
Rt. Sta. 17+12 (21' x 6.7') (At Bridge)	15.6
Lt. Sta. 20+70 (19' x 6.7')	14.1
Rt. Sta. 20+70 (32' x 6.7')	23.8
Rt. Sta. 24+20 (18' x 6.7')	13.4
Lt. Sta. 27+10 (18' x 6.7')	13.4
FAU 5601 (Urban)	
Lt. Sta. 308+50 (16' x 6.7')	11.9
Rt. Sta. 308+50 (22' x 6.7')	16.4
Lt. & Rt. Sta. 315+85 (24' x 6.7')	17.9
Lt. at CE Sta. 309+70 (20' x 6.7')	14.9
Lt. at CE Sta. 310+25+- (20' x 6.7')	14.9
Lt. at CE Sta. 314+10+- (15' x 6.7')	11.2
FAP 698 – (Urban)	
Lt. at PE Sta. 35+00+- (15' x 6.7')	11.2
Sta. 47+47 (27' x 6.7')	<u>20.1</u>
Total	374.3

Raised Reflective Pavement Marker Removal

Location	Each
FAP 698 – (Rural)	
Lt. Sta. 10+81	1
Rt. Sta. 19+90	<u>1</u>
Total	2

Schedule of Work (Continued)

<u>Thermoplastic Pavement Marking – Line 4 Inch</u>	
Location	Foot
FAP 698 – (Rural) (Centerlines)	
Sta. 95+90 – 97+75 (skip dash)	46
Sta. 97+50 – 100+00 (Dashed Lt./Solid Rt.)	313
EQ. 100+00Bk. = 0+00Ah	
Sta. 0+00 – 1+40 (Dashed Lt./Solid Rt.)	175
Lt. & Rt. Sta. 1+40 – 6+86 (Solid Yellow)	1,092
Lt. & Rt. Sta. 7+47 – 7+93 (Solid Yellow)	92
Lt. & Rt. Sta. 10+80 – 14+87 (Solid Yellow)	814
Lt. & Rt. Sta. 17+12 – 20+70 (Solid Yellow)	716
Rt. Sta. 24+20 – 27+10 (Solid Yellow)	290
Lt. & Rt. Sta. 27+10 – 27+85 (Solid Yellow)	150
FAP 698 – (Rural) (Edge lines)	
Lt. & Rt. 95+90 – 100+00	820
EQ. 100+00Bk. = 0+00Ah	
Rt. Sta. 0+00 – 7+93	793
Lt. Sta. 0+00 – 6+55	655
Lt. Sta. 7+45 – 7+93	48
Lt. & Rt. Sta. 10+80 – 14+87	814
Lt. & Rt. Sta. 17+12 – 20+70	716
Rt. Sta. 24+20 – 27+10.	290
FAP 698 – (Urban) (Centerlines)	
Lt. & Rt. Sta. 28+99 – 34+83 (Solid Yellow)	1,168
Sta. 34+83 – 47+47 (Solid Lt./Dashed Rt.)	1,580
FAP 698 – (Urban) (Edge lines)	
Lt. Sta. 29+84 – 47+47	1,763
Rt. Sta. 29+91 – 47+47	1,756
FAU 5601 (Urban) (Center Edge lines)	
Lt. & Rt. Sta. 308+50 – 309+50 (Solid)	200
Lt. & Rt. Sta. 309+93 – 313+02 (Solid)	618
Lt. & Rt. Sta. 314+06 – 315+46 (Dbbl. Yellow)	560
Sta. 315+46 – 315+85 (Dashed)	5
FAU 5601 (Urban) (Edge lines)	
Lt. Sta. 308+50 – 27+10	552
Rt. Sta. 308+50 – 29+91	552
Lt. Sta. 27+10 – 315+85	301
Rt. Sta. 29+84 – 315+85	<u>307</u>
Total	17,186

Schedule of Work (Continued)

Thermoplastic Pavement Marking – Line 8 Inch

Location	Foot
FAP 698 – (Rural)	
Lt. Sta. 10+80 – 11+61 (Lt. Turn Line)	81
Rt. Sta. 19+90 – 20+70 (Lt. Turn Line)	80
Lines around Islands	
NW Island	135
SW Island	133
NE Island	123
SW Island	<u>130</u>
Total	682

Thermoplastic Pavement Marking – Line 12 Inch

Location	Foot
FAP 698 – (Rural)	
Diagonals at Islands (White)	
NW Island	70
SW Island	61
NE Island	62
SW Island	62
FAU 5601 (Urban)	
Sta. 314+06 – 315+46 (Diagonal Yellow in Painted Median)	<u>40</u>
Total	295

Thermoplastic Pavement Marking – Line 24 Inch

Location	Foot
FAP 698 – (Rural)	
Rt. Sta. 27+73 (Stop Bar)	18
FAP 698 – (Urban)	
Lt. Sta. 29+13 (Stop Bar)	18
FAU 5601 (Urban)	
Rt. Sta. 312+92 (Stop Bar)	24
Lt. Sta. 313+96 (Stop Bar)	12
Lt. Sta. 313+02 (In Return - Stop Bar)	22
Rt. Sta. 28+95 (In Return - Stop Bar)	23
Lt. Sta. 313+96 (In Return - Stop Bar)	23
Rt. Sta. 313+96 (In Return - Stop Bar)	<u>23</u>
Total	163

Schedule of Work (Continued)

Thermoplastic Pavement Marking – Letters & Symbols

Location	Sq. Foot
FAP 698 – (Rural)	
Lt. Sta. 10+83 (Lt. Turn Arrow)	15.6
Lt. Sta. 11+58 (Lt. Turn Arrow)	15.6
Rt. Sta. 20+07 (Lt. Turn Arrow)	15.6
Rt. Sta. 20+67 (Lt. Turn Arrow)	<u>15.6</u>
Total	62.4

Raised Reflective Pavement Marker

Location	Each
FAP 698 – (Rural)	
Lt. Sta. 10+80 (1 way Crystal)	1
Lt. Sta. 11+60 (1 way Crystal)	1
Rt. Sta. 19+90 (1 way Crystal)	1
Rt. Sta. 20+70 (1 way Crystal)	<u>1</u>
Total	4

FAP 698 & FAU 5601
 D2 MRS 2005-14
 Bureau County
 Sheet 16 of 25
 Contract Number: 64B02

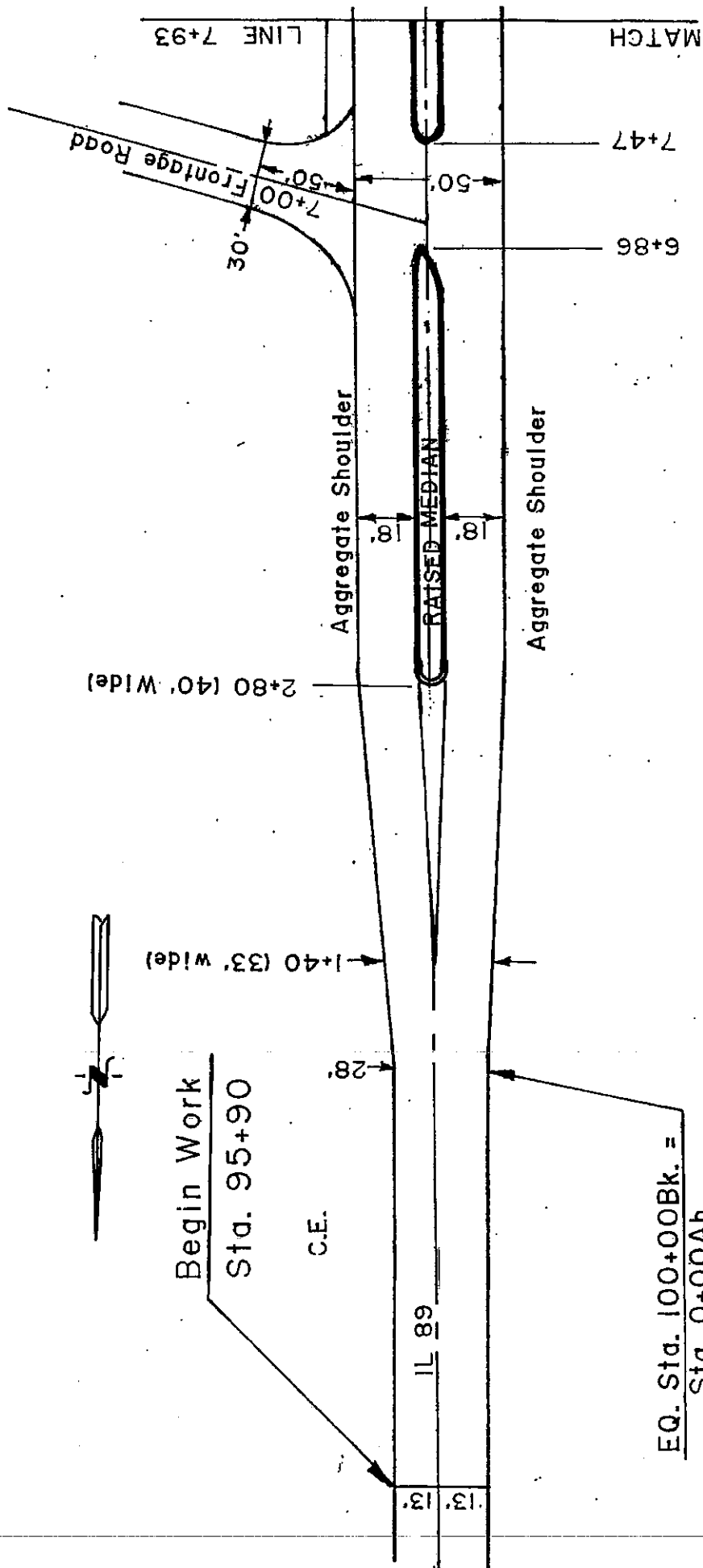

NOT TO SCALE

FAP 698 & FAU 5601
 D2 MRS 2005-14
 Bureau County
 Sheet 17 of 25
 Contract Number: 64B02

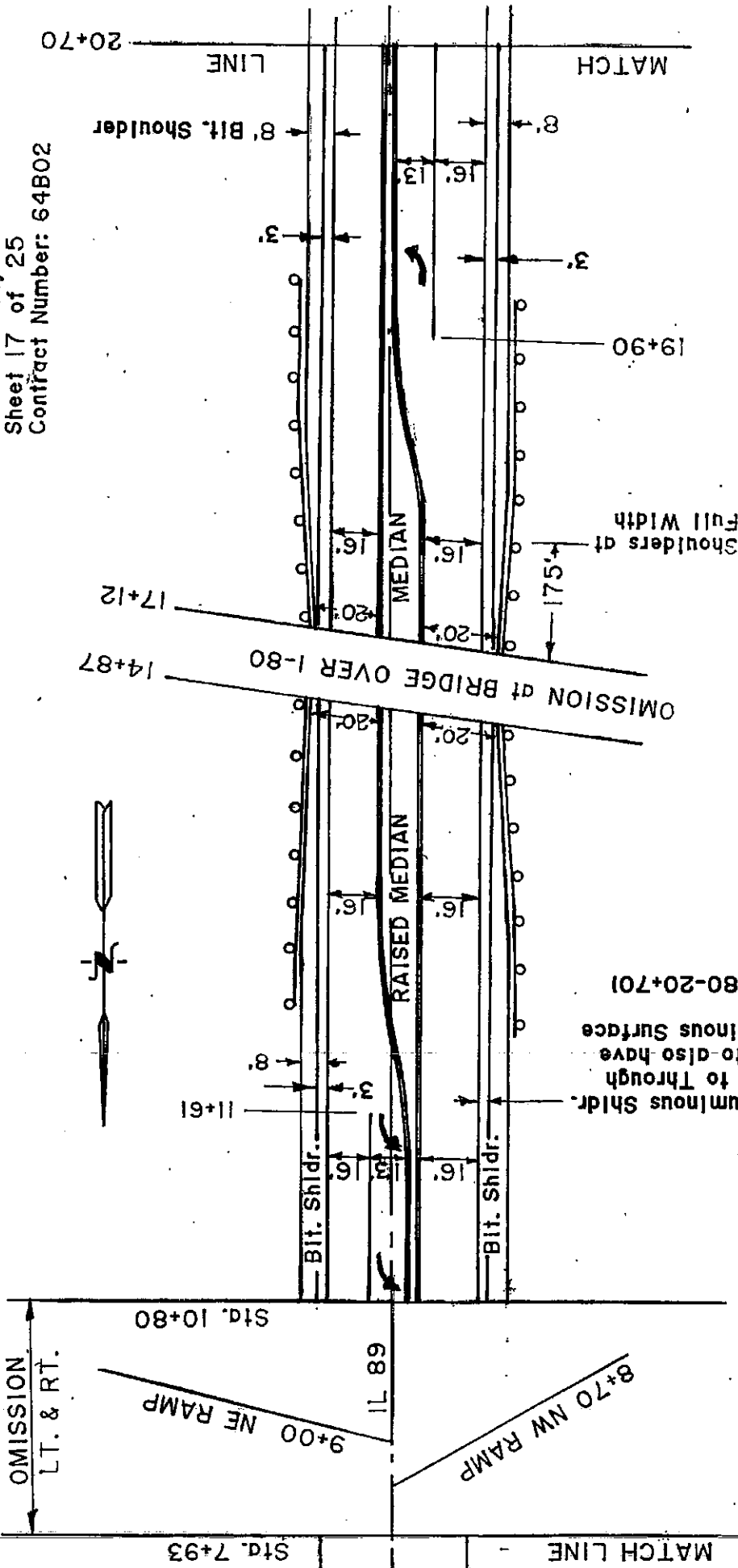

Note: Sta. 20+00 In Pavement

NOT TO SCALE

FAP 698 & FAU 5601
 D2 MRS 2005-14
 Bureau County
 Sheet 18 of 25
 Contract Number: 64B02

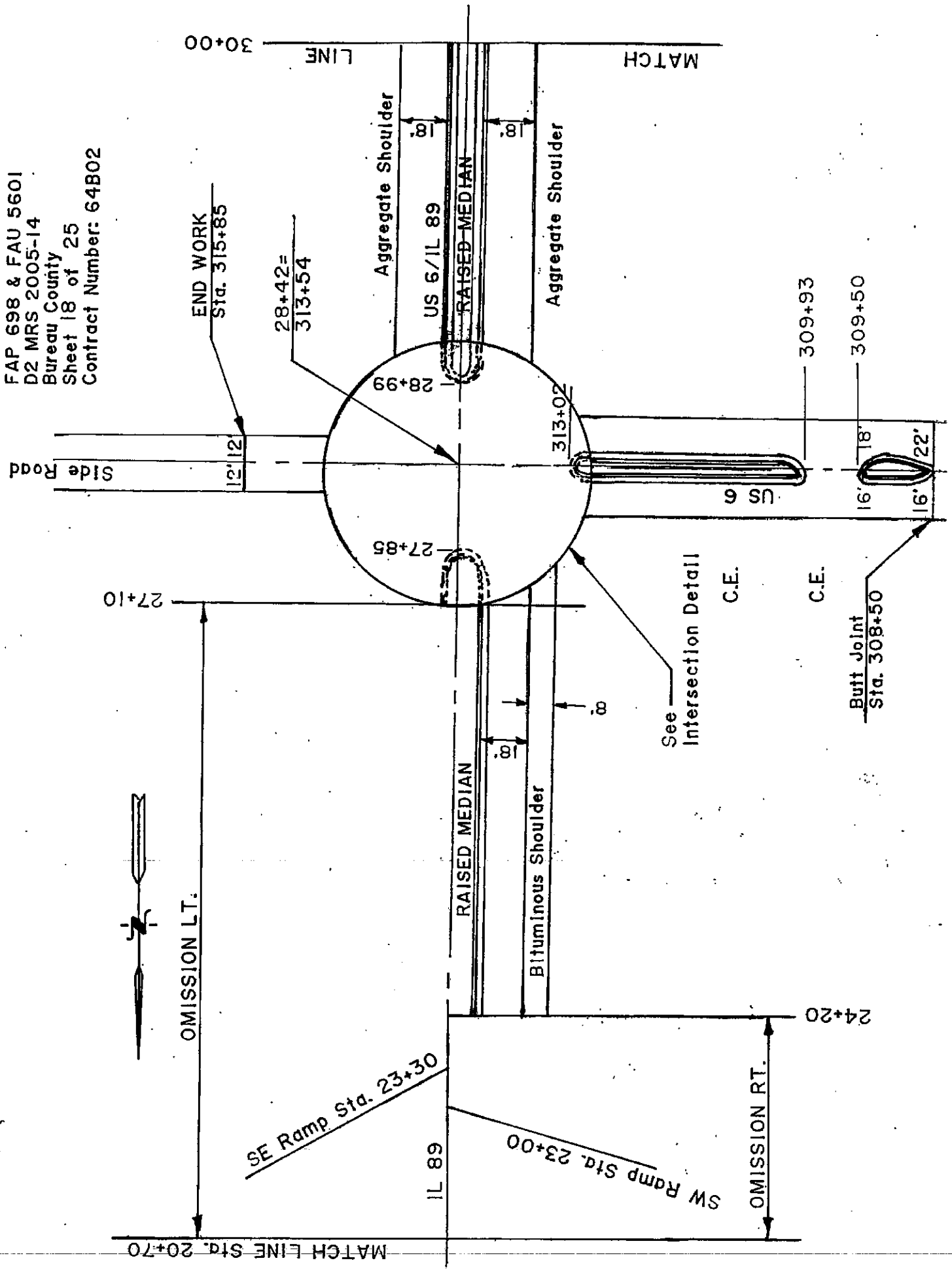

FAP 698 & FAU 5601
 D2 MRS 2005-14
 Bureau County
 Sheet 19 of 25
 Contract Number: 64B02

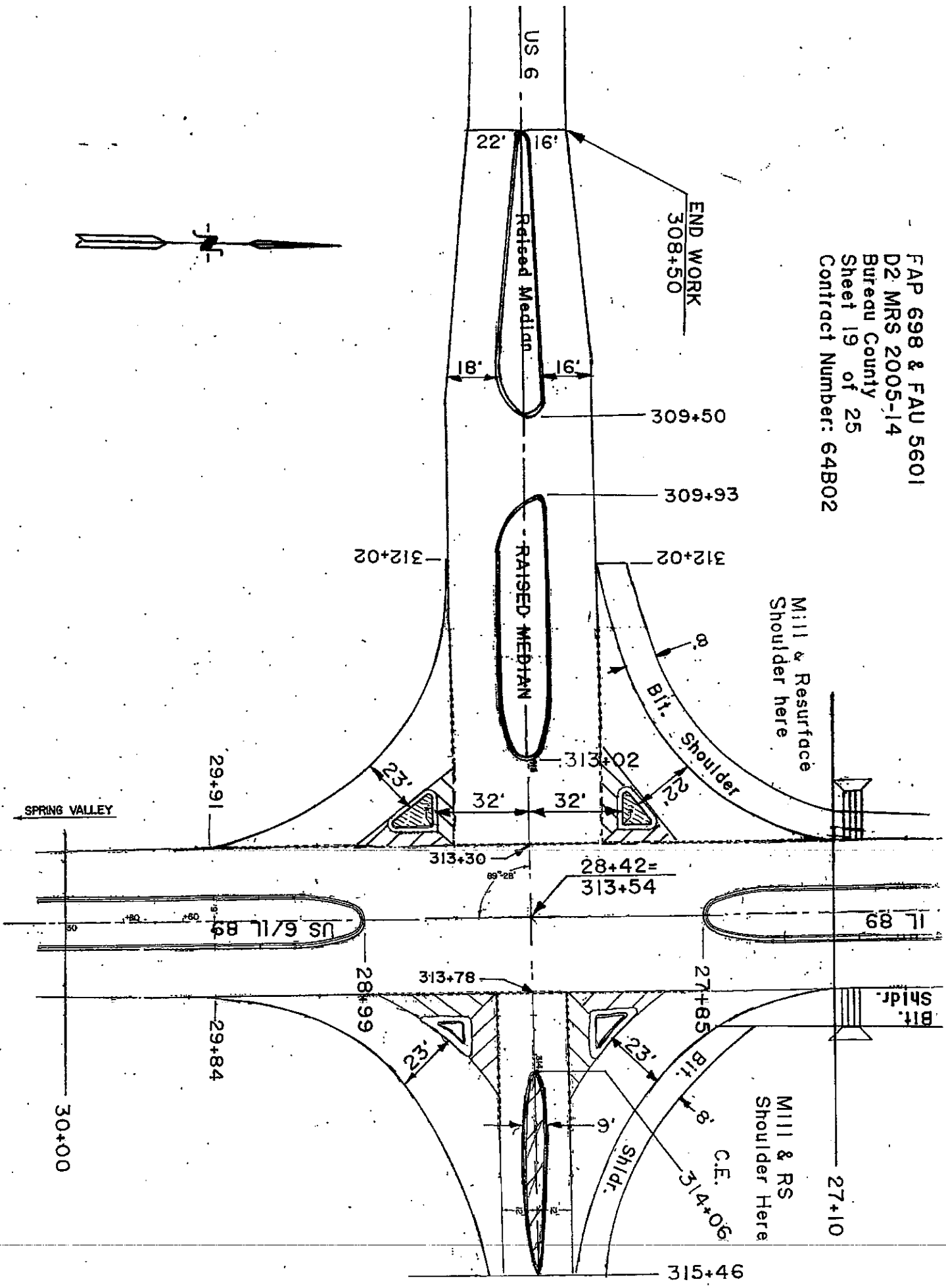

FAP 698 & FAU 5601
D2 MRS 2005-14
Bureau County
Sheet 20 of 25
Contract Number: 64B02



30+00

End Project
Sta. 47+47

P.E.
M.B.T.O.

Aggregate Shoulder

18'

RAISED MEDIAN

18'

Aggregate Shoulder

34+83
(33' wide)

33+33
(40' wide)

13.5
13.5

US 6/IL 89

Match Line

NOT TO SCALE

REQUIRED COLD MILLED SURFACE TEXTURE

FILE	
STA.	
REL.	

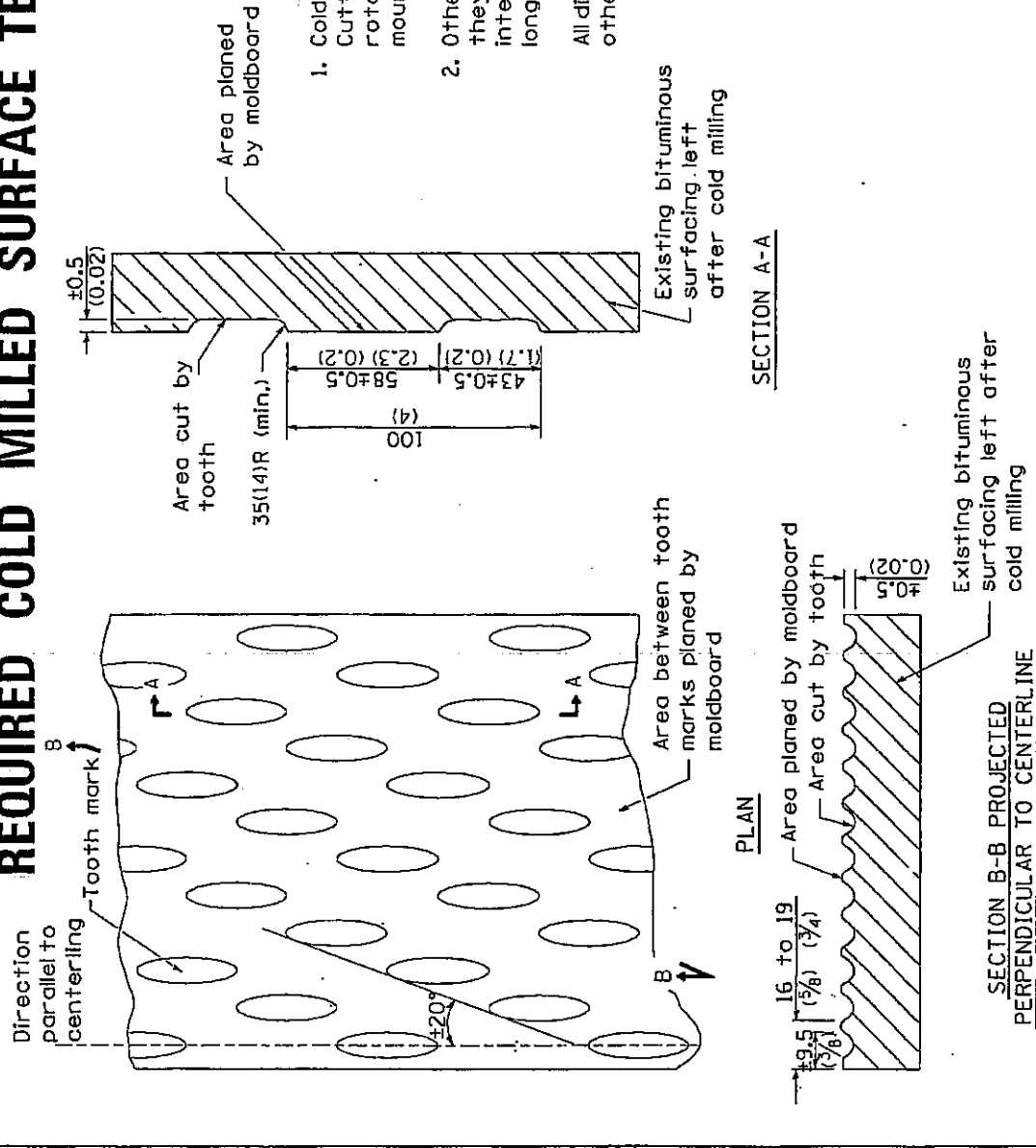

NOTES

1. Cold Milling shall consist of two processes: Cutting with carbide teeth mounted on a rotating drum, and planing with a moldboard mounted immediately behind the cutting drum.
 2. Other similar patterns will be acceptable if they consist of a smooth, flat, planed surface interspersed with a pattern of discontinuous longitudinal striations.
- All dimensions are in millimeters (inches) unless otherwise shown.

ROUGH GROOVED SURFACE SIGN

FAP 698 & FAU 6501
 D2 MRS 2005-14
 Bureau County
 Sheet 22 of 25
 Contract Number: 64B02

ILLINOIS STANDARD WB-1107 SIGN PANEL TYPE 1

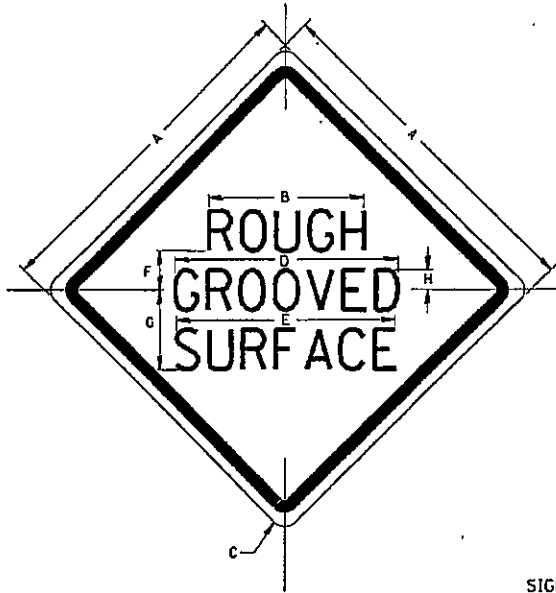

COLOR: LEGEND AND BORDER - BLACK NON-REFLECTIVE
 BACKGROUND - ORANGE REFLECTORIZED

SIGN SIZE	DIMENSIONS							
	A	B	C	D	E	F	G	H
1200x1200 (48x48)	1200 (48.0)	600 (24.1)	75 (3.0)	850 (34.0)	825 (33.0)	150 (6.0)	325 (13.0)	88 (3.5)

SIGN SIZE	SERIES LINES			MARGIN	BORDER	BLANK STD.
	1	2	3			
1200x1200 (48x48)	7C	7C	7C	20 (0.8)	30 (1.2)	B4-48D

ALL DIMENSIONS IN INCHES.

GENERAL NOTES

SIGN PANELS AND FACE MATERIALS SHALL BE ACCORDING TO SECTION 720 OF THE STANDARD SPECIFICATIONS METAL PDSTS SHALL BE IN ACCORDANCE WITH STD. 720011.

ALL MOUNTING HARDWARE SHALL BE ALUMINUM, STAINLESS STEEL, ZINC OR CADMIUM PLATED STEEL AND SHALL BE INCIDENTAL TO THE COST OF THE INSTALLATION.

ALL DIMENSIONS ARE IN MILLIMETERS (INCHES) UNLESS OTHERWISE NOTED.

TRAFFIC CONTROL AND PROTECTION AT TURN BAYS (TO REMAIN OPEN TO TRAFFIC)

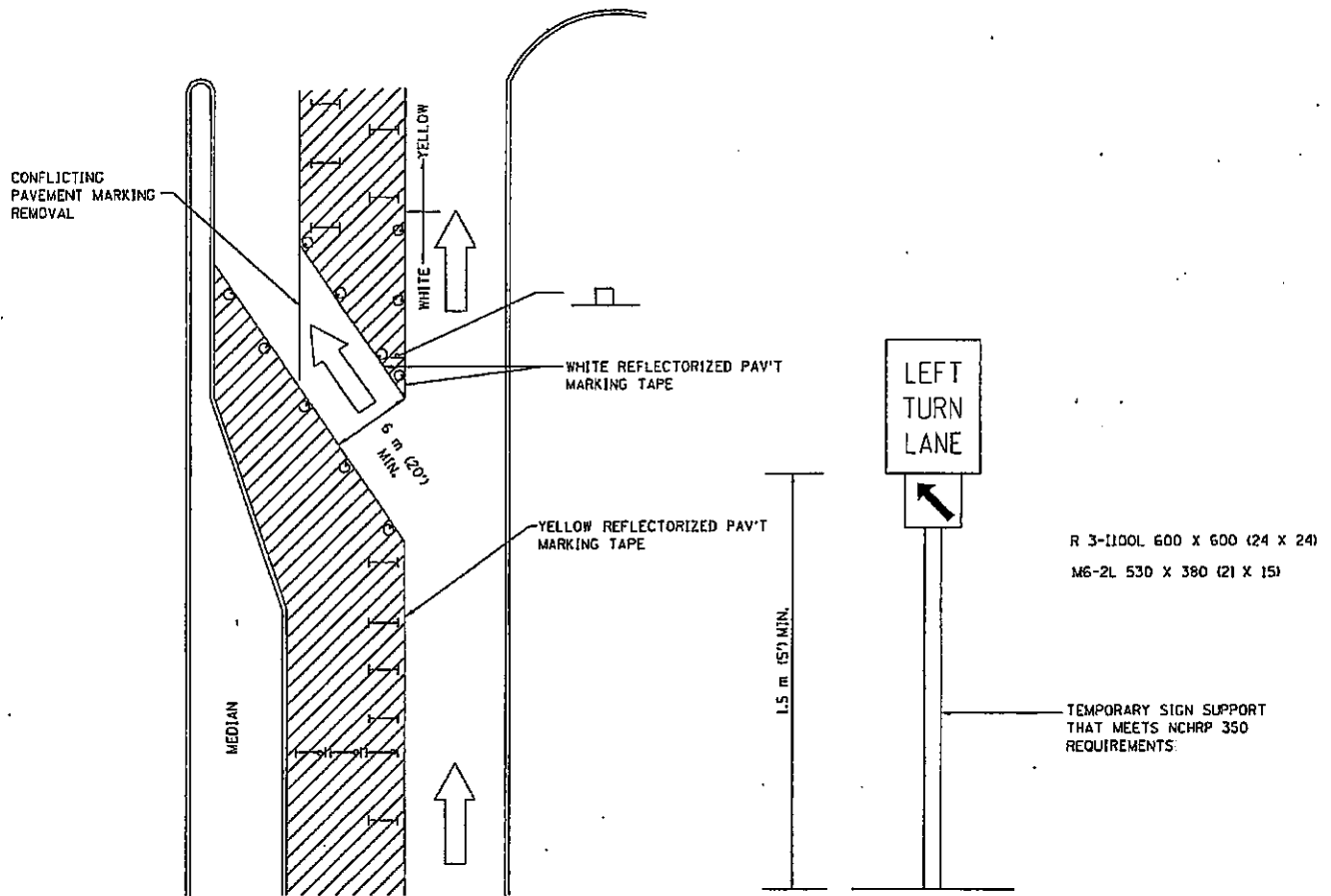

LEGEND

- WORK AREA
- LANE OPEN TO TRAFFIC
- TYPE I OR II BARRICADE OR DRUM WITH FLASHING BURNING LIGHT
- DRUM OR BARRICADE WITH STEADY BURN LIGHT
- SIGN (SEE DETAIL)
- TYPE I OR II CHECK BARRICADE WITH STEADY LIGHT BURN

GENERAL NOTES

- CONES MAY BE SUBSTITUTED FOR BARRICADES OR DRUMS AT HALF THE SPACING DURING DAY OPERATIONS. CONES SHALL BE A MINIMUM OF 710 (28) IN HEIGHT.
- STEADY BURNING LIGHTS WILL NOT BE REQUIRED ON BARRICADES OR DRUMS FOR DAY OPERATIONS. ALL LIGHTS WILL BE MONDIRECTIONAL.
- REFLECTORIZED TEMPORARY PAVEMENT MARKING TAPE SHALL BE PLACED THROUGHOUT THE BARRICADED AREA OF EACH BAY WHERE THE CLOSURE TIME IS GREATER THAN FOURTEEN DAYS.
- THIS APPLICATION ALSO APPLIES WHEN WORK IS BEING PERFORMED IN THE RIGHT LANE(S) AND THE RIGHT TURN BAY IS TO REMAIN OPEN. UNDER THIS CONDITION, "RIGHT TURN LANE" R3-100 600 x 600 (24 x 24) AND M6-2R 530 x 380 (21 x 15) SHALL BE USED.
- THESE CONTROLS SHALL SUPPLEMENT MAINLINE TRAFFIC CONTROL FOR LANE CLOSURES.
- LONGITUDINAL DIMENSIONS MAY BE ADJUSTED TO FIT FIELD CONDITIONS.
- TRAFFIC CONTROL AND PROTECTION AT TURN BAYS (TO REMAIN OPEN TO TRAFFIC) SHALL BE INCLUDED IN THE COST SPECIFIED TRAFFIC CONTROL STANDARDS OR ITEMS.

ALL DIMENSIONS ARE IN MILLIMETERS (INCHES) UNLESS OTHERWISE SHOWN

5th Feb 14 09:00:21 2014
 c:\p\enr\64b02\mtdg\64b02.dgn

TYPICAL PAVEMENT MARKINGS

TYPICAL PAVEMENT MARKING FOR FLUSH MEDIAN

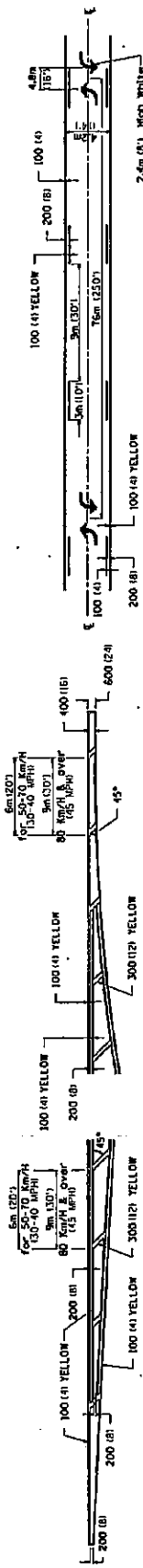

MEDIAN PAVEMENT MARKING

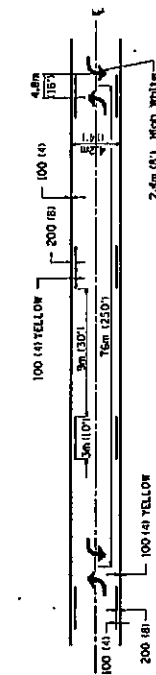

TYPICAL ISLAND OFFSET SHOULDER WIDTH

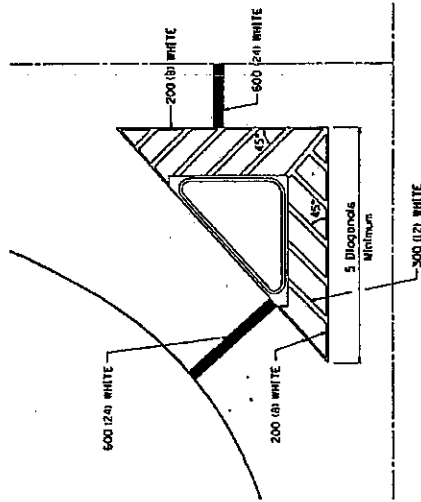

TYPICAL PARKING SPACING

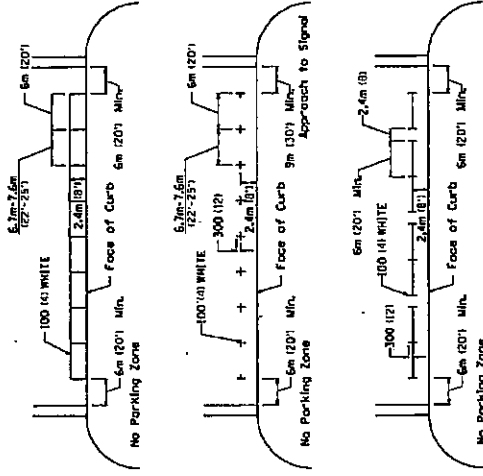

STANDARD CROSSWALK MARKING

See Schedules for Locations

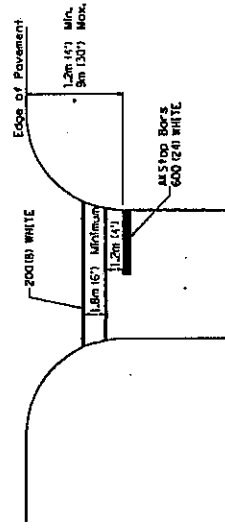

* Distance to the nearest edge of the intersecting roadway in the absence of a marked crosswalk.

** ALL DIMENSIONS ARE IN MILLIMETERS (INCHES/LESS OTHERWISE NOTED).

ILLINOIS DEPARTMENT OF LABOR

PREVAILING WAGES FOR BUREAU COUNTY EFFECTIVE JULY 2005

The Prevailing rates of wages are included in the Contract proposals which are subject to Check Sheet #5 of the Supplemental Specifications and Recurring Special Provisions. The rates have been ascertained and certified by the Illinois Department of Labor for the locality in which the work is to be performed and for each craft or type of work or mechanic needed to execute the work of the Contract. As required by Prevailing Wage Act (820 ILCS 130/0.01, et seq.) and Check Sheet #5 of the Contract, not less than the rates of wages ascertained by the Illinois Department of Labor and as revised during the performance of a Contract shall be paid to all laborers, workers and mechanics performing work under the Contract. Post the scale of wages in a prominent and easily accessible place at the site of work.

If the Illinois Department of Labor revises the prevailing rates of wages to be paid as listed in the specification of rates, the contractor shall post the revised rates of wages and shall pay not less than the revised rates of wages. Current wage rate information shall be obtained by visiting the Illinois Department of Labor web site at <http://www.state.il.us/agency/idol/> or by calling 312-793-2814. It is the responsibility of the contractor to review the rates applicable to the work of the contract at regular intervals in order to insure the timely payment of current rates. Provision of this information to the contractor by means of the Illinois Department of Labor web site satisfies the notification of revisions by the Department to the contractor pursuant to the Act, and the contractor agrees that no additional notice is required. The contractor shall notify each of its subcontractors of the revised rates of wages.

Bureau County Prevailing Wage for July 2005

Trade Name	RG	TYP	C	Base	FRMAN	*M-F>8	OSA	OSH	H/W	Pensn	Vac	Trng
=====	==	==	=	=====	=====	=====	==	==	=====	=====	=====	=====
ASBESTOS ABT-GEN		ALL		23.390	24.140	1.5	1.5	2.0	5.000	4.500	0.000	0.500
ASBESTOS ABT-MEC		BLD		23.300	24.800	1.5	1.5	2.0	3.640	5.520	0.000	0.000
BOILERMAKER		BLD		28.970	31.970	2.0	2.0	2.0	7.020	6.600	0.000	0.210
BRICK MASON		BLD		28.290	29.290	1.5	1.5	2.0	5.570	5.750	0.000	0.370
CARPENTER		BLD		24.970	26.470	1.5	1.5	2.0	5.560	6.670	0.000	0.570
CARPENTER		HWY		23.760	25.510	1.5	1.5	2.0	5.560	6.670	0.000	0.500
CEMENT MASON		ALL		27.000	28.000	2.0	2.0	2.0	4.800	6.590	0.000	0.050
CERAMIC TILE FNSHER		BLD		23.450	0.000	1.5	1.5	2.0	5.150	4.000	0.000	0.320
COMMUNICATION TECH		BLD		27.220	28.720	1.5	1.5	2.0	6.760	8.620	0.000	0.270
ELECTRIC PWR EQMT OP		ALL		28.840	34.100	1.5	1.5	2.0	4.500	7.790	0.000	0.000
ELECTRIC PWR GRNDMAN		ALL		19.790	34.100	1.5	1.5	2.0	4.500	5.340	0.000	0.000
ELECTRIC PWR LINEMAN		ALL		32.040	34.100	1.5	1.5	2.0	4.500	8.650	0.000	0.000
ELECTRIC PWR TRK DRV		ALL		20.760	34.100	1.5	1.5	2.0	4.500	5.600	0.000	0.000
ELECTRICIAN		BLD		32.460	35.380	1.5	1.5	2.0	6.260	10.06	0.000	0.320
ELEVATOR CONSTRUCTOR		BLD		30.090	33.850	2.0	2.0	2.0	7.275	3.420	1.810	0.000
GLAZIER		BLD		25.620	26.370	1.5	1.5	2.0	5.150	5.550	0.000	0.300
HT/FROST INSULATOR		BLD		31.650	33.400	1.5	1.5	2.0	7.260	8.360	0.000	0.230
IRON WORKER		ALL		25.650	27.650	1.5	1.5	2.0	6.440	9.410	0.000	0.570
LABORER		ALL		22.390	23.140	1.5	1.5	2.0	5.000	4.500	0.000	0.500
LABORER, SKILLED		BLD		22.790	23.540	1.5	1.5	2.0	5.000	4.500	0.000	0.500
LABORER, SKILLED		HWY		22.790	23.540	1.5	1.5	2.0	5.000	4.500	0.000	0.500
LATHER		BLD		24.970	26.470	1.5	1.5	2.0	5.560	6.670	0.000	0.570
MACHINIST		BLD		35.630	37.630	2.0	2.0	2.0	3.880	4.750	2.460	0.000
MARBLE FINISHERS		BLD		23.450	0.000	1.5	1.5	2.0	5.150	4.000	0.000	0.320
MARBLE MASON		BLD		26.530	26.780	1.5	1.5	2.0	5.150	5.220	0.000	0.350
MILLWRIGHT		BLD		30.820	33.900	1.5	1.5	2.0	6.100	8.930	0.000	0.560
OPERATING ENGINEER	E	BLD	1	37.750	41.750	2.0	2.0	2.0	6.450	5.150	1.800	0.650
OPERATING ENGINEER	E	BLD	2	36.450	41.750	2.0	2.0	2.0	6.450	5.150	1.800	0.650
OPERATING ENGINEER	E	BLD	3	33.900	41.750	2.0	2.0	2.0	6.450	5.150	1.800	0.650
OPERATING ENGINEER	E	BLD	4	32.150	41.750	2.0	2.0	2.0	6.450	5.150	1.800	0.650
OPERATING ENGINEER	E	HWY	1	37.750	41.750	1.5	1.5	2.0	6.450	5.150	1.800	0.650
OPERATING ENGINEER	E	HWY	2	37.200	41.750	1.5	1.5	2.0	6.450	5.150	1.800	0.650
OPERATING ENGINEER	E	HWY	3	35.150	41.750	1.5	1.5	2.0	6.450	5.150	1.800	0.650
OPERATING ENGINEER	E	HWY	4	33.750	41.750	1.5	1.5	2.0	6.450	5.150	1.800	0.650
OPERATING ENGINEER	E	HWY	5	32.550	41.750	1.5	1.5	2.0	6.450	5.150	1.800	0.650
OPERATING ENGINEER	W	BLD	1	27.310	29.060	1.5	1.5	2.0	4.650	7.750	0.000	0.800
OPERATING ENGINEER	W	BLD	2	25.490	29.060	1.5	1.5	2.0	4.650	7.750	0.000	0.800
OPERATING ENGINEER	W	BLD	3	24.170	29.060	1.5	1.5	2.0	4.650	7.750	0.000	0.800
OPERATING ENGINEER	W	HWY	1	26.920	29.920	1.5	1.5	2.0	4.650	7.750	0.000	0.800
OPERATING ENGINEER	W	HWY	2	24.800	29.920	1.5	1.5	2.0	4.650	7.750	0.000	0.800
OPERATING ENGINEER	W	HWY	3	21.330	29.920	1.5	1.5	2.0	4.650	7.750	0.000	0.800
PAINTER		ALL		26.150	27.150	1.5	1.5	1.5	5.150	5.000	0.000	0.250
PAINTER SIGNS		BLD		25.150	28.240	1.5	1.5	1.5	2.600	2.010	0.000	0.000
PILEDRIVER		BLD		25.220	26.720	1.5	1.5	2.0	5.560	6.670	0.000	0.570
PILEDRIVER		HWY		23.760	25.510	1.5	1.5	2.0	5.560	6.670	0.000	0.500
PIPEFITTER		BLD		36.100	38.100	1.5	1.5	2.0	7.910	6.100	0.000	0.800
PLASTERER		BLD		27.000	28.000	2.0	2.0	2.0	4.800	6.590	0.000	0.050
PLUMBER		BLD		34.960	36.960	1.5	1.5	2.0	4.600	7.490	0.000	0.520
ROOFER		BLD		23.760	24.760	1.5	1.5	2.0	4.120	2.460	0.000	0.320
SHEETMETAL WORKER		BLD		29.740	30.990	1.5	1.5	2.0	5.170	5.430	0.000	0.200
SPRINKLER FITTER		BLD		29.390	30.890	1.5	1.5	2.0	6.100	4.950	0.000	0.250
STONE MASON		BLD		28.290	29.290	1.5	1.5	2.0	5.570	5.750	0.000	0.370
TERRAZZO FINISHER		BLD		23.450	0.000	1.5	1.5	2.0	5.150	4.000	0.000	0.320
TILE LAYER		BLD		24.970	26.470	1.5	1.5	2.0	5.560	6.670	0.000	0.570
TILE MASON		BLD		26.530	26.780	1.5	1.5	2.0	5.150	5.220	0.000	0.350
TRUCK DRIVER		ALL	1	24.755	0.000	1.5	1.5	2.0	7.000	3.100	0.000	0.000
TRUCK DRIVER		ALL	2	25.155	0.000	1.5	1.5	2.0	7.000	3.100	0.000	0.000
TRUCK DRIVER		ALL	3	25.355	0.000	1.5	1.5	2.0	7.000	3.100	0.000	0.000

TRUCK DRIVER	ALL	4	25.605	0.000	1.5	1.5	2.0	7.000	3.100	0.000	0.000
TRUCK DRIVER	ALL	5	26.355	0.000	1.5	1.5	2.0	7.000	3.100	0.000	0.000
TRUCK DRIVER	O&C	1	19.804	0.000	1.5	1.5	2.0	7.000	3.100	0.000	0.000
TRUCK DRIVER	O&C	2	20.124	0.000	1.5	1.5	2.0	7.000	3.100	0.000	0.000
TRUCK DRIVER	O&C	3	20.284	0.000	1.5	1.5	2.0	7.000	3.100	0.000	0.000
TRUCK DRIVER	O&C	4	20.484	0.000	1.5	1.5	2.0	7.000	3.100	0.000	0.000
TRUCK DRIVER	O&C	5	21.084	0.000	1.5	1.5	2.0	7.000	3.100	0.000	0.000
TUCKPOINTER	BLD		28.290	29.290	1.5	1.5	2.0	5.570	5.750	0.000	0.370

Legend:

M-F>8 (Overtime is required for any hour greater than 8 worked each day, Monday through Friday.)

OSA (Overtime is required for every hour worked on Saturday)

OSH (Overtime is required for every hour worked on Sunday and Holidays)

H/W (Health & Welfare Insurance)

Pensn (Pension)

Vac (Vacation)

Trng (Training)

Explanations

BUREAU COUNTY

OPERATING ENGINEERS (EAST) - That part of the county East of Route 26.

The following list is considered as those days for which holiday rates of wages for work performed apply: New Years Day, Memorial/Decoration Day, Fourth of July, Labor Day, Veterans Day, Thanksgiving Day, Christmas Day. Generally, any of these holidays which fall on a Sunday is celebrated on the following Monday. This then makes work performed on that Monday payable at the appropriate overtime rate for holiday pay. Common practice in a given local may alter certain days of celebration such as the day after Thanksgiving for Veterans Day. If in doubt, please check with IDOL.

Oil and chip resealing (O&C) means the application of road oils and liquid asphalt to coat an existing road surface, followed by application of aggregate chips or gravel to coated surface, and subsequent rolling of material to seal the surface.

EXPLANATION OF CLASSES

ASBESTOS - GENERAL - removal of asbestos material/mold and hazardous materials from any place in a building, including mechanical systems where those mechanical systems are to be removed. This includes the removal of asbestos materials/mold and hazardous materials from ductwork or pipes in a building when the building is to be demolished at the time or at some close future date.

ASBESTOS - MECHANICAL - removal of asbestos material from mechanical systems, such as pipes, ducts, and boilers, where the mechanical systems are to remain.

CERAMIC TILE FINISHER, MARBLE FINISHER, TERRAZO FINISHER

Assisting, helping or supporting the tile, marble and terrazzo mechanic by performing their historic and traditional work assignments required to complete the proper installation of the work covered by said crafts. The term "Ceramic" is used for naming the classification only and is in no way a limitation of the product handled. Ceramic takes into consideration most hard tiles.

COMMUNICATION TECHNICIAN

Installation, operation, inspection, maintenance, repair and service of radio, television, recording, voice, sound and vision production and reproduction, telephone and telephone interconnect, facsimile, equipment and appliances used for domestic, commercial, educational and entertainment purposes, pulling of wire through conduit but not the installation of conduit.

LABORER, SKILLED - BUILDING AND HIGHWAY

The skilled laborer building (BLD) and heavy & highway (HWY) classification shall encompass the following types of work, irrespective of the site of the work: flagging, caisson worker plus depth, gunnite nozzle men, lead man on sewer work, welders, cutter burners and torchmen, chain saw operator, paving breaker, jackhammer and drill operators, layout man and/or drainage tile layer, steel form setter - street and highway, air tamping hammerman, signal man on crane, concrete saw operator, concrete saw operator walk behind, screenman on asphalt pavers, front end man on chip spreader, laborers tending masons with hot material or where foreign materials are used, multiple concrete duct - leadman, luteman, asphalt raker, curb asphalt machine operator, ready mix scalemen (permanent, portable or temporary plant), laborers handling masterplate or similar materials, laser beam operator, coring machine operator, plaster tenders, underpinning and shoring of buildings, material selector when working with fire-brick or castable material, fire watch, signaling of all power equipment, tree topper or trimmer when in connection with construction, and diver tender.

TRUCK DRIVER - BUILDING, HEAVY AND HIGHWAY CONSTRUCTION

Class 1. Drivers on 2 axle trucks hauling less than 9 ton. Air compressor and welding machines and brooms, including those pulled by separate units, truck driver helpers, warehouse employees, mechanic helpers, greasers and tiremen, pickup trucks when hauling materials, tools, or workers to and from and on-the-job site, and fork lifts up to 6,000 lb. capacity.

Class 2. Two or three axle trucks hauling more than 9 ton but hauling less than 16 ton. A-frame winch trucks, hydrolift trucks, vector trucks or similar equipment when used for transportation purposes. Fork lifts over 6,000 lb. capacity, winch trucks, four axle combination units, and ticket writers.

Class 3. Two, three or four axle trucks hauling 16 ton or more. Drivers on water pulls, articulated dump trucks, mechanics and working forepersons, and dispatchers. Five axle or more combination units.

Class 4. Low Boy and Oil Distributors.

Class 5. Drivers who require special protective clothing while employed on hazardous waste work.

TRUCK DRIVER - OIL AND CHIP RESEALING ONLY.

This shall encompass laborers, workers and mechanics who drive contractor or subcontractor owned, leased, or hired pickup, dump, service, or oil distributor trucks. The work includes transporting materials and equipment (including but not limited to, oils, aggregate supplies, parts, machinery and tools) to or from the job site; distributing oil or liquid asphalt and aggregate; stock piling material when in connection with the actual oil and chip contract. The Truck Driver (Oil & Chip Resealing) wage classification does not include supplier delivered materials.

OPERATING ENGINEERS - BUILDING - EAST

Class 1. Assistant Craft Foreman; Craft Foreman; Mechanic; Asphalt Plant; Asphalt Spreader; Autograde; Backhoes w/Caisson attachment; Batch Plant; Benoto; Boiler and Throttle Valve; Caisson Rigs; Central Redi-Mix Plant; Combination Back Hoe Front End-loader Machine; Compressor and Throttle Valve; Concrete Breaker (Truck Mounted); Concrete Conveyor; Concrete Paver; Concrete Placer; Concrete Pump (Truck Mounted); Concrete Tower; Cranes, All; Cranes, Hammerhead; Creter Crane; Crusher, Stone, etc.; Derricks, All; Derricks, Traveling; Formless Curb and Gutter Machine; Grader, Elevating; Grouting Machines; Highlift Shovels or Front Endloader 2-1/4 yd. and over; Hoists, Elevators, outside type rack and pinion and similar machines; Hoists, one, two and three Drum; Hoists, Two tigger One Floor; Hydraulic Backhoes; Hydraulic Boom Trucks; Hydro Vac (and similar equipment.); Locomotives, All; Motor Patrol; Pile Drivers and Skid Rig; Post Hole Digger; Pre-Stress Machine; Pump Cretes; Squeeze Cretes-screw Type Pumps; Gypsum Bulker and Pump; Roto Mill Grinder; Scoops - Tractor Drawn; Slip-form Paver; Straddle Buggies; Tournapull; Tractor with Boom and Side Boom; Trenching Machines.

Class 2. Boilers; Broom, All Power Propelled; Bulldozers; Concrete Mixer (Two Bag and Over); Conveyor, Portable; Forklift Trucks; Greaser Engineer; Highlift Shovels or Front Endloaders under 2-1/4 yd.; Hoists, Automatic; Hoists, inside Freight Elevators; Hoists, Sewer Dragging Machine; Hoists, Tigger Single Drum; Laser Screed; Rock Drill (self-propelled); Rock Drill (Truck mounted); Rollers, All; Steam Generators; Tractors, All; Tractor Drawn Vibratory Roller; Winch Trucks with "A" Frame.

Class 3. Air Compressors; Combination - Small Equipment Operator; Generators; Heaters, Mechanical; Hoists, Inside Elevators - (Rheostat Manual Controlled); Hoists, Inside Elevators; Hydraulic Power Units (Pile Driving and Extracting); Vibratory Roller; Lowboys; Pumps, over 3" (1 to 3 not to exceed a total of 300 ft.); Pumps, Well Points; Welding Machines (2 through 5); Winches, 4 small Electric Drill Winches.

Class 4. Bobcat/Skid Steer Loader; Brick Forklift; Hoists, Inside Elevators push button with automatic doors; Oilers.

OPERATING ENGINEERS - HEAVY AND HIGHWAY CONSTRUCTION - EAST

Class 1. Craft Foreman; Asphalt Plant; Asphalt Heater and Planer Combination; Asphalt Heater Scarfire; Asphalt Spreader; Autograder; ABC Paver; Backhoes with Caisson Attachment; Belt Loader; Caisson Rigs; Car Dumper; Central Redi-Mix Plant; Combination Backhoe Front Endloader Machine, (1 cu. yd. Backhoe Bucket or over or with attachments); Concrete Breaker (Truck Mounted); Concrete Conveyor; Concrete Paver over 27E cu. ft.; Concrete Placer; Concrete Tube Float;

Cranes, all attachments; Cranes, Hammerhead, Linden, Peco & Machines of a like nature; Creter Crane; Crusher, Stone, etc.; Derricks, All; Derrick Boats; Derricks, Traveling; Dowell Machine; Dredges; Field Mechanic-Welder; Formless Curb and Gutter Machine; Gradall and Machines of a like nature; Grader, Elevating; Grader, Motor Grader, Motor Patrol, Auto Patrol, Form Grader, Pull Grader, Subgrader; Guard Rail Post Driver Truck Mounted; Hoists, One, Two and Three Drum; Hydraulic Backhoes; Mucking Machine; Pile Drivers and Skid Rig; Pre-Stress Machine; Pump Cretes Dual Ram; Rock/Track Tamper; Rock Drill - Truck Mounted; Roto Mill Grinder; Slip-Form Paver; Soil Test Drill Rig (Truck Mounted); Straddle Buggies; Hydraulic Telescoping form (Tunnel); Tractor Drawn Belt Loader with attached pusher; Tractor with Boom; Tractaire with Attachments; Trenching Machine; Truck Mounted Concrete Pump with Boom; Raised or Blind Hole; Drills (Tunnel Shaft); Underground Boring and/or Mining Machines; Wheel Excavator; Widener (APSCO).

Class 2. Batch Plant; Bituminous Mixer; Boiler and Throttle Valve; Bulldozers; Car Loader Trailing Conveyors; Combination Backhoe Front Endloader Machine (less than 1 cu. yd. Backhoe Bucket or over or with attachments); Compressor and Throttle Valve; Compressor, Common Receiver (3); Concrete Breaker or Hydro Hammer; Concrete Grinding Machine; Concrete Mixer or Paver 7S Series to and including 27 cu. ft.; Concrete Spreader; Concrete Curing Machine, Burlap Machine, Belting Machine and Sealing Machine; Concrete Wheel Saw; Conveyor Muck Cars (Haglund or Similar Type); Drills, All; Finishing Machine - Concrete; Greaser Engine; Highlift Shovels or Front Endloader; Hoist - Sewer Dragging Machine; Hydraulic Boom Trucks (All Attachments); Hydro-Blaster; Locomotives, Dinky; Laser Screed; Pump Cretes; Squeeze Cretes-Screw Type Pumps, Gypsum Bulker and Pump; Rock Drill - Crawler or Skid Rig; Rock Drill - Truck Mounted; Roller, Asphalt; Rotary Snow Plows; Rototiller, Seaman, etc., self-propelled; Scoops - Tractor Drawn; Self-Propelled Compactor; Spreader - Chip - Stone, etc.; Scraper; Scraper - Prime Mover in Tandem; Tank Car Heater; Tractors, Push, Pulling Sheeps Foot, Disc, Compactor, etc. Tug Boats.

Class 3. Boilers; Brooms, All Power Propelled; Cement Supply Tender; Compressor, Common Receiver (2); Concrete Mixer (Two Bag and Over); Conveyor, Portable; Farm-Type Tractors Used for Mowing, Seeding, etc.; Fireman on Boilers; Forklift Trucks; Grouting Machine; Hoists, Automatic; Hoists, All Elevators; Hoists, Tugger Single Drum; Jeep Diggers; Pipe Jacking Machines; Post-Hole Digger; Power Saw, Concrete Power Driven; Pug Mills; Rollers, other than asphalt; Seed and Straw Blower; Steam Generators; Stump Machine; Winch Trucks with "A" Frame; Work Boats; Tamper - Form-Motor Driven.

Class 4. Air Compressor; Combination - Small Equipment Operator; Directional Boring Machine; Generators; Heaters, Mechanical; Hydraulic Power Unit (Pile Driving, Extracting, or Drilling); Hydro-Blaster; Light Plants, All (1 through 5); Pumps, over 3" (1 to 3 not to exceed a total of 300 ft.); Pumps; Tractaire; Welding Machines (2 through 5); Winches.

Class 5. Bobcats (All); Brick Forklifts; Oilers.

OPERATING ENGINEERS - BUILDING - WEST

Class 1. Cranes; Overhead Cranes; Gradall; All Cherry Pickers; Mechanics; Central Concrete Mixing Plant Operator; Road Pavers (27E - Dual Drum - Tri Batchers); Blacktop Plant Operators and Plant Engineers; 3 Drum Hoist; Derricks; Hydro Cranes; Shovels; Skimmer Scoops; Koehring Scooper; Drag Lines; Backhoe; Derrick Boats; Pile Drivers and Skid Rigs; Clamshells; Locomotive Cranes; Dredge (all

types) Motor Patrol; Power Blades - Dumore - Elevating and similar types; Tower Cranes (Crawler-Mobile) and Stationary; Crane-type Backfiller; Drott Yumbo and similar types considered as Cranes; Caisson Rigs; Dozer; Tournadozer; Work Boats; Ross Carrier; Helicopter; Tournapulls - all and similar types; Scoops (all sizes); Pushcats; Endloaders (all types); Asphalt Surfacing Machine; Slip Form Paver; Rock Crusher; Heavy Equipment Greaser; CMI, CMI Belt Placer, Auto Grade & 3 Track and similar types; Side Booms; Multiple Unit Earth Movers; Creter Crane; Trench Machine; Pump-crete-Belt Crete-Squeeze Cretes-Screw-type Pumps and Gypsum; Bulker & Pump - Operator will clean; Formless Finishing Machine; Flaherty Spreader or similar types; Screed Man on Laydown Machine; Wheel Tractors (industrial or Farm-type w/Dozer-Hoe-Endloader or other attachments); F.W.D. & Similar Types; Vermeer Concrete Saw.

Class 2. Dinkeys; Power Launches; PH One-pass Soil Cement Machine (and similar types); Pugmill with Pump; Backfillers; Euclid Loader; Forklifts; Jeeps w/Ditching Machine or other attachments; Tuneluger; Automatic Cement and Gravel Batching Plants; Mobile Drills (Soil Testing) and similar types; Gurries and Similar Types; (1) and (2) Drum Hoists (Buck Hoist and Similar Types); Chicago Boom; Boring Machine & Pipe Jacking Machine; Hydro Boom; Dewatering System; Straw Blower; Hydro Seeder; Assistant Heavy Equipment Greaser on Spread; Tractors (Track type) without Power Unit pulling Rollers; Rollers on Asphalt -- Brick Macadem; Concrete Breakers; Concrete Spreaders; Mule Pulling Rollers; Center Stripper; Cement Finishing Machines & CMI Texture & Reel Curing Machines; Cement Finishing Machine; Barber Green or similar loaders; Vibro Tamper (All similar types) Self-propelled; Winch or Boom Truck; Mechanical Bull Floats; Mixers over 3 Bag to 27E; Tractor pulling Power Blade or Elevating Grader; Porter Rex Rail; Clary Screed; Truck Type Hoptoe Oilers; Fireman; Spray Machine on Paving; Curb Machines; Truck Crane Oilers; Oil Distributor; Truck-Mounted Saws; Directional boring machine.

Class 3. Air Compressor; Power Subgrader; Straight Tractor; Trac Air without attachments; Herman Nelson Heater, Dravo, Warner, Silent Glo, and similar types; Roller: Five (5) Ton and under on Earth or Gravel; Form Grader; Crawler Crane & Skid Rig Oilers; Freight Elevators - permanently installed; Pump; Light Plant; Generator; Conveyor (1) or (2) - Operator will clean; Welding Machine; Mixer (3) Bag and Under (Standard Capacity with skip); Bulk Cement Plant; Oiler on Central Concrete Mixing Plant; Straight framed articulating end dump vehicle; Truck mounted vac unit (separately powered).

OPERATING ENGINEERS - HEAVY AND HIGHWAY CONSTRUCTION - WEST

Class 1. Cranes; Hydro Crane; Shovels; Crane Type Backfiller; Tower Cranes - Mobile & Crawler & Stationary; Derricks & Hoists (3 Drum); Draglines; Drott Yumbo & similar types considered as Cranes; Back Hoe; Derrick Boats; Pile Driver and Skid Rigs; Clam Shell; Locomotive - Cranes; Road Pavers - Single Drum - Dual Drum - Tri Batcher; Motor Patrols & Power Blades - Dumore - Elevating & Similar Types; Mechanics; Central Concrete Mixing Plant Operator; Asphalt Batch Plant Operators and Plant Engineers; Gradall; Caisson Rigs; Skimmer Scoop - Koering Scooper; Dredges (all types); Hoptoe; All Cherry Pickers; Work Boat; Ross Carrier; Helicopter; Dozer; Tournadozer; Tournapulls - all and similar types; Multiple Unit Earth Movers; Scoops (all sizes); Pushcats; Endloaders (all types); Asphalt Surfacing Machine; Slip Form Paver; Rock Crusher; Heavy Equipment Greaser (top greaser on spread); CMI, Auto Grade, CMI Belt Placer & 3 Track and similar types; Side Booms; Starting Engineer on Pipeline; Asphalt Heater & Planer Combination (used to plane streets); Wheel Tractors (with dozer, hoe or endloader attachments); F.W.D. and Similar types; Blaw Knox

Spreader and Similar types; Trench Machines; Pump Crete - Belt Crete - Squeeze Crete - screw type pumps and gypsum (operator will clean); Formless Finishing Machines; Flaherty Spreader or similar types; Screed Man on Laydown Machine; Vermeer Concrete Saw.

Class 2. Bulker & Pump; Power Launches; Boring Machine & Pipe Jacking Machine; Dinkeys; P-H One Pass Soil Cement Machines and similar types; Wheel Tractors (Industry or farm type - other); Back Fillers; Euclid Loader; Fork Lifts; Jeep w/Ditching Machine or other attachments; Tunneluger; Automatic Cement & Gravel Batching Plants; Mobile Drills - Soil Testing and similar types; Pugmill with pump; All (1) and (2) Drum Hoists; Dewatering System; Straw Blower; Hydro-Seeder; Boring Machine; Hydro-Boom; Bump Grinders (self-propelled); Assistant Heavy Equipment Greaser; Apsco Spreader; Tractors (track-type) without Power Units Pulling Rollers on Asphalt - Brick or Macadam; Concrete Breakers; Concrete Spreaders; Cement Strippers; Cement Finishing Machines & CMI Texture & Reel Curing Machines; Vibro-Tampers (all similar types self-propelled); Mechanical Bull Floats; Self-propelled Concrete Saws; Mixers-over three (3) bags to 27E; Winch and Boom Trucks; Tractor Pulling Power Blade or Elevating Grader; Porter Rex Rail; Clary Screed; Mule Pulling Rollers; Pugmill without Pump; Barber Greene or similar Loaders; Track Type Tractor w/Power Unit attached (minimum); Fireman; Spray Machine on Paving; Curb Machines; Paved Ditch Machine; Power Broom; Self-Propelled Conveyors; Power Subgrader; Oil Distributor; Straight Tractor; Truck Crane Oiler; Truck Type Oilers.

Class 3. Trac Air Machine (without attachments); Herman Nelson Heater, Dravo Warner, Silent Glo & similar types; Rollers - five ton and under on earth and gravel; Form Graders; Pumps; Light Plant; Generator; Air Compressor (1) or (2); Conveyor; Welding Machine; Mixer - 3 bags and under; Bulk Cement Plant; Oilers.

Other Classifications of Work:

For definitions of classifications not otherwise set out, the Department generally has on file such definitions which are available. If a task to be performed is not subject to one of the classifications of pay set out, the Department will upon being contacted state which neighboring county has such a classification and provide such rate, such rate being deemed to exist by reference in this document. If no neighboring county rate applies to the task, the Department shall undertake a special determination, such special determination being then deemed to have existed under this determination. If a project requires these, or any classification not listed, please contact IDOL at 618/993-7271 for wage rates or clarifications.

LANDSCAPING

Landscaping work falls under the existing classifications for laborer, operating engineer and truck driver. The work performed by landscape plantsman and landscape laborer is covered by the existing classification of laborer. The work performed by landscape operators (regardless of equipment used or its size) is covered by the classifications of operating engineer. The work performed by landscape truck drivers (regardless of size of truck driven) is covered by the classifications of truck driver.