

INSTRUCTIONS

ABOUT IDOT PROPOSALS: All proposals are potential bidding proposals. Each proposal contains all certifications and affidavits, a proposal signature sheet and a proposal bid bond.

PREQUALIFICATION

Any contractor who desires to become pre-qualified to bid on work advertised by IDOT must submit the properly completed pre-qualification forms to the Bureau of Construction no later than 4:30 p.m. prevailing time twenty-one days prior to the letting of interest. This pre-qualification requirement applies to first time contractors, contractors renewing expired ratings, contractors maintaining continuous pre-qualification or contractors requesting revised ratings. To be eligible to bid, existing pre-qualification ratings must be effective through the date of letting.

WHO CAN BID ?

Bids will be accepted from only those companies that request and receive written Authorization to Bid from IDOT's Central Bureau of Construction. This does not apply to Small Business Set-Asides.

REQUESTS FOR AUTHORIZATION TO BID

Contractors wanting to bid on items included in a particular letting must submit the properly completed "Request for Authorization to Bid/or Not For Bid Status" (BDE 124) and the ORIGINAL "Affidavit of Availability" (BC 57) to the proper office no later than 4:30 p.m. prevailing time, three (3) days prior to the letting date. This does not apply to Small Business Set-Asides.

WHAT CONSTITUTES WRITTEN AUTHORIZATION TO BID?: When a prospective prime bidder submits a "Request for Authorization to Bid/or Not For Bid Status"(BDE 124) he/she must indicate at that time which items are being requested For Bidding purposes. Only those items requested For Bidding will be analyzed. After the request has been analyzed, the bidder will be issued an **Authorization to Bid or Not for Bid Report**, approved by the Central Bureau of Construction that indicates which items have been approved For Bidding. If **Authorization to Bid** cannot be approved, the **Authorization to Bid or Not for Bid Report** will indicate the reason for denial.

ABOUT AUTHORIZATION TO BID: Firms that have not received an Authorization to Bid or Not For Bid Report within a reasonable time of complete and correct original document submittal should contact the department as to the status. Firms unsure as to authorization status should call the Prequalification Section of the Bureau of Construction at the number listed at the end of these instructions. These documents must be received three days before the letting date.

ADDENDA AND REVISIONS: It is the bidder's responsibility to determine which, if any, addenda or revisions pertain to any project they may be bidding. Failure to incorporate all relevant addenda or revisions may cause the bid to be declared unacceptable.

Each addendum or revision will be included with the Electronic Plans and Proposals. Addenda and revisions will also be placed on the Addendum/Revision Checklist and each subscription service subscriber will be notified by e-mail of each addendum and revision issued.

The Internet is the Department's primary way of doing business. The subscription server e-mails are an added courtesy the Department provides. It is suggested that bidders check IDOT's website at <http://www.dot.il.gov/desenv/delett.html> before submitting final bid information.

IDOT IS NOT RESPONSIBLE FOR ANY E-MAIL FAILURES.

Addenda questions may be directed to the Plans and Contracts Office at (217)782-7806 or D&Econtracts@dot.il.gov

Technical questions about downloading these files may be directed to Tim Garman at (217)524-1642 or Timothy.Garman@illinois.gov.

BID SUBMITTAL GUIDELINES AND CHECKLIST

In an effort to eliminate confusion and standardize the bid submission process the Contracts Office has created the following guidelines and checklist for submitting bids.

This information has been compiled from questions received from contractors and from inconsistencies noted on submitted bids. If you have additional questions please refer to the contact information listed below.

ABOUT SUBMITTING BIDS: It is recommended that bidders deliver bid proposals in person to ensure they arrive at the proper location prior to the time specified for the receipt of bids. Any proposals received at the place of letting after the time specified will not be read.

STANDARD GUIDELINES FOR SUBMITTING BIDS

- All pages should be single sided.
- Use the Cover Page that is provided in the Bid Proposal (posted on the IDOT Web Site) as the first page of your submitted bid. This page has the Item number in the upper left-hand corner and lines provided for your company name and address in the upper right-hand corner.
- Do not use report covers, presentation folders or special bindings and do not staple multiple times on left side like a book. Use only 1 staple in the upper left hand corner. Make sure all elements of your bid are stapled together including the bid bond or guaranty check (if required).
- Do not include any certificates of eligibility, your authorization to bid, Addendum Letters or affidavit of availability.
- Do not include the Subcontractor Documentation with your bid (pages i – iii and pages a – g). This documentation is required only after you are awarded the contract.
- Use the envelope cover sheet (provided with the proposal) as the cover for the proposal envelope.
- Do not rely on overnight services to deliver your proposal prior to 10 AM on letting day. It will not be read if it is delivered after 10 AM.
- Do not submit your Substance Abuse Prevention Program (SAPP) with your bid. If you are awarded the contract this form is to be submitted to the district engineer at the pre-construction conference.

Use the following checklist to ensure completeness and the correct order in assembling your bid

Cover page followed by the Pay Items. If you are using special software or CBID to generate your schedule of prices, do not include the blank schedule of prices.

Page 4 (Item 9) – Check “YES” if you will use a subcontractor(s). Include the subcontractor(s) name, address and the dollar amount (if over \$25,000). If you will use subcontractor(s) but are uncertain who or the dollar amount; check “YES” but leave the lines blank.

After page 4, Insert your Cost Adjustments for Steel, Bituminous and Fuel (if applicable), and your State Board of Elections certificate of registration.

Page 10 (Paragraph J) – Check “YES” or “NO” whether your company has any business in Iran.

Page 10 (Paragraph K) – List the Union Local Name and number or certified training programs that you have in place. Do not include certificates with your bid. Keep the certificates in your office in case they are requested by IDOT.

Page 11 (Paragraph L) - Insert a copy of your State Board of Elections certificate of registration after page 4 of the bid proposal. Only include the page that has the date stamp on it. Do not include any other certificates or forms showing that you are an Illinois business.

Page 11 (Paragraph M) – Indicate if your company has hired a lobbyist in connection with the job for which you are submitting the bid proposal.

Page 12 (Paragraph C) – This is a work sheet to determine if a completed Form A is required. It is not part of the form and you do not need to make copies for each Form A that is filled out.

Pages 14-17 (Form A) – One Form A (4 pages) is required for each applicable person in your company. Copies of the Forms can be used and only need to be changed when the financial information changes. The certification signature and date must be original for each letting. Do not staple the forms together.

If you answered “NO” to all of the questions in Paragraph C (page 12), complete the first section (page 14) with your company information and then sign and date the Not Applicable statement on page 17.

Page 18 (Form B) - If you check “YES” to having other current or pending contracts it is acceptable to use the phrase, “See Affidavit of Availability on file”.

Page 20 (Workforce Projection) – Be sure to include the Duration of the Project. It is acceptable to use the phrase “Per Contract Specifications”.

Bid Bond – Submit your bid bond using the current Bid Bond Form provided in the proposal package. The Power of Attorney page should be stapled to the Bid Bond. If you are using an electronic bond, include your bid bond number on the form and attach the Proof of Insurance printed from the Surety 2000 Web Site.

Disadvantaged Business Utilization Plan and/or Good Faith Effort – The last item in your bid should be the DBE Utilization Plan (SBE 2026), DBE Participation Statement (SBE 2025) and supporting paperwork. If you have documentation for a Good Faith Effort, it should follow the SBE Forms.

The Bid Letting is now available in streaming Audio/Video from the IDOT Web Site. A link to the stream will be placed on the main page of the current letting on the day of the Letting. The stream will not begin until 10 AM. The actual reading of the bids does not begin until approximately 10:20 AM.

Following the Letting, the As-Read Tabulation of Bids will be posted by the end of the day. You will find the link on the main page of the current letting.

QUESTIONS: pre-letting up to execution of the contract

Contractor/Subcontractor pre-qualification -----217-782-3413
Small Business, Disadvantaged Business Enterprise (DBE) -----217-785-4611
Contracts, Bids, Letting process or Internet downloads-----217-785-0230
Estimates Unit -----217-785-3483

QUESTIONS: following contract execution

Including Subcontractor documentation, payments -----217-782-3413
Railroad Insurance -----217-785-0275

RETURN WITH BID

4

Proposal Submitted By
Name
Address
City

Letting August 3, 2012

NOTICE TO PROSPECTIVE BIDDERS

This proposal can be used for bidding purposes by only those companies that request and receive written AUTHORIZATION TO BID from IDOT's Central Bureau of Construction. This does not apply to Small Business Set-Asides.

BIDDERS NEED NOT RETURN THE ENTIRE PROPOSAL

Notice to Bidders, Specifications, Proposal, Contract and Contract Bond



**Illinois Department
of Transportation**

Springfield, Illinois 62764

**Contract No. 63718
DUPAGE County
Section 12-PEDTS-00-SP
Various Routes
Project HSIP-4003(012)
District 1 Construction Funds**

PLEASE MARK THE APPROPRIATE BOX BELOW:

- A Bid Bond is included.
- A Cashier's Check or a Certified Check is included

Plans Included
Herein

Prepared by	
Checked by	F

(Printed by authority of the State of Illinois)

Page intentionally left blank

RETURN WITH BID



PROPOSAL

TO THE DEPARTMENT OF TRANSPORTATION

1. Proposal of _____

Taxpayer Identification Number (Mandatory) _____

for the improvement identified and advertised for bids in the Invitation for Bids as:

**Contract No. 63718
DUPAGE County
Section 12-PEDTS-00-SP
Project HSIP-4003(012)
Various Routes
District 1 Construction Funds**

Project consists of installation of pedestrian countdown signal heads at various intersections in DuPage County.

2. The undersigned bidder will furnish all labor, material and equipment to complete the above described project in a good and workmanlike manner as provided in the contract documents provided by the Department of Transportation. This proposal will become part of the contract and the terms and conditions contained in the contract documents shall govern performance and payments.

RETURN WITH BID

3. **ASSURANCE OF EXAMINATION AND INSPECTION/WAIVER.** The undersigned further declares that he/she has carefully examined the proposal, plans, specifications, addenda form of contract and contract bond, and special provisions, and that he/she has inspected in detail the site of the proposed work, and that he/she has familiarized themselves with all of the local conditions affecting the contract and the detailed requirements of construction, and understands that in making this proposal he/she waives all right to plead any misunderstanding regarding the same.
4. **EXECUTION OF CONTRACT AND CONTRACT BOND.** The undersigned further agrees to execute a contract for this work and present the same to the department within fifteen (15) days after the contract has been mailed to him/her. The undersigned further agrees that he/she and his/her surety will execute and present within fifteen (15) days after the contract has been mailed to him/her contract bond satisfactory to and in the form prescribed by the Department of Transportation, in the penal sum of the full amount of the contract, guaranteeing the faithful performance of the work in accordance with the terms of the contract.
5. **PROPOSAL GUARANTY.** Accompanying this proposal is either a bid bond on the department form, executed by a corporate surety company satisfactory to the department, or a proposal guaranty check consisting of a bank cashier's check or a properly certified check for not less than 5 per cent of the amount bid or for the amount specified in the following schedule:

<u>Amount of Bid</u>	<u>Proposal Guaranty</u>	<u>Amount of Bid</u>	<u>Proposal Guaranty</u>
Up to \$5,000	\$150	\$2,000,000	\$100,000
\$5,000 to \$10,000	\$300	\$3,000,000	\$150,000
\$10,000 to \$50,000	\$1,000	\$5,000,000	\$250,000
\$50,000 to \$100,000	\$3,000	\$7,500,000	\$400,000
\$100,000 to \$150,000	\$5,000	\$10,000,000	\$500,000
\$150,000 to \$250,000	\$7,500	\$15,000,000	\$600,000
\$250,000 to \$500,000	\$12,500	\$20,000,000	\$700,000
\$500,000 to \$1,000,000	\$25,000	\$25,000,000	\$800,000
\$1,000,000 to \$1,500,000	\$50,000	\$30,000,000	\$900,000
\$1,500,000 to \$2,000,000	\$75,000	over \$35,000,000	\$1,000,000

Bank cashier's checks or properly certified checks accompanying proposals shall be made payable to the Treasurer, State of Illinois, when the state is awarding authority; the county treasurer, when a county is the awarding authority; or the city, village, or town treasurer, when a city, village, or town is the awarding authority.

If a combination bid is submitted, the proposal guaranties which accompany the individual proposals making up the combination will be considered as also covering the combination bid.

The amount of the proposal guaranty check is _____ \$(_____). If this proposal is accepted and the undersigned shall fail to execute a contract bond as required herein, it is hereby agreed that the amount of the proposal guaranty shall become the property of the State of Illinois, and shall be considered as payment of damages due to delay and other causes suffered by the State because of the failure to execute said contract and contract bond; otherwise, the bid bond shall become void or the proposal guaranty check shall be returned to the undersigned.

Attach Cashier's Check or Certified Check Here

In the event that one proposal guaranty check is intended to cover two or more proposals, the amount must be equal to the sum of the proposal guaranties which would be required for each individual proposal. If the guaranty check is placed in another proposal, state below where it may be found.

The proposal guaranty check will be found in the proposal for: Item _____
 Section No. _____
 County _____

Mark the proposal cover sheet as to the type of proposal guaranty submitted.

RETURN WITH BID

6. **COMBINATION BIDS.** The undersigned further agrees that if awarded the contract for the sections contained in the following combination, he/she will perform the work in accordance with the requirements of each individual proposal comprising the combination bid specified in the schedule below, and that the combination bid shall be prorated against each section in proportion to the bid submitted for the same. If an error is found to exist in the gross sum bid for one or more of the individual sections included in a combination, the combination bid shall be corrected as provided in the specifications.

When a combination bid is submitted, the schedule below must be completed in each proposal comprising the combination.

If alternate bids are submitted for one or more of the sections comprising the combination, a combination bid must be submitted for each alternate.

Schedule of Combination Bids

Combination No.	Sections Included in Combination	Combination Bid	
		Dollars	Cents

7. **SCHEDULE OF PRICES.** The undersigned bidder submits herewith, in accordance with the rules and instructions, a schedule of prices for the items of work for which bids are sought. The unit prices bid are in U.S. dollars and cents, and all extensions and summations have been made. The bidder understands that the quantities appearing in the bid schedule are approximate and are provided for the purpose of obtaining a gross sum for the comparison of bids. If there is an error in the extension of the unit prices, the unit prices shall govern. Payment to the contractor awarded the contract will be made only for actual quantities of work performed and accepted or materials furnished according to the contract. The scheduled quantities of work to be done and materials to be furnished may be increased, decreased or omitted as provided elsewhere in the contract.
8. **AUTHORITY TO DO BUSINESS IN ILLINOIS.** Section 20-43 of the Illinois Procurement Code (30 ILCS 500/20-43) provides that a person (other than an individual acting as a sole proprietor) must be a legal entity authorized to do business in the State of Illinois prior to submitting the bid.
9. **The services of a subcontractor will or may be used.**

Check box Yes
 Check box No

For known subcontractors with subcontracts with an annual value of more than \$25,000, the contract shall include their name, address, and the dollar allocation for each subcontractor.

10. **EXECUTION OF CONTRACT:** The Department of Transportation will, in accordance with the rules governing Department procurements, execute the contract and shall be the sole entity having the authority to accept performance and make payments under the contract. Execution of the contract by the Chief Procurement Officer or the State Purchasing Officer is for approval of the procurement process and execution of the contract by the Department. Neither the Chief Procurement Officer nor the State Purchasing Officer shall be responsible for administration of the contract or determinations respecting performance or payment there under except as otherwise permitted in the Illinois Procurement Code.

STATE JOB # - C-91-373-12
 PPS NBR -

SCHEDULE OF PRICES
 CONTRACT NUMBER - 63718

RUN DATE - 06/07/12
 RUN TIME - 190059

COUNTY NAME	CODE	DIST	SECTION NUMBER	PROJECT NUMBER	ROUTE
DUPAGE	043	01	12-PEDTS-00-SP	HSIP-4003/012/000	VARIOUS

ITEM NUMBER	PAY ITEM DESCRIPTION	UNIT OF MEASURE	QUANTITY	UNIT PRICE		TOTAL PRICE	
				DOLLARS	CENTS	DOLLARS	CTS
67100100	MOBILIZATION	L SUM	1.000 X	=			
70102630	TR CONT & PROT 701601	L SUM	1.000 X	=			
70102635	TR CONT & PROT 701701	L SUM	1.000 X	=			
88102825	PED SH P LED 1F BM CT	EACH	54.000 X	=			
88102845	PED SH P LED 2F BM CT	EACH	29.000 X	=			
88800100	PED PUSH-BUTTON	EACH	79.000 X	=			

TOTAL \$

- NOTE:
1. EACH PAY ITEM SHOULD HAVE A UNIT PRICE AND A TOTAL PRICE.
 2. THE UNIT PRICE SHALL GOVERN IF NO TOTAL PRICE IS SHOWN OR IF THERE IS A DISCREPANCY BETWEEN THE PRODUCT OF THE UNIT PRICE MULTIPLIED BY THE QUANTITY.
 3. IF A UNIT PRICE IS OMITTED, THE TOTAL PRICE WILL BE DIVIDED BY THE QUANTITY IN ORDER TO ESTABLISH A UNIT PRICE.
 4. A BID MAY BE DECLARED UNACCEPTABLE IF NEITHER A UNIT PRICE NOR A TOTAL PRICE IS SHOWN.

RETURN WITH BID

STATE REQUIRED ETHICAL STANDARDS GOVERNING CONTRACT PROCUREMENT: ASSURANCES, CERTIFICATIONS AND DISCLOSURES

I. GENERAL

- A.** Article 50 of the Illinois Procurement Code establishes the duty of all State chief procurement officers, State purchasing officers, and their designees to maximize the value of the expenditure of public moneys in procuring goods, services, and contracts for the State of Illinois and to act in a manner that maintains the integrity and public trust of State government. In discharging this duty, they are charged by law to use all available information, reasonable efforts, and reasonable actions to protect, safeguard, and maintain the procurement process of the State of Illinois.
- B.** In order to comply with the provisions of Article 50 and to carry out the duty established therein, all bidders are to adhere to ethical standards established for the procurement process, and to make such assurances, disclosures and certifications required by law. Except as otherwise required in subsection III, paragraphs J-M, by execution of the Proposal Signature Sheet, the bidder indicates that each of the mandated assurances have been read and understood, that each certification is made and understood, and that each disclosure requirement has been understood and completed.
- C.** In addition to all other remedies provided by law, failure to comply with any assurance, failure to make any disclosure or the making of a false certification shall be grounds for the chief procurement officer to void the contract, or subcontract, and may result in the suspension or debarment of the bidder or subcontractor.

II. ASSURANCES

The assurances hereinafter made by the bidder are each a material representation of fact upon which reliance is placed should the Department enter into the contract with the bidder.

A. Conflicts of Interest

1. The Illinois Procurement Code provides in pertinent part:

Section 50-13. Conflicts of Interest.

- (a) Prohibition. It is unlawful for any person holding an elective office in this State, holding a seat in the General Assembly, or appointed to or employed in any of the offices or agencies of state government and who receives compensation for such employment in excess of 60% of the salary of the Governor of the State of Illinois, or who is an officer or employee of the Capital Development Board or the Illinois Toll Highway Authority, or who is the spouse or minor child of any such person to have or acquire any contract, or any direct pecuniary interest in any contract therein, whether for stationery, printing, paper, or any services, materials, or supplies, that will be wholly or partially satisfied by the payment of funds appropriated by the General Assembly of the State of Illinois or in any contract of the Capital Development Board or the Illinois Toll Highway authority.
- (b) Interests. It is unlawful for any firm, partnership, association or corporation, in which any person listed in subsection (a) is entitled to receive (i) more than 7 1/2% of the total distributable income or (ii) an amount in excess of the salary of the Governor, to have or acquire any such contract or direct pecuniary interest therein.
- (c) Combined interests. It is unlawful for any firm, partnership, association, or corporation, in which any person listed in subsection (a) together with his or her spouse or minor children is entitled to receive (i) more than 15%, in the aggregate, of the total distributable income or (ii) an amount in excess of 2 times the salary of the Governor, to have or acquire any such contract or direct pecuniary interest therein.
- (d) Securities. Nothing in this Section invalidates the provisions of any bond or other security previously offered or to be offered for sale or sold by or for the State of Illinois.
- (e) Prior interests. This Section does not affect the validity of any contract made between the State and an officer or employee of the State or member of the General Assembly, his or her spouse, minor child or any combination of those persons if that contract was in existence before his or her election or employment as an officer, member, or employee. The contract is voidable, however, if it cannot be completed within 365 days after the officer, member, or employee takes office or is employed.

The current salary of the Governor is \$177,412.00. Sixty percent of the salary is \$106,447.20.

RETURN WITH BID

2. The bidder assures the Department that the award and execution of the contract would not cause a violation of Section 50-13, or that an effective exemption has been issued by the Board of Ethics to any individual subject to the Section 50-13 prohibitions pursuant to the provisions of Section 50-20 of the Code and Executive Order Number 3 (1998). Information concerning the exemption process is available from the Department upon request.

B. Negotiations

1. The Illinois Procurement Code provides in pertinent part:

Section 50-15. Negotiations.

(a) It is unlawful for any person employed in or on a continual contractual relationship with any of the offices or agencies of State government to participate in contract negotiations on behalf of that office or agency with any firm, partnership, association, or corporation with whom that person has a contract for future employment or is negotiating concerning possible future employment.

2. The bidder assures the Department that the award and execution of the contract would not cause a violation of Section 50-15, and that the bidder has no knowledge of any facts relevant to the kinds of acts prohibited therein.

C. Inducements

1. The Illinois Procurement Code provides:

Section 50-25. Inducement. Any person who offers or pays any money or other valuable thing to any person to induce him or her not to bid for a State contract or as recompense for not having bid on a State contract is guilty of a Class 4 felony. Any person who accepts any money or other valuable thing for not bidding for a State contract or who withholds a bid in consideration of the promise for the payment of money or other valuable thing is guilty of a Class 4 felony.

2. The bidder assures the Department that the award and execution of the contract would not cause a violation of Section 50-25, and that the bidder has no knowledge of any facts relevant to the kinds of acts prohibited therein.

D. Revolving Door Prohibition

1. The Illinois Procurement Code provides:

Section 50-30. Revolving door prohibition. Chief procurement officers, State purchasing officers, procurement compliance monitors, their designees whose principal duties are directly related to State procurement, and executive officers confirmed by the Senate are expressly prohibited for a period of 2 years after terminating an affected position from engaging in any procurement activity relating to the State agency most recently employing them in an affected position for a period of at least 6 months. The prohibition includes, but is not limited to: lobbying the procurement process; specifying; bidding; proposing bid, proposal, or contract documents; on their own behalf or on behalf of any firm, partnership, association, or corporation. This Section applies only to persons who terminate an affected position on or after January 15, 1999.

2. The bidder assures the Department that the award and execution of the contract would not cause a violation of Section 50-30, and that the bidder has no knowledge of any facts relevant to the kinds of acts prohibited therein.

E. Reporting Anticompetitive Practices

1. The Illinois Procurement Code provides:

Section 50-40. Reporting anticompetitive practices. When, for any reason, any vendor, bidder, contractor, chief procurement officer, State purchasing officer, designee, elected official, or State employee suspects collusion or other anticompetitive practice among any bidders, offerors, contractors, proposers, or employees of the State, a notice of the relevant facts shall be transmitted to the Attorney General and the chief procurement officer.

2. The bidder assures the Department that it has not failed to report any relevant facts concerning the practices addressed in Section 50-40 which may involve the contract for which the bid is submitted.

F. Confidentiality

1. The Illinois Procurement Code provides:

Section 50-45. Confidentiality. Any chief procurement officer, State purchasing officer, designee, or executive officer who willfully uses or allows the use of specifications, competitive bid documents, proprietary competitive information, proposals, contracts, or selection information to compromise the fairness or integrity of the procurement, bidding, or contract process shall be subject to immediate dismissal, regardless of the Personnel code, any contract, or any collective bargaining agreement, and may in addition be subject to criminal prosecution.

2. The bidder assures the Department that it has no knowledge of any fact relevant to the practices addressed in Section 50-45 which may involve the contract for which the bid is submitted.

RETURN WITH BID

G. Insider Information

1. The Illinois Procurement Act provides:

Section 50-50. Insider information. It is unlawful for any current or former elected or appointed State official or State employee to knowingly use confidential information available only by virtue of that office or employment for actual or anticipated gain for themselves or another person.

2. The bidder assures the Department that it has no knowledge of any facts relevant to the practices addressed in Section 50-50 which may involve the contract for which the bid is submitted.

III. CERTIFICATIONS

The certifications hereinafter made by the bidder are each a material representation of fact upon which reliance is placed should the Department enter into the contract with the bidder. Section 50-2 of the Illinois Procurement Code provides that every person that has entered into a multi-year contract and every subcontractor with a multi-year subcontract shall certify, by July 1 of each fiscal year covered by the contract after the initial fiscal year, to the responsible chief procurement officer whether it continues to satisfy the requirements of Article 50 pertaining to the eligibility for a contract award. If a contractor or subcontractor is not able to truthfully certify that it continues to meet all requirements, it shall provide with its certification a detailed explanation of the circumstances leading to the change in certification status. A contractor or subcontractor that makes a false statement material to any given certification required under Article 50 is, in addition to any other penalties or consequences prescribed by law, subject to liability under the Whistleblower Reward and Protection Act for submission of a false claim.

A. Bribery

1. The Illinois Procurement Code provides:

Section 50-5. Bribery.

(a) Prohibition. No person or business shall be awarded a contract or subcontract under this Code who:

(1) has been convicted under the laws of Illinois or any other state of bribery or attempting to bribe an officer or employee of the State of Illinois or any other state in that officer's or employee's official capacity; or

(2) has made an admission of guilt of that conduct that is a matter of record but has not been prosecuted for that conduct.

(b) Businesses. No business shall be barred from contracting with any unit of State or local government, or subcontracting under such a contract, as a result of a conviction under this Section of any employee or agent of the business if the employee or agent is no longer employed by the business and:

(1) the business has been finally adjudicated not guilty; or

(2) the business demonstrates to the governmental entity with which it seeks to contract, or which is signatory to the contract which the subcontract relates, and that entity finds that the commission of the offense was not authorized, requested, commanded, or performed by a director, officer, or high managerial agent on behalf of the business as provided in paragraph (2) of subsection (a) of Section 5-4 of the Criminal Code of 1961.

(c) Conduct on behalf of business. For purposes of this Section, when an official, agent, or employee of a business committed the bribery or attempted bribery on behalf of the business and in accordance with the direction or authorization of a responsible official of the business, the business shall be chargeable with the conduct.

(d) Certification. Every bid submitted to and contract executed by the State, and every subcontract subject to Section 20-120 of the Procurement Code shall contain a certification by the contractor or the subcontractor, respectively, that the contractor or subcontractor is not barred from being awarded a contract or subcontract under this Section and acknowledges that the chief procurement officer may declare the related contract void if any certifications required by this Section are false. A contractor who makes a false statement, material to the certification, commits a Class 3 felony.

2. The contractor or subcontractor certifies that it is not barred from being awarded a contract under Section 50.5.

B. Felons

1. The Illinois Procurement Code provides:

Section 50-10. Felons. Unless otherwise provided, no person or business convicted of a felony shall do business with the State of Illinois or any State agency, or enter into a subcontract, from the date of conviction until 5 years after the date of completion of the sentence for that felony, unless no person held responsible by a prosecutorial office for the facts upon which the conviction was based continues to have any involvement with the business.

1. Certification. Every bid submitted to and contract executed by the State and every subcontract subject to Section 20-120 of the Procurement Code shall contain a certification by the bidder or contractor or subcontractor, respectively, that the bidder, contractor, or subcontractor is not barred from being awarded a contract or subcontract under this Section and acknowledges that the chief procurement officer may declare the related contract void if any of the certifications required by this Section are false.

RETURN WITH BID

C. Debt Delinquency

1. The Illinois Procurement Code provides:

Section 50-11 and 50-12. Debt Delinquency.

The contractor or bidder or subcontractor, respectively, certifies that it, or any affiliate, is not barred from being awarded a contract or subcontract under the Procurement Code. Section 50-11 prohibits a person from entering into a contract with a State agency, or entering into a subcontract, if it knows or should know that it, or any affiliate, is delinquent in the payment of any debt to the State as defined by the Debt Collection Board. Section 50-12 prohibits a person from entering into a contract with a State agency, or entering into a subcontract, if it, or any affiliate, has failed to collect and remit Illinois Use Tax on all sales of tangible personal property into the State of Illinois in accordance with the provisions of the Illinois Use Tax Act. The bidder or contractor or subcontractor, respectively, further acknowledges that the chief procurement officer may declare the related contract void if this certification is false or if the bidder, contractor, or subcontractor, or any affiliate, is determined to be delinquent in the payment of any debt to the State during the term of the contract.

D. Prohibited Bidders, Contractors and Subcontractors

1. The Illinois Procurement Code provides:

Section 50-10.5 and 50-60(c). Prohibited bidders, contractors and subcontractors.

The bidder or contractor or subcontractor, respectively, certifies in accordance with 30 ILCS 500/50-10.5 that no officer, director, partner or other managerial agent of the contracting business has been convicted of a felony under the Sarbanes-Oxley Act of 2002 or a Class 3 or Class 2 felony under the Illinois Securities Law of 1953 or if in violation of Subsection (c) for a period of five years from the date of conviction. Every bid submitted to and contract executed by the State and every subcontract subject to Section 20-120 of the Procurement Code shall contain a certification by the bidder, contractor, or subcontractor, respectively, that the bidder, contractor, or subcontractor is not barred from being awarded a contract or subcontract under this Section and acknowledges that the chief procurement officer shall declare the related contract void if any of the certifications completed pursuant to this Section are false.

E. Section 42 of the Environmental Protection Act

The bidder or contractor or subcontractor, respectively, certifies in accordance with 30 ILCS 500/50-12 that the bidder, contractor, or subcontractor, is not barred from being awarded a contract or entering into a subcontract under this Section which prohibits the bidding on or entering into contracts with the State of Illinois or a State agency, or entering into any subcontract, that is subject to the Procurement Code by a person or business found by a court or the Pollution Control Board to have committed a willful or knowing violation of Section 42 of the Environmental Protection Act for a period of five years from the date of the order. The bidder or contractor or subcontractor, respectively, acknowledges that the chief procurement officer may declare the contract void if this certification is false.

F. Educational Loan

1. Section 3 of the Educational Loan Default Act provides:

§ 3. No State agency shall contract with an individual for goods or services if that individual is in default, as defined in Section 2 of this Act, on an educational loan. Any contract used by any State agency shall include a statement certifying that the individual is not in default on an educational loan as provided in this Section.

2. The bidder, if an individual as opposed to a corporation, partnership or other form of business organization, certifies that the bidder is not in default on an educational loan as provided in Section 3 of the Act.

G. Bid-Rigging/Bid Rotating

1. Section 33E-11 of the Criminal Code of 1961 provides:

§ 33E-11. (a) Every bid submitted to and public contract executed pursuant to such bid by the State or a unit of local government shall contain a certification by the prime contractor that the prime contractor is not barred from contracting with any unit of State or local government as a result of a violation of either Section 33E-3 or 33E-4 of this Article. The State and units of local government shall provide the appropriate forms for such certification.

- (b) A contractor who makes a false statement, material to the certification, commits a Class 3 felony.

A violation of Section 33E-3 would be represented by a conviction of the crime of bid-rigging which, in addition to Class 3 felony sentencing, provides that any person convicted of this offense or any similar offense of any state or the United States which contains the same elements as this offense shall be barred for 5 years from the date of conviction from contracting with any unit of State or local government. No corporation shall be barred from contracting with any unit of State or local government as a result of a conviction under this Section of any employee or agent of such corporation if the employee so convicted is no longer employed by the corporation and: (1) it has been finally adjudicated not guilty or (2) if it demonstrates to the governmental entity with which it seeks to contract and that entity finds that the commission of the offense was neither authorized, requested, commanded, nor performed by a director, officer or a high managerial agent in behalf of the corporation.

RETURN WITH BID

A violation of Section 33E-4 would be represented by a conviction of the crime of bid-rotating which, in addition to Class 2 felony sentencing, provides that any person convicted of this offense or any similar offense of any state or the United States which contains the same elements as this offense shall be permanently barred from contracting with any unit of State or local government. No corporation shall be barred from contracting with any unit of State or local government as a result of a conviction under this Section of any employee or agent of such corporation if the employee so convicted is no longer employed by the corporation and: (1) it has been finally adjudicated not guilty or (2) if it demonstrates to the governmental entity with which it seeks to contract and that entity finds that the commission of the offense was neither authorized, requested, commanded, nor performed by a director, officer or a high managerial agent in behalf of the corporation.

2. The bidder certifies that it is not barred from contracting with the Department by reason of a violation of either Section 33E-3 or Section 33E-4.

H. International Anti-Boycott

1. Section 5 of the International Anti-Boycott Certification Act provides:

§ 5. State contracts. Every contract entered into by the State of Illinois for the manufacture, furnishing, or purchasing of supplies, material, or equipment or for the furnishing of work, labor, or services, in an amount exceeding the threshold for small purchases according to the purchasing laws of this State or \$10,000.00, whichever is less, shall contain certification, as a material condition of the contract, by which the contractor agrees that neither the contractor nor any substantially-owned affiliated company is participating or shall participate in an international boycott in violation of the provisions of the U.S. Export Administration Act of 1979 or the regulations of the U.S. Department of Commerce promulgated under that Act.

2. The bidder makes the certification set forth in Section 5 of the Act.

I. Drug Free Workplace

1. The Illinois "Drug Free Workplace Act" applies to this contract and it is necessary to comply with the provisions of the "Act" if the contractor is a corporation, partnership, or other entity (including a sole proprietorship) which has 25 or more employees.

2. The bidder certifies that if awarded a contract in excess of \$5,000 it will provide a drug free workplace by:

(a) Publishing a statement notifying employees that the unlawful manufacture, distribution, dispensation, possession or use of a controlled substance, including cannabis, is prohibited in the contractor's workplace; specifying the actions that will be taken against employees for violations of such prohibition; and notifying the employee that, as a condition of employment on such contract, the employee shall abide by the terms of the statement, and notify the employer of any criminal drug statute conviction for a violation occurring in the workplace no later than five (5) days after such conviction.

(b) Establishing a drug free awareness program to inform employees about the dangers of drug abuse in the workplace; the contractor's policy of maintaining a drug free workplace; any available drug counseling, rehabilitation, and employee assistance programs; and the penalties that may be imposed upon employees for drug violations.

(c) Providing a copy of the statement required by subparagraph (1) to each employee engaged in the performance of the contract and to post the statement in a prominent place in the workplace.

(d) Notifying the Department within ten (10) days after receiving notice from an employee or otherwise receiving actual notice of the conviction of an employee for a violation of any criminal drug statute occurring in the workplace.

(e) Imposing or requiring, within 30 days after receiving notice from an employee of a conviction or actual notice of such a conviction, an appropriate personnel action, up to and including termination, or the satisfactory participation in a drug abuse assistance or rehabilitation program approved by a federal, state or local health, law enforcement or other appropriate agency.

(f) Assisting employees in selecting a course of action in the event drug counseling, treatment, and rehabilitation is required and indicating that a trained referral team is in place.

(g) Making a good faith effort to continue to maintain a drug free workplace through implementation of the actions and efforts stated in this certification.

RETURN WITH BID

J. Disclosure of Business Operations in Iran

Section 50-36 of the Illinois Procurement Code, 30ILCS 500/50-36 provides that each bid, offer, or proposal submitted for a State contract shall include a disclosure of whether or not the Company acting as the bidder, offeror, or proposing entity, or any of its corporate parents or subsidiaries, within the 24 months before submission of the bid, offer, or proposal had business operations that involved contracts with or provision of supplies or services to the Government of Iran, companies in which the Government of Iran has any direct or indirect equity share, consortiums or projects commissioned by the Government of Iran, or companies involved in consortiums or projects commissioned by the Government of Iran and either of the following conditions apply:

- (1) More than 10% of the Company's revenues produced in or assets located in Iran involve oil-related activities or mineral-extraction activities; less than 75% of the Company's revenues produced in or assets located in Iran involve contracts with or provision of oil-related or mineral-extraction products or services to the Government of Iran or a project or consortium created exclusively by that government; and the Company has failed to take substantial action.
- (2) The Company has, on or after August 5, 1996, made an investment of \$20 million or more, or any combination of investments of at least \$10 million each that in the aggregate equals or exceeds \$20 million in any 12-month period, which directly or significantly contributes to the enhancement of Iran's ability to develop petroleum resources of Iran.

The terms "Business operations", "Company", "Mineral-extraction activities", "Oil-related activities", "Petroleum resources", and "Substantial action" are all defined in the Code.

Failure to make the disclosure required by the Code shall cause the bid, offer or proposal to be considered not responsive. The disclosure will be considered when evaluating the bid, offer, or proposal or awarding the contract. The name of each Company disclosed as doing business or having done business in Iran will be provided to the State Comptroller.

Check the appropriate statement:

Company has no business operations in Iran to disclose.

Company has business operations in Iran as disclosed the attached document.

K. Apprenticeship and Training Certification (Does not apply to federal aid projects)

In accordance with the provisions of Section 30-22 (6) of the Illinois Procurement Code, the bidder certifies that it is a participant, either as an individual or as part of a group program, in the approved apprenticeship and training programs applicable to each type of work or craft that the bidder will perform with its own forces. The bidder further certifies for work that will be performed by subcontract that each of its subcontractors submitted for approval either (a) is, at the time of such bid, participating in an approved, applicable apprenticeship and training program; or (b) will, prior to commencement of performance of work pursuant to this contract, begin participation in an approved apprenticeship and training program applicable to the work of the subcontract. The Department, at any time before or after award, may require the production of a copy of each applicable Certificate of Registration issued by the United States Department of Labor evidencing such participation by the contractor and any or all of its subcontractors. Applicable apprenticeship and training programs are those that have been approved and registered with the United States Department of Labor. The bidder shall list in the space below, the official name of the program sponsor holding the Certificate of Registration for all of the types of work or crafts in which the bidder is a participant and that will be performed with the bidder's forces. Types of work or craft work that will be subcontracted shall be included and listed as subcontract work. The list shall also indicate any type of work or craft job category that does not have an applicable apprenticeship or training program. **The bidder is responsible for making a complete report and shall make certain that each type of work or craft job category that will be utilized on the project as reported on the Construction Employee Workforce Projection (Form BC-1256) and returned with the bid is accounted for and listed.**

NA-FEDERAL

The requirements of this certification and disclosure are a material part of the contract, and the contractor shall require this certification provision to be included in all approved subcontracts. In order to fulfill this requirement, it shall not be necessary that an applicable program sponsor be currently taking or that it will take applications for apprenticeship, training or employment during the performance of the work of this contract.

RETURN WITH BID

L. Political Contributions and Registration with the State Board of Elections

Sections 20-160 and 50-37 of the Illinois Procurement Code regulate political contributions from business entities and any affiliated entities or affiliated persons bidding on or contracting with the state. Generally under Section 50-37, any business entity, and any affiliated entity or affiliated person of the business entity, whose current year contracts with all state agencies exceed an awarded value of \$50,000, are prohibited from making any contributions to any political committees established to promote the candidacy of the officeholder responsible for the awarding of the contracts or any other declared candidate for that office for the duration of the term of office of the incumbent officeholder or a period 2 years after the termination of the contract, whichever is longer. Any business entity and affiliated entities or affiliated persons whose state contracts in the current year do not exceed an awarded value of \$50,000, but whose aggregate pending bids and proposals on state contracts exceed \$50,000, either alone or in combination with contracts not exceeding \$50,000, are prohibited from making any political contributions to any political committee established to promote the candidacy of the officeholder responsible for awarding the pending contract during the period beginning on the date the invitation for bids or request for proposals is issued and ending on the day after the date of award or selection if the entity was not awarded or selected. Section 20-160 requires certification of registration of affected business entities in accordance with procedures found in Section 9-35 of The Election Code.

By submission of a bid, the contractor business entity acknowledges and agrees that it has read and understands Sections 20-160 and 50-37 of the Illinois Procurement Code, and that it makes the following certification:

The undersigned business entity certifies that it has registered as a business with the State Board of Elections and acknowledges a continuing duty to update the registration in accordance with the above referenced statutes. A copy of the certificate of registration shall be submitted with the bid. The bidder is cautioned that the Department will not award a contract without submission of the certificate of registration.

These requirements and compliance with the above referenced statutory sections are a material part of the contract, and any breach thereof shall be cause to void the contract under Section 50-60 of the Illinois Procurement Code. This provision does not apply to Federal-aid contracts.

M. Lobbyist Disclosure

Section 50-38 of the Illinois Procurement Code requires that any bidder or offeror on a State contract that hires a person required to register under the Lobbyist Registration Act to assist in obtaining a contract shall:

- (i) Disclose all costs, fees, compensation, reimbursements, and other remunerations paid or to be paid to the lobbyist related to the contract,
- (ii) Not bill or otherwise cause the State of Illinois to pay for any of the lobbyist's costs, fees, compensation, reimbursements, or other remuneration, and
- (iii) Sign a verification certifying that none of the lobbyist's costs, fees, compensation, reimbursements, or other remuneration were billed to the State.

This information, along with all supporting documents, shall be filed with the agency awarding the contract and with the Secretary of State. The chief procurement officer shall post this information, together with the contract award notice, in the online Procurement Bulletin.

Pursuant to Subsection (c) of this Section, no person or entity shall retain a person or entity to attempt to influence the outcome of a procurement decision made under the Procurement Code for compensation contingent in whole or in part upon the decision or procurement. Any person who violates this subsection is guilty of a business offense and shall be fined not more than \$10,000.

Bidder acknowledges that it is required to disclose the hiring of any person required to register pursuant to the Illinois Lobbyist Registration Act (25 ILCS 170) in connection with this contract.

Bidder has not hired any person required to register pursuant to the Illinois Lobbyist Registration Act in connection with this contract.

Or

Bidder has hired the following persons required to register pursuant to the Illinois Lobbyist Registration Act in connection with the contract:

Name and address of person: _____
All costs, fees, compensation, reimbursements and other remuneration paid to said person: _____

RETURN WITH BID

IV. DISCLOSURES

- A. The disclosures hereinafter made by the bidder are each a material representation of fact upon which reliance is placed should the Department enter into the contract with the bidder. The bidder further certifies that the Department has received the disclosure forms for each bid.

The chief procurement officer may void the bid, contract, or subcontract, respectively, if it is later determined that the bidder or subcontractor rendered a false or erroneous disclosure. A contractor or subcontractor may be suspended or debarred for violations of the Procurement Code. Furthermore, the chief procurement officer may void the contract and the surety providing the performance bond shall be responsible for completion of the contract.

B. Financial Interests and Conflicts of Interest

1. Section 50-35 of the Illinois Procurement Code provides that all bids of more than \$25,000 shall be accompanied by disclosure of the financial interests of the bidder. This disclosed information for the successful bidder, will be maintained as public information subject to release by request pursuant to the Freedom of Information Act, filed with the Procurement Policy Board, and shall be incorporated as a material term of the contract. Furthermore, pursuant to Section 5-5, the Procurement Policy Board may review a proposal, bid, or contract and issue a recommendation to void a contract or reject a proposal or bid based on any violation of the Procurement Code or the existence of a conflict of interest as provided in subsections (b) and (d) of Section 50-35.

The financial interests to be disclosed shall include ownership or distributive income share that is in excess of 5%, or an amount greater than 60% of the annual salary of the Governor, of the bidding entity or its parent entity, whichever is less, unless the contractor or bidder is a publicly traded entity subject to Federal 10K reporting, in which case it may submit its 10K disclosure in place of the prescribed disclosure. If a bidder is a privately held entity that is exempt from Federal 10K reporting, but has more than 200 shareholders, it may submit the information that Federal 10K companies are required to report, and list the names of any person or entity holding any ownership share that is in excess of 5%. The disclosure shall include the names, addresses, and dollar or proportionate share of ownership of each person making the disclosure, their instrument of ownership or beneficial relationship, and notice of any potential conflict of interest resulting from the current ownership or beneficial interest of each person making the disclosure having any of the relationships identified in Section 50-35 and on the disclosure form.

The current annual salary of the Governor is \$177,412.00.

In addition, all disclosures shall indicate any other current or pending contracts, proposals, leases, or other ongoing procurement relationships the bidding entity has with any other unit of state government and shall clearly identify the unit and the contract, proposal, lease, or other relationship.

2. Disclosure Forms. Disclosure Form A is attached for use concerning the individuals meeting the above ownership or distributive share requirements. A separate Disclosure Form A must be submitted with the bid for each individual meeting the above requirements. In addition, a second form (Disclosure Form B) provides for the disclosure of current or pending procurement relationships with other (non-IDOT) state agencies and a total ownership certification. **The forms must be included with each bid.**

C. Disclosure Form Instructions

Form A Instructions for Financial Information & Potential Conflicts of Interest

If the bidder is a publicly traded entity subject to Federal 10K reporting, the 10K Report may be submitted to meet the requirements of Form A. If a bidder is a privately held entity that is exempt from Federal 10K reporting, but has more than 200 shareholders, it may submit the information that Federal 10K companies are required to report, and list the names of any person or entity holding any ownership share that is in excess of 5%. If a bidder is not subject to Federal 10K reporting, the bidder must determine if any individuals are required by law to complete a financial disclosure form. To do this, the bidder should answer each of the following questions. A "YES" answer indicates Form A must be completed. If the answer to each of the following questions is "NO", then the NOT APPLICABLE STATEMENT on Form A must be signed and dated by a person that is authorized to execute contracts for the bidding company. Note: These questions are for assistance only and are not required to be completed.

1. Does anyone in your organization have a direct or beneficial ownership share of greater than 5% of the bidding entity or parent entity? YES ___ NO ___
2. Does anyone in your organization have a direct or beneficial ownership share of less than 5%, but which has a value greater than 60% of the annual salary of the Governor? YES ___ NO ___
3. Does anyone in your organization receive more than 60% of the annual salary of the Governor of the bidding entity's or parent entity's distributive income? YES ___ NO ___
4. Does anyone in your organization receive greater than 5% of the bidding entity's or parent entity's total distributive income, but which is less than 60% of the annual salary of the Governor? YES ___ NO ___

(Note: Only one set of forms needs to be completed per person per bid even if a specific individual would require a yes answer to more than one question.)

A "YES" answer to any of these questions requires the completion of Form A. The bidder must determine each individual in the bidding entity or the bidding entity's parent company that would cause the questions to be answered "Yes". Each form must be signed and dated by a person that is authorized to execute contracts for your organization. **Photocopied or stamped signatures are not acceptable.** The person signing can be, but does not have to be, the person for which the form is being completed. The bidder is responsible for the accuracy of any information provided.

If the answer to each of the above questions is "NO", then the NOT APPLICABLE STATEMENT of Form A must be signed and dated by a person that is authorized to execute contracts for your company.

RETURN WITH BID

Form B: Instructions for Identifying Other Contracts & Procurement Related Information

Disclosure Form B must be completed for each bid submitted by the bidding entity. *Note: Checking the NOT APPLICABLE STATEMENT on Form A does not allow the bidder to ignore Form B. Form B must be completed, checked, and dated or the bidder may be considered nonresponsive and the bid will not be accepted.*

The Bidder shall identify, by checking Yes or No on Form B, whether it has any pending contracts (including leases), bids, proposals, or other ongoing procurement relationship with any other (non-IDOT) State of Illinois agency. If "No" is checked, the bidder only needs to complete the check box on the bottom of Form B. If "Yes" is checked, the bidder must do one of the following:

Option I: If the bidder did not submit an Affidavit of Availability to obtain authorization to bid, the bidder must list all non-IDOT State of Illinois agency pending contracts, leases, bids, proposals, and other ongoing procurement relationships. These items may be listed on Form B or on an attached sheet(s). Do not include IDOT contracts. Contracts with cities, counties, villages, etc. are not considered State of Illinois agency contracts and are not to be included. Contracts with other State of Illinois agencies such as the Department of Natural Resources or the Capital Development Board must be included. Bidders who submit Affidavits of Availability are suggested to use Option II.

Option II: If the bidder is required and has submitted an Affidavit of Availability in order to obtain authorization to bid, the bidder may write or type "See Affidavit of Availability" which indicates that the Affidavit of Availability is incorporated by reference and includes all non-IDOT State of Illinois agency pending contracts, leases, bids, proposals, and other ongoing procurement relationships. For any contracts that are not covered by the Affidavit of Availability, the bidder must identify them on Form B or on an attached sheet(s). These might be such things as leases.

RETURN WITH BID

**ILLINOIS DEPARTMENT
OF TRANSPORTATION**

**Form A
Financial Information &
Potential Conflicts of Interest
Disclosure**

Contractor Name		
Legal Address		
City, State, Zip		
Telephone Number	Email Address	Fax Number (if available)

Disclosure of the information contained in this Form is required by the Section 50-35 of the Illinois Procurement Code (30 ILCS 500). Vendors desiring to enter into a contract with the State of Illinois must disclose the financial information and potential conflict of interest information as specified in this Disclosure Form. This information shall become part of the publicly available contract file. This Form A must be completed for bids in excess of \$25,000, and for all open-ended contracts. **A publicly traded company may submit a 10K disclosure (or equivalent if applicable) in satisfaction of the requirements set forth in Form A. See Disclosure Form Instructions.**

The current annual salary of the Governor is \$177,412.00.

DISCLOSURE OF FINANCIAL INFORMATION

- 1. Disclosure of Financial Information.** The individual named below has an interest in the BIDDER (or its parent) in terms of ownership or distributive income share in excess of 5%, or an interest which has a value of more than 60% of the annual salary of the Governor. **(Make copies of this form as necessary and attach a separate Disclosure Form A for each individual meeting these requirements)**

FOR INDIVIDUAL (type or print information)	
NAME:	_____
ADDRESS	_____
Type of ownership/distributable income share:	
stock _____	sole proprietorship _____
Partnership _____	other: (explain on separate sheet): _____
% or \$ value of ownership/distributable income share: _____	

- 2. Disclosure of Potential Conflicts of Interest.** Check "Yes" or "No" to indicate which, if any, of the following potential conflict of interest relationships apply. If the answer to any question is "Yes", please attach additional pages and describe.

- (a) State employment, currently or in the previous 3 years, including contractual employment of services.
Yes ___ No ___

If your answer is yes, please answer each of the following questions.

- Are you currently an officer or employee of either the Capitol Development Board or the Illinois State Toll Highway Authority? Yes ___ No ___
- Are you currently appointed to or employed by any agency of the State of Illinois? If you are currently appointed to or employed by any agency of the State of Illinois, and your annual salary exceeds 60% of the annual salary of the Governor provide the name the State agency for which you are employed and your annual salary. _____

RETURN WITH BID

- 3. If you are currently appointed to or employed by any agency of the State of Illinois, and your annual salary exceeds 60% of the annual salary of the Governor, are you entitled to receive (i) more than 7 1/2% of the total distributable income of your firm, partnership, association or corporation, or (ii) an amount in excess of 100% of the annual salary of the Governor? Yes ___ No ___

- 4. If you are currently appointed to or employed by any agency of the State of Illinois, and your annual salary exceeds 60% of the annual salary of the Governor, are you and your spouse or minor children entitled to receive (i) more than 15% in aggregate of the total distributable income of your firm, partnership, association or corporation, or (ii) an amount in excess of two times the salary of the Governor? Yes ___ No ___

(b) State employment of spouse, father, mother, son, or daughter, including contractual employment for services in the previous 2 years.

Yes ___ No ___

If your answer is yes, please answer each of the following questions.

- 1. Is your spouse or any minor children currently an officer or employee of the Capitol Development Board or the Illinois State Toll Highway Authority? Yes ___ No ___

- 2. Is your spouse or any minor children currently appointed to or employed by any agency of the State of Illinois? If your spouse or minor children is/are currently appointed to or employed by any agency of the State of Illinois, and his/her annual salary exceeds 60% of the annual salary of the Governor, provide the name of the spouse and/or minor children, the name of the State agency for which he/she is employed and his/her annual salary. _____

- 3. If your spouse or any minor children is/are currently appointed to or employed by any agency of the State of Illinois, and his/her annual salary exceeds 60% of the annual salary of the Governor, are you entitled to receive (i) more than 7 1/2% of the total distributable income of your firm, partnership, association or corporation, or (ii) an amount in excess 100% of the annual salary of the Governor? Yes ___ No ___

- 4. If your spouse or any minor children are currently appointed to or employed by any agency of the State of Illinois, and his/her annual salary exceeds 60% of the annual salary of the Governor, are you and your spouse or any minor children entitled to receive (i) more than 15% in the aggregate of the total distributable income from your firm, partnership, association or corporation, or (ii) an amount in excess of two times the salary of the Governor? Yes ___ No ___

(c) Elective status; the holding of elective office of the State of Illinois, the government of the United States, any unit of local government authorized by the Constitution of the State of Illinois or the statutes of the State of Illinois currently or in the previous 3 years.

Yes ___ No ___

(d) Relationship to anyone holding elective office currently or in the previous 2 years; spouse, father, mother, son, or daughter.

Yes ___ No ___

(e) Appointive office; the holding of any appointive government office of the State of Illinois, the United State of America, or any unit of local government authorized by the Constitution of the State of Illinois or the statutes of the State of Illinois, which office entitles the holder to compensation in excess of the expenses incurred in the discharge of that office currently or in the previous 3 years.

Yes ___ No ___

(f) Relationship to anyone holding appointive office currently or in the previous 2 years; spouse, father, mother, son, or daughter.

Yes ___ No ___

(g) Employment, currently or in the previous 3 years, as or by any registered lobbyist of the State government.

Yes ___ No ___

RETURN WITH BID

(h) Relationship to anyone who is or was a registered lobbyist in the previous 2 years; spouse, father, mother, son, or daughter. Yes ___ No ___

(i) Compensated employment, currently or in the previous 3 years, by any registered election or reelection committee registered with the Secretary of State or any county clerk of the State of Illinois, or any political action committee registered with either the Secretary of State or the Federal Board of Elections. Yes ___ No ___

(j) Relationship to anyone; spouse, father, mother, son, or daughter; who was a compensated employee in the last 2 years by any registered election or re-election committee registered with the Secretary of State or any county clerk of the State of Illinois, or any political action committee registered with either the Secretary of State or the Federal Board of Elections. Yes ___ No ___

3. Communication Disclosure.

Disclose the name and address of each lobbyist and other agent of the bidder or offeror who is not identified in Section 2 of this form, who is has communicated, is communicating, or may communicate with any State officer or employee concerning the bid or offer. This disclosure is a continuing obligation and must be promptly supplemented for accuracy throughout the process and throughout the term of the contract. If no person is identified, enter "None" on the line below:

Name and address of person(s): _____

RETURN WITH BID

4. Debarment Disclosure. For each of the persons identified under Sections 2 and 3 of this form, disclose whether any of the following has occurred within the previous 10 years: debarment from contracting with any governmental entity; professional licensure discipline; bankruptcies; adverse civil judgments and administrative findings; and criminal felony convictions. This disclosure is a continuing obligation and must be promptly supplemented for accuracy throughout the procurement process and term of the contract. If no person is identified, enter "None" on the line below:

Name of person(s): _____

Nature of disclosure: _____

APPLICABLE STATEMENT

This Disclosure Form A is submitted on behalf of the INDIVIDUAL named on previous page. Under penalty of perjury, I certify the contents of this disclosure to be true and accurate to the best of my knowledge.

Completed by: _____
Signature of Individual or Authorized Representative Date

NOT APPLICABLE STATEMENT

Under penalty of perjury, I have determined that no individuals associated with this organization meet the criteria that would require the completion of this Form A.

This Disclosure Form A is submitted on behalf of the CONTRACTOR listed on the previous page.

Signature of Authorized Representative Date

The bidder has a continuing obligation to supplement these disclosures under Sec. 50-35 of the Procurement Code.

RETURN WITH BID

ILLINOIS DEPARTMENT OF TRANSPORTATION

Form B Other Contracts & Financial Related Information Disclosure

Contractor Name, Legal Address, City, State, Zip, Telephone Number, Email Address, Fax Number (if available)

Disclosure of the information contained in this Form is required by the Section 50-35 of the Illinois Procurement Act (30 ILCS 500). This information shall become part of the publicly available contract file. This Form B must be completed for bids in excess of \$25,000, and for all open-ended contracts.

DISCLOSURE OF OTHER CONTRACTS AND PROCUREMENT RELATED INFORMATION

1. Identifying Other Contracts & Procurement Related Information. The BIDDER shall identify whether it has any pending contracts (including leases), bids, proposals, or other ongoing procurement relationship with any other State of Illinois agency: Yes ___ No ___

If "No" is checked, the bidder only needs to complete the signature box on the bottom of this page.

2. If "Yes" is checked. Identify each such relationship by showing State of Illinois agency name and other descriptive information such as bid or project number (attach additional pages as necessary). SEE DISCLOSURE FORM INSTRUCTIONS:

THE FOLLOWING STATEMENT MUST BE CHECKED

Signature of Authorized Representative, Date

OWNERSHIP CERTIFICATION

Please certify that the following statement is true if the individuals for all submitted Form A disclosures do not total 100% of ownership.

Any remaining ownership interest is held by individuals receiving less than \$106,447.20 of the bidding entity's or parent entity's distributive income or holding less than a 5% ownership interest.

Yes No N/A (Form A disclosure(s) established 100% ownership)

RETURN WITH BID

SPECIAL NOTICE TO CONTRACTORS

The following requirements of the Illinois Department of Human Rights' Rules and Regulations are applicable to bidders on all construction contracts advertised by the Illinois Department of Transportation:

CONSTRUCTION EMPLOYEE UTILIZATION PROJECTION

- (a) All bidders on construction contracts shall complete and submit, along with and as part of their bids, a Bidder's Employee Utilization Form (Form BC-1256) setting forth a projection and breakdown of the total workforce intended to be hired and/or allocated to such contract work by the bidder including a projection of minority and female employee utilization in all job classifications on the contract project.
- (b) The Department of Transportation shall review the Employee Utilization Form, and workforce projections contained therein, of the contract awardee to determine if such projections reflect an underutilization of minority persons and/or women in any job classification in accordance with the Equal Employment Opportunity Clause and Section 7.2 of the Illinois Department of Human Rights' Rules and Regulations for Public Contracts adopted as amended on September 17, 1980. If it is determined that the contract awardee's projections reflect an underutilization of minority persons and/or women in any job classification, it shall be advised in writing of the manner in which it is underutilizing and such awardee shall be considered to be in breach of the contract unless, prior to commencement of work on the contract project, it submits revised satisfactory projections or an acceptable written affirmative action plan to correct such underutilization including a specific timetable geared to the completion stages of the contract.
- (c) The Department of Transportation shall provide to the Department of Human Rights a copy of the contract awardee's Employee Utilization Form, a copy of any required written affirmative action plan, and any written correspondence related thereto. The Department of Human Rights may review and revise any action taken by the Department of Transportation with respect to these requirements.



RETURN WITH BID

Contract No. 63718
DUPAGE County
Section 12-PEDTS-00-SP
Project HSIP-4003(012)
Various Routes
District 1 Construction Funds

PART I. IDENTIFICATION

Dept. Human Rights # _____ Duration of Project: _____
Name of Bidder: _____

PART II. WORKFORCE PROJECTION

A. The undersigned bidder has analyzed minority group and female populations, unemployment rates and availability of workers for the location in which this contract work is to be performed, and for the locations from which the bidder recruits employees, and hereby submits the following workforce projection including a projection for minority and female employee utilization in all job categories in the workforce to be allocated to this contract:

Table A: TOTAL Workforce Projection for Contract. Columns include Job Categories, Total Employees (M, F), Minority Employees (Black, Hispanic, *Other Minor.), and Trainees (Apprentices, On the Job Trainees).

Table B: CURRENT EMPLOYEES TO BE ASSIGNED TO CONTRACT. Columns include Total Employees (M, F) and Minority Employees (M, F).

Table C: TOTAL Training Projection for Contract. Columns include Employees in Training (Apprentices, On the Job Trainees) and Total Employees (M, F), Minority Employees (Black, Hispanic, *Other Minor.).

FOR DEPARTMENT USE ONLY

*Other minorities are defined as Asians (A) or Native Americans (N). Please specify race of each employee shown in Other Minorities column.

Note: See instructions on page 2

RETURN WITH BID

**Contract No. 63718
DUPAGE County
Section 12-PEDTS-00-SP
Project HSIP-4003(012)
Various Routes
District 1 Construction Funds**

PART II. WORKFORCE PROJECTION - continued

- B. Included in "Total Employees" under Table A is the total number of **new hires** that would be employed in the event the undersigned bidder is awarded this contract.

The undersigned bidder projects that: (number) _____ new hires would be recruited from the area in which the contract project is located; and/or (number) _____ new hires would be recruited from the area in which the bidder's principal office or base of operation is located.

- C. Included in "Total Employees" under Table A is a projection of numbers of persons to be employed directly by the undersigned bidder as well as a projection of numbers of persons to be employed by subcontractors.

The undersigned bidder estimates that (number) _____ persons will be directly employed by the prime contractor and that (number) _____ persons will be employed by subcontractors.

PART III. AFFIRMATIVE ACTION PLAN

- A. The undersigned bidder understands and agrees that in the event the foregoing minority and female employee utilization projection included under **PART II** is determined to be an underutilization of minority persons or women in any job category, and in the event that the undersigned bidder is awarded this contract, he/she will, prior to commencement of work, develop and submit a written Affirmative Action Plan including a specific timetable (geared to the completion stages of the contract) whereby deficiencies in minority and/or female employee utilization are corrected. Such Affirmative Action Plan will be subject to approval by the contracting agency and the **Department of Human Rights**.
- B. The undersigned bidder understands and agrees that the minority and female employee utilization projection submitted herein, and the goals and timetable included under an Affirmative Action Plan if required, are deemed to be part of the contract specifications.

Company _____ Telephone Number _____

Address _____

NOTICE REGARDING SIGNATURE

The Bidder's signature on the Proposal Signature Sheet will constitute the signing of this form. The following signature block needs to be completed only if revisions are required.

Signature: _____ Title: _____ Date: _____

- Instructions: All tables must include subcontractor personnel in addition to prime contractor personnel.
- Table A - Include both the number of employees that would be hired to perform the contract work and the total number currently employed (Table B) that will be allocated to contract work, and include all apprentices and on-the-job trainees. The "Total Employees" column should include all employees including all minorities, apprentices and on-the-job trainees to be employed on the contract work.
- Table B - Include all employees currently employed that will be allocated to the contract work including any apprentices and on-the-job trainees currently employed.
- Table C - Indicate the racial breakdown of the total apprentices and on-the-job trainees shown in Table A.

RETURN WITH BID

ADDITIONAL FEDERAL REQUIREMENTS

In addition to the Required Contract Provisions for Federal-Aid Construction Contracts (FHWA 1273), all bidders make the following certifications.

- A. By the execution of this proposal, the signing bidder certifies that the bidding entity has not, either directly or indirectly, entered into any agreement, participated in any collusion, or otherwise taken any action, in restraint of free competitive bidding in connection with the submitted bid. This statement made by the undersigned bidder is true and correct under penalty of perjury under the laws of the United States.
- B. CERTIFICATION, EQUAL EMPLOYMENT OPPORTUNITY:
1. Have you participated in any previous contracts or subcontracts subject to the equal opportunity clause. YES _____ NO _____
 2. If answer to #1 is yes, have you filed with the Joint Reporting Committee, the Director of OFCC, any Federal agency, or the former President's Committee on Equal Employment Opportunity, all reports due under the applicable filing requirements of those organizations? YES _____ NO _____

RETURN WITH BID

**Contract No. 63718
DUPAGE County
Section 12-PEDTS-00-SP
Project HSIP-4003(012)
Various Routes
District 1 Construction Funds**

PROPOSAL SIGNATURE SHEET

The undersigned bidder hereby makes and submits this bid on the subject Proposal, thereby assuring the Department that all requirements of the Invitation for Bids and rules of the Department have been met, that there is no misunderstanding of the requirements of paragraph 3 of this Proposal, and that the contract will be executed in accordance with the rules of the Department if an award is made on this bid.

(IF AN INDIVIDUAL)

Firm Name _____
Signature of Owner _____
Business Address _____

(IF A CO-PARTNERSHIP)

Firm Name _____
By _____
Business Address _____
Name and Address of All Members of the Firm: _____

(IF A CORPORATION)

Corporate Name _____
By _____
Signature of Authorized Representative _____
Typed or printed name and title of Authorized Representative _____
Attest _____
Signature _____
(IF A JOINT VENTURE, USE THIS SECTION FOR THE MANAGING PARTY AND THE SECOND PARTY SHOULD SIGN BELOW)
Business Address _____

(IF A JOINT VENTURE)

Corporate Name _____
By _____
Signature of Authorized Representative _____
Typed or printed name and title of Authorized Representative _____
Attest _____
Signature _____
Business Address _____

If more than two parties are in the joint venture, please attach an additional signature sheet.



Return with Bid

Division of Highways
Proposal Bid Bond
(Effective November 1, 1992)

Item No. _____

Letting Date _____

KNOW ALL MEN BY THESE PRESENTS, That We _____

as PRINCIPAL, and _____

_____ as SURETY, are held jointly, severally and firmly bound unto the STATE OF ILLINOIS in the penal sum of 5 percent of the total bid price, or for the amount specified in the bid proposal under "Proposal Guaranty" in effect on the date of the Invitation for Bids, whichever is the lesser sum, well and truly to be paid unto said STATE OF ILLINOIS, for the payment of which we bind ourselves, our heirs, executors, administrators, successors and assigns.

THE CONDITION OF THE FOREGOING OBLIGATION IS SUCH, that whereas, the PRINCIPAL has submitted a bid proposal to the STATE OF ILLINOIS, acting through the Department of Transportation, for the improvement designated by the Transportation Bulletin Item Number and Letting Date indicated above.

NOW, THEREFORE, if the Department shall accept the bid proposal of the PRINCIPAL; and if the PRINCIPAL shall, within the time and as specified in the bidding and contract documents, submit a DBE Utilization Plan that is accepted and approved by the Department; and if, after award by the Department, the PRINCIPAL shall enter into a contract in accordance with the terms of the bidding and contract documents including evidence of the required insurance coverages and providing such bond as specified with good and sufficient surety for the faithful performance of such contract and for the prompt payment of labor and material furnished in the prosecution thereof; or if, in the event of the failure of the PRINCIPAL to make the required DBE submission or to enter into such contract and to give the specified bond, the PRINCIPAL pays to the Department the difference not to exceed the penalty hereof between the amount specified in the bid proposal and such larger amount for which the Department may contract with another party to perform the work covered by said bid proposal, then this obligation shall be null and void, otherwise, it shall remain in full force and effect.

IN THE EVENT the Department determines the PRINCIPAL has failed to comply with any requirement as set forth in the preceding paragraph, then Surety shall pay the penal sum to the Department within fifteen (15) days of written demand therefor. If Surety does not make full payment within such period of time, the Department may bring an action to collect the amount owed. Surety is liable to the Department for all its expenses, including attorney's fees, incurred in any litigation in which it prevails either in whole or in part.

In TESTIMONY WHEREOF, the said PRINCIPAL and the said SURETY have caused this instrument to be signed by

their respective officers this _____ day of _____ A.D., _____ .

PRINCIPAL

SURETY

(Company Name)

(Company Name)

By _____
(Signature & Title)

By: _____
(Signature of Attorney-in-Fact)

Notary Certification for Principal and Surety

STATE OF ILLINOIS,
County of _____

I, _____, a Notary Public in and for said County, do hereby certify that

_____ and _____
(Insert names of individuals signing on behalf of PRINCIPAL & SURETY)

who are each personally known to me to be the same persons whose names are subscribed to the foregoing instrument on behalf of PRINCIPAL and SURETY, appeared before me this day in person and acknowledged respectively, that they signed and delivered said instrument as their free and voluntary act for the uses and purposes therein set forth.

Given under my hand and notarial seal this _____ day of _____ A.D. _____

My commission expires _____

Notary Public

In lieu of completing the above section of the Proposal Bid Form, the Principal may file an Electronic Bid Bond. By signing the proposal and marking the check box next to the Signature and Title line below, the Principal is ensuring the identified electronic bid bond has been executed and the Principal and Surety are firmly bound unto the State of Illinois under the conditions of the bid bond as shown above.

Electronic Bid Bond ID#

Company / Bidder Name



Signature and Title

(1) Policy

It is public policy that disadvantageded businesses as defined in 49 CFR Part 26 and the Special Provision shall have the maximum opportunity to participate in the performance of contracts financed in whole or in part with Federal or State funds. Consequently the requirements of 49 CFR Part 26 apply to this contract.

(2) Obligation

The contractor agrees to ensure that disadvantageded businesses as defined in 49 CFR Part 26 and the Special Provision have the maximum opportunity to participate in the performance of contracts or subcontracts financed in whole or in part with Federal or State funds. The contractor shall take all necessary and reasonable steps in accordance with 49 CFR Part 26 and the Special Provision to ensure that said businesses have the maximum opportunity to compete for and perform under this contract. The contractor shall not discriminate on the basis of race, color, national origin or sex in the award and performance of contracts.

(3) Project and Bid Identification

Complete the following information concerning the project and bid:

Route _____	Total Bid _____
Section _____	Contract DBE Goal _____
Project _____	(Percent) (Dollar Amount)
County _____	
Letting Date _____	
Contract No. _____	
Letting Item No. _____	

(4) Assurance

I, acting in my capacity as an officer of the undersigned bidder (or bidders if a joint venture), hereby assure the Department that on this project my company : (check one)

Meets or exceeds contract award goals and has provided documented participation as follows:
Disadvantaged Business Participation _____ percent

Attached are the signed participation statements, forms SBE 2025, required by the Special Provision evidencing availability and use of each business participating in this plan and assuring that each business will perform a commercially useful function in the work of the contract.

Failed to meet contract award goals and has included good faith effort documentation to meet the goals and that my company has provided participation as follows:

Disadvantaged Business Participation _____ percent

The contract goals should be accordingly modified or waived. Attached is all information required by the Special Provision in support of this request including good faith effort. Also attached are the signed participation statements, forms SBE 2025, required by the Special Provision evidencing availability and use of each business participating in this plan and assuring that each business will perform a commercially useful function in the work of the contract.

Company

By _____

Title _____

Date _____

The "as read" Low Bidder is required to comply with the Special Provision.

Submit only one utilization plan for each project. The utilization plan shall be submitted in accordance with the special provision.

Bureau of Small Business Enterprises **Local Let Projects**
2300 South Dirksen Parkway Submit forms to the
Springfield, Illinois 62764 Local Agency

The Department of Transportation is requesting disclosure of information that is necessary to accomplish the purpose as outlined under State and Federal law. Disclosure of this information is **REQUIRED**. Failure to provide any information will result in the contract not being awarded. This form has been approved by the State Forms Manager Center.



Subcontractor Registration _____

Letting _____

Participation Statement

Item No. _____

(1) Instructions

Contract _____

This form must be completed for each disadvantaged business participating in the Utilization Plan. This form shall be submitted in accordance with the special provision and will be attached to the Utilization Plan form.. If additional space is needed complete an additional form for the firm.

(2) Work

Pay Item No.	Description	Quantity	Unit Price	Total
Total				

(3) Partial Payment Items

For any of the above items which are partial pay items, specifically describe the work and subcontract dollar amount:

(4) Commitment

The undersigned certify that the information included herein is true and correct, and that the DBE firm listed below has agreed to perform a commercially useful function in the work of the contract item(s) listed above and to execute a contract with the prime contractor. The undersigned further understand that no changes to this statement may be made without prior approval from the Department's Bureau of Small Business Enterprises and that complete and accurate information regarding actual work performed on this project and the payment therefore must be provided to the Department.

Signature for Prime Contractor

Signature for DBE Firm

Title _____

Title _____

Date _____

Date _____

Contact _____

Contact Person _____

Phone _____

Phone _____

Firm Name _____

Firm Name _____

Address _____

Address _____

City/State/Zip _____

City/State/Zip _____

E _____

WC _____

The Department of Transportation is requesting disclosure of information that is necessary to accomplish the statutory purpose as outlined under the state and federal law. Disclosure of this information is **REQUIRED**. Failure to provide any information will result in the contract not being awarded. This form has been approved by the State Forms Management Center.

PROPOSAL ENVELOPE



PROPOSALS

for construction work advertised for bids by the
Illinois Department of Transportation

Item No.	Item No.	Item No.

Submitted By:

Name:
Address:
Phone No.

Bidders should use an IDOT proposal envelope or affix this form to the front of a 10" x 13" envelope for the submittal of bids. If proposals are mailed, they should be enclosed in a second or outer envelope addressed to:

Engineer of Design and Environment - Room 326
Illinois Department of Transportation
2300 South Dirksen Parkway
Springfield, Illinois 62764

NOTICE

Individual bids, including Bid Bond and/or supplemental information if required, should be securely stapled.

CONTRACTOR OFFICE COPY OF CONTRACT SPECIFICATIONS

NOTICE

None of the following material needs to be returned with the bid package unless the special provisions require documentation and/or other information to be submitted.

**Contract No. 63718
DUPAGE County
Section 12-PEDTS-00-SP
Project HSIP-4003(012)
Various Routes
District 1 Construction Funds**



Illinois Department of Transportation

SUBCONTRACTOR DOCUMENTATION

Public Acts 96-0795 and 96-0920, enacted substantial changes to the provisions of the Illinois Procurement Code (30 ILCS 500). Among the changes are provisions affecting subcontractors. The Contractor awarded this contract will be required as a material condition of the contract to implement and enforce the contract requirements applicable to subcontractors approved in accordance with article 108.01 of the Standard Specifications for Road and Bridge Construction.

If the Contractor seeks approval of subcontractors to perform a portion of the work, and approval is granted by the Department, the Contractor shall provide a copy of the subcontract to the Chief Procurement Officer within 20 calendar days after execution of the subcontract.

The subcontract shall contain the certifications required to be made by subcontractors pursuant to Article 50 of the Illinois Procurement Code. This Notice to Bidders includes a document incorporating all required subcontractor certifications and disclosures for use by the Contractor in compliance with this mandate. The document is entitled State Required Ethical Standards Governing Subcontractors.

RETURN WITH SUBCONTRACT

STATE ETHICAL STANDARDS GOVERNING SUBCONTRACTORS

Article 50 of the Illinois Procurement Code establishes the duty of all State chief procurement officers, State purchasing officers, and their designees to maximize the value of the expenditure of public moneys in procuring goods, services, and contracts for the State of Illinois and to act in a manner that maintains the integrity and public trust of State government. In discharging this duty, they are charged by law to use all available information, reasonable efforts, and reasonable actions to protect, safeguard, and maintain the procurement process of the State of Illinois.

The certifications hereinafter made by the subcontractor are each a material representation of fact upon which reliance is placed should the Department approve the subcontractor. The chief procurement officer may terminate or void the subcontract approval if it is later determined that the bidder or subcontractor rendered a false or erroneous certification.

Section 50-2 of the Illinois Procurement Code provides that every person that has entered into a multi-year contract and every subcontractor with a multi-year subcontract shall certify, by July 1 of each fiscal year covered by the contract after the initial fiscal year, to the responsible chief procurement officer whether it continues to satisfy the requirements of Article 50 pertaining to the eligibility for a contract award. If a contractor or subcontractor is not able to truthfully certify that it continues to meet all requirements, it shall provide with its certification a detailed explanation of the circumstances leading to the change in certification status. A contractor or subcontractor that makes a false statement material to any given certification required under Article 50 is, in addition to any other penalties or consequences prescribed by law, subject to liability under the Whistleblower Reward and Protection Act for submission of a false claim.

A. Bribery

1. The Illinois Procurement Code provides:

Section 50-5. Bribery.

(a) Prohibition. No person or business shall be awarded a contract or subcontract under this Code who:

(1) has been convicted under the laws of Illinois or any other state of bribery or attempting to bribe an officer or employee of the State of Illinois or any other state in that officer's or employee's official capacity; or

(2) has made an admission of guilt of that conduct that is a matter of record but has not been prosecuted for that conduct.

(b) Businesses. No business shall be barred from contracting with any unit of State or local government, or subcontracting under such a contract, as a result of a conviction under this Section of any employee or agent of the business if the employee or agent is no longer employed by the business and:

(1) the business has been finally adjudicated not guilty; or

(2) the business demonstrates to the governmental entity with which it seeks to contract, or which is signatory to the contract to which the subcontract relates, and that entity finds that the commission of the offense was not authorized, requested, commanded, or performed by a director, officer, or high managerial agent on behalf of the business as provided in paragraph (2) of subsection (a) of Section 5-4 of the Criminal Code of 1961.

(c) Conduct on behalf of business. For purposes of this Section, when an official, agent, or employee of a business committed the bribery or attempted bribery on behalf of the business and in accordance with the direction or authorization of a responsible official of the business, the business shall be chargeable with the conduct.

(d) Certification. Every bid submitted to and contract executed by the State, and every subcontract subject to Section 20-120 of the Procurement Code shall contain a certification by the contractor or the subcontractor, respectively, that the contractor or subcontractor is not barred from being awarded a contract or subcontract under this Section and acknowledges that the chief procurement officer may declare the related contract void if any certifications required by this Section are false. A contractor who makes a false statement, material to the certification, commits a Class 3 felony.

2. The contractor or subcontractor certifies that it is not barred from being awarded a contract under Section 50.5.

B. Felons

1. The Illinois Procurement Code provides:

Section 50-10. Felons. Unless otherwise provided, no person or business convicted of a felony shall do business with the State of Illinois or any State agency, or enter into a subcontract, from the date of conviction until 5 years after the date of completion of the sentence for that felony, unless no person held responsible by a prosecutorial office for the facts upon which the conviction was based continues to have any involvement with the business.

2. Certification. Every bid submitted to and contract executed by the State and every subcontract subject to Section 20-120 of the Procurement Code shall contain a certification by the bidder or contractor or subcontractor, respectively, that the bidder, contractor, or subcontractor is not barred from being awarded a contract or subcontract under this Section and acknowledges that the chief procurement officer may declare the related contract void if any of the certifications required by this Section are false.

RETURN WITH SUBCONTRACT

C. Debt Delinquency

1. The Illinois Procurement Code provides:

Section 50-11 and 50-12. Debt Delinquency.

The contractor or bidder or subcontractor, respectively, certifies that it, or any affiliate, is not barred from being awarded a contract or subcontract under the Procurement Code. Section 50-11 prohibits a person from entering into a contract with a State agency, or entering into a subcontract, if it knows or should know that it, or any affiliate, is delinquent in the payment of any debt to the State as defined by the Debt Collection Board. Section 50-12 prohibits a person from entering into a contract with a State agency, or entering into a subcontract, if it, or any affiliate, has failed to collect and remit Illinois Use Tax on all sales of tangible personal property into the State of Illinois in accordance with the provisions of the Illinois Use Tax Act. The bidder or contractor or subcontractor, respectively, further acknowledges that the chief procurement officer may declare the related contract void if this certification is false or if the bidder, contractor, or subcontractor, or any affiliate, is determined to be delinquent in the payment of any debt to the State during the term of the contract.

D. Prohibited Bidders, Contractors and Subcontractors

1. The Illinois Procurement Code provides:

Section 50-10.5 and 50-60(c). Prohibited bidders, contractors and subcontractors.

The bidder or contractor or subcontractor, respectively, certifies in accordance with 30 ILCS 500/50-10.5 that no officer, director, partner or other managerial agent of the contracting business has been convicted of a felony under the Sarbanes-Oxley Act of 2002 or a Class 3 or Class 2 felony under the Illinois Securities Law of 1953 or if in violation of Subsection (c) for a period of five years from the date of conviction.. Every bid submitted to and contract executed by the State and every subcontract subject to Section 20-120 of the Procurement Code shall contain a certification by the bidder, contractor, or subcontractor, respectively, that the bidder, contractor, or subcontractor is not barred from being awarded a contract or subcontract under this Section and acknowledges that the chief procurement officer shall declare the related contract void if any of the certifications completed pursuant to this Section are false.

E. Section 42 of the Environmental Protection Act

The bidder or contractor or subcontractor, respectively, certifies in accordance with 30 ILCS 500/50-12 that the bidder, contractor, or subcontractor, is not barred from being awarded a contract or entering into a subcontract under this Section which prohibits the bidding on or entering into contracts with the State of Illinois or a State agency, or entering into any subcontract, that is subject to the Procurement Code by a person or business found by a court or the Pollution Control Board to have committed a willful or knowing violation of Section 42 of the Environmental Protection Act for a period of five years from the date of the order. The bidder or contractor or subcontractor, respectively, acknowledges that the chief procurement officer may declare the contract void if this certification is false.

The undersigned, on behalf of the subcontracting company, has read and understands the above certifications and makes the certifications as required by law.

Name of Subcontracting Company

Authorized Officer

Date

RETURN WITH SUBCONTRACT
SUBCONTRACTOR DISCLOSURES

I. DISCLOSURES

- A. The disclosures hereinafter made by the subcontractor are each a material representation of fact upon which reliance is placed. The subcontractor further certifies that the Department has received the disclosure forms for each subcontract.

The chief procurement officer may void the bid, contract, or subcontract, respectively, if it is later determined that the bidder or subcontractor rendered a false or erroneous disclosure. A contractor or subcontractor may be suspended or debarred for violations of the Procurement Code. Furthermore, the chief procurement officer may void the contract or subcontract.

B. Financial Interests and Conflicts of Interest

1. Section 50-35 of the Illinois Procurement Code provides that all subcontracts with a total value of \$25,000 or more, from subcontractors identified in Section 20-120 of the Illinois Procurement Code, shall be accompanied by disclosure of the financial interests of the subcontractor. This disclosed information for the subcontractor, will be maintained as public information subject to release by request pursuant to the Freedom of Information Act, filed with the Procurement Policy Board, and shall be incorporated as a material term of the Prime Contractor's contract. Furthermore, pursuant to this Section, the Procurement Policy Board may recommend to allow or void a contract or subcontract based on a potential conflict of interest.

The financial interests to be disclosed shall include ownership or distributive income share that is in excess of 5%, or an amount greater than 60% of the annual salary of the Governor, of the subcontracting entity or its parent entity, whichever is less, unless the subcontractor is a publicly traded entity subject to Federal 10K reporting, in which case it may submit its 10K disclosure in place of the prescribed disclosure. If a subcontractor is a privately held entity that is exempt from Federal 10K reporting, but has more than 200 shareholders, it may submit the information that Federal 10K companies are required to report, and list the names of any person or entity holding any ownership share that is in excess of 5%. The disclosure shall include the names, addresses, and dollar or proportionate share of ownership of each person making the disclosure, their instrument of ownership or beneficial relationship, and notice of any potential conflict of interest resulting from the current ownership or beneficial interest of each person making the disclosure having any of the relationships identified in Section 50-35 and on the disclosure form.

The current annual salary of the Governor is \$177,412.00.

In addition, all disclosures shall indicate any other current or pending contracts, subcontracts, proposals, leases, or other ongoing procurement relationships the subcontracting entity has with any other unit of state government and shall clearly identify the unit and the contract, subcontract, proposal, lease, or other relationship.

2. Disclosure Forms. Disclosure Form A is attached for use concerning the individuals meeting the above ownership or distributive share requirements. A separate Disclosure Form A must be submitted with the bid for each individual meeting the above requirements. In addition, a second form (Disclosure Form B) provides for the disclosure of current or pending procurement relationships with other (non-IDOT) state agencies and a total ownership certification. **The forms must be included with each bid.**

C. Disclosure Form Instructions

Form A Instructions for Financial Information & Potential Conflicts of Interest

If the subcontractor is a publicly traded entity subject to Federal 10K reporting, the 10K Report may be submitted to meet the requirements of Form A. If a subcontractor is a privately held entity that is exempt from Federal 10K reporting, but has more than 200 shareholders, it may submit the information that Federal 10K companies are required to report, and list the names of any person or entity holding any ownership share that is in excess of 5%. If a subcontractor is not subject to Federal 10K reporting, the subcontractor must determine if any individuals are required by law to complete a financial disclosure form. To do this, the subcontractor should answer each of the following questions. A "YES" answer indicates Form A must be completed. If the answer to each of the following questions is "NO", then the NOT APPLICABLE STATEMENT on the second page of Form A must be signed and dated by a person that is authorized to execute contracts for the subcontracting company. Note: These questions are for assistance only and are not required to be completed.

1. Does anyone in your organization have a direct or beneficial ownership share of greater than 5% of the bidding entity or parent entity? YES ___ NO ___
2. Does anyone in your organization have a direct or beneficial ownership share of less than 5%, but which has a value greater than 60% of the annual salary of the Governor? YES ___ NO ___
3. Does anyone in your organization receive more than 60% of the annual salary of the Governor of the subcontracting entity's or parent entity's distributive income? YES ___ NO ___

(Note: Distributive income is, for these purposes, any type of distribution of profits. An annual salary is not distributive income.)

4. Does anyone in your organization receive greater than 5% of the subcontracting entity's or parent entity's total distributive income, but which is less than 60% of the annual salary of the Governor? YES ___ NO ___

(Note: Only one set of forms needs to be completed per person per subcontract even if a specific individual would require a yes answer to more than one question.)

A "YES" answer to any of these questions requires the completion of Form A. The subcontractor must determine each individual in the subcontracting entity or the subcontracting entity's parent company that would cause the questions to be answered "Yes". Each form must be signed and dated by a person that is authorized to execute contracts for your organization. **Photocopied or stamped signatures are not acceptable.** The person signing can be, but does not have to be, the person for which the form is being completed. The subcontractor is responsible for the accuracy of any information provided.

If the answer to each of the above questions is "NO", then the NOT APPLICABLE STATEMENT on page 2 of Form A must be signed and dated by a person that is authorized to execute contracts for your company.

RETURN WITH SUBCONTRACT

Form B: Instructions for Identifying Other Contracts & Procurement Related Information

Disclosure Form B must be completed for each subcontract submitted by the subcontracting entity. *Note: Checking the NOT APPLICABLE STATEMENT on Form A does not allow the subcontractor to ignore Form B. Form B must be completed, checked, and dated or the subcontract will not be approved.*

The Subcontractor shall identify, by checking Yes or No on Form B, whether it has any pending contracts, subcontracts, leases, bids, proposals, or other ongoing procurement relationship with any other (non-IDOT) State of Illinois agency. If "No" is checked, the subcontractor only needs to complete the check box on the bottom of Form B. If "Yes" is checked, the subcontractor must list all non-IDOT State of Illinois agency pending contracts, subcontracts, leases, bids, proposals, and other ongoing procurement relationships. These items may be listed on Form B or on an attached sheet(s). Contracts with cities, counties, villages, etc. are not considered State of Illinois agency contracts and are not to be included. Contracts or subcontracts with other State of Illinois agencies such as the Department of Natural Resources or the Capital Development Board must be included.

**ILLINOIS DEPARTMENT
OF TRANSPORTATION**

**Form A
Subcontractor: Financial
Information & Potential Conflicts
of Interest Disclosure**

Subcontractor Name		
Legal Address		
City, State, Zip		
Telephone Number	Email Address	Fax Number (if available)

Disclosure of the information contained in this Form is required by the Section 50-35 of the Illinois Procurement Code (30 ILCS 500). Subcontractors desiring to enter into a subcontract of a State of Illinois contract must disclose the financial information and potential conflict of interest information as specified in this Disclosure Form. This information shall become part of the publicly available contract file. This Form A must be completed for subcontracts with a total value of \$25,000 or more, from subcontractors identified in Section 20-120 of the Illinois Procurement Code, and for all open-ended contracts. **A publicly traded company may submit a 10K disclosure (or equivalent if applicable) in satisfaction of the requirements set forth in Form A. See Disclosure Form Instructions.**

The current annual salary of the Governor is \$177,412.00.

DISCLOSURE OF FINANCIAL INFORMATION

1. Disclosure of Financial Information. The individual named below has an interest in the SUBCONTRACTOR (or its parent) in terms of ownership or distributive income share in excess of 5%, or an interest which has a value of more than 60% of the annual salary of the Governor. **(Make copies of this form as necessary and attach a separate Disclosure Form A for each individual meeting these requirements)**

FOR INDIVIDUAL (type or print information)	
NAME:	_____
ADDRESS	_____
Type of ownership/distributable income share:	
stock _____ sole proprietorship _____ Partnership _____ other: (explain on separate sheet):	
% or \$ value of ownership/distributable income share:	_____

2. Disclosure of Potential Conflicts of Interest. Check "Yes" or "No" to indicate which, if any, of the following potential conflict of interest relationships apply. If the answer to any question is "Yes", please attach additional pages and describe.

(a) State employment, currently or in the previous 3 years, including contractual employment of services. Yes ___ No ___

If your answer is yes, please answer each of the following questions.

- Are you currently an officer or employee of either the Capitol Development Board or the Illinois State Toll Highway Authority? Yes ___ No ___
- Are you currently appointed to or employed by any agency of the State of Illinois? If you are currently appointed to or employed by any agency of the State of Illinois, and your annual salary exceeds 60% of the annual salary of the Governor, provide the name the State agency for which you are employed and your annual salary. _____

RETURN WITH SUBCONTRACT

3. If you are currently appointed to or employed by any agency of the State of Illinois, and your annual salary exceeds 60% of the annual salary of the Governor, are you entitled to receive (i) more than 7 1/2% of the total distributable income of your firm, partnership, association or corporation, or (ii) an amount in excess of 100% of the annual salary of the Governor?
Yes ___ No ___

4. If you are currently appointed to or employed by any agency of the State of Illinois, and your annual salary exceeds 60% of the annual salary of the Governor, are you and your spouse or minor children entitled to receive (i) more than 15 % in the aggregate of the total distributable income of your firm, partnership, association or corporation, or (ii) an amount in excess of two times the salary of the Governor?
Yes ___ No ___

(b) State employment of spouse, father, mother, son, or daughter, including contractual employment services in the previous 2 years.

Yes ___ No ___

If your answer is yes, please answer each of the following questions.

1. Is your spouse or any minor children currently an officer or employee of the Capitol Development Board or the Illinois State Toll Highway Authority?
Yes ___ No ___

2. Is your spouse or any minor children currently appointed to or employed by any agency of the State of Illinois? If your spouse or minor children is/are currently appointed to or employed by any agency of the State of Illinois, and his/her annual salary exceeds 60% of the annual salary of the Governor, provide the name of your spouse and/or minor children, the name of the State agency for which he/she is employed and his/her annual salary. _____

3. If your spouse or any minor children is/are currently appointed to or employed by any agency of the State of Illinois, and his/her annual salary exceeds 60% of the annual salary of the Governor, are you entitled to receive (i) more than 7 1/2% of the total distributable income of your firm, partnership, association or corporation, or (ii) an amount in excess of 100% of the annual salary of the Governor?
Yes ___ No ___

4. If your spouse or any minor children are currently appointed to or employed by any agency of the State of Illinois, and his/her annual salary exceeds 60% of the annual salary of the Governor, are you and your spouse or minor children entitled to receive (i) more than 15 % in the aggregate of the total distributable income of your firm, partnership, association or corporation, or (ii) an amount in excess of two times the salary of the Governor?
Yes ___ No ___

(c) Elective status; the holding of elective office of the State of Illinois, the government of the United States, any unit of local government authorized by the Constitution of the State of Illinois or the statutes of the State of Illinois currently or in the previous 3 years.
Yes ___ No ___

(d) Relationship to anyone holding elective office currently or in the previous 2 years; spouse, father, mother, son, or daughter.
Yes ___ No ___

(e) Appointive office; the holding of any appointive government office of the State of Illinois, the United States of America, or any unit of local government authorized by the Constitution of the State of Illinois or the statutes of the State of Illinois, which office entitles the holder to compensation in excess of the expenses incurred in the discharge of that office currently or in the previous 3 years.
Yes ___ No ___

(f) Relationship to anyone holding appointive office currently or in the previous 2 years; spouse, father, mother, son, or daughter.
Yes ___ No ___

(g) Employment, currently or in the previous 3 years, as or by any registered lobbyist of the State government.
Yes ___ No ___

RETURN WITH SUBCONTRACT

(h) Relationship to anyone who is or was a registered lobbyist in the previous 2 years; spouse, father, mother, son, or daughter. Yes ___ No ___

(i) Compensated employment, currently or in the previous 3 years, by any registered election or reelection committee registered with the Secretary of State or any county clerk of the State of Illinois, or any political action committee registered with either the Secretary of State or the Federal Board of Elections. Yes ___ No ___

(j) Relationship to anyone; spouse, father, mother, son, or daughter; who was a compensated employee in the last 2 years by any registered election or re-election committee registered with the Secretary of State or any county clerk of the State of Illinois, or any political action committee registered with either the Secretary of State or the Federal Board of Elections. Yes ___ No ___

3 Communication Disclosure.

Disclose the name and address of each lobbyist and other agent of the bidder or offeror who is not identified in Section 2 of this form, who is has communicated, is communicating, or may communicate with any State officer or employee concerning the bid or offer. This disclosure is a continuing obligation and must be promptly supplemented for accuracy throughout the process and throughout the term of the contract. If no person is identified, enter "None" on the line below:

Name and address of person(s): _____

RETURN WITH SUBCONTRACT

4. Debarment Disclosure. For each of the persons identified under Sections 2 and 3 of this form, disclose whether any of the following has occurred within the previous 10 years: debarment from contracting with any governmental entity; professional licensure discipline; bankruptcies; adverse civil judgments and administrative findings; and criminal felony convictions. This disclosure is a continuing obligation and must be promptly supplemented for accuracy throughout the procurement process and term of the contract. If no person is identified, enter "None" on the line below:

Name of person(s): _____

Nature of disclosure: _____

APPLICABLE STATEMENT

This Disclosure Form A is submitted on behalf of the INDIVIDUAL named on previous page. Under penalty of perjury, I certify the contents of this disclosure to be true and accurate to the best of my knowledge.

Completed by: _____ Date _____
Signature of Individual or Authorized Officer

NOT APPLICABLE STATEMENT

Under penalty of perjury, I have determined that no individuals associated with this organization meet the criteria that would require the completion of this Form A.

This Disclosure Form A is submitted on behalf of the SUBCONTRACTOR listed on the previous page.

_____ Date _____
Signature of Authorized Officer

RETURN WITH SUBCONTRACT

ILLINOIS DEPARTMENT OF TRANSPORTATION

Form B
Subcontractor: Other Contracts & Financial Related Information Disclosure

Form with fields: Subcontractor Name, Legal Address, City, State, Zip, Telephone Number, Email Address, Fax Number (if available)

Disclosure of the information contained in this Form is required by the Section 50-35 of the Illinois Procurement Act (30 ILCS 500). This information shall become part of the publicly available contract file. This Form B must be completed for subcontracts with a total value of \$25,000 or more, from subcontractors identified in Section 20-120 of the Illinois Procurement Code, and for all open-ended contracts.

DISCLOSURE OF OTHER CONTRACTS, SUBCONTRACTS, AND PROCUREMENT RELATED INFORMATION

1. Identifying Other Contracts & Procurement Related Information. The SUBCONTRACTOR shall identify whether it has any pending contracts, subcontracts, including leases, bids, proposals, or other ongoing procurement relationship with any other State of Illinois agency: Yes ___ No ___

If "No" is checked, the subcontractor only needs to complete the signature box on the bottom of this page.

2. If "Yes" is checked. Identify each such relationship by showing State of Illinois agency name and other descriptive information such as bid or project number (attach additional pages as necessary). SEE DISCLOSURE FORM INSTRUCTIONS:

THE FOLLOWING STATEMENT MUST BE CHECKED

Signature box with fields for Signature of Authorized Officer and Date

OWNERSHIP CERTIFICATION

Please certify that the following statement is true if the individuals for all submitted Form A disclosures do not total 100% of ownership

Any remaining ownership interest is held by individuals receiving less than \$106,447.20 of the bidding entity's or parent entity's distributive income or holding less than a 5% ownership interest.

Yes No N/A (Form A disclosure(s) established 100% ownership)



NOTICE TO BIDDERS

1. **TIME AND PLACE OF OPENING BIDS.** Sealed proposals for the improvement described herein will be received by the Department of Transportation at the Harry R. Hanley Building, 2300 South Dirksen Parkway, in Springfield, Illinois until 10:00 o'clock a.m., August 3, 2012. All bids will be gathered, sorted, publicly opened and read in the auditorium at the Department of Transportation's Harry R. Hanley Building shortly after the 10:00 a.m. cut off time.

2. **DESCRIPTION OF WORK.** The proposed improvement is identified and advertised for bids in the Invitation for Bids as:

**Contract No. 63718
DUPAGE County
Section 12-PEDTS-00-SP
Project HSIP-4003(012)
Various Routes
District 1 Construction Funds**

Project consists of installation of pedestrian countdown signal heads at various intersections in DuPage County.

3. **INSTRUCTIONS TO BIDDERS.** (a) This Notice, the invitation for bids, proposal and letter of award shall, together with all other documents in accordance with Article 101.09 of the Standard Specifications for Road and Bridge Construction, become part of the contract. Bidders are cautioned to read and examine carefully all documents, to make all required inspections, and to inquire or seek explanation of the same prior to submission of a bid.

(b) State law, and, if the work is to be paid wholly or in part with Federal-aid funds, Federal law requires the bidder to make various certifications as a part of the proposal and contract. By execution and submission of the proposal, the bidder makes the certification contained therein. A false or fraudulent certification shall, in addition to all other remedies provided by law, be a breach of contract and may result in termination of the contract.

4. **AWARD CRITERIA AND REJECTION OF BIDS.** This contract will be awarded to the lowest responsive and responsible bidder considering conformity with the terms and conditions established by the Department in the rules, Invitation for Bids and contract documents. The issuance of plans and proposal forms for bidding based upon a prequalification rating shall not be the sole determinant of responsibility. The Department reserves the right to determine responsibility at the time of award, to reject any or all proposals, to readvertise the proposed improvement, and to waive technicalities.

By Order of the
Illinois Department of Transportation

Ann L. Schneider,
Secretary

INDEX
FOR
SUPPLEMENTAL SPECIFICATIONS
AND RECURRING SPECIAL PROVISIONS

Adopted January 1, 2012

This index contains a listing of SUPPLEMENTAL SPECIFICATIONS and frequently used RECURRING SPECIAL PROVISIONS.

SUPPLEMENTAL SPECIFICATIONS

Std. Spec. Sec.

Page No.

No Supplemental Specifications this year.

CHECK SHEET
RECURRING SPECIAL PROVISIONS

Adopted January 1, 2012

The following RECURRING SPECIAL PROVISIONS indicated by an "X" are applicable to this contract and are included by reference:

<u>CHECK SHEET #</u>	<u>RECURRING SPECIAL PROVISIONS</u>	<u>PAGE NO.</u>
1	X Additional State Requirements For Federal-Aid Construction Contracts (Eff. 2-1-69) (Rev. 1-1-10)	1
2	X Subletting of Contracts (Federal-Aid Contracts) (Eff. 1-1-88) (Rev. 5-1-93)	4
3	X EEO (Eff. 7-21-78) (Rev. 11-18-80)	5
4	Specific Equal Employment Opportunity Responsibilities Non Federal-Aid Contracts (Eff. 3-20-69) (Rev. 1-1-94)	15
5	Required Provisions - State Contracts (Eff. 4-1-65) (Rev. 1-1-12)	20
6	Asbestos Bearing Pad Removal (Eff. 11-1-03)	25
7	Asbestos Waterproofing Membrane and Asbestos Hot-Mix Asphalt Surface Removal (Eff. 6-1-89) (Rev. 1-1-09)	26
8	Haul Road Stream Crossings, Other Temporary Stream Crossings, and In-Stream Work Pads (Eff. 1-2-92) (Rev. 1-1-98)	27
9	Construction Layout Stakes Except for Bridges (Eff. 1-1-99) (Rev. 1-1-07)	28
10	Construction Layout Stakes (Eff. 5-1-93) (Rev. 1-1-07)	31
11	Use of Geotextile Fabric for Railroad Crossing (Eff. 1-1-95) (Rev. 1-1-07)	34
12	Subsealing of Concrete Pavements (Eff. 11-1-84) (Rev. 1-1-07)	36
13	Hot-Mix Asphalt Surface Correction (Eff. 11-1-87) (Rev. 1-1-09)	40
14	Pavement and Shoulder Resurfacing (Eff. 2-1-00) (Rev. 1-1-09)	42
15	PCC Partial Depth Hot-Mix Asphalt Patching (Eff. 1-1-98) (Rev. 1-1-07)	43
16	Patching with Hot-Mix Asphalt Overlay Removal (Eff. 10-1-95) (Rev. 1-1-07)	45
17	Polymer Concrete (Eff. 8-1-95) (Rev. 1-1-08)	46
18	PVC Pipeliner (Eff. 4-1-04) (Rev. 1-1-07)	48
19	Pipe Underdrains (Eff. 9-9-87) (Rev. 1-1-07)	49
20	Guardrail and Barrier Wall Delineation (Eff. 12-15-93) (Rev. 1-1-12)	50
21	Bicycle Racks (Eff. 4-1-94) (Rev. 1-1-12)	54
22	Temporary Modular Glare Screen System (Eff. 1-1-00) (Rev. 1-1-07)	56
23	Temporary Portable Bridge Traffic Signals (Eff. 8-1-03) (Rev. 1-1-07)	58
24	Work Zone Public Information Signs (Eff. 9-1-02) (Rev. 1-1-07)	60
25	Night Time Inspection of Roadway Lighting (Eff. 5-1-96)	61
26	English Substitution of Metric Bolts (Eff. 7-1-96)	62
27	English Substitution of Metric Reinforcement Bars (Eff. 4-1-96) (Rev. 1-1-03)	63
28	Calcium Chloride Accelerator for Portland Cement Concrete (Eff. 1-1-01)	64
29	Portland Cement Concrete Inlay or Overlay for Pavements (Eff. 11-1-08) (Rev. 1-1-12)	65
30	Quality Control of Concrete Mixtures at the Plant (Eff. 8-1-00) (Rev. 1-1-11)	68
31	Quality Control/Quality Assurance of Concrete Mixtures (Eff. 4-1-92) (Rev. 1-1-11).....	76

CHECK SHEET
LOCAL ROADS AND STREETS RECURRING SPECIAL PROVISIONS

Adopted January 1, 2012

The following LOCAL ROADS AND STREETS RECURRING SPECIAL PROVISIONS indicated by an "X" are applicable to this contract and are included by reference:

<u>CHECK SHEET #</u>	<u>LOCAL ROADS AND STREETS RECURRING SPECIAL PROVISIONS</u>	<u>PAGE NO.</u>
LRS 1	Reserved	89
LRS 2	<input type="checkbox"/> Furnished Excavation (Eff. 1-1-99) (Rev. 1-1-07)	90
LRS 3	<input checked="" type="checkbox"/> Work Zone Traffic Control Surveillance (Eff. 1-1-99) (Rev. 1-1-10).....	91
LRS 4	<input type="checkbox"/> Flaggers in Work Zones (Eff. 1-1-99) (Rev. 1-1-07).....	92
LRS 5	<input type="checkbox"/> Contract Claims (Eff. 1-1-02) (Rev. 1-1-07).....	93
LRS 6	<input type="checkbox"/> Bidding Requirements and Conditions for Contract Proposals (Eff. 1-1-02) (Rev. 1-1-12).....	94
LRS 7	<input type="checkbox"/> Bidding Requirements and Conditions for Material Proposals (Eff. 1-1-02) (Rev. 1-1-12).....	100
LRS 8	Reserved	106
LRS 9	<input type="checkbox"/> Bituminous Surface Treatments (Eff. 1-1-99) (Rev. 1-1-11).....	107
LRS 10	Reserved	108
LRS 11	<input type="checkbox"/> Employment Practices (Eff. 1-1-99)	109
LRS 12	<input type="checkbox"/> Wages of Employees on Public Works (Eff. 1-1-99) (Rev. 1-1-10).....	111
LRS 13	<input type="checkbox"/> Selection of Labor (Eff. 1-1-99) (Rev. 1-1-12).....	112
LRS 14	<input type="checkbox"/> Paving Brick and Concrete Paver Pavements and Sidewalks (Eff. 1-1-04) (Rev. 1-1-09).....	113
LRS 15	<input type="checkbox"/> Partial Payments (Eff. 1-1-07)	116
LRS 16	<input type="checkbox"/> Protests on Local Lettings (Eff. 1-1-07)	117
LRS 17	<input type="checkbox"/> Substance Abuse Prevention Program (Eff. 1-1-08) (Rev. 1-8-08).....	118

TABLE OF CONTENTS

STATE OF ILLINOIS SPECIAL PROVISIONS

<i>LOCATION OF PROJECT</i>	<i>1</i>
<i>DESCRIPTION OF PROJECT</i>	<i>1</i>
Status of Utilities to be Adjusted	1A

TRAFFIC SIGNAL SPECIAL PROVISIONS

DUPAGE COUNTY SPECIAL PROVISIONS

WORK NOTIFICATION AND SIGNAL DAMAGE RESPONSIBILITIES.....	DDOT 1
REMOVE EXISTING PEDESTRIAN SIGNAL HEAD AND INSTALL POLYCARBONATE PEDESTRIAN COUNTDOWN SIGNAL HEAD, LED.....	DDOT 2
REMOVE EXIST AND INSTALL NEW PEDESTRIAN PUSH BUTTON	DDOT 2
VENDOR REPRESENTATION.....	DDOT 3

IDOT DISTRICT I TRAFFIC SIGNAL SPECIAL PROVISIONS (10/28/09)

Traffic Signal Specifications (Effective May 22, 2002; Revised January 1, 2012)	TS 1
Mast Arm Sign Panels.....	TS 1
Submittals.....	TS 1
Inspection of Electrical Systems.....	TS 2
Maintenance and Responsibility.....	TS 3
Damage to Traffic Signal System.....	TS 4
Traffic Signal Inspection (Turn On).....	TS 5
Locating Underground Facilities.....	TS 8
Restoration of Work Area.....	TS 9
Electric Service Installation.....	TS 9
Grounding of Traffic Signals.....	TS 12
Grounding of Existing Handhole Frame and Cover.....	TS 13
Coilable Non-Metallic Conduit.....	TS 13
Handholes.....	TS 14
Grounding Cable.....	TS 14
Railroad Interconnect Cable.....	TS 15
Fiber Optic Tracer Cable.....	TS 15
Maintenance of Existing Traffic Signal Installation.....	TS 16
Traffic Actuated Controller.....	TS 17
Master Controller.....	TS 18
Uninterruptable Power Supply.....	TS 19
Fiber Optic Cable.....	TS 20
Mast Arm Assembly and Pole.....	TS 21
Concrete Foundations.....	TS 22
Light Emitting Diode (LED), Signal Head and Optically Programmed LED Signal Head.....	TS 23
Light Emitting Diode (LED), Signal Head Retrofit.....	TS 23
Light Emitting Diode (LED), Pedestrian Signal Head.....	TS 24
Detector Loop.....	TS 24

TABLE OF CONTENTS

Emergency Vehicle Priority System.....	TS 26
Temporary Traffic Signal Installation.....	TS 27
Remove Existing Traffic Signal Equipment.....	TS 33
Traffic Signal Painting.....	TS 33
Illuminated Street Name Sign.....	TS 34
Re-Optimize Traffic Signal System.....	TS 35
Optimize Traffic Signal System.....	TS 37
Temporary Traffic Signal Timings.....	TS 40
Modify Existing Controller Cabinet.....	TS 41

Material Specifications

Pedestrian Push-Button.....	TS 42
Controller Cabinet and Peripheral Equipment.....	TS 42
Railroad, Full-Actuated Controller and Cabinet.....	TS 43
Uninterruptible Power Supply (UPS).....	TS 44
Electric Cable.....	TS 46
Traffic Signal Post.....	TS 46
Pedestrian Push-Button Post.....	TS 46
Mast Arm Assembly and Pole	TS 46
Light Emitting Diode (LED), Signal Head.....	TS 47
Light Emitting Diode (LED), Pedestrian Signal Head.....	TS 50
Traffic Signal Backplate.....	TS 51
Inductive Loop Detector.....	TS 52
Illuminated Sign, Light Emitting Diode (LED).....	TS 52
Illuminated Street Name Sign.....	TS 52

LOCAL ROADS AND STREETS SPECIAL PROVISIONS

- LR105 Cooperation With Utilities
- LR107-4 Insurance

IDOT BDE SPECIAL PROVISIONS

INDEX LOCAL ROADS AND STREETS SPECIAL PROVISIONS

<u>LR #</u>	<u>Pg #</u>	<u>Special Provision Title</u>	<u>Effective</u>	<u>Revised</u>
LR SD12		<input type="checkbox"/> Slab Movement Detection Device	Nov. 11, 1984	Jan. 1, 2007
LR SD13		<input type="checkbox"/> Required Cold Milled Surface Texture	Nov. 1, 1987	Jan. 1, 2007
LR SD406		<input type="checkbox"/> Safety Edge	April 1, 2011	
LR 102-1		<input type="checkbox"/> Protests on Local Lettings	Jan. 1, 2007	Jan. 2, 2012
LR 102-2		<input type="checkbox"/> Bidding Requirements and Conditions for Contract Proposals	Jan. 1, 2001	Jan. 2, 2012
LR 102-3		<input type="checkbox"/> Bidding Requirements and Conditions for Material Proposals	Jan. 1, 2001	Jan. 2, 2012
LR 105	60	<input checked="" type="checkbox"/> Cooperation with Utilities	Jan. 1, 1999	Jan. 1, 2007
LR 107-2		<input type="checkbox"/> Railroad Protective Liability Insurance for Local Lettings	Mar. 1, 2005	Jan. 1, 2006
LR 107-4	63	<input checked="" type="checkbox"/> Insurance	Feb. 1, 2007	Aug. 1, 2007
LR 107-7		<input type="checkbox"/> Wages of Employees on Public Works	Jan. 1, 1999	Jan. 1, 2012
LR 108		<input type="checkbox"/> Combination Bids	Jan. 1, 1994	Mar. 1, 2005
LR 109		<input type="checkbox"/> Equipment Rental Rates	Jan. 1, 2012	
LR 212		<input type="checkbox"/> Shaping Roadway	Aug. 1, 1969	Jan. 1, 2002
LR 355-1		<input type="checkbox"/> Bituminous Stabilized Base Course, Road Mix or Traveling Plant Mix	Oct. 1, 1973	Jan. 1, 2007
LR 355-2		<input type="checkbox"/> Bituminous Stabilized Base Course, Plant Mix	Feb. 20, 1963	Jan. 1, 2007
LR 400-1		<input type="checkbox"/> Bituminous Treated Earth Surface	Jan. 1, 2007	Apr. 1, 2012
LR 400-2		<input type="checkbox"/> Bituminous Surface Plant Mix (Class B)	Jan. 1, 2008	
LR 400-3		<input type="checkbox"/> Hot In-Place Recycling (HIR) – Surface Recycling	Jan. 1, 2012	
LR 400-4		<input type="checkbox"/> Full-Depth Reclamation (FDR) with Emulsified Asphalt	June 1, 2012	
LR 400-5		<input type="checkbox"/> Cold In-Place Recycling (CIR) With Emulsified Asphalt	June 1, 2012	
LR 400-6		<input type="checkbox"/> Cold In Place Recycling (CIR) with Foamed Asphalt	June 1, 2012	
LR 400-7		<input type="checkbox"/> Full-Depth Reclamation (FDR) with Foamed Asphalt	June 1, 2012	
LR 402		<input type="checkbox"/> Salt Stabilized Surface Course	Feb. 20, 1963	Jan. 1, 2007
LR 403-1		<input type="checkbox"/> Surface Profile Milling of Existing, Recycled or Reclaimed Flexible Pavement	Apr. 1, 2012	Jun. 1, 2012
LR 403-2		<input type="checkbox"/> Bituminous Hot Mix Sand Seal Coat	Aug. 1, 1969	Jan. 1, 2007
LR 406		<input type="checkbox"/> Filling HMA Core Holes with Non-shrink Grout	Jan. 1, 2008	
LR 420		<input type="checkbox"/> PCC Pavement (Special)	May 12, 1964	Jan. 2, 2007
LR 442		<input type="checkbox"/> Bituminous Patching Mixtures for Maintenance Use	Jan. 1, 2004	Jun. 1, 2007
LR 451		<input type="checkbox"/> Crack Filling Bituminous Pavement with Fiber-Asphalt	Oct. 1, 1991	Jan. 1, 2007
LR 503-1		<input type="checkbox"/> Furnishing Class SI Concrete	Oct. 1, 1973	Jan. 1, 2002
LR 503-2		<input type="checkbox"/> Furnishing Class SI Concrete (Short Load)	Jan. 1, 1989	Jan. 1, 2002
LR 542		<input type="checkbox"/> Pipe Culverts, Type _____ (Furnished)	Sep. 1, 1964	Jan. 1, 2007
LR 663		<input type="checkbox"/> Calcium Chloride Applied	Jun. 1, 1958	Jan. 1, 2007
LR 702		<input type="checkbox"/> Construction and Maintenance Signs	Jan. 1, 2004	Jun. 1, 2007
LR 1000-1		<input type="checkbox"/> Cold In-Place Recycling (CIR) and Full Depth Reclamation (FDR) with Emulsified Asphalt Mix Design Procedures	June 1, 2012	
LR 1000-2		<input type="checkbox"/> Cold In-Place Recycling (CIR) and Full Depth Reclamation (FDR) with Foamed Asphalt Mix Design Procedures	June 1, 2012	
LR 1004		<input type="checkbox"/> Coarse Aggregate for Bituminous Surface Treatment	Jan. 1, 2002	Jan. 1, 2007
LR 1030		<input type="checkbox"/> Growth Curve	Mar. 1, 2008	Jan. 1, 2010
LR 1032-1		<input type="checkbox"/> Emulsified Asphalts	Jan. 1, 2007	Feb. 7, 2008
LR 1032-2		<input type="checkbox"/> Multigrade Cold Mix Asphalt	Jan. 1, 2007	Feb. 1, 2007
LR 1102		<input type="checkbox"/> Road Mix or Traveling Plan Mix Equipment	Jan. 1, 2007	

BDE SPECIAL PROVISIONS
For the August 3 and September 21, 2012 Lettings

The following special provisions indicated by an "x" are applicable to this contract. An * indicates a new or revised special provision for the letting.

File Name	Pg #	Special Provision Title	Effective	Revised
80240		Above Grade Inlet Protection	July 1, 2009	Jan. 1, 2012
80099		Accessible Pedestrian Signals (APS)	April 1, 2003	Jan. 1, 2007
80275		Agreement to Plan Quantity	Jan. 1, 2012	
80274		Aggregate Subgrade Improvement	April 1, 2012	Aug 1, 2012
80192		Automated Flagger Assistance Device	Jan. 1, 2008	
80173		Bituminous Materials Cost Adjustments	Nov. 2, 2006	Jan. 1, 2012
80241		Bridge Demolition Debris	July 1, 2009	
80276		Bridge Relief Joint Sealer (NOTE: This special provision was previously named "Concrete Joint Sealer")	Jan. 1, 2012	Aug 1, 2012
50261		Building Removal-Case I (Non-Friable and Friable Asbestos)	Sept. 1, 1990	April 1, 2010
50481		Building Removal-Case II (Non-Friable Asbestos)	Sept. 1, 1990	April 1, 2010
50491		Building Removal-Case III (Friable Asbestos)	Sept. 1, 1990	April 1, 2010
50531		Building Removal-Case IV (No Asbestos)	Sept. 1, 1990	April 1, 2010
80291		Calcium Chloride Accelerator for Class PP-2 Concrete	April 1, 2012	
80292		Coarse Aggregate in Bridge Approach Slabs/Footings	April 1, 2012	
80198		Completion Date (via calendar days)	April 1, 2008	
80199		Completion Date (via calendar days) Plus Working Days	April 1, 2008	
80293		Concrete Box Culverts with Skews > 30 Degrees and Design Fills ≤ 5 Feet	April 1, 2012	
80294		Concrete Box Culverts with Skews ≤ 30 Degrees Regardless of Design Fill and Skews > 30 Degrees with Design Fills > 5 feet	April 1, 2012	
80277		Concrete Mix Design - Department Provided	Jan 1, 2012	
80261	64	X Construction Air Quality – Diesel Retrofit	June 1, 2010	
80237	67	X Construction Air Quality – Diesel Vehicle Emissions Control	April 1, 2009	Jan. 2, 2012
80239	69	X Construction Air Quality – Idling Restrictions	April 1, 2009	
80177		Digital Terrain Modeling for Earthwork Calculations	April 1, 2007	
80029	71	X Disadvantaged Business Enterprise Participation	Sept. 1, 2000	Aug. 2, 2011
80272		Drainage and Inlet Protection Under Traffic	April 1, 2011	Jan. 1, 2012
80296	81	X Errata for the 2012 Standard Specifications	April 1, 2012	Aug 1, 2012
80228		Flagger at Side Roads and Entrances	April 1, 2009	
80265		Friction Aggregate	Jan. 1, 2011	
80229		Fuel Cost Adjustment	April 1, 2009	July 1, 2009
80169		High Tension Cable Median Barrier	Jan. 1, 2007	April 1, 2009
80246		Hot-Mix Asphalt – Density Testing of Longitudinal Joints	Jan. 1, 2010	April 1, 2012
80109		Impact Attenuators	Nov. 1, 2003	Jan. 1, 2012
80110		Impact Attenuators, Temporary	Nov. 1, 2003	Jan. 1, 2012
80045		Material Transfer Device	June 15, 1999	Jan. 1, 2009
80203		Metal Hardware Cast into Concrete	April 1, 2008	Jan. 1, 2012
80297		Modified Urethane Pavement Marking	April 1, 2012	
80165		Moisture Cured Urethane Paint System	Nov. 1, 2006	Jan. 1, 2010
80253		Movable Traffic Barrier	Jan. 1, 2010	Jan. 1, 2012
80231		Pavement Marking Removal	April 1, 2009	
80298		Pavement Marking Tape Type IV	April 1, 2012	
80254		Pavement Patching	Jan. 1, 2010	
80022	82	X Payments to Subcontractors	June 1, 2000	Jan. 1, 2006
80290		Payrolls and Payroll Records	Jan. 2, 2012	
80278		Planting Woody Plants	Jan. 1, 2012	Aug 1, 2012
80279		Portland Cement Concrete	Jan. 1, 2012	
80299		Portland Cement Concrete Inlay or Overlay	April 1, 2012	
80280		Portland Cement Concrete Sidewalk	Jan. 1, 2012	
80300		Preformed Plastic Pavement Marking Type D - Inlaid	April 1, 2012	
80218		Preventive Maintenance – Bituminous Surface Treatment	Jan. 1, 2009	April 1, 2012
80219		Preventive Maintenance – Cape Seal	Jan. 1, 2009	April 1, 2012

File Name	Pg #		Special Provision Title	Effective	Revised
80220			Preventive Maintenance – Micro-Surfacing	Jan. 1, 2009	April 1, 2012
80221			Preventive Maintenance – Slurry Seal	Jan. 1, 2009	April 1, 2012
80281			Quality Control/Quality Assurance of Concrete Mixtures	Jan. 1, 2012	
34261			Railroad Protective Liability Insurance	Dec. 1, 1986	Jan. 1, 2006
80157			Railroad Protective Liability Insurance (5 and 10)	Jan. 1, 2006	
80172			Reclaimed Asphalt Pavement (RAP)	Jan. 1, 2007	Aug. 1, 2012
80282			Reclaimed Asphalt Shingles (RAS)	Jan. 1, 2012	
80283			Removal and Disposal of Regulated Substances	Jan. 1, 2012	
80224			Restoring Bridge Approach Pavements Using High-Density Foam	Jan. 1, 2009	Jan. 1, 2012
80271			Safety Edge	April 1, 2011	
80152			Self-Consolidating Concrete for Cast-In-Place Construction	Nov. 1, 2005	April 1, 2012
80132			Self-Consolidating Concrete for Precast and Precast Prestressed Products	July 1, 2004	April 1, 2012
80284			Shoulder Rumble Strips	Jan. 1, 2012	
80285			Sidewalk, Corner or Crosswalk Closure	Jan. 1, 2012	
80127			Steel Cost Adjustment	April 2, 2004	April 1, 2009
80255			Stone Matrix Asphalt	Jan. 1, 2010	Jan. 1, 2012
80143	84	X	Subcontractor Mobilization Payments	April 2, 2005	April 1, 2011
80075			Surface Testing of Pavements	April 1, 2002	Jan. 1, 2007
80286			Temporary Erosion and Sediment Control	Jan. 1, 2012	
80225			Temporary Raised Pavement Marker	Jan. 1, 2009	
80256			Temporary Water Filled Barrier	Jan. 1, 2010	Jan. 1, 2012
80301			Tracking the Use of Pesticides	Aug. 1, 2012	
80287			Type G Inlet Box	Jan. 1, 2012	
80273	85	X	Traffic Control Deficiency Deduction	Aug. 1, 2011	
20338			Training Special Provisions	Oct. 15, 1975	
80270			Utility Coordination and Conflicts	April 1, 2011	Jan. 1, 2012
80288			Warm Mix Asphalt	Jan. 1, 2012	
80302	86	X	Weekly DBE Trucking Reports	June 1, 2012	
80289			Wet Reflective Thermoplastic Pavement Marking	Jan. 1, 2012	
80071	87	X	Working Days	Jan. 1, 2002	

The following special provisions are either in the 2012 Standard Specification, the 2012 Recurring Special Provisions, or the special provision Portland Cement Concrete:

File Name	Special Provision Title	New Location	Effective	Revised
80186	Alkali-Silica Reaction for Cast-in-Place Concrete	The special provision Portland Cement Concrete	Aug. 1, 2007	Jan. 1, 2009
80213	Alkali-Silica Reaction for Precast and Precast Prestressed Concrete	The special provision Portland Cement Concrete	Jan. 1, 2009	
80207	Approval of Proposed Borrow Areas, Use Areas, and/or Waste Areas	Article 107.22	Nov. 1, 2008	Nov., 1, 2010
80166	Cement	Section 1001	Jan. 1, 2007	April 1, 2011
80260	Certification of Metal Fabricator	Article 106.08	July 1, 2010	
80094	Concrete Admixtures	Section 1021 and the special provision Portland Cement Concrete	Jan. 1, 2003	April 1, 2009
80226	Concrete Mix Designs	The special provision Portland Cement Concrete	April 1, 2009	
80227	Determination of Thickness	Articles 353.12, 353.13, 353.14, 354.09, 355.09, 356.07, 407.10, 482.06 and 483.07	April 1, 2009	
80179	Engineer's Field Office Type A	Articles 670.02 and 670.07	April 1, 2007	Jan. 1, 2011
80205	Engineer's Field Office Type B	Articles 670.04 and 670.07	Aug. 1, 2008	Jan. 1, 2011
80189	Equipment Rental Rates	Articles 105.07 and 109.04	Aug. 2, 2007	Jan. 2, 2008
80249	Frames and Grates	Articles 609.02 and 609.04	Jan. 1, 2010	
80194	HMA - Hauling on Partially Completed Full-Depth Pavement	Article 407.08	Jan. 1, 2008	

<u>File Name</u>	<u>Special Provision Title</u>	<u>New Location</u>	<u>Effective</u>	<u>Revised</u>
80245	Hot-Mix Asphalt - Anti-Stripping Additive	Article 1030.04	Nov.1, 2009	
80250	Hot-Mix Asphalt - Drop-Offs	Article 701.07	Jan. 1, 2010	
80259	Hot-Mix Asphalt - Fine Aggregate	Articles 1003.01 and 1003.03	April 1, 2010	
80252	Improved Subgrade	Articles 302.04, 302.07 302.08, 302.10, 302.11 310.04, 310.08, 310.10 310.11 and 311.05	Jan. 1, 2010	
80266	Lane Closure, Multilane, Intermittent or Moving Operation, for Speeds ≤ 40 MPH	Article 701.19	Jan.1, 2011	Jan. 2, 2011
80230	Liquidated Damages	Article 108.09	April 1, 2009	April 1, 2011
80267	Long-Span Guardrail over Culvert	Articles 630.07 and 630.08	Jan. 1, 2011	
80262	Mulch and Erosion Control Blankets	Articles 251.03, 251.04, 251.06, 251.07 and 1081.06	Nov. 1, 2010	April 1, 2011
80180	National Pollutant Discharge Elimination System / Erosion and Sediment Control Deficiency Deduction	Article 105.03	April 1, 2007	Nov. 1, 2009
80208	Nighttime Work Zone Lighting	Section 702	Nov.,1, 2008	
80232	Pipe Culverts	Article 542.03, 542.04, 542.11 and 1040.04	April 1, 2009	April 1, 2010
80263	Planting Perennial Plants	Section 254 and Article 1081.02	Jan. 1, 2011	
80210	Portland Cement Concrete Inlay or Overlay	Recurring CS #29	Nov. 1, 2008	
80217	Post Clips for Extruded Aluminum Signs	Article 1090.03	Jan. 1, 2009	
80268	Post Mounting of Signs	Article 701.14	Jan. 1, 2011	
80171	Precast Handling Holes	Articles 540.02, 540.06, 542.02, 542.04, 550.02, 550.06, 602.02, 602.07 and 1042.16	Jan. 1, 2007	
80015	Public Convenience and Safety	Article 107.09	Jan. 1, 2000	
80247	Raised Reflective Pavement Markers	Article 781.03	Nov. 1, 2009	April 1, 2010
80131	Seeding	Articles 250.07 and 1081.04	July 1, 2004	July 1, 2010
80264	Selection of Labor	Recurring CS #5	July 2, 2010	
80234	Storm Sewers	Article 550.02, 550.03, 550.06, 550.07, 550.08 and 1040.04	April 1, 2009	April 1, 2010
80087	Temporary Erosion Control	Articles 280.02, 280.03 280.04, 280.07, 280.08 and 1081.15	Nov.1, 2002	Jan. 1, 2011
80257	Traffic Barrier Terminal, Type 6	Article 631.07	Jan. 1, 2010	
80269	Traffic Control Surveillance	Article 701.10	Jan. 1, 2011	
80258	Truck Mounted/Trailer Mounted Attenuators	Articles 701.03, 701.15 and 1106.02	Jan. 1, 2010	

The following special provisions require additional information from the designer. The additional information needs to be included in a separate document attached to this check sheet. The Project Development and Implementation section will then include the information in the applicable special provision. The Special Provisions are:

- Bridge Demolition Debris
- Building Removal-Case I
- Building Removal-Case II
- Building Removal-Case III
- Building Removal-Case IV
- Completion Date
- Completion Date Plus Working Days
- DBE Participation
- Material Transfer Device
- Railroad Protective Liability Insurance
- Training Special Provisions
- Working Days

STATE OF ILLINOIS
SPECIAL PROVISIONS
CONTRACT NUMBER 63718

The following Special Provisions supplement the "Standard Specifications for Road and Bridge Construction", adopted January 1, 2012, the latest edition of the "Manual on Uniform Traffic Control Devices for Streets and Highways", the "Manual of Test Procedures for Materials" in effect on the date of invitation for bids and the "Supplemental Specifications and Recurring Special Provisions" indicated on the Check Sheet included herein which apply to and govern the proposed improvement designated as Section **12-PEDTS-00-SP** , Project Number **HSIP-4003(012)** and Job Number **C-91-373-12**. In case of conflict with any part or parts of said Specifications, the said Special Provisions shall take precedence and shall govern.

LOCATION OF PROJECT

This project is located in DuPage County along the following various DuPage County highways at 33 intersections within DuPage County:

Highway Name (County Route)	Intersections	Municipalities
Hobson Road (C.H. 2)	Greene Road	Woodridge
Bloomington Road (C.H.4)	Edgewater Drive, Schick Road	Bloomington
Roselle Road (C.H. 4)	Bryn Mawr Avenue	Roselle
Park Boulevard (C.H. 5)	College Road, Fawell Boulevard	Glen Ellyn
Eola Road (C.H. 14)	Sheffer Road	Aurora
Cass Avenue(C.H. 15)	59 TH Street	Westmont
Midwest Road/Cass Avenue (C.H. 15)	35 TH Street South	Oak Brook, Westmont
Maple Avenue(C.H. 17)	Patton Road	Lisle
Naperville Road (C.H. 23)	East-West Loop Road	Wheaton
Stearns Road (C.H. 29)	Bartlett Road	Bartlett
75 TH Street (C.H. 33)	Book Road	Naperville
31 ST Street (C.H. 34)	Highland Avenue, Midwest Road	Downers Grove, Oak Brook
College Road (C.H. 40)	Green Trails Drive	Lisle
County Farm Road (C.H. 43)	Stearns Road	Bartlett, Hanover Park

DESCRIPTION OF PROJECT

The work consists of the replacement of existing pedestrian signal heads with LED pedestrian countdown signal heads. The items to be installed under this contract include LED pedestrian countdown signals, pedestrian push buttons and all incidental and collateral work necessary to complete the project as shown on the plans and as described herein.

STATUS OF UTILITIES TO BE ADJUSTED

Effective: January 30, 1987

Revised: July 1, 1994

Utility companies involved in this project have provided the following estimated dates:

<u>Name of Utility</u>	<u>Type</u>	<u>Location</u>	<u>Estimated Dates for Start and Completion of Relocation or Adjustments</u>
Commonwealth Edison P.O. Box 6111 Carol Stream, IL 60197	Electric	Various	30 working days

Note: This work involves removal and replacement of existing pedestrian signal heads. No work is anticipated underground or on the ground, therefore no utility adjustments are expected.

The above represents the best information available to the Department and is included for the convenience of the bidder. The applicable portions of Articles 105.07 and 107.31 of the Standard Specifications shall apply.

DUPAGE COUNTY DIVISION OF TRANSPORTATION TRAFFIC SIGNAL SPECIAL PROVISIONS

Effective: January 1, 2010

The DuPage Division of Transportation (DPCDOT) abides by the most recent provisions of the "Illinois Department of Transportation (IDOT) District One Traffic Signal Special Provisions" (copy attached TS-1 thru TS-55) and the State of Illinois "Standard Specifications for Road and Bridge Construction". In addition to these documents the work performed on all DuPage County facilities shall be governed and comply with "The National Electrical Code", "The National Electrical Manufacturers Association", "The International Municipal Signal Association", "The Institute of Transportation Engineers", "AASHTO Standard Specifications", ;the federal "Manual on Uniform Traffic Control Devices", and the following County Special Provisions. In the event of conflict with any part or parts of said documents, these DuPage Special Provisions shall govern.

The phone number contact at the DuPage County Division of Transportation for all contract electrical questions or requests is **(630) 407-6900**, which includes requests for loop layout approval, transfer of maintenance, maintenance contractor locates, and equipment inspections and turn-ons. In the IDOT specifications wherever the term "State", "IDOT", or "District" is used it shall mean "DuPage County Division of Transportation" in this contract.

WORK NOTIFICATION AND SIGNAL DAMAGE RESPONSIBILITIES

Traffic signal maintenance shall remain the responsibility of the County's current Electrical Maintenance contractor who is Meade Electric Corporation. As such the contractor shall notify Meade Electric of the date work will be performed at the intersection.

The contractor shall be responsible for any damage found to the traffic signal as a result of this work. The Contractor shall notify Meade of its intent to begin work at any signal seven (7) days prior to the start of work (708.243.1444). The contractor or Meade may request a mutual documented inspection of the signal prior to the start of work. If no pre-inspection is made the contractor shall be liable for any damages identified by Meade to be the result of the contractor's work. Meade will repair these damages and submit the invoice to the contractor for payment. All invoices for damages from Meade shall be paid within 30 days of receipt.

After work is complete a final inspection shall be required by Meade and County representatives. It is highly recommended final inspection be requested shortly after signal work is complete. Call the County at (630.407.6900) to request a final inspection.

REMOVE EXISTING PEDESTRIAN SIGNAL HEAD AND INSTALL POLYCARBONATE PEDESTRIAN COUNTDOWN SIGNAL HEAD, LED

Description

This work shall consist of the complete removal of an existing 12 inch pedestrian signal head/brackets and replacement with a LED 16x18 inch pedestrian countdown signal head and two polycarbonate mounting brackets. Included in this item will be any work required to relocate existing cables to the new head. All unused holes in posts or poles shall be plugged with rubber grommets of the appropriate size.

At locations having existing polycarbonate mounting brackets two new polycarbonate brackets shall be installed. If the existing pedestrian head is part of a signal assembly the new head with countdown timer shall remain connected to the signal assembly.

At locations having existing metal mounting bracket assemblies the pedestrian head shall be separated from the existing signal head assembly, the existing cable shall be rerouted, and two new polycarbonate brackets shall be used to mount the new head.

The contractor shall save and return all existing LED pedestrian signal heads and existing polycarbonate mounting brackets to the County's electrical maintenance contractor's DuPage facility. Existing incandescent pedestrian signal heads/brackets shall be salvaged by the contractor with this cost reflected in the contract bid price. All other material removed shall be disposed of by the contractor in the appropriate manner.

In addition to the work described the contractor shall follow the requirements of Article 881 of the Standard Specifications, and the IDOT District 1 Traffic Signal Specifications.

Basis of Payment

This item shall be paid for at the contract unit price each for **PEDESTRIAN COUNTDOWN SIGNAL HEAD, LED**, of the type specified and of the particular material specified, which price shall be payment in full for removal of existing equipment, and payment in full for furnishing the equipment with LED and Countdown timer, mounting hardware, and installing the new equipment in satisfactory operating condition, as described above. The type specified shall indicate the number of faces and method of mounting.

REMOVE EXIST AND INSTALL NEW PEDESTRIAN PUSH-BUTTON

Description

This work shall consist of the removal of an existing pushbutton and sign assembly and installation of a new pushbutton and sign assembly meeting current specifications. All unused holes in posts or poles shall be plugged with rubber grommets of the appropriate size.

Confirmation (pilot) light(s) shall not be included in the new pushbutton assembly.

The contractor shall save and return all existing circuit contact pushbutton assemblies to the County's electrical maintenance contractor's DuPage facility. Existing mechanical contact pushbutton assemblies shall be salvaged by the contractor with this value reflected in the contract bid price.

In addition to the work described shall follow the applicable requirements of Article 888 of the Standard Specifications, and the IDOT District 1 Traffic Signal Specifications.

Basis of Payment

The item shall be paid for at the contract unit price each for **PEDESTRIAN PUSH-BUTTON** which shall be payment in full for removal of the existing equipment, furnishing and installing new equipment in satisfactory operation condition, as described herein.

VENDOR REPRESENTATION

Under this provision, the Engineer reserves the right to request the equipment vendor be present at the activation of new traffic equipment. Equipment covered under this provision includes signal heads, cabinets, controllers, amplifiers, preemption, video detection/monitoring, communication/transmission, fiber-optic/telemetry, radio, microwave, infra-red, illuminated signs, streetlights, push buttons, lighted crosswalks, uninterruptible power supplies, and any other new equipment being installed and activated.

This provision is in addition to the requirement contained herein that the Contractor provide a representative from the control equipment vendor to attend the traffic signal inspection for both permanent and temporary traffic signal "turn-ons".

Any costs associated with equipment vendor representation shall not be paid for separately, but shall be incidental to the cost of the associated traffic equipment being activated. Any unforeseen costs incurred by the Contractor to provide this representation shall not be the responsibility of the County.

IDOT DISTRICT I TRAFFIC SIGNAL SPECIAL PROVISIONS

TRAFFIC SIGNAL SPECIFICATIONS

Effective: May 22, 2002

Revised: January 1, 2012

These Traffic Signal Special Provisions and the "District One Standard Traffic Signal Design Details" supplement the requirements of the State of Illinois "Standard Specifications for Road and Bridge Construction." The intent of these Special Provisions is to prescribe the materials and construction methods commonly used for traffic signal installations. All material furnished shall be new. The locations and the details of all installations shall be as indicated on the Plans or as directed by the Engineer. Traffic signal construction and maintenance work shall be performed by personnel holding IMSA Traffic Signal Technician Level II certification. The work to be done under this contract consists of furnishing and installing all traffic signal work as specified in the Plans and as specified herein in a manner acceptable and approved by the Engineer.

SECTION 720 SIGNING

MAST ARM SIGN PANELS

Add the following to Article 720.02 of the Standard Specifications:

Signs attached to poles or posts (such as mast arm signs) shall have mounting brackets and sign channels which are equal to and completely interchangeable with those used by the District Sign Shops. Signfix Aluminum Channel Framing System is currently recommended, but other brands of mounting hardware are acceptable based upon the Department's approval.

DIVISION 800 ELECTRICAL

SUBMITTALS.

Revise Article 801.05 of the Standard Specifications to read:

All material approval requests shall be submitted in accordance with the District's current Electrical Product Data and Documentation Submittal Guidelines. General requirements include:

1. Material approval requests shall be made at the preconstruction meeting, including major traffic signal items listed in the table in Article 801.05. Material or equipment which is similar or identical shall be the product of the same manufacturer, unless necessary for system continuity. Traffic signal materials and equipment shall bear the U.L. label whenever such labeling is available.
2. Product data and shop drawings shall be assembled by pay item and separated from other pay item submittals. Only the top sheet of each pay item submittal will be stamped by the Department with the review status, except shop drawings for mast arm pole assemblies and the like will be stamped with the review status on each sheet.

PEDESTRIAN COUNTDOWN SIGNAL INSTALLATION
DUPAGE COUNTY SECTION 12-PEDTS-00-SP
CONTRACT NUMBER 63718

3. Partial or incomplete submittals will be returned without review.
4. Certain non-standard mast arm poles and structures will require additional review from IDOT's Central Office. Examples include ornamental/decorative and non-standard length mast arm pole assemblies. The Contractor shall account for the additional review time in his schedule.
5. The contract number or permit number, project location/limits and corresponding pay code number must be on each sheet of correspondence,, catalog cuts and mast arm poles and assemblies drawings.
6. Where certifications and/or warranties are specified, the information submitted for approval shall include certifications and warranties. Certifications involving inspections, and/or tests of material shall be complete with all test data, dates, and times.
7. After the Engineer reviews the submittals for conformance with the design concept of the project, the Engineer will stamp the drawings indicating their status as 'Approved', 'Approved-As-Noted', 'Disapproved', or 'Incomplete'. Since the Engineer's review is for conformance with the design concept only, it is the Contractor's responsibility to coordinate the various items into a working system as specified. The Contractor shall not be relieved from responsibility for errors or omissions in the shop, working, layout drawings, or other documents by the Department's approval thereof. The Contractor must still be in full compliance with contract and specification requirements.
8. All submitted items reviewed and marked 'APPROVED AS NOTED', 'DISAPPROVED', or 'INCOMPLETE' are to be resubmitted in their entirety, unless otherwise indicated within the submittal comments, with a disposition of previous comments to verify contract compliance at no additional cost to the contract.
9. Exceptions to and deviations from the requirements of the Contract Documents will not be allowed. It is the Contractor's responsibility to note any deviations from Contract requirements at the time of submittal and to make any requests for deviations in writing to the Engineer. In general, substitutions will not be acceptable. Requests for substitutions must demonstrate that the proposed substitution is superior to the material or equipment required by the Contract Documents. No exceptions, deviations or substitutions will be permitted without the approval of the Engineer.

INSPECTION OF ELECTRICAL SYSTEMS.

Add the following to Article 801.10 of the Standard Specifications:

(c) All cabinets including temporary traffic signal cabinets shall be assembled by an approved equipment supplier in District One. The Department reserves the right to request any controller and cabinet to be tested at the equipment supplier facilities prior to field installation, at no extra cost to this contract.

MAINTENANCE AND RESPONSIBILITY.

Revise Article 801.11 of the Standard Specifications to read:

- a. Existing traffic signal installations and/or any electrical facilities at all or various locations may be altered or reconstructed totally or partially as part of the work on this Contract. The Contractor is hereby advised that all traffic control equipment, presently installed at these locations, may be the property of the State of Illinois, Department of Transportation, Division of Highways, County, Private Developer, or the Municipality in which they are located. Once the Contractor has begun any work on any portion of the project, all traffic signals within the limits of this contract or those which have the item "Maintenance of Existing Traffic Signal Installation," "Temporary Traffic Signal Installation(s)" and/or "Maintenance of Existing Flashing Beacon Installation," shall become the full responsibility of the Contractor. Automatic Traffic Enforcement equipment is not owned by the State and the Contractor shall not be responsible for maintaining it during construction. The Contractor shall supply the Engineer, Area Traffic Signal Maintenance and Operations Engineer, IDOT ComCenter and the Department's Electrical Maintenance Contractor with two 24-hour emergency contact names and telephone numbers.
- b. When the project has a pay item for "Maintenance of Existing Traffic Signal Installation," "Temporary Traffic Signal Installation(s)" and/or "Maintenance of Existing Flashing Beacon Installation," the Contractor must notify both the Area Traffic Signal Maintenance and Operations Engineer at (847) 705-4424 and the Department's Electrical Maintenance Contractor, of their intent to begin any physical construction work on the Contract or any portion thereof. This notification must be made a minimum of seven (7) working days prior to the start of construction to allow sufficient time for inspection of the existing traffic signal installation(s) and transfer of maintenance to the Contractor. If work is started prior to an inspection, maintenance of the traffic signal installation(s) will be transferred to the Contractor without an inspection. The Contractor will become responsible for repairing or replacing all equipment that is not operating properly or is damaged at no cost to the owner of the traffic signal. Final repairs or replacement of damaged equipment must meet the approval of the Engineer prior to or at the time of final inspection otherwise the traffic signal installation will not be accepted.
- c. Contracts such as pavement grinding or patching which result in the destruction of traffic signal loops do not require maintenance transfer, but require a notification of intent to work and an inspection. A minimum of seven (7) working days prior to the loop removal, the Contractor shall notify the Area Traffic Signal Maintenance and Operations Engineer at (847) 705-4424 and the Department's Electrical Maintenance Contractor, at which time arrangements will be made to adjust the traffic controller timing to compensate for the absence of detection. Damaged Automatic Traffic Enforcement equipment, including cameras, detectors, or other peripheral equipment, shall be replaced by others, per Permit agreement, at no cost to the contract. See additional requirements in these specifications under Inductive Loop Detector.
- d. The Contractor is advised that the existing and/or temporary traffic signal installation must remain in operation during all construction stages, except for the most essential

down time. Any shutdown of the traffic signal installation, which exceeds fifteen (15) minutes, must have prior approval of the Engineer. Approval to shutdown the traffic signal installation will only be granted during the period extending from 10:00 a.m. to 3:00 p.m. on weekdays. Shutdowns shall not be allowed during inclement weather or holiday periods.

- e. The Contractor shall be fully responsible for the safe and efficient operation of the traffic signals. Any inquiry, complaint or request by the Department, the Department's Electrical Maintenance Contractor or the public, shall be investigated and repairs begun within one hour. Failure to provide this service will result in liquidated damages of \$500 per day per occurrence. In addition, the Department reserves the right to assign any work not completed within this timeframe to the Electrical Maintenance Contractor. All costs associated to repair this uncompleted work shall be the responsibility of the Contractor. Failure to pay these costs to the Electrical Maintenance Contractor within one month after the incident will result in additional liquidated damages of \$500 per month per occurrence. Unpaid bills will be deducted from the cost of the Contract. The District's Electrical Maintenance Contractor may inspect any signaling device on the Department's highway system at any time without notification.
- f. Any proposed activity in the vicinity of a highway-rail grade crossing must adhere to the guidelines set forth in the current edition of the Manual on Uniform Traffic Control Devices (MUTCD) regarding work in temporary traffic control zones in the vicinity of highway-rail grade crossings which states that lane restrictions, flagging, or other operations shall not create conditions where vehicles can be queued across the railroad tracks. If the queuing of vehicles across the tracks cannot be avoided, a uniformed law enforcement officer or flagger shall be provided at the crossing to prevent vehicles from stopping on the tracks, even if automatic warning devices are in place.

DAMAGE TO TRAFFIC SIGNAL SYSTEM.

Add the following to Article 801.12(b) of the Standard Specifications to read:

Any traffic signal control equipment damaged or not operating properly from any cause whatsoever shall be replaced with new equipment meeting current District One traffic signal specifications and provided by the Contractor at no additional cost to the Contract and/or owner of the traffic signal system, all as approved by the Engineer. Final replacement of damaged equipment must meet the approval of the Engineer prior to or at the time of final inspection otherwise the traffic signal installation will not be accepted. Cable splices outside the controller cabinet shall not be allowed.

Automatic Traffic Enforcement equipment, such as Red Light Enforcement cameras, detectors, and peripheral equipment, damaged or not operating properly from any cause whatsoever, shall be the responsibility of the municipality or the Automatic Traffic Enforcement company per Permit agreement.

TRAFFIC SIGNAL INSPECTION (TURN-ON).

Revise Article 801.15(b) of the Standard Specifications to read:

It is the intent to have all electric work completed and equipment field tested by the vendor prior to the Department's "turn-on" field inspection. If in the event the Engineer determines work is not complete and the inspection will require more than two (2) hours to complete, the inspection shall be canceled and the Contractor will be required to reschedule at another date. The maintenance of the traffic signals will not be accepted until all punch list work is corrected and re-inspected.

When the road is open to traffic, except as otherwise provided in Section 850 of the Standard Specifications, the Contractor may request a turn-on and inspection of the completed traffic signal installation at each separate location. This request must be made to the Area Traffic Signal Maintenance and Operations Engineer at (847) 705-4424 a minimum of seven (7) working days prior to the time of the requested inspection. The Department will not grant a field inspection until notification is provided from the Contractor that the equipment has been field tested and the intersection is operating according to Contract requirements. The Department's facsimile number is (847) 705-4089. The Contractor must invite local fire department personnel to the turn-on when Emergency Vehicle Preemption (EVP) is included in the project. When the contract includes the item RE-OPTIMIZE TRAFFIC SIGNAL SYSTEM, OPTIMIZE TRAFFIC SIGNAL SYSTEM, or TEMPORARY TRAFFIC SIGNAL TIMINGS, the Contractor must notify the SCAT Consultant of the turn-on/detour implementation schedule, as well as stage changes and phase changes during construction.

The Contractor must have all traffic signal work completed and the electrical service installation connected by the utility company prior to requesting an inspection and turn-on of the traffic signal installation. The Contractor shall be responsible to provide a police officer to direct traffic at the time of testing.

The Contractor shall provide a representative from the control equipment vendor's office to attend the traffic signal inspection for both permanent and temporary traffic signal turn-ons. Upon demonstration that the signals are operating and all work is completed in accordance with the Contract and to the satisfaction of the Engineer, the Engineer will then allow the signals to be placed in continuous operation. The Agency that is responsible for the maintenance of each traffic signal installation will assume the maintenance upon successful completion of this inspection.

The District requires the following from the Contractor at traffic signal turn-ons.

1. One set of signal plans of record with field revisions marked in red ink.
2. Written notification from the Contractor and the equipment vendor of satisfactory field testing.
3. A knowledgeable representative of the controller equipment supplier shall be required at the traffic signal turn-on. The representative shall be knowledgeable of the cabinet design and controller functions.
4. A copy of the approved material letter.
5. One (1) copy of the operation and service manuals of the signal controller and associated control equipment.
6. Five (5) copies 11" x 17" (280 mm X 430 mm) of the cabinet wiring diagrams.

7. The controller manufacturer shall supply a printed form, not to exceed 11" x 17" (280 mm X 430 mm) for recording the traffic signal controller's timings; backup timings; coordination splits, offsets, and cycles; TBC Time of Day, Week and Year Programs; Traffic Responsive Program, Detector Phase Assignment, Type and Detector Switching; and any other functions programmable from the keyboard. The form shall include a location, date, manufacturer's name, controller model and software version. The form shall be approved by the Engineer and a minimum of three (3) copies must be furnished at each turn-on. The manufacturer must provide all programming information used within the controller at the time of turn-on.
8. All manufacturer and contractor warranties and guarantees required by Article 801.14.

Acceptance of the traffic signal equipment by the Department shall be based upon inspection results at the traffic signal "turn on." If approved, traffic signal acceptance shall be verbal at the "turn on" inspection followed by written correspondence from the Engineer. The Contractor shall be responsible for all traffic signal equipment and associated maintenance thereof until Departmental acceptance is granted.

All equipment and/or parts to keep the traffic signal installation operating shall be furnished by the Contractor. No spare traffic signal equipment is available from the Department.

All punch list work shall be completed within two (2) weeks after the final inspection. The Contractor shall notify the Electrical Maintenance Contractor to inspect all punch list work. Failure to meet these time constraints shall result in liquidated damage charges of \$500 per month per incident.

All cost of work and materials required to comply with the above requirements shall be included in the pay item bid prices, under which the subject materials and signal equipment are paid, and no additional compensation will be allowed. Materials and signal equipment not complying with the above requirements shall be subject to removal and disposal at the Contractor's expense.

RECORD DRAWINGS

The requirements listed for Electrical Installation shall apply for Traffic Signal Installations in Article 801.16. Revise the 2nd paragraph of Article 801.16 of the Standard Specifications to read:

- a. "When the work is complete, and seven days before the request for a final inspection, the full-size set of contract drawings. Stamped "RECORD DRAWINGS", shall be submitted to the Engineer for review and approval and shall be stamped with the date and the signature of the Contractor's supervising Engineer or electrician. The record drawings shall be submitted in PDF format on CDROM as well as hardcopy for review and approval.
- b. In addition to the record drawings, copies of the final catalog cuts which have been Approved or Approved as Noted shall be submitted in PDF format along with the record drawings. The PDF files shall clearly indicate the pay item either by filename or PDF Table of Contents referencing the respective pay item

PEDESTRIAN COUNTDOWN SIGNAL INSTALLATION
DUPAGE COUNTY SECTION 12-PEDTS-00-SP
CONTRACT NUMBER 63718

number for multi-item PDF files. Specific part or model numbers of items which have been selected shall be clearly visible.”

- c. Additional requirements are listed in the District’s Electrical Product Data and Documentation Guidelines.

Add the following to Article 801.16 of the Standard Specifications:

“In addition to the specified record drawings, the Contactor shall record GPS coordinates of the following traffic signal components being installed, modified or being affected in other ways by this contract:

- All Mast Arm Poles and Posts
- Handholes
- Conduit roadway crossings
- Controller Cabinets
- Communication Cabinets
- Electric Service Disconnect locations
- CCTV Camera installations
- Fiber Optic Splice Locations

Datum to be used shall be North American 1983.

Data shall be provided electronically and in print form. The electronic format shall be compatible with MS Excel. Latitude and Longitude shall be in decimal degrees with a minimum of 6 decimal places. Each coordinate shall have the following information:

1. Description of item
2. Designation or approximate station if the item is undesignated
3. Latitude
4. Longitude

PEDESTRIAN COUNTDOWN SIGNAL INSTALLATION
 DUPAGE COUNTY SECTION 12-PEDTS-00-SP
 CONTRACT NUMBER 63718

Examples:

Description	Designation	Latitude	Longitude
Mast Arm Pole Assembly (dual, combo, etc)	MP (SW, NW, SE or NE corner)	41.580493	-87.793378
FO mainline splice handhole	HHL-ST31	41.558532	-87.792571
Handhole	HH	41.765532	-87.543571
Electric Service	Elec Srv	41.602248	-87.794053
Conduit crossing	SB IL83 to EB I290 ramp SIDE A	41.584593	-87.793378
PTZ Camera	PTZ	41.584600	-87.793432
Signal Post	Post	41.558532	-87.792571
Controller Cabinet	CC	41.651848	-87.762053
Master Controller Cabinet	MCC	41.580493	-87.793378
Communication Cabinet	ComC	41.558532	-87.789771
Fiber splice connection	Toll Plaza34	41.606928	-87.794053

Prior to the collection of data, the contractor shall provide a sample data collection of at least six data points of known locations to be reviewed and verified by the Engineer to be accurate within 100 feet. Upon verification, data collection can begin. Data collection can be made as construction progresses, or can be collected after all items are installed. If the data is unacceptable the contractor shall make corrections to the data collection equipment and or process and submit the data for review and approval as specified.

Accuracy. Data collected is to be mapping grade. A handheld mapping grade GPS device shall be used for the data collection. The receiver shall support differential correction and data shall have a minimum 5 meter accuracy after post processing.

GPS receivers integrated into cellular communication devices, recreational and automotive GPS devices are not acceptable.

The GPS shall be the product of an established major GPS manufacturer having been in the business for a minimum of 6 years.”

Delete the last sentence of the 3rd paragraph of Article 801.16.

LOCATING UNDERGROUND FACILITIES.

Revise Section 803 to the Standard Specifications to read:

If this Contract requires the services of an Electrical Contractor, the Contractor shall be responsible at his/her own expense for locating existing IDOT electrical facilities prior to performing any work. If this Contract does not require the services of an Electrical Contractor, the Contractor may request one free locate for existing IDOT electrical facilities from the District One Electrical Maintenance Contractor prior to the start of any work. Additional requests may be at the expense of the Contractor. The location of underground traffic facilities does not relieve the Contractor of their responsibility to repair any facilities damaged during construction at their expense.

The exact location of all utilities shall be field verified by the Contractor before the installation of any components of the traffic signal system. For locations of utilities, locally owned equipment, and leased enforcement camera system facilities, the local Counties or Municipalities may need to be contacted: in the City of Chicago contact Digger at (312) 744-7000 and for all other locations contact J.U.L.I.E. at 1-800-892-0123 or 811.

RESTORATION OF WORK AREA.

Add the following article to Section 801 of the Standard Specifications:

801.17 Restoration of work area. Restoration of the traffic signal work area shall be included in the related pay items such as foundation, conduit, handhole, trench and backfill, underground raceways, etc. All roadway surfaces such as shoulders, medians, sidewalks, pavement, etc. shall be replaced in kind. All damage to mowed lawns shall be replaced with an approved sod, and all damage to unmowed fields shall be seeded. All brick pavers disturbed in the work area shall be restored to their original configuration as directed by the Engineer. All damaged brick pavers shall be replaced with a comparable material approved by the Engineer. Restoration of the work area shall be included in the contract without any extra compensation allowed to the Contractor.

ELECTRIC SERVICE INSTALLATION.

Revise Section 805 of the Standard Specifications to read:

Description.

This work shall consist of all materials and labor required to install, modify, or extend the electric service installation. All installations shall meet the requirements of the details in the "District One Standard Traffic Signal Design Details" and applicable portions of the Specifications.

General.

The electric service installation shall be the electric service disconnecting means and it shall be identified as suitable for use as service equipment.

The electric utility contact information is noted on the plans and represents the current information at the time of contract preparation. The Contractor must request in writing for service and/or service modification within 10 days of contract award and must follow-up with the electric utility to assure all necessary documents and payment are received by the utility. The Contractor shall forward copies of all correspondence between the contractor and utility company to the Engineer and Area Traffic Signal Maintenance and Operations Engineer. The service agreement and sketch shall be submitted for signature to the IDOT's Traffic Operations Programs Engineer.

Materials.

- a. General. The completed control panel shall be constructed in accordance with UL Std. 508A, Industrial Control Panel, and carry the UL label. Wire terminations shall be UL listed.

PEDESTRIAN COUNTDOWN SIGNAL INSTALLATION
DUPAGE COUNTY SECTION 12-PEDTS-00-SP
CONTRACT NUMBER 63718

b. Enclosures.

1. Pole Mounted Cabinet. The cabinet shall be UL 50, NEMA Type 4X, unfinished single door design, fabricated from minimum 0.080-inch (2.03 mm) thick Type 5052 H-32 aluminum. Seams shall be continuous welded and ground smooth. Stainless steel screws and clamps shall secure the cover and assure a watertight seal. The cover shall be removable by pulling the continuous stainless steel hinge pin. The cabinet shall have an oil-resistant gasket and a lock kit shall be provided with an internal O-ring in the locking mechanism assuring a watertight and dust-tight seal. The cabinet shall be sized to adequately house all required components with extra space for arrangement and termination of wiring. A minimum size of 14-inches (350 mm) high, 9-inches (225 mm) wide and 8-inches (200 mm) in depth is required. The cabinet shall be channel mounted to a wooden utility pole using assemblies recommended by the manufacturer.
 2. Ground Mounted Cabinet. The cabinet shall be UL 50, NEMA Type 3R unfinished single door design with back panel. The cabinet shall be fabricated from Type 5052 H-32 aluminum with the frame and door 0.125-inch (3.175 mm) thick, the top 0.250-inch (6.350 mm) thick and the bottom 0.500-inch (12.70 mm) thick. Seams shall be continuous welded and ground smooth. The door and door opening shall be double flanged. The door shall be approximately 80% of the front surface, with a full length tamperproof stainless steel .075-inch (1.91 mm) thick hinge bolted to the cabinet with stainless steel carriage bolts and nylocks nuts. The locking mechanism shall be slam-latch type with a keyhole cover. The cabinet shall be sized to adequately house all required components with extra space for arrangement and termination of wiring. A minimum size of 40-inches (1000 mm) high, 16-inches (400 mm) wide and 15-inches (375 mm) in depth is required. The cabinet shall be mounted upon a square Type A concrete foundation as indicated on the plans. The foundation is paid for separately.
- c. Surge Protector. Overvoltage protection, with LED indicator, shall be provided for the 120 volt load circuit by the means MOV and thermal fusing technology. The response time shall be <math><5n</math> seconds and operate within a range of $-40C$ to $+85C$. The surge protector shall be UL 1449 Listed.
- d. Circuit Breakers. Circuit breakers shall be standard UL listed molded case, thermal-magnetic bolt-on type circuit breakers with trip free indicating handles. 120 volt circuit breakers shall have an interrupting rating of not less than 65,000 rms symmetrical amperes. Unless otherwise indicated, the main disconnect circuit breaker for the traffic signal controller shall be rated 60 amperes, 120 V and the auxiliary circuit breakers shall be rated 10 amperes, 120 V.
- e. Fuses, Fuseholders and Power Indicating Light. Fuses shall be small-dimensional cylindrical fuses of the dual element time-delay type. The fuses shall be rated for 600 V AC and shall have a UL listed interrupting rating of not less than 10,000 rms symmetrical amperes at rated voltage. The power indicating light shall be LED type with a green colored lens and shall be energized when electric utility power is present.

PEDESTRIAN COUNTDOWN SIGNAL INSTALLATION
DUPAGE COUNTY SECTION 12-PEDTS-00-SP
CONTRACT NUMBER 63718

- f. Ground and Neutral Bus Bars. A single copper ground and neutral bus bar, mounted on the equipment panel shall be provided. Ground and neutral conductors shall be separated on the bus bar. Compression lugs, plus 2 spare lugs, shall be sized to accommodate the cables with the heads of the connector screws painted green for ground connections and white for neutral connections.
- g. Utility Services Connection. The Contractor shall notify the Utility Company marketing representative a minimum of 30 working days prior to the anticipated date of hook-up. This 30 day advance notification will begin only after the Utility Company marketing representative has received service charge payments from the Contractor. Prior to contacting the Utility Company marketing representative for service connection, the service installation controller cabinet and cable must be installed for inspection by the Utility Company.
- h. Ground Rod. Ground rods shall be copper-clad steel, a minimum of 10 feet (3.0m) in length, and 3/4 inch (20mm) in diameter. Ground rod resistance measurements to ground shall be 25 ohms or less. If necessary additional rods shall be installed to meet resistance requirements at no additional cost to the contract.

Installation.

- a. General. The Contractor shall confirm the orientation of the traffic service installation and its door side with the engineer, prior to installation. All conduit entrances into the service installation shall be sealed with a pliable waterproof material.
- b. Pole Mounted. Brackets designed for pole mounting shall be used. All mounting hardware shall be stainless steel. Mounting height shall be as noted on the plans or as directed by the Engineer.
- c. Ground Mounted. The service installation shall be mounted plumb and level on the foundation and fastened to the anchor bolts with hot-dipped galvanized or stainless steel nuts and washers. The space between the bottom of the enclosure and the top of the foundation shall be caulked at the base with silicone.

Basis of Payment.

The service installation shall be paid for at the contract unit price each for SERVICE INSTALLATION of the type specified which shall be payment in full for furnishing and installing the service installation complete. The CONCRETE FOUNDATION, TYPE A, which includes the ground rod, shall be paid for separately. SERVICE INSTALLATION, POLE MOUNTED shall include the 3/4 inch (20mm) grounding conduit, ground rod, and pole mount assembly. Any charges by the utility companies shall be approved by the engineer and paid for as an addition to the contract according to Article 109.05 of the Standard Specifications.

GROUNDING OF TRAFFIC SIGNAL SYSTEMS.

Revise Section 806 of the Standard Specifications to read:

General.

All traffic signal systems, equipment and appurtenances shall be properly grounded in strict conformance with the NEC. See IDOT District One Traffic Signal detail plan sheets for additional information.

The grounding electrode system shall include a ground rod installed with each traffic signal controller concrete foundation and all mast arm and post concrete foundations. An additional ground rod will be required at locations where measured resistance exceeds 25 ohms. Ground rods are included in the applicable concrete foundation or service installation pay item and will not be paid for separately.

Testing shall be according to Article 801.13 (a) (4) and (5).

- (a) The grounded conductor (neutral conductor) shall be white color coded. This conductor shall be bonded to the equipment grounding conductor only at the Electric Service Installation. All power cables shall include one neutral conductor of the same size.
- (b) The equipment grounding conductor shall be green color coded. The following is in addition to Article 801.04 of the Standard Specifications.
 - 1. Equipment grounding conductors shall be bonded to the grounded conductor (neutral conductor) only at the Electric Service Installation. The equipment grounding conductor is paid for separately and shall be continuous. The Earth shall not be used as the equipment grounding conductor.
 - 2. Equipment grounding conductors shall be bonded, using a Listed grounding connector, to all traffic signal mast arm poles, traffic signal posts, pedestrian posts, pull boxes, handhole frames and covers, conduits, and other metallic enclosures throughout the traffic signal wiring system, except where noted herein. Bonding shall be made with a splice and pigtail connection, using a sized compression type copper sleeve, sealant tape, and heat-shrinkable cap. A Listed electrical joint compound shall be applied to all conductors' terminations, connector threads and contact points. Conduit grounding bushings shall be installed at all conduit terminations.
 - 3. All metallic and non-metallic raceways containing traffic signal circuit runs shall have a continuous equipment grounding conductor, except raceways containing only detector loop lead-in circuits, circuits under 50 volts and/or fiber optic cable will not be required to include an equipment grounding conductor.
 - 4. Individual conductor splices in handholes shall be soldered and sealed with heat shrink. When necessary to maintain effective equipment grounding, a full cable heat shrink shall be provided over individual conductor heat shrinks.
- (c) The grounding electrode conductor shall be similar to the equipment grounding conductor in color coding (green) and size. The grounding electrode conductor is used to connect the ground rod to the equipment grounding conductor and is bonded to ground rods via

exothermic welding, listed pressure connectors, listed clamps or other approved listed means.

GROUNDING EXISTING HANDHOLE FRAME AND COVER.

Description.

This work shall consist of all materials and labor required to bond the equipment grounding conductor to the existing handhole frame and handhole cover. All installations shall meet the requirements of the details in the "District One Standard Traffic Signal Design Details," and applicable portions of the Standard Specifications and these specifications.

The equipment grounding conductor shall be bonded to the handhole frame and to the handhole cover. Two (2) ½-inch diameter x 1 ¼-inch long hex-head stainless steel bolts, spaced 1.75-inches apart center-to-center shall be fully welded to the frame and to the cover to accommodate a heavy duty Listed grounding compression terminal (Burndy type YGHA or approved equal). The grounding compression terminal shall be secured to the bolts with stainless steel split-lock washers and nylon-insert locknuts.

Welding preparation for the stainless steel bolt hex-head to the frame and to the cover shall include thoroughly cleaning the contact and weldment area of all rust, dirt and contaminants. The Contractor shall assure a solid strong weld. The welds shall be smooth and thoroughly cleaned of flux and spatter. The grounding installation shall not affect the proper seating of the cover when closed.

The grounding cable shall be paid for separately.

Method of Measurement.

Units measured for payment will be counted on a per handhole basis, regardless of the type of handhole and its location.

Basis of Payment.

This work shall be paid for at the contract unit price each for GROUNDING EXISTING HANDHOLE FRAME AND COVER which shall be payment in full for grounding the handhole complete.

COILABLE NON-METALLIC CONDUIT.

Description.

This work shall consist of furnishing and installing empty coilable non-metallic conduit (CNC) for detector loop raceways.

General.

The CNC installation shall be in accordance with Sections 810 and 811 of the Standard Specifications except for the following:

Add the following to Article 810.03 of the Standard Specifications:

CNC meeting the requirements of NEC Article 353 shall be used for detector loop raceways to the handholes.

Add the following to Article 811.03 of the Standard Specifications:

On temporary traffic signal installations with detector loops, CNC meeting the requirements of NEC Article 353 shall be used for detector loop raceways from the saw-cut to 10 feet (3m) up the wood pole, unless otherwise shown on the plans

Basis of Payment.

All installations of CNC for loop detection shall be included in the contract and not paid for separately.

HANDHOLES.

Add the following to Section 814 of the Standard Specifications:

All handholes shall be concrete, poured in place, with inside dimensions of 21-1/2 inches (549mm) minimum. Frames and lid openings shall match this dimension. The cover of the handhole frame shall be labeled "Traffic Signals" with legible raised letters.

For grounding purposes the handhole frame shall have provisions for a 7/16 inch (15.875mm) diameter stainless bolt cast into the frame. The covers shall have a stainless steel threaded stint extended from the eye hook assembly for the purpose of attaching the grounding conductor to the handhole cover.

The minimum wall thickness for heavy duty hand holes shall be 12 inches (300mm).

All conduits shall enter the handhole at a depth of 30 inches (760mm) except for the conduits for detector loops when the handhole is less than 5 feet (1.52 m) from the detector loop. All conduit ends should be sealed with a waterproof sealant to prevent the entrance of contaminants into the handhole.

Steel cable hooks shall be coated with hot-dipped galvanization in accordance with AASHTO Specification M111. Hooks shall be a minimum of 1/2 inch (12.7 mm) diameter with two 90 degree bends and extend into the handhole at least 6 inches (150 mm). Hooks shall be placed a minimum of 12 inches (300 mm) below the lid or lower if additional space is required.

GROUNDING CABLE.

The cable shall meet the requirements of Section 817 of the "Standard Specifications," except for the following:

Add the following to Article 817.02 (b) of the Standard Specifications:

Unless otherwise noted on the Plans, traffic signal grounding conductor shall be one conductor, #6 gauge copper, with a green color coded XLP jacket.

The traffic signal grounding conductor shall be bonded, using a Listed grounding connector (Burdny type KC/K2C, as applicable, or approved equal), to all proposed and existing traffic

signal mast arm poles and traffic/pedestrian signal posts, including push button posts. The grounding conductor shall be bonded to all proposed and existing pull boxes, handhole frames and covers and other metallic enclosures throughout the traffic signal wiring system and noted herein and detailed on the plans. The grounding conductor shall be bonded to conduit terminations using rated grounding bushings. Bonding to existing handhole frames and covers shall be paid for separately.

Add the following to Article 817.05 of the Standard Specifications:

Basis of Payment.

Grounding cable shall be measured in place for payment in foot (meter). Payment shall be at the contract unit price for ELECTRIC CABLE IN CONDUIT, GROUNDING, NO. 6, 1C, which price includes all associated labor and material including grounding clamps, splicing, exothermic welds, grounding connectors, conduit grounding bushings, and other hardware.

RAILROAD INTERCONNECT CABLE.

The cable shall meet the requirements of Section 873 of the Standard Specifications, except for the following:

Add to Article 873.02 of the Standard Specifications:

The railroad interconnect cable shall be three conductor stranded #14 copper cable in a clear polyester binder, shielded with #36 AWG tinned copper braid with 85% coverage, and insulated with .016" polyethylene (black, blue, red). The jacket shall be black 0.045 PVC or polyethylene.

Add the following to Article 873.05 of the Standard Specifications:

Basis of Payment.

This work shall be paid for at the contract unit price per foot (meter) for ELECTRIC CABLE IN CONDUIT, RAILROAD, NO. 14 3C, which price shall be payment in full for furnishing, installing, and making all electrical connections in the traffic signal controller cabinet. Connections in the railroad controller cabinet shall be performed by railroad personnel.

FIBER OPTIC TRACER CABLE.

The cable shall meet the requirements of Section 817 of the "Standard Specifications," except for the following:

Add the following to Article 817.03 of the Standard Specifications:

In order to trace the fiber optic cable after installation, the tracer cable shall be installed in the same conduit as the fiber optic cable in locations shown on the plans. The tracer cable shall be continuous, extended into the controller cabinet and terminated on a barrier type terminal strip mounted on the side wall of the controller cabinet. The barrier type terminal strip and tracer cable shall be clearly marked and identified. All tracer cable splices shall be kept to a minimum and shall incorporate maximum lengths of cable supplied by the manufacturer. The tracer cable will be allowed to be spliced at handholes only. The tracer

cable splice shall use a Western Union Splice soldered with resin core flux and shall be soldered using a soldering iron. Blow torches or other devices which oxidize copper cable shall not be allowed for soldering operations. All exposed surfaces of the solder shall be smooth. The splice shall be covered with a black shrink tube meeting UL 224 guidelines, Type V and rated 600v, minimum length 4 inches (100 mm) and with a minimum 1 inch (25 mm) coverage over the XLP insulation, underwater grade.

Add the following to Article 817.05 of the Standard Specifications:

Basis of Payment.

The tracer cable shall be paid for separately as ELECTRIC CABLE IN CONDUIT, TRACER, NO. 14 1C per foot (meter), which price shall include all associated labor and material for installation.

MAINTENANCE OF EXISTING TRAFFIC SIGNAL INSTALLATION.

Revise Articles 850.02 and 850.03 of the Standard Specifications to read:

Procedure.

The energy charges for the operation of the traffic signal installation shall be paid for by others. Full maintenance responsibility shall start as soon as the Contractor begins any physical work on the Contract or any portion thereof.

The Contractor shall have electricians with IMSA Level II certification on staff to provide signal maintenance.

This item shall include maintenance of all traffic signal equipment at the intersection, including emergency vehicle pre-emption equipment, master controllers, uninterruptible power supply (UPS and batteries), telephone service installations, communication cables, conduits to adjacent intersections, and other traffic signal equipment, but shall not include Automatic Traffic Enforcement equipment, such as Red Light Enforcement cameras, detectors, or peripheral equipment, not owned by the State.

Maintenance.

The maintenance shall be according to MAINTENANCE AND RESPONSIBILITY in Division 800 of these specifications and the following:

The Contractor shall check all controllers every two (2) weeks, which will include visually inspecting all timing intervals, relays, detectors, and pre-emption equipment to ensure that they are functioning properly. This item includes, as routine maintenance, all portions of emergency vehicle pre-emption equipment. The Contractor shall maintain in stock at all times a sufficient amount of materials and equipment to provide effective temporary and permanent repairs.

The Contractor shall provide immediate corrective action when any part or parts of the system fail to function properly. Two far side heads facing each approach shall be considered the minimum acceptable signal operation pending permanent repairs. When repairs at a signalized intersection require that the controller be disconnected or otherwise removed from normal operation, and power is available, the Contractor shall place the traffic signal installation on flashing operation. The signals shall flash RED for all directions unless

a different indication has been specified by the Engineer. The Contractor shall be required to place stop signs (R1-1-36) at each approach of the intersection as a temporary means of regulating traffic. When the signals operate in flash, the Contractor shall furnish and equip all their vehicles assigned to the maintenance of traffic signal installations with a sufficient number of stop signs as specified herein. The Contractor shall maintain a sufficient number of spare stop signs in stock at all times to replace stop signs which may be damaged or stolen.

The Contractor shall provide the Engineer with a 24 hour telephone number for the maintenance of the traffic signal installation and for emergency calls by the Engineer.

Traffic signal equipment which is lost or not returned to the Department for any reason shall be replaced with new equipment meeting the requirements of the Standard Specifications and these special provisions.

The Contractor shall respond to all emergency calls from the Department or others within one hour after notification and provide immediate corrective action. When equipment has been damaged or becomes faulty beyond repair, the Contractor shall replace it with new and identical equipment. The cost of furnishing and installing the replaced equipment shall be borne by the Contractor at no additional charge to the contract. The Contractor may institute action to recover damages from a responsible third party. If at any time the Contractor fails to perform all work as specified herein to keep the traffic signal installation in proper operating condition or if the Engineer cannot contact the Contractor's designated personnel, the Engineer shall have the State's Electrical Maintenance Contractor perform the maintenance work required. The State's Electrical Maintenance Contractor shall bill the Contractor for the total cost of the work. The Contractor shall pay this bill within thirty (30) days of the date of receipt of the invoice or the cost of such work will be deducted from the amount due the Contractor. The Contractor shall allow the Electrical Maintenance Contractor to make reviews of the Existing Traffic Signal Installation that has been transferred to the Contractor for Maintenance.

TRAFFIC ACTUATED CONTROLLER.

Add the following to Article 857.02 of the Standard Specifications:

Controllers shall be NTCIP compliant NEMA TS2 Type 1, Econolite ASC/3S-1000 or Eagle/Siemens M50 unless specified otherwise on the plans or elsewhere on these specifications. Only controllers supplied by one of the District One approved closed loop equipment manufacturers will be allowed. The controller shall be the most recent model and software version supplied by the manufacturer at the time of the approval and include the standard data key. The traffic signal controller shall provide features to inhibit simultaneous display of a circular yellow ball and a yellow arrow display. Individual load switches shall be provided for each vehicle, pedestrian, and right turn over lap phase. The controller shall prevent phases from being skipped during program changes and after all preemption events.

Add the following to Article 857.03 of the Standard Specifications:

The Contractor shall arrange to install a standard voice-grade dial-up telephone line to the RAILROAD, FULL-ACTUATED CONTROLLER AND CABINET as called for on the traffic

signal installation plans. If the traffic signal installation is part of a traffic signal system, a telephone line is usually not required, unless a telephone line is called for on the traffic signal plans. The Contractor shall follow the requirements for the telephone service installation as contained in the current District One Traffic Signal Special Provisions under Master Controller.

MASTER CONTROLLER.

Revise Articles 860.02 - Materials and 860.03 - Installation of the Standard Specifications to read:

Only controllers supplied by one of the District approved closed loop equipment manufacturers will be allowed. Only NEMA TS 2 Type 1 Eagle/Siemens and Econolite closed loop systems shall be supplied. The latest model and software version of master controller shall be supplied.

Functional requirements in addition to those in Section 863 of the Standard Specifications include:

The system commands shall consist of, as a minimum, six (6) cycle lengths, five (5) offsets, three (3) splits, and four (4) special functions. The system commands shall also include commands for free or coordinated operation.

Traffic Responsive operation shall consist of the real time acquisition of system detector data, data validation, and the scaling of acquired volumes and occupancies in a deterministic fashion so as to cause the selection and implementation of the most suitable traffic plan.

Upon request by the Engineer, each master shall be delivered with up to three (3) complete sets of the latest edition of registered remote monitoring software with full manufacture's support. Each set shall consist of software on CD, DVD, or other suitable media approved by the Engineer, and a bound set of manuals containing loading and operating instruction. One copy of the software and support data shall be delivered to the Agency in charge of system operation, if other than IDOT. One of these two sets will be provided to the Agency Signal Maintenance Contractor for use in monitoring the system.

The approved manufacturer of equipment shall loan the District one master controller and two intersection controllers of the most recent models and the newest software version to be used for instructional purposes in addition to the equipment to be supplied for the Contract.

The Contractor shall arrange to install a standard voice-grade dial-up telephone line to the master controller. This shall be accomplished through the following process utilizing District One staff. This telephone line may be coupled with a DSL line and a phone filter to isolate the dial-up line. An E911 address is required.

The cabinet shall be provided with an Outdoor Network Interface for termination of the telephone service. It shall be mounted to the inside of the cabinet in a location suitable to provide access for termination of the telephone service at a later date.

PEDESTRIAN COUNTDOWN SIGNAL INSTALLATION
DUPAGE COUNTY SECTION 12-PEDTS-00-SP
CONTRACT NUMBER 63718

Full duplex communication between the master and its local controllers is recommended, but at this time not required. The data rate shall be 1200 baud minimum and shall be capable of speeds to 38,400 or above as technology allows. The controller, when installed in an Ethernet topology, may operate non-serial communications.

The cabinet shall be equipped with a 9600 baud, auto dial/auto answer modem. It shall be a US robotics 33.6K baud rate or equal.

As soon as practical or within one week after the contract has been awarded, the Contractor shall contact (via phone) the Administrative Support Manager in the District One Business Services Section at (847) 705-4011 to request a phone line installation.

A follow-up fax transmittal to the Administrative Support Manager (847-705-4712) with all required information pertaining to the phone installation is required from the Contractor as soon as possible or within one week after the initial request has been made. A copy of this fax transmittal must also be faxed by the Contractor to the Traffic Signal Systems Engineer at (847) 705-4089. The required information to be supplied on the fax shall include (but not limited to): A street address for the new traffic signal controller (or nearby address); a nearby existing telephone number; what type of telephone service is needed; the name and number of the Contractor's employee for the telephone company to contact regarding site work and questions.

The usual time frame for the activation of the phone line is 4-6 weeks after the Business Services Section has received the Contractor supplied fax. It is, therefore, imperative that the phone line conduit and pull-string be installed by the Contractor in anticipation of this time frame. On jobs which include roadway widening in which the conduit cannot be installed until this widening is completed, the Contractor will be allowed to delay the phone line installation request to the Business Services Section until a point in time that is 4-6 weeks prior to the anticipated completion of the traffic signal work. The contractor shall provide the Administrative Support Manager with an expected installation date considering the 4-6 week processing time.

The telephone line shall be installed and activated one month before the system final inspection.

All costs associated with the telephone line installation and activation (not including the Contract specified conduit installation between the point of telephone service and the traffic signal controller cabinet) shall be paid for by the District One Business Services Section (i.e., this will be an IDOT phone number not a Contractor phone number).

UNINTERRUPTABLE POWER SUPPLY.

Add the following to Article 862.01 of the Standard Specifications:

The UPS shall have the power capacity to provide normal operation of a signalized intersection that utilizes all LED type signal head optics, for a minimum of six hours.

Add the following to Article 862.02 of the Standard Specifications:

Materials shall be according to Article 1074.04 as modified in UNINTERRUPTIBLE POWER SUPPLY in Division 1000 of these specifications.

Add the following to Article 862.03 of the Standard Specifications:

The UPS shall additionally include, but not be limited to, a battery cabinet. The UPS shall provide reliable emergency power to the traffic signals in the event of a power failure or interruption.

Revise Article 862.04 of the Standard Specifications to read:

Installation.

When a UPS is installed at an existing traffic signal cabinet, the UPS cabinet shall partially rest on the lip of the existing controller cabinet foundation and be secured to the existing controller cabinet by means of at least four (4) stainless steel bolts. The UPS cabinet shall be completely enclosed with the bottom and back constructed of the same material as the cabinet.

When a UPS is installed at a new signal cabinet and foundation, it shall be mounted as shown on the plans.

At locations where UPS is installed and Emergency Vehicle Priority System is in use, any existing incandescent confirmation beacons shall be replaced with LED lamps in accordance with the District One Emergency Vehicle Priority System specification at no additional cost to the contract. A concrete apron 67 in. x 50 in. x 5 in. (1702mm x 1270mm x 130mm) shall be provided on the side of the existing Type D Foundation, where the UPS cabinet is located. The concrete apron shall follow the District 1 Standard Traffic Signal Design Detail, Type D for Ground Mounted Controller Cabinet and UPS Battery Cabinet. The concrete apron shall follow Articles 424 and 202 of the Standard Specifications.

This item shall include any required modifications to an existing traffic signal controller as a result of the addition of the UPS.

Revise Article 862.05 of the Standard Specifications to read:

Basis of Payment.

This work will be paid for at the contract unit price per each for UNINTERRUPTIBLE POWER SUPPLY SPECIAL. Replacement of Emergency Vehicle Priority System confirmation beacons and any required modifications to the traffic signal controller shall be included in the cost of the UNINTERRUPTIBLE POWER SUPPLY SPECIAL item. The concrete apron and earth excavation required shall be included in the cost of the UNINTERRUPTIBLE POWER SUPPLY SPECIAL item.

FIBER OPTIC CABLE.

Add the following to Article 871.01 of the Standard Specifications:

The Fiber Optic cable shall be installed in conduit or as specified on the plans.

Add the following to Article 872.02 of the Standard Specifications:

The control cabinet distribution enclosure shall be CSC FTWO12KST-W/O 12 Port Fiber Wall Enclosure or an approved equivalent. The fiber optic cable shall provide six fibers per tube for the amount of fibers called for in the Fiber Optic Cable pay item in the Contract. Fiber Optic cable may be gel filled or have an approved water blocking tape.

Add the following to Article 871.04 of the Standard Specifications:

A minimum of six multimode fibers from each cable shall be terminated with approved mechanical connectors at the distribution enclosure. Fibers not being used shall be labeled "spare." Fibers not attached to the distribution enclosure shall be capped and sealed. A minimum of 13.0 feet (4m) of extra cable length shall be provided for controller cabinets. The controller cabinet extra cable length shall be stored as directed by the Engineer.

Add the following to Article 871.06 of the Standard Specifications:

The distribution enclosure and all connectors will be included in the cost of the fiber optic cable.

MAST ARM ASSEMBLY AND POLE.

Revise Article 877.01 of the Standard Specifications to read:

Description.

This work shall consist of furnishing and installing a steel mast arm assembly and pole and a galvanized steel or extruded aluminum shroud for protection of the base plate:

Revise Article 877.03 of the Standard Specifications:

Mast arm assembly and pole shall be as follows.

(a) Steel Mast Arm Assembly and Pole and Steel Combination Mast Arm Assembly and Pole. The steel mast arm assembly and pole and steel combination mast arm assembly and pole shall consist of a traffic signal mast arm, a luminaire mast arm or davit (for combination pole only), a pole, and a base, together with anchor rods and other appurtenances. The configuration of the mast arm assembly, pole, and base shall be according to the details shown on the plans.

(1) Loading. The mast arm assembly and pole, and combination mast arm assembly and pole shall be designed for the loading shown on the Highway Standards or elsewhere on the plans, whichever is greater. The design shall be according to AASHTO "Standard Specification for Structural Supports for Highway Signs, Luminaries and Traffic Signals" 1994 Edition for 80 mph (130 km/hr) wind velocity. However, the arm-to-pole connection for tapered signal and luminaire arms shall be according to the "ring plate" detail as shown in Figure 11-1(f) of the 2002 Interim, to the AASHTO "Standard Specification for Structural Supports for Highway Signs, Luminaries and Traffic Signals" 2001 4th Edition.

(2) Structural Steel Grade. The mast arm and pole shall be fabricated according to ASTM A 595, Grade A or B, ASTM A 572 Grade 55, or ASTM A 1011 Grade 55

HSLAS Class 2. The base and flange plates shall be of structural steel according to AASHTO M 270 Grade 50 (M 270M Grade 345). Luminaire arms and trussed arms 15 ft (4.5 m) or less shall be fabricated from one steel pipe or tube size according to ASTM A 53 Grade B or ASTM A 500 Grade B or C. All mast arm assemblies, poles, and bases shall be galvanized according to AASHTO M 111.

- (3) Fabrication. The design and fabrication of the mast arm assembly, pole, and base shall be according to the requirements of the Standard Specifications for Structural Supports for Highway Signs, Luminaires, and Traffic Signals published by AASHTO. The mast arm and pole may be of single length or sectional design. If section design is used, the overlap shall be at least 150 percent of the maximum diameter of the overlapping section and shall be assembled in the factory.

The manufacturer will be allowed to slot the base plate in which other bolt circles may fit, providing that these slots do not offset the integrity of the pole. Circumferential welds of tapered arms and poles to base plates shall be full penetration welds.

(4) Shop Drawing Approval. The Contractor shall submit detailed drawings showing design materials, thickness of sections, weld sizes, and anchor rods to the Engineer for approval prior to fabrication. These drawings shall be at least 11 x 17 in. (275 x 425 mm) in size and of adequate quality for microfilming. All product data and shop drawings shall be submitted in electronic form on CD-ROM

(b) Anchor Rods. The anchor rods shall be ASTM F 1554 Grade 105, coated by the hot-dip galvanizing process according to AASHTO M 232, and shall be threaded a minimum of 7 1/2 in. (185 mm) at one end and have a bend at the other end. The first 12 in. (300 mm) at the threaded end shall be galvanized. Two nuts, one lock washer, and one flat washer shall be furnished with each anchor rod. All nuts and washers shall be galvanized.

(c) The galvanized steel or extruded aluminum shroud shall have dimensions similar to those detailed in the "District One Standard Traffic Signal Design Details." The shroud shall be installed such that it allow air to circulate throughout the mast arm but not allow infestation of insects or other animals, and such that it is not hazardous to probing fingers and feet.

Add the following to Article 877.04 of the Standard Specifications:

The shroud shall not be paid for separately but shall be included in the cost of the mast arm assembly and pole.

CONCRETE FOUNDATIONS.

Add the following to Article 878.03 of the Standard Specifications:

All anchor bolts shall be according to Article 1006.09, with all anchor bolts hot dipped galvanized a minimum of 12 in. (300 mm) from the threaded end.

Concrete Foundations, Type "A" for Traffic Signal Posts shall provide anchor bolts with the bolt pattern specified within the "District One Standard Traffic Signal Design Details." All Type "A" foundations shall be a minimum depth of 48 inches (1220 mm).

Concrete Foundations, Type "C" for Traffic Signal Cabinets with Uninterruptible Power Supply (UPS) cabinet installations shall be a minimum of 72 inches (1830 mm) long and 31 inches (790 mm) wide. All Type "C" foundations shall be a minimum depth of 48 inches (1220 mm). The concrete apron in front of the Type IV or V cabinet shall be 36 in. x 48 in. x 5 in. (915 mm X 1220 mm X 130 mm). The concrete apron in front of the UPS cabinet shall be 36 in. x 67 in. x 5 in. (915 mm X 1700 mm X 130 mm). Anchor bolts shall provide bolt spacing as required by the manufacturer.

Concrete Foundations, Type "D" for Traffic Signal Cabinets shall be a minimum of 48 inches (1220 mm) long and 31 inches (790 mm) wide. All Type "D" foundations shall be a minimum depth of 48 inches (1220 mm). The concrete apron shall be 36 in. x 48 in. x 5 in. (910 mm X 1220 mm X 130 mm). Anchor bolts shall provide bolt spacing as required by the manufacturer.

Concrete Foundations, Type "E" for Mast Arm and Combination Mast Arm Poles shall meet the current requirements listed in the Highway Standards.

Foundations used for Combination Mast Arm Poles shall provide an extra 2-1/2 inch (65 mm) raceway.

No foundation is to be poured until the Resident Engineer gives his/her approval as to the depth of the foundation.

LIGHT EMITTING DIODE (LED), SIGNAL HEAD AND OPTICALLY PROGRAMMED LED SIGNAL HEAD.

Add the following to the first paragraph of Article 880.04 of the Standard Specifications:

Basis of Payment.

The price shall include furnishing the equipment described above, all mounting hardware and installing them in satisfactory operating condition.

LIGHT EMITTING DIODE (LED), SIGNAL HEAD, RETROFIT

Description.

This work shall consist of retrofitting an existing polycarbonate traffic signal head with a traffic signal module, pedestrian signal module, and pedestrian countdown signal module, with light emitting diodes (LEDs) as specified in the plans.

Materials.

Materials shall be according to LIGHT EMITTING DIODE (LED) AND OPTICALLY PROGRAMMED LED SIGNAL HEAD, AND LIGHT EMITTING DIODE (LED) PEDESTRIAN SIGNAL HEAD in Divisions 880, 881 and 1000 of these specifications.

Add the following to Article 880.04 of the Standard Specifications:

Basis of Payment.

This item shall be paid for at the contract unit price each for SIGNAL HEAD, LED, RETROFIT, or PEDESTRIAN SIGNAL HEAD, LED, RETROFIT, for the type and number of polycarbonate signal heads, faces, and sections specified, which price shall be payment in full for furnishing the equipment described above including LED modules, all mounting hardware, and installing them in satisfactory operating condition. The type specified will indicate the number of faces and the method of mounting.

LIGHT EMITTING DIODE (LED) PEDESTRIAN SIGNAL HEAD

Add the following to the third paragraph of Article 881.03 of the Standard Specifications:

No mixing of different types of pedestrian traffic signals or displays will be permitted.

Add the following to Article 881.03 of the Standard Specifications:

(a) Pedestrian Countdown Signal Heads.

(1) Pedestrian Countdown Signal Heads shall not be installed at signalized intersections where traffic signals and railroad warning devices are interconnected.

(2) Pedestrian Countdown Signal Heads shall be 16 inch (406mm) x 18 inch (457mm), for single units with the housings glossy black polycarbonate. Connecting hardware and mounting brackets shall be polycarbonate (black). A corrosion resistant anti-seize lubricant shall be applied to all metallic mounting bracket joints, and shall be visible to the inspector at the signal turn-on.

(3) Each pedestrian signal LED module shall be fully MUTCD compliant and shall consist of double overlay message combining full LED symbols of an Upraised Hand and a Walking Person. "Egg Crate" type sun shields are not permitted. Numerals shall measure 9 inches (229mm) in height and easily identified from a distance of 120 feet (36.6m).

Add the following to Article 881.04 of the Standard Specifications:

Basis of Payment.

The price shall include furnishing the equipment described above, all mounting hardware and installing them in satisfactory operating condition.

DETECTOR LOOP.

Revise Section 886 of the Standard Specifications to read:

Description.

This work shall consist of furnishing and installing a detector loop in the pavement.

Procedure.

A minimum of seven (7) working days prior to the Contractor cutting loops, the Contractor shall have the proposed loop locations marked and contact the Area Traffic Signal Maintenance and Operations Engineer (847) 705-4424 to inspect and approve the layout. When preformed detector loops are installed, the Contractor shall have them inspected and approved prior to the pouring of the Portland cement concrete surface, using the same notification process as above.

Installation.

Loop detectors shall be installed according to the requirements of the "District One Standard Traffic Signal Design Details." Saw-cuts (homeruns on preformed detector loops) from the loop to the edge of pavement shall be made perpendicular to the edge of pavement when possible in order to minimize the length of the saw-cut (homerun on preformed detector loops) unless directed otherwise by the Engineer or as shown on the plan.

The detector loop cable insulation shall be labeled with the cable specifications.

Each loop detector lead-in wire shall be labeled in the handhole using a Panduit PLFIM water proof tag, or an approved equal, secured to each wire with nylon ties.

Resistance to ground shall be a minimum of 100 mega-ohms under any conditions of weather or moisture. Inductance shall be more than 50 and less than 700 microhenries. Quality readings shall be more than 5.

- (a) Type I. All loops installed in new asphalt pavement shall be installed in the binder course and not in the surface course. The edge of pavement, curb and handhole shall be cut with a 1/4 inch (6.3 mm) deep x 4 inches (100 mm) saw cut to mark location of each loop lead-in.
- (b) Loop sealant shall be a two-component thixotropic chemically cured polyurethane either Chemque Q-Seal 295, Percol Elastic Cement AC Grade or an approved equal. The sealant shall be installed 1/8 inch (3 mm) below the pavement surface, if installed above the surface the overlap shall be removed immediately.
- (c) Detector loop measurements shall include the saw cut and the length of the loop lead-in to the edge of pavement. The lead-in wire, including all necessary connections for proper operations, from the edge of pavement to the handhole, shall be included in the price of the detector loop. Unit duct, trench and backfill, and drilling of pavement or handholes shall be included in detector loop quantities.
- (d) Preformed. This work shall consist of furnishing and installing a rubberized or crosslinked polyethylene heat resistant preformed traffic signal loop in accordance with the Standard Specifications, except for the following:
- (e) Preformed detector loops shall be installed in new pavement constructed of Portland cement concrete using mounting chairs or tied to re-bar or the preformed detector loops may be placed in the sub-base. Loop lead-ins shall be extended to a temporary protective enclosure near the proposed handhole location. The protective enclosure shall provide sufficient protection from other construction activities and may be buried for additional protection.

- (f) Handholes shall be placed next to the shoulder or back of curb when preformed detector loops enter the handhole. Non-metallic coilable duct, included in this pay item, shall be used to protect the preformed lead-ins from back of curb to the handhole.
- (g) Preformed detector loops shall be factory assembled with ends capped and sealed against moisture and other contaminants. Homeruns and interconnects shall be pre-wired and shall be an integral part of the loop assembly. The loop configurations and homerun lengths shall be assembled for the specific application. The loop and homerun shall be constructed using 11/16 inch (17.2 mm) outside diameter (minimum), 3/8 inch (9.5 mm) inside diameter (minimum) Class A oil resistant synthetic cord reinforced hydraulic hose with 250 psi (1,720 kPa) internal pressure rating or a similarly sized XLPE cable jacket. Hose for the loop and homerun assembly shall be one continuous piece. No joints or splices shall be allowed in the hose except where necessary to connect homeruns or interconnects to the loops. This will provide maximum wire protection and loop system strength. Hose tee connections shall be heavy duty high temperature synthetic rubber. The tee shall be of proper size to attach directly to the hose, minimizing glue joints. The tee shall have the same flexible properties as the hose to insure that the whole assembly can conform to pavement movement and shifting without cracking or breaking. For XLPE jacketed preformed loops, all splice connections shall be soldered, sealed, and tested before being sealed in a high impact glass impregnated plastic splice enclosure. The wire used shall be #16 THWN stranded copper. The number of turns in the loop shall be application specific. Homerun wire pairs shall be twisted a minimum of four turns per foot. No wire splices will be allowed in the preformed loop assembly. The loop and homeruns shall be filled and sealed with a flexible sealant to insure complete moisture blockage and further protect the wire. The preformed loops shall be constructed to allow a minimum of 6.5 feet of extra cable in the handhole.

Method of Measurement.

This work will be measured for payment in feet (meters) in place. Type I detector loop will be measured along the sawed slot in the pavement containing the loop and lead-in, rather than the actual length of the wire. Preformed detector loops will be measured along the detector loop and lead-in embedded in the pavement, rather than the actual length of the wire.

Basis of Payment.

This work shall be paid for at the contract unit price per foot (meter) for DETECTOR LOOP, TYPE I or PREFORMED DETECTOR LOOP as specified in the plans, which price shall be payment in full for furnishing and installing the detector loop and all related connections for proper operation.

EMERGENCY VEHICLE PRIORITY SYSTEM.

Revise Section 887 of the Standard Specifications to read:

It shall be the Contractor's responsibility to contact the municipality or fire district to verify the brand of emergency vehicle pre-emption equipment to be installed prior to the contract bidding. The equipment must be completely compatible with all components of the equipment currently in use by the Agency.

All new installations shall be equipped with Confirmation Beacons as shown on the "District One Standard Traffic Signal Design Details." The Confirmation Beacon shall consist of a 6 watt Par 38 LED flood lamp with a 30 degree light spread, maximum 6 watt energy consumption at 120V, and a 2,000 hour warranty for each direction of pre-emption. The lamp shall have an adjustable mount with a weatherproof enclosure for cable splicing. All hardware shall be cast aluminum or stainless steel. Holes drilled into signal poles, mast arms, or posts shall require rubber grommets. In order to maintain uniformity between communities, the confirmation beacons shall indicate when the control equipment receives the pre-emption signal. The pre-emption movement shall be signalized by a flashing indication at the rate specified by Section 4L.01 of the "Manual on Uniform Traffic Control Devices," and other applicable sections of future editions. The stopped pre-empted movements shall be signalized by a continuous indication.

All light operated systems shall include security and transit preemption software and operate at a uniform rate of 14.035 Hz \pm 0.002, or as otherwise required by the Engineer, and provide compatible operation with other light systems currently being operated in the District.

This item shall include any required modifications to an existing traffic signal controller as a result of the addition of the EMERGENCY VEHICLE PRIORITY SYSTEM.

Basis of Payment.

The work shall be paid for at the contract unit price each for furnishing and installing LIGHT DETECTOR and LIGHT DETECTOR AMPLIFIER. Furnishing and installing the confirmation beacon shall be included in the cost of the Light Detector. Any required modifications to the traffic signal controller shall be included in the cost of the LIGHT DETECTOR AMPLIFIER. The preemption detector amplifier shall be paid for on a basis of (1) one each per intersection controller and shall provide operation for all movements required in the pre-emption phase sequence.

TEMPORARY TRAFFIC SIGNAL INSTALLATION.

Revise Section 890 of the Standard Specifications to read:

Description.

This work shall consist of furnishing, installing, maintaining, and removing a temporary traffic signal installation as shown on the plans, including but not limited to temporary signal heads, emergency vehicle priority systems, interconnect, vehicle detectors, uninterruptible power supply, and signing. Temporary traffic signal controllers and cabinets interconnected to railroad traffic control devices shall be new. When temporary traffic signals will be operating within a county or local agency Traffic Management System, the equipment must be NTCIP compliant and compatible with the current operating requirements of the Traffic Management System.

General.

Only an approved equipment vendor will be allowed to assemble the temporary traffic signal cabinet. Also, an approved equipment vendor shall assemble and test a temporary railroad traffic signal cabinet. (Refer to the "Inspection of Controller and Cabinet" specification). A representative of the approved control equipment vendor shall be present at the temporary traffic signal turn-on inspection.

Construction Requirements.

(a) Controllers.

1. Only controllers supplied by one of the District approved closed loop equipment manufacturers will be approved for use at temporary signal locations. All controllers used for temporary traffic signals shall be fully actuated NEMA microprocessor based with RS232 data entry ports compatible with existing monitoring software approved by IDOT District 1, installed in NEMA TS2 cabinets with 8 phase back panels, capable of supplying 255 seconds of cycle length and individual phase length settings up to 99 seconds. On projects with one lane open and two way traffic flow, such as bridge deck repairs, the temporary signal controller shall be capable of providing an adjustable all red clearance setting of up to 30 seconds in length. All controllers used for temporary traffic signals shall meet or exceed the requirements of Section 857 of the Standard Specifications with regards to internal time base coordination and preemption. All railroad interconnected temporary controllers and cabinets shall be new and shall satisfy the requirements of Article 857.02 of the Standard Specifications as modified herein.

2. Only control equipment, including controller cabinet and peripheral equipment, supplied by one of the District approved closed loop equipment manufacturers will be approved for use at temporary traffic signal locations. All control equipment for the temporary traffic signal(s) shall be furnished by the Contractor unless otherwise stated in the plans. On projects with multiple temporary traffic signal installations, all controllers shall be the same manufacturer brand and model number with current software installed.

(b) Cabinets. All temporary traffic signal cabinets shall have a closed bottom made of aluminum alloy. The bottom shall be sealed along the entire perimeter of the cabinet base to ensure a water, dust and insect-proof seal. The bottom shall provide a minimum of two (2) 4 inch (100 mm) diameter holes to run the electric cables through. The 4 inch (100 mm) diameter holes shall have a bushing installed to protect the electric cables and shall be sealed after the electric cables are installed.

(c) Grounding. Grounding shall be provided for the temporary traffic signal cabinet meeting or exceeding the applicable portions of the National Electrical Code, Section 806 of the Standard Specifications and shall meet the requirements of the District 1 Traffic Signal Specifications for "Grounding of Traffic Signal Systems."

(d) Traffic Signal Heads. All traffic signal sections and pedestrian signal sections shall be 12 inches (300 mm). Traffic signal sections shall be LED with expandable view, unless otherwise approved by the Engineer. Pedestrian signal heads shall be Light Emitting Diode (LED) Pedestrian Countdown Signal Heads except when a temporary traffic signal is installed at an intersection interconnected with a railroad grade crossing. When a temporary traffic signal is installed at an intersection interconnected with a railroad grade crossing, Light Emitting Diode (LED) Pedestrian Signal Heads shall be furnished. The temporary traffic signal heads shall be placed as indicated on the temporary traffic signal plan or as directed by the Engineer. The Contractor shall furnish enough extra cable length to relocate heads to any position on the span wire or at locations illustrated on the plans for construction staging. The temporary traffic signal shall remain in operation during all signal head relocations. Each temporary traffic signal head shall have its own cable from the controller cabinet to the signal head.

(e) Interconnect.

1. Temporary traffic signal interconnect shall be provided using fiber optic cable or wireless interconnect technology as specified in the plans. The Contractor may request, in writing, to substitute the fiber optic temporary interconnect indicated in the contract documents with a wireless interconnect. The Contractor must provide assurances that the radio device will operate properly at all times and during all construction staging. If approved for use by the Engineer, the Contractor shall submit marked-up traffic signal plans indicating locations of radios and antennas and installation details. If wireless interconnect is used, and in the opinion of the engineer, it is not viable, or if it fails during testing or operations, the Contractor shall be responsible for installing all necessary poles, fiber optic cable, and other infrastructure for providing temporary fiber optic interconnect at no cost to the contract.

2. The existing system interconnect and phone lines are to be maintained as part of the Temporary Traffic Signal Installation specified for on the plan. The interconnect shall be installed into the temporary controller cabinet as per the notes or details on the plans. All labor and equipment required to install and maintain the existing interconnect as part of the Temporary Traffic Signal Installation shall be included in the item Temporary Traffic Signal Installation. When shown in the plans, temporary traffic signal interconnect equipment shall be furnished and installed. The temporary traffic signal interconnect shall maintain interconnect communications throughout the entire signal system for the duration of the project.

3. Temporary wireless interconnect, complete. The radio interconnect system shall be compatible with Eagle or Econolite controller closed loop systems. This item shall include all temporary wireless interconnect components, complete, at the adjacent existing traffic signal(s) to provide a completely operational closed loop system. This item shall include all materials, labor and testing to provide the completely operational closed loop system as shown on the plans. The radio interconnect system shall include the following components:

- a. Rack or Shelf Mounted RS-232 Frequency Hopping Spread Spectrum (FHSS) Radio
- b. Software for Radio Configuration (Configure Frequency and Hopping Patterns)
- c. Antennas (Omni Directional or Yagi Directional)
- d. Antenna Cables, LMR400, Low Loss. Max. 100-ft from controller cabinet to antenna
- e. Brackets, Mounting Hardware, and Accessories Required for Installation
- f. RS232 Data Cable for Connection from the radio to the local or master controller
- g. All other components required for a fully functional radio interconnect system

All controller cabinet modifications and other modifications to existing equipment that are required for the installation of the radio interconnect system components shall be included in this item.

The radio interconnect system may operate at 900Mhz (902-928) or 2.4 Ghz depending on the results of a site survey. The telemetry shall have an acceptable rate of transmission errors, time outs, etc. comparable to that of a hardwire system.

The proposed master controller and telemetry module shall be configured for use with the radio interconnect at a minimum rate of 9600 baud.

The radio interconnect system shall include all other components required for a complete and fully functional telemetry system and shall be installed in accordance to the manufacturers recommendations.

The following radio equipment is currently approved for use in Region One/District One: Encom Model 5100 and Intuicom Communicator II.

(f) Emergency Vehicle Pre-Emption. All emergency vehicle preemption equipment (light detectors, light detector amplifiers, confirmation beacons, etc.) as shown on the temporary traffic signal plans shall be provided by the Contractor. It shall be the Contractor's responsibility to contact the municipality or fire district to verify the brand of emergency vehicle preemption equipment to be installed prior to the contract bidding. The equipment must be completely compatible with all components of the equipment currently in use by the Agency. All light operated systems shall operate at a uniform rate of 14.035 hz \pm 0.002, or as otherwise required by the Engineer, and provide compatible operation with other light systems currently being operated in the District. All labor and material required to install and maintain the Emergency Vehicle Preemption installation shall be included in the item Temporary Traffic Signal Installation.

(g) Vehicle Detection. All temporary traffic signal installations shall have vehicular detection installed as shown on the plans or as directed by the Engineer. Pedestrian push buttons shall be provided for all pedestrian signal heads/phases as shown on the plans or as directed by the Engineer. All approaches shall have vehicular detection provided by vehicle detection system as shown on the plans or as directed by the Engineer. Microwave vehicle sensors or video vehicle detection system shall be approved by IDOT prior to Contractor furnishing and installing. The Contractor shall install, wire, and adjust the alignment of the microwave vehicle sensor or video vehicle detection system in accordance to the manufacturer's recommendations and requirements. The Contractor shall be responsible for adjusting the alignment of the microwave vehicle sensor or video vehicle detection system for all construction staging changes and for maintaining proper alignment throughout the project. A representative of the approved control equipment vendor shall be present and assist the contractor in setting up and maintaining the microwave vehicle sensor or video vehicle detection system. An in-cabinet video monitor shall be provided with all video vehicle detection systems and shall be included in the item Temporary Traffic Signal Installation.

(h) Uninterruptible Power Supply. All temporary traffic signal installations shall have Uninterruptible Power Supply (UPS). The UPS cabinet shall be mounted to the temporary traffic signal cabinet and meet the requirements of Uninterruptible Power Supply in Divisions 800 and 1000 of these specifications.

(i) Signs. All existing street name and intersection regulatory signs shall be removed from existing poles and relocated to the temporary signal span wire. If new mast arm assembly and pole(s) and posts are specified for the permanent signals, the signs shall be relocated to the new equipment at no extra cost. Any intersection regulatory signs that are required for the temporary traffic signal shall be provided as shown on the plans or as directed by the Engineer. Relocation, removing, bagging and installing the regulatory signs for the various construction stages shall be provided as shown on the plans or as directed by the Engineer.

(j) Energy Charges. The electrical utility energy charges for the operation of the temporary traffic signal installation shall be paid for by others if the installation replaces an existing signal. Otherwise charges shall be paid for under 109.05 of the Standard Specifications.

(k) Maintenance. Maintenance shall meet the requirements of the Standard Specifications and MAINTENANCE OF EXISTING TRAFFIC SIGNAL INSTALLATION in Division 800 of these specifications. Maintenance of temporary signals and of the existing signals shall be included in the cost of the TEMPORARY TRAFFIC SIGNAL INSTALLATION pay item. When temporary traffic signals are to be installed at locations where existing signals are presently operating, the Contractor shall be fully responsible for the maintenance of the existing signal installation as soon as he begins any physical work on the Contract or any portion thereof. In addition, a minimum of seven (7) days prior to assuming maintenance of the existing traffic signal installation(s) under this Contract, the Contractor shall request that the Resident Engineer contact the Bureau of Traffic Operations (847) 705-4424 for an inspection of the installation(s).

(l) Temporary Traffic Signals for Bridge Projects. Temporary Traffic Signals for bridge projects shall follow the State Standards, Standard Specifications, District One Traffic Signal Specifications and any plans for Bridge Temporary Traffic Signals included in the plans. The installation shall meet the Standard Specifications and all other requirements in this TEMPORARY TRAFFIC SIGNAL INSTALLATION specification. In addition all electric cable shall be aurally suspended, at a minimum height of 18 feet (5.5m) on temporary wood poles (Class 5 or better) of 45 feet (13.7 m) minimum height. The signal heads shall be span wire mounted or bracket mounted to the wood pole or as directed by the Engineer. The Controller cabinet shall be mounted to the wood pole as shown in the plans, or as directed by the Engineer. Microwave vehicle sensors or video vehicle detection system may be used in place of detector loops as approved by the Engineer.

(m) Temporary Portable Traffic Signal for Bridge Projects.

1. Unless otherwise directed by the Engineer, temporary portable traffic signals shall be restricted to use on roadways of less than 8000 ADT that have limited access to electric utility service, shall not be installed on projects where the estimated need exceeds ten (10) weeks, and shall not be in operation during the period of November through March. The Contractor shall replace the temporary portable traffic signals with temporary span wire traffic signals noted herein at no cost to the contract if the bridge project or Engineer requires temporary traffic signals to remain in operation into any part of period of November through March. If, in the opinion of the engineer, the reliability and safety of the temporary portable traffic signal is not similar to that of a temporary span wire traffic signal installation, the Contractor shall replace the temporary portable traffic signals with temporary span wire traffic signals noted herein at no cost to the contract.

2. The controller and LED signal displays shall meet the Standard Specifications and all other requirements in this TEMPORARY TRAFFIC SIGNAL INSTALLATION specification.

3. Work shall be according to Article 701.18(b) of the Standard Specifications except as noted herein.

4. General.

PEDESTRIAN COUNTDOWN SIGNAL INSTALLATION
DUPAGE COUNTY SECTION 12-PEDTS-00-SP
CONTRACT NUMBER 63718

- a. The temporary portable bridge traffic signals shall be trailer-mounted units. The trailer-mounted units shall be set up securely and level. Each unit shall be self-contained and consist of two signal heads. The left signal head shall be mounted on a mast arm capable of extending over the travel lane. Each unit shall contain a solar cell system to facilitate battery charging. There shall be a minimum of 12 days backup reserve battery supply and the units shall be capable of operating with a 120 V power supply from a generator or electrical service.
- b. All signal heads located over the travel lane shall be mounted at a minimum height of 17 feet (5m) from the bottom of the signal back plate to the top of the road surface. All far right signal heads located outside the travel lane shall be mounted at a minimum height of 8 feet (2.5m) from the bottom of the signal back plate to the top of the adjacent travel lane surface.
- c. The long all red intervals for the traffic signal controller shall be adjustable up to 250 seconds in one-second increments.
- d. As an alternative to detector loops, temporary portable bridge traffic signals may be equipped with microwave sensors or other approved methods of vehicle detection and traffic actuation.
- e. All portable traffic signal units shall be interconnected using hardwire communication cable. Radio communication equipment may be used only with the approval of the Engineer. If radio communication is used, a site analysis shall be completed to ensure that there is no interference present that would affect the traffic signal operation. The radio equipment shall meet all applicable FCC requirements.
- f. The temporary portable bridge traffic signal system shall meet the physical display and operational requirements of conventional traffic signals as specified in Part IV and other applicable portions of the currently adopted version of the Manual on Uniform Traffic Control Devices (MUTCD) and the Illinois MUTCD. The signal system shall be designed to continuously operate over an ambient temperature range between -30 °F (-34 °C) and 120 °F (48 °C). When not being utilized to inform and direct traffic, portable signals shall be treated as nonoperating equipment according to Article 701.11.
- g. Basis of Payment. This work will be paid for according to Article 701.20(c).

Basis of Payment.

This work shall be paid for at the contract unit price each for TEMPORARY TRAFFIC SIGNAL INSTALLATION, TEMPORARY BRIDGE TRAFFIC SIGNAL INSTALLATION, or TEMPORARY PORTABLE BRIDGE TRAFFIC SIGNAL INSTALLATION, the price of which shall include all costs for the modifications required for traffic staging, changes in signal phasing as required in the Contract plans, microwave vehicle sensors, video vehicle detection system, any maintenance or adjustment to the microwave vehicle sensors/video vehicle detection system, the temporary wireless interconnect system complete, temporary fiber optic interconnect system complete, all material required, the installation and complete removal of the temporary traffic signal. Each intersection will be paid for separately.

REMOVE EXISTING TRAFFIC SIGNAL EQUIPMENT.

Add the following to Article 895.05 of the Standard Specifications:

The traffic signal equipment which is to be removed and is to become the property of the Contractor shall be disposed of outside the right-of-way at the Contractor's expense.

All equipment to be returned to the State shall be delivered by the Contractor to the State's Traffic Signal Maintenance Contractor's main facility. The Contractor shall contact the State's Electrical Maintenance Contractor to schedule an appointment to deliver the equipment. No equipment will be accepted without a prior appointment. All equipment shall be delivered within 30 days of removing it from the traffic signal installation. The Contractor shall provide 5 copies of a list of equipment that is to remain the property of the State, including model and serial numbers, where applicable. The Contractor shall also provide a copy of the Contract plan or special provision showing the quantities and type of equipment. Controllers and peripheral equipment from the same location shall be boxed together (equipment from different locations may not be mixed) and all boxes and controller cabinets shall be clearly marked or labeled with the location from which they were removed. If equipment is not returned with these requirements, it will be rejected by the State's Electrical Maintenance Contractor. The Contractor shall be responsible for the condition of the traffic signal equipment from the time Contractor takes maintenance of the signal installation until the acceptance of a receipt drawn by the State's Electrical Maintenance Contractor indicating the items have been returned in good condition.

The Contractor shall safely store and arrange for pick up or delivery of all equipment to be returned to agencies other than the State. The Contractor shall package the equipment and provide all necessary documentation as stated above.

Traffic signal equipment which is lost or not returned to the Department for any reason shall be replaced with new equipment meeting the requirements of these Specifications at no cost to the contract.

TRAFFIC SIGNAL PAINTING.

Description.

This work shall include surface preparation, powder type painted finish application and packaging of new galvanized steel traffic signal mast arm poles and posts assemblies. All work associated with applying the painted finish shall be performed at the manufacturing facility for the pole assembly or post or at a painting facility approved by the Engineer. Traffic signal mast arm shrouds and post bases shall also be painted the same color as the pole assemblies and posts.

Surface Preparation.

All weld flux and other contaminates shall be mechanically removed. The traffic mast arms and post assemblies shall be degreased, cleaned, and air dried to assure all moisture is removed.

Painted Finish.

All galvanized exterior surfaces shall be coated with a urethane or triglycidyl isocyanurate (TGIC) polyester powder to a dry film thickness of 2.0 mils. Prior to application, the surface

shall be mechanically etched by brush blasting (Ref. SSPC-SP7) and the zinc coated substrate preheated to 450 °F for a minimum one (1) hour. The coating shall be electrostatically applied and cured by elevating the zinc-coated substrate temperature to a minimum of 400 °F.

The finish paint color shall be one of the manufacturer's standard colors and shall be as selected by the local agency responsible for paint costs. The Contractor shall confirm, in writing, the color selection with the local responsible agency and provide a copy of the approval to the Engineer and a copy of the approval shall be included in the material catalog submittal.

Painting of traffic signal heads, pedestrian signal heads and controller cabinets is not included in this pay item.

Any damage to the finish after leaving the manufacturer's facility shall be repaired to the satisfaction of the Engineer using a method recommended by the manufacturer and approved by the Engineer. If while at the manufacturer's facility the finish is damaged, the finish shall be re-applied at no cost to the contract.

Warranty.

The Contractor shall furnish in writing to the Engineer, the paint manufacturer's standard warranty and certification that the paint system has been properly applied.

Packaging.

Prior to shipping, the poles and posts shall be wrapped in ultraviolet-inhibiting plastic foam or rubberized foam.

Basis of Payment.

This work shall be paid for at the contract unit price each for PAINT NEW MAST ARM AND POLE, UNDER 40 FEET (12.19 METER), PAINT NEW MAST ARM AND POLE, 40 FEET (12.19 METER) AND OVER, PAINT NEW COMBINATION MAST ARM AND POLE, UNDER 40 FEET (12.19 METER), PAINT NEW COMBINATION MAST ARM AND POLE, 40 FEET (12.19 METER) AND OVER, or PAINT NEW TRAFFIC SIGNAL POST of the length specified, which shall be payment in full for painting and packaging the traffic signal mast arm poles and posts described above including all shrouds, bases and appurtenances.

ILLUMINATED STREET NAME SIGN

Description.

This work shall consist of furnishing and installing a LED internally illuminated street name sign.

Materials.

Materials shall be in accordance with ILLUMINATED STREET NAME SIGN in Division 1000 of these specifications.

Installation.

The sign can be mounted on most steel mast arm poles. Mounting on aluminum mast arm pole requires supporting structural calculations. Some older or special designed steel mast arm poles may require structural evaluation to assure that construction of the mast arm pole

is adequate for the proposed additional loading. Structural calculations and other supporting documentation as determined by the Engineer shall be provided by the contractor for review by the Department.

The sign shall be located on a steel traffic signal mast arm no further than 8-feet from the center of the pole to the center of the sign at a height of between 16 to 18-feet above traveled pavement. Mounting hardware shall be Pelco model SE-5015, or approved equal, utilizing stainless steel components.

Signs shall be installed such that they are not energized when traffic signals are powered by an alternate energy source such as a generator or uninterruptible power supply (UPS). The signs shall be connected to the generator or UPS bypass circuitry.

Basis of Payment.

This work will be paid for at the contract unit price each for ILLUMINATED STREET NAME SIGN, of the length specified which shall be payment in full for furnishing and installing the LED internally illuminated street sign, complete with circuitry and mounting hardware including photo cell, circuit breaker, fusing, relay, connections and cabling as shown on the plans for proper operation and installation.

RE-OPTIMIZE TRAFFIC SIGNAL SYSTEM.

Description.

This work shall consist of re-optimizing a closed loop traffic signal system according to the following Levels of work.

LEVEL I applies when improvements are made to an existing signalized intersection within an existing closed loop traffic signal system. The purpose of this work is to integrate the improvements to the subject intersection into the signal system while minimizing the impacts to the existing system operation. This type of work would be commonly associated with the addition of signal phases, pedestrian phases, or improvements that do not affect the capacity at an intersection.

LEVEL II applies when improvements are made to an existing signalized intersection within an existing closed loop traffic signal system and detailed analysis of the intersection operation is desired by the engineer, or when a new signalized or existing signalized intersection is being added to an existing system, but optimization of the entire system is not required. The purpose of this work is to optimize the subject intersection, while integrating it into the existing signal system with limited impact to the system operations. This item also includes an evaluation of the overall system operation, including the traffic responsive program.

For the purposes of re-optimization work, an intersection shall include all traffic movements operated by the subject controller and cabinet.

After the signal improvements are completed, the signal shall be re-optimized as specified by an approved Consultant who has previous experience in optimizing Closed Loop Traffic Signal Systems for District One of the Illinois Department of Transportation. The Contractor shall contact the Traffic Signal Engineer at (847) 705-4424 for a listing of approved Consultants. Traffic signal system optimization work, including fine-tuning adjustments of the

optimized system, shall follow the requirements stated in the most recent IDOT District 1 SCAT Guidelines, except as note herein.

A listing of existing signal equipment, interconnect information, phasing data, and timing patterns may be obtained from the Department, if available and as appropriate. The existing SCAT Report is available for review at the District One office and if the Consultant provides blank computer disks, copies of computer simulation files for the existing optimized system and a timing database that includes intersection displays will be made for the Consultant. The Consultant shall confer with the Traffic Signal Engineer prior to optimizing the system to determine if any extraordinary conditions exist that would affect traffic flows in the vicinity of the system, in which case, the Consultant may be instructed to wait until the conditions return to normal or to follow specific instructions regarding the optimization.

(a) LEVEL I Re-Optimization

1. The following tasks are associated with LEVEL I Re-Optimization.

- a. Appropriate signal timings shall be developed for the subject intersection and existing timings shall be utilized for the rest of the intersections in the system.
- b. Proposed signal timing plan for the new or modified intersection(s) shall be forwarded to IDOT for review prior to implementation.
- c. Consultant shall conduct on-site implementation of the timings at the turn-on and make fine-tuning adjustments to the timings of the subject intersection in the field to alleviate observed adverse operating conditions and to enhance operations.

2. The following deliverables shall be provided for LEVEL I Re-Optimization.

- a. Consultant shall furnish to IDOT a cover letter describing the extent of the re-optimization work performed.
- b. Consultant shall furnish an updated intersection graphic display for the subject intersection to IDOT and to IDOT's Traffic Signal Maintenance Contractor.

(b) LEVEL II Re-Optimization

1. In addition to the requirements described in the LEVEL I Re-Optimization above, the following tasks are associated with LEVEL II Re-Optimization.

- a. Traffic counts shall be taken at the subject intersection after the traffic signals are approved for operation by the Area Traffic Signal Operations Engineer. Manual turning movement counts shall be conducted from 6:30 a.m. to 9:30 a.m., 11:00 a.m. to 1:00 p.m., and 3:30 p.m. to 6:30 p.m. on a typical weekday from midday Monday to midday Friday. The turning movement counts shall identify cars, and single-unit, multi-unit heavy vehicles, and transit buses.
- b. As necessary, the intersections shall be re-addressed and all system detectors reassigned in the master controller according to the current standard of District One.
- c. Traffic responsive program operation shall be evaluated to verify proper pattern selection and lack of oscillation and a report of the operation shall be provided to IDOT.

2. The following deliverables shall be provided for LEVEL II Re-Optimization.

- a. Consultant shall furnish to IDOT one (1) copy of a technical memorandum for the optimized system. The technical memorandum shall include the following elements:
 - (1) Brief description of the project
 - (2) Printed copies of the analysis output from Synchro (or other appropriate, approved optimization software file)

- (3) Printed copies of the traffic counts conducted at the subject intersection
- b. Consultant shall furnish to IDOT two (2) CDs for the optimized system. The CDs shall include the following elements:
- (1) Electronic copy of the technical memorandum in PDF format
 - (2) Revised Synchro files (or other appropriate, approved optimization software file) including the new signal and the rest of the signals in the closed loop system
 - (3) Traffic counts conducted at the subject intersection
 - (4) New or updated intersection graphic display file for the subject intersection
 - (5) The CD shall be labeled with the IDOT system number and master location, as well as the submittal date and the consultant logo. The CD case shall include a clearly readable label displaying the same information securely affixed to the side and front.

Basis of Payment.

This work shall be paid for at the contract unit price each for RE-OPTIMIZE TRAFFIC SIGNAL SYSTEM – LEVEL I or RE-OPTIMIZE TRAFFIC SIGNAL SYSTEM – LEVEL II, which price shall be payment in full for performing all work described herein per intersection. Following completion of the timings and submittal of specified deliverables, 100 percent of the bid price will be paid. Each intersection will be paid for separately.

OPTIMIZE TRAFFIC SIGNAL SYSTEM.

Description.

This work shall consist of optimizing a closed loop traffic signal system.

OPTIMIZE TRAFFIC SIGNAL SYSTEM applies when a new or existing closed loop traffic signal system is to be optimized and a formal Signal Coordination and Timing (SCAT) Report is to be prepared. The purpose of this work is to improve system performance by optimizing traffic signal timings, developing a time of day program and a traffic responsive program.

After the signal improvements are completed, the signal system shall be optimized as specified by an approved Consultant who has previous experience in optimizing Closed Loop Traffic Signal Systems for District One of the Illinois Department of Transportation. The Contractor shall contact the Traffic Signal Engineer at (847) 705-4424 for a listing of approved Consultants. Traffic signal system optimization work, including fine-tuning adjustments of the optimized system, shall follow the requirements stated in the most recent IDOT District 1 SCAT Guidelines, except as note herein.

A listing of existing signal equipment, interconnect information, phasing data, and timing patterns may be obtained from the Department, if available and as appropriate. The existing SCAT Report is available for review at the District One office and if the Consultant provides blank computer disks, copies of computer simulation files for the existing optimized system and a timing database that includes intersection displays will be made for the Consultant. The Consultant shall confer with the Traffic Signal Engineer prior to optimizing the system to

determine if any extraordinary conditions exist that would affect traffic flows in the vicinity of the system, in which case, the Consultant may be instructed to wait until the conditions return to normal or to follow specific instructions regarding the optimization.

(a) The following tasks are associated with OPTIMIZE TRAFFIC SIGNAL SYSTEM.

1. Appropriate signal timings and offsets shall be developed for each intersection and appropriate cycle lengths shall be developed for the closed loop signal system.
2. Traffic counts shall be taken at all intersections after the permanent traffic signals are approved for operation by the Area Traffic Signal Operations Engineer. Manual turning movement counts shall be conducted from 6:30 a.m. to 9:30 a.m., 11:00 a.m. to 1:00 p.m., and 3:30 p.m. to 6:30 p.m. on a typical weekday from midday Monday to midday Friday. The turning movement counts shall identify cars, and single-unit and multi-unit heavy vehicles.
3. As necessary, the intersections shall be re-addressed and all system detectors reassigned in the master controller according to the current standard of District One.
4. A traffic responsive program shall be developed, which considers both volume and occupancy. A time-of-day program shall be developed for used as a back-up system.
5. Proposed signal timing plan for the new or modified intersection shall be forwarded to IDOT for review prior to implementation.
6. Consultant shall conduct on-site implementation of the timings and make fine-tuning adjustments to the timings in the field to alleviate observed adverse operating conditions and to enhance operations.
7. Speed and delay studies shall be conducted during each of the count periods along the system corridor in the field before and after implementation of the proposed timing plans for comparative evaluations. These studies should utilize specialized electronic timing and measuring devices.

(b) The following deliverables shall be provided for OPTIMIZE TRAFFIC SIGNAL SYSTEM.

1. Consultant shall furnish to IDOT one (1) copy of a SCAT Report for the optimized system. The SCAT Report shall include the following elements:

<p>Cover Page in color showing a System Map</p> <p>Figures</p> <ol style="list-style-type: none">1. System overview map – showing system number, system schematic map with numbered system detectors, oversaturated movements, master location, system phone number, cycle lengths, and date of completion.2. General location map in color – showing signal system location in the metropolitan area.3. Detail system location map in color – showing cross street names and local controller addresses.4. Controller sequence – showing controller phase sequence diagrams.
--

Table of Contents
Tab 1: Final Report <ol style="list-style-type: none">1. Project Overview2. System and Location Description (Project specific)3. Methodology4. Data Collection5. Data Analysis and Timing Plan Development6. Implementation<ol style="list-style-type: none">a. Traffic Responsive Programming (Table of TRP vs. TOD Operation)7. Evaluation<ol style="list-style-type: none">a. Speed and Delay runs
Tab 2. Turning Movement Counts <ol style="list-style-type: none">1. Turning Movement Counts (Showing turning movement counts in the intersection diagram for each period, including truck percentage)
Tab 3. Synchro Analysis <ol style="list-style-type: none">1. AM: Time-Space diagram in color, followed by intersection Synchro report (Timing report) summarizing the implemented timings.2. Midday: same as AM3. PM: same as AM
Tab 4: Speed, Delay Studies <ol style="list-style-type: none">1. Summary of before and after runs results in two (2) tables showing travel time and delay time.2. Plot of the before and after runs diagram for each direction and time period.
Tab 5: Environmental Report <ol style="list-style-type: none">1. Environmental impact report including gas consumption, NO2, HCCO, improvements.
Tab 6: Electronic Files <ol style="list-style-type: none">1. Two (2) CDs for the optimized system. The CDs shall include the following elements:<ol style="list-style-type: none">a. Electronic copy of the SCAT Report in PDF formatb. Copies of the Synchro files for the optimized systemc. Traffic counts for the optimized systemd. New or updated intersection graphic display files for each of the system intersections and the system graphic display file including system detector locations and addresses.

Basis of Payment.

The work shall be paid for at the contract unit each for OPTIMIZE TRAFFIC SIGNAL SYSTEM, which price shall be payment in full for performing all work described herein for the entire traffic signal system. Following the completion of traffic counts, 25 percent of the bid price will be paid. Following the completion of the Synchro analysis, 25 percent of the bid price will be paid. Following the setup and fine tuning of the timings, the speed-delay study, and the TRP programming, 25 percent of the bid price will be paid. The remaining 25 percent will be paid when the system is working to the satisfaction of the engineer and the report and CD have been submitted.

TEMPORARY TRAFFIC SIGNAL TIMINGS

Description.

This work shall consist of developing and maintaining appropriate traffic signal timings for the specified intersection for the duration of the temporary signalized condition, as well as impact to existing traffic signal timings caused by detours or other temporary conditions.

All timings and adjustments necessary for this work shall be performed by an approved Consultant who has previous experience in optimizing Closed Loop Traffic signal Systems for District One of the Illinois Department of Transportation. The Contractor shall contact the Traffic Signal Engineer at (847) 705-4424 for a listing of approved Consultants.

The following tasks are associated with TEMPORARY TRAFFIC SIGNAL TIMINGS.

(a) Consultant shall attend temporary traffic signal inspection (turn-on) and/or detour meeting and conduct on-site implementation of the traffic signal timings. Make fine-tuning adjustments to the timings in the field to alleviate observed adverse operating conditions and to enhance operations.

(b) Consultant shall provide monthly observation of traffic signal operations in the field.

(c) Consultant shall provide on-site consultation and adjust timings as necessary for construction stage changes, temporary traffic signal phase changes, and any other conditions affecting timing and phasing, including lane closures, detours, and other construction activities.

(d) Consultant shall make timing adjustments and prepare comment responses as directed by the Area Traffic Signal Operations Engineer.

Basis of Payment.

The work shall be paid for at the contract unit price each for TEMPORARY TRAFFIC SIGNAL TIMINGS, which price shall be payment in full for performing all work described herein per intersection. When the temporary traffic signal installation is turned on and/or detour implemented, 50 percent of the bid price will be paid. The remaining 50 percent of the bid price will be paid following the removal of the temporary traffic signal installation and/or detour.

MODIFYING EXISTING CONTROLLER CABINET.

The work shall consist of modifying an existing controller cabinet as follows:

(a) Uninterruptible Power Supply (UPS). The addition of uninterruptible power supply (UPS) to an existing controller cabinet could require the relocation of the existing controller cabinet items to allow for the installation of the uninterruptible power supply (UPS) components inside the existing controller cabinet as outlined under Sections 862 and 1074.04 of the Standard Specifications.

(b) Light Emitting Diode (LED) Signal Heads, Light Emitting Diode (LED) Optically Programmed Signal Heads and Light Emitting Diode (LED) Pedestrian Signal Heads. The contractor shall verify that the existing load switches meet the requirements of Section 1074.03(5)(b)(2) of the Standard Specifications and the recommended load requirements of the light emitting diode (LED) signal heads that are being installed at the existing traffic

PEDESTRIAN COUNTDOWN SIGNAL INSTALLATION
DUPAGE COUNTY SECTION 12-PEDTS-00-SP
CONTRACT NUMBER 63718

signal. If any of the existing load switches do not meet these requirements, they shall be replaced, as directed by the Engineer.

(c) Light Emitting Diode (LED), Signal Head, Retrofit. The contractor shall verify that the existing load switches meet the requirements of Section 1074.03(2) of the Standard Specifications and the recommended load requirements of light emitting diode (LED) traffic signal modules, pedestrian signal modules, and pedestrian countdown signal modules as specified in the plans. If any of the existing load switches do not meet these requirements, they shall be replaced, as directed by the Engineer.

Basis of Payment.

Modifying an existing controller cabinet will be paid for at the contract unit price per each for Modify Existing Controller Cabinet. This shall include all material and labor required to complete the work as described above, the removal and disposal of all items removed from the controller cabinet, as directed by the Engineer. The equipment for the Uninterruptible Power Supply (UPS) and labor to install it in the existing controller cabinet shall be included in the pay item Uninterruptible Power Supply. Modifying an existing controller will be paid for at the contract unit price per each for Modify Existing Controller, per Sections 895.04 and 895.08 of the Standard Specifications.

DIVISION 1000 MATERIALS

PEDESTRIAN PUSH-BUTTON.

Revise Article 1074.02(a) of the Standard Specifications to read:

The pedestrian push-button housing shall be constructed of aluminum alloy according to ASTM B 308 6061-T6 and powder coated yellow, unless otherwise noted on the plans. The housing shall be furnished with suitable mounting hardware.

Revise Article 1074-02(e) of the Standard Specifications to read:

Stations shall be designed to be mounted directly to a post, mast arm pole or wood pole. The station shall be aluminum and shall accept a 3 inch (75mm) round push-button assembly and a regulatory pedestrian instruction sign according to MUTCD, sign series R10-3e 9 x 15 inch sign with arrow(s) for a count-down pedestrian signal. The pedestrian station size without count-down pedestrian signals shall accommodate a MUTCD sign series R10-3b or R10-3d 9 x 12 inch sign with arrow(s).

Add the following to Article 1074.02(a) of the Standard Specifications:

(f) Location. Pedestrian push-buttons and stations shall be mounted directly to a post, mast arm pole or wood pole as shown on the plans and shall be fully accessible from a paved or concrete surface. See the District's Detail sheets for orientation and mounting details.

CONTROLLER CABINET AND PERIPHERAL EQUIPMENT.

Add the following to Article 1074.03 of the Standard Specifications:

(a) (6) Cabinets shall be designed for NEMA TS2 Type 1 operation. All cabinets shall be pre-wired for a minimum of eight (8) phases of vehicular, four (4) phases of pedestrian and four (4) phases of overlap operation.

(b) (5) Cabinets – Provide 1/8" (3.2 mm) thick unpainted aluminum alloy 5052-H32. The surface shall be smooth, free of marks and scratches. All external hardware shall be stainless steel.

(b) (6) Controller Harness – Provide a TS2 Type 2 "A" wired harness in addition to the TS2 Type 1 harness.

(b) (7) Surge Protection – Plug-in type EDCO SHA-1250 or Atlantic/Pacific approved equal.

(b) (8) BIU – Containment screw required.

(b) (9) Transfer Relays – Solid state or mechanical flash relays are acceptable.

(b) (10) Switch Guards – All switches shall be guarded.

(b) (11) Heating – One (1) 200 watt, thermostatically-controlled, Hoffman electric heater, or approved equivalent.

(b) (12) Lighting – One (1) LED Panel shall be placed inside the cabinet top panel and one (1) LED Panel shall be placed on each side of the pull-out drawer/shelf assembly

located beneath the controller support shelf. The LED Panels shall be controlled by a wall switch. Relume Traffic Control Box LED Panels and power supply or approved equivalent.

(b) (13) The cabinet shall be equipped with a pull-out drawer/shelf assembly. A 1 ½ inch (38mm) deep drawer shall be provided in the cabinet, mounted directly beneath the controller support shelf. The drawer shall have a hinged top cover and shall be capable of accommodating one (1) complete set of cabinet prints and manuals. This drawer shall support 50 lbs. (23 kg) in weight when fully extended. The drawer shall open and close smoothly. Drawer dimensions shall make maximum use of available depth offered by the controller shelf and be a minimum of 24 inches (610mm) wide.

(b) (14) Plan & Wiring Diagrams – 12" x 16" (3.05mm x 4.06mm) moisture sealed container attached to door.

(b) (15) Detector Racks – Fully wired and labeled for four (4) channels of emergency vehicle pre-emption and sixteen channels (16) of vehicular operation.

(b) (16) Field Wiring Labels – All field wiring shall be labeled.

(b) (17) Field Wiring Termination – Approved channel lugs required.

(b) (18) Power Panel – Provide a nonconductive shield.

(b) (19) Circuit Breaker – The circuit breaker shall be sized for the proposed load but shall not be rated less than 30 amps.

(b) (20) Police Door – Provide wiring and termination for plug in manual phase advance switch.

(b) (21) Railroad Pre-Emption Test Switch – Eaton 8830K13 SHA 1250 or equivalent.

RAILROAD, FULL-ACTUATED CONTROLLER AND CABINET.

Controller shall comply with Article 1073.01 as amended in these Traffic Signal Special Provisions.

Controller Cabinet and Peripheral Equipment shall comply with Article 1074.03 as amended in these Traffic Signal Special Provisions.

Add the following to Articles 1073.01 (c) (2) and 1074.03 (a) (5) (e) of the Standard Specifications:

Controllers and cabinets shall be new and NEMA TS2 Type 1 design.

A method of monitoring and/or providing redundancy to the railroad preemptor input to the controller shall be included as a component of the Railroad, Full Actuated Controller and Cabinet installation and be verified by the traffic signal equipment supplier prior to installation.

Railroad interconnected controllers and cabinets shall be assembled only by an approved traffic signal equipment supplier. All railroad interconnected (including temporary railroad interconnect) controllers and cabinets shall be new, built, tested and approved by the controller equipment vendor, in the vendor's District One facility, prior to field installation. The vendor shall provide the technical equipment and assistance as required by the Engineer to fully test this equipment.

UNINTERRUPTIBLE POWER SUPPLY (UPS).

Revise Article 1074.04(a)(1) of the Standard Specifications to read:

The UPS shall be line interactive and provide voltage regulation and power conditioning when utilizing utility power. The UPS shall be sized appropriately for the intersection's normal traffic signal operating connected load, plus 20 percent (20%). The total connected traffic signal load shall not exceed the published ratings for the UPS. The UPS shall provide a minimum of six (6) hours of normal operation run-time for signalized intersections with LED type signal head optics at 77 °F (25 °C) (minimum 700 W/1000 VA active output capacity, with 90 percent minimum inverter efficiency).

Revise the first paragraph of Article 1074.04(a)(3) of the Standard Specifications to read:

The UPS shall have a minimum of four (4) sets of normally open (NO) and normally closed (NC) single-pole double-throw (SPDT) relay contact closures, available on a panel mounted terminal block or locking circular connectors, rated at a minimum 120 V/1 A, and labeled so as to identify each contact according to the plans.

Revise Article 1074.04(a)(10) of the Standard Specifications to read:

The UPS shall be compatible with the District's approved traffic controller assemblies utilizing NEMA TS 1 or NEMA TS 2 controllers and cabinet components for full time operation.

Revise Article 1074.04(a)(17) of the Standard Specifications to read:

When the intersection is in battery backup mode, the UPS shall bypass all internal cabinet lights, ventilation fans, cabinet heaters, service receptacles, any lighted street name signs, any automated enforcement equipment and any other devices directed by the Engineer.

Revise Article 1074.04(b)(2)b of the Standard Specifications to read:

Batteries, inverter/charger and power transfer relay shall be housed in a separate NEMA Type 3R cabinet. The cabinet shall be Aluminum alloy, 5052-H32, 0.125-inch thick and have a natural mill finish.

Revise Article 1074.04(b)(2)c of the Standard Specifications to read:

No more than three batteries shall be mounted on individual shelves for a cabinet housing six batteries and no more than four batteries per shelf for a cabinet housing eight batteries.

Revise Article 1074.04(b)(2)e of the Standard Specifications to read:

The battery cabinet housing shall have the following nominal outside dimensions: a width of 25 in. (785 mm), a depth of 16 in. (440 mm), and a height of 41 to 48 in. (1.1 to 1.3 m). Clearance between shelves shall be a minimum of 10 in. (250 mm).

UPS

End of paragraph 1074.04(b) (2)e

The door shall be equipped with a two position doorstop, one a 90° and one at 120°.

Revise Article 1074.04(b)(2)g of the Standard Specifications to read:

The door shall open to the entire cabinet, have a neoprene gasket, an Aluminum continuous piano hinge with stainless steel pin, and a three point locking system. The cabinet shall be provided with a main door lock which shall operate with a traffic industry conventional No. 2 key. Provisions for padlocking the door shall be provided.

Add the following to Article 1074.04(b)(2) of the Standard Specifications:

j. The battery cabinet shall have provisions for an external generator connection.

Add the following to Article 1074.04(c) of the Standard Specifications:

(8) The UPS shall include a tip or kill switch installed in the battery cabinet, which shall completely disconnect power from the UPS when the switch is manually activated.

(9) The UPS shall incorporate a flanged electric generator inlet for charging the batteries and operating the UPS. The generator connector shall be male type, twist-lock, rated as 15A, 125VAC with a NEMA L5-15P configuration and weatherproof lift cover plate (Hubbell model HBL4716C or approved equal). Access to the generator inlet shall be from a secured weatherproof lift cover plate or behind a locked battery cabinet police panel.

Battery System.

Revise Article 1074.04(d)(3) of the Standard Specifications to read:

All batteries supplied in the UPS shall be either gel cell or AGM type, deep cycle, completely sealed, prismatic leadcalcium based, silver alloy, valve regulated lead acid (VRLA) requiring no maintenance. All batteries in a UPS installation shall be the same type; mixing of gel cell and AGM types within a UPS installation is not permitted.

Revise Article 1074.04(d)(4) of the Standard Specifications to read:

Batteries shall be certified by the manufacturer to operate over a temperature range of -13 to 160 °F (-25 to + 71 °C) for gel cell batteries and -40 to 140 °F (-40 to + 60 °C) for AGM type batteries.

Add the following to Article 1074.04(d) of the Standard Specifications:

(9) The UPS shall consist of an even number of batteries that are capable of maintaining normal operation of the signalized intersection for a minimum of six hours. Calculations shall be provided showing the number of batteries of the type supplied that are needed to satisfy this requirement. A minimum of four batteries shall be provided.

Add the following to the Article 1074.04 of the Standard Specifications:

(e) Warranty. The warranty for an uninterruptible power supply (UPS) shall cover a minimum of two years from date the equipment is placed in operation; however, the batteries of the UPS shall be warranted for full replacement for a minimum of five years from the date the traffic signal and UPS are placed into service.

ELECTRIC CABLE.

Delete "or stranded, and No. 12 or" from the last sentence of Article 1076.04 (a) of the Standard Specifications.

Add the following to the Article 1076.04(d) of the Standard Specifications:

Service cable may be single or multiple conductor cable.

TRAFFIC SIGNAL POST.

Add the following to Article 1077.01 (d) of the Standard Specifications:

All posts and bases shall be steel and hot dipped galvanized. If the Department approves painting, powder coating by the manufacturer will be required over the galvanization in accordance with TRAFFIC SIGNAL PAINTING in Division 800 of these specifications.

PEDESTRIAN PUSH-BUTTON POST.

Add the following to Article 1077.02(b) of the Standard Specifications:

All posts and bases shall be steel and hot-dipped galvanized. If the Department approves painting, powder coating by the manufacturer will be required over the galvanization in accordance with Traffic Signal Painting in Division 800 of these specifications.

MAST ARM ASSEMBLY AND POLE.

Add the following to Article 1077.03 (a) of the Standard Specifications:

Traffic signal mast arms shall be one piece construction, unless otherwise approved by the Engineer. All poles shall be galvanized. If the Department approves painting, powder coating by the manufacturer will be required over the galvanization in accordance with with TRAFFIC SIGNAL PAINTING in Division 800 of these specifications.

The shroud shall be of sufficient strength to deter pedestrian and vehicular damage. The shroud shall be constructed and designed to allow air to circulate throughout the mast arm but not allow infestation of insects or other animals, and such that it is not hazardous to probing fingers and feet. All mounting hardware shall be stainless steel.

LIGHT EMITTING DIODE (LED) TRAFFIC SIGNAL HEAD.

Add the following to Section 1078 of the Standard Specifications:

General.

All signal and pedestrian heads shall provide 12" (300 mm) displays with glossy yellow or black polycarbonate housings. All head housings shall be the same color (yellow or black) at the intersection. For new signalized intersections and existing signalized intersections where all signal and/or pedestrian heads are being replaced, the proposed head housings shall be black. Where only selected heads are being replaced, the proposed head housing color (yellow or black) shall match existing head housings. Connecting hardware and mounting brackets shall be polycarbonate (black). A corrosion resistant anti-seize lubricant shall be applied to all metallic mounting bracket joints, and shall be visible to the inspector at the signal turn-on. Post top mounting collars are required on all posts, and shall be constructed of the same material as the brackets.

Pedestrian signal heads shall be furnished with the international symbolic "Walking Person" and "Upraised Palm" displays. Egg crate sun shields are not permitted.

Signal heads shall be positioned according to the "District One Standard Traffic Signal Design Details."

LED signal heads (All Face and Section Quantities), (All Mounting Types) shall conform fully to the requirements of Articles 1078.01 and 1078.02 of the Standard Specifications amended herein.

1. The LED signal modules shall be replaced or repaired if an LED signal module fails to function as intended due to workmanship or material defects within the first 60 months from the date of delivery. LED signal modules which exhibit luminous intensities less than the minimum values specified in Table 1 of the ITE Vehicle Traffic Control Signal Heads: Light Emitting Diode (LED) Circular Signal Supplement (June 27, 2005) [VTSCH], or applicable successor ITE specifications, or show signs of entrance of moisture or contaminants within the first 60 months of the date of delivery shall be replaced or repaired. The manufacturer's written warranty for the LED signal modules shall be dated, signed by an Officer of the company and included in the product submittal to the State.

(a) Physical and Mechanical Requirements

1. Modules can be manufactured under this specification for the following faces:
 - a. 12 inch (300 mm) circular, multi-section
 - b. 12 inch (300 mm) arrow, multi-section
 - c. 12 inch (300 mm) pedestrian, 2 sections
2. The maximum weight of a module shall be 4 lbs. (1.8 kg).
3. Each module shall be a sealed unit to include all parts necessary for operation (a printed circuit board, power supply, a lens and gasket, etc.), and shall be weather proof after installation and connection.

4. Material used for the lens and signal module construction shall conform to ASTM specifications for the materials.
5. The lens of the module shall be tinted with a wavelength-matched color to reduce sun phantom effect and enhance on/off contrast. The tinting shall be uniform across the lens face. Polymeric lens shall provide a surface coating or chemical surface treatment applied to provide abrasion resistance. The lens of the module shall be integral to the unit, convex with a smooth outer surface and made of plastic. The lens shall have a textured surface to reduce glare.
6. The use of tinting or other materials to enhance ON/OFF contrasts shall not affect chromaticity and shall be uniform across the face of the lens.
7. Each module shall have a symbol of the type of module (i.e. circle, arrow, etc.) in the color of the module. The symbol shall be 1 inch (25.4 mm) in diameter. Additionally, the color shall be written out in 1/2 inch (12.7mm) letters next to the symbol.

(b) Photometric Requirements

1. The minimum initial luminous intensity values for the modules shall conform to the values in Table 1 of the VTCSH (2005) for circular signal indications, and as stated in Table 3 of these specifications for arrow and pedestrian indications at 25 °C.
2. The modules shall meet or exceed the illumination values stated in Articles 1078.01 and 1078.02 the Standard Specifications for circular signal indications, and Table 3 of these specifications for arrow and pedestrian indications, throughout the useful life based on normal use in a traffic signal operation over the operating temperature range.
3. The measured chromaticity coordinates of the modules shall conform to the chromaticity requirements of Section 4.2 of the VTCSH (2005) or applicable successor ITE specifications.
4. The LEDs utilized in the modules shall be AlInGaP technology for red, yellow, Portland orange (pedestrian) and white (pedestrian) indications, and GaN for green indications, and shall be the ultra bright type rated for 100,000 hours of continuous operation from -40 °C to +74 °C.

(c) Electrical

1. Maximum power consumption for LED modules is per Table 2.
2. Operating voltage of the modules shall be 120 VAC. All parameters shall be measured at this voltage.
3. The modules shall be operationally compatible with currently used controller assemblies (solid state load switches, flashers, and conflict monitors).
4. When a current of 20 mA AC (or less) is applied to the unit, the voltage read across the two leads shall be 15 VAC or less.

5. The LED modules shall provide constant light output under power. Modules with dimming capabilities shall have the option disabled or set on a non-dimming operation.
6. The individual LEDs shall be wired such that a catastrophic loss or the failure of one or more LED will not result in the loss of the entire module.

(d) Retrofit Traffic Signal Module

1. The following specification requirements apply to the Retrofit module only. All general specifications apply unless specifically superseded in this section.
2. Retrofit modules can be manufactured under this specification for the following faces:
 - a. 12 inch (300 mm) circular, multi-section
 - b. 12 inch (300 mm) arrow, multi-section
 - c. 12 inch (300 mm) pedestrian, 2 sections
3. Each Retrofit module shall be designed to be installed in the doorframe of a standard traffic signal housing. The Retrofit module shall be sealed in the doorframe with a one-piece EPDM (ethylene propylene rubber) gasket.
4. The maximum weight of a Retrofit module shall be 4 lbs. (1.8 kg).
5. Each Retrofit module shall be a sealed unit to include all parts necessary for operation (a printed circuit board, power supply, a lens and gasket, etc.), and shall be weather proof after installation and connection.
6. Electrical conductors for modules, including Retrofit modules, shall be 39.4 inches (1m) in length, with quick disconnect terminals attached.
7. The lens of the Retrofit module shall be integral to the unit, shall be convex with a smooth outer surface and made of plastic or of glass.

(e) The following specification requirements apply to the 12 inch (300 mm) arrow module only. All general specifications apply unless specifically superseded in this section.

1. The arrow module shall meet specifications stated in Section 9.01 of the Equipment and Material Standards of the Institute of Transportation Engineers (November 1998) [ITE Standards], Chapter 2 (Vehicle Traffic Control Signal Heads) or applicable successor ITE specifications for arrow indications.
2. The LEDs arrow indication shall be a solid display with a minimum of three (3) outlining rows of LEDs and at least one (1) fill row of LEDs.

(f) The following specification requirement applies to the 12 inch (300 mm) programmed visibility (PV) module only. All general specifications apply unless specifically superseded in this section.

1. The LED module shall be a module designed and constructed to be installed in a programmed visibility (PV) signal housing without modification to the housing.

(g) The following specification requirements apply to the 12 inch (300 mm) Pedestrian module only. All general specifications apply unless specifically superseded in this section.

1. Each pedestrian signal LED module shall provide the ability to actuate the solid upraised hand and the solid walking person on one 12 inch (300mm) section.
2. Two (2) pedestrian sections shall be installed. The top section shall be wired to illuminate only the upraised hand and the bottom section shall be the walking man.
3. "Egg Crate" type sun shields are not permitted. All figures must be a minimum of 9 inches (225mm) in height and easily identified from a distance of 120-feet (36.6m).

LIGHT EMITTING DIODE (LED) PEDESTRIAN COUNTDOWN SIGNAL HEAD.

Add the following to Article 1078.02 of the Standard Specifications:

General.

1. The module shall operate in one mode: Clearance Cycle Countdown Mode Only. The countdown module shall display actual controller programmed clearance cycle and shall start counting when the flashing clearance signal turns on and shall countdown to "0" and turn off when the steady Upraised Hand (symbolizing Don't Walk) signal turns on. Module shall not have user accessible switches or controls for modification of cycle.
2. At power on, the module shall enter a single automatic learning cycle. During the automatic learning cycle, the countdown display shall remain dark.
3. The module shall re-program itself if it detects any increase or decrease of Pedestrian Timing. The counting unit will go blank once a change is detected and then take one complete pedestrian cycle (with no counter during this cycle) to adjust its buffer timer.
4. The module shall allow for consecutive cycles without displaying the steady Upraised Hand.
5. The module shall recognize preemption events and temporarily modify the crossing cycle accordingly.
6. If the controller preempts during the Walking Person (symbolizing Walk), the countdown will follow the controller's directions and will adjust from Walking Person to flashing Upraised Hand. It will start to count down during the flashing Upraised Hand.
7. If the controller preempts during the flashing Upraised Hand, the countdown will continue to count down without interruption.
8. The next cycle, following the preemption event, shall use the correct, initially programmed values.

9. If the controller output displays Upraised Hand steady condition and the unit has not arrived to zero or if both the Upraised Hand and Walking Person are dark for some reason, the unit suspends any timing and the digits will go dark.
10. The digits will go dark for one pedestrian cycle after loss of power of more than 1.5 seconds.
11. The countdown numerals shall be two (2) "7 segment" digits forming the time display utilizing two rows of LEDs.
12. The LED module shall meet the requirements of the Institute of Transportation Engineers (ITE) LED purchase specification, "Pedestrian Traffic Control Signal Indications - Part 2: LED Pedestrian Traffic Signal Modules," or applicable successor ITE specifications, except as modified herein.
13. The LED modules shall provide constant light output under power. Modules with dimming capabilities shall have the option disabled or set on a non-dimming operation.
14. In the event of a power outage, light output from the LED modules shall cease instantaneously.
15. The LEDs utilized in the modules shall be AlInGaP technology for Portland Orange (Countdown Numerals and Upraised Hand) and GaN technology for Lunar White (Walking Person) indications.
16. The individual LEDs shall be wired such that a catastrophic loss or the failure of one or more LED will not result in the loss of the entire module.

Electrical.

1. Maximum power consumption for LED modules is 29 watts.
2. The measured chromaticity shall remain unchanged over the input line voltage range listed of 80 VAC to 135 VAC.

TRAFFIC SIGNAL BACKPLATE.

Delete 1st sentence of Article 1078.03 of the Standard Specifications and add "All backplates shall be aluminum and louvered".

Add the following to the third paragraph of Article 1078.03 of the Standard Specifications. The reflective backplate shall not contain louvers.

Delete second sentence of the fourth paragraph of Article 1078.03 of the Standard Specifications.

Add the following to the fourth paragraph of Article 1078.03 of the Standard Specifications:

When retro reflective sheeting is specified, it shall be Type ZZ sheeting according to Article 1091.03 and applied in preferred orientation for the maximum angularity according to the

manufacturer's recommendations. The retro reflective sheeting shall be installed under a controlled environment at the manufacturer/supplier before shipment to the contractor. The aluminum backplate shall be prepared and cleaned, following recommendations of the retro reflective sheeting manufacturer.

INDUCTIVE LOOP DETECTOR.

Add the following to Article 1079.01 of the Standard Specifications:

Contracts requiring new cabinets shall provide for rack mounted detector amplifier cards. Detector amplifiers shall provide LCD displays with loop frequency, inductance, and change of inductance readings.

ILLUMINATED SIGN, LIGHT EMITTING DIODE.

Delete last sentence of Article 1084.01(a) and add "Mounting hardware shall be black polycarbonate or galvanized steel and similar to mounting Signal Head hardware and bracket specified herein and shall provide tool free access to the interior."

Revise the second paragraph of Article 1084.01(a) to read:

The exterior surface of the housing shall be acid-etched and shop painted with one coat of zinc-chromate primer and two coats of exterior enamel. The housing shall be the same color (yellow or black) to match the existing or proposed signal heads. The painting shall be according to Section 851.

Add the following to Article 1084.01 (b) of the Standard Specifications:

The message shall be formed by rows of LEDs. The sign face shall be 24 inches (600 mm) by 24 inches (600 mm).

Add the following to Article 1084.01 of the Standard Specifications:

- (d) The light emitting diode (LED) blank out signs shall be manufactured by National Sign & Signal Company, or an approved equal and consist of a weatherproof housing and door, LEDs and transformers.

ILLUMINATED STREET NAME SIGN

The illuminate street name sign shall be as follows.

(a) Description.

The LEDs shall be white in color and utilize InGaN or UV thermally efficient technology. The LED Light Engines shall be designed to fit inside a standard fluorescent illuminated street sign housing in lieu of fluorescent lamps and ballasts or a slim line type housing. The LED internally-illuminated street name sign shall display the designated street name clearly and legibly in the daylight hours without being energized and at night when energized. The sign assembly shall consist of a four-, six-, or eight-foot aluminum housing. White translucent 3M

DG³ reflective sheeting sign faces with the street name applied in 3M/Scotchlite Series 1177 or current 3M equivalent transparent green shall be installed in hinged doors on the side of the sign for easy access to perform general cleaning and maintenance operations. Illumination shall occur with LED Light Engine as specified.

(b) Environmental Requirements.

The LED lamp shall be rated for use in the ambient operating temperature range of -40 to +50°C (-40 to +122°F) for storage in the ambient temperature range of -40 to +75°C (-40 to +167°F).

(c) General Construction.

1. The LED Light Engine shall be a single, self-contained device, for installation in an existing street sign housing. The power supply must be designed to fit and mounted on the inside wall at one end of the street sign housing. The LED Light Engine shall be mounted within the inner top portion of the housing and no components of the light source shall sit between the sign faces.
2. The assembly and manufacturing processes of the LED Light Engine shall be designed to ensure that all LED and electronic components are adequately supported to withstand mechanical shocks and vibrations in compliance with the specifications of the ANSI, C136.31-2001 standards.

(d) Mechanical Construction.

1. The sign shall be constructed using a weatherproof, aluminum housing consisting of an extruded aluminum top with a minimum thickness of .140" x 10 3/4" deep (including the drip edge). The extruded aluminum bottom is .094" thick x 5 7/8" deep. The ends of the housing shall be cast aluminum with a minimum thickness of .250". A six-foot sign shall be 72 5/8" long and 22 5/16" tall and not weigh more than 77 pounds. An eight-foot sign shall be 96 5/8" long and 22 5/16" tall and not weigh more than 92 pounds. All corners are continuous TIG (Tungsten Inert Gas) welded to provide a weatherproof seal around the entire housing.
2. The door shall be constructed of extruded aluminum. Two corners are continuous TIG welded with the other two screwed together to make one side of the door removable for installation of the sign face. The door is fastened to the housing on the bottom by a full length, .040" x 1 1/8" open stainless steel hinge. The door shall be held secure onto a 1" wide by 5/32" thick neoprene gasket by three (six total for two-way sign) quarter-turn fasteners to form a watertight seal between the door and the housing.
3. The sign face shall be constructed of .125" white translucent polycarbonate. The letters shall be 8" upper case and 6" lower case. The sign face legend background shall consist of 3M/Scotchlite Series 4090T or current equivalent 3M translucent DG³ white VIP (Visual Impact Performance) diamond grade sheeting (ATSM Type 9) and 3M/Scotchlite Series 1177 or current 3M equivalent transparent green acrylic EC (electronic cut-able) film applied to the front of the sign face. The legend shall be framed by a white polycarbonate border. A logo symbol and/or name of the community may be included with approval of the Engineer.
4. All surfaces of the sign shall be etched and primed in accordance to industry standards before receiving appropriate color coats of industrial enamel.

PEDESTRIAN COUNTDOWN SIGNAL INSTALLATION
DUPAGE COUNTY SECTION 12-PEDTS-00-SP
CONTRACT NUMBER 63718

5. All fasteners and hardware shall be corrosion resistant stainless steel. No tools are required for routine maintenance.
6. All wiring shall be secured by insulated wire compression nuts.
7. A wire entrance junction box shall be supplied with the sign assembly. The box may be supplied mounted to the exterior or interior of the sign and provide a weather tight seal.
8. A photoelectric switch shall be mounted in the control cabinet to control lighting functions for day and night display. Each sign shall be individually fused.
9. Brackets and Mounting: LED internally-illuminated street name signs will be factory drilled to accommodate mast arm two-point support assembly mounting brackets.

(e) Electrical.

1. Photocell shall be rated 105-305V, turn on at 1.5 fcs. with a 3-5 second delay. A manufacturer's warranty of six (6) years shall be provided. Power consumption shall be no greater than 1 watt at 120V.
2. The LED Light Engine shall operate from a 60 +/- 3 cycle AC line power over a voltage range of 80 to 135 Vac rms. Fluctuations in line voltage over the range of 80 to 135 Vac shall not affect luminous intensity by more than +/- 10%.
3. Total harmonic distortion induced into the AC power line by the LED Light Engine, operated at a nominal operating voltage, and at a temperature of +25°C (+77°F), shall not exceed 20%.
4. The LED Light Engine shall cycled ON and OFF with a photocell as shown on the detail sheet and shall not exceed the following maximum power values:

4-Foot Sign	60 W
6-Foot Sign	90 W
8-Foot Sign	120 W

The signs shall not be energized when traffic signals are powered by an alternate energy source such as a generator or uninterruptable power source (UPS). The signs shall be connected to the generator or UPS bypass circuitry.

(f) Photometric Requirements.

1. The entire surface of the sign panel shall be evenly illuminated. The average maintained luminous intensity measured across the letters, operating under the conditions defined in Environmental Requirements and Wattage Sections shall be of a minimum value of 100 cd/m².
2. The manufacturer shall make available independent laboratory test results to verify compliance to Voltage Range and Luminous Intensity Distribution Sections.
3. Twelve (12) 1.25 watt LED units shall be mounted on 1-inch x 22-inch metal cone printed circuit boards (MCPCB). The viewing angle shall be 120 degrees. LED shall have a color temperature of 5200k nominal, CRI of 80 with a life expectancy of 75,000 hrs.

(g) Quality Assurance.

The LED Light Engine shall be manufactured in accordance with a vendor quality assurance (QA) program. The production QA shall include statistically controlled routine tests to ensure minimum performance levels of the LED Light Engine build to meet this specification. QA process and test result documentations shall be kept on file for a minimum period of seven (7) years. The LED Light Engine that does not satisfy the production QA testing performance requirements shall not be labeled, advertised, or sold as conforming to these specifications. Each LED Light Engine shall be identified by a manufacturer's serial number for warranty purposes. LED Light Engines shall be replaced or repaired if they fail to function as intended due to workmanship or material defects within the first sixty (60) months from the date of acceptance. LED Light Engines that exhibit luminous intensities less than the minimum value specified in Photometric Section within the first thirty-six (36) months from the date of acceptance shall be replaced or repaired.

State of Illinois
Department of Transportation
Bureau of Local Roads and Streets

SPECIAL PROVISION
FOR
COOPERATION WITH UTILITIES

Effective: January 1, 1999
Revised: January 1, 2007

All references to Sections or Articles in this specification shall be construed to mean specific Section or Article of the Standard Specifications for Road and Bridge Construction, adopted by the Department of Transportation.

Replace Article 105.07 of the Standard Specifications with the following:

"105.07 Cooperation with Utilities. The adjustment of utilities consists of the relocation, removal, replacement, rearrangements, reconstruction, improvement, disconnection, connection, shifting, new installation or altering of an existing utility facility in any manner.

When the plans or special provisions include information pertaining to the location of underground utility facilities, such information represents only the opinion of the Department as to the location of such utilities and is only included for the convenience of the bidder. The Department assumes no responsibility in respect to the sufficiency or the accuracy of the information shown on the plans relative to the location of the underground utility facilities.

Utilities which are to be adjusted shall be adjusted by the utility owner or the owner's representative or by the Contractor as a contract item. Generally, arrangements for adjusting existing utilities will be made by the Department prior to project construction; however, utilities will not necessarily be adjusted in advance of project construction and, in some cases, utilities will not be removed from the proposed construction limits. When utility adjustments must be performed in conjunction with construction, the utility adjustment work will be shown on the plans and/or covered by Special Provisions.

When the Contractor discovers a utility has not been adjusted by the owner or the owner's representative as indicated in the contract documents, or the utility is not shown on the plans or described in the Special Provisions as to be adjusted in conjunction with construction, the Contractor shall not interfere with said utility, and shall take proper precautions to prevent damage or interruption of the utility and shall promptly notify the Engineer of the nature and location of said utility.

All necessary adjustments, as determined by the Engineer, of utilities not shown on the plans or not identified by markers, will be made at no cost to the Contractor except traffic structures, light poles, etc., that are normally located within the proposed construction limits as hereinafter defined will not be adjusted unless required by the proposed improvement.

- (a) Limits of Proposed Construction for Utilities Paralleling the Roadway. For the purpose of this Article, limits of proposed construction for utilities extending in the same longitudinal direction as the roadway, shall be defined as follows:
- (1) The horizontal limits shall be a vertical plane, outside of, parallel to, and 600 mm (2 ft) distant at right angles from the plan or revised slope limits.
- In cases where the limits of excavation for structures are not shown on the plans, the horizontal limits shall be a vertical plane 1.2 m (4 ft) outside the edges of structure footings or the structure where no footings are required.
- (2) The upper vertical limits shall be the regulations governing the roadbed clearance for the specific utility involved.
 - (3) The lower vertical limits shall be the top of the utility at the depth below the proposed grade as prescribed by the governing agency or the limits of excavation, whichever is less.
- (b) Limits of Proposed Construction for Utilities Crossing the Roadway. For the purpose of this Article, limits of proposed construction for utilities crossing the roadway in a generally transverse direction shall be defined as follows:
- (1) Utilities crossing excavations for structures that are normally made by trenching such as sewers, underdrains, etc. and all minor structures such as manholes, inlets, foundations for signs, foundations for traffic signals, etc., the limits shall be the space to be occupied by the proposed permanent construction unless otherwise required by the regulations governing the specific utility involved.
 - (2) For utilities crossing the proposed site of major structures such as bridges, sign trusses, etc., the limits shall be as defined above for utilities extending in the same general direction as the roadway.

The Contractor may make arrangements for adjustment of utilities outside of the limits of proposed construction provided the Contractor furnishes the Department with a signed agreement with the utility owner covering the adjustments to be made. The cost of any adjustments made outside the limits of proposed construction shall be the responsibility of the Contractor unless otherwise provided.

The Contractor shall request all utility owners to field locate their facilities according to Article 107.31. The Engineer may make the request for location from the utility after receipt of notice from the Contractor. On request, the Engineer will make an inspection to verify that the utility company has field located its facilities, but will not assume responsibility for the accuracy of such work. The Contractor shall be responsible for maintaining the excavations or markers provided by the utility owners. This field location procedure may be waived if the utility owner has stated in writing to the Department it is satisfied the construction plans are sufficiently accurate. If the utility owner does not submit such statement to the Department, and they do not field locate their facilities in both horizontal and vertical alignment, the Engineer will authorize the Contractor in writing to proceed to locate the facilities in the most economical and reasonable manner, subject to the approval of the Engineer, and be paid according to Article 109.04.

The Contractor shall coordinate with any planned utility adjustment or new installation and the Contractor shall take all precautions to prevent disturbance or damage to utility facilities. Any failure on the part of the utility owner, or their representative, to proceed with any planned utility adjustment or new installation shall be reported promptly by the Contractor to the Engineer orally and in writing.

The Contractor shall take all necessary precautions for the protection of the utility facilities. The Contractor shall be responsible for any damage or destruction of utility facilities resulting from neglect, misconduct, or omission in the Contractor's manner or method of execution or nonexecution of the work, or caused by defective work or the use of unsatisfactory materials. Whenever any damage or destruction of a utility facility occurs as a result of work performed by the Contractor, the utility company will be immediately notified. The utility company will make arrangements to restore such facility to a condition equal to that existing before any such damage or destruction was done.

It is understood and agreed that the Contractor has considered in the bid all of the permanent and temporary utilities in their present and/or adjusted positions.

No additional compensation will be allowed for any delays, inconvenience, or damage sustained by the Contractor due to any interference from the said utility facilities or the operation of relocating the said utility facilities.

62

State of Illinois
Department of Transportation
Bureau of Local Roads and Streets

SPECIAL PROVISION
FOR
INSURANCE

Effective: February 1, 2007
Revised: August 1, 2007

All references to Sections or Articles in this specification shall be construed to mean specific Section or Article of the Standard Specifications for Road and Bridge Construction, adopted by the Department of Transportation.

The Contractor shall name the following entities as additional insured under the Contractor's general liability insurance policy in accordance with Article 107.27:

DuPage County Division of Transportation

The entities listed above and their officers, employees, and agents shall be indemnified and held harmless in accordance with Article 107.26.

CONSTRUCTION AIR QUALITY – DIESEL RETROFIT (BDE)

Effective: June 1, 2010

The reduction of emissions of particulate matter (PM) for off-road equipment shall be accomplished by installing retrofit emission control devices. The term "equipment" refers to diesel fuel powered devices rated at 50 hp and above, to be used on the jobsite in excess of seven calendar days over the course of the construction period on the jobsite (including rental equipment).

Contractor and subcontractor diesel powered off-road equipment assigned to the contract shall be retrofitted using the phased in approach shown below. Equipment that is of a model year older than the year given for that equipment's respective horsepower range shall be retrofitted:

Effective Dates	Horsepower Range	Model Year
June 1, 2010 ^{1/}	600-749	2002
	750 and up	2006
June 1, 2011 ^{2/}	100-299	2003
	300-599	2001
	600-749	2002
	750 and up	2006
June 1, 2012 ^{2/}	50-99	2004
	100-299	2003
	300-599	2001
	600-749	2002
	750 and up	2006

1/ Effective dates apply to Contractor diesel powered off-road equipment assigned to the contract.

2/ Effective dates apply to Contractor and subcontractor diesel powered off-road equipment assigned to the contract.

The retrofit emission control devices shall achieve a minimum PM emission reduction of 50 percent and shall be:

- a) Included on the U.S. Environmental Protection Agency (USEPA) *Verified Retrofit Technology List* (<http://www.epa.gov/otaq/retrofit/verif-list.htm>), or verified by the California Air Resources Board (CARB) (<http://www.arb.ca.gov/diesel/verde/verdev.htm>); or
- b) Retrofitted with a non-verified diesel retrofit emission control device if verified retrofit emission control devices are not available for equipment proposed to be used on the project, and if the Contractor has obtained a performance certification from the retrofit

device manufacturer that the emission control device provides a minimum PM emission reduction of 50 percent.

Note: Large cranes (Crawler mounted cranes) which are responsible for critical lift operations are exempt from installing retrofit emission control devices if such devices adversely affect equipment operation.

Diesel powered off-road equipment with engine ratings of 50 hp and above, which are unable to be retrofitted with verified emission control devices or if performance certifications are not available which will achieve a minimum 50 percent PM reduction, may be granted a waiver by the Department if documentation is provided showing good faith efforts were made by the Contractor to retrofit the equipment.

Construction shall not proceed until the Contractor submits a certified list of the diesel powered off-road equipment that will be used, and as necessary, retrofitted with emission control devices. The list(s) shall include (1) the equipment number, type, make, Contractor/rental company name; and (2) the emission control devices make, model, USEPA or CARB verification number, or performance certification from the retrofit device manufacturer. Equipment reported as fitted with emissions control devices shall be made available to the Engineer for visual inspection of the device installation, prior to being used on the jobsite.

The Contractor shall submit an updated list of retrofitted off-road construction equipment as retrofitted equipment changes or comes on to the jobsite. The addition or deletion of any diesel powered equipment shall be included on the updated list.

If any diesel powered off-road equipment is found to be in non-compliance with any portion of this special provision, the Engineer will issue the Contractor a diesel retrofit deficiency deduction.

Any costs associated with retrofitting any diesel powered off-road equipment with emission control devices shall be considered as included in the contract unit prices bid for the various items of work involved and no additional compensation will be allowed. The Contractor's compliance with this notice and any associated regulations shall not be grounds for a claim.

Diesel Retrofit Deficiency Deduction

When the Engineer determines that a diesel retrofit deficiency exists, a daily monetary deduction will be imposed for each calendar day or fraction thereof the deficiency continues to exist. The calendar day(s) will begin when the time period for correction is exceeded and end with the Engineer's written acceptance of the correction. The daily monetary deduction will be \$1,000.00 for each deficiency identified.

The deficiency will be based on lack of diesel retrofit emissions control.

If a Contractor accumulates three diesel retrofit deficiency deductions for the same piece of equipment in a contract period, the Contractor will be shutdown until the deficiency is corrected.

Such a shutdown will not be grounds for any extension of the contract time, waiver of penalties, or be grounds for any claim.

80261

lde

CONSTRUCTION AIR QUALITY - DIESEL VEHICLE EMISSIONS CONTROL (BDE)

Effective: April 1, 2009

Revised: January 2, 2012

Diesel Vehicle Emissions Control. The reduction of construction air emissions shall be accomplished by using cleaner burning diesel fuel. The term "equipment" refers to any and all diesel fuel powered devices rated at 50 hp and above, to be used on the project site in excess of seven calendar days over the course of the construction period on the project site (including any "rental" equipment).

All equipment on the jobsite, with engine ratings of 50 hp and above, shall be required to: use Ultra-Low Sulfur Diesel fuel (ULSD) exclusively (15 ppm sulfur content or less).

Diesel powered equipment in non-compliance will not be allowed to be used on the project site, and is also subject to a notice of non-compliance as outlined below.

The Contractor shall certify that only ULSD will be used in all jobsite equipment. The certification shall be presented to the Department prior to the commencement of the work.

If any diesel powered equipment is found to be in non-compliance with any portion of this specification, the Engineer will issue the Contractor a notice of non-compliance and identify an appropriate period of time, as outlined below under environmental deficiency deduction, in which to bring the equipment into compliance or remove it from the project site.

Any costs associated with bringing any diesel powered equipment into compliance with these diesel vehicle emissions controls shall be considered as included in the contract unit prices bid for the various items of work involved and no additional compensation will be allowed. The Contractor's compliance with this notice and any associated regulations shall also not be grounds for a claim.

Environmental Deficiency Deduction. When the Engineer is notified, or determines that an environmental control deficiency exists, he/she will notify the Contractor in writing, and direct the Contractor to correct the deficiency within a specified time period. The specified time-period, which begins upon Contractor notification, will be from 1/2 hour to 24 hours long, based on the urgency of the situation and the nature of the deficiency. The Engineer shall be the sole judge regarding the time period.

The deficiency will be based on lack of repair, maintenance and diesel vehicle emissions control.

If the Contractor fails to correct the deficiency within the specified time frame, a daily monetary deduction will be imposed for each calendar day or fraction thereof the deficiency continues to exist. The calendar day(s) will begin when the time period for correction is exceeded and end with the Engineer's written acceptance of the correction. The daily monetary deduction will be \$1,000.00 for each deficiency identified.

If a Contractor or subcontractor accumulates three environmental deficiency deductions in a contract period, the Contractor will be shutdown until the deficiency is corrected. Such a shutdown will not be grounds for any extension of contract time, waiver of penalties, or be grounds for any claim.

80237

CONSTRUCTION AIR QUALITY - IDLING RESTRICTIONS (BDE)

Effective: April 1, 2009

Idling Restrictions. The Contractor shall establish truck-staging areas for all diesel powered vehicles that are waiting to load or unload material at the jobsite. Staging areas shall be located where the diesel emissions from the equipment will have a minimum impact on adjacent sensitive receptors. The Department will review the selection of staging areas, whether within or outside the existing highway right-of-way, to avoid locations near sensitive areas or populations to the extent possible. Sensitive receptors include, but are not limited to, hospitals, schools, residences, motels, hotels, daycare facilities, elderly housing and convalescent facilities. Diesel powered engines shall also be located as far away as possible from fresh air intakes, air conditioners, and windows. The Engineer will approve staging areas before implementation.

Diesel powered vehicle operators may not cause or allow the motor vehicle, when it is not in motion, to idle for more than a total of 10 minutes within any 60 minute period, except under any of the following circumstances:

- 1) The motor vehicle has a gross vehicle weight rating of less than 8000 lb (3630 kg).
- 2) The motor vehicle idles while forced to remain motionless because of on-highway traffic, an official traffic control device or signal, or at the direction of a law enforcement official.
- 3) The motor vehicle idles when operating defrosters, heaters, air conditioners, or other equipment solely to prevent a safety or health emergency.
- 4) A police, fire, ambulance, public safety, other emergency or law enforcement motor vehicle, or any motor vehicle used in an emergency capacity, idles while in an emergency or training mode and not for the convenience of the vehicle operator.
- 5) The primary propulsion engine idles for maintenance, servicing, repairing, or diagnostic purposes if idling is necessary for such activity.
- 6) A motor vehicle idles as part of a government inspection to verify that all equipment is in good working order, provided idling is required as part of the inspection.
- 7) When idling of the motor vehicle is required to operate auxiliary equipment to accomplish the intended use of the vehicle (such as loading, unloading, mixing, or processing cargo; controlling cargo temperature; construction operations, lumbering operations; oil or gas well servicing; or farming operations), provided that this exemption does not apply when the vehicle is idling solely for cabin comfort or to operate non-essential equipment such as air conditioning, heating, microwave ovens, or televisions.
- 8) When the motor vehicle idles due to mechanical difficulties over which the operator has no control.
- 9) The outdoor temperature is less than 32 °F (0 °C) or greater than 80 °F (26 °C).

When the outdoor temperature is greater than or equal to 32 °F (0 °C) or less than or equal to 80 °F (26 °C), a person who operates a motor vehicle operating on diesel fuel shall not cause or allow the motor vehicle to idle for a period greater than 30 minutes in any 60 minute period while waiting to weigh, load, or unload cargo or freight, unless the vehicle is in a line of vehicles that regularly and periodically moves forward.

The above requirements do not prohibit the operation of an auxiliary power unit or generator set as an alternative to idling the main engine of a motor vehicle operating on diesel fuel.

Environmental Deficiency Deduction. When the Engineer is notified, or determines that an environmental control deficiency exists based on non-compliance with the idling restrictions, he/she will notify the Contractor, and direct the Contractor to correct the deficiency.

If the Contractor fails to correct the deficiency a monetary deduction will be imposed. The monetary deduction will be \$1,000.00 for each deficiency identified.

80239

DISADVANTAGED BUSINESS ENTERPRISE PARTICIPATION (BDE)

Effective: September 1, 2000

Revised: August 2, 2011

FEDERAL OBLIGATION. The Department of Transportation, as a recipient of federal financial assistance, is required to take all necessary and reasonable steps to ensure nondiscrimination in the award and administration of contracts. Consequently, the federal regulatory provisions of 49 CFR Part 26 apply to this contract concerning the utilization of disadvantaged business enterprises. For the purposes of this Special Provision, a disadvantaged business enterprise (DBE) means a business certified by the Department in accordance with the requirements of 49 CFR Part 26 and listed in the Illinois Unified Certification Program (IL UCP) DBE Directory.

STATE OBLIGATION. This Special Provision will also be used by the Department to satisfy the requirements of the Business Enterprise for Minorities, Females, and Persons with Disabilities Act, 30 ILCS 575. When this Special Provision is used to satisfy state law requirements on 100 percent state-funded contracts, the federal government has no involvement in such contracts (not a federal-aid contract) and no responsibility to oversee the implementation of this Special Provision by the Department on those contracts. DBE participation on 100 percent state-funded contracts will not be credited toward fulfilling the Department's annual overall DBE goal required by the US Department of Transportation to comply with the federal DBE program requirements.

CONTRACTOR ASSURANCE. The Contractor makes the following assurance and agrees to include the assurance in each subcontract that the Contractor signs with a subcontractor.

The Contractor, subrecipient, or subcontractor shall not discriminate on the basis of race, color, national origin, or sex in the performance of this contract. The Contractor shall carry out applicable requirements of 49 CFR Part 26 in the award and administration of contracts funded in whole or in part with federal or state funds. Failure by the Contractor to carry out these requirements is a material breach of this contract, which may result in the termination of this contract or such other remedy as the recipient deems appropriate.

OVERALL GOAL SET FOR THE DEPARTMENT. As a requirement of compliance with 49 CFR Part 26, the Department has set an overall goal for DBE participation in its federally assisted contracts. That goal applies to all federal-aid funds the Department will expend in its federally assisted contracts for the subject reporting fiscal year. The Department is required to make a good faith effort to achieve the overall goal. The dollar amount paid to all approved DBE companies performing work called for in this contract is eligible to be credited toward fulfillment of the Department's overall goal.

CONTRACT GOAL TO BE ACHIEVED BY THE CONTRACTOR. This contract includes a specific DBE utilization goal established by the Department. The goal has been included because the Department has determined that the work of this contract has subcontracting opportunities that may be suitable for performance by DBE companies. The determination is

based on an assessment of the type of work, the location of the work, and the availability of DBE companies to do a part of the work. The assessment indicates that, in the absence of unlawful discrimination, and in an arena of fair and open competition, DBE companies can be expected to perform 0.00 % of the work. This percentage is set as the DBE participation goal for this contract. Consequently, in addition to the other award criteria established for this contract, the Department will only award this contract to a bidder who makes a good faith effort to meet this goal of DBE participation in the performance of the work. A bidder makes a good faith effort for award consideration if either of the following is done in accordance with the procedures set for in this Special Provision:

- (a) The bidder documents that enough DBE participation has been obtained to meet the goal: or
- (b) The bidder documents that a good faith effort has been made to meet the goal, even though the effort did not succeed in obtaining enough DBE participation to meet the goal.

DBE LOCATOR REFERENCES. Bidders shall consult the IL UCP DBE Directory as a reference source for DBE-certified companies. In addition, the Department maintains a letting and item specific DBE locator information system whereby DBE companies can register their interest in providing quotes on particular bid items advertised for letting. Information concerning DBE companies willing to quote work for particular contracts may be obtained by contacting the Department's Bureau of Small Business Enterprises at telephone number (217)785-4611, or by visiting the Department's website at www.dot.il.gov.

BIDDING PROCEDURES. Compliance with this Special Provision is a material bidding requirement. The failure of the bidder to comply will render the bid not responsive.

- (a) The bidder shall submit a Disadvantaged Business Utilization Plan on Department forms SBE 2025 and 2026 with the bid.
- (b) The Utilization Plan shall indicate that the bidder either has obtained sufficient DBE participation commitments to meet the contract goal or has not obtained enough DBE participation commitments in spite of a good faith effort to meet the goal. The Utilization Plan shall further provide the name, telephone number, and telefax number of a responsible official of the bidder designated for purposes of notification of plan approval or disapproval under the procedures of this Special Provision.
- (c) The Utilization Plan shall include a DBE Participation Commitment Statement, Department form SBE 2025, for each DBE proposed for the performance of work to achieve the contract goal. For bidding purposes, submission of the completed SBE 2025 forms, signed by the DBEs and faxed to the bidder will be acceptable as long as the original is available and provided upon request. All elements of information indicated on the said form shall be provided, including but not limited to the following:
 - (1) The names and addresses of DBE firms that will participate in the contract;

- (2) A description, including pay item numbers, of the work each DBE will perform;
- (3) The dollar amount of the participation of each DBE firm participating. The dollar amount of participation for identified work shall specifically state the quantity, unit price, and total subcontract price for the work to be completed by the DBE. If partial pay items are to be performed by the DBE, indicate the portion of each item, a unit price where appropriate and the subcontract price amount;
- (4) DBE Participation Commitment Statements, form SBE 2025, signed by the bidder and each participating DBE firm documenting the commitment to use the DBE subcontractors whose participation is submitted to meet the contract goal;
- (5) if the bidder is a joint venture comprised of DBE companies and non-DBE companies, the plan must also include a clear identification of the portion of the work to be performed by the DBE partner(s); and,
- (6) If the contract goal is not met, evidence of good faith efforts.

GOOD FAITH EFFORT PROCEDURES. The contract will not be awarded until the Utilization Plan submitted by the apparent successful bidder is approved. All information submitted by the bidder must be complete, accurate and adequately document that enough DBE participation has been obtained or document that good faith efforts of the bidder, in the event enough DBE participation has not been obtained, before the Department will commit to the performance of the contract by the bidder. The Utilization Plan will be approved by the Department if the Utilization Plan documents sufficient commercially useful DBE work performance to meet the contract goal or the bidder submits sufficient documentation of a good faith effort to meet the contract goal pursuant to 49 CFR Part 26, Appendix A. The Utilization Plan will not be approved by the Department if the Utilization Plan does not document sufficient DBE participation to meet the contract goal unless the apparent successful bidder documented in the Utilization Plan that it made a good faith effort to meet the goal. This means that the bidder must show that all necessary and reasonable steps were taken to achieve the contract goal. Necessary and reasonable steps are those which, by their scope, intensity and appropriateness to the objective, could reasonably be expected to obtain sufficient DBE participation, even if they were not successful. The Department will consider the quality, quantity, and intensity of the kinds of efforts that the bidder has made. Mere *pro forma* efforts, in other words, efforts done as a matter of form, are not good faith efforts; rather, the bidder is expected to have taken genuine efforts that would be reasonably expected of a bidder actively and aggressively trying to obtain DBE participation sufficient to meet the contract goal.

- (a) The following is a list of types of action that the Department will consider as part of the evaluation of the bidder's good faith efforts to obtain participation. These listed factors are not intended to be a mandatory checklist and are not intended to be exhaustive. Other factors or efforts brought to the attention of the Department may be relevant in appropriate cases, and will be considered by the Department.

- (1) Soliciting through all reasonable and available means (e.g. attendance at pre-bid meetings, advertising and/or written notices) the interest of all certified DBE companies that have the capability to perform the work of the contract. The bidder must solicit this interest within sufficient time to allow the DBE companies to respond to the solicitation. The bidder must determine with certainty if the DBE companies are interested by taking appropriate steps to follow up initial solicitations.
- (2) Selecting portions of the work to be performed by DBE companies in order to increase the likelihood that the DBE goals will be achieved. This includes, where appropriate, breaking out contract work items into economically feasible units to facilitate DBE participation, even when the prime Contractor might otherwise prefer to perform these work items with its own forces.
- (3) Providing interested DBE companies with adequate information about the plans, specifications, and requirements of the contract in a timely manner to assist them in responding to a solicitation.
- (4) a. Negotiating in good faith with interested DBE companies. It is the bidder's responsibility to make a portion of the work available to DBE subcontractors and suppliers and to select those portions of the work or material needs consistent with the available DBE subcontractors and suppliers, so as to facilitate DBE participation. Evidence of such negotiation includes the names, addresses, and telephone numbers of DBE companies that were considered; a description of the information provided regarding the plans and specifications for the work selected for subcontracting; and evidence as to why additional agreements could not be reached for DBE companies to perform the work.

b. A bidder using good business judgment would consider a number of factors in negotiating with subcontractors, including DBE subcontractors, and would take a firm's price and capabilities as well as contract goals into consideration. However, the fact that there may be some additional costs involved in finding and using DBE companies is not in itself sufficient reason for a bidder's failure to meet the contract DBE goal, as long as such costs are reasonable. Also the ability or desire of a bidder to perform the work of a contract with its own organization does not relieve the bidder of the responsibility to make good faith efforts. Bidders are not, however, required to accept higher quotes from DBE companies if the price difference is excessive or unreasonable.
- (5) Not rejecting DBE companies as being unqualified without sound reasons based on a thorough investigation of their capabilities. The bidder's standing within its industry, membership in specific groups, organizations, or associations and political or social affiliations (for example union vs. non-union employee status) are not legitimate causes for the rejection or non-solicitation of bids in the bidder's efforts to meet the project goal.

- (6) Making efforts to assist interested DBE companies in obtaining bonding, lines of credit, or insurance as required by the recipient or Contractor.
 - (7) Making efforts to assist interested DBE companies in obtaining necessary equipment, supplies, materials, or related assistance or services.
 - (8) Effectively using the services of available minority/women community organizations; minority/women contractors' groups; local, state, and federal minority/women business assistance offices; and other organizations as allowed on a case-by-case basis to provide assistance in the recruitment and placement of DBE companies.
- (b) If the Department determines that the apparent successful bidder has made a good faith effort to secure the work commitment of DBE companies to meet the contract goal, the Department will award the contract provided that it is otherwise eligible for award. If the Department determines that the bidder has failed to meet the requirements of this Special Provision or that a good faith effort has not been made, the Department will notify the responsible company official designated in the Utilization Plan that the bid is not responsive. The notification shall include a statement of reasons for the determination.
- (c) The bidder may request administrative reconsideration of a determination adverse to the bidder within the five working days after the receipt of the notification date of the determination by delivering the request to the Department of Transportation, Bureau of Small Business Enterprises, Contract Compliance Section, 2300 South Dirksen Parkway, Room 319, Springfield, Illinois 62764 (Telefax: (217)785-1524). Deposit of the request in the United States mail on or before the fifth business day shall not be deemed delivery. The determination shall become final if a request is not made and delivered. A request may provide additional written documentation and/or argument concerning the issues raised in the determination statement of reasons, provided the documentation and arguments address efforts made prior to submitting the bid. The request will be forwarded to the Department's Reconsideration Officer. The Reconsideration Officer will extend an opportunity to the bidder to meet in person in order to consider all issues of documentation and whether the bidder made a good faith effort to meet the goal. After the review by the Reconsideration Officer, the bidder will be sent a written decision within ten working days after receipt of the request for consideration, explaining the basis for finding that the bidder did or did not meet the goal or make adequate good faith efforts to do so. A final decision by the Reconsideration Officer that a good faith effort was made shall approve the Utilization Plan submitted by the bidder and shall clear the contract for award. A final decision that a good faith effort was not made shall render the bid not responsive.

CALCULATING DBE PARTICIPATION. The Utilization Plan values represent work anticipated to be performed and paid for upon satisfactory completion. The Department is only able to count toward the achievement of the overall goal and the contract goal the value of payments made for the work actually performed by DBE companies. In addition, a DBE must perform a commercially useful function on the contract to be counted. A commercially useful function is

generally performed when the DBE is responsible for the work and is carrying out its responsibilities by actually performing, managing, and supervising the work involved. The Department and Contractor are governed by the provisions of 49 CFR Part 26.55(c) on questions of commercially useful functions as it affects the work. Specific counting guidelines are provided in 49 CFR Part 26.55, the provisions of which govern over the summary contained herein.

- (a) DBE as the Contractor: 100 percent goal credit for that portion of the work performed by the DBE's own forces, including the cost of materials and supplies. Work that a DBE subcontracts to a non-DBE does not count toward the DBE goals.
- (b) DBE as a joint venture Contractor: 100 percent goal credit for that portion of the total dollar value of the contract equal to the distinct, clearly defined portion of the work performed by the DBE's own forces.
- (c) DBE as a subcontractor: 100 percent goal credit for the work of the subcontract performed by the DBE's own forces, including the cost of materials and supplies, excluding the purchase of materials and supplies or the lease of equipment by the DBE subcontractor from the prime Contractor or its affiliates. Work that a DBE subcontractor in turn subcontracts to a non-DBE does not count toward the DBE goal.
- (d) DBE as a trucker: 100 percent goal credit for trucking participation provided the DBE is responsible for the management and supervision of the entire trucking operation for which it is responsible. At least one truck owned, operated, licensed, and insured by the DBE must be used on the contract. Credit will be given for the following:
 - (1) The DBE may lease trucks from another DBE firm, including an owner-operator who is certified as a DBE. The DBE who leases trucks from another DBE receives credit for the total value of the transportation services the lessee DBE provides on the contract.
 - (2) The DBE may also lease trucks from a non-DBE firm, including from an owner-operator. The DBE who leases trucks from a non-DBE is entitled to credit only for the fee or commission is receives as a result of the lease arrangement.
- (e) DBE as a material supplier:
 - (1) 60 percent goal credit for the cost of the materials or supplies purchased from a DBE regular dealer.
 - (2) 100 percent goal credit for the cost of materials of supplies obtained from a DBE manufacturer.
 - (3) 100 percent credit for the value of reasonable fees and commissions for the procurement of materials and supplies if not a regular dealer or manufacturer.

CONTRACT COMPLIANCE. Compliance with this Special Provision is an essential part of the contract. The Department is prohibited by federal regulations from crediting the participation of a DBE included in the Utilization Plan toward either the contract goal or the Department's overall goal until the amount to be applied toward the goals has been paid to the DBE. The following administrative procedures and remedies govern the compliance by the Contractor with the contractual obligations established by the Utilization Plan. After approval of the Utilization Plan and award of the contract, the Utilization Plan and individual DBE Participation Statements become part of the contract. If the Contractor did not succeed in obtaining enough DBE participation to achieve the advertised contract goal, and the Utilization Plan was approved and contract awarded based upon a determination of good faith, the total dollar value of DBE work calculated in the approved Utilization Plan as a percentage of the awarded contract value shall become the amended contract goal. All work indicated for performance by an approved DBE shall be performed, managed, and supervised by the DBE executing the Participation Statement.

- (a) NO AMENDMENT. No amendment to the Utilization Plan may be made without prior written approval from the Department's Bureau of Small Business Enterprises. All requests for amendment to the Utilization Plan shall be submitted to the Department of Transportation, Bureau of Small Business Enterprises, Contract Compliance Section, 2300 South Dirksen Parkway, Room 319, Springfield, Illinois 62764. Telephone number (217)785-4611. Telefax number (217)785-1524.
- (b) TERMINATION OR REPLACEMENT. The Contractor shall not terminate or replace a DBE listed on the approved Utilization Plan, or perform with other forces work designated for a listed DBE except as provided in the Special Provision.
- (c) CHANGES TO WORK. Any deviation from the DBE condition-of-award or contract plans, specifications, or special provisions must be approved, in writing, by the Department as provided elsewhere in the Contract. The Contractor shall notify affected DBEs in writing of any changes in the scope of work which result in a reduction in the dollar amount condition-of-award to the contract. Where the revision includes work committed to a new DBE subcontractor, not previously involved in the project, then a Request for Approval of Subcontractor, Department form BC 260A, must be signed and submitted. If the commitment of work is in the form of additional tasks assigned to an existing subcontract, then a new Request for Approval of Subcontractor shall not be required. However, the Contractor must document efforts to assure that the existing DBE subcontractor is capable of performing the additional work and has agreed in writing to the change.
- (d) ALTERNATIVE WORK METHODS. In addition to the above requirements for reductions in the condition of award, additional requirements apply to the two cases of Contractor-initiated work substitution proposals. Where the contract allows alternate work methods which serve to delete or create underruns in condition of award DBE work, and the Contractor selects that alternate method or, where the Contractor proposes a substitute work method or material that serves to diminish or delete work committed to a DBE and replace it with other work, then the Contractor must demonstrate one of the following:

- (1) That the replacement work will be performed by the same DBE (as long as the DBE is certified in the respective item of work) in a modification of the condition of award; or
- (2) That the DBE is aware that its work will be deleted or will experience underruns and has agreed in writing to the change. If this occurs, the Contractor shall substitute other work of equivalent value to a certified DBE or provide documentation of good faith efforts to do so; or
- (3) That the DBE is not capable of performing the replacement work or has declined to perform the work at a reasonable competitive price. If this occurs, the Contractor shall substitute other work of equivalent value to a certified DBE or provide documentation of good faith efforts to do so.

(e) TERMINATION AND REPLACEMENT PROCEDURES. The Contractor shall not terminate or replace a DBE subcontractor listed in the approved Utilization Plan without prior written consent. This includes, but is not limited to, instances in which the Contractor seeks to perform work originally designated for a DBE subcontractor with its own forces or those of an affiliate, a non-DBE firm, or with another DBE firm. Written consent will be granted only if the Bureau of Small Business Enterprises agrees, for reasons stated in its concurrence document, that the Contractor has good cause to terminate or replace the DBE firm. Before transmitting to the Bureau of Small Business Enterprises any request to terminate and/or substitute a DBE subcontractor, the Contractor shall give notice in writing to the DBE subcontractor, with a copy to the Bureau, of its intent to request to terminate and/or substitute, and the reason for the request. The Contractor shall give the DBE five days to respond to the Contractor's notice. The DBE so notified shall advise the Bureau and the Contractor of the reasons, if any, why it objects to the proposed termination of its subcontract and why the Bureau should not approve the Contractor's action. If required in a particular case as a matter of public necessity, the Bureau may provide a response period shorter than five days.

For purposes of this paragraph, good cause includes the following circumstances:

- (1) The listed DBE subcontractor fails or refuses to execute a written contract;
- (2) The listed DBE subcontractor fails or refuses to perform the work of its subcontract in a way consistent with normal industry standards. Provided, however, that good cause does not exist if the failure or refusal of the DBE subcontractor to perform its work on the subcontract results from the bad faith or discriminatory action of the prime contractor;
- (3) The listed DBE subcontractor fails or refuses to meet the prime Contractor's reasonable, nondiscriminatory bond requirements;

- (4) The listed DBE subcontractor becomes bankrupt, insolvent, or exhibits credit unworthiness;
- (5) The listed DBE subcontractor is ineligible to work on public works projects because of suspension and debarment proceedings pursuant 2 CFR Parts 180, 215 and 1,200 or applicable state law.
- (6) You have determined that the listed DBE subcontractor is not a responsible contractor;
- (7) The listed DBE subcontractor voluntarily withdraws from the projects and provides to you written notice of its withdrawal;
- (8) The listed DBE is ineligible to receive DBE credit for the type of work required;
- (9) A DBE owner dies or becomes disabled with the result that the listed DBE contractor is unable to complete its work on the contract;
- (10) Other documented good cause that compels the termination of the DBE subcontractor. Provided, that good cause does not exist if the prime Contractor seeks to terminate a DBE it relied upon to obtain the contract so that the prime Contractor can self-perform the work for which the DBE contractor was engaged or so that the prime Contractor can substitute another DBE or non-DBE contractor after contract award.

When a DBE is terminated, or fails to complete its work on the Contract for any reason the Contractor shall make a good faith effort to find another DBE to substitute for the original DBE to perform at least the same amount of work under the contract as the terminated DBE to the extent needed to meet the established Contract goal.

- (f) PAYMENT RECORDS. The Contractor shall maintain a record of payments for work performed to the DBE participants. The records shall be made available to the Department for inspection upon request. After the performance of the final item of work or delivery of material by a DBE and final payment therefore to the DBE by the Contractor, but not later than thirty calendar days after payment has been made by the Department to the Contractor for such work or material, the Contractor shall submit a DBE Payment Agreement on Department form SBE 2115 to the Regional Engineer. If full and final payment has not been made to the DBE, the DBE Payment Agreement shall indicate whether a disagreement as to the payment required exists between the Contractor and the DBE or if the Contractor believes that the work has not been satisfactorily completed. If the Contractor does not have the full amount of work indicated in the Utilization Plan performed by the BDE companies indicated in the Utilization Plan and after good faith efforts are reviewed, the Department may deduct from contract payments to the Contractor the amount of the goal not achieved as liquidated and ascertained damages. The Contractor may request an administrative

| reconsideration of any amount deducted as damages pursuant to subsection (h) of this part.

| (g) ENFORCEMENT. The Department reserves the right to withhold payment to the Contractor to enforce the provisions of this Special Provision. Final payment shall not be made on the contract until such time as the Contractor submits sufficient documentation demonstrating achievement of the goal in accordance with this Special Provision or after liquidated damages have been determined and collected.

| (h) RECONSIDERATION. Notwithstanding any other provision of the contract, including but not limited to Article 109.09 of the Standard Specifications, the Contractor may request administrative reconsideration of a decision to deduct the amount of the goal not achieved as liquidated damages. A request to reconsider shall be delivered to the Contract Compliance Section and shall be handled and considered in the same manner as set forth in paragraph (c) of "Good Faith Effort Procedures" of this Special Provision, except a final decision that a good faith effort was not made during contract performance to achieve the goal agreed to in the Utilization Plan shall be the final administrative decision of the Department.

80029

ERRATA FOR THE 2012 STANDARD SPECIFICATIONS (BDE)

Effective: April 1, 2012

Revised: August 1, 2012

- Page 182 Article 354.12. In the second line of the first paragraph change "Article 353.12" to "Article 353.13".
- Page 183 Article 355.10. In the second line of the first paragraph change "Article 353.12" to "Article 353.13".
- Page 185 Article 356.10. In the second line of the first paragraph change "Article 353.12" to "Article 353.13".
- Page 337 Article 505.04. Revise the subparagraph "(i) Match Making." to "(i) Match Marking."
- Page 360 Article 506.07. In the first line of the second paragraph change "AASHTO/AWS D1.5/D1.5." to "AASHTO/AWS D1.5M/D1.5."
- Page 361 Article 506.08. In the third line of the sixth paragraph change "506.08(a)" to "506.08(b)".
- Page 531 Article 609.07. In the first paragraph delete "TYPE B, C, or D INLET BOX STANDARD 609001 or".
- Page 601 Article 701.18(h). In the first line of the first paragraph change "Standard 701426." to "Standard 701426 and 701427."
- Page 609 Article 703.05. In the first line of the second paragraph delete "or Type II".
- Page 989 Article 1083.02(a). In the seventh line of the first paragraph change "Table 14.7.5.2-2" to "Table 14.7.5.2-1".
- Page 1019 Article 1095.01(b)(1)e. In the table for daylight reflectance for the color yellow, change "75 % min." to "45 % min."

80296

PAYMENTS TO SUBCONTRACTORS (BDE)

Effective: June 1, 2000

Revised: January 1, 2006

Federal regulations found at 49 CFR §26.29 mandate the Department to establish a contract clause to require Contractors to pay subcontractors for satisfactory performance of their subcontracts and to set the time for such payments.

State law also addresses the timing of payments to be made to subcontractors and material suppliers. Section 7 of the Prompt Payment Act, 30 ILCS 540/7, requires that when a Contractor receives any payment from the Department, the Contractor shall make corresponding, proportional payments to each subcontractor and material supplier performing work or supplying material within 15 calendar days after receipt of the Department payment. Section 7 of the Act further provides that interest in the amount of two percent per month, in addition to the payment due, shall be paid to any subcontractor or material supplier by the Contractor if the payment required by the Act is withheld or delayed without reasonable cause. The Act also provides that the time for payment required and the calculation of any interest due applies to transactions between subcontractors and lower-tier subcontractors and material suppliers throughout the contracting chain.

This Special Provision establishes the required federal contract clause, and adopts the 15 calendar day requirement of the State Prompt Payment Act for purposes of compliance with the federal regulation regarding payments to subcontractors. This contract is subject to the following payment obligations.

When progress payments are made to the Contractor according to Article 109.07 of the Standard Specifications, the Contractor shall make a corresponding payment to each subcontractor and material supplier in proportion to the work satisfactorily completed by each subcontractor and for the material supplied to perform any work of the contract. The proportionate amount of partial payment due to each subcontractor and material supplier throughout the contracting chain shall be determined by the quantities measured or otherwise determined as eligible for payment by the Department and included in the progress payment to the Contractor. Subcontractors and material suppliers shall be paid by the Contractor within 15 calendar days after the receipt of payment from the Department. The Contractor shall not hold retainage from the subcontractors. These obligations shall also apply to any payments made by subcontractors and material suppliers to their subcontractors and material suppliers; and to all payments made to lower tier subcontractors and material suppliers throughout the contracting chain. Any payment or portion of a payment subject to this provision may only be withheld from the subcontractor or material supplier to whom it is due for reasonable cause.

This Special Provision does not create any rights in favor of any subcontractor or material supplier against the State or authorize any cause of action against the State on account of any payment, nonpayment, delayed payment, or interest claimed by application of the State Prompt Payment Act. The Department will not approve any delay or postponement of the 15 day requirement except for reasonable cause shown after notice and hearing pursuant to Section

| 7(b) of the State Prompt Payment Act. State law creates other and additional remedies available to any subcontractor or material supplier, regardless of tier, who has not been paid for work properly performed or material furnished. These remedies are a lien against public funds set forth in Section 23(c) of the Mechanics Lien Act, 770 ILCS 60/23(c), and a recovery on the Contractor's payment bond according to the Public Construction Bond Act, 30 ILCS 550.

80022

SUBCONTRACTOR MOBILIZATION PAYMENTS (BDE)

Effective: April 2, 2005

Revised: April 1, 2011

To account for the preparatory work and operations necessary for the movement of subcontractor personnel, equipment, supplies, and incidentals to the project site and for all other work or operations that must be performed or costs incurred when beginning work approved for subcontracting according to Article 108.01 of the Standard Specifications, the Contractor shall make a mobilization payment to each subcontractor.

This mobilization payment shall be made at least 14 days prior to the subcontractor starting work. The amount paid shall be equal to 3 percent of the amount of the subcontract reported on form BC 260A submitted for the approval of the subcontractor's work.

The mobilization payment to the subcontractor is an advance payment of the reported amount of the subcontract and is not a payment in addition to the amount of the subcontract; therefore, the amount of the advance payment will be deducted from future progress payments.

This provision shall be incorporated directly or by reference into each subcontract approved by the Department.

80143

TRAFFIC CONTROL DEFICIENCY DEDUCTION (BDE)

Effective: August 1, 2011

Revise the third sentence of the third paragraph of Article 105.03(b) of the Standard Specifications to read:

“The daily monetary deduction will be \$2,500.”

80273

WEEKLY DBE TRUCKING REPORTS (BDE)

Effective: June 2, 2012

The Contractor shall provide a weekly report of Disadvantaged Business Enterprise (DBE) trucks hired by the Contractor or subcontractors (i.e. not owned by the Contractor or subcontractors) that are used on the jobsite; or used for the delivery and/or removal of equipment/material to and from the jobsite. The jobsite shall also include offsite locations, such as plant sites or storage sites, when those locations are used solely for this contract.

The report shall be submitted on the form provided by the Department within ten business days following the reporting period. The reporting period shall be Monday through Sunday for each week reportable trucking activities occur. The report shall be submitted to the Engineer and a copy shall be provided to the district EEO Officer.

Any costs associated with providing weekly DBE trucking reports shall be considered as included in the contract unit prices bid for the various items of work involved and no additional compensation will be allowed.

80302

80

WORKING DAYS (BDE)

Effective: January 1, 2002

The Contractor shall complete the work within 30 working days.

80071

PROGRAM AND OFFICE ENGINEER: CHARLES F. RIDDLE, P.E. 847-705-4406 SCHAUMBURG, IL

STATE OF ILLINOIS
 DEPARTMENT OF TRANSPORTATION
 DIVISION OF HIGHWAYS

PLANS FOR PROPOSED FEDERAL HIGHWAY

VARIOUS INTERSECTIONS
 PEDESTRIAN COUNTDOWN
 SIGNAL HEADS
 SECTION NO. 12-PEDTS-00-SP
 PROJECT HSIP-4003(012)
 JOB NO. C-91-373-12
 DUPAGE COUNTY

F.A. RTE.	SECTION	COUNTY	TOTAL SHEETS	SHEET NO.
	12-PEDTS-00-SP	DUPAGE	8	1
FED. ROAD DIST. NO.	ILLINOIS		CONTRACT NO. 63718	

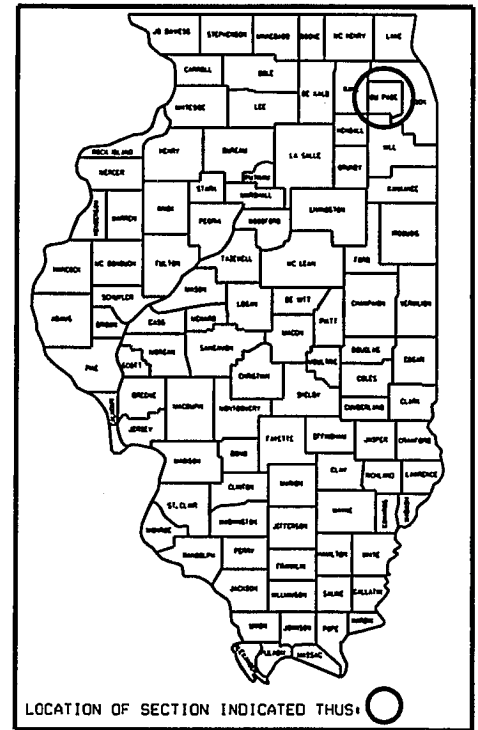

INDEX OF SHEETS

- 1 TITLE SHEET
- 2 GENERAL NOTES
- 3 LOCATION MAP
- 4 SUMMARY OF QUANTITIES
- 5-7 SCHEDULE OF QUANTITIES
- 8 DISTRICT 1 DETAIL TS-05 STATEWIDE STANDARDS

SEE SHEET 3 FOR LOCATION MAP

GROSS LENGTH OF PROJECT = N/A
 NET LENGTH OF PROJECT = N/A

PRINTED BY THE AUTHORITY
 OF THE STATE OF ILLINOIS

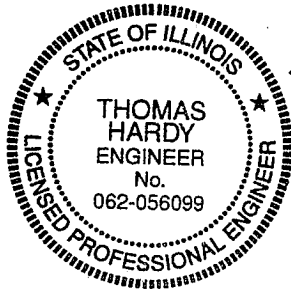

Thomas Hardy
 4/4/12

J.U.L.I.E.
 JOINT UTILITY LOCATION INFORMATION FOR EXCAVATION
 1-800-892-0123
 OR 811

CONTRACT NO. 63718

STATE OF ILLINOIS
 DEPARTMENT OF TRANSPORTATION
 DIVISION OF HIGHWAYS

APPROVED April 4 2012
Christopher Anyday
 DUPAGE COUNTY

PASSED MAY 21 2012
COH/et/et
 DISTRICT 1 ENGINEER OF LOCAL ROADS AND STREETS

RELEASING FOR
 BID BASED ON
 LIMITED REVIEW MAY 23 2012
Diana M. O'Keefe
 DEPUTY DIRECTOR OF HIGHWAYS, REGION ONE ENGINEER

F.A.P. RTE.	SECTION	COUNTY	TOTAL SHEETS	SHEET NO.
	I2-PEDTS-00-SP	DU PAGE	8	2
FED. ROAD DIST. NO. 1	ILLINOIS	CONTRACT NO. 63718		

GENERAL PLAN NOTES:

1. EXISTING CONDITIONS, INCLUDING THE CONDITION AND AVAILABILITY OF CONDUITS MUST BE FIELD VERIFIED BY THE CONTRACTOR.
2. THE ELECTRICAL CONTRACTOR SHALL BE RESPONSIBLE FOR THE LOCATION OF ALL EXISTING TRAFFIC SIGNAL AND LIGHTING FACILITIES IN THE PROJECT LIMITS. IF THERE ARE ANY QUESTIONS CONCERNING EXISTING EQUIPMENT THE CONTRACTOR SHALL CONTACT THE DUPAGE COUNTY DIVISION OF TRANSPORTATION AT (630)-407-6900 FOR TRAFFIC SIGNAL CABLE LOCATIONS A MINIMUM OF 48 HOURS IN ADVANCE (SATURDAYS, SUNDAYS AND HOLIDAYS EXCLUDED) AT ANY LOCATION WITHIN THE RIGHT-OF-WAY.

RESTORATION OF WORK AREA

RESTORATION OF THE TRAFFIC SIGNAL WORK AREA SHALL BE INCIDENTAL TO THE RELATED PAY ITEM SUCH AS FOUNDATION, CONDUIT, HANDHOLE, TRENCH AND BACKFILL, ETC. AND NO EXTRA COMPENSATION SHALL BE ALLOWED. ALL ROADWAY SURFACES SUCH AS SHOULDERS, MEDIANS, SIDEWALKS, PAVEMENT, ETC. SHALL BE REPLACED IN KIND. ALL DAMAGE TO MOWED LAWNS SHALL BE REPLACED WITH AN APPROVED SOD IN ACCORDANCE WITH STANDARD SPECIFICATIONS ARTICLE 252 WHICH SHALL INCLUDE THE REQUIRED WATERING PER ARTICLE 252.08. ALL DAMAGE TO UNMOWED FIELDS SHALL BE SEEDING IN ACCORDANCE WITH STANDARD SPECIFICATIONS ARTICLE 250 AND 251 RESPECTIVELY.

HIGHWAY STANDARDS

TS-05	DISTRICT 1 STANDARD TRAFFIC SIGNAL DESIGN DETAIL
701701-08	URBAN LANE CLOSURE, MULTILANE INTERSECTION
701901-02	TRAFFIC CONTROL DEVICES
880006-01	TRAFFIC SIGNAL MOUNTING DETAILS

REVISIONS	
NAME	DATE

DUPAGE COUNTY DIVISION OF TRANSPORTATION

GENERAL NOTES

SCALE: NONE
DATE: 03/30/12

DRAWN BY: TH
DESIGNED BY: TH
CHECKED BY: DAZ

Project Location Map

Pedestrian Countdown Signal Heads

DuPage County, IL

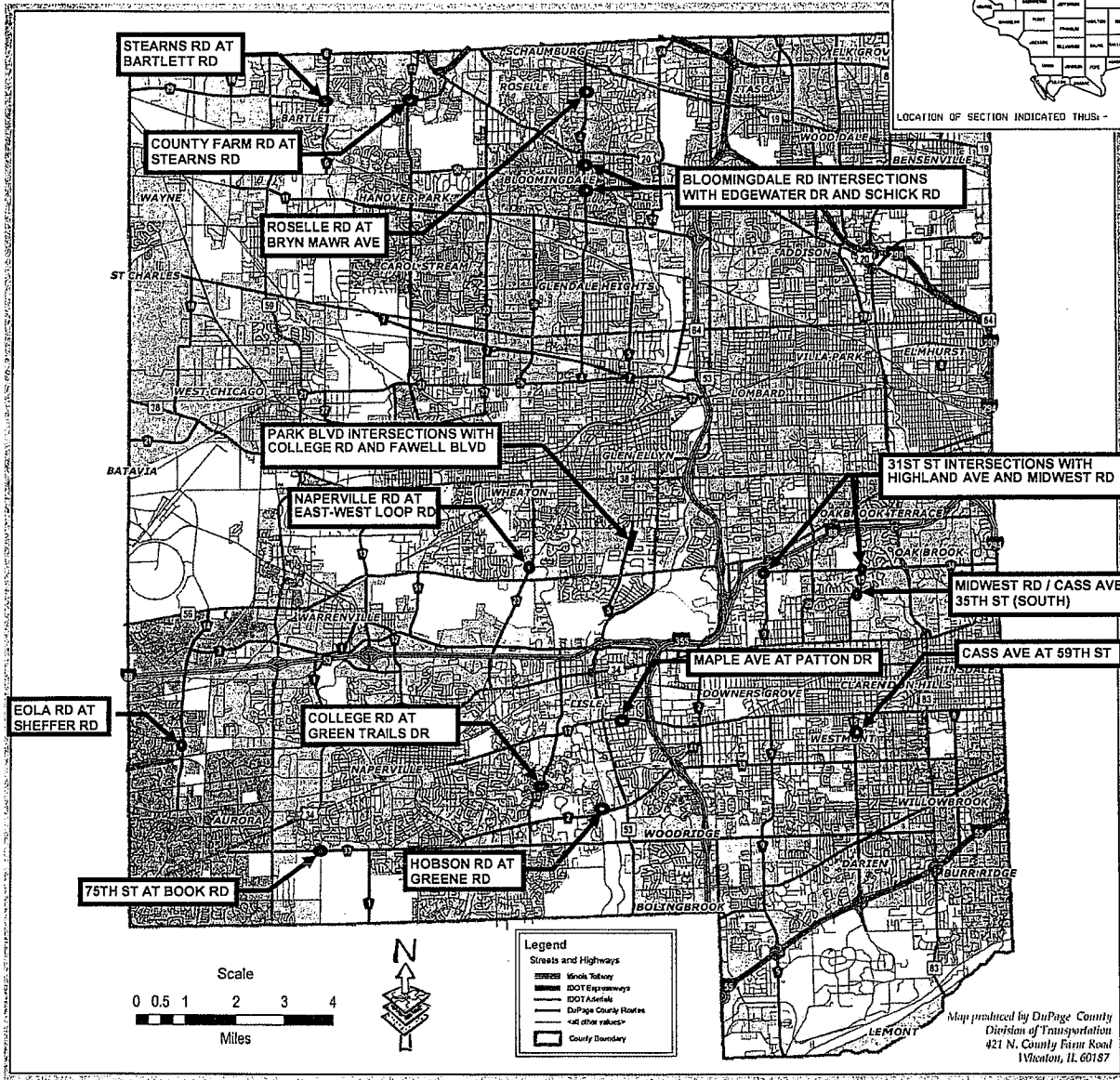
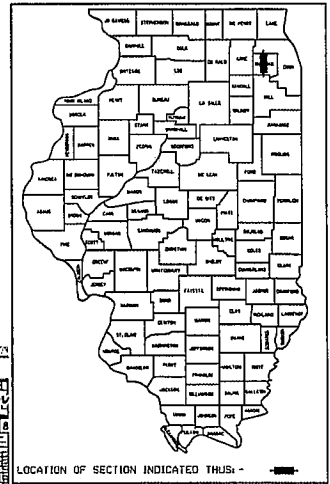

F.A.P. RTE.	SECTION	COUNTY	TOTAL SHEETS	SHEET NO.
	12-PEDTS-00-SP	DUPAGE	8	4
FED. ROAD DIST. NO. 1	ILLINOIS	CONTRACT NO. 63718		

CODE NUMBER	ITEM	UNIT	TOTAL QUANTITY- CONSTRUCT- ION CODE TYPE 0021
67100100	MOBILIZATION	L SUM	1
70102630	TRAFFIC CONTROL AND PROTECTION, STANDARD 701601	L SUM	1
70102635	TRAFFIC CONTROL AND PROTECTION, STANDARD 701701	L SUM	1
88102825	PEDESTRIAN SIGNAL HEAD, POLYCARBONATE, LED, 1-FACE, BRACKET MOUNTED WITH COUNTDOWN TIMER	EACH	54
88102845	PEDESTRIAN SIGNAL HEAD, POLYCARBONATE, LED, 2-FACE, BRACKET MOUNTED WITH COUNTDOWN TIMER	EACH	29
88800100	PEDESTRIAN PUSH BUTTON	EACH	79

REVISIONS	
NAME	DATE

DUPAGE COUNTY DIVISION OF TRANSPORTATION

SUMMARY OF QUANTITIES

SCALE: NONE
DATE: 03/08/12

DRAWN BY: DN
DESIGNED BY: DN
CHECKED BY: DAZ

CODE NUMBER	ITEM	UNIT	TOTAL QUANTITY-CONSTRUCTION TYPE 0021	31ST STREET & HIGHLAND AVENUE	31ST STREET & MIDWEST ROAD	75TH STREET & BOOK ROAD	BLOOMINGDALE ROAD & EDGEWATER DRIVE
88102825	PEDESTRIAN SIGNAL HEAD, POLYCARBONATE, LED, 1-FACE, BRACKET MOUNTED WITH COUNTDOWN TIMER	EACH	54	10	2	8	2
88102845	PEDESTRIAN SIGNAL HEAD, POLYCARBONATE, LED, 2-FACE, BRACKET MOUNTED WITH COUNTDOWN TIMER	EACH	29	1	1		1
88800100	PEDESTRIAN PUSH BUTTON	EACH	79	9	3	8	3

CODE NUMBER	ITEM	UNIT	TOTAL QUANTITY-CONSTRUCTION TYPE 0021	BLOOMINGDALE ROAD & SCHICK ROAD	CASS AVENUE & 59TH STREET	COLLEGE ROAD & GREEN TRAILS DRIVE	COUNTY FARM ROAD & STEARNS ROAD
88102825	PEDESTRIAN SIGNAL HEAD, POLYCARBONATE, LED, 1-FACE, BRACKET MOUNTED WITH COUNTDOWN TIMER	EACH	54	4	6		6
88102845	PEDESTRIAN SIGNAL HEAD, POLYCARBONATE, LED, 2-FACE, BRACKET MOUNTED WITH COUNTDOWN TIMER	EACH	29	2	1	4	1
88800100	PEDESTRIAN PUSH BUTTON	EACH	79	5	7	4	6

REVISIONS	
NAME	DATE

DUPAGE COUNTY DIVISION OF TRANSPORTATION

SCHEDULE OF QUANTITIES

SCALE: NONE
 DATE: 03/30/12

DRAWN BY: TH
 DESIGNED BY: TH
 CHECKED BY: DAZ

CODE NUMBER	ITEM	UNIT	TOTAL QUANTITY-CONSTRUCTION TYPE 0021	LOCATION
88102825	PEDESTRIAN SIGNAL HEAD, POLYCARBONATE, LED, 1-FACE, BRACKET MOUNTED WITH COUNTDOWN TIMER	EACH	54	HOBSON ROAD & GREENE ROAD
88102845	PEDESTRIAN SIGNAL HEAD, POLYCARBONATE, LED, 2-FACE, BRACKET MOUNTED WITH COUNTDOWN TIMER	EACH	29	EOLA ROAD & SHEFFER ROAD
88800100	PEDESTRIAN PUSH BUTTON	EACH	79	MAPLE AVENUE & PATTON ROAD

CODE NUMBER	ITEM	UNIT	TOTAL QUANTITY-CONSTRUCTION TYPE 0021	LOCATION
88102825	PEDESTRIAN SIGNAL HEAD, POLYCARBONATE, LED, 1-FACE, BRACKET MOUNTED WITH COUNTDOWN TIMER	EACH	54	NAPERVILLE ROAD & EAST-WEST LOOP ROAD
88102845	PEDESTRIAN SIGNAL HEAD, POLYCARBONATE, LED, 2-FACE, BRACKET MOUNTED WITH COUNTDOWN TIMER	EACH	29	ROAD/CASS AVENUE & 35TH STREET SOUTH
88800100	PEDESTRIAN PUSH BUTTON	EACH	79	MIDWEST PARK BOULEVARD & COLLEGE ROAD

REVISIONS	
NAME	DATE

DUPAGE COUNTY DIVISION OF TRANSPORTATION

SCHEDULE OF QUANTITIES

SCALE: NONE
 DATE: 03/30/12

DRAWN BY: TH
 DESIGNED BY: TH
 CHECKED BY: DAZ

F.A.P. RTE.	SECTION	COUNTY	TOTAL SHEETS	SHEET NO.
	12-PEDTS-00-SP	DUPAGE	8	7
FED. ROAD DIST. NO. 1	ILLINOIS	CONTRACT NO. 63718		

CODE NUMBER	ITEM	UNIT	TOTAL QUANTITY- CONSTRUCTION TYPE 0021	PARK BOULEVARD & FAWELL BOULEVARD	ROSELLE ROAD & BRYN MAWR AVENUE	STEARNS ROAD & BARTLETT ROAD
88102825	PEDESTRIAN SIGNAL HEAD, POLYCARBONATE; LED, 1-FACE, BRACKET MOUNTED WITH COUNTDOWN TIMER	EACH	54	2	4	
88102845	PEDESTRIAN SIGNAL HEAD, POLYCARBONATE; LED, 2-FACE, BRACKET MOUNTED WITH COUNTDOWN TIMER	EACH	29	2		4
88800100	PEDESTRIAN PUSH BUTTON	EACH	79	4	4	4

REVISIONS	
NAME	DATE

DUPAGE COUNTY DIVISION OF TRANSPORTATION

SCHEDULE OF QUANTITIES

SCALE: NONE

DATE: 03/30/12

DRAWN BY: TH
DESIGNED BY: TH
CHECKED BY: DAZ

TRAFFIC SIGNAL MAST ARM AND SIGNAL POST
MAST ARM MOUNTED SIGNALS IN EXISTING, PROPOSED OR FUTURE SIDEWALK/BICYCLE PATH AREA. INTERSECTION SHOWN WITH PEDESTRIAN SIGNALS AND PEDESTRIAN PUSHBUTTON DETECTORS.

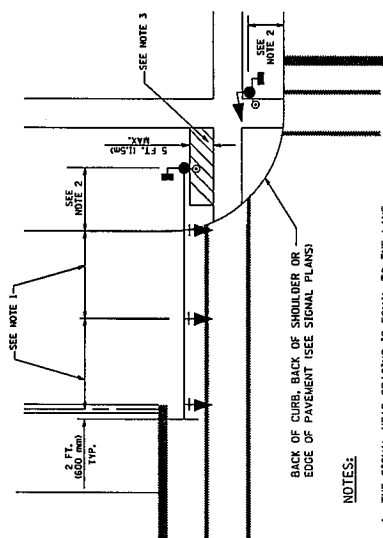

- NOTES:**
1. THE SIGNAL HEAD SPACING IS EQUAL TO THE LANE WIDTH OR AS SHOWN ON THE TRAFFIC SIGNAL PLAN.
 2. REFER TO THE TRAFFIC SIGNAL EQUIPMENT OFFSET TABLE.
 3. PROVIDE A LEVEL, ALL-WEATHER SURFACE (CONCRETE SIDEWALK, ASPHALT BICYCLE PATH SURFACE OR MATCHING MATERIAL TO THE ADJACENT SURFACED UP TO THE MAST ARM SHAFT OR THE SIGNAL POST.
 4. THE FACE OF THE PEDESTRIAN PUSHBUTTON SHALL BE PARALLEL TO THE CROSSWALK TO BE USED.
 5. THE LOCATIONS AND INSTALLATION OF PEDESTRIAN SIGNAL HEADS AND PEDESTRIAN PUSHBUTTONS SHALL MEET THE REQUIREMENTS OF THE MUTCD AND ACCESSIBILITY GUIDELINES FOR BUILDINGS AND FACILITIES.

PEDESTRIAN SIGNAL POST AND PEDESTRIAN PUSH BUTTON POST

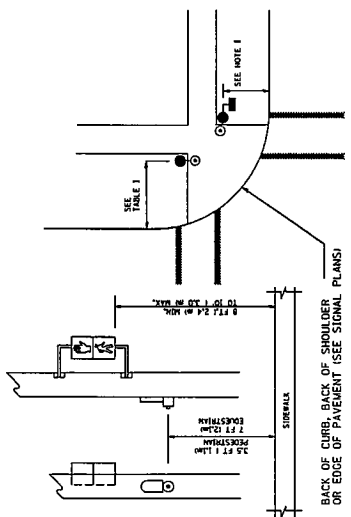

- NOTES:**
1. REFER TO THE TRAFFIC SIGNAL EQUIPMENT OFFSET TABLE.
 2. PROVIDE A LEVEL, ALL-WEATHER SURFACE (CONCRETE SIDEWALK, ASPHALT BICYCLE PATH SURFACE OR MATCHING MATERIAL TO THE ADJACENT SURFACED UP TO THE PEDESTRIAN SIGNAL POST OR THE PEDESTRIAN PUSH BUTTON POST.
 3. THE FACE OF THE PEDESTRIAN PUSHBUTTON SHALL BE PARALLEL TO THE CROSSWALK TO BE USED.
 4. THE LOCATIONS AND INSTALLATION OF PEDESTRIAN SIGNAL HEADS AND PEDESTRIAN PUSHBUTTONS SHALL MEET THE REQUIREMENTS OF THE MUTCD AND INFORMATION FOUND IN THE AMERICANS WITH DISABILITIES ACT ACCESSIBILITY GUIDELINES FOR BUILDINGS AND FACILITIES.

RECOMMENDED PUSHBUTTON LOCATIONS

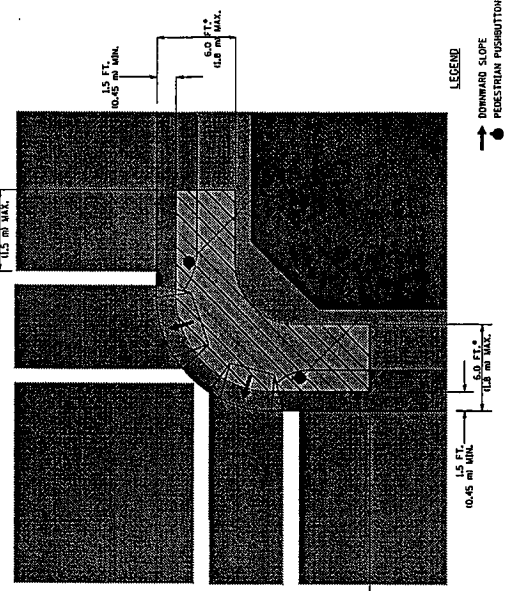

- LEGEND**
- DOWNWARD SLOPE
 - RECOMMENDED PUSHBUTTON
 - PUSHBUTTON LOCATIONS
- WHERE THERE ARE CONSTRAINTS THAT MAKE IT IMPRACTICAL TO PLACE THE PEDESTRIAN PUSHBUTTON BETWEEN 1.5 FT (0.45 m) AND 3 FT (1.8 m) FROM THE EDGE OF THE CURB, SHOULDER, OR PAVEMENT, IT SHOULD NOT BE FURTHER THAN 10 FT (3 m) FROM THE EDGE OF CURB, SHOULDER, OR PAVEMENT.
- ** WHERE THERE ARE CONSTRAINTS ON A PARTICULAR CORNER THAT MAKE IT IMPRACTICAL TO PROVIDE THE 10 FT (3 m) SEPARATION BETWEEN THE TWO PEDESTRIAN PUSHBUTTONS, THE PUSHBUTTONS MAY BE PLACED CLOSER TOGETHER OR ON THE SAME POLE.

TRAFFIC SIGNAL EQUIPMENT OFFSET

TRAFFIC SIGNAL EQUIPMENT	COMBINATION CONCRETE CURB AND GUTTER (MINIMUM DISTANCE FROM BACK OF CURB TO CENTERLINE OF FOUNDATION)	SHOULDER/NON-CURBED AREA (MINIMUM DISTANCE FROM EDGE OF PAVEMENT TO CENTERLINE OF FOUNDATION)
TRAFFIC SIGNAL MAST ARM POLE	6 FT (1.8m)	SHOULDER WIDTH + 2 FT (0.6m), MINIMUM 10 FT (3.0m)
TRAFFIC SIGNAL POST	4 FT (1.2m)	SHOULDER WIDTH + 2 FT (0.6m), MINIMUM 10 FT (3.0m)
PEDESTRIAN SIGNAL POST	4 FT (1.2m)	SHOULDER WIDTH + 2 FT (0.6m), MINIMUM 10 FT (3.0m)
PEDESTRIAN PUSHBUTTON POST	4 FT (1.2m)	SHOULDER WIDTH + 2 FT (0.6m), MINIMUM 10 FT (3.0m)
TEMPORARY WOOD POLE	6 FT (1.8m)	SHOULDER WIDTH + 2 FT (0.6m), MINIMUM 10 FT (3.0m)
CONTROLLER CABINET	6 FT (1.8m) MINIMUM DISTANCE SEE NOTE 2	SHOULDER WIDTH + 5 FT (1.5m), MINIMUM 16 FT (4.9m) SEE NOTE 3.
SERVICE INSTALLATION, GROUND MOUNT	6 FT (1.8m) MINIMUM DISTANCE SEE NOTE 2	SHOULDER WIDTH + 6 FT (1.8m), MINIMUM 16 FT (4.9m) SEE NOTE 3.

- NOTES:**
1. CONTACT THE "AREA TRAFFIC SIGNAL MAINTENANCE AND OPERATIONS ENGINEER" FOR ASSISTANCE IN LOCATING THE TRAFFIC SIGNAL EQUIPMENT WHEN THERE ARE CONFLICTS WITH DITCHES OR THE MINIMUM OFFSET DISTANCES CANNOT BE MET.
 2. MINIMUM DISTANCE FROM THE BACK OF CURB TO THE ROADWAY SIDE OF THE FOUNDATION.
 3. MINIMUM DISTANCE FROM THE EDGE OF PAVEMENT TO THE ROADWAY SIDE OF THE FOUNDATION.
 4. ANY CHANGES TO THE OFFSETS OF THE FOUNDATIONS, FROM THE MINIMUM DISTANCES LISTED IN THE "TRAFFIC SIGNAL EQUIPMENT OFFSET" CHART MUST BE APPROVED BY THE AREA TRAFFIC SIGNAL MAINTENANCE AND OPERATIONS ENGINEER. PEDESTRIAN PUSHBUTTONS, THE SIGNAL HEAD PLACEMENT ON THE MAST ARMS SHALL BE AS PER THE TRAFFIC SIGNAL INSTALLATION PLAN AND THE "TRAFFIC SIGNAL MAST ARM AND SIGNAL POST" DETAIL ABOVE. THE PROPOSED MAST ARM LENGTHS MAY NEED TO BE REVISED TO MEET THE ABOVE REQUIREMENTS. THE PEDESTRIAN SIGNAL HEADS AND PEDESTRIAN PUSHBUTTONS MUST MEET THE REQUIREMENTS UNDER THE DETAILS ON THIS SHEET.

NOTES:

1. PEDESTRIAN SIGNAL HEADS SHALL BE MOUNTED WITH THE BOTTOM OF THE SIGNAL HOUSING INCLUDING BRACKETS NOT LESS THAN 8 FT (2.4 m) OR MORE THAN 10 FT (3 m) ABOVE SIDEWALK LEVEL, AND SHALL BE POSITIONED AND ADJUSTED TO PROVIDE MAXIMUM VISIBILITY AT THE BEGINNING OF THE CONTROLLED CROSSWALK.
2. THE BOTTOM OF THE SIGNAL HOUSING (INCLUDING BRACKETS) OF A VEHICULAR SIGNAL FACE THAT IS NOT LOCATED OVER A HIGHWAY SHALL BE AT LEAST 8 FT (2.4 m) BUT NOT MORE THAN 13 FT (3.9 m) ABOVE THE SIDEWALK OR, IF THERE IS NO SIDEWALK, ABOVE THE PAVEMENT GRADE AT THE CENTER OF THE ROADWAY.
3. THE BOTTOM OF THE SIGNAL HOUSING AND ANY RELATED ATTACHMENTS TO A SIGNAL FACE LOCATED OVER ANY PORTION OF A HIGHWAY SHALL BE ACCORDING TO CURRENT STATE STANDARDS 87700L, 87700Z, 87700G, 87701L AND 87701Z WITH A MINIMUM OF 16 FT (5.0 m) AND A MAXIMUM OF 18 FT (5.5 m) FROM THE HIGHEST POINT OF PAVEMENT.
4. THE BOTTOM OF THE TEMPORARY SPAN WIRE MOUNTED SIGNAL HOUSING AND ANY RELATED ATTACHMENTS TO A SIGNAL FACE LOCATED OVER ANY PORTION OF A HIGHWAY SHALL BE ACCORDING TO CURRENT STATE STANDARD 88000 WITH A MINIMUM OF 11 FT (3.3 m) FROM THE HIGHEST POINT OF PAVEMENT.
5. THE TOP OF THE SIGNAL HOUSING OF A SIGNAL FACE LOCATED OVER ANY PORTION OF A HIGHWAY SHALL NOT BE MORE THAN 25.5 FT (7.8 m) ABOVE THE PAVEMENT.

FILE NAME	USER NAME	DESIGNED	DWG	SECTION	COUNTY	SHEET
		DRAWN	BCX			8
		CHECKED	DAD			
		DATE	10/28/09			
STANDARD TRAFFIC SIGNAL DESIGN DETAILS			DISTRICT 1			
STATE OF ILLINOIS			DEPARTMENT OF TRANSPORTATION			
SHEET NO. 2 OF 6 SHEETS			STA. TO STA.			
CONTRACT NO. 03718			ILLINOIS/EEB JOB PROJECT			

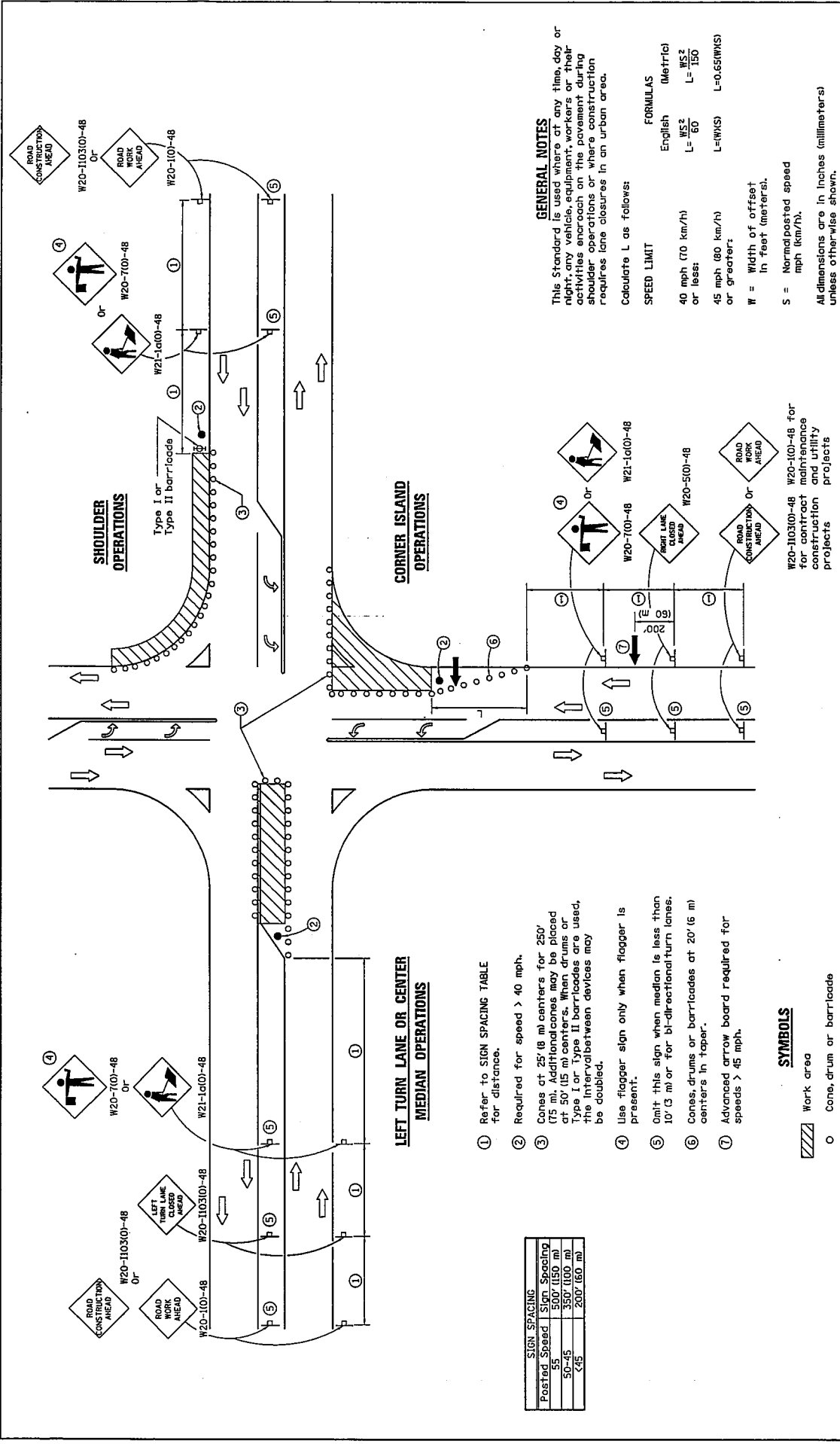

Posted Speed	Sign Spacing
55	500' (150 m)
50-45	350' (100 m)
<45	200' (60 m)

- LEFT TURN LANE OR CENTER MEDIAN OPERATIONS**
- Refer to SIGN SPACING TABLE for distance.
 - Required for speed > 40 mph.
 - Cones at 25' (8 m) centers for 250' (75 m). Additional cones may be placed at 30' (9 m) centers. Flashed drums or Type I or Type II barricades are used. The interval between devices may be doubled.
 - Use flagger sign only when flagger is present.
 - Only this sign when median is less than 10' (3 m) or for bi-directional turn lanes. Centers in taper.
 - Cones, drums or barricades at 20' (6 m) centers in taper.
 - Advanced arrow board required for speeds > 45 mph.

SYMBOLS

- Work area
- Cone, drum or barricade
- Sign on portable or permanent support
- Arrow board
- Barricade or drum with flashing light
- Flagger with traffic control sign

GENERAL NOTES
 This Standard is used where at any time, day or night, any vehicle, equipment, workers or their activities encroach on the pavement during shoulder operations or where construction requires lane closures in an urban area.

Calculate L as follows:

SPEED LIMIT

English $L = \frac{WS^2}{60}$

Metric $L = \frac{WS^2}{150}$

English $L = (W)(S)$

Metric $L = 0.65(W)(S)$

W = Width of offset in feet (meters).

S = Normal posted speed in mph (km/h).

All dimensions are in inches (millimeters) unless otherwise shown.

URBAN LANE CLOSURE, MULTILANE INTERSECTION	
DATE	REVISIONS
1-1-12	Revised flagger sign.
	Omitted W21-I10 sign.
1-1-11	Added advanced arrow board and note ①.

STANDARD 701701-08

Illinois Department of Transportation

APPROVED: *[Signature]* JANUARY 1, 2012
 ENGINEER OF SAFETY ENGINEERING

ISSUED 1-1-97

APPROVED: *[Signature]* JANUARY 1, 2012
 ENGINEER OF DESIGN AND ENVIRONMENT

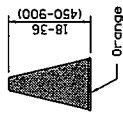

CONE

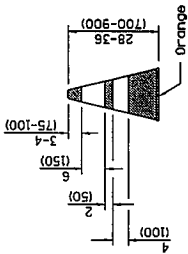

REFLECTORIZED CONE

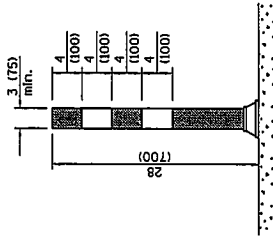

FLEXIBLE DELINEATOR

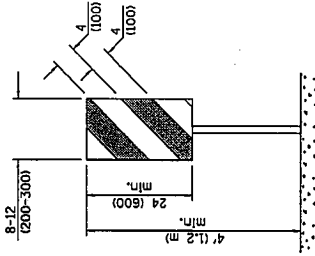

**VERTICAL PANEL
POST MOUNTED**

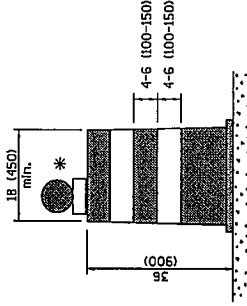

DRUM

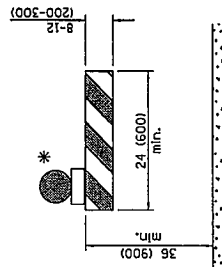

TYPE I BARRICADE

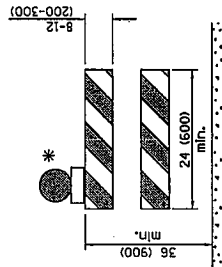

TYPE II BARRICADE

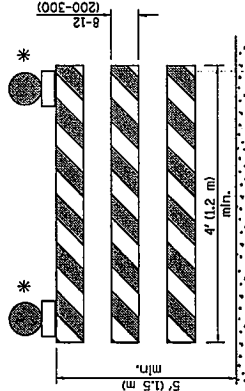

TYPE III BARRICADE

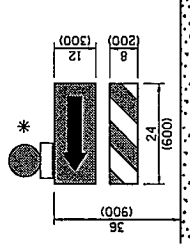

**DIRECTION INDICATOR
BARRICADE**

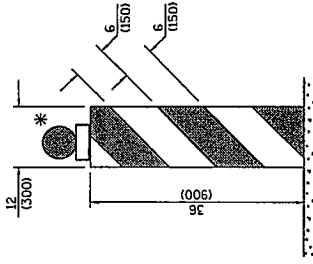

VERTICAL BARRICADE

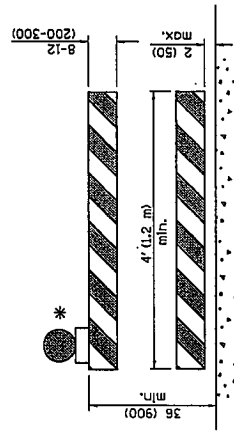

**DETECTABLE PEDESTRIAN
CHANNELIZING BARRICADE**

* Warning lights (if required)

GENERAL NOTES
All heights shown shall be measured above the pavement surface.
All dimensions are in inches (millimeters) unless otherwise shown.

DATE	REVISIONS
1-1-12	Added DETECTABLE PEDESTRIAN CHANNELIZING BARRICADE.
1-1-09	Switched units to English (metric). Omitted light on vertical panel.

**TRAFFIC CONTROL
DEVICES**

(Sheet 1 of 3)

STANDARD 701901-02

Illinois Department of Transportation
 APPROVED: [Signature] January 1, 2012
 ENGINEER OF OPERATIONS
 APPROVED: [Signature] January 1, 2012
 ENGINEER OF DESIGN AND ENVIRONMENT

ISSUED 1-1-97

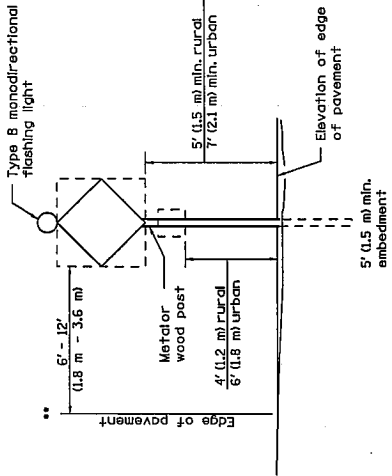

POST MOUNTED SIGNS

** When curb or paved shoulder are present this dimension shall be 24 (600) to the face of curb or 5' (1.5 m) to the outside edge of the paved shoulder.

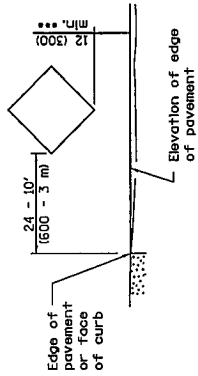

SIGNS ON TEMPORARY SUPPORTS

*** When work operations exceed four days this dimension shall be 5' (1.5 m) min. If located behind other devices, the height shall be sufficient to be seen by motorists.

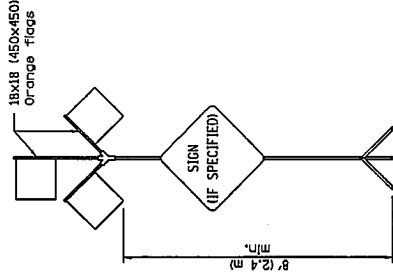

HIGH LEVEL WARNING DEVICE

ROAD CONSTRUCTION NEXT X MILES

620-110-6036

END CONSTRUCTION

620-2a101-6024

This signing is required for all projects 2 miles (3200 m) or more in length.

ROAD CONSTRUCTION NEXT X MILES sign shall be placed 500' (150 m) in advance of project limits.

END CONSTRUCTION sign shall be erected at the end of the job unless another job is within 2 miles (3200 m).

Distance displays shall be utilized on multi-lane highways.

WORK LIMIT SIGNING

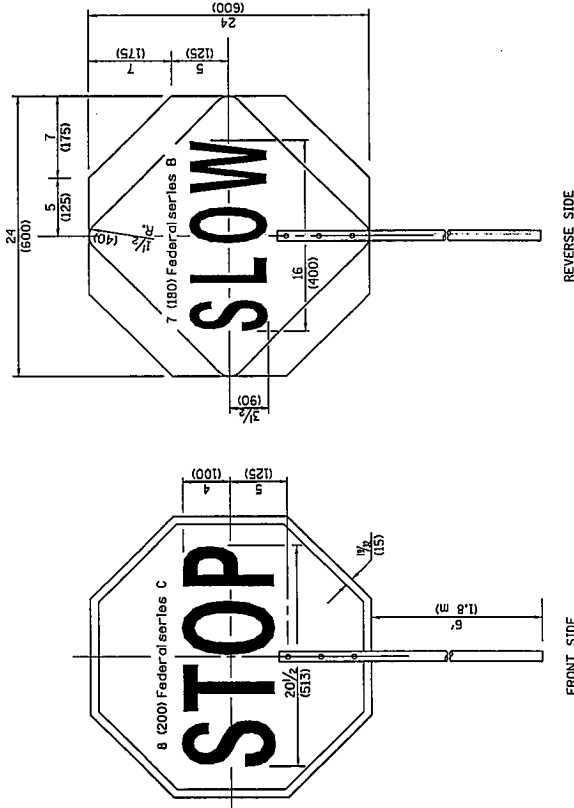

FLAGGER TRAFFIC CONTROL SIGN

REVERSE SIDE

FRONT SIDE

All dimensions are in inches (millimeters) unless otherwise shown.

TRAFFIC CONTROL DEVICES

(Sheet 2 of 3)

STANDARD 701901-02

Illinois Department of Transportation		ISSUED 1-1-97
APPROVED	ENGINYER I. 2012	
APPROVED	ENGINYER OF OPERATIONS	
APPROVED	ENGINYER I. 2012	
ENGINEER OF HIGHWAY AND ENVIRONMENT		

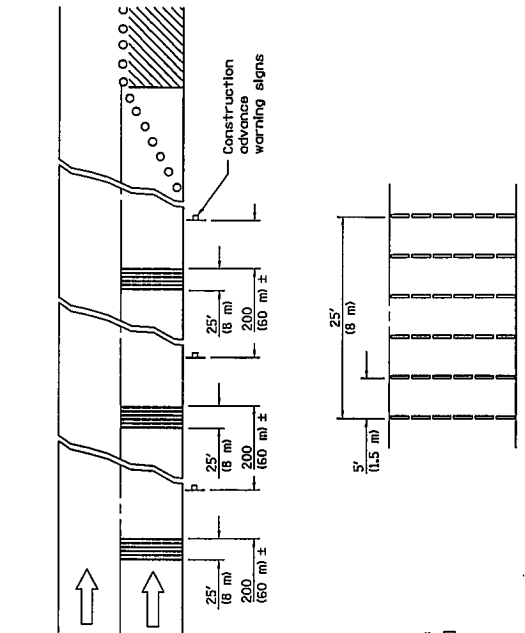

TYPICAL INSTALLATION

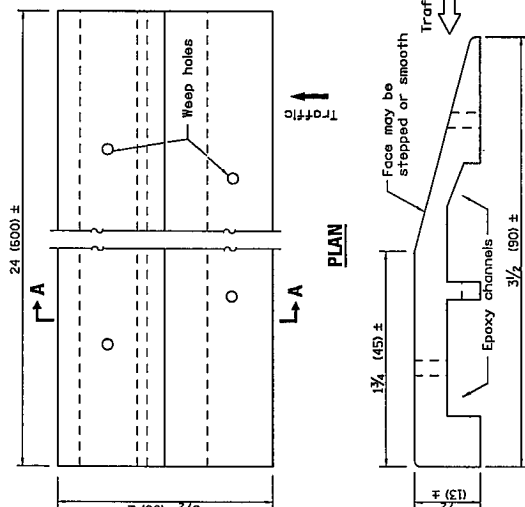

SECTION A-A

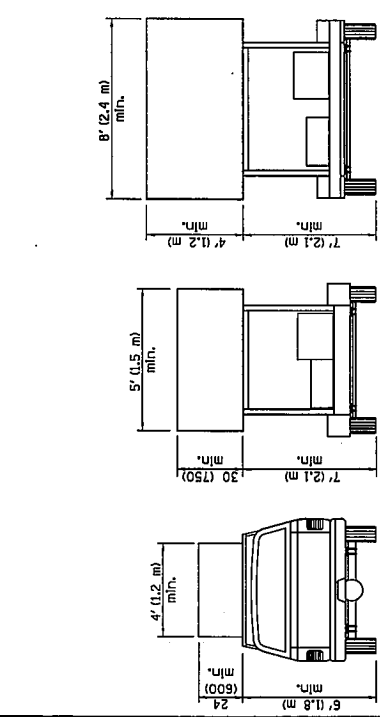

ARROW BOARDS

TEMPORARY RUMBLE STRIPS

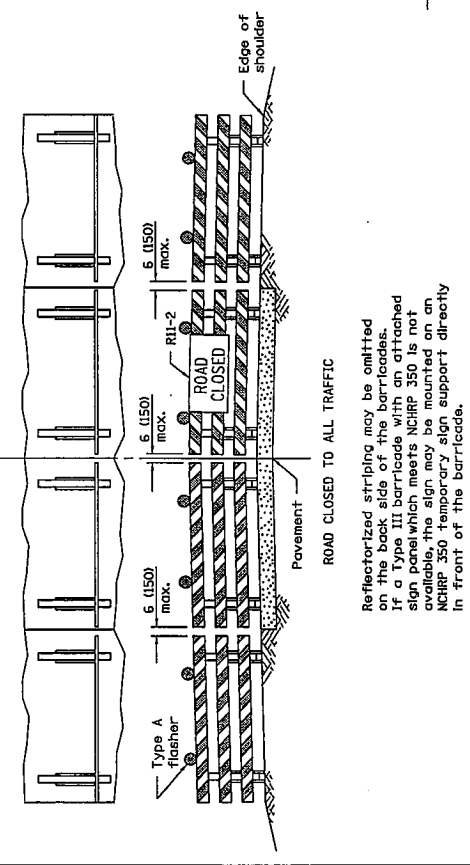
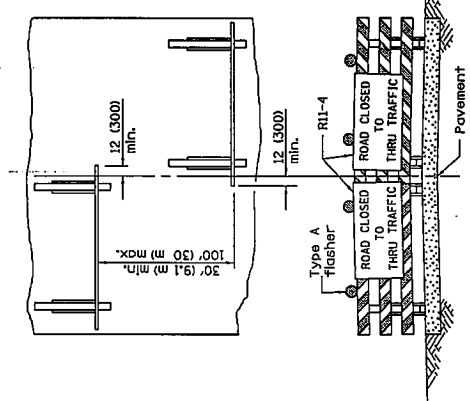

TYPICAL APPLICATIONS OF TYPE III BARRICADES CLOSING A ROAD

TRAFFIC CONTROL DEVICES

STANDARD 701901-02

All dimensions are in inches (millimeters) unless otherwise shown.

Illinois Department of Transportation		ISSUED 1-1-97	
APPROVED	January 1, 2012	APPROVED	January 1, 2012
ENGINEER OF OPERATIONS		ENGINEER OF OPERATIONS	
APPROVED		APPROVED	
ENGINEER OF DESIGN AND ENVIRONMENT			

ReflectORIZED striping shall appear on both sides of the barricades. If a Type III barricade with an attached sign panel which meets NCHRP 350 is no longer used, the signs may be mounted on NCHRP 350 temporary sign supports directly in front of the barricade.

ReflectORIZED striping may be omitted on the back side of the barricades. If a Type III barricade with an attached sign panel which meets NCHRP 350 is no longer used, the signs may be mounted on NCHRP 350 temporary sign support directly in front of the barricade.

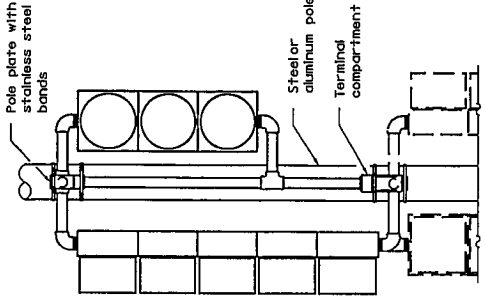

**BRACKET MOUNTED
TRAFFIC SIGNAL HEAD**

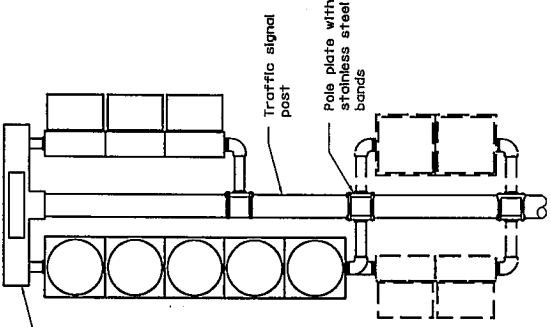

**BRACKET MOUNTED
TRAFFIC SIGNAL HEAD**

TWO WAY

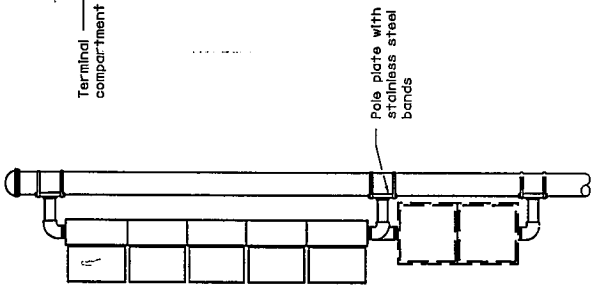

**BRACKET MOUNTED
TRAFFIC SIGNAL HEAD**

ONE WAY

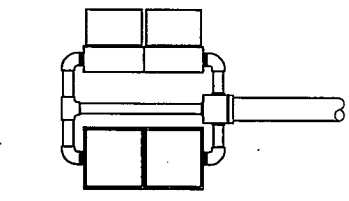

**POST MOUNTED
PEDESTRIAN SIGNAL HEAD**

TWO WAY

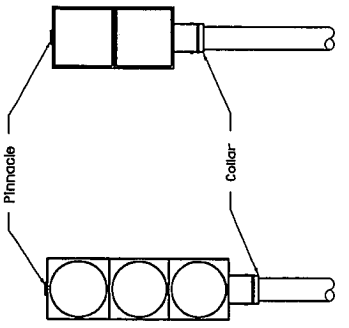

**POST MOUNTED
TRAFFIC SIGNAL HEAD**

ONE WAY

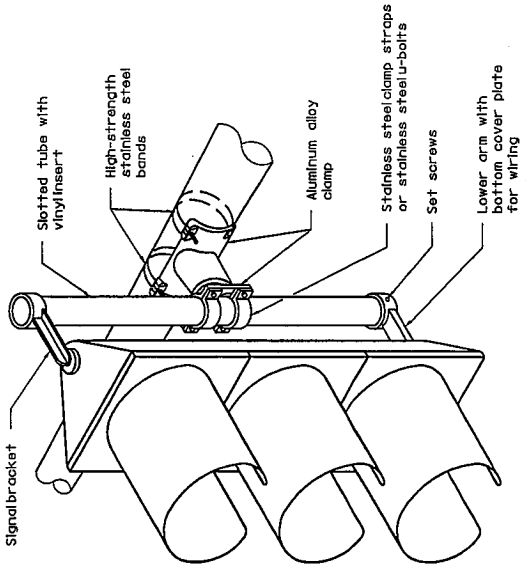

STEEL MAST ARM MOUNTING

DATE	REVISIONS
1-1-09	Omitted note regarding units of length.
1-1-02	Renum. Standard 840005.

**TRAFFIC SIGNAL
MOUNTING DETAILS**

STANDARD 880005-01

Illinois Department of Transportation
 APPROVED: [Signature] January 1, 2009
 ENGINEER OF OPERATIONS
 APPROVED: [Signature] January 1, 2009
 ENGINEER OF DESIGN AND ENVIRONMENT

ISSUED 1-1-02

**REQUIRED CONTRACT PROVISIONS
FEDERAL-AID CONSTRUCTION CONTRACTS**

	Page
I. General	1
II. Nondiscrimination	1
III. Nonsegregated Facilities	3
IV. Payment of Predetermined Minimum Wage.....	3
V. Statements and Payrolls	5
VI. Record of Materials, Supplies, and Labor.....	6
VII. Subletting or Assigning the Contract.....	6
VIII. Safety: Accident Prevention	7
IX. False Statements Concerning Highway Projects.....	7
X. Implementation of Clean Air Act and FederalWater Pollution Control Act	7
XI. Certification Regarding Debarment, Suspension, Ineligibility, and Voluntary Exclusion	8
XII. Certification Regarding Use of Contract Funds for Lobbying	9

ATTACHMENTS

- A. Employment Preference for Appalachian Contracts
(included in Appalachian contracts only)

I. GENERAL

1. These contract provisions shall apply to all work performed on the contract by the contractor's own organization and with the assistance of workers under the contractor's immediate superintendence and to all work performed on the contract by piecework, station work, or by subcontract.

2. Except as otherwise provided for in each section, the contractor shall insert in each subcontract all of the stipulations contained in these Required Contract Provisions, and further require their inclusion in any lower tier subcontract or purchase order that may in turn be made. The Required Contract Provisions shall not be incorporated by reference in any case. The prime contractor shall be responsible for compliance by any subcontractor or lower tier subcontractor with these Required Contract Provisions.

3. A breach of any of the stipulations contained in these Required Contract Provisions shall be sufficient grounds for termination of the contract.

4. A breach of the following clauses of the Required Contract Provisions may also be grounds for debarment as provided in 29 CFR 5.12:

- Section I, paragraph 2;
- Section IV, paragraphs 1, 2, 3, 4 and 7;
- Section V, paragraphs 1 and 2a through 2g.

5. Disputes arising out of the labor standards provisions of Section IV (except paragraph 5) and Section V of these Required Contract Provisions shall not be subject to the general disputes clause of this contract. Such disputes shall be resolved in accordance with the procedures of the U.S. Department of Labor (DOL) as set forth in 29 CFR 5, 6 and 7. Disputes within the meaning of this clause include disputes between the contractor (or any of its subcontractors) and the contracting agency, the DOL, or the contractor's employees or their representatives.

6. Selection of Labor: During the performance of this contract, the contractor shall not:

- a. Discriminate against labor from any other State, possession, or territory of the United States (except for employment preference for Appalachian contracts, when applicable, as specified in Attachment A), or
- b. Employ convict labor for any purpose within the limits of the project unless it is labor performed by convicts who are on parole, supervised release, or probation.

II. NONDISCRIMINATION

(Applicable to all Federal-aid construction contracts and to all related subcontracts of \$10,000 or more.)

1. Equal Employment Opportunity: Equal employment opportunity (EEO) requirements not to discriminate and to take affirmative action to assure equal opportunity as set forth under laws, executive orders, rules, regulations (28 CFR 35, 29 CFR 1630 and 41 CFR 60 (and orders of the Secretary of Labor as modified by the provisions prescribed herein, and imposed pursuant to 23 U.S.C. 140 shall constitute the EEO and specific affirmative action standards for the contractor's project activities under this contract. The Equal Opportunity Construction Contract Specifications set forth under 41 CFR 60-4.3 and the provisions of the American Disabilities Act of 1990 (42 U.S.C. 12101 et seq.) set forth under 28 CFR 35 and 29 CFR 1630 are incorporated by reference in this contract. In the execution of this contract, the contractor agrees to comply with the following minimum specific requirement activities of EEO:

- a. The contractor will work with the State highway agency (SHA) and the Federal Government in carrying out EEO obligations and in their review of his/her activities under the contract.
- b. The contractor will accept as his operating policy the following statement: "It is the policy of this Company to assure that applicants are employed, and that employees are treated during employment, without regard to their race, religion, sex, color, national origin, age or disability. Such action shall include: employment, upgrading, demotion, or transfer; recruitment or recruitment advertising; layoff or termination; rates of pay or other forms of compensation; and selection for training, including apprenticeship, preapprenticeship, and/or on-the-job-training."

2. EEO Officer: The contractor will designate and make known to the SHA contracting officers an EEO Officer who will have the responsibility for an must be capable of effectively administering and promoting an active contractor program of EEO and who must be assigned adequate authority and responsibility to do so.

3. Dissemination of Policy: All members of the contractor's staff who are authorized to hire, supervise, promote, and discharge employees, or who recommend such action, or who are substantially involved in such action, will be made fully cognizant of, and will implement, the contractor's EEO policy and contractual responsibilities to provide EEO in each grade and classification of employment. To ensure that the above agreement will be met, the following actions will be taken as a minimum:

- a. Periodic meetings of supervisory and personnel office employees will be conducted before the start of work and then not less often than once every six months, at which time the contractor's EEO policy and its implementation will be reviewed and explained. The meetings will be conducted by the EEO Officer.
- b. All new supervisory or personnel office employees will be given a thorough indoctrination by the EEO Officer, covering all major aspects of the contractor's EEO obligations within thirty days following their reporting for duty with the contractor.
- c. All personnel who are engaged in direct recruitment for the project will be instructed by the EEO Officer in the contractor's procedures for locating and hiring minority group employees.
- d. Notices and posters setting forth the contractor's EEO policy will be placed in areas readily accessible to employees, applicants for employment and potential employees.
- e. The contractor's EEO policy and the procedures to implement such policy will be brought to the attention of employees by means of meetings, employee handbooks, or other appropriate means.

4. Recruitment: When advertising for employees, the contractor will include in all advertisements for employees the notation: "An Equal Opportunity Employer." All such advertisements will be placed in publications having a large circulation among minority groups in the area from which the project work force would normally be derived.

- a. The contractor will, unless precluded by a valid bargaining agreement, conduct systematic and direct recruitment through public and private employees referral sources likely to yield qualified minority group applicants. To meet this requirement, the contractor will identify sources of potential minority group employees, and establish which such identified sources procedures whereby minority group applicants may be referred

to the contractor for employment consideration.

b. In the event the contractor has a valid bargaining agreement providing for exclusive hiring hall referrals, he is expected to observe the provisions of that agreement to the extent that the system permits the contractor's compliance with EEO contract provisions. (The DOL has held that where implementation of such agreements have the effect of discriminating against minorities or women, or obligates the contractor to do the same, such implementation violates Executive Order 11246, as amended.)

c. The contractor will encourage his present employees to refer minority group applicants for employment. Information and procedures with regard to referring minority group applicants will be discussed with employees.

5. Personnel Actions: Wages, working conditions, and employee benefits shall be established and administered, and personnel actions of every type, including hiring, upgrading, promotion, transfer, demotion, layoff, and termination, shall be taken without regard to race, color, religion, sex, national origin, age or disability. The following procedures shall be followed:

a. The contractor will conduct periodic inspections of project sites to insure that working conditions and employee facilities do not indicate discriminatory treatment of project site personnel.

b. The contractor will periodically evaluate the spread of wages paid within each classification to determine any evidence of discriminatory wage practices.

c. The contractor will periodically review selected personnel actions in depth to determine whether there is evidence of discrimination. Where evidence is found, the contractor will promptly take corrective action. If the review indicates that the discrimination may extend beyond the actions reviewed, such corrective action shall include all affected persons.

d. The contractor will promptly investigate all complaints of alleged discrimination made to the contractor in connection with his obligations under this contract, will attempt to resolve such complaints, and will take appropriate corrective action within a reasonable time. If the investigation indicates that the discrimination may affect persons other than the complainant, such corrective action shall include such other persons. Upon completion of each investigation, the contractor will inform every complainant of all of his avenues of appeal.

6. Training and Promotion:

a. The contractor will assist in locating, qualifying, and increasing the skills of minority group and women employees, and applicants for employment.

b. Consistent with the contractor's work force requirements and as permissible under Federal and State regulations, the contractor shall make full use of training programs, i.e., apprenticeship, and on-the-job training programs for the geographical area of contract performance. Where feasible, 25 percent of apprentices or trainees in each occupation shall be in their first year of apprenticeship or training. In the event a special provision for training is provided under this contract, this subparagraph will be superseded as indicated in the special provision.

c. The contractor will advise employees and applicants for employment of available training programs and entrance requirements for each.

d. The contractor will periodically review the training and promotion potential of minority group and women employees and will encourage eligible employees to apply for such training and promotion.

7. Unions: If the contractor relies in whole or in part upon unions as a source of employees, the contractor will use his/her best efforts to obtain the cooperation of such unions to increase opportunities for minority groups and women within the unions, and to effect referrals by such unions of minority and female employees. Actions by the contractor either directly or through a contractor's association acting as agent will include the procedures set forth below:

a. The contractor will use best efforts to develop, in cooperation with the unions, joint training programs aimed toward qualifying more minority group members and women

for membership in the unions and increasing the skills of minority group employees and women so that they may qualify for higher paying employment.

b. The contractor will use best efforts to incorporate an EEO clause into each union agreement to the end that such union will be contractually bound to refer applicants without regard to their race, color, religion, sex, national origin, age or disability.

c. The contractor is to obtain information as to the referral practices and policies of the labor union except that to the extent such information is within the exclusive possession of the labor union and such labor union refuses to furnish such information to the contractor, the contractor shall so certify to the SHA and shall set forth what efforts have been made to obtain such information.

d. In the event the union is unable to provide the contractor with a reasonable flow of minority and women referrals within the time limit set forth in the collective bargaining agreement, the contractor will, through independent recruitment efforts, fill the employment vacancies without regard to race, color, religion, sex, national origin, age or disability; making full efforts to obtain qualified and/or quailifiable minority group persons and women. (The DOL has held that it shall be no excuse that the union with which the contractor has a collective bargaining agreement providing for exclusive referral failed to refer minority employees.) In the event the union referral practice prevents the contractor from meeting the obligations pursuant to Executive Order 11246, as amended, and these special provisions, such contractor shall immediately notify the SHA.

8. Selection of Subcontractors, Procurement of Materials and Leasing of Equipment: The contractor shall not discriminate on the grounds of race, color, religion, sex, national origin, age or disability in the selection and retention of subcontractors, including procurement of materials and leases of equipment.

a. The contractor shall notify all potential subcontractors and suppliers of his/her EEO obligations under this contract.

b. Disadvantaged business enterprises (DBE), as defined in 49 CFR 23, shall have equal opportunity to compete for and perform subcontracts which the contractor enters into pursuant to this contract. The contractor will use his best efforts to solicit bids from and to utilize DBE subcontractors or subcontractors with meaningful minority group and female representation among their employees. Contractors shall obtain lists of DBE construction firms from SHA personnel.

c. The contractor will use his best efforts to ensure subcontractor compliance with their EEO obligations.

9. Records and Reports: The contractor shall keep such records as necessary to document compliance with the EEO requirements. Such records shall be retained for a period of three years following completion of the contract work and shall be available at reasonable times and places for inspection by authorized representatives of the SHA and the FHWA.

a. The records kept by the contractor shall document the following:

- (1)** The number of minority and non-minority group members and women employed in each work classification on the project;
- (2)** The progress and efforts being made in cooperation with unions, when applicable, to increase employment opportunities for minorities and women;
- (3)** The progress and efforts being made in locating, hiring, training, qualifying, and upgrading minority and female employees; and
- (4)** The progress and efforts being made in securing the services of DBE subcontractors or subcontractors with meaningful minority and female representation among their employees.

b. The contractors will submit an annual report to the SHA each July for the duration of the project, indicating the number of minority, women, and non-minority group employees currently engaged in each work classification required by the

contract work. This information is to be reported on Form FHWA-1391. If on-the-job training is being required by special provision, the contractor will be required to collect and report training data.

III. NONSEGREGATED FACILITIES

(Applicable to all Federal-aid construction contracts and to all related subcontracts of \$10,000 or more.)

a. By submission of this bid, the execution of this contract or subcontract, or the consummation of this material supply agreement or purchase order, as appropriate, the bidder, Federal-aid construction contractor, subcontractor, material supplier, or vendor, as appropriate, certifies that the firm does not maintain or provide for its employees any segregated facilities at any of its establishments, and that the firm does not permit its employees to perform their services at any location, under its control, where segregated facilities are maintained. The firm agrees that a breach of this certification is a violation of the EEO provisions of this contract. The firm further certifies that no employee will be denied access to adequate facilities on the basis of sex or disability.

b. As used in this certification, the term "segregated facilities" means any waiting rooms, work areas, restrooms and washrooms, restaurants and other eating areas, timeclocks, locker rooms, and other storage or dressing areas, parking lots, drinking fountains, recreation or entertainment areas, transportation, and housing facilities provided for employees which are segregated by explicit directive, or are, in fact, segregated on the basis of race, color, religion, national origin, age or disability, because of habit, local custom, or otherwise. The only exception will be for the disabled when the demands for accessibility override (e.g. disabled parking).

c. The contractor agrees that it has obtained or will obtain identical certification from proposed subcontractors or material suppliers prior to award of subcontracts or consummation of material supply agreements of \$10,000 or more and that it will retain such certifications in its files.

IV. PAYMENT OF PREDETERMINED MINIMUM WAGE

(Applicable to all Federal-aid construction contracts exceeding \$2,000 and to all related subcontracts, except for projects located on roadways classified as local roads or rural minor collectors, which are exempt.)

1. General:

a. All mechanics and laborers employed or working upon the site of the work will be paid unconditionally and not less often than once a week and without subsequent deduction or rebate on any account [except such payroll deductions as are permitted by regulations (29 CFR 3) issued by the Secretary of Labor under the Copeland Act (40 U.S.C. 276c)] the full amounts of wages and bona fide fringe benefits (or cash equivalents thereof) due at time of payment. The payment shall be computed at wage rates not less than those contained in the wage determination of the Secretary of Labor (hereinafter "the wage determination") which is attached hereto and made a part hereof, regardless of any contractual relationship which may be alleged to exist between the contractor or its subcontractors and such laborers and mechanics. The wage determination (including any additional classifications and wage rates conformed under paragraph 2 of this Section IV and the DOL poster (WH-1321) or Form FHWA-1495) shall be posted at all times by the contractor and its subcontractors at the site of the work in a prominent and accessible place where it can be easily seen by the workers. For the purpose of this Section, contributions made or costs reasonably anticipated for bona fide fringe benefits under Section 1(b)(2) of the Davis-Bacon Act (40 U.S.C. 276a) on behalf of laborers or mechanics are considered wages paid to such laborers or mechanics, subject to the provisions of Section IV, paragraph 3b, hereof. Also, for the purpose of this Section, regular contributions made or costs incurred for more than a weekly period (but not less often than quarterly) under plans, funds, or programs, which cover the particular weekly period, are deemed to be constructively made or incurred

during such weekly period. Such laborers and mechanics shall be paid the appropriate wage rate and fringe benefits on the wage determination for the classification of work actually performed, without regard to skill, except as provided in paragraphs 4 and 5 of this Section IV.

b. Laborers or mechanics performing work in more than one classification may be compensated at the rate specified for each classification for the time actually worked therein, provided, that the employer's payroll records accurately set forth the time spent in each classification in which work is performed.

c. All rulings and interpretations of the Davis-Bacon Act and related acts contained in 29 CFR 1, 3, and 5 are herein incorporated by reference in this contract.

2. Classification:

a. The SHA contracting officer shall require that any class of laborers or mechanics employed under the contract, which is not listed in the wage determination, shall be classified in conformance with the wage determination.

b. The contracting officer shall approve an additional classification, wage rate and fringe benefits only when the following criteria have been met:

(1) the work to be performed by the additional classification requested is not performed by a classification in the wage determination;

(2) the additional classification is utilized in the area by the construction industry;

(3) the proposed wage rate, including any bona fide fringe benefits, bears a reasonable relationship to the wage rates contained in the wage determination; and

(4) with respect to helpers, when such a classification prevails in the area in which the work is performed.

c. If the contractor or subcontractors, as appropriate, the laborers and mechanics (if known) to be employed in the additional classification or their representatives, and the contracting officer agree on the classification and wage rate (including the amount designated for fringe benefits where appropriate), a report of the action taken shall be sent by the contracting officer to the DOL, Administrator of the Wage and Hour Division, Employment Standards Administration, Washington, D.C. 20210. The Wage and Hour Administrator, or an authorized representative, will approve, modify, or disapprove every additional classification action within 30 days of receipt and so advise the contracting officer or will notify the contracting officer within the 30-day period that additional time is necessary.

d. In the event the contractor or subcontractors, as appropriate, the laborers or mechanics to be employed in the additional classification or their representatives, and the contracting officer do not agree on the proposed classification and wage rate (including the amount designated for fringe benefits, where appropriate), the contracting officer shall refer the question, including the views of all interested parties and the recommendation of the contracting officer, to the Wage and Hour Administrator for determination. Said Administrator, or an authorized representative, will issue a determination within 30 days of receipt and so advise the contracting officer or will notify the contracting officer within the 30-day period that additional time is necessary.

e. The wage rate (including fringe benefits where appropriate) determined pursuant to paragraph 2c or 2d of this Section IV shall be paid to all workers performing work in the additional classification from the first day on which work is performed in the classification.

3. Payment of Fringe Benefits:

a. Whenever the minimum wage rate prescribed in the contract for a class of laborers or mechanics includes a fringe benefit which is not expressed as an hourly rate, the contractor or subcontractors, as

appropriate, shall either pay the benefit as stated in the wage determination or shall pay another bona fide fringe benefit or an hourly case equivalent thereof.

b. If the contractor or subcontractor, as appropriate, does not make payments to a trustee or other third person, he/she may consider as a part of the wages of any laborer or mechanic the amount of any cost reasonably anticipated in providing bona fide fringe benefits under a plan or program, provided that the Secretary of Labor has found, upon the written request of the contractor, that the applicable standards of the Davis-Bacon Act have been met. The Secretary of Labor may require the contractor to set aside in a separate account assets for the meeting of obligations under the plan or program.

4. Apprentices and Trainees (Programs of the U.S. DOL) and Helpers:

a. Apprentices:

(1) Apprentices will be permitted to work at less than the predetermined rate for the work they performed when they are employed pursuant to and individually registered in a bona fide apprenticeship program registered with the DOL, Employment and Training Administration, Bureau of Apprenticeship and Training, or with a State apprenticeship agency recognized by the Bureau, or if a person is employed in his/her first 90 days of probationary employment as an apprentice in such an apprenticeship program, who is not individually registered in the program, but who has been certified by the Bureau of Apprenticeship and Training or a State apprenticeship agency (where appropriate) to be eligible for probationary employment as an apprentice.

(2) The allowable ratio of apprentices to journeyman-level employees on the job site in any craft classification shall not be greater than the ratio permitted to the contractor as to the entire work force under the registered program. Any employee listed on a payroll at an apprentice wage rate, who is not registered or otherwise employed as stated above, shall be paid not less than the applicable wage rate listed in the wage determination for the classification of work actually performed. In addition, any apprentice performing work on the job site in excess of the ratio permitted under the registered program shall be paid not less than the applicable wage rate on the wage determination for the work actually performed. Where a contractor or subcontractor is performing construction on a project in a locality other than that in which its program is registered, the ratios and wage rates (expressed in percentages of the journeyman-level hourly rate) specified in the contractor's or subcontractor's registered program shall be observed.

(3) Every apprentice must be paid at not less than the rate specified in the registered program for the apprentice's level of progress, expressed as a percentage of the journeyman-level hourly rate specified in the applicable wage determination. Apprentices shall be paid fringe benefits in accordance with the provisions of the apprenticeship program. If the apprenticeship program does not specify fringe benefits, apprentices must be paid the full amount of fringe benefits listed on the wage determination for the applicable classification. If the Administrator for the Wage and Hour Division determines that a different practice prevails for the applicable apprentice classification, fringes shall be paid in accordance with that determination.

(4) In the event the Bureau of Apprenticeship and Training, or a State apprenticeship agency recognized by the Bureau, withdraws approval of an apprenticeship program, the contractor or subcontractor will no longer be permitted to utilize apprentices at less than the applicable predetermined rate for the comparable work performed by regular employees until an acceptable program is approved.

b. Trainees:

(1) Except as provided in 29 CFR 5.16, trainees will not be permitted to work at less than the predetermined rate for the work performed unless they are employed pursuant to and

individually registered in a program which has received prior approval, evidenced by formal certification by the DOL, Employment and Training Administration.

(2) The ratio of trainees to journeyman-level employees on the job site shall not be greater than permitted under the plan approved by the Employment and Training Administration. Any employee listed on the payroll at a trainee rate who is not registered and participating in a training plan approved by the Employment and Training Administration shall be paid not less than the applicable wage rate on the wage determination for the classification of work actually performed. In addition, any trainee performing work on the job site in excess of the ratio permitted under the registered program shall be paid not less than the applicable wage rate on the wage determination for the work actually performed.

(3) Every trainee must be paid at not less than the rate specified in the approved program for his/her level of progress, expressed as a percentage of the journeyman-level hourly rate specified in the applicable wage determination. Trainees shall be paid fringe benefits in accordance with the provisions of the trainee program. If the trainee program does not mention fringe benefits, trainees shall be paid the full amount of fringe benefits listed on the wage determination unless the Administrator of the Wage and Hour Division determines that there is an apprenticeship program associated with the corresponding journeyman-level wage rate on the wage determination which provides for less than full fringe benefits for apprentices, in which cases such trainees shall receive the same fringe benefits as apprentices.

(4) In the event the Employment and Training Administration withdraws approval of a training program, the contractor or subcontractor will no longer be permitted to utilize trainees at less than the applicable predetermined rate for the work performed until an acceptable program is approved.

c. Helpers:

Helpers will be permitted to work on a project if the helper classification is specified and defined on the applicable wage determination or is approved pursuant to the conformance procedure set forth in Section IV. 2. Any worker listed on a payroll at a helper wage rate, who is not a helper under a approved definition, shall be paid not less than the applicable wage rate on the wage determination for the classification of work actually performed.

5. Apprentices and Trainees (Programs of the U.S. DOT):

Apprentices and trainees working under apprenticeship and skill training programs which have been certified by the Secretary of Transportation as promoting EEO in connection with Federal-aid highway construction programs are not subject to the requirements of paragraph 4 of this Section IV. The straight time hourly wage rates for apprentices and trainees under such programs will be established by the particular programs. The ratio of apprentices and trainees to journeymen shall not be greater than permitted by the terms of the particular program.

6. Withholding:

The SHA shall upon its own action or upon written request of an authorized representative of the DOL withhold, or cause to be withheld, from the contractor or subcontractor under this contract or any other Federal contract with the same prime contractor or any other Federally-assisted contract subject to Davis-Bacon prevailing wage requirements which is held by the same prime contractor, as much of the accrued payments or advances as may be considered necessary to pay laborers and mechanics, including apprentices, trainee's and helpers, employed by the contractor or any subcontractor the full amount of wages required by the contract. In the event of failure to pay any laborer or mechanic, including any apprentice, trainee, or helper, employed or working on the site of the work, all or part of the wages required by the contract, the SHA contracting officer may, after written notice to the contractor, take

such action as may be necessary to cause the suspension of any further payment, advance, or guarantee of funds until such violations have ceased.

7. Overtime Requirements:

No contractor or subcontractor contracting for any part of the contract work which may require or involve the employment of laborers, mechanics, watchmen, or guards (including apprentices, trainees, and helpers described in paragraphs 4 and 5 above) shall require or permit any laborer, mechanic, watchman, or guard in any workweek in which he/she is employed on such work, to work in excess of 40 hours in such workweek unless such laborer, mechanic, watchman, or guard receives compensation at a rate not less than one-and-one-half times his/her basic rate of pay for all hours worked in excess of 40 hours in such workweek.

8. Violation:

Liability for Unpaid Wages; Liquidated Damages: In the event of any violation of the clause set forth in paragraph 7 above, the contractor and any subcontractor responsible thereof shall be liable to the affected employee for his/her unpaid wages. In addition, such contractor and subcontractor shall be liable to the United States (in the case of work done under contract for the District of Columbia or a territory, to such District or to such territory) for liquidated damages. Such liquidated damages shall be computed with respect to each individual laborer, mechanic, watchman, or guard employed in violation of the clause set forth in paragraph 7, in the sum of \$10 for each calendar day on which such employee was required or permitted to work in excess of the standard work week of 40 hours without payment of the overtime wages required by the clause set forth in paragraph 7.

9. Withholding for Unpaid Wages and Liquidated Damages:

The SHA shall; upon its own action or upon written request of any authorized representative of the DOL withhold, or cause to be withheld, from any monies payable on account of work performed by the contractor or subcontractor under any such contract or any other Federal contract with the same prime contractor, or any other Federally-assisted contract subject to the Contract Work Hours and Safety Standards Act, which is held by the same prime contractor, such sums as may be determined to be necessary to satisfy any liabilities of such contractor or subcontractor for unpaid wages and liquidated damages as provided in the clause set forth in paragraph 8 above.

V. STATEMENTS AND PAYROLLS

(Applicable to all Federal-aid construction contracts exceeding \$2,000 and to all related subcontracts, except for projects located on roadways classified as local roads or rural collectors, which are exempt.)

1. Compliance with Copeland Regulations (29 CFR 3):

The contractor shall comply with the Copeland Regulations of the Secretary of Labor which are herein incorporated by reference.

2. Payrolls and Payroll Records:

- a.** Payrolls and basic records relating thereto shall be maintained by the contractor and each subcontractor during the course of the work and preserved for a period of 3 years from the date of completion of the contract for all laborers, mechanics, apprentices, trainees, watchmen, helpers, and guards working at the site of the work.
- b.** The payroll records shall contain the name, social security number, and address of each such employee; his or her correct classification; hourly rates of wages paid (including rates of

contributions or costs anticipated for bona fide fringe benefits or cash equivalent thereof the types described in Section 1(b)(2)(B) of the Davis Bacon Act); daily and weekly number of hours worked; deductions made; and actual wages paid. In addition, for Appalachian contracts, the payroll records shall contain a notation indicating whether the employee does, or does not, normally reside in the labor area as defined in Attachment A, paragraph 1. Whenever the Secretary of Labor, pursuant to Section IV, paragraph 3b, has found that the wages of any laborer or mechanic include the amount of any costs reasonably anticipated in providing benefits under a plan or program described in Section 1(b)(2)(B) of the Davis Bacon Act, the contractor and each subcontractor shall maintain records which show that the commitment to provide such benefits is enforceable, that the plan or program is financially responsible, that the plan or program has been communicated in writing to the laborers or mechanics affected, and show the cost anticipated or the actual cost incurred in providing benefits. Contractors or subcontractors employing apprentices or trainees under approved programs shall maintain written evidence of the registration of apprentices and trainees, and ratios and wage rates prescribed in the applicable programs.

- c.** Each contractor and subcontractor shall furnish, each week in which any contract work is performed, to the SHA resident engineer a payroll of wages paid each of its employees (including apprentices, trainees, and helpers, described in Section IV, paragraphs 4 and 5, and watchmen and guards engaged on work during the preceding weekly payroll period). The payroll submitted shall set out accurately and completely all of the information required to be maintained under paragraph 2b of this Section V. This information may be submitted in any form desired. Optional Form WH-347 is available for this purpose and may be purchased from the Superintendent of Documents (Federal stock number 029-005-0014-1), U.S. Government Printing Office, Washington, D.C. 20402. The prime contractor is responsible for submitting payroll copies of all subcontractors.
- d.** Each payroll submitted shall be accompanied by a "Statement of Compliance," signed by the Contractor or subcontractor or his/her agent who pays or supervises the payment of the persons employed under the contract and shall certify the following:
 - (1)** that the payroll for the payroll period contains the information required to be maintained under paragraph 2b of this Section V and that such information is correct and complete;
 - (2)** that such laborer or mechanic (including each helper, apprentice, and trainee) employed on the contract during the payroll period has been paid the full weekly wages earned, without rebate, either directly or indirectly, and that no deductions have been made either directly or indirectly from the full wages earned, other than permissible deductions as set forth in the Regulations, 29 CFR 3;
 - (3)** that each laborer or mechanic has been paid not less than the applicable wage rate and fringe benefits or cash equivalent for the classification of worked performed, as specified in the applicable wage determination incorporated into the contract.
- e.** The weekly submission of a properly executed certification set forth on the reverse side of Optional Form WH-347 shall satisfy the requirement for submission of the "Statement of Compliance" required by paragraph 2d of this Section V.
- f.** The falsification of any of the above certifications may subject the contractor to civil or criminal prosecution under 18 U.S.C. 1001 and 31 U.S.C. 231.
- g.** The contractor or subcontractor shall make the records required under paragraph 2b of this Section V available for inspection, copying, or transcription by authorized representatives of the SHA, the FHWA, or the DOL, and shall permit such representatives to interview employees during working hours on the job. If the contractor or subcontractor fails to submit the required records or to make them available, the SHA, the FHWA, the DOL, or all may, after written notice to the contractor, sponsor, applicant, or owner, take such

actions as may be necessary to cause the suspension of any further payment, advance, or guarantee of funds. Furthermore, failure to submit the required records upon request or to make such records available may be grounds for debarment action pursuant to 29 CFR 5.12.

VI. RECORD OF MATERIALS, SUPPLIES, AND LABOR

1. On all federal-aid contracts on the national highway system, except those which provide solely for the installation of protective devices at railroad grade crossings, those which are constructed on a force account or direct labor basis, highway beautification contracts, and contracts for which the total final construction cost for roadway and bridge is less than \$1,000,000 (23 CFR 635) the contractor shall:

- a. Become familiar with the list of specific materials and supplies contained in Form FHWA-47, "Statement of Materials and Labor Used by Contractor of Highway Construction Involving Federal Funds," prior to the commencement of work under this contract.
 - b. Maintain a record of the total cost of all materials and supplies purchased for and incorporated in the work, and also of the quantities of those specific materials and supplies listed on Form FHWA-47, and in the units shown on Form FHWA-47.
 - c. Furnish, upon the completion of the contract, to the SHA resident engineer on /Form FHWA-47 together with the data required in paragraph 1b relative to materials and supplies, a final labor summary of all contract work indicating the total hours worked and the total amount earned.
2. At the prime contractor's option, either a single report covering all contract work or separate reports for the contractor and for each subcontract shall be submitted.

VII. SUBLETTING OR ASSIGNING THE CONTRACT

1. The contractor shall perform with its own organization contract work amounting to not less than 30 percent (or a greater percentage if specified elsewhere in the contract) of the total original contract price, excluding any specialty items designated by the State. Specialty items may be performed by subcontract and the amount of any such specialty items performed may be deducted from the total original contract price before computing the amount of work required to be performed by the contractors' own organization (23 CFR 635).

- a. "Its own organization" shall be construed to include only workers employed and paid directly by the prime contractor and equipment owned or rented by the prime contractor, with or without operators. Such term does not include employees or equipment of a subcontractor, assignee, or agent of the prime contractor.
- b. "Specialty Items" shall be construed to be limited to work that requires highly specialized knowledge, abilities, or equipment not ordinarily available in the type of contracting organizations qualified and expected to bid on the contract as a whole and in general are to be limited to minor components of the overall contract.

2. The contract amount upon which the requirements set forth in paragraph 1 of Section VII is computed includes the cost of material and manufactured products which are to be purchased or produced by the contractor under the contract provisions.

3. The contractor shall furnish (a) a competent superintendent or supervisor who is employed by the firm, has full authority to direct performance of the work in accordance with the contract requirements, and is in charge of all construction operations (regardless of who performs the work) and (b) such other of its own organizational resources (supervision, management, and engineering services) as the SHA contracting officer determines is necessary to assure the performance of the contract.

4. No portion of the contract shall be sublet, assigned or otherwise disposed of except with the written consent of the SHA contracting officer, or authorized representative, and such consent when given shall not be construed to relieve the contractor of any responsibility for the fulfillment of the contract. Written consent will be given only after the SHA has assured that each subcontract is evidenced in writing and that it contains all pertinent provisions and requirements of the prime contract.

VIII. SAFETY: ACCIDENT PREVENTION

1. In the performance of this contract the contractor shall comply with all applicable Federal, State, and local laws governing safety, health, and sanitation (23 CFR 635). The contractor shall provide all safeguards, safety devices and protective equipment and take any other needed actions as it determines, or as the SHA contracting officer may determine, to be reasonably necessary to protect the life and health of employees on the job and the safety of the public and to protect property in connection with the performance of the work covered by the contract.

2. It is a condition of this contract, and shall be made a condition of each subcontract, which the contractor enters into pursuant to this contract, that the contractor and any subcontractor shall not permit any employee, in performance of the contract, to work in surroundings or under conditions which are unsanitary, hazardous or dangerous to his/her health or safety, as determined under construction safety and health standards (29 CFR 1926) promulgated by the Secretary of Labor, in accordance with Section 107 of the Contract Work Hours and Safety Standards Act (40 U.S. C. 333).

3. Pursuant to 29 CFR 1926.3, it is a condition of this contract that the Secretary of Labor or authorized representative thereof, shall have right of entry to any site of contract performance to inspect or investigate the matter of compliance with the construction safety and health standards and to carry out the duties of the Secretary under Section 107 of the Contract Work Hours and Safety Standards Act (40 U.S.C. 333).

IX. FALSE STATEMENTS CONCERNING HIGHWAY PROJECTS

In order to assure high quality and durable construction in conformity with approved plans and specifications and a high degree of reliability on statements and representations made by engineers, contractors, suppliers, and workers on Federal-aid highway projects, it is essential that all persons concerned with the project perform their functions as carefully, thoroughly, and honestly as possible. Willful falsification, distortion, or misrepresentation with respect to any facts related to the project is a violation of Federal law. To prevent any misunderstanding regarding the seriousness of these and similar acts, the following notice shall be posted on each Federal-aid highway project (23 CFR 635) in one or more places where it is readily available to all persons concerned with the project:

NOTICE TO ALL PERSONNEL ENGAGED ON FEDERAL-AID HIGHWAY PROJECTS

18 U.S.C. 1020 reads as follows:

"Whoever, being an officer, agent or employee of the United States, or of any State or Territory, or whoever, whether a person, association, firm, or corporation, knowingly makes any false statement, false representation, or false report as to the character, quality, quantity, or cost of the material used or to be used, or the quantity or quality of the work performed or to be performed, or the cost thereof in connection with the submission of plans, maps, specifications, contracts, or costs of construction on any highway or related project submitted for approval to the Secretary of Transportation; or

Whoever knowingly makes any false statement, false representation, false report or false claim with respect to the character, quality, quantity, or cost of any work performed or to be performed, or materials furnished or to be furnished, in connection with the construction of any highway or related project approved by the Secretary of Transportation; or

Whoever knowingly makes any false statement or false representation as to material fact in any statement, certificate, or report submitted pursuant to provisions of the Federal-aid Roads Act approved July 1, 1916, (39 Stat. 355), as amended and supplemented;

Shall be fined not more than \$10,000 or imprisoned not more than 5 years or both."

X. IMPLEMENTATION OF CLEAN AIR ACT AND FEDERAL WATER POLLUTION CONTROL ACT

(Applicable to all Federal-aid construction contracts and to all related subcontracts of \$100,000 or more).

By submission of this bid or the execution of this contract, or subcontract, as appropriate, the bidder, Federal-aid construction contractor, or subcontractor, as appropriate, will be deemed to have stipulated as follows:

1. That any facility that is or will be utilized in the performance of this contract, unless such contract is exempt under the Clean Air Act, as amended (42 U.S.C. 1857 *et seq.*, as amended by Pub.L. 91-604), and under the Federal Water Pollution Control Act, as amended (33 U.S.C. 1251 *et seq.*, as amended by Pub.L. 92-500), Executive Order 11738, and regulations in implementation thereof (40 CFR 15) is not listed, on the date of contract award, on the U.S. Environmental Protection Agency (EPA) List of Violating Facilities pursuant to 40 CFR 15.20.

2. That the firm agrees to comply and remain in compliance with all the requirements of Section 114 of the Clean Air Act and Section 308 of the Federal Water Pollution Control Act and all regulations and guidelines listed thereunder.

3. That the firm shall promptly notify the SHA of the receipt of any communication from the Director, Office of Federal Activities, EPA indicating that a facility that is or will be utilized for the contract is under consideration to be listed on the EPA List of Violating Facilities.

4. That the firm agrees to include or cause to be included the requirements of paragraph 1 through 4 of this Section X in every nonexempt subcontract, and further agrees to take such action as the government may direct as a means of enforcing such requirements.

XI. CERTIFICATION REGARDING DEBARMENT, SUSPENSION, INELIGIBILITY AND VOLUNTARY EXCLUSION

1. Instructions for Certification - Primary Covered Transactions:

(Applicable to all Federal-aid contracts - 49 CFR 29)

a. By signing and submitting this proposal, the prospective primary participant is providing the certification set out below.

b. The inability of a person to provide the certification set out below will not necessarily result in denial of participation in this covered transaction. The prospective participant shall submit an explanation of why it cannot provide the certification set out below. The certification or explanation will be considered in connection with the department or agency's determination whether to enter into this transaction. However, failure of the prospective primary participant to furnish a certification or an explanation shall disqualify such a person from participation in

this transaction.

c. The certification in this clause is a material representation of fact upon which reliance was placed when the department or agency determined to enter into this transaction. If it is later determined that the prospective primary participant knowingly rendered an erroneous certification, in addition to other remedies available to the Federal Government, the department or agency may terminate this transaction for cause of default.

d. The prospective primary participant shall provide immediate written notice to the department or agency to whom this proposal is submitted if any time the prospective primary participant learns that its certification was erroneous when submitted or has become erroneous by reason of changed circumstances.

e. The terms "covered transaction," "debarred," "suspended," "ineligible," "lower tier covered transaction," "participant," "person," "primary covered transaction," "principal," "proposal," and "voluntarily excluded," as used in this clause, have the meanings set out in the Definitions and Coverage sections of rules implementing Executive Order 12549. You may contact the department or agency to which this proposal is submitted for assistance in obtaining a copy of those regulations.

f. The prospective primary participant agrees by submitting this proposal that, should the proposed covered transaction be entered into, it shall not knowingly enter into any lower tier covered transaction with a person who is debarred, suspended, declared ineligible, or voluntarily excluded from participation in this covered transaction, unless authorized by the department or agency entering into this transaction.

g. The prospective primary participant further agrees by submitting this proposal that it will include the clause titled "Certification Regarding Debarment, Suspension, Ineligibility and Voluntary Exclusion-Lower Tier Covered Transaction," provided by the department or agency entering into this covered transaction, without modification in all lower tier covered transactions and in all solicitations for lower tier covered transactions.

h. A participant in a covered transaction may rely upon a certification of a prospective participant in a lower tier covered transaction that is not debarred, suspended, ineligible, or voluntarily excluded from the covered transaction, unless it knows that the certification is erroneous. A participant may decide the method and frequency by which it determines the eligibility of its principals. Each participant may, but is not required to, check the nonprocurement portion of the "Lists of Parties Excluded from Federal Procurement or Nonprocurement Programs" (Nonprocurement List) which is compiled by the General Services Administration.

i. Nothing contained in the foregoing shall be construed to require establishment of a system of records in order to render in good faith the certification required by this clause. The knowledge and information of participant is not required to exceed that which is normally possessed by a prudent person in the ordinary course of business dealings.

j. Except for transactions authorized under paragraph f of these instructions, if a participant in a covered transaction knowingly enters into a lower tier covered transaction with a person who is suspended, debarred, ineligible, or voluntarily excluded from participation in this transaction, in addition to other remedies available to the Federal Government, the department or agency may terminate this transaction for cause or default.

Certification Regarding Debarment, Suspension, Ineligibility and Voluntary Exclusion-Primary Covered Transactions

1. The prospective primary participant certifies to the best of its knowledge and belief, that it and its principals:

a. Are not presently debarred, suspended, proposed for debarment, declared ineligible, or voluntarily excluded from

- covered transactions by any Federal department or agency;
- b.** Have not within a 3-year period preceding this proposal been convicted of or had a civil judgment rendered against them for commission of fraud or a criminal offense in connection with obtaining, attempting to obtain, or performing a public (Federal, State or local) transaction or contract under a public transaction; violation of Federal or State antitrust statutes or commission of embezzlement, theft, forgery, bribery, falsification or destruction of records, making false statements, or receiving stolen property;
 - c.** Are not presently indicted for or otherwise criminally or civilly charged by a governmental entity (Federal, State or local) with commission of any of the offenses enumerated in paragraph 1b of this certification; and
 - d.** Have not within a 3-year period preceding this application/proposal had one or more public transactions (Federal, State or local) terminated for cause or default.

2. Where the prospective primary participant is unable to certify to any of the statements in this certification, such prospective participant shall attach an explanation to this proposal.

2. Instructions for Certification - Lower Tier Covered Transactions:

(Applicable to all subcontracts, purchase orders and other lower tier transactions of \$25,000 or more - 49 CFR 29)

- a.** By signing and submitting this proposal, the prospective lower tier is providing the certification set out below.
- b.** The certification in this clause is a material representation of fact upon which reliance was placed when this transaction was entered into. If it is later determined that the prospective lower tier participant knowingly rendered an erroneous certification, in addition to other remedies available to the Federal Government, the department, or agency with which this transaction originated may pursue available remedies, including suspension and/or debarment.
- c.** The prospective lower tier participant shall provide immediate written notice to the person to which this proposal is submitted if at any time the prospective lower tier participant learns that its certification was erroneous by reason of changed circumstances.
- d.** The terms "covered transaction," "debarred," "suspended," "ineligible," "primary covered transaction," "participant," "person," "principal," "proposal," and "voluntarily excluded," as used in this clause, have the meanings set out in the Definitions and Coverage sections of rules implementing Executive Order 12549. You may contact the person to which this proposal is submitted for assistance in obtaining a copy of those regulations.
- e.** The prospective lower tier participant agrees by submitting this proposal that, should the proposed covered transaction be entered into, it shall not knowingly enter into any lower tier covered transaction with a person who is debarred, suspended, declared ineligible, or voluntarily excluded from participation in this covered transaction, unless authorized by the department or agency with which this transaction originated.
- f.** The prospective lower tier participant further agrees by submitting this proposal that it will include this clause titled "Certification Regarding Debarment, Suspension, Ineligibility and Voluntary Exclusion-Lower Tier Covered Transaction," without modification, in all lower tier covered transactions and in all solicitations for lower tier covered transactions.
- g.** A participant in a covered transaction may rely upon a certification of a prospective participant in a lower tier covered transaction that is not debarred, suspended, ineligible, or voluntarily excluded from the covered transaction, unless it knows that the certification is erroneous. A participant may decide the method and frequency by which it determines the eligibility of its principals. Each participant may, but is not

- required to, check the Nonprocurement List.
- h.** Nothing contained in the foregoing shall be construed to require establishment of a system of records in order to render in good faith the certification required by this clause. The knowledge and information of participant is not required to exceed that which is normally possessed by a prudent person in the ordinary course of business dealing.
- i.** Except for transactions authorized under paragraph e of these instructions, if a participant in a covered transaction knowingly enters into a lower tier covered transaction with a person who is suspended, debarred, ineligible, or voluntarily excluded from participation in this transaction, in addition to other remedies available to the Federal Government, the department or agency with which this transaction originated may pursue available remedies, including suspension and/or debarment.

Certification Regarding Debarment, Suspension, Ineligibility And Voluntary Exclusion-Lower Tier Covered Transactions:

- 1. The prospective lower tier participant certifies, by submission of this proposal, that neither it nor its principals is presently debarred, suspended, proposed for debarment, declared ineligible, or voluntarily excluded from participation in this transaction by any Federal department or agency.
- 2. Where the prospective lower tier participant is unable to certify to any of the statements in this certification, such prospective participant shall attach an explanation to this proposal.

XII. CERTIFICATION REGARDING USE OF CONTRACT FUNDS FOR LOBBYING

(Applicable to all Federal-aid construction contracts and to all related subcontracts which exceed \$100,000 - 49 CFR 20)

- 1. The prospective participant certifies, by signing and submitting this bid or proposal, to the best of his or her knowledge and belief, that:
 - a.** No Federal appropriated funds have been paid or will be paid, by or on behalf of the undersigned, to any person for influencing or attempting to influence an officer or employee of any Federal agency, a Member of Congress, an officer or employee of Congress, or an employee of a Member of Congress in connection with the awarding of any Federal contract, the making of any Federal grant, the making of any Federal loan, the entering into of any cooperative agreement, and the extension, continuation, renewal, amendment, or modification of any Federal contract, grant, loan, or cooperative agreement.
 - b.** If any funds other than Federal appropriated funds have been paid or will be paid to any person for influencing or attempting to influence an officer or employee of any Federal agency, a Member of Congress, an officer or employee of Congress, or an employee of a Member of Congress in connection with this Federal contract, grant, loan, or cooperative agreement, the undersigned shall complete and submit Standard Form-LLL, "Disclosure Form to Report Lobbying," in accordance with its instructions.

2. This certification is a material representation of fact upon which reliance was placed when this transaction was made or entered into. Submission of this certification is a prerequisite for making or entering into this transaction imposed by 31 U.S.C. 1352. Any person who fails to file the required certification shall be subject to a civil penalty of not less than \$10,000 and not

more than \$100,000 for each such failure.

3. The prospective participant also agrees by submitting his or her bid or proposal that he or she shall require that the language of this certification be included in all lower tier subcontracts, which exceed \$100,000 and that all such recipients shall certify and disclose accordingly.

**MINIMUM WAGES FOR FEDERAL AND FEDERALLY
ASSISTED CONSTRUCTION CONTRACTS**

This project is funded, in part, with Federal-aid funds and, as such, is subject to the provisions of the Davis-Bacon Act of March 3, 1931, as amended (46 Sta. 1494, as amended, 40 U.S.C. 276a) and of other Federal statutes referred to in a 29 CFR Part 1, Appendix A, as well as such additional statutes as may from time to time be enacted containing provisions for the payment of wages determined to be prevailing by the Secretary of Labor in accordance with the Davis-Bacon Act and pursuant to the provisions of 29 CFR Part 1. The prevailing rates and fringe benefits shown in the General Wage Determination Decisions issued by the U.S. Department of Labor shall, in accordance with the provisions of the foregoing statutes, constitute the minimum wages payable on Federal and federally assisted construction projects to laborers and mechanics of the specified classes engaged on contract work of the character and in the localities described therein.

General Wage Determination Decisions, modifications and supersedes decisions thereto are to be used in accordance with the provisions of 29 CFR Parts 1 and 5. Accordingly, the applicable decision, together with any modifications issued, must be made a part of every contract for performance of the described work within the geographic area indicated as required by an applicable DBRA Federal prevailing wage law and 29 CFR Part 5. The wage rates and fringe benefits contained in the General Wage Determination Decision shall be the minimum paid by contractors and subcontractors to laborers and mechanics.

NOTICE

The most current **General Wage Determination Decisions** (wage rates) are available on the IDOT web site. They are located on the Letting and Bidding page at <http://www.dot.state.il.us/desenv/delett.html>.

In addition, ten (10) days prior to the letting, the applicable Federal wage rates will be e-mailed to subscribers. It is recommended that all contractors subscribe to the Federal Wage Rates List or the Contractor's Packet through IDOT's subscription service.

PLEASE NOTE: if you have already subscribed to the Contractor's Packet you will automatically receive the Federal Wage Rates.

The instructions for subscribing are at <http://www.dot.state.il.us/desenv/subsc.html>.

If you have any questions concerning the wage rates, please contact IDOT's Chief Contract Official at 217-782-7806.