

FILE NAME = W:\Projects\2010\100120 PTB 157\25\cadd\Structural\Drawn\03 IL 92 Culverts\Station870+00\00\Final_Submittal_13.0320\870+00\H1-003-ExtensionDet1.dgn

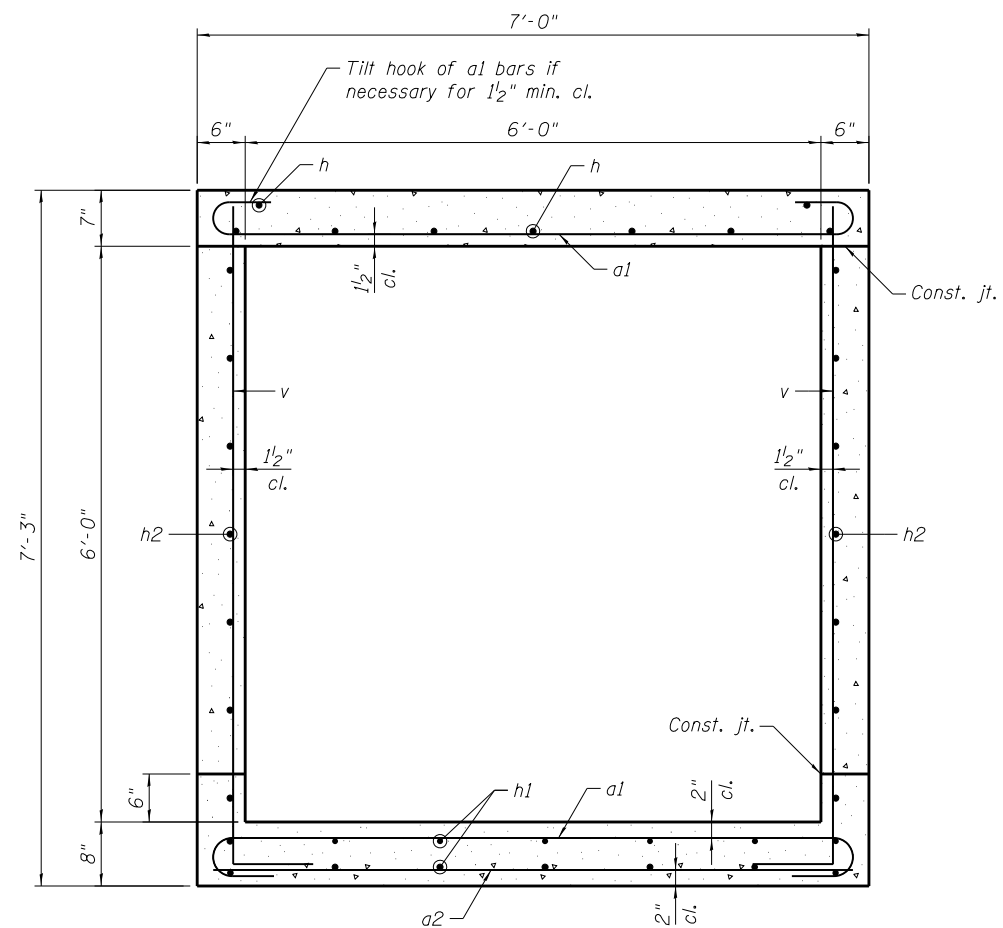

SECTION A-A

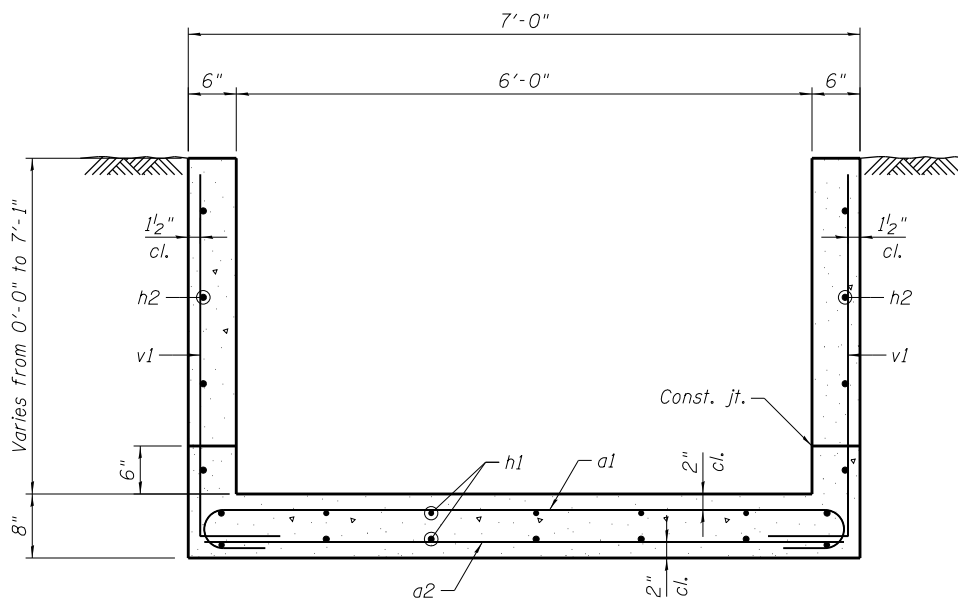

SECTION B-B

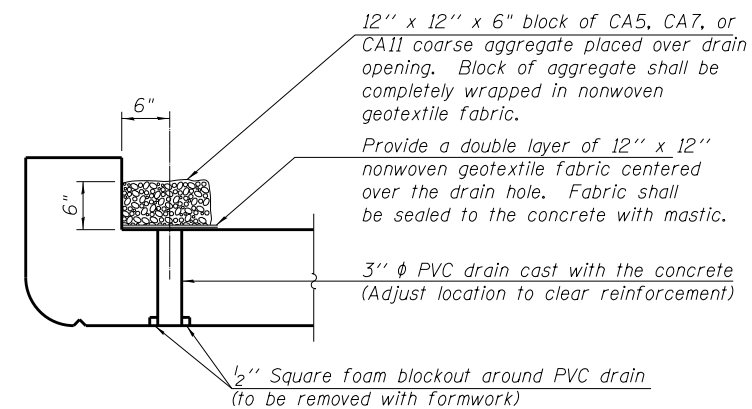

DRAIN DETAIL

(All costs associated with furnishing and constructing the above drain details will not be measured for payment but shall be included in the contract unit price for the end section.)

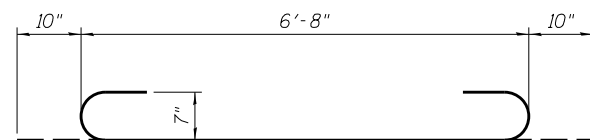

BAR a1

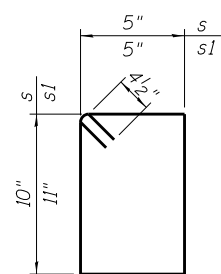

BARS s & s1

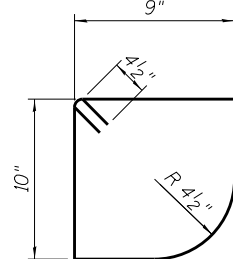

BAR s2

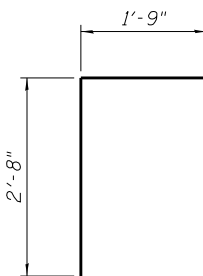

BAR d

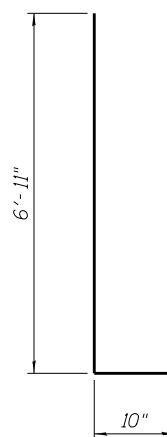

BAR v

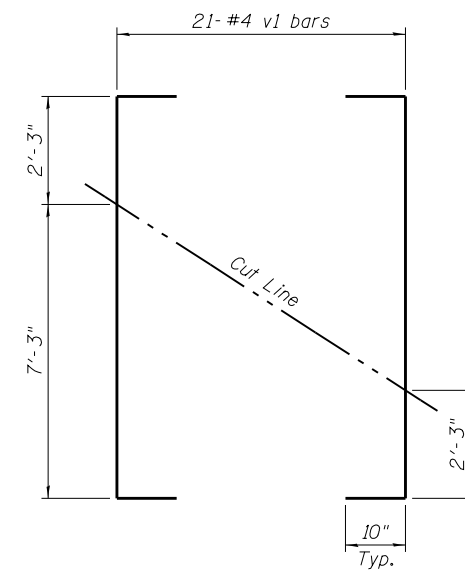

CUTTING DIAGRAM

Order bars full length. Cut as shown and use remainder of bars in opposite wall.

BILL OF MATERIAL

(For Information Only)

Bar	No.	Size	Length	Shape
a1	48	#7	8'-4"	
a2	36	#4	6'-8"	
d	8	#4	4'-5"	
h	9	#7	4'-0"	
h1	14	#4	25'-5"	
h2	14	#5	24'-0"	
h3	12	#6	6'-8"	
h4	2	#5	19'-3"	
h5	12	#5	2'-8"	
h6	10	#6	2'-3"	
s	7	#4	3'-3"	
s1	7	#4	3'-5"	
s2	8	#4	3'-9"	
v	20	#4	7'-9"	
v1	21	#4	11'-2"	
Description		Unit	Quantity	
Concrete Box Culverts		Cu. Yd.	9.7	
Reinforcement Bars		Pound	2,210	