

F.A.U. ROUTE	SECTION	COUNTY	TOTAL SHEETS	SHEET NUMBER
9148	06-00059-00-PV 08-00059-01-PV	ST. CLAIR	61	44
STA 978+71.62 TO		STA. 1032+57.37		
FEDERAL AID PROJECT		CONTRACT 97447		

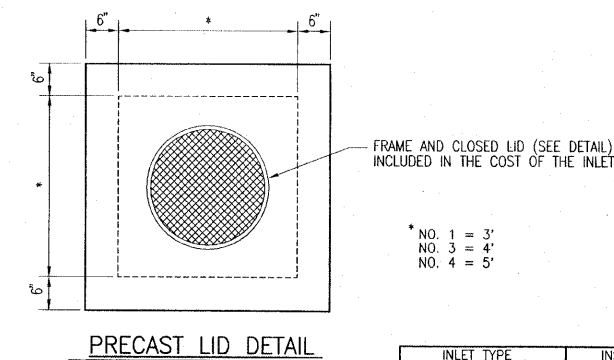

INLET TYPE	INSIDE WIDTH	LID TYPE
INLETS, SPECIAL, NO. 1	3' x 3'	NORMAL
INLETS, SPECIAL, NO. 3	4' x 4'	NORMAL
INLETS, SPECIAL, NO. 4	5' x 5'	NORMAL

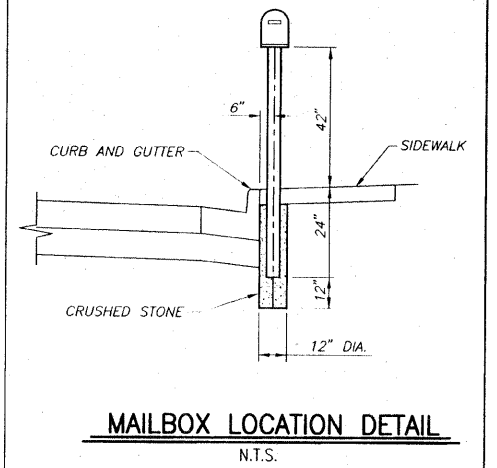
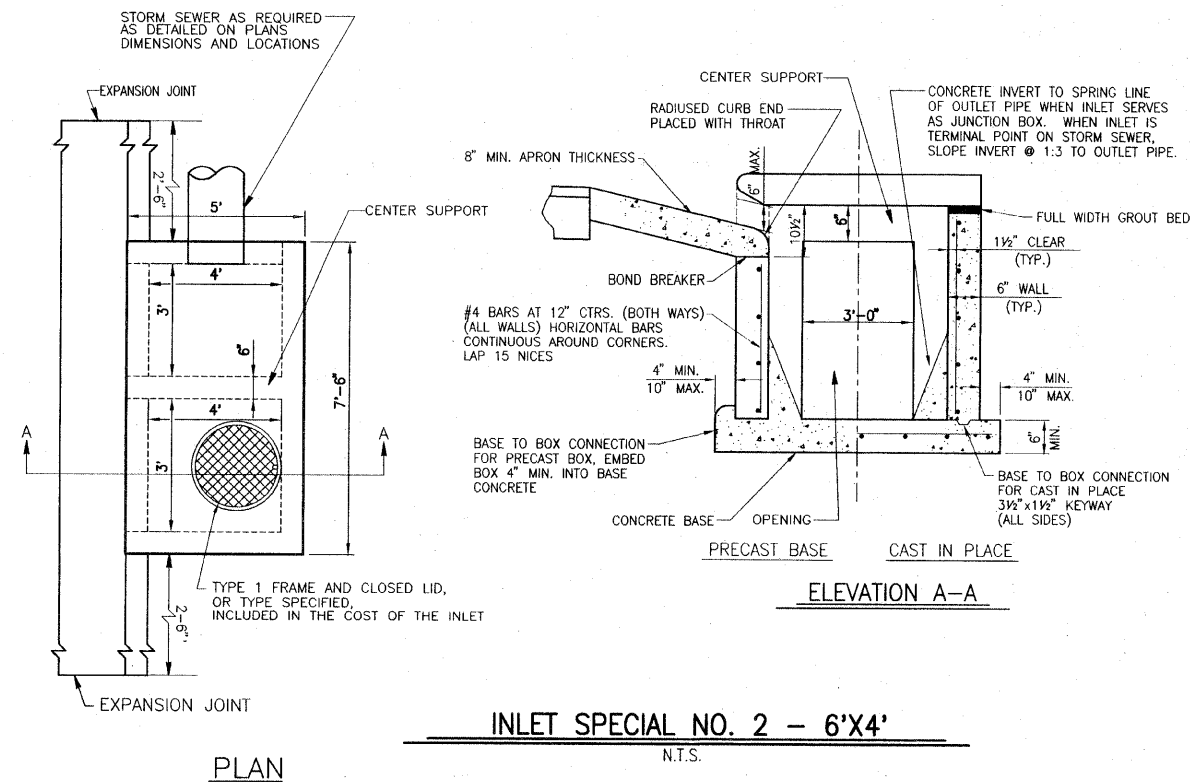
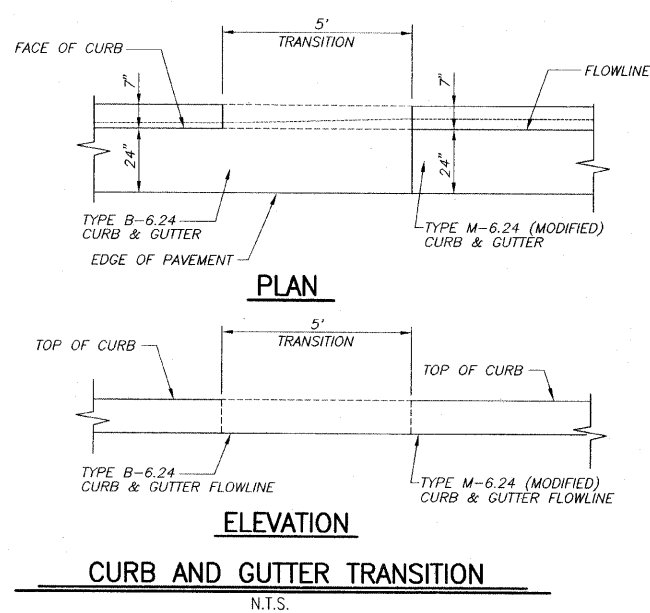
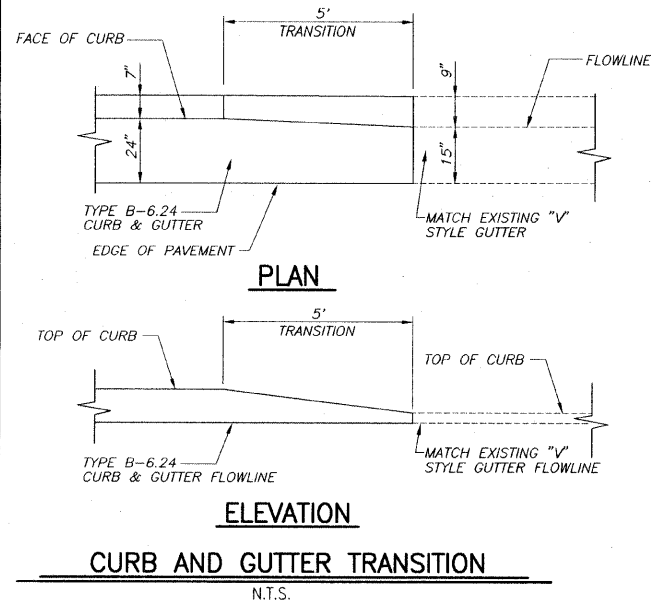
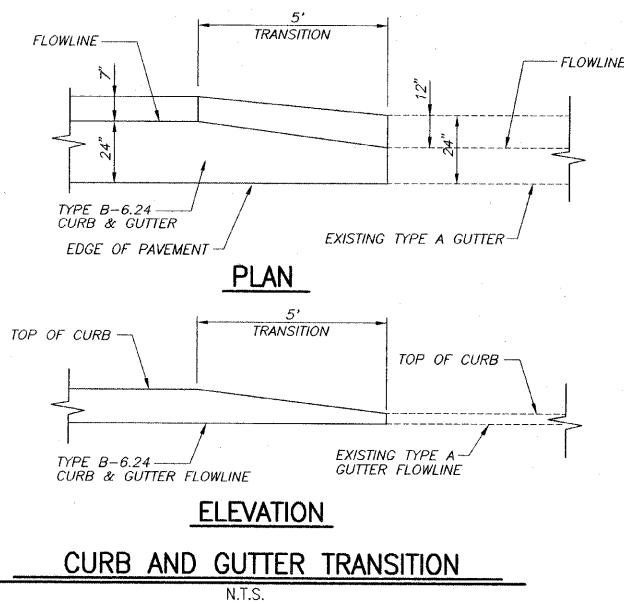
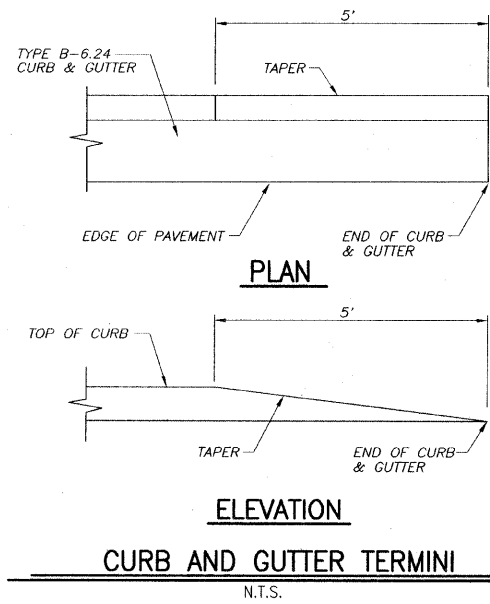