

If you plan to submit a bid directly to the Department of Transportation

PREQUALIFICATION

Any contractor who desires to become pre-qualified to bid on work advertised by IDOT must submit the properly completed pre-qualification forms to the Bureau of Construction no later than 4:30 p.m. prevailing time twenty-one days prior to the letting of interest. This pre-qualification requirement applies to first time contractors, contractors renewing expired ratings, contractors maintaining continuous pre-qualification or contractors requesting revised ratings. To be eligible to bid, existing pre-qualification ratings must be effective through the date of letting.

REQUESTS FOR AUTHORIZATION TO BID

Contractors wanting to bid on items included in a particular letting must submit the properly completed "Request for Authorization to Bid/or Not For Bid Status" (BDE 124) and the ORIGINAL "Affidavit of Availability" (BC 57) to the proper office no later than 4:30 p.m. prevailing time, three (3) days prior to the letting date. This does not apply to Small Business Set-Asides.

WHO CAN BID ?

Bids will be accepted from only those companies that request and receive written **Authorization to Bid** from IDOT's Central Bureau of Construction. This does not apply to Small Business Set-Asides.

WHAT CONSTITUTES WRITTEN AUTHORIZATION TO BID?: When a prospective prime bidder submits a "Request for Authorization to Bid/or Not For Bid Status"(BDE 124) he/she must indicate at that time which items are being requested For Bidding purposes. Only those items requested For Bidding will be analyzed. After the request has been analyzed, the bidder will be issued an **Authorization to Bid or Not for Bid Report**, approved by the Central Bureau of Construction that indicates which items have been approved For Bidding. If **Authorization to Bid** cannot be approved, the **Authorization to Bid or Not for Bid Report** will indicate the reason for denial.

ABOUT AUTHORIZATION TO BID: Firms that have not received an authorization form within a reasonable time of complete and correct original document submittal should contact the department as to status. This is critical in the week before the letting. These documents must be received three days before the letting date. Firms unsure as to authorization status should call the Prequalification Section of the Bureau of Construction at the number listed at the end of these instructions.

ADDENDA AND REVISIONS: It is the contractor's responsibility to determine which, if any, addenda or revisions pertain to any project they may be bidding. Failure to incorporate all relevant addenda or revisions may cause the bid to be declared unacceptable.

Each addendum will be placed with the contract number. Addenda and revisions will also be placed on the Addendum/Revision Checklist and each subscription service subscriber will be notified by e-mail of each addendum and revision issued.

The Internet is the Department's primary way of doing business. The subscription server e-mails are an added courtesy the Department provides. It is suggested that bidders check IDOT's website at <http://www.dot.il.gov/desenv/delett.html> before submitting final bid information.

IDOT IS NOT RESPONSIBLE FOR ANY E-MAIL FAILURES.

Addenda Questions may be directed to the Plans and Contracts Office at (217)782-7806 or D&Econtracts@dot.il.gov

Technical Questions about downloading these files may be directed to Tim Garman (217)524-1642 or Timothy.Garman@illinois.gov.

WHAT MUST BE INCLUDED WHEN BIDS ARE SUBMITTED?: Bidders need not return the entire proposal when bids are submitted. That portion of the proposal that must be returned includes the following:

1. All documents from the Proposal Cover Sheet through the Proposal Bid Bond
2. Other special documentation and/or information that may be required by the contract special provisions

All proposal documents, including Proposal Guaranty Checks or Proposal Bid Bonds, should be stapled together to prevent loss when bids are processed by IDOT personnel.

ABOUT SUBMITTING BIDS: It is recommended that bidders deliver bids in person to insure they arrive at the proper location prior to the time specified for the receipt of bids. Any bid received at the place of letting after the time specified will not be accepted.

WHO SHOULD BE CALLED IF ASSISTANCE IS NEEDED?

Questions Regarding	Call
Prequalification and/or Authorization to Bid	217/782-3413
Preparation and submittal of bids	217/782-7806
Mailing of plans and proposals	217/782-7806

ADDENDUMS AND REVISIONS TO THE PROPOSAL FORMS

Planholders should verify that they have received and incorporated any addendum and/or revision prior to submitting their bid. Failure by the bidder to include an addendum or revision could result in a bid being rejected as irregular.

RETURN WITH BID

118

Proposal Submitted By
Name
Address
City

Letting June 17, 2011

BIDDERS NEED NOT RETURN THE ENTIRE PROPOSAL
(See instructions inside front cover)

NOTICE TO PROSPECTIVE BIDDERS

This proposal can be used for bidding purposes by only those companies that request and receive written AUTHORIZATION TO BID from IDOT's Central Bureau of Construction. This does not apply to Small Business Set-Asides.
(SEE INSTRUCTIONS ON THE INSIDE OF COVER)

**Notice to Bidders,
Specifications,
Proposal, Contract
and Contract Bond**



**Illinois Department
of Transportation**

Springfield, Illinois 62764

Contract No. 78237
FRANKLIN County
Section 11RS-4
Route FAU 9454B
District 9 Construction Funds

PLEASE MARK THE APPROPRIATE BOX BELOW:

- A Bid Bond is included.
- A Cashier's Check or a Certified Check is included.

Plans Included
Herein

Prepared by	
Checked by	S

(Printed by authority of the State of Illinois)

INSTRUCTIONS

ABOUT IDOT PROPOSALS: All proposals issued by IDOT are potential bidding proposals. Each proposal contains all Certifications and Affidavits, a Proposal Signature Sheet and a Proposal Bid Bond. In addition, this proposal contains new statutory requirements applicable to the use of subcontractors and, in particular, includes the State Required Ethical Standards Governing Subcontractors to be signed and incorporated into all subcontracts.

WHO CAN BID?: Bids will be accepted from only those companies that request and receive written **Authorization to Bid** from IDOT's Central Bureau of Construction. To request authorization, a potential bidder must complete and submit Part B of the Request for Authorization to Bid/or Not For Bid Status form (BDE 124) and submit an original Affidavit of Availability (BC 57). This does not apply to Small Business Set-Asides.

WHAT CONSTITUTES WRITTEN AUTHORIZATION TO BID?: When a prospective prime bidder submits a "**Authorization to Bid or Not for Bid**" form, he/she must indicate at that time which items are being requested For Bidding purposes. Only those items requested For Bidding will be analyzed. After the request has been analyzed, the bidder will be issued a **Authorization to Bid or Not for Bid Report**, approved by the Central Bureau of Construction, that indicates which items have been approved For Bidding. If **Authorization to Bid** cannot be approved, the **Authorization to Bid or Not for Bid Report** will indicate the reason for denial. If a contractor has requested to bid but has not received a **Authorization to Bid or Not for Bid Report**, they should contact the Central Bureau of Construction in advance of the letting date.

WHAT MUST BE INCLUDED WHEN BIDS ARE SUBMITTED?: Bidders need not return the entire proposal when bids are submitted. That portion of the proposal that must be returned includes the following:

1. All documents from the Proposal Cover Sheet through the Proposal Bid Bond
2. Other special documentation and/or information that may be required by the contract special provisions

All proposal documents, including Proposal Guaranty Checks or Proposal Bid Bonds, should be stapled together to prevent loss when bids are processed by IDOT personnel.

ABOUT SUBMITTING BIDS: It is recommended that bidders deliver bids in person to insure they arrive at the proper location prior to the time specified for the receipt of bids. Any bid received at the place of letting after the time specified will not be accepted.

WHO SHOULD BE CALLED IF ASSISTANCE IS NEEDED?

Questions Regarding	Call
Prequalification and/or Authorization to Bid	217/782-3413
Preparation and submittal of bids	217/782-7806

RETURN WITH BID



PROPOSAL

TO THE DEPARTMENT OF TRANSPORTATION

1. Proposal of _____

Taxpayer Identification Number (Mandatory) _____ a

for the improvement identified and advertised for bids in the Invitation for Bids as:

**Contract No. 78237
FRANKLIN County
Section 11RS-4
Route FAU 9454B
District 9 Construction Funds**

0.83 mile of resurfacing on IL Route 37 from Benton Square to Capital Street in Benton.

2. The undersigned bidder will furnish all labor, material and equipment to complete the above described project in a good and workmanlike manner as provided in the contract documents provided by the Department of Transportation. This proposal will become part of the contract and the terms and conditions contained in the contract documents shall govern performance and payments.

RETURN WITH BID

3. **ASSURANCE OF EXAMINATION AND INSPECTION/WAIVER.** The undersigned further declares that he/she has carefully examined the proposal, plans, specifications, addenda, form of contract and contract bond, and special provisions, and that he/she has inspected in detail the site of the proposed work, and that he/she has familiarized themselves with all of the local conditions affecting the contract and the detailed requirements of construction, and understands that in making this proposal he/she waives all right to plead any misunderstanding regarding the same.
4. **EXECUTION OF CONTRACT AND CONTRACT BOND.** The undersigned further agrees to execute a contract for this work and present the same to the department within fifteen (15) days after the contract has been mailed to him/her. The undersigned further agrees that he/she and his/her surety will execute and present within fifteen (15) days after the contract has been mailed to him/her contract bond satisfactory to and in the form prescribed by the Department of Transportation, in the penal sum of the full amount of the contract, guaranteeing the faithful performance of the work in accordance with the terms of the contract.
5. **PROPOSAL GUARANTY.** Accompanying this proposal is either a bid bond on the department form, executed by a corporate surety company satisfactory to the department, or a proposal guaranty check consisting of a bank cashier's check or a properly certified check for not less than 5 per cent of the amount bid or for the amount specified in the following schedule:

<u>Amount of Bid</u>		<u>Proposal Guaranty</u>	<u>Amount of Bid</u>		<u>Proposal Guaranty</u>	
Up to	\$5,000	\$150	\$2,000,000	to	\$3,000,000	\$100,000
\$5,000	to \$10,000	\$300	\$3,000,000	to	\$5,000,000	\$150,000
\$10,000	to \$50,000	\$1,000	\$5,000,000	to	\$7,500,000	\$250,000
\$50,000	to \$100,000	\$3,000	\$7,500,000	to	\$10,000,000	\$400,000
\$100,000	to \$150,000	\$5,000	\$10,000,000	to	\$15,000,000	\$500,000
\$150,000	to \$250,000	\$7,500	\$15,000,000	to	\$20,000,000	\$600,000
\$250,000	to \$500,000	\$12,500	\$20,000,000	to	\$25,000,000	\$700,000
\$500,000	to \$1,000,000	\$25,000	\$25,000,000	to	\$30,000,000	\$800,000
\$1,000,000	to \$1,500,000	\$50,000	\$30,000,000	to	\$35,000,000	\$900,000
\$1,500,000	to \$2,000,000	\$75,000	over		\$35,000,000	\$1,000,000

Bank cashier's checks or properly certified checks accompanying proposals shall be made payable to the Treasurer, State of Illinois, when the state is awarding authority; the county treasurer, when a county is the awarding authority; or the city, village, or town treasurer, when a city, village, or town is the awarding authority.

If a combination bid is submitted, the proposal guaranties which accompany the individual proposals making up the combination will be considered as also covering the combination bid.

The amount of the proposal guaranty check is _____ \$(_____). If this proposal is accepted and the undersigned shall fail to execute a contract bond as required herein, it is hereby agreed that the amount of the proposal guaranty shall become the property of the State of Illinois, and shall be considered as payment of damages due to delay and other causes suffered by the State because of the failure to execute said contract and contract bond; otherwise, the bid bond shall become void or the proposal guaranty check shall be returned to the undersigned.

Attach Cashier's Check or Certified Check Here

In the event that one proposal guaranty check is intended to cover two or more proposals, the amount must be equal to the sum of the proposal guaranties which would be required for each individual proposal. If the guaranty check is placed in another proposal, state below where it may be found.

The proposal guaranty check will be found in the proposal for:

Item _____

Section No. _____

County _____

Mark the proposal cover sheet as to the type of proposal guaranty submitted.

RETURN WITH BID

6. **COMBINATION BIDS.** The undersigned further agrees that if awarded the contract for the sections contained in the following combination, he/she will perform the work in accordance with the requirements of each individual proposal comprising the combination bid specified in the schedule below, and that the combination bid shall be prorated against each section in proportion to the bid submitted for the same. If an error is found to exist in the gross sum bid for one or more of the individual sections included in a combination, the combination bid shall be corrected as provided in the specifications.

When a combination bid is submitted, the schedule below must be completed in each proposal comprising the combination.

If alternate bids are submitted for one or more of the sections comprising the combination, a combination bid must be submitted for each alternate.

Schedule of Combination Bids

Combination No.	Sections Included in Combination	Combination Bid	
		Dollars	Cents

7. **SCHEDULE OF PRICES.** The undersigned bidder submits herewith, in accordance with the rules and instructions, a schedule of prices for the items of work for which bids are sought. The unit prices bid are in U.S. dollars and cents, and all extensions and summations have been made. The bidder understands that the quantities appearing in the bid schedule are approximate and are provided for the purpose of obtaining a gross sum for the comparison of bids. If there is an error in the extension of the unit prices, the unit prices shall govern. Payment to the contractor awarded the contract will be made only for actual quantities of work performed and accepted or materials furnished according to the contract. The scheduled quantities of work to be done and materials to be furnished may be increased, decreased or omitted as provided elsewhere in the contract.

8. **AUTHORITY TO DO BUSINESS IN ILLINOIS.** Section 20-43 of the Illinois Procurement Code (30 ILCS 500/20-43) provides that a person (other than an individual acting as a sole proprietor) must be a legal entity authorized to do business in the State of Illinois prior to submitting the bid.

9. **The services of a subcontractor will or may be used.**

Check box Yes
 Check box No

For known subcontractors with subcontracts with an annual value of more than \$25,000, the contract shall include their name, address, and the dollar allocation for each subcontractor.

10. **EXECUTION OF CONTRACT:** The Department of Transportation will, in accordance with the rules governing Department procurements, execute the contract and shall be the sole entity having the authority to accept performance and make payments under the contract. Execution of the contract by the Chief Procurement Officer or the State Purchasing Officer is for approval of the procurement process and execution of the contract by the Department. Neither the Chief Procurement Officer nor the State Purchasing Officer shall be responsible for administration of the contract or determinations respecting performance or payment there under except as otherwise permitted in the Illinois Procurement Code.

ILLINOIS DEPARTMENT OF TRANSPORTATION
 SCHEDULE OF PRICES
 CONTRACT
 NUMBER - 78237

State Job # - C-99-024-11
 PPS NBR - 9-00441-0000
 County Name - FRANKLIN- -
 Code - 55 - -
 District - 9 - -
 Section Number - 11RS-4

Project Number

Route
 FAU 9454B

Item Number	Pay Item Description	Unit of Measure	Quantity	x	Unit Price	=	Total Price
X4420724	CL C PATCH T1 10 SPL	SQ YD	25.000				
Z0048665	RR PROT LIABILITY INS	L SUM	1.000				
40600100	BIT MATLS PR CT	GALLON	1,492.000				
40600300	AGG PR CT	TON	25.000				
40600982	HMA SURF REM BUTT JT	SQ YD	720.000				
40600990	TEMPORARY RAMP	SQ YD	120.000				
40603545	P HMA SC "D" N90	TON	1,779.000				
44000155	HMA SURF REM 1 1/2	SQ YD	15,851.000				
44201353	CL C PATCH T2 10	SQ YD	720.000				
44201357	CL C PATCH T3 10	SQ YD	354.000				
44201359	CL C PATCH T4 10	SQ YD	352.000				
67100100	MOBILIZATION	L SUM	1.000				
70102620	TR CONT & PROT 701501	L SUM	1.000				
70106800	CHANGEABLE MESSAGE SN	CAL MO	2.000				
70300100	SHORT TERM PAVT MKING	FOOT	828.000				

ILLINOIS DEPARTMENT OF TRANSPORTATION
 SCHEDULE OF PRICES
 CONTRACT
 NUMBER - 78237

State Job # - C-99-024-11
 PPS NBR - 9-00441-0000
 County Name - FRANKLIN- -
 Code - 55 - -
 District - 9 - -
 Section Number - 11RS-4

Project Number

Route
 FAU 9454B

Item Number	Pay Item Description	Unit of Measure	Quantity	x	Unit Price	=	Total Price
70300210	TEMP PVT MK LTR & SYM	SQ FT	244.800				
70300220	TEMP PVT MK LINE 4	FOOT	2,501.000				
70300280	TEMP PVT MK LINE 24	FOOT	144.000				
70301000	WORK ZONE PAVT MK REM	SQ FT	276.000				
78000100	THPL PVT MK LTR & SYM	SQ FT	244.800				
78000200	THPL PVT MK LINE 4	FOOT	2,501.000				
78000650	THPL PVT MK LINE 24	FOOT	144.000				
78300200	RAISED REF PVT MK REM	EACH	54.000				

RETURN WITH BID

STATE REQUIRED ETHICAL STANDARDS GOVERNING CONTRACT PROCUREMENT: ASSURANCES, CERTIFICATIONS AND DISCLOSURES

I. GENERAL

A. Article 50 of the Illinois Procurement Code establishes the duty of all State chief procurement officers, State purchasing officers, and their designees to maximize the value of the expenditure of public moneys in procuring goods, services, and contracts for the State of Illinois and to act in a manner that maintains the integrity and public trust of State government. In discharging this duty, they are charged by law to use all available information, reasonable efforts, and reasonable actions to protect, safeguard, and maintain the procurement process of the State of Illinois.

B. In order to comply with the provisions of Article 50 and to carry out the duty established therein, all bidders are to adhere to ethical standards established for the procurement process, and to make such assurances, disclosures and certifications required by law. Except as otherwise required in subsection III, paragraphs J-M, by execution of the Proposal Signature Sheet, the bidder indicates that each of the mandated assurances have been read and understood, that each certification is made and understood, and that each disclosure requirement has been understood and completed.

C. In addition to all other remedies provided by law, failure to comply with any assurance, failure to make any disclosure or the making of a false certification shall be grounds for the chief procurement officer to void the contract, or subcontract, and may result in the suspension or debarment of the bidder or subcontractor.

II. ASSURANCES

The assurances hereinafter made by the bidder are each a material representation of fact upon which reliance is placed should the Department enter into the contract with the bidder.

A. Conflicts of Interest

1. The Illinois Procurement Code provides in pertinent part:

Section 50-13. Conflicts of Interest.

(a) Prohibition. It is unlawful for any person holding an elective office in this State, holding a seat in the General Assembly, or appointed to or employed in any of the offices or agencies of state government and who receives compensation for such employment in excess of 60% of the salary of the Governor of the State of Illinois, or who is an officer or employee of the Capital Development Board or the Illinois Toll Highway Authority, or who is the spouse or minor child of any such person to have or acquire any contract, or any direct pecuniary interest in any contract therein, whether for stationery, printing, paper, or any services, materials, or supplies, that will be wholly or partially satisfied by the payment of funds appropriated by the General Assembly of the State of Illinois or in any contract of the Capital Development Board or the Illinois Toll Highway authority.

(b) Interests. It is unlawful for any firm, partnership, association or corporation, in which any person listed in subsection (a) is entitled to receive (i) more than 7 1/2% of the total distributable income or (ii) an amount in excess of the salary of the Governor, to have or acquire any such contract or direct pecuniary interest therein.

(c) Combined interests. It is unlawful for any firm, partnership, association, or corporation, in which any person listed in subsection (a) together with his or her spouse or minor children is entitled to receive (i) more than 15%, in the aggregate, of the total distributable income or (ii) an amount in excess of 2 times the salary of the Governor, to have or acquire any such contract or direct pecuniary interest therein.

(d) Securities. Nothing in this Section invalidates the provisions of any bond or other security previously offered or to be offered for sale or sold by or for the State of Illinois.

(e) Prior interests. This Section does not affect the validity of any contract made between the State and an officer or employee of the State or member of the General Assembly, his or her spouse, minor child or any combination of those persons if that contract was in existence before his or her election or employment as an officer, member, or employee. The contract is voidable, however, if it cannot be completed within 365 days after the officer, member, or employee takes office or is employed.

The current salary of the Governor is \$177,412.00. Sixty percent of the salary is \$106,447.20.

RETURN WITH BID

2. The bidder assures the Department that the award and execution of the contract would not cause a violation of Section 50-13, or that an effective exemption has been issued by the Board of Ethics to any individual subject to the Section 50-13 prohibitions pursuant to the provisions of Section 50-20 of the Code and Executive Order Number 3 (1998). Information concerning the exemption process is available from the Department upon request.

B. Negotiations

1. The Illinois Procurement Code provides in pertinent part:

Section 50-15. Negotiations.

(a) It is unlawful for any person employed in or on a continual contractual relationship with any of the offices or agencies of State government to participate in contract negotiations on behalf of that office or agency with any firm, partnership, association, or corporation with whom that person has a contract for future employment or is negotiating concerning possible future employment.

2. The bidder assures the Department that the award and execution of the contract would not cause a violation of Section 50-15, and that the bidder has no knowledge of any facts relevant to the kinds of acts prohibited therein.

C. Inducements

1. The Illinois Procurement Code provides:

Section 50-25. Inducement. Any person who offers or pays any money or other valuable thing to any person to induce him or her not to bid for a State contract or as recompense for not having bid on a State contract is guilty of a Class 4 felony. Any person who accepts any money or other valuable thing for not bidding for a State contract or who withholds a bid in consideration of the promise for the payment of money or other valuable thing is guilty of a Class 4 felony.

2. The bidder assures the Department that the award and execution of the contract would not cause a violation of Section 50-25, and that the bidder has no knowledge of any facts relevant to the kinds of acts prohibited therein.

D. Revolving Door Prohibition

1. The Illinois Procurement Code provides:

Section 50-30. Revolving door prohibition. Chief procurement officers, State purchasing officers, procurement compliance monitors, their designees whose principal duties are directly related to State procurement, and executive officers confirmed by the Senate are expressly prohibited for a period of 2 years after terminating an affected position from engaging in any procurement activity relating to the State agency most recently employing them in an affected position for a period of at least 6 months. The prohibition includes, but is not limited to: lobbying the procurement process; specifying; bidding; proposing bid, proposal, or contract documents; on their own behalf or on behalf of any firm, partnership, association, or corporation. This Section applies only to persons who terminate an affected position on or after January 15, 1999.

2. The bidder assures the Department that the award and execution of the contract would not cause a violation of Section 50-30, and that the bidder has no knowledge of any facts relevant to the kinds of acts prohibited therein.

E. Reporting Anticompetitive Practices

1. The Illinois Procurement Code provides:

Section 50-40. Reporting anticompetitive practices. When, for any reason, any vendor, bidder, contractor, chief procurement officer, State purchasing officer, designee, elected official, or State employee suspects collusion or other anticompetitive practice among any bidders, offerors, contractors, proposers, or employees of the State, a notice of the relevant facts shall be transmitted to the Attorney General and the chief procurement officer.

2. The bidder assures the Department that it has not failed to report any relevant facts concerning the practices addressed in Section 50-40 which may involve the contract for which the bid is submitted.

F. Confidentiality

1. The Illinois Procurement Code provides:

Section 50-45. Confidentiality. Any chief procurement officer, State purchasing officer, designee, or executive officer who willfully uses or allows the use of specifications, competitive bid documents, proprietary competitive information, proposals, contracts, or selection information to compromise the fairness or integrity of the procurement, bidding, or contract process shall be subject to immediate dismissal, regardless of the Personnel code, any contract, or any collective bargaining agreement, and may in addition be subject to criminal prosecution.

2. The bidder assures the Department that it has no knowledge of any fact relevant to the practices addressed in Section 50-45 which may involve the contract for which the bid is submitted.

RETURN WITH BID

G. Insider Information

1. The Illinois Procurement Act provides:

Section 50-50. Insider information. It is unlawful for any current or former elected or appointed State official or State employee to knowingly use confidential information available only by virtue of that office or employment for actual or anticipated gain for themselves or another person.

2. The bidder assures the Department that it has no knowledge of any facts relevant to the practices addressed in Section 50-50 which may involve the contract for which the bid is submitted.

III. CERTIFICATIONS

The certifications hereinafter made by the bidder are each a material representation of fact upon which reliance is placed should the Department enter into the contract with the bidder. Section 50-2 of the Illinois Procurement Code provides that every person that has entered into a multi-year contract and every subcontractor with a multi-year subcontract shall certify, by July 1 of each fiscal year covered by the contract after the initial fiscal year, to the responsible chief procurement officer whether it continues to satisfy the requirements of Article 50 pertaining to the eligibility for a contract award. If a contractor or subcontractor is not able to truthfully certify that it continues to meet all requirements, it shall provide with its certification a detailed explanation of the circumstances leading to the change in certification status. A contractor or subcontractor that makes a false statement material to any given certification required under Article 50 is, in addition to any other penalties or consequences prescribed by law, subject to liability under the Whistleblower Reward and Protection Act for submission of a false claim.

A. Bribery

1. The Illinois Procurement Code provides:

Section 50-5. Bribery.

(a) Prohibition. No person or business shall be awarded a contract or subcontract under this Code who:

(1) has been convicted under the laws of Illinois or any other state of bribery or attempting to bribe an officer or employee of the State of Illinois or any other state in that officer's or employee's official capacity; or

(2) has made an admission of guilt of that conduct that is a matter of record but has not been prosecuted for that conduct.

(b) Businesses. No business shall be barred from contracting with any unit of State or local government, or subcontracting under such a contract, as a result of a conviction under this Section of any employee or agent of the business if the employee or agent is no longer employed by the business and:

(1) the business has been finally adjudicated not guilty; or

(2) the business demonstrates to the governmental entity with which it seeks to contract, or which is signatory to the contract which the subcontract relates, and that entity finds that the commission of the offense was not authorized, requested, commanded, or performed by a director, officer, or high managerial agent on behalf of the business as provided in paragraph (2) of subsection (a) of Section 5-4 of the Criminal Code of 1961.

(c) Conduct on behalf of business. For purposes of this Section, when an official, agent, or employee of a business committed the bribery or attempted bribery on behalf of the business and in accordance with the direction or authorization of a responsible official of the business, the business shall be chargeable with the conduct.

(d) Certification. Every bid submitted to and contract executed by the State, and every subcontract subject to Section 20-120 of the Procurement Code shall contain a certification by the contractor or the subcontractor, respectively, that the contractor or subcontractor is not barred from being awarded a contract or subcontract under this Section and acknowledges that the chief procurement officer may declare the related contract void if any certifications required by this Section are false. A contractor who makes a false statement, material to the certification, commits a Class 3 felony.

2. The contractor or subcontractor certifies that it is not barred from being awarded a contract under Section 50.5.

B. Felons

1. The Illinois Procurement Code provides:

Section 50-10. Felons. Unless otherwise provided, no person or business convicted of a felony shall do business with the State of Illinois or any State agency, or enter into a subcontract, from the date of conviction until 5 years after the date of completion of the sentence for that felony, unless no person held responsible by a prosecutorial office for the facts upon which the conviction was based continues to have any involvement with the business.

2. Certification. Every bid submitted to and contract executed by the State and every subcontract subject to Section 20-120 of the Procurement Code shall contain a certification by the bidder or contractor or subcontractor, respectively, that the bidder, contractor, or subcontractor is not barred from being awarded a contract or subcontract under this Section and acknowledges that the chief procurement officer may declare the related contract void if any of the certifications required by this Section are false.

RETURN WITH BID

C. Debt Delinquency

1. The Illinois Procurement Code provides:

Section 50-11 and 50-12. Debt Delinquency.

The contractor or bidder or subcontractor, respectively, certifies that it, or any affiliate, is not barred from being awarded a contract or subcontract under the Procurement Code. Section 50-11 prohibits a person from entering into a contract with a State agency, or entering into a subcontract, if it knows or should know that it, or any affiliate, is delinquent in the payment of any debt to the State as defined by the Debt Collection Board. Section 50-12 prohibits a person from entering into a contract with a State agency, or entering into a subcontract, if it, or any affiliate, has failed to collect and remit Illinois Use Tax on all sales of tangible personal property into the State of Illinois in accordance with the provisions of the Illinois Use Tax Act. The bidder or contractor or subcontractor, respectively, further acknowledges that the chief procurement officer may declare the related contract void if this certification is false or if the bidder, contractor, or subcontractor, or any affiliate, is determined to be delinquent in the payment of any debt to the State during the term of the contract.

D. Prohibited Bidders, Contractors and Subcontractors

1. The Illinois Procurement Code provides:

Section 50-10.5 and 50-60(c). Prohibited bidders, contractors and subcontractors.

The bidder or contractor or subcontractor, respectively, certifies in accordance with 30 ILCS 500/50-10.5 that no officer, director, partner or other managerial agent of the contracting business has been convicted of a felony under the Sarbanes-Oxley Act of 2002 or a Class 3 or Class 2 felony under the Illinois Securities Law of 1953 or if in violation of Subsection (c) for a period of five years from the date of conviction. Every bid submitted to and contract executed by the State and every subcontract subject to Section 20-120 of the Procurement Code shall contain a certification by the bidder, contractor, or subcontractor, respectively, that the bidder, contractor, or subcontractor is not barred from being awarded a contract or subcontract under this Section and acknowledges that the chief procurement officer shall declare the related contract void if any of the certifications completed pursuant to this Section are false.

E. Section 42 of the Environmental Protection Act

The bidder or contractor or subcontractor, respectively, certifies in accordance with 30 ILCS 500/50-12 that the bidder, contractor, or subcontractor, is not barred from being awarded a contract or entering into a subcontract under this Section which prohibits the bidding on or entering into contracts with the State of Illinois or a State agency, or entering into any subcontract, that is subject to the Procurement Code by a person or business found by a court or the Pollution Control Board to have committed a willful or knowing violation of Section 42 of the Environmental Protection Act for a period of five years from the date of the order. The bidder or contractor or subcontractor, respectively, acknowledges that the chief procurement officer may declare the contract void if this certification is false.

F. Educational Loan

1. Section 3 of the Educational Loan Default Act provides:

§ 3. No State agency shall contract with an individual for goods or services if that individual is in default, as defined in Section 2 of this Act, on an educational loan. Any contract used by any State agency shall include a statement certifying that the individual is not in default on an educational loan as provided in this Section.

2. The bidder, if an individual as opposed to a corporation, partnership or other form of business organization, certifies that the bidder is not in default on an educational loan as provided in Section 3 of the Act.

G. Bid-Rigging/Bid Rotating

1. Section 33E-11 of the Criminal Code of 1961 provides:

§ 33E-11. (a) Every bid submitted to and public contract executed pursuant to such bid by the State or a unit of local government shall contain a certification by the prime contractor that the prime contractor is not barred from contracting with any unit of State or local government as a result of a violation of either Section 33E-3 or 33E-4 of this Article. The State and units of local government shall provide the appropriate forms for such certification.

- (b) A contractor who makes a false statement, material to the certification, commits a Class 3 felony.

A violation of Section 33E-3 would be represented by a conviction of the crime of bid-rigging which, in addition to Class 3 felony sentencing, provides that any person convicted of this offense or any similar offense of any state or the United States which contains the same elements as this offense shall be barred for 5 years from the date of conviction from contracting with any unit of State or local government. No corporation shall be barred from contracting with any unit of State or local government as a result of a conviction under this Section of any employee or agent of such corporation if the employee so convicted is no longer employed by the corporation and: (1) it has been finally adjudicated not guilty or (2) if it demonstrates to the governmental entity with which it seeks to contract and that entity finds that the commission of the offense was neither authorized, requested, commanded, nor performed by a director, officer or a high managerial agent in behalf of the corporation.

RETURN WITH BID

A violation of Section 33E-4 would be represented by a conviction of the crime of bid-rotating which, in addition to Class 2 felony sentencing, provides that any person convicted of this offense or any similar offense of any state or the United States which contains the same elements as this offense shall be permanently barred from contracting with any unit of State or local government. No corporation shall be barred from contracting with any unit of State or local government as a result of a conviction under this Section of any employee or agent of such corporation if the employee so convicted is no longer employed by the corporation and: (1) it has been finally adjudicated not guilty or (2) if it demonstrates to the governmental entity with which it seeks to contract and that entity finds that the commission of the offense was neither authorized, requested, commanded, nor performed by a director, officer or a high managerial agent in behalf of the corporation.

2. The bidder certifies that it is not barred from contracting with the Department by reason of a violation of either Section 33E-3 or Section 33E-4.

H. International Anti-Boycott

1. Section 5 of the International Anti-Boycott Certification Act provides:

§ 5. State contracts. Every contract entered into by the State of Illinois for the manufacture, furnishing, or purchasing of supplies, material, or equipment or for the furnishing of work, labor, or services, in an amount exceeding the threshold for small purchases according to the purchasing laws of this State or \$10,000.00, whichever is less, shall contain certification, as a material condition of the contract, by which the contractor agrees that neither the contractor nor any substantially-owned affiliated company is participating or shall participate in an international boycott in violation of the provisions of the U.S. Export Administration Act of 1979 or the regulations of the U.S. Department of Commerce promulgated under that Act.

2. The bidder makes the certification set forth in Section 5 of the Act.

I. Drug Free Workplace

1. The Illinois "Drug Free Workplace Act" applies to this contract and it is necessary to comply with the provisions of the "Act" if the contractor is a corporation, partnership, or other entity (including a sole proprietorship) which has 25 or more employees.

2. The bidder certifies that if awarded a contract in excess of \$5,000 it will provide a drug free workplace by:

(a) Publishing a statement notifying employees that the unlawful manufacture, distribution, dispensation, possession or use of a controlled substance, including cannabis, is prohibited in the contractor's workplace; specifying the actions that will be taken against employees for violations of such prohibition; and notifying the employee that, as a condition of employment on such contract, the employee shall abide by the terms of the statement, and notify the employer of any criminal drug statute conviction for a violation occurring in the workplace no later than five (5) days after such conviction.

(b) Establishing a drug free awareness program to inform employees about the dangers of drug abuse in the workplace; the contractor's policy of maintaining a drug free workplace; any available drug counseling, rehabilitation, and employee assistance programs; and the penalties that may be imposed upon employees for drug violations.

(c) Providing a copy of the statement required by subparagraph (1) to each employee engaged in the performance of the contract and to post the statement in a prominent place in the workplace.

(d) Notifying the Department within ten (10) days after receiving notice from an employee or otherwise receiving actual notice of the conviction of an employee for a violation of any criminal drug statute occurring in the workplace.

(e) Imposing or requiring, within 30 days after receiving notice from an employee of a conviction or actual notice of such a conviction, an appropriate personnel action, up to and including termination, or the satisfactory participation in a drug abuse assistance or rehabilitation program approved by a federal, state or local health, law enforcement or other appropriate agency.

(f) Assisting employees in selecting a course of action in the event drug counseling, treatment, and rehabilitation is required and indicating that a trained referral team is in place.

(g) Making a good faith effort to continue to maintain a drug free workplace through implementation of the actions and efforts stated in this certification.

RETURN WITH BID

J. Disclosure of Business Operations in Iran

Section 50-36 of the Illinois Procurement Code, 30ILCS 500/50-36 provides that each bid, offer, or proposal submitted for a State contract shall include a disclosure of whether or not the Company acting as the bidder, offeror, or proposing entity, or any of its corporate parents or subsidiaries, within the 24 months before submission of the bid, offer, or proposal had business operations that involved contracts with or provision of supplies or services to the Government of Iran, companies in which the Government of Iran has any direct or indirect equity share, consortiums or projects commissioned by the Government of Iran, or companies involved in consortiums or projects commissioned by the Government of Iran and either of the following conditions apply:

- (1) More than 10% of the Company's revenues produced in or assets located in Iran involve oil-related activities or mineral-extraction activities; less than 75% of the Company's revenues produced in or assets located in Iran involve contracts with or provision of oil-related or mineral-extraction products or services to the Government of Iran or a project or consortium created exclusively by that government; and the Company has failed to take substantial action.
- (2) The Company has, on or after August 5, 1996, made an investment of \$20 million or more, or any combination of investments of at least \$10 million each that in the aggregate equals or exceeds \$20 million in any 12-month period, which directly or significantly contributes to the enhancement of Iran's ability to develop petroleum resources of Iran.

The terms "Business operations", "Company", "Mineral-extraction activities", "Oil-related activities", "Petroleum resources", and "Substantial action" are all defined in the Code.

Failure to make the disclosure required by the Code shall cause the bid, offer or proposal to be considered not responsive. The disclosure will be considered when evaluating the bid, offer, or proposal or awarding the contract. The name of each Company disclosed as doing business or having done business in Iran will be provided to the State Comptroller.

Check the appropriate statement:

Company has no business operations in Iran to disclose.

Company has business operations in Iran as disclosed the attached document.

K. Apprenticeship and Training Certification (Does not apply to federal aid projects)

In accordance with the provisions of Section 30-22 (6) of the Illinois Procurement Code, the bidder certifies that it is a participant, either as an individual or as part of a group program, in the approved apprenticeship and training programs applicable to each type of work or craft that the bidder will perform with its own forces. The bidder further certifies for work that will be performed by subcontract that each of its subcontractors submitted for approval either (a) is, at the time of such bid, participating in an approved, applicable apprenticeship and training program; or (b) will, prior to commencement of performance of work pursuant to this contract, begin participation in an approved apprenticeship and training program applicable to the work of the subcontract. The Department, at any time before or after award, may require the production of a copy of each applicable Certificate of Registration issued by the United States Department of Labor evidencing such participation by the contractor and any or all of its subcontractors. Applicable apprenticeship and training programs are those that have been approved and registered with the United States Department of Labor. The bidder shall list in the space below, the official name of the program sponsor holding the Certificate of Registration for all of the types of work or crafts in which the bidder is a participant and that will be performed with the bidder's forces. Types of work or craft work that will be subcontracted shall be included and listed as subcontract work. The list shall also indicate any type of work or craft job category that does not have an applicable apprenticeship or training program. **The bidder is responsible for making a complete report and shall make certain that each type of work or craft job category that will be utilized on the project as reported on the Construction Employee Workforce Projection (Form BC-1256) and returned with the bid is accounted for and listed.**

The requirements of this certification and disclosure are a material part of the contract, and the contractor shall require this certification provision to be included in all approved subcontracts. In order to fulfill this requirement, it shall not be necessary that an applicable program sponsor be currently taking or that it will take applications for apprenticeship, training or employment during the performance of the work of this contract.

TO BE RETURNED WITH BID

L. Political Contributions and Registration with the State Board of Elections

Sections 20-160 and 50-37 of the Illinois Procurement Code regulate political contributions from business entities and any affiliated entities or affiliated persons bidding on or contracting with the state. Generally under Section 50-37, any business entity, and any affiliated entity or affiliated person of the business entity, whose current year contracts with all state agencies exceed an awarded value of \$50,000, are prohibited from making any contributions to any political committees established to promote the candidacy of the officeholder responsible for the awarding of the contracts or any other declared candidate for that office for the duration of the term of office of the incumbent officeholder or a period 2 years after the termination of the contract, whichever is longer. Any business entity and affiliated entities or affiliated persons whose state contracts in the current year do not exceed an awarded value of \$50,000, but whose aggregate pending bids and proposals on state contracts exceed \$50,000, either alone or in combination with contracts not exceeding \$50,000, are prohibited from making any political contributions to any political committee established to promote the candidacy of the officeholder responsible for awarding the pending contract during the period beginning on the date the invitation for bids or request for proposals is issued and ending on the day after the date of award or selection if the entity was not awarded or selected. Section 20-160 requires certification of registration of affected business entities in accordance with procedures found in Section 9-35 of The Election Code.

By submission of a bid, the contractor business entity acknowledges and agrees that it has read and understands Sections 20-160 and 50-37 of the Illinois Procurement Code, and that it makes the following certification:

The undersigned business entity certifies that it has registered as a business with the State Board of Elections and acknowledges a continuing duty to update the registration in accordance with the above referenced statutes. A copy of the certificate of registration shall be submitted with the bid. The bidder is cautioned that the Department will not award a contract without submission of the certificate of registration.

These requirements and compliance with the above referenced statutory sections are a material part of the contract, and any breach thereof shall be cause to void the contract under Section 50-60 of the Illinois Procurement Code. This provision does not apply to Federal-aid contracts.

M. Lobbyist Disclosure

Section 50-38 of the Illinois Procurement Code requires that any bidder or offeror on a State contract that hires a person required to register under the Lobbyist Registration Act to assist in obtaining a contract shall:

- (i) Disclose all costs, fees, compensation, reimbursements, and other remunerations paid or to be paid to the lobbyist related to the contract,
- (ii) Not bill or otherwise cause the State of Illinois to pay for any of the lobbyist's costs, fees, compensation, reimbursements, or other remuneration, and
- (iii) Sign a verification certifying that none of the lobbyist's costs, fees, compensation, reimbursements, or other remuneration were billed to the State.

This information, along with all supporting documents, shall be filed with the agency awarding the contract and with the Secretary of State. The chief procurement officer shall post this information, together with the contract award notice, in the online Procurement Bulletin.

Pursuant to Subsection (c) of this Section, no person or entity shall retain a person or entity to attempt to influence the outcome of a procurement decision made under the Procurement Code for compensation contingent in whole or in part upon the decision or procurement. Any person who violates this subsection is guilty of a business offense and shall be fined not more than \$10,000.

Bidder acknowledges that it is required to disclose the hiring of any person required to register pursuant to the Illinois Lobbyist Registration Act (25 ILCS 170) in connection with this contract.

Bidder has not hired any person required to register pursuant to the Illinois Lobbyist Registration Act in connection with this contract.

Or

Bidder has hired the following persons required to register pursuant to the Illinois Lobbyist Registration Act in connection with the contract:

Name and address of person: _____
All costs, fees, compensation, reimbursements and other remuneration paid to said person: _____

RETURN WITH BID

IV. DISCLOSURES

- A. The disclosures hereinafter made by the bidder are each a material representation of fact upon which reliance is placed should the Department enter into the contract with the bidder. The bidder further certifies that the Department has received the disclosure forms for each bid.

The chief procurement officer may void the bid, contract, or subcontract, respectively, if it is later determined that the bidder or subcontractor rendered a false or erroneous disclosure. A contractor or subcontractor may be suspended or debarred for violations of the Procurement Code. Furthermore, the chief procurement officer may void the contract and the surety providing the performance bond shall be responsible for completion of the contract.

B. Financial Interests and Conflicts of Interest

1. Section 50-35 of the Illinois Procurement Code provides that all bids of more than \$25,000 shall be accompanied by disclosure of the financial interests of the bidder. This disclosed information for the successful bidder, will be maintained as public information subject to release by request pursuant to the Freedom of Information Act, filed with the Procurement Policy Board, and shall be incorporated as a material term of the contract. Furthermore, pursuant to Section 5-5, the Procurement Policy Board may review a proposal, bid, or contract and issue a recommendation to void a contract or reject a proposal or bid based on any violation of the Procurement Code or the existence of a conflict of interest as provided in subsections (b) and (d) of Section 50-35.

The financial interests to be disclosed shall include ownership or distributive income share that is in excess of 5%, or an amount greater than 60% of the annual salary of the Governor, of the bidding entity or its parent entity, whichever is less, unless the contractor or bidder is a publicly traded entity subject to Federal 10K reporting, in which case it may submit its 10K disclosure in place of the prescribed disclosure. If a bidder is a privately held entity that is exempt from Federal 10K reporting, but has more than 400 shareholders, it may submit the information that Federal 10K companies are required to report, and list the names of any person or entity holding any ownership share that is in excess of 5%. The disclosure shall include the names, addresses, and dollar or proportionate share of ownership of each person making the disclosure, their instrument of ownership or beneficial relationship, and notice of any potential conflict of interest resulting from the current ownership or beneficial interest of each person making the disclosure having any of the relationships identified in Section 50-35 and on the disclosure form.

The current annual salary of the Governor is \$177,412.00

In addition, all disclosures shall indicate any other current or pending contracts, proposals, leases, or other ongoing procurement relationships the bidding entity has with any other unit of state government and shall clearly identify the unit and the contract, proposal, lease, or other relationship.

2. Disclosure Forms. Disclosure Form A is attached for use concerning the individuals meeting the above ownership or distributive share requirements. Subject individuals should be covered each by one form. In addition, a second form (Disclosure Form B) provides for the disclosure of current or pending procurement relationships with other (non-IDOT) state agencies. **The forms must be included with each bid.**

C. Disclosure Form Instructions

Form A Instructions for Financial Information & Potential Conflicts of Interest

If the bidder is a publicly traded entity subject to Federal 10K reporting, the 10K Report may be submitted to meet the requirements of Form A. If a bidder is a privately held entity that is exempt from Federal 10K reporting, but has more than 400 shareholders, it may submit the information that Federal 10K companies are required to report, and list the names of any person or entity holding any ownership share that is in excess of 5%. If a bidder is not subject to Federal 10K reporting, the bidder must determine if any individuals are required by law to complete a financial disclosure form. To do this, the bidder should answer each of the following questions. A "YES" answer indicates Form A must be completed. If the answer to each of the following questions is "NO", then the NOT APPLICABLE STATEMENT on Form A must be signed and dated by a person that is authorized to execute contracts for the bidding company. Note: These questions are for assistance only and are not required to be completed.

1. Does anyone in your organization have a direct or beneficial ownership share of greater than 5% of the bidding entity or parent entity? YES ___ NO ___
2. Does anyone in your organization have a direct or beneficial ownership share of less than 5%, but which has a value greater than 60% of the annual salary of the Governor? YES ___ NO ___
3. Does anyone in your organization receive more than 60% of the annual salary of the Governor of the bidding entity's or parent entity's distributive income? YES ___ NO ___

(Note: Distributive income is, for these purposes, any type of distribution of profits. An annual salary is not distributive income.)

4. Does anyone in your organization receive greater than 5% of the bidding entity's or parent entity's total distributive income, but which is less than 60% of the annual salary of the Governor? YES ___ NO ___

(Note: Only one set of forms needs to be completed per person per bid even if a specific individual would require a yes answer to more than one question.)

A "YES" answer to any of these questions requires the completion of Form A. The bidder must determine each individual in the bidding entity or the bidding entity's parent company that would cause the questions to be answered "Yes". Each form must be signed and dated by a person that is authorized to execute contracts for your organization. **Photocopied or stamped signatures are not acceptable.** The person signing can be, but does not have to be, the person for which the form is being completed. The bidder is responsible for the accuracy of any information provided.

If the answer to each of the above questions is "NO", then the NOT APPLICABLE STATEMENT of Form A must be signed and dated by a person that is authorized to execute contracts for your company.

RETURN WITH BID

Form B: Instructions for Identifying Other Contracts & Procurement Related Information

Disclosure Form B must be completed for each bid submitted by the bidding entity. *Note: Checking the NOT APPLICABLE STATEMENT on Form A does not allow the bidder to ignore Form B. Form B must be completed, checked, and dated or the bidder may be considered nonresponsive and the bid will not be accepted.*

The Bidder shall identify, by checking Yes or No on Form B, whether it has any pending contracts (including leases), bids, proposals, or other ongoing procurement relationship with any other (non-IDOT) State of Illinois agency. If "No" is checked, the bidder only needs to complete the check box on the bottom of Form B. If "Yes" is checked, the bidder must do one of the following:

Option I: If the bidder did not submit an Affidavit of Availability to obtain authorization to bid, the bidder must list all non-IDOT State of Illinois agency pending contracts, leases, bids, proposals, and other ongoing procurement relationships. These items may be listed on Form B or on an attached sheet(s). Do not include IDOT contracts. Contracts with cities, counties, villages, etc. are not considered State of Illinois agency contracts and are not to be included. Contracts with other State of Illinois agencies such as the Department of Natural Resources or the Capital Development Board must be included. Bidders who submit Affidavits of Availability are suggested to use Option II.

Option II: If the bidder is required and has submitted an Affidavit of Availability in order to obtain authorization to bid, the bidder may write or type "See Affidavit of Availability" which indicates that the Affidavit of Availability is incorporated by reference and includes all non-IDOT State of Illinois agency pending contracts, leases, bids, proposals, and other ongoing procurement relationships. For any contracts that are not covered by the Affidavit of Availability, the bidder must identify them on Form B or on an attached sheet(s). These might be such things as leases.

**ILLINOIS DEPARTMENT
OF TRANSPORTATION**

**Form A
Financial Information &
Potential Conflicts of Interest
Disclosure**

Contractor Name		
Legal Address		
City, State, Zip		
Telephone Number	Email Address	Fax Number (if available)

Disclosure of the information contained in this Form is required by the Section 50-35 of the Illinois Procurement Code (30 ILCS 500). Vendors desiring to enter into a contract with the State of Illinois must disclose the financial information and potential conflict of interest information as specified in this Disclosure Form. This information shall become part of the publicly available contract file. This Form A must be completed for bids in excess of \$25,000, and for all open-ended contracts. **A publicly traded company may submit a 10K disclosure (or equivalent if applicable) in satisfaction of the requirements set forth in Form A. See Disclosure Form Instructions.**

The current annual salary of the Governor is \$177,412.00.

DISCLOSURE OF FINANCIAL INFORMATION

1. Disclosure of Financial Information. The individual named below has an interest in the BIDDER (or its parent) in terms of ownership or distributive income share in excess of 5%, or an interest which has a value of more than 60% of the annual salary of the Governor. **(Make copies of this form as necessary and attach a separate Disclosure Form A for each individual meeting these requirements)**

FOR INDIVIDUAL (type or print information)	
NAME:	_____
ADDRESS	_____
Type of ownership/distributable income share:	
stock _____	sole proprietorship _____ Partnership _____ other: (explain on separate sheet):
% or \$ value of ownership/distributable income share: _____	

2. Disclosure of Potential Conflicts of Interest. Check "Yes" or "No" to indicate which, if any, of the following potential conflict of interest relationships apply. If the answer to any question is "Yes", please attach additional pages and describe.

(a) State employment, currently or in the previous 3 years, including contractual employment of services. Yes ___ No ___

If your answer is yes, please answer each of the following questions.

1. Are you currently an officer or employee of either the Capitol Development Board or the Illinois State Toll Highway Authority? Yes ___ No ___

2. Are you currently appointed to or employed by any agency of the State of Illinois? If you are currently appointed to or employed by any agency of the State of Illinois, and your annual salary exceeds 60% of the annual salary of the Governor, provide the name the State agency for which you are employed and your annual salary. _____

RETURN WITH BID

3. If you are currently appointed to or employed by any agency of the State of Illinois, and your annual salary exceeds 60% of the annual salary of the Governor, are you entitled to receive (i) more than 7 1/2% of the total distributable income of your firm, partnership, association or corporation, or (ii) an amount in excess of 100% of the annual salary of the Governor?
Yes ___ No ___

4. If you are currently appointed to or employed by any agency of the State of Illinois, and your annual salary exceeds 60% of the annual salary of the Governor, are you and your spouse or minor children entitled to receive (i) more than 15 % in the aggregate of the total distributable income of your firm, partnership, association or corporation, or (ii) an amount in excess of two times the salary of the Governor?
Yes ___ No ___

(b) State employment of spouse, father, mother, son, or daughter, including contractual employment services in the previous 2 years.

Yes ___ No ___

If your answer is yes, please answer each of the following questions.

1. Is your spouse or any minor children currently an officer or employee of the Capitol Development Board or the Illinois State Toll Highway Authority?
Yes ___ No ___

2. Is your spouse or any minor children currently appointed to or employed by any agency of the State of Illinois? If your spouse or minor children is/are currently appointed to or employed by any agency of the State of Illinois, and his/her annual salary exceeds 60% of the annual salary of the Governor, provide the name of your spouse and/or minor children, the name of the State agency for which he/she is employed and his/her annual salary. _____

3. If your spouse or any minor children is/are currently appointed to or employed by any agency of the State of Illinois, and his/her annual salary exceeds 60% of the annual salary of the Governor, as of 7/1/07 are you entitled to receive (i) more than 7 1/2% of the total distributable income of your firm, partnership, association or corporation, or (ii) an amount in excess of 100% of the annual salary of the Governor?
Yes ___ No ___

4. If your spouse or any minor children are currently appointed to or employed by any agency of the State of Illinois, and his/her annual salary exceeds 60% of the annual salary of the Governor, are you and your spouse or minor children entitled to receive (i) more than 15 % in the aggregate of the total distributable income of your firm, partnership, association or corporation, or (ii) an amount in excess of 2 times the salary of the Governor?
Yes ___ No ___

(c) Elective status; the holding of elective office of the State of Illinois, the government of the United States, any unit of local government authorized by the Constitution of the State of Illinois or the statutes of the State of Illinois currently or in the previous 3 years.
Yes ___ No ___

(d) Relationship to anyone holding elective office currently or in the previous 2 years; spouse, father, mother, son, or daughter.
Yes ___ No ___

(e) Appointive office; the holding of any appointive government office of the State of Illinois, the United States of America, or any unit of local government authorized by the Constitution of the State of Illinois or the statutes of the State of Illinois, which office entitles the holder to compensation in excess of the expenses incurred in the discharge of that office currently or in the previous 3 years.
Yes ___ No ___

(f) Relationship to anyone holding appointive office currently or in the previous 2 years; spouse, father, mother, son, or daughter.
Yes ___ No ___

(g) Employment, currently or in the previous 3 years, as or by any registered lobbyist of the State government.
Yes ___ No ___

RETURN WITH BID/OFFER

(h) Relationship to anyone who is or was a registered lobbyist in the previous 2 years; spouse, father, mother, son, or daughter. Yes ___ No ___

(i) Compensated employment, currently or in the previous 3 years, by any registered election or reelection committee registered with the Secretary of State or any county clerk of the State of Illinois, or any political action committee registered with either the Secretary of State or the Federal Board of Elections. Yes ___ No ___

(j) Relationship to anyone; spouse, father, mother, son, or daughter; who was a compensated employee in the last 2 years by any registered election or re-election committee registered with the Secretary of State or any county clerk of the State of Illinois, or any political action committee registered with either the Secretary of State or the Federal Board of Elections. Yes ___ No ___

2. Communication Disclosure.

Disclose the name and address of each lobbyist and other agent of the bidder or offeror who is not identified in Section 2 of this form, who is has communicated, is communicating, or may communicate with any State officer or employee concerning the bid or offer. This disclosure is a continuing obligation and must be promptly supplemented for accuracy throughout the process and throughout the term of the contract. If no person is identified, enter "None" on the line below:

Name and address of person(s): _____

RETURN WITH BID

4. Debarment Disclosure. For each of the persons identified under Sections 2 and 3 of this form, disclose whether any of the following has occurred within the previous 10 years: debarment from contracting with any governmental entity; professional licensure discipline; bankruptcies; adverse civil judgments and administrative findings; and criminal felony convictions. This disclosure is a continuing obligation and must be promptly supplemented for accuracy throughout the procurement process and term of the contract. If no person is identified, enter "None" on the line below:

Name of person(s): _____

Nature of disclosure: _____

APPLICABLE STATEMENT

This Disclosure Form A is submitted on behalf of the INDIVIDUAL named on previous page. Under penalty of perjury, I certify the contents of this disclosure to be true and accurate to the best of my knowledge.

Completed by: _____ Date _____
Signature of Individual or Authorized Representative

NOT APPLICABLE STATEMENT

Under penalty of perjury, I have determined that no individuals associated with this organization meet the criteria that would require the completion of this Form A.

This Disclosure Form A is submitted on behalf of the CONTRACTOR listed on the previous page.

_____ Date _____
Signature of Authorized Representative

The bidder has a continuing obligation to supplement these disclosures under Sec. 50-35 of the Procurement Code.

RETURN WITH BID

ILLINOIS DEPARTMENT OF TRANSPORTATION

Form B Other Contracts & Procurement Related Information Disclosure

Contractor Name, Legal Address, City, State, Zip, Telephone Number, Email Address, Fax Number (if available)

Disclosure of the information contained in this Form is required by the Section 50-35 of the Illinois Procurement Act (30 ILCS 500). This information shall become part of the publicly available contract file. This Form B must be completed for bids in excess of \$25,000, and for all open-ended contracts.

DISCLOSURE OF OTHER CONTRACTS AND PROCUREMENT RELATED INFORMATION

1. Identifying Other Contracts & Procurement Related Information. The BIDDER shall identify whether it has any pending contracts (including leases), bids, proposals, or other ongoing procurement relationship with any other State of Illinois agency: Yes ___ No ___

If "No" is checked, the bidder only needs to complete the signature box on the bottom of this page.

2. If "Yes" is checked. Identify each such relationship by showing State of Illinois agency name and other descriptive information such as bid or project number (attach additional pages as necessary). SEE DISCLOSURE FORM INSTRUCTIONS:

THE FOLLOWING STATEMENT MUST BE CHECKED

Signature of Authorized Representative, Date

RETURN WITH BID

SPECIAL NOTICE TO CONTRACTORS

The following requirements of the Illinois Department of Human Rights' Rules and Regulations are applicable to bidders on all construction contracts advertised by the Illinois Department of Transportation:

CONSTRUCTION EMPLOYEE UTILIZATION PROJECTION

- (a) All bidders on construction contracts shall complete and submit, along with and as part of their bids, a Bidder's Employee Utilization Form (Form BC-1256) setting forth a projection and breakdown of the total workforce intended to be hired and/or allocated to such contract work by the bidder including a projection of minority and female employee utilization in all job classifications on the contract project.
- (b) The Department of Transportation shall review the Employee Utilization Form, and workforce projections contained therein, of the contract awardee to determine if such projections reflect an underutilization of minority persons and/or women in any job classification in accordance with the Equal Employment Opportunity Clause and Section 7.2 of the Illinois Department of Human Rights' Rules and Regulations for Public Contracts adopted as amended on September 17, 1980. If it is determined that the contract awardee's projections reflect an underutilization of minority persons and/or women in any job classification, it shall be advised in writing of the manner in which it is underutilizing and such awardee shall be considered to be in breach of the contract unless, prior to commencement of work on the contract project, it submits revised satisfactory projections or an acceptable written affirmative action plan to correct such underutilization including a specific timetable geared to the completion stages of the contract.
- (c) The Department of Transportation shall provide to the Department of Human Rights a copy of the contract awardee's Employee Utilization Form, a copy of any required written affirmative action plan, and any written correspondence related thereto. The Department of Human Rights may review and revise any action taken by the Department of Transportation with respect to these requirements.



**Contract No. 78237
FRANKLIN County
Section 11RS-4
Route FAU 9454B
District 9 Construction Funds**

PART I. IDENTIFICATION

Dept. Human Rights # _____ Duration of Project: _____

Name of Bidder: _____

PART II. WORKFORCE PROJECTION

A. The undersigned bidder has analyzed minority group and female populations, unemployment rates and availability of workers for the location in which this contract work is to be performed, and for the locations from which the bidder recruits employees, and hereby submits the following workforce projection including a projection for minority and female employee utilization in all job categories in the workforce to be allocated to this contract:

TABLE A

TABLE B

TOTAL Workforce Projection for Contract												
JOB CATEGORIES	TOTAL EMPLOYEES		MINORITY EMPLOYEES						TRAINEES			
			BLACK		HISPANIC		*OTHER MINOR.		APPRENTICES		ON THE JOB TRAINEES	
	M	F	M	F	M	F	M	F	M	F	M	F
OFFICIALS (MANAGERS)												
SUPERVISORS												
FOREMEN												
CLERICAL												
EQUIPMENT OPERATORS												
MECHANICS												
TRUCK DRIVERS												
IRONWORKERS												
CARPENTERS												
CEMENT MASONS												
ELECTRICIANS												
PIPEFITTERS, PLUMBERS												
PAINTERS												
LABORERS, SEMI-SKILLED												
LABORERS, UNSKILLED												
TOTAL												

CURRENT EMPLOYEES TO BE ASSIGNED TO CONTRACT			
TOTAL EMPLOYEES		MINORITY EMPLOYEES	
M	F	M	F

TABLE C

TOTAL Training Projection for Contract								
EMPLOYEES IN TRAINING	TOTAL EMPLOYEES		BLACK		HISPANIC		*OTHER MINOR.	
	M	F	M	F	M	F	M	F
APPRENTICES								
ON THE JOB TRAINEES								

FOR DEPARTMENT USE ONLY

* Other minorities are defined as Asians (A) or Native Americans (N). Please specify race of each employee shown in Other Minorities column.

Note: See instructions on page 2

RETURN WITH BID

**Contract No. 78237
FRANKLIN County
Section 11RS-4
Route FAU 9454B
District 9 Construction Funds**

PART II. WORKFORCE PROJECTION - continued

- B. Included in "Total Employees" under Table A is the total number of **new hires** that would be employed in the event the undersigned bidder is awarded this contract.

The undersigned bidder projects that: (number) _____ new hires would be recruited from the area in which the contract project is located; and/or (number) _____ new hires would be recruited from the area in which the bidder's principal office or base of operation is located.

- C. Included in "Total Employees" under Table A is a projection of numbers of persons to be employed directly by the undersigned bidder as well as a projection of numbers of persons to be employed by subcontractors.

The undersigned bidder estimates that (number) _____ persons will be directly employed by the prime contractor and that (number) _____ persons will be employed by subcontractors.

PART III. AFFIRMATIVE ACTION PLAN

- A. The undersigned bidder understands and agrees that in the event the foregoing minority and female employee utilization projection included under **PART II** is determined to be an underutilization of minority persons or women in any job category, and in the event that the undersigned bidder is awarded this contract, he/she will, prior to commencement of work, develop and submit a written Affirmative Action Plan including a specific timetable (geared to the completion stages of the contract) whereby deficiencies in minority and/or female employee utilization are corrected. Such Affirmative Action Plan will be subject to approval by the contracting agency and the **Department of Human Rights**.
- B. The undersigned bidder understands and agrees that the minority and female employee utilization projection submitted herein, and the goals and timetable included under an Affirmative Action Plan if required, are deemed to be part of the contract specifications.

Company _____ Telephone Number _____

Address _____

NOTICE REGARDING SIGNATURE

The Bidder's signature on the Proposal Signature Sheet will constitute the signing of this form. The following signature block needs to be completed if revisions are required.

Signature: _____ Title: _____ Date: _____

- Instructions: All tables must include subcontractor personnel in addition to prime contractor personnel.
- Table A - Include both the number of employees that would be hired to perform the contract work and the total number currently employed (Table B) that will be allocated to contract work, and include all apprentices and on-the-job trainees. The "Total Employees" column should include all employees including all minorities, apprentices and on-the-job trainees to be employed on the contract work.
- Table B - Include all employees currently employed that will be allocated to the contract work including any apprentices and on-the-job trainees currently employed.
- Table C - Indicate the racial breakdown of the total apprentices and on-the-job trainees shown in Table A.

RETURN WITH BID

Contract No. 78237

FRANKLIN County

Section 11RS-4

Route FAU 9454B

District 9 Construction Funds

PROPOSAL SIGNATURE SHEET

The undersigned bidder hereby makes and submits this bid on the subject Proposal, thereby assuring the Department that all requirements of the Invitation for Bids and rules of the Department have been met, that there is no misunderstanding of the requirements of paragraph 3 of this Proposal, and that the contract will be executed in accordance with the rules of the Department if an award is made on this bid.

(IF AN INDIVIDUAL) Firm Name _____
Signature of Owner _____
Business Address _____

(IF A CO-PARTNERSHIP) Firm Name _____
By _____
Business Address _____
Name and Address of All Members of the Firm:

(IF A CORPORATION) Corporate Name _____
By _____
Signature of Authorized Representative _____
Typed or printed name and title of Authorized Representative _____
Attest _____
Signature _____
(IF A JOINT VENTURE, USE THIS SECTION FOR THE MANAGING PARTY AND THE SECOND PARTY SHOULD SIGN BELOW) Business Address _____

(IF A JOINT VENTURE) Corporate Name _____
By _____
Signature of Authorized Representative _____
Typed or printed name and title of Authorized Representative _____
Attest _____
Signature _____
Business Address _____

If more than two parties are in the joint venture, please attach an additional signature sheet.



Item No. _____

Letting Date _____

KNOW ALL MEN BY THESE PRESENTS, That We _____

as PRINCIPAL, and _____

_____ as SURETY, are held jointly, severally and firmly bound unto the STATE OF ILLINOIS in the penal sum of 5 percent of the total bid price, or for the amount specified in Article 102.09 of the "Standard Specifications for Road and Bridge Construction" in effect on the date of invitation for bids, whichever is the lesser sum, well and truly to be paid unto said STATE OF ILLINOIS, for the payment of which we bind ourselves, our heirs, executors, administrators, successors and assigns.

THE CONDITION OF THE FOREGOING OBLIGATION IS SUCH, that whereas, the PRINCIPAL has submitted a bid proposal to the STATE OF ILLINOIS, acting through the Department of Transportation, for the improvement designated by the Transportation Bulletin Item Number and Letting Date indicated above.

NOW, THEREFORE, if the Department shall accept the bid proposal of the PRINCIPAL; and if the PRINCIPAL shall, within the time and as specified in the bidding and contract documents, submit a DBE Utilization Plan that is accepted and approved by the Department; and if, after award by the Department, the PRINCIPAL shall enter into a contract in accordance with the terms of the bidding and contract documents including evidence of the required insurance coverages and providing such bond as specified with good and sufficient surety for the faithful performance of such contract and for the prompt payment of labor and material furnished in the prosecution thereof; or if, in the event of the failure of the PRINCIPAL to make the required DBE submission or to enter into such contract and to give the specified bond, the PRINCIPAL pays to the Department the difference not to exceed the penalty hereof between the amount specified in the bid proposal and such larger amount for which the Department may contract with another party to perform the work covered by said bid proposal, then this obligation shall be null and void, otherwise, it shall remain in full force and effect.

IN THE EVENT the Department determines the PRINCIPAL has failed to comply with any requirement as set forth in the preceding paragraph, then Surety shall pay the penal sum to the Department within fifteen (15) days of written demand therefor. If Surety does not make full payment within such period of time, the Department may bring an action to collect the amount owed. Surety is liable to the Department for all its expenses, including attorney's fees, incurred in any litigation in which it prevails either in whole or in part.

In TESTIMONY WHEREOF, the said PRINCIPAL and the said SURETY have caused this instrument to be signed by their respective officers this _____ day of _____ A.D., _____.

PRINCIPAL

SURETY

(Company Name)

(Company Name)

By _____
(Signature & Title)

By: _____
(Signature of Attorney-in-Fact)

Notary Certification for Principal and Surety

STATE OF ILLINOIS,
County of _____

I, _____, a Notary Public in and for said County, do hereby certify that _____ and _____
(Insert names of individuals signing on behalf of PRINCIPAL & SURETY)

who are each personally known to me to be the same persons whose names are subscribed to the foregoing instrument on behalf of PRINCIPAL and SURETY, appeared before me this day in person and acknowledged respectively, that they signed and delivered said instrument as their free and voluntary act for the uses and purposes therein set forth.

Given under my hand and notarial seal this _____ day of _____ A.D. _____

My commission expires _____

Notary Public

In lieu of completing the above section of the Proposal Bid Form, the Principal may file an Electronic Bid Bond. By signing the proposal and marking the check box next to the Signature and Title line below, the Principal is ensuring the identified electronic bid bond has been executed and the Principal and Surety are firmly bound unto the State of Illinois under the conditions of the bid bond as shown above.

Electronic Bid Bond ID# _____ Company / Bidder Name _____ _____
Signature and Title

(1) Policy

It is public policy that disadvantageded businesses as defined in 49 CFR Part 26 and the Special Provision shall have the maximum opportunity to participate in the performance of contracts financed in whole or in part with Federal or State funds. Consequently the requirements of 49 CFR Part 26 apply to this contract.

(2) Obligation

The contractor agrees to ensure that disadvantageded businesses as defined in 49 CFR Part 26 and the Special Provision have the maximum opportunity to participate in the performance of contracts or subcontracts financed in whole or in part with Federal or State funds. The contractor shall take all necessary and reasonable steps in accordance with 49 CFR Part 26 and the Special Provision to ensure that said businesses have the maximum opportunity to compete for and perform under this contract. The contractor shall not discriminate on the basis of race, color, national origin or sex in the award and performance of contracts.

(3) Project and Bid Identification

Complete the following information concerning the project and bid:

Route _____	Total Bid _____
Section _____	Contract DBE Goal _____
Project _____	(Percent) (Dollar Amount)
County _____	
Letting Date _____	
Contract No. _____	
Letting Item No. _____	

(4) Assurance

I, acting in my capacity as an officer of the undersigned bidder (or bidders if a joint venture), hereby assure the Department that on this project my company : (check one)

- Meets or exceeds contract award goals and has provided documented participation as follows:
Disadvantaged Business Participation _____ percent

Attached are the signed participation statements, forms SBE 2025, required by the Special Provision evidencing availability and use of each business participating in this plan and assuring that each business will perform a commercially useful function in the work of the contract.

- Failed to meet contract award goals and has included good faith effort documentation to meet the goals and that my company has provided participation as follows:
Disadvantaged Business Participation _____ percent

The contract goals should be accordingly modified or waived. Attached is all information required by the Special Provision in support of this request including good faith effort. Also attached are the signed participation statements, forms SBE 2025, required by the Special Provision evidencing availability and use of each business participating in this plan and assuring that each business will perform a commercially useful function in the work of the contract.

_____ Company

By _____

Title _____

Date _____

The "as read" Low Bidder is required to comply with the Special Provision.

Submit only one utilization plan for each project. The utilization plan shall be submitted in accordance with the special provision.

Bureau of Small Business Enterprises **Local Let Projects**
2300 South Dirksen Parkway Submit forms to the
Springfield, Illinois 62764 Local Agency



**Illinois Department
of Transportation**

DBE Participation Statement

Subcontractor Registration _____

Letting _____

Participation Statement

Item No. _____

(1) Instructions

Contract _____

This form must be completed for each disadvantaged business participating in the Utilization Plan. This form shall be submitted in accordance with the special provision and will be attached to the Utilization Plan form. If additional space is needed complete an additional form for the firm.

(2) Work

Pay Item No.	Description	Quantity	Unit Price	Total
Total				

(3) Partial Payment Items

For any of the above items which are partial pay items, specifically describe the work and subcontract dollar amount:

(4) Commitment

The undersigned certify that the information included herein is true and correct, and that the DBE firm listed below has agreed to perform a commercially useful function in the work of the contract item(s) listed above and to execute a contract with the prime contractor. The undersigned further understand that no changes to this statement may be made without prior approval from the Department’s Bureau of Small Business Enterprises and that complete and accurate information regarding actual work performed on this project and the payment therefore must be provided to the Department.

Signature for Prime Contractor

Signature for DBE Firm

Title _____

Title _____

Date _____

Date _____

Contact _____

Contact _____

Phone _____

Phone _____

Firm Name _____

Firm Name _____

Address _____

Address _____

City/State/Zip _____

City/State/Zip _____

E _____

WC _____

The Department of Transportation is requesting disclosure of information that is necessary to accomplish the statutory purpose as outlined under the state and federal law. Disclosure of this information is **REQUIRED**. Failure to provide any information will result in the contract not being awarded. This form has been approved by the State Forms Management Center.

PROPOSAL ENVELOPE



PROPOSALS

for construction work advertised for bids by the
Illinois Department of Transportation

Item No.	Item No.	Item No.

Submitted By:

Name:
Address:
Phone No.

Bidders should use an IDOT proposal envelope or affix this form to the front of a 10" x 13" envelope for the submittal of bids. If proposals are mailed, they should be enclosed in a second or outer envelope addressed to:

Engineer of Design and Environment - Room 326
Illinois Department of Transportation
2300 South Dirksen Parkway
Springfield, Illinois 62764

NOTICE

Individual bids, including Bid Bond and/or supplemental information if required, should be securely stapled.

CONTRACTOR OFFICE COPY OF CONTRACT SPECIFICATIONS

NOTICE

None of the following material needs to be returned with the bid package unless the special provisions require documentation and/or other information to be submitted.

**Contract No. 78237
FRANKLIN County
Section 11RS-4
Route FAU 9454B
District 9 Construction Funds**



Illinois Department of Transportation

SUBCONTRACTOR DOCUMENTATION

Public Acts 96-0795 and 96-0920, enacted substantial changes to the provisions of the Illinois Procurement Code (30 ILCS 500). Among the changes are provisions affecting subcontractors. The Contractor awarded this contract will be required as a material condition of the contract to implement and enforce the contract requirements applicable to subcontractors approved in accordance with article 108.01 of the Standard Specifications for Road and Bridge Construction.

If the Contractor seeks approval of subcontractors to perform a portion of the work, and approval is granted by the Department, the Contractor shall provide a copy of the subcontract to the Chief Procurement Officer within 20 calendar days after execution of the subcontract.

The subcontract shall contain the certifications required to be made by subcontractors pursuant to Article 50 of the Illinois Procurement Code. This Notice to Bidders includes a document incorporating all required subcontractor certifications and disclosures for use by the Contractor in compliance with this mandate. The document is entitled State Required Ethical Standards Governing Subcontractors.

RETURN WITH SUBCONTRACT

STATE ETHICAL STANDARDS GOVERNING SUBCONTRACTORS

Article 50 of the Illinois Procurement Code establishes the duty of all State chief procurement officers, State purchasing officers, and their designees to maximize the value of the expenditure of public moneys in procuring goods, services, and contracts for the State of Illinois and to act in a manner that maintains the integrity and public trust of State government. In discharging this duty, they are charged by law to use all available information, reasonable efforts, and reasonable actions to protect, safeguard, and maintain the procurement process of the State of Illinois.

The certifications hereinafter made by the subcontractor are each a material representation of fact upon which reliance is placed should the Department approve the subcontractor. The chief procurement officer may terminate or void the subcontract approval if it is later determined that the bidder or subcontractor rendered a false or erroneous certification.

Section 50-2 of the Illinois Procurement Code provides that every person that has entered into a multi-year contract and every subcontractor with a multi-year subcontract shall certify, by July 1 of each fiscal year covered by the contract after the initial fiscal year, to the responsible chief procurement officer whether it continues to satisfy the requirements of Article 50 pertaining to the eligibility for a contract award. If a contractor or subcontractor is not able to truthfully certify that it continues to meet all requirements, it shall provide with its certification a detailed explanation of the circumstances leading to the change in certification status. A contractor or subcontractor that makes a false statement material to any given certification required under Article 50 is, in addition to any other penalties or consequences prescribed by law, subject to liability under the Whistleblower Reward and Protection Act for submission of a false claim.

A. Bribery

1. The Illinois Procurement Code provides:

Section 50-5. Bribery.

(a) Prohibition. No person or business shall be awarded a contract or subcontract under this Code who:

(1) has been convicted under the laws of Illinois or any other state of bribery or attempting to bribe an officer or employee of the State of Illinois or any other state in that officer's or employee's official capacity; or

(2) has made an admission of guilt of that conduct that is a matter of record but has not been prosecuted for that conduct.

(b) Businesses. No business shall be barred from contracting with any unit of State or local government, or subcontracting under such a contract, as a result of a conviction under this Section of any employee or agent of the business if the employee or agent is no longer employed by the business and:

(1) the business has been finally adjudicated not guilty; or

(2) the business demonstrates to the governmental entity with which it seeks to contract, or which is signatory to the contract to which the subcontract relates, and that entity finds that the commission of the offense was not authorized, requested, commanded, or performed by a director, officer, or high managerial agent on behalf of the business as provided in paragraph (2) of subsection (a) of Section 5-4 of the Criminal Code of 1961.

(c) Conduct on behalf of business. For purposes of this Section, when an official, agent, or employee of a business committed the bribery or attempted bribery on behalf of the business and in accordance with the direction or authorization of a responsible official of the business, the business shall be chargeable with the conduct.

(d) Certification. Every bid submitted to and contract executed by the State, and every subcontract subject to Section 20-120 of the Procurement Code shall contain a certification by the contractor or the subcontractor, respectively, that the contractor or subcontractor is not barred from being awarded a contract or subcontract under this Section and acknowledges that the chief procurement officer may declare the related contract void if any certifications required by this Section are false. A contractor who makes a false statement, material to the certification, commits a Class 3 felony.

2. The contractor or subcontractor certifies that it is not barred from being awarded a contract under Section 50.5.

B. Felons

1. The Illinois Procurement Code provides:

Section 50-10. Felons. Unless otherwise provided, no person or business convicted of a felony shall do business with the State of Illinois or any State agency, or enter into a subcontract, from the date of conviction until 5 years after the date of completion of the sentence for that felony, unless no person held responsible by a prosecutorial office for the facts upon which the conviction was based continues to have any involvement with the business.

2. Certification. Every bid submitted to and contract executed by the State and every subcontract subject to Section 20-120 of the Procurement Code shall contain a certification by the bidder or contractor or subcontractor, respectively, that the bidder, contractor, or subcontractor is not barred from being awarded a contract or subcontract under this Section and acknowledges that the chief procurement officer may declare the related contract void if any of the certifications required by this Section are false.

RETURN WITH SUBCONTRACT

C. Debt Delinquency

1. The Illinois Procurement Code provides:

Section 50-11 and 50-12. Debt Delinquency.

The contractor or bidder or subcontractor, respectively, certifies that it, or any affiliate, is not barred from being awarded a contract or subcontract under the Procurement Code. Section 50-11 prohibits a person from entering into a contract with a State agency, or entering into a subcontract, if it knows or should know that it, or any affiliate, is delinquent in the payment of any debt to the State as defined by the Debt Collection Board. Section 50-12 prohibits a person from entering into a contract with a State agency, or entering into a subcontract, if it, or any affiliate, has failed to collect and remit Illinois Use Tax on all sales of tangible personal property into the State of Illinois in accordance with the provisions of the Illinois Use Tax Act. The bidder or contractor or subcontractor, respectively, further acknowledges that the chief procurement officer may declare the related contract void if this certification is false or if the bidder, contractor, or subcontractor, or any affiliate, is determined to be delinquent in the payment of any debt to the State during the term of the contract.

D. Prohibited Bidders, Contractors and Subcontractors

1. The Illinois Procurement Code provides:

Section 50-10.5 and 50-60(c). Prohibited bidders, contractors and subcontractors.

The bidder or contractor or subcontractor, respectively, certifies in accordance with 30 ILCS 500/50-10.5 that no officer, director, partner or other managerial agent of the contracting business has been convicted of a felony under the Sarbanes-Oxley Act of 2002 or a Class 3 or Class 2 felony under the Illinois Securities Law of 1953 or if in violation of Subsection (c) for a period of five years from the date of conviction.. Every bid submitted to and contract executed by the State and every subcontract subject to Section 20-120 of the Procurement Code shall contain a certification by the bidder, contractor, or subcontractor, respectively, that the bidder, contractor, or subcontractor is not barred from being awarded a contract or subcontract under this Section and acknowledges that the chief procurement officer shall declare the related contract void if any of the certifications completed pursuant to this Section are false.

E. Section 42 of the Environmental Protection Act

The bidder or contractor or subcontractor, respectively, certifies in accordance with 30 ILCS 500/50-12 that the bidder, contractor, or subcontractor, is not barred from being awarded a contract or entering into a subcontract under this Section which prohibits the bidding on or entering into contracts with the State of Illinois or a State agency, or entering into any subcontract, that is subject to the Procurement Code by a person or business found by a court or the Pollution Control Board to have committed a willful or knowing violation of Section 42 of the Environmental Protection Act for a period of five years from the date of the order. The bidder or contractor or subcontractor, respectively, acknowledges that the chief procurement officer may declare the contract void if this certification is false.

The undersigned, on behalf of the subcontracting company, has read and understands the above certifications and makes the certifications as required by law.

_____ Name of Subcontracting Company		
_____ Authorized Officer	_____ Date	

RETURN WITH SUBCONTRACT
SUBCONTRACTOR DISCLOSURES

I. DISCLOSURES

- A.** The disclosures hereinafter made by the subcontractor are each a material representation of fact upon which reliance is placed. The subcontractor further certifies that the Department has received the disclosure forms for each subcontract.

The chief procurement officer may void the bid, contract, or subcontract, respectively, if it is later determined that the bidder or subcontractor rendered a false or erroneous disclosure. A contractor or subcontractor may be suspended or debarred for violations of the Procurement Code. Furthermore, the chief procurement officer may void the contract or subcontract.

B. Financial Interests and Conflicts of Interest

1. Section 50-35 of the Illinois Procurement Code provides that all subcontracts with a total value of \$25,000 or more from subcontractors identified in Section 20-120 of the Illinois Procurement Code, shall be accompanied by disclosure of the financial interests of the subcontractor. This disclosed information for the subcontractor, will be maintained as public information subject to release by request pursuant to the Freedom of Information Act, filed with the Procurement Policy Board, and shall be incorporated as a material term of the Prime Contractor's contract. Furthermore, pursuant to this Section, the Procurement Policy Board may recommend to allow or void a contract or subcontract based on a potential conflict of interest.

The financial interests to be disclosed shall include ownership or distributive income share that is in excess of 5%, or an amount greater than 60% of the annual salary of the Governor, of the subcontracting entity or its parent entity, whichever is less, unless the subcontractor is a publicly traded entity subject to Federal 10K reporting, in which case it may submit its 10K disclosure in place of the prescribed disclosure. If a subcontractor is a privately held entity that is exempt from Federal 10K reporting, but has more than 400 shareholders, it may submit the information that Federal 10K companies are required to report, and list the names of any person or entity holding any ownership share that is in excess of 5%. The disclosure shall include the names, addresses, and dollar or proportionate share of ownership of each person making the disclosure, their instrument of ownership or beneficial relationship, and notice of any potential conflict of interest resulting from the current ownership or beneficial interest of each person making the disclosure having any of the relationships identified in Section 50-35 and on the disclosure form.

The current annual salary of the Governor is \$177,412.00.

In addition, all disclosures shall indicate any other current or pending contracts, subcontracts, proposals, leases, or other ongoing procurement relationships the subcontracting entity has with any other unit of state government and shall clearly identify the unit and the contract, subcontract, proposal, lease, or other relationship.

2. Disclosure Forms. Disclosure Form A is attached for use concerning the individuals meeting the above ownership or distributive share requirements. Subject individuals should be covered each by one form. In addition, a second form (Disclosure Form B) provides for the disclosure of current or pending procurement relationships with other (non-IDOT) state agencies.

C. Disclosure Form Instructions

Form A Instructions for Financial Information & Potential Conflicts of Interest

If the subcontractor is a publicly traded entity subject to Federal 10K reporting, the 10K Report may be submitted to meet the requirements of Form A. If a subcontractor is a privately held entity that is exempt from Federal 10K reporting, but has more than 400 shareholders, it may submit the information that Federal 10K companies are required to report, and list the names of any person or entity holding any ownership share that is in excess of 5%. If a subcontractor is not subject to Federal 10K reporting, the subcontractor must determine if any individuals are required by law to complete a financial disclosure form. To do this, the subcontractor should answer each of the following questions. A "YES" answer indicates Form A must be completed. If the answer to each of the following questions is "NO", then the NOT APPLICABLE STATEMENT on the second page of Form A must be signed and dated by a person that is authorized to execute contracts for the subcontracting company. Note: These questions are for assistance only and are not required to be completed.

1. Does anyone in your organization have a direct or beneficial ownership share of greater than 5% of the bidding entity or parent entity? YES ___ NO ___
2. Does anyone in your organization have a direct or beneficial ownership share of less than 5%, but which has a value greater than 60% of the annual salary of the Governor? YES ___ NO ___
3. Does anyone in your organization receive more than 60% of the annual salary of the Governor of the subcontracting entity's or parent entity's distributive income? YES ___ NO ___

(Note: Distributive income is, for these purposes, any type of distribution of profits. An annual salary is not distributive income.)

4. Does anyone in your organization receive greater than 5% of the subcontracting entity's or parent entity's total distributive income, but which is less than 60% of the annual salary of the Governor? YES ___ NO ___

(Note: Only one set of forms needs to be completed per person per subcontract even if a specific individual would require a yes answer to more than one question.)

A "YES" answer to any of these questions requires the completion of Form A. The subcontractor must determine each individual in the subcontracting entity or the subcontracting entity's parent company that would cause the questions to be answered "Yes". Each form must be signed and dated by a person that is authorized to execute contracts for your organization. **Photocopied or stamped signatures are not acceptable.** The person signing can be, but does not have to be, the person for which the form is being completed. The subcontractor is responsible for the accuracy of any information provided.

If the answer to each of the above questions is "NO", then the NOT APPLICABLE STATEMENT on page 2 of Form A must be signed and dated by a person that is authorized to execute contracts for your company.

RETURN WITH SUBCONTRACT

Form B: Instructions for Identifying Other Contracts & Procurement Related Information

Disclosure Form B must be completed for each subcontract submitted by the subcontracting entity. *Note: Checking the NOT APPLICABLE STATEMENT on Form A does not allow the subcontractor to ignore Form B. Form B must be completed, checked, and dated or the subcontract will not be approved.*

The Subcontractor shall identify, by checking Yes or No on Form B, whether it has any pending contracts, subcontracts, leases, bids, proposals, or other ongoing procurement relationship with any other (non-IDOT) State of Illinois agency. If "No" is checked, the subcontractor only needs to complete the check box on the bottom of Form B. If "Yes" is checked, the subcontractor must list all non-IDOT State of Illinois agency pending contracts, subcontracts, leases, bids, proposals, and other ongoing procurement relationships. These items may be listed on Form B or on an attached sheet(s). Contracts with cities, counties, villages, etc. are not considered State of Illinois agency contracts and are not to be included. Contracts or subcontracts with other State of Illinois agencies such as the Department of Natural Resources or the Capital Development Board must be included.

ILLINOIS DEPARTMENT OF TRANSPORTATION

Form A Subcontractor: Financial Information & Potential Conflicts of Interest Disclosure

Subcontractor Name, Legal Address, City, State, Zip, Telephone Number, Email Address, Fax Number (if available)

Disclosure of the information contained in this Form is required by the Section 50-35 of the Illinois Procurement Code (30 ILCS 500). Subcontractors desiring to enter into a subcontract of a State of Illinois contract must disclose the financial information and potential conflict of interest information as specified in this Disclosure Form.

The current annual salary of the Governor is \$177,412.00.

DISCLOSURE OF FINANCIAL INFORMATION

1. Disclosure of Financial Information. The individual named below has an interest in the SUBCONTRACTOR (or its parent) in terms of ownership or distributive income share in excess of 5%, or an interest which has a value of more than 60% of the annual salary of the Governor.

FOR INDIVIDUAL (type or print information) NAME: ADDRESS Type of ownership/distributable income share: stock sole proprietorship Partnership other: (explain on separate sheet): % or \$ value of ownership/distributable income share:

2. Disclosure of Potential Conflicts of Interest. Check "Yes" or "No" to indicate which, if any, of the following potential conflict of interest relationships apply. If the answer to any question is "Yes", please attach additional pages and describe.

(a) State employment, currently or in the previous 3 years, including contractual employment of services. Yes ___ No ___

If your answer is yes, please answer each of the following questions.

- 1. Are you currently an officer or employee of either the Capitol Development Board or the Illinois State Toll Highway Authority? Yes ___ No ___
2. Are you currently appointed to or employed by any agency of the State of Illinois? If you are currently appointed to or employed by any agency of the State of Illinois, and your annual salary exceeds 60% of the annual salary of the Governor, provide the name the State agency for which you are employed and your annual salary.

RETURN WITH SUBCONTRACT

3. If you are currently appointed to or employed by any agency of the State of Illinois, and your annual salary exceeds 60% of the annual salary of the Governor, are you entitled to receive (i) more than 7 1/2% of the total distributable income of your firm, partnership, association or corporation, or (ii) an amount in excess of 100% of the annual salary of the Governor?
Yes ___ No ___

4. If you are currently appointed to or employed by any agency of the State of Illinois, and your annual salary exceeds 60% of the annual salary of the Governor, are you and your spouse or minor children entitled to receive (i) more than 15 % in the aggregate of the total distributable income of your firm, partnership, association or corporation, or (ii) an amount in excess of two times the salary of the Governor?
Yes ___ No ___

(b) State employment of spouse, father, mother, son, or daughter, including contractual employment services in the previous 2 years.

Yes ___ No ___

If your answer is yes, please answer each of the following questions.

1. Is your spouse or any minor children currently an officer or employee of the Capitol Development Board or the Illinois Toll Highway Authority?
Yes ___ No ___

2. Is your spouse or any minor children currently appointed to or employed by any agency of the State of Illinois? If your spouse or minor children is/are currently appointed to or employed by any agency of the State of Illinois, and his/her annual salary exceeds 60% of the annual salary of the Governor, provide the name of your spouse and/or minor children, the name of the State agency for which he/she is employed and his/her annual salary. _____

3. If your spouse or any minor children is/are currently appointed to or employed by any agency of the State of Illinois, and his/her annual salary exceeds 60% of the annual salary of the Governor, as of 7/1/07 are you entitled to receive (i) more than 7 1/2% of the total distributable income of your firm, partnership, association or corporation, or (ii) an amount in excess of 100% of the annual salary of the Governor?
Yes ___ No ___

4. If your spouse or any minor children are currently appointed to or employed by any agency of the State of Illinois, and his/her annual salary exceeds 60% of the annual salary of the Governor, are you and your spouse or minor children entitled to receive (i) more than 15 % in the aggregate of the total distributable income of your firm, partnership, association or corporation, or (ii) an amount in excess of two times the annual salary of the Governor?
Yes ___ No ___

(c) Elective status; the holding of elective office of the State of Illinois, the government of the United States, any unit of local government authorized by the Constitution of the State of Illinois or the statutes of the State of Illinois currently or in the previous 3 years.
Yes ___ No ___

(d) Relationship to anyone holding elective office currently or in the previous 2 years; spouse, father, mother, son, or daughter.
Yes ___ No ___

(e) Appointive office; the holding of any appointive government office of the State of Illinois, the United States of America, or any unit of local government authorized by the Constitution of the State of Illinois or the statutes of the State of Illinois, which office entitles the holder to compensation in excess of the expenses incurred in the discharge of that office currently or in the previous 3 years.
Yes ___ No ___

(f) Relationship to anyone holding appointive office currently or in the previous 2 years; spouse, father, mother, son, or daughter.
Yes ___ No ___

(g) Employment, currently or in the previous 3 years, as or by any registered lobbyist of the State government.
Yes ___ No ___

RETURN WITH SUBCONTRACT

(h) Relationship to anyone who is or was a registered lobbyist in the previous 2 years; spouse, father, mother, son, or daughter. Yes ___ No ___

(i) Compensated employment, currently or in the previous 3 years, by any registered election or reelection committee registered with the Secretary of State or any county clerk of the State of Illinois, or any political action committee registered with either the Secretary of State or the Federal Board of Elections. Yes ___ No ___

(j) Relationship to anyone; spouse, father, mother, son, or daughter; who was a compensated employee in the last 2 years by any registered election or re-election committee registered with the Secretary of State or any county clerk of the State of Illinois, or any political action committee registered with either the Secretary of State or the Federal Board of Elections. Yes ___ No ___

3. Communication Disclosure.

Disclose the name and address of each lobbyist and other agent of the bidder or offeror who is not identified in Section 2 of this form, who is has communicated, is communicating, or may communicate with any State officer or employee concerning the bid or offer. This disclosure is a continuing obligation and must be promptly supplemented for accuracy throughout the process and throughout the term of the contract. If no person is identified, enter "None" on the line below:

Name and address of person(s): _____

RETURN WITH SUBCONTRACT

4. Debarment Disclosure. For each of the persons identified under Sections 2 and 3 of this form, disclose whether any of the following has occurred within the previous 10 years: debarment from contracting with any governmental entity; professional licensure discipline; bankruptcies; adverse civil judgments and administrative findings; and criminal felony convictions. This disclosure is a continuing obligation and must be promptly supplemented for accuracy throughout the procurement process and term of the contract. If no person is identified, enter "None" on the line below:

Name of person(s): _____

Nature of disclosure: _____

APPLICABLE STATEMENT

This Disclosure Form A is submitted on behalf of the INDIVIDUAL named on previous page. Under penalty of perjury, I certify the contents of this disclosure to be true and accurate to the best of my knowledge.

Completed by: _____ Date _____
Signature of Individual or Authorized Officer

NOT APPLICABLE STATEMENT

Under penalty of perjury, I have determined that no individuals associated with this organization meet the criteria that would require the completion of this Form A.

This Disclosure Form A is submitted on behalf of the SUBCONTRACTOR listed on the previous page.

_____ Date _____
Signature of Authorized Officer

RETURN WITH SUBCONTRACT

ILLINOIS DEPARTMENT
OF TRANSPORTATION

Form B
Subcontractor: Other Contracts &
Procurement Related Information
Disclosure

Subcontractor Name		
Legal Address		
City, State, Zip		
Telephone Number	Email Address	Fax Number (if available)

Disclosure of the information contained in this Form is required by the Section 50-35 of the Illinois Procurement Act (30 ILCS 500). This information shall become part of the publicly available contract file. This Form B must be completed for subcontracts with a total value of \$25,000 or more, from subcontractors identified in Section 20-120 of the Illinois Procurement Code, and for all open-ended contracts.

DISCLOSURE OF OTHER CONTRACTS, SUBCONTRACTS, AND PROCUREMENT RELATED INFORMATION

1. Identifying Other Contracts & Procurement Related Information. The SUBCONTRACTOR shall identify whether it has any pending contracts, subcontracts, including leases, bids, proposals, or other ongoing procurement relationship with any other State of Illinois agency: Yes ___ No ___

If "No" is checked, the subcontractor only needs to complete the signature box on the bottom of this page.

2. If "Yes" is checked. Identify each such relationship by showing State of Illinois agency name and other descriptive information such as bid or project number (attach additional pages as necessary). SEE DISCLOSURE FORM INSTRUCTIONS:

THE FOLLOWING STATEMENT MUST BE CHECKED

<input type="checkbox"/>	_____	_____
	Signature of Authorized Officer	Date



- 1. TIME AND PLACE OF OPENING BIDS.** Sealed proposals for the improvement described herein will be received by the Department of Transportation at the Harry R. Hanley Building, 2300 South Dirksen Parkway, in Springfield, Illinois until 10:00 o'clock a.m., June 17, 2011. All bids will be gathered, sorted, publicly opened and read in the auditorium at the Department of Transportation's Harry R. Hanley Building shortly after the 10:00 a.m. cut off time.
- 2. DESCRIPTION OF WORK.** The proposed improvement is identified and advertised for bids in the Invitation for Bids as:

**Contract No. 78237
FRANKLIN County
Section 11RS-4
Route FAU 9454B
District 9 Construction Funds**

0.83 mile of resurfacing on IL Route 37 from Benton Square to Capital Street in Benton.

- 3. INSTRUCTIONS TO BIDDERS.** (a) This Notice, the invitation for bids, proposal and letter of award shall, together with all other documents in accordance with Article 101.09 of the Standard Specifications for Road and Bridge Construction, become part of the contract. Bidders are cautioned to read and examine carefully all documents, to make all required inspections, and to inquire or seek explanation of the same prior to submission of a bid.

(b) State law, and, if the work is to be paid wholly or in part with Federal-aid funds, Federal law requires the bidder to make various certifications as a part of the proposal and contract. By execution and submission of the proposal, the bidder makes the certification contained therein. A false or fraudulent certification shall, in addition to all other remedies provided by law, be a breach of contract and may result in termination of the contract.
- 4. AWARD CRITERIA AND REJECTION OF BIDS.** This contract will be awarded to the lowest responsive and responsible bidder considering conformity with the terms and conditions established by the Department in the rules, Invitation for Bids and contract documents. The issuance of plans and proposal forms for bidding based upon a prequalification rating shall not be the sole determinant of responsibility. The Department reserves the right to determine responsibility at the time of award, to reject any or all proposals, to readvertise the proposed improvement, and to waive technicalities.

By Order of the
Illinois Department of Transportation

Gary Hannig,
Secretary

INDEX
 FOR
 SUPPLEMENTAL SPECIFICATIONS
 AND RECURRING SPECIAL PROVISIONS

Adopted January 1, 2011

This index contains a listing of SUPPLEMENTAL SPECIFICATIONS and frequently used RECURRING SPECIAL PROVISIONS.

ERRATA Standard Specifications for Road and Bridge Construction (Adopted 1-1-07) (Revised 1-1-11)

SUPPLEMENTAL SPECIFICATIONS

<u>Std. Spec. Sec.</u>	<u>Page No.</u>
201 Clearing, Tree Removal and Protection	1
205 Embankment	2
251 Mulch	3
253 Planting Woody Plants	4
280 Temporary Erosion Control	6
406 Hot-Mix Asphalt Binder and Surface Course	7
420 Portland Cement Concrete Pavement	11
443 Reflective Crack Control Treatment	12
501 Removal of Existing Structures	15
502 Excavation for Structures	16
503 Concrete Structures	17
504 Precast Concrete Structures	18
505 Steel Structures	19
508 Reinforcement Bars	20
540 Box Culverts	21
581 Waterproofing Membrane System	22
606 Concrete Gutter, Curb, Median, and Paved Ditch	23
630 Steel Plate Beam Guardrail	24
633 Removing and Reerecting Guardrail and Terminals	25
637 Concrete Barrier	26
664 Chain Link Fence	27
669 Removal and Disposal of Regulated Substances	28
672 Sealing Abandoned Water Wells	29
701 Work Zone Traffic Control and Protection	30
720 Sign Panels and Appurtenances	32
721 Sign Panel Overlay	33
722 Demountable Sign Legend Characters and Arrows	34
726 Mile Post Marker Assembly	35
733 Overhead Sign Structures	36
780 Pavement Striping	37
782 Prismatic Reflectors	42
783 Pavement Marking and Marker Removal	43
801 Electrical Requirements	44
805 Electrical Service Installation – Traffic Signals	45
821 Roadway Luminaires	46
836 Pole Foundation	47
838 Breakaway Devices	48
843 Removal of Navigational Obstruction Warning Lighting System	49
862 Uninterruptable Power Supply	50
873 Electric Cable	52
878 Traffic Signal Concrete Foundation	54
1003 Fine Aggregates	55
1004 Coarse Aggregates	56
1005 Stone and Broken Concrete	57
1006 Metals	58

1008	Structural Steel Coatings	60
1010	Finely Divided Materials	65
1020	Portland Cement Concrete	66
1022	Concrete Curing Materials	77
1024	Nonshrink Grout	78
1026	Concrete Sealer	79
1030	Hot-Mix Asphalt	80
1032	Bituminous Materials	87
1042	Precast Concrete Products	90
1062	Reflective Crack Control System	92
1069	Pole and Tower	94
1074	Control Equipment	97
1076	Wire and Cable	102
1077	Post and Foundation	103
1080	Fabric Materials	105
1081	Materials for Planting	106
1083	Elastomeric Bearings	108
1090	Sign Base	109
1091	Sign Face	111
1092	Sign Legend and Supplemental Panels	119
1093	Sign Supports	120
1094	Overhead Sign Structures	122
1095	Pavement Markings	128
1097	Reflectors	136
1101	General Equipment	137
1102	Hot-Mix Asphalt Equipment	138
1103	Portland Cement Concrete Equipment	140
1105	Pavement Marking Equipment	141
1106	Work Zone Traffic Control Devices	143

RECURRING SPECIAL PROVISIONS

The following RECURRING SPECIAL PROVISIONS indicated by an "X" are applicable to this contract and are included by reference:

<u>CHECK SHEET #</u>	<u>PAGE NO.</u>
1	145
2	148
3	149
4	159
5	164
6	169
7	170
8	171
9	172
10	175
11	178
12	180
13	184
14	186
15	187
16	189
17	190
18	192
19	193
20	194
21	198
22	200
23	202
24	204
25	205
26	206
27	207
28	208
29	209
30	210
31	218
32	230
33	231

TABLE OF CONTENTS

LOCATION OF PROJECT 1

DESCRIPTION OF PROJECT 1

UTILITIES..... 1

TRAFFIC CONTROL PLAN 1

TWO WEEK NOTIFICATION PRIOR TO STARTING WORK..... 3

PORTABLE CHANGEABLE MESSAGE SIGNS 3

MIXTURE REQUIREMENTS 3

APPROVAL OF PROPOSED BORROW AREAS, USE AREAS, AND/OR WASTE AREAS INSIDE ILLINOIS STATE BORDERS (BDE) 4

AUTOMATED FLAGGER ASSISTANCE DEVICES (BDE)..... 4

CONSTRUCTION AIR QUALITY - DIESEL VEHICLE EMISSIONS CONTROL (BDE) 6

CONSTRUCTION AIR QUALITY - IDLING RESTRICTIONS (BDE)..... 7

DISADVANTAGED BUSINESS ENTERPRISE PARTICIPATION (BDE) 8

DRAINAGE AND INLET PROTECTION UNDER TRAFFIC (BDE)..... 16

EQUIPMENT RENTAL RATES (BDE)..... 17

FLAGGER AT SIDE ROADS AND ENTRANCES (BDE) 18

FRICTION AGGREGATE (BDE) 18

HOT-MIX ASPHALT – ANTI-STRIPPING ADDITIVE (BDE) 21

HOT-MIX ASPHALT - DENSITY TESTING OF LONGITUDINAL JOINTS (BDE) 21

HOT-MIX ASPHALT – DROP-OFFS (BDE) 22

HOT-MIX ASPHALT - FINE AGGREGATE (BDE) 22

LIQUIDATED DAMAGES (BDE)..... 23

NATIONAL POLLUTANT DISCHARGE ELIMINATION SYSTEM / EROSION AND SEDIMENT CONTROL DEFICIENCY DEDUCTION (BDE) 23

PAVEMENT MARKING REMOVAL (BDE)..... 24

PAVEMENT PATCHING (BDE)..... 24

PAYMENTS TO SUBCONTRACTORS (BDE) 25

POST MOUNTING OF SIGNS (BDE)..... 26

RR PROTECTIVE LIABILITY INSURANCE INFO - UPRR 27

UNION PACIFIC RAILROAD MINIMUM REQUIREMENTS (FOR INFORMATION ONLY) 28

RR PROTECTIVE LIABILITY INSURANCE INFORMATION - CN 40

RECLAIMED ASPHALT PAVEMENT (RAP) (BDE) 41

SELECTION OF LABOR (BDE)..... 5

SUBCONTRACTOR MOBILIZATION PAYMENTS (BDE) 6

TRUCK MOUNTED/TRAILER MOUNTED ATTENUATORS (BDE) 6

UTILITY COORDINATION AND CONFLICTS (BDE)..... 7

WORKING DAYS (BDE) 12

BITUMINOUS MATERIALS COST ADJUSTMENTS (BDE) (RETURN FORM WITH BID) 12

STATE OF ILLINOIS
SPECIAL PROVISIONS

The following Special Provisions supplement the "Standard Specifications for Road and Bridge Construction," adopted January 1, 2007, the latest edition of the "Manual on Uniform Traffic Control Devices for Streets and Highways," and the "Manual of Test Procedures for Materials" in effect on the date of invitation for bids, and the Supplemental Specifications and Recurring Special Provisions indicated on the Check Sheet included herein which apply to and govern the construction of FAU Route 9454B (IL 37), Section 11RS-4; Franklin County, Contract No. 78237 and in case of conflict with any part or parts of said Specifications, the said Special Provisions shall take precedence and shall govern.

LOCATION OF PROJECT

This project is located on IL 37 between the Benton Square and Capital St.

DESCRIPTION OF PROJECT

The project is 0.83 mile in length and involves patching, 1½" milling, and 2" resurfacing.

UTILITIES

Effective 1984

Revised 1/2/97

Additional utility information may be obtained by calling the "Joint Utility Location Information for Excavators" phone number, 800-892-0123. This project is located in the West Frankfort Township.

Add the following after the first paragraph of Article 107.31 of the Standard Specifications:

The Contractor is advised that this project includes areas of highway illumination and/or signalized intersections. These areas have underground cable or conduit throughout which is to remain in service. Before driving any posts or beginning any excavation operations, the Contractor shall locate, uncover by hand and relocate any wiring which conflicts with the proposed work. Any cable or conduit which is damaged as a result of the Contractor's operations shall be replaced by him at his expense. Replacement material and methods shall meet or exceed the original specifications for the wiring. Splicing will not be permitted.

TRAFFIC CONTROL PLAN

Effective 1985

Revised 2/17/99

Traffic control shall be in accordance with the applicable sections of the Standard Specifications for Road and Bridge Construction, the guidelines contained in the National Manual on Uniform Traffic Control Devices for Streets and Highways, the Supplemental Specifications, these Special Provisions, and any special details and highway standards contained herein and in the plans.

Special attention is called to Articles 107.09 and 107.14 of the Standard Specifications for Road and Bridge Construction and the following traffic control related (1) Highway Standards; (2) Supplemental Specifications and Recurring Special Provisions; (3) other Special Provisions; and (4) Plan Details which are included in this contract:

1. Standards:
701001, 701006, 701011, 701301, 701311, 701501, 701901
2. Supplemental Specifications and Recurring Special Provisions:
3. Special Provisions:
Portable Changeable Message Signs.
4. Plan Details:

Traffic control standards shall be applied as directed by the Engineer. Suggested applications for each standard are as follow:

701001 This standard should be used on where at all times all vehicles, equipment, workers or their activities are more than 15' from the edge of pavement.

701006 This standard should be used on where any vehicles, equipment, workers or their activities will encroach in the area 15' to 24" from the edge of pavement.

701011 This standard should be used on where at any time, any vehicle, equipment, workers or their activities require an intermittent or continuous moving operation on the shoulder, where the average speed is 1 mph or less.

701301 This standard will apply when short time work operations are being performed. Typical such operations are bituminous density testing, application of temporary pavement marking, marking patches, and miscellaneous survey operations.

701311 This standard should be used for pavement marking or other continuous or intermittent moving operations where the average speed is greater than 3 mph.

701501 This standard is used where at any time, day or night, any vehicle, equipment, workers or their activities encroach on the pavement requiring the closure of one traffic lane in an urban area.

During the entire construction period, the road shall be kept open to traffic as follows:

- (a) In accordance with the applicable portions of the Standard Specifications during the widening, patching and resurfacing operations.
- (b) The highway shall be kept open to at least one lane of traffic at all times, and to two lanes of traffic to the greatest extent possible.

Prior to allowing traffic on any portion of the roadway that has been coldmilled; the Contractor shall have erected "Rough Grooved Surface" and "Uneven Pavement" signs that conform to the details shown in the plans. A minimum of one sign at each end of the improvement will be required.

The Contractor shall maintain the "Rough Grooved Surface" signs until the coldmilled surface is covered with surface course. The contractor shall maintain the "Uneven Pavement" signs until the resurfacing operations are completed.

If at any time the signs are in place but not applicable, they shall be turned from the view of motorists or covered as directed by the Engineer.

The cost of furnishing, erecting, maintaining, and removing the required signs shall be incidental to the contract.

TWO WEEK NOTIFICATION PRIOR TO STARTING WORK

Effective December 2005

Revise the first sentence of Article 107.09 Public Convenience and Safety to the following "The Contractor shall notify the Engineer at least 14 days in advance of starting any construction work.

This additional notification is required so that the public can be notified of the pending construction.

PORTABLE CHANGEABLE MESSAGE SIGNS

This work consists of furnishing, placing, and maintaining changeable message sign(s) according to the Standard Specifications and the following:

A total of 4 changeable message sign shall be required in this contract, one located on IL 37 south of the project, one on IL 37/IL 14 north of the project, one on IL 14 west of the project and one on IL 34 east of the project. All signs must be in place and operational for a minimum of 14 calendar days prior to lane closures. Each sign shall state the day work will begin and delays are possible. The exact message will be approved by the Engineer. The Contractor may be required to relocate each sign multiple times during the contract at his or her expense. The exact location of the placement of these signs shall be determined in the field by the Engineer.

The furnishing, place and maintaining of portable changeable message sign(s) shall be paid for per calendar month as CHANGEABLE MESSAGE SIGN.

MIXTURE REQUIREMENTS

Location(s):	Hot Mix Asphalt Surface Course
Mixture Use(s):	Polymerized Hot Mix Asphalt Surface Course, Mix D, N90
AC/PG:	PG76-22
RAP % (Max):	0
Design Air Voids:	4.0 %, 90 Gyration Design
Mixture Composition: (Gradation Mixture)	IL-9.5 mm or IL12.5 mm
Friction Aggregate:	D Surface

APPROVAL OF PROPOSED BORROW AREAS, USE AREAS, AND/OR WASTE AREAS INSIDE ILLINOIS STATE BORDERS (BDE)

Effective: November 1, 2008

Revised: November 1, 2010

Revise the title of Article 107.22 of the Standard Specifications to read:

“107.22 Approval of Proposed Borrow Areas, Use Areas, and/or Waste Areas Inside Illinois State Borders.”

Add the following sentence to the end of Replace the first paragraph of Article 107.22 of the Standard Specifications with the following:

“Proposed borrow areas, use areas, and/or waste areas outside of Illinois shall comply with Article 107.01. All proposed borrow areas, including commercial borrow areas; use areas, including, but not limited to temporary access roads, detours, runarounds, plant sites, and staging and storage areas; and/or waste areas are to be designated by the Contractor to the Engineer and approved prior to their use. Such areas outside the State of Illinois shall be evaluated, at no additional cost to the Department, according to the requirements of the state in which the area lies; and approval by the authority within that state having jurisdiction for such areas shall be forwarded to the Engineer. Such areas within Illinois shall be evaluated as described herein.

A location map delineating the proposed borrow area, use area, and/or waste area shall be submitted to the Engineer for approval along with an agreement from the property owner granting the Department permission to enter the property and conduct cultural and biological resource reconnaissance surveys of the site for archaeological resources, threatened or endangered species or their designated essential habitat, wetlands, prairies, and savannahs. The type of location map submitted shall be a topographic map, a plat map, or a 7.5 minute quadrangle map. Submittals shall include the intended use of the site and provide sufficient detail for the Engineer to determine the extent of impacts to the site. The Engineer will initiate cultural and biological resource reconnaissance surveys of the site, as necessary, at no cost to the Contractor. The Engineer will advise the Contractor of the expected time required to complete all surveys. If the proposed area is within 150 ft (45 m) of the highway right-of-way, a topographic map of the proposed site will be required as specified in Article 204.02.”

AUTOMATED FLAGGER ASSISTANCE DEVICES (BDE)

Effective: January 1, 2008

Description. This work shall consist of furnishing and operating automated flagger assistance devices (AFADs) as part of the work zone traffic control and protection for two-lane highways where two-way traffic is maintained over one lane of pavement. Use of these devices shall be at the option of the Contractor.

Equipment. AFADs shall be according to the FHWA memorandum, “MUTCD - Revised Interim Approval for the use of Automated Flagger Assistance Devices in Temporary Traffic Control Zones (IA-4R)”, dated January 28, 2005. The devices shall be mounted on a trailer or a moveable cart and shall meet the requirements of NCHRP 350, Category 4.

The AFAD shall be the Stop/Slow type. This device uses remotely controlled “STOP” and “SLOW” signs to alternately control right-of-way.

Signs for the AFAD shall be according to Article 701.03 of the Standard Specifications and the MUTCD. The signs shall be 24 x 24 in. (600 x 600 mm) having an octagon shaped "STOP" sign on one side and a diamond shaped "SLOW" sign on the opposite side. The letters on the signs shall be 8 in. (200 mm) high. If the "STOP" sign has louvers, the full sign face shall be visible at a distance of 50 ft (15 m) and greater.

The signs shall be supplemented with one of the following types of lights.

- (a) Flashing Lights. When flashing lights are used, white or red flashing lights shall be mounted within the "STOP" sign face and white or yellow flashing lights within the "SLOW" sign face.
- (b) Stop and Warning Beacons. When beacons are used, a stop beacon shall be mounted 24 in. (600 mm) or less above the "STOP" sign face and a warning beacon mounted 24 in. (600 mm) or less above, below, or to the side of the "SLOW" sign face. As an option, a Type B warning light may be used in lieu of the warning beacon.

A "WAIT ON STOP" sign shall be placed on the right hand side of the roadway at a point where drivers are expected to stop. The sign shall be 24 x 30 in. (600 x 750 mm) with a black legend and border on a white background. The letters shall be at least 6 in. (150 mm) high.

This device may include a gate arm or mast arm that descends to a horizontal position when the "STOP" sign is displayed and rises to a vertical position when the "SLOW" sign is displayed. When included, the end of the arm shall reach at least to the center of the lane being controlled. The arm shall have alternating red and white retroreflective stripes, on both sides, sloping downward at 45 degrees toward the side on which traffic will pass. The stripes shall be 6 in. (150 mm) in width and at least 2 in. (50 mm) in height.

Flagging Requirements. Flaggers and flagging requirements shall be according to Article 701.13 of the Standard Specifications and the following.

AFADs shall be placed at each end of the traffic control, where a flagger is shown on the plans. The flaggers shall be able to view the face of the AFAD and approaching traffic during operation.

To stop traffic, the "STOP" sign shall be displayed, the corresponding lights/beacon shall flash, and when included, the gate arm shall descend to a horizontal position. To permit traffic to move, the "SLOW" sign shall be displayed, the corresponding lights/beacon shall flash, and when included, the gate arm shall rise to a vertical position.

If used at night, the AFAD location shall be illuminated according to Section 701 of the Standard Specifications.

When not in use, AFADs will be considered nonoperating equipment and shall be stored according to Article 701.11 of the Standard Specifications.

Basis of Payment. This work will not be paid for separately but shall be considered as included in the cost of the various traffic control items included in the contract.

CONSTRUCTION AIR QUALITY - DIESEL VEHICLE EMISSIONS CONTROL (BDE)

Effective: April 1, 2009

Revised: July 1, 2009

Diesel Vehicle Emissions Control. The reduction of construction air emissions shall be accomplished by using cleaner burning diesel fuel. The term "equipment" refers to any and all diesel fuel powered devices rated at 50 hp and above, to be used on the project site in excess of seven calendar days over the course of the construction period on the project site (including any "rental" equipment).

All equipment on the jobsite, with engine ratings of 50 hp and above, shall be required to: use Ultra Low Sulfur Diesel fuel (ULSD) exclusively (15 ppm sulfur content or less).

In addition, all construction motor vehicles (both on-road and off-road, gasoline or diesel fuel powered) shall comply with all pertinent State and Federal regulations relative to exhaust emission controls and safety, including opacity. Frequently Asked Questions (FAQ's) regarding Illinois Environmental Protection Agency (IEPA) emissions testing for gasoline powered vehicles can be accessed at (<http://www.epa.state.il.us/air/vim/faqs.html>) . Regulations regarding diesel powered vehicles over 16,000 lb (7260 kg), and the Diesel Emission Inspection Program (Title 92: Transportation Part 460, Diesel Emission Inspection Program, Subpart A: General) can be accessed at (<http://www.ilga.gov/commission/jcar/admincode/092/09200460sections.html>). Diesel powered vehicles less than 16,000 lb (7260 kg) are exempt from testing by the Department. All diesel powered equipment used on the project site shall be subject to reasonable, random spot checks for compliance with the required emissions controls and proper diesel fuel usage. The Secretary of State, Illinois State Police and other law enforcement officers will enforce Part 460. For additional information concerning Illinois diesel emission inspection requirements, please call the Illinois Department of Transportation, Diesel Emission Inspections Unit, at 217-557-6081.

Diesel powered equipment in non-compliance will not be allowed to be used on the project site, and is also subject to a notice of non-compliance as outlined below.

The Contractor shall submit copies of monthly summary reports and include certified copies of the ULSD diesel fuel delivery slips for diesel fuel delivered to the jobsite for the reporting time period, noting the quantity of diesel fuel used, with each piece of diesel powered equipment. The addition or deletion of any diesel powered equipment shall be included in the summary and noted on the monthly report.

If any diesel powered equipment is found to be in non-compliance with any portion of this specification, the Engineer will issue the Contractor a notice of non-compliance and identify an appropriate period of time, as outlined below under environmental deficiency deduction, in which to bring the equipment into compliance or remove it from the project site.

Any costs associated with bringing any diesel powered equipment into compliance with these diesel vehicle emissions controls shall be considered as included in the contract unit prices bid for the various items of work involved and no additional compensation will be allowed. The Contractor's compliance with this notice and any associated regulations shall also not be grounds for a claim.

Environmental Deficiency Deduction. When the Engineer is notified, or determines that an environmental control deficiency exists, he/she will notify the Contractor in writing, and direct the Contractor to correct the deficiency within a specified time period.

The specified time-period, which begins upon Contractor notification, will be from 1/2 hour to 24 hours long, based on the urgency of the situation and the nature of the deficiency. The Engineer shall be the sole judge regarding the time period.

The deficiency will be based on lack of repair, maintenance and diesel vehicle emissions control.

If the Contractor fails to correct the deficiency within the specified time frame, a daily monetary deduction will be imposed for each calendar day or fraction thereof the deficiency continues to exist. The calendar day(s) will begin when the time period for correction is exceeded and end with the Engineer's written acceptance of the correction. The daily monetary deduction will be \$1,000.00 for each deficiency identified.

If a Contractor or subcontractor accumulates three environmental deficiency deductions in a contract period, the Contractor will be shutdown until the deficiency is corrected. Such a shutdown will not be grounds for any extension of contract time, waiver of penalties, or be grounds for any claim.

CONSTRUCTION AIR QUALITY - IDLING RESTRICTIONS (BDE)

Effective: April 1, 2009

Idling Restrictions. The Contractor shall establish truck-staging areas for all diesel powered vehicles that are waiting to load or unload material at the jobsite. Staging areas shall be located where the diesel emissions from the equipment will have a minimum impact on adjacent sensitive receptors. The Department will review the selection of staging areas, whether within or outside the existing highway right-of-way, to avoid locations near sensitive areas or populations to the extent possible. Sensitive receptors include, but are not limited to, hospitals, schools, residences, motels, hotels, daycare facilities, elderly housing and convalescent facilities. Diesel powered engines shall also be located as far away as possible from fresh air intakes, air conditioners, and windows. The Engineer will approve staging areas before implementation.

Diesel powered vehicle operators may not cause or allow the motor vehicle, when it is not in motion, to idle for more than a total of 10 minutes within any 60 minute period, except under any of the following circumstances:

- 1) The motor vehicle has a gross vehicle weight rating of less than 8000 lb (3630 kg).
- 2) The motor vehicle idles while forced to remain motionless because of on-highway traffic, an official traffic control device or signal, or at the direction of a law enforcement official.
- 3) The motor vehicle idles when operating defrosters, heaters, air conditioners, or other equipment solely to prevent a safety or health emergency.
- 4) A police, fire, ambulance, public safety, other emergency or law enforcement motor vehicle, or any motor vehicle used in an emergency capacity, idles while in an emergency or training mode and not for the convenience of the vehicle operator.
- 5) The primary propulsion engine idles for maintenance, servicing, repairing, or diagnostic purposes if idling is necessary for such activity.
- 6) A motor vehicle idles as part of a government inspection to verify that all equipment is in good working order, provided idling is required as part of the inspection.

- 7) When idling of the motor vehicle is required to operate auxiliary equipment to accomplish the intended use of the vehicle (such as loading, unloading, mixing, or processing cargo; controlling cargo temperature; construction operations, lumbering operations; oil or gas well servicing; or farming operations), provided that this exemption does not apply when the vehicle is idling solely for cabin comfort or to operate non-essential equipment such as air conditioning, heating, microwave ovens, or televisions.
- 8) When the motor vehicle idles due to mechanical difficulties over which the operator has no control.
- 9) The outdoor temperature is less than 32 °F (0 °C) or greater than 80 °F (26 °C).

When the outdoor temperature is greater than or equal to 32 °F (0 °C) or less than or equal to 80 °F (26 °C), a person who operates a motor vehicle operating on diesel fuel shall not cause or allow the motor vehicle to idle for a period greater than 30 minutes in any 60 minute period while waiting to weigh, load, or unload cargo or freight, unless the vehicle is in a line of vehicles that regularly and periodically moves forward.

The above requirements do not prohibit the operation of an auxiliary power unit or generator set as an alternative to idling the main engine of a motor vehicle operating on diesel fuel.

Environmental Deficiency Deduction. When the Engineer is notified, or determines that an environmental control deficiency exists based on non-compliance with the idling restrictions, he/she will notify the Contractor, and direct the Contractor to correct the deficiency.

If the Contractor fails to correct the deficiency a monetary deduction will be imposed. The monetary deduction will be \$1,000.00 for each deficiency identified.

DISADVANTAGED BUSINESS ENTERPRISE PARTICIPATION (DBE)

Effective: September 1, 2000

Revised: January 1, 2011

FEDERAL OBLIGATION. The Department of Transportation, as a recipient of federal financial assistance, is required to take all necessary and reasonable steps to ensure nondiscrimination in the award and administration of contracts. Consequently, the federal regulatory provisions of 49 CFR part 26 apply to this contract concerning the utilization of disadvantaged business enterprises. For the purposes of this Special Provision, a disadvantaged business enterprise (DBE) means a business certified by the Department in accordance with the requirements of 49 CFR part 26 and listed in the Illinois Unified Certification Program (IL UCP) DBE Directory.

STATE OBLIGATION. This Special Provision will also be used by the Department to satisfy the requirements of the Business Enterprise for Minorities, Females, and Persons with Disabilities Act, 30 ILCS 575. When this Special Provision is used to satisfy state law requirements on 100 percent state-funded contracts, the federal government has no involvement in such contracts (not a federal-aid contract) and no responsibility to oversee the implementation of this Special Provision by the Department on those contracts. DBE participation on 100 percent state-funded contracts will not be credited toward fulfilling the Department's annual overall DBE goal required by the US Department of Transportation to comply with the federal DBE program requirements.

CONTRACTOR ASSURANCE. The Contractor makes the following assurance and agrees to include the assurance in each subcontract that the Contractor signs with a subcontractor:

The Contractor, subrecipient, or subcontractor shall not discriminate on the basis of race, color, national origin, or sex in the performance of this contract. The Contractor shall carry out applicable requirements of 49 CFR part 26 in the award and administration of contracts funded in whole or in part with federal or state funds. Failure by the Contractor to carry out these requirements is a material breach of this contract, which may result in the termination of this contract or such other remedy as the recipient deems appropriate.

OVERALL GOAL SET FOR THE DEPARTMENT. As a requirement of compliance with 49 CFR part 26, the Department has set an overall goal for DBE participation in its federally assisted contracts. That goal applies to all federal-aid funds the Department will expend in its federally assisted contracts for the subject reporting fiscal year. The Department is required to make a good faith effort to achieve the overall goal. The dollar amount paid to all approved DBE companies performing work called for in this contract is eligible to be credited toward fulfillment of the Department's overall goal.

CONTRACT GOAL TO BE ACHIEVED BY THE CONTRACTOR. This contract includes a specific DBE utilization goal established by the Department. The goal has been included because the Department has determined that the work of this contract has subcontracting opportunities that may be suitable for performance by DBE companies. This determination is based on an assessment of the type of work, the location of the work, and the availability of DBE companies to do a part of the work. The assessment indicates that, in the absence of unlawful discrimination, and in an arena of fair and open competition, DBE companies can be expected to perform 5.00% of the work. This percentage is set as the DBE participation goal for this contract. Consequently, in addition to the other award criteria established for this contract, the Department will only award this contract to a bidder who makes a good faith effort to meet this goal of DBE participation in the performance of the work. A bidder makes a good faith effort for award consideration if either of the following is done in accordance with the procedures set forth in this Special Provision:

- (a) The bidder documents that enough DBE participation has been obtained to meet the goal; or
- (b) The bidder documents that a good faith effort has been made to meet the goal, even though the effort did not succeed in obtaining enough DBE participation to meet the goal.

DBE LOCATOR REFERENCES. Bidders may consult the IL UCP DBE Directory as a reference source for DBE-certified companies. In addition, the Department maintains a letting and item specific DBE locator information system whereby DBE companies can register their interest in providing quotes on particular bid items advertised for letting. Information concerning DBE companies willing to quote work for particular contracts may be obtained by contacting the Department's Bureau of Small Business Enterprises at telephone number (217)785-4611, or by visiting the Department's web site at www.dot.il.gov.

BIDDING PROCEDURES. Compliance with this Special Provision is a material bidding requirement. The failure of the bidder to comply will render the bid not responsive.

- (a) The bidder shall submit a Disadvantaged Business Utilization Plan on Department forms SBE 2025 and 2026 with the bid.

- (b) The Utilization Plan shall indicate that the bidder either has obtained sufficient DBE participation commitments to meet the contract goal or has not obtained enough DBE participation commitments in spite of a good faith effort to meet the goal. The Utilization Plan shall further provide the name, telephone number, and telefax number of a responsible official of the bidder designated for purposes of notification of plan approval or disapproval under the procedures of this Special Provision.
- (c) The Utilization Plan shall include a DBE Participation Commitment Statement, Department form SBE 2025, for each DBE proposed for the performance of work to achieve the contract goal. For bidding purposes, submission of the completed SBE 2025 forms, signed by the DBEs and faxed to the bidder will be acceptable as long as the original is available and provided upon request. All elements of information indicated on the said form shall be provided, including but not limited to the following:
- (1) The names and addresses of DBE firms that will participate in the contract;
 - (2) A description, including pay item numbers, of the work each DBE will perform;
 - (3) The dollar amount of the participation of each DBE firm participating. The dollar amount of participation for identified work shall specifically state the quantity, unit price, and total subcontract price for the work to be completed by the DBE. If partial pay items are to be performed by the DBE, indicate the portion of each item, a unit price where appropriate and the subcontract price amount;
 - (4) DBE Participation Commitment Statements, form SBE 2025, signed by the bidder and each participating DBE firm documenting the commitment to use the DBE subcontractors whose participation is submitted to meet the contract goal;
 - (5) If the bidder is a joint venture comprised of DBE companies and non-DBE companies, the plan must also include a clear identification of the portion of the work to be performed by the DBE partner(s); and,
 - (6) If the contract goal is not met, evidence of good faith efforts.

GOOD FAITH EFFORT PROCEDURES. The contract will not be awarded until the Utilization Plan submitted by the apparent successful bidder is approved. All information submitted by the bidder must be complete, accurate and adequately document that enough DBE participation has been obtained or document the good faith efforts of the bidder, in the event enough DBE participation has not been obtained, before the Department will commit to the performance of the contract by the bidder. The Utilization Plan will be approved by the Department if the Utilization Plan documents sufficient commercially useful DBE work performance to meet the contract goal or the bidder submits sufficient documentation of a good faith effort to meet the contract goal pursuant to 49 CFR part 26, Appendix A. The Utilization Plan will not be approved by the Department if the Utilization Plan does not document sufficient DBE participation to meet the contract goal unless the apparent successful bidder documented in the Utilization Plan that it made a good faith effort to meet the goal. This means that the bidder must show that all necessary and reasonable steps were taken to achieve the contract goal. Necessary and reasonable steps are those which, by their scope, intensity and appropriateness to the objective, could reasonably be expected to obtain sufficient DBE participation, even if they were not successful. The Department will consider the quality, quantity, and intensity of the kinds of efforts that the bidder has made. Mere *pro forma* efforts, in other words, efforts done as a matter of form, are not good faith efforts; rather, the bidder is expected to have taken genuine efforts that would be reasonably expected of a bidder actively and aggressively trying to obtain DBE participation sufficient to meet the contract goal.

- (a) The following is a list of types of action that the Department will consider as part of the evaluation of the bidder's good faith efforts to obtain participation. These listed factors are not intended to be a mandatory checklist and are not intended to be exhaustive. Other factors or efforts brought to the attention of the Department may be relevant in appropriate cases, and will be considered by the Department.
- (1) Soliciting through all reasonable and available means (e.g. attendance at pre-bid meetings, advertising and/or written notices) the interest of all certified DBE companies that have the capability to perform the work of the contract. The bidder must solicit this interest within sufficient time to allow the DBE companies to respond to the solicitation. The bidder must determine with certainty if the DBE companies are interested by taking appropriate steps to follow up initial solicitations.
 - (2) Selecting portions of the work to be performed by DBE companies in order to increase the likelihood that the DBE goals will be achieved. This includes, where appropriate, breaking out contract work items into economically feasible units to facilitate DBE participation, even when the prime Contractor might otherwise prefer to perform these work items with its own forces.
 - (3) Providing interested DBE companies with adequate information about the plans, specifications, and requirements of the contract in a timely manner to assist them in responding to a solicitation.
 - (4) a. Negotiating in good faith with interested DBE companies. It is the bidder's responsibility to make a portion of the work available to DBE subcontractors and suppliers and to select those portions of the work or material needs consistent with the available DBE subcontractors and suppliers, so as to facilitate DBE participation. Evidence of such negotiation includes the names, addresses, and telephone numbers of DBE companies that were considered; a description of the information provided regarding the plans and specifications for the work selected for subcontracting; and evidence as to why additional agreements could not be reached for DBE companies to perform the work.

b. A bidder using good business judgment would consider a number of factors in negotiating with subcontractors, including DBE subcontractors, and would take a firm's price and capabilities as well as contract goals into consideration. However, the fact that there may be some additional costs involved in finding and using DBE companies is not in itself sufficient reason for a bidder's failure to meet the contract DBE goal, as long as such costs are reasonable. Also, the ability or desire of a bidder to perform the work of a contract with its own organization does not relieve the bidder of the responsibility to make good faith efforts. Bidders are not, however, required to accept higher quotes from DBE companies if the price difference is excessive or unreasonable.
 - (5) Not rejecting DBE companies as being unqualified without sound reasons based on a thorough investigation of their capabilities. The bidder's standing within its industry, membership in specific groups, organizations, or associations and political or social affiliations (for example union vs. non-union employee status) are not legitimate causes for the rejection or non-solicitation of bids in the bidder's efforts to meet the project goal.

- (6) Making efforts to assist interested DBE companies in obtaining bonding, lines of credit, or insurance as required by the recipient or Contractor.
 - (7) Making efforts to assist interested DBE companies in obtaining necessary equipment, supplies, materials, or related assistance or services.
 - (8) Effectively using the services of available minority/women community organizations; minority/women contractors' groups; local, state, and federal minority/women business assistance offices; and other organizations as allowed on a case-by-case basis to provide assistance in the recruitment and placement of DBE companies.
- (b) If the Department determines that the apparent successful bidder has made a good faith effort to secure the work commitment of DBE companies to meet the contract goal, the Department will award the contract provided that it is otherwise eligible for award. If the Department determines that the bidder has failed to meet the requirements of this Special Provision or that a good faith effort has not been made, the Department will notify the responsible company official designated in the Utilization Plan that the bid is not responsive. The notification shall include a statement of reasons for the determination.
- (c) The bidder may request administrative reconsideration of a determination adverse to the bidder within the five working days after receipt of the notification date of the determination by delivering the request to the Department of Transportation, Bureau of Small Business Enterprises, Contract Compliance Section, 2300 South Dirksen Parkway, Room 319, Springfield, Illinois 62764 (Telefax: (217)785-1524). Deposit of the request in the United States mail on or before the fifth business day shall not be deemed delivery. The determination shall become final if a request is not made and delivered. A request may provide additional written documentation and/or argument concerning the issues raised in the determination statement of reasons, provided the documentation and arguments address efforts made prior to submitting the bid. The request will be forwarded to the Department's Reconsideration Officer. The Reconsideration Officer will extend an opportunity to the bidder to meet in person in order to consider all issues of documentation and whether the bidder made a good faith effort to meet the goal. After the review by the Reconsideration Officer, the bidder will be sent a written decision within ten working days after receipt of the request for reconsideration, explaining the basis for finding that the bidder did or did not meet the goal or make adequate good faith efforts to do so. A final decision by the Reconsideration Officer that a good faith effort was made shall approve the Utilization Plan submitted by the bidder and shall clear the contract for award. A final decision that a good faith effort was not made shall render the bid not responsive.

CALCULATING DBE PARTICIPATION. The Utilization Plan values represent work anticipated to be performed and paid for upon satisfactory completion. The Department is only able to count toward the achievement of the overall goal and the contract goal the value of payments made for the work actually performed by DBE companies. In addition, a DBE must perform a commercially useful function on the contract to be counted. A commercially useful function is generally performed when the DBE is responsible for the work and is carrying out its responsibilities by actually performing, managing, and supervising the work involved. The Department and Contractor are governed by the provisions of 49 CFR part 26.55(c) on questions of commercially useful functions as it affects the work. Specific counting guidelines are provided in 49 CFR part 26.55, the provisions of which govern over the summary contained herein.

- (a) DBE as the Contractor: 100 percent goal credit for that portion of the work performed by the DBE's own forces, including the cost of materials and supplies. Work that a DBE subcontracts to a non-DBE does not count toward the DBE goals.
- (b) DBE as a joint venture Contractor: 100 percent goal credit for that portion of the total dollar value of the contract equal to the distinct, clearly defined portion of the work performed by the DBE's own forces.
- (c) DBE as a subcontractor: 100 percent goal credit for the work of the subcontract performed by the DBE's own forces, including the cost of materials and supplies, excluding the purchase of materials and supplies or the lease of equipment by the DBE subcontractor from the prime Contractor or its affiliates. Work that a DBE subcontractor in turn subcontracts to a non-DBE does not count toward the DBE goal.
- (d) DBE as a trucker: 100 percent goal credit for trucking participation provided the DBE is responsible for the management and supervision of the entire trucking operation for which it is responsible. At least one truck owned, operated, licensed, and insured by the DBE must be used on the contract. Credit will be given for the following:
 - (1) The DBE may lease trucks from another DBE firm, including an owner-operator who is certified as a DBE. The DBE who leases trucks from another DBE receives credit for the total value of the transportation services the lessee DBE provides on the contract.
 - (2) The DBE may also lease trucks from a non-DBE firm, including from an owner-operator. The DBE who leases trucks from a non-DBE is entitled to credit only for the fee or commission it receives as a result of the lease arrangement.
- (e) DBE as a material supplier:
 - (1) 60 percent goal credit for the cost of the materials or supplies purchased from a DBE regular dealer.
 - (2) 100 percent goal credit for the cost of materials or supplies obtained from a DBE manufacturer.
 - (3) 100 percent credit for the value of reasonable fees and commissions for the procurement of materials and supplies if not a regular dealer or manufacturer.

CONTRACT COMPLIANCE. Compliance with this Special Provision is an essential part of the contract. The Department is prohibited by federal regulations from crediting the participation of a DBE included in the Utilization Plan toward either the contract goal or the Department's overall goal until the amount to be applied toward the goals has been paid to the DBE. The following administrative procedures and remedies govern the compliance by the Contractor with the contractual obligations established by the Utilization Plan. After approval of the Utilization Plan and award of the contract, the Utilization Plan and individual DBE Participation Statements become part of the contract. If the Contractor did not succeed in obtaining enough DBE participation to achieve the advertised contract goal, and the Utilization Plan was approved and contract awarded based upon a determination of good faith, the total dollar value of DBE work calculated in the approved Utilization Plan as a percentage of the awarded contract value shall become the amended contract goal.

- (a) No amendment to the Utilization Plan may be made without prior written approval from the Department's Bureau of Small Business Enterprises. All requests for amendment to the Utilization Plan shall be submitted to the Department of Transportation, Bureau of Small Business Enterprises, Contract Compliance Section, 2300 South Dirksen Parkway, Room 319, Springfield, Illinois 62764. Telephone number (217) 785-4611. Telefax number (217) 785-1524.
- (b) The Contractor must notify and obtain written approval from the Department's Bureau of Small Business Enterprises prior to replacing a DBE or making any change in the participation of a DBE. Approval for replacement will be granted only if it is demonstrated that the DBE is unable or unwilling to perform. The Contractor must make every good faith effort to find another certified DBE subcontractor to substitute for the original DBE. The good faith efforts shall be directed at finding another DBE to perform at least the same amount of work under the contract as the original DBE, to the extent needed to meet the contract goal.
- (c) Any deviation from the DBE condition-of-award or contract specifications must be approved, in writing, by the Department. The Contractor shall notify affected DBEs in writing of any changes in the scope of work which result in a reduction in the dollar amount condition-of-award to the contract.
- (d) In addition to the above requirements for reductions in the condition of award, additional requirements apply to the two cases of Contractor-initiated work substitution proposals. Where the contract allows alternate work methods which serve to delete or create underruns in condition of award DBE work, and the Contractor selects that alternate method or, where the Contractor proposes a substitute work method or material that serves to diminish or delete work committed to a DBE and replace it with other work, then the Contractor must demonstrate one of the following:
 - (1) That the replacement work will be performed by the same DBE (as long as the DBE is certified in the respective item of work) in a modification of the condition of award; or
 - (2) That the DBE is aware that its work will be deleted or will experience underruns and has agreed in writing to the change. If this occurs, the Contractor shall substitute other work of equivalent value to a certified DBE or provide documentation of good faith efforts to do so; or
 - (3) That the DBE is not capable of performing the replacement work or has declined to perform the work at a reasonably competitive price. If this occurs, the Contractor shall substitute other work of equivalent value to a certified DBE or provide documentation of good faith efforts to do so.
- (e) Where the revision includes work committed to a new DBE subcontractor, not previously involved in the project, then a Request for Approval of Subcontractor, Department form BC 260A, must be signed and submitted.
- (f) If the commitment of work is in the form of additional tasks assigned to an existing subcontract, then a new Request for Approval of Subcontractor shall not be required. However, the Contractor must document efforts to assure that the existing DBE subcontractor is capable of performing the additional work and has agreed in writing to the change.

- (g) All work indicated for performance by an approved DBE shall be performed, managed, and supervised by the DBE executing the Participation Statement. The Contractor shall not terminate for convenience a DBE listed in the Utilization Plan and then perform the work of the terminated DBE with its own forces, those of an affiliate or those of another subcontractor, whether DBE or not, without first obtaining the written consent of the Bureau of Small Business Enterprises to amend the Utilization Plan. The Contractor shall notify the Bureau of Small Business Enterprises of any termination for reasons other than convenience, and shall obtain approval for inclusion of the substitute DBE in the Utilization Plan. If good faith efforts following a termination of a DBE for cause are not successful, the Contractor shall contact the Bureau of Small Business Enterprises and provide a full accounting of the efforts undertaken to obtain substitute DBE participation. The Bureau of Small Business Enterprises will evaluate the good faith efforts in light of all circumstances surrounding the performance status of the contract, and determine whether the contract goal should be amended.
- (h) The Contractor shall maintain a record of payments for work performed to the DBE participants. The records shall be made available to the Department for inspection upon request. After the performance of the final item of work or delivery of material by a DBE and final payment therefore to the DBE by the Contractor, but not later than thirty calendar days after payment has been made by the Department to the Contractor for such work or material, the Contractor shall submit a DBE Payment Agreement on Department form SBE 2115 to the Regional Engineer. If full and final payment has not been made to the DBE, the DBE Payment Agreement shall indicate whether a disagreement as to the payment required exists between the Contractor and the DBE or if the Contractor believes that the work has not been satisfactorily completed. If the Contractor does not have the full amount of work indicated in the Utilization Plan performed by the DBE companies indicated in the Utilization Plan and after good faith efforts are reviewed, the Department may deduct from contract payments to the Contractor the amount of the goal not achieved as liquidated and ascertained damages. The Contractor may request an administrative reconsideration of any amount deducted as damages pursuant to subsection (j) of this part.
- (i) The Department reserves the right to withhold payment to the Contractor to enforce the provisions of this Special Provision. Final payment shall not be made on the contract until such time as the Contractor submits sufficient documentation demonstrating achievement of the goal in accordance with this Special Provision or after liquidated damages have been determined and collected.
- (j) Notwithstanding any other provision of the contract, including but not limited to Article 109.09 of the Standard Specifications, the Contractor may request administrative reconsideration of a decision to deduct the amount of the goal not achieved as liquidated damages. A request to reconsider shall be delivered to the Contract Compliance Section and shall be handled and considered in the same manner as set forth in paragraph (c) of "Good Faith Effort Procedures" of this Special Provision, except a final decision that a good faith effort was not made during contract performance to achieve the goal agreed to in the Utilization Plan shall be the final administrative decision of the Department.

DRAINAGE AND INLET PROTECTION UNDER TRAFFIC (BDE)

Effective: April 1, 2011

Add the following to Article 603.02 of the Standard Specifications:

- “(i) Temporary Hot-Mix Asphalt (HMA) Ramp (Note 1) 1030
- “(j) Temporary Rubber Ramps (Note 2)

Note 1. The HMA shall have maximum aggregate size of 3/8 in. (95 mm).

Note 2. The rubber material shall be according to the following.

Property	Test Method	Requirement
Durometer Hardness, Shore A	ASTM D 2240	75 ±15
Tensile Strength, psi (kPa)	ASTM D 412	300 (2000) min
Elongation, percent	ASTM D 412	90 min
Specific Gravity	ASTM D 792	1.0 - 1.3
Brittleness, °F (°C)	ASTM D 746	-40 (-40)”

Revise Article 603.07 of the Standard Specifications to read:

“603.07 Protection Under Traffic. After the casting has been adjusted and Class SI concrete has been placed, the work shall be protected by a barricade and two lights for at least 72 hours.

When castings are under traffic before the final surfacing operation has been started, properly sized temporary ramps shall be placed around the drainage and/or utility castings according to the following methods.

- (a) Temporary Asphalt Ramps. Temporary hot-mix asphalt ramps shall be placed around the casting, flush with its surface and decreasing to a featheredge in a distance of 2 ft (600 mm) around the entire surface of the casting.
- (b) Temporary Rubber Ramps. Temporary rubber ramps shall only be used on roadways with permanent posted speeds of 40 mph or less and when the height of the casting to be protected meets the proper sizing requirements for the rubber ramps as shown below.

Dimension	Requirement
Inside Opening	Outside dimensions of casting + 1 in. (25 mm)
Thickness at inside edge	Height of casting ± 1/4 in. (6 mm)
Thickness at outside edge	1/4 in. (6 mm) max.
Width, measured from inside opening to outside edge	8 1/2 in. (215 mm) min

Placement shall be according to the manufacturer’s specifications.

Temporary ramps for castings shall remain in place until surfacing operations are undertaken within the immediate area of the structure. Prior to placing the surface course, the temporary ramp shall be removed. Excess material shall be disposed of according to Article 202.03.”

EQUIPMENT RENTAL RATES (BDE)

Effective: August 2, 2007

Revised: January 2, 2008

Replace the second and third paragraphs of Article 105.07(b)(4)a. of the Standard Specifications with the following:

“Equipment idled which cannot be used on other work, and which is authorized to standby on the project site by the Engineer, will be paid for according to Article 109.04(b)(4).”

Replace Article 109.04(b)(4) of the Standard Specifications with the following:

“(4) Equipment. Equipment used for extra work shall be authorized by the Engineer. The equipment shall be specifically described, be of suitable size and capacity for the work to be performed, and be in good operating condition. For such equipment, the Contractor will be paid as follows.

- a. Contractor Owned Equipment. Contractor owned equipment will be paid for by the hour using the applicable FHWA hourly rate from the “Equipment Watch Rental Rate Blue Book” (Blue Book). The applicable hourly rate is defined as the FHWA hourly rate, from the time period in effect when the force account work begins, adjusted for both the model year of the equipment and the Illinois region. The FHWA hourly rate is calculated as follows.

$$\text{FHWA hourly rate} = (\text{monthly rate}/176) \times (\text{model year adj.}) \times (\text{Illinois adj.}) + \text{EOC}$$

Where: EOC = Estimated Operating Costs per hour (from the Blue Book)

The time allowed will be the actual time the equipment is operating on the extra work. For the time required to move the equipment to and from the site of the extra work and any authorized idle (standby) time, payment will be made according to the following hourly rate: $0.5 \times (\text{AHR FHWA hourly rate} - \text{EOC})$.

Where: AHR = Applicable Hourly Rate (defined above)

EOC = Estimated Operating Costs per hour (from the Blue Book)

All time allowed shall fall within the working hours authorized for the extra work.

The rates above include the cost of fuel, oil, lubrication, supplies, small tools, necessary attachments, repairs, overhaul and maintenance of any kind, depreciation, storage, overhead, profits, insurance, and all incidentals. The rates do not include labor.

The Contractor shall submit to the Engineer sufficient information for each piece of equipment and its attachments to enable the Engineer to determine the proper equipment category. If a rate is not established in the Blue Book for a particular piece of equipment, the Engineer will establish a rate for that piece of equipment that is consistent with its cost and use in the industry.

- b. Rented Equipment. Whenever it is necessary for the Contractor to rent equipment to perform extra work, the rental and transportation costs of the equipment plus five percent for overhead will be paid. In no case shall the rental rates exceed those of established distributors or equipment rental agencies.

All prices shall be agreed to in writing before the equipment is used.”

FLAGGER AT SIDE ROADS AND ENTRANCES (BDE)

Effective: April 1, 2009

Revise the second paragraph of Article 701.13(a) of the Standard Specifications to read:

“The Engineer will determine when a side road or entrance shall be closed to traffic. A flagger will be required at each side road or entrance remaining open to traffic within the operation where two-way traffic is maintained on one lane of pavement. The flagger shall be positioned as shown on the plans or as directed by the Engineer.”

Revise the first and second paragraph of Article 701.20(i) of the Standard Specifications to read:

“Signs, barricades, or other traffic control devices required by the Engineer over and above those specified will be paid for according to Article 109.04. All flaggers required at side roads and entrances remaining open to traffic including those that are shown on the Highway Standards and/or additional barricades required by the Engineer to close side roads and entrances will be paid for according to Article 109.04.”

FRICTION AGGREGATE (BDE)

Effective: January 1, 2011

Revise Article 1004.01(a)(4) of the Standard Specifications to read:

“(4)Crushed Stone. Crushed stone shall be the angular fragments resulting from crushing undisturbed, consolidated deposits of rock by mechanical means. Crushed stone shall be divided into the following, when specified.

- a. Carbonate Crushed Stone. Carbonate crushed stone shall be either dolomite or limestone. Dolomite shall contain 11.0 percent or more magnesium oxide (MgO). Limestone shall contain less than 11.0 percent magnesium oxide (MgO).
- b. Crystalline Crushed Stone. Crystalline crushed stone shall be either metamorphic or igneous stone, including but is not limited to, quartzite, granite, rhyolite and diabase.”

Revise Article 1004.03(a) of the Standard Specifications to read:

“**1004.03 Coarse Aggregate for Hot-Mix Asphalt (HMA).** The aggregate shall be according to Article 1004.01 and the following.

- (a) Description. The coarse aggregate for HMA shall be according to the following table.

Use	Mixture	Aggregates Allowed
Class A	Seal or Cover	<u>Allowed Alone or in Combination:</u> Gravel Crushed Gravel Carbonate Crushed Stone Crystalline Crushed Stone Crushed Sandstone Crushed Slag (ACBF) Crushed Steel Slag Crushed Concrete
HMA All Other	Stabilized Subbase or Shoulders	<u>Allowed Alone or in Combination:</u> Gravel Crushed Gravel Carbonate Crushed Stone Crystalline Crushed Stone Crushed Sandstone Crushed Slag (ACBF) Crushed Steel Slag ^{1/} Crushed Concrete
HMA High ESAL Low ESAL	Binder IL-25.0, IL-19.0, or IL-19.0L SMA Binder	<u>Allowed Alone or in Combination:</u> Crushed Gravel Carbonate Crushed Stone ^{2/} Crystalline Crushed Stone Crushed Sandstone Crushed Slag (ACBF) Crushed Concrete ^{3/}
HMA High ESAL Low ESAL	C Surface and Leveling Binder IL-12.5,IL-9.5, or IL-9.5L SMA Ndesign 50 Surface	<u>Allowed Alone or in Combination:</u> Crushed Gravel Carbonate Crushed Stone ^{2/} Crystalline Crushed Stone Crushed Sandstone Crushed Slag (ACBF) Crushed Steel Slag ^{4/} Crushed Concrete ^{3/}
HMA High ESAL	D Surface and Leveling Binder IL-12.5 or IL-9.5 SMA Ndesign 50 Surface	<u>Allowed Alone or in Combination:</u> Crushed Gravel Carbonate Crushed Stone (other than Limestone) ^{2/} Crystalline Crushed Stone Crushed Sandstone Crushed Slag (ACBF) ^{5/} Crushed Steel Slag ^{4/ 5/} Crushed Concrete ^{3/}

		<u>Other Combinations Allowed:</u>	
		<i>Up to...</i>	<i>With...</i>
		25% Limestone	Dolomite
		50% Limestone	Any Mixture D aggregate other than Dolomite
		75% Limestone	Crushed Slag (ACBF) ^{5/} or Crushed Sandstone
HMA High ESAL	E Surface IL-12.5 or IL-9.5 SMA Ndesign 80 Surface	<u>Allowed Alone or in Combination:</u>	
		Crushed Gravel Crystalline Crushed Stone Crushed Sandstone Crushed Slag (ACBF) ^{5/} Crushed Steel Slag ^{5/} Crushed Concrete ^{3/}	
		No Limestone.	
		<u>Other Combinations Allowed:</u>	
		<i>Up to...</i>	<i>With...</i>
		50% Dolomite ^{2/}	Any Mixture E aggregate
75% Dolomite ^{2/}	Crushed Sandstone, Crushed Slag (ACBF) ^{5/} , Crushed Steel Slag ^{5/} , or Crystalline Crushed Stone		
75% Crushed Gravel or Crushed Concrete ^{3/}	Crushed Sandstone, Crystalline Crushed Stone, Crushed Slag (ACBF) ^{5/} , or Crushed Steel Slag ^{5/}		
HMA High ESAL	F Surface IL-12.5 or IL-9.5 SMA Ndesign 80 Surface	<u>Allowed Alone or in Combination:</u>	
		Crystalline Crushed Stone Crushed Sandstone Crushed Slag (ACBF) ^{5/} Crushed Steel Slag ^{5/} No Limestone.	
		<u>Other Combinations Allowed:</u>	
		<i>Up to...</i>	<i>With...</i>
		50% Crushed Gravel, Crushed Concrete ^{3/} , or Dolomite ^{2/}	Crushed Sandstone, Crushed Slag (ACBF) ^{5/} , Crushed Steel Slag ^{5/} , or Crystalline Crushed Stone

- 1/ Crushed steel slag allowed in shoulder surface only.
- 2/ Carbonate crushed stone shall not be used in SMA Ndesign 80. In SMA Ndesign 50, carbonate crushed stone shall not be blended with any of the other aggregates allowed alone in Ndesign 50 SMA binder or Ndesign 50 SMA surface.
- 3/ Crushed concrete will not be permitted in SMA mixes.
- 4/ Crushed steel slag shall not be used as leveling binder.
- 5/ When either slag is used, the blend percentages listed shall be by volume.”

HOT-MIX ASPHALT – ANTI-STRIPPING ADDITIVE (BDE)

Effective: November 1, 2009

Revise the first and second paragraphs of Article 1030.04(c) of the Standard Specifications to read:

“(c) Determination of Need for Anti-Stripping Additive. The mixture designer shall determine if an additive is needed in the mix to prevent stripping. The determination will be made on the basis of tests performed according to Illinois Modified AASHTO T 283. To be considered acceptable by the Department as a mixture not susceptible to stripping, the conditioned to unconditioned split tensile strength ratio (TSR) shall be equal to or greater than 0.85 for 6 in. (150 mm) specimens. Mixtures, either with or without an additive, with TSRs less than 0.85 for 6 in. (150 mm) specimens will be considered unacceptable. Also, the conditioned tensile strength for mixtures containing an anti-strip additive shall not be lower than the original conditioned tensile strength determined for the same mixture without the anti-strip additive.

If it is determined that an additive is required, the additive may be hydrated lime, slaked quicklime, or a liquid additive, at the Contractor's option.”

HOT-MIX ASPHALT - DENSITY TESTING OF LONGITUDINAL JOINTS (BDE)

Effective: January 1, 2010

Description. This work shall consist of testing the density of longitudinal joints as part of the quality control/quality assurance (QC/QA) of hot-mix asphalt (HMA). Work shall be according to Section 1030 of the Standard Specifications except as follows.

Quality Control/Quality Assurance (QC/QA). Delete the second and third sentence of the third paragraph of Article 1030.05(d)(3) of the Standard Specifications.

Add the following paragraphs to the end of Article 1030.05(d)(3) of the Standard Specifications:

“Longitudinal joint density testing shall be performed at each random density test location. Longitudinal joint testing shall be located at a distance equal to the lift thickness or a minimum of 2 in. (50 mm), from each pavement edge. (i.e. for a 4 in. (100 mm) lift the near edge of the density gauge or core barrel shall be within 4 in. (100 mm) from the edge of pavement.) Longitudinal joint density testing shall be performed using either a correlated nuclear gauge or cores.

- a. Confined Edge. Each confined edge density shall be represented by a one-minute nuclear density reading or a core density and shall be included in the average of density readings or core densities taken across the mat which represents the Individual Test.
- b. Unconfined Edge. Each unconfined edge joint density shall be represented by an average of three one-minute density readings or a single core density at the given density test location and shall meet the density requirements specified herein. The three one-minute readings shall be spaced ten feet apart longitudinally along the unconfined pavement edge and centered at the random density test location.”

Revise the Density Control Limits table in Article 1030.05(d)(4) of the Standard Specifications to read:

"Mixture Composition	Parameter	Individual Test (includes confined edges)	Unconfined Edge Joint Density Minimum
IL-9.5, IL-12.5	Ndesign ≥ 90	92.0 – 96.0%	90.0%
IL-9.5, IL-9.5L, IL-12.5	Ndesign < 90	92.5 – 97.4%	90.0%
IL-19.0, IL-25.0	Ndesign ≥ 90	93.0 – 96.0%	90.0%
IL-19.0, IL-19.0L, IL-25.0	Ndesign < 90	93.0 – 97.4%	90.0%
SMA	Ndesign = 50 & 80	93.5 – 97.4%	91.0%
All Other	Ndesign = 30	93.0 - 97.4%	90.0%"

HOT-MIX ASPHALT – DROP-OFFS (BDE)

Effective: January 1, 2010

Revise the third paragraph of Article 701.07 of the Standard Specifications to read:

“At locations where construction operations result in a differential in elevation exceeding 3 in. (75 mm) between the edge of pavement or edge of shoulder within 3 ft (900 mm) of the edge of the pavement and the earth or aggregate shoulders, Type I or II barricades or vertical panels shall be placed at 100 ft (30 m) centers on roadways where the posted speed limit is 45 mph or greater and at 50 ft (15 m) centers on roadways where the posted speed limit is less than 45 mph.”

HOT-MIX ASPHALT - FINE AGGREGATE (BDE)

Effective: April 1, 2010

Add the following to the gradation tables of Article 1003.01(c) of the Standard Specifications:

"FINE AGGREGATE GRADATIONS					
Grad No.	Sieve Size and Percent Passing				
	3/8	No. 4	No. 8	No. 16	No. 200
FA 22	100	6/	6/	8±8	2±2

FINE AGGREGATE GRADATIONS (Metric)					
Grad No.	Sieve Size and Percent Passing				
	9.5 mm	4.75 mm	2.36 mm	1.18 mm	75 µm
FA 22	100	6/	6/	8±8	2±2

6/ For the fine aggregate gradation FA 22, the aggregate producer shall set the midpoint percent passing, and the Department will apply a range of ± ten percent. The midpoint shall not be changed without Department approval.”

Revise Article 1003.03(a) of the Standard Specifications to read:

“(a) Description. Fine aggregate for HMA shall consist of sand, stone sand, chats, slag sand, or steel slag sand. For gradation FA 22, uncrushed material will not be permitted.”

Revise Article 1003.03(c) of the Standard Specifications to read:

“(c) Gradation. The fine aggregate gradation for all HMA shall be FA 1, FA 2, FA 20, FA 21, or FA 22.

Gradation FA 1, FA 2, or FA 3 shall be used when required for prime coat aggregate application for HMA.”

LIQUIDATED DAMAGES (BDE)

Effective: April 1, 2009

Revised: April 1, 2011

Revise the table in Article 108.09 of the Standard Specifications to read:

“Schedule of Deductions for Each Day of Overrun in Contract Time			
Original Contract Amount		Daily Charges	
From More Than	To and Including	Calendar Day	Work Day
\$ 0	\$ 100,000	\$ 475	\$ 675
100,000	500,000	750	1,050
500,000	1,000,000	1,025	1,425
1,000,000	3,000,000	1,275	1,725
3,000,000	6,000,000	1,425	2,000
6,000,000	12,000,000	2,300	3,450
12,000,000	And over	5,800	8,125”

NATIONAL POLLUTANT DISCHARGE ELIMINATION SYSTEM / EROSION AND SEDIMENT CONTROL DEFICIENCY DEDUCTION (BDE)

Effective: April 1, 2007

Revised: November 1, 2009

Revise Article 105.03(a) of the Standard Specifications to read:

“(a) National Pollutant Discharge Elimination System (NPDES) / Erosion and Sediment Control Deficiency Deduction When the Engineer is notified or determines an erosion and/or sediment control deficiency(s) exists, or the Contractor’s activities represents a violation of the Department’s NPDES permits, the Engineer will notify and direct the Contractor to correct the deficiency within a specified time. The specified time, which begins upon notification to the Contractor, will be from 1/2 hour to 1 week based on the urgency of the situation and the nature of the work effort required. The Engineer will be the sole judge.

A deficiency may be any lack of repair, maintenance, or implementation of erosion and/or sediment control devices included in the contract, or any failure to comply with the conditions of the Department’s NPDES permits. A deficiency may also be applied to situations where corrective action is not an option such as the failure to participate in a jobsite inspection of the project, failure to install required measures prior to initiating earth moving operations, disregard of concrete washout requirements, or other disregard of the NPDES permit.

If the Contractor fails to correct a deficiency within the specified time, a daily monetary deduction will be imposed for each calendar day or portion of a calendar day until the deficiency is corrected to the satisfaction of the Engineer. The calendar day(s) will begin with notification to the Contractor and end with the Engineer's acceptance of the correction. The base value of the daily monetary deduction is \$1000.00 and will be applied to each location for which a deficiency exists. The value of the deficiency deduction assessed for each infraction will be determined by multiplying the base value by a Gravity Adjustment Factor provided in Table A. Except for failure to participate in a required jobsite inspection of the project prior to initiating earthmoving operations which will be based on the total acreage of planned disturbance at the following multipliers: <5 Acres: 1; 5-10 Acres: 2; >10-25 Acres: 3; >25 Acres: 5. For those deficiencies where corrective action was not an option, the monetary deduction will be immediate and will be valued at one calendar day multiplied by a Gravity Adjustment Factor.

Table A Deficiency Deduction Gravity Adjustment Factors				
Types of Violations	Soil Disturbed and Not Permanently Stabilized At Time of Violation			
	< 5 Acres	5 - 10 Acres	>10 - 25 Acres	> 25 Acres
Failure to Install or Properly Maintain BMP	0.1 - 0.5	0.2 - 1.0	0.5 - 2.5	1.0 - 5
Careless Destruction of BMP	0.2 - 1	0.5 - 2.5	1.0 - 5.	1.0 - 5
Intrusion into Protected Resource	1.0 - 5	1.0 - 5	2.0 - 10	2.0 - 10
Failure to properly manage Chemicals, Concrete Washouts or Residuals, Litter or other Wastes	0.2 - 1	0.2 - 1	0.5 - 2.5	1.0 - 5
Improper Vehicle and Equipment Maintenance, Fueling or Cleaning	0.1 - 0.5	0.2 - 1	0.2 - 1	0.5 - 2.5
Failure to Provide or Update Written or Graphic Plans Required by SWPPP	0.2 - 1	0.5 - 2.5	1.0 - 5	1.0 - 5
Failure to comply with Other Provisions of the NPDES Permit	0.1 - 0.5	0.2 - 1	0.2 - 1	0.5 - 2.5"

PAVEMENT MARKING REMOVAL (BDE)

Effective: April 1, 2009

Add the following to the end of the first paragraph of Article 783.03(a) of the Standard Specifications:

“The use of grinders will not be allowed on new surface courses.”

PAVEMENT PATCHING (BDE)

Effective: January 1, 2010

Revise the first sentence of the second paragraph of Article 701.17(e)(1) of the Standard Specifications to read:

“In addition to the traffic control and protection shown elsewhere in the contract for pavement, two devices shall be placed immediately in front of each open patch, open hole, and broken pavement where temporary concrete barriers are not used to separate traffic from the work area.”

PAYMENTS TO SUBCONTRACTORS (BDE)

Effective: June 1, 2000

Revised: January 1, 2006

Federal regulations found at 49 CFR §26.29 mandate the Department to establish a contract clause to require Contractors to pay subcontractors for satisfactory performance of their subcontracts and to set the time for such payments.

State law also addresses the timing of payments to be made to subcontractors and material suppliers. Section 7 of the Prompt Payment Act, 30 ILCS 540/7, requires that when a Contractor receives any payment from the Department, the Contractor shall make corresponding, proportional payments to each subcontractor and material supplier performing work or supplying material within 15 calendar days after receipt of the Department payment. Section 7 of the Act further provides that interest in the amount of two percent per month, in addition to the payment due, shall be paid to any subcontractor or material supplier by the Contractor if the payment required by the Act is withheld or delayed without reasonable cause. The Act also provides that the time for payment required and the calculation of any interest due applies to transactions between subcontractors and lower-tier subcontractors and material suppliers throughout the contracting chain.

This Special Provision establishes the required federal contract clause, and adopts the 15 calendar day requirement of the State Prompt Payment Act for purposes of compliance with the federal regulation regarding payments to subcontractors. This contract is subject to the following payment obligations.

When progress payments are made to the Contractor according to Article 109.07 of the Standard Specifications, the Contractor shall make a corresponding payment to each subcontractor and material supplier in proportion to the work satisfactorily completed by each subcontractor and for the material supplied to perform any work of the contract. The proportionate amount of partial payment due to each subcontractor and material supplier throughout the contracting chain shall be determined by the quantities measured or otherwise determined as eligible for payment by the Department and included in the progress payment to the Contractor. Subcontractors and material suppliers shall be paid by the Contractor within 15 calendar days after the receipt of payment from the Department. The Contractor shall not hold retainage from the subcontractors. These obligations shall also apply to any payments made by subcontractors and material suppliers to their subcontractors and material suppliers; and to all payments made to lower tier subcontractors and material suppliers throughout the contracting chain. Any payment or portion of a payment subject to this provision may only be withheld from the subcontractor or material supplier to whom it is due for reasonable cause.

This Special Provision does not create any rights in favor of any subcontractor or material supplier against the State or authorize any cause of action against the State on account of any payment, nonpayment, delayed payment, or interest claimed by application of the State Prompt Payment Act. The Department will not approve any delay or postponement of the 15 day requirement except for reasonable cause shown after notice and hearing pursuant to Section 7(b) of the State Prompt Payment Act. State law creates other and additional remedies available to any subcontractor or material supplier, regardless of tier, who has not been paid for work properly performed or material furnished. These remedies are a lien against public funds set forth in Section 23(c) of the Mechanics Lien Act, 770 ILCS 60/23(c), and a recovery on the Contractor's payment bond according to the Public Construction Bond Act, 30 ILCS 550.

POST MOUNTING OF SIGNS (BDE)

Effective: January 1, 2011

Revise the second paragraph of Article 701.14 of the Standard Specifications to read:

“Post mounted signs shall be a breakaway design. The sign shall be within five degrees of vertical. Two posts shall be used for signs greater than 16 sq ft (1.5 sq m) in area or where the height between the sign and the ground exceeds 7 ft (2.1 m).”

RR PROTECTIVE LIABILITY INSURANCE INFO - UPRR

RAILROAD PROTECTIVE LIABILITY INSURANCE (5 and 10) (BDE)

Effective: January 1, 2006

Description. Railroad Protective Liability and Property Damage Liability Insurance shall be carried in accordance with Article 107.11 of the Standard Specifications, except the limits shall be a minimum of \$5,000,000 combined single limit per occurrence for bodily injury liability and property damage liability with an aggregate limit of \$10,000,000 over the life of the policy. A separate policy is required for each railroad indicated below unless otherwise noted.

Special UPRR Requirements as follows:

1. Increased limits of 5,000,000 per occurrence and 10,000,000 aggregate REQUIRED on Railroad Protective Liability insurance.
2. Contractors Commercial General Liability insurance shall carry the following endorsements:
 - a. The employee and workers compensation related exclusions in the above policy apply only to contractors employees.
 - b. The exclusions for railroads (except where the job site is more than fifty feet (50') from any railroad including but not limited to tracks, bridges, trestles, roadbeds, terminals, underpasses or crossings), and explosion, collapse and underground hazard shall be removed.
 - c. Waiver of subrogation.
3. Railroad Protective Liability Insurance can be obtained at the following:
www.uprr.com/reus/rrinsure/insurovr.shtml

NAMED INSURED & ADDRESS	NUMBER AND SPEED OF PASSENGER TRAINS	NUMBER & SPEED OF FREIGHT TRAINS
Union Pacific Railroad Company 1416 Dodge Street Omaha, NE 68179	0	21 up to 30 MPH
Dot/AAR No-431102H	Mile Post-298.63	
Division-St. Louis	Sub Division-Mt. Vernon	

FOR FREIGHT/PASSENGER INFORMATION CONTACT:

Mr. Dave McKernan, Mgr. of Industry & Public Projects Phone: 314-331-0682

FOR INSURANCE INFORMATION CONTACT:

Mr. Dave McKernan, Mgr. of Industry & Public Projects Phone: 314-331-0682

APPROVAL OF INSURANCE: The ORIGINAL and one CERTIFIED copy of each required policy shall be submitted to the following address for approval:

Illinois Department of Transportation
Bureau of Design and Environment
2300 South Dirksen Parkway, Room 326
Springfield, Illinois 62764

The Contractor will be advised when the Department has received approval of the insurance from the railroad(s). Before any work begins on railroad right-of-way, the Contractor shall submit to the Engineer evidence that the required insurance has been approved by the railroad(s). The Contractor shall also provide the Engineer with the expiration date of each required policy. Some railroads require contractors to obtain a Right Of Entry Permit before entering upon railroad right of way. It is the responsibility of the Contractor to obtain a Railroad Right of Entry permit from the railroad if required by the railroad(s).

Basis of Payment: Providing Railroad Protective Liability and Property Damage Insurance will be paid for at the contract unit price per Lump Sum for RAILROAD PROTECTIVE LIABILITY INSURANCE.

UNION PACIFIC RAILROAD MINIMUM REQUIREMENTS (FOR INFORMATION ONLY)

PART 1 – GENERAL

DESCRIPTION

This project includes construction work within the Right-of-Way and/or properties of the Union Pacific Railroad Company "UPRR" and adjacent to tracks, wire lines and other facilities. This section describes the special requirements for coordination with UPRR when work by the Contractor will be performed upon, over or under the UPRR Right-of-Way or may impact current or future UPRR operations. The Contractor will coordinate with UPRR while performing the work outlined in this Contract, and shall afford the same cooperation with UPRR as it does with the Agency. All submittals and work shall be completed in accordance with UPRR Guidelines and AREMA recommendations as modified by these minimum special requirements or as directed in writing by the UPRR Designated Representative.

For purposes of this project, the UPRR Designated Representative shall be the person or persons designated by the UPRR Manager of Industry and Public Projects to handle specific tasks related to the project.

DEFINITION OF AGENCY AND CONTRACTOR

As used in these UPRR requirements, the term "Agency" shall mean the **Insert name of Political Entity**.

As used in these UPRR requirements, the term "Contractor" shall mean the contractor or contractor's hired by the Agency to perform any project work on any portion of UPRR's property and shall also include the contractor's subcontractors and the contractor's and subcontractor's respective officer, agents and employees, and others acting under its or their authority.

UPRR CONTACTS

The primary UPRR point of contact for this project is:

Name

Manager Industry and Public Projects
Union Pacific Railroad Company

Address

Phone:

Fax:

For UPRR flagging services and track work, contact:

Name

Manager Track Maintenance
Union Pacific Railroad Company

Address

Phone:

Fax:

REQUEST FOR INFORMATION / CLARIFICATION

All Requests for Information ("RFI") involving work within any UPRR Right-Of-Way shall be in accordance with the procedures listed elsewhere in these bid documents. All RFI's shall be submitted to the Engineer of Record. The Engineer of Record will submit the RFI to the UPRR Designated Representative for review and approval for corresponding to work within the UPRR Right-Of-Way. The Contractor shall allow four (4) weeks for the review and approval process by UPRR.

PLANS / SPECIFICATIONS

The plans and specifications for this project, affecting the UPRR, are subject to the written approval by the UPRR and changes in the plans may be required after award of the Contract. Such changes are subject to the approval of the Agency and the UPRR.

PART 2 – UTILITIES AND FIBER OPTIC

All installations shall be constructed in accordance with current AREMA recommendations and UPRR specifications and requirements. UPRR general guidelines and the required application forms for utility installations can be found on the UPRR website at www.uprr.com.

GENERAL

Contractor shall perform all work in compliance with all applicable UPRR and FRA rules and regulations. Contractor shall arrange and conduct all work in such manner and at such times as shall not endanger or interfere with the safe operation of the tracks and property of UPRR and the traffic moving on such tracks, or the wires, signals and other property of UPRR, its tenants or licensees, at or in the vicinity of the work. UPRR shall be reimbursed by Contractor or Agency for train delay costs and lost revenue claims due to any delays or interruption of train operations resulting from Contractor's construction work or other activities.

Construction activities will be permitted within 12 feet of the centerline of operational tracks only if absolutely necessary and UPRR's Designated Representative grants approval. Construction activities within 12 feet of the operational track(s) must allow the tracks to stay operational.

Track protection is required for all work equipment (including rubber tired equipment) operating within 25 feet from nearest rail.

The Contractor is also advised that new railroad facilities within the project may be built by UPRR and that certain Contractor's activities cannot proceed until that work is completed. The Contractor shall be aware of the limits of responsibilities and allow sufficient time in the schedule for that work to be accomplished and shall coordinate its efforts with the UPRR.

RAILROAD OPERATIONS

The Contractor shall be advised that trains and/or equipment are expected on any track, at any time, in either direction. Contractor shall become familiar with the train schedules in this location and structure its bid assuming intermittent track windows in this period, as defined in Paragraph B below.

All railroad tracks within and adjacent to the Contract Site are active, and rail traffic over these facilities shall be maintained throughout the Project. Activities may include both through moves and switching moves to local customers. Railroad traffic and operations will occur continuously throughout the day and night on these tracks and shall be maintained at all times as defined herein. The Contractor shall coordinate and schedule the work so that construction activities do not interfere with railroad operations.

Work windows for this Contract shall be coordinated with the Agency's and the UPRR's Designated Representatives. Types of work windows include Conditional Work Windows and Absolute Work Windows, as defined below:

Conditional Work Window: A Conditional Work Window is a period of time that railroad operations have priority over construction activities. When construction activities may occur on and adjacent to the railroad tracks within 25 feet of the nearest track, a UPRR flag person will be required. At the direction of the UPRR flag person, upon approach of a train, and when trains are present on the tracks, the tracks must be cleared (i.e., no construction equipment, materials or personnel within 25 feet, or as directed by the UPRR Designated Representative, from the tracks). Conditional Work Windows are available for the Project.

Absolute Work Window: An Absolute Work Window is a period of time that construction activities are given priority over railroad operations. During this time frame the designated railroad track(s) will be inactive for train movements and may be fouled by the Contractor. At the end of an Absolute Work Window the railroad tracks and/or signals must be completely operational for train operations and all UPRR, Public Utilities Commission (PUC) and Federal Railroad Administration (FRA) requirements, codes and regulations for operational tracks must be complied with. In the situation where the operating tracks and/or signals have been affected, the UPRR will perform inspections of the work prior to placing that track back into service. UPRR flag persons will be required for construction activities requiring an Absolute Work Window. Absolute Work Windows will not generally be granted. Any request will require a detailed explanation for UPRR review.

RIGHT OF ENTRY, ADVANCE NOTICE AND WORK STOPPAGES

A. Prior to beginning any work on or over the property of, or affecting the facilities of, the UPRR, the Contractor shall notify the primary railroad representative at least ten (10) working days in advance of such work and at least ten (10) working days in advance of proposed performance of any work by contractor in which any person or equipment will be within twenty-five (25) feet of any track or will be near enough to any track that any equipment extension (such as, but not limited to, a crane boom) will reach within twenty-five (25) feet of any track. If the contractor will be on UPRR property outside the limits of the State's easements, Contractor shall enter into an agreement with the UPRR in the form of the "Contractor's Right of Entry Agreement", attached as Appendix [REDACTED], or latest version thereof provided by the UPRR. There is a fee for processing of the agreement. This cost shall be borne by the Contractor. Contractor shall submit a copy of the executed agreement and the insurance policies, binders, certificates and endorsements set forth therein to the Agency prior to commencing work on UPRR property. The right of entry agreement shall specify working time frames, flagging and inspection requirements, and any other items specified by the UPRR.

The Contractor shall give the advance notice to the UPRR as required above before commencing work in connection with construction upon or over UPRR's Right-of-Way and shall observe UPRR's rules and regulations with respect thereto.

All work upon UPRR's Right-of-Way shall be done at such times and in such manner so as not to interfere with or endanger the operations of UPRR. Whenever work may affect the operations or safety of trains, the method of doing such work shall first be submitted to UPRR's Designated Representative for approval, but such approval shall not relieve the Contractor from liability. Any work to be performed by the Contractor, which requires flagging and/or inspection service, shall be deferred until the flagging protection required by UPRR is available at the job site. See Section 3.18 for railroad flagging requirements.

The Contractor shall make requests in writing for both Absolute and Conditional Work Windows, at least two weeks in advance of any work. The written request must include:

Exactly what the work entails.

The days and hours that work will be performed.

The exact location of work, and proximity to the tracks.

The type of window requested and the amount of time requested.

The designated contact person.

The Contractor shall provide a written confirmation notice to the UPRR at least 48 hours before commencing work in connection with approved work windows when work will be performed within 25 feet of any track center line. All work shall be performed in accordance with previously approved work plans.

Should a condition arising from, or in connection with the work, require that immediate and unusual provisions be made to protect operations and property of UPRR, the Contractor shall make such provisions. If in the judgment of UPRR's Designated Representative such provisions are insufficient, the UPRR's Designated Representative may require or provide such provisions as deemed necessary. In any event, such provisions shall be at the Contractor's expense and without cost to the UPRR. UPRR or the Agency shall have the right to order Contractor to temporarily cease operations in the event of an emergency or, if in the opinion of the UPRR's Designated Representative, the Contractor's operations could endanger UPRR's operations. In the event such an order is given, Contractor shall immediately notify the Agency of the order.

INSURANCE

Contractor shall not begin work upon or over UPRR's Right-of-Way until UPRR has been furnished the insurance policies, binders, certificates and endorsements as defined in Section 3.20 below and UPRR's Designated Representative has advised the Agency that such insurance is in accordance with the Agreement. The required insurance shall be kept in full force and effect during the performance of work and thereafter until Contractor removes all tools, equipment, and material from UPRR's property and cleans the premises in a manner reasonably satisfactory to UPRR. For the benefit of the Contractor and the Insurer(s), the current railroad traffic in the project area is estimated at [REDACTED] train movements per day at a maximum speed of [REDACTED] MPH.

RAILROAD SAFETY ORIENTATION

All personnel employed by the Contractor and all subcontractors must complete the UPRR course "Orientation for Contractor's Safety", and be registered prior to working on UPRR property. This orientation is available at www.contractororientation.com. This course is required to be completed annually.

COOPERATION

UPRR will cooperate with Contractor so that work may be conducted in an efficient manner, and will cooperate with Contractor in enabling use of UPRR's right-of-way in performing the work.

MINIMUM CONSTRUCTION CLEARANCES FOR FALSEWORK AND OTHER TEMPORARY STRUCTURES

The Contractor shall abide by the following minimum temporary clearances during the course of construction:

- 12' – 0" horizontal from centerline of track
- 21' – 6" vertically above top of rail.

For construction clearance less than listed above, local Operating Unit review and approval is required.

APPROVAL OF REDUCED CLEARANCES

The minimum track clearances to be maintained by the Contractor during construction are specified in Section 3.07 herein.

Any proposed infringement on the specified minimum clearances due to the Contractor's operations shall be submitted to UPRR's Designated Representative through the Agency at least 30 days in advance of the work and shall not be undertaken until approved in writing by the UPRR's Designated Representative.

No work shall commence until the Contractor receives in writing assurance from UPRR's Designated Representative that arrangements have been made for flagging service, as may be necessary and receives permission from UPRR's Designated Representative to proceed with the work.

CONSTRUCTION AND AS-BUILT SUBMITTALS

Submittals are required for construction materials and procedures as outlined below. The submittals shall include all review comments from the Agency and the Engineer of Record. All design submittals shall be stamped and signed by a Professional Engineer registered in the State of Illinois.

The tables below provide UPRR's minimum submittal requirements for the construction items noted. Submittal requirements are in addition to those specified elsewhere in these bid documents. The minimum review times indicated below represent UPRR's requirements only. The Contractor shall allow additional time for the Agency's review time as stated elsewhere in these bid documents.

Submittals shall be made by the Agency to the UPRR Manager of Industry and Public Projects unless otherwise directed by the Railroad. Items in Table 1 shall be submitted for both railroad overpass and underpass projects, as applicable. Items in Table 2 shall be submitted for railroad underpass projects only.

TABLE 1

ITEM	DESCRIPTION	SETS REQD.	UPRR's Minimum Review Time
1	Shoring design and details	4	4 weeks
2	Falsework design and details	4	4 weeks
3	Drainage design provisions	4	4 weeks
4	Erection diagrams and sequence	4	4 weeks
5	Demolition diagram and sequence	4	4 weeks

Prior to or during construction of railroad underpass structures, the UPRR requires the review of drawings, reports, test data and material data sheets to determine compliance with the specifications. Product information for items noted in Table 2 be submitted to UPRR's Designated Representative through the Agency for their own review and approval of the material. The signed submittal and the Agency's review comments will be reviewed by UPRR or their consultant. If a consultant performs the reviews, the consultant may reply directly to the Agency or its Designated Representative after consultation with UPRR. Review of the submittals will not be conducted until after review by the Agency or its Designated Representative. Review of the submittal items will require a minimum of four (4) weeks after receipt from the Agency.

TABLE 2

ITEM	DESCRIPTION	SETS REQD.	NOTES
1	Shop drawings	4	Steel and Concrete members
2	Bearings	4	For entire structures
3	Concrete Mix Designs	4	For entire structures
4	Rebar & Strand certifications	4	For superstructure only
5	28 day concrete strength	4	For superstructure only
6	Waterproofing material certifications and installation procedure	4	Waterproofing & protective boards
7	Structural steel certifications	4	All fracture critical members & other members requiring improved notch toughness

8	Fabrication and Test reports	4	All fracture critical members & other members requiring improved notch toughness
9	Welding Procedures and Welder Certification	4	AWS requirements
10	Foundation Construction Reports	4	Pile driving, drilled shaft construction, bearing pressure test reports for spread footings
11	Compaction testing reports for backfill at abutments	4	Must meet 95% maximum dry density, Modified Proctor ASTM D1557

As-Built Records shall be submitted to the UPRR within 60 days of completion of the structures. These records shall consist of the following items:

Overpass Projects

Electronic files of all structure design drawings with as-constructed modifications shown, in Microstation J or Acrobat .PDF format.

Hard copies of all structure design drawings with as-constructed modifications shown.

Underpass Projects

Electronic files of all structure design drawings with as-constructed modifications shown, in Microstation J or Acrobat .PDF format.

Hard copies of all structure design drawings with as-constructed modifications shown.

Final approved copies of shop drawings for concrete and steel members.

Foundation Construction Reports

Compaction testing reports for backfill at abutments

APPROVAL OF DETAILS

The details of the construction affecting the UPRR tracks and property not already included in the Contract Plans shall be submitted to UPRR's Designated Representative through the Agency for UPRR's review and written approval before such work is undertaken. Review and approval of these submittals will require a minimum of four (4) weeks in addition to the Agency's review time as stated elsewhere in these bid documents.

MAINTENANCE OF RAILROAD FACILITIES

A. The Contractor shall be required to maintain all ditches and drainage structures free of silt or other obstructions which may result from Contractor's operations; to promptly repair eroded areas within UPRR's right of way and to repair any other damage to the property of UPRR, or its tenants.

B. All such maintenance and repair of damages due to the Contractor's operations shall be done at the Contractor's expense.

C. The Contractor must submit a proposed method of erosion control and have the method reviewed by the UPRR prior to beginning any grading on the Project Site. Erosion control methods must comply with all applicable local, state and federal regulations.

SITE INSPECTIONS BY UPRR'S DESIGNATED REPRESENTATIVE

A. In addition to the office reviews of construction submittals, site inspections may be performed by UPRR's Designated Representative at significant points during construction, including but not limited to the following:

Preconstruction meetings.

Pile driving, drilling of caissons or drilled shafts.

Reinforcement and concrete placement for railroad bridge substructure and/or superstructure.

Erection of precast concrete or steel bridge superstructure.

Placement of waterproofing (prior to placing ballast on bridge deck).

Completion of the bridge structure.

B. Site inspection is not limited to the milestone events listed above. Site visits to check progress of the work may be performed at any time throughout the construction as deemed necessary by UPRR.

C. A detailed construction schedule, including the proposed temporary horizontal and vertical clearances and construction sequence for all work to be performed, shall be provided to the Agency for submittal to UPRR's Designated Representative for review prior to commencement of work. This schedule shall also include the anticipated dates when the above listed events will occur. This schedule shall be updated for the above listed events as necessary, but at least monthly so that site visits may be scheduled.

UPRR REPRESENTATIVES

A. UPRR representatives, conductors, flag person or watch person will be provided by UPRR at expense of the Agency or Contractor (as stated elsewhere in these bid documents) to protect UPRR facilities, property and movements of its trains or engines. In general, UPRR will furnish such personnel or other protective services as follows:

When any part of any equipment is standing or being operated within 25 feet, measured horizontally, from centerline of any track on which trains may operate, or when any object is off the ground and any dimension thereof could extend inside the 25 foot limit, or when any erection or construction activities are in progress within such limits, regardless of elevation above or below track.

For any excavation below elevation of track subgrade if, in the opinion of UPRR's Designated Representative, track or other UPRR facilities may be subject to settlement or movement.

During any clearing, grubbing, excavation or grading in proximity to UPRR facilities, which, in the opinion of UPRR's Designated Representative, may endanger UPRR facilities or operations.

During any contractor's operations when, in the opinion of UPRR's Designated Representative, UPRR facilities, including, but not limited to, tracks, buildings, signals, wire lines, or pipe lines, may be endangered.

The Contractor shall arrange with the UPRR Designated Representative to provide the adequate number of flag persons to accomplish the work.

WALKWAYS REQUIRED

Along the outer side of each exterior track of multiple operated track, and on each side of single operated track, an unobstructed continuous space suitable for trainman's use in walking along trains, extending to a line not less than twelve feet (12') from centerline of track, shall be maintained. Any temporary impediments to walkways and track drainage encroachments or obstructions allowed during work hours while UPRR's flagman service is provided shall be removed before the close of each work day. Walkways with railings shall be constructed by Contractor over open excavation areas when in close proximity of track, and railings shall not be closer than 8' – 6" horizontally from center line of tangent track or 9' – 6" horizontally from centerline of curved track.

COMMUNICATIONS AND SIGNAL LINES

If required, UPRR will rearrange its communications and signal lines, its grade crossing warning devices, train signals and tracks, and facilities that are in use and maintained by UPRR's forces in connection with its operation at expense of the Agency. This work by UPRR will be done by its own forces and it is not a part of the Work under this Contract.

TRAFFIC CONTROL

Contractor's operations that control traffic across or around UPRR facilities shall be coordinated with and approved by the UPRR's Designated Representative.

CONSTRUCTION EXCAVATIONS

The Contractor shall be required to take special precaution and care in connection with excavating and shoring. Excavations for construction of footings, piers, columns, walls or other facilities that require shoring shall comply with requirements of OSHA, AREMA and UPRR "Guidelines for Temporary Shoring".

B. The Contractor shall contact UPRR's "Call Before Your Dig" at least 48 hours prior to commencing work at 1-800-336-9193 during normal business hours (6:30 a.m. to 8:00 p.m. central time, Monday through Friday, except holidays - also a 24 hour, 7 day a week number for emergency calls) to determine location of fiber optics. If a telecommunications system is buried anywhere on or near UPRR property, the Contractor will co-ordinate with UPRR and the Telecommunication Company(ies) to arrange for relocation or other protection of the system prior to beginning any work on or near UPRR property.

RAILROAD FLAGGING

A. Performance of any work by the Contractor in which person(s) or equipment will be within twenty-five (25) feet of any track, or will be near enough to any track that any equipment extension (such as, but not limited to, a crane boom) will reach within twenty-five (25) feet of any track, may require railroad flagging services or other protective measures.

Contractor shall give the advance notice to the UPRR as required in Section 3.03 above before commencing any such work, so that the UPRR may determine the need for flagging or other protective measures to ensure the safety of the railroad's operations. Contractor shall comply with all other requirements regarding flagging as specified by Union Pacific. Any costs associated with failure to abide by these requirements will be borne by the Contractor.

B. Reimbursement to Railroad will be required covering the full eight-hour day during which any flagman is furnished, unless the flagman can be assigned to other Railroad work during a portion of such day, in which event reimbursement will not be required for the portion of the day during which the flagman is engaged in other Railroad work. Reimbursement will also be required for any day not actually worked by the flagman following the flagman's assignment to work on the project for which Railroad is required to pay the flagman and which could not reasonably be avoided by Railroad by assignment of such flagman to other work, even though Contractor may not be working during such time. When it becomes necessary for Railroad to bulletin and assign an employee to a flagging position in compliance with union collective bargaining agreements, Contractor must provide Railroad a minimum of five (5) days notice prior to the cessation of the need for a flagman. If five (5) days notice of cessation is not given, Contractor will still be required to pay flagging charges for the five (5) day notice period required by union agreement to be given to the employee, even though flagging is not required for that period. An additional ten (10) days notice must then be given to Railroad if flagging services are needed again after such five day cessation notice has been given to Railroad. The estimated pay rate for each flag person is \$ [REDACTED] per day for an 8 hour work day with time and one-half for overtime, Saturdays, Sundays; double time and one-half for holidays. Flagging rates are set by the UPRR and are subject to change.

CLEANING OF RIGHT-OF-WAY

Contractor shall, upon completion of the work to be performed by Contractor upon the premises, over or beneath the tracks of UPRR, promptly remove from the Right-of-Way of UPRR all of Contractor's tools, implements, and other materials whether brought upon the Right-of-Way by Contractor or any subcontractors, employee or agent of Contractor or of any subcontractor, and leave the Right-of-Way in a clean and presentable condition to satisfaction of UPRR.

INSURANCE PROVISIONS

Contractor shall, at its sole cost and expense, procure and maintain during the course of the Project and until all Project work on Railroad's property has been completed and the Contractor has removed all equipment and materials from the Railroad's property and has cleaned and restored Railroad's property to Railroad's satisfaction, the following insurance coverage:

A. Commercial General Liability insurance. Commercial general liability (CGL) with a limit of not less than \$5,000,000 each occurrence and an aggregate limit of not less than \$10,000,000. CGL insurance must be written on ISO occurrence form CG 00 01 12 04 (or a substitute form providing equivalent coverage).

The policy must also contain the following endorsement, which must be stated on the certificate of insurance:

Contractual Liability Railroads ISO form CG 24 17 10 01 (or a substitute form providing equivalent coverage) showing "Union Pacific Railroad Company Property" as the Designated Job Site.

B. Business Automobile Coverage insurance. Business auto coverage written on ISO form CA 00 01 (or a substitute form providing equivalent liability coverage) with a combined single limit of not less \$5,000,00 for each accident.

The policy must contain the following endorsements, which must be stated on the certificate of insurance:

Coverage For Certain Operations In Connection With Railroads ISO form CA 20 70 10 01 (or substitute form providing equivalent coverage) showing "Union Pacific Property" as the Designated Job Site.

Motor Carrier Act Endorsement – Hazardous materials clean up (MCS-90) if required by law.

C. Workers Compensation and Employers Liability insurance. Coverage must include but not be limited to:

Contractor's statutory liability under the workers' compensation laws of the state(s) affected by this Agreement.

Employers' Liability (Part B) with limits of at least \$500,000 each accident, \$500,000 disease policy limit \$500,000 each employee.

If Contractor is self-insured, evidence of state approval and excel workers compensation coverage must be provided. Coverage must include liability arising out of the U.S. Longshoremen's and Harbor Workers' Act, the Jones Act, and the Outer Continental Shelf Land Act, if applicable.

The policy must contain the following endorsement, which must be stated on the certificate of insurance:

Alternate Employer endorsement ISO form WC 00 03 01 A (or a substitute form providing equivalent coverage) showing Railroad in the schedule as the alternate employer (or a substitute form providing equivalent coverage).

D. Railroad Protective Liability insurance. Contractor must maintain Railroad Protective Liability insurance written on ISO occurrence form CG 00 35 12 04 (or a substitute form providing equivalent coverage) on behalf of Railroad as named insured, with a limit of not less than \$5,000,000 per occurrence and an aggregate of \$10,000,000. A binder stating the policy is in place must be submitted to Railroad before the work may be commenced and until the original policy is forwarded to Railroad.

E. Umbrella or Excess insurance. If Contractor utilizes umbrella or excess policies, these policies must "follow form" and afford no less coverage than the primary policy.

F. Pollution Liability insurance. Pollution liability coverage must be written on ISO form Pollution Liability Coverage Form Designated Sites CG 00 39 12 04 (or a substitute form providing equivalent liability coverage), with limits of at least \$5,000,000 per occurrence and an aggregate limit of \$10,000,000.

If the scope of work as defined in this Agreement includes the disposal of any hazardous or non-hazardous materials from the job site, Contractor must furnish to Railroad evidence of pollution legal liability insurance maintained by the disposal site operator for losses arising from the insured facility accepting the materials, with coverage in minimum amounts of \$1,000,000 per loss, and an annual aggregate of \$2,000,000.

Other Requirements

G. All policy(ies) required above (except worker's compensation and employers liability) must include Railroad as "Additional Insured" using ISO Additional Insured Endorsements CG 20 26, and CA 20 48 (or substitute forms providing equivalent coverage). The coverage provided to Railroad as additional insured shall, to the extent provided under ISO Additional Insured Endorsement CG 20 26, and CA 20 48 provide coverage for Railroad's negligence whether sole or partial, active or passive, and shall not be limited by Contractor's liability under the indemnity provisions of this Agreement.

H. Punitive damages exclusion, if any, must be deleted (and the deletion indicated on the certificate of insurance), unless the law governing this Agreement prohibits all punitive damages that might arise under this Agreement.

I. Contractor waives all rights of recovery, and its insurers also waive all rights of subrogation of damages against Railroad and its agents, officers, directors and employees. This waiver must be stated on the certificate of insurance.

J. Prior to commencing the work, Contractor shall furnish Railroad with a certificate(s) of insurance, executed by a duly authorized representative of each insurer, showing compliance with the insurance requirements in this Agreement.

K. All insurance policies must be written by a reputable insurance company acceptable to Railroad or with a current Best's Insurance Guide Rating of A- and Class VII or better, and authorized to do business in the state(s) in which the work is to be performed.

L. The fact that insurance is obtained by Contractor or by Railroad on behalf of Contractor will not be deemed to release or diminish the liability of Contractor, including, without limitation, liability under the indemnity provisions of this Agreement. Damages recoverable by Railroad from Contractor or any third party will not be limited by the amount of the required insurance coverage.

END OF SECTION

RR PROTECTIVE LIABILITY INSURANCE INFORMATION - CN

RAILROAD PROTECTIVE LIABILITY INSURANCE (5 and 10) (BDE)

Effective: January 1, 2006

Description. Railroad Protective Liability and Property Damage Liability Insurance shall be carried in accordance with Article 107.11 of the Standard Specifications, except the limits shall be a minimum of \$5,000,000 combined single limit per occurrence for bodily injury liability and property damage liability with an aggregate limit of \$10,000,000 over the life of the policy. A separate policy is required for each railroad indicated below unless otherwise noted.

Special CN/IC Requirements as follows:

1. Exclusion Asbestos (CG T4 78 02 90) must be removed.
2. War Liability Exclusion (CG 00 64 12 02) must be removed.
3. Cap on Losses from Certified Acts of Terrorism (CG 21 70 11 02) must be removed.

NAMED INSURED & ADDRESS	NUMBER AND SPEED OF PASSENGER TRAINS	NUMBER & SPEED OF FREIGHT TRAINS
"Illinois Central Railroad Company" and Its Parents 17641 South Ashland Avenue Homewood, Illinois 60430-1345	0	2 up to 10 MPH
Dot/AAR No. 293719G	Mile Post-89.79	
Division-Northern	Sub Division-Eldorado	

FOR FREIGHT/PASSENGER INFORMATION CONTACT:

Illinois Central Railroad Company and Its Parents

Mr. John Griffith, Technical Service Engineer

Phone: 708-332-6581

FOR INSURANCE INFORMATION CONTACT:

Illinois Central Railroad Company and Its Parents

Mr. Rob Glass, Program Engineer, CN

Phone: 708-332-6673

APPROVAL OF INSURANCE: The ORIGINAL and one CERTIFIED copy of each required policy shall be submitted to the following address for approval:

Illinois Department of Transportation
Bureau of Design and Environment
2300 South Dirksen Parkway, Room 326
Springfield, Illinois 62764

The Contractor will be advised when the Department has received approval of the insurance from the railroad(s). Before any work begins on railroad right-of-way, the Contractor shall submit to the Engineer evidence that the required insurance has been approved by the railroad(s). The Contractor shall also provide the Engineer with the expiration date of each required policy. Some railroads require contractors to obtain a Right Of Entry Permit before entering upon railroad right of way. It is the responsibility of the Contractor to obtain a Railroad Right of Entry permit from the railroad if required by the railroad(s).

Basis of Payment: Providing Railroad Protective Liability and Property Damage Insurance will be paid for at the contract unit price per Lump Sum for RAILROAD PROTECTIVE LIABILITY INSURANCE.

RECLAIMED ASPHALT PAVEMENT (RAP) (BDE)

Effective: January 1, 2007
2010 January 1, 2011

Revised: January 1,

In Article 1030.02(g), delete the last sentence of the first paragraph in (Note 2).

Revise Section 1031 of the Standard Specifications to read:

“SECTION 1031. RECLAIMED ASPHALT PAVEMENT

1031.01 Description. Reclaimed asphalt pavement (RAP) is reclaimed asphalt pavement resulting from cold milling or crushing of an existing dense graded hot-mix asphalt (HMA) pavement. The Contractor shall supply written documentation that the RAP originated from routes or airfields under federal, state, or local agency jurisdiction.

1031.02 Stockpiles. The Contractor shall construct individual, sealed RAP stockpiles meeting one of the following definitions. No additional RAP shall be added to the pile after the pile has been sealed. Stockpiles shall be sufficiently separated to prevent intermingling at the base. Stockpiles shall be identified by signs indicating the type as listed below (i.e. “Homogeneous Surface”).

Prior to milling, the Contractor shall request the District to provide verification of the quality of the RAP to clarify appropriate stockpile.

- (a) Fractionated RAP (FRAP). FRAP shall consist of RAP from Class I, Superpave (High ESAL), HMA (High ESAL), or equivalent mixtures. The coarse aggregate in FRAP shall be crushed aggregate and may represent more than one aggregate type and/or quality but shall be at least C quality. All FRAP shall be fractionated prior to testing by screening into a minimum of two size fractions with the separation occurring on or between the #4 (4.75 mm) and 1/2 in. (12.5 mm) sieves. Agglomerations shall be minimized such that 100 percent of the RAP in the coarse fraction shall pass one sieve size larger than the maximum sieve size specified for the mix the RAP will be used in.
- (b) Homogeneous. Homogeneous RAP stockpiles shall consist of RAP from Class I, Superpave (High ESAL), HMA (High ESAL), or equivalent mixtures and represent: 1) the same aggregate quality, but shall be at least C quality; 2) the same type of crushed aggregate (either crushed natural aggregate, ACBF slag, or steel slag); 3) similar gradation; and 4) similar asphalt binder content. If approved by the Engineer, combined single pass surface/binder millings may be considered “homogenous” with a quality rating dictated by the lowest coarse aggregate quality present in the mixture.

- (c) Conglomerate. Conglomerate RAP stockpiles shall consist of RAP from Class I, Superpave (High ESAL), HMA (High ESAL), or equivalent mixtures. The coarse aggregate in this RAP shall be crushed aggregate and may represent more than one aggregate type and/or quality but shall be at least C quality. This RAP may have an inconsistent gradation and/or asphalt binder content prior to processing. All conglomerate RAP shall be processed prior to testing by crushing to where all RAP shall pass the 5/8 in. (16 mm) or smaller screen. Conglomerate RAP stockpiles shall not contain steel slag or other expansive material as determined by the Department.
- (d) Conglomerate "D" Quality (DQ). Conglomerate DQ RAP stockpiles shall consist of RAP from Class I, Superpave (High or Low ESAL), HMA (High or Low ESAL), or equivalent mixtures. The coarse aggregate in this RAP may be crushed or round but shall be at least D quality. This RAP may have an inconsistent gradation and/or asphalt binder content. Conglomerate DQ RAP stockpiles shall not contain steel slag or other expansive material as determined by the Department.
- (e) Non-Quality. RAP stockpiles that do not meet the requirements of the stockpile categories listed above shall be classified as "Non-Quality".

RAP/FRAP containing contaminants, such as earth, brick, sand, concrete, sheet asphalt, bituminous surface treatment (i.e. chip seal), pavement fabric, joint sealants, etc., will be unacceptable unless the contaminants are removed to the satisfaction of the Engineer. Sheet asphalt shall be stockpiled separately.

1031.03 Testing. When used in HMA, the RAP/FRAP shall be sampled and tested either during or after stockpiling.

For testing during stockpiling, washed extraction samples shall be run at the minimum frequency of one sample per 500 tons (450 metric tons) for the first 2000 tons (1800 metric tons) and one sample per 2000 tons (1800 metric tons) thereafter. A minimum of five tests shall be required for stockpiles less than 4000 tons (3600 metric tons).

For testing after stockpiling, the Contractor shall submit a plan for approval to the District proposing a satisfactory method of sampling and testing the RAP/FRAP pile either in-situ or by restockpiling. The sampling plan shall meet the minimum frequency required above and detail the procedure used to obtain representative samples throughout the pile for testing.

Before extraction, each field sample shall be split to obtain two samples of test sample size. One of the two test samples from the final split shall be labeled and stored for Department use. The Contractor shall extract the other test sample according to Department procedure. The Engineer reserves the right to test any sample (split or Department-taken) to verify Contractor test results.

Evaluation of Test Results. All of the extraction results shall be compiled and averaged for asphalt binder content and gradation and, when applicable G_{mm} . Individual extraction test results, when compared to the averages, will be accepted if within the tolerances listed below.

Parameter	FRAP/Homogeneous/Conglomerate	Conglomerate "D" Quality
1 in. (25 mm)		± 5 %
1/2 in. (12.5 mm)	± 8 %	± 15 %
No. 4 (4.75 mm)	± 6 %	± 13 %
No. 8 (2.36 mm)	± 5 %	
No. 16 (1.18 mm)		± 15 %
No. 30 (600 μm)	± 5 %	
No. 200 (75 μm)	± 2.0 %	± 4.0 %
Asphalt Binder	± 0.4 % ^{1/}	± 0.5 %
G _{mm}	± 0.03	

1/ The tolerance for FRAP shall be ± 0.3 %.

If more than 20 percent of the individual sieves are out of the gradation tolerances, or if more than 20 percent of the asphalt binder content test results fall outside the appropriate tolerances, the RAP/FRAP shall not be used in HMA unless the RAP/FRAP representing the failing tests is removed from the stockpile. All test data and acceptance ranges shall be sent to the District for evaluation.

With the approval of the Engineer, the ignition oven may be substituted for extractions according to the Illinois Test Procedure, "Calibration of the Ignition Oven for the Purpose of Characterizing Reclaimed Asphalt Pavement (RAP)".

1031.04 Quality Designation of Aggregate in RAP/FRAP.

(a) The aggregate quality of the RAP for homogenous, conglomerate, and conglomerate "D" quality stockpiles shall be set by the lowest quality of coarse aggregate in the RAP stockpile and are designated as follows.

- (1) RAP from Class I, Superpave (High ESAL)/HMA (High ESAL), or HMA (Low ESAL) IL-9.5L surface mixtures are designated as containing Class B quality coarse aggregate.
- (2) RAP from Superpave (Low ESAL)/HMA (Low ESAL) IL-19.0L binder mixture is designated as Class D quality coarse aggregate.
- (3) RAP from Class I, Superpave (High ESAL), or HMA (High ESAL) binder mixtures, bituminous base course mixtures, and bituminous base course widening mixtures are designated as containing Class C quality coarse aggregate.
- (4) RAP from bituminous stabilized subbase and BAM shoulders are designated as containing Class D quality coarse aggregate.

(b) The aggregate quality of FRAP shall be determined as follows.

- (1) If the Engineer has documentation of the quality of the FRAP aggregate, the Contractor shall use the assigned quality provided by the Engineer. If the quality is not known, the quality shall be determined according to Article 1031.04(b)(2).
- (2) Fractionated stockpiles containing plus #4 (4.75 mm) sieve coarse aggregate shall have a maximum tonnage of 5000 tons (4500 metric tons). The Contractor shall obtain a representative sample witnessed by the Engineer.

The sample shall be a minimum of 50 lb (25 kg). The sample shall be extracted according to Illinois Modified AASHTO T 164 by a consultant prequalified by the Department for the specified testing. The consultant shall submit the test results along with the recovered aggregate to the District Office. The cost for this testing shall be paid by the Contractor. The District will forward the sample to the BMPR Aggregate Lab for MicroDeval Testing, according to Illinois Modified AASHTO T 327. A maximum loss of 15.0 percent will be applied for all HMA applications.”

1031.05 Use of RAP/FRAP in HMA. The use of RAP/FRAP shall be a Contractor’s option when constructing HMA in all contracts. The use of RAP/FRAP in HMA shall be as follows.

- (a) Coarse Aggregate Size. The coarse aggregate in all RAP shall be equal to or less than the nominal maximum size requirement for the HMA mixture to be produced.
- (b) Steel Slag Stockpiles. RAP stockpiles containing steel slag or other expansive material, as determined by the Department, shall be homogeneous and will be approved for use in HMA (High ESAL and Low ESAL) surface mixtures only.
- (c) Use in HMA Surface Mixtures (High and Low ESAL). RAP/FRAP stockpiles for use in HMA surface mixtures (High and Low ESAL) shall be FRAP or homogeneous in which the coarse aggregate is Class B quality or better.
- (d) Use in HMA Binder Mixtures (High and Low ESAL), HMA Base Course, and HMA Base Course Widening. RAP/FRAP stockpiles for use in HMA binder mixtures (High and Low ESAL), HMA base course, and HMA base course widening shall be FRAP, homogeneous, or conglomerate, in which the coarse aggregate is Class C quality or better.
- (e) Use in Shoulders and Subbase. RAP/FRAP stockpiles for use in HMA shoulders and stabilized subbase (HMA) shall be FRAP, homogeneous, conglomerate, or conglomerate DQ.
- (f) When the Contractor chooses the RAP option, the percentage of RAP shall not exceed the amounts indicated in the table below for a given N Design.

Max RAP Percentage			
HMA Mixtures ^{1/, 3/}	Maximum % RAP		
Ndesign	Binder/Leveling Binder	Surface	Polymer Modified
30	30	30	10
50	25	15	10
70	15 / 25 ^{2/}	10 / 15 ^{2/}	10
90	10	10	10
105	10	10	10

1/ For HMA shoulder and stabilized subbase (HMA) N-30, the amount of RAP shall not exceed 50% of the mixture.

2/ Value of Max % RAP if homogeneous RAP stockpile of IL-9.5 RAP is utilized.

- 3/ When RAP exceeds 20 percent, the high and low virgin asphalt binder grades shall each be reduced by one grade (i.e. 25 percent RAP would require a virgin asphalt binder grade of PG64-22 to be reduced to a PG58-28). If warm mix asphalt (WMA) technology is utilized, and production temperatures do not exceed 275 °F (135 °C) the grades shall be reduced as follows:

Overlays:

When WMA contains between 20 and 30 percent RAP the high temperature shall be reduced by one grade (i.e. 25 percent RAP would require a virgin asphalt binder grade of PG64-22 to be reduced to a PG58-22). When WMA contains 30 percent or more RAP the high and low temperature grades shall each be reduced by one grade (i.e. 35 percent RAP would require a virgin asphalt binder grade of PG64-22 to be reduced to a PG58-28).

Full Depth:

When WMA contains between 20 and 30 percent RAP, the low temperature shall be reduced by one grade (i.e. 25 percent RAP would require a virgin asphalt binder grade of PG64-22 to be reduced to a PG64-28). When the WMA contains 30 percent or more RAP the high and low temperature grades shall each be reduced by one grade (i.e. 35 percent RAP would require a virgin asphalt binder grade of PG64-22 to be reduced to a PG58-28).

- (g) When the Contractor chooses the FRAP option, the percentage of FRAP shall not exceed the amounts indicated in the table below for a given N Design.

Max FRAP Percentage

HMA Mixtures ^{1/, 2/}	Maximum % FRAP		
	Binder/Leveling Binder	Surface	Polymer Modified
Ndesign 30	35	35	10
50	30	25	10
70	25	20	10
90	20	15	10
105	10	10	10

- 1/ For HMA shoulder and stabilized subbase (HMA) N30, the amount of FRAP shall not exceed 50 percent of the mixture.
- 2/ When FRAP exceeds 20 percent, the high and low virgin asphalt binder grades shall each be reduced by one grade (i.e. 25 percent FRAP would require a virgin asphalt binder grade of PG64-22 to be reduced to a PG58-28). If warm mix asphalt (WMA) technology is utilized, and production temperatures do not exceed 275°F (135 °C) the grades shall be reduced as follows:

Overlays:

When WMA contains between 20 and 30 percent FRAP the high temperature shall be reduced by one grade (i.e. 25 percent FRAP would require a virgin asphalt binder grade of PG64-22 to be reduced to a PG58-22). When WMA contains 30 percent or more FRAP the high and low temperature grades shall each be reduced by one grade (i.e. 35 percent FRAP would require a virgin asphalt binder grade of PG64-22 to be reduced to a PG58-28).

Full Depth:

When WMA contains between 20 and 30 percent FRAP, the low temperature shall be reduced by one grade (i.e. 25 percent FRAP would require a virgin asphalt binder grade of PG64-22 to be reduced to a PG64-28). When the WMA contains 30 percent or more FRAP the high and low temperature grades shall each be reduced by one grade (i.e. 35 percent FRAP would require a virgin asphalt binder grade of PG64-22 to be reduced to a PG58-28).

1031.06 HMA Mix Designs. At the Contractor's option, HMA mixtures may be constructed utilizing RAP/FRAP material meeting the above detailed requirements.

RAP/FRAP designs shall be submitted for volumetric verification. If additional RAP/FRAP stockpiles are tested and found that no more than 20 percent of the results, as defined under "Testing" herein, are outside of the control tolerances set for the original RAP/FRAP stockpile and HMA mix design, and meets all of the requirements herein, the additional RAP/FRAP stockpiles may be used in the original mix design at the percent previously verified.

1031.07 HMA Production. The coarse aggregate in all RAP used shall be equal to or less than the nominal maximum size requirement for the HMA mixture being produced.

To remove or reduce agglomerated material, a scalping screen, gator, crushing unit, or comparable sizing device approved by the Engineer shall be used in the RAP feed system to remove or reduce oversized material. If material passing the sizing device adversely affects the mix production or quality of the mix, the sizing device shall be set at a size specified by the Engineer.

If the RAP/FRAP control tolerances or QC/QA test results require corrective action, the Contractor shall cease production of the mixture containing RAP/FRAP and either switch to the virgin aggregate design or submit a new RAP/FRAP design.

HMA plants utilizing RAP/FRAP shall be capable of automatically recording and printing the following information.

(a) Dryer Drum Plants.

- (1) Date, month, year, and time to the nearest minute for each print.
- (2) HMA mix number assigned by the Department.
- (3) Accumulated weight of dry aggregate (combined or individual) in tons (metric tons) to the nearest 0.1 ton (0.1 metric ton).
- (4) Accumulated dry weight of RAP/FRAP in tons (metric tons) to the nearest 0.1 ton (0.1 metric ton).
- (5) Accumulated mineral filler in revolutions, tons (metric tons), etc. to the nearest 0.1 unit.
- (6) Accumulated asphalt binder in gallons (liters), tons (metric tons), etc. to the nearest 0.1 unit.

- (7) Residual asphalt binder in the RAP/FRAP material as a percent of the total mix to the nearest 0.1 percent.
- (8) Aggregate and RAP/FRAP moisture compensators in percent as set on the control panel. (Required when accumulated or individual aggregate and RAP/FRAP are printed in wet condition.)

(b) Batch Plants.

- (1) Date, month, year, and time to the nearest minute for each print.
- (2) HMA mix number assigned by the Department.
- (3) Individual virgin aggregate hot bin batch weights to the nearest pound (kilogram).
- (4) Mineral filler weight to the nearest pound (kilogram).
- (5) RAP/FRAP weight to the nearest pound (kilogram).
- (6) Virgin asphalt binder weight to the nearest pound (kilogram).
- (7) Residual asphalt binder in the RAP/FRAP material as a percent of the total mix to the nearest 0.1 percent.

The printouts shall be maintained in a file at the plant for a minimum of one year or as directed by the Engineer and shall be made available upon request. The printing system will be inspected by the Engineer prior to production and verified at the beginning of each construction season thereafter.

1031.08 RAP in Aggregate Surface Course and Aggregate Shoulders. The use of RAP in aggregate surface course and aggregate shoulders shall be as follows.

- (a) Stockpiles and Testing. RAP stockpiles may be any of those listed in Article 1031.02, except "Non-Quality" and "FRAP". The testing requirements of Article 1031.03 shall not apply.
- (b) Gradation. One hundred percent of the RAP material shall pass the 1 1/2 in. (37.5 mm) sieve. The RAP material shall be reasonably well graded from coarse to fine. RAP material that is gap-graded or single sized will not be accepted."

SELECTION OF LABOR (BDE)

Effective: July 2, 2010

Revise Section I of Check Sheet #5 of the Recurring Special Provisions to read:

"I. SELECTION OF LABOR

The Contractor shall comply with all Illinois statutes pertaining to the selection of labor.

EMPLOYMENT OF ILLINOIS WORKERS DURING PERIODS OF EXCESSIVE UNEMPLOYMENT

Whenever there is a period of excessive unemployment in Illinois, which is defined herein as any month immediately following two consecutive calendar months during which the level of unemployment in the State of Illinois has exceeded five percent as measured by the United States Bureau of Labor Statistics in its monthly publication of employment and unemployment figures, the Contractor shall employ at least 90 percent Illinois laborers.

"Illinois laborer" means any person who has resided in Illinois for at least 30 days and intends to become or remain an Illinois resident.

Other laborers may be used when Illinois laborers as defined herein are not available, or are incapable of performing the particular type of work involved, if so certified by the Contractor and approved by the Engineer. The Contractor may place no more than three of his/her regularly employed non-resident executive and technical experts, who do not qualify as Illinois laborers, to do work encompassed by this contract during period of excessive unemployment.

This provision applies to all labor, whether skilled, semi-skilled, or unskilled, whether manual or non-manual."

SUBCONTRACTOR MOBILIZATION PAYMENTS (BDE)

Effective: April 2, 2005

Revised: April 1, 2011

To account for the preparatory work and operations necessary for the movement of subcontractor personnel, equipment, supplies, and incidentals to the project site and for all other work or operations that must be performed or costs incurred when beginning work approved for subcontracting according to Article 108.01 of the Standard Specifications, the Contractor shall make a mobilization payment to each subcontractor.

This mobilization payment shall be made at least 14 days prior to the subcontractor starting work. The amount paid shall be equal to 3 percent of the amount of the subcontract reported on form BC 260A submitted for the approval of the subcontractor's work.

The mobilization payment to the subcontractor is an advance payment of the reported amount of the subcontract and is not a payment in addition to the amount of the subcontract; therefore, the amount of the advance payment will be deducted from future progress payments.

This provision shall be incorporated directly or by reference into each subcontract approved by the Department.

TRUCK MOUNTED/TRAILER MOUNTED ATTENUATORS (BDE)

Effective: January 1, 2010

Revise Article 701.03(k) of the Standard Specifications to read:

"(k) Truck Mounted/Trailer Mounted Attenuators 1106.02"

Revise Article 701.15(h) of the Standard Specifications to read:

"(h) Truck Mounted/Trailer Mounted Attenuators (TMA). TMA units shall have a roll ahead distance in the event of an impact. The TMA shall be between 100 and 200 ft (30 and 60 m) behind the vehicle ahead or the workers. This distance may be extended by the Engineer.

TMA host vehicles shall have the parking brake engaged when stationary.

The driver and passengers of the TMA host vehicle should exit the vehicle if the TMA is to remain stationary for 15 minutes or more in duration.”

Revise Article 1106.02(g) of the Standard Specifications to read:

“(g) Truck Mounted/Trailer Mounted Attenuators. The attenuator shall be a NCHRP 350 approved unit for Test Level 3. Test Level 2 may be used as directed by the Engineer for normal posted speeds less than or equal to 45 mph.”

UTILITY COORDINATION AND CONFLICTS (BDE)

Effective: April 1, 2011

Revise Article 105.07 of the Standard Specifications to read:

“**105.07 Cooperation with Utilities.** The Department reserves the right at any time to allow work by utilities on or near the work covered by the contract. The Contractor shall conduct his/her work so as not to interfere with or hinder the progress or completion of the work being performed by utilities. The Contractor shall also arrange the work and shall place and dispose of the materials being used so as not to interfere with the operations of utility work in the area.

The Contractor shall cooperate with the owners of utilities in their removal and rearrangement operations so work may progress in a reasonable manner, duplication or rearrangement of work may be reduced to a minimum, and services rendered by those parties will not be unnecessarily interrupted.

The Contractor shall coordinate with any planned utility adjustment or new installation and the Contractor shall take all precautions to prevent disturbance or damage to utility facilities. Any failure on the part of the utility owner, or their representative, to proceed with any planned utility adjustment or new installation shall be reported promptly by the Contractor to the Engineer.”

Revise the first sentence of the last paragraph of Article 107.19 of the Standard Specifications to read:

“When the Contractor encounters unexpected regulated substances due to the presence of utilities in unanticipated locations, the provisions of Article 107.40 shall apply; otherwise, if the Engineer does not direct a resumption of operations, the provisions of Article 108.07 shall apply.”

Revise Article 107.31 of the Standard Specification to read:

“**107.31 Reserved.**”

Add the following four Articles to Section 107 of the Standard Specifications:

“**107.37 Locations of Utilities within the Project Limits.** All known utilities existing within the limits of construction are either indicated on the plans or visible above ground. For the purpose of this Article, the limits of proposed construction are defined as follows:

(a) Limits of Proposed Construction for Utilities Paralleling the Roadway.

- (1) The horizontal limits shall be a vertical plane, outside of, parallel to, and 2 ft (600 mm) distant at right angles from the plan or revised slope limits.

In cases where the limits of excavation for structures are not shown on the plans, the horizontal limits shall be a vertical plane 4 ft (1.2 m) outside the edges of structure footings or the structure where no footings are required.

- (2) The upper vertical limits shall be the regulations governing the roadbed clearance for the specific utility involved.
- (3) The lower vertical limits shall be either the top of the utility at the depth below the proposed grade as prescribed by the governing agency or the limits of excavation, whichever is less.

(b) Limits of Proposed Construction for Utilities Crossing the Roadway in a Generally Transverse Direction.

- (1) Utilities crossing excavations for structures that are normally made by trenching such as sewers, underdrains, etc. and all minor structures such as manholes, inlets, foundations for signs, foundations for traffic signals, etc., the limits shall be the space to be occupied by the proposed permanent construction, unless otherwise required by the regulations governing the specific utility involved.
- (2) For utilities crossing the proposed site of major structures such as bridges, sign trusses, etc., the limits shall be as defined above for utilities extending in the same general direction as the roadway.

It is understood and agreed that the Contractor has considered in the bid all of the permanent and temporary utilities in their present and/or adjusted positions as indicated in the contract. It is further understood the actual location of the utilities may be located anywhere within the tolerances provided in 220 ILCS 50/2.8 or Administrative Code Title 92 Part 530.40(c), and the proximity of some utilities to construction may require extraordinary measures by the Contractor to protect those utilities.

No additional compensation will be allowed for any delays, inconveniences, or damages sustained by the Contractor due to the presence of or any claimed interference from known utility facilities or any adjustment of them, except as specifically provided in the contract.

107.38 Adjustments of Utilities within the Project Limits. The adjustment of utilities consists of the relocation, removal, replacement, rearrangements, reconstruction, improvement, disconnection, connection, shifting, new installation, or altering of an existing utility facility in any manner.

Utilities which are to be adjusted shall be adjusted by the utility owner or the owner's representative or by the Contractor as a contract item. Generally, arrangements for adjusting known utilities will be made by the Department prior to project construction; however, utilities will not necessarily be adjusted in advance of project construction and, in some cases, utilities will not be removed from the proposed construction limits as described in Article 107.37. When utility adjustments must be performed in conjunction with construction, the utility adjustment work will be indicated in the contract.

The Contractor may make arrangements for adjustment of utilities indicated in the contract, but not scheduled by the Department for adjustment, provided the Contractor furnishes the Department with a signed agreement with the utility owner covering the adjustments to be made. The cost of any such adjustments shall be the responsibility of the Contractor.

107.39 Contractor’s Responsibility for Locating and Protecting Utility Property and Services. At points where the Contractor’s operations are adjacent to properties or facilities of utility companies, or are adjacent to other property, damage to which might result in considerable expense, loss, or inconvenience, work shall not be commenced until all arrangements necessary for the protection thereof have been made.

Within the State of Illinois, a State-Wide One Call Notice System has been established for notifying utilities. Outside the city limits of the City of Chicago, the system is known as the Joint Utility Locating Information for Excavators (JULIE) System. Within the city limits of the City of Chicago the system is known as DIGGER. All utility companies and municipalities which have buried utility facilities in the State of Illinois are a part of this system.

The Contractor shall call JULIE (800-892-0123) or DIGGER (312-744-7000), a minimum of 48 hours in advance of work being done in the area, and they will notify all member utility companies involved their respective utility should be located.

For utilities which are not members of JULIE or DIGGER, the Contractor shall contact the owners directly. The plan general notes will indicate which utilities are not members of JULIE or DIGGER.

The following table indicates the color of markings required of the State-Wide One Call Notification System.

Utility Service	Color
Electric Power, Distribution and Transmission	Safety Red
Municipal Electric Systems	Safety Red
Gas Distribution and Transmission	High Visibility Safety Yellow
Oil Distribution and Transmission	High Visibility Safety Yellow
Telephone and Telegraph System	Safety Alert Orange
Community Antenna Television Systems	Safety Alert Orange
Water Systems	Safety Precaution Blue
Sewer Systems	Safety Green
Non-Potable Water and Slurry Lines	Safety Purple
Temporary Survey	Safety Pink
Proposed Excavation	Safety White (Black when snow is on the ground)

The State-Wide One Call Notification System will provide for horizontal locations of utilities. When it is determined that the vertical location of the utility is necessary to facilitate construction, the Engineer may make the request for location from the utility after receipt of notice from the Contractor. If the utility owner does not field locate their facilities to the satisfaction of the Engineer, the Engineer will authorize the Contractor in writing to proceed to locate the facilities in the most economical and reasonable manner, subject to the approval of the Engineer, and be paid according to Article 109.04.

The Contractor shall be responsible for maintaining the excavations or markers provided by the utility owners.

The Contractor shall take all necessary precautions for the protection of the utility facilities. The Contractor shall be responsible for any damage or destruction of utility facilities resulting from neglect, misconduct, or omission in the Contractor's manner or method of execution or nonexecution of the work, or caused by defective work or the use of unsatisfactory materials. Whenever any damage or destruction of a utility facility occurs as a result of work performed by the Contractor, the utility company will be immediately notified. The utility company will make arrangements to restore such facility to a condition equal to that existing before any such damage or destruction was done.

In the event of interruption of utility services as a result of accidental breakage or as a result of being exposed or unsupported, the Contractor shall promptly notify the proper authority and shall cooperate with the said authority in the restoration of service. If water service is interrupted, repair work shall be continuous until the service is restored. No work shall be undertaken around fire hydrants until provisions for continued service have been approved by the local fire authority.

107.40 Conflicts with Utilities. Except as provided hereinafter, the discovery of a utility in an unanticipated location will be evaluated according to Article 104.03. It is understood and agreed that the Contractor has considered in the bid all facilities not meeting the definition of a utility in an unanticipated location and no additional compensation will be allowed for any delays, inconveniences, or damages sustained by the Contractor due to the presence of or any claimed interference from such facilities.

When the Contractor discovers a utility in an unanticipated location, the Contractor shall not interfere with said utility, shall take proper precautions to prevent damage or interruption of the utility, and shall promptly notify the Engineer of the nature and location of said utility.

- (a) Definition. A utility in an unanticipated location is defined as an active or inactive utility, which is either:
 - (1) Located underground and (a) not shown in any way in any location on the contract documents; (b) not identified in writing by the Department to the Contractor prior to the letting; or (c) not located relative to the location shown in the contract within the tolerances provided in 220 ILCS 50/2.8 or Administrative Code Title 92 Part 530.40(c); or
 - (2) Located above ground or underground and not relocated as provided in the contract.

Service connections shall not be considered to be utilities in unanticipated locations.

- (b) Compensation. Compensation will not be allowed for delays, inconveniences, or damages sustained by the Contractor from conflicts with facilities not meeting the above definition; or if a conflict with a utility in an unanticipated location does not cause a shutdown of the work applicable to the utility or a documentable reduction in the rate of progress exceeding the limits set herein. The provisions of Article 104.03 notwithstanding, compensation for delays caused by a utility in an unanticipated location will be paid according to the provisions of this Article governing minor and major delays or reduced rate of production which are defined as follows:

- (1) Minor Delay. A minor delay occurs when the Contractor's operation is completely stopped by a utility in an unanticipated location for more than two hours, but not to exceed three weeks.
 - (2) Major Delay. A major delay occurs when the Contractor's operation is completely stopped by a utility in an unanticipated location for more than three weeks.
 - (3) Reduced Rate of Production Delay. A reduced rate of production delay occurs when the contractor's rate of production decreases by more than 25 percent and lasts longer than seven days.
- (c) Payment. Payment for Minor, Major and Reduced Rate of Production Delays will be made as follows.

- (1) Minor Delay. Labor idled which cannot be used on other work will be paid for according to Article 109.04(b)(1) and (2) for the time between start of the delay and the minimum remaining hours in the work shift required by the prevailing practice in the area.

Equipment idled which cannot be used on other work will be paid for according to Article 109.04(b)(4). The length of time paid for will be the time between start of delay and eight hours working time from start of shift being worked.

For delays exceeding the initial shift, excluding Saturdays, Sundays, and holidays, Contractor-owned equipment idled by the delay which cannot be used on other work and remaining at the work site, will be paid at one-half the rate permitted in Article 109.04(b)(4) using a maximum eight hours per day for computation purposes. Equipment rented from an independent source will be paid at rates being paid by the Contractor plus move-in move-out costs, but the total amount paid will not exceed three weeks rental.

- (2) Major Delay. Labor will be the same as for a minor delay.

Equipment will be the same as for a minor delay, except Contractor-owned equipment will be limited to three weeks plus the cost of move-out to either the Contractor's yard or another job, whichever is less. Rental equipment may be paid for longer than three weeks provided the Contractor presents adequate support to the Department (including lease agreement) to show retaining equipment on the job is the most economical course to follow and in the public interest.

- (3) Reduced Rate of Production Delay. The Contractor will be compensated for the reduced productivity for labor and equipment time in excess of the 25 percent threshold for that portion of the delay in excess of seven days. Determination of compensation will be in accordance with Article 104.02, except labor and material additives will not be permitted.

Whether covered by (1), (2) or (3) above, additional traffic control required as a result of the operation(s) delayed will be paid for according to Article 109.04 for the total length of the delay.

If the delay is clearly shown to have caused work, which would have otherwise been completed, to be done after material or labor costs have increased, such increases may be paid. Payment for materials will be limited to increased cost substantiated by documentation furnished by the Contractor. Payment for increased labor rates will include those items in Article 109.04(b)(1) and (2), except the 35 percent and ten percent additives will not be permitted. On a working day contract, a delay occurring between November 30 and May 1, when work has not started, will not be considered as eligible for payment of measured labor and material costs.

Project overhead (not including interest) will be allowed when all progress on the contract has been delayed, and will be calculated as 15 percent of the delay claim.

- (d) Other Obligations of Contractor. Upon payment of a claim under this provision, the Contractor shall assign subrogation rights to the Department for the Department's efforts of recovery from any other party for monies paid by the Department as a result of any claim under this Provision. The Contractor shall fully cooperate with the Department in its efforts to recover from another party any money paid to the Contractor for delay damages under this Provision."

WORKING DAYS (BDE)

Effective: January 1, 2002

The Contractor shall complete the work within 25 working days.

BITUMINOUS MATERIALS COST ADJUSTMENTS (BDE) (RETURN FORM WITH BID)

Effective: November 2, 2006
2009

Revised: January 2, 2007 April 1,

Description. For projects with at least 1200 tons (1100 metric tons) of work involving applicable bituminous materials, Bituminous material cost adjustments will be made to provide additional compensation to the Contractor, or credit to the Department, for fluctuations in the cost of bituminous materials when optioned by the Contractor. The adjustments shall apply to permanent and temporary hot-mix asphalt (HMA) mixtures, bituminous surface treatments (cover and seal coats), and pavement preservation type surface treatments. The adjustments shall not apply to bituminous prime coats, tack coats, crack filling/sealing, or joint filling/sealing.

The bidder shall indicate on the attached form whether or not this special provision will be part of the contract and submit the completed form with his/her bid. Failure to submit the form, or failure to fill out the form completely, shall make this contract exempt of bituminous materials cost adjustments.

Method of Adjustment. Bituminous materials cost adjustments will be computed as follows.

$$CA = (BPI_P - BPI_L) \times (\%AC_V / 100) \times Q$$

- Where: CA = Cost Adjustment, \$.
BPI_P = Bituminous Price Index, as published by the Department for the month the work is performed, \$/ton (\$/metric ton).
BPI_L = Bituminous Price Index, as published by the Department for the month prior to the letting, \$/ton (\$/metric ton).
%AC_V = Percent of virgin Asphalt Cement in the Quantity being adjusted. For HMA mixtures, the % AC_V will be determined from the adjusted job mix formula. For bituminous materials applied, a performance graded or cutback asphalt will be considered to be 100% AC_V and undiluted emulsified asphalt will be considered to be 65% AC_V.
Q = Authorized construction Quantity, tons (metric tons) (see below).

For HMA mixtures measured in square yards: $Q, \text{ tons} = A \times D \times (G_{mb} \times 46.8) / 2000$. For HMA mixtures measured in square meters: $Q, \text{ metric tons} = A \times D \times (G_{mb} \times 24.99) / 1000$. When computing adjustments for full-depth HMA pavement, separate calculations will be made for the binder and surface courses to account for their different G_{mb} and % AC_V.

For bituminous materials measured in gallons: $Q, \text{ tons} = V \times 8.33 \text{ lb/gal} \times SG / 2000$
For bituminous materials measured in liters: $Q, \text{ metric tons} = V \times 1.0 \text{ kg/L} \times SG / 1000$

- Where: A = Area of the HMA mixture, sq yd (sq m).
D = Depth of the HMA mixture, in. (mm).
 G_{mb} = Average bulk specific gravity of the mixture, from the approved mix design.
V = Volume of the bituminous material, gal (L).
SG = Specific Gravity of bituminous material as shown on the bill of lading.

Basis of Payment. Bituminous materials cost adjustments may be positive or negative but will only be made when there is a difference between the BPI_L and BPI_P in excess of five percent, as calculated by:

$$\text{Percent Difference} = \{(BPI_L - BPI_P) \div BPI_L\} \times 100$$

Bituminous materials cost adjustments will be calculated for each calendar month in which applicable bituminous material is placed; and will be paid or deducted when all other contract requirements for the items of work placed during the month are satisfied. The adjustments shall not apply during contract time subject to liquidated damages for completion of the entire contract.

RETURN WITH BID

**ILLINOIS DEPARTMENT
OF TRANSPORTATION**

**OPTION FOR
BITUMINOUS MATERIALS COST ADJUSTMENTS**

The bidder shall submit this completed form with his/her bid. Failure to submit the form, or failure to fill out the form completely, shall make this contract exempt of bituminous materials cost adjustments. After award, this form, when submitted, shall become part of the contract.

Contract No.: _____

Company Name: _____

Contractor's Option:

Is your company opting to include this special provision as part of the contract?

Yes No

Signature: _____ **Date:** _____

STATE OF ILLINOIS
 DEPARTMENT OF TRANSPORTATION
 DIVISION OF HIGHWAYS

FAU 9454B/EAS-2882 (IL 37)
 SECTION 11RS-4
 FRANKLIN COUNTY
 SHEET 1 OF 13
 C-99-024-11

**PROPOSED
 HIGHWAY PLANS**

FAU 9454B (IL 37)
 SECTION 11RS-4
 RESURFACING
 FRANKLIN COUNTY

D-99-014-11

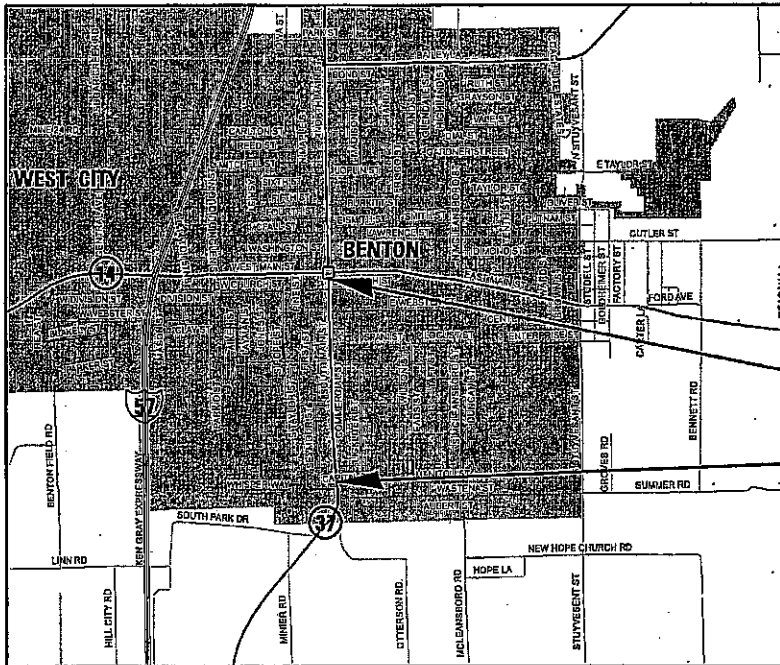

BEGIN PROJECT BENTON SQUARE
 STA 0 + 34.25
END PROJECT
 STA 44 + 00.00

FOR SIGNATURE SHEET, SEE SHEET NO. 2
 FOR INDEX OF SHEETS, SEE SHEET NO. 3
 FOR GENERAL NOTES, SEE SHEET NO. 4
 FOR SUMMARY OF QUANTITIES, SEE SHEET NO. 5

MAP NOT TO SCALE

PROJECT ENGINEER: SUSAN POE 618-549-2171 CENTREX 782-4554
 DESIGNER: TRAVIS BRADLEY 618-549-2171

TRAFFIC DATA (2009)
 IL 37: ADT = 6,200 7.1% TRUCKS

OMISSIONS: RAILROAD CROSSINGS
 STA 11 + 63.33 TO STA 12 + 55.33
 STA 21 + 56.50 TO STA 22 + 87.50

TOWNSHIP: BENTON
 CONTRACT NO. 78237

GROSS LENGTH = 4,365.75 FT = 0.83 MILE
 NET LENGTH = 4,142.75 FT = 0.78 MILE

SUBMITTED	<i>Mary E. Jamie</i> 3/10/2011 DEPUTY DIRECTOR OF HIGHWAYS, REGION ENGINEER
PASSED	ENGINEER OF DESIGN & ENVIRONMENT
APPROVED	DIRECTOR, DIVISION OF HIGHWAYS

JULIE
 JOINT UTILITY LOCATION INFORMATION FOR EXCAVATION
 1-800-892-0123
 DR 811 www.juliecall.com

SIGNATURE SHEET

PREPARED BY:

Joe Zdaniewicz
DISTRICT STUDIES & PLANS ENGINEER

EXAMINED BY:

James Louis Emery
DISTRICT LAND ACQUISITION ENGINEER

EXAMINED BY:

Carrie Nula
DISTRICT PROGRAM DEVELOPMENT ENGINEER

EXAMINED BY:

Ken Kelly
DISTRICT OPERATIONS ENGINEER

EXAMINED BY:

[Signature]
DISTRICT CONSTRUCTION ENGINEER

EXAMINED BY:

Bruce W. Hedges
DISTRICT MATERIALS ENGINEER

INDEX OF SHEETS

<u>SHEET NO.</u>	<u>DESCRIPTION</u>
1	COVER SHEET
2	SIGNATURE SHEET
3	INDEX OF SHEETS, STANDARDS
4	GENERAL NOTES, COMMITMENTS
5	SUMMARY OF QUANTITIES
6	TYPICAL SECTION
7	HMA PAVEMENT SCHEDULE
8	PAVEMENT MARKING SCHEDULE
9	DETAIL: CLASS C PATCHES (SPÉCIAL)
10	DETAIL: BUTT JOINT DETAIL
11	DETAIL: UNEVEN LANES SIGN
12	DETAIL: ROUGH GROOVED SURFACE
13	DETAIL: TEMP HOT-MIX ASPHALT TRANSITIONS

STANDARDS

000001-06 STANDARD SYMBOLS, ABBREVIATIONS AND PATTERNS
001006 DECIMAL OF AN INCH AND OF A FOOT
442201-03 CLASS C PATCHES
701001-02 OFF-ROAD OPERATIONS, 2L, 2W, MORE THAN 15' AWAY
701006-03 OFF-ROAD OPERATIONS, 2L, 2W, 15' TO 24' FROM PAVEMENT EDGE
701011-02 OFF-ROAD MOVING OPERATIONS, 2L, 2W, DAY ONLY
701301-04 LANE CLOSURE, 2L, 2W, SHORT TIME OPERATIONS
701311-03 LANE CLOSURE, 2L, 2W, MOVING OPERATIONS - DAY ONLY
701501-06 URBAN LANE CLOSURE, 2L, 2W, UNDIVIDED
780001-02 TYPICAL PAVEMENT MARKINGS
701901-01

GENERAL NOTES

FACTORS USED FOR ESTIMATING PLAN QUANTITIES ARE AS FOLLOWS AND SHALL NOT BE USED FOR THE BASIS OF FINAL QUANTITIES:

ALL HOT-MIX ASPHALT	2.016 TONS/CU. YD.
ALL AGGREGATE	2.05 TONS/CU. YD.
BITUMINOUS MATERIALS:	
ON PAVEMENT	0.09 GAL./SQ. YD.
ON AGGREGATE SURFACE	0.32 GAL./SQ. YD.
AGGREGATE (PRIME COAT)	0.0015 TONS/SQ. YD.
RIPRAP	1.50 TONS/CU. YD.

THE QUANTITY OF SHORT TERM PAVEMENT MARKING SHOWN IN THE PLANS IS BASED ON ONE APPLICATION.

ALL PAVEMENT MARKINGS SHALL BE LOCATED AND RECORDED BEFORE PAVEMENT REMOVAL.

PRIOR TO PLACEMENT OF THE FINAL PAVEMENT MARKINGS THE RESIDENT ENGINEER SHOULD CONTACT THE BUREAU OF OPERATIONS AND ARRANGE FOR INSPECTION AND APPROVAL OF THE PAVEMENT MARKING LAYOUT.

THE USE OF A VIBRATORY ROLLER SHALL BE PROHIBITED. THE CONTRACTOR MAY BE REQUIRED TO MAKE ROLLING PATTERN ADJUSTMENTS TO OBTAIN THE REQUIRED FIELD DENSITY.

THERE ARE NO AVAILABLE WASTE SITES ON THE EXISTING RIGHT OF WAY WITHIN THE PROJECT LIMITS. DISPOSAL WILL BE THE RESPONSIBILITY OF THE CONTRACTOR AND WASTE MUST BE DISPOSED OF IN ACCORDANCE WITH ARTICLE 202.03 OF THE STANDARD SPECIFICATIONS.

STATIONING SHOWN IN THE SCHEDULES IS BASED ON STAMPED STATIONS IN THE EXISTING PAVEMENT AND FROM OLD PLANS. MINOR ADJUSTMENTS MAY BE REQUIRED AS DIRECTED BY THE ENGINEER.

PLAN DIMENSIONS AND DETAILS RELATIVE TO EXISTING PLANS ARE SUBJECT TO NOMINAL CONSTRUCTION VARIATIONS. THE CONTRACTOR SHALL FIELD VERIFY EXISTING DIMENSIONS AND DETAILS AFFECTING NEW CONSTRUCTION AND MAKE NECESSARY APPROVED ADJUSTMENTS PRIOR TO CONSTRUCTION OR ORDERING OF MATERIALS. SUCH VARIATIONS SHALL NOT BE CAUSE FOR ADDITIONAL COMPENSTATION FOR A CHANGE IN THE SCOPE OF THE WORK. HOWEVER, THE CONTRACTOR WILL BE PAID FOR THE QUANTITY ACTUALLY FURNISHED AT THE UNIT PRICE BID FOR THE WORK.

QUANTITIES SHOWN IN THE PLANS FOR PATCHING ARE ESTIMATES. THE ACTUAL AMOUNT OF PATCHING REQUIRED WILL BE DETERMINED BY THE ENGINEER.

THE THICKNESS OF HOT MIX ASPHALT MIXTURE SHOWN ON THE PLANS IS THE NOMINAL THICKNESS. DEVIATIONS FROM THE NOMINAL THICKNESS WILL BE PERMITTED WHEN SUCH DEVIATIONS OCCUR DUE TO IRREGULARITIES IN THE EXISTING SURFACE OR BASE ON WHICH THE HOT MIX ASPHALT MIXTURE IS PLACED.

THE CONTRACTOR SHALL STAMP STATIONING IN THE PROPOSED HOT MIX ASPHALT SURFACE AT 300 FT. INTERVALS ON ALTERNATING SIDES OF THE PAVEMENT AND AS DIRECTED BY THE ENGINEER. ~~THE STATION SYMBOL STAMPS USED SHALL BE FURNISHED BY THE CONTRACTOR. THEY SHALL BE 5 1/2 IN. TALL OF A DESIGN APPROVED BY THE ENGINEER, AND SHALL REMAIN THE PROPERTY OF THE CONTRACTOR.~~

BITUMINOUS RESURFACING SHALL BE PLACED IN A SEQUENCE THAT WILL MINIMIZE THE TIME THE CENTERLINE EDGE IS EXPOSED TO TRAFFIC. WHEN AT THE END OF A DAY'S OPERATION THE EXPOSED CENTERLINE EDGE IS GREATER THAN 2000 FT THE CONTRACTOR SHALL BE REQUIRED TO PAVE IN THE ADJACENT LANE ON THE FOLLOWING WORK DAY. PRIOR TO WINTER SHUTDOWN, RESURFACING ON ADJACENT LANES IS TO BE BROUGHT UP TO THE SAME ELEVATION.

COMMITMENTS

NONE

SUMMARY OF QUANTITIES

100% STATE

FAU 9454B/FAS 2882 (IL 37)
SECTION 11RS-4
CONTRACT NO 78237
FRANKLIN COUNTY
SHEET 5 OF 13

CODE NUMBER	ITEM	CONSTRUCTION TYPE CODE	TOTAL
			QUANTITIES ILLINOIS 37
X44ZOTZ4	CLASS C PATCHES, TYPE I, 10 INCH (SPECIAL)	SQ YD	25
Z0048665	RAILROAD PROTECTIVE LIABILITY INSURANCE	L SUM	1
40600100	BITUMINOUS MATERIALS (PRIME COAT)	GAL	1492
40600300	AGGREGATE (PRIME COAT)	TON	25
40600982	HOT-MIX ASPHALT SURFACE REMOVAL - BUTT JOINT	SQ YD	720
40600990	TEMPORARY RAMP	SQ YD	120
40603545	POLYMERIZED HOT-MIX ASPHALT SURFACE COURSE, MIX "D", N90	TON	1779
44000155	HOT-MIX ASPHALT SURFACE REMOVAL, 1 1/2"	SQ YD	15851
44201353	CLASS C PATCHES, TYPE II, 10 INCH	SQ YD	720
44201357	CLASS C PATCHES, TYPE III, 10 INCH	SQ YD	354
44201359	CLASS C PATCHES, TYPE IV, 10 INCH	SQ YD	352
67100100	MOBILIZATION	L SUM	1
70102620	TRAFFIC CONTROL AND PROTECTION, STANDARD 701501	L SUM	1
70106800	CHANGEABLE MESSAGE SIGN	CAL MO	2
70300100	SHORT TERM PAVEMENT MARKING	FOOT	828
70300210	TEMPORARY PAVEMENT MARKING - LETTERS AND SYMBOLS	SQ FT	244.8
70300220	TEMPORARY PAVEMENT MARKING - LINE 4"	FOOT	2501
70300280	TEMPORARY PAVEMENT MARKING - LINE 24"	FOOT	144
70301000	WORK ZONE PAVEMENT MARKING REMOVAL	SQ FT	276
* 78000100	THERMOPLASTIC PAVEMENT MARKING - LETTERS AND SYMBOLS	SQ FT	244.8
* 78000200	THERMOPLASTIC PAVEMENT MARKING - LINE 4"	FOOT	2501
* 78000650	THERMOPLASTIC PAVEMENT MARKING - LINE 24"	FOOT	144
78300200	RAISED REFLECTIVE PAVEMENT MARKER REMOVAL	EACH	54

*SPECIALTY ITEM

TYPICAL SECTION

IL 37

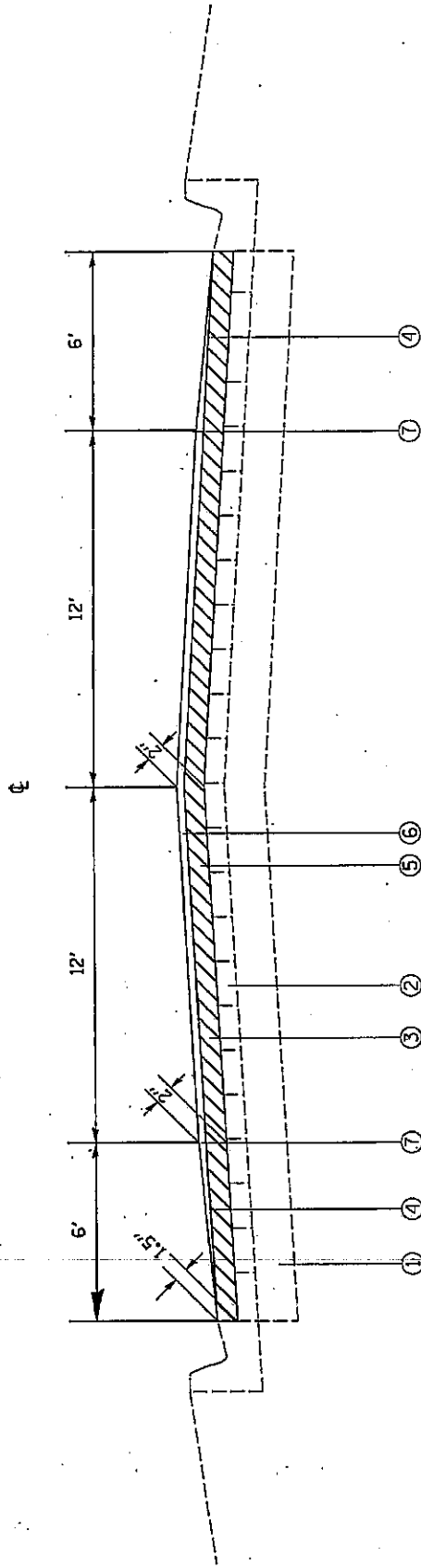

TO BE USED:

STA. 0+34.25 TO STA. 44+00
 OMIT
 STA 11+63.33 TO STA 12+55.33 (RR OMISSION)
 STA 21+56.50 TO STA 22+87.50 (RR OMISSION)

- 1 EXISTING PAVEMENT
- 2 EXISTING BRICK PAVEMENT
- 3 EXISTING RESURFACING
- 4 EXISTING SHOULDERS
- 5 PROPOSED HOT-MIX ASPHALT SURFACE REMOVAL 1 1/2"
- 6 PROPOSED POLYMERIZED HOT-MIX ASPHALT SURFACE COURSE, MIX "D", N90 2" AND VAR

FAU 9454B/FAS 2882 (IL 37)
 SECTION 11RS-4
 CONTRACT NO. 78237
 FRANKLIN COUNTY
 SHEET 6 OF 13

HMA PAVEMENT SCHEDULE

FAU 9454B/FAS 2882
SECTION 11RS-4
CONTRACT NO 78237
FRANKLIN COUNTY
SHEET 7 OF 13

LOCATION STATION TO STATION	POLYMERIZED HMA SURFACE COURSE, MIX "D", N90		BITUMINOUS MATERIALS (PRIME COAT)		AGGREGATE (PRIME COAT)		HOT-MIX ASPHALT SURFACE REMOVAL		HOT-MIX ASPHALT SURFACE REMOVAL - BUTT JOINT	
	TON	TON	GALLON	GALLON	TON	TON	SQ YD	SQ YD	SQ YD	SQ YD
0+34.25 TO 2+53	93.9		78.8		1.3		755		120	
2+53 TO 7+39	208.7		175.0		2.9		1944			
7+39 TO 11+08	158.4		132.8		2.2		1476			
11+08 TO 11+63.33	23.8		19.9		0.3		101.3		120	
11+63.33 TO 12+55.33 OMISSION										
12+55.33 TO 14+30	75.0		62.9		1.0		698.7		120	
14+30 TO 17+60	141.7		118.8		2.0		1200			
17+60 TO 21+33	160.1		134.3		2.2		1372			
21+33 TO 21+56.50	10.1		8.5		0.1		94		120	
21+56.50 TO 22+87.50 OMISSION										
22+87.50 TO 24+43	66.8		56.0		0.9		502		120	
24+43 TO 27+42	128.4		107.6		1.8		1196			
27+42 TO 30+70	140.8		118.1		2.0		1312			
30+70 TO 34+35	156.7		131.4		2.2		1460			
34+35 TO 37+50	135.2		113.4		1.9		1260			
37+50 TO 40+75	139.5		117.0		2.0		1300			
40+75 TO 44+00	139.5		117.0		2.0		1180		120	
TOTALS	1779		1491.4		24.9		15851		720	

PAVEMENT MARKING SCHEDULE

FAU 9454B/FAS 2882
SECTION 11RS-4
CONTRACT NO 78237
FRANKLIN COUNTY
SHEET 8 OF 13

LOCATION STATION TO STATION	THERMOPLASTIC PAVEMENT MARKING - LINE 4"	THERMOPLASTIC PAVEMENT MARKING - LINE 24"	THERMOPLASTIC PAVEMENT MARKING - LETTERS & SYMBOLS
	FOOT	FOOT	SQ FT
0+34.25 TO 2+53	54.6		
2+53 TO 7+39	121.5		
7+39 TO 11+08	92.2		
11+08 TO 11+63.33	13.8	36	61.2
11+63.33 TO 12+55.33	24		
12+55.33 TO 14+30	43.6	36	61.2
14+30 TO 17+60	82.5		
17+60 TO 21+33	93.2		
21+33 TO 21+56.50	5.8	36	61.2
21+56.50 TO 22+87.50	33		
22+87.50 TO 24+43	38.8	36	61.2
24+43 TO 27+42	74.7		
27+42 TO 30+70	161		
30+70 TO 34+35	456.2		
34+35 TO 37+50	393.7		
37+50 TO 40+75	406.2		
40+75 TO 44+00	406.2		
TOTALS	2501	144	244.8

CLASS C PATCHES (SPECIAL)

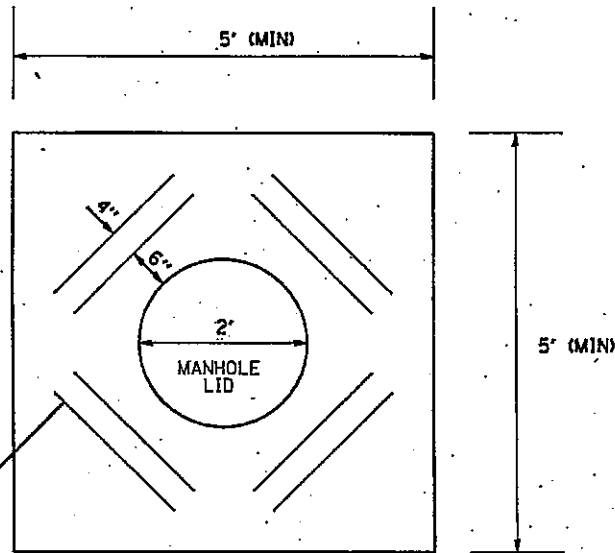

2 - NO. 5 X 2'-0" (TYPICAL)
REINFORCEMENT BARS
(8 TOTAL) PLACED AT
PAVEMENT MID-DEPTH
COST INCLUDED IN COST OF PATCH.

PATCHES SHALL BE 10" IN DEPTH AND
CONSTRUCTED ACCORDING TO HIGHWAY
STANDARD 442201-03 AND SECTION 442
OF THE STANDARD SPECIFICATIONS.

BUTT JOINT DETAIL

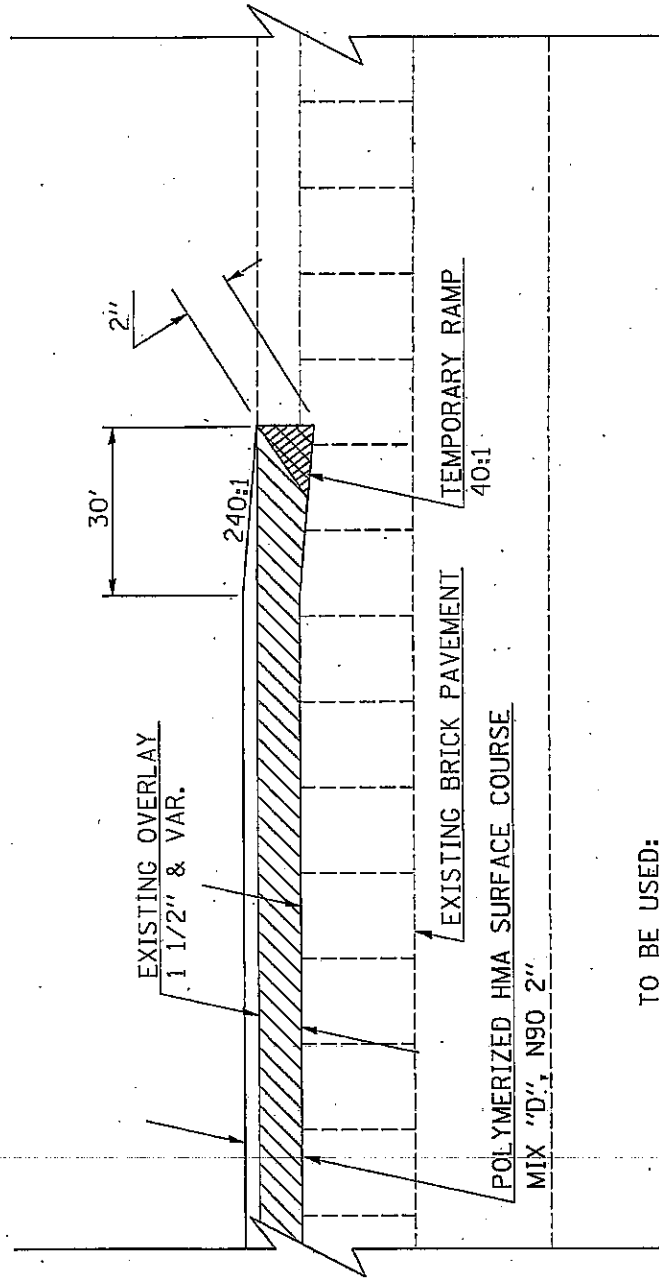

TO BE USED:

- STA. 0+34.25
- STA. 11+63.33
- STA. 12+55.33
- STA. 21+56.50
- STA. 22+87.50
- STA. 44+00.00

ADJACENT TO EXISTING RR IMPROVEMENT

UNEVEN LANES SIGN

W8-11 (48" x 48")

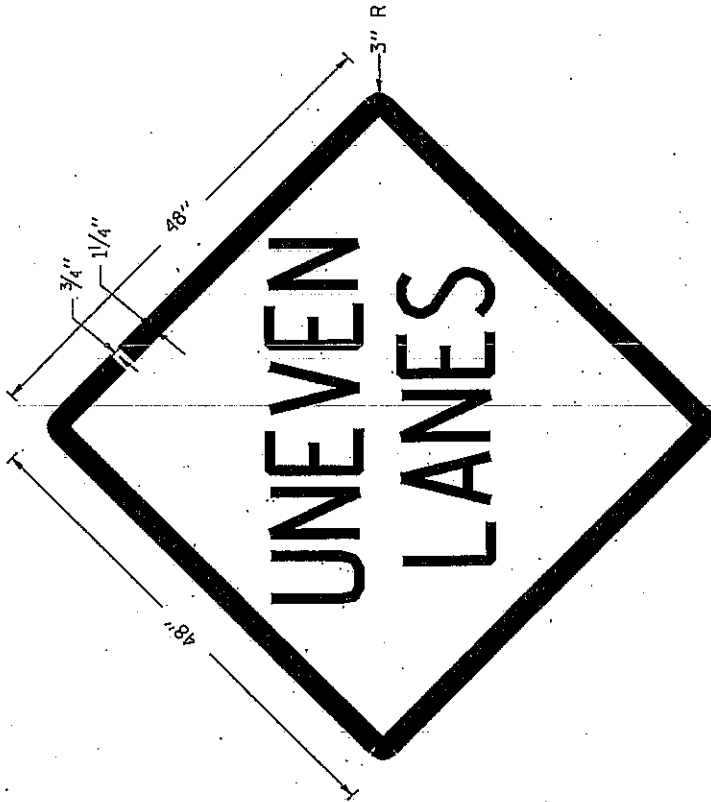

COLORS:

LEGEND AND BORDER - BLACK NON-REFLECTORIZED
BACKGROUND - ORANGE REFLECTORIZED

NOTE: PRIOR TO ALLOWING TRAFFIC ON ANY PORTION OF THE ROADWAY THAT HAS BEEN COLDMILLED OR BEFORE RESURFACING OPERATIONS BEGIN, THE CONTRACTOR SHALL HAVE ERECTED "UNEVEN PAVEMENT" SIGNS THAT CONFORM TO THE ABOVE DETAILS. A MINIMUM OF ONE SIGN AT EACH END OF THE IMPROVEMENT WILL BE REQUIRED. THE CONTRACTOR SHALL MAINTAIN THE "UNEVEN PAVEMENT" SIGNS UNTIL THE RESURFACING OPERATIONS ARE COMPLETED.

IF AT ANY TIME THE SIGNS ARE IN PLACE BUT NOT APPLICABLE, THEY SHALL BE TURNED FROM THE VIEW OF MOTORISTS OR COVERED AS DIRECTED BY THE ENGINEER.

THE COST OF FURNISHING, ERECTING, MAINTAINING, AND REMOVING THE REQUIRED SIGNS SHALL BE INCLUDED IN THE CONTRACT.

FAU 9454B/FAS 2882 (IL 37)
SECTION 11RS-4
CONTRACT NO. 78237
FRANKLIN COUNTY
SHEET 11 OF 13

REVISIONS	
DRAWN	2-15-83
REVISED	4-9-83
REDESIGNED	7-23-84

STD. 9-41

ILLINOIS STANDARD

W8-1106

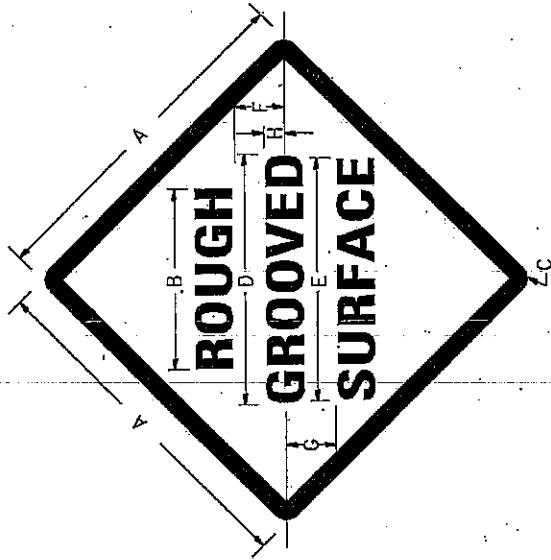

COLORS:

LEGEND AND BORDER- BLACK NON-REFLECTORIZED
BACKGROUND- ORANGE REFLECTORIZED

SIGN SIZE	DIMENSIONS							
	A	B	C	D	E	F	G	H
48X48	48.0	24.1	3.0	34.0	33.0	6.0	13.0	3.5

SIGN SIZE	SERIES LINES			MAR-BOR- BLANK	
	1	2	3	GIN	DER STD.
48X48	7C	7C	7C	0.8	1-2 B4-48D

ALL DIMENSIONS IN INCHES

FAU 9454B/FAS 2882 (IL 37)
SECTION 11RS-4
CONTRACT NO. 78237
FRANKLIN COUNTY
SHEET 12 OF 13

REVISIONS	
REDRAWN	2-15-89
REVISED	4-5-89
REVISED	4-5-89
REVISED	

STD. -9-39

NOTES:

PRIOR TO ALLOWING TRAFFIC ON ANY PORTION OF THE ROADWAY THAT HAS BEEN COLDMILLED, THE CONTRACTOR SHALL HAVE ERECTED "ROUGH GROOVED SURFACE" SIGNS THAT CONFORM TO THE ABOVE DETAILS. A MINIMUM OF ONE SIGN AT EACH END OF THE IMPROVEMENT WILL BE REQUIRED. THE CONTRACTOR SHALL MAINTAIN THE "ROUGH GROOVED SURFACE" SIGNS UNTIL THE COLDMILLED SURFACE IS COVERED WITH LEVELING BINDER OR SURFACE COURSE.

IF AT ANY TIME THE SIGNS ARE IN PLACE BUT NOT APPLICABLE, THEY SHALL BE TURNED FROM THE VIEW OF MOTORISTS OR COVERED AS DIRECTED BY THE ENGINEER.

THE COST OF FURNISHING, ERECTING, MAINTAINING, AND REMOVING THE REQUIRED SIGNS SHALL BE INCLUDED IN THE CONTRACT.

TEMPORARY HOT-MIX ASPHALT TRANSITIONS

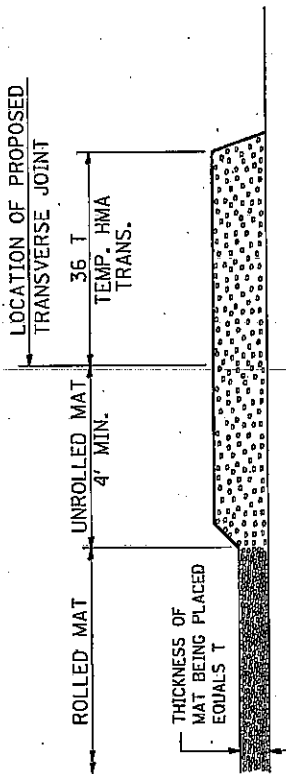

STEP I

1. PLACE HOT-MIX ASPHALT MAT, LENGTH 36 TIMES THE THICKNESS OF THE MAT BEING PLACED PAST THE PROPOSED TRANSVERSE JOINT LOCATION USING NORMAL OPERATING PROCEDURES.
2. EXTREME CARE SHOULD BE TAKEN TO MAINTAIN ENOUGH MATERIAL IN FRONT OF THE SCREED TO MAINTAIN REQUIRED PAVING DEPTH.

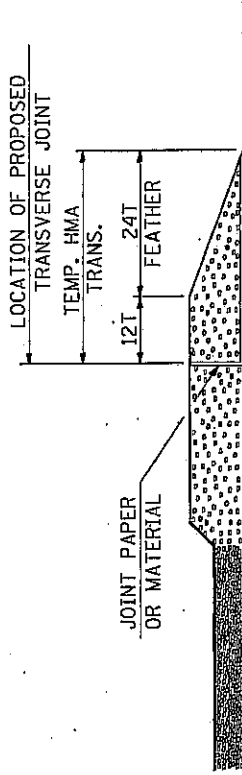

STEP III

1. JOINT PAPER OR OTHER PRESELECTED JOINT MATERIAL IS THEN PLACED IN THE CLEARED AREA AND THE EXCESS ASPHALT USED TO HAND FORM A TRANSITION TO THE DIMENSIONS SHOWN ABOVE.
2. NOTE THAT IN CONSTRUCTING THE TRANSITION, THE MAT DEPTH IS CONTINUED AS PART OF THE TRANSITION BEFORE FORMING THE FEATHER.

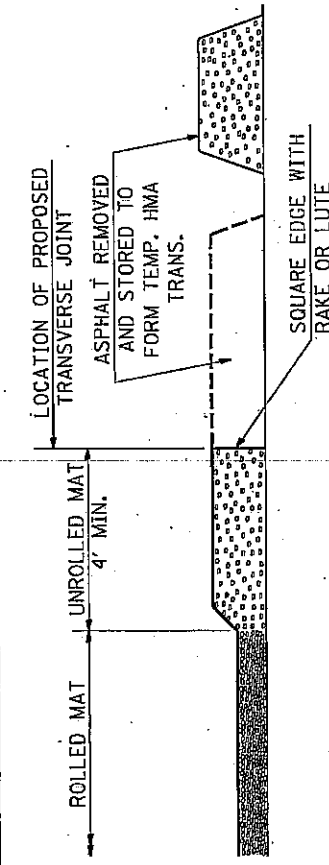

STEP II

1. MOVE THE PAVER OUT OF THE WAY AND REMOVE THE ASPHALT FROM THE AREA OF THE PROPOSED TEMPORARY HOT-MIX ASPHALT TRANSITION.
2. SQUARE UP THE END OF THE MAT WITH A RAKE OR LUTE.
3. NOTE THAT THE MAT WITHIN 4' OF THE END OF JOINT IS NOT TO BE ROLLED AT THIS TIME.

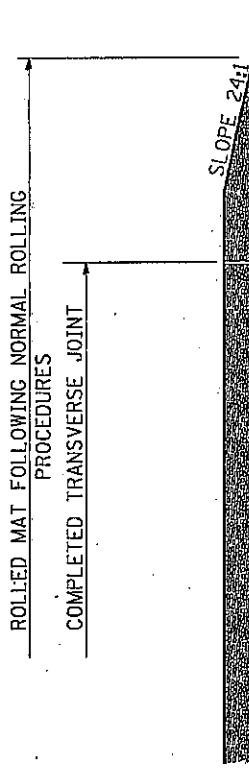

STEP IV

1. COMPLETE TEMPORARY TRANSITION BY ROLLING.
2. TO RESUME PAVING, AT THE JOINT, REMOVE TEMPORARY TRANSITION AND DISPOSE OF THE MATERIAL ACCORDING TO ART. 202.03 OF THE STD. SPECS. (COST INCLUDED IN THE CONTRACT).
3. CONSTRUCTING THE TEMPORARY TRANSITIONS WILL NOT BE PAID FOR SEPARATELY IN ACCORDANCE WITH ARTICLE 406.14 OF THE STANDARD SPECIFICATIONS.

FAL 9454B/FAS 2882 (IL 37)
SECTION 11RS-4
CONTRACT NO. 78237
FRANKLIN COUNTY
SHEET 13 OF 13

REVISIONS	
REVISION 2-15-78	
REVISED 8-23-74	
REVISED 01-09-70	

STD. 9-26

ILLINOIS DEPARTMENT OF LABOR

PREVAILING WAGES FOR FRANKLIN COUNTY EFFECTIVE MAY 2011

The Prevailing rates of wages are included in the Contract proposals which are subject to Check Sheet #5 of the Supplemental Specifications and Recurring Special Provisions. The rates have been ascertained and certified by the Illinois Department of Labor for the locality in which the work is to be performed and for each craft or type of work or mechanic needed to execute the work of the Contract. As required by Prevailing Wage Act (820 ILCS 130/0.01, et seq.) and Check Sheet #5 of the Contract, not less than the rates of wages ascertained by the Illinois Department of Labor and as revised during the performance of a Contract shall be paid to all laborers, workers and mechanics performing work under the Contract. Post the scale of wages in a prominent and easily accessible place at the site of work.

If the Illinois Department of Labor revises the prevailing rates of wages to be paid as listed in the specification of rates, the contractor shall post the revised rates of wages and shall pay not less than the revised rates of wages. Current wage rate information shall be obtained by visiting the Illinois Department of Labor web site at <http://www.state.il.us/agency/idol/> or by calling 312-793-2814. It is the responsibility of the contractor to review the rates applicable to the work of the contract at regular intervals in order to insure the timely payment of current rates. Provision of this information to the contractor by means of the Illinois Department of Labor web site satisfies the notification of revisions by the Department to the contractor pursuant to the Act, and the contractor agrees that no additional notice is required. The contractor shall notify each of its subcontractors of the revised rates of wages.

Franklin County Prevailing Wage for May 2011

Trade Name	RG	TYP	C	Base	FRMAN	*M-F>8	OSA	OSH	H/W	Pensn	Vac	Trng
=====	==	===	=	=====	=====	=====	===	===	=====	=====	=====	=====
ASBESTOS ABT-GEN		ALL		24.400	24.850	1.5	1.5	2.0	5.550	9.450	0.000	0.900
ASBESTOS ABT-MEC		BLD		20.800	0.000	2.0	2.0	2.0	5.500	4.200	0.000	0.000
BOILERMAKER		BLD		31.500	34.000	1.5	1.5	2.0	6.820	11.43	1.500	0.350
BRICK MASON		BLD		27.220	28.720	1.5	1.5	2.0	7.950	6.690	0.000	0.430
CARPENTER		BLD		30.490	31.990	1.5	1.5	2.0	6.050	5.750	0.000	0.350
CARPENTER		HWY		30.440	31.940	1.5	1.5	2.0	6.050	5.750	0.000	0.350
CEMENT MASON		BLD		26.750	28.250	1.5	1.5	2.0	5.900	4.800	0.000	0.300
CEMENT MASON		HWY		26.350	27.350	1.5	1.5	2.0	5.900	4.350	0.000	0.300
CERAMIC TILE FNSHER		BLD		25.720	0.000	1.5	1.5	2.0	7.950	6.690	0.000	0.430
ELECTRICIAN		ALL		36.830	39.080	1.5	1.5	2.0	5.350	8.470	0.000	0.730
ELECTRONIC SYS TECH		BLD		29.530	31.280	1.5	1.5	2.0	5.250	3.840	0.000	0.250
FLOOR LAYER		BLD		28.930	29.680	1.5	1.5	2.0	6.050	5.750	0.000	0.350
GLAZIER		BLD		26.330	27.580	1.5	1.5	2.0	4.850	5.200	0.000	0.300
HT/FROST INSULATOR		BLD		28.920	29.920	1.5	1.5	2.0	4.800	8.160	0.000	0.280
IRON WORKER		ALL		27.020	28.270	1.5	1.5	2.0	5.760	9.600	0.000	0.345
LABORER		BLD		24.400	24.850	1.5	1.5	2.0	5.550	9.450	0.000	0.800
LABORER		HWY		24.400	24.850	1.5	1.5	2.0	5.550	9.450	0.000	0.800
LABORER		O&C		17.740	18.190	1.5	1.5	2.0	5.450	8.450	0.000	0.800
MACHINIST		BLD		43.160	45.160	1.5	1.5	2.0	7.640	8.700	0.000	0.000
MARBLE FINISHERS		BLD		25.720	0.000	1.5	1.5	2.0	7.950	6.690	0.000	0.430
MARBLE MASON		BLD		27.220	28.720	1.5	1.5	2.0	7.950	6.690	0.000	0.430
MILLWRIGHT		BLD		30.490	31.990	1.5	1.5	2.0	6.050	5.750	0.000	0.350
MILLWRIGHT		HWY		30.440	31.940	1.5	1.5	2.0	6.050	5.750	0.000	0.350
OE RIVER 1		RIV 1		32.100	33.100	1.5	1.5	2.0	6.500	8.300	0.000	1.350
OE RIVER 2		RIV 2		28.750	33.100	1.5	1.5	2.0	6.500	8.300	0.000	1.350
OPERATING ENGINEER		ALL 1		32.100	33.100	1.5	1.5	2.0	6.500	8.300	0.000	1.350
OPERATING ENGINEER		ALL 2		30.200	33.100	1.5	1.5	2.0	6.500	8.300	0.000	1.350
OPERATING ENGINEER		ALL 3		24.150	33.100	1.5	1.5	2.0	6.500	8.300	0.000	1.350
OPERATING ENGINEER		ALL 4		21.400	27.800	1.5	1.5	2.0	5.650	6.100	0.000	1.100
OPERATING ENGINEER		O&C 1		24.080	25.080	1.5	1.5	2.0	6.500	8.300	0.000	1.350
OPERATING ENGINEER		O&C 2		22.650	25.080	1.5	1.5	2.0	6.500	8.300	0.000	1.350
OPERATING ENGINEER		O&C 3		18.120	25.080	1.5	1.5	2.0	6.500	8.300	0.000	1.350
OPERATING ENGINEER		O&C 4		16.050	21.100	1.5	1.5	2.0	5.650	6.100	0.000	1.100
PAINTER		BLD		26.260	27.760	1.5	1.5	2.0	6.130	6.950	0.000	0.450
PAINTER		HWY		30.560	32.060	1.5	1.5	2.0	6.130	6.950	0.000	0.450
PAINTER OVER 30FT		BLD		27.260	28.760	1.5	1.5	2.0	6.130	6.950	0.000	0.450
PAINTER PWR EQMT		BLD		27.260	28.760	1.5	1.5	2.0	6.130	6.950	0.000	0.450
PAINTER PWR EQMT		HWY		31.560	33.060	1.5	1.5	2.0	6.130	6.950	0.000	0.450
PILEDRIVER		BLD		30.490	31.990	1.5	1.5	2.0	6.050	5.750	0.000	0.350
PILEDRIVER		HWY		30.440	31.940	1.5	1.5	2.0	6.050	5.750	0.000	0.350
PIPEFITTER		BLD		32.250	35.470	1.5	1.5	2.0	8.250	8.850	0.000	1.200
PLASTERER		BLD		26.750	28.250	1.5	1.5	2.0	5.900	4.800	0.000	0.300
PLUMBER		BLD		32.250	35.470	1.5	1.5	2.0	8.250	8.850	0.000	1.200
ROOFER		BLD		22.250	23.250	1.5	1.5	2.0	7.900	3.800	0.000	0.000
SHEETMETAL WORKER		ALL		31.390	32.890	1.5	1.5	2.0	6.430	6.490	1.890	0.360
SPRINKLER FITTER		BLD		36.140	38.890	1.5	1.5	2.0	8.100	8.200	0.000	0.350
STONE MASON		BLD		27.220	28.720	1.5	1.5	2.0	7.950	6.690	0.000	0.430
TERRAZZO FINISHER		BLD		25.720	0.000	1.5	1.5	2.0	7.950	6.690	0.000	0.430
TERRAZZO MASON		BLD		28.500	28.800	1.5	1.5	2.0	6.400	5.700	0.000	0.430
TRUCK DRIVER		ALL 1		28.430	0.000	1.5	1.5	2.0	9.050	5.500	0.000	0.250
TRUCK DRIVER		ALL 2		28.850	0.000	1.5	1.5	2.0	9.050	5.500	0.000	0.250
TRUCK DRIVER		ALL 3		29.050	0.000	1.5	1.5	2.0	9.050	5.500	0.000	0.250
TRUCK DRIVER		ALL 4		29.320	0.000	1.5	1.5	2.0	9.050	5.500	0.000	0.250
TRUCK DRIVER		ALL 5		30.100	0.000	1.5	1.5	2.0	9.050	5.500	0.000	0.250
TRUCK DRIVER		O&C 1		22.750	0.000	1.5	1.5	2.0	2.920	6.700	0.000	0.250
TRUCK DRIVER		O&C 2		19.150	0.000	1.5	1.5	2.0	2.920	6.700	0.000	0.250
TRUCK DRIVER		O&C 3		19.650	0.000	1.5	1.5	2.0	2.920	6.700	0.000	0.250
TUCKPONTER		BLD		27.220	28.720	1.5	1.5	2.0	7.950	6.690	0.000	0.430

Legend:

M-F>8 (Overtime is required for any hour greater than 8 worked each day, Monday through Friday.)

OSA (Overtime is required for every hour worked on Saturday)

OSH (Overtime is required for every hour worked on Sunday and Holidays)

H/W (Health & Welfare Insurance)

Pensn (Pension)

Vac (Vacation)

Trng (Training)

Explanations

FRANKLIN COUNTY

The following list is considered as those days for which holiday rates of wages for work performed apply: New Years Day, Memorial Day, Fourth of July, Labor Day, Thanksgiving Day, Christmas Day and Veterans Day in some classifications/counties. Generally, any of these holidays which fall on a Sunday is celebrated on the following Monday. This then makes work performed on that Monday payable at the appropriate overtime rate for holiday pay. Common practice in a given local may alter certain days of celebration. If in doubt, please check with IDOL.

Oil and Chip Resealing (O&C) means the application of road oils and liquid asphalt to coat an existing road surface, followed by application of aggregate chips or gravel to coated surface, and subsequent rolling of material to seal the surface.

EXPLANATION OF CLASSES

ASBESTOS - GENERAL - removal of asbestos material/mold and hazardous materials from any place in a building, including mechanical systems where those mechanical systems are to be removed. This includes the removal of asbestos materials/mold and hazardous materials from ductwork or pipes in a building when the building is to be demolished at the time or at some close future date.

ASBESTOS - MECHANICAL - removal of asbestos material from mechanical systems, such as pipes, ducts, and boilers, where the mechanical systems are to remain.

CERAMIC TILE FINISHER, MARBLE FINISHER, TERRAZZO FINISHER

Assisting, helping or supporting the tile, marble and terrazzo mechanic by performing their historic and traditional work assignments required to complete the proper installation of the work covered by said crafts. The term "Ceramic" is used for naming the classification only, and is in no a limitation of the product handled. Ceramic takes into consideration most hard tiles.

LABORER - OIL AND CHIP RESEALING ONLY

Hook and unhook chip box from aggregate truck; distribute material within chip box; perform flagging work related to oil and chip resealing; hand spray oil fluids; handle traffic control, including setting-up and maintaining barricades, drums, cones, delineators, signs and other such items, as well as laying-out and applying or removing temporary roadway markings used to control traffic in job site related to oil and chip resealing; and perform clean-up related to oil and chip resealing.

ELECTRONIC SYSTEMS TECHNICIAN

Installation, service and maintenance of low-voltage systems which utilizes the transmission and/or transference of voice, sound, vision, or digital for commercial, education, security and entertainment purposes for the following: TV monitoring and surveillance, background/foreground music, intercom and telephone interconnect, field programming, inventory control systems, microwave transmission, multi-media, multiplex, radio page, school, intercom and sound burglar alarms and low voltage master clock systems.

Excluded from this classification are energy management systems, life safety systems, supervisory controls and data acquisition systems not intrinsic with the above listed systems, fire alarm systems, nurse call systems and raceways exceeding fifteen feet in length.

TRUCK DRIVER - BUILDING, HEAVY AND HIGHWAY CONSTRUCTION

Class 1. Drivers on 2 axle trucks hauling less than 9 ton. Air compressor and welding machines and brooms, including those pulled by separate units, truck driver helpers, warehouse employees, mechanic helpers, greasers and tiremen, pickup trucks when hauling materials, tools, or workers to and from and on-the-job site, and fork lifts up to 6,000 lb. capacity.

Class 2. Two or three axle trucks hauling more than 9 ton but hauling less than 16 ton. A-frame winch trucks, hydrolift trucks, vector trucks or similar equipment when used for transportation purposes. Fork lifts over 6,000 lb. capacity, winch trucks, four axle combination units, and ticket writers.

Class 3. Two, three or four axle trucks hauling 16 ton or more. Drivers on water pulls, articulated dump trucks, mechanics and working forepersons, and dispatchers. Five axle or more combination units.

Class 4. Low Boy and Oil Distributors.

Class 5. Drivers who require special protective clothing while employed on hazardous waste work.

TRUCK DRIVER - O & C - (Oil and Chip Resealing)

It involves driving of contractor or subcontractor owned, leased, or hired pickup, dump, service, or oil distributor trucks. Includes transporting materials and equipment (including, but not limited to oils, aggregate supplies, parts, machinery and tools) to or from the job site; distributing oil or liquid asphalt and aggregate; stock piling material; and maintaining trucks at job site related to oil and chip resealing.

Class 1. Distributors, liquid asphalt hauling and hauling of asphalt rubber-tired rollers.

Class 2. Stockpiling.

Class 3. Tandem hauling to job site.

OPERATING ENGINEERS - BUILDING, HEAVY AND HIGHWAY CONSTRUCTION

Class 1. APSCO or Equal Spreading Machine, Backhoe, Backfiller, Boom or Winch Cat, Bituminous Mixplane Machine, Blacksmith, Bituminous Surfacing Machine, Bull-Dozer, Crane, Shovel, Dragline, Truck Crane, Pile Driver, Concrete Breaker, Concrete or Pumpcrete Pumps, Dinky or Standard Locomotives, Well or Caisson Drills, Elevating Grader, Fork Lifts, Flexplane, Gradeall, Hi-Lift Hoists, Guy-Derricks, Hysters, Mechanic Motor Patrol, Mixers-21 cu. ft. or over, Push Cats, Pulls and Scrapers, Two Well Point Pumps, Pulverizer or Tiller, PugMill, Rubber-Tired Farm Type Tractor with Bulldozer/Blade/Auger or hi-lift over 1/2 yd., Jersey Spreader, Tract-Air used with Drill or Hi-Lift, Trenching or Ditching Machines, Wood Chipper w/Tractor, Self-Propelled Roller w/Blade, Equipment Greaser, Self-Propelled Bump Grinder on Concrete pavement, Boat Operator, Skid-Loaders, Tuggers, Lazer Screed, and Self-Propelled Chip Spreader (when others run conveyors).

Class 2. Any type tractor pulling any type roller or disc, Two Air Compressors (220 cu. ft. capacity or over), Two AirTract Drills, Air-Track Drill w/Compressor, Automatic Bins or Scales w/Compressor or Generator, Pipeline Boring Machine, Bulk Cement Plant w/Separate Compressor, Power Operated Bull Float, Hydra-Lift w/Single Motor, Straw Mulcher Blower w/Spout, Self-Propelled Roller/Compactor, Back-End man on Bituminous Surfacing Machine, oiler on milling machine.

Class 3. Air Compressor w/Valve driving piling, Boom or Winch Type Truck, Two Conveyors, Self-Propelled Concrete Saw, Form Grader, Truck Crane Oiler, Self-Propelled Vibrator, Rubber Tired Farm Type Tractor w/Blade/Bulldozer/Auger/hi-lift - 1/2 yd. or less, Elevator Operator, Man Lift (scissor lift) when lifting materials.

Class 4. Air-Track Drill (one), Belt Drag Machine, Power Broom, Mechanical Plasterer Applicator, Trac-Air, Air Compressor (220 cu. ft. or over) One, Air Compressor (under 220 cu. ft) four, Automatic Bin, Bulk Cement Plant w/Built-in Compressor running off same motor or electric motor, Fireman or Switchman, Self-Propelled Form Tamper, Light Plants (4), Welding Machines (4), Pumps (4), or Combination of four (4) Pumps, Light Plants, Welding Machines, Air-Compressors (under 220 cu. ft.), Mudjacks or Wood Chipper, Mixers - less than 21 cu. ft. Mortar Mixer w/Skip or Pump, Pipeline Tract Jack. One Operating Engineer may operate and maintain any combination of the following pieces of equipment, not to exceed four (4) which shall be within a reasonable distance, such combination may include any equipment in this classification: (Compressors, Light Plants, Generators, Welding Machines, Pumps or Conveyors), One Well- Point Pump, Two Motor Driven Heaters, One Air Compressor (under 220 cu. ft.), One Engine-Driven Conveyor, One Motor Driven Heater, One Light Plant, One Pump, One Welding Machine, One Ulmac or Equal Spreader, Oilers, and one Generator 10 kw or greater.

OPERATING ENGINEER - O & C (Oil and Chip Resealing ONLY.)

Includes the operation of all motorized heavy equipment used in oil and chip rsealing, including but not limited to operating self-propelled chip spreaders, and all types of rollers (both hard and rubber tired); and other duties pertaining to the operation or maintenance of heavy equipment related to oil and chip resealing.

Class 1. See Class 1 above for types of equipment operated.

Class 2. See Class 2 above for types of equipment operated.

Class 3. See Class 3 above for types of equipment operated.

Class 4. See Class 4 above for types of equipment operated.

OPERATING ENGINEER RIVER WORK 1 - operate the following machines when working on River Work and Levee Work on the Mississippi and Ohio Rivers, Lakes and Tributaries: Crane, Shovel, Drageline, Scrapers, Dredge, Derrick, Pile-Driver, Push Boat, all power boat operators, Mechanic, Engineman on Dredge, Leverman on Dredge, All Bituminous Spreader machines, Backhoe, Backfiller, Boom, or Winch Cat, Bituminous Mixplane Machine, Blacksmith, Bituminous Surfacing Machine, Bulldozer, Truck Cranes, Hydraulic Truck Mounted Boom/Crane, Concrete Finishing Machine, or Spreader Machine, Concrete Breaker, Concrete or Pumpcrete Machines, Concrete Plant Operator, All Off Road Material Hauling Equipment, Dinky or Standard Locomotives, Well Drill, Elevating Grader, Fork-Lifts, Flexplane, Gradeall, Hi-Lift, Power Handblade Tugger type Hoist, Hoist Two Drum (or over one), Gyderrick, Hyster, Motor Patrol, Mixers - 21 Cu. Ft. or over, Push Cat, Pulls, & Scrapers, Pumps-Two Well Points, Equipment Greaser, P & H Pulverizer or Pulverizer equal to Pugmill, Pugmill, Rubber-Tired farm type tractor w/Bulldozer/Blade/Auger or Hi-Lift over ½ yard, Skimmer Scoops, Seaman Tiller, Jersey Spreader, Tract-Air used with Drill or Hi-Lift, Trenching or Ditching Machine, Wood Chipper w/Tractor, self-propelled roller w/Blade, Concrete Pumps and Small Equipment Operators.

OPERATING ENGINEER RIVER 2 - when working on River Work and Levee Work on the Mississippi and Ohio Rivers, Lakes and Tributaries shall be employed as the Oiler or Fireman on Crane, Dragline, Shovel, Dredge, Truck Crane, Pile Driver, Gradeall, Dinky or Standard Locomotive, Guy Derrick, Trenching Machine or Ditching Machine 80 H.P. and over, All Terrain (cherry-picker) with over 40 ton Lifting Capacity, Deck Oiler and Deckhands.

Other Classifications of Work:

For definitions of classifications not otherwise set out, the Department generally has on file such definitions which are available. If a task to be performed is not subject to one of the classifications of pay set out, the Department will upon being contacted state which neighboring county has such a classification and provide such rate, such rate being deemed to exist by reference in this document. If no neighboring county rate applies to the task, the Department shall undertake a special determination, such special determination being then deemed to have existed under this determination. If a project requires these, or any classification not listed, please contact IDOL at 217-782-1710 for wage rates or clarifications.

LANDSCAPING

Landscaping work falls under the existing classifications for laborer, operating engineer and truck driver. The work performed by landscape plantsman and landscape laborer is covered by the existing classification of laborer. The work performed by landscape operators (regardless of equipment used or its size) is covered by the classifications of operating engineer. The work performed by landscape truck drivers (regardless of size of truck driven) is covered by the classifications of truck driver.