

**RETURN WITH BID**

State of \_\_\_\_\_ )  
 ) ss.  
County of \_\_\_\_\_ )

**AFFIDAVIT**

\_\_\_\_\_, of \_\_\_\_\_,  
*(name of affiant)* *(bidder)*

being first duly sworn upon oath, states as follows:

1. That I am the \_\_\_\_\_ of \_\_\_\_\_  
*(Officer or position)* *(Bidder)*  
and have personal knowledge of the facts herein stated.
2. That, if selected under this bid proposal, \_\_\_\_\_ will  
*(Bidder)*  
maintain a business office in the State of Illinois which will be located in \_\_\_\_\_  
County, Illinois.
3. That this business office will serve as the primary place of employment for any persons  
employed in the construction contemplated by this bid proposal.
4. That this Affidavit is given as a requirement of state law as provided in Section 30-22(8) of  
the Illinois Procurement Code.

\_\_\_\_\_  
*(Signature)*

\_\_\_\_\_  
*(Printed name of Affiant)*

This instrument was signed and attested before me on the \_\_\_\_\_ day of \_\_\_\_\_, 20 \_\_\_\_

by \_\_\_\_\_.  
*(Notary Public Name)*

\_\_\_\_\_  
*(Notary Public Signature)*

(NOTARY SEAL)

# **BID PROPOSAL INSTRUCTIONS**

**ABOUT IDOT PROPOSALS:** All proposals are potential bidding proposals. Each proposal contains all certifications and affidavits, a proposal signature sheet and a proposal bid bond.

## **PREQUALIFICATION**

Any contractor who desires to become pre-qualified to bid on work advertised by IDOT must submit the properly completed pre-qualification forms to the Bureau of Construction no later than 4:30 p.m. prevailing time twenty-one days prior to the letting of interest. This pre-qualification requirement applies to first time contractors, contractors renewing expired ratings, contractors maintaining continuous pre-qualification or contractors requesting revised ratings. To be eligible to bid, existing pre-qualification ratings must be effective through the date of letting.

## **WHO CAN BID ?**

Bids will be accepted from only those companies that request and receive written Authorization to Bid from IDOT's Central Bureau of Construction.

## **REQUESTS FOR AUTHORIZATION TO BID**

Contractors wanting to bid on items included in a particular letting must submit the properly completed "Request for Authorization to Bid/or Not For Bid Status" (BDE 124) and the ORIGINAL "Affidavit of Availability" (BC 57) to the proper office no later than 4:30 p.m. prevailing time, three (3) days prior to the letting date.

## **WHAT CONSTITUTES WRITTEN AUTHORIZATION TO BID?**

When a prospective prime bidder submits a "Request for Authorization to Bid/or Not For Bid Status"(BDE 124) he/she must indicate at that time which items are being requested For Bidding purposes. Only those items requested For Bidding will be analyzed. After the request has been analyzed, the bidder will be issued an **Authorization to Bid or Not for Bid Report**, approved by the Central Bureau of Construction and the Chief Procurement Officer that indicates which items have been approved For Bidding. If **Authorization to Bid** cannot be approved, the **Authorization to Bid or Not for Bid Report** will indicate the reason for denial.

## **ABOUT AUTHORIZATION TO BID**

Firms that have not received an Authorization to Bid or Not For Bid Report within a reasonable time of complete and correct original document submittal should contact the Department as to the status. Firms unsure as to authorization status should call the Prequalification Section of the Bureau of Construction at the number listed at the end of these instructions.

## **ADDENDA AND REVISIONS**

It is the bidder's responsibility to determine which, if any, addenda or revisions pertain to any project they may be bidding. Failure to incorporate all relevant addenda or revisions may cause the bid to be declared unacceptable.

Each addendum or revision will be included with the Electronic Plans and Proposals. Addenda and revisions will also be placed on the Addendum/Revision Checklist and each subscription service subscriber will be notified by e-mail of each addendum and revision issued.

The Internet is the Department's primary way of doing business. The subscription service emails are an added courtesy the Department provides. It is suggested that bidders check IDOT's website at <http://www.dot.il.gov/desenv/delett.html> before submitting final bid information.

***IDOT IS NOT RESPONSIBLE FOR ANY E-MAIL FAILURES.***

Addenda questions may be directed to the Contracts Office at (217)782-7806 or [DOT.D&Econtracts@illinois.gov](mailto:DOT.D&Econtracts@illinois.gov)

Technical questions about downloading these files may be directed to Tim Garman at (217)524-1642 or [Timothy.Garman@illinois.gov](mailto:Timothy.Garman@illinois.gov).

## **STANDARD GUIDELINES FOR SUBMITTING BIDS**

- All pages should be single sided.
- Use the Cover Page that is provided in the Bid Proposal (posted on the IDOT Web Site) as the first page of your submitted bid. It has the item number in large bold type in the upper left-hand corner and lines provided for your company name and address in the upper right-hand corner.
- Do not use report covers, presentation folders or special bindings and do not staple multiple times on left side like a book. Use only 1 staple in the upper left hand corner. Make sure all elements of your bid are stapled together including the bid bond or guaranty check (if required).
- Do not include any certificates of eligibility, your authorization to bid, Addendum Letters or affidavit of availability.
- Do not include the Subcontractor Documentation with your bid (pages i – iii and pages a – g). This documentation is required only if you are awarded the project.
- Use the envelope cover sheet (provided with the proposal) as the cover for the proposal envelope.
- Do not rely on overnight services to deliver your proposal prior to 10 AM on letting day. It will not be read if it is delivered after 10 AM.
- Do not submit your Substance Abuse Prevention Program (SAPP) with your bid. If you are awarded the contract this form is to be submitted to the district engineer at the pre-construction conference.

## **BID SUBMITTAL CHECKLIST**

- Cover page** (the sheet that has the item number on it) – This should be the first page of your bid proposal, **followed by your bid (the Schedule of Prices/Pay Items)**. If you are using special software or CBID to generate your schedule of prices, do not include the blank pages of the schedule of prices that came with the proposal package.
- Page 4 (Item 9)** – Check “YES” if you will use a subcontractor(s) with an annual value over \$50,000. Include the subcontractor(s) name, address, general type of work to be performed and the dollar amount. If you will use subcontractor(s) but are uncertain who or the dollar amount; check “YES” but leave the lines blank.
- After page 4** – Insert the following documents: The **Illinois Office Affidavit** (Not applicable to federally funded projects) followed by Cost Adjustments for Steel, Bituminous and Fuel (if applicable) and the Contractor Letter of Assent (if applicable). The general rule should be, if you don’t know where it goes, put it after page 4.
- Page 10 (Paragraph J)** – Check “YES” or “NO” whether your company has any business in Iran.
- Page 10 (Paragraph K)** – (Not applicable to federally funded projects) List the name of the apprenticeship and training program sponsor holding the certificate of registration from the US Department of Labor. If no applicable program exists, please indicate the work/job category **Your bid will not be read if this is not completed.** Do not include certificates with your bid. Keep the certificates in your office in case they are requested by IDOT.
- Page 11 (Paragraph L)** – A copy of your State Board of Elections certificate of registration is no longer required with your bid.
- Page 11 (Paragraph M)** – Indicate if your company has hired a lobbyist in connection with the job for which you are submitting the bid proposal.
- Page 12 (Paragraph C)** – This is a work sheet to determine if a completed Form A is required. It is not part of the form and you do not need to make copies for each completed Form A.
- Pages 14-17 (Form A)** – One Form A (4 pages) is required for each applicable person in your company. Copies of the forms can be used and only need to be changed when the information changes. The certification signature and date must be original for each letting. **Do not staple the forms together.** If you answered “NO” to all of the questions in Paragraph C (page 12), complete the first section (page 14) with your company information and then sign and date the Not Applicable statement on page 17.
- Page 18 (Form B)** - If you check “YES” to having other current or pending contracts it is acceptable to use the phrase, “See Affidavit of Availability on file”. **Ownership Certification** (at the bottom of the page) - Check N/A if the Form A(s) you submitted accounts for 100 percent of the company ownership. Check YES if any percentage of ownership falls outside of the parameters that require reporting on the Form A. Checking NO indicates that the Form A(s) you submitted is not correct and you will be required to submit a revised Form A.
- Page 20 (Workforce Projection)** – Be sure to include the Duration of the Project. It is acceptable to use the phrase “Per Contract Specifications”.

**Proposal Bid Bond** – (Insert after the proposal signature page) Submit your proposal Proposal Bid Bond (if applicable) using the current Proposal Bid Bond form provided in the proposal package. The Power of Attorney page should be stapled to the Proposal Bid Bond. If you are using an electronic bond, include your bid bond number on the Proposal Bid Bond and attach the Proof of Insurance printed from the Surety’s Web Site.

**Disadvantaged Business Utilization Plan and/or Good Faith Effort** – The last items in your bid should be the DBE Utilization Plan (SBE 2026), followed by the DBE Participation Statement (SBE 2025) and supporting paperwork. If you have documentation of a Good Faith Effort, it is to follow the SBE Forms.

**The Bid Letting is now available in streaming Audio/Video from the IDOT Web Site.** A link to the stream will be placed on the main page of the current letting on the day of the Letting. The stream will not begin until 10 AM. The actual reading of the bids does not begin until approximately 10:30 AM.

Following the Letting, the As-Read Tabulation of Bids will be posted by the end of the day. You will find the link on the main Web page for the current letting.

**QUESTIONS: pre-letting up to execution of the contract**

Contractor pre-qualification ..... 217-782-3413  
Small Business, Disadvantaged Business Enterprise (DBE) ..... 217-785-4611  
Contracts, Bids, Letting process or Internet downloads ..... 217-782-7806  
Estimates Unit..... 217-785-3483  
Aeronautics..... 217-785-8515  
IDNR (Land Reclamation, Water Resources, Natural Resources)..... 217-782-6302

**QUESTIONS: following contract execution**

Subcontractor documentation, payments ..... 217-782-3413  
Railroad Insurance ..... 217-785-0275

# 253

RETURN WITH BID

Proposal Submitted By
Name
Address
City

Letting June 13, 2014

**NOTICE TO PROSPECTIVE BIDDERS**

This proposal can be used for bidding purposes by only those companies that request and receive written AUTHORIZATION TO BID from IDOT's Central Bureau of Construction.

**BIDDERS NEED NOT RETURN THE ENTIRE PROPOSAL**

# Notice to Bidders, Specifications, Proposal, Contract and Contract Bond



**Illinois Department  
of Transportation**

Springfield, Illinois 62764

**Contract No. 76G23  
Various Counties  
Section DIST 8 GUARDRAIL 2015-1  
Various Routes  
District 8 Construction Funds**

PLEASE MARK THE APPROPRIATE BOX BELOW:

- A Bid Bond is included.
- A Cashier's Check or a Certified Check is included.
- An Annual Bid Bond is included or is on file with IDOT.

Plans Included  
Herein

Prepared by

S

Checked by

(Printed by authority of the State of Illinois)

**Page intentionally left blank**

RETURN WITH BID



PROPOSAL

TO THE DEPARTMENT OF TRANSPORTATION

1. Proposal of \_\_\_\_\_

\_\_\_\_\_

Taxpayer Identification Number (Mandatory) \_\_\_\_\_ a

For the improvement identified and advertised for bids in the Invitation for Bids as:

**Contract No. 76G23  
Various Counties  
Section DIST 8 GUARDRAIL 2015-1  
Various Routes  
District 8 Construction Funds**

**This project consists of repairing or replacing existing damaged steel plate beam guardrail, traffic barrier terminals, impact attenuators and median cable throughout District 8 on a work order basis.**

2. The undersigned bidder will furnish all labor, material and equipment to complete the above described project in a good and workmanlike manner as provided in the contract documents provided by the Department of Transportation. This proposal will become part of the contract and the terms and conditions contained in the contract documents will govern performance and payments.





**RETURN WITH BID**

6. **COMBINATION BIDS.** The undersigned bidder further agrees that if awarded the contract for the sections contained in the following combination, he/she will perform the work in accordance with the requirements of each individual contract comprising the combination bid specified in the schedule below, and that the combination bid shall be prorated against each section in proportion to the bid submitted for the same. If an error is found to exist in the gross sum bid for one or more of the individual sections included in a combination, the combination bid shall be corrected as provided in the specifications.

**When a combination bid is submitted, the schedule below must be completed in each proposal comprising the combination.**

**If alternate bids are submitted for one or more of the sections comprising the combination, a combination bid must be submitted for each alternate.**

**Schedule of Combination Bids**

Combination No.	Sections Included in Combination	Combination Bid	
		Dollars	Cents

7. **SCHEDULE OF PRICES.** The undersigned bidder submits herewith, in accordance with the rules and instructions, a schedule of prices for the items of work for which bids are sought. The unit prices bid are in U.S. dollars and cents, and all extensions and summations have been made. The bidder understands that the quantities appearing in the bid schedule are approximate and are provided for the purpose of obtaining a gross sum for the comparison of bids. If there is an error in the extension of the unit prices, the unit prices will govern. Payment to the contractor awarded the contract will be made only for actual quantities of work performed and accepted or materials furnished according to the contract. The scheduled quantities of work to be done and materials to be furnished may be increased, decreased or omitted as provided elsewhere in the contract.
8. **AUTHORITY TO DO BUSINESS IN ILLINOIS.** Section 20-43 of the Illinois Procurement Code (the Code) (30 ILCS 500/20-43) provides that a person (other than an individual acting as a sole proprietor) must be a legal entity authorized to do business in the State of Illinois prior to submitting the bid.
9. **EXECUTION OF CONTRACT:** The Department of Transportation will, in accordance with the rules governing Department procurements, execute the contract and shall be the sole entity having the authority to accept performance and make payments under the contract. Execution of the contract by the Chief Procurement Officer (CPO) or the State Purchasing Officer (SPO) is for approval of the procurement process and execution of the contract by the Department. Neither the CPO nor the SPO shall be responsible for administration of the contract or determinations respecting performance or payment there under except as otherwise permitted in the Code.

10. **The services of a subcontractor will be used.**

Check box Yes   
 Check box No

For known subcontractors with subcontracts with an annual value of more than \$50,000, the contract shall include their name, address, general type of work to be performed, and the dollar allocation for each subcontractor.  
 (30 ILCS 500/20-120)

---



---

ILLINOIS DEPARTMENT OF TRANSPORTATION  
 SCHEDULE OF PRICES  
 CONTRACT  
 NUMBER - 76G23

State Job # - C-98-024-13

Project Number

Route

County Name - VARIOUS-

VARIOUS

Code - 0 - -

District - 0 - -

Section Number - DIST 8 GUARDRAIL 2015-1

Item Number	Pay Item Description	Unit of Measure	Quantity	x	Unit Price	=	Total Price
X0325972	CABLE GUARD POST	EACH	100.000				
X0326466	HT CABLE POST REPAIR	EACH	30.000				
X0326468	MEDIAN CABLE	FOOT	200.000				
X6300210	GUARDRAIL BLOCKS	EACH	400.000				
X6300215	RAIL ELEMENT PLATES	EACH	200.000				
X6300217	RAIL ELEM PLATE RAD	EACH	25.000				
X6300220	EXTRUDER HEAD	EACH	10.000				
X6300225	SINGLE END SECTION	EACH	2.000				
X6300231	STEEL POST ATTACH STR	EACH	3.000				
X6300236	STEEL POSTS 6'	EACH	300.000				
X6300239	STEEL POSTS 9'	EACH	100.000				
X6331110	STEEL POSTS SPECIAL	EACH	10.000				
X6430210	REM REIN IMP ATTEN	EACH	20.000				
X7010410	SPEED DISPLAY TRAILER	CAL MO	1.000				
X7011834	TC-PROT CALL OUT WORK	EACH	176.000				

ILLINOIS DEPARTMENT OF TRANSPORTATION  
 SCHEDULE OF PRICES  
 CONTRACT  
 NUMBER -

State Job # - C-98-024-13

76G23

Project Number

Route

County Name - VARIOUS-

VARIOUS

Code - 0 - -

District - 0 - -

Section Number - DIST 8 GUARDRAIL 2015-1

Item Number	Pay Item Description	Unit of Measure	Quantity	x	Unit Price	=	Total Price
X7011836	TC-PROT XPWY CALL OUT	EACH	175.000				
X8030110	LOC UNDERGR CABLE SPL	EACH	5.000				
Z0029655	HT CBL ROAD GUARDPOST	EACH	200.000				
Z0029657	HTC SYSTEM MAINTENANCE	EACH	10.000				
Z0029658	REP TB TERM T1 SP PST	EACH	14.000				
Z0029662	REPL HT CBL POST FDN	EACH	5.000				
Z0052410	REPAIR TRBT T1 SP TAN	EACH	44.000				
Z0052415	REPAIR TRBT T1 SP FLR	EACH	10.000				
Z0052600	REPAIR TR BAR TERM T2	EACH	5.000				
Z0052800	REPAIR TR BAR TERM 3A	EACH	5.000				
Z0053000	REPAIR TR BAR TERM T5	EACH	2.000				
Z0053200	REPAIR TR BAR TERM T6	EACH	5.000				
Z0059660	REP TB TERM T1 SP RLP	EACH	7.000				
63000350	LSG OV CUL 12'6" SPAN	FOOT	162.500				
63100045	TRAF BAR TERM T2	EACH	4.000				

ILLINOIS DEPARTMENT OF TRANSPORTATION  
 SCHEDULE OF PRICES  
 CONTRACT  
 NUMBER - 76G23

State Job # - C-98-024-13

Project Number

Route

County Name - VARIOUS-

VARIOUS

Code - 0 - -

District - 0 - -

Section Number - DIST 8 GUARDRAIL 2015-1

Item Number	Pay Item Description	Unit of Measure	Quantity	x	Unit Price	=	Total Price
63100070	TRAF BAR TERM T5	EACH	4.000				
63100085	TRAF BAR TERM T6	EACH	8.000				
63100167	TR BAR TRM T1 SPL TAN	EACH	65.000				
63100169	TR BAR TRM T1 SPL FLR	EACH	5.000				
64300260	IMP ATTEN FRD NAR TL3	EACH	3.000				
64300370	IMP ATTEN FRD WID TL3	EACH	3.000				
67100100	MOBILIZATION	L SUM	1.000				

**CONTRACT NUMBER**

**76G23**

**THIS IS THE TOTAL BID**

**\$ \_\_\_\_\_**

**NOTES:**

1. Each PAY ITEM should have a UNIT PRICE and a TOTAL PRICE.
2. The UNIT PRICE shall govern if no TOTAL PRICE is shown or if there is a discrepancy between the product of the UNIT PRICE multiplied by the QUANTITY.
3. If a UNIT PRICE is omitted, the TOTAL PRICE will be divided by the QUANTITY in order to establish a UNIT PRICE.
4. A bid may be declared UNACCEPTABLE if neither a unit price nor a total price is shown.

## RETURN WITH BID

### **STATE REQUIRED ETHICAL STANDARDS GOVERNING CONTRACT PROCUREMENT: ASSURANCES, CERTIFICATIONS AND DISCLOSURES**

#### I. GENERAL

A. Article 50 of the Code establishes the duty of all State CPOs, SPOs, and their designees to maximize the value of the expenditure of public moneys in procuring goods, services, and contracts for the State of Illinois and to act in a manner that maintains the integrity and public trust of State government. In discharging this duty, they are charged by law to use all available information, reasonable efforts, and reasonable actions to protect, safeguard, and maintain the procurement process of the State of Illinois.

B. In order to comply with the provisions of Article 50 and to carry out the duty established therein, all bidders are to adhere to ethical standards established for the procurement process, and to make such assurances, disclosures and certifications required by law. Except as otherwise required in subsection III, paragraphs J-M, by execution of the Proposal Signature Sheet, the bidder indicates that each of the mandated assurances have been read and understood, that each certification is made and understood, and that each disclosure requirement has been understood and completed.

C. In addition to all other remedies provided by law, failure to comply with any assurance, failure to make any disclosure or the making of a false certification shall be grounds for the CPO to void the contract, and may result in the suspension or debarment of the bidder or subcontractor. If a false certification is made by a subcontractor the contractor's submitted bid and the executed contract may not be declared void unless the contractor refuses to terminate the subcontract upon the State's request after a finding that the subcontractor's certification was false.

I acknowledge, understand and accept these terms and conditions.

#### II. ASSURANCES

The assurances hereinafter made by the bidder are each a material representation of fact upon which reliance is placed should the Department enter into the contract with the bidder.

##### A. Conflicts of Interest

Section 50-13. Conflicts of Interest.

(a) Prohibition. It is unlawful for any person holding an elective office in this State, holding a seat in the General Assembly, or appointed to or employed in any of the offices or agencies of state government and who receives compensation for such employment in excess of 60% of the salary of the Governor of the State of Illinois, or who is an officer or employee of the Capital Development Board or the Illinois State Toll Highway Authority, or who is the spouse or minor child of any such person to have or acquire any contract, or any direct pecuniary interest in any contract therein, whether for stationery, printing, paper, or any services, materials, or supplies, that will be wholly or partially satisfied by the payment of funds appropriated by the General Assembly of the State of Illinois or in any contract of the Capital Development Board or the Illinois State Toll Highway Authority.

(b) Interests. It is unlawful for any firm, partnership, association or corporation, in which any person listed in subsection (a) is entitled to receive (i) more than 7 1/2% of the total distributable income or (ii) an amount in excess of the salary of the Governor, to have or acquire any such contract or direct pecuniary interest therein.

(c) Combined interests. It is unlawful for any firm, partnership, association, or corporation, in which any person listed in subsection (a) together with his or her spouse or minor children is entitled to receive (i) more than 15%, in the aggregate, of the total distributable income or (ii) an amount in excess of 2 times the salary of the Governor, to have or acquire any such contract or direct pecuniary interest therein.

(d) Securities. Nothing in this Section invalidates the provisions of any bond or other security previously offered or to be offered for sale or sold by or for the State of Illinois.

(e) Prior interests. This Section does not affect the validity of any contract made between the State and an officer or employee of the State or member of the General Assembly, his or her spouse, minor child or any combination of those persons if that contract was in existence before his or her election or employment as an officer, member, or employee. The contract is voidable, however, if it cannot be completed within 365 days after the officer, member, or employee takes office or is employed.

The current salary of the Governor is \$177,412.00. Sixty percent of the salary is \$106,447.20.

## RETURN WITH BID

The bidder assures the Department that the award and execution of the contract would not cause a violation of Section 50-13, or that an effective exemption has been issued by the Board of Ethics to any individual subject to the Section 50-13 prohibitions pursuant to the provisions of Section 50-20 of the Code. Information concerning the exemption process is available from the Department upon request.

### **B. Negotiations**

Section 50-15. Negotiations.

It is unlawful for any person employed in or on a continual contractual relationship with any of the offices or agencies of State government to participate in contract negotiations on behalf of that office or agency with any firm, partnership, association, or corporation with whom that person has a contract for future employment or is negotiating concerning possible future employment.

The bidder assures the Department that the award and execution of the contract would not cause a violation of Section 50-15, and that the bidder has no knowledge of any facts relevant to the kinds of acts prohibited therein.

### **C. Inducements**

Section 50-25. Inducement.

Any person who offers or pays any money or other valuable thing to any person to induce him or her not to bid for a State contract or as recompense for not having bid on a State contract is guilty of a Class 4 felony. Any person who accepts any money or other valuable thing for not bidding for a State contract or who withholds a bid in consideration of the promise for the payment of money or other valuable thing is guilty of a Class 4 felony.

The bidder assures the Department that the award and execution of the contract would not cause a violation of Section 50-25, and that the bidder has no knowledge of any facts relevant to the kinds of acts prohibited therein.

### **D. Revolving Door Prohibition**

Section 50-30. Revolving door prohibition.

CPOs, SPOs, procurement compliance monitors, their designees whose principal duties are directly related to State procurement, and executive officers confirmed by the Senate are expressly prohibited for a period of 2 years after terminating an affected position from engaging in any procurement activity relating to the State agency most recently employing them in an affected position for a period of at least 6 months. The prohibition includes, but is not limited to: lobbying the procurement process; specifying; bidding; proposing bid, proposal, or contract documents; on their own behalf or on behalf of any firm, partnership, association, or corporation. This Section applies only to persons who terminate an affected position on or after January 15, 1999.

The bidder assures the Department that the award and execution of the contract would not cause a violation of Section 50-30, and that the bidder has no knowledge of any facts relevant to the kinds of acts prohibited therein.

### **E. Reporting Anticompetitive Practices**

Section 50-40. Reporting anticompetitive practices.

When, for any reason, any vendor, bidder, contractor, CPO, SPO, designee, elected official, or State employee suspects collusion or other anticompetitive practice among any bidders, offerors, contractors, proposers, or employees of the State, a notice of the relevant facts shall be transmitted to the Attorney General and the CPO.

The bidder assures the Department that it has not failed to report any relevant facts concerning the practices addressed in Section 50-40 which may involve the contract for which the bid is submitted.

### **F. Confidentiality**

Section 50-45. Confidentiality.

Any CPO, SPO, designee, or executive officer who willfully uses or allows the use of specifications, competitive bid documents, proprietary competitive information, proposals, contracts, or selection information to compromise the fairness or integrity of the procurement, bidding, or contract process shall be subject to immediate dismissal, regardless of the Personnel code, any contract, or any collective bargaining agreement, and may in addition be subject to criminal prosecution.

The bidder assures the Department that it has no knowledge of any fact relevant to the practices addressed in Section 50-45 which may involve the contract for which the bid is submitted.

## RETURN WITH BID

### G. Insider Information

Section 50-50. Insider information.

It is unlawful for any current or former elected or appointed State official or State employee to knowingly use confidential information available only by virtue of that office or employment for actual or anticipated gain for themselves or another person.

The bidder assures the Department that it has no knowledge of any facts relevant to the practices addressed in Section 50-50 which may involve the contract for which the bid is submitted.

I acknowledge, understand and accept these terms and conditions for the above assurances.

### III. CERTIFICATIONS

The certifications hereinafter made by the bidder are each a material representation of fact upon which reliance is placed should the Department enter into the contract with the bidder. Section 50-2 of the Code provides that every person that has entered into a multi-year contract and every subcontractor with a multi-year subcontract shall certify, by July 1 of each fiscal year covered by the contract after the initial fiscal year, to the responsible CPO whether it continues to satisfy the requirements of Article 50 pertaining to the eligibility for a contract award. If a contractor or subcontractor is not able to truthfully certify that it continues to meet all requirements, it shall provide with its certification a detailed explanation of the circumstances leading to the change in certification status. A contractor or subcontractor that makes a false statement material to any given certification required under Article 50 is, in addition to any other penalties or consequences prescribed by law, subject to liability under the Whistleblower Reward and Protection Act for submission of a false claim.

#### A. Bribery

Section 50-5. Bribery.

(a) Prohibition. No person or business shall be awarded a contract or subcontract under this Code who:

(1) has been convicted under the laws of Illinois or any other state of bribery or attempting to bribe an officer or employee of the State of Illinois or any other state in that officer's or employee's official capacity; or

(2) has made an admission of guilt of that conduct that is a matter of record but has not been prosecuted for that conduct.

(b) Businesses. No business shall be barred from contracting with any unit of State or local government, or subcontracting under such a contract, as a result of a conviction under this Section of any employee or agent of the business if the employee or agent is no longer employed by the business and:

(1) the business has been finally adjudicated not guilty; or

(2) the business demonstrates to the governmental entity with which it seeks to contract, or which is signatory to the contract which the subcontract relates, and that entity finds that the commission of the offense was not authorized, requested, commanded, or performed by a director, officer, or high managerial agent on behalf of the business as provided in paragraph (2) of subsection (a) of Section 5-4 of the Criminal Code of 2012.

(c) Conduct on behalf of business. For purposes of this Section, when an official, agent, or employee of a business committed the bribery or attempted bribery on behalf of the business and in accordance with the direction or authorization of a responsible official of the business, the business shall be chargeable with the conduct.

(d) Certification. Every bid submitted to and contract executed by the State, and every subcontract subject to Section 20-120 of the Code shall contain a certification by the contractor or the subcontractor, respectively, that the contractor or subcontractor is not barred from being awarded a contract or subcontract under this Section and acknowledges that the CPO may declare the related contract void if any certifications required by this Section are false. A contractor who makes a false statement, material to the certification, commits a Class 3 felony.

The contractor or subcontractor certifies that it is not barred from being awarded a contract under Section 50.5.

#### B. Felons

Section 50-10. Felons.

(a) Unless otherwise provided, no person or business convicted of a felony shall do business with the State of Illinois or any State agency, or enter into a subcontract, from the date of conviction until 5 years after the date of completion of the sentence for that felony, unless no person held responsible by a prosecutorial office for the facts upon which the conviction was based continues to have any involvement with the business.

(b) Certification. Every bid submitted to and contract executed by the State and every subcontract subject to Section 20-120 of the Code shall contain a certification by the bidder or contractor or subcontractor, respectively, that the bidder, contractor, or subcontractor is not barred from being awarded a contract or subcontract under this Section and acknowledges that the CPO may declare the related contract void if any of the certifications required by this Section are false.



## RETURN WITH BID

### **C. Debt Delinquency**

Section 50-11 and 50-12. Debt Delinquency.

The contractor or bidder or subcontractor, respectively, certifies that it, or any affiliate, is not barred from being awarded a contract or subcontract under the Code. Section 50-11 prohibits a person from entering into a contract with a State agency, or entering into a subcontract, if it knows or should know that it, or any affiliate, is delinquent in the payment of any debt to the State as defined by the Debt Collection Board. Section 50-12 prohibits a person from entering into a contract with a State agency, or entering into a subcontract, if it, or any affiliate, has failed to collect and remit Illinois Use Tax on all sales of tangible personal property into the State of Illinois in accordance with the provisions of the Illinois Use Tax Act. The bidder or contractor or subcontractor, respectively, further acknowledges that the CPO may declare the related contract void if this certification is false or if the bidder, contractor, or subcontractor, or any affiliate, is determined to be delinquent in the payment of any debt to the State during the term of the contract.

### **D. Prohibited Bidders, Contractors and Subcontractors**

Section 50-10.5 and 50-60(c). Prohibited bidders, contractors and subcontractors.

The bidder or contractor or subcontractor, respectively, certifies in accordance with 30 ILCS 500/50-10.5 that no officer, director, partner or other managerial agent of the contracting business has been convicted of a felony under the Sarbanes-Oxley Act of 2002 or a Class 3 or Class 2 felony under the Illinois Securities Law of 1953 or if in violation of Subsection (c) for a period of five years from the date of conviction. Every bid submitted to and contract executed by the State and every subcontract subject to Section 20-120 of the Code shall contain a certification by the bidder, contractor, or subcontractor, respectively, that the bidder, contractor, or subcontractor is not barred from being awarded a contract or subcontract under this Section and acknowledges that the CPO shall declare the related contract void if any of the certifications completed pursuant to this Section are false.

### **E. Section 42 of the Environmental Protection Act**

The bidder or contractor or subcontractor, respectively, certifies in accordance with 30 ILCS 500/50-14 that the bidder, contractor, or subcontractor, is not barred from being awarded a contract or entering into a subcontract under this Section which prohibits the bidding on or entering into contracts with the State of Illinois or a State agency, or entering into any subcontract, that is subject to the Code by a person or business found by a court or the Pollution Control Board to have committed a willful or knowing violation of Section 42 of the Environmental Protection Act for a period of five years from the date of the order. The bidder or contractor or subcontractor, respectively, acknowledges that the CPO may declare the contract void if this certification is false.

### **F. Educational Loan**

Section 3 of the Educational Loan Default Act provides no State agency shall contract with an individual for goods or services if that individual is in default, as defined in Section 2 of this Act, on an educational loan. Any contract used by any State agency shall include a statement certifying that the individual is not in default on an educational loan as provided in this Section.

The bidder, if an individual as opposed to a corporation, partnership or other form of business organization, certifies that the bidder is not in default on an educational loan as provided in Section 3 of the Act.

### **G. Bid-Rigging/Bid Rotating**

Section 33E-11 of the Criminal Code of 2012 provides:

(a) Every bid submitted to and public contract executed pursuant to such bid by the State or a unit of local government shall contain a certification by the prime contractor that the prime contractor is not barred from contracting with any unit of State or local government as a result of a violation of either Section 33E-3 or 33E-4 of this Article

(b) A contractor who makes a false statement, material to the certification, commits a Class 3 felony.

A violation of Section 33E-3 would be represented by a conviction of the crime of bid-rigging which, in addition to Class 3 felony sentencing, provides that any person convicted of this offense or any similar offense of any state or the United States which contains the same elements as this offense shall be barred for 5 years from the date of conviction from contracting with any unit of State or local government. No corporation shall be barred from contracting with any unit of State or local government as a result of a conviction under this Section of any employee or agent of such corporation if the employee so convicted is no longer employed by the corporation and: (1) it has been finally adjudicated not guilty or (2) if it demonstrates to the governmental entity with which it seeks to contract and that entity finds that the commission of the offense was neither authorized, requested, commanded, nor performed by a director, officer or a high managerial agent in behalf of the corporation.

## RETURN WITH BID

A violation of Section 33E-4 would be represented by a conviction of the crime of bid-rotating which, in addition to Class 2 felony sentencing, provides that any person convicted of this offense or any similar offense of any state or the United States which contains the same elements as this offense shall be permanently barred from contracting with any unit of State or local government. No corporation shall be barred from contracting with any unit of State or local government as a result of a conviction under this Section of any employee or agent of such corporation if the employee so convicted is no longer employed by the corporation and: (1) it has been finally adjudicated not guilty or (2) if it demonstrates to the governmental entity with which it seeks to contract and that entity finds that the commission of the offense was neither authorized, requested, commanded, nor performed by a director, officer or a high managerial agent in behalf of the corporation.

The bidder certifies that it is not barred from contracting with the Department by reason of a violation of either Section 33E-3 or Section 33E-4.

### **H. International Anti-Boycott**

Section 5 of the International Anti-Boycott Certification Act provides every contract entered into by the State of Illinois for the manufacture, furnishing, or purchasing of supplies, material, or equipment or for the furnishing of work, labor, or services, in an amount exceeding the threshold for small purchases according to the purchasing laws of this State or \$10,000.00, whichever is less, shall contain certification, as a material condition of the contract, by which the contractor agrees that neither the contractor nor any substantially-owned affiliated company is participating or shall participate in an international boycott in violation of the provisions of the U.S. Export Administration Act of 1979 or the regulations of the U.S. Department of Commerce promulgated under that Act.

The bidder makes the certification set forth in Section 5 of the Act.

### **I. Drug Free Workplace**

The Illinois "Drug Free Workplace Act" applies to this contract and it is necessary to comply with the provisions of the "Act" if the contractor is a corporation, partnership, or other entity (including a sole proprietorship) which has 25 or more employees.

The bidder certifies that if awarded a contract in excess of \$5,000 it will provide a drug free workplace in compliance with the provisions of the Act.

### **J. Disclosure of Business Operations in Iran**

Section 50-36 of the Code, 30ILCS 500/50-36 provides that each bid, offer, or proposal submitted for a State contract shall include a disclosure of whether or not the Company acting as the bidder, offeror, or proposing entity, or any of its corporate parents or subsidiaries, within the 24 months before submission of the bid, offer, or proposal had business operations that involved contracts with or provision of supplies or services to the Government of Iran, companies in which the Government of Iran has any direct or indirect equity share, consortiums or projects commissioned by the Government of Iran, or companies involved in consortiums or projects commissioned by the Government of Iran and either of the following conditions apply:

- (1) More than 10% of the Company's revenues produced in or assets located in Iran involve oil-related activities or mineral-extraction activities; less than 75% of the Company's revenues produced in or assets located in Iran involve contracts with or provision of oil-related or mineral-extraction products or services to the Government of Iran or a project or consortium created exclusively by that government; and the Company has failed to take substantial action.
- (2) The Company has, on or after August 5, 1996, made an investment of \$20 million or more, or any combination of investments of at least \$10 million each that in the aggregate equals or exceeds \$20 million in any 12-month period, which directly or significantly contributes to the enhancement of Iran's ability to develop petroleum resources of Iran.

The terms "Business operations", "Company", "Mineral-extraction activities", "Oil-related activities", "Petroleum resources", and "Substantial action" are all defined in the Code.

Failure to make the disclosure required by the Code shall cause the bid, offer or proposal to be considered not responsive. The disclosure will be considered when evaluating the bid or awarding the contract. The name of each Company disclosed as doing business or having done business in Iran will be provided to the State Comptroller.

Check the appropriate statement:

Company has no business operations in Iran to disclose.

Company has business operations in Iran as disclosed the attached document.

## RETURN WITH BID

### **K. Apprenticeship and Training Certification (Does not apply to federal aid projects)**

In accordance with the provisions of Section 30-22 (6) of the Code, the bidder certifies that it is a participant, either as an individual or as part of a group program, in the approved apprenticeship and training programs applicable to each type of work or craft that the bidder will perform with its own forces. The bidder further certifies for work that will be performed by subcontract that each of its subcontractors submitted for approval either (a) is, at the time of such bid, participating in an approved, applicable apprenticeship and training program; or (b) will, prior to commencement of performance of work pursuant to this contract, begin participation in an approved apprenticeship and training program applicable to the work of the subcontract. The Department, at any time before or after award, may require the production of a copy of each applicable Certificate of Registration issued by the United States Department of Labor evidencing such participation by the contractor and any or all of its subcontractors. Applicable apprenticeship and training programs are those that have been approved and registered with the United States Department of Labor. The bidder shall list in the space below, the official name of the program sponsor holding the Certificate of Registration for all of the types of work or crafts in which the bidder is a participant and that will be performed with the bidder's forces. Types of work or craft work that will be subcontracted shall be included and listed as subcontract work. The list shall also indicate any type of work or craft job category that does not have an applicable apprenticeship or training program. **The bidder is responsible for making a complete report and shall make certain that each type of work or craft job category that will be utilized on the project as reported on the Construction Employee Workforce Projection (Form BC-1256) and returned with the bid is accounted for and listed.**

---

---

---

The requirements of this certification and disclosure are a material part of the contract, and the contractor shall require this certification provision to be included in all approved subcontracts. In order to fulfill this requirement, it shall not be necessary that an applicable program sponsor be currently taking or that it will take applications for apprenticeship, training or employment during the performance of the work of this contract.

**TO BE RETURNED WITH BID**

**L. Political Contributions and Registration with the State Board of Elections**

Sections 20-160 and 50-37 of the Code regulate political contributions from business entities and any affiliated entities or affiliated persons bidding on or contracting with the state. Generally under Section 50-37, any business entity, and any affiliated entity or affiliated person of the business entity, whose current year contracts with all state agencies exceed an awarded value of \$50,000, are prohibited from making any contributions to any political committees established to promote the candidacy of the officeholder responsible for the awarding of the contracts or any other declared candidate for that office for the duration of the term of office of the incumbent officeholder or a period 2 years after the termination of the contract, whichever is longer. Any business entity and affiliated entities or affiliated persons whose state contracts in the current year do not exceed an awarded value of \$50,000, but whose aggregate pending bids and proposals on state contracts exceed \$50,000, either alone or in combination with contracts not exceeding \$50,000, are prohibited from making any political contributions to any political committee established to promote the candidacy of the officeholder responsible for awarding the pending contract during the period beginning on the date the invitation for bids or request for proposals is issued and ending on the day after the date of award or selection if the entity was not awarded or selected. Section 20-160 requires certification of registration of affected business entities in accordance with procedures found in Section 9-35 of The Election Code.

By submission of a bid, the contractor business entity acknowledges and agrees that it has read and understands Sections 20-160 and 50-37 of the Code, and that it makes the following certification:

**The undersigned bidder certifies that it has registered as a business with the State Board of Elections and acknowledges a continuing duty to update the registration in accordance with the above referenced statutes. If the business entity is required to register, the CPO shall verify that it is in compliance on the date the bid or proposal is due. The CPO shall not accept a bid or proposal if the business entity is not in compliance with the registration requirements.**

These requirements and compliance with the above referenced statutory sections are a material part of the contract, and any breach thereof shall be cause to void the contract under Section 50-60 of the Code. This provision does not apply to Federal-aid contracts.

**M. Lobbyist Disclosure**

Section 50-38 of the Code requires that any bidder or offeror on a State contract that hires a person required to register under the Lobbyist Registration Act to assist in obtaining a contract shall:

- (i) Disclose all costs, fees, compensation, reimbursements, and other remunerations paid or to be paid to the lobbyist related to the contract,
- (ii) Not bill or otherwise cause the State of Illinois to pay for any of the lobbyist's costs, fees, compensation, reimbursements, or other remuneration, and
- (iii) Sign a verification certifying that none of the lobbyist's costs, fees, compensation, reimbursements, or other remuneration were billed to the State.

This information, along with all supporting documents, shall be filed with the agency awarding the contract and with the Secretary of State. The CPO shall post this information, together with the contract award notice, in the online Procurement Bulletin.

Pursuant to Subsection (c) of this Section, no person or entity shall retain a person or entity to attempt to influence the outcome of a procurement decision made under the Code for compensation contingent in whole or in part upon the decision or procurement. Any person who violates this subsection is guilty of a business offense and shall be fined not more than \$10,000.

Bidder acknowledges that it is required to disclose the hiring of any person required to register pursuant to the Illinois Lobbyist Registration Act (25 ILCS 170) in connection with this contract.

Bidder has not hired any person required to register pursuant to the Illinois Lobbyist Registration Act in connection with this contract.

Or

Bidder has hired the following persons required to register pursuant to the Illinois Lobbyist Registration Act in connection with the contract:

Name and address of person: \_\_\_\_\_  
All costs, fees, compensation, reimbursements and other remuneration paid to said person: \_\_\_\_\_

\_\_\_\_\_

I acknowledge, understand and accept these terms and conditions for the above certifications.

## RETURN WITH BID

### IV. DISCLOSURES

- A. The disclosures hereinafter made by the bidder are each a material representation of fact upon which reliance is placed should the Department enter into the contract with the bidder. The bidder further certifies that the Department has received the disclosure forms for each bid.

The CPO may void the bid, or contract, respectively, if it is later determined that the bidder or subcontractor rendered a false or erroneous disclosure. A contractor or subcontractor may be suspended or debarred for violations of the Code. Furthermore, the CPO may void the contract and the surety providing the performance bond shall be responsible for completion of the contract.

### B. Financial Interests and Conflicts of Interest

1. Section 50-35 of the Code provides that all bids of more than \$25,000 shall be accompanied by disclosure of the financial interests of the bidder. This disclosed information for the successful bidder, will be maintained as public information subject to release by request pursuant to the Freedom of Information Act, filed with the Procurement Policy Board, and shall be incorporated as a material term of the contract. Furthermore, pursuant to Section 5-5, the Procurement Policy Board may review a proposal, bid, or contract and issue a recommendation to void a contract or reject a proposal or bid based on any violation of the Code or the existence of a conflict of interest as provided in subsections (b) and (d) of Section 50-35.

The financial interests to be disclosed shall include ownership or distributive income share that is in excess of 5%, or an amount greater than 60% of the annual salary of the Governor, of the bidding entity or its parent entity, whichever is less, unless the contractor or bidder is a publicly traded entity subject to Federal 10K reporting, in which case it may submit its 10K disclosure in place of the prescribed disclosure. If a bidder is a privately held entity that is exempt from Federal 10K reporting, but has more than 200 shareholders, it may submit the information that Federal 10K companies are required to report, and list the names of any person or entity holding any ownership share that is in excess of 5%. The disclosure shall include the names, addresses, and dollar or proportionate share of ownership of each person making the disclosure, their instrument of ownership or beneficial relationship, and notice of any potential conflict of interest resulting from the current ownership or beneficial interest of each person making the disclosure having any of the relationships identified in Section 50-35 and on the disclosure form.

**The current annual salary of the Governor is \$177,412.00**

In addition, all disclosures shall indicate any other current or pending contracts, proposals, leases, or other ongoing procurement relationships the bidding entity has with any other unit of state government and shall clearly identify the unit and the contract, proposal, lease, or other relationship.

2. Disclosure Forms. Disclosure Form A is attached for use concerning the individuals meeting the above ownership or distributive share requirements. A separate Disclosure Form A must be submitted with the bid for each individual meeting the above requirements. In addition, a second form (Disclosure Form B) provides for the disclosure of current or pending procurement relationships with other (non-IDOT) state agencies and a total ownership certification. **The forms must be included with each bid.**

### C. Disclosure Form Instructions

#### Form A Instructions for Financial Information & Potential Conflicts of Interest

If the bidder is a publicly traded entity subject to Federal 10K reporting, the 10K Report may be submitted to meet the requirements of Form A. If a bidder is a privately held entity that is exempt from Federal 10K reporting, but has more than 200 shareholders, it may submit the information that Federal 10K companies are required to report, and list the names of any person or entity holding any ownership share that is in excess of 5%. If a bidder is not subject to Federal 10K reporting, the bidder must determine if any individuals are required by law to complete a financial disclosure form. To do this, the bidder should answer each of the following questions. A "YES" answer indicates Form A must be completed. If the answer to each of the following questions is "NO", then the NOT APPLICABLE STATEMENT on Form A must be signed and dated by a person that is authorized to execute contracts for the bidding company. Note: These questions are for assistance only and are not required to be completed.

1. Does anyone in your organization have a direct or beneficial ownership share of greater than 5% of the bidding entity or parent entity? YES \_\_\_ NO \_\_\_
2. Does anyone in your organization have a direct or beneficial ownership share of less than 5%, but which has a value greater than 60% of the annual salary of the Governor? YES \_\_\_ NO \_\_\_
3. Does anyone in your organization receive more than 60% of the annual salary of the Governor of the bidding entity's or parent entity's distributive income? YES \_\_\_ NO \_\_\_

(Note: Distributive income is, for these purposes, any type of distribution of profits. An annual salary is not distributive income.)

4. Does anyone in your organization receive greater than 5% of the bidding entity's or parent entity's total distributive income, but which is less than 60% of the annual salary of the Governor? YES \_\_\_ NO \_\_\_

(Note: Only one set of forms needs to be completed per person per bid even if a specific individual would require a yes answer to more than one question.)

A "YES" answer to any of these questions requires the completion of Form A. The bidder must determine each individual in the bidding entity or the bidding entity's parent company that would cause the questions to be answered "Yes". Each form must be signed and dated by a person that is authorized to execute contracts for your organization. **Photocopied or stamped signatures are not acceptable.** The person signing can be, but does not have to be, the person for which the form is being completed. The bidder is responsible for the accuracy of any information provided.

If the answer to each of the above questions is "NO", then the NOT APPLICABLE STATEMENT of Form A must be signed and dated by a person that is authorized to execute contracts for your company.

## RETURN WITH BID

### **Form B: Instructions for Identifying Other Contracts & Procurement Related Information**

Disclosure Form B must be completed for each bid submitted by the bidding entity. *Note: Checking the NOT APPLICABLE STATEMENT on Form A does not allow the bidder to ignore Form B. Form B must be completed, checked, and dated or the bidder may be considered nonresponsive and the bid will not be accepted.*

The Bidder shall identify, by checking Yes or No on Form B, whether it has any pending contracts (including leases), bids, proposals, or other ongoing procurement relationship with any other (non-IDOT) State of Illinois agency. If "No" is checked, the bidder only needs to complete the check box on the bottom of Form B. If "Yes" is checked, the bidder must do one of the following:

Option I: If the bidder did not submit an Affidavit of Availability to obtain authorization to bid, the bidder must list all non-IDOT State of Illinois agency pending contracts, leases, bids, proposals, and other ongoing procurement relationships. These items may be listed on Form B or on an attached sheet(s). Do not include IDOT contracts. Contracts with cities, counties, villages, etc. are not considered State of Illinois agency contracts and are not to be included. Contracts with other State of Illinois agencies such as the Department of Natural Resources or the Capital Development Board must be included. Bidders who submit Affidavits of Availability are suggested to use Option II.

Option II: If the bidder is required and has submitted an Affidavit of Availability in order to obtain authorization to bid, the bidder may write or type "See Affidavit of Availability" which indicates that the Affidavit of Availability is incorporated by reference and includes all non-IDOT State of Illinois agency pending contracts, leases, bids, proposals, and other ongoing procurement relationships. For any contracts that are not covered by the Affidavit of Availability, the bidder must identify them on Form B or on an attached sheet(s). These might be such things as leases.

**ILLINOIS DEPARTMENT  
OF TRANSPORTATION**

**Form A  
Financial Information &  
Potential Conflicts of Interest  
Disclosure**

Contractor Name		
Legal Address		
City, State, Zip		
Telephone Number	Email Address	Fax Number (if available)

Disclosure of the information contained in this Form is required by the Section 50-35 of the Code (30 ILCS 500). Vendors desiring to enter into a contract with the State of Illinois must disclose the financial information and potential conflict of interest information as specified in this Disclosure Form. This information shall become part of the publicly available contract file. This Form A must be completed for bids in excess of \$25,000, and for all open-ended contracts. **A publicly traded company may submit a 10K disclosure (or equivalent if applicable) in satisfaction of the requirements set forth in Form A. See Disclosure Form Instructions.**

*The current annual salary of the Governor is \$177,412.00.*

**DISCLOSURE OF FINANCIAL INFORMATION**

**1. Disclosure of Financial Information.** The individual named below has an interest in the BIDDER (or its parent) in terms of ownership or distributive income share in excess of 5%, or an interest which has a value of more than 60% of the annual salary of the Governor. **(Make copies of this form as necessary and attach a separate Disclosure Form A for each individual meeting these requirements)**

<b>FOR INDIVIDUAL (type or print information)</b>	
<b>NAME:</b>	_____
<b>ADDRESS</b>	_____
<b>Type of ownership/distributable income share:</b>	
stock _____ sole proprietorship _____ Partnership _____ other: (explain on separate sheet):	
% or \$ value of ownership/distributable income share:	_____

**2. Disclosure of Potential Conflicts of Interest.** Check "Yes" or "No" to indicate which, if any, of the following potential conflict of interest relationships apply. If the answer to any question is "Yes", please attach additional pages and describe.

- (a) State employment, currently or in the previous 3 years, including contractual employment of services. Yes \_\_\_ No \_\_\_

If your answer is yes, please answer each of the following questions.

- Are you currently an officer or employee of either the Capitol Development Board or the Illinois State Toll Highway Authority? Yes \_\_\_ No \_\_\_
- Are you currently appointed to or employed by any agency of the State of Illinois? If you are currently appointed to or employed by any agency of the State of Illinois, and your annual salary exceeds 60% of the annual salary of the Governor, provide the name the State agency for which you are employed and your annual salary. \_\_\_\_\_

## RETURN WITH BID

3. If you are currently appointed to or employed by any agency of the State of Illinois, and your annual salary exceeds 60% of the annual salary of the Governor, are you entitled to receive (i) more than 7 1/2% of the total distributable income of your firm, partnership, association or corporation, or (ii) an amount in excess of 100% of the annual salary of the Governor?  
Yes \_\_\_ No \_\_\_

4. If you are currently appointed to or employed by any agency of the State of Illinois, and your annual salary exceeds 60% of the annual salary of the Governor, are you and your spouse or minor children entitled to receive (i) more than 15 % in the aggregate of the total distributable income of your firm, partnership, association or corporation, or (ii) an amount in excess of two times the salary of the Governor?  
Yes \_\_\_ No \_\_\_

---

(b) State employment of spouse, father, mother, son, or daughter, including contractual employment for services in the previous 2 years.

Yes \_\_\_ No \_\_\_

If your answer is yes, please answer each of the following questions.

1. Is your spouse or any minor children currently an officer or employee of the Capitol Development Board or the Illinois State Toll Highway Authority?  
Yes \_\_\_ No \_\_\_

2. Is your spouse or any minor children currently appointed to or employed by any agency of the State of Illinois? If your spouse or minor children is/are currently appointed to or employed by any agency of the State of Illinois, and his/her annual salary exceeds 60% of the annual salary of the Governor, provide the name of your spouse and/or minor children, the name of the State agency for which he/she is employed and his/her annual salary. \_\_\_\_\_  
\_\_\_\_\_

3. If your spouse or any minor children is/are currently appointed to or employed by any agency of the State of Illinois, and his/her annual salary exceeds 60% of the annual salary of the Governor, are you entitled to receive (i) more than 7 1/2% of the total distributable income of your firm, partnership, association or corporation, or (ii) an amount in excess of 100% of the annual salary of the Governor?  
Yes \_\_\_ No \_\_\_

4. If your spouse or any minor children are currently appointed to or employed by any agency of the State of Illinois, and his/her annual salary exceeds 60% of the annual salary of the Governor, are you and your spouse or minor children entitled to receive (i) more than 15 % in the aggregate of the total distributable income of your firm, partnership, association or corporation, or (ii) an amount in excess of two times the salary of the Governor?  
Yes \_\_\_ No \_\_\_

---

(c) Elective status; the holding of elective office of the State of Illinois, the government of the United States, any unit of local government authorized by the Constitution of the State of Illinois or the statutes of the State of Illinois currently or in the previous 3 years.  
Yes \_\_\_ No \_\_\_

---

(d) Relationship to anyone holding elective office currently or in the previous 2 years; spouse, father, mother, son, or daughter.  
Yes \_\_\_ No \_\_\_

---

(e) Appointive office; the holding of any appointive government office of the State of Illinois, the United States of America, or any unit of local government authorized by the Constitution of the State of Illinois or the statutes of the State of Illinois, which office entitles the holder to compensation in excess of the expenses incurred in the discharge of that office currently or in the previous 3 years.  
Yes \_\_\_ No \_\_\_

---

(f) Relationship to anyone holding appointive office currently or in the previous 2 years; spouse, father, mother, son, or daughter.  
Yes \_\_\_ No \_\_\_

---

(g) Employment, currently or in the previous 3 years, as or by any registered lobbyist of the State government.  
Yes \_\_\_ No \_\_\_

---



**RETURN WITH BID**

(h) Relationship to anyone who is or was a registered lobbyist in the previous 2 years; spouse, father, mother, son, or daughter. Yes \_\_\_ No \_\_\_

---

(i) Compensated employment, currently or in the previous 3 years, by any registered election or reelection committee registered with the Secretary of State or any county clerk of the State of Illinois, or any political action committee registered with either the Secretary of State or the Federal Board of Elections. Yes \_\_\_ No \_\_\_

---

(j) Relationship to anyone; spouse, father, mother, son, or daughter; who was a compensated employee in the last 2 years by any registered election or re-election committee registered with the Secretary of State or any county clerk of the State of Illinois, or any political action committee registered with either the Secretary of State or the Federal Board of Elections. Yes \_\_\_ No \_\_\_

---

**3. Communication Disclosure.**

Disclose the name and address of each lobbyist and other agent of the bidder or offeror who is not identified in Section 2 of this form, who is has communicated, is communicating, or may communicate with any State officer or employee concerning the bid or offer. This disclosure is a continuing obligation and must be promptly supplemented for accuracy throughout the process and throughout the term of the contract. If no person is identified, enter "None" on the line below:

Name and address of person(s): \_\_\_\_\_  
\_\_\_\_\_  
\_\_\_\_\_  
\_\_\_\_\_

**RETURN WITH BID**

**4. Debarment Disclosure.** For each of the persons identified under Sections 2 and 3 of this form, disclose whether any of the following has occurred within the previous 10 years: debarment from contracting with any governmental entity; professional licensure discipline; bankruptcies; adverse civil judgments and administrative findings; and criminal felony convictions. This disclosure is a continuing obligation and must be promptly supplemented for accuracy throughout the procurement process and term of the contract. If no person is identified, enter "None" on the line below:

Name of person(s): \_\_\_\_\_

Nature of disclosure: \_\_\_\_\_  
\_\_\_\_\_  
\_\_\_\_\_

**APPLICABLE STATEMENT**

**This Disclosure Form A is submitted on behalf of the INDIVIDUAL named on previous page. Under penalty of perjury, I certify the contents of this disclosure to be true and accurate to the best of my knowledge.**

Completed by:  \_\_\_\_\_ Date \_\_\_\_\_  
Signature of Individual or Authorized Representative

**NOT APPLICABLE STATEMENT**

**Under penalty of perjury, I have determined that no individuals associated with this organization meet the criteria that would require the completion of this Form A.**

**This Disclosure Form A is submitted on behalf of the CONTRACTOR listed on the previous page.**

\_\_\_\_\_ Date \_\_\_\_\_  
Signature of Authorized Representative

**The bidder has a continuing obligation to supplement these disclosures under Sec. 50-35 of the Code.**

RETURN WITH BID

ILLINOIS DEPARTMENT OF TRANSPORTATION

Form B Other Contracts & Financial Related Information Disclosure

Contractor Name, Legal Address, City, State, Zip, Telephone Number, Email Address, Fax Number (if available)

Disclosure of the information contained in this Form is required by the Section 50-35 of the Code (30 ILCS 500). This information shall become part of the publicly available contract file. This Form B must be completed for bids in excess of \$25,000, and for all open-ended contracts.

DISCLOSURE OF OTHER CONTRACTS AND PROCUREMENT RELATED INFORMATION

1. Identifying Other Contracts & Procurement Related Information. The BIDDER shall identify whether it has any pending contracts (including leases), bids, proposals, or other ongoing procurement relationship with any other State of Illinois agency: Yes \_\_\_ No \_\_\_

If "No" is checked, the bidder only needs to complete the signature box on the bottom of this page.

2. If "Yes" is checked. Identify each such relationship by showing State of Illinois agency name and other descriptive information such as bid or project number (attach additional pages as necessary). SEE DISCLOSURE FORM INSTRUCTIONS:

THE FOLLOWING STATEMENT MUST BE CHECKED

Signature of Authorized Representative, Date

OWNERSHIP CERTIFICATION

Please certify that the following statement is true if the individuals for all submitted Form A disclosures do not total 100% of ownership.

Any remaining ownership interest is held by individuals receiving less than \$106,447.20 of the bidding entity's or parent entity's distributive income or holding less than a 5% ownership interest.

Yes No N/A (Form A disclosure(s) established 100% ownership)

## **RETURN WITH BID**

### **SPECIAL NOTICE TO CONTRACTORS**

The following requirements of the Illinois Department of Human Rights' Rules and Regulations are applicable to bidders on all construction contracts advertised by the Illinois Department of Transportation:

#### **CONSTRUCTION EMPLOYEE UTILIZATION PROJECTION**

- (a) All bidders on construction contracts shall complete and submit, along with and as part of their bids, a Bidder's Employee Utilization Form (Form BC-1256) setting forth a projection and breakdown of the total workforce intended to be hired and/or allocated to such contract work by the bidder including a projection of minority and female employee utilization in all job classifications on the contract project.
- (b) The Department of Transportation shall review the Employee Utilization Form, and workforce projections contained therein, of the contract awardee to determine if such projections reflect an underutilization of minority persons and/or women in any job classification in accordance with the Equal Employment Opportunity Clause and Section 7.2 of the Illinois Department of Human Rights' Rules and Regulations for Public Contracts adopted as amended on September 17, 1980. If it is determined that the contract awardee's projections reflect an underutilization of minority persons and/or women in any job classification, it shall be advised in writing of the manner in which it is underutilizing and such awardee shall be considered to be in breach of the contract unless, prior to commencement of work on the contract project, it submits revised satisfactory projections or an acceptable written affirmative action plan to correct such underutilization including a specific timetable geared to the completion stages of the contract.
- (c) The Department of Transportation shall provide to the Department of Human Rights a copy of the contract awardee's Employee Utilization Form, a copy of any required written affirmative action plan, and any written correspondence related thereto. The Department of Human Rights may review and revise any action taken by the Department of Transportation with respect to these requirements.



**RETURN WITH BID**

**Contract No. 76G23  
Various Counties  
Section DIST 8 GUARDRAIL 2015-1  
Various Routes  
District 8 Construction Funds**

**PART II. WORKFORCE PROJECTION - continued**

- B. Included in "Total Employees" under Table A is the total number of **new hires** that would be employed in the event the undersigned bidder is awarded this contract.

The undersigned bidder projects that: (number) \_\_\_\_\_ new hires would be recruited from the area in which the contract project is located; and/or (number) \_\_\_\_\_ new hires would be recruited from the area in which the bidder's principal office or base of operation is located.

- C. Included in "Total Employees" under Table A is a projection of numbers of persons to be employed directly by the undersigned bidder as well as a projection of numbers of persons to be employed by subcontractors.

The undersigned bidder estimates that (number) \_\_\_\_\_ persons will be directly employed by the prime contractor and that (number) \_\_\_\_\_ persons will be employed by subcontractors.

**PART III. AFFIRMATIVE ACTION PLAN**

- A. The undersigned bidder understands and agrees that in the event the foregoing minority and female employee utilization projection included under **PART II** is determined to be an underutilization of minority persons or women in any job category, and in the event that the undersigned bidder is awarded this contract, he/she will, prior to commencement of work, develop and submit a written Affirmative Action Plan including a specific timetable (geared to the completion stages of the contract) whereby deficiencies in minority and/or female employee utilization are corrected. Such Affirmative Action Plan will be subject to approval by the contracting agency and the **Department of Human Rights**.
- B. The undersigned bidder understands and agrees that the minority and female employee utilization projection submitted herein, and the goals and timetable included under an Affirmative Action Plan if required, are deemed to be part of the contract specifications.

Company \_\_\_\_\_ Telephone Number \_\_\_\_\_

Address \_\_\_\_\_

**NOTICE REGARDING SIGNATURE**

The Bidder's signature on the Proposal Signature Sheet will constitute the signing of this form. The following signature block needs to be completed if revisions are required.

Signature:  \_\_\_\_\_ Title: \_\_\_\_\_ Date: \_\_\_\_\_

- Instructions: All tables must include subcontractor personnel in addition to prime contractor personnel.
- Table A - Include both the number of employees that would be hired to perform the contract work and the total number currently employed (Table B) that will be allocated to contract work, and include all apprentices and on-the-job trainees. The "Total Employees" column should include all employees including all minorities, apprentices and on-the-job trainees to be employed on the contract work.
- Table B - Include all employees currently employed that will be allocated to the contract work including any apprentices and on-the-job trainees currently employed.
- Table C - Indicate the racial breakdown of the total apprentices and on-the-job trainees shown in Table A.

**RETURN WITH BID**  
**Contract No. 76G23**  
**Various Counties**  
**Section DIST 8 GUARDRAIL 2015-1**  
**Various Routes**  
**District 8 Construction Funds**

PROPOSAL SIGNATURE SHEET

The undersigned bidder hereby makes and submits this bid on the subject Proposal, thereby assuring the Department that all requirements of the Invitation for Bids and rules of the Department have been met, that there is no misunderstanding of the requirements of paragraph 3 of this Proposal, and that the contract will be executed in accordance with the rules of the Department if an award is made on this bid.

(IF AN INDIVIDUAL)

Firm Name \_\_\_\_\_

Signature of Owner \_\_\_\_\_

Business Address \_\_\_\_\_

\_\_\_\_\_

---

---

(IF A CO-PARTNERSHIP)

Firm Name \_\_\_\_\_

By \_\_\_\_\_

Business Address \_\_\_\_\_

\_\_\_\_\_

Name and Address of All Members of the Firm:

\_\_\_\_\_

\_\_\_\_\_

---

---

(IF A CORPORATION)

Corporate Name \_\_\_\_\_

By \_\_\_\_\_

Signature of Authorized Representative

\_\_\_\_\_

Typed or printed name and title of Authorized Representative

Attest \_\_\_\_\_

Signature

(IF A JOINT VENTURE, USE THIS SECTION FOR THE MANAGING PARTY AND THE SECOND PARTY SHOULD SIGN BELOW)

Business Address \_\_\_\_\_

\_\_\_\_\_

---

---

(IF A JOINT VENTURE)

Corporate Name \_\_\_\_\_

By \_\_\_\_\_

Signature of Authorized Representative

\_\_\_\_\_

Typed or printed name and title of Authorized Representative

Attest \_\_\_\_\_

Signature

Business Address \_\_\_\_\_

\_\_\_\_\_

---

---

If more than two parties are in the joint venture, please attach an additional signature sheet.

---

---



This Annual Proposal Bid Bond shall become effective at 12:01 AM (CDST) on \_\_\_\_\_ and shall be valid until \_\_\_\_\_ 11:59 PM (CDST).

KNOW ALL PERSONS BY THESE PRESENTS, That We \_\_\_\_\_

as PRINCIPAL, and \_\_\_\_\_

as SURETY, and held jointly, severally and firmly bound unto the STATE OF ILLINOIS in the penal sum of 5 percent of the total bid price, or for the amount specified in the bid proposal under "Proposal Guaranty" in effect on the date of the Invitation for Bids, whichever is the lesser sum, well and truly to be paid unto said STATE OF ILLINOIS, for the payment of which we bind ourselves, our heirs, executors, administrators, successors and assigns.

THE CONDITION OF THE FOREGOING OBLIGATION IS SUCH that whereas, the PRINCIPAL may submit bid proposal(s) to the STATE OF ILLINOIS, acting through the Department of Transportation, for various improvements published in the Transportation Bulletin during the effective term indicated above.

NOW, THEREFORE, if the Department shall accept the bid proposal(s) of the PRINCIPAL; and if the PRINCIPAL shall, within the time and as specified in the bidding and contract documents; and if, after award by the Department, the PRINCIPAL shall enter into a contract in accordance with the terms of the bidding and contract documents including evidence of the required insurance coverages and providing such bond as specified with good and sufficient surety for the faithful performance of such contract and for the prompt payment of labor and material furnished in the prosecution thereof; or if, in the event of the failure of the PRINCIPAL to enter into such contract and to give the specified bond, the PRINCIPAL pays to the Department the difference not to exceed the penalty hereof between the amount specified in the bid proposal and such larger amount for which the Department may contract with another party to perform the work covered by said bid proposal, then this obligation shall be null and void, otherwise, it shall remain in full force and effect.

IN THE EVENT the Department determines the PRINCIPAL has failed to comply with any requirement as set forth in the preceding paragraph, then Surety shall pay the penal sum to the Department within fifteen (15) days of written demand therefor. If Surety does not make full payment within such period of time, the Department may bring an action to collect the amount owed. Surety is liable to the Department for all its expenses, including attorney's fees, incurred in any litigation in which it prevails either in whole or in part.

In TESTIMONY WHEREOF, the said PRINCIPAL has caused this instrument to be signed by its officer \_\_\_\_\_ day of \_\_\_\_\_ A.D., \_\_\_\_\_

In TESTIMONY WHEREOF, the said SURETY has caused this instrument to be signed by its officer \_\_\_\_\_ day of \_\_\_\_\_ A.D., \_\_\_\_\_

\_\_\_\_\_  
(Company Name)

\_\_\_\_\_  
(Company Name)

By \_\_\_\_\_  
(Signature and Title)

By \_\_\_\_\_  
(Signature of Attorney-in-Fact)

**Notary for PRINCIPAL**

**Notary for SURETY**

STATE OF \_\_\_\_\_  
COUNTY OF \_\_\_\_\_

STATE OF \_\_\_\_\_  
COUNTY OF \_\_\_\_\_

Signed and attested before me on \_\_\_\_\_ (date)

Signed and attested before me on \_\_\_\_\_ (date)

by \_\_\_\_\_  
(Name of Notary Public)

by \_\_\_\_\_  
(Name of Notary Public)

(Seal) \_\_\_\_\_  
(Signature of Notary Public)

(Seal) \_\_\_\_\_  
(Signature of Notary Public)

\_\_\_\_\_  
(Date Commission Expires)

\_\_\_\_\_  
(Date Commission Expires)



In lieu of completing the above section of the Annual Proposal Bid Bond form, the Principal may file an Electronic Bid Bond. By signing the proposal(s) the Principal is ensuring the identified electronic bid bond has been executed and the Principal and Surety are firmly bound unto the State of Illinois under the conditions of the bid bond as shown above.

---

Electronic Bid Bond ID #	Company/Bidder Name	Signature and Title
--------------------------	---------------------	---------------------

This bond may be terminated, at Surety's request, upon giving not less than thirty (30) days prior written notice of the cancellation/termination of the bond. Said written notice shall be issued to the Illinois Department of Transportation, Chief Contracts Official, 2300 South Dirksen Parkway, Springfield, Illinois, 62764, and shall be served in person, by receipted courier delivery or certified or registered mail, return receipt requested. Said notice period shall commence on the first calendar day following the Department's receipt of written cancellation/termination notice. Surety shall remain firmly bound to all obligations herein for proposals submitted prior to the cancellation/termination. Surety shall be released and discharged from any obligation(s) for proposals submitted for any letting or date after the effective date of cancellation/termination.



Item No. \_\_\_\_\_

Letting Date \_\_\_\_\_

KNOW ALL PERSONS BY THESE PRESENTS, That We \_\_\_\_\_

as PRINCIPAL, and \_\_\_\_\_

as SURETY, and held jointly, severally and firmly bound unto the STATE OF ILLINOIS in the penal sum of 5 percent of the total bid price, or for the amount specified in the bid proposal under "Proposal Guaranty" in effect on the date of the Invitation for Bids, whichever is the lesser sum, well and truly to be paid unto said STATE OF ILLINOIS, for the payment of which we bind ourselves, our heirs, executors, administrators, successors and assigns.

THE CONDITION OF THE FOREGOING OBLIGATION IS SUCH that whereas, the PRINCIPAL has submitted a bid proposal to the STATE OF ILLINOIS, acting through the Department of Transportation, for the improvement designated by the Transportation Bulletin Item Number and Letting Date indicated above.

NOW, THEREFORE, if the Department shall accept the bid proposal of the PRINCIPAL; and if the PRINCIPAL shall, within the time and as specified in the bidding and contract documents; and if, after award by the Department, the PRINCIPAL shall enter into a contract in accordance with the terms of the bidding and contract documents including evidence of the required insurance coverages and providing such bond as specified with good and sufficient surety for the faithful performance of such contract and for the prompt payment of labor and material furnished in the prosecution thereof; or if, in the event of the failure of the PRINCIPAL to enter into such contract and to give the specified bond, the PRINCIPAL pays to the Department the difference not to exceed the penalty hereof between the amount specified in the bid proposal and such larger amount for which the Department may contract with another party to perform the work covered by said bid proposal, then this obligation shall be null and void, otherwise, it shall remain in full force and effect.

IN THE EVENT the Department determines the PRINCIPAL has failed to comply with any requirement as set forth in the preceding paragraph, then Surety shall pay the penal sum to the Department within fifteen (15) days of written demand therefor. If Surety does not make full payment within such period of time, the Department may bring an action to collect the amount owed. Surety is liable to the Department for all its expenses, including attorney's fees, incurred in any litigation in which it prevails either in whole or in part.

In TESTIMONY WHEREOF, the said PRINCIPAL has caused this instrument to be signed by its officer  
\_\_\_\_\_ day of \_\_\_\_\_ A.D., \_\_\_\_\_.

In TESTIMONY WHEREOF, the said SURETY has caused this instrument to be signed by its officer  
\_\_\_\_\_ day of \_\_\_\_\_ A.D., \_\_\_\_\_.

\_\_\_\_\_  
(Company Name)

\_\_\_\_\_  
(Company Name)

By \_\_\_\_\_  
(Signature and Title)

By \_\_\_\_\_  
(Signature of Attorney-in-Fact)

**Notary for PRINCIPAL**

**Notary for SURETY**

STATE OF \_\_\_\_\_  
COUNTY OF \_\_\_\_\_

STATE OF \_\_\_\_\_  
COUNTY OF \_\_\_\_\_

Signed and attested before me on \_\_\_\_\_ (date)  
by \_\_\_\_\_  
(Name of Notary Public)

Signed and attested before me on \_\_\_\_\_ (date)  
by \_\_\_\_\_  
(Name of Notary Public)

(Seal) \_\_\_\_\_  
(Signature of Notary Public)

(Seal) \_\_\_\_\_  
(Signature of Notary Public)

\_\_\_\_\_  
(Date Commission Expires)

\_\_\_\_\_  
(Date Commission Expires)

In lieu of completing the above section of the Proposal Bid Bond form, the Principal may file an Electronic Bid Bond. By signing the proposal the Principal is ensuring the identified electronic bid bond has been executed and the Principal and Surety are firmly bound unto the State of Illinois under the conditions of the bid bond as shown above.

Electronic Bid Bond ID # \_\_\_\_\_ Company/Bidder Name \_\_\_\_\_ Signature and Title \_\_\_\_\_



**(1) Policy**

It is public policy that disadvantageded businesses as defined in 49 CFR Part 26 and the Special Provision shall have the maximum opportunity to participate in the performance of contracts financed in whole or in part with Federal or State funds. Consequently the requirements of 49 CFR Part 26 apply to this contract.

**(2) Obligation**

The contractor agrees to ensure that disadvantageded businesses as defined in 49 CFR Part 26 and the Special Provision have the maximum opportunity to participate in the performance of contracts or subcontracts financed in whole or in part with Federal or State funds. The contractor shall take all necessary and reasonable steps in accordance with 49 CFR Part 26 and the Special Provision to ensure that said businesses have the maximum opportunity to compete for and perform under this contract. The contractor shall not discriminate on the basis of race, color, national origin or sex in the award and performance of contracts.

**(3) Project and Bid Identification**

Complete the following information concerning the project and bid:

Route \_\_\_\_\_

Section \_\_\_\_\_

Project \_\_\_\_\_

County \_\_\_\_\_

Letting Date \_\_\_\_\_

Contract No. \_\_\_\_\_

Letting Item No. \_\_\_\_\_

Total Bid \_\_\_\_\_

Contract DBE Goal \_\_\_\_\_

(Percent)                      (Dollar Amount)

**(4) Assurance**

I, acting in my capacity as an officer of the undersigned bidder (or bidders if a joint venture), hereby assure the Department that on this project my company : (check one)

- Meets or exceeds contract award goals and has provided documented participation as follows:  
Disadvantaged Business Participation \_\_\_\_\_ percent

Attached are the signed participation statements, forms SBE 2025, required by the Special Provision evidencing availability and use of each business participating in this plan and assuring that each business will perform a commercially useful function in the work of the contract.

- Failed to meet contract award goals and has included good faith effort documentation to meet the goals and that my company has provided participation as follows:  
Disadvantaged Business Participation \_\_\_\_\_ percent

The contract goals should be accordingly modified or waived. Attached is all information required by the Special Provision in support of this request including good faith effort. Also attached are the signed participation statements, forms SBE 2025, required by the Special Provision evidencing availability and use of each business participating in this plan and assuring that each business will perform a commercially useful function in the work of the contract.

\_\_\_\_\_ Company

By \_\_\_\_\_

Title \_\_\_\_\_

Date \_\_\_\_\_

The "as read" Low Bidder is required to comply with the Special Provision.

Submit only one utilization plan for each project. The utilization plan shall be submitted in accordance with the special provision.

Bureau of Small Business Enterprises                      **Local Let Projects**  
 2300 South Dirksen Parkway                                      Submit forms to the  
 Springfield, Illinois 62764    Local Agency

The Department of Transportation is requesting disclosure of information that is necessary to accomplish the purpose as outlined under State and Federal law. Disclosure of this information is **REQUIRED**. Failure to provide any information will result in the contract not being awarded. This form has been approved by the State Forms Manager Center.



# PROPOSAL ENVELOPE



# PROPOSALS

for construction work advertised for bids by the  
Illinois Department of Transportation

Item No.	Item No.	Item No.

Submitted By:

Name:
Address:
Phone No.

Bidders should use an IDOT proposal envelope or affix this form to the front of a 10" x 13" envelope for the submittal of bids. If proposals are mailed, they should be enclosed in a second or outer envelope addressed to:

Engineer of Design and Environment - Room 326  
Illinois Department of Transportation  
2300 South Dirksen Parkway  
Springfield, Illinois 62764

## **NOTICE**

**Individual bids, including Bid Bond and/or supplemental information if required, should be securely stapled.**

# CONTRACTOR OFFICE COPY OF CONTRACT SPECIFICATIONS

---

## NOTICE

None of the following material needs to be returned with the bid package unless the special provisions require documentation and/or other information to be submitted.

**Contract No. 76G23**  
**Various Counties**  
**Section DIST 8 GUARDRAIL 2015-1**  
**Various Routes**  
**District 8 Construction Funds**



**Illinois Department of Transportation**

## **SUBCONTRACTOR DOCUMENTATION**

Public Acts 96-0795, 96-0920, and 97-0895 enacted substantial changes to the provisions of the Code (30 ILCS 500). Among the changes are provisions affecting subcontractors. The Contractor awarded this contract will be required as a material condition of the contract to implement and enforce the contract requirements applicable to subcontractors that entered into a contractual agreement with a total value of \$50,000 or more with a person or entity who has a contract subject to the Code and approved in accordance with article 108.01 of the Standard Specifications for Road and Bridge Construction.

If the Contractor seeks approval of subcontractors to perform a portion of the work, and approval is granted by the Department, the Contractor shall provide a copy of the subcontract to the Illinois Department of Transportation's CPO upon request within 15 calendar days after execution of the subcontract.

Financial disclosures required pursuant to Sec. 50-35 of the Code must be submitted for all applicable subcontractors. The subcontract shall contain the certifications required to be made by subcontractors pursuant to Article 50 of the Code. This Notice to Bidders includes a document incorporating all required subcontractor certifications and disclosures for use by the Contractor in compliance with this mandate. The document is entitled State Required Ethical Standards Governing Subcontractors.

## RETURN WITH SUBCONTRACT

### STATE ETHICAL STANDARDS GOVERNING SUBCONTRACTORS

Article 50 of the Code establishes the duty of all State CPOs, SPOs, and their designees to maximize the value of the expenditure of public moneys in procuring goods, services, and contracts for the State of Illinois and to act in a manner that maintains the integrity and public trust of State government. In discharging this duty, they are charged by law to use all available information, reasonable efforts, and reasonable actions to protect, safeguard, and maintain the procurement process of the State of Illinois.

The certifications hereinafter made by the subcontractor are each a material representation of fact upon which reliance is placed should the Department approve the subcontractor. The CPO may terminate or void the contract approval if it is later determined that the bidder or subcontractor rendered a false or erroneous certification. If a false certification is made by a subcontractor the contractor's submitted bid and the executed contract may not be declared void unless the contractor refuses to terminate the subcontract upon the State's request after a finding that the subcontractor's certification was false.

Section 50-2 of the Code provides that every person that has entered into a multi-year contract and every subcontractor with a multi-year subcontract shall certify, by July 1 of each fiscal year covered by the contract after the initial fiscal year, to the responsible CPO whether it continues to satisfy the requirements of Article 50 pertaining to the eligibility for a contract award. If a contractor or subcontractor is not able to truthfully certify that it continues to meet all requirements, it shall provide with its certification a detailed explanation of the circumstances leading to the change in certification status. A contractor or subcontractor that makes a false statement material to any given certification required under Article 50 is, in addition to any other penalties or consequences prescribed by law, subject to liability under the Whistleblower Reward and Protection Act for submission of a false claim.

#### **A. Bribery**

Section 50-5. Bribery.

(a) Prohibition. No person or business shall be awarded a contract or subcontract under this Code who:

(1) has been convicted under the laws of Illinois or any other state of bribery or attempting to bribe an officer or employee of the State of Illinois or any other state in that officer's or employee's official capacity; or

(2) has made an admission of guilt of that conduct that is a matter of record but has not been prosecuted for that conduct.

(b) Businesses. No business shall be barred from contracting with any unit of State or local government, or subcontracting under such a contract, as a result of a conviction under this Section of any employee or agent of the business if the employee or agent is no longer employed by the business and:

(1) the business has been finally adjudicated not guilty; or

(2) the business demonstrates to the governmental entity with which it seeks to contract, or which is signatory to the contract to which the subcontract relates, and that entity finds that the commission of the offense was not authorized, requested, commanded, or performed by a director, officer, or high managerial agent on behalf of the business as provided in paragraph (2) of subsection (a) of Section 5-4 of the Criminal Code of 2012.

(c) Conduct on behalf of business. For purposes of this Section, when an official, agent, or employee of a business committed the bribery or attempted bribery on behalf of the business and in accordance with the direction or authorization of a responsible official of the business, the business shall be chargeable with the conduct.

(d) Certification. Every bid submitted to and contract executed by the State, and every subcontract subject to Section 20-120 of the Code shall contain a certification by the contractor or the subcontractor, respectively, that the contractor or subcontractor is not barred from being awarded a contract or subcontract under this Section and acknowledges that the CPO may declare the related contract void if any certifications required by this Section are false. A contractor who makes a false statement, material to the certification, commits a Class 3 felony.

The contractor or subcontractor certifies that it is not barred from being awarded a contract under Section 50.5.

#### **B. Felons**

Section 50-10. Felons.

Unless otherwise provided, no person or business convicted of a felony shall do business with the State of Illinois or any State agency, or enter into a subcontract, from the date of conviction until 5 years after the date of completion of the sentence for that felony, unless no person held responsible by a prosecutorial office for the facts upon which the conviction was based continues to have any involvement with the business.

Certification. Every bid submitted to and contract executed by the State and every subcontract subject to Section 20-120 of the Code shall contain a certification by the bidder or contractor or subcontractor, respectively, that the bidder, contractor, or subcontractor is not barred from being awarded a contract or subcontract under this Section and acknowledges that the CPO may declare the related contract void if any of the certifications required by this Section are false.



**RETURN WITH SUBCONTRACT**

**C. Debt Delinquency**

Section 50-11 and 50-12. Debt Delinquency.

The contractor or bidder or subcontractor, respectively, certifies that it, or any affiliate, is not barred from being awarded a contract or subcontract under the Code. Section 50-11 prohibits a person from entering into a contract with a State agency, or entering into a subcontract, if it knows or should know that it, or any affiliate, is delinquent in the payment of any debt to the State as defined by the Debt Collection Board. Section 50-12 prohibits a person from entering into a contract with a State agency, or entering into a subcontract, if it, or any affiliate, has failed to collect and remit Illinois Use Tax on all sales of tangible personal property into the State of Illinois in accordance with the provisions of the Illinois Use Tax Act. The bidder or contractor or subcontractor, respectively, further acknowledges that the CPO may declare the related contract void if this certification is false or if the bidder, contractor, or subcontractor, or any affiliate, is determined to be delinquent in the payment of any debt to the State during the term of the contract.

**D. Prohibited Bidders, Contractors and Subcontractors**

Section 50-10.5 and 50-60(c). Prohibited bidders, contractors and subcontractors.

The bidder or contractor or subcontractor, respectively, certifies in accordance with 30 ILCS 500/50-10.5 that no officer, director, partner or other managerial agent of the contracting business has been convicted of a felony under the Sarbanes-Oxley Act of 2002 or a Class 3 or Class 2 felony under the Illinois Securities Law of 1953 or if in violation of Subsection (c) for a period of five years from the date of conviction. Every bid submitted to and contract executed by the State and every subcontract subject to Section 20-120 of the Code shall contain a certification by the bidder, contractor, or subcontractor, respectively, that the bidder, contractor, or subcontractor is not barred from being awarded a contract or subcontract under this Section and acknowledges that the CPO shall declare the related contract void if any of the certifications completed pursuant to this Section are false.

**E. Section 42 of the Environmental Protection Act**

The bidder or contractor or subcontractor, respectively, certifies in accordance with 30 ILCS 500/50-14 that the bidder, contractor, or subcontractor, is not barred from being awarded a contract or entering into a subcontract under this Section which prohibits the bidding on or entering into contracts with the State of Illinois or a State agency, or entering into any subcontract, that is subject to the Code by a person or business found by a court or the Pollution Control Board to have committed a willful or knowing violation of Section 42 of the Environmental Protection Act for a period of five years from the date of the order. The bidder or contractor or subcontractor, respectively, acknowledges that the CPO may declare the contract void if this certification is false.

**The undersigned, on behalf of the subcontracting company, has read and understands the above certifications and makes the certifications as required by law.**

Name of Subcontracting Company		
Authorized Officer	Date	

**RETURN WITH SUBCONTRACT**  
**SUBCONTRACTOR DISCLOSURES**

**I. DISCLOSURES**

- A.** The disclosures hereinafter made by the subcontractor are each a material representation of fact upon which reliance is placed. The subcontractor further certifies that the Department has received the disclosure forms for each subcontract.

The CPO may void the bid, contract, or subcontract, respectively, if it is later determined that the bidder or subcontractor rendered a false or erroneous disclosure. A contractor or subcontractor may be suspended or debarred for violations of the Code. Furthermore, the CPO may void the contract.

**B. Financial Interests and Conflicts of Interest**

1. Section 50-35 of the Code provides that all subcontracts with a total value of \$50,000 or more from subcontractors identified in Section 20-120 of the Code, shall be accompanied by disclosure of the financial interests of the subcontractor. This disclosed information for the subcontractor, will be maintained as public information subject to release by request pursuant to the Freedom of Information Act, filed with the Procurement Policy Board, and shall be incorporated as a material term of the Prime Contractor's contract. Furthermore, pursuant to this Section, the Procurement Policy Board may recommend to allow or void a contract or subcontract based on a potential conflict of interest.

The financial interests to be disclosed shall include ownership or distributive income share that is in excess of 5%, or an amount greater than 60% of the annual salary of the Governor, of the subcontracting entity or its parent entity, whichever is less, unless the subcontractor is a publicly traded entity subject to Federal 10K reporting, in which case it may submit its 10K disclosure in place of the prescribed disclosure. If a subcontractor is a privately held entity that is exempt from Federal 10K reporting, but has more than 200 shareholders, it may submit the information that Federal 10K companies are required to report, and list the names of any person or entity holding any ownership share that is in excess of 5%. The disclosure shall include the names, addresses, and dollar or proportionate share of ownership of each person making the disclosure, their instrument of ownership or beneficial relationship, and notice of any potential conflict of interest resulting from the current ownership or beneficial interest of each person making the disclosure having any of the relationships identified in Section 50-35 and on the disclosure form.

**The current annual salary of the Governor is \$177,412.00.**

In addition, all disclosures shall indicate any other current or pending contracts, subcontracts, proposals, leases, or other ongoing procurement relationships the subcontracting entity has with any other unit of state government and shall clearly identify the unit and the contract, subcontract, proposal, lease, or other relationship.

2. Disclosure Forms. Disclosure Form A is attached for use concerning the individuals meeting the above ownership or distributive share requirements. A separate Disclosure Form A must be submitted with the bid for each individual meeting the above requirements. In addition, a second form (Disclosure Form B) provides for the disclosure of current or pending procurement relationships with other (non-IDOT) state agencies and a total ownership certification. **The forms must be included with each bid.**

**C. Disclosure Form Instructions**

**Form A Instructions for Financial Information & Potential Conflicts of Interest**

If the subcontractor is a publicly traded entity subject to Federal 10K reporting, the 10K Report may be submitted to meet the requirements of Form A. If a subcontractor is a privately held entity that is exempt from Federal 10K reporting, but has more than 200 shareholders, it may submit the information that Federal 10K companies are required to report, and list the names of any person or entity holding any ownership share that is in excess of 5%. If a subcontractor is not subject to Federal 10K reporting, the subcontractor must determine if any individuals are required by law to complete a financial disclosure form. To do this, the subcontractor should answer each of the following questions. A "YES" answer indicates Form A must be completed. If the answer to each of the following questions is "NO", then the NOT APPLICABLE STATEMENT on the second page of Form A must be signed and dated by a person that is authorized to execute contracts for the subcontracting company. Note: These questions are for assistance only and are not required to be completed.

1. Does anyone in your organization have a direct or beneficial ownership share of greater than 5% of the bidding entity or parent entity? YES \_\_\_ NO \_\_\_
2. Does anyone in your organization have a direct or beneficial ownership share of less than 5%, but which has a value greater than 60% of the annual salary of the Governor? YES \_\_\_ NO \_\_\_
3. Does anyone in your organization receive more than 60% of the annual salary of the Governor of the subcontracting entity's or parent entity's distributive income? YES \_\_\_ NO \_\_\_

(Note: Distributive income is, for these purposes, any type of distribution of profits. An annual salary is not distributive income.)

4. Does anyone in your organization receive greater than 5% of the subcontracting entity's or parent entity's total distributive income, but which is less than 60% of the annual salary of the Governor? YES \_\_\_ NO \_\_\_

(Note: Only one set of forms needs to be completed per person per subcontract even if a specific individual would require a yes answer to more than one question.)

A "YES" answer to any of these questions requires the completion of Form A. The subcontractor must determine each individual in the subcontracting entity or the subcontracting entity's parent company that would cause the questions to be answered "Yes". Each form must be signed and dated by a person that is authorized to execute contracts for your organization. **Photocopied or stamped signatures are not acceptable.** The person signing can be, but does not have to be, the person for which the form is being completed. The subcontractor is responsible for the accuracy of any information provided.

If the answer to each of the above questions is "NO", then the NOT APPLICABLE STATEMENT on page 2 of Form A must be signed and dated by a person that is authorized to execute contracts for your company.

## RETURN WITH SUBCONTRACT

### **Form B: Instructions for Identifying Other Contracts & Procurement Related Information**

Disclosure Form B must be completed for each subcontract submitted by the subcontracting entity. *Note: Checking the NOT APPLICABLE STATEMENT on Form A does not allow the subcontractor to ignore Form B. Form B must be completed, checked, and dated or the subcontract will not be approved.*

The Subcontractor shall identify, by checking Yes or No on Form B, whether it has any pending contracts, subcontracts, leases, bids, proposals, or other ongoing procurement relationship with any other (non-IDOT) State of Illinois agency. If "No" is checked, the subcontractor only needs to complete the check box on the bottom of Form B. If "Yes" is checked, the subcontractor must list all non-IDOT State of Illinois agency pending contracts, subcontracts, leases, bids, proposals, and other ongoing procurement relationships. These items may be listed on Form B or on an attached sheet(s). Contracts with cities, counties, villages, etc. are not considered State of Illinois agency contracts and are not to be included. Contracts or subcontracts with other State of Illinois agencies such as the Department of Natural Resources or the Capital Development Board must be included.

RETURN WITH SUBCONTRACT

ILLINOIS DEPARTMENT OF TRANSPORTATION

Form A Subcontractor: Financial Information & Potential Conflicts of Interest Disclosure

Subcontractor Name, Legal Address, City, State, Zip, Telephone Number, Email Address, Fax Number (if available)

Disclosure of the information contained in this Form is required by the Section 50-35 of the Code (30 ILCS 500). Subcontractors desiring to enter into a subcontract of a State of Illinois contract must disclose the financial information and potential conflict of interest information as specified in this Disclosure Form.

The current annual salary of the Governor is \$177,412.00.

DISCLOSURE OF FINANCIAL INFORMATION

1. Disclosure of Financial Information. The individual named below has an interest in the SUBCONTRACTOR (or its parent) in terms of ownership or distributive income share in excess of 5%, or an interest which has a value of more than 60% of the annual salary of the Governor.

FOR INDIVIDUAL (type or print information) NAME: ADDRESS Type of ownership/distributable income share: stock sole proprietorship Partnership other: (explain on separate sheet): % or \$ value of ownership/distributable income share:

2. Disclosure of Potential Conflicts of Interest. Check "Yes" or "No" to indicate which, if any, of the following potential conflict of interest relationships apply. If the answer to any question is "Yes", please attach additional pages and describe.

(a) State employment, currently or in the previous 3 years, including contractual employment of services. Yes \_\_\_ No \_\_\_

If your answer is yes, please answer each of the following questions.

1. Are you currently an officer or employee of either the Capitol Development Board or the Illinois State Toll Highway Authority? Yes \_\_\_ No \_\_\_

2. Are you currently appointed to or employed by any agency of the State of Illinois? If you are currently appointed to or employed by any agency of the State of Illinois, and your annual salary exceeds 60% of the annual salary of the Governor, provide the name the State agency for which you are employed and your annual salary.

**RETURN WITH SUBCONTRACT**

3. If you are currently appointed to or employed by any agency of the State of Illinois, and your annual salary exceeds 60% of the annual salary of the Governor, are you entitled to receive (i) more than 7 1/2% of the total distributable income of your firm, partnership, association or corporation, or (ii) an amount in excess of 100% of the annual salary of the Governor?  
Yes \_\_\_ No \_\_\_

4. If you are currently appointed to or employed by any agency of the State of Illinois, and your annual salary exceeds 60% of the annual salary of the Governor, are you and your spouse or minor children entitled to receive (i) more than 15 % in the aggregate of the total distributable income of your firm, partnership, association or corporation, or (ii) an amount in excess of two times the salary of the Governor?  
Yes \_\_\_ No \_\_\_

---

(b) State employment of spouse, father, mother, son, or daughter, including contractual employment services in the previous 2 years.

Yes \_\_\_ No \_\_\_

If your answer is yes, please answer each of the following questions.

1. Is your spouse or any minor children currently an officer or employee of the Capitol Development Board or the Illinois Toll Highway Authority?  
Yes \_\_\_ No \_\_\_

2. Is your spouse or any minor children currently appointed to or employed by any agency of the State of Illinois? If your spouse or minor children is/are currently appointed to or employed by any agency of the State of Illinois, and his/her annual salary exceeds 60% of the annual salary of the Governor, provide the name of your spouse and/or minor children, the name of the State agency for which he/she is employed and his/her annual salary. \_\_\_\_\_

---

3. If your spouse or any minor children is/are currently appointed to or employed by any agency of the State of Illinois, and his/her annual salary exceeds 60% of the annual salary of the Governor, as of 7/1/07) are you entitled to receive (i) more then 7 1/2% of the total distributable income of your firm, partnership, association or corporation, or (ii) an amount in excess of 100% of the annual salary of the Governor?  
Yes \_\_\_ No \_\_\_

4. If your spouse or any minor children are currently appointed to or employed by any agency of the State of Illinois, and his/her annual salary exceeds 60% of the annual salary of the Governor, are you and your spouse or minor children entitled to receive (i) more than 15 % in the aggregate of the total distributable income of your firm, partnership, association or corporation, or (ii) an amount in excess of two times the annual salary of the Governor?  
Yes \_\_\_ No \_\_\_

---

(c) Elective status; the holding of elective office of the State of Illinois, the government of the United States, any unit of local government authorized by the Constitution of the State of Illinois or the statutes of the State of Illinois currently or in the previous 3 years.  
Yes \_\_\_ No \_\_\_

---

(d) Relationship to anyone holding elective office currently or in the previous 2 years; spouse, father, mother, son, or daughter.  
Yes \_\_\_ No \_\_\_

---

(e) Appointive office; the holding of any appointive government office of the State of Illinois, the United States of America, or any unit of local government authorized by the Constitution of the State of Illinois or the statutes of the State of Illinois, which office entitles the holder to compensation in excess of the expenses incurred in the discharge of that office currently or in the previous 3 years.  
Yes \_\_\_ No \_\_\_

---

(f) Relationship to anyone holding appointive office currently or in the previous 2 years; spouse, father, mother, son, or daughter.  
Yes \_\_\_ No \_\_\_

---

(g) Employment, currently or in the previous 3 years, as or by any registered lobbyist of the State government.  
Yes \_\_\_ No \_\_\_

---

**RETURN WITH SUBCONTRACT**

(h) Relationship to anyone who is or was a registered lobbyist in the previous 2 years; spouse, father, mother, son, or daughter. Yes \_\_\_ No \_\_\_

---

(i) Compensated employment, currently or in the previous 3 years, by any registered election or reelection committee registered with the Secretary of State or any county clerk of the State of Illinois, or any political action committee registered with either the Secretary of State or the Federal Board of Elections. Yes \_\_\_ No \_\_\_

---

(j) Relationship to anyone; spouse, father, mother, son, or daughter; who was a compensated employee in the last 2 years by any registered election or re-election committee registered with the Secretary of State or any county clerk of the State of Illinois, or any political action committee registered with either the Secretary of State or the Federal Board of Elections. Yes \_\_\_ No \_\_\_

---

**3 Communication Disclosure.**

Disclose the name and address of each lobbyist and other agent of the bidder or offeror who is not identified in Section 2 of this form, who is has communicated, is communicating, or may communicate with any State officer or employee concerning the bid or offer. This disclosure is a continuing obligation and must be promptly supplemented for accuracy throughout the process and throughout the term of the contract. If no person is identified, enter "None" on the line below:

Name and address of person(s): \_\_\_\_\_  
\_\_\_\_\_  
\_\_\_\_\_  
\_\_\_\_\_

**RETURN WITH SUBCONTRACT**

**4. Debarment Disclosure.** For each of the persons identified under Sections 2 and 3 of this form, disclose whether any of the following has occurred within the previous 10 years: debarment from contracting with any governmental entity; professional licensure discipline; bankruptcies; adverse civil judgments and administrative findings; and criminal felony convictions. This disclosure is a continuing obligation and must be promptly supplemented for accuracy throughout the procurement process and term of the contract. If no person is identified, enter "None" on the line below:

Name of person(s): \_\_\_\_\_

Nature of disclosure: \_\_\_\_\_  
\_\_\_\_\_  
\_\_\_\_\_

**APPLICABLE STATEMENT**

**This Disclosure Form A is submitted on behalf of the INDIVIDUAL named on previous page. Under penalty of perjury, I certify the contents of this disclosure to be true and accurate to the best of my knowledge.**

Completed by:  \_\_\_\_\_ Date \_\_\_\_\_  
Signature of Individual or Authorized Officer

**NOT APPLICABLE STATEMENT**

**Under penalty of perjury, I have determined that no individuals associated with this organization meet the criteria that would require the completion of this Form A.**

**This Disclosure Form A is submitted on behalf of the SUBCONTRACTOR listed on the previous page.**

\_\_\_\_\_ Date \_\_\_\_\_  
Signature of Authorized Officer

RETURN WITH SUBCONTRACT

ILLINOIS DEPARTMENT OF TRANSPORTATION

Form B
Subcontractor: Other Contracts & Financial Related Information Disclosure

Form with fields: Subcontractor Name, Legal Address, City, State, Zip, Telephone Number, Email Address, Fax Number (if available)

Disclosure of the information contained in this Form is required by the Section 50-35 of the Code (30 ILCS 500). This information shall become part of the publicly available contract file. This Form B must be completed for subcontracts with a total value of \$50,000 or more, from subcontractors identified in Section 20-120 of the Code, and for all open-ended contracts.

DISCLOSURE OF OTHER CONTRACTS, SUBCONTRACTS, AND PROCUREMENT RELATED INFORMATION

1. Identifying Other Contracts & Procurement Related Information. The SUBCONTRACTOR shall identify whether it has any pending contracts, subcontracts, including leases, bids, proposals, or other ongoing procurement relationship with any other State of Illinois agency: Yes \_\_\_ No \_\_\_

If "No" is checked, the subcontractor only needs to complete the signature box on the bottom of this page.

2. If "Yes" is checked. Identify each such relationship by showing State of Illinois agency name and other descriptive information such as bid or project number (attach additional pages as necessary). SEE DISCLOSURE FORM INSTRUCTIONS:

THE FOLLOWING STATEMENT MUST BE CHECKED

Signature box with fields: Signature of Authorized Representative, Date

OWNERSHIP CERTIFICATION

Please certify that the following statement is true if the individuals for all submitted Form A disclosures do not total 100% of ownership

Any remaining ownership interest is held by individuals receiving less than \$106,447.20 of the bidding entity's or parent entity's distributive income or holding less than a 5% ownership interest.

Yes No N/A (Form A disclosure(s) established 100% ownership)





## NOTICE TO BIDDERS

**1. TIME AND PLACE OF OPENING BIDS.** Sealed proposals for the improvement described herein will be received by the Department of Transportation. Electronic bids are to be submitted to the electronic bidding system (icx-Integrated Contractors Exchange). Paper-based bids are to be submitted to the Chief Procurement Officer for the Department of Transportation in care of the Chief Contracts Official at the Harry R. Hanley Building, 2300 South Dirksen Parkway, in Springfield, Illinois until 10:00 o'clock a.m. June 13, 2014. All bids will be gathered, sorted, publicly opened and read in the auditorium at the Department of Transportation's Harry R. Hanley Building shortly after the 10:00 a.m. cut off time.

**2. DESCRIPTION OF WORK.** The proposed improvement is identified and advertised for bids in the Invitation for Bids as:

**Contract No. 76G23  
Various Counties  
Section DIST 8 GUARDRAIL 2015-1  
Various Routes  
District 8 Construction Funds**

**This project consists of repairing or replacing existing damaged steel plate beam guardrail, traffic barrier terminals, impact attenuators and median cable throughout District 8 on a work order basis.**

**3. INSTRUCTIONS TO BIDDERS.** (a) This Notice, the invitation for bids, proposal and letter of award shall, together with all other documents in accordance with Article 101.09 of the Standard Specifications for Road and Bridge Construction, become part of the contract. Bidders are cautioned to read and examine carefully all documents, to make all required inspections, and to inquire or seek explanation of the same prior to submission of a bid.

(b) State law, and, if the work is to be paid wholly or in part with Federal-aid funds, Federal law requires the bidder to make various certifications as a part of the proposal and contract. By execution and submission of the proposal, the bidder makes the certification contained therein. A false or fraudulent certification shall, in addition to all other remedies provided by law, be a breach of contract and may result in termination of the contract.

**4. AWARD CRITERIA AND REJECTION OF BIDS.** This contract will be awarded to the lowest responsive and responsible bidder considering conformity with the terms and conditions established by the Department in the rules, Invitation for Bids and contract documents. The issuance of plans and proposal forms for bidding based upon a prequalification rating shall not be the sole determinant of responsibility. The Department reserves the right to determine responsibility at the time of award, to reject any or all proposals, to readvertise the proposed improvement, and to waive technicalities.

By Order of the  
Illinois Department of Transportation

Ann L. Schneider,  
Secretary

INDEX  
FOR  
SUPPLEMENTAL SPECIFICATIONS  
AND RECURRING SPECIAL PROVISIONS

Adopted January 1, 2014

This index contains a listing of SUPPLEMENTAL SPECIFICATIONS, frequently used RECURRING SPECIAL PROVISIONS, and LOCAL ROADS AND STREETS RECURRING SPECIAL PROVISIONS.

ERRATA Standard Specifications for Road and Bridge Construction (Adopted 1-1-12) (Revised 1-1-14)

SUPPLEMENTAL SPECIFICATIONS

<u>Std. Spec. Sec.</u>	<u>Page No.</u>
101 Definition of Terms .....	1
102 Advertisement, Bidding, Award, and Contract Execution .....	2
105 Control of Work .....	3
106 Control of Materials .....	5
107 Legal Regulations and Responsibility to Public .....	6
108 Prosecution and Progress .....	14
109 Measurement and Payment .....	15
202 Earth and Rock Excavation .....	17
211 Topsoil and Compost .....	18
253 Planting Woody Plants .....	19
280 Temporary Erosion and Sediment Control .....	21
312 Stabilized Subbase .....	22
406 Hot-Mix Asphalt Binder and Surface Course .....	23
407 Hot-Mix Asphalt Pavement (Full-Depth) .....	26
420 Portland Cement Concrete Pavement .....	30
424 Portland Cement Concrete Sidewalk .....	32
440 Removal of Existing Pavement and Appurtenances .....	33
503 Concrete Structures .....	34
504 Precast Concrete Structures .....	37
506 Cleaning and Painting New Steel Structures .....	38
512 Piling .....	39
516 Drilled Shafts .....	40
521 Bearings .....	41
540 Box Culverts .....	42
588 Bridge Relief Joint System .....	43
589 Elastic Joint Sealer .....	45
602 Catch Basin, Manhole, Inlet, Drainage Structure, and Valve Vault Construction, Adjustment, and Reconstruction .....	46
603 Adjusting Frames and Grates of Drainage and Utility Structures .....	47
606 Concrete Gutter, Curb, Median, and Paved Ditch .....	49
610 Shoulder Inlets with Curb .....	50
639 Precast Prestressed Concrete Sight Screen .....	51
642 Shoulder Rumble Strips .....	52
643 Impact Attenuators .....	53
644 High Tension Cable Median Barrier .....	55
701 Work Zone Traffic Control and Protection .....	57
706 Impact Attenuators, Temporary .....	60
707 Movable Traffic Barrier .....	63
708 Temporary Water Filled Barrier .....	65
730 Wood Sign Support .....	67
780 Pavement Striping .....	68
860 Master Controller .....	73
1001 Cement .....	74
1003 Fine Aggregates .....	75
1004 Coarse Aggregates .....	77
1006 Metals .....	81
1011 Mineral Filler .....	83
1017 Packaged, Dry, Combined Materials for Mortar .....	84
1018 Packaged Rapid Hardening Mortar or Concrete .....	85
1019 Controlled Low-Strength Material .....	86
1020 Portland Cement Concrete .....	87

Various-Route  
Section Dist. 8 Guardrail 2015-1  
Various Counties  
Contract No. 76G23

1024	Grout and Nonshrink Grout .....	126
1030	Hot-Mix Asphalt .....	127
1040	Drain Pipe, Tile, Drainage Mat, and Wall Drain .....	132
1042	Precast Concrete Products .....	133
1070	Foundation and Breakaway Devices .....	134
1073	Controller .....	135
1081	Materials for Planting .....	136
1082	Preformed Bearing Pads .....	137
1083	Elastomeric Bearings .....	138
1095	Pavement Markings .....	139
1101	General Equipment .....	142
1102	Hot-Mix Asphalt Equipment .....	144
1105	Pavement Marking Equipment .....	146
1106	Work Zone Traffic Control Devices .....	147

RECURRING SPECIAL PROVISIONS

The following RECURRING SPECIAL PROVISIONS indicated by an "X" are applicable to this contract and are included by reference:

<u>CHECK SHEET #</u>	<u>PAGE NO.</u>
1	Additional State Requirements for Federal-Aid Construction Contracts (Eff. 2-1-69) (Rev. 1-1-10) ..... 149
2	Subletting of Contracts (Federal-Aid Contracts) (Eff. 1-1-88) (Rev. 5-1-93) ..... 152
3	X EEO (Eff. 7-21-78) (Rev. 11-18-80) ..... 153
4	X Specific Equal Employment Opportunity Responsibilities Non Federal-Aid Contracts (Eff. 3-20-69) (Rev. 1-1-94) ..... 163
5	X Required Provisions - State Contracts (Eff. 4-1-65) (Rev. 1-1-13) ..... 168
6	Asbestos Bearing Pad Removal (Eff. 11-1-03) ..... 173
7	Asbestos Waterproofing Membrane and Asbestos Hot-Mix Asphalt Surface Removal (Eff. 6-1-89) (Rev. 1-1-09) ..... 174
8	Haul Road Stream Crossings, Other Temporary Stream Crossings, and In-Stream Work Pads (Eff. 1-2-92) (Rev. 1-1-98) ..... 175
9	Construction Layout Stakes Except for Bridges (Eff. 1-1-99) (Rev. 1-1-07) ..... 176
10	Construction Layout Stakes (Eff. 5-1-93) (Rev. 1-1-07) ..... 179
11	Use of Geotextile Fabric for Railroad Crossing (Eff. 1-1-95) (Rev. 1-1-07) ..... 182
12	Subsealing of Concrete Pavements (Eff. 11-1-84) (Rev. 1-1-07) ..... 184
13	Hot-Mix Asphalt Surface Correction (Eff. 11-1-87) (Rev. 1-1-09) ..... 188
14	Pavement and Shoulder Resurfacing (Eff. 2-1-00) (Rev. 1-1-09) ..... 190
15	PCC Partial Depth Hot-Mix Asphalt Patching (Eff. 1-1-98) (Rev. 1-1-07) ..... 191
16	Patching with Hot-Mix Asphalt Overlay Removal (Eff. 10-1-95) (Rev. 1-1-07) ..... 193
17	Polymer Concrete (Eff. 8-1-95) (Rev. 1-1-08) ..... 194
18	PVC Pipeliner (Eff. 4-1-04) (Rev. 1-1-07) ..... 196
19	Pipe Underdrains (Eff. 9-9-87) (Rev. 1-1-07) ..... 197
20	X Guardrail and Barrier Wall Delineation (Eff. 12-15-93) (Rev. 1-1-12) ..... 198
21	Bicycle Racks (Eff. 4-1-94) (Rev. 1-1-12) ..... 202
22	Temporary Modular Glare Screen System (Eff. 1-1-00) (Rev. 1-1-07) ..... 204
23	Temporary Portable Bridge Traffic Signals (Eff. 8-1-03) (Rev. 1-1-07) ..... 206
24	X Work Zone Public Information Signs (Eff. 9-1-02) (Rev. 1-1-07) ..... 208
25	Night Time Inspection of Roadway Lighting (Eff. 5-1-96) ..... 209
26	English Substitution of Metric Bolts (Eff. 7-1-96) ..... 210
27	English Substitution of Metric Reinforcement Bars (Eff. 4-1-96) (Rev. 1-1-03) ..... 211
28	Calcium Chloride Accelerator for Portland Cement Concrete (Eff. 1-1-01) (Rev. 1-1-13) ..... 212
29	Portland Cement Concrete Inlay or Overlay for Pavements (Eff. 11-1-08) (Rev. 1-1-13) ..... 213
30	Quality Control of Concrete Mixtures at the Plant (Eff. 8-1-00) (Rev. 1-1-14) ..... 216
31	Quality Control/Quality Assurance of Concrete Mixtures (Eff. 4-1-92) (Rev. 1-1-14) ..... 224
32	Digital Terrain Modeling for Earthwork Calculations (Eff. 4-1-07) ..... 240
33	Pavement Marking Removal (Eff. 4-1-09) ..... 242
34	Preventive Maintenance – Bituminous Surface Treatment (Eff. 1-1-09) (Rev. 1-1-12) ..... 243
35	Preventive Maintenance – Cape Seal (Eff. 1-1-09) (Rev. 1-1-12) ..... 249
36	Preventive Maintenance – Micro-Surfacing (Eff. 1-1-09) (Rev. 1-1-12) ..... 264
37	Preventive Maintenance – Slurry Seal (Eff. 1-1-09) (Rev. 1-1-12) ..... 275
38	Temporary Raised Pavement Markers (Eff. 1-1-09) (Rev. 1-1-14) ..... 285
39	Restoring Bridge Approach Pavements Using High-Density Foam (Eff. 1-1-09) (Rev. 1-1-12) ..... 286

**TABLE OF CONTENTS**

LOCATION OF PROJECT ..... 1  
DESCRIPTION OF PROJECT ..... 1  
MONTHLY LABOR SUMMARY AND ACTIVITY REPORTING SYSTEM ..... 1  
TRAFFIC CONTROL PLAN ..... 4  
CONSTRUCTION AND MAINTENANCE SIGN SUPPORTS ..... 5  
TERM OF CONTRACT ..... 5  
PROSECUTION OF THE WORK ..... 5  
CONTROL OF WORK ..... 5  
FAILURE TO COMPLETE OR REPAIR – LIQUIDATED DAMAGES ..... 6  
WORK DURING PEAK HOURS ..... 6  
PENALTY DURING PEAK HOURS ..... 7  
WORK ZONE LANE CLOSURE REQUEST ..... 7  
INTERPRETATION OF QUANTITIES AND PAYMENT ..... 9  
WORK ORDER ..... 9  
CLASS OF WORK ..... 12  
COMPLETION TIME FOR WORK ORDERS ..... 12  
CALENDAR DAYS ..... 12  
CONTRACTOR’S RESPONSIBILITY FOR DAMAGE TO EXISTING STRUCTURES ..... 13  
THE CONTRACTOR’S LIABILITY ..... 13  
PROTECTION FOR DAMAGED LOCATIONS ..... 13  
REALIGNING POSTS ..... 14  
REMOVAL OR REPAIR OF GUARDRAIL ..... 14  
FINAL CLEAN UP ..... 15  
CONTRACTOR CONTACTS ..... 15  
CLEARING ..... 15  
GUARDRAIL BLOCKS ..... 15  
RAIL ELEMENT PLATES ..... 16  
RAIL ELEMENT PLATES (RADIUS) ..... 16  
TRAFFIC BARRIER TERMINAL, TYPE 1, SPECIAL ..... 17  
REPAIR TRAFFIC BARRIER TERMINAL TYPE 1 SPECIAL – POST ..... 18  
REPAIR TRAFFIC BARRIER TERMINAL TYPE 1, SPECIAL – RAIL ELEMENT PLATE ..... 18  
TRAFFIC BARRIER TERMINAL, TYPE 5 & 6 ..... 18  
SINGLE END SECTION ..... 19  
TRAFFIC BARRIER TERMINAL, TYPE 2 ..... 19

STEEL POSTS .....20

STEEL POSTS (SPECIAL).....20

STEEL POSTS, ATTACHED TO STRUCTURES .....21

REMOVE AND REINSTALL IMPACT ATTENUATORS .....21

REPAIR TRAFFIC BARRIER TERMINAL TYPE 1 SPECIAL (TANGENT) .....21

EXTRUDER HEAD .....22

REPAIR TRAFFIC BARRIER TERMINAL TYPE 1 SPECIAL (FLARED) AND TYPE 3A.....22

REPAIR TRAFFIC BARRIER TERMINAL TYPE 2, 5 AND 6 .....23

CABLE GUARD POST .....23

HIGH TENSION CABLE ROAD GUARDPOST .....24

HIGH TENSION CABLE POST REPAIR .....24

REPLACE HIGH TENSION CABLE GUARDPOST FOUNDATION .....24

HIGH TENSION CABLE SYSTEM MAINTENANCE .....25

MEDIAN CABLE .....25

LOCATING UNDERGROUND CABLE, SPECIAL.....25

STATUS OF UTILITIES TO BE ADJUSTED .....25

AUTOMATED FLAGGER ASSISTANCE DEVICES (BDE) .....26

CONSTRUCTION AIR QUALITY – DIESEL RETROFIT (BDE) .....27

CONTRACT CLAIMS (BDE).....29

SPEED DISPLAY TRAILER (BDE).....30

DISADVANTAGED BUSINESS ENTERPRISE PARTICIPATION (BDE).....31

PAYROLLS AND PAYROLL RECORDS (BDE) .....41

PROGRESS PAYMENTS (BDE) .....43

REMOVAL AND DISPOSAL OF REGULATED SUBSTANCES (BDE).....44

REMOVAL AND DISPOSAL OF SURPLUS MATERIALS (BDE).....48

TRACKING THE USE OF PESTICIDES (BDE).....49

TRAFFIC CONTROL SETUP AND REMOVAL FREEWAY/EXPRESSWAY (BDE) .....49

WEEKLY DBE TRUCKING REPORTS (BDE).....49

STEEL COST ADJUSTMENT (BDE) (RETURN FORM WITH BID).....50

## STATE OF ILLINOIS

---

### SPECIAL PROVISIONS

The following Special Provisions supplement the "Standard Specifications for Road and Bridge Construction," adopted January 1, 2012, the latest edition of the "Manual on Uniform Traffic Control Devices for Streets and Highways," and the "Manual of Test Procedures for Materials" in effect on the date of invitation for bids, and the Supplemental Specifications and Recurring Special Provisions indicated on the Check Sheet included herein which apply to and govern the construction of Various Routes; Section Dist. 8 Guardrail 2015-1; Various Counties; **Contract No. 76G23** and in case of conflict with any part or parts of said Specifications, the said Special Provisions shall take precedence and shall govern.

#### LOCATION OF PROJECT

This work is located on various State maintained routes district wide in Calhoun, Greene, Jersey, Madison, Bond, Clinton, St. Clair, Monroe, Washington and Randolph Counties.

#### DESCRIPTION OF PROJECT

The work to be completed under this contract consists of repairing or replacing existing damaged steel plate beam guardrail, traffic barrier terminals, impact attenuators, median cable and all associated appurtenances on a work order basis. Guardrail shall be repaired or replaced in accordance with the details and standards in the plans as directed by the Resident Engineer/Technician.

#### MONTHLY LABOR SUMMARY AND ACTIVITY REPORTING SYSTEM

Effective: 1-1-1995

Revised June 2001

##### I. Monthly Labor Summary Report, Form SBE 148

The prime contractor and each first and second tier sub-contractor, (hereinafter referred to as "subcontractor") shall submit a certified Monthly Labor Summary Report directly to the District Engineer.

This report is in lieu of submittal of the Monthly Workforce Analysis Report, Form SBE 956.

This report must be received in District Eight no later than the tenth day of the next month.

This Report shall be submitted by the prime contractor and each subcontractor, for each consecutive month, from the start, to the completion of their work on the contract.

The data source for this Report will be a summation of all personnel and hours worked on each subject contract for the month based on weekly payrolls for that month.

The Monthly Labor Summary Report is required to be submitted in one of the following formats:

- a.) For contractors having IDOT contracts valued in the aggregate at \$250,000 or less, the report may be typed or clearly handwritten using Form SBE 148 for submittal to the District Engineer for District Eight.
- b.) For contractors having IDOT contracts valued in the aggregate at more than \$250,000, the report must be submitted in a specific "Fixed Length Comma Delimited ASCII Text File Format". The subject file format is detailed on the next page. Submittal of this file may be by 3.5 inch disk, modem, or by e-mail.

II. Monthly Contract Activity Report, Form SBE 248

The prime contractor and each subcontractor shall submit a monthly report directly to the District Engineer reflecting their contract activity on all Illinois Department of Transportation contracts they have in force in District Eight.

This report shall be submitted for each consecutive month, from the start, to the completion of all contracts in District Eight.

The report must be received in the District Office no later than the tenth day of the next month.

Monthly Labor Summary and Activity Reporting System Codes and Formats

Indicated below for your reference are the Employee Codes and File Formats required for this system.

I.) Monthly Labor Summary Report, Form SBE 148

The following employee codes are to be used to identify each individual on the Summary Report:

- 1. **Gender:**        **M** - Male        **F** - Female
- 2. **Ethnic Group:**        **1** - White        **2** - Black        **3** - Hispanic  
                                 **4** - American Indian/Alaskan Native        **5** - Asian/Pacific Islander
- 3. **Work Classification:** **OF** - Official        **SU** - Supervisor        **FO** - Foremen  
                                 **CL** - Clerical        **CA** - Carpenter        **EO** - Operator        **ME** - Mechanic  
                                 **TD** - Truck Driver        **IW** - Ironworker        **PA** - Painter        **OT** - Other  
                                 **EL** - Electrician        **PP** - Pipefitter        **TE** - Technical        **LA** - Laborer  
                                 **CM** - Cement Mason





Compliance with this Special Provision shall be considered incidental to the cost of the contract and no additional compensation will be allowed for any costs incurred.

This Special Provision must be included in each subcontract agreement.

## TRAFFIC CONTROL PLAN

*Effective: July 12, 1993*

*Revised: May 12, 1997*

Traffic control shall be in accordance with the applicable sections of the "Standard Specifications for Road and Bridge Construction", the applicable guidelines contained in the "National Manual on Uniform Traffic Control Devices for Streets and Highways", Illinois Supplement to the National Manual of Uniform Traffic Control Devices, these Special Provisions, and any special details and Highway Standards contained herein and in the plans.

Special attention is called to Articles 107.09 and 107.14 of the "Standard Specifications for Road and Bridge Construction" and the following Highway Standards relating to traffic control:

701001	701006	701011	701101	701106	701201
701301	701400	701406	701421	701428	701456
701501	701502	701601	701602	701606	701701
701901					

In addition, the following Special Provision(s) will also govern traffic control for this project:

- Construction and Maintenance Sign Supports
- Work During Peak Hours
- Penalty During Peak Hours
- Work Zone Lane Closure Request
- Automated Flagger Assistance Device
- Traffic Control Setup and Removal Freeway/Expressway

**Method of Measurement and Basis of Payment.** The appropriate Traffic Control and Protection Standard shall be used at the work location as stated on the Work Order. Traffic Control and Protection Standards 701201, 701501, 701502, 701601, 701602, 701606, and 701701 will be paid for at the contract unit price per each for TRAFFIC CONTROL AND PROTECTION, CALL OUT WORK. Traffic Control and Protection Standards 701406, 701421, 701428, and 701456 will be paid for at the contract unit price per each for TRAFFIC CONTROL AND PROTECTION, FREEWAY/EXPRESSWAY, and CALL OUT WORK.

## **CONSTRUCTION AND MAINTENANCE SIGN SUPPORTS**

*Effective: April 21, 1981*

*Revised: November 1, 2006*

This work shall be done according to Section 1106 of the Standard Specifications and Highway Standard 701901 except as herein modified.

All construction signs mounted on permanent support for use in temporary traffic control having an area of 10 square feet (1 square meter) or more shall be mounted on two 4 in x 4 in (100 mm x 100 mm) or two 4 in x 6 in (100 mm x 150 mm) wood posts.

Type A metal post (two for each sign) conforming to Article 1006.29 of the Standard Specifications may be used in lieu of wood posts. Type A metal posts used for these signs may be unfinished.

This work shall not be paid for separately; but shall be considered included in the cost of the traffic control items in this contract.

## **TERM OF CONTRACT**

The term of this contract shall start on date of contract execution and end **365 calendar days** later.

## **PROSECUTION OF THE WORK**

The Resident Engineer/Technician will issue a work order to the Contractor prior to the Contractor proceeding with any work on this contract.

## **CONTROL OF WORK**

The Department may conduct frequent inspections of the respective work order locations to determine if the Contractor is performing repairs promptly and satisfactorily and in the manner specified in the contract. A final inspection will be made by the Department of all work locations and final quantities can be adjusted at that time.

The Department reserves the right to place maximum or minimum limits on the work force and/or equipment utilized by the Contractor to execute a work order.

**FAILURE TO COMPLETE OR REPAIR – LIQUIDATED DAMAGES**

Time is of the essence in the completion of each work order issued by the Department. Failure to make timely repairs will cause public inconvenience, endanger the public safety and subject the Department to public criticism. All repairs shall be completed within the completion time designated for each work order. The Contractor understands and agrees that performance will be expected in varying amounts and at various locations on the roadways designated in the contract according to the work orders issued by the Resident Engineer/Technician.

Should the Contractor fail to complete the work order within the completion time stipulated, the Contractor shall be liable to the Department for liquidated damages as specified in the following amounts:

<b>WORK ORDER AMOUNT</b>		<b>LIQUIDATED DAMAGES PER DAY</b>
From More Than	To And Including	
\$0	\$500	\$25
\$500	\$1000	\$50
\$1000	And over	\$100

The Department will deduct these liquidated damages from the monies due or to become due to the Contractor from the Department.

All repairs in progress may be halted immediately by the Resident Engineer/Technician and completion will not be permitted until the Contractor complies with the terms and conditions of the contract.

**WORK DURING PEAK HOURS**

Contractor will be permitted to work on any day from dawn to dusk unless work requires a lane restriction in a high volume area in which work may be restricted to non-rush hours.

Due to extremely high volume of traffic and on-going construction work on the Metro-St. Louis area river bridges and approaches and urban interstates, the following traffic control restrictions shall apply.

The Contractor shall have all lanes of traffic open during peak hours in the appropriate direction. The Contractor will not be allowed to conduct any type of operation in the open lanes or any type of operation that would impede the flow of traffic during peak hours. Peak hours are defined as:

I-55-70, I-64, I-270	6:00 a.m. to 9:00 a.m. WB	3:00 p.m. to 6:00 p.m. EB
I-255 (N of I-64)	6:00 a.m. to 9:00 a.m. SB	3:00 p.m. to 6:00 p.m. NB
I-255 (S of I-64)	6:00 a.m. to 9:00 a.m. NB	3:00 p.m. to 6:00 p.m. SB
IL 15	6:00 a.m. to 9:00 a.m. WB	3:00 p.m. to 6:00 p.m. EB
IL 3 (Waterloo to PSB)	6:00 a.m. to 9:00 a.m. NB	3:00 p.m. to 6:00 p.m. SB
IL 3 (PSB to I-270)	3:00 p.m. to 6:00 p.m. NB	6:00 a.m. to 9:00 a.m. SB

For all routes not listed above, the peak hours shall be determined by the Resident Engineer/Technician and will be noted on the Work Order.

### **PENALTY DURING PEAK HOURS**

If the Contractor fails to have all lanes of traffic open during the peak hour for traffic or conducts operations that will impede the flow of traffic during peak hours, a monetary penalty shall be assessed to the Contractor. The penalty shall be \$500 for each 15-minute period or a portion thereof during the peak hours.

### **WORK ZONE LANE CLOSURE REQUEST**

The Contractor will submit a lane closure request form for the work in the areas above. The IDOT Resident Engineer/Technician shall submit a work zone lane closure request to the Department before 2:00 p.m. the day before the closure will be implemented. The Department will review the request and will either approve or reject the request. If the Department rejects the request, the Contractor will not be allowed to implement the work zone.

All personnel, equipment and all traffic control shall be removed from lanes during the Peak Hours and no additional compensation shall be allowed for meeting these requirements.

Conformance to these traffic control and protection standards shall not be paid for as separate item, but shall be considered included in the cost of the contract.

The Contractor must notify Resident Engineer/Technician at (618) 394-2167 or other phone number as coordinated with the Resident Engineer/Technician or by fax number (618) 394-2196 of the scheduling of work one workday prior to repair. The jobs should be listed in order of repair. A penalty of the loss of traffic control value for the project will be assessed if work is started prior to notification. If no traffic control is associated with the project, a penalty of \$100 will be assessed for each start of work prior to notification. Verification of telephone contact may be made by facsimile machine to District Headquarters, Bureau of Operations, at Fax Number (618) 346-3266.

Damaged areas to be repaired will be identified in orange fluorescent paint and/or survey ribbon. The work order number should be visible at the repair site.

The traffic control standard recommended is based on the Department's estimate of the nature of work, duration and equipment required to perform the repairs. Any deviation must remain in compliance to the Standard Specifications for Road and Bridge Construction, IDOT Highway Standards, and the Manual on Uniform Traffic Control Devices, most recent edition and prior approval by the Department is required.

**WORK ZONE LANE CLOSURE REQUEST**

Must be called in to Jane Morgando (618-394-2162) or fax (618-394-2196) to IDOT by 2:00 P.M. for daytime closure (1:00 PM Friday for Sat, Sun, & Mon closures), 11:00 AM for same night.  
**DO NOT COMBINE CLOSURES USE INDIVIDUAL SHEETS FOR EACH HIGHWAY**

Date(s) of Closure   **Night**

>>> \* Use tomorrow's date if closure is after 4 P.M. <<<

⇔ HIGHWAY & DIRECTION ⇔

<input type="checkbox"/> I 55/70 <input type="checkbox"/> I 64 <input type="checkbox"/> I 70 <input type="checkbox"/> I 255 <input type="checkbox"/> I-270  <input type="checkbox"/> IL 3  <input type="checkbox"/> IL 15 <input type="checkbox"/> MLK Bridge	<input type="checkbox"/> EB <input type="checkbox"/> WB <input type="checkbox"/> EB <input type="checkbox"/> WB <input type="checkbox"/> EB <input type="checkbox"/> WB <input type="checkbox"/> NB <input type="checkbox"/> SB <input type="checkbox"/> EB <input type="checkbox"/> WB  <input style="width: 100px; height: 15px;" type="text"/>  <input type="checkbox"/> NB <input type="checkbox"/> SB  <input type="checkbox"/> EB <input type="checkbox"/> WB <input type="checkbox"/> EB <input type="checkbox"/> WB	<input type="checkbox"/> POPLAR ST. COMPLEX <input type="checkbox"/> I 55/70 (Mainline) <input type="checkbox"/> EB <input type="checkbox"/> WB  <input type="checkbox"/> WB C-D <input type="checkbox"/> EB C-D <input type="checkbox"/> Ramp 'G' Main St. to WB C-D <input type="checkbox"/> Ramp 'S' WB C-D to Tudor <input type="checkbox"/> Ramp 'D' EB C-D to Tudor <input type="checkbox"/> Ramp 'H' EB C-D to 4 <sup>th</sup> St. <input type="checkbox"/> Ramp 'A' Tudor West to PSB <input type="checkbox"/> Ramp 'M' North to PSB <input type="checkbox"/> Ramp 'P' North to EB C-D <input type="checkbox"/> Ramp 'O' WB C-D to IL 3 South <input type="checkbox"/> Ramp 'N' EB C-D to IL 3 South
--	--	--

<b>LOCATION:</b>		FROM	<b>To:</b>	
------------------	--	------	------------	--

<b>LANES:</b> <<Left In. to Right In>> <input type="checkbox"/> 1 <input type="checkbox"/> 2 <input type="checkbox"/> 3 <input type="checkbox"/> 4 <input type="checkbox"/> 5/6	<b>SHOULDER</b> <input type="checkbox"/> Left <input type="checkbox"/> Right	<b>RAMPS</b> <input type="checkbox"/> Full <input type="checkbox"/> Exit <input type="checkbox"/> Partial (1/2) <input type="checkbox"/> Entrance
<input type="checkbox"/> <b>MOVING</b>	<input type="checkbox"/> <b>STATIONARY</b>	

**TIMES:** From: \_\_\_\_\_  A.M. /  P.M. To: \_\_\_\_\_  A.M. /  P.M.

From: \_\_\_\_\_  A.M. /  P.M. To: \_\_\_\_\_  A.M. /  P.M.

CLOSURE DESCRIPTION			
	LANE#	M	M
	LANE#	M	M
	LANE#	M	M
	LANE#	M	M

<b>CONTRACTOR/YARD:</b>	
<b>TRAFFIC CONTROL BY:</b>	
<b>SUBMITTED BY:</b>	

<b>PHONE NO:</b>	<b>FAX NO:</b>
<b>MOBILE NO:</b>	<b>PAGER NO:</b>

**Peak Hour Restrictions; Two (2) Lanes shall remain open at all times**

I 55/70, I 64, I 270, MLK Bridge	6:00 a to 9:00a WB	3:00p to 6:00p EB
I 255 from I 270 to JB Bridge	6:00a to 9:00a NB&SB	3:00p to 6:00p NB&SB
Ill. 3 from Ill.158 to I 270	6:00a to 9:00a NB&SB	3:00p to 6:00p NB&SB
Ill. 15 from Ill. 159 to Missouri	6:00a to 9:00a WB	3:00p to 6:00p EB

**INTERPRETATION OF QUANTITIES AND PAYMENT**

The quantities in the Summary of Quantities are approximate and include items necessary to repair existing damaged guardrail.

The quantities in the Summary of Quantities may be increased, decreased or deleted. Adjustments in contract unit prices shall not be made due to an increase, decrease or deletion of items.

Payment for the work under this contract shall be made according to the schedule of prices in the contract. Before any payment for work is authorized, for a given work order, all repairs must be completed satisfactorily and the guardrail installation must be functional as intended.

The Contractor is hereby informed that payment shall be made only for actual quantities utilized and accepted as satisfactory.

**WORK ORDER**

No work, except for priority work, is to be performed by the Contractor without the issuance of a work order authorizing the work. A work order will show the class of work, date issued to the Contractor, claim number, location, item description, and quantity of removals or repairs to be made. Only the amount of replacement or repairs shown on the work order is to be done by the Contractor. If, at the time repairs are being made, it is found that additional work is needed, prior approval must be obtained from the Resident Engineer/Technician before work is done. Any additional work done by the Contractor, without prior approval of the Resident Engineer/Technician, will not be paid. A sample work order (project identification sheet) is included in the special provisions.

The Contractor shall contact the Resident Engineer/Technician by telephone no later than 7:00 AM each work day, or at another time specified by the Resident Engineer/Technician, to coordinate and obtain approval for daily work. The Contractor shall not revise the sequence of daily planned work without the Resident Engineer/Technician's approval. The Contractor shall contact the Resident Engineer/Technician on Monday through Friday, and at least 24 hours in advance of Saturday, Sunday or holiday work.

The Resident Engineer/Technician will issue all work orders except priority work to the Contractor at a location or method as approved by the Resident Engineer/Technician.

The Contractor shall inspect in detail the site of the work to determine the traffic control and protection requirements before proceeding with the work.

After the work is completed, inspected and accepted, the work order will be signed and dated by the Resident Engineer/Technician. The Contractor will be given one copy of the work order for their records.

Priority work will be initiated by a verbal order from the Resident Engineer/Technician. This verbal order will always be confirmed by a written work order.





**PROJECT IDENTIFICATION SHEET**

Claim # : C-12                      Date: \_\_\_\_\_  
 Location : \_\_\_\_\_  
  
 County : \_\_\_\_\_  
 Appr. Shoulder Width : \_\_\_\_\_



- TRAFFIC CONTROL
- |                                 |  |
|---------------------------------|--|
| 701421 <input type="checkbox"/> | 701201 <input type="checkbox"/>        |
| 701406 <input type="checkbox"/> | 701701 <input type="checkbox"/>        |
| 701101 <input type="checkbox"/> | No Work 6-9AM <input type="checkbox"/> |
|                                 | No Work 3-6PM <input type="checkbox"/> |

ITEM CODE	QUANTITY	UNIT COST	TOTAL	DESCRIPTION OF WORK
				GUARDRAIL BLOCKS
				RAIL ELEMENT PLATES
				TRAFFIC BARRIER TERM TYPE 1 SPL (FLARED)
				REPAIR T.B. TYPE 1 SPECIAL - POST
				REPAIR T.B. TYPE 1 SPL. RAIL ELEMENT PLATE
				TRAFFIC BARRIER TERM. TYPE 5
				SINGLE END SECTION
				TRAFFIC BARRIER TERM TYPE 1B
				STEEL POST
				STEEL POST, ATTACHED TO STRUCTURE
				STEEL POST (SPECIAL)
				REMOVAL/REINSTALLATION OF EXISTING IMPACT ATT
				REPAIR T.B. TERM. TYPE 1 SPL (TANGENT)
				REPAIR T.B. TERM TYPE 2
				FURNISHING AND INSTALLING EXTRUDER HEAD
				CABLE GUARD POST
				HIGH TENSION CABLE POST REPAIR
				REPAIR HIGH TENSION CABLE
				MEDIAN CABLE
				TRAFFIC BARRIER TERM TYPE 2
				REPLACE HIGH TENSION CABLE GUARDPOST FOUNDATION
				LOCATE UNDERGROUND CABLE SPECIAL
				ADDITIONAL WARNING LIGHTS BILLED <input checked="" type="radio"/> Yes <input type="radio"/> No
<b>TOTAL:</b>				

Note: All miscellaneous nuts, bolts, hardware, etc. are assumed required, and incidental.

Office Use Only

Survey \_\_\_\_\_  
 Completed \_\_\_\_\_ Accepted \_\_\_\_\_ By \_\_\_\_\_

## **CLASS OF WORK**

### **1. Priority Work**

Priority work is defined as work that is required to correct a condition which is an immediate hazard to the public, or is designated by the Resident Engineer/Technician to be an immediate hazard of such severity that life and/or property are potentially endangered and first priority corrective action is required.

The location of guardrail and appurtenances to be repaired as priority work shall be determined by the Resident Engineer/Technician and may be required at any time.

### **2. Regular Work**

Regular Work is defined as work that involves those situations where the amount or nature of damage does not pose an immediate hazard to the public. Work of this type shall generally be grouped by locations for efficiency of repair.

## **COMPLETION TIME FOR WORK ORDERS**

The Contractor shall schedule his/her operations in order to complete a Priority Work Order within 24 to 48 hours after the date issued.

The Contractor shall schedule his/her operations in order to complete a Regular Work Order within fifteen (15) calendar days after the date issued.

## **CALENDAR DAYS**

A calendar day is every day shown on the calendar and starts at 12:00 midnight and ends at the following 12:00 midnight, twenty-four (24) hours later.

A calendar day will be charged for every day shown on the calendar except as follows:

- a) When the temperature, as officially reported by the Bureau of Operations in District 8, reaches zero degrees Fahrenheit or below during any portion of that day.
- b) When weather conditions, emergency conditions and/or unforeseen highway operational reasons prevent shoulder or lane closures required for the work.
- c) When the Contractor requests and is denied approval from the Department for lane, ramp and shoulder closures required for the work.
- d) During any legal holiday period as defined in Article 107.09 of the Standard Specifications for Road and Bridge Construction.

The Contractor shall petition the Resident Engineer/Technician in writing within 48 hours for each non-chargeable calendar day request. Failure to petition in time shall be just cause to deny the petition. Approval of non-chargeable calendar day requests shall be by the sole determination of the Resident Engineer/Technician.

### **CONTRACTOR'S RESPONSIBILITY FOR DAMAGE TO EXISTING STRUCTURES**

Extreme care shall be exercised when driving posts since there are drainage structures, storm sewers, sign foundations, culverts, electrical and surveillance conduit, and other existing objects within the immediate work limits of this project. Operations are to be conducted in a manner, which will minimize damage to the surrounding area.

The Contractor shall be held responsible for any damage to existing structures resulting from his operations. The Contractor shall, at his own expense, restore the damaged structures to a condition equal to that existing before such damage was done by repairing, rebuilding or replacing it as directed by the Resident Engineer/Technician. Where, in the opinion of the Resident Engineer/Technician, the Contractor through his operations has excessively damaged the surrounding area, the Contractor shall restore the surrounding area to a condition meeting the satisfaction of the Resident Engineer/Technician at his own expense.

No extra compensation will be allowed to the Contractor for compliance with this requirement.

### **THE CONTRACTOR'S LIABILITY**

The trees, shrubs and seeded areas on or adjacent to the work should be protected from unnecessary damage by the Contractor's operations in a manner satisfactory to the Resident Engineer/Technician. The Contractor shall be responsible for the damage or destruction of property of any character resulting from neglect, misconduct, or omission in the execution or non-execution of the work, or caused by defective work or the use of unsatisfactory materials. Such responsibilities shall not be released until the work has been completed and accepted according to the requirements of these Special Provisions.

The Contractor shall repair damage to any property, public or private, to a condition equivalent to its original condition at no cost to the Department. This work shall be done according to the applicable sections of the Standard Specifications or to the satisfaction of the Resident Engineer/Technician.

### **PROTECTION FOR DAMAGED LOCATIONS**

The Contractor shall be required to install and maintain barricades with flashing lights at priority work locations that have not been repaired within 48 hours after the date of the issuance of the work order.

The Department will initially have barricades installed at the priority work locations and the Contractor will have the option to assume the cost of these rented barricades after the 48 hours referred to above or have the barricades replaced with others. If the Contractor fails to exercise either of the above options, he shall be liable to the Department in the amount of \$1.40 per barricade per day, not as a penalty but as liquidated damages.

## **REALIGNING POSTS**

At designated locations of steel plate beam guardrail where the existing undamaged posts can be realigned and restored to the proper alignment without removing said posts from the ground, the posts shall be so plumbed and realigned by a method which does not require the pulling of the posts out of the existing post holes. The posts shall be straightened with their front faces on the line shown on the plans, or as ordered by the Resident Engineer/Technician and with their tops and bolt holes at the correct height so that the rail element plates bolted to them will be parallel to the surface of the shoulder.

The work as described herein shall be included in the contract unit price for the pay items involved.

## **REMOVAL OR REPAIR OF GUARDRAIL**

No guardrail shall be removed from State right-of-way under this contract unless each section to be removed is clearly marked for removal. A representative of the Department of Transportation will paint an "X" on each piece of guardrail to be removed. The type and quantity of each piece so marked will be listed on a work order. This work order, when issued to the Contractor, will be authorization for the removal or repair of the guardrail.

Material removed from State right-of-way will be disposed of by the Contractor outside the right-of-way limits at locations provided by him. None of this material shall be reused on this project. The removal, transportation and storage/disposal of material removed from the State right-of-way under this contract will not be paid for separately, but the cost thereof shall be included in the contract unit price for replacement items.

New material shall conform to the dimensions and shapes of the material to be replaced except as noted, and shall meet the requirements as specified under each item in these Special Provisions and on the plans. Damaged guardrail that has been removed shall be totally and completely replaced on the same day that it has been removed.

Any ground bituminous material adjacent to a concrete footing, which is removed or disturbed during the removal operations, shall be restored to its original condition and to the satisfaction of the Resident Engineer/Technician after the work has been completed. This restoration will not be paid for separately but shall be considered included in this item of work.

After the work is completed, the Contractor shall mark a rail element plate in the repair area using a paint stick with the work order number and date of repairs.

Immediately after the specified repairs have been made, all nut, bolts, washers, posts, rail elements and any other guardrail components, damaged or undamaged, which are to be scrapped, shall be completely removed from the State right-of-way. Failure to do so will be cause for rejection of work.

The cost of furnishing, installing, maintaining and removal of the Type I or Type II Barricades will not be paid for separately, but shall be included in the contract unit price for the pay items involved.

### **FINAL CLEAN UP**

Final clean-up shall conform to the requirements set forth in Article 104.06 of the Standard Specifications.

This will be required at each location where repair has been completed.

This work will not be paid for separately but shall be included in the contract unit price for the pay items involved.

### **CONTRACTOR CONTACTS**

The Contractor shall furnish a cellular phone with "Hands Free" capabilities which shall meet the approval of the Resident Engineer/Technician. The Contractor shall also provide the Resident Engineer/Technician with a digital camera as needed by the Resident Engineer/Technician. The cost of the above items shall be included in the contract unit price for the pay items involved and no additional compensation will be allowed.

### **CLEARING**

The Contractor is hereby informed and shall understand that at some locations of repairs shrubs, brush, weeds, and other vegetation may be encountered that must be removed in order to make the necessary repairs. The cleaning of shrubs, brush, weeds and other vegetation will not be paid for separately but shall be included in the contract unit price for the pay items involved. All work shall be done in a neat and workmanlike manner and to the satisfaction of the Resident Engineer/Technician.

### **GUARDRAIL BLOCKS**

This work shall consist of removing and replacing existing damaged guardrail block-outs. This work shall be done as directed by the Resident Engineer/Technician and according to Sections 630 and 632 of the Standard Specifications and details in the plans.

Replacement block-outs shall conform to the details and standards included in the plans.

Removal, furnishing, and installing of all bolts, nuts, washers and other hardware necessary to complete the work will not be paid for separately, but shall be included in the contract unit price for the pay items involved.

This work shall be paid for at the contract unit price per each for GUARDRAIL BLOCKS.

### **RAIL ELEMENT PLATES**

This work shall consist of removing all sections of damaged rail element plates including all associated hardware, and furnishing and installing new rail elements including all necessary hardware. This work shall be done as directed by the Resident Engineer/Technician and according to Sections 630 and 632 of the Standard Specifications.

Plates, nuts, bolts, washers and other hardware shall be galvanized and shall match the original and adjacent installation as to type and design.

The Contractor shall adjust and realign existing rail element plates adjacent to rail elements removed and replaced as directed by the Resident Engineer/Technician. Unbolting, bolting, adjusting, realigning or any other work necessary to accomplish the desired realignment shall be included in the contract unit price for the pay items involved.

The furnishing and installing of all bolts, nuts, washers and other hardware necessary to comply with the above mentioned Special Provision will not be paid for separately, but shall be included in the contract unit price for the pay items involved.

In order to clarify measurement and payment for work, the standard length of rail element plate shall be considered to be 12'-6". In the event existing damaged rail element plates to be removed and replaced measures 25 feet in length, they shall be considered as two (2) rail element plates of standard 12'-6" length.

This work shall be paid for at the contract unit price each for RAIL ELEMENT PLATES.

### **RAIL ELEMENT PLATES (RADIUS)**

This work shall consist of removing all sections of damaged radius rail element plates including all associated hardware, and furnishing and installing new rail elements including all necessary hardware. This work shall be done as directed by the Resident Engineer/Technician and according to Sections 630 and 632 of the Standard Specifications.

Plates, nuts, bolts, washers and other hardware shall be galvanized and shall match the original and adjacent installation as to type and design.

The Contractor shall adjust and realign existing rail element plates adjacent to radius rail elements removed and replaced as directed by the Resident Engineer/Technician. Unbolting, bolting, adjusting, realigning or any other work necessary to accomplish the desired realignment shall be included in the contract unit price for the pay items involved.

The furnishing and installing of all bolts, nuts, washers and other hardware necessary to comply with the above mentioned Special Provision will not be paid for separately, but shall be included in the contract unit price for the pay items involved.

In order to clarify measurement and payment for work, the standard length of radius rail element plate shall be considered to be 12'-6". In the event existing damaged radius rail element plate to be removed and replaced measures 25 feet in length, they shall be considered as two (2) radius rail element plates of standard 12'-6" length.

This work shall be paid for at the contract unit price each for RAIL ELEMENT PLATES (RADIUS).

#### **TRAFFIC BARRIER TERMINAL, TYPE 1, SPECIAL**

This work shall consist of removal and disposal of existing traffic barrier terminals and furnishing and installing a Traffic Barrier Terminal Type 1, Special of the type specified.

The Contractor shall completely remove the existing traffic barrier terminal. All posts, rail element plates and related components of the existing traffic barrier terminal, including the steel end post, shall be removed. The existing steel end post may be set in a concrete anchor or may have been driven according to the alternate requirements permissible at the time of the guardrail installation. In the event a concrete anchor is encountered, said concrete anchor shall be completely removed. After the concrete anchor is removed, the remaining hole shall be filled with sand or other suitable material approved by the Resident Engineer/Technician.

The Contractor shall completely remove any guardrail necessary to accommodate the new Traffic Barrier Terminal Type 1, Special. The Engineer (or Inspector) will make this determination and inform the Contractor prior to commencing repairs. All old posts shall be removed and the remaining holes shall be filled with sand or other suitable material approved by the Resident Engineer/Technician.

The Contractor shall adjust and realign existing rail element plates and posts adjacent to the new traffic barrier terminal, as directed by the Resident Engineer/Technician. Unbolting, bolting, adjusting, realigning, guardrail removal, or any other work necessary to accomplish the desired realignment shall be included in the contract unit price for the pay items involved.

The Contractor shall install a new Traffic Barrier Terminal, Type 1, Special or Flared as determined by the Resident Engineer/Technician according to Section 631.

The Contractor shall also install a Terminal Marker – Direct Applied according to the Recurring Special Provision for Guardrail and Barrier Wall Delineation, except the Terminal Marker – Direct Applied will not be paid for separately.

This work shall be paid for at the contract unit price each for TRAFFIC BARRIER TERMINAL TYPE 1, (SPECIAL) TANGENT and for TRAFFIC BARRIER TERMINAL TYPE 1, (SPECIAL) FLARED.

**REPAIR TRAFFIC BARRIER TERMINAL TYPE 1 SPECIAL – POST**

This work shall consist of removal and replacement of a damaged post, block and related hardware of a Traffic Barrier Terminal Type 1 Special. This work shall be done as directed by the Resident Engineer/Technician and according to Sections 631 of the Standard Specifications.

The Contractor shall adjust and realign existing rail element plates and posts adjacent to the traffic barrier terminal repaired, as directed by the Resident Engineer/Technician. Unbolting, bolting, adjusting, realigning or any other work necessary to accomplish the desired realignment shall be included in the contract unit price for the pay items involved.

Soil tubes shall be included in the cost of this item.

This work will be paid for at the contract unit price each for REPAIR TRAFFIC BARRIER TERMINAL TYPE 1 SPECIAL – POST.

**REPAIR TRAFFIC BARRIER TERMINAL TYPE 1, SPECIAL – RAIL ELEMENT PLATE**

This work shall consist of removal and replacement of 25 feet of damaged rail element plate and related hardware of a Traffic Barrier Terminal Type 1, Special. This work shall be done as directed by the Resident Engineer/Technician and according to Sections 631 of the Standard Specifications.

The Contractor shall adjust and realign existing rail element plates and posts adjacent to the traffic barrier terminal repaired, as directed by the Resident Engineer/Technician. Unbolting, bolting, adjusting, realigning or any other work necessary to accomplish the desired realignment shall be included in the contract unit price for the pay items involved.

This work will be paid for at the contract unit price each for REPAIR TRAFFIC BARRIER TERMINAL TYPE 1 SPECIAL - RAIL ELEMENT PLATE.

**TRAFFIC BARRIER TERMINAL, TYPE 5 & 6**

This work shall consist of furnishing and installing a Traffic Barrier Terminal Type 5 or 6 at the locations as specified by the Resident Engineer/Technician according to Section 631 of the Standard Specifications and the details in the plans.



The Contractor shall completely remove existing damaged or undamaged sub standard, Traffic Barrier Terminal Type 5 or Type 6. All posts, rail element plates and related components of the existing terminal section, as well as any length of the guardrail types needed to accommodate the new Traffic Barrier Type 5 or 6 shall be removed.

The Contractor shall install new Traffic Barrier Terminal Type 5 or 6 and all shims and blocks required by the Resident Engineer/Technician to facilitate proper attachment to structure walls.

The Contractor shall adjust and realign existing rail element plates and posts adjacent to the new traffic barrier terminal, as directed by the Resident Engineer/Technician. Unbolting, bolting, adjusting, realigning, guardrail removal, or any other work necessary to accomplish the desired realignment shall be included in the contract unit price for the pay items involved.

This work will be paid for at the contract unit price each for TRAFFIC BARRIER TERMINAL, TYPE 5 and TRAFFIC BARRIER TERMINAL, TYPE 6.

### **SINGLE END SECTION**

This work shall consist of removing a damaged steel plate beam guardrail end section or shoe and erecting a new end section or shoe at the same location. Refer to Standard 630001.

The end section is to match the existing and adjacent guardrail as to type and design.

The Contractor shall remove, furnish, and install all bolts, nuts, washers and other hardware necessary to complete the work.

This work shall be paid for at the contract unit price each for SINGLE END SECTION.

### **TRAFFIC BARRIER TERMINAL, TYPE 2**

This work shall consist of removal and disposal of existing traffic barrier terminals and furnishing and installing a Traffic Barrier Terminal, Type 2 at the locations as specified by the Resident Engineer/Technician according to Section 631 of the Standard Specifications and the details in the plans.

The Contractor shall completely remove existing damaged or undamaged terminal section having a minimum length of approximately 12.5 feet and may be as long as 25 feet with a Texas Turndown section. All posts, rail element plates and related components of the existing terminal section, including the steel end post, shall be removed. The existing steel end post encountered may be set in a concrete anchor or may have been driven in accord with the alternate requirements permissible at the time of the guardrail installation. In the event a concrete anchor is encountered, said concrete anchor shall be completely removed. After the concrete anchor is removed, the remaining hole shall be filled with sand or other suitable material approved by the Resident Engineer/Technician.

The Contractor shall install new Traffic Barrier Terminal, Type 2.

The Contractor shall adjust and realign existing rail element plates and posts adjacent to the new traffic barrier terminal, as directed by the Resident Engineer/Technician. Unbolting, bolting, adjusting, realigning, or any other work necessary to accomplish the desired realignment shall be included in the contract unit price for the pay items involved.

This work shall be paid for at the contract unit price each for TRAFFIC BARRIER TERMINAL, TYPE 2.

### **STEEL POSTS**

This work shall consist of removing a damaged guardrail post and erecting a new guardrail post at the same location. Refer to Standard 630001. This work shall be performed as directed by the Resident Engineer/Technician and according to Sections 630 and 632 of the Standard Specifications.

The proposed guardrail post will match the existing and adjacent guardrail posts as to type, length, and design.

The Contractor shall remove, furnish, and install all bolts, nuts, washers and other hardware necessary to complete the work.

This work shall be paid for at the contract unit price each for STEEL POSTS, of the length specified.

### **STEEL POSTS (SPECIAL)**

This work shall consist of unbolting the rail elements, removing a guardrail post that could be set in concrete, and furnishing and setting a new guardrail post set in portland cement concrete. Refer to Standard 630001. This work shall be performed as directed by the Resident Engineer/Technician and according to Sections 630 and 632 of the Standard Specifications and the detail in the plans.

The Contractor shall remove the damaged guardrail post and concrete, where existing damaged posts are set in concrete. The Contractor shall set a new guardrail post of the same length as that removed in concrete on the same alignment and at the proper height to coincide with the adjacent and adjoining guardrail. New guardrail posts shall match the existing installation.

Where existing damaged posts are not set in concrete and are shorter than the length specified in the appropriate standard due to impervious material or underground utilities encountered, the new guardrail posts shall be set in concrete according to the details as shown in Standard 630001 and at the proper height to coincide with the adjacent guardrail. New guardrail posts shall match the existing installation.

This work shall be paid for at the contract unit price each for STEEL POSTS (SPECIAL).

### **STEEL POSTS, ATTACHED TO STRUCTURES**

This work shall consist of removing a damaged guardrail post attached to a structure and erecting a new guardrail post attached to a structure at the same location. Refer to Standard 630101. This work shall be performed as directed by the Resident Engineer/Technician and according to Sections 630 and 632 of the Standard Specifications and the detail in the plans.

The proposed and replacement guardrail post shall match the existing and adjacent guardrail posts as to type, length and design.

The Contractor shall remove, furnish and install all bolts, nuts, washers and other hardware necessary to complete the work.

This work shall be paid for at the contract unit price each for STEEL POSTS, ATTACHED TO STRUCTURES.

### **REMOVE AND REINSTALL IMPACT ATTENUATORS**

This work shall consist of removing and replacing a damaged sand barrel impact attenuator at the locations specified by the Resident Engineer/Technician.

The Contractor shall replace sand barrels in kind with no additional compensation for the amount of sand used in the various types of barrels. The spacer or cone to determine the amount of sand is also included in this pay item.

This work shall be paid for at the contract unit price each for REMOVE AND REINSTALL IMPACT ATTENUATORS.

### **REPAIR TRAFFIC BARRIER TERMINAL TYPE 1 SPECIAL (TANGENT)**

This work shall consist of removing and replacing all damaged components from the approach nose of the terminal, up to and including the second post and the first 25 feet of rail element plate at the locations as specified by the Resident Engineer/Technician and according to Section 631 of the Standard Specifications.

The Contractor shall adjust and realign existing rail element plates and posts adjacent to or within the traffic barrier terminal repaired, as directed by the Resident Engineer/Technician. Unbolting, bolting, adjusting, realigning, excavating, filling post holes or any other work necessary to accomplish the desired realignment shall be included in the contract unit price for the pay items involved.

The Contractor shall replace the entire 25 feet of guardrail when the existing guardrail is damaged. Replacement of the 25 feet of steel plate beam guardrail shall not be included in the measurement for payment but shall be considered included in the cost of the item. Also included in the cost of this item are cable assemblies, strut, soil tubes, and all other hardware, excluding the extruder head.

The existing extruder head shall be reused and reattached to the Traffic Barrier Terminal if undamaged.

This work will be paid for at the contract unit price per each for REPAIR TRAFFIC BARRIER TERMINAL TYPE 1 SPECIAL (TANGENT).

When the extruder head is damaged, a new extruder head will be paid for separately as EXTRUDER HEAD.

### **EXTRUDER HEAD**

This work shall consist of removal and replacement of a Traffic Barrier Terminal Type 1 Extruder Head as specified by the Resident Engineer/Technician and according to Section 631 of the Standard Specifications.

This work will be used in conjunction with the pay item REPAIR TRAFFIC BARRIER TERMINAL TYPE 1 SPECIAL.

The Contractor shall also install a Terminal Marker – Direct Applied according to the Recurring Special Provision for Guardrail and Barrier Wall Delineation, except the Terminal Marker – Direct Applied will not be paid for separately.

This work will be paid for at the contract unit price per each for EXTRUDER HEAD.

### **REPAIR TRAFFIC BARRIER TERMINAL TYPE 1 SPECIAL (FLARED) AND TYPE 3A**

This work shall consist of removing and replacing all damaged components from the approach nose of the terminal, up to and including the second post and the first 25 feet of rail element plate at the locations as specified by the Resident Engineer/Technician and according to Section 631 of the Standard Specifications.

The Contractor shall adjust and realign existing rail element plates and posts adjacent to or within the traffic barrier terminal repaired, as directed by the Resident Engineer/Technician. Unbolting, bolting, adjusting, realigning, excavating, filling post holes or any other work necessary to accomplish the desired realignment shall be included in the contract unit price for the pay items involved.

The Contractor shall also install a Terminal Marker – Direct Applied according to the Recurring Special Provision for Guardrail and Barrier Wall Delineation, except the Terminal Marker – Direct Applied will not be paid for separately.

The entire 25 feet of guardrail shall be replaced when the existing guardrail is damaged. Replacement of the 25 feet of steel plate beam guardrail shall not be included in the measurement for payment but shall be considered included in the cost of this item. Also included in the cost of this item are cable assemblies, noses, strut, and all other hardware.

The repair of type 3A shall include repairing an existing C.A.T. system only.

This work will be paid for at the contract unit price per each for REPAIR TRAFFIC BARRIER TERMINAL TYPE 1 SPECIAL (FLARED) and REPAIR TRAFFIC BARRIER TERMINAL TYPE 3A.

### **REPAIR TRAFFIC BARRIER TERMINAL TYPE 2, 5 AND 6**

This work shall consist of removing and replacing damaged components of existing Traffic Barrier Terminals Type 2, 5 and 6 at the locations as specified by the Resident Engineer/Technician according to the applicable portions of the Standard Specifications, and Highway Standards 631011, 631026, 631031.

The Contractor shall adjust and realign existing rail element plates and posts adjacent to the traffic barrier terminal repaired, as directed by the Resident Engineer/Technician. Unbolting, bolting, adjusting, realigning, excavating or any other work necessary to accomplish the desired realignment shall be included in the contract unit price for the pay items involved.

This work will be paid for at the contract unit price each for REPAIR TRAFFIC BARRIER TERMINAL, of the type specified.

### **CABLE GUARD POST**

This work shall consist of removing a damaged cable road guard post and erecting a new cable road guard post at the same location. Refer to Standard 636001. This work shall be done as directed by the Resident Engineer/Technician and according to Sections 636 and 632 of the Standard Specifications.

The replacement cable road guard post shall conform to the length, size and type of the original installation of the cable road guard post. If required, reflectors, meeting the manufacturer's specifications for the type of guard post being replaced, or as approved by the Engineer, shall also be included with the replaced guard post, at a spacing determined by the Engineer.

Reinstalling and re-tensioning of the cable and all hardware necessary to complete the work including cable splices and turn buckles will not be paid for separately, but shall be included in the contract unit price for the pay items involved.

This work shall be paid for at the contract unit price each for CABLE GUARD POST.

### **HIGH TENSION CABLE ROAD GUARDPOST**

This work shall consist of removing a damaged high tension cable road guard post and erecting a new high tension cable road guard post at the same location. This work shall be done as directed by the Resident Engineer/Technician and according to the manufacturer's specifications.

The replacement high tension cable road guard post shall conform to the length, size and type of the original installation of the high tension cable road guard post.

If required, reflectors, meeting the manufacturer's specifications for the type of guard post being replaced, or as approved by the Resident Engineer/Technician, shall also be included with the replaced guard post, at a spacing determined by the Resident Engineer/Technician.

Retensioning of the cable will not be paid for separately.

This work shall be paid for at the contract unit price each for HIGH TENSION CABLE ROAD GUARDPOST.

### **HIGH TENSION CABLE POST REPAIR**

This work shall consist of repairing or replacing of all the necessary hardware on a high tension cable posts at locations specified by the Resident Engineer/Technician. This will include all necessary hardware including, but not limited to hairpin and lock plates, J-Bolts and washers at end sections or cable guides.

This work shall be paid for at the contract unit price each for HIGH TENSION CABLE POST REPAIR.

### **REPLACE HIGH TENSION CABLE GUARDPOST FOUNDATION**

This work shall consist of removing a damaged high tension cable guard post foundation and erecting a new high tension cable guard post foundation at the same location. This work shall be performed as directed by the Resident Engineer/Technician and according to the manufacturer's specifications.

The proposed high tension cable guard post foundation shall match the existing as to type, length, and design.

This work shall be paid for at the contract unit price each for REPLACE HIGH TENSION CABLE GUARDPOST FOUNDATION.

#### **HIGH TENSION CABLE SYSTEM MAINTENANCE**

This work shall consist of re-connecting median cable and replacing any splices, turnbuckles and anchor fittings as needed in order to re-tension the median cable to the manufacturer's specifications as warranted by the system being repaired at locations specified by the Resident Engineer/Technician Engineer.

This work shall be paid for at the contract unit price per each for HIGH TENSION CABLE SYSTEM MAINTENANCE.

#### **MEDIAN CABLE**

This work shall consist of installing median cable at locations specified by the Resident Engineer/Technician Engineer including all necessary hardware according to the manufacturer's specification as warranted by the existing system being repaired.

This work shall be paid for at the contract unit price per foot for MEDIAN CABLE.

#### **LOCATING UNDERGROUND CABLE, SPECIAL**

This work shall consist of locating and marking all state owned buried cable.

The Contractor shall take whatever precautions to protect the underground cable from damage during location and construction operations. In the event that the cable is damaged, the Contractor shall replace the cable in a manner satisfactory to the Resident Engineer/Technician, at his/her own expense.

This work will be paid for at the contract unit price each for LOCATING UNDERGROUND CABLE, SPECIAL.

#### **STATUS OF UTILITIES TO BE ADJUSTED**

##### **NO UTILITIES TO BE ADJUSTED**

The above represents the best information of the Department and is only included for the convenience of the bidder. The applicable provisions of Sections 102, 103, and Articles 105.07 and 107.20 of the Standard Specifications for Road and Bridge Construction shall apply.

If any utility adjustment or removal has not been completed when required by the Contractor's operation, the Contractor should notify the Engineer in writing. A request for an extension of time will be considered to the extent the Contractor's operations were affected.

## **AUTOMATED FLAGGER ASSISTANCE DEVICES (BDE)**

Effective: January 1, 2008

Description. This work shall consist of furnishing and operating automated flagger assistance devices (AFADs) as part of the work zone traffic control and protection for two-lane highways where two-way traffic is maintained over one lane of pavement. Use of these devices shall be at the option of the Contractor.

Equipment. AFADs shall be according to the FHWA memorandum, "MUTCD - Revised Interim Approval for the use of Automated Flagger Assistance Devices in Temporary Traffic Control Zones (IA-4R)", dated January 28, 2005. The devices shall be mounted on a trailer or a moveable cart and shall meet the requirements of NCHRP 350, Category 4.

The AFAD shall be the Stop/Slow type. This device uses remotely controlled "STOP" and "SLOW" signs to alternately control right-of-way.

Signs for the AFAD shall be according to Article 701.03 of the Standard Specifications and the MUTCD. The signs shall be 24 x 24 in. (600 x 600 mm) having an octagon shaped "STOP" sign on one side and a diamond shaped "SLOW" sign on the opposite side. The letters on the signs shall be 8 in. (200 mm) high. If the "STOP" sign has louvers, the full sign face shall be visible at a distance of 50 ft (15 m) and greater.

The signs shall be supplemented with one of the following types of lights.

- (a) Flashing Lights. When flashing lights are used, white or red flashing lights shall be mounted within the "STOP" sign face and white or yellow flashing lights within the "SLOW" sign face.
- (b) Stop and Warning Beacons. When beacons are used, a stop beacon shall be mounted 24 in. (600 mm) or less above the "STOP" sign face and a warning beacon mounted 24 in. (600 mm) or less above, below, or to the side of the "SLOW" sign face. As an option, a Type B warning light may be used in lieu of the warning beacon.

A "WAIT ON STOP" sign shall be placed on the right hand side of the roadway at a point where drivers are expected to stop. The sign shall be 24 x 30 in. (600 x 750 mm) with a black legend and border on a white background. The letters shall be at least 6 in. (150 mm) high.



This device may include a gate arm or mast arm that descends to a horizontal position when the "STOP" sign is displayed and rises to a vertical position when the "SLOW" sign is displayed. When included, the end of the arm shall reach at least to the center of the lane being controlled. The arm shall have alternating red and white retroreflective stripes, on both sides, sloping downward at 45 degrees toward the side on which traffic will pass. The stripes shall be 6 in. (150 mm) in width and at least 2 in. (50 mm) in height.

Flagging Requirements. Flaggers and flagging requirements shall be according to Article 701.13 of the Standard Specifications and the following.

AFADs shall be placed at each end of the traffic control, where a flagger is shown on the plans. The flaggers shall be able to view the face of the AFAD and approaching traffic during operation.

To stop traffic, the "STOP" sign shall be displayed, the corresponding lights/beacon shall flash, and when included, the gate arm shall descend to a horizontal position. To permit traffic to move, the "SLOW" sign shall be displayed, the corresponding lights/beacon shall flash, and when included, the gate arm shall rise to a vertical position.

If used at night, the AFAD location shall be illuminated according to Section 701 of the Standard Specifications.

When not in use, AFADs will be considered nonoperating equipment and shall be stored according to Article 701.11 of the Standard Specifications.

Basis of Payment. This work will not be paid for separately but shall be considered as included in the cost of the various traffic control items included in the contract.

## **CONSTRUCTION AIR QUALITY – DIESEL RETROFIT (BDE)**

| Effective: June 1, 2010

Revised: January 1, 2014

The reduction of emissions of particulate matter (PM) for off-road equipment shall be accomplished by installing retrofit emission control devices. The term "equipment" refers to diesel fuel powered devices rated at 50 hp and above, to be used on the jobsite in excess of seven calendar days over the course of the construction period on the jobsite (including rental equipment).

Contractor and subcontractor diesel powered off-road equipment assigned to the contract shall be retrofitted using the phased in approach shown below. Equipment that is of a model year older than the year given for that equipment's respective horsepower range shall be retrofitted:

Effective Dates	Horsepower Range	Model Year
June 1, 2010 <sup>1/</sup>	600-749	2002
	750 and up	2006
June 1, 2011 <sup>2/</sup>	100-299	2003
	300-599	2001
	600-749	2002
	750 and up	2006
June 1, 2012 <sup>2/</sup>	50-99	2004
	100-299	2003
	300-599	2001
	600-749	2002
	750 and up	2006

- 1/ Effective dates apply to Contractor diesel powered off-road equipment assigned to the contract.
- 2/ Effective dates apply to Contractor and subcontractor diesel powered off-road equipment assigned to the contract.

The retrofit emission control devices shall achieve a minimum PM emission reduction of 50 percent and shall be:

- a) Included on the U.S. Environmental Protection Agency (USEPA) *Verified Retrofit Technology List* (<http://www.epa.gov/cleandiesel/verification/verif-list.htm>), or verified by the California Air Resources Board (CARB) (<http://www.arb.ca.gov/diesel/verdev/vt/cvt.htm>); or
- b) Retrofitted with a non-verified diesel retrofit emission control device if verified retrofit emission control devices are not available for equipment proposed to be used on the project, and if the Contractor has obtained a performance certification from the retrofit device manufacturer that the emission control device provides a minimum PM emission reduction of 50 percent.

Note: Large cranes (Crawler mounted cranes) which are responsible for critical lift operations are exempt from installing retrofit emission control devices if such devices adversely affect equipment operation.

Diesel powered off-road equipment with engine ratings of 50 hp and above, which are unable to be retrofitted with verified emission control devices or if performance certifications are not available which will achieve a minimum 50 percent PM reduction, may be granted a waiver by the Department if documentation is provided showing good faith efforts were made by the Contractor to retrofit the equipment.

Construction shall not proceed until the Contractor submits a certified list of the diesel powered off-road equipment that will be used, and as necessary, retrofitted with emission control devices. The list(s) shall include (1) the equipment number, type, make, Contractor/rental company name; and (2) the emission control devices make, model, USEPA or CARB verification number, or performance certification from the retrofit device manufacturer. Equipment reported as fitted with emissions control devices shall be made available to the Engineer for visual inspection of the device installation, prior to being used on the jobsite.

The Contractor shall submit an updated list of retrofitted off-road construction equipment as retrofitted equipment changes or comes on to the jobsite. The addition or deletion of any diesel powered equipment shall be included on the updated list.

If any diesel powered off-road equipment is found to be in non-compliance with any portion of this special provision, the Engineer will issue the Contractor a diesel retrofit deficiency deduction.

Any costs associated with retrofitting any diesel powered off-road equipment with emission control devices shall be considered as included in the contract unit prices bid for the various items of work involved and no additional compensation will be allowed. The Contractor's compliance with this notice and any associated regulations shall not be grounds for a claim.

#### **Diesel Retrofit Deficiency Deduction**

When the Engineer determines that a diesel retrofit deficiency exists, a daily monetary deduction will be imposed for each calendar day or fraction thereof the deficiency continues to exist. The calendar day(s) will begin when the time period for correction is exceeded and end with the Engineer's written acceptance of the correction. The daily monetary deduction will be \$1,000.00 for each deficiency identified.

The deficiency will be based on lack of diesel retrofit emissions control.

If a Contractor accumulates three diesel retrofit deficiency deductions for the same piece of equipment in a contract period, the Contractor will be shutdown until the deficiency is corrected. Such a shutdown will not be grounds for any extension of the contract time, waiver of penalties, or be grounds for any claim.

#### **CONTRACT CLAIMS (BDE)**

Effective: April 1, 2014

Revise the first paragraph of Article 109.09(a) of the Standard Specifications to read:

“(a) Submission of Claim. All claims filed by the Contractor shall be in writing and in sufficient detail to enable the Department to ascertain the basis and amount of the claim. As a minimum, the following information must accompany each claim submitted.”

Revise Article 109.09(e) of the Standard Specifications to read:

“(e) Procedure. The Department provides two administrative levels for claims review.

- Level I Engineer of Construction
- Level II Chief Engineer/Director of Highways or Designee

- (1) Level I. All claims shall first be submitted at Level I. Two copies each of the claim and supporting documentation shall be submitted simultaneously to the District and the Engineer of Construction. The Engineer of Construction, in consultation with the District, will consider all information submitted with the claim and render a decision on the claim within 90 days after receipt by the Engineer of Construction. Claims not conforming to this Article will be returned without consideration. The Engineer of Construction may schedule a claim presentation meeting if in the Engineer of Construction’s judgment such a meeting would aid in resolution of the claim, otherwise a decision will be made based on the claim documentation submitted. If a Level I decision is not rendered within 90 days of receipt of the claim, or if the Contractor disputes the decision, an appeal to Level II may be made by the Contractor.
- (2) Level II. An appeal to Level II shall be made in writing to the Engineer of Construction within 45 days after the date of the Level I decision. Review of the claim at Level II shall be conducted as a full evaluation of the claim. A claim presentation meeting may be scheduled if the Chief Engineer/Director of Highways determines that such a meeting would aid in resolution of the claim, otherwise a decision will be made based on the claim documentation submitted. A Level II final decision will be rendered within 90 days of receipt of the written request for appeal.

Full compliance by the Contractor with the provisions specified in this Article is a contractual condition precedent to the Contractor’s right to seek relief in the Court of Claims. The Director’s written decision shall be the final administrative action of the Department. Unless the Contractor files a claim for adjudication by the Court of Claims within 60 days after the date of the written decision, the failure to file shall constitute a release and waiver of the claim.”

## **SPEED DISPLAY TRAILER (BDE)**

Effective: April 2, 2014

Add the following to Article 701.15(l) of the Standard Specifications:

- “(l) Speed Display Trailer. A speed display trailer shall be utilized on freeways and expressways as part of Highway Standard 701400. The trailer shall be placed on the right hand side of the roadway adjacent to, or within 100 ft (30 m) beyond, the first work zone speed limit sign.

Whenever the speed display trailer is not in use, it shall be considered non-operating equipment and shall be stored according to Article 701.11.”

Add the following to Article 701.20 of the Standard Specifications:

“(k) Speed Display Trailer will be paid for at the contract unit price per calendar month or fraction thereof for each trailer as SPEED DISPLAY TRAILER.”

Add the following to Article 1106.02 of the Standard Specifications:

“(o) Speed Display Trailer. The speed display trailer shall consist of a LED speed indicator display with self-contained, one-direction radar mounted on an orange see-through trailer. The height of the display and radar shall be such that it will function and be visible when located behind concrete barrier.

The speed measurement shall be by radar and provide a minimum detection distance of 1000 ft (300 m). The radar shall have an accuracy of  $\pm 1$  mile per hour.

The speed indicator display shall face approaching traffic and shall have a sign legend of “YOUR SPEED” immediately above or below the speed display. The digital speed display shall show two digits (00 to 99) in mph. The color of the changeable message legend shall be a yellow legend on a black background. The minimum height of the numerals shall be 18 in. (450 mm), and the nominal legibility distance shall be at least 750 ft (250 m).

The speed indicator display shall be equipped with a violation alert that flashes the displayed detected speed when the posted limit is exceeded. The speed indicator shall have a maximum speed cutoff. The display shall include automatic dimming for nighttime operation.

The speed indicator measurement and display functions shall be equipped with the power supply capable of providing 24 hours of uninterrupted service.”

## **DISADVANTAGED BUSINESS ENTERPRISE PARTICIPATION (BDE)**

Effective: September 1, 2000

Revised: August 2, 2011

**FEDERAL OBLIGATION.** The Department of Transportation, as a recipient of federal financial assistance, is required to take all necessary and reasonable steps to ensure nondiscrimination in the award and administration of contracts. Consequently, the federal regulatory provisions of 49 CFR Part 26 apply to this contract concerning the utilization of disadvantaged business enterprises. For the purposes of this Special Provision, a disadvantaged business enterprise (DBE) means a business certified by the Department in accordance with the requirements of 49 CFR Part 26 and listed in the Illinois Unified Certification Program (IL UCP) DBE Directory.

STATE OBLIGATION. This Special Provision will also be used by the Department to satisfy the requirements of the Business Enterprise for Minorities, Females, and Persons with Disabilities Act, 30 ILCS 575. When this Special Provision is used to satisfy state law requirements on 100 percent state-funded contracts, the federal government has no involvement in such contracts (not a federal-aid contract) and no responsibility to oversee the implementation of this Special Provision by the Department on those contracts. DBE participation on 100 percent state-funded contracts will not be credited toward fulfilling the Department's annual overall DBE goal required by the US Department of Transportation to comply with the federal DBE program requirements.

CONTRACTOR ASSURANCE. The Contractor makes the following assurance and agrees to include the assurance in each subcontract that the Contractor signs with a subcontractor.

The Contractor, subrecipient, or subcontractor shall not discriminate on the basis of race, color, national origin, or sex in the performance of this contract. The Contractor shall carry out applicable requirements of 49 CFR Part 26 in the award and administration of contracts funded in whole or in part with federal or state funds. Failure by the Contractor to carry out these requirements is a material breach of this contract, which may result in the termination of this contract or such other remedy as the recipient deems appropriate.

OVERALL GOAL SET FOR THE DEPARTMENT. As a requirement of compliance with 49 CFR Part 26, the Department has set an overall goal for DBE participation in its federally assisted contracts. That goal applies to all federal-aid funds the Department will expend in its federally assisted contracts for the subject reporting fiscal year. The Department is required to make a good faith effort to achieve the overall goal. The dollar amount paid to all approved DBE companies performing work called for in this contract is eligible to be credited toward fulfillment of the Department's overall goal.

CONTRACT GOAL TO BE ACHIEVED BY THE CONTRACTOR. This contract includes a specific DBE utilization goal established by the Department. The goal has been included because the Department has determined that the work of this contract has subcontracting opportunities that may be suitable for performance by DBE companies. The determination is based on an assessment of the type of work, the location of the work, and the availability of DBE companies to do a part of the work. The assessment indicates that, in the absence of unlawful discrimination, and in an arena of fair and open competition, DBE companies can be expected to perform **0.00%** of the work. This percentage is set as the DBE participation goal for this contract. Consequently, in addition to the other award criteria established for this contract, the Department will only award this contract to a bidder who makes a good faith effort to meet this goal of DBE participation in the performance of the work. A bidder makes a good faith effort for award consideration if either of the following is done in accordance with the procedures set for in this Special Provision:

- (a) The bidder documents that enough DBE participation has been obtained to meet the goal: or

- (b) The bidder documents that a good faith effort has been made to meet the goal, even though the effort did not succeed in obtaining enough DBE participation to meet the goal.

**DBE LOCATOR REFERENCES.** Bidders shall consult the IL UCP DBE Directory as a reference source for DBE-certified companies. In addition, the Department maintains a letting and item specific DBE locator information system whereby DBE companies can register their interest in providing quotes on particular bid items advertised for letting. Information concerning DBE companies willing to quote work for particular contracts may be obtained by contacting the Department's Bureau of Small Business Enterprises at telephone number (217)785-4611, or by visiting the Department's website at [www.dot.il.gov](http://www.dot.il.gov).

**BIDDING PROCEDURES.** Compliance with this Special Provision is a material bidding requirement. The failure of the bidder to comply will render the bid not responsive.

- (a) The bidder shall submit a Disadvantaged Business Utilization Plan on Department forms SBE 2025 and 2026 with the bid.
- (b) The Utilization Plan shall indicate that the bidder either has obtained sufficient DBE participation commitments to meet the contract goal or has not obtained enough DBE participation commitments in spite of a good faith effort to meet the goal. The Utilization Plan shall further provide the name, telephone number, and telefax number of a responsible official of the bidder designated for purposes of notification of plan approval or disapproval under the procedures of this Special Provision.
- (c) The Utilization Plan shall include a DBE Participation Commitment Statement, Department form SBE 2025, for each DBE proposed for the performance of work to achieve the contract goal. For bidding purposes, submission of the completed SBE 2025 forms, signed by the DBEs and faxed to the bidder will be acceptable as long as the original is available and provided upon request. All elements of information indicated on the said form shall be provided, including but not limited to the following:
  - (1) The names and addresses of DBE firms that will participate in the contract;
  - (2) A description, including pay item numbers, of the work each DBE will perform;
  - (3) The dollar amount of the participation of each DBE firm participating. The dollar amount of participation for identified work shall specifically state the quantity, unit price, and total subcontract price for the work to be completed by the DBE. If partial pay items are to be performed by the DBE, indicate the portion of each item, a unit price where appropriate and the subcontract price amount;
  - (4) DBE Participation Commitment Statements, form SBE 2025, signed by the bidder and each participating DBE firm documenting the commitment to use the DBE subcontractors whose participation is submitted to meet the contract goal;

- (5) if the bidder is a joint venture comprised of DBE companies and non-DBE companies, the plan must also include a clear identification of the portion of the work to be performed by the DBE partner(s); and,
- (6) If the contract goal is not met, evidence of good faith efforts.

GOOD FAITH EFFORT PROCEDURES. The contract will not be awarded until the Utilization Plan submitted by the apparent successful bidder is approved. All information submitted by the bidder must be complete, accurate and adequately document that enough DBE participation has been obtained or document that good faith efforts of the bidder, in the event enough DBE participation has not been obtained, before the Department will commit to the performance of the contract by the bidder. The Utilization Plan will be approved by the Department if the Utilization Plan documents sufficient commercially useful DBE work performance to meet the contract goal or the bidder submits sufficient documentation of a good faith effort to meet the contract goal pursuant to 49 CFR Part 26, Appendix A. The Utilization Plan will not be approved by the Department if the Utilization Plan does not document sufficient DBE participation to meet the contract goal unless the apparent successful bidder documented in the Utilization Plan that it made a good faith effort to meet the goal. This means that the bidder must show that all necessary and reasonable steps were taken to achieve the contract goal. Necessary and reasonable steps are those which, by their scope, intensity and appropriateness to the objective, could reasonably be expected to obtain sufficient DBE participation, even if they were not successful. The Department will consider the quality, quantity, and intensity of the kinds of efforts that the bidder has made. Mere *pro forma* efforts, in other words, efforts done as a matter of form, are not good faith efforts; rather, the bidder is expected to have taken genuine efforts that would be reasonably expected of a bidder actively and aggressively trying to obtain DBE participation sufficient to meet the contract goal.

- (a) The following is a list of types of action that the Department will consider as part of the evaluation of the bidder's good faith efforts to obtain participation. These listed factors are not intended to be a mandatory checklist and are not intended to be exhaustive. Other factors or efforts brought to the attention of the Department may be relevant in appropriate cases, and will be considered by the Department.
  - (1) Soliciting through all reasonable and available means (e.g. attendance at pre-bid meetings, advertising and/or written notices) the interest of all certified DBE companies that have the capability to perform the work of the contract. The bidder must solicit this interest within sufficient time to allow the DBE companies to respond to the solicitation. The bidder must determine with certainty if the DBE companies are interested by taking appropriate steps to follow up initial solicitations.
  - (2) Selecting portions of the work to be performed by DBE companies in order to increase the likelihood that the DBE goals will be achieved. This includes, where appropriate, breaking out contract work items into economically feasible units to facilitate DBE participation, even when the prime Contractor might otherwise prefer to perform these work items with its own forces.



- (3) Providing interested DBE companies with adequate information about the plans, specifications, and requirements of the contract in a timely manner to assist them in responding to a solicitation.
- (4) a. Negotiating in good faith with interested DBE companies. It is the bidder's responsibility to make a portion of the work available to DBE subcontractors and suppliers and to select those portions of the work or material needs consistent with the available DBE subcontractors and suppliers, so as to facilitate DBE participation. Evidence of such negotiation includes the names, addresses, and telephone numbers of DBE companies that were considered; a description of the information provided regarding the plans and specifications for the work selected for subcontracting; and evidence as to why additional agreements could not be reached for DBE companies to perform the work.
  - b. A bidder using good business judgment would consider a number of factors in negotiating with subcontractors, including DBE subcontractors, and would take a firm's price and capabilities as well as contract goals into consideration. However, the fact that there may be some additional costs involved in finding and using DBE companies is not in itself sufficient reason for a bidder's failure to meet the contract DBE goal, as long as such costs are reasonable. Also the ability or desire of a bidder to perform the work of a contract with its own organization does not relieve the bidder of the responsibility to make good faith efforts. Bidders are not, however, required to accept higher quotes from DBE companies if the price difference is excessive or unreasonable.
- (5) Not rejecting DBE companies as being unqualified without sound reasons based on a thorough investigation of their capabilities. The bidder's standing within its industry, membership in specific groups, organizations, or associations and political or social affiliations (for example union vs. non-union employee status) are not legitimate causes for the rejection or non-solicitation of bids in the bidder's efforts to meet the project goal.
- (6) Making efforts to assist interested DBE companies in obtaining bonding, lines of credit, or insurance as required by the recipient or Contractor.
- (7) Making efforts to assist interested DBE companies in obtaining necessary equipment, supplies, materials, or related assistance or services.
- (8) Effectively using the services of available minority/women community organizations; minority/women contractors' groups; local, state, and federal minority/women business assistance offices; and other organizations as allowed on a case-by-case basis to provide assistance in the recruitment and placement of DBE companies.

- (b) If the Department determines that the apparent successful bidder has made a good faith effort to secure the work commitment of DBE companies to meet the contract goal, the Department will award the contract provided that it is otherwise eligible for award. If the Department determines that the bidder has failed to meet the requirements of this Special Provision or that a good faith effort has not been made, the Department will notify the responsible company official designated in the Utilization Plan that the bid is not responsive. The notification shall include a statement of reasons for the determination.
- (c) The bidder may request administrative reconsideration of a determination adverse to the bidder within the five working days after the receipt of the notification date of the determination by delivering the request to the Department of Transportation, Bureau of Small Business Enterprises, Contract Compliance Section, 2300 South Dirksen Parkway, Room 319, Springfield, Illinois 62764 (Telefax: (217)785-1524). Deposit of the request in the United States mail on or before the fifth business day shall not be deemed delivery. The determination shall become final if a request is not made and delivered. A request may provide additional written documentation and/or argument concerning the issues raised in the determination statement of reasons, provided the documentation and arguments address efforts made prior to submitting the bid. The request will be forwarded to the Department's Reconsideration Officer. The Reconsideration Officer will extend an opportunity to the bidder to meet in person in order to consider all issues of documentation and whether the bidder made a good faith effort to meet the goal. After the review by the Reconsideration Officer, the bidder will be sent a written decision within ten working days after receipt of the request for consideration, explaining the basis for finding that the bidder did or did not meet the goal or make adequate good faith efforts to do so. A final decision by the Reconsideration Officer that a good faith effort was made shall approve the Utilization Plan submitted by the bidder and shall clear the contract for award. A final decision that a good faith effort was not made shall render the bid not responsive.

CALCULATING DBE PARTICIPATION. The Utilization Plan values represent work anticipated to be performed and paid for upon satisfactory completion. The Department is only able to count toward the achievement of the overall goal and the contract goal the value of payments made for the work actually performed by DBE companies. In addition, a DBE must perform a commercially useful function on the contract to be counted. A commercially useful function is generally performed when the DBE is responsible for the work and is carrying out its responsibilities by actually performing, managing, and supervising the work involved. The Department and Contractor are governed by the provisions of 49 CFR Part 26.55(c) on questions of commercially useful functions as it affects the work. Specific counting guidelines are provided in 49 CFR Part 26.55, the provisions of which govern over the summary contained herein.

- (a) DBE as the Contractor: 100 percent goal credit for that portion of the work performed by the DBE's own forces, including the cost of materials and supplies. Work that a DBE subcontracts to a non-DBE does not count toward the DBE goals.

- (b) DBE as a joint venture Contractor: 100 percent goal credit for that portion of the total dollar value of the contract equal to the distinct, clearly defined portion of the work performed by the DBE's own forces.
- (c) DBE as a subcontractor: 100 percent goal credit for the work of the subcontract performed by the DBE's own forces, including the cost of materials and supplies, excluding the purchase of materials and supplies or the lease of equipment by the DBE subcontractor from the prime Contractor or its affiliates. Work that a DBE subcontractor in turn subcontracts to a non-DBE does not count toward the DBE goal.
- (d) DBE as a trucker: 100 percent goal credit for trucking participation provided the DBE is responsible for the management and supervision of the entire trucking operation for which it is responsible. At least one truck owned, operated, licensed, and insured by the DBE must be used on the contract. Credit will be given for the following:
  - (1) The DBE may lease trucks from another DBE firm, including an owner-operator who is certified as a DBE. The DBE who leases trucks from another DBE receives credit for the total value of the transportation services the lessee DBE provides on the contract.
  - (2) The DBE may also lease trucks from a non-DBE firm, including from an owner-operator. The DBE who leases trucks from a non-DBE is entitled to credit only for the fee or commission is receives as a result of the lease arrangement.
- (e) DBE as a material supplier:
  - (1) 60 percent goal credit for the cost of the materials or supplies purchased from a DBE regular dealer.
  - (2) 100 percent goal credit for the cost of materials of supplies obtained from a DBE manufacturer.
  - (3) 100 percent credit for the value of reasonable fees and commissions for the procurement of materials and supplies if not a regular dealer or manufacturer.

**CONTRACT COMPLIANCE.** Compliance with this Special Provision is an essential part of the contract. The Department is prohibited by federal regulations from crediting the participation of a DBE included in the Utilization Plan toward either the contract goal or the Department's overall goal until the amount to be applied toward the goals has been paid to the DBE. The following administrative procedures and remedies govern the compliance by the Contractor with the contractual obligations established by the Utilization Plan. After approval of the Utilization Plan and award of the contract, the Utilization Plan and individual DBE Participation Statements become part of the contract. If the Contractor did not succeed in obtaining enough DBE participation to achieve the advertised contract goal, and the Utilization Plan was approved and contract awarded based upon a determination of good faith, the total dollar value of DBE work calculated in the approved Utilization Plan as a percentage of the awarded contract value shall become the amended contract goal. All work indicated for performance by an approved DBE shall be performed, managed, and supervised by the DBE executing the Participation Statement.

- (a) NO AMENDMENT. No amendment to the Utilization Plan may be made without prior written approval from the Department's Bureau of Small Business Enterprises. All requests for amendment to the Utilization Plan shall be submitted to the Department of Transportation, Bureau of Small Business Enterprises, Contract Compliance Section, 2300 South Dirksen Parkway, Room 319, Springfield, Illinois 62764. Telephone number (217)785-4611. Telefax number (217)785-1524.
- (b) TERMINATION OR REPLACEMENT. The Contractor shall not terminate or replace a DBE listed on the approved Utilization Plan, or perform with other forces work designated for a listed DBE except as provided in the Special Provision.
- (c) CHANGES TO WORK. Any deviation from the DBE condition-of-award or contract plans, specifications, or special provisions must be approved, in writing, by the Department as provided elsewhere in the Contract. The Contractor shall notify affected DBEs in writing of any changes in the scope of work which result in a reduction in the dollar amount condition-of-award to the contract. Where the revision includes work committed to a new DBE subcontractor, not previously involved in the project, then a Request for Approval of Subcontractor, Department form BC 260A, must be signed and submitted. If the commitment of work is in the form of additional tasks assigned to an existing subcontract, then a new Request for Approval of Subcontractor shall not be required. However, the Contractor must document efforts to assure that the existing DBE subcontractor is capable of performing the additional work and has agreed in writing to the change.
- (d) ALTERNATIVE WORK METHODS. In addition to the above requirements for reductions in the condition of award, additional requirements apply to the two cases of Contractor-initiated work substitution proposals. Where the contract allows alternate work methods which serve to delete or create underruns in condition of award DBE work, and the Contractor selects that alternate method or, where the Contractor proposes a substitute work method or material that serves to diminish or delete work committed to a DBE and replace it with other work, then the Contractor must demonstrate one of the following:
- (1) That the replacement work will be performed by the same DBE (as long as the DBE is certified in the respective item of work) in a modification of the condition of award;  
or
  - (2) That the DBE is aware that its work will be deleted or will experience underruns and has agreed in writing to the change. If this occurs, the Contractor shall substitute other work of equivalent value to a certified DBE or provide documentation of good faith efforts to do so; or
  - (3) That the DBE is not capable of performing the replacement work or has declined to perform the work at a reasonable competitive price. If this occurs, the Contractor shall substitute other work of equivalent value to a certified DBE or provide documentation of good faith efforts to do so.

(e) TERMINATION AND REPLACEMENT PROCEDURES. The Contractor shall not terminate or replace a DBE subcontractor listed in the approved Utilization Plan without prior written consent. This includes, but is not limited to, instances in which the Contractor seeks to perform work originally designated for a DBE subcontractor with its own forces or those of an affiliate, a non-DBE firm, or with another DBE firm. Written consent will be granted only if the Bureau of Small Business Enterprises agrees, for reasons stated in its concurrence document, that the Contractor has good cause to terminate or replace the DBE firm. Before transmitting to the Bureau of Small Business Enterprises any request to terminate and/or substitute a DBE subcontractor, the Contractor shall give notice in writing to the DBE subcontractor, with a copy to the Bureau, of its intent to request to terminate and/or substitute, and the reason for the request. The Contractor shall give the DBE five days to respond to the Contractor's notice. The DBE so notified shall advise the Bureau and the Contractor of the reasons, if any, why it objects to the proposed termination of its subcontract and why the Bureau should not approve the Contractor's action. If required in a particular case as a matter of public necessity, the Bureau may provide a response period shorter than five days.

For purposes of this paragraph, good cause includes the following circumstances:

- (1) The listed DBE subcontractor fails or refuses to execute a written contract;
- (2) The listed DBE subcontractor fails or refuses to perform the work of its subcontract in a way consistent with normal industry standards. Provided, however, that good cause does not exist if the failure or refusal of the DBE subcontractor to perform its work on the subcontract results from the bad faith or discriminatory action of the prime contractor;
- (3) The listed DBE subcontractor fails or refuses to meet the prime Contractor's reasonable, nondiscriminatory bond requirements;
- (4) The listed DBE subcontractor becomes bankrupt, insolvent, or exhibits credit unworthiness;
- (5) The listed DBE subcontractor is ineligible to work on public works projects because of suspension and debarment proceedings pursuant 2 CFR Parts 180, 215 and 1,200 or applicable state law.
- (6) You have determined that the listed DBE subcontractor is not a responsible contractor;
- (7) The listed DBE subcontractor voluntarily withdraws from the projects and provides to you written notice of its withdrawal;
- (8) The listed DBE is ineligible to receive DBE credit for the type of work required;
- (9) A DBE owner dies or becomes disabled with the result that the listed DBE contractor is unable to complete its work on the contract;

- (10) Other documented good cause that compels the termination of the DBE subcontractor. Provided, that good cause does not exist if the prime Contractor seeks to terminate a DBE it relied upon to obtain the contract so that the prime Contractor can self-perform the work for which the DBE contractor was engaged or so that the prime Contractor can substitute another DBE or non-DBE contractor after contract award.

When a DBE is terminated, or fails to complete its work on the Contract for any reason the Contractor shall make a good faith effort to find another DBE to substitute for the original DBE to perform at least the same amount of work under the contract as the terminated DBE to the extent needed to meet the established Contract goal.

- (f) PAYMENT RECORDS. The Contractor shall maintain a record of payments for work performed to the DBE participants. The records shall be made available to the Department for inspection upon request. After the performance of the final item of work or delivery of material by a DBE and final payment therefore to the DBE by the Contractor, but not later than thirty calendar days after payment has been made by the Department to the Contractor for such work or material, the Contractor shall submit a DBE Payment Agreement on Department form SBE 2115 to the Regional Engineer. If full and final payment has not been made to the DBE, the DBE Payment Agreement shall indicate whether a disagreement as to the payment required exists between the Contractor and the DBE or if the Contractor believes that the work has not been satisfactorily completed. If the Contractor does not have the full amount of work indicated in the Utilization Plan performed by the BDE companies indicated in the Utilization Plan and after good faith efforts are reviewed, the Department may deduct from contract payments to the Contractor the amount of the goal not achieved as liquidated and ascertained damages. The Contractor may request an administrative reconsideration of any amount deducted as damages pursuant to subsection (h) of this part.
- (g) ENFORCEMENT. The Department reserves the right to withhold payment to the Contractor to enforce the provisions of this Special Provision. Final payment shall not be made on the contract until such time as the Contractor submits sufficient documentation demonstrating achievement of the goal in accordance with this Special Provision or after liquidated damages have been determined and collected.
- (h) RECONSIDERATION. Notwithstanding any other provision of the contract, including but not limited to Article 109.09 of the Standard Specifications, the Contractor may request administrative reconsideration of a decision to deduct the amount of the goal not achieved as liquidated damages. A request to reconsider shall be delivered to the Contract Compliance Section and shall be handled and considered in the same manner as set forth in paragraph (c) of "Good Faith Effort Procedures" of this Special Provision, except a final decision that a good faith effort was not made during contract performance to achieve the goal agreed to in the Utilization Plan shall be the final administrative decision of the Department.

## **PAYROLLS AND PAYROLL RECORDS (BDE)**

Effective: January 1, 2014

FEDERAL AID CONTRACTS. Revise the following section of Check Sheet #1 of the Recurring Special Provisions to read:

### **“STATEMENTS AND PAYROLLS**

The payroll records shall include the worker’s name, the worker’s address, the worker’s telephone number when available, the worker’s social security number, the worker’s classification or classifications, the worker’s gross and net wages paid in each pay period, the worker’s number of hours worked each day, the worker’s starting and ending times of work each day. However, any Contractor or subcontractor who remits contributions to a fringe benefit fund that is not jointly maintained and jointly governed by one or more employers and one or more labor organization must additionally submit the worker’s hourly wage rate, the worker’s hourly overtime wage rate, the worker’s hourly fringe benefit rates, the name and address of each fringe benefit fund, the plan sponsor of each fringe benefit, if applicable, and the plan administrator of each fringe benefit, if applicable.

The Contractor and each subcontractor shall submit payroll records to the Engineer each week from the start to the completion of their respective work, except that full social security numbers and home addresses shall not be included on weekly transmittals. Instead, the payrolls shall include an identification number for each employee (e.g., the last four digits of the employee’s social security number). In addition, starting and ending times of work each day may be omitted from the payroll records submitted to the Engineer. The submittals shall be on the Department’s form SBE 48, or an approved facsimile. When there has been no activity during a work week, a payroll record shall still be submitted with the appropriate box (“No Work”, “Suspended”, or “Complete”) checked on the form.”

STATE CONTRACTS. Revise Section IV of Check Sheet #5 of the Recurring Special Provisions to read:

### **“IV.COMPLIANCE WITH THE PREVAILING WAGE ACT**

1. Prevailing Wages. All wages paid by the Contractor and each subcontractor shall be in compliance with The Prevailing Wage Act (820 ILCS 130), as amended, except where a prevailing wage violates a federal law, order, or ruling, the rate conforming to the federal law, order, or ruling shall govern. The Contractor shall be responsible to notify each subcontractor of the wage rates set forth in this contract and any revisions thereto. If the Department of Labor revises the wage rates, the Contractor will not be allowed additional compensation on account of said revisions.

2. Payroll Records. The Contractor and each subcontractor shall make and keep, for a period of five years from the later of the date of final payment under the contract or completion of the contract, records of the wages paid to his/her workers. The payroll records shall include the worker's name, the worker's address, the worker's telephone number when available, the worker's social security number, the worker's classification or classifications, the worker's gross and net wages paid in each pay period, the worker's number of hours worked each day, the worker's starting and ending times of work each day. However, any contractor or subcontractor who remits contributions to a fringe benefit fund that is not jointly maintained and jointly governed by one or more employers and one or more labor organization must additionally submit the worker's hourly wage rate, the worker's hourly overtime wage rate, the worker's hourly fringe benefit rates, the name and address of each fringe benefit fund, the plan sponsor of each fringe benefit, if applicable, and the plan administrator of each fringe benefit, if applicable. Upon seven business days' notice, these records shall be available at a location within the State, during reasonable hours, for inspection by the Department or the Department of Labor; and Federal, State, or local law enforcement agencies and prosecutors.
  
3. Submission of Payroll Records. The Contractor and each subcontractor shall submit payroll records to the Engineer each week from the start to the completion of their respective work, except that full social security numbers and home addresses shall not be included on weekly transmittals. Instead the payrolls shall include an identification number for each employee (e.g., the last four digits of the employee's social security number). In addition, starting and ending times of work each day may be omitted from the payroll records submitted to the Engineer. The submittals shall be on the Department's form SBE 48, or an approved facsimile. When there has been no activity during a work week, a payroll record shall still be submitted with the appropriate box ("No Work", "Suspended", or "Complete") checked on the form.

Each submittal shall be accompanied by a statement signed by the Contractor or subcontractor, or an officer, employee, or officer thereof, which avers that: (i) he or she has examined the records and such records are true and accurate; (ii) the hourly rate paid to each worker is not less than the general prevailing rate of hourly wages required by the Act; and (iii) the Contractor or subcontractor is aware that filing a payroll record that he/she knows to be false is a Class A misdemeanor.

4. Employee Interviews. The Contractor and each subcontractor shall permit his/her employees to be interviewed on the job, during working hours, by compliance investigators of the Department or the Department of Labor."



## **PROGRESS PAYMENTS (BDE)**

Effective: November 2, 2013

Revise Article 109.07(a) of the Standard Specifications to read:

“(a) Progress Payments. At least once each month, the Engineer will make a written estimate of the quantity of work performed in accordance with the contract, and the value thereof at the contract unit prices. The amount of the estimate approved as due for payment will be vouchered by the Department and presented to the State Comptroller for payment. No amount less than \$1000.00 will be approved for payment other than the final payment.

Progress payments may be reduced by liens filed pursuant to Section 23(c) of the Mechanics' Lien Act, 770 ILCS 60/23(c).

If a Contractor or subcontractor has defaulted on a loan issued under the Department's Disadvantaged Business Revolving Loan Program (20 ILCS 2705/2705-610), progress payments may be reduced pursuant to the terms of that loan agreement. In such cases, the amount of the estimate related to the work performed by the Contractor or subcontractor, in default of the loan agreement, will be offset, in whole or in part, and vouchered by the Department to the Working Capital Revolving Fund or designated escrow account. Payment for the work shall be considered as issued and received by the Contractor or subcontractor on the date of the offset voucher. Further, the amount of the offset voucher shall be a credit against the Department's obligation to pay the Contractor, the Contractor's obligation to pay the subcontractor, and the Contractor's or subcontractor's total loan indebtedness to the Department. The offset shall continue until such time as the entire loan indebtedness is satisfied. The Department will notify the Contractor and Fund Control Agent in a timely manner of such offset. The Contractor or subcontractor shall not be entitled to additional payment in consideration of the offset.

The failure to perform any requirement, obligation, or term of the contract by the Contractor shall be reason for withholding any progress payments until the Department determines that compliance has been achieved.”

## REMOVAL AND DISPOSAL OF REGULATED SUBSTANCES (BDE)

Effective: January 1, 2012

Revised: November 2, 2012

Revise Article 669.01 of the Standard Specifications to read:

**“669.01 Description.** This work shall consist of the transportation and proper disposal of contaminated soil and water. This work shall also consist of the removal, transportation, and proper disposal of underground storage tanks (UST), their content and associated underground piping to the point where the piping is above the ground, including determining the content types and estimated quantities.”

Revise Article 669.08 of the Standard Specifications to read:

**“669.08 Contaminated Soil and/or Groundwater Monitoring.** The Contractor shall hire a qualified environmental firm to monitor the area containing the regulated substances. The affected area shall be monitored with a photoionization detector (PID) utilizing a lamp of 10.6eV or greater or a flame ionization detector (FID). Any field screen reading on the PID or FID in excess of background levels indicates the potential presence of contaminated material requiring handling as a non-special waste, special waste, or hazardous waste. No excavated soils can be taken to a clean construction and demolition debris (CCDD) facility or an uncontaminated soil fill operation with detectable PID or FID meter readings that are above background. The PID or FID meter shall be calibrated on-site and background level readings taken and recorded daily. All testing shall be done by a qualified engineer/technician. Such testing and monitoring shall be included in the work. The Contractor shall identify the exact limits of removal of non-special waste, special waste, or hazardous waste. All limits shall be approved by the Engineer prior to excavation. The Contractor shall take all necessary precautions.

Based upon the land use history of the subject property and/or PID or FID readings indicating contamination, a soil or groundwater sample shall be taken from the same location and submitted to an approved laboratory. Soil or groundwater samples shall be analyzed for the contaminants of concern, including pH, based on the property's land use history or the parameters listed in the maximum allowable concentration (MAC) for chemical constituents in uncontaminated soil established pursuant to Subpart F of 35 Illinois Administrative Code 1100.605. The analytical results shall serve to document the level of soil contamination. Soil and groundwater samples may be required at the discretion of the Engineer to verify the level of soil and groundwater contamination.

Samples shall be grab samples (not combined with other locations). The samples shall be taken with decontaminated or disposable instruments. The samples shall be placed in sealed containers and transported in an insulated container to the laboratory. The container shall maintain a temperature of 39 °F (4 °C). All samples shall be clearly labeled. The labels shall indicate the sample number; date sampled location and elevation, and any other observations.

The laboratory shall use analytical methods which are able to meet the lowest appropriate practical quantitation limits (PQL) or estimated quantitation limit (EQL) specified in "Test Methods for Evaluating Solid Wastes, Physical/Chemical Methods", EPA Publication No. SW-846 and "Methods for the Determination of Organic Compounds in Drinking Water", EPA, EMSL, EPA-600/4-88/039. For parameters where the specified cleanup objective is below the acceptable detection limit (ADL), the ADL shall serve as the cleanup objective. For other parameters the ADL shall be equal to or below the specified cleanup objective."

Replace the first two paragraphs of Article 669.09 of the Standard Specifications with the following:

**"669.09 Contaminated Soil and/or Groundwater Management and Disposal.** The management and disposal of contaminated soil and/or groundwater shall be according to the following:

- (a) Soil Analytical Results Exceed Most Stringent MAC. When the soil analytical results indicate that detected levels exceed the most stringent maximum allowable concentration (MAC) for chemical constituents in uncontaminated soil established pursuant to Subpart F of 35 Illinois Administrative Code 1100.605, the soil shall be managed as follows:
  - (1) When analytical results indicate inorganic chemical constituents exceed the most stringent MAC but they are still considered within area background levels by the Engineer, the excavated soil can be utilized within the construction limits as fill, when suitable. Such soil excavated for storm sewers can be placed back into the excavated trench as backfill, when suitable, unless trench backfill is specified. If the soils cannot be utilized within the construction limits, they shall be managed and disposed of off-site as a non-special waste, special waste, or hazardous waste as applicable.
  - (2) When analytical results indicate chemical constituents exceed the most stringent MAC but do not exceed the MAC for a Metropolitan Statistical Area (MSA) County, the excavated soil can be utilized within the construction limits as fill, when suitable, or managed and disposed of off-site as "uncontaminated soil" at a CCDD facility or an uncontaminated soil fill operation within an MSA County provided the pH of the soil is within the range of 6.25 - 9.0, inclusive.
  - (3) When analytical results indicate chemical constituents exceed the most stringent MAC but do not exceed the MAC for an MSA County excluding Chicago, or the MAC within the Chicago corporate limits, the excavated soil can be utilized within the construction limits as fill, when suitable, or managed and disposed of off-site as "uncontaminated soil" at a CCDD facility or an uncontaminated soil fill operation within an MSA County excluding Chicago or within the Chicago corporate limits provided the pH of the soil is within the range of 6.25 - 9.0, inclusive.

- (4) When analytical results indicate chemical constituents exceed the most stringent MAC but do not exceed the MAC for an MSA County excluding Chicago, the excavated soil can be utilized within the construction limits as fill, when suitable, or managed and disposed of off-site as "uncontaminated soil" at a CCDD facility or an uncontaminated soil fill operation within an MSA County excluding Chicago provided the pH of the soil is within the range of 6.25 - 9.0, inclusive.
- (5) When the Engineer determines soil cannot be managed according to Articles 669.09(a)(1) through (a)(4) above, the soil shall be managed and disposed of off-site as a non-special waste, special waste, or hazardous waste as applicable.
- (b) Soil Analytical Results Do Not Exceed Most Stringent MAC. When the soil analytical results indicate that detected levels do not exceed the most stringent MAC but the pH of the soil is less than 6.25 or greater than 9.0, the excavated soil can be utilized within the construction limits or managed and disposed of off-site as "uncontaminated soil" according to Article 202.03. However the excavated soil cannot be taken to a CCDD facility or an uncontaminated soil fill operation.
- (c) Groundwater. When groundwater analytical results indicate the detected levels are above Appendix B, Table E of 35 Illinois Administrative Code 742, the most stringent Tier 1 Groundwater Remediation Objectives for Groundwater Component of the Groundwater Ingestion Route for Class 1 groundwater, the groundwater shall be managed off-site as a special waste.

All groundwater encountered within lateral trenches may be managed within the trench and allowed to infiltrate back into the ground. If the groundwater cannot be managed within the trench it must be removed as a special or hazardous waste. The Contractor is prohibited from managing groundwater within the trench by discharging it through any existing or new storm sewer. The Contractor shall install backfill plugs within the area of groundwater contamination.

One backfill plug shall be placed down gradient to the area of groundwater contamination. Backfill plugs shall be installed at intervals not to exceed 50 ft (15 m). Backfill plugs are to be 4 ft (1.2 m) long, measured parallel to the trench, full trench width and depth. Backfill plugs shall not have any fine aggregate bedding or backfill, but shall be entirely cohesive soil or any class of concrete. The Contractor shall provide test data that the material has a permeability of less than  $10^{-7}$  cm/sec according to ASTM D 5084, Method A or per another test method approved by the Engineer."

Revise Article 669.14 of the Standard Specifications to read:

**“669.14 Final Environmental Construction Report.** At the end of the project, the Contractor will prepare and submit three copies of the Environmental Construction Report on the activities conducted during the life of the project, one copy shall be submitted to the Resident Engineer, one copy shall be submitted to the District's Environmental Studies Unit, and one copy shall be submitted with an electronic copy in Adode.pdf format to the Geologic and Waste Assessment Unit, Bureau of Design and Environment, IDOT, 2300 South Dirksen Parkway, Springfield, Illinois 62764. The technical report shall include all pertinent information regarding the project including, but not limited to:

- (a) Measures taken to identify, monitor, handle, and dispose of soil or groundwater containing regulated substances, to prevent further migration of regulated substances, and to protect workers,
- (b) Cost of identifying, monitoring, handling, and disposing of soil or groundwater containing regulated substances, the cost of preventing further migration of regulated substances, and the cost for worker protection from the regulated substances. All cost should be in the format of the contract pay items listed in the contract plans (identified by the preliminary environmental site investigation (PESA) site number),
- (c) Plan sheets showing the areas containing the regulated substances,
- (d) Field sampling and testing results used to identify the nature and extent of the regulated substances,
- (e) Waste manifests (identified by the preliminary environmental site investigation (PESA) site number) for special or hazardous waste disposal, and
- (f) Landfill tickets (identified by the preliminary environmental site investigation (PESA) site number) for non-special waste disposal.”

Revise the second paragraph of Article 669.16 of the Standard Specifications to read:

“The transportation and disposal of soil and other materials from an excavation determined to be contaminated will be paid for at the contract unit price per cubic yard (cubic meter) for NON-SPECIAL WASTE DISPOSAL, SPECIAL WASTE DISPOSAL, or HAZARDOUS WASTE DISPOSAL.”

## REMOVAL AND DISPOSAL OF SURPLUS MATERIALS (BDE)

Effective: November 2, 2012

Revise the first four paragraphs of Article 202.03 of the Standard Specifications to read:

**“202.03 Removal and Disposal of Surplus, Unstable, Unsuitable, and Organic Materials.** Suitable excavated materials shall not be wasted without permission of the Engineer. The Contractor shall dispose of all surplus, unstable, unsuitable, and organic materials, in such a manner that public or private property will not be damaged or endangered.

Suitable earth, stones and boulders naturally occurring within the right-of-way may be placed in fills or embankments in lifts and compacted according to Section 205. Broken concrete without protruding metal bars, bricks, rock, stone, reclaimed asphalt pavement with no expansive aggregate, or uncontaminated dirt and sand generated from construction or demolition activities may be used in embankment or in fill. If used in fills or embankments, these materials shall be placed and compacted to the satisfaction of the Engineer; shall be buried under a minimum of 2 ft (600 mm) of earth cover (except when the materials include only uncontaminated dirt); and shall not create an unsightly appearance or detract from the natural topographic features of an area. Broken concrete without protruding metal bars, bricks, rock, or stone may be used as riprap as approved by the Engineer. If the materials are used for fill in locations within the right-of-way but outside project construction limits, the Contractor must specify to the Engineer, in writing, how the landscape restoration of the fill areas will be accomplished. Placement of fill in such areas shall not commence until the Contractor's landscape restoration plan is approved by the Engineer.

Aside from the materials listed above, all other construction and demolition debris or waste shall be disposed of in a licensed landfill, recycled, reused, or otherwise disposed of as allowed by State or Federal laws and regulations. When the Contractor chooses to dispose of uncontaminated soil at a clean construction and demolition debris (CCDD) facility or at an uncontaminated soil fill operation, it shall be the Contractor's responsibility to have the pH of the material tested to ensure the value is between 6.25 and 9.0, inclusive. A copy of the pH test results shall be provided to the Engineer.

A permit shall be obtained from IEPA and made available to the Engineer prior to open burning of organic materials (i.e., plant refuse resulting from pruning or removal of trees or shrubs) or other construction or demolition debris. Organic materials originating within the right-of-way limits may be chipped or shredded and placed as mulch around landscape plantings within the right-of-way when approved by the Engineer. Chipped or shredded material to be placed as mulch shall not exceed a depth of 6 in. (150 mm).”

### **TRACKING THE USE OF PESTICIDES (BDE)**

Effective: August 1, 2012

Add the following paragraph after the first paragraph of Article 107.23 of the Standard Specifications:

“Within 48 hours of the application of pesticides, including but not limited to herbicides, insecticides, algaecides, and fungicides, the Contractor shall complete and return to the Engineer, Operations form “OPER 2720”.”

### **TRAFFIC CONTROL SETUP AND REMOVAL FREEWAY/EXPRESSWAY (BDE)**

Effective: January 1, 2014

Add the following to the Article 701.18 of the Standard Specifications:

“(l) Standard 701428. When the shoulder width will not allow placement of the shoulder truck and provide 9 ft (3.0 m) of unobstructed lane width in the lane being closed, the shoulder truck shall not be used.”

Revise Article 701.19(a) of the Standard Specifications to read:

“(a) Not Measured. Traffic control and protection required under Standards 701001, 701006, 701011, 701101, 701106, 701301, 701311, 701400, 701426, 701427, and 701428 will not be measured for payment.”

### **WEEKLY DBE TRUCKING REPORTS (BDE)**

Effective: June 2, 2012

The Contractor shall provide a weekly report of Disadvantaged Business Enterprise (DBE) trucks hired by the Contractor or subcontractors (i.e. not owned by the Contractor or subcontractors) that are used on the jobsite; or used for the delivery and/or removal of equipment/material to and from the jobsite. The jobsite shall also include offsite locations, such as plant sites or storage sites, when those locations are used solely for this contract.

The report shall be submitted on the form provided by the Department within ten business days following the reporting period. The reporting period shall be Monday through Sunday for each week reportable trucking activities occur. The report shall be submitted to the Engineer and a copy shall be provided to the district EEO Officer.

Any costs associated with providing weekly DBE trucking reports shall be considered as included in the contract unit prices bid for the various items of work involved and no additional compensation will be allowed.

### **STEEL COST ADJUSTMENT (BDE) (RETURN FORM WITH BID)**

Effective: April 2, 2004

Revised: April 1, 2009

Description. Steel cost adjustments will be made to provide additional compensation to the Contractor, or a credit to the Department, for fluctuations in steel prices when optioned by the Contractor. The bidder shall indicate on the attached form whether or not this special provision will be part of the contract and submit the completed form with his/her bid. Failure to submit the form or failure to indicate contract number, company name, and sign and date the form shall make this contract exempt of steel cost adjustments for all items of steel. Failure to indicate "Yes" for any item of work will make that item of steel exempt from steel cost adjustment.

Types of Steel Products. An adjustment will be made for fluctuations in the cost of steel used in the manufacture of the following items:

- Metal Piling (excluding temporary sheet piling)
- Structural Steel
- Reinforcing Steel

Other steel materials such as dowel bars, tie bars, mesh reinforcement, guardrail, steel traffic signal and light poles, towers and mast arms, metal railings (excluding wire fence), and frames and grates will be subject to a steel cost adjustment when the pay items they are used in has a contract value of \$10,000 or greater.

Documentation. Sufficient documentation shall be furnished to the Engineer to verify the following:

- (a) The dates and quantity of steel, in lb (kg), shipped from the mill to the fabricator.
- (b) The quantity of steel, in lb (kg), incorporated into the various items of work covered by this special provision. The Department reserves the right to verify submitted quantities.

Method of Adjustment. Steel cost adjustments will be computed as follows:

$$SCA = Q \times D$$

- Where:
- SCA = steel cost adjustment, in dollars
  - Q = quantity of steel incorporated into the work, in lb (kg)
  - D = price factor, in dollars per lb (kg)



$$D = MPI_M - MPI_L$$

Where:  $MPI_M$  = The Materials Cost Index for steel as published by the Engineering News-Record for the month the steel is shipped from the mill. The indices will be converted from dollars per 100 lb to dollars per lb (kg).

$MPI_L$  = The Materials Cost Index for steel as published by the Engineering News-Record for the month prior to the letting. The indices will be converted from dollars per 100 lb to dollars per lb (kg).

The unit weights (masses) of steel that will be used to calculate the steel cost adjustment for the various items are shown in the attached table.

No steel cost adjustment will be made for any products manufactured from steel having a mill shipping date prior to the letting date.

If the Contractor fails to provide the required documentation, the method of adjustment will be calculated as described above; however, the  $MPI_M$  will be based on the date the steel arrives at the job site. In this case, an adjustment will only be made when there is a decrease in steel costs.

Basis of Payment. Steel cost adjustments may be positive or negative but will only be made when there is a difference between the  $MPI_L$  and  $MPI_M$  in excess of five percent, as calculated by:

$$\text{Percent Difference} = \{(MPI_L - MPI_M) \div MPI_L\} \times 100$$

Steel cost adjustments will be calculated by the Engineer and will be paid or deducted when all other contract requirements for the items of work are satisfied. Adjustments will only be made for fluctuations in the cost of the steel as described herein. No adjustment will be made for changes in the cost of manufacturing, fabrication, shipping, storage, etc.

The adjustments shall not apply during contract time subject to liquidated damages for completion of the entire contract.

**Attachment**

Item	Unit Mass (Weight)
Metal Piling (excluding temporary sheet piling)	
Furnishing Metal Pile Shells 12 in. (305 mm), 0.179 in. (3.80 mm) wall thickness)	23 lb/ft (34 kg/m)
Furnishing Metal Pile Shells 12 in. (305 mm), 0.250 in. (6.35 mm) wall thickness)	32 lb/ft (48 kg/m)
Furnishing Metal Pile Shells 14 in. (356 mm), 0.250 in. (6.35 mm) wall thickness)	37 lb/ft (55 kg/m)
Other piling	See plans
Structural Steel	See plans for weights (masses)
Reinforcing Steel	See plans for weights (masses)
Dowel Bars and Tie Bars	6 lb (3 kg) each
Mesh Reinforcement	63 lb/100 sq ft (310 kg/sq m)
Guardrail	
Steel Plate Beam Guardrail, Type A w/steel posts	20 lb/ft (30 kg/m)
Steel Plate Beam Guardrail, Type B w/steel posts	30 lb/ft (45 kg/m)
Steel Plate Beam Guardrail, Types A and B w/wood posts	8 lb/ft (12 kg/m)
Steel Plate Beam Guardrail, Type 2	305 lb (140 kg) each
Steel Plate Beam Guardrail, Type 6	1260 lb (570 kg) each
Traffic Barrier Terminal, Type 1 Special (Tangent)	730 lb (330 kg) each
Traffic Barrier Terminal, Type 1 Special (Flared)	410 lb (185 kg) each
Steel Traffic Signal and Light Poles, Towers and Mast Arms	
Traffic Signal Post	11 lb/ft (16 kg/m)
Light Pole, Tenon Mount and Twin Mount, 30 - 40 ft (9 - 12 m)	14 lb/ft (21 kg/m)
Light Pole, Tenon Mount and Twin Mount, 45 - 55 ft (13.5 - 16.5 m)	21 lb/ft (31 kg/m)
Light Pole w/Mast Arm, 30 - 50 ft (9 - 15.2 m)	13 lb/ft (19 kg/m)
Light Pole w/Mast Arm, 55 - 60 ft (16.5 - 18 m)	19 lb/ft (28 kg/m)
Light Tower w/Luminaire Mount, 80 - 110 ft (24 - 33.5 m)	31 lb/ft (46 kg/m)
Light Tower w/Luminaire Mount, 120 - 140 ft (36.5 - 42.5 m)	65 lb/ft (97 kg/m)
Light Tower w/Luminaire Mount, 150 - 160 ft (45.5 - 48.5 m)	80 lb/ft (119 kg/m)
Metal Railings (excluding wire fence)	
Steel Railing, Type SM	64 lb/ft (95 kg/m)
Steel Railing, Type S-1	39 lb/ft (58 kg/m)
Steel Railing, Type T-1	53 lb/ft (79 kg/m)
Steel Bridge Rail	52 lb/ft (77 kg/m)
Frames and Grates	
Frame	250 lb (115 kg)
Lids and Grates	150 lb (70 kg)

Return with Bid

**ILLINOIS DEPARTMENT  
OF TRANSPORTATION**

**OPTION FOR  
STEEL COST ADJUSTMENT**

The bidder shall submit this completed form with his/her bid. Failure to submit the form or properly complete contract number, company name, and sign and date the form shall make this contract exempt of steel cost adjustments for all items of steel. Failure to indicate "Yes" for any item of work will make that item of steel exempt from steel cost adjustment. After award, this form, when submitted shall become part of the contract.

**Contract No.:** \_\_\_\_\_

**Company Name:** \_\_\_\_\_

**Contractor's Option:**

Is your company opting to include this special provision as part of the contract plans for the following items of work?

- Metal Piling Yes
- Structural Steel Yes
- Reinforcing Steel Yes
- Dowel Bars, Tie Bars and Mesh Reinforcement Yes
- Guardrail Yes
- Steel Traffic Signal and Light Poles, Towers and Mast Arms Yes
- Metal Railings (excluding wire fence) Yes
- Frames and Grates Yes

**Signature:** \_\_\_\_\_ **Date:** \_\_\_\_\_

ADDITIONAL  
3/12/2014  
c:\pzw\work\chall\lande\enke\080301989\0876g23\st-r-plan.dgn

# STATE OF ILLINOIS

DEPARTMENT OF TRANSPORTATION

PLANS FOR PROPOSED

VARIOUS ROUTES  
SECTION DIST 8  
GUARDRAIL 2015-1  
VARIOUS COUNTIES

C-98-024-13

GUARDRAIL REPAIR &  
CABLE RAIL



LOCATION OF SECTION INDICATED THUS 

D-98-022-13

SEE PAGE 2  
FOR LOCATION MAP

JOINT UTILITY LOCATION  
INFORMATION FOR EXCAVATIONS  
PHONE: (800) 892-0123

SUBMITTED March 18, 2014

Jeffrey Z. K...  
DEPUTY DIRECTOR OF HIGHWAYS  
REGION FIVE ENGINEER

PASSED \_\_\_\_\_

\_\_\_\_\_  
ENGINEER OF DESIGN & ENVIRONMENT

APPROVED \_\_\_\_\_

\_\_\_\_\_  
DIRECTOR, DIVISION OF HIGHWAYS

PROJECT ENGINEER: PATTI LeBEAU (618) 346-3179  
SQUAD LEADER: BILLIE OWEN (618) 346-3209

CONTRACT NO. 76G23

PRINTED BY THE AUTHORITY OF THE STATE OF ILLINOIS  
PLOT DATE: 3/12/2014

# INDEX OF SHEETS

TOTAL SHEETS	SHEET NO.
18	2
CONTRACT NO. 76023	

- 1 COVER SHEET
- 2 LOCATION MAP, INDEX OF SHEETS
- 3-5 HIGHWAY STANDARDS AND GENERAL NOTES
- 6-8 SUMMARY OF QUANTITIES
- 9 HIGH TENSION CABLE LOCATION MAP
- 10-18 GUARDRAIL DETAILS



## LOCATION MAP AND INDEX OF SHEETS

VARIOUS ROUTES  
SECTION DIST 8 GUARDRAIL 2015-1  
VARIOUS COUNTIES

PLOT DATE: 3/12/2014

TOTAL SHEETS	SHEET NO.
18	3
CONTRACT NO. 76G23	

HIGHWAY STANDARDS

000001-06	631011-09	636001-02	701106-02	701421-06	701601-09
630001-10	631026-05	701001-02	701201-04	701428	701602-07
630101-09	631031-12	701006-05	701301-04	701456-03	701606-09
630301-06	635001-01	701011-04	701400-07	701501-06	701701-09
631006-08	635006-03	701101-04	701406-08	701502-06	701901-03

GENERAL NOTES

1. BEFORE ORDERING THE IMPACT ATTENUATORS, THE CONTRACTOR MUST CONTACT THE MAINTENANCE ENGINEER AT (618) 346-3279 OR (618) 346-3233 TO RECEIVE APPROVAL OF THE PROPOSED INSTALLATION.
2. ALL WORK IS TO BE REPLACED IN KIND OR AS INDICATED ON THE CONTRACT PLANS AND PROVISIONS.
3. THE LOCATIONS OF THE REPAIR AREAS SHALL BE DETERMINED BY THE ENGINEER.
4. GUARDRAIL WORK WILL INCLUDE ALIGNMENT AS NECESSARY TO RESTORE THE RAIL AND POST TO THE ORIGINAL CONDITIONS.
5. NO MATERIAL SHALL BE LEFT ON OR NEAR THE ROADWAY DURING NON-WORKING HOURS.
6. ANY NECESSARY TRAFFIC CONTROL WILL BE PROVIDED BY THE CONTRACTOR; APPROPRIATE STANDARDS ARE LISTED ABOVE.
7. THE LIMITS OF THE DAMAGED GUARDRAIL WILL BE MARKED WITH PAINT. THE REPLACEMENT PARTS AND THE QUANTITIES INDICATED ARE WITHIN THESE LIMITS AS MARKED.
8. GUARDRAIL MARKERS SHALL NOT BE ATTACHED TO TERMINAL SECTIONS. ALL OTHER MARKERS SHALL BE PLACED AT THE DISCRETION OF THE ENGINEER. COST OF MARKERS TO BE INCLUDED IN THE GUARDRAIL PAY ITEMS.
9. ILLINOIS STATE LAW REQUIRES A 48-HOUR NOTICE TO BE GIVEN TO UTILITIES BEFORE DIGGING. FIELD MARKING OF FACILITIES MAY BE OBTAINED BY CONTACTING J.U.L.I.E. (PHONE: 800 892-0123) OR FOR NON-MEMBER, THE UTILITY COMPANY DIRECTLY.

**HIGHWAY STANDARDS AND  
GENERAL NOTES**

VARIOUS ROUTES  
SECTION DIST 8 GUARDRAIL 2015-1  
VARIOUS COUNTIES

PLOT DATE: 3/12/2014

\*\*\*DATE\*\*  
3/12/2014  
c:\pwwork\prado\chellendesk\0331989\0876g23-sh-t-plen.dgn

TOTAL SHEETS	SHEET NO.
18	4
CONTRACT NO. 76G23	

GENERAL NOTES (CONTINUED)

10. A FLAGGER SHALL BE REQUIRED AT ALL TIMES WHEN WORKERS OR EQUIPMENT ARE ENCREACHING THE LANE OF TRAFFIC.
11. WHEN NO WORK IS BEING PERFORMED, THE FLAGGERS WILL NOT BE REQUIRED. IF THE FLAGGERS ARE NOT PRESENT, THE FLAGGER SIGNS SHALL BE REMOVED OR COVERED.
12. LIGHTS WILL NOT BE REQUIRED FOR DAY OPERATIONS.
13. UTILITY INTERFERENCES ARE NOT ANTICIPATED ON THIS CONTRACT. IT SHALL BE THE CONTRACTORS RESPONSIBILITY TO COORDINATE HIS CONSTRUCTION ACTIVITIES WITH THE VARIOUS UTILITY OWNERS. ALL POTENTIAL CONFLICTS SHALL BE INVESTIGATED AND REMEDIAL ACTION TAKEN PRIOR TO INTERRUPTION OF THE CONTRACTORS PROGRESS. NO ADDITIONAL COST SHALL BE ADDED TO THE CONTRACT RESULTING FROM UTILITY CONFLICTS.
14. PRIOR TO ORDERING ANY MATERIALS, THE CONTRACTOR SHALL CONFIRM THE TYPES AND SPECIFIC MANUFACTURER FOR THE GUARDRAIL AND CABLE REPAIRS REQUIRED.
15. 45 & 55 MPH SIGNS ARE INCLUDED IN ALL INTERSTATE LANE CLOSURES. IF THE LANE CLOSURE DURATION IS LESS THAN 4 HOURS, THE 45 & 55 MPH SIGNS ARE NOT REQUIRED.
16. ANY WORK ORDER MAY BE CANCELLED AT THE ENGINEER'S DISCRETION.
17. CORTEN ITEMS SHALL BE PAID FOR THE SAME AS REGULAR ITEMS.
18. NO OVERNIGHT LANE CLOSURES WILL BE ALLOWED.
19. ARTICLE 701.20 OF THE STANDARD SPECIFICATIONS DISCUSSES AN ADJUSTED UNIT PRICE. NO ADJUSTMENTS SHALL BE MADE TO THE TRAFFIC CONTROL PAY ITEMS FOR THIS CONTRACT.
20. THE CONTRACTOR SHALL BE ADVISED THAT THE GUARDRAIL PAY ITEMS INCLUDED IN THE PLANS MAY BE USED TO REPLACE/REPAIR SPBGR AND TRAFFIC BARRIER TERMINALS FOR EITHER THE CURRENT MIDWEST STYLES AS SHOWN IN THE HIGHWAY STANDARDS OR SPBGR AND TRAFFIC BARRIER TERMINALS INSTALLED PRIOR TO JAN. 1 2007 AS SHOWN IN THE PLAN DETAILS. NO ADDITIONAL COMPENSATION WILL BE ALLOWED FOR UTILIZING THE CURRENT MIDWEST STANDARDS.

GENERAL NOTES (CONT.)

VARIOUS ROUTES  
SECTION DIST 8 GUARDRAIL 2015-1  
VARIOUS COUNTIES

PLOT DATE: 3/12/2014

DATE: 3/12/2014  
C:\pwwork\pwwork\chell\endesk\ed0331989\ed876g23-sht-plen.dgn

TOTAL SHEETS	SHEET NO.
18	5
CONTRACT NO. 76G23	

GENERAL NOTES (CONTINUED)

21. THE DEPARTMENT STRONGLY ENCOURAGES THE PRIME CONTRACTOR AND THEIR APPROVED SUB-CONTRACTORS TO HIRE MINORITY, WOMEN AND DISADVANTAGED INDIVIDUALS FROM ITS FEDERALLY FUNDED HIGHWAY CONSTRUCTION CAREERS TRAINING PROGRAM (HCCTP) TO HELP MEET WORKFORCE AND TRAINEE GOALS. THIS PROGRAM IS TRAINING MINORITIES, WOMEN AND DISADVANTAGED INDIVIDUALS IN HIGHWAY CONSTRUCTION-RELATED SKILLS, E.G., MATH FOR THE TRADES, JOB READINESS, TECHNICAL SKILLS COURSEWORK (CARPENTRY, CONCRETE FLATWORK, BLUEPRINT READING, SITE PLANS, SITE WORK, TOOLS USE, ETC.) AND OSHA 10 HOUR CERTIFICATION, TO PREPARE THEM FOR A CAREER IN THE HIGHWAY CONSTRUCTION TRADES. GRADUATES ARE WELL-TRAINED AND READY TO BECOME PRODUCTIVE ENTRY-LEVEL CONSTRUCTION WORKERS. CONTACT THE DISTRICT 8 EEO OFFICE AT 618-346-3360 AND/OR THE HCCTP COORDINATOR AT 618-874-6528 TO LEARN MORE ABOUT THE PROGRAM AND FOR ASSISTANCE IN MEETING WORKFORCE AND TRAINEE GOALS.

GENERAL NOTES (CONT.)

VARIOUS ROUTES  
SECTION DIST 8 GUARDRAIL 2015-1  
VARIOUS COUNTIES

PLOT DATE: 3/12/2014



CODE NO	ITEM	UNIT	100% STATE 0021 TOTAL QUANTITIES
63000350	LONG-SPAN GUARDRAIL OVER CULVERT, 12 FT 6 IN SPAN	FOOT	162.5
63100045	TRAFFIC BARRIER TERMINAL, TYPE 2	EACH	4
63100070	TRAFFIC BARRIER TERMINAL, TYPE 5	EACH	4
63100085	TRAFFIC BARRIER TERMINAL, TYPE 6	EACH	8
63100167	TRAFFIC BARRIER TERMINAL, TYPE 1 (SPECIAL) TANGENT	EACH	65
63100169	TRAFFIC BARRIER TERMINAL, TYPE 1 (SPECIAL) FLARED	EACH	5
64300260	IMPACT ATTENUATORS (FULLY REDIRECTIVE, NARROW), TEST LEVEL 3	EACH	3
64300370	IMPACT ATTENUATORS (FULLY REDIRECTIVE, WIDE), TEST LEVEL 3	EACH	3
67100100	MOBILIZATION	L SUM	1
X0325972	CABLE GUARD POST	EACH	100
X0326466	HIGH TENSION CABLE POST REPAIR	EACH	30
X0326468	MEDIAN CABLE	FOOT	200
X6300210	GUARDRAIL BLOCKS	EACH	400
X6300215	RAIL ELEMENT PLATES	EACH	200
X6300217	RAIL ELEMENT PLATES (RADIUS)	EACH	25
X6300220	EXTRUDER HEAD	EACH	10
X6300225	SINGLE END SECTION	EACH	2

### SUMMARY OF QUANTITIES

VARIOUS ROUTES  
SECTION DIST 8 GUARDRAIL 2015-1  
VARIOUS COUNTIES

PLOT DATE: 3/12/2014

# SUMMARY OF QUANTITIES

TOTAL SHEETS	SHEET NO.
18	7
CONTRACT NO. 1 76G23	

CODE NO	ITEM	UNIT	100% STATE 0021 TOTAL QUANTITIES
X6300231	STEEL POST, ATTACHED TO STRUCTURES	EACH	3
X6300236	STEEL POSTS 6'	EACH	300
X6300239	STEEL POSTS 9'	EACH	100
X6331110	STEEL POSTS, SPECIAL	EACH	10
X6430210	REMOVE AND REINSTALL IMPACT ATTENUATORS	EACH	20
X7011834	TRAFFIC CONTROL AND PROTECTION, CALL OUT WORK	EACH	176
X7011836	TRAFFIC CONTROL AND PROTECTION, FREEWAY/EXPRESSWAY, CALL OUT WORK	EACH	175
X8030110	LOCATING UNDERGROUND CABLE, SPECIAL	EACH	5
Z0029655	HIGH TENSION CABLE ROAD GUARDPOST	EACH	200
Z0029657	HIGH TENSION CABLE SYSTEM MAINTENANCE	EACH	10
Z0029658	REPAIR TRAFFIC BARRIER TERMINAL TYPE 1 SPECIAL - POST	EACH	14
Z0029662	REPLACE HIGH TENSION CABLE GUARDPOST FOUNDATION	EACH	5
Z0052410	REPAIR TRAFFIC BARRIER TERMINAL, TYPE 1 SPECIAL (TANGENT)	EACH	44
Z0052415	REPAIR TRAFFIC BARRIER TERMINAL, TYPE 1 SPECIAL (FLARED)	EACH	10
Z0052600	REPAIR TRAFFIC BARRIER TERMINAL, TYPE 2	EACH	5
Z0052800	REPAIR TRAFFIC BARRIER TERMINAL, TYPE 3A	EACH	5

## SUMMARY OF QUANTITIES

VARIOUS ROUTES  
SECTION DIST 8 GUARDRAIL 2015-1  
VARIOUS COUNTIES

PLOT DATE: 3/12/2014

\*\*DATE\*\*  
 3/12/2014  
 c:\p\work\p\1001\chell\andeka\08331989\0876g23-sht-plen.dgn

# SUMMARY OF QUANTITIES

TOTAL SHEETS	SHEET NO.
18	8
CONTRACT NO. 76G23	

CODE NO	ITEM	UNIT	100% STATE 0021 TOTAL QUANTITIES
Z0053000	REPAIR TRAFFIC BARRIER TERMINAL, TYPE 5	EACH	2
Z0053200	REPAIR TRAFFIC BARRIER TERMINAL, TYPE 6	EACH	5
Z0059660	REPAIR TRAFFIC BARRIER TERMINAL TYPE 1 SPECIAL - RAIL ELEMENT PLATE	EACH	7
X7010410	SPEED DISPLAY TRAILER	CAL MO	1

## SUMMARY OF QUANTITIES

VARIOUS ROUTES  
SECTION DIST 8 GUARDRAIL 2015-1  
VARIOUS COUNTIES

PLOT DATE: 3/12/2014

\*\*DATE\*\*  
 3/12/2014  
 c:\pwworkspace\pwworkspace\chelland\desk\08331989\0876g23-sht-plen.dgn

TOTAL SHEETS	SHEET NO.
18	9
CONTRACT NO. 76G23	

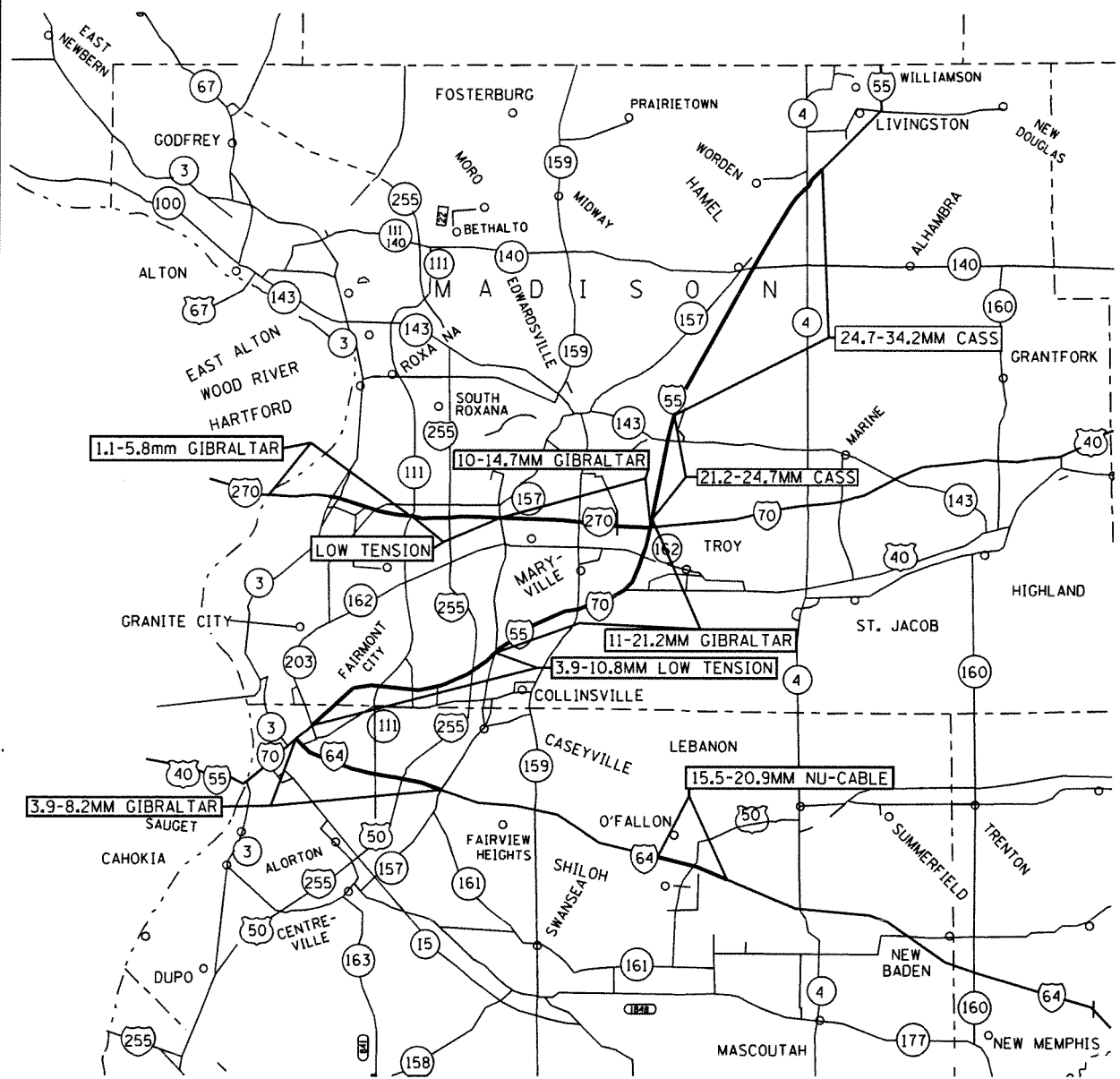

**HIGH TENSION CABLE  
LOCATION MAP**

VARIOUS ROUTES  
SECTION DIST 8 GUARDRAIL 2015-1  
VARIOUS COUNTIES

PLOT DATE: 3/12/2014

DATE: 3/12/2014  
 C:\p-work\p\p\dot\chell\endesk\ed0331989\ed76g23-sht-pl.mxd

DATE: 3/12/2014  
 C:\pwork\pseudot\challengest\0331989\087623-st-plendgn

TOTAL SHEETS	SHEET NO.
18	10

CONTRACT NO. 76G23

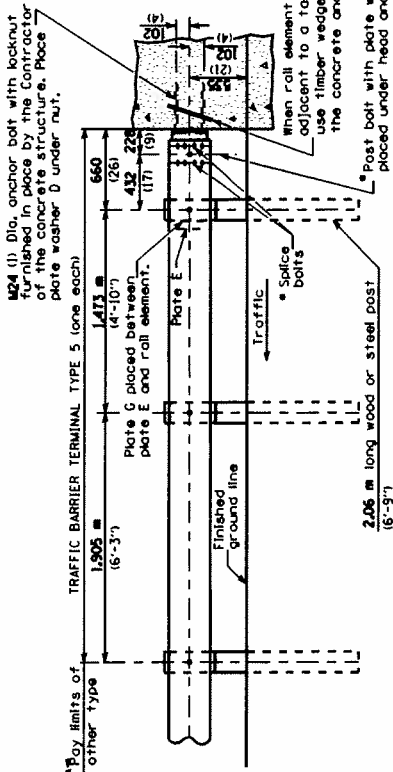

**TYPE 5 - CONCRETE BRIDGE PARAPET**

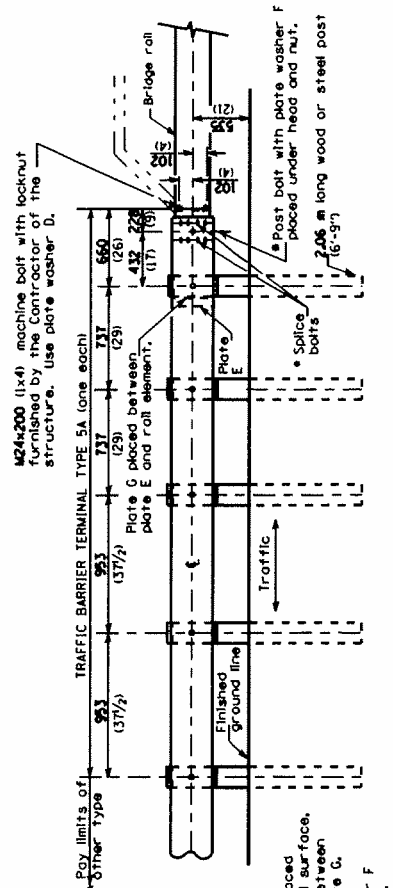

**TYPE 5A - STEEL BRIDGE RAIL**

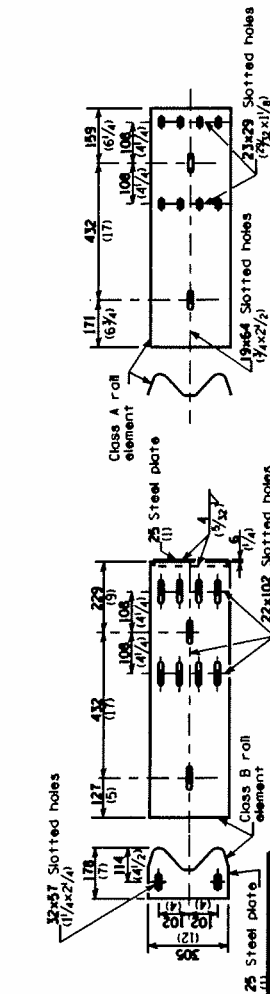

**PLATE G**

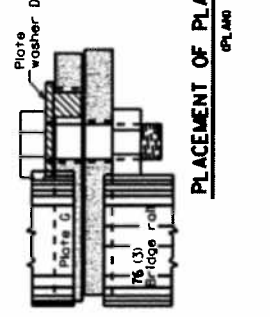

**PLATE E**

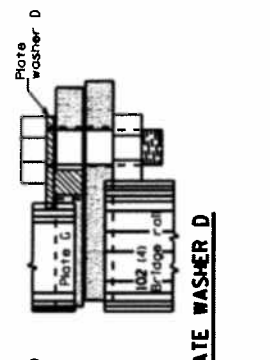

**PLACEMENT OF PLATE WASHER D**

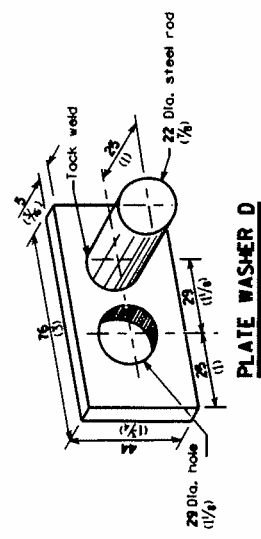

**PLATE WASHER D**

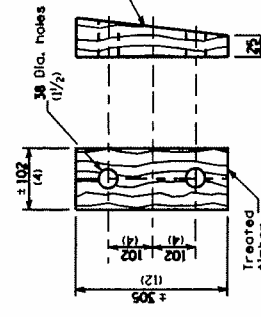

**WEDGE M**

**GENERAL NOTES**

Install plate washer D so that the 25 mm (1") projection fills the remainder of the slotted holes in the 25 mm (1") end plate on plate G after the M24 (1") dia. bolts are in place.

• Bolts shall be provided with locknut or double nut and shall be tightened only to a point that will allow plate G to be free to move when an expansion joint exists below the connector.

All dimensions are in millimeters (inches) unless otherwise shown.

**TRAFFIC BARRIER  
 TERMINAL  
 TYPE 5 & 5A  
 VARIOUS ROUTES  
 SECTION DIST 8 GUARDRAIL 2015-1  
 VARIOUS COUNTIES**

PLOT DATE: 3/12/2014

This detail is applicable to the guardrail system used prior to January 1, 2007. For details on the M-1000 Guardrail System, see Standard 63000L.

TOTAL SHEETS	SHEET NO.
18	11
CONTRACT NO. 76G23	

**PARAPET OR WINGWALL**

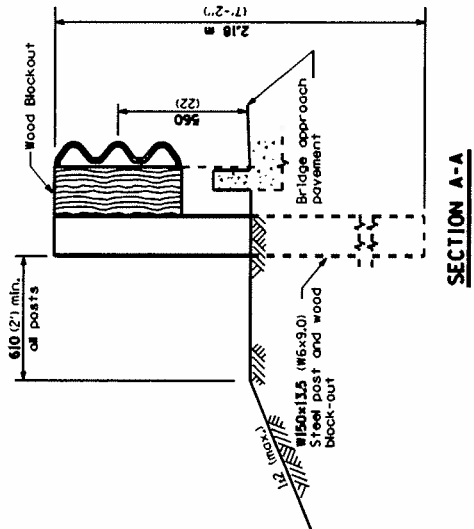
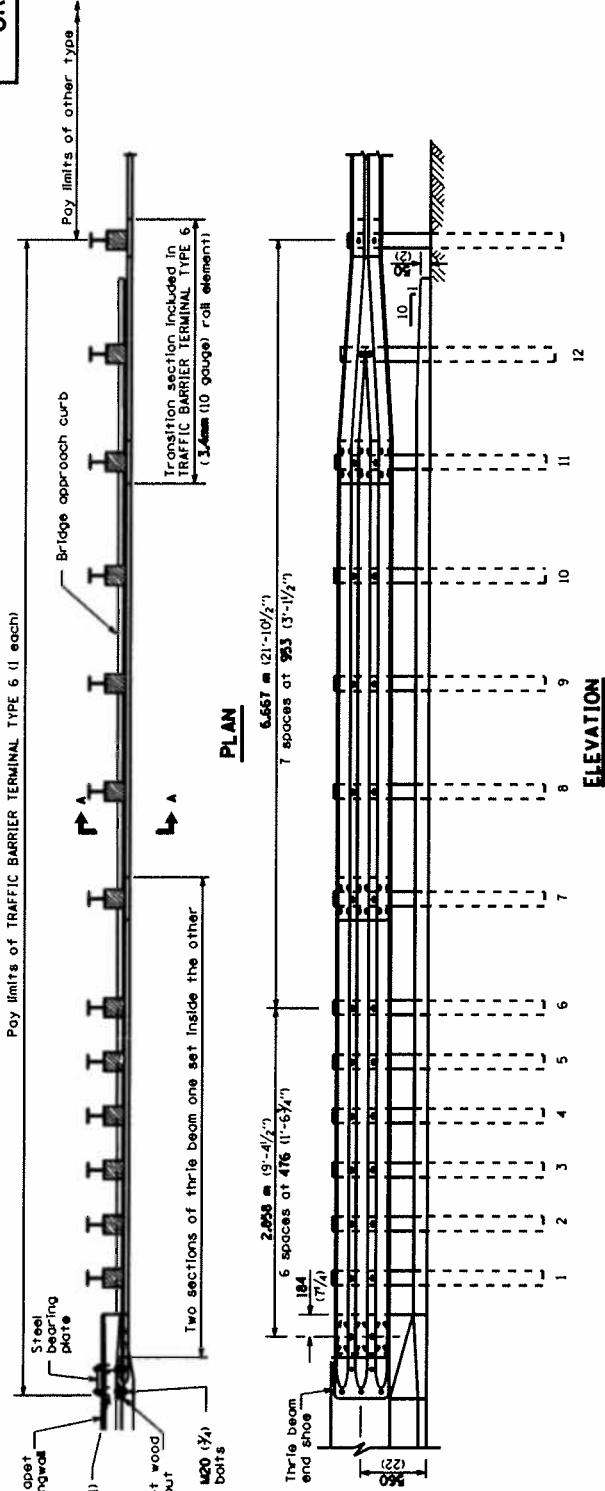

**GENERAL NOTES**

- Thrie beam rail shall be bolted to block-out at all posts.
- All slope ratios are expressed as units of vertical displacement to units of horizontal displacement (V/H).
- All dimensions are in millimeters (inches) unless otherwise shown.

**TRAFFIC BARRIER TERMINAL, TYPE 6**

VARIOUS ROUTES  
SECTION DIST 8 GUARDRAIL 2015-1  
VARIOUS COUNTIES

This detail is applicable to the guardrail system used prior to January 1, 2007. For details on the Midwest Guardrail System, see Standard 630001.

DATE: 3/12/2014  
C:\p\work\pride\challend\sketch\31589\0876g23-sht-plan.dgn

TOTAL SHEETS	SHEET NO.
18	12
CONTRACT NO. 76023	

**OTHER CONCRETE STRUCTURE**

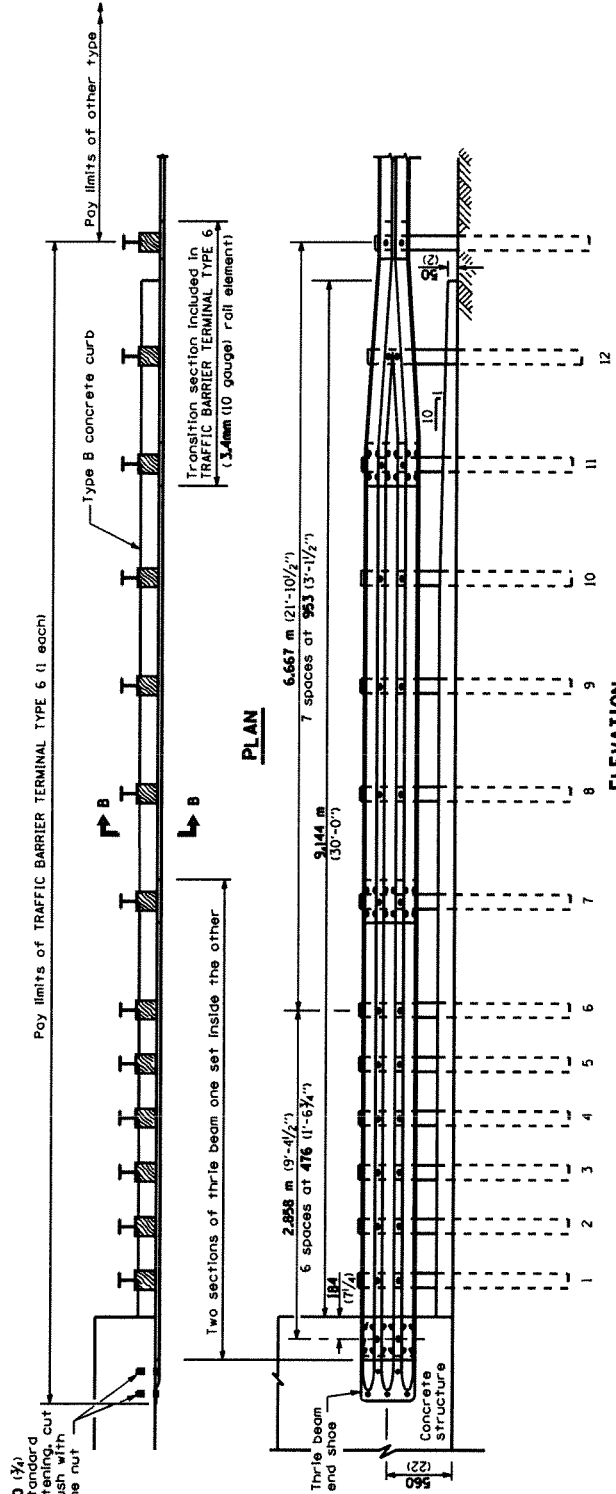

5. Epoxy grouted M20 (3/4) bars with standard washers. Tighten the anchor bolts flush with nuts, and damage the nut to prevent it from loosening.

This detail is applicable to the guardrail system used prior to January 1, 2007. For details on the Midwest Guardrail System, see Standard 630001.

**TRAFFIC BARRIER TERMINAL, TYPE 6**

VARIOUS ROUTES  
SECTION DIST 8 GUARDRAIL 2015-1  
VARIOUS COUNTIES

PLOT DATE: 3/12/2014

\*\*\*DATE\*\*\*  
 3/12/2014  
 c:\pwwork\pwwork\challenged\031989\087623-sht-plen.dgn

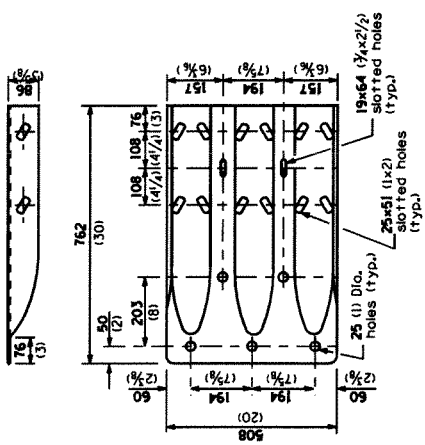

**THREE BEAM END SHOE DETAIL**

This detail is applicable to the guardrail system used prior to January 1, 2007. For details on the Midwest Guardrail System, see Standard 630001.

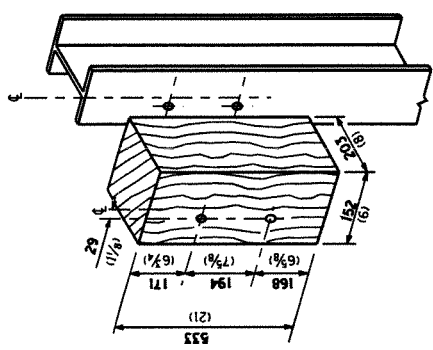

**POSTS 1-11 WOOD BLOCKOUT DETAIL**

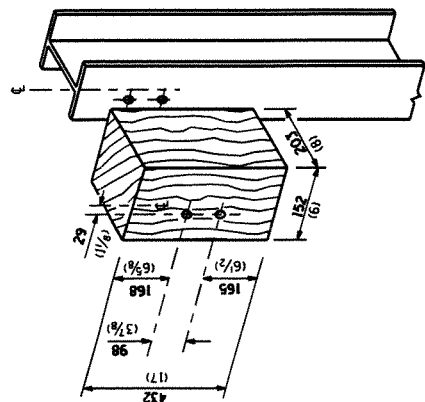

**POST 12 WOOD BLOCKOUT DETAIL**

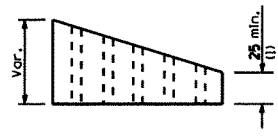

**PARAPET WOOD BLOCK-OUT DETAIL**

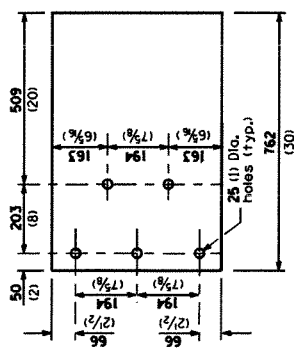

**PARAPET STEEL BEARING PLATE DETAIL**

(5 each individual 12x12x1/4 steel plates with centered 25 (1) holes may be substituted for the plate shown.)

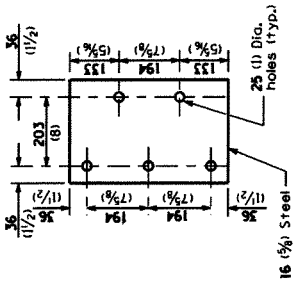

**TRAFFIC BARRIER  
 TERMINAL, TYPE 6**

VARIOUS ROUTES  
 SECTION DIST 8 GUARDRAIL 2015-1  
 VARIOUS COUNTIES

TOTAL SHEETS	SHEET NO.
18	13
CONTRACT NO. 76G23	



DATE: 3/12/2014  
 C:\pwworking\pwworking\chellandeste\0331989\087623-sht-plen.dgn

(Sheet 1 of 4)

TOTAL SHEETS	SHEET NO.
18	14
CONTRACT NO. 76G23	

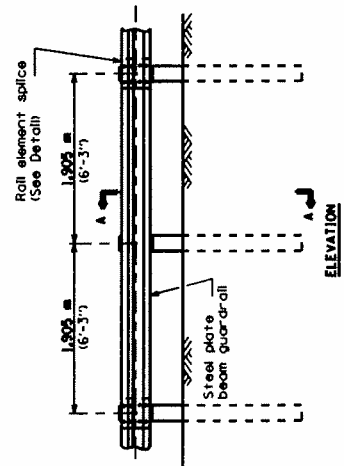

**TYPE A**  
 1,905 m (6'-3") Typical post spacing

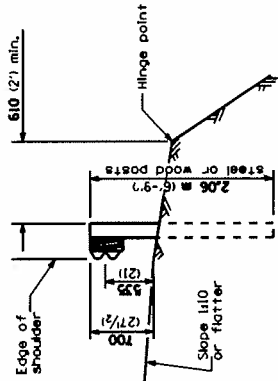

SECTION A-A

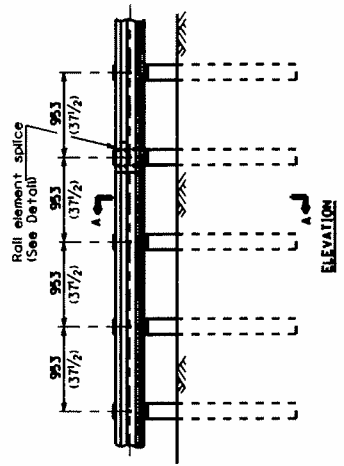

**TYPE B**  
 953 (317 1/2) Closed post spacing

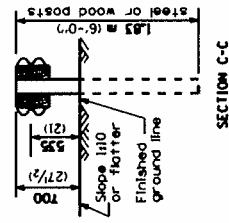

SECTION C-C

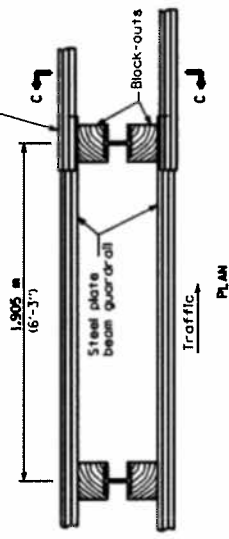

**TYPE D**  
 Double steel plate beam guardrail  
 1,905 m (6'-3") typical post spacing

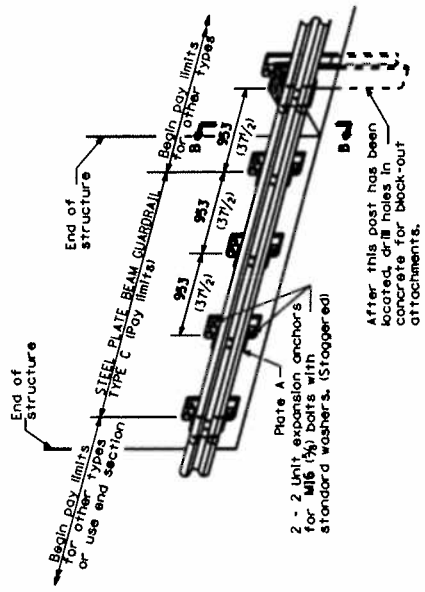

**TYPE C**  
 953 (317 1/2) Block-out spacing

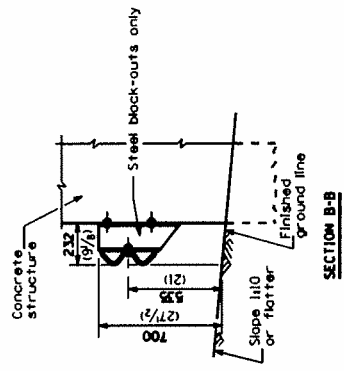

SECTION B-B

**GENERAL NOTES**

All slope ratios are expressed as units of vertical displacement to units of horizontal displacement (V:H).  
 All dimensions are in millimeters (inches) unless otherwise shown.  
 The existing steel posts may be drilled to match the bolt pattern shown herein for the wood block-out, or a new steel post shall be provided.  
 This detail is applicable to the guardrail system used prior to January 1, 2007. For details on the Midwest Guardrail System, see Standard 630001.

**STEEL PLATE BEAM  
 GUARDRAIL**

VARIOUS ROUTES  
 SECTION DIST 8 GUARDRAIL 2015-1  
 VARIOUS COUNTIES

Plot Date: 3/12/2014

This detail is applicable to the guardrail system used prior to January 1, 2007. For details on the Midwest Guardrail System, see Standard 630001.

2 - 2 Unit expansion anchors for M16 (5/8") bolts with standard washers. (Staggered)  
 After this post has been located, drill holes in concrete for block-out attachments.

TOTAL SHEETS	SHEET NO.
18	15
CONTRACT NO. 76223	

\*\*DATES\*\*  
 3/12/2014  
 C:\pwwork\prido\chellandaska\031989\087623-shr-plate.dgn

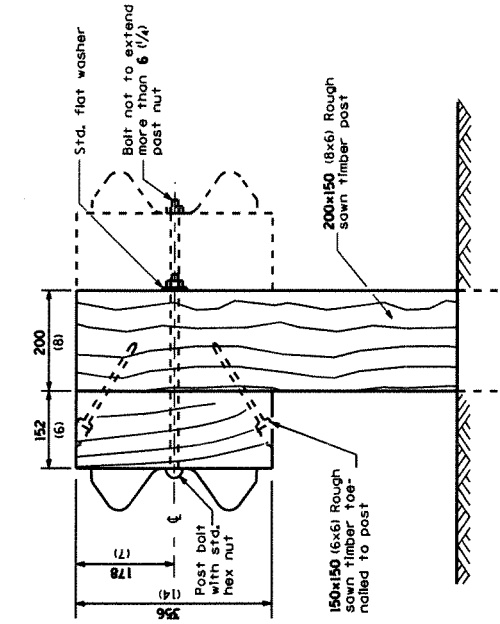

**WOOD POST CONSTRUCTION**

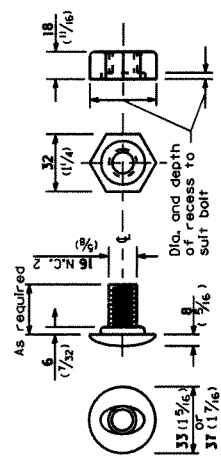

**POST OR SPLICE BOLT & NUT**

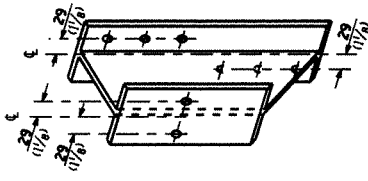

**STEEL BLOCK-OUT DETAIL**

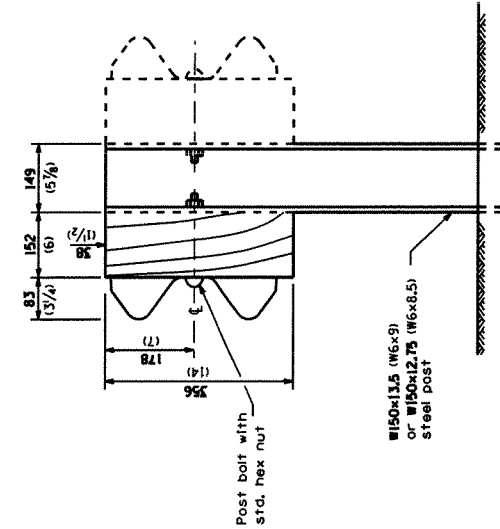

**STEEL POST CONSTRUCTION**

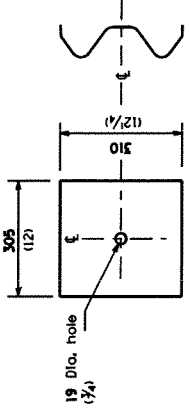

**NOTE**

Plate A shall be placed between rail element and block-out at non-splice mounting points only when steel block-outs are used.

**PLATE A**

This detail is applicable to the guardrail system used prior to January 1, 2007. For details on the Midwest Guardrail System, see Standard 630001.

**STEEL PLATE BEAM GUARDRAIL**

VARIOUS ROUTES  
 SECTION DIST 8 GUARDRAIL 2015-1  
 VARIOUS COUNTIES

PLOT DATE: 3/12/2014

DATE: 3/12/2014  
 C:\pwork\pndot\chall\endstke\0931\899\0876g23-sht-plen.dgn

(Sheet 3 of 4)

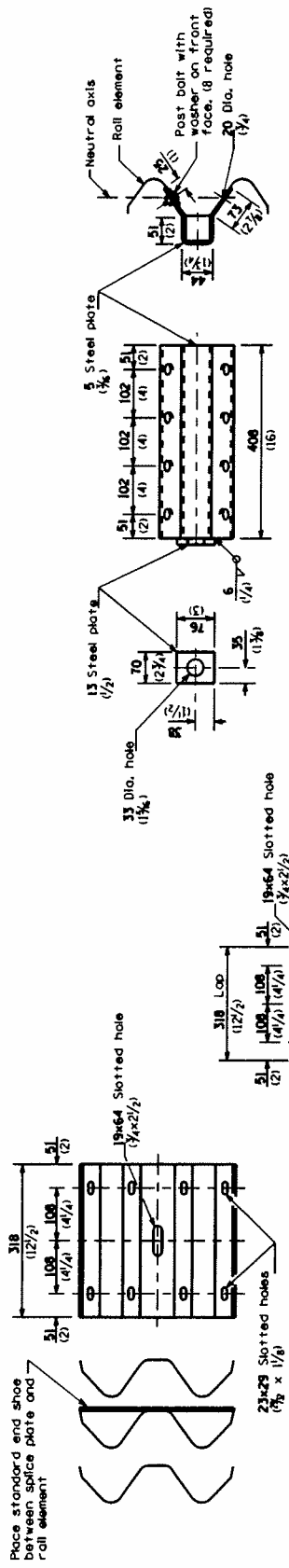

**SPLICE PLATE**

23x29 Slotted holes (7/8 x 1/4)

19x64 Slotted holes (7/8 x 2/2)

318 (127/2)

108 (47/4)

51 (2)

Place standard end shoe between splice plate and roll element

**ANCHOR PLATE I DETAILS**

5 Steel plates (3/8)

13 Steel plates (1/2)

33 Dia. hole (1 3/8)

70 (27/4)

35 (13/4)

NOTE: Anchor plates I shall be used to attach cables directly to steel when required on traffic barrier terminals.

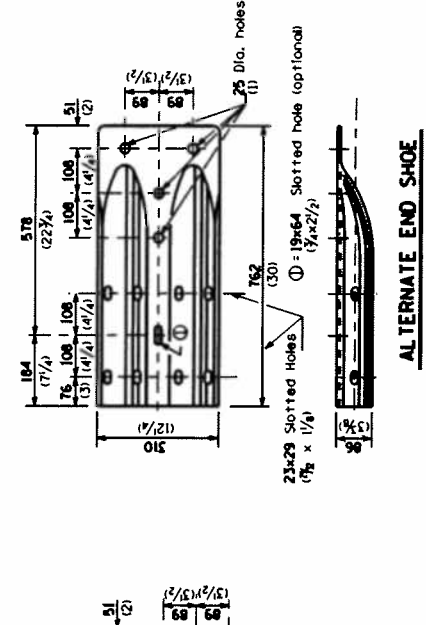

**RAIL ELEMENT SPLICE**

23x76 (7/8 x 3) Slots for splice bolts with std. galv. washer placed under locknut

102, 108, 106 (47/4) (47/4) (47/4)

51 (2)

68 (2)

152 (6)

914 (36)

25 Dia. holes (1)

19x89 (7/8 x 3/2) Slotted hole

**END SECTION**

100± (277/2±)

216 (87/2)

159 (62)

167/4 (67/4)

199 (79)

159 (62)

167/4 (67/4)

310 (127/4)

Class A roll element

**ALTERNATE END SHOE**

23x29 Slotted Holes (7/8 x 1/4)

19x64 Slotted hole (optional) (7/8 x 2/2)

25 Dia. holes (1)

184 (77/4)

76 (3)

108 (47/4)

108 (47/4)

108 (47/4)

51 (2)

68 (2)

68 (2)

762 (30)

**NOTE**

When end shoe is attached to a bridge parapet which has an expansion joint, the bolts shall be provided with a locknut or double nut and shall be tightened only to a point that will allow guardrail movement.

The standard end shoe shall be attached to the concrete with pre-drilled or self-drilling anchor bolts. The anchor cone shall be set flush with the surface of the concrete.

Externally threaded studs protruding from the surface of the concrete will not be permitted.

TOTAL SHEETS	SHEET NO.
18	16
CONTRACT NO. 76G23	

**STEEL PLATE BEAM GUARDRAIL**

VARIOUS ROUTES  
 SECTION DIST 8 GUARDRAIL 2015-1  
 VARIOUS COUNTIES

PLOT DATE: 3/12/2014

3/12/2014  
 s:\p\work\pridat\challengesk\0331989\087623-sht-pln.dgn

(Sheet 4 of 4)

This detail is applicable to the guardrail system used prior to January 1, 2007. For details on the Midwest Guardrail System, see Standard 630001.

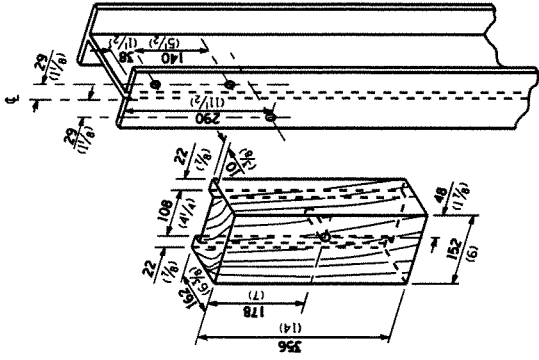

**WOOD BLOCK-OUT AND STEEL POST DETAILS**

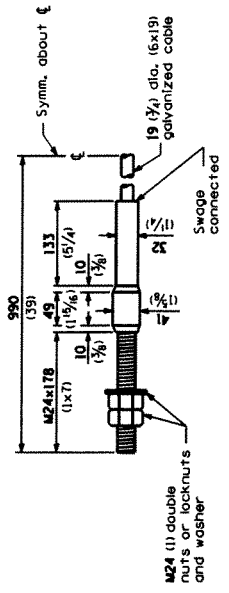

**CABLE ASSEMBLY**  
 (18,100 kg (40,000 lbs) min. breaking strength)  
 Tighten to taut tension.

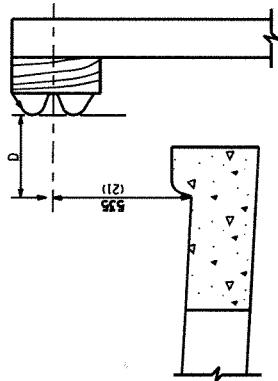

**Note:**  
 If it is necessary for D to be more than 300 (12) and less than 400 (16), type #5 #4-2 curb and gutter (630001) shall be used in front of and in advance of the guardrail.

**GUARDRAIL PLACED BEHIND CURB**  
 (D = 0 desirable to 300 (12) maximum)

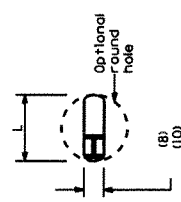

**PLAN**

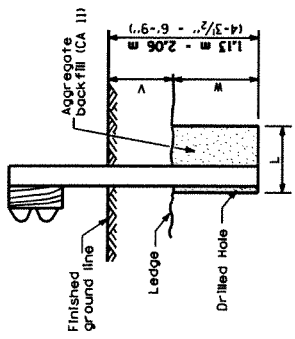

**ELEVATION**

**Note:**  
 Ledge line is top of rock ledge or hard slog fill.

- (0 - 18) (24) (21) (23)
- (>18 - 41.5) (12) (8) (10)
- (>41.5 - 53.5) (12 - 0) (8) (10)

**FOOTING FOR POST WHEN IMPERVIOUS MATERIAL IS ENCOUNTERED**

**STEEL PLATE BEAM GUARDRAIL**

VARIOUS ROUTES  
 SECTION DIST 8 GUARDRAIL 2015-1  
 VARIOUS COUNTIES

PLOT DATE: 3/12/2014

TOTAL SHEETS	SHEET NO.
18	17
CONTRACT NO. 76G23	

TOTAL SHEETS	SHEET NO.
18	18
CONTRACT NO. J 76G23	

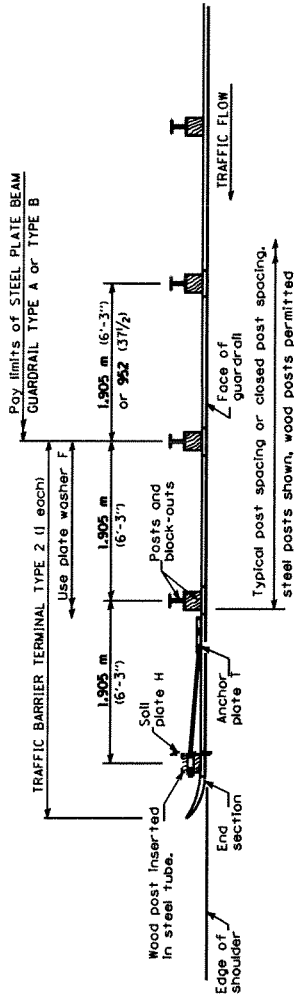

**PLAN**

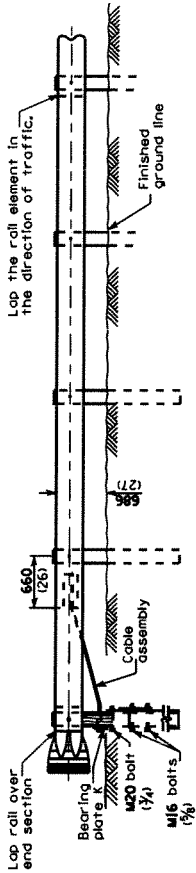

**ELEVATION**

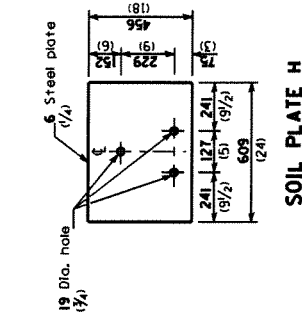

**SOIL PLATE H**

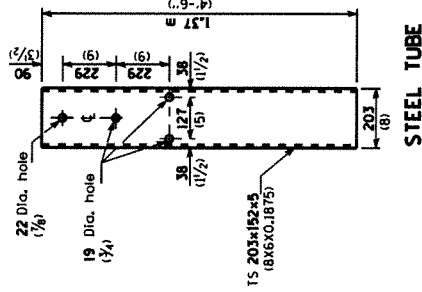

**STEEL TUBE**

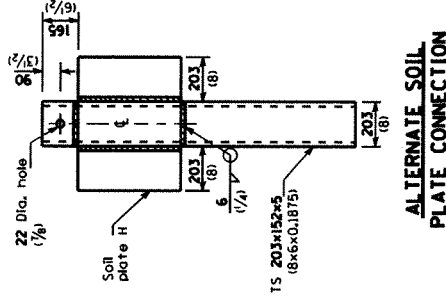

**ALTERNATE SOIL PLATE CONNECTION**

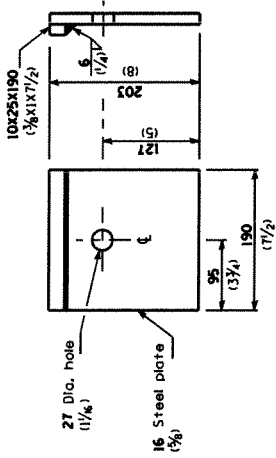

**BEARING PLATE K**

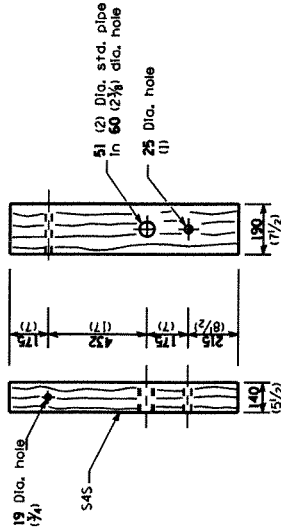

**WOOD POST**

**GENERAL NOTES**

- Use plate washer F at all posts.
- The bearing plate K shall be held in position by (2) two eight penny nails driven into the post and bent over the top of the plate.
- All dimensions are in millimeters (inches) unless otherwise shown.

**TRAFFIC BARRIER TERMINAL TYPE 2**

VARIOUS ROUTES  
SECTION DIST 8 GUARDRAIL 2015-1  
VARIOUS COUNTIES

PLOT DATE: 3/12/2014

This detail is applicable to the guardrail system used prior to January 1, 2007. For details on the Midwest Guardrail System, see Standard 630001.

## ILLINOIS DEPARTMENT OF LABOR

### PREVAILING WAGES FOR J5 F-CI G COUNT-9G EFFECTIVE MAY 2014

The Prevailing rates of wages are included in the Contract proposals which are subject to Check Sheet #5 of the Supplemental Specifications and Recurring Special Provisions. The rates have been ascertained and certified by the Illinois Department of Labor for the locality in which the work is to be performed and for each craft or type of work or mechanic needed to execute the work of the Contract. As required by Prevailing Wage Act (820 ILCS 130/0.01, et seq.) and Check Sheet #5 of the Contract, not less than the rates of wages ascertained by the Illinois Department of Labor and as revised during the performance of a Contract shall be paid to all laborers, workers and mechanics performing work under the Contract. Post the scale of wages in a prominent and easily accessible place at the site of work.

If the Illinois Department of Labor revises the prevailing rates of wages to be paid as listed in the specification of rates, the contractor shall post the revised rates of wages and shall pay not less than the revised rates of wages. Current wage rate information shall be obtained by visiting the Illinois Department of Labor web site at <http://www.state.il.us/agency/idol/> or by calling 312-793-2814. It is the responsibility of the contractor to review the rates applicable to the work of the contract at regular intervals in order to insure the timely payment of current rates. Provision of this information to the contractor by means of the Illinois Department of Labor web site satisfies the notification of revisions by the Department to the contractor pursuant to the Act, and the contractor agrees that no additional notice is required. The contractor shall notify each of its subcontractors of the revised rates of wages.

# Bond County Prevailing Wage for May 2014

(See explanation of column headings at bottom of wages)

Trade Name	RG	TYP	C	Base	FRMAN	M-F>8	OSA	OSH	H/W	Pensn	Vac	Trng
=====	==	===	=	=====	=====	=====	===	===	=====	=====	=====	=====
ASBESTOS ABT-GEN		ALL		26.460	26.960	1.5	1.5	2.0	6.300	14.84	0.000	0.800
ASBESTOS ABT-MEC		BLD		30.360	31.360	1.5	1.5	2.0	7.450	3.000	0.000	0.000
BOILERMAKER		BLD		32.060	34.560	1.5	1.5	2.0	7.070	21.27	1.000	0.350
BRICK MASON		BLD		29.640	33.540	1.5	1.5	2.0	8.000	10.09	2.000	0.400
CARPENTER		ALL		34.970	36.470	1.5	1.5	2.0	6.800	7.250	0.000	0.400
CEMENT MASON		ALL		31.500	32.500	1.5	1.5	2.0	9.500	12.25	0.000	0.200
CERAMIC TILE FNSHER		BLD		25.890	0.000	1.5	1.5	2.0	6.400	5.450	0.000	0.580
ELECTRIC PWR EQMT OP E		ALL	1	36.770	0.000	1.5	1.5	2.0	5.760	10.29	0.000	0.370
ELECTRIC PWR EQMT OP E		ALL	2	32.820	0.000	1.5	1.5	2.0	5.760	9.190	0.000	0.330
ELECTRIC PWR EQMT OP W		ALL		38.150	0.000	1.5	1.5	2.0	6.950	10.68	0.000	0.380
ELECTRIC PWR GRNDMAN E		ALL		27.020	0.000	1.5	1.5	2.0	5.760	7.570	0.000	0.270
ELECTRIC PWR GRNDMAN W		ALL		28.490	0.000	1.5	1.5	2.0	5.190	7.970	0.000	0.280
ELECTRIC PWR LINEMAN E		ALL		46.100	49.220	1.5	1.5	2.0	5.760	12.91	0.000	0.460
ELECTRIC PWR LINEMAN W		ALL		43.860	0.000	1.5	1.5	2.0	7.990	12.29	0.000	0.440
ELECTRIC PWR TRK DRV W		ALL		31.140	0.000	1.5	1.5	2.0	5.670	8.720	0.000	0.310
ELECTRICIAN		E	ALL	40.300	42.550	1.5	1.5	2.0	6.410	10.08	0.000	0.800
ELECTRICIAN		W	ALL	37.350	39.590	1.5	1.5	2.0	7.990	9.720	0.000	0.650
ELECTRONIC SYS TECH E		BLD		32.570	34.320	1.5	1.5	2.0	6.250	4.210	0.000	0.400
ELECTRONIC SYS TECH W		BLD		31.280	33.280	1.5	1.5	2.0	3.650	8.190	0.000	0.400
ELEVATOR CONSTRUCTOR		BLD		44.370	49.920	2.0	2.0	2.0	12.73	13.46	3.550	0.600
FLOOR LAYER		BLD		29.580	30.330	1.5	1.5	2.0	6.800	7.250	0.000	0.400
GLAZIER		BLD		32.780	0.000	2.0	2.0	2.0	9.020	10.80	2.630	0.310
HT/FROST INSULATOR		BLD		37.660	38.660	1.5	1.5	2.0	8.350	11.26	0.000	0.500
IRON WORKER		ALL		31.500	33.500	1.5	1.5	2.0	8.110	13.85	0.000	0.420
LABORER		ALL		25.960	26.460	1.5	1.5	2.0	6.300	14.84	0.000	0.800
MACHINIST		BLD		43.920	46.420	1.5	1.5	2.0	6.760	8.950	1.850	0.000
MARBLE FINISHERS		BLD		25.890	0.000	1.5	1.5	2.0	6.400	5.450	0.000	0.580
MARBLE MASON		BLD		29.640	33.540	1.5	1.5	2.0	8.000	10.09	2.000	0.400
MILLWRIGHT		ALL		34.970	36.470	1.5	1.5	2.0	6.800	7.250	0.000	0.400
OPERATING ENGINEER		BLD	1	34.700	37.700	1.5	1.5	2.0	10.00	17.20	0.000	1.000
OPERATING ENGINEER		BLD	2	33.570	37.700	1.5	1.5	2.0	10.00	17.20	0.000	1.000
OPERATING ENGINEER		BLD	3	29.090	37.700	1.5	1.5	2.0	10.00	17.20	0.000	1.000
OPERATING ENGINEER		BLD	4	29.150	37.700	1.5	1.5	2.0	10.00	17.20	0.000	1.000
OPERATING ENGINEER		BLD	5	28.820	37.700	1.5	1.5	2.0	10.00	17.20	0.000	1.000
OPERATING ENGINEER		BLD	6	36.250	37.700	1.5	1.5	2.0	10.00	17.20	0.000	1.000
OPERATING ENGINEER		BLD	7	36.550	37.700	1.5	1.5	2.0	10.00	17.20	0.000	1.000
OPERATING ENGINEER		BLD	8	36.830	37.700	1.5	1.5	2.0	10.00	17.20	0.000	1.000
OPERATING ENGINEER		BLD	9	35.700	37.700	1.5	1.5	2.0	10.00	17.20	0.000	1.000
OPERATING ENGINEER		HWY	1	33.200	36.200	1.5	1.5	2.0	10.00	17.20	0.000	1.000
OPERATING ENGINEER		HWY	2	32.070	36.200	1.5	1.5	2.0	10.00	17.20	0.000	1.000
OPERATING ENGINEER		HWY	3	27.590	36.200	1.5	1.5	2.0	10.00	17.20	0.000	1.000
OPERATING ENGINEER		HWY	4	27.650	36.200	1.5	1.5	2.0	10.00	17.20	0.000	1.000
OPERATING ENGINEER		HWY	5	27.320	36.200	1.5	1.5	2.0	10.00	17.20	0.000	1.000
OPERATING ENGINEER		HWY	6	34.750	36.200	1.5	1.5	2.0	10.00	17.20	0.000	1.000
OPERATING ENGINEER		HWY	7	35.050	36.200	1.5	1.5	2.0	10.00	17.20	0.000	1.000
OPERATING ENGINEER		HWY	8	35.330	36.200	1.5	1.5	2.0	10.00	17.20	0.000	1.000
OPERATING ENGINEER		HWY	9	34.200	36.200	1.5	1.5	2.0	10.00	17.20	0.000	1.000
PAINTER		BLD		29.250	30.750	1.5	1.5	2.0	5.250	9.170	0.000	0.650
PAINTER		HWY		30.450	31.950	1.5	1.5	2.0	5.250	9.170	0.000	0.650
PAINTER OVER 30FT		BLD		30.250	31.750	1.5	1.5	2.0	5.250	9.170	0.000	0.650
PAINTER PWR EQMT		BLD		30.250	31.750	1.5	1.5	2.0	5.250	9.170	0.000	0.650
PAINTER PWR EQMT		HWY		31.450	32.950	1.5	1.5	2.0	5.250	9.170	0.000	0.650
PILEDRIVER		ALL		34.970	36.470	1.5	1.5	2.0	6.800	7.250	0.000	0.400
PIPEFITTER		BLD		38.460	40.380	2.0	2.0	2.0	4.750	8.450	0.000	0.300
PLASTERER		BLD		30.250	31.250	1.5	1.5	2.0	9.500	9.150	0.000	0.050
PLUMBER		BLD		38.460	40.380	2.0	2.0	2.0	4.750	8.450	0.000	0.300

ROOFER	BLD	30.100	32.100	1.5	1.5	2.0	8.800	7.100	0.000	0.240
SHEETMETAL WORKER	ALL	32.250	33.750	1.5	1.5	2.0	8.330	7.320	1.940	0.360
SPRINKLER FITTER	BLD	37.120	39.870	1.5	1.5	2.0	8.420	8.500	0.000	0.350
SURVEY WORKER	ALL	25.860	26.360	1.5	1.5	2.0	5.750	14.34	0.000	0.800
TERRAZZO FINISHER	BLD	31.240	0.000	1.5	1.5	2.0	6.400	3.800	0.000	0.270
TERRAZZO MASON	BLD	32.530	32.830	1.5	1.5	2.0	6.400	5.550	0.000	0.290
TRUCK DRIVER	ALL 1	31.340	0.000	1.5	1.5	2.0	10.30	5.010	0.000	0.250
TRUCK DRIVER	ALL 2	31.780	0.000	1.5	1.5	2.0	10.30	5.010	0.000	0.250
TRUCK DRIVER	ALL 3	32.020	0.000	1.5	1.5	2.0	10.30	5.010	0.000	0.250
TRUCK DRIVER	ALL 4	32.280	0.000	1.5	1.5	2.0	10.30	5.010	0.000	0.250
TRUCK DRIVER	ALL 5	33.130	0.000	1.5	1.5	2.0	10.30	5.010	0.000	0.250
TRUCK DRIVER	O&C 1	25.070	0.000	1.5	1.5	2.0	10.30	5.010	0.000	0.250
TRUCK DRIVER	O&C 2	25.420	0.000	1.5	1.5	2.0	10.30	5.010	0.000	0.250
TRUCK DRIVER	O&C 3	25.620	0.000	1.5	1.5	2.0	10.30	5.010	0.000	0.250
TRUCK DRIVER	O&C 4	25.820	0.000	1.5	1.5	2.0	10.30	5.010	0.000	0.250
TRUCK DRIVER	O&C 5	26.500	0.000	1.5	1.5	2.0	10.30	5.010	0.000	0.250

**Legend:** RG (Region)

TYP (Trade Type - All,Highway,Building,Floating,Oil & Chip,Rivers)

C (Class)

Base (Base Wage Rate)

FRMAN (Foreman Rate)

M-F>8 (OT required for any hour greater than 8 worked each day, Mon through Fri.

OSA (Overtime (OT) is required for every hour worked on Saturday)

OSH (Overtime is required for every hour worked on Sunday and Holidays)

H/W (Health & Welfare Insurance)

Pensn (Pension)

Vac (Vacation)

Trng (Training)

## Explanations

### BOND COUNTY

ELECTRICIANS AND ELECTRONIC SYSTEMS TECHNICIAN (EAST) - Townships of Mulberry Grove, Pleasant Mount & Tamalco.

ELECTRICIANS AND ELECTRONIC SYSTEMS TECHNICIAN (WEST) - Townships of Shoal Creek, LaGrange, Old Ripley, Central, Burgess & Mills

The following list is considered as those days for which holiday rates of wages for work performed apply: New Years Day, Memorial Day, Fourth of July, Labor Day, Thanksgiving Day, Christmas Day and Veterans Day in some classifications/counties. Generally, any of these holidays which fall on a Sunday is celebrated on the following Monday. This then makes work performed on that Monday payable at the



appropriate overtime rate for holiday pay. Common practice in a given local may alter certain days of celebration. If in doubt, please check with IDOL.

Oil and chip resealing (O&C) means the application of road oils and liquid asphalt to coat an existing road surface, followed by application of aggregate chips or gravel to coated surface, and subsequent rolling of material to seal the surface.

#### EXPLANATION OF CLASSES

ASBESTOS - GENERAL - removal of asbestos material/mold and hazardous materials from any place in a building, including mechanical systems where those mechanical systems are to be removed. This includes the removal of asbestos materials/mold and hazardous materials from ductwork or pipes in a building when the building is to be demolished at the time or at some close future date.

ASBESTOS - MECHANICAL - removal of asbestos material from mechanical systems, such as pipes, ducts, and boilers, where the mechanical systems are to remain.

#### CERAMIC TILE FINISHER AND MARBLE FINISHER

The handling, at the building site, of all sand, cement, tile, marble or stone and all other materials that may be used and installed by [a] tile layer or marble mason. In addition, the grouting, cleaning, sealing, and mixing on the job site, and all other work as required in assisting the setter. The term "Ceramic" is used for naming the classification only and is in no way a limitation of the product handled. Ceramic takes into consideration most hard tiles.

#### ELECTRONIC SYSTEMS TECHNICIAN

Installation, service and maintenance of low-voltage systems which utilizes the transmission and/or transference of voice, sound, vision, or digital for commercial, education, security and entertainment purposes for the following: TV monitoring and surveillance, background/foreground music, intercom and telephone interconnect, field programming, inventory control systems, microwave transmission, multi-media, multiplex, radio page, school, intercom and sound burglar alarms and low voltage master clock systems.

Excluded from this classification are energy management systems, life safety systems, supervisory controls and data acquisition systems not intrinsic with the above listed systems, fire alarm systems, nurse call systems and raceways exceeding fifteen feet in length.

#### OPERATING ENGINEER - BUILDING

GROUP I. Cranes, Dragline, Shovels, Skimmer Scoops, Clamshells or Derrick Boats, Pile Drivers, Crane-Type Backhoes, Asphalt Plant Operators, Concrete Plant Operators, Dredges, Asphalt Spreading Machines, All Locomotives, Cable Ways or Tower Machines, Hoists, Hydraulic Backhoes, Ditching Machines or Backfiller, Cherrypickers, Overhead Cranes, Roller - Steam or Gas, Concrete Pavers, Excavators, Concrete Breakers, Concrete Pumps, Bulk Cement Plants, Cement Pumps, Derrick-Type Drills, Boat Operators, Motor Graders or Pushcats, Scoops or Tournapulls, Bulldozers, Endloaders or Fork Lifts, Power Blade or Elevating Graders, Winch Cats, Boom or Winch Trucks or Boom Tractors, Pipe Wrapping or Painting Machines, Asphalt Plant Engineer, Journeyman Lubricating Engineer, Drills (other than Derrick Type), Mud Jacks, or Well Drilling Machines, Boring Machines or Track Jacks, Mixers,

Conveyors (Two), Air Compressors (Two), Water Pumps regardless of size (Two), Welding Machines (Two), Siphons or Jets (Two), Winch Heads or Apparatuses (Two), Light Plants (Two), All Tractors regardless of size (straight tractor only), Fireman on Stationary Boilers, Automatic Elevators, Form Grading Machines, Finishing Machines, Power Sub-Grader or Ribbon Machines, Longitudinal Floats, Distributor Operators on Trucks, Winch Heads or Apparatuses (One), Mobil Track air and heaters (two to five), Heavy Equipment Greaser, Relief Operator, Assistant Master Mechanic and Heavy Duty Mechanic, self-propelled concrete saws of all types and sizes with their attachments, gob-hoppers, excavators all sizes, the repair and greasing of all diesel hammers, the operation and set-up of bidwells, water blasters of all sizes and their clutches, hydraulic jacks where used for hoisting, operation of log skidders, iceolators used on and off of pipeline, condor cranes, bow boats, survey boats, bobcats and all their attachments, skid steer loaders and all their attachments, creter cranes, batch plants, operator (all sizes), self propelled roto mills, operation of conveyor systems of any size and any configuration, operation, repair and service of all vibratory hammers, all power pacs and their controls regardless of location, curtains or brush burning machines, stump cutter machines, Nail launchers when mounted on a machine or self-propelled, operation of con-cover machines, and all Operators except those listed below).

GROUP II. Assistant Operators.

GROUP III. Air Compressors (One), Water Pumps, regardless of Size (One), Waterblasters (one), Welding Machine (One), Mixers (One Bag), Conveyor (One), Siphon or Jet (One), Light Plant (One), Heater (One), Immobile Track Air (One), and Self Propelled Walk-Behind Rollers.

GROUP IV. Asphalt Spreader Oilers, Fireman on Whirlies and Heavy Equipment Oilers, Truck Cranes, Dredges, Monigans, Large Cranes - (Over 65-ton rated capacity) Concrete Plant Oiler, Blacktop Plant Oiler, and Creter Crane Oiler (when required).

GROUP V. Oiler.

GROUP VI. Operators on equipment with Booms, including jibs, 100 feet and over, and less than 150 feet long.

GROUP VII. Operators on equipment with Booms, including jibs, 150 feet and over, and less than 200 feet long.

GROUP VIII. Operators on Equipment with Booms, including jibs, 200 feet and over; Tower Cranes; and Whirlie Cranes.

GROUP IX. Master Mechanic

OPERATING ENGINEERS - Highway

GROUP I. Cranes, Dragline, Shovels, Skimmer Scoops, Clamshells or Derrick Boats, Pile Drivers, Crane-Type Backhoes, Asphalt Plant Operators, Concrete Plant Operators, Dredges, Asphalt Spreading Machines, All Locomotives, Cable Ways or Tower Machines, Hoists, Hydraulic Backhoes, Ditching Machines or Backfiller, Cherrypickers, Overhead Cranes, Roller - Steam or Gas, Concrete Pavers, Excavators, Concrete Breakers, Concrete Pumps, Bulk Cement Plants, Cement Pumps, Derrick-Type Drills, Boat Operators, Motor Graders or Pushcats, Scoops or Tournapulls, Bulldozers, Endloaders or Fork Lifts, Power Blade or Elevating Graders, Winch Cats, Boom or Winch Trucks or Boom Tractors, Pipe Wrapping or Painting Machines, Asphalt Plant Engineer, Journeyman Lubricating Engineer, Drills (other than Derrick Type), Mud Jacks,

Well Drilling Machines, Boring Machines, Track Jacks, Mixers, Conveyors (Two), Air Compressors (Two), Water Pumps regardless of size (Two), Welding Machines (Two), Siphons or Jets (Two), Winch Heads or Apparatuses (Two), Light Plants (Two), All Tractors regardless of size (straight tractor only), Fireman on Stationary Boilers, Automatic Elevators, Form Grading Machines, Finishing Machines, Power Sub-Grader or Ribbon Machines, Longitudinal Floats, Distributor Operators on Trucks, Winch Heads or Apparatuses (One), Mobil Track air and heaters (two to five), Heavy Equipment Greaser, Relief Operator, Assistant Master Mechanic and Heavy Duty Mechanic, self-propelled concrete saws of all types and sizes with their attachments, gob-hoppers, excavators all sizes, the repair and greasing of all diesel hammers, the operation and set-up of bidwells, water blasters of all sizes and their clutches, hydraulic jacks where used for hoisting, operation of log skidders, iceolators used on and off of pipeline, condor cranes, bow boats, survey boats, bobcats and all their attachments, skid steer loaders and all their attachments, creter cranes, batch plants, operator (all sizes), self propelled roto mills, operation of conveyor systems of any size and any configuration, operation, repair and service of all vibratory hammers, all power pacs and their controls regardless of location, curtains or brush burning machines, stump cutter machines, Nail launchers when mounted on a machine or self-propelled, operation of con-cover machines, and all Operators (except those listed below).

GROUP II. Assistant Operators.

GROUP III. Air Compressors (One), Water Pumps, regardless of Size (One), Waterblasters (one), Welding Machine (One), Mixers (One Bag), Conveyor (One), Siphon or Jet (One), Light Plant (One), Heater (One), Immobile Track Air (One), and Self Propelled Walk-Behind Rollers.

GROUP IV. Asphalt Spreader Oilers, Fireman on Whirlies and Heavy Equipment Oilers, Truck Cranes, Dredges, Monigans, Large Cranes - (Over 65-ton rated capacity) Concrete Plant Oiler, Blacktop Plant Oiler, and Creter Crane Oiler (when required).

GROUP V. Oiler.

GROUP VI. Operators on equipment with Booms, including jibs, 100 feet and over, and less than 150 feet long.

GROUP VII. Operators on equipment with Booms, including jibs, 150 feet and over, and less than 200 feet long.

GROUP VIII. Operators on Equipment with Booms, including jibs, 200 feet and over; Tower Cranes; and Whirlie Cranes.

GROUP IX. Mechanic

SURVEY WORKER - Operated survey equipment including data collectors, G.P.S. and robotic instruments, as well as conventional levels and transits.

TRUCK DRIVER - BUILDING, HEAVY AND HIGHWAY CONSTRUCTION

Class 1. Drivers on 2 axle trucks hauling less than 9 ton. Air compressor and welding machines and brooms, including those pulled by separate units, truck driver helpers, warehouse employees, mechanic helpers, greasers and tiremen, pickup trucks when hauling materials, tools, or workers to and from and on-the-job site, and fork lifts up to 6,000 lb. capacity.

Class 2. Two or three axle trucks hauling more than 9 ton but hauling less than 16 ton. A-frame winch trucks, hydrolift trucks, vactor trucks or similar equipment when used for transportation purposes. Fork lifts over 6,000 lb. capacity, winch trucks, four axle combination units, and ticket writers.

Class 3. Two, three or four axle trucks hauling 16 ton or more. Drivers on water pulls, articulated dump trucks, mechanics and working forepersons, and dispatchers. Five axle or more combination units.

Class 4. Low Boy and Oil Distributors.

Class 5. Drivers who require special protective clothing while employed on hazardous waste work.

TRUCK DRIVER - OIL AND CHIP RESEALING ONLY.

This shall encompass laborers, workers and mechanics who drive contractor or subcontractor owned, leased, or hired pickup, dump, service, or oil distributor trucks. The work includes transporting materials and equipment (including but not limited to, oils, aggregate supplies, parts, machinery and tools) to or from the job site; distributing oil or liquid asphalt and aggregate; stock piling material when in connection with the actual oil and chip contract. The Truck Driver (Oil & Chip Resealing) wage classification does not include supplier delivered materials.

TERRAZZO FINISHER

The handling of all materials used for Mosaic and Terrazzo work including preparing, mixing by hand, by mixing machine or transporting of pre-mixed materials and distributing with shovel, rake, hoe, or pail, all kinds of concrete foundations necessary for Mosaic and Terrazzo work, all cement terrazzo, magnesite terrazzo, Do-O-Tex terrazzo, epoxy matrix ter-razzo, exposed aggregate, rustic or rough washed for exterior or interior of buildings placed either by machine or by hand, and any other kind of mixture of plastics composed of chips or granules when mixed with cement, rubber, neoprene, vinyl, magnesium chloride or any other resinous or chemical substances used for seamless flooring systems, and all other building materials, all similar materials and all precast terrazzo work on jobs, all scratch coat used for Mosaic and Terrazzo work and sub-bed, tar paper and wire mesh (2x2 etc.) or lath. The rubbing, grinding, cleaning and finishing of same either by hand or by machine or by terrazzo resurfacing equipment on new or existing floors. When necessary finishers shall be allowed to assist the mechanics to spread sand bed, lay tarpaper and wire mesh (2x2 etc.) or lath. The finishing of cement floors where additional aggregate of stone is added by spreading or sprinkling on top of the finished base, and troweled or rolled into the finish and then the surface is ground by grinding machines.

Other Classifications of Work:

For definitions of classifications not otherwise set out, the Department generally has on file such definitions which are available. If a task to be performed is not subject to one of the classifications of pay set out, the Department will upon being contacted state which neighboring county has such a classification and provide such rate, such rate being deemed to exist by reference in this document. If no neighboring county rate applies to the task, the

Department shall undertake a special determination, such special determination being then deemed to have existed under this determination. If a project requires these, or any classification not listed, please contact IDOL at 217-782-1710 for wage rates or clarifications.

#### LANDSCAPING

Landscaping work falls under the existing classifications for laborer, operating engineer and truck driver. The work performed by landscape plantsman and landscape laborer is covered by the existing classification of laborer. The work performed by landscape operators (regardless of equipment used or its size) is covered by the classifications of operating engineer. The work performed by landscape truck drivers (regardless of size of truck driven) is covered by the classifications of truck driver.

# Calhoun County Prevailing Wage for May 2014

(See explanation of column headings at bottom of wages)

Trade Name	RG	TYP	C	Base	FRMAN	M-F>8	OSA	OSH	H/W	Pensn	Vac	Trng
=====	==	===	=	=====	=====	=====	===	===	=====	=====	=====	=====
ASBESTOS ABT-GEN		ALL		31.040	31.540	1.5	1.5	2.0	6.300	10.26	0.000	0.800
ASBESTOS ABT-MEC		BLD		30.360	31.360	1.5	1.5	2.0	7.450	3.000	0.000	0.000
BOILERMAKER		BLD		32.060	34.560	1.5	1.5	2.0	7.070	21.27	1.000	0.350
BRICK MASON		BLD		29.640	33.540	1.5	1.5	2.0	8.000	10.09	2.000	0.400
CARPENTER		ALL		34.970	36.470	1.5	1.5	2.0	6.800	7.250	0.000	0.400
CEMENT MASON		ALL		31.500	32.500	1.5	1.5	2.0	9.500	12.25	0.000	0.200
CERAMIC TILE FNSHER		BLD		25.890	0.000	1.5	1.5	2.0	6.400	5.450	0.000	0.580
ELECTRIC PWR EQMT OP		ALL		36.690	44.520	1.5	2.0	2.0	5.000	9.170	0.000	0.280
ELECTRIC PWR GRNDMAN		ALL		24.940	44.520	1.5	2.0	2.0	5.000	6.240	0.000	0.190
ELECTRIC PWR LINEMAN		ALL		42.210	44.520	1.5	2.0	2.0	5.000	10.56	0.000	0.320
ELECTRIC PWR TRK DRV		ALL		25.560	44.520	1.5	2.0	2.0	5.000	6.390	0.000	0.190
ELECTRICIAN		ALL		36.400	38.650	1.5	1.5	2.0	7.500	9.090	0.000	0.550
ELECTRONIC SYS TECH		BLD		28.740	30.490	1.5	1.5	2.0	7.500	5.860	0.000	0.400
FLOOR LAYER		BLD		29.580	30.330	1.5	1.5	2.0	6.800	7.250	0.000	0.400
GLAZIER		BLD		32.780	0.000	2.0	2.0	2.0	9.020	10.80	2.630	0.310
HT/FROST INSULATOR		BLD		37.660	38.660	1.5	1.5	2.0	8.350	11.26	0.000	0.500
IRON WORKER		ALL		31.500	33.500	1.5	1.5	2.0	8.110	13.85	0.000	0.420
LABORER		ALL		30.540	31.040	1.5	1.5	2.0	6.300	10.26	0.000	0.800
MACHINIST		BLD		43.920	46.420	1.5	1.5	2.0	6.760	8.950	1.850	0.000
MARBLE FINISHERS		BLD		25.890	0.000	1.5	1.5	2.0	6.400	5.450	0.000	0.580
MILLWRIGHT		ALL		34.970	36.470	1.5	1.5	2.0	6.800	7.250	0.000	0.400
OPERATING ENGINEER		BLD	1	34.700	37.700	1.5	1.5	2.0	10.00	17.20	0.000	1.000
OPERATING ENGINEER		BLD	2	33.570	37.700	1.5	1.5	2.0	10.00	17.20	0.000	1.000
OPERATING ENGINEER		BLD	3	29.090	37.700	1.5	1.5	2.0	10.00	17.20	0.000	1.000
OPERATING ENGINEER		BLD	4	29.150	37.700	1.5	1.5	2.0	10.00	17.20	0.000	1.000
OPERATING ENGINEER		BLD	5	28.820	37.700	1.5	1.5	2.0	10.00	17.20	0.000	1.000
OPERATING ENGINEER		BLD	6	36.250	37.700	1.5	1.5	2.0	10.00	17.20	0.000	1.000
OPERATING ENGINEER		BLD	7	36.550	37.700	1.5	1.5	2.0	10.00	17.20	0.000	1.000
OPERATING ENGINEER		BLD	8	36.830	37.700	1.5	1.5	2.0	10.00	17.20	0.000	1.000
OPERATING ENGINEER		BLD	9	35.700	37.700	1.5	1.5	2.0	10.00	17.20	0.000	1.000
OPERATING ENGINEER		HWY	1	33.200	36.200	1.5	1.5	2.0	10.00	17.20	0.000	1.000
OPERATING ENGINEER		HWY	2	32.070	36.200	1.5	1.5	2.0	10.00	17.20	0.000	1.000
OPERATING ENGINEER		HWY	3	27.590	36.200	1.5	1.5	2.0	10.00	17.20	0.000	1.000
OPERATING ENGINEER		HWY	4	27.650	36.200	1.5	1.5	2.0	10.00	17.20	0.000	1.000
OPERATING ENGINEER		HWY	5	27.320	36.200	1.5	1.5	2.0	10.00	17.20	0.000	1.000
OPERATING ENGINEER		HWY	6	34.750	36.200	1.5	1.5	2.0	10.00	17.20	0.000	1.000
OPERATING ENGINEER		HWY	7	35.050	36.200	1.5	1.5	2.0	10.00	17.20	0.000	1.000
OPERATING ENGINEER		HWY	8	35.330	36.200	1.5	1.5	2.0	10.00	17.20	0.000	1.000
OPERATING ENGINEER		HWY	9	34.200	36.200	1.5	1.5	2.0	10.00	17.20	0.000	1.000
PAINTER		BLD		29.250	30.750	1.5	2.0	2.0	5.250	9.170	0.000	0.650
PAINTER		HWY		30.450	31.950	1.5	1.5	2.0	5.250	9.170	0.000	0.650
PAINTER OVER 30FT		BLD		30.250	31.750	1.5	2.0	2.0	5.250	9.170	0.000	0.650
PAINTER PWR EQMT		BLD		30.250	31.750	1.5	2.0	2.0	5.250	9.170	0.000	0.650
PAINTER PWR EQMT		HWY		31.450	32.950	1.5	1.5	2.0	5.250	9.170	0.000	0.650
PILEDRIVER		ALL		34.970	36.470	1.5	1.5	2.0	6.800	7.250	0.000	0.400
PIPEFITTER		BLD		38.460	40.380	2.0	2.0	2.0	4.750	8.450	0.000	0.300
PLASTERER		BLD		30.250	31.250	1.5	1.5	2.0	9.500	9.150	0.000	0.050
PLUMBER		BLD		38.460	40.380	2.0	2.0	2.0	4.750	8.450	0.000	0.300
ROOFER		BLD		30.100	32.100	1.5	1.5	2.0	8.800	7.100	0.000	0.240
SHEETMETAL WORKER		BLD		26.390	28.220	1.5	1.5	2.0	7.140	9.960	0.000	0.550
SPRINKLER FITTER		BLD		40.030	43.030	2.0	2.0	2.0	8.370	11.18	0.000	1.250
SURVEY WORKER		ALL		30.360	30.860	1.5	1.5	2.0	5.750	9.840	0.000	0.800
TERRAZZO FINISHER		BLD		31.240	0.000	1.5	1.5	2.0	6.400	3.800	0.000	0.270
TERRAZZO MASON		BLD		32.530	32.830	1.5	1.5	2.0	6.400	5.550	0.000	0.290
TRUCK DRIVER		ALL	1	31.340	0.000	1.5	1.5	2.0	10.30	5.010	0.000	0.250
TRUCK DRIVER		ALL	2	31.780	0.000	1.5	1.5	2.0	10.30	5.010	0.000	0.250

TRUCK DRIVER	ALL	3	32.020	0.000	1.5	1.5	2.0	10.30	5.010	0.000	0.250
TRUCK DRIVER	ALL	4	32.280	0.000	1.5	1.5	2.0	10.30	5.010	0.000	0.250
TRUCK DRIVER	ALL	5	33.130	0.000	1.5	1.5	2.0	10.30	5.010	0.000	0.250
TRUCK DRIVER	O&C	1	25.070	0.000	1.5	1.5	2.0	10.30	5.010	0.000	0.250
TRUCK DRIVER	O&C	2	25.420	0.000	1.5	1.5	2.0	10.30	5.010	0.000	0.250
TRUCK DRIVER	O&C	3	25.620	0.000	1.5	1.5	2.0	10.30	5.010	0.000	0.250
TRUCK DRIVER	O&C	4	25.820	0.000	1.5	1.5	2.0	10.30	5.010	0.000	0.250
TRUCK DRIVER	O&C	5	26.500	0.000	1.5	1.5	2.0	10.30	5.010	0.000	0.250

**Legend:** RG (Region)

TYP (Trade Type - All,Highway,Building,Floating,Oil & Chip,Rivers)

C (Class)

Base (Base Wage Rate)

FRMAN (Foreman Rate)

M-F>8 (OT required for any hour greater than 8 worked each day, Mon through Fri.)

OSA (Overtime (OT) is required for every hour worked on Saturday)

OSH (Overtime is required for every hour worked on Sunday and Holidays)

H/W (Health & Welfare Insurance)

Pensn (Pension)

Vac (Vacation)

Trng (Training)

## Explanations

### CALHOUN COUNTY

The following list is considered as those days for which holiday rates of wages for work performed apply: New Years Day, Memorial Day, Fourth of July, Labor Day, Thanksgiving Day, Christmas Day and Veterans Day in some classifications/counties. Generally, any of these holidays which fall on a Sunday is celebrated on the following Monday. This then makes work performed on that Monday payable at the appropriate overtime rate for holiday pay. Common practice in a given local may alter certain days of celebration. If in doubt, please check with IDOL.

Oil and chip resealing (O&C) means the application of road oils and liquid asphalt to coat an existing road surface, followed by application of aggregate chips or gravel to coated surface, and subsequent rolling of material to seal the surface.

### EXPLANATION OF CLASSES

ASBESTOS - GENERAL - removal of asbestos material/mold and hazardous materials from any place in a building, including mechanical systems where those mechanical systems are to be removed. This includes the

removal of asbestos materials/mold and hazardous materials from ductwork or pipes in a building when the building is to be demolished at the time or at some close future date.

ASBESTOS - MECHANICAL - removal of asbestos material from mechanical systems, such as pipes, ducts, and boilers, where the mechanical systems are to remain.

#### CERAMIC TILE FINISHER AND MARBLE FINISHER

The handling, at the building site, of all sand, cement, tile, marble or stone and all other materials that may be used and installed by [a] tile layer or marble mason. In addition, the grouting, cleaning, sealing, and mixing on the job site, and all other work as required in assisting the setter. The term "Ceramic" is used for naming the classification only and is in no way a limitation of the product handled. Ceramic takes into consideration most hard tiles.

#### ELECTRONIC SYSTEMS TECHNICIAN

Installation, service and maintenance of low-voltage systems which utilizes the transmission and/or transference of voice, sound, vision, or digital for commercial, education, security and entertainment purposes for the following: TV monitoring and surveillance, background/foreground music, intercom and telephone interconnect, field programming, inventory control systems, microwave transmission, multi-media, multiplex, radio page, school, intercom and sound burglar alarms and low voltage master clock systems.

Excluded from this classification are energy management systems, life safety systems, supervisory controls and data acquisition systems not intrinsic with the above listed systems, fire alarm systems, nurse call systems and raceways exceeding fifteen feet in length.

#### OPERATING ENGINEER - BUILDING

GROUP I. Cranes, Dragline, Shovels, Skimmer Scoops, Clamshells or Derrick Boats, Pile Drivers, Crane-Type Backhoes, Asphalt Plant Operators, Concrete Plant Operators, Dredges, Asphalt Spreading Machines, All Locomotives, Cable Ways or Tower Machines, Hoists, Hydraulic Backhoes, Ditching Machines or Backfiller, Cherrypickers, Overhead Cranes, Roller - Steam or Gas, Concrete Pavers, Excavators, Concrete Breakers, Concrete Pumps, Bulk Cement Plants, Cement Pumps, Derrick-Type Drills, Boat Operators, Motor Graders or Pushcats, Scoops or Tournapulls, Bulldozers, Endloaders or Fork Lifts, Power Blade or Elevating Graders, Winch Cats, Boom or Winch Trucks or Boom Tractors, Pipe Wrapping or Painting Machines, Asphalt Plant Engineer, Journeyman Lubricating Engineer, Drills (other than Derrick Type), Mud Jacks, or Well Drilling Machines, Boring Machines or Track Jacks, Mixers, Conveyors (Two), Air Compressors (Two), Water Pumps regardless of size (Two), Welding Machines (Two), Siphons or Jets (Two), Winch Heads or Apparatuses (Two), Light Plants (Two), All Tractors regardless of size (straight tractor only), Fireman on Stationary Boilers, Automatic Elevators, Form Grading Machines, Finishing Machines, Power Sub-Grader or Ribbon Machines, Longitudinal Floats, Distributor Operators on Trucks, Winch Heads or Apparatuses (One), Mobil Track air and heaters (two to five), Heavy Equipment Greaser, Relief Operator, Assistant Master Mechanic and Heavy Duty Mechanic, self-propelled concrete saws of all types and sizes with their attachments, gob-hoppers, excavators all sizes, the repair and greasing of all diesel hammers, the operation and set-up of bidwells, water blasters of all sizes and their clutches, hydraulic jacks where used for hoisting, operation of log skidders, iceolators used on and off of pipeline, condor cranes,



bow boats, survey boats, bobcats and all their attachments, skid steer loaders and all their attachments, creter cranes, batch plants, operator (all sizes), self propelled roto mills, operation of conveyor systems of any size and any configuration, operation, repair and service of all vibratory hammers, all power pacs and their controls regardless of location, curtains or brush burning machines, stump cutter machines, Nail launchers when mounted on a machine or self-propelled, operation of con-cover machines, and all Operators except those listed below).

GROUP II. Assistant Operators.

GROUP III. Air Compressors (One), Water Pumps, regardless of Size (One), Waterblasters (one), Welding Machine (One), Mixers (One Bag), Conveyor (One), Siphon or Jet (One), Light Plant (One), Heater (One), Immobile Track Air (One), and Self Propelled Walk-Behind Rollers.

GROUP IV. Asphalt Spreader Oilers, Fireman on Whirlies and Heavy Equipment Oilers, Truck Cranes, Dredges, Monigans, Large Cranes - (Over 65-ton rated capacity) Concrete Plant Oiler, Blacktop Plant Oiler, and Creter Crane Oiler (when required).

GROUP V. Oiler.

GROUP VI. Operators on equipment with Booms, including jibs, 100 feet and over, and less than 150 feet long.

GROUP VII. Operators on equipment with Booms, including jibs, 150 feet and over, and less than 200 feet long.

GROUP VIII. Operators on Equipment with Booms, including jibs, 200 feet and over; Tower Cranes; and Whirlie Cranes.

GROUP IX. Master Mechanic

OPERATING ENGINEERS - Highway

GROUP I. Cranes, Dragline, Shovels, Skimmer Scoops, Clamshells or Derrick Boats, Pile Drivers, Crane-Type Backhoes, Asphalt Plant Operators, Concrete Plant Operators, Dredges, Asphalt Spreading Machines, All Locomotives, Cable Ways or Tower Machines, Hoists, Hydraulic Backhoes, Ditching Machines or Backfiller, Cherrypickers, Overhead Cranes, Roller - Steam or Gas, Concrete Pavers, Excavators, Concrete Breakers, Concrete Pumps, Bulk Cement Plants, Cement Pumps, Derrick-Type Drills, Boat Operators, Motor Graders or Pushcats, Scoops or Tournapulls, Bulldozers, Endloaders or Fork Lifts, Power Blade or Elevating Graders, Winch Cats, Boom or Winch Trucks or Boom Tractors, Pipe Wrapping or Painting Machines, Asphalt Plant Engineer, Journeyman Lubricating Engineer, Drills (other than Derrick Type), Mud Jacks, Well Drilling Machines, Boring Machines, Track Jacks, Mixers, Conveyors (Two), Air Compressors (Two), Water Pumps regardless of size (Two), Welding Machines (Two), Siphons or Jets (Two), Winch Heads or Apparatuses (Two), Light Plants (Two), All Tractors regardless of size (straight tractor only), Fireman on Stationary Boilers, Automatic Elevators, Form Grading Machines, Finishing Machines, Power Sub-Grader or Ribbon Machines, Longitudinal Floats, Distributor Operators on Trucks, Winch Heads or Apparatuses (One), Mobil Track air and heaters (two to five), Heavy Equipment Greaser, Relief Operator, Assistant Master Mechanic and Heavy Duty Mechanic, self-propelled concrete saws of all types and sizes with their attachments, gob-hoppers, excavators all sizes, the repair and greasing of all diesel hammers, the operation and set-up of bidwells, water blasters of all sizes and their clutches, hydraulic jacks where used for hoisting, operation of

log skidders, iceolators used on and off of pipeline, condor cranes, bow boats, survey boats, bobcats and all their attachments, skid steer loaders and all their attachments, creter cranes, batch plants, operator (all sizes), self propelled roto mills, operation of conveyor systems of any size and any configuration, operation, repair and service of all vibratory hammers, all power pacs and their controls regardless of location, curtains or brush burning machines, stump cutter machines, Nail launchers when mounted on a machine or self-propelled, operation of con-cover machines, and all Operators (except those listed below).

GROUP II. Assistant Operators.

GROUP III. Air Compressors (One), Water Pumps, regardless of Size (One), Waterblasters (one), Welding Machine (One), Mixers (One Bag), Conveyor (One), Siphon or Jet (One), Light Plant (One), Heater (One), Immobile Track Air (One), and Self Propelled Walk-Behind Rollers.

GROUP IV. Asphalt Spreader Oilers, Fireman on Whirlies and Heavy Equipment Oilers, Truck Cranes, Dredges, Monigans, Large Cranes - (Over 65-ton rated capacity) Concrete Plant Oiler, Blacktop Plant Oiler, and Creter Crane Oiler (when required).

GROUP V. Oiler.

GROUP VI. Operators on equipment with Booms, including jibs, 100 feet and over, and less than 150 feet long.

GROUP VII. Operators on equipment with Booms, including jibs, 150 feet and over, and less than 200 feet long.

GROUP VIII. Operators on Equipment with Booms, including jibs, 200 feet and over; Tower Cranes; and Whirlie Cranes.

GROUP IX. Mechanic

SURVEY WORKER - Operated survey equipment including data collectors, G.P.S. and robotic instruments, as well as conventional levels and transits.

TRUCK DRIVER - BUILDING, HEAVY AND HIGHWAY CONSTRUCTION

Class 1. Drivers on 2 axle trucks hauling less than 9 ton. Air compressor and welding machines and brooms, including those pulled by separate units, truck driver helpers, warehouse employees, mechanic helpers, greasers and tiremen, pickup trucks when hauling materials, tools, or workers to and from and on-the-job site, and fork lifts up to 6,000 lb. capacity.

Class 2. Two or three axle trucks hauling more than 9 ton but hauling less than 16 ton. A-frame winch trucks, hydrolift trucks, vector trucks or similar equipment when used for transportation purposes. Fork lifts over 6,000 lb. capacity, winch trucks, four axle combination units, and ticket writers.

Class 3. Two, three or four axle trucks hauling 16 ton or more. Drivers on water pulls, articulated dump trucks, mechanics and working forepersons, and dispatchers. Five axle or more combination units.

Class 4. Low Boy and Oil Distributors.

Class 5. Drivers who require special protective clothing while employed on hazardous waste work.

SURVEY WORKER - Operated survey equipment including data collectors, G.P.S. and robotic instruments, as well as conventional levels and transits.

TRUCK DRIVER - OIL AND CHIP RESEALING ONLY.

This shall encompass laborers, workers and mechanics who drive contractor or subcontractor owned, leased, or hired pickup, dump, service, or oil distributor trucks. The work includes transporting materials and equipment (including but not limited to, oils, aggregate supplies, parts, machinery and tools) to or from the job site; distributing oil or liquid asphalt and aggregate; stock piling material when in connectin with the actual oil and chip contract. The Truck Driver (Oil & Chip Resealing) wage classification does not include supplier delivered materials.

TERRAZZO FINISHER

The handling of all materials used for Mosaic and Terrazzo work including preparing, mixing by hand, by mixing machine or transporting of pre-mixed materials and distributing with shovel, rake, hoe, or pail, all kinds of concrete foundations necessary for Mosaic and Terrazzo work, all cement terrazzo, magnesite terrazzo, Do-O-Tex terrazzo, epoxy matrix ter-razzo, exposed aggregate, rustic or rough washed for exterior or interior of buildings placed either by machine or by hand, and any other kind of mixture of plastics composed of chips or granules when mixed with cement, rubber, neoprene, vinyl, magnesium chloride or any other resinous or chemical substances used for seamless flooring systems, and all other building materials, all similar materials and all precast terrazzo work on jobs, all scratch coat used for Mosaic and Terrazzo work and sub-bed, tar paper and wire mesh (2x2 etc.) or lath. The rubbing, grinding, cleaning and finishing of same either by hand or by machine or by terrazzo resurfacing equipment on new or existing floors. When necessary finishers shall be allowed to assist the mechanics to spread sand bed, lay tarpaper and wire mesh (2x2 etc.) or lath. The finishing of cement floors where additional aggregate of stone is added by spreading or sprinkling on top of the finished base, and troweled or rolled into the finish and then the surface is ground by grinding machines.

Other Classifications of Work:

For definitions of classifications not otherwise set out, the Department generally has on file such definitions which are available. If a task to be performed is not subject to one of the classifications of pay set out, the Department will upon being contacted state which neighboring county has such a classification and provide such rate, such rate being deemed to exist by reference in this document. If no neighboring county rate applies to the task, the Department shall undertake a special determination, such special determination being then deemed to have existed under this determination. If a project requires these, or any classification not listed, please contact IDOL at 217-782-1710 for wage rates or clarifications.

LANDSCAPING

Landscaping work falls under the existing classifications for laborer,

operating engineer and truck driver. The work performed by landscape plantsman and landscape laborer is covered by the existing classification of laborer. The work performed by landscape operators (regardless of equipment used or its size) is covered by the classifications of operating engineer. The work performed by landscape truck drivers (regardless of size of truck driven) is covered by the classifications of truck driver.

# Clinton County Prevailing Wage for May 2014

(See explanation of column headings at bottom of wages)

Trade Name	RG	TYP	C	Base	FRMAN	M-F>8	OSA	OSH	H/W	Pensn	Vac	Trng
=====	==	===	=	=====	=====	=====	===	===	=====	=====	=====	=====
ASBESTOS ABT-GEN		ALL		26.750	27.250	1.5	1.5	2.0	5.850	15.00	0.000	0.800
ASBESTOS ABT-MEC		BLD		30.360	31.360	1.5	1.5	2.0	7.450	3.000	0.000	0.000
BOILERMAKER		BLD		32.060	34.560	1.5	1.5	2.0	7.070	21.27	1.000	0.350
BRICK MASON		BLD		29.640	33.540	1.5	1.5	2.0	8.000	10.09	2.000	0.400
CARPENTER		ALL		34.970	36.470	1.5	1.5	2.0	6.800	7.250	0.000	0.400
CEMENT MASON		ALL		31.500	32.500	1.5	1.5	2.0	9.500	12.25	0.000	0.200
CERAMIC TILE FNSHER		BLD		25.890	0.000	1.5	1.5	2.0	6.400	5.450	0.000	0.580
ELECTRIC PWR EQMT OP E	E	ALL	1	36.770	0.000	1.5	1.5	2.0	5.760	10.29	0.000	0.370
ELECTRIC PWR EQMT OP E	E	ALL	2	32.820	0.000	1.5	1.5	2.0	5.760	9.190	0.000	0.330
ELECTRIC PWR EQMT OP W	W	ALL		38.150	0.000	1.5	1.5	2.0	6.950	10.68	0.000	0.380
ELECTRIC PWR GRNDMAN E	E	ALL		27.020	0.000	1.5	1.5	2.0	5.760	7.570	0.000	0.270
ELECTRIC PWR GRNDMAN W	W	ALL		28.490	0.000	1.5	1.5	2.0	5.190	7.970	0.000	0.280
ELECTRIC PWR LINEMAN E	E	ALL		46.100	49.220	1.5	1.5	2.0	5.760	12.91	0.000	0.460
ELECTRIC PWR LINEMAN W	W	ALL		43.860	0.000	1.5	1.5	2.0	7.990	12.29	0.000	0.440
ELECTRIC PWR TRK DRV W	W	ALL		31.140	0.000	1.5	1.5	2.0	5.670	8.720	0.000	0.310
ELECTRICIAN	E	ALL		40.300	42.550	1.5	1.5	2.0	6.410	10.08	0.000	0.800
ELECTRICIAN	W	ALL		37.350	39.590	1.5	1.5	2.0	7.990	9.720	0.000	0.650
ELECTRONIC SYS TECH E	E	BLD		32.570	34.320	1.5	1.5	2.0	6.250	4.210	0.000	0.400
ELECTRONIC SYS TECH W	W	BLD		31.280	33.280	1.5	1.5	2.0	3.650	8.190	0.000	0.400
ELEVATOR CONSTRUCTOR		BLD		44.370	49.920	2.0	2.0	2.0	12.73	13.46	3.550	0.600
FLOOR LAYER		BLD		29.580	30.330	1.5	1.5	2.0	6.800	7.250	0.000	0.400
GLAZIER		BLD		32.780	0.000	2.0	2.0	2.0	9.020	10.80	2.630	0.310
HT/FROST INSULATOR		BLD		37.660	38.660	1.5	1.5	2.0	8.350	11.26	0.000	0.500
IRON WORKER		ALL		31.500	33.500	1.5	1.5	2.0	8.110	13.85	0.000	0.420
LABORER		ALL		26.250	26.750	1.5	1.5	2.0	5.850	15.00	0.000	0.800
MACHINIST		BLD		43.920	46.420	1.5	1.5	2.0	6.760	8.950	1.850	0.000
MARBLE FINISHERS		BLD		25.890	0.000	1.5	1.5	2.0	6.400	5.450	0.000	0.580
MILLWRIGHT		ALL		34.970	36.470	1.5	1.5	2.0	6.800	7.250	0.000	0.400
OPERATING ENGINEER		BLD	1	34.700	37.700	1.5	1.5	2.0	10.00	17.20	0.000	1.000
OPERATING ENGINEER		BLD	2	33.570	37.700	1.5	1.5	2.0	10.00	17.20	0.000	1.000
OPERATING ENGINEER		BLD	3	29.090	37.700	1.5	1.5	2.0	10.00	17.20	0.000	1.000
OPERATING ENGINEER		BLD	4	29.150	37.700	1.5	1.5	2.0	10.00	17.20	0.000	1.000
OPERATING ENGINEER		BLD	5	28.820	37.700	1.5	1.5	2.0	10.00	17.20	0.000	1.000
OPERATING ENGINEER		BLD	6	36.250	37.700	1.5	1.5	2.0	10.00	17.20	0.000	1.000
OPERATING ENGINEER		BLD	7	36.550	37.700	1.5	1.5	2.0	10.00	17.20	0.000	1.000
OPERATING ENGINEER		BLD	8	36.830	37.700	1.5	1.5	2.0	10.00	17.20	0.000	1.000
OPERATING ENGINEER		BLD	9	35.700	37.700	1.5	1.5	2.0	10.00	17.20	0.000	1.000
OPERATING ENGINEER		HWY	1	33.200	36.200	1.5	1.5	2.0	10.00	17.20	0.000	1.000
OPERATING ENGINEER		HWY	2	32.070	36.200	1.5	1.5	2.0	10.00	17.20	0.000	1.000
OPERATING ENGINEER		HWY	3	27.590	36.200	1.5	1.5	2.0	10.00	17.20	0.000	1.000
OPERATING ENGINEER		HWY	4	27.650	36.200	1.5	1.5	2.0	10.00	17.20	0.000	1.000
OPERATING ENGINEER		HWY	5	27.320	36.200	1.5	1.5	2.0	10.00	17.20	0.000	1.000
OPERATING ENGINEER		HWY	6	34.750	36.200	1.5	1.5	2.0	10.00	17.20	0.000	1.000
OPERATING ENGINEER		HWY	7	35.050	36.200	1.5	1.5	2.0	10.00	17.20	0.000	1.000
OPERATING ENGINEER		HWY	8	35.330	36.200	1.5	1.5	2.0	10.00	17.20	0.000	1.000
OPERATING ENGINEER		HWY	9	34.200	36.200	1.5	1.5	2.0	10.00	17.20	0.000	1.000
PAINTER		BLD		29.250	30.750	1.5	2.0	2.0	5.250	9.170	0.000	0.650
PAINTER		HWY		30.450	31.950	1.5	1.5	2.0	5.250	9.170	0.000	0.650
PAINTER OVER 30FT		BLD		30.250	31.750	1.5	2.0	2.0	5.250	9.170	0.000	0.650
PAINTER PWR EQMT		BLD		30.250	31.750	1.5	2.0	2.0	5.250	9.170	0.000	0.650
PAINTER PWR EQMT		HWY		31.450	32.950	1.5	1.5	2.0	5.250	9.170	0.000	0.650
PILEDRIVER		ALL		34.970	36.470	1.5	1.5	2.0	6.800	7.250	0.000	0.400
PIPEFITTER	E	BLD		35.450	39.000	1.5	1.5	2.0	6.200	7.000	0.000	0.900
PIPEFITTER	NW	BLD		37.250	39.250	1.5	1.5	2.0	6.740	8.000	0.000	0.750
PIPEFITTER	SW	BLD		36.500	39.000	1.5	1.5	2.0	8.150	5.600	0.000	0.580
PLASTERER		BLD		30.250	31.250	1.5	1.5	2.0	9.500	9.150	0.000	0.050

PLUMBER	E	BLD	35.450	39.000	1.5	1.5	2.0	6.200	7.000	0.000	0.900
PLUMBER	NW	BLD	37.050	39.550	1.5	1.5	2.0	6.500	6.850	0.000	0.500
PLUMBER	SW	BLD	36.500	39.000	1.5	1.5	2.0	8.150	5.600	0.000	0.580
ROOFER		BLD	30.100	32.100	1.5	1.5	2.0	8.800	7.100	0.000	0.240
SHEETMETAL WORKER		ALL	32.250	33.750	1.5	1.5	2.0	8.330	7.320	1.940	0.360
SPRINKLER FITTER		BLD	40.030	43.030	2.0	2.0	2.0	8.370	11.18	0.000	1.250
SURVEY WORKER		ALL	25.200	25.700	1.5	1.5	2.0	5.750	15.00	0.000	0.800
TERRAZZO FINISHER		BLD	31.240	0.000	1.5	1.5	2.0	6.400	3.800	0.000	0.270
TERRAZZO MASON		BLD	32.530	32.830	1.5	1.5	2.0	6.400	5.550	0.000	0.290
TRUCK DRIVER	ALL	1	31.340	0.000	1.5	1.5	2.0	10.30	5.010	0.000	0.250
TRUCK DRIVER	ALL	2	31.780	0.000	1.5	1.5	2.0	10.30	5.010	0.000	0.250
TRUCK DRIVER	ALL	3	32.020	0.000	1.5	1.5	2.0	10.30	5.010	0.000	0.250
TRUCK DRIVER	ALL	4	32.280	0.000	1.5	1.5	2.0	10.30	5.010	0.000	0.250
TRUCK DRIVER	ALL	5	33.130	0.000	1.5	1.5	2.0	10.30	5.010	0.000	0.250
TRUCK DRIVER	O&C	1	25.070	0.000	1.5	1.5	2.0	10.30	5.010	0.000	0.250
TRUCK DRIVER	O&C	2	25.420	0.000	1.5	1.5	2.0	10.30	5.010	0.000	0.250
TRUCK DRIVER	O&C	3	25.620	0.000	1.5	1.5	2.0	10.30	5.010	0.000	0.250
TRUCK DRIVER	O&C	4	25.820	0.000	1.5	1.5	2.0	10.30	5.010	0.000	0.250
TRUCK DRIVER	O&C	5	26.500	0.000	1.5	1.5	2.0	10.30	5.010	0.000	0.250

**Legend:** RG (Region)

TYP (Trade Type - All,Highway,Building,Floating,Oil & Chip,Rivers)

C (Class)

Base (Base Wage Rate)

FRMAN (Foreman Rate)

M-F>8 (OT required for any hour greater than 8 worked each day, Mon through Fri.

OSA (Overtime (OT) is required for every hour worked on Saturday)

OSH (Overtime is required for every hour worked on Sunday and Holidays)

H/W (Health & Welfare Insurance)

Pensn (Pension)

Vac (Vacation)

Trng (Training)

## Explanations

### CLINTON COUNTY

ELECTRICIANS & ELECTRONIC SYSTEMS TECHNICIAN (WEST) - Townships of St. Rose, Wheatfield, Sugar Creek, Breese, Wade, Carlyle, Looking Glass, and Germantown.

ELECTRICIANS & ELECTRONIC SYSTEMS TECHNICIAN (EAST) - Townships not included in WEST.

PLUMBERS & PIPEFITTERS (EAST) - That part of the county East of a North-South line 2.5 miles East of Rt. 127.

PLUMBERS & PIPEFITTERS (SOUTHWEST) - That part of the county South of New Route 50 and West of Route 127 inclusive.

The following list is considered as those days for which holiday rates of wages for work performed apply: New Years Day, Memorial Day, Fourth of July, Labor Day, Thanksgiving Day, Christmas Day and Veterans Day in some classifications/counties. Generally, any of these holidays which fall on a Sunday is celebrated on the following Monday. This then makes work performed on that Monday payable at the appropriate overtime rate for holiday pay. Common practice in a given local may alter certain days of celebration. If in doubt, please check with IDOL.

Oil and chip resealing (O&C) means the application of road oils and liquid asphalt to coat an existing road surface, followed by application of aggregate chips or gravel to coated surface, and subsequent rolling of material to seal the surface.

#### EXPLANATION OF CLASSES

ASBESTOS - GENERAL - removal of asbestos material/mold and hazardous materials from any place in a building, including mechanical systems where those mechanical systems are to be removed. This includes the removal of asbestos materials/mold and hazardous materials from ductwork or pipes in a building when the building is to be demolished at the time or at some close future date.

ASBESTOS - MECHANICAL - removal of asbestos material from mechanical systems, such as pipes, ducts, and boilers, where the mechanical systems are to remain.

#### CERAMIC TILE FINISHER AND MARBLE FINISHER

The handling, at the building site, of all sand, cement, tile, marble or stone and all other materials that may be used and installed by [a] tile layer or marble mason. In addition, the grouting, cleaning, sealing, and mixing on the job site, and all other work as required in assisting the setter. The term "Ceramic" is used for naming the classification only and is in no way a limitation of the product handled. Ceramic takes into consideration most hard tiles.

#### ELECTRONIC SYSTEMS TECHNICIAN

Installation, service and maintenance of low-voltage systems which utilizes the transmission and/or transference of voice, sound, vision, or digital for commercial, education, security and entertainment purposes for the following: TV monitoring and surveillance, background/foreground music, intercom and telephone interconnect, field programming, inventory control systems, microwave transmission, multi-media, multiplex, radio page, school, intercom and sound burglar alarms and low voltage master clock systems.

Excluded from this classification are energy management systems, life safety systems, supervisory controls and data acquisition systems not intrinsic with the above listed systems, fire alarm systems, nurse call systems and raceways exceeding fifteen feet in length.

#### OPERATING ENGINEER - BUILDING

GROUP I. Cranes, Dragline, Shovels, Skimmer Scoops, Clamshells or Derrick Boats, Pile Drivers, Crane-Type Backhoes, Asphalt Plant Operators, Concrete Plant Operators, Dredges, Asphalt Spreading Machines, All Locomotives, Cable Ways or Tower Machines, Hoists,

Hydraulic Backhoes, Ditching Machines or Backfiller, Cherrypickers, Overhead Cranes, Roller - Steam or Gas, Concrete Pavers, Excavators, Concrete Breakers, Concrete Pumps, Bulk Cement Plants, Cement Pumps, Derrick-Type Drills, Boat Operators, Motor Graders or Pushcats, Scoops or Tournapulls, Bulldozers, Endloaders or Fork Lifts, Power Blade or Elevating Graders, Winch Cats, Boom or Winch Trucks or Boom Tractors, Pipe Wrapping or Painting Machines, Asphalt Plant Engineer, Journeyman Lubricating Engineer, Drills (other than Derrick Type), Mud Jacks, or Well Drilling Machines, Boring Machines or Track Jacks, Mixers, Conveyors (Two), Air Compressors (Two), Water Pumps regardless of size (Two), Welding Machines (Two), Siphons or Jets (Two), Winch Heads or Apparatuses (Two), Light Plants (Two), All Tractors regardless of size (straight tractor only), Fireman on Stationary Boilers, Automatic Elevators, Form Grading Machines, Finishing Machines, Power Sub-Grader or Ribbon Machines, Longitudinal Floats, Distributor Operators on Trucks, Winch Heads or Apparatuses (One), Mobil Track air and heaters (two to five), Heavy Equipment Greaser, Relief Operator, Assistant Master Mechanic and Heavy Duty Mechanic, self-propelled concrete saws of all types and sizes with their attachments, gob-hoppers, excavators all sizes, the repair and greasing of all diesel hammers, the operation and set-up of bidwells, water blasters of all sizes and their clutches, hydraulic jacks where used for hoisting, operation of log skidders, iceolators used on and off of pipeline, condor cranes, bow boats, survey boats, bobcats and all their attachments, skid steer loaders and all their attachments, creter cranes, batch plants, operator (all sizes), self propelled roto mills, operation of conveyor systems of any size and any configuration, operation, repair and service of all vibratory hammers, all power pacs and their controls regardless of location, curtains or brush burning machines, stump cutter machines, Nail launchers when mounted on a machine or self-propelled, operation of con-cover machines, and all Operators except those listed below).

GROUP II. Assistant Operators.

GROUP III. Air Compressors (One), Water Pumps, regardless of Size (One), Waterblasters (one), Welding Machine (One), Mixers (One Bag), Conveyor (One), Siphon or Jet (One), Light Plant (One), Heater (One), Immobile Track Air (One), and Self Propelled Walk-Behind Rollers.

GROUP IV. Asphalt Spreader Oilers, Fireman on Whirlies and Heavy Equipment Oilers, Truck Cranes, Dredges, Monigans, Large Cranes - (Over 65-ton rated capacity) Concrete Plant Oiler, Blacktop Plant Oiler, and Creter Crane Oiler (when required).

GROUP V. Oiler.

GROUP VI. Operators on equipment with Booms, including jibs, 100 feet and over, and less than 150 feet long.

GROUP VII. Operators on equipment with Booms, including jibs, 150 feet and over, and less than 200 feet long.

GROUP VIII. Operators on Equipment with Booms, including jibs, 200 feet and over; Tower Cranes; and Whirlie Cranes.

GROUP IX. Master Mechanic

OPERATING ENGINEERS - Highway

GROUP I. Cranes, Dragline, Shovels, Skimmer Scoops, Clamshells or Derrick Boats, Pile Drivers, Crane-Type Backhoes, Asphalt Plant Operators, Concrete Plant Operators, Dredges, Asphalt Spreading



Machines, All Locomotives, Cable Ways or Tower Machines, Hoists, Hydraulic Backhoes, Ditching Machines or Backfiller, Cherrypickers, Overhead Cranes, Roller - Steam or Gas, Concrete Pavers, Excavators, Concrete Breakers, Concrete Pumps, Bulk Cement Plants, Cement Pumps, Derrick-Type Drills, Boat Operators, Motor Graders or Pushcats, Scoops or Tournapulls, Bulldozers, Endloaders or Fork Lifts, Power Blade or Elevating Graders, Winch Cats, Boom or Winch Trucks or Boom Tractors, Pipe Wrapping or Painting Machines, Asphalt Plant Engineer, Journeyman Lubricating Engineer, Drills (other than Derrick Type), Mud Jacks, Well Drilling Machines, Boring Machines, Track Jacks, Mixers, Conveyors (Two), Air Compressors (Two), Water Pumps regardless of size (Two), Welding Machines (Two), Siphons or Jets (Two), Winch Heads or Apparatuses (Two), Light Plants (Two), All Tractors regardless of size (straight tractor only), Fireman on Stationary Boilers, Automatic Elevators, Form Grading Machines, Finishing Machines, Power Sub-Grader or Ribbon Machines, Longitudinal Floats, Distributor Operators on Trucks, Winch Heads or Apparatuses (One), Mobil Track air and heaters (two to five), Heavy Equipment Greaser, Relief Operator, Assistant Master Mechanic and Heavy Duty Mechanic, self-propelled concrete saws of all types and sizes with their attachments, gob-hoppers, excavators all sizes, the repair and greasing of all diesel hammers, the operation and set-up of bidwells, water blasters of all sizes and their clutches, hydraulic jacks where used for hoisting, operation of log skidders, iceolators used on and off of pipeline, condor cranes, bow boats, survey boats, bobcats and all their attachments, skid steer loaders and all their attachments, creter cranes, batch plants, operator (all sizes), self propelled roto mills, operation of conveyor systems of any size and any configuration, operation, repair and service of all vibratory hammers, all power pacs and their controls regardless of location, curtains or brush burning machines, stump cutter machines, Nail launchers when mounted on a machine or self-propelled, operation of con-cover machines, and all Operators (except those listed below).

GROUP II. Assistant Operators.

GROUP III. Air Compressors (One), Water Pumps, regardless of Size (One), Waterblasters (one), Welding Machine (One), Mixers (One Bag), Conveyor (One), Siphon or Jet (One), Light Plant (One), Heater (One), Immobile Track Air (One), and Self Propelled Walk-Behind Rollers.

GROUP IV. Asphalt Spreader Oilers, Fireman on Whirlies and Heavy Equipment Oilers, Truck Cranes, Dredges, Monigans, Large Cranes - (Over 65-ton rated capacity) Concrete Plant Oiler, Blacktop Plant Oiler, and Creter Crane Oiler (when required).

GROUP V. Oiler.

GROUP VI. Operators on equipment with Booms, including jibs, 100 feet and over, and less than 150 feet long.

GROUP VII. Operators on equipment with Booms, including jibs, 150 feet and over, and less than 200 feet long.

GROUP VIII. Operators on Equipment with Booms, including jibs, 200 feet and over; Tower Cranes; and Whirlie Cranes.

GROUP IX. Mechanic

SURVEY WORKER - Operated survey equipment including data collectors, G.P.S. and robotic instruments, as well as conventional levels and transits.

TRUCK DRIVER - BUILDING, HEAVY AND HIGHWAY CONSTRUCTION

Class 1. Drivers on 2 axle trucks hauling less than 9 ton. Air compressor and welding machines and brooms, including those pulled by separate units, truck driver helpers, warehouse employees, mechanic helpers, greasers and tiremen, pickup trucks when hauling materials, tools, or workers to and from and on-the-job site, and fork lifts up to 6,000 lb. capacity.

Class 2. Two or three axle trucks hauling more than 9 ton but hauling less than 16 ton. A-frame winch trucks, hydrolift trucks, vector trucks or similar equipment when used for transportation purposes. Fork lifts over 6,000 lb. capacity, winch trucks, four axle combination units, and ticket writers.

Class 3. Two, three or four axle trucks hauling 16 ton or more. Drivers on water pulls, articulated dump trucks, mechanics and working forepersons, and dispatchers. Five axle or more combination units.

Class 4. Low Boy and Oil Distributors.

Class 5. Drivers who require special protective clothing while employed on hazardous waste work.

TRUCK DRIVER - OIL AND CHIP RESEALING ONLY.

This shall encompass laborers, workers and mechanics who drive contractor or subcontractor owned, leased, or hired pickup, dump, service, or oil distributor trucks. The work includes transporting materials and equipment (including but not limited to, oils, aggregate supplies, parts, machinery and tools) to or from the job site; distributing oil or liquid asphalt and aggregate; stock piling material when in connection with the actual oil and chip contract. The Truck Driver (Oil & Chip Resealing) wage classification does not include supplier delivered materials.

TERRAZZO FINISHER

The handling of all materials used for Mosaic and Terrazzo work including preparing, mixing by hand, by mixing machine or transporting of pre-mixed materials and distributing with shovel, rake, hoe, or pail, all kinds of concrete foundations necessary for Mosaic and Terrazzo work, all cement terrazzo, magnesite terrazzo, Do-O-Tex terrazzo, epoxy matrix ter-razzo, exposed aggregate, rustic or rough washed for exterior or interior of buildings placed either by machine or by hand, and any other kind of mixture of plastics composed of chips or granules when mixed with cement, rubber, neoprene, vinyl, magnesium chloride or any other resinous or chemical substances used for seamless flooring systems, and all other building materials, all similar materials and all precast terrazzo work on jobs, all scratch coat used for Mosaic and Terrazzo work and sub-bed, tar paper and wire mesh (2x2 etc.) or lath. The rubbing, grinding, cleaning and finishing of same either by hand or by machine or by terrazzo resurfacing equipment on new or existing floors. When necessary finishers shall be allowed to assist the mechanics to spread sand bed, lay tarpaper and wire mesh (2x2 etc.) or lath. The finishing of cement floors where additional aggregate of stone is added by spreading or sprinkling on top of the finished base, and troweled or rolled into the finish and then the surface is ground by grinding machines.

Other Classifications of Work:

For definitions of classifications not otherwise set out, the Department generally has on file such definitions which are available. If a task to be performed is not subject to one of the classifications of pay set out, the Department will upon being contacted state which neighboring county has such a classification and provide such rate, such rate being deemed to exist by reference in this document. If no neighboring county rate applies to the task, the Department shall undertake a special determination, such special determination being then deemed to have existed under this determination. If a project requires these, or any classification not listed, please contact IDOL at 217-782-1710 for wage rates or clarifications.

#### LANDSCAPING

Landscaping work falls under the existing classifications for laborer, operating engineer and truck driver. The work performed by landscape plantsman and landscape laborer is covered by the existing classification of laborer. The work performed by landscape operators (regardless of equipment used or its size) is covered by the classifications of operating engineer. The work performed by landscape truck drivers (regardless of size of truck driven) is covered by the classifications of truck driver.

# Greene County Prevailing Wage for May 2014

(See explanation of column headings at bottom of wages)

Trade Name	RG	TYP	C	Base	FRMAN	M-F>8	OSA	OSH	H/W	Pensn	Vac	Trng
=====	==	===	=	=====	=====	=====	===	===	=====	=====	=====	=====
ASBESTOS ABT-GEN		ALL		31.040	31.540	1.5	1.5	2.0	6.300	10.26	0.000	0.800
ASBESTOS ABT-MEC		BLD		30.360	31.360	1.5	1.5	2.0	7.450	3.000	0.000	0.000
BOILERMAKER		BLD		32.060	34.560	1.5	1.5	2.0	7.070	21.27	1.000	0.350
BRICK MASON		BLD		29.730	30.730	1.5	1.5	2.0	8.450	9.400	0.000	0.580
CARPENTER		BLD		27.670	29.920	1.5	1.5	2.0	7.700	15.58	0.000	0.520
CARPENTER		HWY		29.020	30.770	1.5	1.5	2.0	7.700	14.73	0.000	0.520
CEMENT MASON		ALL		31.500	32.500	1.5	1.5	2.0	9.500	12.25	0.000	0.200
CERAMIC TILE FNSHER		BLD		26.480	0.000	1.5	1.5	2.0	8.450	7.300	0.000	0.000
ELECTRIC PWR EQMT OP		ALL		36.690	44.520	1.5	2.0	2.0	5.000	9.170	0.000	0.280
ELECTRIC PWR GRNDMAN		ALL		24.940	44.520	1.5	2.0	2.0	5.000	6.240	0.000	0.190
ELECTRIC PWR LINEMAN		ALL		42.210	44.520	1.5	2.0	2.0	5.000	10.56	0.000	0.320
ELECTRIC PWR TRK DRV		ALL		25.560	44.520	1.5	2.0	2.0	5.000	6.390	0.000	0.190
ELECTRICIAN		ALL		36.400	38.650	1.5	1.5	2.0	7.500	9.090	0.000	0.550
ELECTRONIC SYS TECH		BLD		28.740	30.490	1.5	1.5	2.0	7.500	5.860	0.000	0.400
ELEVATOR CONSTRUCTOR		BLD		44.370	49.920	2.0	2.0	2.0	12.73	13.46	3.550	0.600
GLAZIER		BLD		32.780	0.000	2.0	2.0	2.0	9.020	10.80	2.630	0.310
HT/FROST INSULATOR		BLD		37.660	38.660	1.5	1.5	2.0	8.350	11.26	0.000	0.500
IRON WORKER		BLD		30.000	32.000	1.5	1.5	2.0	8.200	11.88	0.000	0.660
IRON WORKER		HWY		30.750	32.500	1.5	1.5	2.0	8.200	12.35	0.000	0.660
LABORER		ALL		30.540	31.040	1.5	1.5	2.0	6.300	10.26	0.000	0.800
LATHER		BLD		27.670	29.920	1.5	1.5	2.0	7.700	15.58	0.000	0.520
MACHINIST		BLD		43.920	46.420	1.5	1.5	2.0	6.760	8.950	1.850	0.000
MARBLE FINISHERS		BLD		26.480	0.000	1.5	1.5	2.0	8.450	7.300	0.000	0.000
MARBLE MASON		BLD		27.980	28.730	1.5	1.5	2.0	8.450	7.300	0.000	0.000
MILLWRIGHT		BLD		29.620	31.870	1.5	1.5	2.0	7.700	14.09	0.000	0.520
MILLWRIGHT		HWY		31.690	33.440	1.5	1.5	2.0	7.700	14.64	0.000	0.520
OPERATING ENGINEER		BLD 1		34.700	37.700	1.5	1.5	2.0	10.00	17.20	0.000	1.000
OPERATING ENGINEER		BLD 2		33.570	37.700	1.5	1.5	2.0	10.00	17.20	0.000	1.000
OPERATING ENGINEER		BLD 3		29.090	37.700	1.5	1.5	2.0	10.00	17.20	0.000	1.000
OPERATING ENGINEER		BLD 4		29.150	37.700	1.5	1.5	2.0	10.00	17.20	0.000	1.000
OPERATING ENGINEER		BLD 5		28.820	37.700	1.5	1.5	2.0	10.00	17.20	0.000	1.000
OPERATING ENGINEER		BLD 6		36.250	37.700	1.5	1.5	2.0	10.00	17.20	0.000	1.000
OPERATING ENGINEER		BLD 7		36.550	37.700	1.5	1.5	2.0	10.00	17.20	0.000	1.000
OPERATING ENGINEER		BLD 8		36.830	37.700	1.5	1.5	2.0	10.00	17.20	0.000	1.000
OPERATING ENGINEER		BLD 9		35.700	37.700	1.5	1.5	2.0	10.00	17.20	0.000	1.000
OPERATING ENGINEER		HWY 1		33.200	36.200	1.5	1.5	2.0	10.00	17.20	0.000	1.000
OPERATING ENGINEER		HWY 2		32.070	36.200	1.5	1.5	2.0	10.00	17.20	0.000	1.000
OPERATING ENGINEER		HWY 3		27.590	36.200	1.5	1.5	2.0	10.00	17.20	0.000	1.000
OPERATING ENGINEER		HWY 4		27.650	36.200	1.5	1.5	2.0	10.00	17.20	0.000	1.000
OPERATING ENGINEER		HWY 5		27.320	36.200	1.5	1.5	2.0	10.00	17.20	0.000	1.000
OPERATING ENGINEER		HWY 6		34.750	36.200	1.5	1.5	2.0	10.00	17.20	0.000	1.000
OPERATING ENGINEER		HWY 7		35.050	36.200	1.5	1.5	2.0	10.00	17.20	0.000	1.000
OPERATING ENGINEER		HWY 8		35.330	36.200	1.5	1.5	2.0	10.00	17.20	0.000	1.000
OPERATING ENGINEER		HWY 9		34.200	36.200	1.5	1.5	2.0	10.00	17.20	0.000	1.000
PAINTER		BLD		29.250	30.750	1.5	2.0	2.0	5.250	9.170	0.000	0.650
PAINTER		HWY		30.450	31.950	1.5	1.5	2.0	5.250	9.170	0.000	0.650
PAINTER OVER 30FT		BLD		30.250	31.750	1.5	2.0	2.0	5.250	9.170	0.000	0.650
PAINTER PWR EQMT		BLD		30.250	31.750	1.5	2.0	2.0	5.250	9.170	0.000	0.650
PAINTER PWR EQMT		HWY		31.450	32.950	1.5	1.5	2.0	5.250	9.170	0.000	0.650
PILEDRIVER		BLD		28.170	30.420	1.5	1.5	2.0	7.700	15.58	0.000	0.520
PILEDRIVER		HWY		30.020	31.770	1.5	1.5	2.0	7.700	14.73	0.000	0.520
PIPEFITTER		BLD		38.460	40.380	2.0	2.0	2.0	4.750	8.450	0.000	0.300
PLASTERER		BLD		30.250	31.250	1.5	1.5	2.0	9.500	9.150	0.000	0.050
PLUMBER		BLD		38.460	40.380	2.0	2.0	2.0	4.750	8.450	0.000	0.300
ROOFER		BLD		30.100	32.100	1.5	1.5	2.0	8.800	7.100	0.000	0.240
SHEETMETAL WORKER		ALL		32.250	33.750	1.5	1.5	2.0	8.330	7.320	1.940	0.360

SPRINKLER FITTER	BLD	40.030	43.030	2.0	2.0	2.0	8.370	11.18	0.000	1.250
STONE MASON	BLD	29.730	30.730	1.5	1.5	2.0	8.450	9.400	0.000	0.580
SURVEY WORKER	ALL	30.360	30.860	1.5	1.5	2.0	5.750	9.840	0.000	0.800
TERRAZZO FINISHER	BLD	26.480	0.000	1.5	1.5	2.0	8.450	7.300	0.000	0.000
TERRAZZO MASON	BLD	27.980	28.730	1.5	1.5	2.0	8.450	7.300	0.000	0.000
TILE MASON	BLD	27.980	28.730	1.5	1.5	2.0	8.450	7.300	0.000	0.000
TRUCK DRIVER	ALL 1	31.340	0.000	1.5	1.5	2.0	10.30	5.010	0.000	0.250
TRUCK DRIVER	ALL 2	31.780	0.000	1.5	1.5	2.0	10.30	5.010	0.000	0.250
TRUCK DRIVER	ALL 3	32.020	0.000	1.5	1.5	2.0	10.30	5.010	0.000	0.250
TRUCK DRIVER	ALL 4	32.280	0.000	1.5	1.5	2.0	10.30	5.010	0.000	0.250
TRUCK DRIVER	ALL 5	33.130	0.000	1.5	1.5	2.0	10.30	5.010	0.000	0.250
TRUCK DRIVER	O&C 1	25.070	0.000	1.5	1.5	2.0	10.30	5.010	0.000	0.250
TRUCK DRIVER	O&C 2	25.420	0.000	1.5	1.5	2.0	10.30	5.010	0.000	0.250
TRUCK DRIVER	O&C 3	25.620	0.000	1.5	1.5	2.0	10.30	5.010	0.000	0.250
TRUCK DRIVER	O&C 4	25.820	0.000	1.5	1.5	2.0	10.30	5.010	0.000	0.250
TRUCK DRIVER	O&C 5	26.500	0.000	1.5	1.5	2.0	10.30	5.010	0.000	0.250
TUCKPOINTER	BLD	29.730	30.730	1.5	1.5	2.0	8.450	9.400	0.000	0.580

Legend: RG (Region)

TYP (Trade Type - All,Highway,Building,Floating,Oil & Chip,Rivers)

C (Class)

Base (Base Wage Rate)

FRMAN (Foreman Rate)

M-F>8 (OT required for any hour greater than 8 worked each day, Mon through Fri.)

OSA (Overtime (OT) is required for every hour worked on Saturday)

OSH (Overtime is required for every hour worked on Sunday and Holidays)

H/W (Health & Welfare Insurance)

Pensn (Pension)

Vac (Vacation)

Trng (Training)

## Explanations

### GREENE COUNTY

The following list is considered as those days for which holiday rates of wages for work performed apply: New Years Day, Memorial Day, Fourth of July, Labor Day, Thanksgiving Day, Christmas Day and Veterans Day in some classifications/counties. Generally, any of these holidays which fall on a Sunday is celebrated on the following Monday. This then makes work performed on that Monday payable at the appropriate overtime rate for holiday pay. Common practice in a given local may alter certain days of celebration. If in doubt, please check with IDOL.

Oil and chip resealing (O&C) means the application of road oils and liquid asphalt to coat an existing road surface, followed by application of aggregate chips or gravel to coated surface, and subsequent rolling of material to seal the surface.

#### EXPLANATION OF CLASSES

ASBESTOS - GENERAL - removal of asbestos material/mold and hazardous materials from any place in a building, including mechanical systems where those mechanical systems are to be removed. This includes the removal of asbestos materials/mold and hazardous materials from ductwork or pipes in a building when the building is to be demolished at the time or at some close future date.

ASBESTOS - MECHANICAL - removal of asbestos material from mechanical systems, such as pipes, ducts, and boilers, where the mechanical systems are to remain.

#### CERAMIC TILE FINISHER, MARBLE FINISHER, TERRAZZO FINISHER

Assisting, helping or supporting the tile, marble and terrazzo mechanic by performing their historic and traditional work assignments required to complete the proper installation of the work covered by said crafts. The term "Ceramic" is used for naming the classification only and is in no way a limitation of the product handled. Ceramic takes into consideration most hard tiles.

#### ELECTRONIC SYSTEMS TECHNICIAN

Installation, service and maintenance of low-voltage systems which utilizes the transmission and/or transference of voice, sound, vision, or digital for commercial, education, security and entertainment purposes for the following: TV monitoring and surveillance, background/foreground music, intercom and telephone interconnect, field programming, inventory control systems, microwave transmission, multi-media, multiplex, radio page, school, intercom and sound burglar alarms and low voltage master clock systems.

Excluded from this classification are energy management systems, life safety systems, supervisory controls and data acquisition systems not intrinsic with the above listed systems, fire alarm systems, nurse call systems and raceways exceeding fifteen feet in length.

#### OPERATING ENGINEER - BUILDING

GROUP I. Cranes, Dragline, Shovels, Skimmer Scoops, Clamshells or Derrick Boats, Pile Drivers, Crane-Type Backhoes, Asphalt Plant Operators, Concrete Plant Operators, Dredges, Asphalt Spreading Machines, All Locomotives, Cable Ways or Tower Machines, Hoists, Hydraulic Backhoes, Ditching Machines or Backfiller, Cherrypickers, Overhead Cranes, Roller - Steam or Gas, Concrete Pavers, Excavators, Concrete Breakers, Concrete Pumps, Bulk Cement Plants, Cement Pumps, Derrick-Type Drills, Boat Operators, Motor Graders or Pushcats, Scoops or Tournapulls, Bulldozers, Endloaders or Fork Lifts, Power Blade or Elevating Graders, Winch Cats, Boom or Winch Trucks or Boom Tractors, Pipe Wrapping or Painting Machines, Asphalt Plant Engineer, Journeyman Lubricating Engineer, Drills (other than Derrick Type), Mud Jacks, or Well Drilling Machines, Boring Machines or Track Jacks, Mixers, Conveyors (Two), Air Compressors (Two), Water Pumps regardless of size (Two), Welding Machines (Two), Siphons or Jets (Two), Winch Heads or Apparatuses (Two), Light Plants (Two), All Tractors regardless of size (straight tractor only), Fireman on Stationary Boilers, Automatic Elevators, Form Grading Machines, Finishing Machines, Power Sub-Grader

or Ribbon Machines, Longitudinal Floats, Distributor Operators on Trucks, Winch Heads or Apparatuses (One), Mobil Track air and heaters (two to five), Heavy Equipment Greaser, Relief Operator, Assistant Master Mechanic and Heavy Duty Mechanic, self-propelled concrete saws of all types and sizes with their attachments, gob-hoppers, excavators all sizes, the repair and greasing of all diesel hammers, the operation and set-up of bidwells, water blasters of all sizes and their clutches, hydraulic jacks where used for hoisting, operation of log skidders, iceolators used on and off of pipeline, condor cranes, bow boats, survey boats, bobcats and all their attachments, skid steer loaders and all their attachments, creter cranes, batch plants, operator (all sizes), self propelled roto mills, operation of conveyor systems of any size and any configuration, operation, repair and service of all vibratory hammers, all power pacs and their controls regardless of location, curtains or brush burning machines, stump cutter machines, Nail launchers when mounted on a machine or self-propelled, operation of con-cover machines, and all Operators except those listed below).

GROUP II. Assistant Operators.

GROUP III. Air Compressors (One), Water Pumps, regardless of Size (One), Waterblasters (one), Welding Machine (One), Mixers (One Bag), Conveyor (One), Siphon or Jet (One), Light Plant (One), Heater (One), Immobile Track Air (One), and Self Propelled Walk-Behind Rollers.

GROUP IV. Asphalt Spreader Oilers, Fireman on Whirlies and Heavy Equipment Oilers, Truck Cranes, Dredges, Monigans, Large Cranes - (Over 65-ton rated capacity) Concrete Plant Oiler, Blacktop Plant Oiler, and Creter Crane Oiler (when required).

GROUP V. Oiler.

GROUP VI. Operators on equipment with Booms, including jibs, 100 feet and over, and less than 150 feet long.

GROUP VII. Operators on equipment with Booms, including jibs, 150 feet and over, and less than 200 feet long.

GROUP VIII. Operators on Equipment with Booms, including jibs, 200 feet and over; Tower Cranes; and Whirlie Cranes.

GROUP IX. Master Mechanic

OPERATING ENGINEERS - Highway

GROUP I. Cranes, Dragline, Shovels, Skimmer Scoops, Clamshells or Derrick Boats, Pile Drivers, Crane-Type Backhoes, Asphalt Plant Operators, Concrete Plant Operators, Dredges, Asphalt Spreading Machines, All Locomotives, Cable Ways or Tower Machines, Hoists, Hydraulic Backhoes, Ditching Machines or Backfiller, Cherrypickers, Overhead Cranes, Roller - Steam or Gas, Concrete Pavers, Excavators, Concrete Breakers, Concrete Pumps, Bulk Cement Plants, Cement Pumps, Derrick-Type Drills, Boat Operators, Motor Graders or Pushcats, Scoops or Tournapulls, Bulldozers, Endloaders or Fork Lifts, Power Blade or Elevating Graders, Winch Cats, Boom or Winch Trucks or Boom Tractors, Pipe Wrapping or Painting Machines, Asphalt Plant Engineer, Journeyman Lubricating Engineer, Drills (other than Derrick Type), Mud Jacks, Well Drilling Machines, Boring Machines, Track Jacks, Mixers, Conveyors (Two), Air Compressors (Two), Water Pumps regardless of size (Two), Welding Machines (Two), Siphons or Jets (Two), Winch Heads or Apparatuses (Two), Light Plants (Two), All Tractors regardless of size (straight tractor only), Fireman on Stationary Boilers, Automatic

Elevators, Form Grading Machines, Finishing Machines, Power Sub-Grader or Ribbon Machines, Longitudinal Floats, Distributor Operators on Trucks, Winch Heads or Apparatuses (One), Mobil Track air and heaters (two to five), Heavy Equipment Greaser, Relief Operator, Assistant Master Mechanic and Heavy Duty Mechanic, self-propelled concrete saws of all types and sizes with their attachments, gob-hoppers, excavators all sizes, the repair and greasing of all diesel hammers, the operation and set-up of bidwells, water blasters of all sizes and their clutches, hydraulic jacks where used for hoisting, operation of log skidders, iceolators used on and off of pipeline, condor cranes, bow boats, survey boats, bobcats and all their attachments, skid steer loaders and all their attachments, creter cranes, batch plants, operator (all sizes), self propelled roto mills, operation of conveyor systems of any size and any configuration, operation, repair and service of all vibratory hammers, all power pacs and their controls regardless of location, curtains or brush burning machines, stump cutter machines, Nail launchers when mounted on a machine or self-propelled, operation of con-cover machines, and all Operators (except those listed below).

GROUP II. Assistant Operators.

GROUP III. Air Compressors (One), Water Pumps, regardless of Size (One), Waterblasters (one), Welding Machine (One), Mixers (One Bag), Conveyor (One), Siphon or Jet (One), Light Plant (One), Heater (One), Immobile Track Air (One), and Self Propelled Walk-Behind Rollers.

GROUP IV. Asphalt Spreader Oilers, Fireman on Whirlies and Heavy Equipment Oilers, Truck Cranes, Dredges, Monigans, Large Cranes - (Over 65-ton rated capacity) Concrete Plant Oiler, Blacktop Plant Oiler, and Creter Crane Oiler (when required).

GROUP V. Oiler.

GROUP VI. Operators on equipment with Booms, including jibs, 100 feet and over, and less than 150 feet long.

GROUP VII. Operators on equipment with Booms, including jibs, 150 feet and over, and less than 200 feet long.

GROUP VIII. Operators on Equipment with Booms, including jibs, 200 feet and over; Tower Cranes; and Whirlie Cranes.

GROUP IX. Mechanic

SURVEY WORKER - Operated survey equipment including data collectors, G.P.S. and robotic instruments, as well as conventional levels and transits.

TRUCK DRIVER - BUILDING, HEAVY AND HIGHWAY CONSTRUCTION

Class 1. Drivers on 2 axle trucks hauling less than 9 ton. Air compressor and welding machines and brooms, including those pulled by separate units, truck driver helpers, warehouse employees, mechanic helpers, greasers and tiremen, pickup trucks when hauling materials, tools, or workers to and from and on-the-job site, and fork lifts up to 6,000 lb. capacity.

Class 2. Two or three axle trucks hauling more than 9 ton but hauling less than 16 ton. A-frame winch trucks, hydrolift trucks, vactor trucks or similar equipment when used for transportation purposes. Fork lifts over 6,000 lb. capacity, winch trucks, four axle combination units, and ticket writers.



Class 3. Two, three or four axle trucks hauling 16 ton or more. Drivers on water pulls, articulated dump trucks, mechanics and working forepersons, and dispatchers. Five axle or more combination units.

Class 4. Low Boy and Oil Distributors.

Class 5. Drivers who require special protective clothing while employed on hazardous waste work.

TRUCK DRIVER - OIL AND CHIP RESEALING ONLY.

This shall encompass laborers, workers and mechanics who drive contractor or subcontractor owned, leased, or hired pickup, dump, service, or oil distributor trucks. The work includes transporting materials and equipment (including but not limited to, oils, aggregate supplies, parts, machinery and tools) to or from the job site; distributing oil or liquid asphalt and aggregate; stock piling material when in connection with the actual oil and chip contract. The Truck Driver (Oil & Chip Resealing) wage classification does not include supplier delivered materials.

#### Other Classifications of Work:

For definitions of classifications not otherwise set out, the Department generally has on file such definitions which are available. If a task to be performed is not subject to one of the classifications of pay set out, the Department will upon being contacted state which neighboring county has such a classification and provide such rate, such rate being deemed to exist by reference in this document. If no neighboring county rate applies to the task, the Department shall undertake a special determination, such special determination being then deemed to have existed under this determination. If a project requires these, or any classification not listed, please contact IDOL at 217-782-1710 for wage rates or clarifications.

#### LANDSCAPING

Landscaping work falls under the existing classifications for laborer, operating engineer and truck driver. The work performed by landscape plantsman and landscape laborer is covered by the existing classification of laborer. The work performed by landscape operators (regardless of equipment used or its size) is covered by the classifications of operating engineer. The work performed by landscape truck drivers (regardless of size of truck driven) is covered by the classifications of truck driver.

# Jersey County Prevailing Wage for May 2014

(See explanation of column headings at bottom of wages)

Trade Name	RG	TYP	C	Base	FRMAN	M-F>8	OSA	OSH	H/W	Pensn	Vac	Trng
=====	==	===	=	=====	=====	=====	===	===	=====	=====	=====	=====
ASBESTOS ABT-GEN		ALL		31.040	31.540	1.5	1.5	2.0	6.300	10.26	0.000	0.800
ASBESTOS ABT-MEC		BLD		30.360	31.360	1.5	1.5	2.0	7.450	3.000	0.000	0.000
BOILERMAKER		BLD		32.060	34.560	1.5	1.5	2.0	7.070	21.27	1.000	0.350
BRICK MASON		BLD		29.640	33.540	1.5	1.5	2.0	8.000	10.09	2.000	0.400
CARPENTER		ALL		34.970	36.470	1.5	1.5	2.0	6.800	7.250	0.000	0.400
CEMENT MASON		ALL		31.500	32.500	1.5	1.5	2.0	9.500	12.25	0.000	0.200
CERAMIC TILE FNSHER		BLD		25.890	0.000	1.5	1.5	2.0	6.400	5.450	0.000	0.580
ELECTRIC PWR EQMT OP		ALL		36.690	44.520	1.5	2.0	2.0	5.000	9.170	0.000	0.280
ELECTRIC PWR GRNDMAN		ALL		24.940	44.520	1.5	2.0	2.0	5.000	6.240	0.000	0.190
ELECTRIC PWR LINEMAN		ALL		42.210	44.520	1.5	2.0	2.0	5.000	10.56	0.000	0.320
ELECTRIC PWR TRK DRV		ALL		25.560	44.520	1.5	2.0	2.0	5.000	6.390	0.000	0.190
ELECTRICIAN		ALL		36.400	38.650	1.5	1.5	2.0	7.500	9.090	0.000	0.550
ELECTRONIC SYS TECH		BLD		28.740	30.490	1.5	1.5	2.0	7.500	5.860	0.000	0.400
ELEVATOR CONSTRUCTOR		BLD		44.370	49.920	2.0	2.0	2.0	12.73	13.46	3.550	0.600
FLOOR LAYER		BLD		29.580	30.330	1.5	1.5	2.0	6.800	7.250	0.000	0.400
GLAZIER		BLD		32.780	0.000	2.0	2.0	2.0	9.020	10.80	2.630	0.310
HT/FROST INSULATOR		BLD		37.660	38.660	1.5	1.5	2.0	8.350	11.26	0.000	0.500
IRON WORKER		ALL		31.500	33.500	1.5	1.5	2.0	8.110	13.85	0.000	0.420
LABORER		ALL		30.540	31.040	1.5	1.5	2.0	6.300	10.26	0.000	0.800
MACHINIST		BLD		43.920	46.420	1.5	1.5	2.0	6.760	8.950	1.850	0.000
MARBLE FINISHERS		BLD		25.890	0.000	1.5	1.5	2.0	6.400	5.450	0.000	0.580
MILLWRIGHT		ALL		34.970	36.470	1.5	1.5	2.0	6.800	7.250	0.000	0.400
OPERATING ENGINEER		BLD 1		34.700	37.700	1.5	1.5	2.0	10.00	17.20	0.000	1.000
OPERATING ENGINEER		BLD 2		33.570	37.700	1.5	1.5	2.0	10.00	17.20	0.000	1.000
OPERATING ENGINEER		BLD 3		29.090	37.700	1.5	1.5	2.0	10.00	17.20	0.000	1.000
OPERATING ENGINEER		BLD 4		29.150	37.700	1.5	1.5	2.0	10.00	17.20	0.000	1.000
OPERATING ENGINEER		BLD 5		28.820	37.700	1.5	1.5	2.0	10.00	17.20	0.000	1.000
OPERATING ENGINEER		BLD 6		36.250	37.700	1.5	1.5	2.0	10.00	17.20	0.000	1.000
OPERATING ENGINEER		BLD 7		36.550	37.700	1.5	1.5	2.0	10.00	17.20	0.000	1.000
OPERATING ENGINEER		BLD 8		36.830	37.700	1.5	1.5	2.0	10.00	17.20	0.000	1.000
OPERATING ENGINEER		BLD 9		35.700	37.700	1.5	1.5	2.0	10.00	17.20	0.000	1.000
OPERATING ENGINEER		HWY 1		33.200	36.200	1.5	1.5	2.0	10.00	17.20	0.000	1.000
OPERATING ENGINEER		HWY 2		32.070	36.200	1.5	1.5	2.0	10.00	17.20	0.000	1.000
OPERATING ENGINEER		HWY 3		27.590	36.200	1.5	1.5	2.0	10.00	17.20	0.000	1.000
OPERATING ENGINEER		HWY 4		27.650	36.200	1.5	1.5	2.0	10.00	17.20	0.000	1.000
OPERATING ENGINEER		HWY 5		27.320	36.200	1.5	1.5	2.0	10.00	17.20	0.000	1.000
OPERATING ENGINEER		HWY 6		34.750	36.200	1.5	1.5	2.0	10.00	17.20	0.000	1.000
OPERATING ENGINEER		HWY 7		35.050	36.200	1.5	1.5	2.0	10.00	17.20	0.000	1.000
OPERATING ENGINEER		HWY 8		35.330	36.200	1.5	1.5	2.0	10.00	17.20	0.000	1.000
OPERATING ENGINEER		HWY 9		34.200	36.200	1.5	1.5	2.0	10.00	17.20	0.000	1.000
PAINTER		BLD		29.250	30.750	1.5	2.0	2.0	5.250	9.170	0.000	0.650
PAINTER		HWY		30.450	31.950	1.5	1.5	2.0	5.250	9.170	0.000	0.650
PAINTER OVER 30FT		BLD		30.250	31.750	1.5	2.0	2.0	5.250	9.170	0.000	0.650
PAINTER PWR EQMT		BLD		30.250	31.750	1.5	2.0	2.0	5.250	9.170	0.000	0.650
PAINTER PWR EQMT		HWY		31.450	32.950	1.5	1.5	2.0	5.250	9.170	0.000	0.650
PILEDRIVER		ALL		34.970	36.470	1.5	1.5	2.0	6.800	7.250	0.000	0.400
PIPEFITTER		BLD		38.460	40.380	2.0	2.0	2.0	4.750	8.450	0.000	0.300
PLASTERER		BLD		30.250	31.250	1.5	1.5	2.0	9.500	9.150	0.000	0.050
PLUMBER		BLD		38.460	40.380	2.0	2.0	2.0	4.750	8.450	0.000	0.300
ROOFER		BLD		30.100	32.100	1.5	1.5	2.0	8.800	7.100	0.000	0.240
SHEETMETAL WORKER		ALL		32.250	33.750	1.5	1.5	2.0	8.330	7.320	1.940	0.360
SPRINKLER FITTER		BLD		40.030	43.030	2.0	2.0	2.0	8.370	11.18	0.000	1.250
SURVEY WORKER		ALL		30.360	30.860	1.5	1.5	2.0	5.750	9.840	0.000	0.800
TERRAZZO FINISHER		BLD		31.240	0.000	1.5	1.5	2.0	6.400	3.800	0.000	0.270
TERRAZZO MASON		BLD		32.530	32.830	1.5	1.5	2.0	6.400	5.550	0.000	0.290
TRUCK DRIVER		ALL 1		31.340	0.000	1.5	1.5	2.0	10.30	5.010	0.000	0.250

TRUCK DRIVER	ALL	2	31.780	0.000	1.5	1.5	2.0	10.30	5.010	0.000	0.250
TRUCK DRIVER	ALL	3	32.020	0.000	1.5	1.5	2.0	10.30	5.010	0.000	0.250
TRUCK DRIVER	ALL	4	32.280	0.000	1.5	1.5	2.0	10.30	5.010	0.000	0.250
TRUCK DRIVER	ALL	5	33.130	0.000	1.5	1.5	2.0	10.30	5.010	0.000	0.250
TRUCK DRIVER	O&C	1	25.070	0.000	1.5	1.5	2.0	10.30	5.010	0.000	0.250
TRUCK DRIVER	O&C	2	25.420	0.000	1.5	1.5	2.0	10.30	5.010	0.000	0.250
TRUCK DRIVER	O&C	3	25.620	0.000	1.5	1.5	2.0	10.30	5.010	0.000	0.250
TRUCK DRIVER	O&C	4	25.820	0.000	1.5	1.5	2.0	10.30	5.010	0.000	0.250
TRUCK DRIVER	O&C	5	26.500	0.000	1.5	1.5	2.0	10.30	5.010	0.000	0.250

**Legend:** RG (Region)

TYP (Trade Type - All,Highway,Building,Floating,Oil & Chip,Rivers)

C (Class)

Base (Base Wage Rate)

FRMAN (Foreman Rate)

M-F>8 (OT required for any hour greater than 8 worked each day, Mon through Fri.)

OSA (Overtime (OT) is required for every hour worked on Saturday)

OSH (Overtime is required for every hour worked on Sunday and Holidays)

H/W (Health & Welfare Insurance)

Pensn (Pension)

Vac (Vacation)

Trng (Training)

## Explanations

### JERSEY COUNTY

The following list is considered as those days for which holiday rates of wages for work performed apply: New Years Day, Memorial Day, Fourth of July, Labor Day, Thanksgiving Day, Christmas Day and Veterans Day in some classifications/counties. Generally, any of these holidays which fall on a Sunday is celebrated on the following Monday. This then makes work performed on that Monday payable at the appropriate overtime rate for holiday pay. Common practice in a given local may alter certain days of celebration. If in doubt, please check with IDOL.

Oil and chip resealing (O&C) means the application of road oils and liquid asphalt to coat an existing road surface, followed by application of aggregate chips or gravel to coated surface, and subsequent rolling of material to seal the surface.

### EXPLANATION OF CLASSES

ASBESTOS - GENERAL - removal of asbestos material/mold and hazardous materials from any place in a building, including mechanical systems

where those mechanical systems are to be removed. This includes the removal of asbestos materials/mold and hazardous materials from ductwork or pipes in a building when the building is to be demolished at the time or at some close future date.

ASBESTOS - MECHANICAL - removal of asbestos material from mechanical systems, such as pipes, ducts, and boilers, where the mechanical systems are to remain.

#### CERAMIC TILE FINISHER AND MARBLE FINISHER

The handling, at the building site, of all sand, cement, tile, marble or stone and all other materials that may be used and installed by [a] tile layer or marble mason. In addition, the grouting, cleaning, sealing, and mixing on the job site, and all other work as required in assisting the setter. The term "Ceramic" is used for naming the classification only and is in no way a limitation of the product handled. Ceramic takes into consideration most hard tiles.

#### ELECTRONIC SYSTEMS TECHNICIAN

Installation, service and maintenance of low-voltage systems which utilizes the transmission and/or transference of voice, sound, vision, or digital for commercial, education, security and entertainment purposes for the following: TV monitoring and surveillance, background/foreground music, intercom and telephone interconnect, field programming, inventory control systems, microwave transmission, multi-media, multiplex, radio page, school, intercom and sound burglar alarms and low voltage master clock systems.

Excluded from this classification are energy management systems, life safety systems, supervisory controls and data acquisition systems not intrinsic with the above listed systems, fire alarm systems, nurse call systems and raceways exceeding fifteen feet in length.

#### OPERATING ENGINEER - BUILDING

GROUP I. Cranes, Dragline, Shovels, Skimmer Scoops, Clamshells or Derrick Boats, Pile Drivers, Crane-Type Backhoes, Asphalt Plant Operators, Concrete Plant Operators, Dredges, Asphalt Spreading Machines, All Locomotives, Cable Ways or Tower Machines, Hoists, Hydraulic Backhoes, Ditching Machines or Backfiller, Cherrypickers, Overhead Cranes, Roller - Steam or Gas, Concrete Pavers, Excavators, Concrete Breakers, Concrete Pumps, Bulk Cement Plants, Cement Pumps, Derrick-Type Drills, Boat Operators, Motor Graders or Pushcats, Scoops or Tournapulls, Bulldozers, Endloaders or Fork Lifts, Power Blade or Elevating Graders, Winch Cats, Boom or Winch Trucks or Boom Tractors, Pipe Wrapping or Painting Machines, Asphalt Plant Engineer, Journeyman Lubricating Engineer, Drills (other than Derrick Type), Mud Jacks, or Well Drilling Machines, Boring Machines or Track Jacks, Mixers, Conveyors (Two), Air Compressors (Two), Water Pumps regardless of size (Two), Welding Machines (Two), Siphons or Jets (Two), Winch Heads or Apparatuses (Two), Light Plants (Two), All Tractors regardless of size (straight tractor only), Fireman on Stationary Boilers, Automatic Elevators, Form Grading Machines, Finishing Machines, Power Sub-Grader or Ribbon Machines, Longitudinal Floats, Distributor Operators on Trucks, Winch Heads or Apparatuses (One), Mobil Track air and heaters (two to five), Heavy Equipment Greaser, Relief Operator, Assistant Master Mechanic and Heavy Duty Mechanic, self-propelled concrete saws of all types and sizes with their attachments, gob-hoppers, excavators all sizes, the repair and greasing of all diesel hammers, the operation and set-up of bidwells, water blasters of all sizes and their clutches, hydraulic jacks where used for hoisting, operation of log skidders, iceolators used on and off of pipeline, condor cranes,

bow boats, survey boats, bobcats and all their attachments, skid steer loaders and all their attachments, creter cranes, batch plants, operator (all sizes), self propelled roto mills, operation of conveyor systems of any size and any configuration, operation, repair and service of all vibratory hammers, all power pacs and their controls regardless of location, curtains or brush burning machines, stump cutter machines, Nail launchers when mounted on a machine or self-propelled, operation of con-cover machines, and all Operators except those listed below).

GROUP II. Assistant Operators.

GROUP III. Air Compressors (One), Water Pumps, regardless of Size (One), Waterblasters (one), Welding Machine (One), Mixers (One Bag), Conveyor (One), Siphon or Jet (One), Light Plant (One), Heater (One), Immobile Track Air (One), and Self Propelled Walk-Behind Rollers.

GROUP IV. Asphalt Spreader Oilers, Fireman on Whirlies and Heavy Equipment Oilers, Truck Cranes, Dredges, Monigans, Large Cranes - (Over 65-ton rated capacity) Concrete Plant Oiler, Blacktop Plant Oiler, and Creter Crane Oiler (when required).

GROUP V. Oiler.

GROUP VI. Operators on equipment with Booms, including jibs, 100 feet and over, and less than 150 feet long.

GROUP VII. Operators on equipment with Booms, including jibs, 150 feet and over, and less than 200 feet long.

GROUP VIII. Operators on Equipment with Booms, including jibs, 200 feet and over; Tower Cranes; and Whirlie Cranes.

GROUP IX. Master Mechanic

OPERATING ENGINEERS - Highway

GROUP I. Cranes, Dragline, Shovels, Skimmer Scoops, Clamshells or Derrick Boats, Pile Drivers, Crane-Type Backhoes, Asphalt Plant Operators, Concrete Plant Operators, Dredges, Asphalt Spreading Machines, All Locomotives, Cable Ways or Tower Machines, Hoists, Hydraulic Backhoes, Ditching Machines or Backfiller, Cherrypickers, Overhead Cranes, Roller - Steam or Gas, Concrete Pavers, Excavators, Concrete Breakers, Concrete Pumps, Bulk Cement Plants, Cement Pumps, Derrick-Type Drills, Boat Operators, Motor Graders or Pushcats, Scoops or Tournapulls, Bulldozers, Endloaders or Fork Lifts, Power Blade or Elevating Graders, Winch Cats, Boom or Winch Trucks or Boom Tractors, Pipe Wrapping or Painting Machines, Asphalt Plant Engineer, Journeyman Lubricating Engineer, Drills (other than Derrick Type), Mud Jacks, Well Drilling Machines, Boring Machines, Track Jacks, Mixers, Conveyors (Two), Air Compressors (Two), Water Pumps regardless of size (Two), Welding Machines (Two), Siphons or Jets (Two), Winch Heads or Apparatuses (Two), Light Plants (Two), All Tractors regardless of size (straight tractor only), Fireman on Stationary Boilers, Automatic Elevators, Form Grading Machines, Finishing Machines, Power Sub-Grader or Ribbon Machines, Longitudinal Floats, Distributor Operators on Trucks, Winch Heads or Apparatuses (One), Mobil Track air and heaters (two to five), Heavy Equipment Greaser, Relief Operator, Assistant Master Mechanic and Heavy Duty Mechanic, self-propelled concrete saws of all types and sizes with their attachments, gob-hoppers, excavators all sizes, the repair and greasing of all diesel hammers, the operation and set-up of bidwells, water blasters of all sizes and their clutches, hydraulic jacks where used for hoisting, operation of

log skidders, iceolators used on and off of pipeline, condor cranes, bow boats, survey boats, bobcats and all their attachments, skid steer loaders and all their attachments, creter cranes, batch plants, operator (all sizes), self propelled roto mills, operation of conveyor systems of any size and any configuration, operation, repair and service of all vibratory hammers, all power pacs and their controls regardless of location, curtains or brush burning machines, stump cutter machines, Nail launchers when mounted on a machine or self-propelled, operation of con-cover machines, and all Operators (except those listed below).

GROUP II. Assistant Operators.

GROUP III. Air Compressors (One), Water Pumps, regardless of Size (One), Waterblasters (one), Welding Machine (One), Mixers (One Bag), Conveyor (One), Siphon or Jet (One), Light Plant (One), Heater (One), Immobile Track Air (One), and Self Propelled Walk-Behind Rollers.

GROUP IV. Asphalt Spreader Oilers, Fireman on Whirlies and Heavy Equipment Oilers, Truck Cranes, Dredges, Monigans, Large Cranes - (Over 65-ton rated capacity) Concrete Plant Oiler, Blacktop Plant Oiler, and Creter Crane Oiler (when required).

GROUP V. Oiler.

GROUP VI. Operators on equipment with Booms, including jibs, 100 feet and over, and less than 150 feet long.

GROUP VII. Operators on equipment with Booms, including jibs, 150 feet and over, and less than 200 feet long.

GROUP VIII. Operators on Equipment with Booms, including jibs, 200 feet and over; Tower Cranes; and Whirlie Cranes.

GROUP IX. Mechanic

SURVEY WORKER - Operated survey equipment including data collectors, G.P.S. and robotic instruments, as well as conventional levels and transits.

TRUCK DRIVER - BUILDING, HEAVY AND HIGHWAY CONSTRUCTION

Class 1. Drivers on 2 axle trucks hauling less than 9 ton. Air compressor and welding machines and brooms, including those pulled by separate units, truck driver helpers, warehouse employees, mechanic helpers, greasers and tiremen, pickup trucks when hauling materials, tools, or workers to and from and on-the-job site, and fork lifts up to 6,000 lb. capacity.

Class 2. Two or three axle trucks hauling more than 9 ton but hauling less than 16 ton. A-frame winch trucks, hydrolift trucks, vactor trucks or similar equipment when used for transportation purposes. Fork lifts over 6,000 lb. capacity, winch trucks, four axle combination units, and ticket writers.

Class 3. Two, three or four axle trucks hauling 16 ton or more. Drivers on water pulls, articulated dump trucks, mechanics and working forepersons, and dispatchers. Five axle or more combination units.

Class 4. Low Boy and Oil Distributors.

Class 5. Drivers who require special protective clothing while employed on hazardous waste work.

#### TRUCK DRIVER - OIL AND CHIP RESEALING ONLY.

This shall encompass laborers, workers and mechanics who drive contractor or subcontractor owned, leased, or hired pickup, dump, service, or oil distributor trucks. The work includes transporting materials and equipment (including but not limited to, oils, aggregate supplies, parts, machinery and tools) to or from the job site; distributing oil or liquid asphalt and aggregate; stock piling material when in connection with the actual oil and chip contract. The Truck Driver (Oil & Chip Resealing) wage classification does not include supplier delivered materials.

#### TERRAZZO FINISHER

The handling of all materials used for Mosaic and Terrazzo work including preparing, mixing by hand, by mixing machine or transporting of pre-mixed materials and distributing with shovel, rake, hoe, or pail, all kinds of concrete foundations necessary for Mosaic and Terrazzo work, all cement terrazzo, magnesite terrazzo, Do-O-Tex terrazzo, epoxy matrix terrazzo, exposed aggregate, rustic or rough washed for exterior or interior of buildings placed either by machine or by hand, and any other kind of mixture of plastics composed of chips or granules when mixed with cement, rubber, neoprene, vinyl, magnesium chloride or any other resinous or chemical substances used for seamless flooring systems, and all other building materials, all similar materials and all precast terrazzo work on jobs, all scratch coat used for Mosaic and Terrazzo work and sub-bed, tar paper and wire mesh (2x2 etc.) or lath. The rubbing, grinding, cleaning and finishing of same either by hand or by machine or by terrazzo resurfacing equipment on new or existing floors. When necessary finishers shall be allowed to assist the mechanics to spread sand bed, lay tarpaper and wire mesh (2x2 etc.) or lath. The finishing of cement floors where additional aggregate of stone is added by spreading or sprinkling on top of the finished base, and troweled or rolled into the finish and then the surface is ground by grinding machines.

#### Other Classifications of Work:

For definitions of classifications not otherwise set out, the Department generally has on file such definitions which are available. If a task to be performed is not subject to one of the classifications of pay set out, the Department will upon being contacted state which neighboring county has such a classification and provide such rate, such rate being deemed to exist by reference in this document. If no neighboring county rate applies to the task, the Department shall undertake a special determination, such special determination being then deemed to have existed under this determination. If a project requires these, or any classification not listed, please contact IDOL at 217-782-1710 for wage rates or clarifications.

#### LANDSCAPING

Landscaping work falls under the existing classifications for laborer, operating engineer and truck driver. The work performed by landscape plantsman and landscape laborer is covered by the existing classification of laborer. The work performed by landscape operators (regardless of equipment used or its size) is covered by the classifications of operating engineer. The work performed by

landscape truck drivers (regardless of size of truck driven) is covered by the classifications of truck driver.



# Madison County Prevailing Wage for May 2014

(See explanation of column headings at bottom of wages)

Trade Name	RG	TYP	C	Base	FRMAN	M-F>8	OSA	OSH	H/W	Pensn	Vac	Trng
=====	==	===	=	=====	=====	=====	===	===	=====	=====	=====	=====
ASBESTOS ABT-GEN	NW	ALL		31.040	31.540	1.5	1.5	2.0	6.300	10.26	0.000	0.800
ASBESTOS ABT-GEN	SE	ALL		29.800	30.300	1.5	1.5	2.0	6.650	11.15	0.000	0.800
ASBESTOS ABT-MEC		BLD		30.360	31.360	1.5	1.5	2.0	7.450	3.000	0.000	0.000
BOILERMAKER		BLD		32.060	34.560	1.5	1.5	2.0	7.070	21.27	1.000	0.350
BRICK MASON		BLD		29.640	33.540	1.5	1.5	2.0	8.000	10.09	2.000	0.400
CARPENTER		ALL		34.970	36.470	1.5	1.5	2.0	6.800	7.250	0.000	0.400
CEMENT MASON		ALL		31.500	32.500	1.5	1.5	2.0	9.500	12.25	0.000	0.200
CERAMIC TILE FNSHER		BLD		25.890	0.000	1.5	1.5	2.0	6.400	5.450	0.000	0.580
ELECTRIC PWR EQMT OP	NW	ALL		36.690	44.520	1.5	2.0	2.0	5.000	9.170	0.000	0.280
ELECTRIC PWR EQMT OP	SE	ALL		38.150	0.000	1.5	1.5	2.0	6.950	10.68	0.000	0.380
ELECTRIC PWR GRNDMAN	NW	ALL		24.940	44.520	1.5	2.0	2.0	5.000	6.240	0.000	0.190
ELECTRIC PWR GRNDMAN	SE	ALL		28.490	0.000	1.5	1.5	2.0	5.190	7.970	0.000	0.280
ELECTRIC PWR LINEMAN	NW	ALL		42.210	44.520	1.5	2.0	2.0	5.000	10.56	0.000	0.320
ELECTRIC PWR LINEMAN	SE	ALL		43.860	0.000	1.5	1.5	2.0	7.990	12.29	0.000	0.440
ELECTRIC PWR TRK DRV	NW	ALL		25.560	44.520	1.5	2.0	2.0	5.000	6.390	0.000	0.190
ELECTRIC PWR TRK DRV	SE	ALL		31.140	0.000	1.5	1.5	2.0	5.670	8.720	0.000	0.310
ELECTRICIAN	NW	ALL		36.400	38.650	1.5	1.5	2.0	7.500	9.090	0.000	0.550
ELECTRICIAN	SE	ALL		37.350	39.590	1.5	1.5	2.0	7.990	9.720	0.000	0.650
ELECTRONIC SYS TECH	NW	BLD		28.740	30.490	1.5	1.5	2.0	7.500	5.860	0.000	0.400
ELECTRONIC SYS TECH	SE	BLD		31.280	33.280	1.5	1.5	2.0	3.650	8.190	0.000	0.400
ELEVATOR CONSTRUCTOR		BLD		44.370	49.920	2.0	2.0	2.0	12.73	13.46	3.550	0.600
FLOOR LAYER		BLD		29.580	30.330	1.5	1.5	2.0	6.800	7.250	0.000	0.400
GLAZIER		BLD		32.780	0.000	2.0	2.0	2.0	9.020	10.80	2.630	0.310
HT/FROST INSULATOR		BLD		37.660	38.660	1.5	1.5	2.0	8.350	11.26	0.000	0.500
IRON WORKER		ALL		31.500	33.500	1.5	1.5	2.0	8.110	13.85	0.000	0.420
LABORER	NW	ALL		30.540	31.040	1.5	1.5	2.0	6.300	10.26	0.000	0.800
LABORER	SE	ALL		29.300	29.800	1.5	1.5	2.0	6.650	11.15	0.000	0.800
MACHINIST		BLD		43.920	46.420	1.5	1.5	2.0	6.760	8.950	1.850	0.000
MARBLE FINISHERS		BLD		25.890	0.000	1.5	1.5	2.0	6.400	5.450	0.000	0.580
MARBLE MASON		BLD		29.640	33.540	1.5	1.5	2.0	8.000	10.09	2.000	0.400
MILLWRIGHT		ALL		34.970	36.470	1.5	1.5	2.0	6.800	7.250	0.000	0.400
OPERATING ENGINEER		BLD	1	34.700	37.700	1.5	1.5	2.0	10.00	17.20	0.000	1.000
OPERATING ENGINEER		BLD	2	33.570	37.700	1.5	1.5	2.0	10.00	17.20	0.000	1.000
OPERATING ENGINEER		BLD	3	29.090	37.700	1.5	1.5	2.0	10.00	17.20	0.000	1.000
OPERATING ENGINEER		BLD	4	29.150	37.700	1.5	1.5	2.0	10.00	17.20	0.000	1.000
OPERATING ENGINEER		BLD	5	28.820	37.700	1.5	1.5	2.0	10.00	17.20	0.000	1.000
OPERATING ENGINEER		BLD	6	36.250	37.700	1.5	1.5	2.0	10.00	17.20	0.000	1.000
OPERATING ENGINEER		BLD	7	36.550	37.700	1.5	1.5	2.0	10.00	17.20	0.000	1.000
OPERATING ENGINEER		BLD	8	36.830	37.700	1.5	1.5	2.0	10.00	17.20	0.000	1.000
OPERATING ENGINEER		BLD	9	35.700	37.700	1.5	1.5	2.0	10.00	17.20	0.000	1.000
OPERATING ENGINEER		HWY	1	33.200	36.200	1.5	1.5	2.0	10.00	17.20	0.000	1.000
OPERATING ENGINEER		HWY	2	32.070	36.200	1.5	1.5	2.0	10.00	17.20	0.000	1.000
OPERATING ENGINEER		HWY	3	27.590	36.200	1.5	1.5	2.0	10.00	17.20	0.000	1.000
OPERATING ENGINEER		HWY	4	27.650	36.200	1.5	1.5	2.0	10.00	17.20	0.000	1.000
OPERATING ENGINEER		HWY	5	27.320	36.200	1.5	1.5	2.0	10.00	17.20	0.000	1.000
OPERATING ENGINEER		HWY	6	34.750	36.200	1.5	1.5	2.0	10.00	17.20	0.000	1.000
OPERATING ENGINEER		HWY	7	35.050	36.200	1.5	1.5	2.0	10.00	17.20	0.000	1.000
OPERATING ENGINEER		HWY	8	35.330	36.200	1.5	1.5	2.0	10.00	17.20	0.000	1.000
OPERATING ENGINEER		HWY	9	34.200	36.200	1.5	1.5	2.0	10.00	17.20	0.000	1.000
PAINTER		BLD		29.250	30.750	1.5	2.0	2.0	5.250	9.170	0.000	0.650
PAINTER		HWY		30.450	31.950	1.5	1.5	2.0	5.250	9.170	0.000	0.650
PAINTER OVER 30FT		BLD		30.250	31.750	1.5	2.0	2.0	5.250	9.170	0.000	0.650
PAINTER PWR EQMT		BLD		30.250	31.750	1.5	2.0	2.0	5.250	9.170	0.000	0.650
PAINTER PWR EQMT		HWY		31.450	32.950	1.5	1.5	2.0	5.250	9.170	0.000	0.650
PILEDRIIVER		ALL		34.970	36.470	1.5	1.5	2.0	6.800	7.250	0.000	0.400
PIPEFITTER	N	BLD		38.460	40.380	2.0	2.0	2.0	4.750	8.450	0.000	0.300

PIPEFITTER	S	BLD	37.250	39.250	1.5	1.5	2.0	6.740	8.000	0.000	0.750
PLASTERER		BLD	30.250	31.250	1.5	1.5	2.0	9.500	9.150	0.000	0.050
PLUMBER	N	BLD	38.460	40.380	2.0	2.0	2.0	4.750	8.450	0.000	0.300
PLUMBER	S	BLD	37.050	39.550	1.5	1.5	2.0	6.500	6.850	0.000	0.500
ROOFER		BLD	30.100	32.100	1.5	1.5	2.0	8.800	7.100	0.000	0.240
SHEETMETAL WORKER		ALL	32.250	33.750	1.5	1.5	2.0	8.330	7.320	1.940	0.360
SPRINKLER FITTER		BLD	40.030	43.030	2.0	2.0	2.0	8.370	11.18	0.000	1.250
SURVEY WORKER	NW	ALL	30.360	30.860	1.5	1.5	2.0	5.750	9.840	0.000	0.800
SURVEY WORKER	SE	ALL	29.300	29.800	1.5	1.5	2.0	6.050	10.60	0.000	0.800
TERRAZZO FINISHER		BLD	31.240	0.000	1.5	1.5	2.0	6.400	3.800	0.000	0.270
TERRAZZO MASON		BLD	32.530	32.830	1.5	1.5	2.0	6.400	5.550	0.000	0.290
TRUCK DRIVER		ALL 1	31.340	0.000	1.5	1.5	2.0	10.30	5.010	0.000	0.250
TRUCK DRIVER		ALL 2	31.780	0.000	1.5	1.5	2.0	10.30	5.010	0.000	0.250
TRUCK DRIVER		ALL 3	32.020	0.000	1.5	1.5	2.0	10.30	5.010	0.000	0.250
TRUCK DRIVER		ALL 4	32.280	0.000	1.5	1.5	2.0	10.30	5.010	0.000	0.250
TRUCK DRIVER		ALL 5	33.130	0.000	1.5	1.5	2.0	10.30	5.010	0.000	0.250
TRUCK DRIVER		O&C 1	25.070	0.000	1.5	1.5	2.0	10.30	5.010	0.000	0.250
TRUCK DRIVER		O&C 2	25.420	0.000	1.5	1.5	2.0	10.30	5.010	0.000	0.250
TRUCK DRIVER		O&C 3	25.620	0.000	1.5	1.5	2.0	10.30	5.010	0.000	0.250
TRUCK DRIVER		O&C 4	25.820	0.000	1.5	1.5	2.0	10.30	5.010	0.000	0.250
TRUCK DRIVER		O&C 5	26.500	0.000	1.5	1.5	2.0	10.30	5.010	0.000	0.250

**Legend:** RG (Region)

TYP (Trade Type - All,Highway,Building,Floating,Oil & Chip,Rivers)

C (Class)

Base (Base Wage Rate)

FRMAN (Foreman Rate)

M-F>8 (OT required for any hour greater than 8 worked each day, Mon through Fri.)

OSA (Overtime (OT) is required for every hour worked on Saturday)

OSH (Overtime is required for every hour worked on Sunday and Holidays)

H/W (Health & Welfare Insurance)

Pensn (Pension)

Vac (Vacation)

Trng (Training)

## Explanations

### MADISON COUNTY

ELECTRICIANS AND ELECTRIC SYSTEMS TECHNICIAN (NORTHWEST) - Townships of Godfrey, Foster and Wood River, and the western one mile of Moro, Ft. Russell and Edwardsville, south to the north side of Hwy. 66 and west to the Mississippi River. This includes SIU-Edwardsville Dental Facility and Alton Mental Health Hospital.

ELECTRICIANS AND ELECTRIC SYSTEMS TECHNICIAN (SOUTHEAST) - Remainder of county not covered by ELECTRICIANS AND ELECTRIC SYSTEMS TECHNICIAN (NW) including SIU-Edwardsville Main Campus.

LABORERS (NORTHWEST) - That area northwest of a diagonal line running from the Mississippi River at the intersection of the waterway known as Wood River at Maple Island, northeast through the highway intersection of Illinois Routes 3 and 143 and following the boundary of Alton/East Alton, then preceding northeast to the county line at a point approximately one mile west of Illinois Route 159.

PLUMBERS AND PIPEFITTERS (SOUTH) - That part of the county South of a line between Mitchell and Highland including the town of Glen Carbon.

The following list is considered as those days for which holiday rates of wages for work performed apply: New Years Day, Memorial Day, Fourth of July, Labor Day, Thanksgiving Day, Christmas Day and Veterans Day in some classifications/counties. Generally, any of these holidays which fall on a Sunday is celebrated on the following Monday. This then makes work performed on that Monday payable at the appropriate overtime rate for holiday pay. Common practice in a given local may alter certain days of celebration. If in doubt, please check with IDOL.

Oil and chip resealing (O&C) means the application of road oils and liquid asphalt to coat an existing road surface, followed by application of aggregate chips or gravel to coated surface, and subsequent rolling of material to seal the surface.

#### EXPLANATION OF CLASSES

ASBESTOS - GENERAL - removal of asbestos material/mold and hazardous materials from any place in a building, including mechanical systems where those mechanical systems are to be removed. This includes the removal of asbestos materials/mold and hazardous materials from ductwork or pipes in a building when the building is to be demolished at the time or at some close future date.

ASBESTOS - MECHANICAL - removal of asbestos material from mechanical systems, such as pipes, ducts, and boilers, where the mechanical systems are to remain.

#### CERAMIC TILE FINISHER AND MARBLE FINISHER

The handling, at the building site, of all sand, cement, tile, marble or stone and all other materials that may be used and installed by [a] tile layer or marble mason. In addition, the grouting, cleaning, sealing, and mixing on the job site, and all other work as required in assisting the setter. The term "Ceramic" is used for naming the classification only and is in no way a limitation of the product handled. Ceramic takes into consideration most hard tiles.

#### ELECTRONIC SYSTEMS TECHNICIAN

Installation, service and maintenance of low-voltage systems which utilizes the transmission and/or transference of voice, sound, vision, or digital for commercial, education, security and entertainment purposes for the following: TV monitoring and surveillance, background/foreground music, intercom and telephone interconnect, field programming, inventory control systems, microwave transmission, multi-media, multiplex, radio page, school, intercom and sound burglar alarms and low voltage master clock systems.

Excluded from this classification are energy management systems, life safety systems, supervisory controls and data acquisition systems not intrinsic with the above listed systems, fire alarm systems, nurse call systems and raceways exceeding fifteen feet in length.

#### OPERATING ENGINEER - BUILDING

GROUP I. Cranes, Dragline, Shovels, Skimmer Scoops, Clamshells or Derrick Boats, Pile Drivers, Crane-Type Backhoes, Asphalt Plant Operators, Concrete Plant Operators, Dredges, Asphalt Spreading Machines, All Locomotives, Cable Ways or Tower Machines, Hoists, Hydraulic Backhoes, Ditching Machines or Backfiller, Cherrypickers, Overhead Cranes, Roller - Steam or Gas, Concrete Pavers, Excavators, Concrete Breakers, Concrete Pumps, Bulk Cement Plants, Cement Pumps, Derrick-Type Drills, Boat Operators, Motor Graders or Pushcats, Scoops or Tournapulls, Bulldozers, Endloaders or Fork Lifts, Power Blade or Elevating Graders, Winch Cats, Boom or Winch Trucks or Boom Tractors, Pipe Wrapping or Painting Machines, Asphalt Plant Engineer, Journeyman Lubricating Engineer, Drills (other than Derrick Type), Mud Jacks, or Well Drilling Machines, Boring Machines or Track Jacks, Mixers, Conveyors (Two), Air Compressors (Two), Water Pumps regardless of size (Two), Welding Machines (Two), Siphons or Jets (Two), Winch Heads or Apparatuses (Two), Light Plants (Two), All Tractors regardless of size (straight tractor only), Fireman on Stationary Boilers, Automatic Elevators, Form Grading Machines, Finishing Machines, Power Sub-Grader or Ribbon Machines, Longitudinal Floats, Distributor Operators on Trucks, Winch Heads or Apparatuses (One), Mobil Track air and heaters (two to five), Heavy Equipment Greaser, Relief Operator, Assistant Master Mechanic and Heavy Duty Mechanic, self-propelled concrete saws of all types and sizes with their attachments, gob-hoppers, excavators all sizes, the repair and greasing of all diesel hammers, the operation and set-up of bidwells, water blasters of all sizes and their clutches, hydraulic jacks where used for hoisting, operation of log skidders, iceolators used on and off of pipeline, condor cranes, bow boats, survey boats, bobcats and all their attachments, skid steer loaders and all their attachments, creter cranes, batch plants, operator (all sizes), self propelled roto mills, operation of conveyor systems of any size and any configuration, operation, repair and service of all vibratory hammers, all power pacs and their controls regardless of location, curtains or brush burning machines, stump cutter machines, Nail launchers when mounted on a machine or self-propelled, operation of con-cover machines, and all Operators except those listed below).

GROUP II. Assistant Operators.

GROUP III. Air Compressors (One), Water Pumps, regardless of Size (One), Waterblasters (one), Welding Machine (One), Mixers (One Bag), Conveyor (One), Siphon or Jet (One), Light Plant (One), Heater (One), Immobile Track Air (One), and Self Propelled Walk-Behind Rollers.

GROUP IV. Asphalt Spreader Oilers, Fireman on Whirlies and Heavy Equipment Oilers, Truck Cranes, Dredges, Monigans, Large Cranes - (Over 65-ton rated capacity) Concrete Plant Oiler, Blacktop Plant Oiler, and Creter Crane Oiler (when required).

GROUP V. Oiler.

GROUP VI. Operators on equipment with Booms, including jibs, 100 feet and over, and less than 150 feet long.

GROUP VII. Operators on equipment with Booms, including jibs, 150 feet

and over, and less than 200 feet long.

GROUP VIII. Operators on Equipment with Booms, including jibs, 200 feet and over; Tower Cranes; and Whirlie Cranes.

GROUP IX. Master Mechanic

OPERATING ENGINEERS - Highway

GROUP I. Cranes, Dragline, Shovels, Skimmer Scoops, Clamshells or Derrick Boats, Pile Drivers, Crane-Type Backhoes, Asphalt Plant Operators, Concrete Plant Operators, Dredges, Asphalt Spreading Machines, All Locomotives, Cable Ways or Tower Machines, Hoists, Hydraulic Backhoes, Ditching Machines or Backfiller, Cherrypickers, Overhead Cranes, Roller - Steam or Gas, Concrete Pavers, Excavators, Concrete Breakers, Concrete Pumps, Bulk Cement Plants, Cement Pumps, Derrick-Type Drills, Boat Operators, Motor Graders or Pushcats, Scoops or Tournapulls, Bulldozers, Endloaders or Fork Lifts, Power Blade or Elevating Graders, Winch Cats, Boom or Winch Trucks or Boom Tractors, Pipe Wrapping or Painting Machines, Asphalt Plant Engineer, Journeyman Lubricating Engineer, Drills (other than Derrick Type), Mud Jacks, Well Drilling Machines, Boring Machines, Track Jacks, Mixers, Conveyors (Two), Air Compressors (Two), Water Pumps regardless of size (Two), Welding Machines (Two), Siphons or Jets (Two), Winch Heads or Apparatuses (Two), Light Plants (Two), All Tractors regardless of size (straight tractor only), Fireman on Stationary Boilers, Automatic Elevators, Form Grading Machines, Finishing Machines, Power Sub-Grader or Ribbon Machines, Longitudinal Floats, Distributor Operators on Trucks, Winch Heads or Apparatuses (One), Mobil Track air and heaters (two to five), Heavy Equipment Greaser, Relief Operator, Assistant Master Mechanic and Heavy Duty Mechanic, self-propelled concrete saws of all types and sizes with their attachments, gob-hoppers, excavators all sizes, the repair and greasing of all diesel hammers, the operation and set-up of bidwells, water blasters of all sizes and their clutches, hydraulic jacks where used for hoisting, operation of log skidders, iceolators used on and off of pipeline, condor cranes, bow boats, survey boats, bobcats and all their attachments, skid steer loaders and all their attachments, creter cranes, batch plants, operator (all sizes), self propelled roto mills, operation of conveyor systems of any size and any configuration, operation, repair and service of all vibratory hammers, all power pacs and their controls regardless of location, curtains or brush burning machines, stump cutter machines, Nail launchers when mounted on a machine or self-propelled, operation of con-cover machines, and all Operators (except those listed below).

GROUP II. Assistant Operators.

GROUP III. Air Compressors (One), Water Pumps, regardless of Size (One), Waterblasters (one), Welding Machine (One), Mixers (One Bag), Conveyor (One), Siphon or Jet (One), Light Plant (One), Heater (One), Immobile Track Air (One), and Self Propelled Walk-Behind Rollers.

GROUP IV. Asphalt Spreader Oilers, Fireman on Whirlies and Heavy Equipment Oilers, Truck Cranes, Dredges, Monigans, Large Cranes - (Over 65-ton rated capacity) Concrete Plant Oiler, Blacktop Plant Oiler, and Creter Crane Oiler (when required).

GROUP V. Oiler.

GROUP VI. Operators on equipment with Booms, including jibs, 100 feet and over, and less than 150 feet long.

GROUP VII. Operators on equipment with Booms, including jibs, 150 feet and over, and less than 200 feet long.

GROUP VIII. Operators on Equipment with Booms, including jibs, 200 feet and over; Tower Cranes; and Whirlie Cranes.

GROUP IX. Mechanic

SURVEY WORKER - Operated survey equipment including data collectors, G.P.S. and robotic instruments, as well as conventional levels and transits.

TRUCK DRIVER - BUILDING, HEAVY AND HIGHWAY CONSTRUCTION

Class 1. Drivers on 2 axle trucks hauling less than 9 ton. Air compressor and welding machines and brooms, including those pulled by separate units, truck driver helpers, warehouse employees, mechanic helpers, greasers and tiremen, pickup trucks when hauling materials, tools, or workers to and from and on-the-job site, and fork lifts up to 6,000 lb. capacity.

Class 2. Two or three axle trucks hauling more than 9 ton but hauling less than 16 ton. A-frame winch trucks, hydrolift trucks, vector trucks or similar equipment when used for transportation purposes. Fork lifts over 6,000 lb. capacity, winch trucks, four axle combination units, and ticket writers.

Class 3. Two, three or four axle trucks hauling 16 ton or more. Drivers on water pulls, articulated dump trucks, mechanics and working forepersons, and dispatchers. Five axle or more combination units.

Class 4. Low Boy and Oil Distributors.

Class 5. Drivers who require special protective clothing while employed on hazardous waste work.

TRUCK DRIVER - OIL AND CHIP RESEALING ONLY.

This shall encompass laborers, workers and mechanics who drive contractor or subcontractor owned, leased, or hired pickup, dump, service, or oil distributor trucks. The work includes transporting materials and equipment (including but not limited to, oils, aggregate supplies, parts, machinery and tools) to or from the job site; distributing oil or liquid asphalt and aggregate; stock piling material when in connection with the actual oil and chip contract. The Truck Driver (Oil & Chip Resealing) wage classification does not include supplier delivered materials.

TERRAZZO FINISHER

The handling of all materials used for Mosaic and Terrazzo work including preparing, mixing by hand, by mixing machine or transporting of pre-mixed materials and distributing with shovel, rake, hoe, or pail, all kinds of concrete foundations necessary for Mosaic and Terrazzo work, all cement terrazzo, magnesite terrazzo, Do-O-Tex terrazzo, epoxy matrix ter-razzo, exposed aggregate, rustic or rough washed for exterior or interior of buildings placed either by machine or by hand, and any other kind of mixture of plastics composed of chips or granules when mixed with cement, rubber, neoprene, vinyl, magnesium chloride or any other resinous or chemical substances used for seamless flooring systems, and all other building materials, all similar materials and all precast terrazzo work on jobs, all scratch

coat used for Mosaic and Terrazzo work and sub-bed, tar paper and wire mesh (2x2 etc.) or lath. The rubbing, grinding, cleaning and finishing of same either by hand or by machine or by terrazzo resurfacing equipment on new or existing floors. When necessary finishers shall be allowed to assist the mechanics to spread sand bed, lay tarpaper and wire mesh (2x2 etc.) or lath. The finishing of cement floors where additional aggregate of stone is added by spreading or sprinkling on top of the finished base, and troweled or rolled into the finish and then the surface is ground by grinding machines.

#### Other Classifications of Work:

For definitions of classifications not otherwise set out, the Department generally has on file such definitions which are available. If a task to be performed is not subject to one of the classifications of pay set out, the Department will upon being contacted state which neighboring county has such a classification and provide such rate, such rate being deemed to exist by reference in this document. If no neighboring county rate applies to the task, the Department shall undertake a special determination, such special determination being then deemed to have existed under this determination. If a project requires these, or any classification not listed, please contact IDOL at 217-782-1710 for wage rates or clarifications.

#### LANDSCAPING

Landscaping work falls under the existing classifications for laborer, operating engineer and truck driver. The work performed by landscape plantsman and landscape laborer is covered by the existing classification of laborer. The work performed by landscape operators (regardless of equipment used or its size) is covered by the classifications of operating engineer. The work performed by landscape truck drivers (regardless of size of truck driven) is covered by the classifications of truck driver.

# Marion County Prevailing Wage for May 2014

(See explanation of column headings at bottom of wages)

Trade Name	RG	TYP	C	Base	FRMAN	M-F>8	OSA	OSH	H/W	Pensn	Vac	Trng
=====	==	===	=	=====	=====	=====	===	===	=====	=====	=====	=====
ASBESTOS ABT-GEN		ALL		27.030	27.480	1.5	1.5	2.0	6.350	11.57	0.000	0.900
ASBESTOS ABT-MEC		BLD		30.360	31.360	1.5	1.5	2.0	7.450	3.000	0.000	0.000
BOILERMAKER		BLD		32.060	34.560	1.5	1.5	2.0	7.070	21.27	1.000	0.350
BRICK MASON		BLD		29.640	33.540	1.5	1.5	2.0	8.000	10.09	2.000	0.400
CARPENTER		BLD		32.230	33.730	1.5	1.5	2.0	6.800	7.250	0.000	0.400
CARPENTER		HWY		32.230	33.980	1.5	1.5	2.0	6.800	7.250	0.000	0.400
CEMENT MASON		BLD		29.050	30.550	1.5	1.5	2.0	7.200	6.400	0.000	0.500
CEMENT MASON		HWY		28.150	29.650	1.5	1.5	2.0	7.200	6.430	0.000	0.300
CERAMIC TILE FNSHER		BLD		25.890	0.000	1.5	1.5	2.0	6.400	5.450	0.000	0.580
ELECTRIC PWR EQMT OP		ALL	1	36.770	0.000	1.5	1.5	2.0	5.760	10.29	0.000	0.370
ELECTRIC PWR EQMT OP		ALL	2	32.820	0.000	1.5	1.5	2.0	5.760	9.190	0.000	0.330
ELECTRIC PWR GRNDMAN		ALL		27.020	0.000	1.5	1.5	2.0	5.760	7.570	0.000	0.270
ELECTRIC PWR LINEMAN		ALL		46.100	49.220	1.5	1.5	2.0	5.760	12.91	0.000	0.460
ELECTRICIAN		ALL		40.300	42.550	1.5	1.5	2.0	6.410	10.08	0.000	0.800
ELECTRONIC SYS TECH		BLD		32.570	34.320	1.5	1.5	2.0	6.250	4.210	0.000	0.400
FLOOR LAYER		BLD		29.580	30.330	1.5	1.5	2.0	6.800	7.250	0.000	0.400
GLAZIER		BLD		32.780	0.000	2.0	2.0	2.0	9.020	10.80	2.630	0.310
HT/FROST INSULATOR		BLD		37.660	38.660	1.5	1.5	2.0	8.350	11.26	0.000	0.500
IRON WORKER		ALL		31.500	33.500	1.5	1.5	2.0	8.110	13.85	0.000	0.420
LABORER		BLD		26.030	26.480	1.5	1.5	2.0	6.350	11.57	0.000	0.800
LABORER		HWY		26.030	26.480	1.5	1.5	2.0	6.350	11.57	0.000	0.800
MACHINIST		BLD		43.920	46.420	1.5	1.5	2.0	6.760	8.950	1.850	0.000
MARBLE FINISHERS		BLD		25.890	0.000	1.5	1.5	2.0	6.400	5.450	0.000	0.580
MARBLE MASON		BLD		29.640	33.540	1.5	1.5	2.0	8.000	10.09	2.000	0.400
MILLWRIGHT		BLD		32.230	33.730	1.5	1.5	2.0	6.800	7.250	0.000	0.400
MILLWRIGHT		HWY		32.730	34.480	1.5	1.5	2.0	6.800	7.250	0.000	0.400
OPERATING ENGINEER		BLD	1	34.700	37.700	1.5	1.5	2.0	10.00	17.20	0.000	1.000
OPERATING ENGINEER		BLD	2	33.570	37.700	1.5	1.5	2.0	10.00	17.20	0.000	1.000
OPERATING ENGINEER		BLD	3	29.090	37.700	1.5	1.5	2.0	10.00	17.20	0.000	1.000
OPERATING ENGINEER		BLD	4	29.150	37.700	1.5	1.5	2.0	10.00	17.20	0.000	1.000
OPERATING ENGINEER		BLD	5	28.820	37.700	1.5	1.5	2.0	10.00	17.20	0.000	1.000
OPERATING ENGINEER		BLD	6	36.250	37.700	1.5	1.5	2.0	10.00	17.20	0.000	1.000
OPERATING ENGINEER		BLD	7	36.550	37.700	1.5	1.5	2.0	10.00	17.20	0.000	1.000
OPERATING ENGINEER		BLD	8	36.830	37.700	1.5	1.5	2.0	10.00	17.20	0.000	1.000
OPERATING ENGINEER		BLD	9	35.700	37.700	1.5	1.5	2.0	10.00	17.20	0.000	1.000
OPERATING ENGINEER		HWY	1	33.200	36.200	1.5	1.5	2.0	10.00	17.20	0.000	1.000
OPERATING ENGINEER		HWY	2	32.070	36.200	1.5	1.5	2.0	10.00	17.20	0.000	1.000
OPERATING ENGINEER		HWY	3	27.590	36.200	1.5	1.5	2.0	10.00	17.20	0.000	1.000
OPERATING ENGINEER		HWY	4	27.650	36.200	1.5	1.5	2.0	10.00	17.20	0.000	1.000
OPERATING ENGINEER		HWY	5	27.320	36.200	1.5	1.5	2.0	10.00	17.20	0.000	1.000
OPERATING ENGINEER		HWY	6	34.750	36.200	1.5	1.5	2.0	10.00	17.20	0.000	1.000
OPERATING ENGINEER		HWY	7	35.050	36.200	1.5	1.5	2.0	10.00	17.20	0.000	1.000
OPERATING ENGINEER		HWY	8	35.330	36.200	1.5	1.5	2.0	10.00	17.20	0.000	1.000
OPERATING ENGINEER		HWY	9	34.200	36.200	1.5	1.5	2.0	10.00	17.20	0.000	1.000
PAINTER		ALL		23.190	23.690	1.5	1.5	2.0	5.250	8.090	0.000	0.530
PAINTER OVER 30FT		ALL		26.290	26.790	1.5	1.5	2.0	5.250	8.090	0.000	0.530
PAINTER PWR EQMT		ALL		26.290	26.790	1.5	1.5	2.0	5.250	8.090	0.000	0.530
PILEDRIVER		BLD		32.230	33.730	1.5	1.5	2.0	6.800	7.250	0.000	0.400
PILEDRIVER		HWY		32.730	34.480	1.5	1.5	2.0	6.800	7.250	0.000	0.400
PIPEFITTER		BLD		35.450	39.000	1.5	1.5	2.0	6.200	7.000	0.000	0.900
PLASTERER		BLD		29.050	30.550	1.5	1.5	2.0	7.200	6.400	0.000	0.500
PLUMBER		BLD		35.450	39.000	1.5	1.5	2.0	6.200	7.000	0.000	0.900
ROOFER		BLD		24.400	25.400	1.5	1.5	2.0	8.900	3.800	0.000	0.000
SHEETMETAL WORKER		ALL		32.250	33.750	1.5	1.5	2.0	8.330	7.320	1.940	0.360
SPRINKLER FITTER		BLD		37.120	39.870	1.5	1.5	2.0	8.420	8.500	0.000	0.350
SURVEY WORKER		ALL		25.850	26.300	1.5	1.5	2.0	5.850	10.95	0.000	0.800



TERRAZZO FINISHER	BLD		31.240	0.000	1.5	1.5	2.0	6.400	3.800	0.000	0.270
TERRAZZO MASON	BLD		32.530	32.830	1.5	1.5	2.0	6.400	5.550	0.000	0.290
TRUCK DRIVER	ALL	1	31.340	0.000	1.5	1.5	2.0	10.30	5.010	0.000	0.250
TRUCK DRIVER	ALL	2	31.780	0.000	1.5	1.5	2.0	10.30	5.010	0.000	0.250
TRUCK DRIVER	ALL	3	32.020	0.000	1.5	1.5	2.0	10.30	5.010	0.000	0.250
TRUCK DRIVER	ALL	4	32.280	0.000	1.5	1.5	2.0	10.30	5.010	0.000	0.250
TRUCK DRIVER	ALL	5	33.130	0.000	1.5	1.5	2.0	10.30	5.010	0.000	0.250
TRUCK DRIVER	O&C	1	25.070	0.000	1.5	1.5	2.0	10.30	5.010	0.000	0.250
TRUCK DRIVER	O&C	2	25.420	0.000	1.5	1.5	2.0	10.30	5.010	0.000	0.250
TRUCK DRIVER	O&C	3	25.620	0.000	1.5	1.5	2.0	10.30	5.010	0.000	0.250
TRUCK DRIVER	O&C	4	25.820	0.000	1.5	1.5	2.0	10.30	5.010	0.000	0.250
TRUCK DRIVER	O&C	5	26.500	0.000	1.5	1.5	2.0	10.30	5.010	0.000	0.250

Legend: RG (Region)

TYP (Trade Type - All,Highway,Building,Floating,Oil & Chip,Rivers)

C (Class)

Base (Base Wage Rate)

FRMAN (Foreman Rate)

M-F>8 (OT required for any hour greater than 8 worked each day, Mon through Fri.)

OSA (Overtime (OT) is required for every hour worked on Saturday)

OSH (Overtime is required for every hour worked on Sunday and Holidays)

H/W (Health & Welfare Insurance)

Pensn (Pension)

Vac (Vacation)

Trng (Training)

## Explanations

### MARION COUNTY

The following list is considered as those days for which holiday rates of wages for work performed apply: New Years Day, Memorial Day, Fourth of July, Labor Day, Thanksgiving Day, Christmas Day and Veterans Day in some classifications/counties. Generally, any of these holidays which fall on a Sunday is celebrated on the following Monday. This then makes work performed on that Monday payable at the appropriate overtime rate for holiday pay. Common practice in a given local may alter certain days of celebration. If in doubt, please check with IDOL.

Oil and chip resealing (O&C) means the application of road oils and liquid asphalt to coat an existing road surface, followed by application of aggregate chips or gravel to coated surface, and subsequent rolling of material to seal the surface.

### EXPLANATION OF CLASSES

ASBESTOS - GENERAL - removal of asbestos material/mold and hazardous materials from any place in a building, including mechanical systems where those mechanical systems are to be removed. This includes the removal of asbestos materials/mold and hazardous materials from ductwork or pipes in a building when the building is to be demolished at the time or at some close future date.

ASBESTOS - MECHANICAL - removal of asbestos material from mechanical systems, such as pipes, ducts, and boilers, where the mechanical systems are to remain.

#### CERAMIC TILE FINISHER AND MARBLE FINISHER

The handling, at the building site, of all sand, cement, tile, marble or stone and all other materials that may be used and installed by [a] tile layer or marble mason. In addition, the grouting, cleaning, sealing, and mixing on the job site, and all other work as required in assisting the setter. The term "Ceramic" is used for naming the classification only and is in no way a limitation of the product handled. Ceramic takes into consideration most hard tiles.

#### ELECTRIC POWER LINEMAN

Construction, maintenance and dismantling of overhead and underground electric power lines, including high voltage pipe type cable work, and associated structures and equipment.

#### ELECTRIC POWER EQUIPMENT OPERATOR - CLASS 1

Operation of all crawler type equipment D-4 and larger from the ground to assist the Electric Power Linemen in performing their duties.

#### ELECTRIC POWER EQUIPMENT OPERATORS - CLASS 2

Operation of all other equipment from the ground to assist the Electric Power Linemen in performing their duties.

#### ELECTRIC POWER GROUNDMAN

Applies to workers who assist the Electric Power Lineman from the ground.

#### ELECTRONIC SYSTEMS TECHNICIAN

Installation, service and maintenance of low-voltage systems which utilizes the transmission and/or transference of voice, sound, vision, or digital for commercial, education, security and entertainment purposes for the following: TV monitoring and surveillance, background/foreground music, intercom and telephone interconnect, field programming, inventory control systems, microwave transmission, multi-media, multiplex, radio page, school, intercom and sound burglar alarms and low voltage master clock systems.

Excluded from this classification are energy management systems, life safety systems, supervisory controls and data acquisition systems not intrinsic with the above listed systems, fire alarm systems, nurse call systems and raceways exceeding fifteen feet in length.

#### OPERATING ENGINEER - BUILDING

GROUP I. Cranes, Dragline, Shovels, Skimmer Scoops, Clamshells or Derrick Boats, Pile Drivers, Crane-Type Backhoes, Asphalt Plant

Operators, Concrete Plant Operators, Dredges, Asphalt Spreading Machines, All Locomotives, Cable Ways or Tower Machines, Hoists, Hydraulic Backhoes, Ditching Machines or Backfiller, Cherrypickers, Overhead Cranes, Roller - Steam or Gas, Concrete Pavers, Excavators, Concrete Breakers, Concrete Pumps, Bulk Cement Plants, Cement Pumps, Derrick-Type Drills, Boat Operators, Motor Graders or Pushcats, Scoops or Tournapulls, Bulldozers, Endloaders or Fork Lifts, Power Blade or Elevating Graders, Winch Cats, Boom or Winch Trucks or Boom Tractors, Pipe Wrapping or Painting Machines, Asphalt Plant Engineer, Journeyman Lubricating Engineer, Drills (other than Derrick Type), Mud Jacks, or Well Drilling Machines, Boring Machines or Track Jacks, Mixers, Conveyors (Two), Air Compressors (Two), Water Pumps regardless of size (Two), Welding Machines (Two), Siphons or Jets (Two), Winch Heads or Apparatuses (Two), Light Plants (Two), All Tractors regardless of size (straight tractor only), Fireman on Stationary Boilers, Automatic Elevators, Form Grading Machines, Finishing Machines, Power Sub-Grader or Ribbon Machines, Longitudinal Floats, Distributor Operators on Trucks, Winch Heads or Apparatuses (One), Mobil Track air and heaters (two to five), Heavy Equipment Greaser, Relief Operator, Assistant Master Mechanic and Heavy Duty Mechanic, self-propelled concrete saws of all types and sizes with their attachments, gob-hoppers, excavators all sizes, the repair and greasing of all diesel hammers, the operation and set-up of bidwells, water blasters of all sizes and their clutches, hydraulic jacks where used for hoisting, operation of log skidders, iceolators used on and off of pipeline, condor cranes, bow boats, survey boats, bobcats and all their attachments, skid steer loaders and all their attachments, creter cranes, batch plants, operator (all sizes), self propelled roto mills, operation of conveyor systems of any size and any configuration, operation, repair and service of all vibratory hammers, all power pacs and their controls regardless of location, curtains or brush burning machines, stump cutter machines, Nail launchers when mounted on a machine or self-propelled, operation of con-cover machines, and all Operators except those listed below).

GROUP II. Assistant Operators.

GROUP III. Air Compressors (One), Water Pumps, regardless of Size (One), Waterblasters (one), Welding Machine (One), Mixers (One Bag), Conveyor (One), Siphon or Jet (One), Light Plant (One), Heater (One), Immobile Track Air (One), and Self Propelled Walk-Behind Rollers.

GROUP IV. Asphalt Spreader Oilers, Fireman on Whirlies and Heavy Equipment Oilers, Truck Cranes, Dredges, Monigans, Large Cranes - (Over 65-ton rated capacity) Concrete Plant Oiler, Blacktop Plant Oiler, and Creter Crane Oiler (when required).

GROUP V. Oiler.

GROUP VI. Operators on equipment with Booms, including jibs, 100 feet and over, and less than 150 feet long.

GROUP VII. Operators on equipment with Booms, including jibs, 150 feet and over, and less than 200 feet long.

GROUP VIII. Operators on Equipment with Booms, including jibs, 200 feet and over; Tower Cranes; and Whirlie Cranes.

GROUP IX. Master Mechanic

OPERATING ENGINEERS - Highway

GROUP I. Cranes, Dragline, Shovels, Skimmer Scoops, Clamshells or

Derrick Boats, Pile Drivers, Crane-Type Backhoes, Asphalt Plant Operators, Concrete Plant Operators, Dredges, Asphalt Spreading Machines, All Locomotives, Cable Ways or Tower Machines, Hoists, Hydraulic Backhoes, Ditching Machines or Backfiller, Cherrypickers, Overhead Cranes, Roller - Steam or Gas, Concrete Pavers, Excavators, Concrete Breakers, Concrete Pumps, Bulk Cement Plants, Cement Pumps, Derrick-Type Drills, Boat Operators, Motor Graders or Pushcats, Scoops or Tournapulls, Bulldozers, Endloaders or Fork Lifts, Power Blade or Elevating Graders, Winch Cats, Boom or Winch Trucks or Boom Tractors, Pipe Wrapping or Painting Machines, Asphalt Plant Engineer, Journeyman Lubricating Engineer, Drills (other than Derrick Type), Mud Jacks, Well Drilling Machines, Boring Machines, Track Jacks, Mixers, Conveyors (Two), Air Compressors (Two), Water Pumps regardless of size (Two), Welding Machines (Two), Siphons or Jets (Two), Winch Heads or Apparatuses (Two), Light Plants (Two), All Tractors regardless of size (straight tractor only), Fireman on Stationary Boilers, Automatic Elevators, Form Grading Machines, Finishing Machines, Power Sub-Grader or Ribbon Machines, Longitudinal Floats, Distributor Operators on Trucks, Winch Heads or Apparatuses (One), Mobil Track air and heaters (two to five), Heavy Equipment Greaser, Relief Operator, Assistant Master Mechanic and Heavy Duty Mechanic, self-propelled concrete saws of all types and sizes with their attachments, gob-hoppers, excavators all sizes, the repair and greasing of all diesel hammers, the operation and set-up of bidwells, water blasters of all sizes and their clutches, hydraulic jacks where used for hoisting, operation of log skidders, iceolators used on and off of pipeline, condor cranes, bow boats, survey boats, bobcats and all their attachments, skid steer loaders and all their attachments, creter cranes, batch plants, operator (all sizes), self propelled roto mills, operation of conveyor systems of any size and any configuration, operation, repair and service of all vibratory hammers, all power pacs and their controls regardless of location, curtains or brush burning machines, stump cutter machines, Nail launchers when mounted on a machine or self-propelled, operation of con-cover machines, and all Operators (except those listed below).

GROUP II. Assistant Operators.

GROUP III. Air Compressors (One), Water Pumps, regardless of Size (One), Waterblasters (one), Welding Machine (One), Mixers (One Bag), Conveyor (One), Siphon or Jet (One), Light Plant (One), Heater (One), Immobile Track Air (One), and Self Propelled Walk-Behind Rollers.

GROUP IV. Asphalt Spreader Oilers, Fireman on Whirlies and Heavy Equipment Oilers, Truck Cranes, Dredges, Monigans, Large Cranes - (Over 65-ton rated capacity) Concrete Plant Oiler, Blacktop Plant Oiler, and Creter Crane Oiler (when required).

GROUP V. Oiler.

GROUP VI. Operators on equipment with Booms, including jibs, 100 feet and over, and less than 150 feet long.

GROUP VII. Operators on equipment with Booms, including jibs, 150 feet and over, and less than 200 feet long.

GROUP VIII. Operators on Equipment with Booms, including jibs, 200 feet and over; Tower Cranes; and Whirlie Cranes.

GROUP IX. Mechanic

SURVEY WORKER - Operated survey equipment including data collectors,

G.P.S. and robotic instruments, as well as conventional levels and transits.

#### TRUCK DRIVER - BUILDING, HEAVY AND HIGHWAY CONSTRUCTION

Class 1. Drivers on 2 axle trucks hauling less than 9 ton. Air compressor and welding machines and brooms, including those pulled by separate units, truck driver helpers, warehouse employees, mechanic helpers, greasers and tiremen, pickup trucks when hauling materials, tools, or workers to and from and on-the-job site, and fork lifts up to 6,000 lb. capacity.

Class 2. Two or three axle trucks hauling more than 9 ton but hauling less than 16 ton. A-frame winch trucks, hydrolift trucks, vactor trucks or similar equipment when used for transportation purposes. Fork lifts over 6,000 lb. capacity, winch trucks, four axle combination units, and ticket writers.

Class 3. Two, three or four axle trucks hauling 16 ton or more. Drivers on water pulls, articulated dump trucks, mechanics and working forepersons, and dispatchers. Five axle or more combination units.

Class 4. Low Boy and Oil Distributors.

Class 5. Drivers who require special protective clothing while employed on hazardous waste work.

#### TRUCK DRIVER - OIL AND CHIP RESEALING ONLY.

This shall encompass laborers, workers and mechanics who drive contractor or subcontractor owned, leased, or hired pickup, dump, service, or oil distributor trucks. The work includes transporting materials and equipment (including but not limited to, oils, aggregate supplies, parts, machinery and tools) to or from the job site; distributing oil or liquid asphalt and aggregate; stock piling material when in connection with the actual oil and chip contract. The Truck Driver (Oil & Chip Resealing) wage classification does not include supplier delivered materials.

#### TERRAZZO FINISHER

The handling of all materials used for Mosaic and Terrazzo work including preparing, mixing by hand, by mixing machine or transporting of pre-mixed materials and distributing with shovel, rake, hoe, or pail, all kinds of concrete foundations necessary for Mosaic and Terrazzo work, all cement terrazzo, magnesite terrazzo, Do-O-Tex terrazzo, epoxy matrix ter-razzo, exposed aggregate, rustic or rough washed for exterior or interior of buildings placed either by machine or by hand, and any other kind of mixture of plastics composed of chips or granules when mixed with cement, rubber, neoprene, vinyl, magnesium chloride or any other resinous or chemical substances used for seamless flooring systems, and all other building materials, all similar materials and all precast terrazzo work on jobs, all scratch coat used for Mosaic and Terrazzo work and sub-bed, tar paper and wire mesh (2x2 etc.) or lath. The rubbing, grinding, cleaning and finishing of same either by hand or by machine or by terrazzo resurfacing equipment on new or existing floors. When necessary finishers shall be allowed to assist the mechanics to spread sand bed, lay tarpaper and wire mesh (2x2 etc.) or lath. The finishing of cement floors where additional aggregate of stone is added by spreading or sprinkling on top of the finished base, and troweled or rolled into the finish and then the surface is ground by grinding machines.

#### Other Classifications of Work:

For definitions of classifications not otherwise set out, the Department generally has on file such definitions which are available. If a task to be performed is not subject to one of the classifications of pay set out, the Department will upon being contacted state which neighboring county has such a classification and provide such rate, such rate being deemed to exist by reference in this document. If no neighboring county rate applies to the task, the Department shall undertake a special determination, such special determination being then deemed to have existed under this determination. If a project requires these, or any classification not listed, please contact IDOL at 217-782-1710 for wage rates or clarifications.

#### LANDSCAPING

Landscaping work falls under the existing classifications for laborer, operating engineer and truck driver. The work performed by landscape plantsman and landscape laborer is covered by the existing classification of laborer. The work performed by landscape operators (regardless of equipment used or its size) is covered by the classifications of operating engineer. The work performed by landscape truck drivers (regardless of size of truck driven) is covered by the classifications of truck driver.

# Monroe County Prevailing Wage for May 2014

(See explanation of column headings at bottom of wages)

Trade Name	RG	TYP	C	Base	FRMAN	M-F>8	OSA	OSH	H/W	Pensn	Vac	Trng
=====	==	===	=	=====	=====	=====	===	===	=====	=====	=====	=====
ASBESTOS ABT-GEN		ALL		27.710	28.210	1.5	1.5	2.0	5.850	14.04	0.000	0.800
ASBESTOS ABT-MEC		BLD		30.360	31.360	1.5	1.5	2.0	7.450	3.000	0.000	0.000
BOILERMAKER		BLD		32.060	34.560	1.5	1.5	2.0	7.070	21.27	1.000	0.350
BRICK MASON		BLD		29.640	33.540	1.5	1.5	2.0	8.000	10.09	2.000	0.400
CARPENTER		ALL		34.970	36.470	1.5	1.5	2.0	6.800	7.250	0.000	0.400
CEMENT MASON		ALL		31.500	32.500	1.5	1.5	2.0	9.500	12.25	0.000	0.200
CERAMIC TILE FNSHER		BLD		25.890	0.000	1.5	1.5	2.0	6.400	5.450	0.000	0.580
ELECTRIC PWR EQMT OP		ALL		38.150	0.000	1.5	1.5	2.0	6.950	10.68	0.000	0.380
ELECTRIC PWR GRNDMAN		ALL		28.490	0.000	1.5	1.5	2.0	5.190	7.970	0.000	0.280
ELECTRIC PWR LINEMAN		ALL		43.860	0.000	1.5	1.5	2.0	7.990	12.29	0.000	0.440
ELECTRIC PWR TRK DRV		ALL		31.140	0.000	1.5	1.5	2.0	5.670	8.720	0.000	0.310
ELECTRICIAN		ALL		37.350	39.590	1.5	1.5	2.0	7.990	9.720	0.000	0.650
ELECTRONIC SYS TECH		BLD		31.280	33.280	1.5	1.5	2.0	3.650	8.190	0.000	0.400
ELEVATOR CONSTRUCTOR		BLD		44.370	49.920	2.0	2.0	2.0	12.73	13.46	3.550	0.600
FLOOR LAYER		BLD		29.580	30.330	1.5	1.5	2.0	6.800	7.250	0.000	0.400
GLAZIER		BLD		32.780	0.000	2.0	2.0	2.0	9.020	10.80	2.630	0.310
HT/FROST INSULATOR		BLD		37.660	38.660	1.5	1.5	2.0	8.350	11.26	0.000	0.500
IRON WORKER		ALL		31.500	33.500	1.5	1.5	2.0	8.110	13.85	0.000	0.420
LABORER		ALL		27.210	27.710	1.5	1.5	2.0	5.850	14.04	0.000	0.800
MACHINIST		BLD		43.920	46.420	1.5	1.5	2.0	6.760	8.950	1.850	0.000
MARBLE FINISHERS		BLD		25.890	0.000	1.5	1.5	2.0	6.400	5.450	0.000	0.580
MARBLE MASON		BLD		29.640	33.540	1.5	1.5	2.0	8.000	10.09	2.000	0.400
MILLWRIGHT		ALL		34.970	36.470	1.5	1.5	2.0	6.800	7.250	0.000	0.400
OPERATING ENGINEER		BLD 1		34.700	37.700	1.5	1.5	2.0	10.00	17.20	0.000	1.000
OPERATING ENGINEER		BLD 2		33.570	37.700	1.5	1.5	2.0	10.00	17.20	0.000	1.000
OPERATING ENGINEER		BLD 3		29.090	37.700	1.5	1.5	2.0	10.00	17.20	0.000	1.000
OPERATING ENGINEER		BLD 4		29.150	37.700	1.5	1.5	2.0	10.00	17.20	0.000	1.000
OPERATING ENGINEER		BLD 5		28.820	37.700	1.5	1.5	2.0	10.00	17.20	0.000	1.000
OPERATING ENGINEER		BLD 6		36.250	37.700	1.5	1.5	2.0	10.00	17.20	0.000	1.000
OPERATING ENGINEER		BLD 7		36.550	37.700	1.5	1.5	2.0	10.00	17.20	0.000	1.000
OPERATING ENGINEER		BLD 8		36.830	37.700	1.5	1.5	2.0	10.00	17.20	0.000	1.000
OPERATING ENGINEER		BLD 9		35.700	37.700	1.5	1.5	2.0	10.00	17.20	0.000	1.000
OPERATING ENGINEER		HWY 1		33.200	36.200	1.5	1.5	2.0	10.00	17.20	0.000	1.000
OPERATING ENGINEER		HWY 2		32.070	36.200	1.5	1.5	2.0	10.00	17.20	0.000	1.000
OPERATING ENGINEER		HWY 3		27.590	36.200	1.5	1.5	2.0	10.00	17.20	0.000	1.000
OPERATING ENGINEER		HWY 4		27.650	36.200	1.5	1.5	2.0	10.00	17.20	0.000	1.000
OPERATING ENGINEER		HWY 5		27.320	36.200	1.5	1.5	2.0	10.00	17.20	0.000	1.000
OPERATING ENGINEER		HWY 6		34.750	36.200	1.5	1.5	2.0	10.00	17.20	0.000	1.000
OPERATING ENGINEER		HWY 7		35.050	36.200	1.5	1.5	2.0	10.00	17.20	0.000	1.000
OPERATING ENGINEER		HWY 8		35.330	36.200	1.5	1.5	2.0	10.00	17.20	0.000	1.000
OPERATING ENGINEER		HWY 9		34.200	36.200	1.5	1.5	2.0	10.00	17.20	0.000	1.000
PAINTER		BLD		29.250	30.750	1.5	2.0	2.0	5.250	9.170	0.000	0.650
PAINTER		HWY		30.450	31.950	1.5	1.5	2.0	5.250	9.170	0.000	0.650
PAINTER OVER 30FT		BLD		30.250	31.750	1.5	2.0	2.0	5.250	9.170	0.000	0.650
PAINTER PWR EQMT		BLD		30.250	31.750	1.5	2.0	2.0	5.250	9.170	0.000	0.650
PAINTER PWR EQMT		HWY		31.450	32.950	1.5	1.5	2.0	5.250	9.170	0.000	0.650
PILEDRIIVER		ALL		34.970	36.470	1.5	1.5	2.0	6.800	7.250	0.000	0.400
PIPEFITTER		BLD		37.250	39.250	1.5	1.5	2.0	6.740	8.000	0.000	0.750
PLASTERER		BLD		30.250	31.250	1.5	1.5	2.0	9.500	9.150	0.000	0.050
PLUMBER		BLD		37.050	39.550	1.5	1.5	2.0	6.500	6.850	0.000	0.500
ROOFER		BLD		30.100	32.100	1.5	1.5	2.0	8.800	7.100	0.000	0.240
SHEETMETAL WORKER		ALL		32.250	33.750	1.5	1.5	2.0	8.330	7.320	1.940	0.360
SPRINKLER FITTER		BLD		40.030	43.030	2.0	2.0	2.0	8.370	11.18	0.000	1.250
SURVEY WORKER		ALL		26.500	27.000	1.5	1.5	2.0	5.750	13.70	0.000	0.800
TERRAZZO FINISHER		BLD		31.240	0.000	1.5	1.5	2.0	6.400	3.800	0.000	0.270
TERRAZZO MASON		BLD		32.530	32.830	1.5	1.5	2.0	6.400	5.550	0.000	0.290

TRUCK DRIVER	ALL 1	31.340	0.000	1.5	1.5	2.0	10.30	5.010	0.000	0.250
TRUCK DRIVER	ALL 2	31.780	0.000	1.5	1.5	2.0	10.30	5.010	0.000	0.250
TRUCK DRIVER	ALL 3	32.020	0.000	1.5	1.5	2.0	10.30	5.010	0.000	0.250
TRUCK DRIVER	ALL 4	32.280	0.000	1.5	1.5	2.0	10.30	5.010	0.000	0.250
TRUCK DRIVER	ALL 5	33.130	0.000	1.5	1.5	2.0	10.30	5.010	0.000	0.250
TRUCK DRIVER	O&C 1	25.070	0.000	1.5	1.5	2.0	10.30	5.010	0.000	0.250
TRUCK DRIVER	O&C 2	25.420	0.000	1.5	1.5	2.0	10.30	5.010	0.000	0.250
TRUCK DRIVER	O&C 3	25.620	0.000	1.5	1.5	2.0	10.30	5.010	0.000	0.250
TRUCK DRIVER	O&C 4	25.820	0.000	1.5	1.5	2.0	10.30	5.010	0.000	0.250
TRUCK DRIVER	O&C 5	26.500	0.000	1.5	1.5	2.0	10.30	5.010	0.000	0.250

Legend: RG (Region)  
TYP (Trade Type - All,Highway,Building,Floating,Oil & Chip,Rivers)  
C (Class)  
Base (Base Wage Rate)  
FRMAN (Foreman Rate)  
M-F>8 (OT required for any hour greater than 8 worked each day, Mon through Fri.  
OSA (Overtime (OT) is required for every hour worked on Saturday)  
OSH (Overtime is required for every hour worked on Sunday and Holidays)  
H/W (Health & Welfare Insurance)  
Pensn (Pension)  
Vac (Vacation)  
Trng (Training)

## Explanations

### MONROE COUNTY

The following list is considered as those days for which holiday rates of wages for work performed apply: New Years Day, Memorial Day, Fourth of July, Labor Day, Thanksgiving Day, Christmas Day and Veterans Day in some classifications/counties. Generally, any of these holidays which fall on a Sunday is celebrated on the following Monday. This then makes work performed on that Monday payable at the appropriate overtime rate for holiday pay. Common practice in a given local may alter certain days of celebration. If in doubt, please check with IDOL.

Oil and chip resealing (O&C) means the application of road oils and liquid asphalt to coat an existing road surface, followed by application of aggregate chips or gravel to coated surface, and subsequent rolling of material to seal the surface.

### EXPLANATION OF CLASSES



ASBESTOS - GENERAL - removal of asbestos material/mold and hazardous materials from any place in a building, including mechanical systems where those mechanical systems are to be removed. This includes the removal of asbestos materials/mold and hazardous materials from ductwork or pipes in a building when the building is to be demolished at the time or at some close future date.

ASBESTOS - MECHANICAL - removal of asbestos material from mechanical systems, such as pipes, ducts, and boilers, where the mechanical systems are to remain.

#### CERAMIC TILE FINISHER AND MARBLE FINISHER

The handling, at the building site, of all sand, cement, tile, marble or stone and all other materials that may be used and installed by [a] tile layer or marble mason. In addition, the grouting, cleaning, sealing, and mixing on the job site, and all other work as required in assisting the setter. The term "Ceramic" is used for naming the classification only and is in no way a limitation of the product handled. Ceramic takes into consideration most hard tiles.

#### ELECTRONIC SYSTEMS TECHNICIAN

Installation, service and maintenance of low-voltage systems which utilizes the transmission and/or transference of voice, sound, vision, or digital for commercial, education, security and entertainment purposes for the following: TV monitoring and surveillance, background/foreground music, intercom and telephone interconnect, field programming, inventory control systems, microwave transmission, multi-media, multiplex, radio page, school, intercom and sound burglar alarms and low voltage master clock systems.

Excluded from this classification are energy management systems, life safety systems, supervisory controls and data acquisition systems not intrinsic with the above listed systems, fire alarm systems, nurse call systems and raceways exceeding fifteen feet in length.

#### OPERATING ENGINEER - BUILDING

GROUP I. Cranes, Dragline, Shovels, Skimmer Scoops, Clamshells or Derrick Boats, Pile Drivers, Crane-Type Backhoes, Asphalt Plant Operators, Concrete Plant Operators, Dredges, Asphalt Spreading Machines, All Locomotives, Cable Ways or Tower Machines, Hoists, Hydraulic Backhoes, Ditching Machines or Backfiller, Cherrypickers, Overhead Cranes, Roller - Steam or Gas, Concrete Pavers, Excavators, Concrete Breakers, Concrete Pumps, Bulk Cement Plants, Cement Pumps, Derrick-Type Drills, Boat Operators, Motor Graders or Pushcats, Scoops or Tournapulls, Bulldozers, Endloaders or Fork Lifts, Power Blade or Elevating Graders, Winch Cats, Boom or Winch Trucks or Boom Tractors, Pipe Wrapping or Painting Machines, Asphalt Plant Engineer, Journeyman Lubricating Engineer, Drills (other than Derrick Type), Mud Jacks, or Well Drilling Machines, Boring Machines or Track Jacks, Mixers, Conveyors (Two), Air Compressors (Two), Water Pumps regardless of size (Two), Welding Machines (Two), Siphons or Jets (Two), Winch Heads or Apparatuses (Two), Light Plants (Two), All Tractors regardless of size (straight tractor only), Fireman on Stationary Boilers, Automatic Elevators, Form Grading Machines, Finishing Machines, Power Sub-Grader or Ribbon Machines, Longitudinal Floats, Distributor Operators on Trucks, Winch Heads or Apparatuses (One), Mobil Track air and heaters (two to five), Heavy Equipment Greaser, Relief Operator, Assistant Master Mechanic and Heavy Duty Mechanic, self-propelled concrete saws of all types and sizes with their attachments, gob-hoppers, excavators

all sizes, the repair and greasing of all diesel hammers, the operation and set-up of bidwells, water blasters of all sizes and their clutches, hydraulic jacks where used for hoisting, operation of log skidders, iceolators used on and off of pipeline, condor cranes, bow boats, survey boats, bobcats and all their attachments, skid steer loaders and all their attachments, creter cranes, batch plants, operator (all sizes), self propelled roto mills, operation of conveyor systems of any size and any configuration, operation, repair and service of all vibratory hammers, all power pacs and their controls regardless of location, curtains or brush burning machines, stump cutter machines, Nail launchers when mounted on a machine or self-propelled, operation of con-cover machines, and all Operators except those listed below).

GROUP II. Assistant Operators.

GROUP III. Air Compressors (One), Water Pumps, regardless of Size (One), Waterblasters (one), Welding Machine (One), Mixers (One Bag), Conveyor (One), Siphon or Jet (One), Light Plant (One), Heater (One), Immobile Track Air (One), and Self Propelled Walk-Behind Rollers.

GROUP IV. Asphalt Spreader Oilers, Fireman on Whirlies and Heavy Equipment Oilers, Truck Cranes, Dredges, Monigans, Large Cranes - (Over 65-ton rated capacity) Concrete Plant Oiler, Blacktop Plant Oiler, and Creter Crane Oiler (when required).

GROUP V. Oiler.

GROUP VI. Operators on equipment with Booms, including jibs, 100 feet and over, and less than 150 feet long.

GROUP VII. Operators on equipment with Booms, including jibs, 150 feet and over, and less than 200 feet long.

GROUP VIII. Operators on Equipment with Booms, including jibs, 200 feet and over; Tower Cranes; and Whirlie Cranes.

GROUP IX. Master Mechanic

OPERATING ENGINEERS - Highway

GROUP I. Cranes, Dragline, Shovels, Skimmer Scoops, Clamshells or Derrick Boats, Pile Drivers, Crane-Type Backhoes, Asphalt Plant Operators, Concrete Plant Operators, Dredges, Asphalt Spreading Machines, All Locomotives, Cable Ways or Tower Machines, Hoists, Hydraulic Backhoes, Ditching Machines or Backfiller, Cherrypickers, Overhead Cranes, Roller - Steam or Gas, Concrete Pavers, Excavators, Concrete Breakers, Concrete Pumps, Bulk Cement Plants, Cement Pumps, Derrick-Type Drills, Boat Operators, Motor Graders or Pushcats, Scoops or Tournapulls, Bulldozers, Endloaders or Fork Lifts, Power Blade or Elevating Graders, Winch Cats, Boom or Winch Trucks or Boom Tractors, Pipe Wrapping or Painting Machines, Asphalt Plant Engineer, Journeyman Lubricating Engineer, Drills (other than Derrick Type), Mud Jacks, Well Drilling Machines, Boring Machines, Track Jacks, Mixers, Conveyors (Two), Air Compressors (Two), Water Pumps regardless of size (Two), Welding Machines (Two), Siphons or Jets (Two), Winch Heads or Apparatuses (Two), Light Plants (Two), All Tractors regardless of size (straight tractor only), Fireman on Stationary Boilers, Automatic Elevators, Form Grading Machines, Finishing Machines, Power Sub-Grader or Ribbon Machines, Longitudinal Floats, Distributor Operators on Trucks, Winch Heads or Apparatuses (One), Mobil Track air and heaters (two to five), Heavy Equipment Greaser, Relief Operator, Assistant Master Mechanic and Heavy Duty Mechanic, self-propelled concrete saws

of all types and sizes with their attachments, gob-hoppers, excavators all sizes, the repair and greasing of all diesel hammers, the operation and set-up of bidwells, water blasters of all sizes and their clutches, hydraulic jacks where used for hoisting, operation of log skidders, iceolators used on and off of pipeline, condor cranes, bow boats, survey boats, bobcats and all their attachments, skid steer loaders and all their attachments, creter cranes, batch plants, operator (all sizes), self propelled roto mills, operation of conveyor systems of any size and any configuration, operation, repair and service of all vibratory hammers, all power pacs and their controls regardless of location, curtains or brush burning machines, stump cutter machines, Nail launchers when mounted on a machine or self-propelled, operation of con-cover machines, and all Operators (except those listed below).

GROUP II. Assistant Operators.

GROUP III. Air Compressors (One), Water Pumps, regardless of Size (One), Waterblasters (one), Welding Machine (One), Mixers (One Bag), Conveyor (One), Siphon or Jet (One), Light Plant (One), Heater (One), Immobile Track Air (One), and Self Propelled Walk-Behind Rollers.

GROUP IV. Asphalt Spreader Oilers, Fireman on Whirlies and Heavy Equipment Oilers, Truck Cranes, Dredges, Monigans, Large Cranes - (Over 65-ton rated capacity) Concrete Plant Oiler, Blacktop Plant Oiler, and Creter Crane Oiler (when required).

GROUP V. Oiler.

GROUP VI. Operators on equipment with Booms, including jibs, 100 feet and over, and less than 150 feet long.

GROUP VII. Operators on equipment with Booms, including jibs, 150 feet and over, and less than 200 feet long.

GROUP VIII. Operators on Equipment with Booms, including jibs, 200 feet and over; Tower Cranes; and Whirlie Cranes.

GROUP IX. Mechanic

SURVEY WORKER - Operated survey equipment including data collectors, G.P.S. and robotic instruments, as well as conventional levels and transits.

TRUCK DRIVER - BUILDING, HEAVY AND HIGHWAY CONSTRUCTION

Class 1. Drivers on 2 axle trucks hauling less than 9 ton. Air compressor and welding machines and brooms, including those pulled by separate units, truck driver helpers, warehouse employees, mechanic helpers, greasers and tiremen, pickup trucks when hauling materials, tools, or workers to and from and on-the-job site, and fork lifts up to 6,000 lb. capacity.

Class 2. Two or three axle trucks hauling more than 9 ton but hauling less than 16 ton. A-frame winch trucks, hydrolift trucks, vactor trucks or similar equipment when used for transportation purposes. Fork lifts over 6,000 lb. capacity, winch trucks, four axle combination units, and ticket writers.

Class 3. Two, three or four axle trucks hauling 16 ton or more. Drivers on water pulls, articulated dump trucks, mechanics and working forepersons, and dispatchers. Five axle or more combination units.

Class 4. Low Boy and Oil Distributors.

Class 5. Drivers who require special protective clothing while employed on hazardous waste work.

#### TRUCK DRIVER - OIL AND CHIP RESEALING ONLY.

This shall encompass laborers, workers and mechanics who drive contractor or subcontractor owned, leased, or hired pickup, dump, service, or oil distributor trucks. The work includes transporting materials and equipment (including but not limited to, oils, aggregate supplies, parts, machinery and tools) to or from the job site; distributing oil or liquid asphalt and aggregate; stock piling material when in connection with the actual oil and chip contract. The Truck Driver (Oil & Chip Resealing) wage classification does not include supplier delivered materials.

#### TERRAZZO FINISHER

The handling of all materials used for Mosaic and Terrazzo work including preparing, mixing by hand, by mixing machine or transporting of pre-mixed materials and distributing with shovel, rake, hoe, or pail, all kinds of concrete foundations necessary for Mosaic and Terrazzo work, all cement terrazzo, magnesite terrazzo, Do-O-Tex terrazzo, epoxy matrix ter-razzo, exposed aggregate, rustic or rough washed for exterior or interior of buildings placed either by machine or by hand, and any other kind of mixture of plastics composed of chips or granules when mixed with cement, rubber, neoprene, vinyl, magnesium chloride or any other resinous or chemical substances used for seamless flooring systems, and all other building materials, all similar materials and all precast terrazzo work on jobs, all scratch coat used for Mosaic and Terrazzo work and sub-bed, tar paper and wire mesh (2x2 etc.) or lath. The rubbing, grinding, cleaning and finishing of same either by hand or by machine or by terrazzo resurfacing equipment on new or existing floors. When necessary finishers shall be allowed to assist the mechanics to spread sand bed, lay tarpaper and wire mesh (2x2 etc.) or lath. The finishing of cement floors where additional aggregate of stone is added by spreading or sprinkling on top of the finished base, and troweled or rolled into the finish and then the surface is ground by grinding machines.

#### Other Classifications of Work:

For definitions of classifications not otherwise set out, the Department generally has on file such definitions which are available. If a task to be performed is not subject to one of the classifications of pay set out, the Department will upon being contacted state which neighboring county has such a classification and provide such rate, such rate being deemed to exist by reference in this document. If no neighboring county rate applies to the task, the Department shall undertake a special determination, such special determination being then deemed to have existed under this determination. If a project requires these, or any classification not listed, please contact IDOL at 217-782-1710 for wage rates or clarifications.

#### LANDSCAPING

Landscaping work falls under the existing classifications for laborer, operating engineer and truck driver. The work performed by landscape plantsman and landscape laborer is covered by the existing

classification of laborer. The work performed by landscape operators (regardless of equipment used or its size) is covered by the classifications of operating engineer. The work performed by landscape truck drivers (regardless of size of truck driven) is covered by the classifications of truck driver.

# Randolph County Prevailing Wage for May 2014

(See explanation of column headings at bottom of wages)

Trade Name	RG	TYP	C	Base	FRMAN	M-F>8	OSA	OSH	H/W	Pensn	Vac	Trng
=====	==	===	=	=====	=====	=====	===	===	=====	=====	=====	=====
ASBESTOS ABT-GEN		ALL		28.420	28.920	1.5	1.5	2.0	5.850	13.33	0.000	0.800
ASBESTOS ABT-MEC		BLD		30.360	31.360	1.5	1.5	2.0	7.450	3.000	0.000	0.000
BOILERMAKER		BLD		32.060	34.560	1.5	1.5	2.0	7.070	21.27	1.000	0.350
BRICK MASON		BLD		29.250	30.750	1.5	1.5	2.0	8.450	7.100	0.000	0.480
CARPENTER		ALL		34.970	36.470	1.5	1.5	2.0	6.800	7.250	0.000	0.400
CEMENT MASON		BLD		29.050	30.550	1.5	1.5	2.0	7.200	6.400	0.000	0.500
CEMENT MASON		HWY		28.040	29.040	1.5	1.5	2.0	7.200	6.110	0.000	0.400
CERAMIC TILE FNSHER		BLD		27.750	0.000	1.5	1.5	2.0	8.450	7.100	0.000	0.480
ELECTRIC PWR EQMT OP NW	ALL			38.150	0.000	1.5	1.5	2.0	6.950	10.68	0.000	0.380
ELECTRIC PWR EQMT OP SE	ALL	1		36.770	0.000	1.5	1.5	2.0	5.760	10.29	0.000	0.370
ELECTRIC PWR EQMT OP SE	ALL	2		32.820	0.000	1.5	1.5	2.0	5.760	9.190	0.000	0.330
ELECTRIC PWR GRNDMAN NW	ALL			28.490	0.000	1.5	1.5	2.0	5.190	7.970	0.000	0.280
ELECTRIC PWR GRNDMAN SE	ALL			27.020	0.000	1.5	1.5	2.0	5.760	7.570	0.000	0.270
ELECTRIC PWR LINEMAN NW	ALL			43.860	0.000	1.5	1.5	2.0	7.990	12.29	0.000	0.440
ELECTRIC PWR LINEMAN SE	ALL			46.100	49.220	1.5	1.5	2.0	5.760	12.91	0.000	0.460
ELECTRIC PWR TRK DRV NW	ALL			31.140	0.000	1.5	1.5	2.0	5.670	8.720	0.000	0.310
ELECTRICIAN	NW	ALL		37.350	39.590	1.5	1.5	2.0	7.990	9.720	0.000	0.650
ELECTRICIAN	SE	ALL		40.300	42.550	1.5	1.5	2.0	6.410	10.08	0.000	0.800
ELECTRONIC SYS TECH NW	BLD			31.280	33.280	1.5	1.5	2.0	3.650	8.190	0.000	0.400
ELECTRONIC SYS TECH SE	BLD			32.570	34.320	1.5	1.5	2.0	6.250	4.210	0.000	0.400
ELEVATOR CONSTRUCTOR	BLD			44.370	49.920	2.0	2.0	2.0	12.73	13.46	3.550	0.600
FLOOR LAYER	BLD			29.580	30.330	1.5	1.5	2.0	6.800	7.250	0.000	0.400
GLAZIER	BLD			32.780	0.000	2.0	2.0	2.0	9.020	10.80	2.630	0.310
HT/FROST INSULATOR	BLD			37.660	38.660	1.5	1.5	2.0	8.350	11.26	0.000	0.500
IRON WORKER	ALL			31.500	33.500	1.5	1.5	2.0	8.110	13.85	0.000	0.420
LABORER	ALL			27.920	28.420	1.5	1.5	2.0	5.850	13.33	0.000	0.800
MACHINIST	BLD			43.920	46.420	1.5	1.5	2.0	6.760	8.950	1.850	0.000
MARBLE FINISHERS	BLD			27.750	0.000	1.5	1.5	2.0	8.450	7.100	0.000	0.480
MARBLE MASON	BLD			29.250	30.750	1.5	1.5	2.0	8.450	7.100	0.000	0.480
MILLWRIGHT	ALL			34.970	36.470	1.5	1.5	2.0	6.800	7.250	0.000	0.400
OPERATING ENGINEER	BLD	1		34.700	37.700	1.5	1.5	2.0	10.00	17.20	0.000	1.000
OPERATING ENGINEER	BLD	2		33.570	37.700	1.5	1.5	2.0	10.00	17.20	0.000	1.000
OPERATING ENGINEER	BLD	3		29.090	37.700	1.5	1.5	2.0	10.00	17.20	0.000	1.000
OPERATING ENGINEER	BLD	4		29.150	37.700	1.5	1.5	2.0	10.00	17.20	0.000	1.000
OPERATING ENGINEER	BLD	5		28.820	37.700	1.5	1.5	2.0	10.00	17.20	0.000	1.000
OPERATING ENGINEER	BLD	6		36.250	37.700	1.5	1.5	2.0	10.00	17.20	0.000	1.000
OPERATING ENGINEER	BLD	7		36.550	37.700	1.5	1.5	2.0	10.00	17.20	0.000	1.000
OPERATING ENGINEER	BLD	8		36.830	37.700	1.5	1.5	2.0	10.00	17.20	0.000	1.000
OPERATING ENGINEER	BLD	9		35.700	37.700	1.5	1.5	2.0	10.00	17.20	0.000	1.000
OPERATING ENGINEER	HWY	1		33.200	36.200	1.5	1.5	2.0	10.00	17.20	0.000	1.000
OPERATING ENGINEER	HWY	2		32.070	36.200	1.5	1.5	2.0	10.00	17.20	0.000	1.000
OPERATING ENGINEER	HWY	3		27.590	36.200	1.5	1.5	2.0	10.00	17.20	0.000	1.000
OPERATING ENGINEER	HWY	4		27.650	36.200	1.5	1.5	2.0	10.00	17.20	0.000	1.000
OPERATING ENGINEER	HWY	5		27.320	36.200	1.5	1.5	2.0	10.00	17.20	0.000	1.000
OPERATING ENGINEER	HWY	6		34.750	36.200	1.5	1.5	2.0	10.00	17.20	0.000	1.000
OPERATING ENGINEER	HWY	7		35.050	36.200	1.5	1.5	2.0	10.00	17.20	0.000	1.000
OPERATING ENGINEER	HWY	8		35.330	36.200	1.5	1.5	2.0	10.00	17.20	0.000	1.000
OPERATING ENGINEER	HWY	9		34.200	36.200	1.5	1.5	2.0	10.00	17.20	0.000	1.000
PAINTER	BLD			26.260	27.760	1.5	1.5	2.0	7.050	7.580	0.000	0.550
PAINTER	HWY			30.560	32.060	1.5	1.5	2.0	7.050	7.580	0.000	0.550
PAINTER OVER 30FT	BLD			27.260	28.760	1.5	1.5	2.0	7.050	7.580	0.000	0.550
PAINTER PWR EQMT	BLD			27.260	28.760	1.5	1.5	2.0	7.050	7.580	0.000	0.550
PAINTER PWR EQMT	HWY			31.560	33.060	1.5	1.5	2.0	7.050	7.580	0.000	0.550
PILEDRIVER	ALL			34.970	36.470	1.5	1.5	2.0	6.800	7.250	0.000	0.400
PIPEFITTER	N	BLD		36.500	39.000	1.5	1.5	2.0	8.150	5.600	0.000	0.580
PIPEFITTER	SE	BLD		42.280	46.500	1.5	2.0	2.0	8.700	5.870	0.000	1.350

PIPEFITTER	W	BLD	37.250	39.250	1.5	1.5	2.0	6.740	8.000	0.000	0.750
PLASTERER		BLD	29.050	30.550	1.5	1.5	2.0	7.200	6.400	0.000	0.500
PLUMBER	N	BLD	36.500	39.000	1.5	1.5	2.0	8.150	5.600	0.000	0.580
PLUMBER	SE	BLD	42.280	46.500	1.5	2.0	2.0	8.700	5.870	0.000	1.350
PLUMBER	W	BLD	37.050	39.550	1.5	1.5	2.0	6.500	6.850	0.000	0.500
ROOFER		BLD	30.100	32.100	1.5	1.5	2.0	8.800	7.100	0.000	0.240
SHEETMETAL WORKER		ALL	32.250	33.750	1.5	1.5	2.0	8.330	7.320	1.940	0.360
SPRINKLER FITTER		BLD	40.030	43.030	2.0	2.0	2.0	8.370	11.18	0.000	1.250
STONE MASON		BLD	29.250	30.750	1.5	1.5	2.0	8.450	7.100	0.000	0.480
SURVEY WORKER		ALL	27.620	28.120	1.5	1.5	2.0	5.750	12.58	0.000	0.800
TERRAZZO FINISHER		BLD	27.750	0.000	1.5	1.5	2.0	8.450	7.100	0.000	0.480
TERRAZZO MASON		BLD	29.250	30.750	1.5	1.5	2.0	8.450	7.100	0.000	0.480
TRUCK DRIVER		ALL 1	31.340	0.000	1.5	1.5	2.0	10.30	5.010	0.000	0.250
TRUCK DRIVER		ALL 2	31.780	0.000	1.5	1.5	2.0	10.30	5.010	0.000	0.250
TRUCK DRIVER		ALL 3	32.020	0.000	1.5	1.5	2.0	10.30	5.010	0.000	0.250
TRUCK DRIVER		ALL 4	32.280	0.000	1.5	1.5	2.0	10.30	5.010	0.000	0.250
TRUCK DRIVER		ALL 5	33.130	0.000	1.5	1.5	2.0	10.30	5.010	0.000	0.250
TRUCK DRIVER		O&C 1	25.070	0.000	1.5	1.5	2.0	10.30	5.010	0.000	0.250
TRUCK DRIVER		O&C 2	25.420	0.000	1.5	1.5	2.0	10.30	5.010	0.000	0.250
TRUCK DRIVER		O&C 3	25.620	0.000	1.5	1.5	2.0	10.30	5.010	0.000	0.250
TRUCK DRIVER		O&C 4	25.820	0.000	1.5	1.5	2.0	10.30	5.010	0.000	0.250
TRUCK DRIVER		O&C 5	26.500	0.000	1.5	1.5	2.0	10.30	5.010	0.000	0.250
TUCKPOINTER		BLD	29.250	30.750	1.5	1.5	2.0	8.450	7.100	0.000	0.480

**Legend:** RG (Region)

TYP (Trade Type - All,Highway,Building,Floating,Oil & Chip,Rivers)

C (Class)

Base (Base Wage Rate)

FRMAN (Foreman Rate)

M-F>8 (OT required for any hour greater than 8 worked each day, Mon through Fri.

OSA (Overtime (OT) is required for every hour worked on Saturday)

OSH (Overtime is required for every hour worked on Sunday and Holidays)

H/W (Health & Welfare Insurance)

Pensn (Pension)

Vac (Vacation)

Trng (Training)

## Explanations

RANDOLPH COUNTY

ELECTRICIANS AND ELECTRONIC SYSTEMS TECHNICIAN (NORTHWEST) - Township of Red Bud.

PLUMBERS & PIPEFITTERS (NORTH) - Towns of Red Bud, Prairie, and Ruma.

PLUMBERS & PIPEFITTERS (SOUTHEAST) - That part of the county East of a line between Ste. Genevieve, Mo. and Rt. 155 then south of a diagonal line to the North-East corner of the county.

PLUMBERS & PIPEFITTERS (WEST) - Towns of Roots, Kellog, Modoc and Prairie DuRocher.

The following list is considered as those days for which holiday rates of wages for work performed apply: New Years Day, Memorial Day, Fourth of July, Labor Day, Thanksgiving Day, Christmas Day and Veterans Day in some classifications/counties. Generally, any of these holidays which fall on a Sunday is celebrated on the following Monday. This then makes work performed on that Monday payable at the appropriate overtime rate for holiday pay. Common practice in a given local may alter certain days of celebration. If in doubt, please check with IDOL.

Oil and chip resealing (O&C) means the application of road oils and liquid asphalt to coat an existing road surface, followed by application of aggregate chips or gravel to coated surface, and subsequent rolling of material to seal the surface.

#### EXPLANATION OF CLASSES

ASBESTOS - GENERAL - removal of asbestos material/mold and hazardous materials from any place in a building, including mechanical systems where those mechanical systems are to be removed. This includes the removal of asbestos materials/mold and hazardous materials from ductwork or pipes in a building when the building is to be demolished at the time or at some close future date.

ASBESTOS - MECHANICAL - removal of asbestos material from mechanical systems, such as pipes, ducts, and boilers, where the mechanical systems are to remain.

#### CERAMIC TILE FINISHER, MARBLE FINISHER, TERRAZZO FINISHER

Assisting, helping or supporting the tile, marble and terrazzo mechanic by performing their historic and traditional work assignments required to complete the proper installation of the work covered by said crafts. The term "Ceramic" is used for naming the classification only, and is in no a limitation of the product handled. Ceramic takes into consideration most hard tiles.

#### ELECTRONIC SYSTEMS TECHNICIAN

Installation, service and maintenance of low-voltage systems which utilizes the transmission and/or transference of voice, sound, vision, or digital for commercial, education, security and entertainment purposes for the following: TV monitoring and surveillance, background/foreground music, intercom and telephone interconnect, field programming, inventory control systems, microwave transmission, multi-media, multiplex, radio page, school, intercom and sound burglar alarms and low voltage master clock systems.

Excluded from this classification are energy management systems, life safety systems, supervisory controls and data acquisition systems not intrinsic with the above listed systems, fire alarm systems, nurse call systems and raceways exceeding fifteen feet in length.

#### OPERATING ENGINEER - BUILDING

GROUP I. Cranes, Dragline, Shovels, Skimmer Scoops, Clamshells or Derrick Boats, Pile Drivers, Crane-Type Backhoes, Asphalt Plant



Operators, Concrete Plant Operators, Dredges, Asphalt Spreading Machines, All Locomotives, Cable Ways or Tower Machines, Hoists, Hydraulic Backhoes, Ditching Machines or Backfiller, Cherrypickers, Overhead Cranes, Roller - Steam or Gas, Concrete Pavers, Excavators, Concrete Breakers, Concrete Pumps, Bulk Cement Plants, Cement Pumps, Derrick-Type Drills, Boat Operators, Motor Graders or Pushcats, Scoops or Tournapulls, Bulldozers, Endloaders or Fork Lifts, Power Blade or Elevating Graders, Winch Cats, Boom or Winch Trucks or Boom Tractors, Pipe Wrapping or Painting Machines, Asphalt Plant Engineer, Journeyman Lubricating Engineer, Drills (other than Derrick Type), Mud Jacks, or Well Drilling Machines, Boring Machines or Track Jacks, Mixers, Conveyors (Two), Air Compressors (Two), Water Pumps regardless of size (Two), Welding Machines (Two), Siphons or Jets (Two), Winch Heads or Apparatuses (Two), Light Plants (Two), All Tractors regardless of size (straight tractor only), Fireman on Stationary Boilers, Automatic Elevators, Form Grading Machines, Finishing Machines, Power Sub-Grader or Ribbon Machines, Longitudinal Floats, Distributor Operators on Trucks, Winch Heads or Apparatuses (One), Mobil Track air and heaters (two to five), Heavy Equipment Greaser, Relief Operator, Assistant Master Mechanic and Heavy Duty Mechanic, self-propelled concrete saws of all types and sizes with their attachments, gob-hoppers, excavators all sizes, the repair and greasing of all diesel hammers, the operation and set-up of bidwells, water blasters of all sizes and their clutches, hydraulic jacks where used for hoisting, operation of log skidders, iceolators used on and off of pipeline, condor cranes, bow boats, survey boats, bobcats and all their attachments, skid steer loaders and all their attachments, creter cranes, batch plants, operator (all sizes), self propelled roto mills, operation of conveyor systems of any size and any configuration, operation, repair and service of all vibratory hammers, all power pacs and their controls regardless of location, curtains or brush burning machines, stump cutter machines, Nail launchers when mounted on a machine or self-propelled, operation of con-cover machines, and all Operators except those listed below).

GROUP II. Assistant Operators.

GROUP III. Air Compressors (One), Water Pumps, regardless of Size (One), Waterblasters (one), Welding Machine (One), Mixers (One Bag), Conveyor (One), Siphon or Jet (One), Light Plant (One), Heater (One), Immobile Track Air (One), and Self Propelled Walk-Behind Rollers.

GROUP IV. Asphalt Spreader Oilers, Fireman on Whirlies and Heavy Equipment Oilers, Truck Cranes, Dredges, Monigans, Large Cranes - (Over 65-ton rated capacity) Concrete Plant Oiler, Blacktop Plant Oiler, and Creter Crane Oiler (when required).

GROUP V. Oiler.

GROUP VI. Operators on equipment with Booms, including jibs, 100 feet and over, and less than 150 feet long.

GROUP VII. Operators on equipment with Booms, including jibs, 150 feet and over, and less than 200 feet long.

GROUP VIII. Operators on Equipment with Booms, including jibs, 200 feet and over; Tower Cranes; and Whirlie Cranes.

GROUP IX. Master Mechanic

OPERATING ENGINEERS - Highway

GROUP I. Cranes, Dragline, Shovels, Skimmer Scoops, Clamshells or

Derrick Boats, Pile Drivers, Crane-Type Backhoes, Asphalt Plant Operators, Concrete Plant Operators, Dredges, Asphalt Spreading Machines, All Locomotives, Cable Ways or Tower Machines, Hoists, Hydraulic Backhoes, Ditching Machines or Backfiller, Cherrypickers, Overhead Cranes, Roller - Steam or Gas, Concrete Pavers, Excavators, Concrete Breakers, Concrete Pumps, Bulk Cement Plants, Cement Pumps, Derrick-Type Drills, Boat Operators, Motor Graders or Pushcats, Scoops or Tournapulls, Bulldozers, Endloaders or Fork Lifts, Power Blade or Elevating Graders, Winch Cats, Boom or Winch Trucks or Boom Tractors, Pipe Wrapping or Painting Machines, Asphalt Plant Engineer, Journeyman Lubricating Engineer, Drills (other than Derrick Type), Mud Jacks, Well Drilling Machines, Boring Machines, Track Jacks, Mixers, Conveyors (Two), Air Compressors (Two), Water Pumps regardless of size (Two), Welding Machines (Two), Siphons or Jets (Two), Winch Heads or Apparatuses (Two), Light Plants (Two), All Tractors regardless of size (straight tractor only), Fireman on Stationary Boilers, Automatic Elevators, Form Grading Machines, Finishing Machines, Power Sub-Grader or Ribbon Machines, Longitudinal Floats, Distributor Operators on Trucks, Winch Heads or Apparatuses (One), Mobil Track air and heaters (two to five), Heavy Equipment Greaser, Relief Operator, Assistant Master Mechanic and Heavy Duty Mechanic, self-propelled concrete saws of all types and sizes with their attachments, gob-hoppers, excavators all sizes, the repair and greasing of all diesel hammers, the operation and set-up of bidwells, water blasters of all sizes and their clutches, hydraulic jacks where used for hoisting, operation of log skidders, iceolators used on and off of pipeline, condor cranes, bow boats, survey boats, bobcats and all their attachments, skid steer loaders and all their attachments, creter cranes, batch plants, operator (all sizes), self propelled roto mills, operation of conveyor systems of any size and any configuration, operation, repair and service of all vibratory hammers, all power pacs and their controls regardless of location, curtains or brush burning machines, stump cutter machines, Nail launchers when mounted on a machine or self-propelled, operation of con-cover machines, and all Operators (except those listed below).

GROUP II. Assistant Operators.

GROUP III. Air Compressors (One), Water Pumps, regardless of Size (One), Waterblasters (one), Welding Machine (One), Mixers (One Bag), Conveyor (One), Siphon or Jet (One), Light Plant (One), Heater (One), Immobile Track Air (One), and Self Propelled Walk-Behind Rollers.

GROUP IV. Asphalt Spreader Oilers, Fireman on Whirlies and Heavy Equipment Oilers, Truck Cranes, Dredges, Monigans, Large Cranes - (Over 65-ton rated capacity) Concrete Plant Oiler, Blacktop Plant Oiler, and Creter Crane Oiler (when required).

GROUP V. Oiler.

GROUP VI. Operators on equipment with Booms, including jibs, 100 feet and over, and less than 150 feet long.

GROUP VII. Operators on equipment with Booms, including jibs, 150 feet and over, and less than 200 feet long.

GROUP VIII. Operators on Equipment with Booms, including jibs, 200 feet and over; Tower Cranes; and Whirlie Cranes.

GROUP IX. Mechanic

SURVEY WORKER - Operated survey equipment including data collectors, G.P.S. and robotic instruments, as well as conventional levels and

transits.

#### TRUCK DRIVER - BUILDING, HEAVY AND HIGHWAY CONSTRUCTION

Class 1. Drivers on 2 axle trucks hauling less than 9 ton. Air compressor and welding machines and brooms, including those pulled by separate units, truck driver helpers, warehouse employees, mechanic helpers, greasers and tiremen, pickup trucks when hauling materials, tools, or workers to and from and on-the-job site, and fork lifts up to 6,000 lb. capacity.

Class 2. Two or three axle trucks hauling more than 9 ton but hauling less than 16 ton. A-frame winch trucks, hydrolift trucks, vector trucks or similar equipment when used for transportation purposes. Fork lifts over 6,000 lb. capacity, winch trucks, four axle combination units, and ticket writers.

Class 3. Two, three or four axle trucks hauling 16 ton or more. Drivers on water pulls, articulated dump trucks, mechanics and working forepersons, and dispatchers. Five axle or more combination units.

Class 4. Low Boy and Oil Distributors.

Class 5. Drivers who require special protective clothing while employed on hazardous waste work.

#### TRUCK DRIVER - OIL AND CHIP RESEALING ONLY.

This shall encompass laborers, workers and mechanics who drive contractor or subcontractor owned, leased, or hired pickup, dump, service, or oil distributor trucks. The work includes transporting materials and equipment (including but not limited to, oils, aggregate supplies, parts, machinery and tools) to or from the job site; distributing oil or liquid asphalt and aggregate; stock piling material when in connection with the actual oil and chip contract. The Truck Driver (Oil & Chip Resealing) wage classification does not include supplier delivered materials.

#### Other Classifications of Work:

For definitions of classifications not otherwise set out, the Department generally has on file such definitions which are available. If a task to be performed is not subject to one of the classifications of pay set out, the Department will upon being contacted state which neighboring county has such a classification and provide such rate, such rate being deemed to exist by reference in this document. If no neighboring county rate applies to the task, the Department shall undertake a special determination, such special determination being then deemed to have existed under this determination. If a project requires these, or any classification not listed, please contact IDOL at 217-782-1710 for wage rates or clarifications.

#### LANDSCAPING

Landscaping work falls under the existing classifications for laborer, operating engineer and truck driver. The work performed by landscape plantsman and landscape laborer is covered by the existing classification of laborer. The work performed by landscape operators (regardless of equipment used or its size) is covered by the classifications of operating engineer. The work performed by landscape truck drivers (regardless of size of truck driven) is covered by the classifications of truck driver.



# Saint Clair County Prevailing Wage for May 2014

(See explanation of column headings at bottom of wages)

Trade Name	RG	TYP	C	Base	FRMAN	M-F>8	OSA	OSH	H/W	Pensn	Vac	Trng
=====	==	===	=	=====	=====	=====	===	===	=====	=====	=====	=====
ASBESTOS ABT-GEN		BLD		29.800	30.300	1.5	1.5	2.0	6.650	11.15	0.000	0.800
ASBESTOS ABT-MEC		BLD		30.360	31.360	1.5	1.5	2.0	7.450	3.000	0.000	0.000
BOILERMAKER		BLD		32.060	34.560	1.5	1.5	2.0	7.070	21.27	1.000	0.350
BRICK MASON		BLD		29.640	33.540	1.5	1.5	2.0	8.000	10.09	2.000	0.400
CARPENTER		ALL		34.970	36.470	1.5	1.5	2.0	6.800	7.250	0.000	0.400
CEMENT MASON		ALL		31.500	32.500	1.5	1.5	2.0	9.500	12.25	0.000	0.200
CERAMIC TILE FNSHER		BLD		25.890	0.000	1.5	1.5	2.0	6.400	5.450	0.000	0.580
ELECTRIC PWR EQMT OP		ALL		38.150	0.000	1.5	1.5	2.0	6.950	10.68	0.000	0.380
ELECTRIC PWR GRNDMAN		ALL		28.490	0.000	1.5	1.5	2.0	5.190	7.970	0.000	0.280
ELECTRIC PWR LINEMAN		ALL		43.860	0.000	1.5	1.5	2.0	7.990	12.29	0.000	0.440
ELECTRIC PWR TRK DRV		ALL		31.140	0.000	1.5	1.5	2.0	5.670	8.720	0.000	0.310
ELECTRICIAN		ALL		37.350	39.590	1.5	1.5	2.0	7.990	9.720	0.000	0.650
ELECTRONIC SYS TECH		BLD		31.280	33.280	1.5	1.5	2.0	3.650	8.190	0.000	0.400
ELEVATOR CONSTRUCTOR		BLD		44.370	49.920	2.0	2.0	2.0	12.73	13.46	3.550	0.600
FLOOR LAYER		BLD		29.580	30.330	1.5	1.5	2.0	6.800	7.250	0.000	0.400
GLAZIER		BLD		32.780	0.000	2.0	2.0	2.0	9.020	10.80	2.630	0.310
HT/FROST INSULATOR		BLD		37.660	38.660	1.5	1.5	2.0	8.350	11.26	0.000	0.500
IRON WORKER		ALL		31.500	33.500	1.5	1.5	2.0	8.110	13.85	0.000	0.420
LABORER	N	ALL		29.300	29.800	1.5	1.5	2.0	6.650	11.15	0.000	0.800
LABORER	S	ALL		27.920	28.420	1.5	1.5	2.0	5.850	13.33	0.000	0.800
MACHINIST		BLD		43.920	46.420	1.5	1.5	2.0	6.760	8.950	1.850	0.000
MARBLE FINISHERS		BLD		25.890	0.000	1.5	1.5	2.0	6.400	5.450	0.000	0.580
MARBLE MASON		BLD		29.640	33.540	1.5	1.5	2.0	8.000	10.09	2.000	0.400
MILLWRIGHT		ALL		34.970	36.470	1.5	1.5	2.0	6.800	7.250	0.000	0.400
OPERATING ENGINEER		BLD	1	34.700	37.700	1.5	1.5	2.0	10.00	17.20	0.000	1.000
OPERATING ENGINEER		BLD	2	33.570	37.700	1.5	1.5	2.0	10.00	17.20	0.000	1.000
OPERATING ENGINEER		BLD	3	29.090	37.700	1.5	1.5	2.0	10.00	17.20	0.000	1.000
OPERATING ENGINEER		BLD	4	29.150	37.700	1.5	1.5	2.0	10.00	17.20	0.000	1.000
OPERATING ENGINEER		BLD	5	28.820	37.700	1.5	1.5	2.0	10.00	17.20	0.000	1.000
OPERATING ENGINEER		BLD	6	36.250	37.700	1.5	1.5	2.0	10.00	17.20	0.000	1.000
OPERATING ENGINEER		BLD	7	36.550	37.700	1.5	1.5	2.0	10.00	17.20	0.000	1.000
OPERATING ENGINEER		BLD	8	36.830	37.700	1.5	1.5	2.0	10.00	17.20	0.000	1.000
OPERATING ENGINEER		BLD	9	35.700	37.700	1.5	1.5	2.0	10.00	17.20	0.000	1.000
OPERATING ENGINEER		HWY	1	33.200	36.200	1.5	1.5	2.0	10.00	17.20	0.000	1.000
OPERATING ENGINEER		HWY	2	32.070	36.200	1.5	1.5	2.0	10.00	17.20	0.000	1.000
OPERATING ENGINEER		HWY	3	27.590	36.200	1.5	1.5	2.0	10.00	17.20	0.000	1.000
OPERATING ENGINEER		HWY	4	27.650	36.200	1.5	1.5	2.0	10.00	17.20	0.000	1.000
OPERATING ENGINEER		HWY	5	27.320	36.200	1.5	1.5	2.0	10.00	17.20	0.000	1.000
OPERATING ENGINEER		HWY	6	34.750	36.200	1.5	1.5	2.0	10.00	17.20	0.000	1.000
OPERATING ENGINEER		HWY	7	35.050	36.200	1.5	1.5	2.0	10.00	17.20	0.000	1.000
OPERATING ENGINEER		HWY	8	35.330	36.200	1.5	1.5	2.0	10.00	17.20	0.000	1.000
OPERATING ENGINEER		HWY	9	34.200	36.200	1.5	1.5	2.0	10.00	17.20	0.000	1.000
PAINTER		BLD		29.250	30.750	1.5	2.0	2.0	5.250	9.170	0.000	0.650
PAINTER		HWY		30.450	31.950	1.5	1.5	2.0	5.250	9.170	0.000	0.650
PAINTER OVER 30FT		BLD		30.250	31.750	1.5	2.0	2.0	5.250	9.170	0.000	0.650
PAINTER PWR EQMT		BLD		30.250	31.750	1.5	2.0	2.0	5.250	9.170	0.000	0.650
PAINTER PWR EQMT		HWY		31.450	32.950	1.5	1.5	2.0	5.250	9.170	0.000	0.650
PILEDRIVER		ALL		34.970	36.470	1.5	1.5	2.0	6.800	7.250	0.000	0.400
PIPEFITTER	NW	BLD		37.250	39.250	1.5	1.5	2.0	6.740	8.000	0.000	0.750
PIPEFITTER	SE	BLD		36.500	39.000	1.5	1.5	2.0	8.150	5.600	0.000	0.580
PLASTERER		BLD		30.250	31.250	1.5	1.5	2.0	9.500	9.150	0.000	0.050
PLUMBER	NW	BLD		37.050	39.550	1.5	1.5	2.0	6.500	6.850	0.000	0.500
PLUMBER	SE	BLD		36.500	39.000	1.5	1.5	2.0	8.150	5.600	0.000	0.580
ROOFER		BLD		30.100	32.100	1.5	1.5	2.0	8.800	7.100	0.000	0.240
SHEETMETAL WORKER		ALL		32.250	33.750	1.5	1.5	2.0	8.330	7.320	1.940	0.360
SPRINKLER FITTER		BLD		40.030	43.030	2.0	2.0	2.0	8.370	11.18	0.000	1.250

SURVEY WORKER	N	ALL	29.300	29.800	1.5	1.5	2.0	6.050	10.60	0.000	0.800
SURVEY WORKER	S	ALL	27.620	28.120	1.5	1.5	2.0	5.750	12.58	0.000	0.800
TERRAZZO FINISHER		BLD	31.240	0.000	1.5	1.5	2.0	6.400	3.800	0.000	0.270
TERRAZZO MASON		BLD	32.530	32.830	1.5	1.5	2.0	6.400	5.550	0.000	0.290
TRUCK DRIVER		ALL 1	31.340	0.000	1.5	1.5	2.0	10.30	5.010	0.000	0.250
TRUCK DRIVER		ALL 2	31.780	0.000	1.5	1.5	2.0	10.30	5.010	0.000	0.250
TRUCK DRIVER		ALL 3	32.020	0.000	1.5	1.5	2.0	10.30	5.010	0.000	0.250
TRUCK DRIVER		ALL 4	32.280	0.000	1.5	1.5	2.0	10.30	5.010	0.000	0.250
TRUCK DRIVER		ALL 5	33.130	0.000	1.5	1.5	2.0	10.30	5.010	0.000	0.250
TRUCK DRIVER		O&C 1	25.070	0.000	1.5	1.5	2.0	10.30	5.010	0.000	0.250
TRUCK DRIVER		O&C 2	25.420	0.000	1.5	1.5	2.0	10.30	5.010	0.000	0.250
TRUCK DRIVER		O&C 3	25.620	0.000	1.5	1.5	2.0	10.30	5.010	0.000	0.250
TRUCK DRIVER		O&C 4	25.820	0.000	1.5	1.5	2.0	10.30	5.010	0.000	0.250
TRUCK DRIVER		O&C 5	26.500	0.000	1.5	1.5	2.0	10.30	5.010	0.000	0.250

**Legend:** RG (Region)

TYP (Trade Type - All,Highway,Building,Floating,Oil & Chip,Rivers)

C (Class)

Base (Base Wage Rate)

FRMAN (Foreman Rate)

M-F>8 (OT required for any hour greater than 8 worked each day, Mon through Fri.)

OSA (Overtime (OT) is required for every hour worked on Saturday)

OSH (Overtime is required for every hour worked on Sunday and Holidays)

H/W (Health & Welfare Insurance)

Pensn (Pension)

Vac (Vacation)

Trng (Training)

## Explanations

### ST. CLAIR COUNTY

LABORERS (NORTH) - The area bounded by Route 159 to a point south of Fairview Heights and west-southwest to Route 3 at Monroe County line.

PLUMBERS & PIPEFITTERS (SOUTHEAST) - That part of the county bordered by Rt. 50 on the North and West including Belleville.

PLUMBERS (NORTHWEST) - Towns of Aloraton, Brooklyn, Cahokia, Caseyville, Centreville, Dupo, East Carondelet, E. St. Louis, Fairview Heights, French Village, National City, O'Fallon, Sauget, and Washington Park.

The following list is considered as those days for which holiday rates of wages for work performed apply: New Years Day, Memorial Day, Fourth of July, Labor Day, Thanksgiving Day, Christmas Day and

Veterans Day in some classifications/counties. Generally, any of these holidays which fall on a Sunday is celebrated on the following Monday. This then makes work performed on that Monday payable at the appropriate overtime rate for holiday pay. Common practice in a given local may alter certain days of celebration. If in doubt, please check with IDOL.

Oil and chip resealing (O&C) means the application of road oils and liquid asphalt to coat an existing road surface, followed by application of aggregate chips or gravel to coated surface, and subsequent rolling of material to seal the surface.

#### EXPLANATION OF CLASSES

ASBESTOS - GENERAL - removal of asbestos material/mold and hazardous materials from any place in a building, including mechanical systems where those mechanical systems are to be removed. This includes the removal of asbestos materials/mold and hazardous materials from ductwork or pipes in a building when the building is to be demolished at the time or at some close future date.

ASBESTOS - MECHANICAL - removal of asbestos material from mechanical systems, such as pipes, ducts, and boilers, where the mechanical systems are to remain.

#### CERAMIC TILE FINISHER AND MARBLE FINISHER

The handling, at the building site, of all sand, cement, tile, marble or stone and all other materials that may be used and installed by [a] tile layer or marble mason. In addition, the grouting, cleaning, sealing, and mixing on the job site, and all other work as required in assisting the setter. The term "Ceramic" is used for naming the classification only and is in no way a limitation of the product handled. Ceramic takes into consideration most hard tiles.

#### ELECTRONIC SYSTEMS TECHNICIAN

Installation, service and maintenance of low-voltage systems which utilizes the transmission and/or transference of voice, sound, vision, or digital for commercial, education, security and entertainment purposes for the following: TV monitoring and surveillance, background/foreground music, intercom and telephone interconnect, field programming, inventory control systems, microwave transmission, multi-media, multiplex, radio page, school, intercom and sound burglar alarms and low voltage master clock systems.

Excluded from this classification are energy management systems, life safety systems, supervisory controls and data acquisition systems not intrinsic with the above listed systems, fire alarm systems, nurse call systems and raceways exceeding fifteen feet in length.

#### OPERATING ENGINEER - BUILDING

GROUP I. Cranes, Dragline, Shovels, Skimmer Scoops, Clamshells or Derrick Boats, Pile Drivers, Crane-Type Backhoes, Asphalt Plant Operators, Concrete Plant Operators, Dredges, Asphalt Spreading Machines, All Locomotives, Cable Ways or Tower Machines, Hoists, Hydraulic Backhoes, Ditching Machines or Backfiller, Cherrypickers, Overhead Cranes, Roller - Steam or Gas, Concrete Pavers, Excavators, Concrete Breakers, Concrete Pumps, Bulk Cement Plants, Cement Pumps, Derrick-Type Drills, Boat Operators, Motor Graders or Pushcats, Scoops or Tournapulls, Bulldozers, Endloaders or Fork Lifts, Power Blade or

Elevating Graders, Winch Cats, Boom or Winch Trucks or Boom Tractors, Pipe Wrapping or Painting Machines, Asphalt Plant Engineer, Journeyman Lubricating Engineer, Drills (other than Derrick Type), Mud Jacks, or Well Drilling Machines, Boring Machines or Track Jacks, Mixers, Conveyors (Two), Air Compressors (Two), Water Pumps regardless of size (Two), Welding Machines (Two), Siphons or Jets (Two), Winch Heads or Apparatuses (Two), Light Plants (Two), All Tractors regardless of size (straight tractor only), Fireman on Stationary Boilers, Automatic Elevators, Form Grading Machines, Finishing Machines, Power Sub-Grader or Ribbon Machines, Longitudinal Floats, Distributor Operators on Trucks, Winch Heads or Apparatuses (One), Mobil Track air and heaters (two to five), Heavy Equipment Greaser, Relief Operator, Assistant Master Mechanic and Heavy Duty Mechanic, self-propelled concrete saws of all types and sizes with their attachments, gob-hoppers, excavators all sizes, the repair and greasing of all diesel hammers, the operation and set-up of bidwells, water blasters of all sizes and their clutches, hydraulic jacks where used for hoisting, operation of log skidders, iceolators used on and off of pipeline, condor cranes, bow boats, survey boats, bobcats and all their attachments, skid steer loaders and all their attachments, creter cranes, batch plants, operator (all sizes), self propelled roto mills, operation of conveyor systems of any size and any configuration, operation, repair and service of all vibratory hammers, all power pacs and their controls regardless of location, curtains or brush burning machines, stump cutter machines, Nail launchers when mounted on a machine or self-propelled, operation of con-cover machines, and all Operators except those listed below).

GROUP II. Assistant Operators.

GROUP III. Air Compressors (One), Water Pumps, regardless of Size (One), Waterblasters (one), Welding Machine (One), Mixers (One Bag), Conveyor (One), Siphon or Jet (One), Light Plant (One), Heater (One), Immobile Track Air (One), and Self Propelled Walk-Behind Rollers.

GROUP IV. Asphalt Spreader Oilers, Fireman on Whirlies and Heavy Equipment Oilers, Truck Cranes, Dredges, Monigans, Large Cranes - (Over 65-ton rated capacity) Concrete Plant Oiler, Blacktop Plant Oiler, and Creter Crane Oiler (when required).

GROUP V. Oiler.

GROUP VI. Operators on equipment with Booms, including jibs, 100 feet and over, and less than 150 feet long.

GROUP VII. Operators on equipment with Booms, including jibs, 150 feet and over, and less than 200 feet long.

GROUP VIII. Operators on Equipment with Booms, including jibs, 200 feet and over; Tower Cranes; and Whirlie Cranes.

GROUP IX. Master Mechanic

OPERATING ENGINEERS - Highway

GROUP I. Cranes, Dragline, Shovels, Skimmer Scoops, Clamshells or Derrick Boats, Pile Drivers, Crane-Type Backhoes, Asphalt Plant Operators, Concrete Plant Operators, Dredges, Asphalt Spreading Machines, All Locomotives, Cable Ways or Tower Machines, Hoists, Hydraulic Backhoes, Ditching Machines or Backfiller, Cherrypickers, Overhead Cranes, Roller - Steam or Gas, Concrete Pavers, Excavators, Concrete Breakers, Concrete Pumps, Bulk Cement Plants, Cement Pumps, Derrick-Type Drills, Boat Operators, Motor Graders or Pushcats, Scoops



or Tournapulls, Bulldozers, Endloaders or Fork Lifts, Power Blade or Elevating Graders, Winch Cats, Boom or Winch Trucks or Boom Tractors, Pipe Wrapping or Painting Machines, Asphalt Plant Engineer, Journeyman Lubricating Engineer, Drills (other than Derrick Type), Mud Jacks, Well Drilling Machines, Boring Machines, Track Jacks, Mixers, Conveyors (Two), Air Compressors (Two), Water Pumps regardless of size (Two), Welding Machines (Two), Siphons or Jets (Two), Winch Heads or Apparatuses (Two), Light Plants (Two), All Tractors regardless of size (straight tractor only), Fireman on Stationary Boilers, Automatic Elevators, Form Grading Machines, Finishing Machines, Power Sub-Grader or Ribbon Machines, Longitudinal Floats, Distributor Operators on Trucks, Winch Heads or Apparatuses (One), Mobil Track air and heaters (two to five), Heavy Equipment Greaser, Relief Operator, Assistant Master Mechanic and Heavy Duty Mechanic, self-propelled concrete saws of all types and sizes with their attachments, gob-hoppers, excavators all sizes, the repair and greasing of all diesel hammers, the operation and set-up of bidwells, water blasters of all sizes and their clutches, hydraulic jacks where used for hoisting, operation of log skidders, iceolators used on and off of pipeline, condor cranes, bow boats, survey boats, bobcats and all their attachments, skid steer loaders and all their attachments, creter cranes, batch plants, operator (all sizes), self propelled roto mills, operation of conveyor systems of any size and any configuration, operation, repair and service of all vibratory hammers, all power pacs and their controls regardless of location, curtains or brush burning machines, stump cutter machines, Nail launchers when mounted on a machine or self-propelled, operation of con-cover machines, and all Operators (except those listed below).

GROUP II. Assistant Operators.

GROUP III. Air Compressors (One), Water Pumps, regardless of Size (One), Waterblasters (one), Welding Machine (One), Mixers (One Bag), Conveyor (One), Siphon or Jet (One), Light Plant (One), Heater (One), Immobile Track Air (One), and Self Propelled Walk-Behind Rollers.

GROUP IV. Asphalt Spreader Oilers, Fireman on Whirlies and Heavy Equipment Oilers, Truck Cranes, Dredges, Monigans, Large Cranes - (Over 65-ton rated capacity) Concrete Plant Oiler, Blacktop Plant Oiler, and Creter Crane Oiler (when required).

GROUP V. Oiler.

GROUP VI. Operators on equipment with Booms, including jibs, 100 feet and over, and less than 150 feet long.

GROUP VII. Operators on equipment with Booms, including jibs, 150 feet and over, and less than 200 feet long.

GROUP VIII. Operators on Equipment with Booms, including jibs, 200 feet and over; Tower Cranes; and Whirlie Cranes.

GROUP IX. Mechanic

SURVEY WORKER - Operated survey equipment including data collectors, G.P.S. and robotic instruments, as well as conventional levels and transits.

TRUCK DRIVER - BUILDING, HEAVY AND HIGHWAY CONSTRUCTION

Class 1. Drivers on 2 axle trucks hauling less than 9 ton. Air compressor and welding machines and brooms, including those pulled by separate units, truck driver helpers, warehouse employees, mechanic helpers, greasers and tiremen, pickup trucks when hauling materials,

tools, or workers to and from and on-the-job site, and fork lifts up to 6,000 lb. capacity.

Class 2. Two or three axle trucks hauling more than 9 ton but hauling less than 16 ton. A-frame winch trucks, hydrolift trucks, vactor trucks or similar equipment when used for transportation purposes. Fork lifts over 6,000 lb. capacity, winch trucks, four axle combination units, and ticket writers.

Class 3. Two, three or four axle trucks hauling 16 ton or more. Drivers on water pulls, articulated dump trucks, mechanics and working forepersons, and dispatchers. Five axle or more combination units.

Class 4. Low Boy and Oil Distributors.

Class 5. Drivers who require special protective clothing while employed on hazardous waste work.

TRUCK DRIVER - OIL AND CHIP RESEALING ONLY.

This shall encompass laborers, workers and mechanics who drive contractor or subcontractor owned, leased, or hired pickup, dump, service, or oil distributor trucks. The work includes transporting materials and equipment (including but not limited to, oils, aggregate supplies, parts, machinery and tools) to or from the job site; distributing oil or liquid asphalt and aggregate; stock piling material when in connection with the actual oil and chip contract. The Truck Driver (Oil & Chip Resealing) wage classification does not include supplier delivered materials.

#### TERRAZZO FINISHER

The handling of all materials used for Mosaic and Terrazzo work including preparing, mixing by hand, by mixing machine or transporting of pre-mixed materials and distributing with shovel, rake, hoe, or pail, all kinds of concrete foundations necessary for Mosaic and Terrazzo work, all cement terrazzo, magnesite terrazzo, Do-O-Tex terrazzo, epoxy matrix ter-razzo, exposed aggregate, rustic or rough washed for exterior or interior of buildings placed either by machine or by hand, and any other kind of mixture of plastics composed of chips or granules when mixed with cement, rubber, neoprene, vinyl, magnesium chloride or any other resinous or chemical substances used for seamless flooring systems, and all other building materials, all similar materials and all precast terrazzo work on jobs, all scratch coat used for Mosaic and Terrazzo work and sub-bed, tar paper and wire mesh (2x2 etc.) or lath. The rubbing, grinding, cleaning and finishing of same either by hand or by machine or by terrazzo resurfacing equipment on new or existing floors. When necessary finishers shall be allowed to assist the mechanics to spread sand bed, lay tarpaper and wire mesh (2x2 etc.) or lath. The finishing of cement floors where additional aggregate of stone is added by spreading or sprinkling on top of the finished base, and troweled or rolled into the finish and then the surface is ground by grinding machines.

#### Other Classifications of Work:

For definitions of classifications not otherwise set out, the Department generally has on file such definitions which are available. If a task to be performed is not subject to one of the classifications of pay set out, the Department will upon being

contacted state which neighboring county has such a classification and provide such rate, such rate being deemed to exist by reference in this document. If no neighboring county rate applies to the task, the Department shall undertake a special determination, such special determination being then deemed to have existed under this determination. If a project requires these, or any classification not listed, please contact IDOL at 217-782-1710 for wage rates or clarifications.

#### LANDSCAPING

Landscaping work falls under the existing classifications for laborer, operating engineer and truck driver. The work performed by landscape plantsman and landscape laborer is covered by the existing classification of laborer. The work performed by landscape operators (regardless of equipment used or its size) is covered by the classifications of operating engineer. The work performed by landscape truck drivers (regardless of size of truck driven) is covered by the classifications of truck driver.

# Washington County Prevailing Wage for May 2014

(See explanation of column headings at bottom of wages)

Trade Name	RG	TYP	C	Base	FRMAN	M-F>8	OSA	OSH	H/W	Pensn	Vac	Trng
=====	==	===	=	=====	=====	=====	===	===	=====	=====	=====	=====
ASBESTOS ABT-GEN		ALL		28.420	28.920	1.5	1.5	2.0	5.850	13.33	0.000	0.800
ASBESTOS ABT-MEC		BLD		30.360	31.360	1.5	1.5	2.0	7.450	3.000	0.000	0.000
BOILERMAKER		BLD		32.060	34.560	1.5	1.5	2.0	7.070	21.27	1.000	0.350
BRICK MASON		BLD		29.640	33.540	1.5	1.5	2.0	8.000	10.09	2.000	0.400
CARPENTER		ALL		34.970	36.470	1.5	1.5	2.0	6.800	7.250	0.000	0.400
CEMENT MASON		BLD		29.050	30.550	1.5	1.5	2.0	7.200	6.400	0.000	0.500
CEMENT MASON		HWY		35.150	35.650	1.5	1.5	2.0	7.100	11.00	0.000	0.700
CERAMIC TILE FNSHER		BLD		25.890	0.000	1.5	1.5	2.0	6.400	5.450	0.000	0.580
ELECTRIC PWR EQMT OP		ALL	1	36.770	0.000	1.5	1.5	2.0	5.760	10.29	0.000	0.370
ELECTRIC PWR EQMT OP		ALL	2	32.820	0.000	1.5	1.5	2.0	5.760	9.190	0.000	0.330
ELECTRIC PWR GRNDMAN		ALL		27.020	0.000	1.5	1.5	2.0	5.760	7.570	0.000	0.270
ELECTRIC PWR LINEMAN		ALL		46.100	49.220	1.5	1.5	2.0	5.800	12.91	0.000	0.440
ELECTRICIAN		NW	ALL	37.350	39.590	1.5	1.5	2.0	7.990	9.720	0.000	0.650
ELECTRICIAN		SE	ALL	40.300	42.550	1.5	1.5	2.0	6.410	10.08	0.000	0.800
ELECTRONIC SYS TECH		BLD		32.570	34.320	1.5	1.5	2.0	6.250	4.210	0.000	0.400
ELEVATOR CONSTRUCTOR		BLD		44.370	49.920	2.0	2.0	2.0	12.73	13.46	3.550	0.600
FLOOR LAYER		BLD		29.580	30.330	1.5	1.5	2.0	6.800	7.250	0.000	0.400
GLAZIER		BLD		32.780	0.000	2.0	2.0	2.0	9.020	10.80	2.630	0.310
HT/FROST INSULATOR		BLD		37.660	38.660	1.5	1.5	2.0	8.350	11.26	0.000	0.500
IRON WORKER		ALL		31.000	33.000	1.5	1.5	2.0	7.110	12.35	0.000	0.420
LABORER		ALL		27.920	28.420	1.5	1.5	2.0	5.850	13.33	0.000	0.800
MACHINIST		BLD		43.920	46.420	1.5	1.5	2.0	6.760	8.950	1.850	0.000
MARBLE FINISHERS		BLD		25.890	0.000	1.5	1.5	2.0	6.400	5.450	0.000	0.580
MARBLE MASON		BLD		29.640	33.540	1.5	1.5	2.0	8.000	10.09	2.000	0.400
MILLWRIGHT		ALL		34.970	36.470	1.5	1.5	2.0	6.800	7.250	0.000	0.400
OPERATING ENGINEER		BLD	1	34.700	37.700	1.5	1.5	2.0	10.00	17.20	0.000	1.000
OPERATING ENGINEER		BLD	2	33.570	37.700	1.5	1.5	2.0	10.00	17.20	0.000	1.000
OPERATING ENGINEER		BLD	3	29.090	37.700	1.5	1.5	2.0	10.00	17.20	0.000	1.000
OPERATING ENGINEER		BLD	4	29.150	37.700	1.5	1.5	2.0	10.00	17.20	0.000	1.000
OPERATING ENGINEER		BLD	5	28.820	37.700	1.5	1.5	2.0	10.00	17.20	0.000	1.000
OPERATING ENGINEER		BLD	6	36.250	37.700	1.5	1.5	2.0	10.00	17.20	0.000	1.000
OPERATING ENGINEER		BLD	7	36.550	37.700	1.5	1.5	2.0	10.00	17.20	0.000	1.000
OPERATING ENGINEER		BLD	8	36.830	37.700	1.5	1.5	2.0	10.00	17.20	0.000	1.000
OPERATING ENGINEER		BLD	9	35.700	37.700	1.5	1.5	2.0	10.00	17.20	0.000	1.000
OPERATING ENGINEER		HWY	1	33.200	36.200	1.5	1.5	2.0	10.00	17.20	0.000	1.000
OPERATING ENGINEER		HWY	2	32.070	36.200	1.5	1.5	2.0	10.00	17.20	0.000	1.000
OPERATING ENGINEER		HWY	3	27.590	36.200	1.5	1.5	2.0	10.00	17.20	0.000	1.000
OPERATING ENGINEER		HWY	4	27.650	36.200	1.5	1.5	2.0	10.00	17.20	0.000	1.000
OPERATING ENGINEER		HWY	5	27.320	36.200	1.5	1.5	2.0	10.00	17.20	0.000	1.000
OPERATING ENGINEER		HWY	6	34.750	36.200	1.5	1.5	2.0	10.00	17.20	0.000	1.000
OPERATING ENGINEER		HWY	7	35.050	36.200	1.5	1.5	2.0	10.00	17.20	0.000	1.000
OPERATING ENGINEER		HWY	8	35.330	36.200	1.5	1.5	2.0	10.00	17.20	0.000	1.000
OPERATING ENGINEER		HWY	9	34.200	36.200	1.5	1.5	2.0	10.00	17.20	0.000	1.000
PAINTER		BLD		29.250	30.750	1.5	2.0	2.0	5.250	9.170	0.000	0.650
PAINTER		HWY		30.450	31.950	1.5	1.5	2.0	5.250	9.170	0.000	0.650
PAINTER OVER 30FT		BLD		30.250	31.750	1.5	2.0	2.0	5.250	9.170	0.000	0.650
PAINTER PWR EQMT		BLD		30.250	31.750	1.5	2.0	2.0	5.250	9.170	0.000	0.650
PAINTER PWR EQMT		HWY		31.450	32.950	1.5	1.5	2.0	5.250	9.170	0.000	0.650
PILEDRIVER		ALL		34.970	36.470	1.5	1.5	2.0	6.800	7.250	0.000	0.400
PIPEFITTER		E	BLD	35.450	39.000	1.5	1.5	2.0	6.200	7.000	0.000	0.900
PIPEFITTER		W	BLD	36.500	39.000	1.5	1.5	2.0	8.150	5.600	0.000	0.580
PLASTERER		BLD		29.050	30.550	1.5	1.5	2.0	7.200	6.400	0.000	0.500
PLUMBER		E	BLD	35.450	39.000	1.5	1.5	2.0	6.200	7.000	0.000	0.900
PLUMBER		W	BLD	36.500	39.000	1.5	1.5	2.0	8.150	5.600	0.000	0.580
ROOFER		BLD		30.100	32.100	1.5	1.5	2.0	8.800	7.100	0.000	0.240
SHEETMETAL WORKER		ALL		32.250	33.750	1.5	1.5	2.0	8.330	7.320	1.940	0.360

SPRINKLER FITTER	BLD	40.030	43.030	2.0	2.0	2.0	8.370	11.18	0.000	1.250
SURVEY WORKER	ALL	27.620	28.120	1.5	1.5	2.0	5.750	12.58	0.000	0.800
TERRAZZO FINISHER	BLD	31.240	0.000	1.5	1.5	2.0	6.400	3.800	0.000	0.270
TERRAZZO MASON	BLD	32.530	32.830	1.5	1.5	2.0	6.400	5.550	0.000	0.290
TRUCK DRIVER	ALL 1	31.340	0.000	1.5	1.5	2.0	10.30	5.010	0.000	0.250
TRUCK DRIVER	ALL 2	31.780	0.000	1.5	1.5	2.0	10.30	5.010	0.000	0.250
TRUCK DRIVER	ALL 3	32.020	0.000	1.5	1.5	2.0	10.30	5.010	0.000	0.250
TRUCK DRIVER	ALL 4	32.280	0.000	1.5	1.5	2.0	10.30	5.010	0.000	0.250
TRUCK DRIVER	ALL 5	33.130	0.000	1.5	1.5	2.0	10.30	5.010	0.000	0.250
TRUCK DRIVER	O&C 1	25.070	0.000	1.5	1.5	2.0	10.30	5.010	0.000	0.250
TRUCK DRIVER	O&C 2	25.420	0.000	1.5	1.5	2.0	10.30	5.010	0.000	0.250
TRUCK DRIVER	O&C 3	25.620	0.000	1.5	1.5	2.0	10.30	5.010	0.000	0.250
TRUCK DRIVER	O&C 4	25.820	0.000	1.5	1.5	2.0	10.30	5.010	0.000	0.250
TRUCK DRIVER	O&C 5	26.500	0.000	1.5	1.5	2.0	10.30	5.010	0.000	0.250

**Legend:** RG (Region)

TYP (Trade Type - All,Highway,Building,Floating,Oil & Chip,Rivers)

C (Class)

Base (Base Wage Rate)

FRMAN (Foreman Rate)

M-F>8 (OT required for any hour greater than 8 worked each day, Mon through Fri.)

OSA (Overtime (OT) is required for every hour worked on Saturday)

OSH (Overtime is required for every hour worked on Sunday and Holidays)

H/W (Health & Welfare Insurance)

Pensn (Pension)

Vac (Vacation)

Trng (Training)

## Explanations

### WASHINGTON COUNTY

ELECTRICIANS (NORTHWEST) - Township of Venedy.

PLUMBERS & PIPEFITTERS (WEST) - That part of the county West of a line 2.5 miles East of Rt. 127 including the towns of Posin, Beacoup and New Minden.

PLUMBERS & PIPEFITTERS (EAST) - That part of the county East of a North-South line 2.5 miles East of Rt. 127.

The following list is considered as those days for which holiday rates of wages for work performed apply: New Years Day, Memorial Day, Fourth of July, Labor Day, Thanksgiving Day, Christmas Day and Veterans Day in some classifications/counties. Generally, any of these holidays which fall on a Sunday is celebrated on the following

Monday. This then makes work performed on that Monday payable at the appropriate overtime rate for holiday pay. Common practice in a given local may alter certain days of celebration. If in doubt, please check with IDOL.

Oil and chip resealing (O&C) means the application of road oils and liquid asphalt to coat an existing road surface, followed by application of aggregate chips or gravel to coated surface, and subsequent rolling of material to seal the surface.

#### EXPLANATION OF CLASSES

ASBESTOS - GENERAL - removal of asbestos material/mold and hazardous materials from any place in a building, including mechanical systems where those mechanical systems are to be removed. This includes the removal of asbestos materials/mold and hazardous materials from ductwork or pipes in a building when the building is to be demolished at the time or at some close future date.

ASBESTOS - MECHANICAL - removal of asbestos material from mechanical systems, such as pipes, ducts, and boilers, where the mechanical systems are to remain.

#### CERAMIC TILE FINISHER AND MARBLE FINISHER

The handling, at the building site, of all sand, cement, tile, marble or stone and all other materials that may be used and installed by [a] tile layer or marble mason. In addition, the grouting, cleaning, sealing, and mixing on the job site, and all other work as required in assisting the setter. The term "Ceramic" is used for naming the classification only and is in no way a limitation of the product handled. Ceramic takes into consideration most hard tiles.

#### ELECTRONIC SYSTEMS TECHNICIAN

Installation, service and maintenance of low-voltage systems which utilizes the transmission and/or transference of voice, sound, vision, or digital for commercial, education, security and entertainment purposes for the following: TV monitoring and surveillance, background/foreground music, intercom and telephone interconnect, field programming, inventory control systems, microwave transmission, multi-media, multiplex, radio page, school, intercom and sound burglar alarms and low voltage master clock systems.

Excluded from this classification are energy management systems, life safety systems, supervisory controls and data acquisition systems not intrinsic with the above listed systems, fire alarm systems, nurse call systems and raceways exceeding fifteen feet in length.

#### OPERATING ENGINEER - BUILDING

GROUP I. Cranes, Dragline, Shovels, Skimmer Scoops, Clamshells or Derrick Boats, Pile Drivers, Crane-Type Backhoes, Asphalt Plant Operators, Concrete Plant Operators, Dredges, Asphalt Spreading Machines, All Locomotives, Cable Ways or Tower Machines, Hoists, Hydraulic Backhoes, Ditching Machines or Backfiller, Cherrypickers, Overhead Cranes, Roller - Steam or Gas, Concrete Pavers, Excavators, Concrete Breakers, Concrete Pumps, Bulk Cement Plants, Cement Pumps, Derrick-Type Drills, Boat Operators, Motor Graders or Pushcats, Scoops or Tournapulls, Bulldozers, Endloaders or Fork Lifts, Power Blade or Elevating Graders, Winch Cats, Boom or Winch Trucks or Boom Tractors, Pipe Wrapping or Painting Machines, Asphalt Plant Engineer, Journeyman Lubricating Engineer, Drills (other than Derrick Type), Mud Jacks, or

Well Drilling Machines, Boring Machines or Track Jacks, Mixers, Conveyors (Two), Air Compressors (Two), Water Pumps regardless of size (Two), Welding Machines (Two), Siphons or Jets (Two), Winch Heads or Apparatuses (Two), Light Plants (Two), All Tractors regardless of size (straight tractor only), Fireman on Stationary Boilers, Automatic Elevators, Form Grading Machines, Finishing Machines, Power Sub-Grader or Ribbon Machines, Longitudinal Floats, Distributor Operators on Trucks, Winch Heads or Apparatuses (One), Mobil Track air and heaters (two to five), Heavy Equipment Greaser, Relief Operator, Assistant Master Mechanic and Heavy Duty Mechanic, self-propelled concrete saws of all types and sizes with their attachments, gob-hoppers, excavators all sizes, the repair and greasing of all diesel hammers, the operation and set-up of bidwells, water blasters of all sizes and their clutches, hydraulic jacks where used for hoisting, operation of log skidders, iceolators used on and off of pipeline, condor cranes, bow boats, survey boats, bobcats and all their attachments, skid steer loaders and all their attachments, creter cranes, batch plants, operator (all sizes), self propelled roto mills, operation of conveyor systems of any size and any configuration, operation, repair and service of all vibratory hammers, all power pacs and their controls regardless of location, curtains or brush burning machines, stump cutter machines, Nail launchers when mounted on a machine or self-propelled, operation of con-cover machines, and all Operators except those listed below).

GROUP II. Assistant Operators.

GROUP III. Air Compressors (One), Water Pumps, regardless of Size (One), Waterblasters (one), Welding Machine (One), Mixers (One Bag), Conveyor (One), Siphon or Jet (One), Light Plant (One), Heater (One), Immobile Track Air (One), and Self Propelled Walk-Behind Rollers.

GROUP IV. Asphalt Spreader Oilers, Fireman on Whirlies and Heavy Equipment Oilers, Truck Cranes, Dredges, Monigans, Large Cranes - (Over 65-ton rated capacity) Concrete Plant Oiler, Blacktop Plant Oiler, and Creter Crane Oiler (when required).

GROUP V. Oiler.

GROUP VI. Operators on equipment with Booms, including jibs, 100 feet and over, and less than 150 feet long.

GROUP VII. Operators on equipment with Booms, including jibs, 150 feet and over, and less than 200 feet long.

GROUP VIII. Operators on Equipment with Booms, including jibs, 200 feet and over; Tower Cranes; and Whirlie Cranes.

GROUP IX. Master Mechanic

OPERATING ENGINEERS - Highway

GROUP I. Cranes, Dragline, Shovels, Skimmer Scoops, Clamshells or Derrick Boats, Pile Drivers, Crane-Type Backhoes, Asphalt Plant Operators, Concrete Plant Operators, Dredges, Asphalt Spreading Machines, All Locomotives, Cable Ways or Tower Machines, Hoists, Hydraulic Backhoes, Ditching Machines or Backfiller, Cherrypickers, Overhead Cranes, Roller - Steam or Gas, Concrete Pavers, Excavators, Concrete Breakers, Concrete Pumps, Bulk Cement Plants, Cement Pumps, Derrick-Type Drills, Boat Operators, Motor Graders or Pushcats, Scoops or Tournapulls, Bulldozers, Endloaders or Fork Lifts, Power Blade or Elevating Graders, Winch Cats, Boom or Winch Trucks or Boom Tractors, Pipe Wrapping or Painting Machines, Asphalt Plant Engineer, Journeyman

Lubricating Engineer, Drills (other than Derrick Type), Mud Jacks, Well Drilling Machines, Boring Machines, Track Jacks, Mixers, Conveyors (Two), Air Compressors (Two), Water Pumps regardless of size (Two), Welding Machines (Two), Siphons or Jets (Two), Winch Heads or Apparatuses (Two), Light Plants (Two), All Tractors regardless of size (straight tractor only), Fireman on Stationary Boilers, Automatic Elevators, Form Grading Machines, Finishing Machines, Power Sub-Grader or Ribbon Machines, Longitudinal Floats, Distributor Operators on Trucks, Winch Heads or Apparatuses (One), Mobil Track air and heaters (two to five), Heavy Equipment Greaser, Relief Operator, Assistant Master Mechanic and Heavy Duty Mechanic, self-propelled concrete saws of all types and sizes with their attachments, gob-hoppers, excavators all sizes, the repair and greasing of all diesel hammers, the operation and set-up of bidwells, water blasters of all sizes and their clutches, hydraulic jacks where used for hoisting, operation of log skidders, iceolators used on and off of pipeline, condor cranes, bow boats, survey boats, bobcats and all their attachments, skid steer loaders and all their attachments, creter cranes, batch plants, operator (all sizes), self propelled roto mills, operation of conveyor systems of any size and any configuration, operation, repair and service of all vibratory hammers, all power pacs and their controls regardless of location, curtains or brush burning machines, stump cutter machines, Nail launchers when mounted on a machine or self-propelled, operation of con-cover machines, and all Operators (except those listed below).

GROUP II. Assistant Operators.

GROUP III. Air Compressors (One), Water Pumps, regardless of Size (One), Waterblasters (one), Welding Machine (One), Mixers (One Bag), Conveyor (One), Siphon or Jet (One), Light Plant (One), Heater (One), Immobile Track Air (One), and Self Propelled Walk-Behind Rollers.

GROUP IV. Asphalt Spreader Oilers, Fireman on Whirlies and Heavy Equipment Oilers, Truck Cranes, Dredges, Monigans, Large Cranes - (Over 65-ton rated capacity) Concrete Plant Oiler, Blacktop Plant Oiler, and Creter Crane Oiler (when required).

GROUP V. Oiler.

GROUP VI. Operators on equipment with Booms, including jibs, 100 feet and over, and less than 150 feet long.

GROUP VII. Operators on equipment with Booms, including jibs, 150 feet and over, and less than 200 feet long.

GROUP VIII. Operators on Equipment with Booms, including jibs, 200 feet and over; Tower Cranes; and Whirlie Cranes.

GROUP IX. Mechanic

SURVEY WORKER - Operated survey equipment including data collectors, G.P.S. and robotic instruments, as well as conventional levels and transits.

TRUCK DRIVER - BUILDING, HEAVY AND HIGHWAY CONSTRUCTION

Class 1. Drivers on 2 axle trucks hauling less than 9 ton. Air compressor and welding machines and brooms, including those pulled by separate units, truck driver helpers, warehouse employees, mechanic helpers, greasers and tiremen, pickup trucks when hauling materials, tools, or workers to and from and on-the-job site, and fork lifts up to 6,000 lb. capacity.



Class 2. Two or three axle trucks hauling more than 9 ton but hauling less than 16 ton. A-frame winch trucks, hydrolift trucks, vactor trucks or similar equipment when used for transportation purposes. Fork lifts over 6,000 lb. capacity, winch trucks, four axle combination units, and ticket writers.

Class 3. Two, three or four axle trucks hauling 16 ton or more. Drivers on water pulls, articulated dump trucks, mechanics and working forepersons, and dispatchers. Five axle or more combination units.

Class 4. Low Boy and Oil Distributors.

Class 5. Drivers who require special protective clothing while employed on hazardous waste work. Jurisdiction in Bond, Calhoun, Clinton, Fayette, Greene, Jefferson, Jersey, Macoupin, Madison, Marion, Monroe, Montgomery, Perry, Randolph, St. Clair, and Washington.

TRUCK DRIVER - OIL AND CHIP RESEALING ONLY.

This shall encompass laborers, workers and mechanics who drive contractor or subcontractor owned, leased, or hired pickup, dump, service, or oil distributor trucks. The work includes transporting materials and equipment (including but not limited to, oils, aggregate supplies, parts, machinery and tools) to or from the job site; distributing oil or liquid asphalt and aggregate; stock piling material when in connection with the actual oil and chip contract. The Truck Driver (Oil & Chip Resealing) wage classification does not include supplier delivered materials.

TERRAZZO FINISHER

The handling of all materials used for Mosaic and Terrazzo work including preparing, mixing by hand, by mixing machine or transporting of pre-mixed materials and distributing with shovel, rake, hoe, or pail, all kinds of concrete foundations necessary for Mosaic and Terrazzo work, all cement terrazzo, magnesite terrazzo, Do-O-Tex terrazzo, epoxy matrix ter-razzo, exposed aggregate, rustic or rough washed for exterior or interior of buildings placed either by machine or by hand, and any other kind of mixture of plastics composed of chips or granules when mixed with cement, rubber, neoprene, vinyl, magnesium chloride or any other resinous or chemical substances used for seamless flooring systems, and all other building materials, all similar materials and all precast terrazzo work on jobs, all scratch coat used for Mosaic and Terrazzo work and sub-bed, tar paper and wire mesh (2x2 etc.) or lath. The rubbing, grinding, cleaning and finishing of same either by hand or by machine or by terrazzo resurfacing equipment on new or existing floors. When necessary finishers shall be allowed to assist the mechanics to spread sand bed, lay tarpaper and wire mesh (2x2 etc.) or lath. The finishing of cement floors where additional aggregate of stone is added by spreading or sprinkling on top of the finished base, and troweled or rolled into the finish and then the surface is ground by grinding machines.

Other Classifications of Work:

For definitions of classifications not otherwise set out, the Department generally has on file such definitions which are available. If a task to be performed is not subject to one of the

classifications of pay set out, the Department will upon being contacted state which neighboring county has such a classification and provide such rate, such rate being deemed to exist by reference in this document. If no neighboring county rate applies to the task, the Department shall undertake a special determination, such special determination being then deemed to have existed under this determination. If a project requires these, or any classification not listed, please contact IDOL at 217-782-1710 for wage rates or clarifications.

#### LANDSCAPING

Landscaping work falls under the existing classifications for laborer, operating engineer and truck driver. The work performed by landscape plantsman and landscape laborer is covered by the existing classification of laborer. The work performed by landscape operators (regardless of equipment used or its size) is covered by the classifications of operating engineer. The work performed by landscape truck drivers (regardless of size of truck driven) is covered by the classifications of truck driver.