

RETURN WITH BID

State of _____)
) ss.
County of _____)

AFFIDAVIT

_____, of _____,
(name of affiant) *(bidder)*

being first duly sworn upon oath, states as follows:

1. That I am the _____ of _____
(Officer or position) *(Bidder)*
and have personal knowledge of the facts herein stated.
2. That, if selected under this bid proposal, _____ will
(Bidder)
maintain a business office in the State of Illinois which will be located in _____
County, Illinois.
3. That this business office will serve as the primary place of employment for any persons
employed in the construction contemplated by this bid proposal.
4. That this Affidavit is given as a requirement of state law as provided in Section 30-22(8) of
the Illinois Procurement Code.

(Signature)

(Printed name of Affiant)

This instrument was signed and attested before me on the _____ day of _____, 20 ____

by _____.
(Notary Public Name)

(Notary Public Signature)

(NOTARY SEAL)

BID PROPOSAL INSTRUCTIONS

ABOUT IDOT PROPOSALS: All proposals are potential bidding proposals. Each proposal contains all certifications and affidavits, a proposal signature sheet and a proposal bid bond.

PREQUALIFICATION

Any contractor who desires to become pre-qualified to bid on work advertised by IDOT must submit the properly completed pre-qualification forms to the Bureau of Construction no later than 4:30 p.m. prevailing time twenty-one days prior to the letting of interest. This pre-qualification requirement applies to first time contractors, contractors renewing expired ratings, contractors maintaining continuous pre-qualification or contractors requesting revised ratings. To be eligible to bid, existing pre-qualification ratings must be effective through the date of letting.

WHO CAN BID ?

Bids will be accepted from only those companies that request and receive written Authorization to Bid from IDOT's Central Bureau of Construction.

REQUESTS FOR AUTHORIZATION TO BID

Contractors wanting to bid on items included in a particular letting must submit the properly completed "Request for Authorization to Bid/or Not For Bid Status" (BDE 124) and the ORIGINAL "Affidavit of Availability" (BC 57) to the proper office no later than 4:30 p.m. prevailing time, three (3) days prior to the letting date.

WHAT CONSTITUTES WRITTEN AUTHORIZATION TO BID?

When a prospective prime bidder submits a "Request for Authorization to Bid/or Not For Bid Status"(BDE 124) he/she must indicate at that time which items are being requested For Bidding purposes. Only those items requested For Bidding will be analyzed. After the request has been analyzed, the bidder will be issued an **Authorization to Bid or Not for Bid Report**, approved by the Central Bureau of Construction and the Chief Procurement Officer that indicates which items have been approved For Bidding. If **Authorization to Bid** cannot be approved, the **Authorization to Bid or Not for Bid Report** will indicate the reason for denial.

ABOUT AUTHORIZATION TO BID

Firms that have not received an Authorization to Bid or Not For Bid Report within a reasonable time of complete and correct original document submittal should contact the Department as to the status. Firms unsure as to authorization status should call the Prequalification Section of the Bureau of Construction at the number listed at the end of these instructions.

ADDENDA AND REVISIONS

It is the bidder's responsibility to determine which, if any, addenda or revisions pertain to any project they may be bidding. Failure to incorporate all relevant addenda or revisions may cause the bid to be declared unacceptable.

Each addendum or revision will be included with the Electronic Plans and Proposals. Addenda and revisions will also be placed on the Addendum/Revision Checklist and each subscription service subscriber will be notified by e-mail of each addendum and revision issued.

The Internet is the Department's primary way of doing business. The subscription service emails are an added courtesy the Department provides. It is suggested that bidders check IDOT's website at <http://www.dot.il.gov/desenv/delett.html> before submitting final bid information.

IDOT IS NOT RESPONSIBLE FOR ANY E-MAIL FAILURES.

Addenda questions may be directed to the Contracts Office at (217)782-7806 or DOT.D&Econtracts@illinois.gov

Technical questions about downloading these files may be directed to Tim Garman at (217)524-1642 or Timothy.Garman@illinois.gov.

STANDARD GUIDELINES FOR SUBMITTING BIDS

- All pages should be single sided.
- Use the Cover Page that is provided in the Bid Proposal (posted on the IDOT Web Site) as the first page of your submitted bid. It has the item number in large bold type in the upper left-hand corner and lines provided for your company name and address in the upper right-hand corner.
- Do not use report covers, presentation folders or special bindings and do not staple multiple times on left side like a book. Use only 1 staple in the upper left hand corner. Make sure all elements of your bid are stapled together including the bid bond or guaranty check (if required).
- Do not include any certificates of eligibility, your authorization to bid, Addendum Letters or affidavit of availability.
- Do not include the Subcontractor Documentation with your bid (pages i – iii and pages a – g). This documentation is required only if you are awarded the project.
- Use the envelope cover sheet (provided with the proposal) as the cover for the proposal envelope.
- Do not rely on overnight services to deliver your proposal prior to 10 AM on letting day. It will not be read if it is delivered after 10 AM.
- Do not submit your Substance Abuse Prevention Program (SAPP) with your bid. If you are awarded the contract this form is to be submitted to the district engineer at the pre-construction conference.

BID SUBMITTAL CHECKLIST

- Cover page** (the sheet that has the item number on it) – This should be the first page of your bid proposal, **followed by your bid (the Schedule of Prices/Pay Items)**. If you are using special software or CBID to generate your schedule of prices, do not include the blank pages of the schedule of prices that came with the proposal package.
- Page 4 (Item 9)** – Check “YES” if you will use a subcontractor(s) with an annual value over \$50,000. Include the subcontractor(s) name, address, general type of work to be performed and the dollar amount. If you will use subcontractor(s) but are uncertain who or the dollar amount; check “YES” but leave the lines blank.
- After page 4** – Insert the following documents: The **Illinois Office Affidavit** (Not applicable to federally funded projects) followed by Cost Adjustments for Steel, Bituminous and Fuel (if applicable) and the Contractor Letter of Assent (if applicable). The general rule should be, if you don’t know where it goes, put it after page 4.
- Page 10 (Paragraph J)** – Check “YES” or “NO” whether your company has any business in Iran.
- Page 10 (Paragraph K)** – (Not applicable to federally funded projects) List the name of the apprenticeship and training program sponsor holding the certificate of registration from the US Department of Labor. If no applicable program exists, please indicate the work/job category **Your bid will not be read if this is not completed.** Do not include certificates with your bid. Keep the certificates in your office in case they are requested by IDOT.
- Page 11 (Paragraph L)** – A copy of your State Board of Elections certificate of registration is no longer required with your bid.
- Page 11 (Paragraph M)** – Indicate if your company has hired a lobbyist in connection with the job for which you are submitting the bid proposal.
- Page 12 (Paragraph C)** – This is a work sheet to determine if a completed Form A is required. It is not part of the form and you do not need to make copies for each completed Form A.
- Pages 14-17 (Form A)** – One Form A (4 pages) is required for each applicable person in your company. Copies of the forms can be used and only need to be changed when the information changes. The certification signature and date must be original for each letting. **Do not staple the forms together.** If you answered “NO” to all of the questions in Paragraph C (page 12), complete the first section (page 14) with your company information and then sign and date the Not Applicable statement on page 17.
- Page 18 (Form B)** - If you check “YES” to having other current or pending contracts it is acceptable to use the phrase, “See Affidavit of Availability on file”. **Ownership Certification** (at the bottom of the page) - Check N/A if the Form A(s) you submitted accounts for 100 percent of the company ownership. Check YES if any percentage of ownership falls outside of the parameters that require reporting on the Form A. Checking NO indicates that the Form A(s) you submitted is not correct and you will be required to submit a revised Form A.
- Page 20 (Workforce Projection)** – Be sure to include the Duration of the Project. It is acceptable to use the phrase “Per Contract Specifications”.

Proposal Bid Bond – (Insert after the proposal signature page) Submit your proposal Proposal Bid Bond (if applicable) using the current Proposal Bid Bond form provided in the proposal package. The Power of Attorney page should be stapled to the Proposal Bid Bond. If you are using an electronic bond, include your bid bond number on the Proposal Bid Bond and attach the Proof of Insurance printed from the Surety’s Web Site.

Disadvantaged Business Utilization Plan and/or Good Faith Effort – The last items in your bid should be the DBE Utilization Plan (SBE 2026), followed by the DBE Participation Statement (SBE 2025) and supporting paperwork. If you have documentation of a Good Faith Effort, it is to follow the SBE Forms.

The Bid Letting is now available in streaming Audio/Video from the IDOT Web Site. A link to the stream will be placed on the main page of the current letting on the day of the Letting. The stream will not begin until 10 AM. The actual reading of the bids does not begin until approximately 10:30 AM.

Following the Letting, the As-Read Tabulation of Bids will be posted by the end of the day. You will find the link on the main Web page for the current letting.

QUESTIONS: pre-letting up to execution of the contract

Contractor pre-qualification	217-782-3413
Small Business, Disadvantaged Business Enterprise (DBE)	217-785-4611
Contracts, Bids, Letting process or Internet downloads	217-782-7806
Estimates Unit.....	217-785-3483
Aeronautics.....	217-785-8515
IDNR (Land Reclamation, Water Resources, Natural Resources).....	217-782-6302

QUESTIONS: following contract execution

Subcontractor documentation, payments	217-782-3413
Railroad Insurance	217-785-0275

65

RETURN WITH BID

Proposal Submitted By
Name
Address
City

Letting June 13, 2014

NOTICE TO PROSPECTIVE BIDDERS

This proposal can be used for bidding purposes by only those companies that request and receive written **AUTHORIZATION TO BID** from IDOT's Central Bureau of Construction.

BIDDERS NEED NOT RETURN THE ENTIRE PROPOSAL

Notice to Bidders, Specifications, Proposal, Contract and Contract Bond



**Illinois Department
of Transportation**

Springfield, Illinois 62764

**Contract No. 64K05
WINNEBAGO County
Section (148CS)TS
Route FAP 303
District 2 Construction Funds**

PLEASE MARK THE APPROPRIATE BOX BELOW:

- A Bid Bond is included.
- A Cashier's Check or a Certified Check is included.
- An Annual Bid Bond is included or is on file with IDOT.

Plans Included
Herein

Prepared by

S

Checked by

(Printed by authority of the State of Illinois)

Page intentionally left blank

RETURN WITH BID



PROPOSAL

TO THE DEPARTMENT OF TRANSPORTATION

1. Proposal of _____

Taxpayer Identification Number (Mandatory) _____ a

For the improvement identified and advertised for bids in the Invitation for Bids as:

**Contract No. 64K05
WINNEBAGO County
Section (148CS)TS
Route FAP 303
District 2 Construction Funds**

Traffic control upgrade at five intersections along WB US Business Route 20 (Jefferson St.) in Rockford.

2. The undersigned bidder will furnish all labor, material and equipment to complete the above described project in a good and workmanlike manner as provided in the contract documents provided by the Department of Transportation. This proposal will become part of the contract and the terms and conditions contained in the contract documents will govern performance and payments.

RETURN WITH BID

6. **COMBINATION BIDS.** The undersigned bidder further agrees that if awarded the contract for the sections contained in the following combination, he/she will perform the work in accordance with the requirements of each individual contract comprising the combination bid specified in the schedule below, and that the combination bid shall be prorated against each section in proportion to the bid submitted for the same. If an error is found to exist in the gross sum bid for one or more of the individual sections included in a combination, the combination bid shall be corrected as provided in the specifications.

When a combination bid is submitted, the schedule below must be completed in each proposal comprising the combination.

If alternate bids are submitted for one or more of the sections comprising the combination, a combination bid must be submitted for each alternate.

Schedule of Combination Bids

Combination No.	Sections Included in Combination	Combination Bid	
		Dollars	Cents

7. **SCHEDULE OF PRICES.** The undersigned bidder submits herewith, in accordance with the rules and instructions, a schedule of prices for the items of work for which bids are sought. The unit prices bid are in U.S. dollars and cents, and all extensions and summations have been made. The bidder understands that the quantities appearing in the bid schedule are approximate and are provided for the purpose of obtaining a gross sum for the comparison of bids. If there is an error in the extension of the unit prices, the unit prices will govern. Payment to the contractor awarded the contract will be made only for actual quantities of work performed and accepted or materials furnished according to the contract. The scheduled quantities of work to be done and materials to be furnished may be increased, decreased or omitted as provided elsewhere in the contract.
8. **AUTHORITY TO DO BUSINESS IN ILLINOIS.** Section 20-43 of the Illinois Procurement Code (the Code) (30 ILCS 500/20-43) provides that a person (other than an individual acting as a sole proprietor) must be a legal entity authorized to do business in the State of Illinois prior to submitting the bid.
9. **EXECUTION OF CONTRACT:** The Department of Transportation will, in accordance with the rules governing Department procurements, execute the contract and shall be the sole entity having the authority to accept performance and make payments under the contract. Execution of the contract by the Chief Procurement Officer (CPO) or the State Purchasing Officer (SPO) is for approval of the procurement process and execution of the contract by the Department. Neither the CPO nor the SPO shall be responsible for administration of the contract or determinations respecting performance or payment there under except as otherwise permitted in the Code.

10. **The services of a subcontractor will be used.**

Check box Yes
 Check box No

For known subcontractors with subcontracts with an annual value of more than \$50,000, the contract shall include their name, address, general type of work to be performed, and the dollar allocation for each subcontractor.
 (30 ILCS 500/20-120)

ILLINOIS DEPARTMENT OF TRANSPORTATION
 SCHEDULE OF PRICES
 CONTRACT
 NUMBER -

64K05

State Job # - C-92-033-14

Project Number

Route

County Name - WINNEBAGO- -

FAP 303

Code - 201 - -

District - 2 - -

Section Number - (148CS)TS

Item Number	Pay Item Description	Unit of Measure	Quantity	x	Unit Price	=	Total Price
67100100	MOBILIZATION	L SUM	1.000				
70102622	TR CONT & PROT 701502	L SUM	1.000				
70102625	TR CONT & PROT 701606	L SUM	1.000				
70102630	TR CONT & PROT 701601	L SUM	1.000				
70102640	TR CONT & PROT 701801	L SUM	1.000				
85000300	MAIN EX TR SIG INSTAL	L SUM	1.000				
85700100	FAC T3 CAB	EACH	4.000				
87502480	TS POST GALVS 14	EACH	3.000				
88040070	SH P LED 1F 3S BM	EACH	12.000				
88040090	SH P LED 1F 3S MAM	EACH	15.000				
88102825	PED SH P LED 1F BM CT	EACH	32.000				
88200100	TS BACKPLATE	EACH	15.000				
88500100	INDUCTIVE LOOP DETECT	EACH	9.000				
89502375	REMOV EX TS EQUIP	EACH	5.000				

CONTRACT NUMBER

64K05

THIS IS THE TOTAL BID

\$ _____

NOTES:

1. Each PAY ITEM should have a UNIT PRICE and a TOTAL PRICE.
2. The UNIT PRICE shall govern if no TOTAL PRICE is shown or if there is a discrepancy between the product of the UNIT PRICE multiplied by the QUANTITY.
3. If a UNIT PRICE is omitted, the TOTAL PRICE will be divided by the QUANTITY in order to establish a UNIT PRICE.
4. A bid may be declared UNACCEPTABLE if neither a unit price nor a total price is shown.

RETURN WITH BID

STATE REQUIRED ETHICAL STANDARDS GOVERNING CONTRACT PROCUREMENT: ASSURANCES, CERTIFICATIONS AND DISCLOSURES

I. GENERAL

A. Article 50 of the Code establishes the duty of all State CPOs, SPOs, and their designees to maximize the value of the expenditure of public moneys in procuring goods, services, and contracts for the State of Illinois and to act in a manner that maintains the integrity and public trust of State government. In discharging this duty, they are charged by law to use all available information, reasonable efforts, and reasonable actions to protect, safeguard, and maintain the procurement process of the State of Illinois.

B. In order to comply with the provisions of Article 50 and to carry out the duty established therein, all bidders are to adhere to ethical standards established for the procurement process, and to make such assurances, disclosures and certifications required by law. Except as otherwise required in subsection III, paragraphs J-M, by execution of the Proposal Signature Sheet, the bidder indicates that each of the mandated assurances have been read and understood, that each certification is made and understood, and that each disclosure requirement has been understood and completed.

C. In addition to all other remedies provided by law, failure to comply with any assurance, failure to make any disclosure or the making of a false certification shall be grounds for the CPO to void the contract, and may result in the suspension or debarment of the bidder or subcontractor. If a false certification is made by a subcontractor the contractor's submitted bid and the executed contract may not be declared void unless the contractor refuses to terminate the subcontract upon the State's request after a finding that the subcontractor's certification was false.

I acknowledge, understand and accept these terms and conditions.

II. ASSURANCES

The assurances hereinafter made by the bidder are each a material representation of fact upon which reliance is placed should the Department enter into the contract with the bidder.

A. Conflicts of Interest

Section 50-13. Conflicts of Interest.

(a) Prohibition. It is unlawful for any person holding an elective office in this State, holding a seat in the General Assembly, or appointed to or employed in any of the offices or agencies of state government and who receives compensation for such employment in excess of 60% of the salary of the Governor of the State of Illinois, or who is an officer or employee of the Capital Development Board or the Illinois State Toll Highway Authority, or who is the spouse or minor child of any such person to have or acquire any contract, or any direct pecuniary interest in any contract therein, whether for stationery, printing, paper, or any services, materials, or supplies, that will be wholly or partially satisfied by the payment of funds appropriated by the General Assembly of the State of Illinois or in any contract of the Capital Development Board or the Illinois State Toll Highway Authority.

(b) Interests. It is unlawful for any firm, partnership, association or corporation, in which any person listed in subsection (a) is entitled to receive (i) more than 7 1/2% of the total distributable income or (ii) an amount in excess of the salary of the Governor, to have or acquire any such contract or direct pecuniary interest therein.

(c) Combined interests. It is unlawful for any firm, partnership, association, or corporation, in which any person listed in subsection (a) together with his or her spouse or minor children is entitled to receive (i) more than 15%, in the aggregate, of the total distributable income or (ii) an amount in excess of 2 times the salary of the Governor, to have or acquire any such contract or direct pecuniary interest therein.

(d) Securities. Nothing in this Section invalidates the provisions of any bond or other security previously offered or to be offered for sale or sold by or for the State of Illinois.

(e) Prior interests. This Section does not affect the validity of any contract made between the State and an officer or employee of the State or member of the General Assembly, his or her spouse, minor child or any combination of those persons if that contract was in existence before his or her election or employment as an officer, member, or employee. The contract is voidable, however, if it cannot be completed within 365 days after the officer, member, or employee takes office or is employed.

The current salary of the Governor is \$177,412.00. Sixty percent of the salary is \$106,447.20.

RETURN WITH BID

The bidder assures the Department that the award and execution of the contract would not cause a violation of Section 50-13, or that an effective exemption has been issued by the Board of Ethics to any individual subject to the Section 50-13 prohibitions pursuant to the provisions of Section 50-20 of the Code. Information concerning the exemption process is available from the Department upon request.

B. Negotiations

Section 50-15. Negotiations.

It is unlawful for any person employed in or on a continual contractual relationship with any of the offices or agencies of State government to participate in contract negotiations on behalf of that office or agency with any firm, partnership, association, or corporation with whom that person has a contract for future employment or is negotiating concerning possible future employment.

The bidder assures the Department that the award and execution of the contract would not cause a violation of Section 50-15, and that the bidder has no knowledge of any facts relevant to the kinds of acts prohibited therein.

C. Inducements

Section 50-25. Inducement.

Any person who offers or pays any money or other valuable thing to any person to induce him or her not to bid for a State contract or as recompense for not having bid on a State contract is guilty of a Class 4 felony. Any person who accepts any money or other valuable thing for not bidding for a State contract or who withholds a bid in consideration of the promise for the payment of money or other valuable thing is guilty of a Class 4 felony.

The bidder assures the Department that the award and execution of the contract would not cause a violation of Section 50-25, and that the bidder has no knowledge of any facts relevant to the kinds of acts prohibited therein.

D. Revolving Door Prohibition

Section 50-30. Revolving door prohibition.

CPOs, SPOs, procurement compliance monitors, their designees whose principal duties are directly related to State procurement, and executive officers confirmed by the Senate are expressly prohibited for a period of 2 years after terminating an affected position from engaging in any procurement activity relating to the State agency most recently employing them in an affected position for a period of at least 6 months. The prohibition includes, but is not limited to: lobbying the procurement process; specifying; bidding; proposing bid, proposal, or contract documents; on their own behalf or on behalf of any firm, partnership, association, or corporation. This Section applies only to persons who terminate an affected position on or after January 15, 1999.

The bidder assures the Department that the award and execution of the contract would not cause a violation of Section 50-30, and that the bidder has no knowledge of any facts relevant to the kinds of acts prohibited therein.

E. Reporting Anticompetitive Practices

Section 50-40. Reporting anticompetitive practices.

When, for any reason, any vendor, bidder, contractor, CPO, SPO, designee, elected official, or State employee suspects collusion or other anticompetitive practice among any bidders, offerors, contractors, proposers, or employees of the State, a notice of the relevant facts shall be transmitted to the Attorney General and the CPO.

The bidder assures the Department that it has not failed to report any relevant facts concerning the practices addressed in Section 50-40 which may involve the contract for which the bid is submitted.

F. Confidentiality

Section 50-45. Confidentiality.

Any CPO, SPO, designee, or executive officer who willfully uses or allows the use of specifications, competitive bid documents, proprietary competitive information, proposals, contracts, or selection information to compromise the fairness or integrity of the procurement, bidding, or contract process shall be subject to immediate dismissal, regardless of the Personnel code, any contract, or any collective bargaining agreement, and may in addition be subject to criminal prosecution.

The bidder assures the Department that it has no knowledge of any fact relevant to the practices addressed in Section 50-45 which may involve the contract for which the bid is submitted.

RETURN WITH BID

G. Insider Information

Section 50-50. Insider information.

It is unlawful for any current or former elected or appointed State official or State employee to knowingly use confidential information available only by virtue of that office or employment for actual or anticipated gain for themselves or another person.

The bidder assures the Department that it has no knowledge of any facts relevant to the practices addressed in Section 50-50 which may involve the contract for which the bid is submitted.

I acknowledge, understand and accept these terms and conditions for the above assurances.

III. CERTIFICATIONS

The certifications hereinafter made by the bidder are each a material representation of fact upon which reliance is placed should the Department enter into the contract with the bidder. Section 50-2 of the Code provides that every person that has entered into a multi-year contract and every subcontractor with a multi-year subcontract shall certify, by July 1 of each fiscal year covered by the contract after the initial fiscal year, to the responsible CPO whether it continues to satisfy the requirements of Article 50 pertaining to the eligibility for a contract award. If a contractor or subcontractor is not able to truthfully certify that it continues to meet all requirements, it shall provide with its certification a detailed explanation of the circumstances leading to the change in certification status. A contractor or subcontractor that makes a false statement material to any given certification required under Article 50 is, in addition to any other penalties or consequences prescribed by law, subject to liability under the Whistleblower Reward and Protection Act for submission of a false claim.

A. Bribery

Section 50-5. Bribery.

(a) Prohibition. No person or business shall be awarded a contract or subcontract under this Code who:

(1) has been convicted under the laws of Illinois or any other state of bribery or attempting to bribe an officer or employee of the State of Illinois or any other state in that officer's or employee's official capacity; or

(2) has made an admission of guilt of that conduct that is a matter of record but has not been prosecuted for that conduct.

(b) Businesses. No business shall be barred from contracting with any unit of State or local government, or subcontracting under such a contract, as a result of a conviction under this Section of any employee or agent of the business if the employee or agent is no longer employed by the business and:

(1) the business has been finally adjudicated not guilty; or

(2) the business demonstrates to the governmental entity with which it seeks to contract, or which is signatory to the contract which the subcontract relates, and that entity finds that the commission of the offense was not authorized, requested, commanded, or performed by a director, officer, or high managerial agent on behalf of the business as provided in paragraph (2) of subsection (a) of Section 5-4 of the Criminal Code of 2012.

(c) Conduct on behalf of business. For purposes of this Section, when an official, agent, or employee of a business committed the bribery or attempted bribery on behalf of the business and in accordance with the direction or authorization of a responsible official of the business, the business shall be chargeable with the conduct.

(d) Certification. Every bid submitted to and contract executed by the State, and every subcontract subject to Section 20-120 of the Code shall contain a certification by the contractor or the subcontractor, respectively, that the contractor or subcontractor is not barred from being awarded a contract or subcontract under this Section and acknowledges that the CPO may declare the related contract void if any certifications required by this Section are false. A contractor who makes a false statement, material to the certification, commits a Class 3 felony.

The contractor or subcontractor certifies that it is not barred from being awarded a contract under Section 50.5.

B. Felons

Section 50-10. Felons.

(a) Unless otherwise provided, no person or business convicted of a felony shall do business with the State of Illinois or any State agency, or enter into a subcontract, from the date of conviction until 5 years after the date of completion of the sentence for that felony, unless no person held responsible by a prosecutorial office for the facts upon which the conviction was based continues to have any involvement with the business.

(b) Certification. Every bid submitted to and contract executed by the State and every subcontract subject to Section 20-120 of the Code shall contain a certification by the bidder or contractor or subcontractor, respectively, that the bidder, contractor, or subcontractor is not barred from being awarded a contract or subcontract under this Section and acknowledges that the CPO may declare the related contract void if any of the certifications required by this Section are false.

RETURN WITH BID

C. Debt Delinquency

Section 50-11 and 50-12. Debt Delinquency.

The contractor or bidder or subcontractor, respectively, certifies that it, or any affiliate, is not barred from being awarded a contract or subcontract under the Code. Section 50-11 prohibits a person from entering into a contract with a State agency, or entering into a subcontract, if it knows or should know that it, or any affiliate, is delinquent in the payment of any debt to the State as defined by the Debt Collection Board. Section 50-12 prohibits a person from entering into a contract with a State agency, or entering into a subcontract, if it, or any affiliate, has failed to collect and remit Illinois Use Tax on all sales of tangible personal property into the State of Illinois in accordance with the provisions of the Illinois Use Tax Act. The bidder or contractor or subcontractor, respectively, further acknowledges that the CPO may declare the related contract void if this certification is false or if the bidder, contractor, or subcontractor, or any affiliate, is determined to be delinquent in the payment of any debt to the State during the term of the contract.

D. Prohibited Bidders, Contractors and Subcontractors

Section 50-10.5 and 50-60(c). Prohibited bidders, contractors and subcontractors.

The bidder or contractor or subcontractor, respectively, certifies in accordance with 30 ILCS 500/50-10.5 that no officer, director, partner or other managerial agent of the contracting business has been convicted of a felony under the Sarbanes-Oxley Act of 2002 or a Class 3 or Class 2 felony under the Illinois Securities Law of 1953 or if in violation of Subsection (c) for a period of five years from the date of conviction. Every bid submitted to and contract executed by the State and every subcontract subject to Section 20-120 of the Code shall contain a certification by the bidder, contractor, or subcontractor, respectively, that the bidder, contractor, or subcontractor is not barred from being awarded a contract or subcontract under this Section and acknowledges that the CPO shall declare the related contract void if any of the certifications completed pursuant to this Section are false.

E. Section 42 of the Environmental Protection Act

The bidder or contractor or subcontractor, respectively, certifies in accordance with 30 ILCS 500/50-14 that the bidder, contractor, or subcontractor, is not barred from being awarded a contract or entering into a subcontract under this Section which prohibits the bidding on or entering into contracts with the State of Illinois or a State agency, or entering into any subcontract, that is subject to the Code by a person or business found by a court or the Pollution Control Board to have committed a willful or knowing violation of Section 42 of the Environmental Protection Act for a period of five years from the date of the order. The bidder or contractor or subcontractor, respectively, acknowledges that the CPO may declare the contract void if this certification is false.

F. Educational Loan

Section 3 of the Educational Loan Default Act provides no State agency shall contract with an individual for goods or services if that individual is in default, as defined in Section 2 of this Act, on an educational loan. Any contract used by any State agency shall include a statement certifying that the individual is not in default on an educational loan as provided in this Section.

The bidder, if an individual as opposed to a corporation, partnership or other form of business organization, certifies that the bidder is not in default on an educational loan as provided in Section 3 of the Act.

G. Bid-Rigging/Bid Rotating

Section 33E-11 of the Criminal Code of 2012 provides:

(a) Every bid submitted to and public contract executed pursuant to such bid by the State or a unit of local government shall contain a certification by the prime contractor that the prime contractor is not barred from contracting with any unit of State or local government as a result of a violation of either Section 33E-3 or 33E-4 of this Article

(b) A contractor who makes a false statement, material to the certification, commits a Class 3 felony.

A violation of Section 33E-3 would be represented by a conviction of the crime of bid-rigging which, in addition to Class 3 felony sentencing, provides that any person convicted of this offense or any similar offense of any state or the United States which contains the same elements as this offense shall be barred for 5 years from the date of conviction from contracting with any unit of State or local government. No corporation shall be barred from contracting with any unit of State or local government as a result of a conviction under this Section of any employee or agent of such corporation if the employee so convicted is no longer employed by the corporation and: (1) it has been finally adjudicated not guilty or (2) if it demonstrates to the governmental entity with which it seeks to contract and that entity finds that the commission of the offense was neither authorized, requested, commanded, nor performed by a director, officer or a high managerial agent in behalf of the corporation.

RETURN WITH BID

A violation of Section 33E-4 would be represented by a conviction of the crime of bid-rotating which, in addition to Class 2 felony sentencing, provides that any person convicted of this offense or any similar offense of any state or the United States which contains the same elements as this offense shall be permanently barred from contracting with any unit of State or local government. No corporation shall be barred from contracting with any unit of State or local government as a result of a conviction under this Section of any employee or agent of such corporation if the employee so convicted is no longer employed by the corporation and: (1) it has been finally adjudicated not guilty or (2) if it demonstrates to the governmental entity with which it seeks to contract and that entity finds that the commission of the offense was neither authorized, requested, commanded, nor performed by a director, officer or a high managerial agent in behalf of the corporation.

The bidder certifies that it is not barred from contracting with the Department by reason of a violation of either Section 33E-3 or Section 33E-4.

H. International Anti-Boycott

Section 5 of the International Anti-Boycott Certification Act provides every contract entered into by the State of Illinois for the manufacture, furnishing, or purchasing of supplies, material, or equipment or for the furnishing of work, labor, or services, in an amount exceeding the threshold for small purchases according to the purchasing laws of this State or \$10,000.00, whichever is less, shall contain certification, as a material condition of the contract, by which the contractor agrees that neither the contractor nor any substantially-owned affiliated company is participating or shall participate in an international boycott in violation of the provisions of the U.S. Export Administration Act of 1979 or the regulations of the U.S. Department of Commerce promulgated under that Act.

The bidder makes the certification set forth in Section 5 of the Act.

I. Drug Free Workplace

The Illinois "Drug Free Workplace Act" applies to this contract and it is necessary to comply with the provisions of the "Act" if the contractor is a corporation, partnership, or other entity (including a sole proprietorship) which has 25 or more employees.

The bidder certifies that if awarded a contract in excess of \$5,000 it will provide a drug free workplace in compliance with the provisions of the Act.

J. Disclosure of Business Operations in Iran

Section 50-36 of the Code, 30ILCS 500/50-36 provides that each bid, offer, or proposal submitted for a State contract shall include a disclosure of whether or not the Company acting as the bidder, offeror, or proposing entity, or any of its corporate parents or subsidiaries, within the 24 months before submission of the bid, offer, or proposal had business operations that involved contracts with or provision of supplies or services to the Government of Iran, companies in which the Government of Iran has any direct or indirect equity share, consortiums or projects commissioned by the Government of Iran, or companies involved in consortiums or projects commissioned by the Government of Iran and either of the following conditions apply:

- (1) More than 10% of the Company's revenues produced in or assets located in Iran involve oil-related activities or mineral-extraction activities; less than 75% of the Company's revenues produced in or assets located in Iran involve contracts with or provision of oil-related or mineral-extraction products or services to the Government of Iran or a project or consortium created exclusively by that government; and the Company has failed to take substantial action.
- (2) The Company has, on or after August 5, 1996, made an investment of \$20 million or more, or any combination of investments of at least \$10 million each that in the aggregate equals or exceeds \$20 million in any 12-month period, which directly or significantly contributes to the enhancement of Iran's ability to develop petroleum resources of Iran.

The terms "Business operations", "Company", "Mineral-extraction activities", "Oil-related activities", "Petroleum resources", and "Substantial action" are all defined in the Code.

Failure to make the disclosure required by the Code shall cause the bid, offer or proposal to be considered not responsive. The disclosure will be considered when evaluating the bid or awarding the contract. The name of each Company disclosed as doing business or having done business in Iran will be provided to the State Comptroller.

Check the appropriate statement:

Company has no business operations in Iran to disclose.

Company has business operations in Iran as disclosed the attached document.

RETURN WITH BID

K. Apprenticeship and Training Certification (Does not apply to federal aid projects)

In accordance with the provisions of Section 30-22 (6) of the Code, the bidder certifies that it is a participant, either as an individual or as part of a group program, in the approved apprenticeship and training programs applicable to each type of work or craft that the bidder will perform with its own forces. The bidder further certifies for work that will be performed by subcontract that each of its subcontractors submitted for approval either (a) is, at the time of such bid, participating in an approved, applicable apprenticeship and training program; or (b) will, prior to commencement of performance of work pursuant to this contract, begin participation in an approved apprenticeship and training program applicable to the work of the subcontract. The Department, at any time before or after award, may require the production of a copy of each applicable Certificate of Registration issued by the United States Department of Labor evidencing such participation by the contractor and any or all of its subcontractors. Applicable apprenticeship and training programs are those that have been approved and registered with the United States Department of Labor. The bidder shall list in the space below, the official name of the program sponsor holding the Certificate of Registration for all of the types of work or crafts in which the bidder is a participant and that will be performed with the bidder's forces. Types of work or craft work that will be subcontracted shall be included and listed as subcontract work. The list shall also indicate any type of work or craft job category that does not have an applicable apprenticeship or training program. **The bidder is responsible for making a complete report and shall make certain that each type of work or craft job category that will be utilized on the project as reported on the Construction Employee Workforce Projection (Form BC-1256) and returned with the bid is accounted for and listed.**

The requirements of this certification and disclosure are a material part of the contract, and the contractor shall require this certification provision to be included in all approved subcontracts. In order to fulfill this requirement, it shall not be necessary that an applicable program sponsor be currently taking or that it will take applications for apprenticeship, training or employment during the performance of the work of this contract.

TO BE RETURNED WITH BID

L. Political Contributions and Registration with the State Board of Elections

Sections 20-160 and 50-37 of the Code regulate political contributions from business entities and any affiliated entities or affiliated persons bidding on or contracting with the state. Generally under Section 50-37, any business entity, and any affiliated entity or affiliated person of the business entity, whose current year contracts with all state agencies exceed an awarded value of \$50,000, are prohibited from making any contributions to any political committees established to promote the candidacy of the officeholder responsible for the awarding of the contracts or any other declared candidate for that office for the duration of the term of office of the incumbent officeholder or a period 2 years after the termination of the contract, whichever is longer. Any business entity and affiliated entities or affiliated persons whose state contracts in the current year do not exceed an awarded value of \$50,000, but whose aggregate pending bids and proposals on state contracts exceed \$50,000, either alone or in combination with contracts not exceeding \$50,000, are prohibited from making any political contributions to any political committee established to promote the candidacy of the officeholder responsible for awarding the pending contract during the period beginning on the date the invitation for bids or request for proposals is issued and ending on the day after the date of award or selection if the entity was not awarded or selected. Section 20-160 requires certification of registration of affected business entities in accordance with procedures found in Section 9-35 of The Election Code.

By submission of a bid, the contractor business entity acknowledges and agrees that it has read and understands Sections 20-160 and 50-37 of the Code, and that it makes the following certification:

The undersigned bidder certifies that it has registered as a business with the State Board of Elections and acknowledges a continuing duty to update the registration in accordance with the above referenced statutes. If the business entity is required to register, the CPO shall verify that it is in compliance on the date the bid or proposal is due. The CPO shall not accept a bid or proposal if the business entity is not in compliance with the registration requirements.

These requirements and compliance with the above referenced statutory sections are a material part of the contract, and any breach thereof shall be cause to void the contract under Section 50-60 of the Code. This provision does not apply to Federal-aid contracts.

M. Lobbyist Disclosure

Section 50-38 of the Code requires that any bidder or offeror on a State contract that hires a person required to register under the Lobbyist Registration Act to assist in obtaining a contract shall:

- (i) Disclose all costs, fees, compensation, reimbursements, and other remunerations paid or to be paid to the lobbyist related to the contract,
- (ii) Not bill or otherwise cause the State of Illinois to pay for any of the lobbyist's costs, fees, compensation, reimbursements, or other remuneration, and
- (iii) Sign a verification certifying that none of the lobbyist's costs, fees, compensation, reimbursements, or other remuneration were billed to the State.

This information, along with all supporting documents, shall be filed with the agency awarding the contract and with the Secretary of State. The CPO shall post this information, together with the contract award notice, in the online Procurement Bulletin.

Pursuant to Subsection (c) of this Section, no person or entity shall retain a person or entity to attempt to influence the outcome of a procurement decision made under the Code for compensation contingent in whole or in part upon the decision or procurement. Any person who violates this subsection is guilty of a business offense and shall be fined not more than \$10,000.

Bidder acknowledges that it is required to disclose the hiring of any person required to register pursuant to the Illinois Lobbyist Registration Act (25 ILCS 170) in connection with this contract.

Bidder has not hired any person required to register pursuant to the Illinois Lobbyist Registration Act in connection with this contract.

Or

Bidder has hired the following persons required to register pursuant to the Illinois Lobbyist Registration Act in connection with the contract:

Name and address of person: _____
All costs, fees, compensation, reimbursements and other remuneration paid to said person: _____

I acknowledge, understand and accept these terms and conditions for the above certifications.

RETURN WITH BID

IV. DISCLOSURES

- A. The disclosures hereinafter made by the bidder are each a material representation of fact upon which reliance is placed should the Department enter into the contract with the bidder. The bidder further certifies that the Department has received the disclosure forms for each bid.

The CPO may void the bid, or contract, respectively, if it is later determined that the bidder or subcontractor rendered a false or erroneous disclosure. A contractor or subcontractor may be suspended or debarred for violations of the Code. Furthermore, the CPO may void the contract and the surety providing the performance bond shall be responsible for completion of the contract.

B. Financial Interests and Conflicts of Interest

1. Section 50-35 of the Code provides that all bids of more than \$25,000 shall be accompanied by disclosure of the financial interests of the bidder. This disclosed information for the successful bidder, will be maintained as public information subject to release by request pursuant to the Freedom of Information Act, filed with the Procurement Policy Board, and shall be incorporated as a material term of the contract. Furthermore, pursuant to Section 5-5, the Procurement Policy Board may review a proposal, bid, or contract and issue a recommendation to void a contract or reject a proposal or bid based on any violation of the Code or the existence of a conflict of interest as provided in subsections (b) and (d) of Section 50-35.

The financial interests to be disclosed shall include ownership or distributive income share that is in excess of 5%, or an amount greater than 60% of the annual salary of the Governor, of the bidding entity or its parent entity, whichever is less, unless the contractor or bidder is a publicly traded entity subject to Federal 10K reporting, in which case it may submit its 10K disclosure in place of the prescribed disclosure. If a bidder is a privately held entity that is exempt from Federal 10K reporting, but has more than 200 shareholders, it may submit the information that Federal 10K companies are required to report, and list the names of any person or entity holding any ownership share that is in excess of 5%. The disclosure shall include the names, addresses, and dollar or proportionate share of ownership of each person making the disclosure, their instrument of ownership or beneficial relationship, and notice of any potential conflict of interest resulting from the current ownership or beneficial interest of each person making the disclosure having any of the relationships identified in Section 50-35 and on the disclosure form.

The current annual salary of the Governor is \$177,412.00

In addition, all disclosures shall indicate any other current or pending contracts, proposals, leases, or other ongoing procurement relationships the bidding entity has with any other unit of state government and shall clearly identify the unit and the contract, proposal, lease, or other relationship.

2. Disclosure Forms. Disclosure Form A is attached for use concerning the individuals meeting the above ownership or distributive share requirements. A separate Disclosure Form A must be submitted with the bid for each individual meeting the above requirements. In addition, a second form (Disclosure Form B) provides for the disclosure of current or pending procurement relationships with other (non-IDOT) state agencies and a total ownership certification. **The forms must be included with each bid.**

C. Disclosure Form Instructions

Form A Instructions for Financial Information & Potential Conflicts of Interest

If the bidder is a publicly traded entity subject to Federal 10K reporting, the 10K Report may be submitted to meet the requirements of Form A. If a bidder is a privately held entity that is exempt from Federal 10K reporting, but has more than 200 shareholders, it may submit the information that Federal 10K companies are required to report, and list the names of any person or entity holding any ownership share that is in excess of 5%. If a bidder is not subject to Federal 10K reporting, the bidder must determine if any individuals are required by law to complete a financial disclosure form. To do this, the bidder should answer each of the following questions. A "YES" answer indicates Form A must be completed. If the answer to each of the following questions is "NO", then the NOT APPLICABLE STATEMENT on Form A must be signed and dated by a person that is authorized to execute contracts for the bidding company. Note: These questions are for assistance only and are not required to be completed.

1. Does anyone in your organization have a direct or beneficial ownership share of greater than 5% of the bidding entity or parent entity? YES ___ NO ___
2. Does anyone in your organization have a direct or beneficial ownership share of less than 5%, but which has a value greater than 60% of the annual salary of the Governor? YES ___ NO ___
3. Does anyone in your organization receive more than 60% of the annual salary of the Governor of the bidding entity's or parent entity's distributive income? YES ___ NO ___

(Note: Distributive income is, for these purposes, any type of distribution of profits. An annual salary is not distributive income.)

4. Does anyone in your organization receive greater than 5% of the bidding entity's or parent entity's total distributive income, but which is less than 60% of the annual salary of the Governor? YES ___ NO ___

(Note: Only one set of forms needs to be completed per person per bid even if a specific individual would require a yes answer to more than one question.)

A "YES" answer to any of these questions requires the completion of Form A. The bidder must determine each individual in the bidding entity or the bidding entity's parent company that would cause the questions to be answered "Yes". Each form must be signed and dated by a person that is authorized to execute contracts for your organization. **Photocopied or stamped signatures are not acceptable.** The person signing can be, but does not have to be, the person for which the form is being completed. The bidder is responsible for the accuracy of any information provided.

If the answer to each of the above questions is "NO", then the NOT APPLICABLE STATEMENT of Form A must be signed and dated by a person that is authorized to execute contracts for your company.

RETURN WITH BID

Form B: Instructions for Identifying Other Contracts & Procurement Related Information

Disclosure Form B must be completed for each bid submitted by the bidding entity. *Note: Checking the NOT APPLICABLE STATEMENT on Form A does not allow the bidder to ignore Form B. Form B must be completed, checked, and dated or the bidder may be considered nonresponsive and the bid will not be accepted.*

The Bidder shall identify, by checking Yes or No on Form B, whether it has any pending contracts (including leases), bids, proposals, or other ongoing procurement relationship with any other (non-IDOT) State of Illinois agency. If "No" is checked, the bidder only needs to complete the check box on the bottom of Form B. If "Yes" is checked, the bidder must do one of the following:

Option I: If the bidder did not submit an Affidavit of Availability to obtain authorization to bid, the bidder must list all non-IDOT State of Illinois agency pending contracts, leases, bids, proposals, and other ongoing procurement relationships. These items may be listed on Form B or on an attached sheet(s). Do not include IDOT contracts. Contracts with cities, counties, villages, etc. are not considered State of Illinois agency contracts and are not to be included. Contracts with other State of Illinois agencies such as the Department of Natural Resources or the Capital Development Board must be included. Bidders who submit Affidavits of Availability are suggested to use Option II.

Option II: If the bidder is required and has submitted an Affidavit of Availability in order to obtain authorization to bid, the bidder may write or type "See Affidavit of Availability" which indicates that the Affidavit of Availability is incorporated by reference and includes all non-IDOT State of Illinois agency pending contracts, leases, bids, proposals, and other ongoing procurement relationships. For any contracts that are not covered by the Affidavit of Availability, the bidder must identify them on Form B or on an attached sheet(s). These might be such things as leases.

**ILLINOIS DEPARTMENT
OF TRANSPORTATION**

**Form A
Financial Information &
Potential Conflicts of Interest
Disclosure**

Contractor Name		
Legal Address		
City, State, Zip		
Telephone Number	Email Address	Fax Number (if available)

Disclosure of the information contained in this Form is required by the Section 50-35 of the Code (30 ILCS 500). Vendors desiring to enter into a contract with the State of Illinois must disclose the financial information and potential conflict of interest information as specified in this Disclosure Form. This information shall become part of the publicly available contract file. This Form A must be completed for bids in excess of \$25,000, and for all open-ended contracts. **A publicly traded company may submit a 10K disclosure (or equivalent if applicable) in satisfaction of the requirements set forth in Form A. See Disclosure Form Instructions.**

The current annual salary of the Governor is \$177,412.00.

DISCLOSURE OF FINANCIAL INFORMATION

1. Disclosure of Financial Information. The individual named below has an interest in the BIDDER (or its parent) in terms of ownership or distributive income share in excess of 5%, or an interest which has a value of more than 60% of the annual salary of the Governor. **(Make copies of this form as necessary and attach a separate Disclosure Form A for each individual meeting these requirements)**

FOR INDIVIDUAL (type or print information)	
NAME:	_____
ADDRESS	_____
Type of ownership/distributable income share:	
stock _____ sole proprietorship _____ Partnership _____ other: (explain on separate sheet):	
% or \$ value of ownership/distributable income share:	_____

2. Disclosure of Potential Conflicts of Interest. Check "Yes" or "No" to indicate which, if any, of the following potential conflict of interest relationships apply. If the answer to any question is "Yes", please attach additional pages and describe.

(a) State employment, currently or in the previous 3 years, including contractual employment of services. Yes ___ No ___

If your answer is yes, please answer each of the following questions.

1. Are you currently an officer or employee of either the Capitol Development Board or the Illinois State Toll Highway Authority? Yes ___ No ___

2. Are you currently appointed to or employed by any agency of the State of Illinois? If you are currently appointed to or employed by any agency of the State of Illinois, and your annual salary exceeds 60% of the annual salary of the Governor, provide the name the State agency for which you are employed and your annual salary. _____

RETURN WITH BID

3. If you are currently appointed to or employed by any agency of the State of Illinois, and your annual salary exceeds 60% of the annual salary of the Governor, are you entitled to receive (i) more than 7 1/2% of the total distributable income of your firm, partnership, association or corporation, or (ii) an amount in excess of 100% of the annual salary of the Governor?
Yes ___ No ___

4. If you are currently appointed to or employed by any agency of the State of Illinois, and your annual salary exceeds 60% of the annual salary of the Governor, are you and your spouse or minor children entitled to receive (i) more than 15 % in the aggregate of the total distributable income of your firm, partnership, association or corporation, or (ii) an amount in excess of two times the salary of the Governor?
Yes ___ No ___

(b) State employment of spouse, father, mother, son, or daughter, including contractual employment for services in the previous 2 years.

Yes ___ No ___

If your answer is yes, please answer each of the following questions.

1. Is your spouse or any minor children currently an officer or employee of the Capitol Development Board or the Illinois State Toll Highway Authority?
Yes ___ No ___

2. Is your spouse or any minor children currently appointed to or employed by any agency of the State of Illinois? If your spouse or minor children is/are currently appointed to or employed by any agency of the State of Illinois, and his/her annual salary exceeds 60% of the annual salary of the Governor, provide the name of your spouse and/or minor children, the name of the State agency for which he/she is employed and his/her annual salary. _____

3. If your spouse or any minor children is/are currently appointed to or employed by any agency of the State of Illinois, and his/her annual salary exceeds 60% of the annual salary of the Governor, are you entitled to receive (i) more than 7 1/2% of the total distributable income of your firm, partnership, association or corporation, or (ii) an amount in excess of 100% of the annual salary of the Governor?
Yes ___ No ___

4. If your spouse or any minor children are currently appointed to or employed by any agency of the State of Illinois, and his/her annual salary exceeds 60% of the annual salary of the Governor, are you and your spouse or minor children entitled to receive (i) more than 15 % in the aggregate of the total distributable income of your firm, partnership, association or corporation, or (ii) an amount in excess of two times the salary of the Governor?
Yes ___ No ___

(c) Elective status; the holding of elective office of the State of Illinois, the government of the United States, any unit of local government authorized by the Constitution of the State of Illinois or the statutes of the State of Illinois currently or in the previous 3 years.
Yes ___ No ___

(d) Relationship to anyone holding elective office currently or in the previous 2 years; spouse, father, mother, son, or daughter.
Yes ___ No ___

(e) Appointive office; the holding of any appointive government office of the State of Illinois, the United States of America, or any unit of local government authorized by the Constitution of the State of Illinois or the statutes of the State of Illinois, which office entitles the holder to compensation in excess of the expenses incurred in the discharge of that office currently or in the previous 3 years.
Yes ___ No ___

(f) Relationship to anyone holding appointive office currently or in the previous 2 years; spouse, father, mother, son, or daughter.
Yes ___ No ___

(g) Employment, currently or in the previous 3 years, as or by any registered lobbyist of the State government.
Yes ___ No ___

RETURN WITH BID

(h) Relationship to anyone who is or was a registered lobbyist in the previous 2 years; spouse, father, mother, son, or daughter. Yes ___ No ___

(i) Compensated employment, currently or in the previous 3 years, by any registered election or reelection committee registered with the Secretary of State or any county clerk of the State of Illinois, or any political action committee registered with either the Secretary of State or the Federal Board of Elections. Yes ___ No ___

(j) Relationship to anyone; spouse, father, mother, son, or daughter; who was a compensated employee in the last 2 years by any registered election or re-election committee registered with the Secretary of State or any county clerk of the State of Illinois, or any political action committee registered with either the Secretary of State or the Federal Board of Elections. Yes ___ No ___

3. Communication Disclosure.

Disclose the name and address of each lobbyist and other agent of the bidder or offeror who is not identified in Section 2 of this form, who is has communicated, is communicating, or may communicate with any State officer or employee concerning the bid or offer. This disclosure is a continuing obligation and must be promptly supplemented for accuracy throughout the process and throughout the term of the contract. If no person is identified, enter "None" on the line below:

Name and address of person(s): _____

RETURN WITH BID

4. Debarment Disclosure. For each of the persons identified under Sections 2 and 3 of this form, disclose whether any of the following has occurred within the previous 10 years: debarment from contracting with any governmental entity; professional licensure discipline; bankruptcies; adverse civil judgments and administrative findings; and criminal felony convictions. This disclosure is a continuing obligation and must be promptly supplemented for accuracy throughout the procurement process and term of the contract. If no person is identified, enter "None" on the line below:

Name of person(s): _____

Nature of disclosure: _____

APPLICABLE STATEMENT

This Disclosure Form A is submitted on behalf of the INDIVIDUAL named on previous page. Under penalty of perjury, I certify the contents of this disclosure to be true and accurate to the best of my knowledge.

Completed by: _____ Date _____
Signature of Individual or Authorized Representative

NOT APPLICABLE STATEMENT

Under penalty of perjury, I have determined that no individuals associated with this organization meet the criteria that would require the completion of this Form A.

This Disclosure Form A is submitted on behalf of the CONTRACTOR listed on the previous page.

_____ Date _____
Signature of Authorized Representative

The bidder has a continuing obligation to supplement these disclosures under Sec. 50-35 of the Code.

RETURN WITH BID

ILLINOIS DEPARTMENT OF TRANSPORTATION

Form B Other Contracts & Financial Related Information Disclosure

Contractor Name, Legal Address, City, State, Zip, Telephone Number, Email Address, Fax Number (if available)

Disclosure of the information contained in this Form is required by the Section 50-35 of the Code (30 ILCS 500). This information shall become part of the publicly available contract file. This Form B must be completed for bids in excess of \$25,000, and for all open-ended contracts.

DISCLOSURE OF OTHER CONTRACTS AND PROCUREMENT RELATED INFORMATION

1. Identifying Other Contracts & Procurement Related Information. The BIDDER shall identify whether it has any pending contracts (including leases), bids, proposals, or other ongoing procurement relationship with any other State of Illinois agency: Yes ___ No ___

If "No" is checked, the bidder only needs to complete the signature box on the bottom of this page.

2. If "Yes" is checked. Identify each such relationship by showing State of Illinois agency name and other descriptive information such as bid or project number (attach additional pages as necessary). SEE DISCLOSURE FORM INSTRUCTIONS:

THE FOLLOWING STATEMENT MUST BE CHECKED

Signature of Authorized Representative, Date

OWNERSHIP CERTIFICATION

Please certify that the following statement is true if the individuals for all submitted Form A disclosures do not total 100% of ownership.

Any remaining ownership interest is held by individuals receiving less than \$106,447.20 of the bidding entity's or parent entity's distributive income or holding less than a 5% ownership interest.

Yes No N/A (Form A disclosure(s) established 100% ownership)

RETURN WITH BID

SPECIAL NOTICE TO CONTRACTORS

The following requirements of the Illinois Department of Human Rights' Rules and Regulations are applicable to bidders on all construction contracts advertised by the Illinois Department of Transportation:

CONSTRUCTION EMPLOYEE UTILIZATION PROJECTION

- (a) All bidders on construction contracts shall complete and submit, along with and as part of their bids, a Bidder's Employee Utilization Form (Form BC-1256) setting forth a projection and breakdown of the total workforce intended to be hired and/or allocated to such contract work by the bidder including a projection of minority and female employee utilization in all job classifications on the contract project.
- (b) The Department of Transportation shall review the Employee Utilization Form, and workforce projections contained therein, of the contract awardee to determine if such projections reflect an underutilization of minority persons and/or women in any job classification in accordance with the Equal Employment Opportunity Clause and Section 7.2 of the Illinois Department of Human Rights' Rules and Regulations for Public Contracts adopted as amended on September 17, 1980. If it is determined that the contract awardee's projections reflect an underutilization of minority persons and/or women in any job classification, it shall be advised in writing of the manner in which it is underutilizing and such awardee shall be considered to be in breach of the contract unless, prior to commencement of work on the contract project, it submits revised satisfactory projections or an acceptable written affirmative action plan to correct such underutilization including a specific timetable geared to the completion stages of the contract.
- (c) The Department of Transportation shall provide to the Department of Human Rights a copy of the contract awardee's Employee Utilization Form, a copy of any required written affirmative action plan, and any written correspondence related thereto. The Department of Human Rights may review and revise any action taken by the Department of Transportation with respect to these requirements.

RETURN WITH BID

**Contract No. 64K05
WINNEBAGO County
Section (148CS)TS
Route FAP 303
District 2 Construction Funds**

PART II. WORKFORCE PROJECTION - continued

- B. Included in "Total Employees" under Table A is the total number of **new hires** that would be employed in the event the undersigned bidder is awarded this contract.

The undersigned bidder projects that: (number) _____ new hires would be recruited from the area in which the contract project is located; and/or (number) _____ new hires would be recruited from the area in which the bidder's principal office or base of operation is located.

- C. Included in "Total Employees" under Table A is a projection of numbers of persons to be employed directly by the undersigned bidder as well as a projection of numbers of persons to be employed by subcontractors.

The undersigned bidder estimates that (number) _____ persons will be directly employed by the prime contractor and that (number) _____ persons will be employed by subcontractors.

PART III. AFFIRMATIVE ACTION PLAN

- A. The undersigned bidder understands and agrees that in the event the foregoing minority and female employee utilization projection included under **PART II** is determined to be an underutilization of minority persons or women in any job category, and in the event that the undersigned bidder is awarded this contract, he/she will, prior to commencement of work, develop and submit a written Affirmative Action Plan including a specific timetable (geared to the completion stages of the contract) whereby deficiencies in minority and/or female employee utilization are corrected. Such Affirmative Action Plan will be subject to approval by the contracting agency and the **Department of Human Rights**.
- B. The undersigned bidder understands and agrees that the minority and female employee utilization projection submitted herein, and the goals and timetable included under an Affirmative Action Plan if required, are deemed to be part of the contract specifications.

Company _____ Telephone Number _____

Address _____

NOTICE REGARDING SIGNATURE

The Bidder's signature on the Proposal Signature Sheet will constitute the signing of this form. The following signature block needs to be completed if revisions are required.

Signature: _____ Title: _____ Date: _____

Instructions: All tables must include subcontractor personnel in addition to prime contractor personnel.

Table A - Include both the number of employees that would be hired to perform the contract work and the total number currently employed (Table B) that will be allocated to contract work, and include all apprentices and on-the-job trainees. The "Total Employees" column should include all employees including all minorities, apprentices and on-the-job trainees to be employed on the contract work.

Table B - Include all employees currently employed that will be allocated to the contract work including any apprentices and on-the-job trainees currently employed.

Table C - Indicate the racial breakdown of the total apprentices and on-the-job trainees shown in Table A.

RETURN WITH BID

**Contract No. 64K05
WINNEBAGO County
Section (148CS)TS
Route FAP 303
District 2 Construction Funds**

PROPOSAL SIGNATURE SHEET

The undersigned bidder hereby makes and submits this bid on the subject Proposal, thereby assuring the Department that all requirements of the Invitation for Bids and rules of the Department have been met, that there is no misunderstanding of the requirements of paragraph 3 of this Proposal, and that the contract will be executed in accordance with the rules of the Department if an award is made on this bid.

(IF AN INDIVIDUAL) Firm Name _____
Signature of Owner _____
Business Address _____

(IF A CO-PARTNERSHIP) Firm Name _____
By _____
Business Address _____
Name and Address of All Members of the Firm:

(IF A CORPORATION)
(IF A JOINT VENTURE, USE THIS SECTION FOR THE MANAGING PARTY AND THE SECOND PARTY SHOULD SIGN BELOW)

Corporate Name _____
By _____
Signature of Authorized Representative _____
Typed or printed name and title of Authorized Representative _____
Attest _____
Signature _____
Business Address _____

(IF A JOINT VENTURE)

Corporate Name _____
By _____
Signature of Authorized Representative _____
Typed or printed name and title of Authorized Representative _____
Attest _____
Signature _____
Business Address _____

If more than two parties are in the joint venture, please attach an additional signature sheet.



This Annual Proposal Bid Bond shall become effective at 12:01 AM (CDST) on _____ and shall be valid until _____ 11:59 PM (CDST).

KNOW ALL PERSONS BY THESE PRESENTS, That We _____

as PRINCIPAL, and _____

as SURETY, and held jointly, severally and firmly bound unto the STATE OF ILLINOIS in the penal sum of 5 percent of the total bid price, or for the amount specified in the bid proposal under "Proposal Guaranty" in effect on the date of the Invitation for Bids, whichever is the lesser sum, well and truly to be paid unto said STATE OF ILLINOIS, for the payment of which we bind ourselves, our heirs, executors, administrators, successors and assigns.

THE CONDITION OF THE FOREGOING OBLIGATION IS SUCH that whereas, the PRINCIPAL may submit bid proposal(s) to the STATE OF ILLINOIS, acting through the Department of Transportation, for various improvements published in the Transportation Bulletin during the effective term indicated above.

NOW, THEREFORE, if the Department shall accept the bid proposal(s) of the PRINCIPAL; and if the PRINCIPAL shall, within the time and as specified in the bidding and contract documents; and if, after award by the Department, the PRINCIPAL shall enter into a contract in accordance with the terms of the bidding and contract documents including evidence of the required insurance coverages and providing such bond as specified with good and sufficient surety for the faithful performance of such contract and for the prompt payment of labor and material furnished in the prosecution thereof; or if, in the event of the failure of the PRINCIPAL to enter into such contract and to give the specified bond, the PRINCIPAL pays to the Department the difference not to exceed the penalty hereof between the amount specified in the bid proposal and such larger amount for which the Department may contract with another party to perform the work covered by said bid proposal, then this obligation shall be null and void, otherwise, it shall remain in full force and effect.

IN THE EVENT the Department determines the PRINCIPAL has failed to comply with any requirement as set forth in the preceding paragraph, then Surety shall pay the penal sum to the Department within fifteen (15) days of written demand therefor. If Surety does not make full payment within such period of time, the Department may bring an action to collect the amount owed. Surety is liable to the Department for all its expenses, including attorney's fees, incurred in any litigation in which it prevails either in whole or in part.

In TESTIMONY WHEREOF, the said PRINCIPAL has caused this instrument to be signed by its officer _____ day of _____ A.D., _____

In TESTIMONY WHEREOF, the said SURETY has caused this instrument to be signed by its officer _____ day of _____ A.D., _____

(Company Name)

(Company Name)

By _____
(Signature and Title)

By _____
(Signature of Attorney-in-Fact)

Notary for PRINCIPAL

Notary for SURETY

STATE OF _____
COUNTY OF _____

STATE OF _____
COUNTY OF _____

Signed and attested before me on _____ (date)

Signed and attested before me on _____ (date)

by _____
(Name of Notary Public)

by _____
(Name of Notary Public)

(Seal) _____
(Signature of Notary Public)

(Seal) _____
(Signature of Notary Public)

(Date Commission Expires)

(Date Commission Expires)

In lieu of completing the above section of the Annual Proposal Bid Bond form, the Principal may file an Electronic Bid Bond. By signing the proposal(s) the Principal is ensuring the identified electronic bid bond has been executed and the Principal and Surety are firmly bound unto the State of Illinois under the conditions of the bid bond as shown above.

Electronic Bid Bond ID #	Company/Bidder Name	Signature and Title
--------------------------	---------------------	---------------------

This bond may be terminated, at Surety's request, upon giving not less than thirty (30) days prior written notice of the cancellation/termination of the bond. Said written notice shall be issued to the Illinois Department of Transportation, Chief Contracts Official, 2300 South Dirksen Parkway, Springfield, Illinois, 62764, and shall be served in person, by receipted courier delivery or certified or registered mail, return receipt requested. Said notice period shall commence on the first calendar day following the Department's receipt of written cancellation/termination notice. Surety shall remain firmly bound to all obligations herein for proposals submitted prior to the cancellation/termination. Surety shall be released and discharged from any obligation(s) for proposals submitted for any letting or date after the effective date of cancellation/termination.



Item No. _____

Letting Date _____

KNOW ALL PERSONS BY THESE PRESENTS, That We _____

as PRINCIPAL, and _____

as SURETY, and held jointly, severally and firmly bound unto the STATE OF ILLINOIS in the penal sum of 5 percent of the total bid price, or for the amount specified in the bid proposal under "Proposal Guaranty" in effect on the date of the Invitation for Bids, whichever is the lesser sum, well and truly to be paid unto said STATE OF ILLINOIS, for the payment of which we bind ourselves, our heirs, executors, administrators, successors and assigns.

THE CONDITION OF THE FOREGOING OBLIGATION IS SUCH that whereas, the PRINCIPAL has submitted a bid proposal to the STATE OF ILLINOIS, acting through the Department of Transportation, for the improvement designated by the Transportation Bulletin Item Number and Letting Date indicated above.

NOW, THEREFORE, if the Department shall accept the bid proposal of the PRINCIPAL; and if the PRINCIPAL shall, within the time and as specified in the bidding and contract documents; and if, after award by the Department, the PRINCIPAL shall enter into a contract in accordance with the terms of the bidding and contract documents including evidence of the required insurance coverages and providing such bond as specified with good and sufficient surety for the faithful performance of such contract and for the prompt payment of labor and material furnished in the prosecution thereof; or if, in the event of the failure of the PRINCIPAL to enter into such contract and to give the specified bond, the PRINCIPAL pays to the Department the difference not to exceed the penalty hereof between the amount specified in the bid proposal and such larger amount for which the Department may contract with another party to perform the work covered by said bid proposal, then this obligation shall be null and void, otherwise, it shall remain in full force and effect.

IN THE EVENT the Department determines the PRINCIPAL has failed to comply with any requirement as set forth in the preceding paragraph, then Surety shall pay the penal sum to the Department within fifteen (15) days of written demand therefor. If Surety does not make full payment within such period of time, the Department may bring an action to collect the amount owed. Surety is liable to the Department for all its expenses, including attorney's fees, incurred in any litigation in which it prevails either in whole or in part.

In TESTIMONY WHEREOF, the said PRINCIPAL has caused this instrument to be signed by its officer _____ day of _____ A.D., _____.

In TESTIMONY WHEREOF, the said SURETY has caused this instrument to be signed by its officer _____ day of _____ A.D., _____.

(Company Name)

(Company Name)

By _____
(Signature and Title)

By _____
(Signature of Attorney-in-Fact)

Notary for PRINCIPAL

Notary for SURETY

STATE OF _____
COUNTY OF _____

STATE OF _____
COUNTY OF _____

Signed and attested before me on _____ (date)
by _____
(Name of Notary Public)

Signed and attested before me on _____ (date)
by _____
(Name of Notary Public)

(Seal) _____
(Signature of Notary Public)

(Seal) _____
(Signature of Notary Public)

(Date Commission Expires)

(Date Commission Expires)

In lieu of completing the above section of the Proposal Bid Bond form, the Principal may file an Electronic Bid Bond. By signing the proposal the Principal is ensuring the identified electronic bid bond has been executed and the Principal and Surety are firmly bound unto the State of Illinois under the conditions of the bid bond as shown above.

Electronic Bid Bond ID # _____ Company/Bidder Name _____ Signature and Title _____



(1) Policy

It is public policy that disadvantageded businesses as defined in 49 CFR Part 26 and the Special Provision shall have the maximum opportunity to participate in the performance of contracts financed in whole or in part with Federal or State funds. Consequently the requirements of 49 CFR Part 26 apply to this contract.

(2) Obligation

The contractor agrees to ensure that disadvantageded businesses as defined in 49 CFR Part 26 and the Special Provision have the maximum opportunity to participate in the performance of contracts or subcontracts financed in whole or in part with Federal or State funds. The contractor shall take all necessary and reasonable steps in accordance with 49 CFR Part 26 and the Special Provision to ensure that said businesses have the maximum opportunity to compete for and perform under this contract. The contractor shall not discriminate on the basis of race, color, national origin or sex in the award and performance of contracts.

(3) Project and Bid Identification

Complete the following information concerning the project and bid:

Route _____

Section _____

Project _____

County _____

Letting Date _____

Contract No. _____

Letting Item No. _____

Total Bid _____

Contract DBE Goal _____

(Percent) (Dollar Amount)

(4) Assurance

I, acting in my capacity as an officer of the undersigned bidder (or bidders if a joint venture), hereby assure the Department that on this project my company : (check one)

- Meets or exceeds contract award goals and has provided documented participation as follows:
Disadvantaged Business Participation _____ percent

Attached are the signed participation statements, forms SBE 2025, required by the Special Provision evidencing availability and use of each business participating in this plan and assuring that each business will perform a commercially useful function in the work of the contract.

- Failed to meet contract award goals and has included good faith effort documentation to meet the goals and that my company has provided participation as follows:
Disadvantaged Business Participation _____ percent

The contract goals should be accordingly modified or waived. Attached is all information required by the Special Provision in support of this request including good faith effort. Also attached are the signed participation statements, forms SBE 2025, required by the Special Provision evidencing availability and use of each business participating in this plan and assuring that each business will perform a commercially useful function in the work of the contract.

_____ Company

By _____

Title _____

Date _____

The "as read" Low Bidder is required to comply with the Special Provision.

Submit only one utilization plan for each project. The utilization plan shall be submitted in accordance with the special provision.

Bureau of Small Business Enterprises **Local Let Projects**
2300 South Dirksen Parkway Submit forms to the
Springfield, Illinois 62764 Local Agency

The Department of Transportation is requesting disclosure of information that is necessary to accomplish the purpose as outlined under State and Federal law. Disclosure of this information is **REQUIRED**. Failure to provide any information will result in the contract not being awarded. This form has been approved by the State Forms Manager Center.

PROPOSAL ENVELOPE



PROPOSALS

for construction work advertised for bids by the
Illinois Department of Transportation

Item No.	Item No.	Item No.

Submitted By:

Name:
Address:
Phone No.

Bidders should use an IDOT proposal envelope or affix this form to the front of a 10" x 13" envelope for the submittal of bids. If proposals are mailed, they should be enclosed in a second or outer envelope addressed to:

Engineer of Design and Environment - Room 326
Illinois Department of Transportation
2300 South Dirksen Parkway
Springfield, Illinois 62764

NOTICE

Individual bids, including Bid Bond and/or supplemental information if required, should be securely stapled.

CONTRACTOR OFFICE COPY OF CONTRACT SPECIFICATIONS

NOTICE

None of the following material needs to be returned with the bid package unless the special provisions require documentation and/or other information to be submitted.

**Contract No. 64K05
WINNEBAGO County
Section (148CS)TS
Route FAP 303
District 2 Construction Funds**



Illinois Department of Transportation

SUBCONTRACTOR DOCUMENTATION

Public Acts 96-0795, 96-0920, and 97-0895 enacted substantial changes to the provisions of the Code (30 ILCS 500). Among the changes are provisions affecting subcontractors. The Contractor awarded this contract will be required as a material condition of the contract to implement and enforce the contract requirements applicable to subcontractors that entered into a contractual agreement with a total value of \$50,000 or more with a person or entity who has a contract subject to the Code and approved in accordance with article 108.01 of the Standard Specifications for Road and Bridge Construction.

If the Contractor seeks approval of subcontractors to perform a portion of the work, and approval is granted by the Department, the Contractor shall provide a copy of the subcontract to the Illinois Department of Transportation's CPO upon request within 15 calendar days after execution of the subcontract.

Financial disclosures required pursuant to Sec. 50-35 of the Code must be submitted for all applicable subcontractors. The subcontract shall contain the certifications required to be made by subcontractors pursuant to Article 50 of the Code. This Notice to Bidders includes a document incorporating all required subcontractor certifications and disclosures for use by the Contractor in compliance with this mandate. The document is entitled State Required Ethical Standards Governing Subcontractors.

RETURN WITH SUBCONTRACT

STATE ETHICAL STANDARDS GOVERNING SUBCONTRACTORS

Article 50 of the Code establishes the duty of all State CPOs, SPOs, and their designees to maximize the value of the expenditure of public moneys in procuring goods, services, and contracts for the State of Illinois and to act in a manner that maintains the integrity and public trust of State government. In discharging this duty, they are charged by law to use all available information, reasonable efforts, and reasonable actions to protect, safeguard, and maintain the procurement process of the State of Illinois.

The certifications hereinafter made by the subcontractor are each a material representation of fact upon which reliance is placed should the Department approve the subcontractor. The CPO may terminate or void the contract approval if it is later determined that the bidder or subcontractor rendered a false or erroneous certification. If a false certification is made by a subcontractor the contractor's submitted bid and the executed contract may not be declared void unless the contractor refuses to terminate the subcontract upon the State's request after a finding that the subcontractor's certification was false.

Section 50-2 of the Code provides that every person that has entered into a multi-year contract and every subcontractor with a multi-year subcontract shall certify, by July 1 of each fiscal year covered by the contract after the initial fiscal year, to the responsible CPO whether it continues to satisfy the requirements of Article 50 pertaining to the eligibility for a contract award. If a contractor or subcontractor is not able to truthfully certify that it continues to meet all requirements, it shall provide with its certification a detailed explanation of the circumstances leading to the change in certification status. A contractor or subcontractor that makes a false statement material to any given certification required under Article 50 is, in addition to any other penalties or consequences prescribed by law, subject to liability under the Whistleblower Reward and Protection Act for submission of a false claim.

A. Bribery

Section 50-5. Bribery.

(a) Prohibition. No person or business shall be awarded a contract or subcontract under this Code who:

(1) has been convicted under the laws of Illinois or any other state of bribery or attempting to bribe an officer or employee of the State of Illinois or any other state in that officer's or employee's official capacity; or

(2) has made an admission of guilt of that conduct that is a matter of record but has not been prosecuted for that conduct.

(b) Businesses. No business shall be barred from contracting with any unit of State or local government, or subcontracting under such a contract, as a result of a conviction under this Section of any employee or agent of the business if the employee or agent is no longer employed by the business and:

(1) the business has been finally adjudicated not guilty; or

(2) the business demonstrates to the governmental entity with which it seeks to contract, or which is signatory to the contract to which the subcontract relates, and that entity finds that the commission of the offense was not authorized, requested, commanded, or performed by a director, officer, or high managerial agent on behalf of the business as provided in paragraph (2) of subsection (a) of Section 5-4 of the Criminal Code of 2012.

(c) Conduct on behalf of business. For purposes of this Section, when an official, agent, or employee of a business committed the bribery or attempted bribery on behalf of the business and in accordance with the direction or authorization of a responsible official of the business, the business shall be chargeable with the conduct.

(d) Certification. Every bid submitted to and contract executed by the State, and every subcontract subject to Section 20-120 of the Code shall contain a certification by the contractor or the subcontractor, respectively, that the contractor or subcontractor is not barred from being awarded a contract or subcontract under this Section and acknowledges that the CPO may declare the related contract void if any certifications required by this Section are false. A contractor who makes a false statement, material to the certification, commits a Class 3 felony.

The contractor or subcontractor certifies that it is not barred from being awarded a contract under Section 50.5.

B. Felons

Section 50-10. Felons.

Unless otherwise provided, no person or business convicted of a felony shall do business with the State of Illinois or any State agency, or enter into a subcontract, from the date of conviction until 5 years after the date of completion of the sentence for that felony, unless no person held responsible by a prosecutorial office for the facts upon which the conviction was based continues to have any involvement with the business.

Certification. Every bid submitted to and contract executed by the State and every subcontract subject to Section 20-120 of the Code shall contain a certification by the bidder or contractor or subcontractor, respectively, that the bidder, contractor, or subcontractor is not barred from being awarded a contract or subcontract under this Section and acknowledges that the CPO may declare the related contract void if any of the certifications required by this Section are false.

RETURN WITH SUBCONTRACT

C. Debt Delinquency

Section 50-11 and 50-12. Debt Delinquency.

The contractor or bidder or subcontractor, respectively, certifies that it, or any affiliate, is not barred from being awarded a contract or subcontract under the Code. Section 50-11 prohibits a person from entering into a contract with a State agency, or entering into a subcontract, if it knows or should know that it, or any affiliate, is delinquent in the payment of any debt to the State as defined by the Debt Collection Board. Section 50-12 prohibits a person from entering into a contract with a State agency, or entering into a subcontract, if it, or any affiliate, has failed to collect and remit Illinois Use Tax on all sales of tangible personal property into the State of Illinois in accordance with the provisions of the Illinois Use Tax Act. The bidder or contractor or subcontractor, respectively, further acknowledges that the CPO may declare the related contract void if this certification is false or if the bidder, contractor, or subcontractor, or any affiliate, is determined to be delinquent in the payment of any debt to the State during the term of the contract.

D. Prohibited Bidders, Contractors and Subcontractors

Section 50-10.5 and 50-60(c). Prohibited bidders, contractors and subcontractors.

The bidder or contractor or subcontractor, respectively, certifies in accordance with 30 ILCS 500/50-10.5 that no officer, director, partner or other managerial agent of the contracting business has been convicted of a felony under the Sarbanes-Oxley Act of 2002 or a Class 3 or Class 2 felony under the Illinois Securities Law of 1953 or if in violation of Subsection (c) for a period of five years from the date of conviction. Every bid submitted to and contract executed by the State and every subcontract subject to Section 20-120 of the Code shall contain a certification by the bidder, contractor, or subcontractor, respectively, that the bidder, contractor, or subcontractor is not barred from being awarded a contract or subcontract under this Section and acknowledges that the CPO shall declare the related contract void if any of the certifications completed pursuant to this Section are false.

E. Section 42 of the Environmental Protection Act

The bidder or contractor or subcontractor, respectively, certifies in accordance with 30 ILCS 500/50-14 that the bidder, contractor, or subcontractor, is not barred from being awarded a contract or entering into a subcontract under this Section which prohibits the bidding on or entering into contracts with the State of Illinois or a State agency, or entering into any subcontract, that is subject to the Code by a person or business found by a court or the Pollution Control Board to have committed a willful or knowing violation of Section 42 of the Environmental Protection Act for a period of five years from the date of the order. The bidder or contractor or subcontractor, respectively, acknowledges that the CPO may declare the contract void if this certification is false.

The undersigned, on behalf of the subcontracting company, has read and understands the above certifications and makes the certifications as required by law.

_____ Name of Subcontracting Company		
_____ Authorized Officer	_____ Date	

RETURN WITH SUBCONTRACT
SUBCONTRACTOR DISCLOSURES

I. DISCLOSURES

- A.** The disclosures hereinafter made by the subcontractor are each a material representation of fact upon which reliance is placed. The subcontractor further certifies that the Department has received the disclosure forms for each subcontract.

The CPO may void the bid, contract, or subcontract, respectively, if it is later determined that the bidder or subcontractor rendered a false or erroneous disclosure. A contractor or subcontractor may be suspended or debarred for violations of the Code. Furthermore, the CPO may void the contract.

B. Financial Interests and Conflicts of Interest

1. Section 50-35 of the Code provides that all subcontracts with a total value of \$50,000 or more from subcontractors identified in Section 20-120 of the Code, shall be accompanied by disclosure of the financial interests of the subcontractor. This disclosed information for the subcontractor, will be maintained as public information subject to release by request pursuant to the Freedom of Information Act, filed with the Procurement Policy Board, and shall be incorporated as a material term of the Prime Contractor's contract. Furthermore, pursuant to this Section, the Procurement Policy Board may recommend to allow or void a contract or subcontract based on a potential conflict of interest.

The financial interests to be disclosed shall include ownership or distributive income share that is in excess of 5%, or an amount greater than 60% of the annual salary of the Governor, of the subcontracting entity or its parent entity, whichever is less, unless the subcontractor is a publicly traded entity subject to Federal 10K reporting, in which case it may submit its 10K disclosure in place of the prescribed disclosure. If a subcontractor is a privately held entity that is exempt from Federal 10K reporting, but has more than 200 shareholders, it may submit the information that Federal 10K companies are required to report, and list the names of any person or entity holding any ownership share that is in excess of 5%. The disclosure shall include the names, addresses, and dollar or proportionate share of ownership of each person making the disclosure, their instrument of ownership or beneficial relationship, and notice of any potential conflict of interest resulting from the current ownership or beneficial interest of each person making the disclosure having any of the relationships identified in Section 50-35 and on the disclosure form.

The current annual salary of the Governor is \$177,412.00.

In addition, all disclosures shall indicate any other current or pending contracts, subcontracts, proposals, leases, or other ongoing procurement relationships the subcontracting entity has with any other unit of state government and shall clearly identify the unit and the contract, subcontract, proposal, lease, or other relationship.

2. Disclosure Forms. Disclosure Form A is attached for use concerning the individuals meeting the above ownership or distributive share requirements. A separate Disclosure Form A must be submitted with the bid for each individual meeting the above requirements. In addition, a second form (Disclosure Form B) provides for the disclosure of current or pending procurement relationships with other (non-IDOT) state agencies and a total ownership certification. **The forms must be included with each bid.**

C. Disclosure Form Instructions

Form A Instructions for Financial Information & Potential Conflicts of Interest

If the subcontractor is a publicly traded entity subject to Federal 10K reporting, the 10K Report may be submitted to meet the requirements of Form A. If a subcontractor is a privately held entity that is exempt from Federal 10K reporting, but has more than 200 shareholders, it may submit the information that Federal 10K companies are required to report, and list the names of any person or entity holding any ownership share that is in excess of 5%. If a subcontractor is not subject to Federal 10K reporting, the subcontractor must determine if any individuals are required by law to complete a financial disclosure form. To do this, the subcontractor should answer each of the following questions. A "YES" answer indicates Form A must be completed. If the answer to each of the following questions is "NO", then the NOT APPLICABLE STATEMENT on the second page of Form A must be signed and dated by a person that is authorized to execute contracts for the subcontracting company. Note: These questions are for assistance only and are not required to be completed.

1. Does anyone in your organization have a direct or beneficial ownership share of greater than 5% of the bidding entity or parent entity? YES ___ NO ___
2. Does anyone in your organization have a direct or beneficial ownership share of less than 5%, but which has a value greater than 60% of the annual salary of the Governor? YES ___ NO ___
3. Does anyone in your organization receive more than 60% of the annual salary of the Governor of the subcontracting entity's or parent entity's distributive income? YES ___ NO ___

(Note: Distributive income is, for these purposes, any type of distribution of profits. An annual salary is not distributive income.)

4. Does anyone in your organization receive greater than 5% of the subcontracting entity's or parent entity's total distributive income, but which is less than 60% of the annual salary of the Governor? YES ___ NO ___

(Note: Only one set of forms needs to be completed per person per subcontract even if a specific individual would require a yes answer to more than one question.)

A "YES" answer to any of these questions requires the completion of Form A. The subcontractor must determine each individual in the subcontracting entity or the subcontracting entity's parent company that would cause the questions to be answered "Yes". Each form must be signed and dated by a person that is authorized to execute contracts for your organization. **Photocopied or stamped signatures are not acceptable.** The person signing can be, but does not have to be, the person for which the form is being completed. The subcontractor is responsible for the accuracy of any information provided.

If the answer to each of the above questions is "NO", then the NOT APPLICABLE STATEMENT on page 2 of Form A must be signed and dated by a person that is authorized to execute contracts for your company.

RETURN WITH SUBCONTRACT

Form B: Instructions for Identifying Other Contracts & Procurement Related Information

Disclosure Form B must be completed for each subcontract submitted by the subcontracting entity. *Note: Checking the NOT APPLICABLE STATEMENT on Form A does not allow the subcontractor to ignore Form B. Form B must be completed, checked, and dated or the subcontract will not be approved.*

The Subcontractor shall identify, by checking Yes or No on Form B, whether it has any pending contracts, subcontracts, leases, bids, proposals, or other ongoing procurement relationship with any other (non-IDOT) State of Illinois agency. If "No" is checked, the subcontractor only needs to complete the check box on the bottom of Form B. If "Yes" is checked, the subcontractor must list all non-IDOT State of Illinois agency pending contracts, subcontracts, leases, bids, proposals, and other ongoing procurement relationships. These items may be listed on Form B or on an attached sheet(s). Contracts with cities, counties, villages, etc. are not considered State of Illinois agency contracts and are not to be included. Contracts or subcontracts with other State of Illinois agencies such as the Department of Natural Resources or the Capital Development Board must be included.

ILLINOIS DEPARTMENT OF TRANSPORTATION

Form A Subcontractor: Financial Information & Potential Conflicts of Interest Disclosure

Subcontractor Name, Legal Address, City, State, Zip, Telephone Number, Email Address, Fax Number (if available)

Disclosure of the information contained in this Form is required by the Section 50-35 of the Code (30 ILCS 500). Subcontractors desiring to enter into a subcontract of a State of Illinois contract must disclose the financial information and potential conflict of interest information as specified in this Disclosure Form.

The current annual salary of the Governor is \$177,412.00.

DISCLOSURE OF FINANCIAL INFORMATION

1. Disclosure of Financial Information. The individual named below has an interest in the SUBCONTRACTOR (or its parent) in terms of ownership or distributive income share in excess of 5%, or an interest which has a value of more than 60% of the annual salary of the Governor.

FOR INDIVIDUAL (type or print information) NAME: ADDRESS Type of ownership/distributable income share: stock sole proprietorship Partnership other: (explain on separate sheet): % or \$ value of ownership/distributable income share:

2. Disclosure of Potential Conflicts of Interest. Check "Yes" or "No" to indicate which, if any, of the following potential conflict of interest relationships apply. If the answer to any question is "Yes", please attach additional pages and describe.

(a) State employment, currently or in the previous 3 years, including contractual employment of services. Yes ___ No ___

If your answer is yes, please answer each of the following questions.

1. Are you currently an officer or employee of either the Capitol Development Board or the Illinois State Toll Highway Authority? Yes ___ No ___

2. Are you currently appointed to or employed by any agency of the State of Illinois? If you are currently appointed to or employed by any agency of the State of Illinois, and your annual salary exceeds 60% of the annual salary of the Governor, provide the name the State agency for which you are employed and your annual salary.

RETURN WITH SUBCONTRACT

3. If you are currently appointed to or employed by any agency of the State of Illinois, and your annual salary exceeds 60% of the annual salary of the Governor, are you entitled to receive (i) more than 7 1/2% of the total distributable income of your firm, partnership, association or corporation, or (ii) an amount in excess of 100% of the annual salary of the Governor?
Yes ___ No ___

4. If you are currently appointed to or employed by any agency of the State of Illinois, and your annual salary exceeds 60% of the annual salary of the Governor, are you and your spouse or minor children entitled to receive (i) more than 15 % in the aggregate of the total distributable income of your firm, partnership, association or corporation, or (ii) an amount in excess of two times the salary of the Governor?
Yes ___ No ___

(b) State employment of spouse, father, mother, son, or daughter, including contractual employment services in the previous 2 years.

Yes ___ No ___

If your answer is yes, please answer each of the following questions.

1. Is your spouse or any minor children currently an officer or employee of the Capitol Development Board or the Illinois Toll Highway Authority?
Yes ___ No ___

2. Is your spouse or any minor children currently appointed to or employed by any agency of the State of Illinois? If your spouse or minor children is/are currently appointed to or employed by any agency of the State of Illinois, and his/her annual salary exceeds 60% of the annual salary of the Governor, provide the name of your spouse and/or minor children, the name of the State agency for which he/she is employed and his/her annual salary. _____

3. If your spouse or any minor children is/are currently appointed to or employed by any agency of the State of Illinois, and his/her annual salary exceeds 60% of the annual salary of the Governor, as of 7/1/07) are you entitled to receive (i) more then 7 1/2% of the total distributable income of your firm, partnership, association or corporation, or (ii) an amount in excess of 100% of the annual salary of the Governor?
Yes ___ No ___

4. If your spouse or any minor children are currently appointed to or employed by any agency of the State of Illinois, and his/her annual salary exceeds 60% of the annual salary of the Governor, are you and your spouse or minor children entitled to receive (i) more than 15 % in the aggregate of the total distributable income of your firm, partnership, association or corporation, or (ii) an amount in excess of two times the annual salary of the Governor?
Yes ___ No ___

(c) Elective status; the holding of elective office of the State of Illinois, the government of the United States, any unit of local government authorized by the Constitution of the State of Illinois or the statutes of the State of Illinois currently or in the previous 3 years.
Yes ___ No ___

(d) Relationship to anyone holding elective office currently or in the previous 2 years; spouse, father, mother, son, or daughter.
Yes ___ No ___

(e) Appointive office; the holding of any appointive government office of the State of Illinois, the United States of America, or any unit of local government authorized by the Constitution of the State of Illinois or the statutes of the State of Illinois, which office entitles the holder to compensation in excess of the expenses incurred in the discharge of that office currently or in the previous 3 years.
Yes ___ No ___

(f) Relationship to anyone holding appointive office currently or in the previous 2 years; spouse, father, mother, son, or daughter.
Yes ___ No ___

(g) Employment, currently or in the previous 3 years, as or by any registered lobbyist of the State government.
Yes ___ No ___

RETURN WITH SUBCONTRACT

(h) Relationship to anyone who is or was a registered lobbyist in the previous 2 years; spouse, father, mother, son, or daughter. Yes ___ No ___

(i) Compensated employment, currently or in the previous 3 years, by any registered election or reelection committee registered with the Secretary of State or any county clerk of the State of Illinois, or any political action committee registered with either the Secretary of State or the Federal Board of Elections. Yes ___ No ___

(j) Relationship to anyone; spouse, father, mother, son, or daughter; who was a compensated employee in the last 2 years by any registered election or re-election committee registered with the Secretary of State or any county clerk of the State of Illinois, or any political action committee registered with either the Secretary of State or the Federal Board of Elections. Yes ___ No ___

3 Communication Disclosure.

Disclose the name and address of each lobbyist and other agent of the bidder or offeror who is not identified in Section 2 of this form, who is has communicated, is communicating, or may communicate with any State officer or employee concerning the bid or offer. This disclosure is a continuing obligation and must be promptly supplemented for accuracy throughout the process and throughout the term of the contract. If no person is identified, enter "None" on the line below:

Name and address of person(s): _____

RETURN WITH SUBCONTRACT

4. Debarment Disclosure. For each of the persons identified under Sections 2 and 3 of this form, disclose whether any of the following has occurred within the previous 10 years: debarment from contracting with any governmental entity; professional licensure discipline; bankruptcies; adverse civil judgments and administrative findings; and criminal felony convictions. This disclosure is a continuing obligation and must be promptly supplemented for accuracy throughout the procurement process and term of the contract. If no person is identified, enter "None" on the line below:

Name of person(s): _____

Nature of disclosure: _____

APPLICABLE STATEMENT

This Disclosure Form A is submitted on behalf of the INDIVIDUAL named on previous page. Under penalty of perjury, I certify the contents of this disclosure to be true and accurate to the best of my knowledge.

Completed by: _____ Date _____
Signature of Individual or Authorized Officer

NOT APPLICABLE STATEMENT

Under penalty of perjury, I have determined that no individuals associated with this organization meet the criteria that would require the completion of this Form A.

This Disclosure Form A is submitted on behalf of the SUBCONTRACTOR listed on the previous page.

_____ Date _____
Signature of Authorized Officer

RETURN WITH SUBCONTRACT

ILLINOIS DEPARTMENT OF TRANSPORTATION

Form B
Subcontractor: Other Contracts & Financial Related Information Disclosure

Form with fields: Subcontractor Name, Legal Address, City, State, Zip, Telephone Number, Email Address, Fax Number (if available)

Disclosure of the information contained in this Form is required by the Section 50-35 of the Code (30 ILCS 500). This information shall become part of the publicly available contract file. This Form B must be completed for subcontracts with a total value of \$50,000 or more, from subcontractors identified in Section 20-120 of the Code, and for all open-ended contracts.

DISCLOSURE OF OTHER CONTRACTS, SUBCONTRACTS, AND PROCUREMENT RELATED INFORMATION

1. Identifying Other Contracts & Procurement Related Information. The SUBCONTRACTOR shall identify whether it has any pending contracts, subcontracts, including leases, bids, proposals, or other ongoing procurement relationship with any other State of Illinois agency: Yes ___ No ___

If "No" is checked, the subcontractor only needs to complete the signature box on the bottom of this page.

2. If "Yes" is checked. Identify each such relationship by showing State of Illinois agency name and other descriptive information such as bid or project number (attach additional pages as necessary). SEE DISCLOSURE FORM INSTRUCTIONS:

THE FOLLOWING STATEMENT MUST BE CHECKED

Signature box with fields: Signature of Authorized Representative, Date

OWNERSHIP CERTIFICATION

Please certify that the following statement is true if the individuals for all submitted Form A disclosures do not total 100% of ownership

Any remaining ownership interest is held by individuals receiving less than \$106,447.20 of the bidding entity's or parent entity's distributive income or holding less than a 5% ownership interest.

Yes No N/A (Form A disclosure(s) established 100% ownership)



NOTICE TO BIDDERS

1. TIME AND PLACE OF OPENING BIDS. Sealed proposals for the improvement described herein will be received by the Department of Transportation. Electronic bids are to be submitted to the electronic bidding system (icx-Integrated Contractors Exchange). Paper-based bids are to be submitted to the Chief Procurement Officer for the Department of Transportation in care of the Chief Contracts Official at the Harry R. Hanley Building, 2300 South Dirksen Parkway, in Springfield, Illinois until 10:00 o'clock a.m. June 13, 2014. All bids will be gathered, sorted, publicly opened and read in the auditorium at the Department of Transportation's Harry R. Hanley Building shortly after the 10:00 a.m. cut off time.

2. DESCRIPTION OF WORK. The proposed improvement is identified and advertised for bids in the Invitation for Bids as:

**Contract No. 64K05
WINNEBAGO County
Section (148CS)TS
Route FAP 303
District 2 Construction Funds**

Traffic control upgrade at five intersections along WB US Business Route 20 (Jefferson St.) in Rockford.

3. INSTRUCTIONS TO BIDDERS. (a) This Notice, the invitation for bids, proposal and letter of award shall, together with all other documents in accordance with Article 101.09 of the Standard Specifications for Road and Bridge Construction, become part of the contract. Bidders are cautioned to read and examine carefully all documents, to make all required inspections, and to inquire or seek explanation of the same prior to submission of a bid.

(b) State law, and, if the work is to be paid wholly or in part with Federal-aid funds, Federal law requires the bidder to make various certifications as a part of the proposal and contract. By execution and submission of the proposal, the bidder makes the certification contained therein. A false or fraudulent certification shall, in addition to all other remedies provided by law, be a breach of contract and may result in termination of the contract.

4. AWARD CRITERIA AND REJECTION OF BIDS. This contract will be awarded to the lowest responsive and responsible bidder considering conformity with the terms and conditions established by the Department in the rules, Invitation for Bids and contract documents. The issuance of plans and proposal forms for bidding based upon a prequalification rating shall not be the sole determinant of responsibility. The Department reserves the right to determine responsibility at the time of award, to reject any or all proposals, to readvertise the proposed improvement, and to waive technicalities.

By Order of the
Illinois Department of Transportation

Ann L. Schneider,
Secretary

INDEX
 FOR
 SUPPLEMENTAL SPECIFICATIONS
 AND RECURRING SPECIAL PROVISIONS

Adopted January 1, 2014

This index contains a listing of SUPPLEMENTAL SPECIFICATIONS, frequently used RECURRING SPECIAL PROVISIONS, and LOCAL ROADS AND STREETS RECURRING SPECIAL PROVISIONS.

ERRATA Standard Specifications for Road and Bridge Construction (Adopted 1-1-12) (Revised 1-1-14)

SUPPLEMENTAL SPECIFICATIONS

<u>Std. Spec. Sec.</u>	<u>Page No.</u>
101 Definition of Terms	1
102 Advertisement, Bidding, Award, and Contract Execution	2
105 Control of Work	3
106 Control of Materials	5
107 Legal Regulations and Responsibility to Public	6
108 Prosecution and Progress	14
109 Measurement and Payment	15
202 Earth and Rock Excavation	17
211 Topsoil and Compost	18
253 Planting Woody Plants	19
280 Temporary Erosion and Sediment Control	21
312 Stabilized Subbase	22
406 Hot-Mix Asphalt Binder and Surface Course	23
407 Hot-Mix Asphalt Pavement (Full-Depth)	26
420 Portland Cement Concrete Pavement	30
424 Portland Cement Concrete Sidewalk	32
440 Removal of Existing Pavement and Appurtenances	33
503 Concrete Structures	34
504 Precast Concrete Structures	37
506 Cleaning and Painting New Steel Structures	38
512 Piling	39
516 Drilled Shafts	40
521 Bearings	41
540 Box Culverts	42
588 Bridge Relief Joint System	43
589 Elastic Joint Sealer	45
602 Catch Basin, Manhole, Inlet, Drainage Structure, and Valve Vault Construction, Adjustment, and Reconstruction	46
603 Adjusting Frames and Grates of Drainage and Utility Structures	47
606 Concrete Gutter, Curb, Median, and Paved Ditch	49
610 Shoulder Inlets with Curb	50
639 Precast Prestressed Concrete Sight Screen	51
642 Shoulder Rumble Strips	52
643 Impact Attenuators	53
644 High Tension Cable Median Barrier	55
701 Work Zone Traffic Control and Protection	57

706	Impact Attenuators, Temporary	60
707	Movable Traffic Barrier	63
708	Temporary Water Filled Barrier	65
730	Wood Sign Support	67
780	Pavement Striping	68
860	Master Controller	73
1001	Cement	74
1003	Fine Aggregates	75
1004	Coarse Aggregates	77
1006	Metals	81
1011	Mineral Filler	83
1017	Packaged, Dry, Combined Materials for Mortar	84
1018	Packaged Rapid Hardening Mortar or Concrete	85
1019	Controlled Low-Strength Material	86
1020	Portland Cement Concrete	87
1024	Grout and Nonshrink Grout	126
1030	Hot-Mix Asphalt	127
1040	Drain Pipe, Tile, Drainage Mat, and Wall Drain	132
1042	Precast Concrete Products	133
1070	Foundation and Breakaway Devices	134
1073	Controller	135
1081	Materials for Planting	136
1082	Prefomed Bearing Pads	137
1083	Elastomeric Bearings	138
1095	Pavement Markings	139
1101	General Equipment	142
1102	Hot-Mix Asphalt Equipment	144
1105	Pavement Marking Equipment	146
1106	Work Zone Traffic Control Devices	147

RECURRING SPECIAL PROVISIONS

The following RECURRING SPECIAL PROVISIONS indicated by an “X” are applicable to this contract and are included by reference:

<u>CHECK SHEET #</u>	<u>PAGE NO.</u>
1	149
	Additional State Requirements for Federal-Aid Construction Contracts (Eff. 2-1-69) (Rev. 1-1-10)
2	152
	Subletting of Contracts (Federal-Aid Contracts) (Eff. 1-1-88) (Rev. 5-1-93)
3	153
X	EEO (Eff. 7-21-78) (Rev. 11-18-80)
4	163
X	Specific Equal Employment Opportunity Responsibilities Non Federal-Aid Contracts (Eff. 3-20-69) (Rev. 1-1-94)
5	168
X	Required Provisions - State Contracts (Eff. 4-1-65) (Rev. 1-1-13)
6	173
	Asbestos Bearing Pad Removal (Eff. 11-1-03)
7	174
	Asbestos Waterproofing Membrane and Asbestos Hot-Mix Asphalt Surface Removal (Eff. 6-1-89) (Rev. 1-1-09)
8	175
	Haul Road Stream Crossings, Other Temporary Stream Crossings, and In-Stream Work Pads (Eff. 1-2-92) (Rev. 1-1-98)
9	176
	Construction Layout Stakes Except for Bridges (Eff. 1-1-99) (Rev. 1-1-07)
10	179
	Construction Layout Stakes (Eff. 5-1-93) (Rev. 1-1-07)
11	182
	Use of Geotextile Fabric for Railroad Crossing (Eff. 1-1-95) (Rev. 1-1-07)
12	184
	Subsealing of Concrete Pavements (Eff. 11-1-84) (Rev. 1-1-07)
13	188
	Hot-Mix Asphalt Surface Correction (Eff. 11-1-87) (Rev. 1-1-09)
14	190
	Pavement and Shoulder Resurfacing (Eff. 2-1-00) (Rev. 1-1-09)
15	191
	PCC Partial Depth Hot-Mix Asphalt Patching (Eff. 1-1-98) (Rev. 1-1-07)
16	193
	Patching with Hot-Mix Asphalt Overlay Removal (Eff. 10-1-95) (Rev. 1-1-07)
17	194
	Polymer Concrete (Eff. 8-1-95) (Rev. 1-1-08)
18	196
	PVC Pipeliner (Eff. 4-1-04) (Rev. 1-1-07)
19	197
	Pipe Underdrains (Eff. 9-9-87) (Rev. 1-1-07)
20	198
	Guardrail and Barrier Wall Delineation (Eff. 12-15-93) (Rev. 1-1-12)
21	202
	Bicycle Racks (Eff. 4-1-94) (Rev. 1-1-12)
22	204
	Temporary Modular Glare Screen System (Eff. 1-1-00) (Rev. 1-1-07)
23	206
	Temporary Portable Bridge Traffic Signals (Eff. 8-1-03) (Rev. 1-1-07)
24	208
	Work Zone Public Information Signs (Eff. 9-1-02) (Rev. 1-1-07)
25	209
	Night Time Inspection of Roadway Lighting (Eff. 5-1-96)
26	210
	English Substitution of Metric Bolts (Eff. 7-1-96)
27	211
	English Substitution of Metric Reinforcement Bars (Eff. 4-1-96) (Rev. 1-1-03)
28	212
	Calcium Chloride Accelerator for Portland Cement Concrete (Eff. 1-1-01) (Rev. 1-1-13)
29	213
	Portland Cement Concrete Inlay or Overlay for Pavements (Eff. 11-1-08) (Rev. 1-1-13)
30	216
	Quality Control of Concrete Mixtures at the Plant (Eff. 8-1-00) (Rev. 1-1-14)
31	224
	Quality Control/Quality Assurance of Concrete Mixtures (Eff. 4-1-92) (Rev. 1-1-14)
32	240
	Digital Terrain Modeling for Earthwork Calculations (Eff. 4-1-07)
33	242
	Pavement Marking Removal (Eff. 4-1-09)
34	243
	Preventive Maintenance – Bituminous Surface Treatment (Eff. 1-1-09) (Rev. 1-1-12)
35	249
	Preventive Maintenance – Cape Seal (Eff. 1-1-09) (Rev. 1-1-12)
36	264
	Preventive Maintenance – Micro-Surfacing (Eff. 1-1-09) (Rev. 1-1-12)
37	275
	Preventive Maintenance – Slurry Seal (Eff. 1-1-09) (Rev. 1-1-12)
38	285
	Temporary Raised Approach Markers (Eff. 1-1-09) (Rev. 1-1-14)
39	286
	Restoring Bridge Approach Pavements Using High-Density Foam (Eff. 1-1-09) (Rev. 1-1-12)

TABLE OF CONTENTS

LOCATION OF PROJECT	1
DESCRIPTION OF PROJECT	1
TRAFFIC CONTROL PLAN	1
MAINTENANCE OF EXISTING TRAFFIC SIGNAL INSTALLATION	3
FULL ACTUATED CONTROLLER AND TYPE III CABINET	4
REMOVE EXISTING TRAFFIC SIGNAL EQUIPMENT	5
CONTRACT CLAIMS (BDE)	6
DISADVANTAGED BUSINESS ENTERPRISE PARTICIPATION (BDE)	7
PAYROLLS AND PAYROLL RECORDS (BDE)	17
PROGRESS PAYMENTS (BDE)	19
REMOVAL AND DISPOSAL OF REGULATED SUBSTANCES (BDE)	19
REMOVAL AND DISPOSAL OF SURPLUS MATERIALS (BDE)	23
TRACKING THE USE OF PESTICIDES (BDE)	24
WEEKLY DBE TRUCKING REPORTS (BDE)	24
WORKING DAYS (BDE)	25

STATE OF ILLINOIS

SPECIAL PROVISIONS

The following Special Provisions supplement the "Standard Specifications for Road and Bridge Construction, Adopted January 1, 2012", the latest edition of the "Manual on Uniform Traffic Control Devices for Streets and Highways", and the "Manual of Test Procedures for Materials" in effect on the date of invitation for bids, and the "Supplemental Specifications and Recurring Special Provisions" indicated on the Check Sheet included herein, which apply to and govern the construction of FAP 303 (US 20), Section (148CS)TS, Winnebago County, Contract 64K05, and in case of conflict with any part, or parts, of said Specifications, the said Special Provisions shall take precedence and shall govern.

LOCATION OF PROJECT

Along westbound Business Route 20 (Jefferson Street) from Main Street to 3rd Street in Rockford.

DESCRIPTION OF PROJECT

Upgrade traffic signal equipment at five intersections along westbound Business Route US 20 (Jefferson Street)

TRAFFIC CONTROL PLAN

Effective January 14, 1999

Revised: August 23, 2013

Traffic Control shall be according to the applicable sections of the Standard Specifications for Road and Bridge Construction, the applicable guidelines contained in the National Manual on Uniform Traffic Control Devices for Streets and Highways, Illinois Supplement to the National Manual on Uniform Traffic Control Devices, these special provisions, and any special details and Highway Standards contained herein and in the plans.

Special attention is called to Articles 107.09 and 107.14 of the Standard Specifications for Road and Bridge Construction and the following Highway Standards relating to traffic control.

Standards:

701006

701502

701601

701606

701801

701901

Signs:

No bracing shall be allowed on post-mounted signs.

All signs are required on both sides of the road when the median is greater than 10 feet and on one way roadways.

The "WORKERS" (W21-1a(O)-48) signs shall be replaced with symbol "Right or Left Lane Closed Ahead" (W4-2R or L(O)-48) signs on multilane sections with a lane closure.

Devices:

Cones or reflectorized cones shall not be used during hours of darkness.

A minimum of 3 drums spaced at 4 feet shall be placed at each return when the sideroad is open.

On all standards, and the devices listed in Section 701 of the Standard Specifications, the device spacing shall be revised to the following dimensions:

Where the spacing shown on the standard is 25 feet, the devices shall be placed at 20 feet.
Where the spacing shown on the standard is 50 feet, the devices shall be placed at 40 feet.
Where the spacing shown on the standard is 100 feet, the devices shall be placed at 80 feet.

Direction Indicator Barricades shall exclusively be used in lane closure tapers. They shall be used only when traffic is being merged with an adjacent through lane or shifted onto a median crossover. The backside of the direction indicator barricade shall look like a standard Type II barricade when opposing traffic is within 12' of the device.

Vertical barricades shall not be used as a device where the existing speed limit is 65 mph or greater.

Flagger at Sideroads and Commercial Entrances:

Effective: August 1, 2011

Flaggers shall comply with all requirements contained in the Department's "Flagger Handbook" dated September 2011. The flagger equipment listed for flaggers employed by the Illinois Department of Transportation shall apply to all flaggers.

All workers and flaggers shall wear ANSI Class E pants and an ANSI Class 2 vest that in combination meet the requirements of ANSI/ISEA 107-2004 for Conspicuity Class 3 garments during hours of darkness.

In addition to the flaggers shown on applicable standards, on major sideroads flaggers shall be required on all legs of the intersection. Flaggers are required on all legs of the intersections using 701201 or 701301.

When the mainline flagger is within 200 feet of an intersection, the sideroad flagger shall be required.

When the road is closed to through traffic and it is necessary to provide access for local traffic, all flaggers as shown on the applicable standards will be required. No reduction in the number of flaggers shall be allowed.

Revise the first and second paragraph of Article 701.20(i) of the Standard Specifications to read:

“Signs, barricades, or other traffic control devices required by the Engineer, over and above those shown on the standard or detailed in the plans and provisions, will be paid for according to Article 109.04. All flaggers required at sideroads and commercial entrances remaining open to traffic not shown on the Highway Standards, required by article 701.13(a) or listed above, shall be paid for according to Article 109.04.”

Maintenance of Traffic:

The Contractor shall have all lanes open on weekends.

No lane closures are allowed during non-working hours.

Traffic on Jefferson Street, 2nd Street (IL 251 southbound), and 3rd Street (IL 251 northbound) shall be maintained using Standard 701601. Standard 701601 shall be used to close the right turn lane on Jefferson Street at Wyman.

The allowable work hours for closing two lanes on Jefferson and IL 251 are from 9:00 AM to 1:00 PM. At all other times only one lane may be closed.

Traffic on 1st Street shall be maintained using Traffic Control Detail in the plans for work along the east side of 1st Street. This work shall be paid for according to Traffic Control and Protection Standard 701502. Standard 701006 shall be used for work along the west side of 1st Street.

Traffic on Wyman Street shall be maintained using Traffic Control Detail in the plans. This work shall be paid for according to Standard 701606.

Traffic on Main Street shall be maintained using 701006.

MAINTENANCE OF EXISTING TRAFFIC SIGNAL INSTALLATION

This work shall be in accordance with Section 850 of the current Standard and Specifications for Road and Bridge Construction.

This work shall consist of maintaining an existing traffic signal installation that has been designated to remain in operation during modification.

Basis of Payment: This work will be paid for at the contract unit price lump sum. Each completed work at an intersection has been pro-rated at a percentage for **MAINTENANCE OF EXISTING TRAFFIC SIGNAL INSTALLATION**.

FULL ACTUATED CONTROLLER AND TYPE III CABINET

This item shall consist of furnishing, installing and placing into operation a multi-phase microprocessor based controller at the location indicated on the plans, or as directed by the Engineer. The controller shall comply with the requirements of Section 857, 1073.01 and 1074.03 of the current "Standard Specifications for Road and Bridge Construction" and the following additions and exceptions.

The controller shall meet the requirements of the NEMA TS2 standards for a Type 2 controller. Data entry shall be by keyboard or personal computer.

The cabinet shall have an aluminum finish. If rivets are exposed on the outside of the cabinet, they shall be either stainless steel or aluminum to prevent oxidation.

The police door compartment shall contain a manual control cord which the signals may be operated manually. The inside door toggle switch shall be protected from accidental contact by vertical metal slats. The slats shall extend beyond the switches, in a manner similar to the terminals on the back panel. A plastic plans holder shall be installed on the cabinet door. The holder shall be at least 11 inches high by 17 inches wide, shall open from the side and shall not interfere with the filter. The holder shall have a means of closing the side opening to prevent water from entering.

A Plexiglas cover, or other high strength nonconductive cover, shall be installed over, and completely cover, the power panel. The cover shall completely shield the service wires, and circuit breaker wires from accidental contact.

A Plexiglas cover, or other high strength nonconductive cover, shall be installed over and completely cover, the power terminals for the thermostatically controlled exhaust fan. The thermostat shall be of the knob type capable of adjustment by hand and without tools. The thermostat and terminals shall be mounted on the left or right side of the controller cabinet.

The traffic signal cabinet shall be equipped with a cabinet-door-switchable LED service light fixture.

The contractor shall have a factory-trained technician from the manufacturer and/or supplier, with expertise in the controllers being installed, present during the controller installation. He will be expected to be able to program the controller timer, trouble-shoot and correct any problems with the equipment that arises and verify that the equipment is functioning according to the plans and specifications.

The traffic signal controller and cabinet assembly shall be fully tested by the equipment supplier. The supplier of the controller assembly shall provide a Certificate of Acceptance verifying that the conflict monitor has been tested, under load, for all possible combinations and functions properly.

TRANSFER SWITCH

This work shall consist of furnishing and installing a Transfer Switch on the outside of a traffic controller cabinet, no less than 24" above ground level, for the use of an emergency generator to power the signals in case of a signal blackout. The Transfer Switch shall in accordance with the 2002 National Electrical Code Article 702.6 to prevent feeding back to the utility source.

The switch shall be rated for 20 amps at 125 volts with a jumper cord for transitioned from the twist-lok plug in the transfer switch to the standard 120 volt plug for the generator.

A circuit breaker-base switch shall be required to have overload protection in accordance with the National Electric Code/NFPA70.

The housing shall be no less than a heavy duty 12 gauge rust and corrosion-resistant material.

The housing surface shall be smooth, free of marks and scratches and provide an unpainted aluminum finish.

The housing shall be rain tight with the outlet connect underneath the box to maintain the rain tight rating.

The Switch shall be equipped with a sliding interlock to prevent the generator and the utility from feeding the circuit at the same time.

The Switch shall be tamper resistant with a #2 key lock system.

The Transfer Switch shall come with a 2 year warranty.

This item will not be paid for separately, but shall be included in the cost of the FULL ACTUATED CONTROLLER TYPE III CABINET.

Basis of Payment:

This item shall be paid for at the contract unit price EACH for **FULL ACTUATED CONTROLLER TYPE III CABINET**, which price shall be payment in full for furnishing the equipment described above and installing it in satisfactory operating condition.

REMOVE EXISTING TRAFFIC SIGNAL EQUIPMENT

This work shall consist of removing all the existing traffic signal equipment at the following intersections. The City shall retain all 12 inch signal heads, all 12 inch (crate style) pedestrian heads and any salvageable cabinets. All 8 inch signal heads or other non-salvageable items can be retained by the Contractor at these locations:

US BR 20 (East Jefferson Street) at 1st Street
Controller Cabinet Type III
1 Signal Post
1 3- Section Bracket Mounted Signal Head
8 Pedestrian Signal Heads

US BR 20 (East Jefferson Street) at 2nd Street (IL 251 SB)

Controller Cabinet Type III

1 Signal Post

1 3- Section Bracket Mounted Signal Head

6 3-Section Mast Arm Mounted Signal Heads

8 Pedestrian Signal Heads

US BR 20 (East Jefferson Street) at 3rd Street (IL 251 NB)

Controller Cabinet Type III

1 Signal Post

1 3- Section Bracket Mounted Signal Head

3 3-Section Mast Arm Mounted Signal Heads

8 Pedestrian Signal Heads

US BR 20 (West Jefferson Street) at Wyman Street (IL 2 NB)

1 3- Section Bracket Mounted Signal Head

4 3-Section Mast Arm Mounted Signal Heads

8 Pedestrian Signal Heads

US BR 20 (Jefferson Street) at Main Street

Controller Cabinet Type III

8 3- Section Bracket Mounted Signal Head

2 3-Section Mast Arm Mounted Signal Heads

8 Pedestrian Signal Heads

Other incidental equipment may be included as directed by the Engineer and shall remain the property of the Contractor or City accordingly. The Contractor shall be responsible for repairing or replacing any items of equipment damaged during the process to the satisfaction of the Engineer.

This also will be in accordance with Section 895 of the current "Standard Specifications for Road and Bridge Construction".

Basis of Payment:

This work will be paid for at the contract unit price each for **REMOVE EXISTING TRAFFIC SIGNAL EQUIPMENT**, which price shall be payment in full for removing the equipment and disposing of it as directed.

CONTRACT CLAIMS (BDE)

Effective: April 1, 2014

Revise the first paragraph of Article 109.09(a) of the Standard Specifications to read:

"(a) Submission of Claim. All claims filed by the Contractor shall be in writing and in sufficient detail to enable the Department to ascertain the basis and amount of the claim. As a minimum, the following information must accompany each claim submitted."

Revise Article 109.09(e) of the Standard Specifications to read:

“(e) Procedure. The Department provides two administrative levels for claims review.

Level I Engineer of Construction
Level II Chief Engineer/Director of Highways or Designee

- (1) Level I. All claims shall first be submitted at Level I. Two copies each of the claim and supporting documentation shall be submitted simultaneously to the District and the Engineer of Construction. The Engineer of Construction, in consultation with the District, will consider all information submitted with the claim and render a decision on the claim within 90 days after receipt by the Engineer of Construction. Claims not conforming to this Article will be returned without consideration. The Engineer of Construction may schedule a claim presentation meeting if in the Engineer of Construction’s judgment such a meeting would aid in resolution of the claim, otherwise a decision will be made based on the claim documentation submitted. If a Level I decision is not rendered within 90 days of receipt of the claim, or if the Contractor disputes the decision, an appeal to Level II may be made by the Contractor.
- (2) Level II. An appeal to Level II shall be made in writing to the Engineer of Construction within 45 days after the date of the Level I decision. Review of the claim at Level II shall be conducted as a full evaluation of the claim. A claim presentation meeting may be scheduled if the Chief Engineer/Director of Highways determines that such a meeting would aid in resolution of the claim, otherwise a decision will be made based on the claim documentation submitted. A Level II final decision will be rendered within 90 days of receipt of the written request for appeal.

Full compliance by the Contractor with the provisions specified in this Article is a contractual condition precedent to the Contractor’s right to seek relief in the Court of Claims. The Director’s written decision shall be the final administrative action of the Department. Unless the Contractor files a claim for adjudication by the Court of Claims within 60 days after the date of the written decision, the failure to file shall constitute a release and waiver of the claim.”

DISADVANTAGED BUSINESS ENTERPRISE PARTICIPATION (BDE)

Effective: September 1, 2000

Revised: August 2, 2011

FEDERAL OBLIGATION. The Department of Transportation, as a recipient of federal financial assistance, is required to take all necessary and reasonable steps to ensure nondiscrimination in the award and administration of contracts. Consequently, the federal regulatory provisions of 49 CFR Part 26 apply to this contract concerning the utilization of disadvantaged business enterprises. For the purposes of this Special Provision, a disadvantaged business enterprise (DBE) means a business certified by the Department in accordance with the requirements of 49 CFR Part 26 and listed in the Illinois Unified Certification Program (IL UCP) DBE Directory.

STATE OBLIGATION. This Special Provision will also be used by the Department to satisfy the requirements of the Business Enterprise for Minorities, Females, and Persons with Disabilities Act, 30 ILCS 575. When this Special Provision is used to satisfy state law requirements on 100 percent state-funded contracts, the federal government has no involvement in such contracts (not a federal-aid contract) and no responsibility to oversee the implementation of this Special Provision by the Department on those contracts. DBE participation on 100 percent state-funded contracts will not be credited toward fulfilling the Department's annual overall DBE goal required by the US Department of Transportation to comply with the federal DBE program requirements.

CONTRACTOR ASSURANCE. The Contractor makes the following assurance and agrees to include the assurance in each subcontract that the Contractor signs with a subcontractor.

The Contractor, subrecipient, or subcontractor shall not discriminate on the basis of race, color, national origin, or sex in the performance of this contract. The Contractor shall carry out applicable requirements of 49 CFR Part 26 in the award and administration of contracts funded in whole or in part with federal or state funds. Failure by the Contractor to carry out these requirements is a material breach of this contract, which may result in the termination of this contract or such other remedy as the recipient deems appropriate.

OVERALL GOAL SET FOR THE DEPARTMENT. As a requirement of compliance with 49 CFR Part 26, the Department has set an overall goal for DBE participation in its federally assisted contracts. That goal applies to all federal-aid funds the Department will expend in its federally assisted contracts for the subject reporting fiscal year. The Department is required to make a good faith effort to achieve the overall goal. The dollar amount paid to all approved DBE companies performing work called for in this contract is eligible to be credited toward fulfillment of the Department's overall goal.

CONTRACT GOAL TO BE ACHIEVED BY THE CONTRACTOR. This contract includes a specific DBE utilization goal established by the Department. The goal has been included because the Department has determined that the work of this contract has subcontracting opportunities that may be suitable for performance by DBE companies. The determination is based on an assessment of the type of work, the location of the work, and the availability of DBE companies to do a part of the work. The assessment indicates that, in the absence of unlawful discrimination, and in an arena of fair and open competition, DBE companies can be expected to perform 0.00% of the work. This percentage is set as the DBE participation goal for this contract. Consequently, in addition to the other award criteria established for this contract, the Department will only award this contract to a bidder who makes a good faith effort to meet this goal of DBE participation in the performance of the work. A bidder makes a good faith effort for award consideration if either of the following is done in accordance with the procedures set for in this Special Provision:

- (a) The bidder documents that enough DBE participation has been obtained to meet the goal: or
- (b) The bidder documents that a good faith effort has been made to meet the goal, even though the effort did not succeed in obtaining enough DBE participation to meet the goal.

DBE LOCATOR REFERENCES. Bidders shall consult the IL UCP DBE Directory as a reference source for DBE-certified companies. In addition, the Department maintains a letting and item specific DBE locator information system whereby DBE companies can register their interest in providing quotes on particular bid items advertised for letting. Information concerning DBE companies willing to quote work for particular contracts may be obtained by contacting the Department's Bureau of Small Business Enterprises at telephone number (217)785-4611, or by visiting the Department's website at www.dot.il.gov.

BIDDING PROCEDURES. Compliance with this Special Provision is a material bidding requirement. The failure of the bidder to comply will render the bid not responsive.

- (a) The bidder shall submit a Disadvantaged Business Utilization Plan on Department forms SBE 2025 and 2026 with the bid.
- (b) The Utilization Plan shall indicate that the bidder either has obtained sufficient DBE participation commitments to meet the contract goal or has not obtained enough DBE participation commitments in spite of a good faith effort to meet the goal. The Utilization Plan shall further provide the name, telephone number, and telefax number of a responsible official of the bidder designated for purposes of notification of plan approval or disapproval under the procedures of this Special Provision.
- (c) The Utilization Plan shall include a DBE Participation Commitment Statement, Department form SBE 2025, for each DBE proposed for the performance of work to achieve the contract goal. For bidding purposes, submission of the completed SBE 2025 forms, signed by the DBEs and faxed to the bidder will be acceptable as long as the original is available and provided upon request. All elements of information indicated on the said form shall be provided, including but not limited to the following:
 - (1) The names and addresses of DBE firms that will participate in the contract;
 - (2) A description, including pay item numbers, of the work each DBE will perform;
 - (3) The dollar amount of the participation of each DBE firm participating. The dollar amount of participation for identified work shall specifically state the quantity, unit price, and total subcontract price for the work to be completed by the DBE. If partial pay items are to be performed by the DBE, indicate the portion of each item, a unit price where appropriate and the subcontract price amount;
 - (4) DBE Participation Commitment Statements, form SBE 2025, signed by the bidder and each participating DBE firm documenting the commitment to use the DBE subcontractors whose participation is submitted to meet the contract goal;
 - (5) if the bidder is a joint venture comprised of DBE companies and non-DBE companies, the plan must also include a clear identification of the portion of the work to be performed by the DBE partner(s); and,
 - (6) If the contract goal is not met, evidence of good faith efforts.

GOOD FAITH EFFORT PROCEDURES. The contract will not be awarded until the Utilization Plan submitted by the apparent successful bidder is approved. All information submitted by the bidder must be complete, accurate and adequately document that enough DBE participation has been obtained or document that good faith efforts of the bidder, in the event enough DBE participation has not been obtained, before the Department will commit to the performance of the contract by the bidder. The Utilization Plan will be approved by the Department if the Utilization Plan documents sufficient commercially useful DBE work performance to meet the contract goal or the bidder submits sufficient documentation of a good faith effort to meet the contract goal pursuant to 49 CFR Part 26, Appendix A. The Utilization Plan will not be approved by the Department if the Utilization Plan does not document sufficient DBE participation to meet the contract goal unless the apparent successful bidder documented in the Utilization Plan that it made a good faith effort to meet the goal. This means that the bidder must show that all necessary and reasonable steps were taken to achieve the contract goal. Necessary and reasonable steps are those which, by their scope, intensity and appropriateness to the objective, could reasonably be expected to obtain sufficient DBE participation, even if they were not successful. The Department will consider the quality, quantity, and intensity of the kinds of efforts that the bidder has made. Mere *pro forma* efforts, in other words, efforts done as a matter of form, are not good faith efforts; rather, the bidder is expected to have taken genuine efforts that would be reasonably expected of a bidder actively and aggressively trying to obtain DBE participation sufficient to meet the contract goal.

- (a) The following is a list of types of action that the Department will consider as part of the evaluation of the bidder's good faith efforts to obtain participation. These listed factors are not intended to be a mandatory checklist and are not intended to be exhaustive. Other factors or efforts brought to the attention of the Department may be relevant in appropriate cases, and will be considered by the Department.
- (1) Soliciting through all reasonable and available means (e.g. attendance at pre-bid meetings, advertising and/or written notices) the interest of all certified DBE companies that have the capability to perform the work of the contract. The bidder must solicit this interest within sufficient time to allow the DBE companies to respond to the solicitation. The bidder must determine with certainty if the DBE companies are interested by taking appropriate steps to follow up initial solicitations.
 - (2) Selecting portions of the work to be performed by DBE companies in order to increase the likelihood that the DBE goals will be achieved. This includes, where appropriate, breaking out contract work items into economically feasible units to facilitate DBE participation, even when the prime Contractor might otherwise prefer to perform these work items with its own forces.
 - (3) Providing interested DBE companies with adequate information about the plans, specifications, and requirements of the contract in a timely manner to assist them in responding to a solicitation.

- (4) a. Negotiating in good faith with interested DBE companies. It is the bidder's responsibility to make a portion of the work available to DBE subcontractors and suppliers and to select those portions of the work or material needs consistent with the available DBE subcontractors and suppliers, so as to facilitate DBE participation. Evidence of such negotiation includes the names, addresses, and telephone numbers of DBE companies that were considered; a description of the information provided regarding the plans and specifications for the work selected for subcontracting; and evidence as to why additional agreements could not be reached for DBE companies to perform the work.
 - b. A bidder using good business judgment would consider a number of factors in negotiating with subcontractors, including DBE subcontractors, and would take a firm's price and capabilities as well as contract goals into consideration. However, the fact that there may be some additional costs involved in finding and using DBE companies is not in itself sufficient reason for a bidder's failure to meet the contract DBE goal, as long as such costs are reasonable. Also the ability or desire of a bidder to perform the work of a contract with its own organization does not relieve the bidder of the responsibility to make good faith efforts. Bidders are not, however, required to accept higher quotes from DBE companies if the price difference is excessive or unreasonable.
- (5) Not rejecting DBE companies as being unqualified without sound reasons based on a thorough investigation of their capabilities. The bidder's standing within its industry, membership in specific groups, organizations, or associations and political or social affiliations (for example union vs. non-union employee status) are not legitimate causes for the rejection or non-solicitation of bids in the bidder's efforts to meet the project goal.
 - (6) Making efforts to assist interested DBE companies in obtaining bonding, lines of credit, or insurance as required by the recipient or Contractor.
 - (7) Making efforts to assist interested DBE companies in obtaining necessary equipment, supplies, materials, or related assistance or services.
 - (8) Effectively using the services of available minority/women community organizations; minority/women contractors' groups; local, state, and federal minority/women business assistance offices; and other organizations as allowed on a case-by-case basis to provide assistance in the recruitment and placement of DBE companies.
- (b) If the Department determines that the apparent successful bidder has made a good faith effort to secure the work commitment of DBE companies to meet the contract goal, the Department will award the contract provided that it is otherwise eligible for award. If the Department determines that the bidder has failed to meet the requirements of this Special Provision or that a good faith effort has not been made, the Department will notify the responsible company official designated in the Utilization Plan that the bid is not responsive. The notification shall include a statement of reasons for the determination.

- (c) The bidder may request administrative reconsideration of a determination adverse to the bidder within the five working days after the receipt of the notification date of the determination by delivering the request to the Department of Transportation, Bureau of Small Business Enterprises, Contract Compliance Section, 2300 South Dirksen Parkway, Room 319, Springfield, Illinois 62764 (Telefax: (217)785-1524). Deposit of the request in the United States mail on or before the fifth business day shall not be deemed delivery. The determination shall become final if a request is not made and delivered. A request may provide additional written documentation and/or argument concerning the issues raised in the determination statement of reasons, provided the documentation and arguments address efforts made prior to submitting the bid. The request will be forwarded to the Department's Reconsideration Officer. The Reconsideration Officer will extend an opportunity to the bidder to meet in person in order to consider all issues of documentation and whether the bidder made a good faith effort to meet the goal. After the review by the Reconsideration Officer, the bidder will be sent a written decision within ten working days after receipt of the request for consideration, explaining the basis for finding that the bidder did or did not meet the goal or make adequate good faith efforts to do so. A final decision by the Reconsideration Officer that a good faith effort was made shall approve the Utilization Plan submitted by the bidder and shall clear the contract for award. A final decision that a good faith effort was not made shall render the bid not responsive.

CALCULATING DBE PARTICIPATION. The Utilization Plan values represent work anticipated to be performed and paid for upon satisfactory completion. The Department is only able to count toward the achievement of the overall goal and the contract goal the value of payments made for the work actually performed by DBE companies. In addition, a DBE must perform a commercially useful function on the contract to be counted. A commercially useful function is generally performed when the DBE is responsible for the work and is carrying out its responsibilities by actually performing, managing, and supervising the work involved. The Department and Contractor are governed by the provisions of 49 CFR Part 26.55(c) on questions of commercially useful functions as it affects the work. Specific counting guidelines are provided in 49 CFR Part 26.55, the provisions of which govern over the summary contained herein.

- (a) DBE as the Contractor: 100 percent goal credit for that portion of the work performed by the DBE's own forces, including the cost of materials and supplies. Work that a DBE subcontracts to a non-DBE does not count toward the DBE goals.
- (b) DBE as a joint venture Contractor: 100 percent goal credit for that portion of the total dollar value of the contract equal to the distinct, clearly defined portion of the work performed by the DBE's own forces.
- (c) DBE as a subcontractor: 100 percent goal credit for the work of the subcontract performed by the DBE's own forces, including the cost of materials and supplies, excluding the purchase of materials and supplies or the lease of equipment by the DBE subcontractor from the prime Contractor or its affiliates. Work that a DBE subcontractor in turn subcontracts to a non-DBE does not count toward the DBE goal.

(d) DBE as a trucker: 100 percent goal credit for trucking participation provided the DBE is responsible for the management and supervision of the entire trucking operation for which it is responsible. At least one truck owned, operated, licensed, and insured by the DBE must be used on the contract. Credit will be given for the following:

- (1) The DBE may lease trucks from another DBE firm, including an owner-operator who is certified as a DBE. The DBE who leases trucks from another DBE receives credit for the total value of the transportation services the lessee DBE provides on the contract.
- (2) The DBE may also lease trucks from a non-DBE firm, including from an owner-operator. The DBE who leases trucks from a non-DBE is entitled to credit only for the fee or commission is receives as a result of the lease arrangement.

(e) DBE as a material supplier:

- (1) 60 percent goal credit for the cost of the materials or supplies purchased from a DBE regular dealer.
- (2) 100 percent goal credit for the cost of materials of supplies obtained from a DBE manufacturer.
- (3) 100 percent credit for the value of reasonable fees and commissions for the procurement of materials and supplies if not a regular dealer or manufacturer.

CONTRACT COMPLIANCE. Compliance with this Special Provision is an essential part of the contract. The Department is prohibited by federal regulations from crediting the participation of a DBE included in the Utilization Plan toward either the contract goal or the Department's overall goal until the amount to be applied toward the goals has been paid to the DBE. The following administrative procedures and remedies govern the compliance by the Contractor with the contractual obligations established by the Utilization Plan. After approval of the Utilization Plan and award of the contract, the Utilization Plan and individual DBE Participation Statements become part of the contract. If the Contractor did not succeed in obtaining enough DBE participation to achieve the advertised contract goal, and the Utilization Plan was approved and contract awarded based upon a determination of good faith, the total dollar value of DBE work calculated in the approved Utilization Plan as a percentage of the awarded contract value shall become the amended contract goal. All work indicated for performance by an approved DBE shall be performed, managed, and supervised by the DBE executing the Participation Statement.

- (a) **NO AMENDMENT.** No amendment to the Utilization Plan may be made without prior written approval from the Department's Bureau of Small Business Enterprises. All requests for amendment to the Utilization Plan shall be submitted to the Department of Transportation, Bureau of Small Business Enterprises, Contract Compliance Section, 2300 South Dirksen Parkway, Room 319, Springfield, Illinois 62764. Telephone number (217)785-4611. Telefax number (217)785-1524.

- (b) TERMINATION OR REPLACEMENT. The Contractor shall not terminate or replace a DBE listed on the approved Utilization Plan, or perform with other forces work designated for a listed DBE except as provided in the Special Provision.
- (c) CHANGES TO WORK. Any deviation from the DBE condition-of-award or contract plans, specifications, or special provisions must be approved, in writing, by the Department as provided elsewhere in the Contract. The Contractor shall notify affected DBEs in writing of any changes in the scope of work which result in a reduction in the dollar amount condition-of-award to the contract. Where the revision includes work committed to a new DBE subcontractor, not previously involved in the project, then a Request for Approval of Subcontractor, Department form BC 260A, must be signed and submitted. If the commitment of work is in the form of additional tasks assigned to an existing subcontract, then a new Request for Approval of Subcontractor shall not be required. However, the Contractor must document efforts to assure that the existing DBE subcontractor is capable of performing the additional work and has agreed in writing to the change.
- (d) ALTERNATIVE WORK METHODS. In addition to the above requirements for reductions in the condition of award, additional requirements apply to the two cases of Contractor-initiated work substitution proposals. Where the contract allows alternate work methods which serve to delete or create underruns in condition of award DBE work, and the Contractor selects that alternate method or, where the Contractor proposes a substitute work method or material that serves to diminish or delete work committed to a DBE and replace it with other work, then the Contractor must demonstrate one of the following:
- (1) That the replacement work will be performed by the same DBE (as long as the DBE is certified in the respective item of work) in a modification of the condition of award; or
 - (2) That the DBE is aware that its work will be deleted or will experience underruns and has agreed in writing to the change. If this occurs, the Contractor shall substitute other work of equivalent value to a certified DBE or provide documentation of good faith efforts to do so; or
 - (3) That the DBE is not capable of performing the replacement work or has declined to perform the work at a reasonable competitive price. If this occurs, the Contractor shall substitute other work of equivalent value to a certified DBE or provide documentation of good faith efforts to do so.

(e) TERMINATION AND REPLACEMENT PROCEDURES. The Contractor shall not terminate or replace a DBE subcontractor listed in the approved Utilization Plan without prior written consent. This includes, but is not limited to, instances in which the Contractor seeks to perform work originally designated for a DBE subcontractor with its own forces or those of an affiliate, a non-DBE firm, or with another DBE firm. Written consent will be granted only if the Bureau of Small Business Enterprises agrees, for reasons stated in its concurrence document, that the Contractor has good cause to terminate or replace the DBE firm. Before transmitting to the Bureau of Small Business Enterprises any request to terminate and/or substitute a DBE subcontractor, the Contractor shall give notice in writing to the DBE subcontractor, with a copy to the Bureau, of its intent to request to terminate and/or substitute, and the reason for the request. The Contractor shall give the DBE five days to respond to the Contractor's notice. The DBE so notified shall advise the Bureau and the Contractor of the reasons, if any, why it objects to the proposed termination of its subcontract and why the Bureau should not approve the Contractor's action. If required in a particular case as a matter of public necessity, the Bureau may provide a response period shorter than five days.

For purposes of this paragraph, good cause includes the following circumstances:

- (1) The listed DBE subcontractor fails or refuses to execute a written contract;
- (2) The listed DBE subcontractor fails or refuses to perform the work of its subcontract in a way consistent with normal industry standards. Provided, however, that good cause does not exist if the failure or refusal of the DBE subcontractor to perform its work on the subcontract results from the bad faith or discriminatory action of the prime contractor;
- (3) The listed DBE subcontractor fails or refuses to meet the prime Contractor's reasonable, nondiscriminatory bond requirements;
- (4) The listed DBE subcontractor becomes bankrupt, insolvent, or exhibits credit unworthiness;
- (5) The listed DBE subcontractor is ineligible to work on public works projects because of suspension and debarment proceedings pursuant 2 CFR Parts 180, 215 and 1,200 or applicable state law.
- (6) You have determined that the listed DBE subcontractor is not a responsible contractor;
- (7) The listed DBE subcontractor voluntarily withdraws from the projects and provides to you written notice of its withdrawal;
- (8) The listed DBE is ineligible to receive DBE credit for the type of work required;
- (9) A DBE owner dies or becomes disabled with the result that the listed DBE contractor is unable to complete its work on the contract;

- (10) Other documented good cause that compels the termination of the DBE subcontractor. Provided, that good cause does not exist if the prime Contractor seeks to terminate a DBE it relied upon to obtain the contract so that the prime Contractor can self-perform the work for which the DBE contractor was engaged or so that the prime Contractor can substitute another DBE or non-DBE contractor after contract award.

When a DBE is terminated, or fails to complete its work on the Contract for any reason the Contractor shall make a good faith effort to find another DBE to substitute for the original DBE to perform at least the same amount of work under the contract as the terminated DBE to the extent needed to meet the established Contract goal.

- (f) PAYMENT RECORDS. The Contractor shall maintain a record of payments for work performed to the DBE participants. The records shall be made available to the Department for inspection upon request. After the performance of the final item of work or delivery of material by a DBE and final payment therefore to the DBE by the Contractor, but not later than thirty calendar days after payment has been made by the Department to the Contractor for such work or material, the Contractor shall submit a DBE Payment Agreement on Department form SBE 2115 to the Regional Engineer. If full and final payment has not been made to the DBE, the DBE Payment Agreement shall indicate whether a disagreement as to the payment required exists between the Contractor and the DBE or if the Contractor believes that the work has not been satisfactorily completed. If the Contractor does not have the full amount of work indicated in the Utilization Plan performed by the BDE companies indicated in the Utilization Plan and after good faith efforts are reviewed, the Department may deduct from contract payments to the Contractor the amount of the goal not achieved as liquidated and ascertained damages. The Contractor may request an administrative reconsideration of any amount deducted as damages pursuant to subsection (h) of this part.
- (g) ENFORCEMENT. The Department reserves the right to withhold payment to the Contractor to enforce the provisions of this Special Provision. Final payment shall not be made on the contract until such time as the Contractor submits sufficient documentation demonstrating achievement of the goal in accordance with this Special Provision or after liquidated damages have been determined and collected.
- (h) RECONSIDERATION. Notwithstanding any other provision of the contract, including but not limited to Article 109.09 of the Standard Specifications, the Contractor may request administrative reconsideration of a decision to deduct the amount of the goal not achieved as liquidated damages. A request to reconsider shall be delivered to the Contract Compliance Section and shall be handled and considered in the same manner as set forth in paragraph (c) of "Good Faith Effort Procedures" of this Special Provision, except a final decision that a good faith effort was not made during contract performance to achieve the goal agreed to in the Utilization Plan shall be the final administrative decision of the Department.

PAYROLLS AND PAYROLL RECORDS (BDE)

Effective: January 1, 2014

FEDERAL AID CONTRACTS. Revise the following section of Check Sheet #1 of the Recurring Special Provisions to read:

“STATEMENTS AND PAYROLLS

The payroll records shall include the worker's name, the worker's address, the worker's telephone number when available, the worker's social security number, the worker's classification or classifications, the worker's gross and net wages paid in each pay period, the worker's number of hours worked each day, the worker's starting and ending times of work each day. However, any Contractor or subcontractor who remits contributions to a fringe benefit fund that is not jointly maintained and jointly governed by one or more employers and one or more labor organization must additionally submit the worker's hourly wage rate, the worker's hourly overtime wage rate, the worker's hourly fringe benefit rates, the name and address of each fringe benefit fund, the plan sponsor of each fringe benefit, if applicable, and the plan administrator of each fringe benefit, if applicable.

The Contractor and each subcontractor shall submit payroll records to the Engineer each week from the start to the completion of their respective work, except that full social security numbers and home addresses shall not be included on weekly transmittals. Instead, the payrolls shall include an identification number for each employee (e.g., the last four digits of the employee's social security number). In addition, starting and ending times of work each day may be omitted from the payroll records submitted to the Engineer. The submittals shall be on the Department's form SBE 48, or an approved facsimile. When there has been no activity during a work week, a payroll record shall still be submitted with the appropriate box (“No Work”, “Suspended”, or “Complete”) checked on the form.”

STATE CONTRACTS. Revise Section IV of Check Sheet #5 of the Recurring Special Provisions to read:

“IV.COMPLIANCE WITH THE PREVAILING WAGE ACT

1. **Prevailing Wages.** All wages paid by the Contractor and each subcontractor shall be in compliance with The Prevailing Wage Act (820 ILCS 130), as amended, except where a prevailing wage violates a federal law, order, or ruling, the rate conforming to the federal law, order, or ruling shall govern. The Contractor shall be responsible to notify each subcontractor of the wage rates set forth in this contract and any revisions thereto. If the Department of Labor revises the wage rates, the Contractor will not be allowed additional compensation on account of said revisions.

2. Payroll Records. The Contractor and each subcontractor shall make and keep, for a period of five years from the later of the date of final payment under the contract or completion of the contract, records of the wages paid to his/her workers. The payroll records shall include the worker's name, the worker's address, the worker's telephone number when available, the worker's social security number, the worker's classification or classifications, the worker's gross and net wages paid in each pay period, the worker's number of hours worked each day, the worker's starting and ending times of work each day. However, any contractor or subcontractor who remits contributions to a fringe benefit fund that is not jointly maintained and jointly governed by one or more employers and one or more labor organization must additionally submit the worker's hourly wage rate, the worker's hourly overtime wage rate, the worker's hourly fringe benefit rates, the name and address of each fringe benefit fund, the plan sponsor of each fringe benefit, if applicable, and the plan administrator of each fringe benefit, if applicable. Upon seven business days' notice, these records shall be available at a location within the State, during reasonable hours, for inspection by the Department or the Department of Labor; and Federal, State, or local law enforcement agencies and prosecutors.
3. Submission of Payroll Records. The Contractor and each subcontractor shall submit payroll records to the Engineer each week from the start to the completion of their respective work, except that full social security numbers and home addresses shall not be included on weekly transmittals. Instead the payrolls shall include an identification number for each employee (e.g., the last four digits of the employee's social security number). In addition, starting and ending times of work each day may be omitted from the payroll records submitted to the Engineer. The submittals shall be on the Department's form SBE 48, or an approved facsimile. When there has been no activity during a work week, a payroll record shall still be submitted with the appropriate box ("No Work", "Suspended", or "Complete") checked on the form.

Each submittal shall be accompanied by a statement signed by the Contractor or subcontractor, or an officer, employee, or officer thereof, which avers that: (i) he or she has examined the records and such records are true and accurate; (ii) the hourly rate paid to each worker is not less than the general prevailing rate of hourly wages required by the Act; and (iii) the Contractor or subcontractor is aware that filing a payroll record that he/she knows to be false is a Class A misdemeanor.

4. Employee Interviews. The Contractor and each subcontractor shall permit his/her employees to be interviewed on the job, during working hours, by compliance investigators of the Department or the Department of Labor."

PROGRESS PAYMENTS (BDE)

Effective: November 2, 2013

Revise Article 109.07(a) of the Standard Specifications to read:

“(a) Progress Payments. At least once each month, the Engineer will make a written estimate of the quantity of work performed in accordance with the contract, and the value thereof at the contract unit prices. The amount of the estimate approved as due for payment will be vouchered by the Department and presented to the State Comptroller for payment. No amount less than \$1000.00 will be approved for payment other than the final payment.

Progress payments may be reduced by liens filed pursuant to Section 23(c) of the Mechanics’ Lien Act, 770 ILCS 60/23(c).

If a Contractor or subcontractor has defaulted on a loan issued under the Department’s Disadvantaged Business Revolving Loan Program (20 ILCS 2705/2705-610), progress payments may be reduced pursuant to the terms of that loan agreement. In such cases, the amount of the estimate related to the work performed by the Contractor or subcontractor, in default of the loan agreement, will be offset, in whole or in part, and vouchered by the Department to the Working Capital Revolving Fund or designated escrow account. Payment for the work shall be considered as issued and received by the Contractor or subcontractor on the date of the offset voucher. Further, the amount of the offset voucher shall be a credit against the Department’s obligation to pay the Contractor, the Contractor’s obligation to pay the subcontractor, and the Contractor’s or subcontractor’s total loan indebtedness to the Department. The offset shall continue until such time as the entire loan indebtedness is satisfied. The Department will notify the Contractor and Fund Control Agent in a timely manner of such offset. The Contractor or subcontractor shall not be entitled to additional payment in consideration of the offset.

The failure to perform any requirement, obligation, or term of the contract by the Contractor shall be reason for withholding any progress payments until the Department determines that compliance has been achieved.”

REMOVAL AND DISPOSAL OF REGULATED SUBSTANCES (BDE)

Effective: January 1, 2012

Revised: November 2, 2012

Revise Article 669.01 of the Standard Specifications to read:

“**669.01 Description.** This work shall consist of the transportation and proper disposal of contaminated soil and water. This work shall also consist of the removal, transportation, and proper disposal of underground storage tanks (UST), their content and associated underground piping to the point where the piping is above the ground, including determining the content types and estimated quantities.”

Revise Article 669.08 of the Standard Specifications to read:

“669.08 Contaminated Soil and/or Groundwater Monitoring. The Contractor shall hire a qualified environmental firm to monitor the area containing the regulated substances. The affected area shall be monitored with a photoionization detector (PID) utilizing a lamp of 10.6eV or greater or a flame ionization detector (FID). Any field screen reading on the PID or FID in excess of background levels indicates the potential presence of contaminated material requiring handling as a non-special waste, special waste, or hazardous waste. No excavated soils can be taken to a clean construction and demolition debris (CCDD) facility or an uncontaminated soil fill operation with detectable PID or FID meter readings that are above background. The PID or FID meter shall be calibrated on-site and background level readings taken and recorded daily. All testing shall be done by a qualified engineer/technician. Such testing and monitoring shall be included in the work. The Contractor shall identify the exact limits of removal of non-special waste, special waste, or hazardous waste. All limits shall be approved by the Engineer prior to excavation. The Contractor shall take all necessary precautions.

Based upon the land use history of the subject property and/or PID or FID readings indicating contamination, a soil or groundwater sample shall be taken from the same location and submitted to an approved laboratory. Soil or groundwater samples shall be analyzed for the contaminants of concern, including pH, based on the property's land use history or the parameters listed in the maximum allowable concentration (MAC) for chemical constituents in uncontaminated soil established pursuant to Subpart F of 35 Illinois Administrative Code 1100.605. The analytical results shall serve to document the level of soil contamination. Soil and groundwater samples may be required at the discretion of the Engineer to verify the level of soil and groundwater contamination.

Samples shall be grab samples (not combined with other locations). The samples shall be taken with decontaminated or disposable instruments. The samples shall be placed in sealed containers and transported in an insulated container to the laboratory. The container shall maintain a temperature of 39 °F (4 °C). All samples shall be clearly labeled. The labels shall indicate the sample number, date sampled, location and elevation, and any other observations.

The laboratory shall use analytical methods which are able to meet the lowest appropriate practical quantitation limits (PQL) or estimated quantitation limit (EQL) specified in "Test Methods for Evaluating Solid Wastes, Physical/Chemical Methods", EPA Publication No. SW-846 and "Methods for the Determination of Organic Compounds in Drinking Water", EPA, EMSL, EPA-600/4-88/039. For parameters where the specified cleanup objective is below the acceptable detection limit (ADL), the ADL shall serve as the cleanup objective. For other parameters the ADL shall be equal to or below the specified cleanup objective.”

Replace the first two paragraphs of Article 669.09 of the Standard Specifications with the following:

“669.09 Contaminated Soil and/or Groundwater Management and Disposal. The management and disposal of contaminated soil and/or groundwater shall be according to the following:

- (a) Soil Analytical Results Exceed Most Stringent MAC. When the soil analytical results indicate that detected levels exceed the most stringent maximum allowable concentration (MAC) for chemical constituents in uncontaminated soil established pursuant to Subpart F of 35 Illinois Administrative Code 1100.605, the soil shall be managed as follows:
 - (1) When analytical results indicate inorganic chemical constituents exceed the most stringent MAC but they are still considered within area background levels by the Engineer, the excavated soil can be utilized within the construction limits as fill, when suitable. Such soil excavated for storm sewers can be placed back into the excavated trench as backfill, when suitable, unless trench backfill is specified. If the soils cannot be utilized within the construction limits, they shall be managed and disposed of off-site as a non-special waste, special waste, or hazardous waste as applicable.
 - (2) When analytical results indicate chemical constituents exceed the most stringent MAC but do not exceed the MAC for a Metropolitan Statistical Area (MSA) County, the excavated soil can be utilized within the construction limits as fill, when suitable, or managed and disposed of off-site as “uncontaminated soil” at a CCDD facility or an uncontaminated soil fill operation within an MSA County provided the pH of the soil is within the range of 6.25 - 9.0, inclusive.
 - (3) When analytical results indicate chemical constituents exceed the most stringent MAC but do not exceed the MAC for an MSA County excluding Chicago, or the MAC within the Chicago corporate limits, the excavated soil can be utilized within the construction limits as fill, when suitable, or managed and disposed of off-site as “uncontaminated soil” at a CCDD facility or an uncontaminated soil fill operation within an MSA County excluding Chicago or within the Chicago corporate limits provided the pH of the soil is within the range of 6.25 - 9.0, inclusive.
 - (4) When analytical results indicate chemical constituents exceed the most stringent MAC but do not exceed the MAC for an MSA County excluding Chicago, the excavated soil can be utilized within the construction limits as fill, when suitable, or managed and disposed of off-site as “uncontaminated soil” at a CCDD facility or an uncontaminated soil fill operation within an MSA County excluding Chicago provided the pH of the soil is within the range of 6.25 - 9.0, inclusive.
 - (5) When the Engineer determines soil cannot be managed according to Articles 669.09(a)(1) through (a)(4) above, the soil shall be managed and disposed of off-site as a non-special waste, special waste, or hazardous waste as applicable.

- (b) Soil Analytical Results Do Not Exceed Most Stringent MAC. When the soil analytical results indicate that detected levels do not exceed the most stringent MAC but the pH of the soil is less than 6.25 or greater than 9.0, the excavated soil can be utilized within the construction limits or managed and disposed of off-site as “uncontaminated soil” according to Article 202.03. However the excavated soil cannot be taken to a CCDD facility or an uncontaminated soil fill operation.
- (c) Groundwater. When groundwater analytical results indicate the detected levels are above Appendix B, Table E of 35 Illinois Administrative Code 742, the most stringent Tier 1 Groundwater Remediation Objectives for Groundwater Component of the Groundwater Ingestion Route for Class 1 groundwater, the groundwater shall be managed off-site as a special waste.

All groundwater encountered within lateral trenches may be managed within the trench and allowed to infiltrate back into the ground. If the groundwater cannot be managed within the trench it must be removed as a special or hazardous waste. The Contractor is prohibited from managing groundwater within the trench by discharging it through any existing or new storm sewer. The Contractor shall install backfill plugs within the area of groundwater contamination.

One backfill plug shall be placed down gradient to the area of groundwater contamination. Backfill plugs shall be installed at intervals not to exceed 50 ft (15 m). Backfill plugs are to be 4 ft (1.2 m) long, measured parallel to the trench, full trench width and depth. Backfill plugs shall not have any fine aggregate bedding or backfill, but shall be entirely cohesive soil or any class of concrete. The Contractor shall provide test data that the material has a permeability of less than 10^{-7} cm/sec according to ASTM D 5084, Method A or per another test method approved by the Engineer.”

Revise Article 669.14 of the Standard Specifications to read:

“669.14 Final Environmental Construction Report. At the end of the project, the Contractor will prepare and submit three copies of the Environmental Construction Report on the activities conducted during the life of the project, one copy shall be submitted to the Resident Engineer, one copy shall be submitted to the District's Environmental Studies Unit, and one copy shall be submitted with an electronic copy in Adode.pdf format to the Geologic and Waste Assessment Unit, Bureau of Design and Environment, IDOT, 2300 South Dirksen Parkway, Springfield, Illinois 62764. The technical report shall include all pertinent information regarding the project including, but not limited to:

- (a) Measures taken to identify, monitor, handle, and dispose of soil or groundwater containing regulated substances, to prevent further migration of regulated substances, and to protect workers,
- (b) Cost of identifying, monitoring, handling, and disposing of soil or groundwater containing regulated substances, the cost of preventing further migration of regulated substances, and the cost for worker protection from the regulated substances. All cost should be in the format of the contract pay items listed in the contract plans (identified by the preliminary environmental site investigation (PESA) site number),

- (c) Plan sheets showing the areas containing the regulated substances,
- (d) Field sampling and testing results used to identify the nature and extent of the regulated substances,
- (e) Waste manifests (identified by the preliminary environmental site investigation (PESA) site number) for special or hazardous waste disposal, and
- (f) Landfill tickets (identified by the preliminary environmental site investigation (PESA) site number) for non-special waste disposal.”

Revise the second paragraph of Article 669.16 of the Standard Specifications to read:

“The transportation and disposal of soil and other materials from an excavation determined to be contaminated will be paid for at the contract unit price per cubic yard (cubic meter) for NON-SPECIAL WASTE DISPOSAL, SPECIAL WASTE DISPOSAL, or HAZARDOUS WASTE DISPOSAL.”

REMOVAL AND DISPOSAL OF SURPLUS MATERIALS (BDE)

Effective: November 2, 2012

Revise the first four paragraphs of Article 202.03 of the Standard Specifications to read:

“202.03 Removal and Disposal of Surplus, Unstable, Unsuitable, and Organic Materials. Suitable excavated materials shall not be wasted without permission of the Engineer. The Contractor shall dispose of all surplus, unstable, unsuitable, and organic materials, in such a manner that public or private property will not be damaged or endangered.

Suitable earth, stones and boulders naturally occurring within the right-of-way may be placed in fills or embankments in lifts and compacted according to Section 205. Broken concrete without protruding metal bars, bricks, rock, stone, reclaimed asphalt pavement with no expansive aggregate, or uncontaminated dirt and sand generated from construction or demolition activities may be used in embankment or in fill. If used in fills or embankments, these materials shall be placed and compacted to the satisfaction of the Engineer; shall be buried under a minimum of 2 ft (600 mm) of earth cover (except when the materials include only uncontaminated dirt); and shall not create an unsightly appearance or detract from the natural topographic features of an area. Broken concrete without protruding metal bars, bricks, rock, or stone may be used as riprap as approved by the Engineer. If the materials are used for fill in locations within the right-of-way but outside project construction limits, the Contractor must specify to the Engineer, in writing, how the landscape restoration of the fill areas will be accomplished. Placement of fill in such areas shall not commence until the Contractor's landscape restoration plan is approved by the Engineer.

Aside from the materials listed above, all other construction and demolition debris or waste shall be disposed of in a licensed landfill, recycled, reused, or otherwise disposed of as allowed by State or Federal laws and regulations. When the Contractor chooses to dispose of uncontaminated soil at a clean construction and demolition debris (CCDD) facility or at an uncontaminated soil fill operation, it shall be the Contractor's responsibility to have the pH of the material tested to ensure the value is between 6.25 and 9.0, inclusive. A copy of the pH test results shall be provided to the Engineer.

A permit shall be obtained from IEPA and made available to the Engineer prior to open burning of organic materials (i.e., plant refuse resulting from pruning or removal of trees or shrubs) or other construction or demolition debris. Organic materials originating within the right-of-way limits may be chipped or shredded and placed as mulch around landscape plantings within the right-of-way when approved by the Engineer. Chipped or shredded material to be placed as mulch shall not exceed a depth of 6 in. (150 mm)."

TRACKING THE USE OF PESTICIDES (BDE)

Effective: August 1, 2012

Add the following paragraph after the first paragraph of Article 107.23 of the Standard Specifications:

"Within 48 hours of the application of pesticides, including but not limited to herbicides, insecticides, algaecides, and fungicides, the Contractor shall complete and return to the Engineer, Operations form "OPER 2720"."

WEEKLY DBE TRUCKING REPORTS (BDE)

Effective: June 2, 2012

The Contractor shall provide a weekly report of Disadvantaged Business Enterprise (DBE) trucks hired by the Contractor or subcontractors (i.e. not owned by the Contractor or subcontractors) that are used on the jobsite; or used for the delivery and/or removal of equipment/material to and from the jobsite. The jobsite shall also include offsite locations, such as plant sites or storage sites, when those locations are used solely for this contract.

The report shall be submitted on the form provided by the Department within ten business days following the reporting period. The reporting period shall be Monday through Sunday for each week reportable trucking activities occur. The report shall be submitted to the Engineer and a copy shall be provided to the district EEO Officer.

Any costs associated with providing weekly DBE trucking reports shall be considered as included in the contract unit prices bid for the various items of work involved and no additional compensation will be allowed.

WORKING DAYS (BDE)

Effective: January 1, 2002

The Contractor shall complete the work within **15** working days.

STATE OF ILLINOIS
DEPARTMENT OF TRANSPORTATION
DIVISION OF HIGHWAYS

**PROPOSED
SIGNAL PLANS**

FAP ROUTE 303(US BR 20)
SECTION (148CS)TS
D-92-016-14
WINNEBAGO COUNTY
C-92-033-14

- INDEX OF SHEETS
1. COVER SHEET AND INDEX OF SHEETS
 2. SUMMARY OF QUANTITIES
 3. SCHEDULE OF QUANTITIES
 - 4.-13. PLAN SHEETS
 14. - 15. TRAFFIC CONTROL DETAILS

STANDARD
701006-05
701502-06
701601-09
701606-09
701801-05
701901-03
720001-01
720011-01
728001-01
729001-01
857001-01
880006-01

SCALE
JOINT UTILITY LOCATION INFORMATION FOR EXCAVATION
1-888-932-4123
OR 811

PROJECT MANAGER SCOTT KULLERSTRAND 815-284-5668
PROJECT ENGINEER STEVEN MENDOZA 815-440-4436

CONTRACT NO. 64K05

CONTRACT NO. 64K05

DPS-816-14

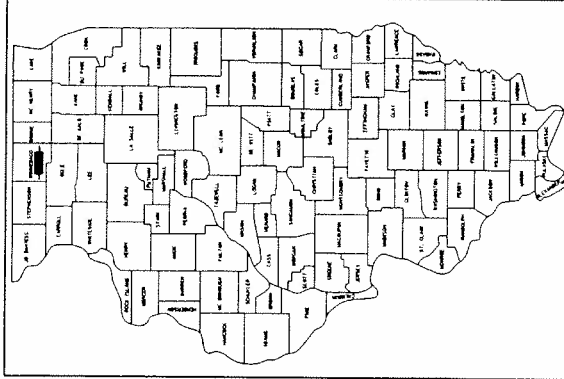

LOCATION OF SECTION INDICATED THEREIN

STATE OF ILLINOIS
DEPARTMENT OF TRANSPORTATION
DIVISION OF HIGHWAYS

SUBMITTED March 14, 2014

David C. Ruff
DEPUTY DIRECTOR OF HIGHWAYS, REGION ENGINEER

PRINTED BY THE AUTHORITY
OF THE STATE OF ILLINOIS



US BR 20
JEFFERSON STREET
AT
THIRD STREET
SECOND STREET
FIRST STREET
WYMAN STREET
MAIN STREET

URBAN
0021
100% STATE

PAY ITEM	SUMMARY OF QUANTITIES	UNIT	QUANTITY
67100100	MOBILIZATION	L SUM	1
70102622	TRAFFIC CONTROL AND PROTECTION, STANDARD 701502	L SUM	1
70102625	TRAFFIC CONTROL AND PROTECTION, STANDARD 701606	L SUM	1
70102630	TRAFFIC CONTROL AND PROTECTION, STANDARD 701601	L SUM	1
70102640	TRAFFIC CONTROL AND PROTECTION, STANDARD 701801	L SUM	1
85000300	MAINTENANCE OF EXISTING TRAFFIC SIGNAL INSTALLATION	L SUM	1
85700100	FULL-ACTUATED CONTROLLER AND TYPE III CABINET	EACH	4
87502480	TRAFFIC SIGNAL POST, GALVANIZED STEEL 14 FT.	EACH	3
88040070	SIGNAL HEAD, POLYCARBONATE, LED, 1-FACE, 3-SECTION, BRACKET MOUNTED	EACH	12
88102825	PEDESTRIAN SIGNAL HEAD, POLYCARBONATE, LED, 1-FACE, BRACKET MOUNTED, WITH COUNTDOWN TIMER	EACH	32
88040090	SIGNAL HEAD, POLYCARBONATE, LED, 1-FACE, 3-SECTION, MAST ARM MOUNTED	EACH	15
88200100	TRAFFIC SIGNAL BACK-PLATE	EACH	15
88500100	INDUCTIVE LOOP DETECTOR	EACH	9
89502375	REMOVE EXISTING TRAFFIC SIGNAL EQUIPMENT	EACH	5

SHEET 2 OF 15
CONTRACT 64K05
WINNEBAGO COUNTY
FAP 303 (US BR 20)
JEFFERSON ST

Rev
TOTAL SHEETS
SHEETS NO.
CONTRACT NO.
ILLINOIS DOT PROJECT

SCALE: SHEETS OF SHEETS TO STA.

STATE OF ILLINOIS
DEPARTMENT OF TRANSPORTATION

CABINET REPLACEMENT PROJECT
TRAFFIC CONTROL

FILE NAME: I:\11111
DRAWN BY: [Name]
CHECKED: [Name]
DATE: 12/10/14 2:14
REVISED: [Name]
REVISED: [Name]
REVISED: [Name]

14

US BR 20 - JEFFERSON ST AT MAIN ST
PLAN SHEET

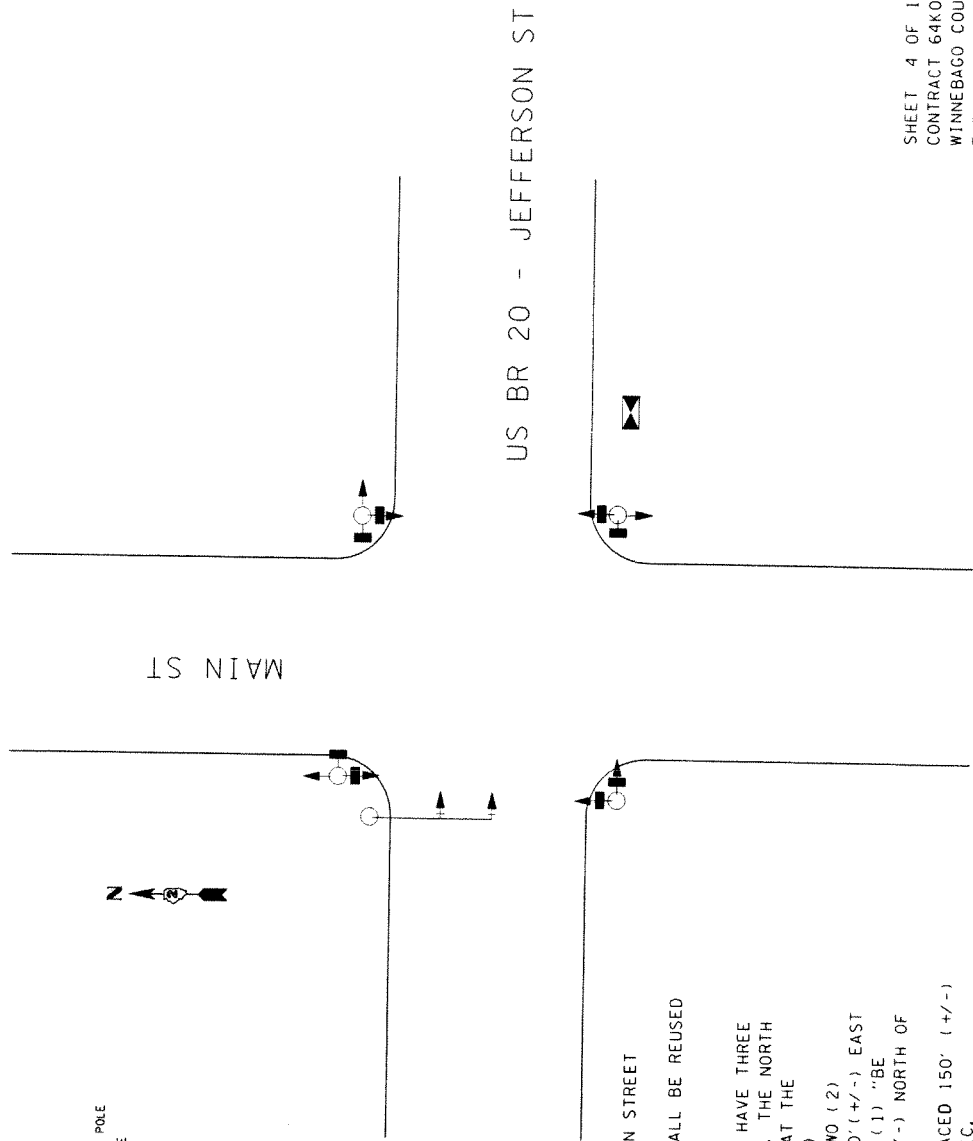

- LEGEND**
- EXISTING CONTROLLER
 - NEW CONTROLLER
 - EXISTING STEEL MAST ARM ASSEMBLY AND POLE
 - NEW STEEL MAST ARM ASSEMBLY AND POLE
 - EXISTING SIGNAL HEAD
 - NEW SIGNAL HEAD
 - NEW SIGNAL HEAD WITH BACKPLATE
 - EXISTING PEDESTRIAN HEAD
 - NEW PEDESTRIAN HEAD
 - PEDESTRIAN PUSHBUTTON
 - EXISTING HANDHOLE
 - NEW HANDHOLE
 - EXISTING LUMINAIRE
 - NEW LUMINAIRE

GENERAL NOTES:

INTERSECTION OF US BR 20 - JEFFERSON ST AT MAIN STREET

EXISTING CABINET FOUNDATION (33 1/2" X 21") SHALL BE REUSED FOR NEW CABINET.

WHEN REPLACING THE CABINET, THE EAST LEG SHALL HAVE THREE (3) TEMPORARY "STOP" SIGNS AT THE INTERSECTION, THE NORTH LEG SHALL HAVE TWO (2) TEMPORARY "STOP" SIGNS AT THE INTERSECTION. THE SOUTH LEG SHALL HAVE TWO (2) TEMPORARY "STOP" SIGNS AT THE INTERSECTION. TWO (2) "BE PREPARED TO STOP" SIGNS SHALL BE PLACED 150' (+/-) EAST OF THE INTERSECTION FOR WESTBOUND TRAFFIC, ONE (1) "BE PREPARED TO STOP" SIGN SHALL BE PLACED 150' (+/-) NORTH OF THE INTERSECTION FOR SOUTHBOUND TRAFFIC AND ONE (1) "BE PREPARED TO STOP" SIGN SHALL BE PLACED 150' (+/-) SOUTH OF THE INTERSECTION FOR NORTHBOUND TRAFFIC. TRAFFIC CONTROL STANDARD 701606, 701601, 701801

SHEET 4 OF 15
CONTRACT 64K05
WINNEBAGO COUNTY
FAP 303 (US BR 20)
JEFFERSON ST

STATE OF ILLINOIS DEPARTMENT OF TRANSPORTATION		US BR 20 WINNEBAGO COUNTY		SHEET NO. OF SHEETS		CONTRACT NO.	
FILE NO.	DATE	DESIGNED	REVIEWED	SCALE	TO STA.	FROM STA.	ILLINOIS STATE PROJECT
PROJECT NO.	DATE	CHECKED	REVIEWED				
PROJECT NAME	DATE	DATE	DATE				

US BR 20 - JEFFERSON ST AT MAIN ST CABLE PLAN

PHASE DESIGNATION DIAGRAM

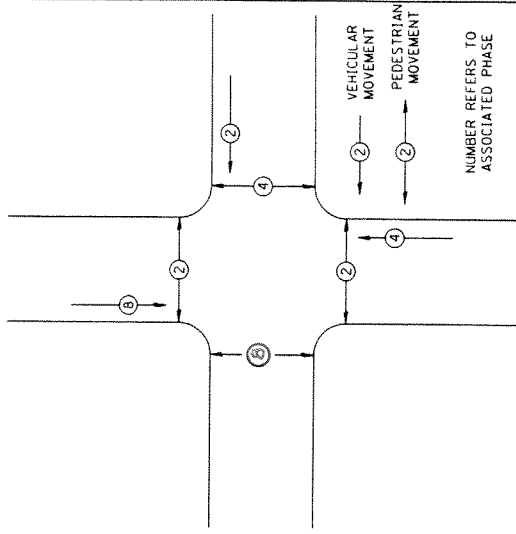

REFER TO STANDARD 857001

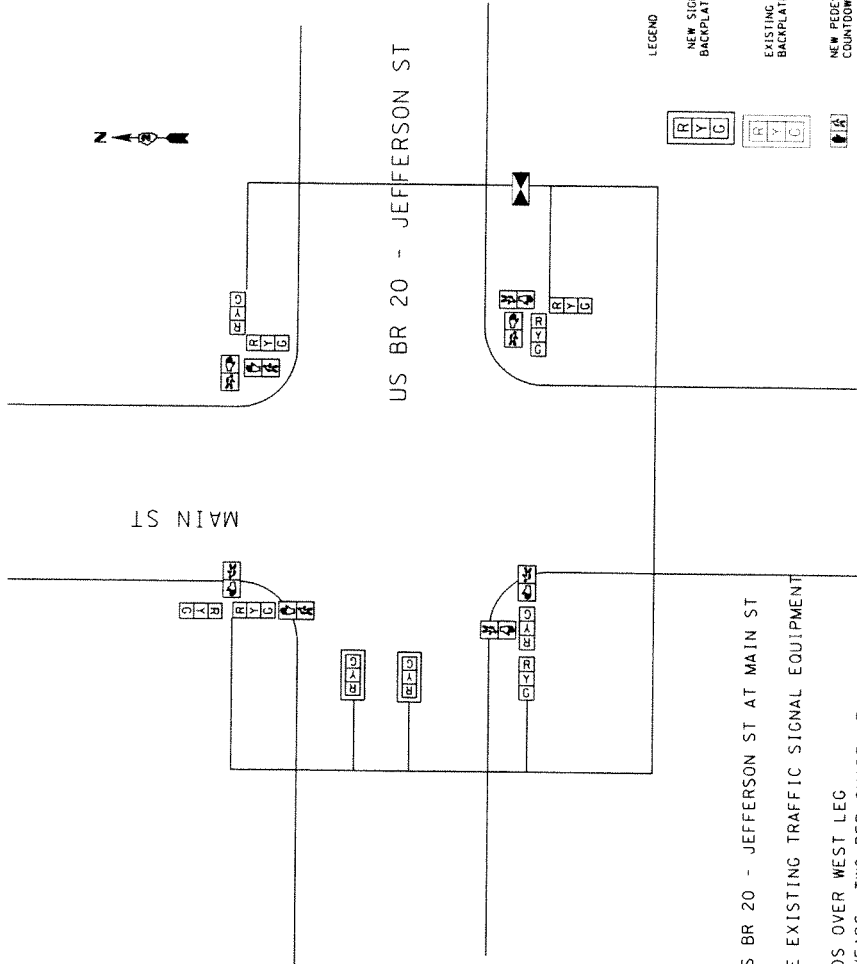

LEGEND

NEW SIGNAL HEAD WITH OR WITHOUT BACKPLATE

EXISTING SIGNAL HEAD WITH OR WITHOUT BACKPLATE

NEW PEDESTRIAN HEAD - LED WITH COUNTDOWN TIMER

- GENERAL NOTES:
INTERSECTION OF US BR 20 - JEFFERSON ST AT MAIN ST
- 1 - CABINET
 - 2 - 3 SEC MAM HEADS OVER WEST LEG
 - 8 - 3 SECTION BM HEADS, TWO PER QUADRANT
 - 8 - PED HEADS WITH COUNTDOWN TIMERS, TWO PER QUADRANT

SHEET 5 OF 15
CONTRACT 64K05
WINNEBAGO COUNTY
FAP 303 (US BR 20)
JEFFERSON ST

Rev.

STATE OF ILLINOIS DEPARTMENT OF TRANSPORTATION	US BR 20 WINNEBAGO COUNTY	SHEET NO. OF SHEETS TOTAL	PROJECT NO.
DESIGNED BY	CHECKED BY	DATE	PROJECT NO.
DRAWN BY	CHECKED BY	DATE	PROJECT NO.
REVISIONS	REVISIONS	REVISIONS	REVISIONS

US BR 20 - JEFFERSON ST AT NB IL 2 - WYMAN ST
 PLAN SHEET

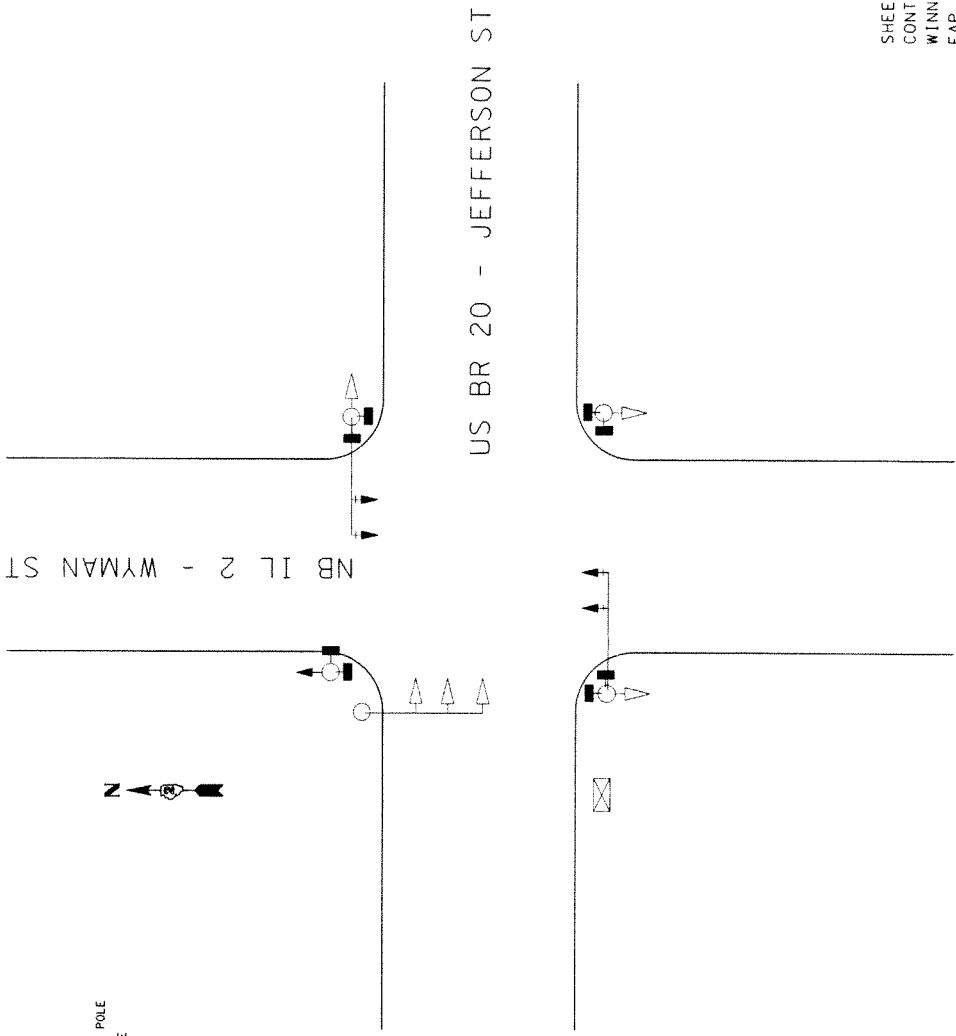

- LEGEND**
- EXISTING CONTROLLER
 - NEW CONTROLLER
 - EXISTING STEEL MAST ARM ASSEMBLY AND POLE
 - NEW STEEL MAST ARM ASSEMBLY AND POLE
 - EXISTING SIGNAL HEAD
 - NEW SIGNAL HEAD
 - NEW SIGNAL HEAD WITH BACKPLATE
 - EXISTING PEDESTRIAN HEAD
 - NEW PEDESTRIAN HEAD
 - PEDESTRIAN PUSHBUTTON
 - EXISTING HANDHOLE
 - NEW HANDHOLE
 - EXISTING LUMINAIRE
 - NEW LUMINAIRE

GENERAL NOTES:
 TRAFFIC CONTROL STANDARD
 701506 MODIFIED
 CLOSE RIGHT TURN LANE WITH 701601

SHEET 6 OF 15
 CONTRACT 64K05
 WINNEBAGO COUNTY
 FAP 303 (US BR 20)
 JEFFERSON ST

PROJECT NO.	DATE	BY	DATE	BY	DATE
DESIGNED BY	DESIGNED	CHECKED	CHECKED	DATE	DATE
DRAWN	DRAWN	DATE	DATE	DATE	DATE
SCALE	SCALE	SHEET NO.	OF	SHEETS	SHEET NO.
US BR 20	WINNEBAGO COUNTY	CONTRACT NO.			
STATE OF ILLINOIS	DEPARTMENT OF TRANSPORTATION				

US BR 20 - JEFFERSON ST AT NB IL 2 - WYMAN ST
CABLE SHEET

PHASE DESIGNATION DIAGRAM

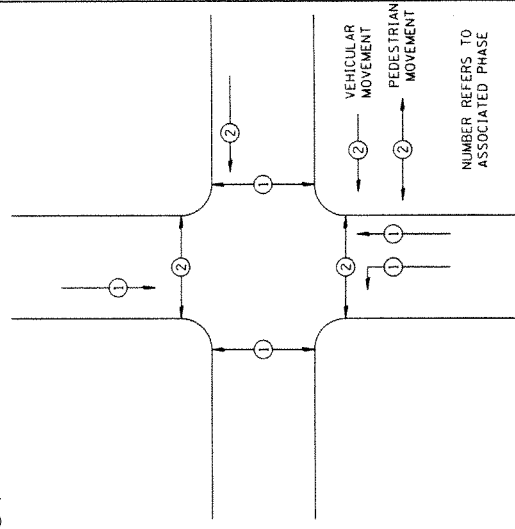

REFER TO STANDARD 857001

US BR 20 - JEFFERSON ST

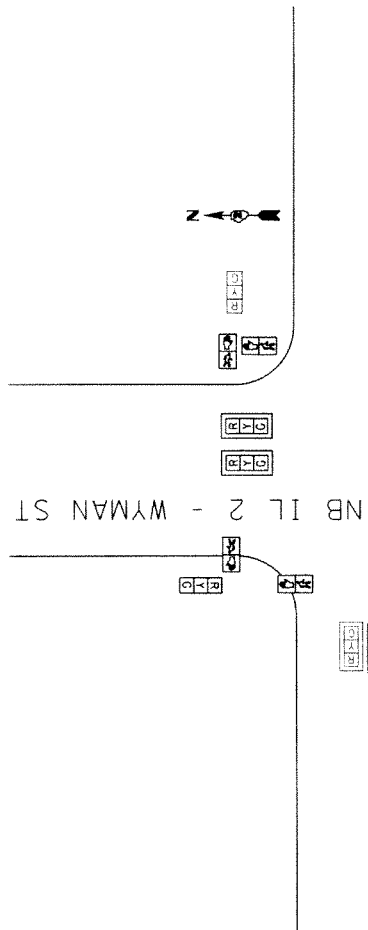

LEGEND

- NEW SIGNAL HEAD WITH OR WITHOUT BACKPLATE
- EXISTING SIGNAL HEAD WITH OR WITHOUT BACKPLATE
- NEW PEDESTRIAN HEAD - LED WITH COUNTDOWN TIMER

- GENERAL NOTES:
 INTERSECTION OF US BR 20 - JEFFERSON ST AT MAIN ST
 REMOVE AND REPLACE EXISTING TRAFFIC SIGNAL EQUIPMENT
- 4 - 3 SEC MAM HEADS TWO OVER NORTH LEG, TWO OVER SOUTH LEG
 - 1 - 3 SECTION BM HEADS, ON NORTHWEST QUADRANT
 - 8 - PED HEADS WITH COUNTDOWN TIMERS, TWO PER QUADRANT

SHEET 7 OF 15
 CONTRACT 64K05
 WINNEBAGO COUNTY
 FAP 303 (US BR 20)
 JEFFERSON ST

PROJECT NAME: JEFFERSON ST AT NB IL 2 - WYMAN ST PROJECT NO.: 64K05 SHEET NO.: 7 OF 15		COUNTY: WINNEBAGO COUNTY SECTION: FAP 303 (US BR 20) SHEET NO.: 7 OF 15	
DESIGNED: [] CHECKED: [] DATE: []		STATE OF ILLINOIS DEPARTMENT OF TRANSPORTATION	
REVISIONS: [] REVISIONS: [] REVISIONS: []		CONTRACT NO.: [] PROJECT NO.: []	

US BR 20 - JEFFERSON ST AT 1ST STREET
PLAN SHEET

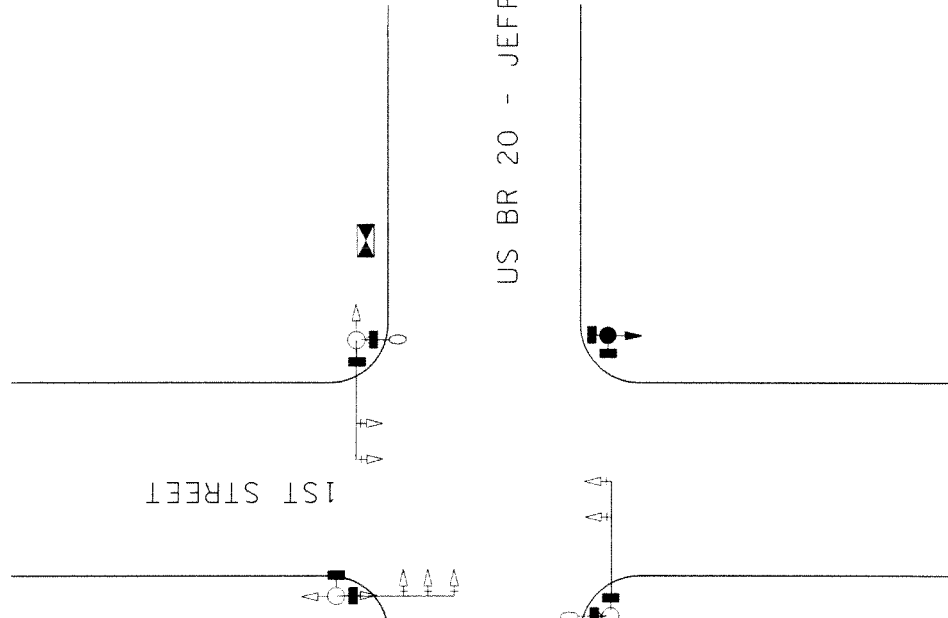

- LEGEND**
- EXISTING CONTROLLER
 - NEW CONTROLLER
 - EXISTING STEEL MAST ARM ASSEMBLY AND POLE
 - NEW STEEL MAST ARM ASSEMBLY AND POLE
 - EXISTING SIGNAL HEAD
 - NEW SIGNAL HEAD
 - NEW SIGNAL HEAD WITH BACKPLATE
 - EXISTING PEDESTRIAN HEAD
 - NEW PEDESTRIAN HEAD
 - PEDESTRIAN PUSH-BUTTON
 - EXISTING HANDHOLE
 - NEW HANDHOLE
 - EXISTING LUMINAIRE
 - NEW LUMINAIRE

GENERAL NOTES:
 INTERSECTION OF US BR 20 - JEFFERSON ST AT 1ST ST
 RELOCATE EXISTING SIGNS (2) ONTO NEW POST ON SOUTHEAST QUADRANT. THIS COST IS INCIDENTAL TO THE STATE PAY ITEM, TRAFFIC SIGNAL POST GALVANIZED STEEL 14 FT.

EXISTING CABINET FOUNDATION (40" X 21 1/2") SHALL BE REUSED FOR NEW CABINET.

WHEN REPLACING THE CABINET, THE EAST LEG SHALL HAVE THREE (3) TEMPORARY "STOP" SIGNS AT THE INTERSECTION BETWEEN THE TRAVEL LANES, AND THE NORTH LEG SHALL HAVE TWO (2) TEMPORARY "STOP" SIGNS AT THE INTERSECTION BETWEEN THE TRAVEL LANES, AND THE SOUTH LEG SHALL HAVE THREE (3) TEMPORARY "STOP" SIGNS AT THE INTERSECTION BETWEEN THE TRAVEL LANES. TWO (2) "BE PREPARED TO STOP" SIGNS SHALL BE PLACED 150' (+/-) EAST OF THE INTERSECTION FOR WESTBOUND TRAFFIC, ONE (1) "BE PREPARED TO STOP" SIGN SHALL BE PLACED 150' (+/-) NORTH OF THE INTERSECTION FOR SOUTHBOUND TRAFFIC AND ONE (1) "BE PREPARED TO STOP" SIGN SHALL BE PLACED 150' (+/-) SOUTH OF THE INTERSECTION FOR NORTHBOUND TRAFFIC. TRAFFIC CONTROL STANDARD 701502 MODIFIED, 701601, 701801.

SHEET 8 OF 15
 CONTRACT 64K05
 WINNEBAGO COUNTY
 FAP 303 (US BR 20)
 JEFFERSON ST

STATE OF ILLINOIS DEPARTMENT OF TRANSPORTATION	US BR 20 WINNEBAGO COUNTY	SECTION COUNTY SHEETS NO. CONTRACT NO.
SCALE: _____ SHEET NO. OF _____ SHEETS TOTAL	SCALE: _____ SHEET NO. OF _____ SHEETS TOTAL	SCALE: _____ SHEET NO. OF _____ SHEETS TOTAL
DESIGNED _____ REVISION _____ CHECKED _____ DATE _____	DESIGNED _____ REVISION _____ CHECKED _____ DATE _____	DESIGNED _____ REVISION _____ CHECKED _____ DATE _____

US BR 20 - JEFFERSON ST AT 1ST STREET CABLE PLAN

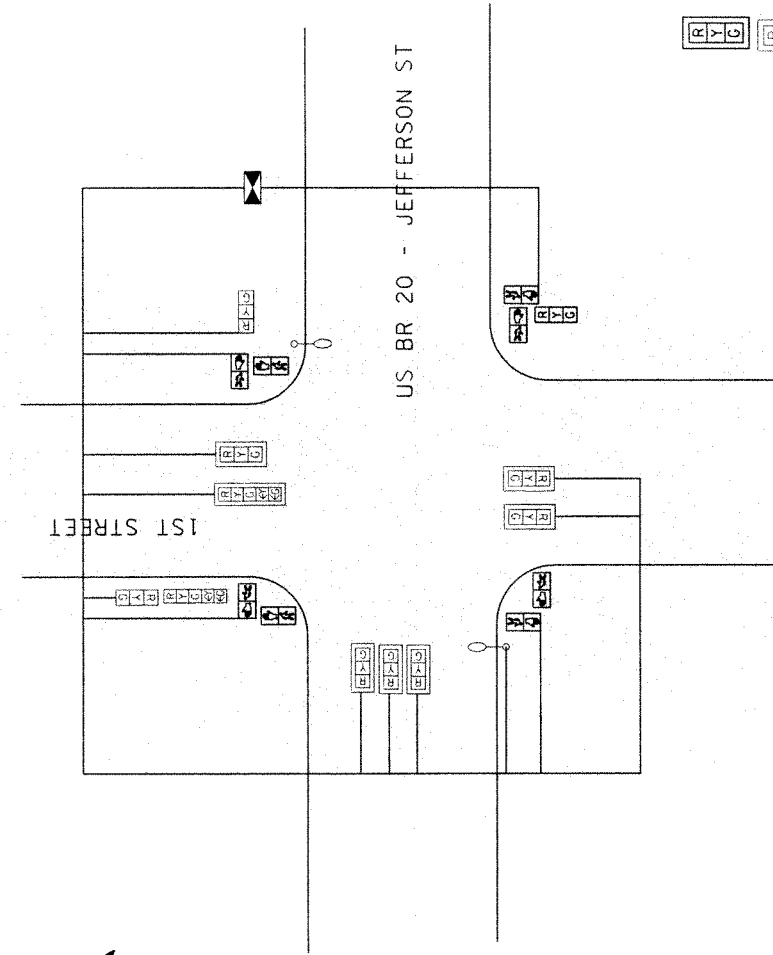

- GENERAL NOTES:
 INTERSECTION OF US BR 20 - JEFFERSON ST AT 1 ST STREET
 REMOVE AND REPLACE EXISTING TRAFFIC SIGNAL EQUIPMENT
 1 - CABINET
 1 - 3 SECTION BM HEADS, SOUTHEAST QUADRANT
 8 - PED HEADS WITH COUNTDOWN TIMERS, TWO PER QUADRANT

PHASE DESIGNATION DIAGRAM

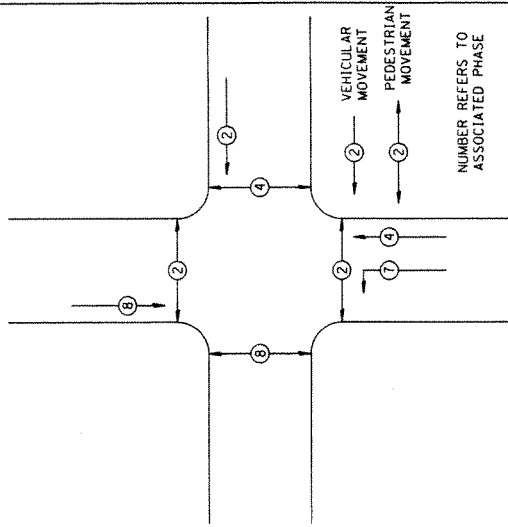

NUMBER REFERS TO ASSOCIATED PHASE

REFER TO STANDARD 85T001

LEGEND

NEW SIGNAL HEAD WITH OR WITHOUT BACKPLATE

EXISTING SIGNAL HEAD WITH OR WITHOUT BACKPLATE

NEW PEDESTRIAN HEAD - LED WITH COUNTDOWN TIMER

EXISTING LUMINAIRE, 250 WATT



SHEET 9 OF 15
 CONTRACT 64K05
 WINNEBAGO COUNTY
 FAP 303 (US BR 20)
 JEFFERSON ST

PROJECT NO.	DATE	DESIGNED	DATE	STATE OF ILLINOIS	US BR 20	SECTION	COUNTY
PROJECT NO.	DATE	REVISION	DATE	DEPARTMENT OF TRANSPORTATION	WINNEBAGO COUNTY	DATE	WINNEBAGO COUNTY
PROJECT NO.	DATE	REVISION	DATE			DATE	CONTRACT NO.
PROJECT NO.	DATE	REVISION	DATE			DATE	BLANKETS TO PROJECT

US BR 20 - JEFFERSON ST AT IL 251 SB - 2ND STREET
PLAN SHEET

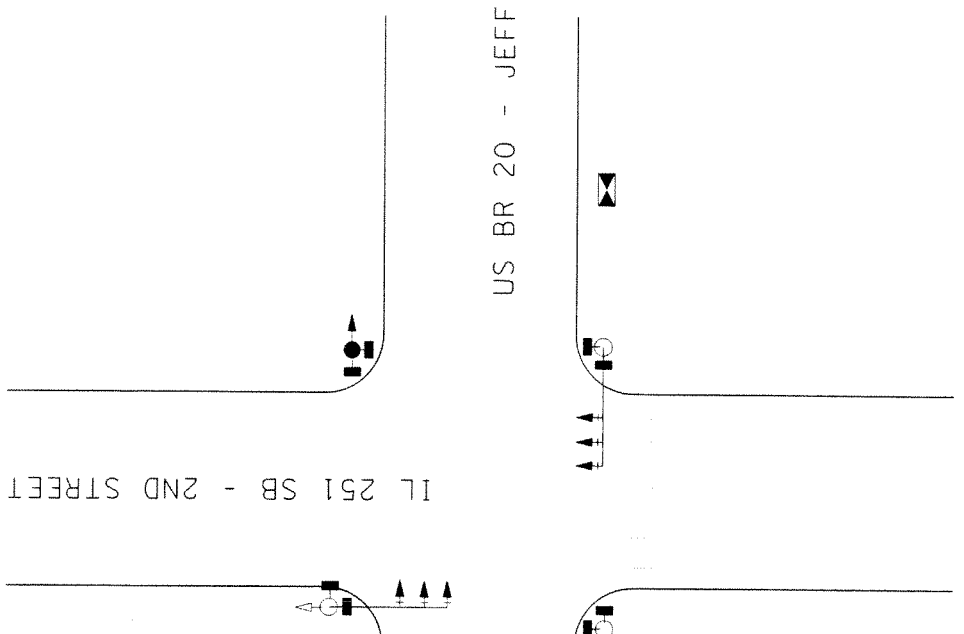

- LEGEND**
- EXISTING CONTROLLER
 - NEW CONTROLLER
 - EXISTING STEEL MAST ARM ASSEMBLY AND POLE
 - NEW STEEL MAST ARM ASSEMBLY AND POLE
 - EXISTING SIGNAL HEAD
 - NEW SIGNAL HEAD
 - NEW SIGNAL HEAD WITH BACKPLATE
 - EXISTING PEDESTRIAN HEAD
 - NEW PEDESTRIAN HEAD
 - PEDESTRIAN PUSHBUTTON
 - EXISTING HANDHOLE
 - NEW HANDHOLE
 - EXISTING LUMINAIRE
 - NEW LUMINAIRE
 - EXISTING DETECTOR LOOPS

GENERAL NOTES:
INTERSECTION OF US BR 20 - JEFFERSON ST AT IL 251 SB - 2ND STREET
EXISTING CABINET FOUNDATION (32 1/2" x 29") SHALL BE REUSED
FOR NEW CABINET.

RELOCATE EXISTING TWO (2) SIGNS ONTO NEW POST ON NORTHEAST QUADRANT. THIS COST IS INCIDENTAL TO THE STATE PAY ITEM, TRAFFIC SIGNAL POST GALVANIZED STEEL 14 FT.

SIX (6) INDUCTIVE LOOP DETECTORS SHALL BE USED TO COUNT VEHICLES. THREE (3) WILL DETECT EASTBOUND TRAVEL AND THREE (3) WILL DETECT SOUTHBOUND TRAVEL. THE NEW DETECTORS WILL BE CONNECTING INTO EXISTING DETECTOR LOOPS.

WHEN REPLACING THE CABINET, THE EAST LEG SHALL HAVE FOUR (4) TEMPORARY "STOP" SIGNS AT THE INTERSECTION BETWEEN THE TRAVEL LANES. THE NORTH LEG SHALL HAVE FOUR (4) TEMPORARY "STOP" SIGNS AT THE INTERSECTION BETWEEN THE TRAVEL LANES. TWO (2) "BE PREPARED TO STOP" SIGNS SHALL BE PLACED 150' (+/-) EAST OF THE INTERSECTION FOR WESTBOUND TRAFFIC, TWO (2) "BE PREPARED TO STOP" SIGNS SHALL BE PLACED 150' (+/-) NORTH OF THE INTERSECTION FOR SOUTHBOUND TRAFFIC. TRAFFIC CONTROL STANDARD 701601, 701801

US BR 20 - JEFFERSON ST

SHEET 10 OF 15
CONTRACT 64K05
WINNEBAGO COUNTY
FAP 303 (US BR 20)
JEFFERSON ST

FILE NO. 7	DATE: 08/11/2011	DESIGNED: []	REVIEWED: []
PROJECT NO. 64K05	DATE: 08/11/2011	CHECKED: []	REVIEWED: []
PROJECT NAME: US BR 20 - JEFFERSON ST	DATE: 08/11/2011	CHECKED: []	REVIEWED: []
STATE OF ILLINOIS DEPARTMENT OF TRANSPORTATION		US BR 20 WINNEBAGO COUNTY	
SHEET NO. 10 OF 15		SHEETS 1 TO 15	
SECTION: JEFFERSON ST		CONTRACT NO. 64K05	
COUNTY: WINNEBAGO		SHEET NO. 10 OF 15	

US BR 20 - JEFFERSON ST AT IL 251 SB - 2ND STREET
CABLE SHEET

PHASE DESIGNATION DIAGRAM

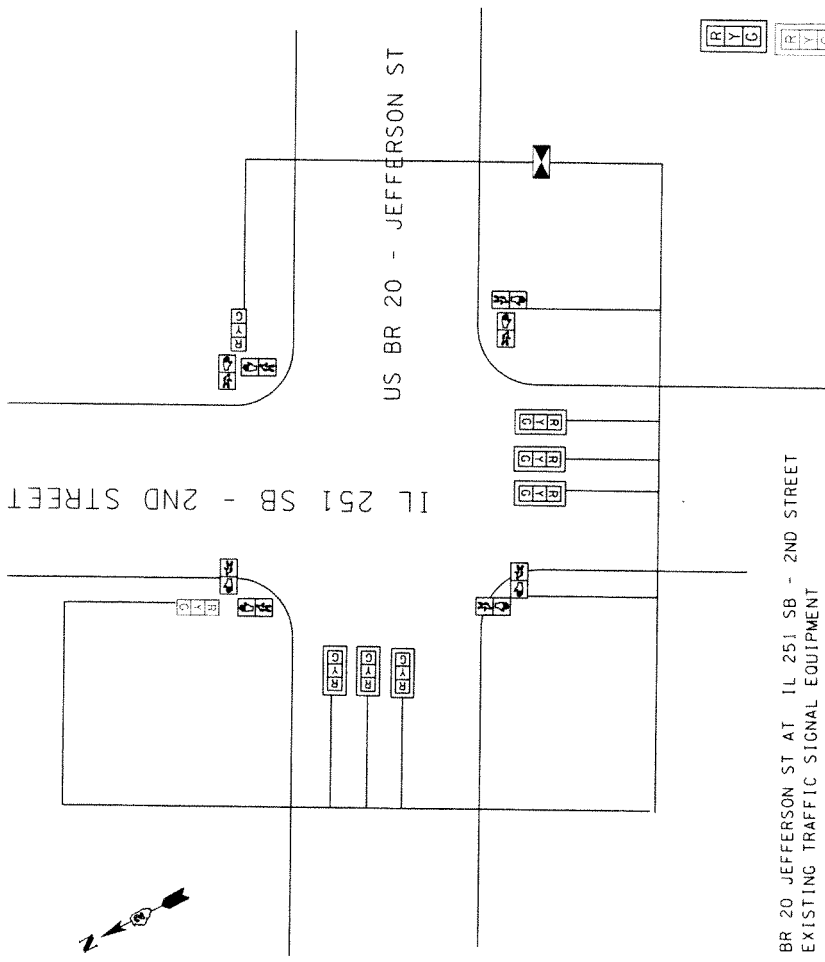
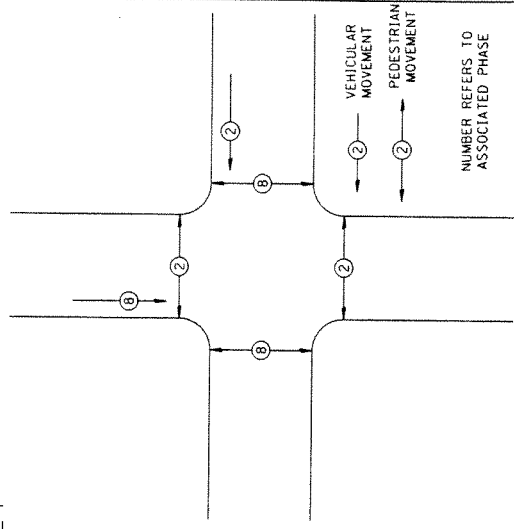

- LEGEND
- NEW SIGNAL HEAD WITH OR WITHOUT BACKPLATE
 - EXISTING SIGNAL HEAD WITH OR WITHOUT BACKPLATE
 - NEW PEDESTRIAN HEAD - LED WITH COUNTDOWN TIMER

- GENERAL NOTES:
- INTERSECTION OF US BR 20 JEFFERSON ST AT IL 251 SB - 2ND STREET REMOVE AND REPLACE EXISTING TRAFFIC SIGNAL EQUIPMENT
 - 1 - CABINET
 - 6 - 3 SEC MAM HEADS THREE OVER WEST LEG, THREE OVER SOUTH LEG
 - 1 - 3 SEC BM HEADS, TWO PER QUADRANT
 - 8 - PED HEADS WITH COUNTDOWN TIMERS, TWO PER QUADRANT

SHEET 11 OF 15
CONTRACT 64K05
WINNEBAGO COUNTY
FAP 303 (US BR 20)
JEFFERSON ST

DATE	BY	CHECKED	DATE	SCALE	SHEET NO. OF	SHEETS	STA.	TO STA.	CONTRACT NO.	PROJECT
					US BR 20	WINNEBAGO COUNTY				

US BR 20 - JEFFERSON ST AT IL 251 NB - 3RD STREET
 PLAN SHEET

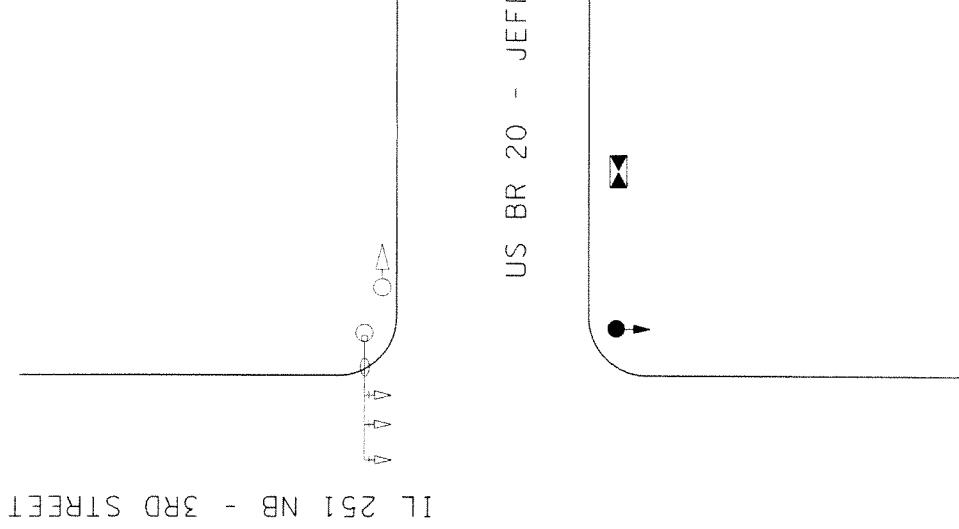

- LEGEND**
- EXISTING CONTROLLER
 - NEW CONTROLLER
 - EXISTING STEEL MAST ARM ASSEMBLY AND POLE
 - NEW STEEL MAST ARM ASSEMBLY AND POLE
 - EXISTING SIGNAL HEAD
 - NEW SIGNAL HEAD
 - EXISTING SIGNAL HEAD WITH BACKPLATE
 - EXISTING PEDESTRIAN HEAD
 - NEW PEDESTRIAN HEAD
 - PEDESTRIAN PUSHBUTTON
 - EXISTING HANDHOLE
 - NEW HANDHOLE
 - EXISTING LUMINAIRE
 - NEW LUMINAIRE
 - EXISTING DETECTOR LOOP

GENERAL NOTES:

1. INTERSECTION OF US BR 20 JEFFERSON ST AT IL 251 NB 3RD STREET
2. RELOCATE EXISTING ONE (1) SIGN ONTO NEW POST ON SOUTHEAST QUADRANT. THIS COST IS INCIDENTAL TO THE PROJECT.
3. THREE (3) INDUCTIVE LOOP DETECTORS SHALL BE USED TO COUNT EASTBOUND VEHICLES. THE NEW DETECTORS WILL BE CONNECTING INTO EXISTING DETECTOR LOOPS.
4. EXISTING CABINET FOUNDATION (40" X 22 1/2") SHALL BE REUSED FOR NEW CABINET. THE NEW CABINET SHALL HAVE A MANUALLY OPERATED TRANSFER SWITCH.
5. WHEN REPLACING THE CABINET, THE EAST LEG SHALL HAVE THREE (3) TEMPORARY "STOP" SIGNS AT THE INTERSECTION BETWEEN TRAVEL LANES, THE SOUTH LEG SHALL HAVE THREE (3) TEMPORARY "STOP" SIGNS AT THE INTERSECTION BETWEEN TRAVEL LANES.
6. TWO (2) "BE PREPARED TO STOP" SIGNS SHALL BE PLACED 150' (+/-) EAST OF THE INTERSECTION FOR WESTBOUND TRAFFIC, TWO (2) "BE PREPARED TO STOP" SIGNS SHALL BE PLACED 150' (+/-) SOUTH OF THE INTERSECTION FOR NORTHBOUND TRAFFIC.
7. TRAFFIC CONTROL STANDARD 701601, 701801

SHEET 12 OF 15
 CONTRACT 64K05
 WINNEBAGO COUNTY
 FAP 303 (US BR 20)
 JEFFERSON ST

DATE: 01/15/10	DESIGNED: [Signature]	REVISION:	US BR 20	SECTION:	TOTAL SHEETS:
DATE: 01/15/10	CHECKED: [Signature]	REVISION:	WINNEBAGO COUNTY	CONTRACT NO.:	12 OF 15
DATE: 01/15/10	DATE: 01/15/10	REVISION:	STATE OF ILLINOIS	PROJECT NO.:	
DATE: 01/15/10	DATE: 01/15/10	REVISION:	DEPARTMENT OF TRANSPORTATION	SHEET NO. OF SHEETS:	12 OF 15

TRAFFIC CONTROL DETAIL

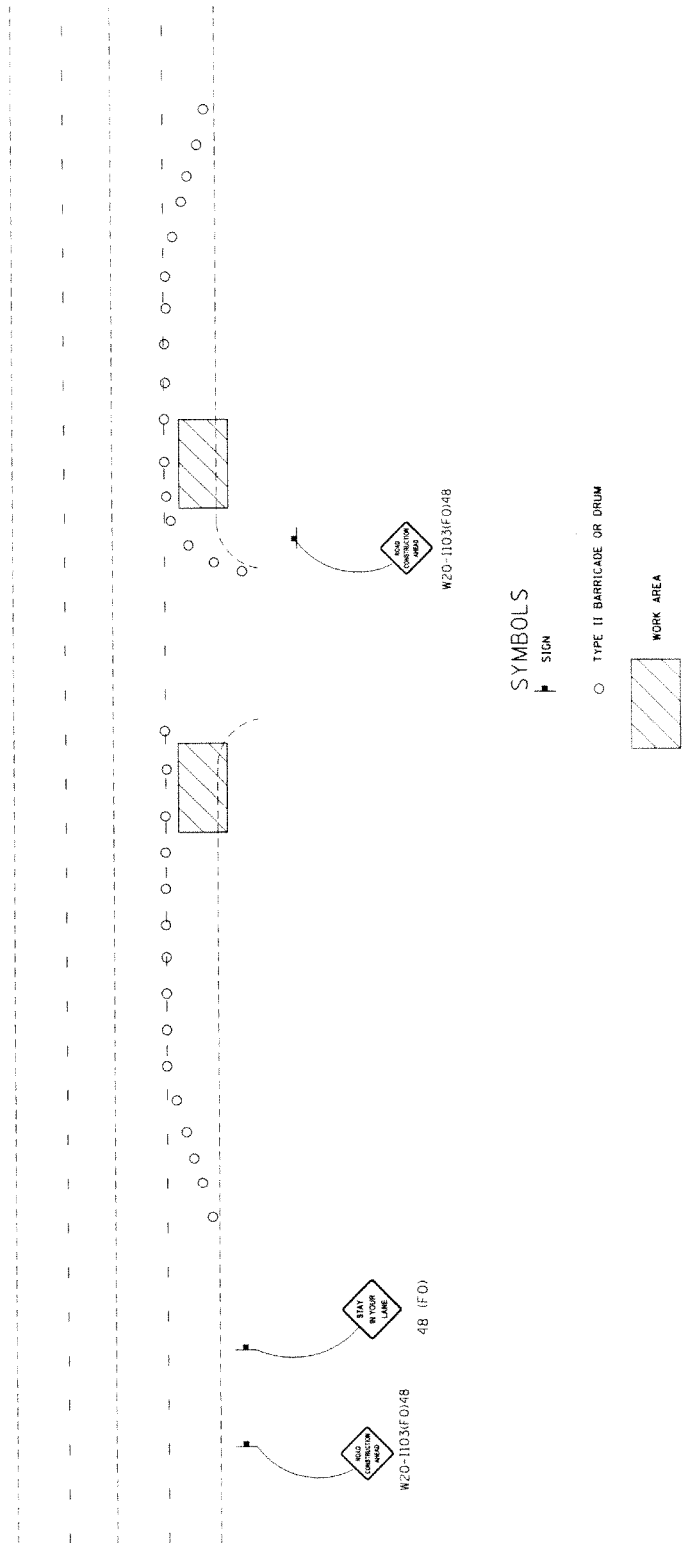

SHEET 14 OF 15
 CONTRACT 64K05
 WINNEBAGO COUNTY
 FAP 303 (US BR 20)
 JEFFERSON ST

NOTES:
 USE T01006 WHEN NEEDING TO WORK
 ON SB WORK

FILE NAME PROJECT NUMBER SHEET NO. OF TOTAL SHEETS	DESIGNED DRAWN CHECKED DATE	REVISIONS NO. DATE BY DESCRIPTION	COUNTY SECTION SCALE SHEET NO. OF TOTAL SHEETS
STATE OF ILLINOIS DEPARTMENT OF TRANSPORTATION		TRAFFIC CONTROL	

TRAFFIC CONTROL DETAILS

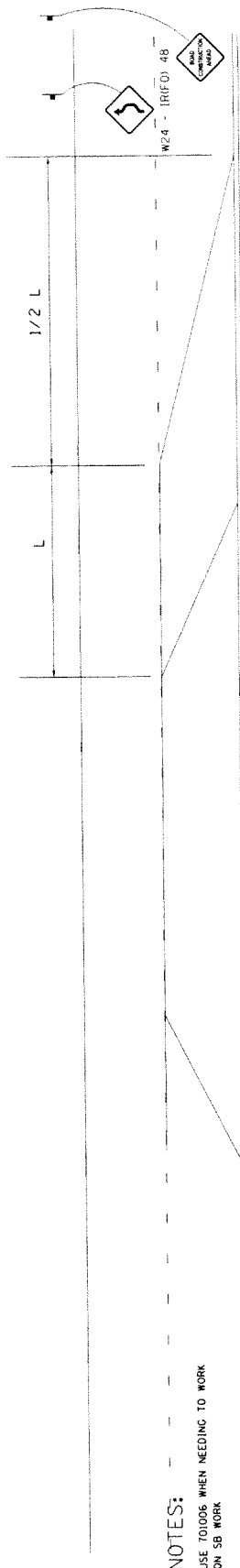
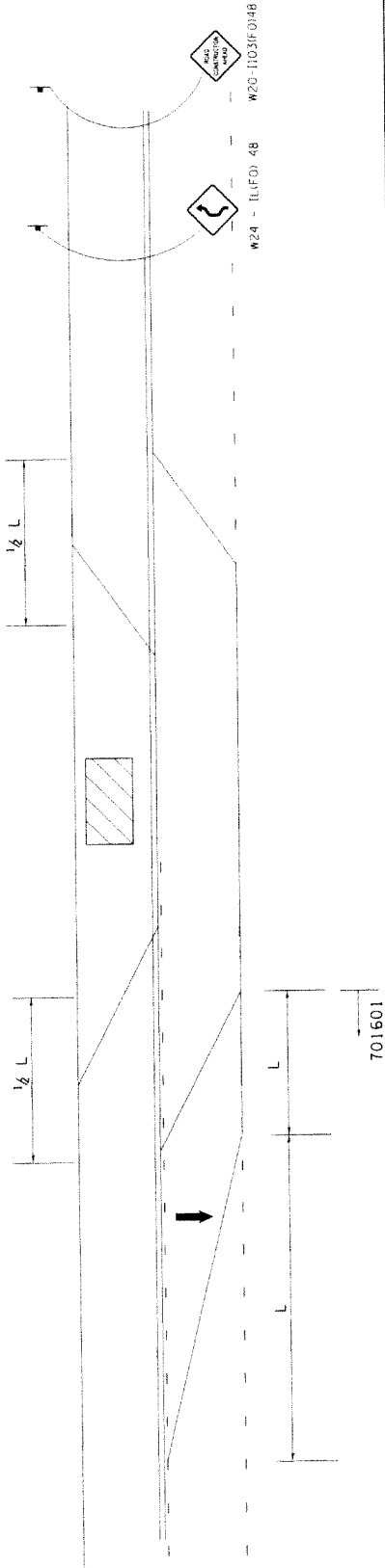

NOTES:

USE 701006 WHEN NEEDING TO WORK ON SB WORK

SYMBOLS

- SIGN
- TYPE II BARRICADE OR DRUM
- ▨ WORK AREA
- ➔ MESSAGE BOARD
- WS²
- L = 60

SHEET 15 OF 15
 CONTRACT 64K05
 WINNEBAGO COUNTY
 FAP 303 (US BR 20)
 JEFFERSON ST

DATE	DESIGNED	TRAFFIC CONTROL	SECTION	COUNTY	SHEET NO.
DATE	DRAWN	STATE OF ILLINOIS	SECTION	COUNTY	SHEET NO.
DATE	CHECKED	DEPARTMENT OF TRANSPORTATION	SECTION	COUNTY	SHEET NO.
DATE	REVISION		SECTION	COUNTY	SHEET NO.
DATE	REVISION		SECTION	COUNTY	SHEET NO.
DATE	REVISION		SECTION	COUNTY	SHEET NO.

ILLINOIS DEPARTMENT OF LABOR

**PREVAILING WAGES FOR
K-BB965 ; C COUNTY
EFFECTIVE MAY 2014**

The Prevailing rates of wages are included in the Contract proposals which are subject to Check Sheet #5 of the Supplemental Specifications and Recurring Special Provisions. The rates have been ascertained and certified by the Illinois Department of Labor for the locality in which the work is to be performed and for each craft or type of work or mechanic needed to execute the work of the Contract. As required by Prevailing Wage Act (820 ILCS 130/0.01, et seq.) and Check Sheet #5 of the Contract, not less than the rates of wages ascertained by the Illinois Department of Labor and as revised during the performance of a Contract shall be paid to all laborers, workers and mechanics performing work under the Contract. Post the scale of wages in a prominent and easily accessible place at the site of work.

If the Illinois Department of Labor revises the prevailing rates of wages to be paid as listed in the specification of rates, the contractor shall post the revised rates of wages and shall pay not less than the revised rates of wages. Current wage rate information shall be obtained by visiting the Illinois Department of Labor web site at <http://www.state.il.us/agency/idol/> or by calling 312-793-2814. It is the responsibility of the contractor to review the rates applicable to the work of the contract at regular intervals in order to insure the timely payment of current rates. Provision of this information to the contractor by means of the Illinois Department of Labor web site satisfies the notification of revisions by the Department to the contractor pursuant to the Act, and the contractor agrees that no additional notice is required. The contractor shall notify each of its subcontractors of the revised rates of wages.

Winnebago County Prevailing Wage for May 2014

(See explanation of column headings at bottom of wages)

Trade Name	RG	TYP	C	Base	FRMAN	M-F>8	OSA	OSH	H/W	Pensn	Vac	Trng
=====	==	===	=	=====	=====	=====	===	===	=====	=====	=====	=====
ASBESTOS ABT-GEN		BLD		30.570	31.820	1.5	1.5	2.0	8.240	12.95	0.000	0.800
ASBESTOS ABT-MEC		BLD		18.950	0.000	1.5	1.5	2.0	2.700	3.350	0.000	0.000
BOILERMAKER		BLD		44.240	48.220	2.0	2.0	2.0	6.970	17.54	0.000	0.350
BRICK MASON		BLD		36.420	39.170	1.5	1.5	2.0	8.650	12.05	0.000	0.630
CARPENTER		BLD		36.410	40.420	1.5	1.5	2.0	8.300	11.55	0.000	0.600
CARPENTER		HWY		41.080	42.830	1.5	1.5	2.0	8.300	10.00	0.000	0.490
CEMENT MASON		ALL		35.240	37.990	1.5	1.5	2.0	8.750	12.00	0.000	0.500
CERAMIC TILE FNSHER		BLD		32.450	0.000	1.5	1.5	2.0	8.300	4.930	0.000	0.550
COMMUNICATION TECH		BLD		36.440	40.080	1.5	1.5	2.0	10.39	12.09	0.000	0.760
ELECTRIC PWR EQMT OP		ALL		36.610	49.750	1.5	1.5	2.0	5.000	11.35	0.000	0.270
ELECTRIC PWR GRNDMAN		ALL		28.310	49.750	1.5	1.5	2.0	5.000	8.780	0.000	0.210
ELECTRIC PWR LINEMAN		ALL		43.830	49.750	1.5	1.5	2.0	5.000	13.58	0.000	0.330
ELECTRIC PWR TRK DRV		ALL		29.310	49.750	1.5	1.5	2.0	5.000	9.090	0.000	0.220
ELECTRICIAN		BLD		41.500	45.650	1.5	1.5	2.0	10.39	17.43	0.000	0.830
ELEVATOR CONSTRUCTOR		BLD		46.050	51.810	2.0	2.0	2.0	12.73	13.46	3.680	0.600
GLAZIER		BLD		35.730	37.730	1.5	1.5	2.0	9.950	8.200	0.000	1.250
HT/FROST INSULATOR		BLD		33.930	36.470	1.5	1.5	2.0	7.450	14.77	0.000	0.000
IRON WORKER		ALL		35.090	36.840	2.0	2.0	2.0	8.340	22.19	0.000	0.500
LABORER		BLD		30.570	31.820	1.5	1.5	2.0	8.240	12.95	0.000	0.800
LABORER		HWY		33.200	33.950	1.5	1.5	2.0	8.240	13.95	0.000	0.800
LABORER, SKILLED		HWY		35.650	36.400	1.5	1.5	2.0	8.240	13.95	0.000	0.800
LATHER		BLD		36.410	40.420	1.5	1.5	2.0	8.300	11.55	0.000	0.600
MACHINIST		BLD		43.920	46.420	1.5	1.5	2.0	6.760	8.950	1.850	0.000
MARBLE FINISHERS		BLD		32.450	0.000	1.5	1.5	2.0	8.300	4.930	0.000	0.550
MARBLE MASON		BLD		35.130	35.380	1.5	1.5	2.0	8.300	7.240	0.000	0.580
MATERIAL TESTER I		ALL		21.550	0.000	1.5	1.5	2.0	7.460	4.840	0.000	0.170
MATERIALS TESTER II		ALL		26.550	0.000	1.5	1.5	2.0	7.460	4.840	0.000	0.170
MILLWRIGHT		BLD		35.500	39.050	1.5	1.5	2.0	8.300	14.37	0.000	0.500
OPERATING ENGINEER		BLD	1	41.800	45.800	2.0	2.0	2.0	16.65	10.30	2.350	1.000
OPERATING ENGINEER		BLD	2	41.100	45.800	2.0	2.0	2.0	16.65	10.30	2.350	1.000
OPERATING ENGINEER		BLD	3	38.650	45.800	2.0	2.0	2.0	16.65	10.30	2.350	1.000
OPERATING ENGINEER		BLD	4	36.650	45.800	2.0	2.0	2.0	16.65	10.30	2.350	1.000
OPERATING ENGINEER		BLD	5	45.550	45.800	2.0	2.0	2.0	16.65	10.30	2.350	1.000
OPERATING ENGINEER		BLD	6	44.800	45.800	2.0	2.0	2.0	16.65	10.30	2.350	1.000
OPERATING ENGINEER		BLD	7	41.800	45.800	2.0	2.0	2.0	16.65	10.30	2.350	1.000
OPERATING ENGINEER		HWY	1	41.650	45.650	1.5	1.5	2.0	16.65	10.30	2.350	1.300
OPERATING ENGINEER		HWY	2	41.100	45.650	1.5	1.5	2.0	16.65	10.30	2.350	1.300
OPERATING ENGINEER		HWY	3	39.800	45.650	1.5	1.5	2.0	16.65	10.30	2.350	1.300
OPERATING ENGINEER		HWY	4	38.350	45.650	1.5	1.5	2.0	16.65	10.30	2.350	1.300
OPERATING ENGINEER		HWY	5	36.900	45.650	1.5	1.5	2.0	16.65	10.30	2.350	1.300
OPERATING ENGINEER		HWY	6	44.650	45.650	1.5	1.5	2.0	16.65	10.30	2.350	1.300
OPERATING ENGINEER		HWY	7	42.650	45.650	1.5	1.5	2.0	16.65	10.30	2.350	1.300
PAINTER		ALL		35.800	37.800	1.5	1.5	1.5	10.00	8.200	0.000	1.350
PILEDRIVER		BLD		37.410	41.530	1.5	1.5	2.0	8.300	11.55	0.000	0.600
PILEDRIVER		HWY		41.080	42.830	1.5	1.5	2.0	8.300	10.00	0.000	0.490
PIPEFITTER		BLD		42.100	45.050	1.5	1.5	2.0	7.980	11.04	0.000	1.000
PLASTERER		BLD		33.780	37.160	1.5	1.5	2.0	8.750	11.60	0.000	0.500
PLUMBER		BLD		42.100	45.050	1.5	1.5	2.0	7.980	11.04	0.000	1.000
ROOFER		BLD		39.200	42.200	1.5	1.5	2.0	8.280	9.690	0.000	0.430
SHEETMETAL WORKER		BLD		37.400	39.330	1.5	1.5	2.0	5.700	16.50	0.520	0.290
SPRINKLER FITTER		BLD		37.120	39.870	1.5	1.5	2.0	8.420	8.500	0.000	0.350
STONE MASON		BLD		36.420	39.170	1.5	1.5	2.0	8.650	12.05	0.000	0.630
SURVEY WORKER		ALL		35.650	36.400	1.5	1.5	2.0	8.240	13.95	0.000	0.800
TERRAZZO FINISHER		BLD		32.450	0.000	1.5	1.5	2.0	8.300	4.930	0.000	0.550
TERRAZZO MASON		BLD		35.130	35.380	1.5	1.5	2.0	8.300	7.240	0.000	0.580
TILE LAYER		BLD		36.410	40.420	1.5	1.5	2.0	8.300	11.55	0.000	0.600

TILE MASON	BLD	35.130	35.380	1.5	1.5	2.0	8.300	7.240	0.000	0.580
TRUCK DRIVER	ALL 1	32.960	33.420	1.5	1.5	2.0	6.900	8.220	0.000	0.000
TRUCK DRIVER	ALL 2	33.110	33.420	1.5	1.5	2.0	6.900	8.220	0.000	0.000
TRUCK DRIVER	ALL 3	33.310	33.420	1.5	1.5	2.0	6.900	8.220	0.000	0.000
TRUCK DRIVER	ALL 4	33.420	33.420	1.5	1.5	2.0	6.900	8.220	0.000	0.000
TUCKPOINTER	BLD	36.420	39.170	1.5	1.5	2.0	8.650	12.05	0.000	0.630

Legend: RG (Region)

TYP (Trade Type - All,Highway,Building,Floating,Oil & Chip,Rivers)

C (Class)

Base (Base Wage Rate)

FRMAN (Foreman Rate)

M-F>8 (OT required for any hour greater than 8 worked each day, Mon through Fri.)

OSA (Overtime (OT) is required for every hour worked on Saturday)

OSH (Overtime is required for every hour worked on Sunday and Holidays)

H/W (Health & Welfare Insurance)

Pensn (Pension)

Vac (Vacation)

Trng (Training)

Explanations

WINNEBAGO COUNTY

The following list is considered as those days for which holiday rates of wages for work performed apply: New Years Day, Memorial Day, Fourth of July, Labor Day, Thanksgiving Day, Christmas Day and Veterans Day in some classifications/counties. Generally, any of these holidays which fall on a Sunday is celebrated on the following Monday. This then makes work performed on that Monday payable at the appropriate overtime rate for holiday pay. Common practice in a given local may alter certain days of celebration. If in doubt, please check with IDOL.

EXPLANATION OF CLASSES

ASBESTOS - GENERAL - removal of asbestos material/mold and hazardous materials from any place in a building, including mechanical systems where those mechanical systems are to be removed. This includes the removal of asbestos materials/mold and hazardous materials from ductwork or pipes in a building when the building is to be demolished at the time or at some close future date.

ASBESTOS - MECHANICAL - removal of asbestos material from mechanical systems, such as pipes, ducts, and boilers, where the mechanical systems are to remain.

CERAMIC TILE FINISHER, MARBLE FINISHER, TERRAZZO FINISHER

Assisting, helping or supporting the tile, marble and terrazzo mechanic by performing their historic and traditional work assignments required to complete the proper installation of the work covered by said crafts. The term "Ceramic" is used for naming the classification only and is in no way a limitation of the product handled. Ceramic takes into consideration most hard tiles.

COMMUNICATIONS TECHNICIAN

Installing, manufacturing, assembling and maintaining sound and intercom, protection alarm (security), fire alarm, master antenna television, closed circuit television, low voltage control for computers and/or door monitoring, school communications systems, telephones and servicing of nurse and emergency calls, and the installation and maintenance of transmit and receive antennas, transmitters, receivers, and associated apparatus which operates in conjunction with above systems. All work associated with these system installations will be included EXCEPT the installation of protective metallic conduit in new construction projects (excluding less than ten-foot, runs strictly for protection of cable) and 120 volt AC (or higher) power wiring and associated hardware.

LABORER, SKILLED - HIGHWAY

Individuals engaged in the following types of work, irrespective of the site of the work: asbestos abatement worker, handling of any materials with any foreign matter harmful to skin or clothing, track laborer, cement handlers, chloride handlers, the unloading and loading with steel workers and re-bars, concrete workers wet, tunnel helpers in free air, batch dumpers, mason tenders, kettle and tar men, tank cleaners, plastic installers, scaffold workers, motorized buggies or motorized unit used for wet concrete or handling of building materials, laborers with de-watering systems, sewer workers plus depth, rod and chainmen with technical engineers, rod and chainmen with land surveyors, rod and chainmen with surveyors, vibrator operators, cement silica, clay, fly ash, lime and plasters, handlers (bulk or bag), cofferdam workers plus depth, on concrete paving, placing, cutting and tying of reinforcing, deck hand, dredge hand, and shore laborers, bankmen on floating plant, grade checker, power tools, front end man on chip spreaders, cession workers plus depth, gunnite nozzle men, lead man on sewer work, welders, cutters, burners and torchmen, chainsaw operators, jackhammer and drill operators, layout man and/or drainage tile layer, steel form setter - street and highway, air tamping hammermen, signal man on crane, concrete saw operator, screedman on asphalt pavers, laborers tending masons with hot material or where foreign materials are used, mortar mixer operators, multiple concrete duct - leadsman, lumen, asphalt raker, curb asphalt machine operator, ready mix scalemen (permanent, portable or temporary plant), laborers handling masterplate or similar materials, laser beam operator, con-crete burning machine operator, coring machine operator, plaster ten-der, underpinning and shoring of buildings, pump men, manhole and catch basin, dirt and stone tamper, hose men on concrete pumps, haz-ardous waste worker, lead base paint abatement worker, lining of pipe, refusing machine, assisting on direct boring machine, the work of lay-ing watermain, fire hydrants, all mechanical joints to watermain work, sewer worker, and tapping water service and forced lift station mechanical worker.

MATERIAL TESTER I: Hand coring and drilling for testing of materials; field inspection of uncured concrete and asphalt.

MATERIAL TESTER II: Field inspection of welds, structural steel, fireproofing, masonry, soil, facade, reinforcing steel, formwork, cured concrete, and concrete and asphalt batch plants; adjusting proportions of bituminous mixtures.

OPERATING ENGINEERS - BUILDING

Class 1. Asphalt Plant; Asphalt Spreader; Autograde; Backhoes with Caisson Attachment; Batch Plant; Benoto (requires Two Engineers); Boiler and Throttle Valve; Caisson Rigs; Central Redi-Mix Plant; Combination Back Hoe Front End-loader Machine; Compressor and Throttle Valve; Concrete Breaker (Truck Mounted); Concrete Conveyor; Concrete Paver (over 27E cu. ft.): Concrete Paver (27 cu. ft. and under); Concrete Placer; Concrete Pump (Truck Mounted); Concrete Conveyor (Truck Mounted); Concrete Tower; Cranes, All; GCI and similar types (required two operators only); Cranes, Hammerhead; Creter Crane; Crusher, Stone, etc.; Derricks, All; Derricks, Traveling; Formless Curb and Gutter Machine; Grader, Elevating; Grouting Machines; Highlift Shovels or Front Endloader 2-1/4 yd. and over; Hoists, Elevators, outside type rack and pinion and similar machines; Hoists, one, two and three Drum; Hoists, Two Tugger One Floor; Hydraulic Backhoes; Hydraulic Boom Trucks; Hydro Vac (and similar equipment - excluding hose work and any sewer work); Locomotives, All; Lubrication Technician; Manipulators; Motor Patrol; Pile Drivers and Skid Rig; Post Hole Digger; Pre-Stress Machine; Pump Cretes Dual Ram; Pump Cretes: Squeeze Cretes - Screw Type Pumps, Gypsum Bulker and Pump; Raised and Blind Hole Drill; Rock Drill (self-propelled); Rock Drill - Truck Mounted; Roto Mill Grinder; Scoops - Tractor Drawn; Slipform Paver; Scrapers Prime Movers; Straddle Buggies; Tie Back Machine; Tractor with Boom and Side Boom; Trenching Machines.

Class 2. Bobcat (over 3/4 cu. yd.); Boilers; Brick Forklift; Broom, All Power Propelled; Bulldozers; Concrete Mixer (Two Bag and Over); Conveyor, Portable; Forklift Trucks; Highlift Shovels or Front Endloaders under 2-1/4 yd.; Hoists, Automatic; Hoists, Sewer Dragging Machine; Hoists, Tugger Single Drum; Laser Screed; Rollers, All; Steam Generators; Tractors, All; Tractor Drawn Vibratory Roller; Winch Trucks with "A" Frame.

Class 3. Air Compressor; Asphalt Spreader; Combination - Small Equipment Operator; Generators; Heaters, Mechanical; Hoists, Inside Elevators - (Rheostat Manual Controlled); Hydraulic Power Units (Pile Driving, Extracting, or Drilling - with a seat); Lowboys; Pumps, Over 3" (1 to 3 not to exceed total of 300 ft.); Pumps, Well Points; Welding Machines (2 through 5); Winches, 4 Small Electric Drill Winches; Bobcat (up to and including 3/4 cu. yd.).

Class 4. Elevator push button with automatic doors; Hoists, Inside; Oilers; Brick Forklift.

Class 5. Assistant Craft Foreman

Class 6. Mechanics; Welders.

Class 7. Gradall

OPERATING ENGINEERS - HIGHWAY CONSTRUCTION

Class 1. Asphalt Plant; Asphalt Heater and Planer Combination; Asphalt Heater Scarfire; Asphalt Silo Tender; Asphalt Spreader; Autograder; ABG Paver; Backhoes with Caisson Attachment; Ballast Regulator; Belt Loader; Caisson Rigs; Car Dumper; Central Redi-Mix Plant; Backhoe w/shear attachments; Combination Backhoe Front Endloader Machine, (1 cu. yd. Backhoe Bucket or over or with attachments); Concrete Breaker (Truck Mounted); Concrete Conveyor; Concrete Paver over 27E cu. ft.; Concrete Placer; Concrete Tube Float; Cranes, all attachments; Cranes, Tower of all types; Creter Crane; Crusher, Stone, etc.; Derricks, All; Derrick Boats; Derricks, Traveling; Directional Boring Machine over 12"; Dredges; Formless Curb and Gutter Machine; Grader, Elevating; Grader, Motor Grader, Motor Patrol, Auto Patrol, Form Grader, Pull Grader, Subgrader; Guard Rail Post Driver Mounted; Hoists, One, Two and Three Drum; Hydraulic Backhoes; Hydro Vac, Self Propelled, Truck Mounted (excluding hose work and any sewer work); Lubrication Technician; Manipulators; Pile Drivers and Skid Rig; Pre-Stress Machine; Pump Cretes Dual Ram; Rock Drill - Crawler or Skid Rig; Rock Drill - Truck Mounted; Rock/Track Tamper; Roto Mill Grinder; Slip-Form Paver; Snow Melters; Soil Test Drill Rig (Truck Mounted); Straddle Buggies; GCI Crane; Hydraulic Telescoping Form (Tunnel); Tie Back Machine; Tractor Drawn Belt Loader; Tractor Drawn Belt Loader with attached pusher; Tractor with Boom; Tractaire with Attachments; Traffic Barrier Conveyor Machine; Raised or Blind Hole Drills; Trenching Machine (over 12"); Truck Mounted Concrete Pump with Boom; Truck Mounted Concrete Conveyor; Work Boat (no license required - 90 h.p. or above); Underground Boring and/or Mining Machines; Wheel Excavator; Widener (APSCO).

Class 2. Batch Plant; Bituminous Mixer; Boiler and Throttle Valve; Bulldozers; Car Loader Trailing Conveyors; Combination Backhoe Front Endloader Machine (less than 1 cu. yd. Backhoe Bucket or over or with attachments); Compressor and Throttle Valve; Compressor, Common Receiver (3); Concrete Breaker or Hydro Hammer; Concrete Grinding Machine; Concrete Mixer or Paver 7S Series to and including 27 cu. ft.; Concrete Spreader; Concrete Curing Machine, Burlap Machine, Belting Machine and Sealing Machine; Concrete Wheel Saw (large self-propelled - excluding walk-behinds and hand-held); Conveyor Muck Cars (Haglund or Similar Type); Drills, all; Finishing Machine - Concrete; Highlift Shovels or Front Endloader; Hoist - Sewer Dragging Machine; Hydraulic Boom Trucks (All Attachments); Hydro Blaster; All Locomotives, Dinky; Off-Road Hauling Units; Non-Self Loading Dump; Ejection Dump; Pump Cretes: Squeeze Cretes - Screw Type Pumps, Gypsum Bulker and Pump; Roller, Asphalt; Rotary Snow Plows; Rototiller, Seaman, etc., self-propelled; Scoops - Tractor Drawn; Self-Propelled Compactor; Spreader - Chip - Stone, etc.; Scraper; Scraper - Prime Mover in Tandem (Regardless of Size); Tank Car Heater; Tractors, Push, Pulling Sheeps Foot, Disc, Compactor, etc.; Tug Boats.

Class 3. Boilers; Brooms, All Power Propelled; Cement Supply Tender; Compressor, Common Receiver (2); Concrete Mixer (Two Bag and Over); Conveyor, Portable; Farm-Type Tractors Used for Mowing, Seeding, etc.; Fireman on Boilers; Forklift Trucks; Grouting Machine; Hoists, Automatic; Hoists, All Elevators; Hoists, Tugger Single Drum; Jeep Diggers; Low Boys; Pipe Jacking Machines; Post-Hole Digger; Power Saw, Concrete Power Driven; Pug Mills; Rollers, other than asphalt; Seed and Straw Blower; Steam Generators; Stump Machine; Winch Trucks with "A" Frame; Work Boats; Tamper - Form - Motor Driven.

Class 4. Air Compressor - Small and Large; Asphalt Spreader, Backend Man; Bobcat (Skid Steer) all; Brick Forklift; Combination - Small Equipment Operator; Directional Boring Machine up to 12"; Generators; Heaters, Mechanical; Hydraulic Power Unit (Pile Driving, Extracting, or Drilling); Hydro-Blaster; Light Plants, All (1 through 5); Pumps,

over 3" (1 to 3 not to exceed a total of 300 ft.); Pumps, Well Points; Tractaire; Trencher 12" and under; Welding Machines (2 through 5); Winches, 4 Small Electric Drill Winches.

Class 5. Oilers and Directional Boring Machine Locator.

Class 6. Field Mechanics and Field Welders

Class 7. Gradall and machines of like nature.

SURVEY WORKER - Operated survey equipment including data collectors, G.P.S. and robotic instruments, as well as conventional levels and transits.

TRUCK DRIVER - BUILDING, HEAVY AND HIGHWAY CONSTRUCTION

Class 1. Two or three Axle Trucks. A-frame Truck when used for transportation purposes; Air Compressors and Welding Machines, including those pulled by cars, pick-up trucks and tractors; Ambulances; Batch Gate Lockers; Batch Hopperman; Car and Truck Washers; Carry-alls; Fork Lifts and Hoisters; Helpers; Mechanics Helpers and Greasers; Oil Distributors 2-man operation; Pavement Breakers; Pole Trailer, up to 40 feet; Power Mower Tractors; Self-propelled Chip Spreader; Skipman; Slurry Trucks, 2-man operation; Slurry Truck Conveyor Operation, 2 or 3 man; TTeamsters Unskilled dumpman; and Truck Drivers hauling warning lights, barricades, and portable toilets on the job site.

Class 2. Four axle trucks; Dump Crets and Adgetors under 7 yards; Dumpsters, Track Trucks, Euclids, Hug Bottom Dump Turnapulls or Turnatrailers when pulling other than self-loading equipment or similar equipment under 16 cubic yards; Mixer Trucks under 7 yards; Ready-mix Plant Hopper Operator, and Winch Trucks, 2 Axles.

Class 3. Five axle trucks; Dump Crets and Adgetors 7 yards and over; Dumpsters, Track Trucks, Euclids, Hug Bottom Dump Turnatrailers or turnapulls when pulling other than self-loading equipment or similar equipment over 16 cubic yards; Explosives and/or Fission Material Trucks; Mixer Trucks 7 yards or over; Mobile Cranes while in transit; Oil Distributors, 1-man operation; Pole Trailer, over 40 feet; Pole and Expandable Trailers hauling material over 50 feet long; Slurry trucks, 1-man operation; Winch trucks, 3 axles or more; Mechanic--Truck Welder and Truck Painter.

Class 4. Six axle trucks; Dual-purpose vehicles, such as mounted crane trucks with hoist and accessories; Foreman; Master Mechanic; Self-loading equipment like P.B. and trucks with scoops on the front.

Other Classifications of Work:

For definitions of classifications not otherwise set out, the Department generally has on file such definitions which are available. If a task to be performed is not subject to one of the classifications of pay set out, the Department will upon being contacted state which neighboring county has such a classification and provide such rate, such rate being deemed to exist by reference in this document. If no neighboring county rate applies to the task, the Department shall undertake a special determination, such special determination being then deemed to have existed under this determination. If a project requires these, or any classification not listed, please contact IDOL at 217-782-1710 for wage rates or clarifications.

LANDSCAPING

Landscaping work falls under the existing classifications for laborer, operating engineer and truck driver. The work performed by landscape plantsman and landscape laborer is covered by the existing classification of laborer. The work performed by landscape operators (regardless of equipment used or its size) is covered by the classifications of operating engineer. The work performed by landscape truck drivers (regardless of size of truck driven) is covered by the classifications of truck driver.