

**If you plan to submit a bid directly to the Department of Transportation**

**PREQUALIFICATION**

Any contractor who desires to become pre-qualified to bid on work advertised by IDOT must submit the properly completed pre-qualification forms to the Bureau of Construction no later than 4:30 p.m. prevailing time twenty-one days prior to the letting of interest. This pre-qualification requirement applies to first time contractors, contractors renewing expired ratings, contractors maintaining continuous pre-qualification or contractors requesting revised ratings. To be eligible to bid, existing pre-qualification ratings must be effective through the date of letting.

**REQUESTS FOR AUTHORIZATION TO BID**

Contractors wanting to bid on items included in a particular letting must submit the properly completed "Request for Authorization to Bid/or Not For Bid Status" (BDE 124INT) and the ORIGINAL "Affidavit of Availability" (BC 57) to the proper office no later than 4:30 p.m. prevailing time, three (3) days prior to the letting date.

**WHO CAN BID ?**

Bids will be accepted from only those companies that request and receive written **Authorization to Bid** from IDOT's Central Bureau of Construction.

**WHAT CONSTITUTES WRITTEN AUTHORIZATION TO BID?:** When a prospective prime bidder submits a "Request for Authorization to Bid/or Not For Bid Status"(BDE 124INT) he/she must indicate at that time which items are being requested For Bidding purposes. Only those items requested For Bidding will be analyzed. After the request has been analyzed, the bidder will be issued a **Proposal Denial and/or Authorization Form**, approved by the Central Bureau of Construction, that indicates which items have been approved For Bidding. If **Authorization to Bid** cannot be approved, the **Proposal Denial and/or Authorization Form** will indicate the reason for denial.

**ABOUT AUTHORIZATION TO BID:** Firms that have not received an authorization form within a reasonable time of complete and correct original document submittal should contact the department as to status. This is critical in the week before the letting. These documents must be received three days before the letting date. Firms unsure as to authorization status should call the Prequalification Section of the Bureau of Construction at the number listed at the end of these instructions.

**ADDENDA AND REVISIONS:** It is the contractor's responsibility to determine which, if any, addenda or revisions pertain to any project they may be bidding. Failure to incorporate all relevant addenda or revisions may cause the bid to be declared unacceptable.

Each addendum will be placed with the contract number. Addenda and revisions will also be placed on the Addendum/Revision Checklist and each subscription service subscriber will be notified by e-mail of each addendum and revision issued.

The Internet is the Department's primary way of doing business. The subscription server e-mails are an added courtesy the Department provides. It is suggested that bidders check IDOT's website at <http://www.dot.il.gov/desenv/delett.html> before submitting final bid information.

***IDOT IS NOT RESPONSIBLE FOR ANY E-MAIL FAILURES.***

Addenda Questions may be directed to the Contracts Office at (217)782-7806 or [D&Econtracts@dot.il.gov](mailto:D&Econtracts@dot.il.gov)

Technical Questions about downloading these files may be directed to Tim Garman (217)524-1642 or [Timothy.Garman@illinois.gov](mailto:Timothy.Garman@illinois.gov).

**WHAT MUST BE INCLUDED WHEN BIDS ARE SUBMITTED?:** Bidders need not return the entire proposal when bids are submitted. That portion of the proposal that must be returned includes the following:

1. All documents from the Proposal Cover Sheet through the Proposal Bid Bond
2. Other special documentation and/or information that may be required by the contract special provisions

All proposal documents, including Proposal Guaranty Checks or Proposal Bid Bonds, should be stapled together to prevent loss when bids are processed by IDOT personnel.

**ABOUT SUBMITTING BIDS:** It is recommended that bidders deliver bids in person to insure they arrive at the proper location prior to the time specified for the receipt of bids. Any bid received at the place of letting after the time specified will not be accepted.

**WHO SHOULD BE CALLED IF ASSISTANCE IS NEEDED?**

<b>Questions Regarding</b>	<b>Call</b>
Prequalification and/or Authorization to Bid	217/782-3413
Preparation and submittal of bids	217/782-7806
Mailing of plans and proposals	217/782-7806

**ADDENDUMS AND REVISIONS TO THE PROPOSAL FORMS**

Planholders should verify that they have received and incorporated any addendum and/or revision prior to submitting their bid. Failure by the bidder to include an addendum or revision could result in a bid being rejected as irregular.

# 240

RETURN WITH BID

Proposal Submitted By
Name
Address
City

## Letting June 12, 2009

**BIDDERS NEED NOT RETURN THE ENTIRE PROPOSAL**  
(See instructions inside front cover)

### NOTICE TO PROSPECTIVE BIDDERS

This proposal can be used for bidding purposes by only those companies that request and receive written AUTHORIZATION TO BID from IDOT's Central Bureau of Construction.  
(SEE INSTRUCTIONS ON THE INSIDE OF COVER)

# Notice To Bidders, Specifications, Proposal, Contract and Contract Bond



**Illinois Department  
of Transportation**

Springfield, Illinois 62764

Contract No. 63169  
MCHENRY County  
Section 08-00109-00-RS (Woodstock)  
Route FAU 33 (South Street)  
Project M-9003(182)  
District 1 Construction Funds

PLEASE MARK THE APPROPRIATE BOX BELOW:

- A Bid Bond is included.
- A Cashier's Check or a Certified Check is included

Prepared by

Checked by

F

(Printed by authority of the State of Illinois)

---

---

## INSTRUCTIONS

**ABOUT IDOT PROPOSALS:** All proposals issued by IDOT are potential bidding proposals. Each proposal contains all Certifications and Affidavits, a Proposal Signature Sheet and a Proposal Bid Bond required for Prime Contractors to submit a bid after written **Authorization to Bid** has been issued by IDOT's Central Bureau of Construction.

**WHO CAN BID?:** Bids will be accepted from only those companies that request and receive written **Authorization to Bid** from IDOT's Central Bureau of Construction. To request authorization, a potential bidder must complete and submit Part B of the Request for Authorization to Bid/or Not For Bid Status form (BDE 124 INT) and submit an original Affidavit of Availability (BC 57).

**WHAT CONSTITUTES WRITTEN AUTHORIZATION TO BID?:** When a prospective prime bidder submits a "Request for Proposal Forms and Plans" he/she must indicate at that time which items are being requested For Bidding purposes. Only those items requested For Bidding will be analyzed. After the request has been analyzed, the bidder will be issued a **Proposal Denial and/or Authorization Form**, approved by the Central Bureau of Construction, that indicates which items have been approved For Bidding. If **Authorization to Bid** cannot be approved, the **Proposal Denial and/or Authorization Form** will indicate the reason for denial. If a contractor has requested to bid but has not received a **Proposal Denial and/or Authorization Form**, they should contact the Central Bureau of Construction in advance of the letting date.

**WHAT MUST BE INCLUDED WHEN BIDS ARE SUBMITTED?:** Bidders need not return the entire proposal when bids are submitted. That portion of the proposal that must be returned includes the following:

1. All documents from the Proposal Cover Sheet through the Proposal Bid Bond
2. Other special documentation and/or information that may be required by the contract special provisions

All proposal documents, including Proposal Guaranty Checks or Proposal Bid Bonds, should be stapled together to prevent loss when bids are processed by IDOT personnel.

**ABOUT SUBMITTING BIDS:** It is recommended that bidders deliver bids in person to insure they arrive at the proper location prior to the time specified for the receipt of bids. Any bid received at the place of letting after the time specified will not be accepted.

### WHO SHOULD BE CALLED IF ASSISTANCE IS NEEDED?

Questions Regarding	Call
Prequalification and/or Authorization to Bid	217/782-3413
Preparation and submittal of bids	217/782-7806
Mailing of CD-ROMS	217/782-7806

RETURN WITH BID



PROPOSAL

TO THE DEPARTMENT OF TRANSPORTATION

1. Proposal of \_\_\_\_\_  
\_\_\_\_\_

Taxpayer Identification Number (Mandatory) \_\_\_\_\_

for the improvement identified and advertised for bids in the Invitation for Bids as:

**Contract No. 63169  
MCHENRY County  
Section 08-00109-00-RS (Woodstock)  
Project M-9003(182)  
Route FAU 33 (South Street)  
District 1 Construction Funds**

**Patching, milling and resurfacing, construction of new sidewalk and curb and gutter, remove and replace sidewalks and curb and gutter, installation of storm sewers and the extension of a box culvert from west of Morain Drive to Tara Drive in the city of Woodstock.**

2. The undersigned bidder will furnish all labor, material and equipment to complete the above described project in a good and workmanlike manner as provided in the contract documents provided by the Department of Transportation. This proposal will become part of the contract and the terms and conditions contained in the contract documents shall govern performance and payments.

**RETURN WITH BID**

3. **ASSURANCE OF EXAMINATION AND INSPECTION/WAIVER.** The undersigned further declares that he/she has carefully examined the proposal, plans, specifications, form of contract and contract bond, and special provisions, and that he/she has inspected in detail the site of the proposed work, and that he/she has familiarized themselves with all of the local conditions affecting the contract and the detailed requirements of construction, and understands that in making this proposal he/she waives all right to plead any misunderstanding regarding the same.
4. **EXECUTION OF CONTRACT AND CONTRACT BOND.** The undersigned further agrees to execute a contract for this work and present the same to the department within fifteen (15) days after the contract has been mailed to him/her. The undersigned further agrees that he/she and his/her surety will execute and present within fifteen (15) days after the contract has been mailed to him/her contract bond satisfactory to and in the form prescribed by the Department of Transportation, in the penal sum of the full amount of the contract, guaranteeing the faithful performance of the work in accordance with the terms of the contract.
5. **PROPOSAL GUARANTY.** Accompanying this proposal is either a bid bond on the department form, executed by a corporate surety company satisfactory to the department, or a proposal guaranty check consisting of a bank cashier's check or a properly certified check for not less than 5 per cent of the amount bid or for the amount specified in the following schedule:

<u>Amount of Bid</u>		<u>Proposal Guaranty</u>	<u>Amount of Bid</u>		<u>Proposal Guaranty</u>	
Up to	\$5,000 .....	\$150	\$2,000,000	to	\$3,000,000 .....	\$100,000
\$5,000	to \$10,000 .....	\$300	\$3,000,000	to	\$5,000,000 .....	\$150,000
\$10,000	to \$50,000 .....	\$1,000	\$5,000,000	to	\$7,500,000 .....	\$250,000
\$50,000	to \$100,000 .....	\$3,000	\$7,500,000	to	\$10,000,000 .....	\$400,000
\$100,000	to \$150,000 .....	\$5,000	\$10,000,000	to	\$15,000,000 .....	\$500,000
\$150,000	to \$250,000 .....	\$7,500	\$15,000,000	to	\$20,000,000 .....	\$600,000
\$250,000	to \$500,000 .....	\$12,500	\$20,000,000	to	\$25,000,000 .....	\$700,000
\$500,000	to \$1,000,000 .....	\$25,000	\$25,000,000	to	\$30,000,000 .....	\$800,000
\$1,000,000	to \$1,500,000 .....	\$50,000	\$30,000,000	to	\$35,000,000 .....	\$900,000
\$1,500,000	to \$2,000,000 .....	\$75,000	over		\$35,000,000 .....	\$1,000,000

Bank cashier's checks or properly certified checks accompanying proposals shall be made payable to the Treasurer, State of Illinois, when the state is awarding authority; the county treasurer, when a county is the awarding authority; or the city, village, or town treasurer, when a city, village, or town is the awarding authority.

If a combination bid is submitted, the proposal guaranties which accompany the individual proposals making up the combination will be considered as also covering the combination bid.

The amount of the proposal guaranty check is \_\_\_\_\_ \$( \_\_\_\_\_ ). If this proposal is accepted and the undersigned shall fail to execute a contract bond as required herein, it is hereby agreed that the amount of the proposal guaranty shall become the property of the State of Illinois, and shall be considered as payment of damages due to delay and other causes suffered by the State because of the failure to execute said contract and contract bond; otherwise, the bid bond shall become void or the proposal guaranty check shall be returned to the undersigned.

<b>Attach Cashier's Check or Certified Check Here</b>	
In the event that one proposal guaranty check is intended to cover two or more proposals, the amount must be equal to the sum of the proposal guaranties which would be required for each individual proposal. If the guaranty check is placed in another proposal, state below where it may be found.	
The proposal guaranty check will be found in the proposal for:	Item _____
	Section No. _____
	County _____

**Mark the proposal cover sheet as to the type of proposal guaranty submitted.**

**RETURN WITH BID**

6. **COMBINATION BIDS.** The undersigned further agrees that if awarded the contract for the sections contained in the following combination, he/she will perform the work in accordance with the requirements of each individual proposal comprising the combination bid specified in the schedule below, and that the combination bid shall be prorated against each section in proportion to the bid submitted for the same. If an error is found to exist in the gross sum bid for one or more of the individual sections included in a combination, the combination bid shall be corrected as provided in the specifications.

**When a combination bid is submitted, the schedule below must be completed in each proposal comprising the combination.**

**If alternate bids are submitted for one or more of the sections comprising the combination, a combination bid must be submitted for each alternate.**

**Schedule of Combination Bids**

Combination No.	Sections Included in Combination	Combination Bid	
		Dollars	Cents

7. **SCHEDULE OF PRICES.** The undersigned bidder submits herewith, in accordance with the rules and instructions, a schedule of prices for the items of work for which bids are sought. The unit prices bid are in U.S. dollars and cents, and all extensions and summations have been made. The bidder understands that the quantities appearing in the bid schedule are approximate and are provided for the purpose of obtaining a gross sum for the comparison of bids. If there is an error in the extension of the unit prices, the unit prices shall govern. Payment to the contractor awarded the contract will be made only for actual quantities of work performed and accepted or materials furnished according to the contract. The scheduled quantities of work to be done and materials to be furnished may be increased, decreased or omitted as provided elsewhere in the contract.
8. **CERTIFICATE OF AUTHORITY.** The undersigned bidder, if a business organized under the laws of another State, assures the Department that it will furnish a copy of its certificate of authority to do business in the State of Illinois with the return of the executed contract and bond. Failure to furnish the certificate within the time provided for execution of an awarded contract may be cause for cancellation of the award and forfeiture of the proposal guaranty to the State.

COUNTY NAME	CODE	DIST	SECTION NUMBER	PROJECT NUMBER	ROUTE
MCHENRY	111	01	08-00109-00-RS (WOODSTOCK)	M-9003/182/000	FAU 33

ITEM NUMBER	PAY ITEM DESCRIPTION	UNIT OF MEASURE	QUANTITY	UNIT PRICE		TOTAL PRICE	
				DOLLARS	CENTS	DOLLARS	CTS
XX006806	HMA DRIVEWAY PAVEMENT	SQ YD	156.000 X				
XX008020	CB TA.4 DIA SP F & OL	EACH	1.000 X				
XX008024	CB TA.4 DIA SPL F&G 1	EACH	1.000 X				
XX008025	CB TC SPL F OL	EACH	2.000 X				
XX008026	CB TC SPL F&G 1	EACH	3.000 X				
XX008027	INLETS TA SPL F&G 1	EACH	5.000 X				
X0322054	REM PRC FL END SEC	EACH	4.000 X				
X0322256	TEMP INFO SIGNING	SQ FT	52.000 X				
X0656300	PAVEMENT REM & REPL	SQ YD	405.000 X				
Z0056900	SAN SEW 8	FOOT	154.000 X				
Z0076600	TRAINEES	HOUR	500.000 X		0.80		400.00
20100110	TREE REMOV 6-15	UNIT	8.000 X				
20100210	TREE REMOV OVER 15	UNIT	16.000 X				
20200100	EARTH EXCAVATION	CU YD	371.000 X				
20201500	SUB GRAN MAT B	TON	198.000 X				



ITEM NUMBER	PAY ITEM DESCRIPTION	UNIT OF MEASURE	QUANTITY	UNIT PRICE		TOTAL PRICE	
				DOLLARS	CENTS	DOLLARS	CTS
20400800	FURNISHED EXCAV	CU YD	713.000 X				
20800150	TRENCH BACKFILL	CU YD	234.000 X				
21101615	TOPSOIL F & P 4	SQ YD	5,514.000 X				
25000115	SEEDING CL 1B	ACRE	1.100 X				
25100630	EROSION CONTR BLANKET	SQ YD	5,514.000 X				
28000400	PERIMETER EROS BAR	FOOT	1,476.000 X				
28000510	INLET FILTERS	EACH	19.000 X				
40300200	BIT MATLS PR CT	TON	913.000 X				
40600300	AGG PR CT	TON	36.000 X				
40600625	LEV BIND MM N50	TON	258.000 X				
40603310	HMA SC "C" N50	TON	821.000 X				
42001300	PROTECTIVE COAT	SQ YD	2,082.000 X				
42400200	PC CONC SIDEWALK 5	SQ FT	13,452.000 X				
42400400	PC CONC SIDEWALK 7	SQ FT	994.000 X				
42400800	DETECTABLE WARNINGS	SQ FT	88.000 X				

ITEM NUMBER	PAY ITEM DESCRIPTION	UNIT OF MEASURE	QUANTITY	UNIT PRICE		TOTAL PRICE	
				DOLLARS	CENTS	DOLLARS	CTS
44000198	HMA SURF REM VAR DP	SQ YD	2,744.000 X	=			
44000200	DRIVE PAVEMENT REM	SQ YD	225.000 X	=			
44000500	COMB CURB GUTTER REM	FOOT	762.000 X	=			
44000600	SIDEWALK REM	SQ FT	751.000 X	=			
44300200	STRIP REF CR CON TR	FOOT	1,566.000 X	=			
48101200	AGGREGATE SHLDS B	TON	110.000 X	=			
48203013	HMA SHOULDERS 4	SQ YD	177.000 X	=			
50105200	REM EXIST CULVERTS	EACH	4.000 X	=			
50200100	STRUCTURE EXCAVATION	CU YD	9.000 X	=			
54003000	CONC BOX CUL	CU YD	5.600 X	=			
54213657	PRC FLAR END SEC 12	EACH	1.000 X	=			
550A0050	STORM SEW CL A 1 12	FOOT	654.000 X	=			
550A0340	STORM SEW CL A 2 12	FOOT	260.000 X	=			
56400100	FIRE HYDNPTS TO BE MVD	EACH	2.000 X	=			
59300100	CONTR LOW-STRENG MATL	CU YD	75.000 X	=			

FAU 33  
 08-00109-00-RS (WOODSTOCK)  
 MCHENRY

ILLINOIS DEPARTMENT OF TRANSPORTATION  
 SCHEDULE OF PRICES  
 CONTRACT NUMBER - 63169

ECMS002 DTGECM03 ECMR003 PAGE 4  
 RUN DATE - 05/13/09  
 RUN TIME - 193328

ITEM NUMBER	PAY ITEM DESCRIPTION	UNIT OF MEASURE	QUANTITY	UNIT PRICE		TOTAL PRICE	
				DOLLARS	CENTS	DOLLARS	CTS
60220240	MAN TA 4D W/SPL FR CL	EACH	2.000 X				
60255500	MAN ADJUST	EACH	3.000 X				
60500060	REMOV INLETS	EACH	2.000 X				
60603800	COMB CC&G TB6.12	FOOT	2,120.000 X				
63000001	SPBGR TY A 6FT POSTS	FOOT	450.000 X				
63100041	TRAF BAR TERM T1B	EACH	1.000 X				
63100085	TRAF BAR TERM T6	EACH	1.000 X				
63200310	GUARDRAIL REMOV	FOOT	560.000 X				
63301300	REM RE-E TERM SEC 1RL	EACH	1.000 X				
70101800	TRAF CONT & PROT SPL	L SUM	1.000 X				
70300100	SHORT-TERM PAVT MKING	FOOT	550.000 X				
70300220	TEMP PVT MK LINE 4	FOOT	12,600.000 X				
78000200	THPL PVT MK LINE 4	FOOT	9,720.000 X				
78000400	THPL PVT MK LINE 6	FOOT	544.000 X				
78000650	THPL PVT MK LINE 24	FOOT	95.000 X				

ITEM NUMBER	PAY ITEM DESCRIPTION	UNIT OF MEASURE	QUANTITY	UNIT PRICE		TOTAL PRICE	
				DOLLARS	CENTS	DOLLARS	CTS
78200405	GUARDRAIL MARKERS	EACH	22.000 X				
78300100	PAVT MARKING REMOVAL	SQ FT	3,400.000 X				

TOTAL \$

- NOTE:
1. EACH PAY ITEM SHOULD HAVE A UNIT PRICE AND A TOTAL PRICE.
  2. THE UNIT PRICE SHALL GOVERN IF NO TOTAL PRICE IS SHOWN OR IF THERE IS A DISCREPANCY BETWEEN THE PRODUCT OF THE UNIT PRICE MULTIPLIED BY THE QUANTITY.
  3. IF A UNIT PRICE IS OMITTED, THE TOTAL PRICE WILL BE DIVIDED BY THE QUANTITY IN ORDER TO ESTABLISH A UNIT PRICE.
  4. A BID MAY BE DECLARED UNACCEPTABLE IF NEITHER A UNIT PRICE NOR A TOTAL PRICE IS SHOWN.

## RETURN WITH BID

### **STATE REQUIRED ETHICAL STANDARDS GOVERNING CONTRACT PROCUREMENT: ASSURANCES, CERTIFICATIONS AND DISCLOSURES**

#### **I. GENERAL**

A. Article 50 of the Illinois Procurement Code establishes the duty of all State chief procurement officers, State purchasing officers, and their designees to maximize the value of the expenditure of public moneys in procuring goods, services, and contracts for the State of Illinois and to act in a manner that maintains the integrity and public trust of State government. In discharging this duty, they are charged by law to use all available information, reasonable efforts, and reasonable actions to protect, safeguard, and maintain the procurement process of the State of Illinois.

B. In order to comply with the provisions of Article 50 and to carry out the duty established therein, all bidders are to adhere to ethical standards established for the procurement process, and to make such assurances, disclosures and certifications required by law. By execution of the Proposal Signature Sheet, the bidder indicates that each of the mandated assurances has been read and understood, that each certification is made and understood, and that each disclosure requirement has been understood and completed.

C. In addition to all other remedies provided by law, failure to comply with any assurance, failure to make any disclosure or the making of a false certification shall be grounds for termination of the contract and the suspension or debarment of the bidder.

#### **II. ASSURANCES**

A. The assurances hereinafter made by the bidder are each a material representation of fact upon which reliance is placed should the Department enter into the contract with the bidder. The Department may terminate the contract if it is later determined that the bidder rendered a false or erroneous assurance, and the surety providing the performance bond shall be responsible for the completion of the contract.

##### **B. Felons**

1. The Illinois Procurement Code provides:

Section 50-10. Felons. Unless otherwise provided, no person or business convicted of a felony shall do business with the State of Illinois or any state agency from the date of conviction until 5 years after the date of completion of the sentence for that felony, unless no person held responsible by a prosecutorial office for the facts upon which the conviction was based continues to have any involvement with the business.

2. The bidder assures the Department that the award and execution of the contract would not cause a violation of Section 50-10.

##### **C. Conflicts of Interest**

1. The Illinois Procurement Code provides in pertinent part:

Section 50-13. Conflicts of Interest.

(a) Prohibition. It is unlawful for any person holding an elective office in this State, holding a seat in the General Assembly, or appointed to or employed in any of the offices or agencies of state government and who receives compensation for such employment in excess of 60% of the salary of the Governor of the State of Illinois, or who is an officer or employee of the Capital Development Board or the Illinois Toll Highway Authority, or who is the spouse or minor child of any such person to have or acquire any contract, or any direct pecuniary interest in any contract therein, whether for stationery, printing, paper, or any services, materials, or supplies, that will be wholly or partially satisfied by the payment of funds appropriated by the General Assembly of the State of Illinois or in any contract of the Capital Development Board or the Illinois Toll Highway authority.

(b) Interests. It is unlawful for any firm, partnership, association or corporation, in which any person listed in subsection (a) is entitled to receive (i) more than 7 1/2% of the total distributable income or (ii) an amount in excess of the salary of the Governor, to have or acquire any such contract or direct pecuniary interest therein.

(c) Combined interests. It is unlawful for any firm, partnership, association, or corporation, in which any person listed in subsection (a) together with his or her spouse or minor children is entitled to receive (i) more than 15%, in the aggregate, of the total distributable income or (ii) an amount in excess of 2 times the salary of the Governor, to have or acquire any such contract or direct pecuniary interest therein.

(d) Securities. Nothing in this Section invalidates the provisions of any bond or other security previously offered or to be offered for sale or sold by or for the State of Illinois.

(e) Prior interests. This Section does not affect the validity of any contract made between the State and an officer or employee of the State or member of the General Assembly, his or her spouse, minor child or any combination of those persons if that contract was in existence before his or her election or employment as an officer, member, or employee. The contract is voidable, however, if it cannot be completed within 365 days after the officer, member, or employee takes office or is employed.

The current salary of the Governor is \$177,412.00. Sixty percent of the salary is \$106,447.20.

## RETURN WITH BID

2. The bidder assures the Department that the award and execution of the contract would not cause a violation of Section 50-13, or that an effective exemption has been issued by the Board of Ethics to any individual subject to the Section 50-13 prohibitions pursuant to the provisions of Section 50-20 of the Code and Executive Order Number 3 (1998). Information concerning the exemption process is available from the Department upon request.

### **D. Negotiations**

1. The Illinois Procurement Code provides in pertinent part:

Section 50-15. Negotiations.

(a) It is unlawful for any person employed in or on a continual contractual relationship with any of the offices or agencies of State government to participate in contract negotiations on behalf of that office or agency with any firm, partnership, association, or corporation with whom that person has a contract for future employment or is negotiating concerning possible future employment.

2. The bidder assures the Department that the award and execution of the contract would not cause a violation of Section 50-15, and that the bidder has no knowledge of any facts relevant to the kinds of acts prohibited therein.

### **E. Inducements**

1. The Illinois Procurement Code provides:

Section 50-25. Inducement. Any person who offers or pays any money or other valuable thing to any person to induce him or her not to bid for a State contract or as recompense for not having bid on a State contract is guilty of a Class 4 felony. Any person who accepts any money or other valuable thing for not bidding for a State contract or who withholds a bid in consideration of the promise for the payment of money or other valuable thing is guilty of a Class 4 felony.

2. The bidder assures the Department that the award and execution of the contract would not cause a violation of Section 50-25, and that the bidder has no knowledge of any facts relevant to the kinds of acts prohibited therein.

### **F. Revolving Door Prohibition**

1. The Illinois Procurement Code provides:

Section 50-30. Revolving door prohibition. Chief procurement officers, associate procurement officers, State purchasing officers, their designees whose principal duties are directly related to State procurement, and executive officers confirmed by the Senate are expressly prohibited for a period of 2 years after terminating an affected position from engaging in any procurement activity relating to the State agency most recently employing them in an affected position for a period of at least 6 months. The prohibition includes, but is not limited to: lobbying the procurement process; specifying; bidding; proposing bid, proposal, or contract documents; on their own behalf or on behalf of any firm, partnership, association, or corporation. This Section applies only to persons who terminate an affected position on or after January 15, 1999.

2. The bidder assures the Department that the award and execution of the contract would not cause a violation of Section 50-30, and that the bidder has no knowledge of any facts relevant to the kinds of acts prohibited therein.

### **G. Reporting Anticompetitive Practices**

1. The Illinois Procurement Code provides:

Section 50-40. Reporting anticompetitive practices. When, for any reason, any vendor, bidder, contractor, chief procurement officer, State purchasing officer, designee, elected official, or State employee suspects collusion or other anticompetitive practice among any bidders, offerors, contractors, proposers, or employees of the State, a notice of the relevant facts shall be transmitted to the Attorney General and the chief procurement officer.

2. The bidder assures the Department that it has not failed to report any relevant facts concerning the practices addressed in Section 50-40 which may involve the contract for which the bid is submitted.

### **H. Confidentiality**

1. The Illinois Procurement Code provides:

Section 50-45. Confidentiality. Any chief procurement officer, State purchasing officer, designee, or executive officer who willfully uses or allows the use of specifications, competitive bid documents, proprietary competitive information, proposals, contracts, or selection information to compromise the fairness or integrity of the procurement, bidding, or contract process shall be subject to immediate dismissal, regardless of the Personnel code, any contract, or any collective bargaining agreement, and may in addition be subject to criminal prosecution.

2. The bidder assures the Department that it has no knowledge of any fact relevant to the practices addressed in Section 50-45 which may involve the contract for which the bid is submitted.

## RETURN WITH BID

### **I. Insider Information**

1. The Illinois Procurement Act provides:

Section 50-50. Insider information. It is unlawful for any current or former elected or appointed State official or State employee to knowingly use confidential information available only by virtue of that office or employment for actual or anticipated gain for themselves or another person.

2. The bidder assures the Department that it has no knowledge of any facts relevant to the practices addressed in Section 50-50 which may involve the contract for which the bid is submitted.

### **III. CERTIFICATIONS**

**A.** The certifications hereinafter made by the bidder are each a material representation of fact upon which reliance is placed should the Department enter into the contract with the bidder. The Department may terminate the contract if it is later determined that the bidder rendered a false or erroneous certification, and the surety providing the performance bond shall be responsible for completion of the contract.

#### **B. Bribery**

1. The Illinois Procurement Code provides:

Section 50-5. Bribery.

- (a) Prohibition. No person or business shall be awarded a contract or subcontract under this Code who:

- (1) has been convicted under the laws of Illinois or any other state of bribery or attempting to bribe an officer or employee of the State of Illinois or any other state in that officer's or employee's official capacity; or

- (2) has made an admission of guilt of that conduct that is a matter of record but has not been prosecuted for that conduct.

- (b) Businesses. No business shall be barred from contracting with any unit of State or local government as a result of a conviction under this Section of any employee or agent of the business if the employee or agent is no longer employed by the business and:

- (1) the business has been finally adjudicated not guilty; or

- (2) the business demonstrates to the governmental entity with which it seeks to contract, and that entity finds that the commission of the offense was not authorized, requested, commanded, or performed by a director, officer, or high managerial agent on behalf of the business as provided in paragraph (2) of subsection (a) of Section 5-4 of the Criminal Code of 1961.

- (c) Conduct on behalf of business. For purposes of this Section, when an official, agent, or employee of a business committed the bribery or attempted bribery on behalf of the business and in accordance with the direction or authorization of a responsible official of the business, the business shall be chargeable with the conduct.

- (d) Certification. Every bid submitted to and contract executed by the State shall contain a certification by the contractor that the contractor is not barred from being awarded a contract or subcontract under this Section. A contractor who makes a false statement, material to the certification, commits a Class 3 felony.

2. The bidder certifies that it is not barred from being awarded a contract under Section 50.5.

#### **C. Educational Loan**

1. Section 3 of the Educational Loan Default Act provides:

§ 3. No State agency shall contract with an individual for goods or services if that individual is in default, as defined in Section 2 of this Act, on an educational loan. Any contract used by any State agency shall include a statement certifying that the individual is not in default on an educational loan as provided in this Section.

2. The bidder, if an individual as opposed to a corporation, partnership or other form of business organization, certifies that the bidder is not in default on an educational loan as provided in Section 3 of the Act.

#### **D. Bid-Rigging/Bid Rotating**

1. Section 33E-11 of the Criminal Code of 1961 provides:

§ 33E-11. (a) Every bid submitted to and public contract executed pursuant to such bid by the State or a unit of local government shall contain a certification by the prime contractor that the prime contractor is not barred from contracting with any unit of State or local government as a result of a violation of either Section 33E-3 or 33E-4 of this Article. The State and units of local government shall provide the appropriate forms for such certification.

## RETURN WITH BID

(b) A contractor who makes a false statement, material to the certification, commits a Class 3 felony.

A violation of Section 33E-3 would be represented by a conviction of the crime of bid-rigging which, in addition to Class 3 felony sentencing, provides that any person convicted of this offense or any similar offense of any state or the United States which contains the same elements as this offense shall be barred for 5 years from the date of conviction from contracting with any unit of State or local government. No corporation shall be barred from contracting with any unit of State or local government as a result of a conviction under this Section of any employee or agent of such corporation if the employee so convicted is no longer employed by the corporation and: (1) it has been finally adjudicated not guilty or (2) if it demonstrates to the governmental entity with which it seeks to contract and that entity finds that the commission of the offense was neither authorized, requested, commanded, nor performed by a director, officer or a high managerial agent in behalf of the corporation.

A violation of Section 33E-4 would be represented by a conviction of the crime of bid-rotating which, in addition to Class 2 felony sentencing, provides that any person convicted of this offense or any similar offense of any state or the United States which contains the same elements as this offense shall be permanently barred from contracting with any unit of State or local government. No corporation shall be barred from contracting with any unit of State or local government as a result of a conviction under this Section of any employee or agent of such corporation if the employee so convicted is no longer employed by the corporation and: (1) it has been finally adjudicated not guilty or (2) if it demonstrates to the governmental entity with which it seeks to contract and that entity finds that the commission of the offense was neither authorized, requested, commanded, nor performed by a director, officer or a high managerial agent in behalf of the corporation.

2. The bidder certifies that it is not barred from contracting with the Department by reason of a violation of either Section 33E-3 or Section 33E-4.

### **E. International Anti-Boycott**

1. Section 5 of the International Anti-Boycott Certification Act provides:

§ 5. State contracts. Every contract entered into by the State of Illinois for the manufacture, furnishing, or purchasing of supplies, material, or equipment or for the furnishing of work, labor, or services, in an amount exceeding the threshold for small purchases according to the purchasing laws of this State or \$10,000.00, whichever is less, shall contain certification, as a material condition of the contract, by which the contractor agrees that neither the contractor nor any substantially-owned affiliated company is participating or shall participate in an international boycott in violation of the provisions of the U.S. Export Administration Act of 1979 or the regulations of the U.S. Department of Commerce promulgated under that Act.

2. The bidder makes the certification set forth in Section 5 of the Act.

### **F. Drug Free Workplace**

1. The Illinois "Drug Free Workplace Act" applies to this contract and it is necessary to comply with the provisions of the "Act" if the contractor is a corporation, partnership, or other entity (including a sole proprietorship) which has 25 or more employees.

2. The bidder certifies that if awarded a contract in excess of \$5,000 it will provide a drug free workplace by:

(a) Publishing a statement notifying employees that the unlawful manufacture, distribution, dispensation, possession or use of a controlled substance, including cannabis, is prohibited in the contractor's workplace; specifying the actions that will be taken against employees for violations of such prohibition; and notifying the employee that, as a condition of employment on such contract, the employee shall abide by the terms of the statement, and notify the employer of any criminal drug statute conviction for a violation occurring in the workplace no later than five (5) days after such conviction.

(b) Establishing a drug free awareness program to inform employees about the dangers of drug abuse in the workplace; the contractor's policy of maintaining a drug free workplace; any available drug counseling, rehabilitation, and employee assistance programs; and the penalties that may be imposed upon employees for drug violations.

(c) Providing a copy of the statement required by subparagraph (1) to each employee engaged in the performance of the contract and to post the statement in a prominent place in the workplace.

(d) Notifying the Department within ten (10) days after receiving notice from an employee or otherwise receiving actual notice of the conviction of an employee for a violation of any criminal drug statute occurring in the workplace.

(e) Imposing or requiring, within 30 days after receiving notice from an employee of a conviction or actual notice of such a conviction, an appropriate personnel action, up to and including termination, or the satisfactory participation in a drug abuse assistance or rehabilitation program approved by a federal, state or local health, law enforcement or other appropriate agency.

(f) Assisting employees in selecting a course of action in the event drug counseling, treatment, and rehabilitation is required and indicating that a trained referral team is in place.

(g) Making a good faith effort to continue to maintain a drug free workplace through implementation of the actions and efforts stated in this certification.



## RETURN WITH BID

### **G. Debt Delinquency**

1. The Illinois Procurement Code provides:

Section 50-11 and 50-12. Debt Delinquency.

The contractor or bidder certifies that it, or any affiliate, is not barred from being awarded a contract under 30 ILCS 500. Section 50-11 prohibits a person from entering into a contract with a State agency if it knows or should know that it, or any affiliate, is delinquent in the payment of any debt to the State as defined by the Debt Collection Board. Section 50-12 prohibits a person from entering into a contract with a State agency if it, or any affiliate, has failed to collect and remit Illinois Use Tax on all sales of tangible personal property into the State of Illinois in accordance with the provisions of the Illinois Use Tax Act. The contractor further acknowledges that the contracting State agency may declare the contract void if this certification is false or if the contractor, or any affiliate, is determined to be delinquent in the payment of any debt to the State during the term of the contract.

### **H. Sarbanes-Oxley Act of 2002**

1. The Illinois Procurement Code, Section 50-60(c), provides:

The contractor certifies in accordance with 30 ILCS 500/50-10.5 that no officer, director, partner or other managerial agent of the contracting business has been convicted of a felony under the Sarbanes-Oxley Act of 2002 or a Class 3 or Class 2 felony under the Illinois Securities Law of 1953 for a period of five years prior to the date of the bid or contract. The contractor acknowledges that the contracting agency shall declare the contract void if this certification is false.

### **I. Addenda**

The contractor or bidder certifies that all relevant addenda have been incorporated in to this contract. Failure to do so may cause the bid to be declared unacceptable.

### **J. Section 42 of the Environmental Protection Act**

The contractor certifies in accordance with 30 ILCS 500/50-12 that the bidder or contractor is not barred from being awarded a contract under this Section which prohibits the bidding on or entering into contracts with the State of Illinois or a State agency by a person or business found by a court or the Pollution Control Board to have committed a willful or knowing violation of Section 42 of the Environmental Protection Act for a period of five years from the date of the order. The contractor acknowledges that the contracting agency may declare the contract void if this certification is false.

### **K. Apprenticeship and Training Certification (Does not apply to federal aid projects)**

In accordance with the provisions of Section 30-22 (6) of the Illinois Procurement Code, the bidder certifies that it is a participant, either as an individual or as part of a group program, in the approved apprenticeship and training programs applicable to each type of work or craft that the bidder will perform with its own forces. The bidder further certifies for work that will be performed by subcontract that each of its subcontractors submitted for approval either (a) is, at the time of such bid, participating in an approved, applicable apprenticeship and training program; or (b) will, prior to commencement of performance of work pursuant to this contract, begin participation in an approved apprenticeship and training program applicable to the work of the subcontract. The Department, at any time before or after award, may require the production of a copy of each applicable Certificate of Registration issued by the United States Department of Labor evidencing such participation by the contractor and any or all of its subcontractors. Applicable apprenticeship and training programs are those that have been approved and registered with the United States Department of Labor. The bidder shall list in the space below, the official name of the program sponsor holding the Certificate of Registration for all of the types of work or crafts in which the bidder is a participant and that will be performed with the bidder's forces. Types of work or craft work that will be subcontracted shall be included and listed as subcontract work. The list shall also indicate any type of work or craft job category that does not have an applicable apprenticeship or training program. **The bidder is responsible for making a complete report and shall make certain that each type of work or craft job category that will be utilized on the project as reported on the Construction Employee Workforce Projection (Form BC-1256) and returned with the bid is accounted for and listed.**

**NA - FEDERAL**

---

---

The requirements of this certification and disclosure are a material part of the contract, and the contractor shall require this certification provision to be included in all approved subcontracts. In order to fulfill this requirement, it shall not be necessary that an applicable program sponsor be currently taking or that it will take applications for apprenticeship, training or employment during the performance of the work of this contract.

### **L. Executive Order Number 1 (2007) Regarding Lobbying on Government Procurements**

The bidder hereby warrants and certifies that they have complied and will comply with the requirements set forth in this Order. The requirements of this warrant and certification are a material part of the contract, and the contractor shall require this warrant and certification provision to be included in all approved subcontracts.

## RETURN WITH BID

### **M. Disclosure of Business Operations in Iran**

Section 50-36 of the Illinois Procurement Code, 30ILCS 500/50-36 provides that each bid, offer, or proposal submitted for a State contract shall include a disclosure of whether or not the Company acting as the bidder, offer or, or proposing entity, or any of its corporate parents or subsidiaries, within the 24 months before submission of the bid, offer, or proposal had business operations that involved contracts with or provision of supplies or services to the Government of Iran, companies in which the Government of Iran has any direct or indirect equity share, consortiums or projects commissioned by the Government of Iran, or companies involved in consortiums or projects commissioned by the Government of Iran and either of the following conditions apply:

- (1) More than 10% of the Company's revenues produced in or assets located in Iran involve oil-related activities or mineral-extraction activities; less than 75% of the Company's revenues produced in or assets located in Iran involve contracts with or provision of oil-related or mineral-extraction products or services to the Government of Iran or a project or consortium created exclusively by that government; and the Company has failed to take substantial action.
- (2) The Company has, on or after August 5, 1996, made an investment of \$20 million or more, or any combination of investments of at least \$10 million each that in the aggregate equals or exceeds \$20 million in any 12-month period, which directly or significantly contributes to the enhancement of Iran's ability to develop petroleum resources of Iran.

The terms "Business operations", "Company", "Mineral-extraction activities", "Oil-related activities", "Petroleum resources", and "Substantial action" are all defined in the Code.

Failure to make the disclosure required by the Code shall cause the bid, offer or proposal to be considered not responsive. The disclosure will be considered when evaluating the bid, offer, or proposal or awarding the contract. The name of each Company disclosed as doing business or having done business in Iran will be provided to the State Comptroller.

Check the appropriate statement:

Company has no business operations in Iran to disclose.

Company has business operations in Iran as disclosed the attached document.

### **N. Political Contributions and Registration with the State Board of Elections**

Sections 20-160 and 50-37 of the Illinois Procurement Code regulate political contributions from business entities and any affiliated entities or affiliated persons bidding on or contracting with the state. Generally under Section 50-37, any business entity, and any affiliated entity or affiliated person of the business entity, whose current year contracts with all state agencies exceed an awarded value of \$50,000, are prohibited from making any contributions to any political committees established to promote the candidacy of the officeholder responsible for the awarding of the contracts or any other declared candidate for that office for the duration of the term of office of the incumbent officeholder or a period 2 years after the termination of the contract, whichever is longer. Any business entity and affiliated entities or affiliated persons whose state contracts in the current year do not exceed an awarded value of \$50,000, but whose aggregate pending bids and proposals on state contracts exceed \$50,000, either alone or in combination with contracts not exceeding \$50,000, are prohibited from making any political contributions to any political committee established to promote the candidacy of the officeholder responsible for awarding the pending contract during the period beginning on the date the invitation for bids or request for proposals is issued and ending on the day after the date of award or selection if the entity was not awarded or selected. Section 20-160 requires certification of registration of affected business entities in accordance with procedures found in Section 9-35 of The Election Code.

By submission of a bid, the contractor business entity acknowledges and agrees that it has read and understands Sections 20-160 and 50-37 of the Illinois Procurement Code, and that it makes the following certification:

**The undersigned business entity certifies that it has registered as a business with the State Board of Elections and acknowledges a continuing duty to update the registration in accordance with the above referenced statutes. A copy of the certificate of registration shall be submitted with the bid. The bidder is cautioned that the Department will not award a contract without submission of the certificate of registration.**

These requirements and compliance with the above referenced statutory sections are a material part of the contract, and any breach thereof shall be cause to void the contract under Section 50-60 of the Illinois Procurement Code. This provision does not apply to Federal-aid contracts.

**TO BE RETURNED WITH BID**

**IV. DISCLOSURES**

**A.** The disclosures hereinafter made by the bidder are each a material representation of fact upon which reliance is placed should the Department enter into the contract with the bidder. The Department may terminate the contract if it is later determined that the bidder rendered a false or erroneous disclosure, and the surety providing the performance bond shall be responsible for completion of the contract.

**B. Financial Interests and Conflicts of Interest**

1. Section 50-35 of the Illinois Procurement Code provides that all bids of more than \$10,000 shall be accompanied by disclosure of the financial interests of the bidder. This disclosed information for the successful bidder, will be maintained as public information subject to release by request pursuant to the Freedom of Information Act.

The financial interests to be disclosed shall include ownership or distributive income share that is in excess of 5%, or an amount greater than 60% of the annual salary of the Governor, of the bidding entity or its parent entity, whichever is less, unless the contractor or bidder is a publicly traded entity subject to Federal 10K reporting, in which case it may submit its 10K disclosure in place of the prescribed disclosure. If a bidder is a privately held entity that is exempt from Federal 10K reporting, but has more than 400 shareholders, it may submit the information that Federal 10K companies are required to report, and list the names of any person or entity holding any ownership share that is in excess of 5%. The disclosure shall include the names, addresses, and dollar or proportionate share of ownership of each person making the disclosure, their instrument of ownership or beneficial relationship, and notice of any potential conflict of interest resulting from the current ownership or beneficial interest of each person making the disclosure having any of the relationships identified in Section 50-35 and on the disclosure form.

In addition, all disclosures shall indicate any other current or pending contracts, proposals, leases, or other ongoing procurement relationships the bidding entity has with any other unit of state government and shall clearly identify the unit and the contract, proposal, lease, or other relationship.

2. Disclosure Forms. Disclosure Form A is attached for use concerning the individuals meeting the above ownership or distributive share requirements. Subject individuals should be covered each by one form. In addition, a second form (Disclosure Form B) provides for the disclosure of current or pending procurement relationships with other (non-IDOT) state agencies. **The forms must be included with each bid or incorporated by reference.**

**C. Disclosure Form Instructions**

**Form A: For bidders that have previously submitted the information requested in Form A**

The Department has retained the Form A disclosures submitted by all bidders responding to these requirements for the April 24, 1998 or any subsequent letting conducted by the Department. The bidder has the option of submitting the information again or the bidder may check the following certification statement indicating that the information previously submitted by the bidder is, as of the date of submission, current and accurate. Before checking this certification, the bidder should carefully review its prior submissions to ensure the Certification is correct. If the Bidder checks the Certification, the Bidder should proceed to Form B instructions.

**CERTIFICATION STATEMENT**

**I have determined that the Form A disclosure information previously submitted is current and accurate, and all forms are hereby incorporated by reference in this bid. Any necessary additional forms or amendments to previously submitted forms are attached to this bid.**

\_\_\_\_\_  
(Bidding Company)



\_\_\_\_\_  
Signature of Authorized Representative

\_\_\_\_\_  
Date

**Form A: For bidders who have NOT previously submitted the information requested in Form A**

If the bidder is a publicly traded entity subject to Federal 10K reporting, the 10K Report may be submitted to meet the requirements of Form A. If a bidder is a privately held entity that is exempt from Federal 10K reporting, but has more than 400 shareholders, it may submit the information that Federal 10K companies are required to report, and list the names of any person or entity holding any ownership share that is in excess of 5%. If a bidder is not subject to Federal 10K reporting, the bidder must determine if any individuals are required by law to complete a financial disclosure form. To do this, the bidder should answer each of the following questions. A "YES" answer indicates Form A must be completed. If the answer to each of the following questions is "NO", then the NOT APPLICABLE STATEMENT on the second page of Form A must be signed and dated by a person that is authorized to execute contracts for the bidding company. Note: These questions are for assistance only and are not required to be completed.

1. Does anyone in your organization have a direct or beneficial ownership share of greater than 5% of the bidding entity or parent entity? YES \_\_\_ NO \_\_\_
2. Does anyone in your organization have a direct or beneficial ownership share of less than 5%, but which has a value greater than \$102,600.00? YES \_\_\_ NO \_\_\_
3. Does anyone in your organization receive more than \$106,447.20 of the bidding entity's or parent entity's distributive income? (Note: Distributive income is, for these purposes, any type of distribution of profits. An annual salary is not distributive income.) YES \_\_\_ NO \_\_\_
4. Does anyone in your organization receive greater than 5% of the bidding entity's or parent entity's total distributive income, but which is less than \$106,447.20? YES \_\_\_ NO \_\_\_  
(Note: Only one set of forms needs to be completed per person per bid even if a specific individual would require a yes answer to more than one question.)

A "YES" answer to any of these questions requires the completion of Form A. The bidder must determine each individual in the bidding entity or the bidding entity's parent company that would cause the questions to be answered "Yes". Each form must be signed and dated by a person that is authorized to execute contracts for your organization. **Photocopied or stamped signatures are not acceptable.** The person signing can be, but does not have to be, the person for which the form is being completed. The bidder is responsible for the accuracy of any information provided.

If the answer to each of the above questions is "NO", then the NOT APPLICABLE STATEMENT on page 2 of Form A must be signed and dated by a person that is authorized to execute contracts for your company.

**Form B: Identifying Other Contracts & Procurement Related Information** Disclosure Form B must be completed for each bid submitted by the bidding entity. Note: *Checking the NOT APPLICABLE STATEMENT on Form A does not allow the bidder to ignore Form B. Form B must be completed, checked, and dated or the bidder may be considered nonresponsive and the bid will not be accepted.*

The Bidder shall identify, by checking Yes or No on Form B, whether it has any pending contracts (including leases), bids, proposals, or other ongoing procurement relationship with any other (non-IDOT) State of Illinois agency. If "No" is checked, the bidder only needs to complete the check box on the bottom of Form B. If "Yes" is checked, the bidder must do one of the following:

Option I: If the bidder did not submit an Affidavit of Availability to obtain authorization to bid, the bidder must list all non-IDOT State of Illinois agency pending contracts, leases, bids, proposals, and other ongoing procurement relationships. These items may be listed on Form B or on an attached sheet(s). Do not include IDOT contracts. Contracts with cities, counties, villages, etc. are not considered State of Illinois agency contracts and are not to be included. Contracts with other State of Illinois agencies such as the Department of Natural Resources or the Capital Development Board must be included. Bidders who submit Affidavits of Availability are suggested to use Option II.

Option II: If the bidder is required and has submitted an Affidavit of Availability in order to obtain authorization to bid, the bidder may write or type "See Affidavit of Availability" which indicates that the Affidavit of Availability is incorporated by reference and includes all non-IDOT State of Illinois agency pending contracts, leases, bids, proposals, and other ongoing procurement relationships. For any contracts that are not covered by the Affidavit of Availability, the bidder must identify them on Form B or on an attached sheet(s). These might be such things as leases.

**D. Bidders Submitting More Than One Bid**

Bidders submitting multiple bids may submit one set of forms consisting of all required Form A disclosures and one Form B for use with all bids. Please indicate in the space provided below the bid item that contains the original disclosure forms and the bid items which incorporate the forms by reference.

- The bid submitted for letting item \_\_\_\_\_ contains the Form A disclosures or Certification Statement and the Form B disclosures. The following letting items incorporate the said forms by reference:

---



---

RETURN WITH BID/OFFER

ILLINOIS DEPARTMENT OF TRANSPORTATION

Form A Financial Information & Potential Conflicts of Interest Disclosure

Contractor Name, Legal Address, City, State, Zip, Telephone Number, Email Address, Fax Number (if available)

Disclosure of the information contained in this Form is required by the Section 50-35 of the Illinois Procurement Code (30 ILCS 500). Vendors desiring to enter into a contract with the State of Illinois must disclose the financial information and potential conflict of interest information as specified in this Disclosure Form. This information shall become part of the publicly available contract file. This Form A must be completed for bids in excess of \$10,000, and for all open-ended contracts. A publicly traded company may submit a 10K disclosure (or equivalent if applicable) in satisfaction of the requirements set forth in Form A. See Disclosure Form Instructions.

DISCLOSURE OF FINANCIAL INFORMATION

1. Disclosure of Financial Information. The individual named below has an interest in the BIDDER (or its parent) in terms of ownership or distributive income share in excess of 5%, or an interest which has a value of more than \$106,447.20 (60% of the Governor's salary as of 3/1/09). (Make copies of this form as necessary and attach a separate Disclosure Form A for each individual meeting these requirements)

FOR INDIVIDUAL (type or print information)

NAME:

\_\_\_\_\_

ADDRESS

\_\_\_\_\_

Type of ownership/distributable income share:

stock \_\_\_\_\_ sole proprietorship \_\_\_\_\_ Partnership \_\_\_\_\_ other: (explain on separate sheet): % or \$ value of ownership/distributable income share: \_\_\_\_\_

2. Disclosure of Potential Conflicts of Interest. Check "Yes" or "No" to indicate which, if any, of the following potential conflict of interest relationships apply. If the answer to any question is "Yes", please attach additional pages and describe.

(a) State employment, currently or in the previous 3 years, including contractual employment of services. Yes \_\_\_ No \_\_\_

If your answer is yes, please answer each of the following questions.

1. Are you currently an officer or employee of either the Capitol Development Board or the Illinois Toll Highway Authority? Yes \_\_\_ No \_\_\_

2. Are you currently appointed to or employed by any agency of the State of Illinois? If you are currently appointed to or employed by any agency of the State of Illinois, and your annual salary exceeds \$106,447.20, (60% of the Governor's salary as of 3/1/09) provide the name the State agency for which you are employed and your annual salary. \_\_\_\_\_

**RETURN WITH BID/OFFER**

- 3. If you are currently appointed to or employed by any agency of the State of Illinois, and your annual salary exceeds \$106,447.20, (60% of the Governor's salary as of 3/1/09) are you entitled to receive (i) more than 7 1/2% of the total distributable income of your firm, partnership, association or corporation, or (ii) an amount in excess of the salary of the Governor? Yes \_\_\_ No \_\_\_
  
- 4. If you are currently appointed to or employed by any agency of the State of Illinois, and your annual salary exceeds \$106,447.20, (60% of the Governor's salary as of 3/1/09) are you and your spouse or minor children entitled to receive (i) more than 15% in aggregate of the total distributable income of your firm, partnership, association or corporation, or (ii) an amount in excess of 2 times the salary of the Governor? Yes \_\_\_ No \_\_\_

---

(b) State employment of spouse, father, mother, son, or daughter, including contractual employment for services in the previous 2 years.

Yes \_\_\_ No \_\_\_

If your answer is yes, please answer each of the following questions.

- 1. Is your spouse or any minor children currently an officer or employee of the Capitol Development Board or the Illinois Toll Highway Authority? Yes \_\_\_ No \_\_\_
  
- 2. Is your spouse or any minor children currently appointed to or employed by any agency of the State of Illinois? If your spouse or minor children is/are currently appointed to or employed by any agency of the State of Illinois, and his/her annual salary exceeds \$106,447.20, (60% of the Governor's salary as of 3/1/09) provide the name of the spouse and/or minor children, the name of the State agency for which he/she is employed and his/her annual salary. \_\_\_\_\_
  
- 3. If your spouse or any minor children is/are currently appointed to or employed by any agency of the State of Illinois, and his/her annual salary exceeds \$106,447.20.00, (60% of the salary of the Governor as of 3/1/09) are you entitled to receive (i) more than 7 1/2% of the total distributable income of your firm, partnership, association or corporation, or (ii) an amount in excess of the salary of the Governor? Yes \_\_\_ No \_\_\_
  
- 4. If your spouse or any minor children are currently appointed to or employed by any agency of the State of Illinois, and his/her annual salary exceeds \$106,447.20, (60% of the Governor's salary as of 3/1/09) are you and your spouse or any minor children entitled to receive (i) more than 15% in the aggregate of the total distributable income from your firm, partnership, association or corporation, or (ii) an amount in excess of 2 times the salary of the Governor? Yes \_\_\_ No \_\_\_

---

(c) Elective status; the holding of elective office of the State of Illinois, the government of the United States, any unit of local government authorized by the Constitution of the State of Illinois or the statutes of the State of Illinois currently or in the previous 3 years.

Yes \_\_\_ No \_\_\_

---

(d) Relationship to anyone holding elective office currently or in the previous 2 years; spouse, father, mother, son, or daughter.

Yes \_\_\_ No \_\_\_

---

(e) Appointive office; the holding of any appointive government office of the State of Illinois, the United State of America, or any unit of local government authorized by the Constitution of the State of Illinois or the statutes of the State of Illinois, which office entitles the holder to compensation in excess of the expenses incurred in the discharge of that office currently or in the previous 3 years.

Yes \_\_\_ No \_\_\_

---

(f) Relationship to anyone holding appointive office currently or in the previous 2 years; spouse, father, mother, son, or daughter.

Yes \_\_\_ No \_\_\_

---

(g) Employment, currently or in the previous 3 years, as or by any registered lobbyist of the State government.

Yes \_\_\_ No \_\_\_

**RETURN WITH BID/OFFER**

(h) Relationship to anyone who is or was a registered lobbyist in the previous 2 years; spouse, father, mother, son, or daughter. Yes \_\_\_ No \_\_\_

(i) Compensated employment, currently or in the previous 3 years, by any registered election or reelection committee registered with the Secretary of State or any county clerk of the State of Illinois, or any political action committee registered with either the Secretary of State or the Federal Board of Elections. Yes \_\_\_ No \_\_\_

(j) Relationship to anyone; spouse, father, mother, son, or daughter; who was a compensated employee in the last 2 years by any registered election or re-election committee registered with the Secretary of State or any county clerk of the State of Illinois, or any political action committee registered with either the Secretary of State or the Federal Board of Elections. Yes \_\_\_ No \_\_\_

**APPLICABLE STATEMENT**

**This Disclosure Form A is submitted on behalf of the INDIVIDUAL named on previous page.**

Completed by:  \_\_\_\_\_ Date \_\_\_\_\_  
Signature of Individual or Authorized Representative

**NOT APPLICABLE STATEMENT**

**I have determined that no individuals associated with this organization meet the criteria that would require the completion of this Form A.**

**This Disclosure Form A is submitted on behalf of the CONTRACTOR listed on the previous page.**

\_\_\_\_\_ Date \_\_\_\_\_  
Signature of Authorized Representative

RETURN WITH BID/OFFER

**ILLINOIS DEPARTMENT  
OF TRANSPORTATION**

**Form B  
Other Contracts &  
Procurement Related Information  
Disclosure**

Contractor Name		
Legal Address		
City, State, Zip		
Telephone Number	Email Address	Fax Number (if available)

Disclosure of the information contained in this Form is required by the Section 50-35 of the Illinois Procurement Act (30 ILCS 500). This information shall become part of the publicly available contract file. This Form B must be completed for bids in excess of \$10,000, and for all open-ended contracts.

**DISCLOSURE OF OTHER CONTRACTS AND PROCUREMENT RELATED INFORMATION**

**1. Identifying Other Contracts & Procurement Related Information.** The BIDDER shall identify whether it has any pending contracts (including leases), bids, proposals, or other ongoing procurement relationship with any other State of Illinois agency: Yes \_\_\_ No \_\_\_

If "No" is checked, the bidder only needs to complete the signature box on the bottom of this page.

**2. If "Yes" is checked.** Identify each such relationship by showing State of Illinois agency name and other descriptive information such as bid or project number (attach additional pages as necessary). SEE DISCLOSURE FORM INSTRUCTIONS:

**THE FOLLOWING STATEMENT MUST BE CHECKED**

<input type="checkbox"/>	_____	_____
	Signature of Authorized Representative	Date



## **RETURN WITH BID**

### **SPECIAL NOTICE TO CONTRACTORS**

The following requirements of the Illinois Department of Human Rights' Rules and Regulations are applicable to bidders on all construction contracts advertised by the Illinois Department of Transportation:

#### **CONSTRUCTION EMPLOYEE UTILIZATION PROJECTION**

- (a) All bidders on construction contracts shall complete and submit, along with and as part of their bids, a Bidder's Employee Utilization Form (Form BC-1256) setting forth a projection and breakdown of the total workforce intended to be hired and/or allocated to such contract work by the bidder including a projection of minority and female employee utilization in all job classifications on the contract project.
- (b) The Department of Transportation shall review the Employee Utilization Form, and workforce projections contained therein, of the contract awardee to determine if such projections reflect an underutilization of minority persons and/or women in any job classification in accordance with the Equal Employment Opportunity Clause and Section 7.2 of the Illinois Department of Human Rights' Rules and Regulations for Public Contracts adopted as amended on September 17, 1980. If it is determined that the contract awardee's projections reflect an underutilization of minority persons and/or women in any job classification, it shall be advised in writing of the manner in which it is underutilizing and such awardee shall be considered to be in breach of the contract unless, prior to commencement of work on the contract project, it submits revised satisfactory projections or an acceptable written affirmative action plan to correct such underutilization including a specific timetable geared to the completion stages of the contract.
- (c) The Department of Transportation shall provide to the Department of Human Rights a copy of the contract awardee's Employee Utilization Form, a copy of any required written affirmative action plan, and any written correspondence related thereto. The Department of Human Rights may review and revise any action taken by the Department of Transportation with respect to these requirements.



RETURN WITH BID

**Contract No. 63169**  
**MCHENRY County**  
**Section 08-00109-00-RS (Woodstock)**  
**Project M-9003(182)**  
**Route FAU 33 (South Street)**  
**District 1 Construction Funds**

**PART I. IDENTIFICATION**

Dept. Human Rights # \_\_\_\_\_ Duration of Project: \_\_\_\_\_

Name of Bidder: \_\_\_\_\_

**PART II. WORKFORCE PROJECTION**

A. The undersigned bidder has analyzed minority group and female populations, unemployment rates and availability of workers for the location in which this contract work is to be performed, and for the locations from which the bidder recruits employees, and hereby submits the following workforce projection including a projection for minority and female employee utilization in all job categories in the workforce to be allocated to this contract:

TABLE A TOTAL Workforce Projection for Contract													TABLE B CURRENT EMPLOYEES TO BE ASSIGNED TO CONTRACT			
JOB CATEGORIES	TOTAL EMPLOYEES		MINORITY EMPLOYEES						TRAINEES				TOTAL EMPLOYEES		MINORITY EMPLOYEES	
	M	F	BLACK		HISPANIC		*OTHER MINOR.		APPREN- TICES		ON THE JOB TRAINEES		M	F	M	F
			M	F	M	F	M	F	M	F	M	F				
OFFICIALS (MANAGERS)																
SUPERVISORS																
FOREMEN																
CLERICAL																
EQUIPMENT OPERATORS																
MECHANICS																
TRUCK DRIVERS																
IRONWORKERS																
CARPENTERS																
CEMENT MASONS																
ELECTRICIANS																
PIPEFITTERS, PLUMBERS																
PAINTERS																
LABORERS, SEMI-SKILLED																
LABORERS, UNSKILLED																
TOTAL																

TABLE C TOTAL Training Projection for Contract								
EMPLOYEES IN TRAINING	TOTAL EMPLOYEES		BLACK		HISPANIC		*OTHER MINOR.	
	M	F	M	F	M	F	M	F
APPRENTICES								
ON THE JOB TRAINEES								

FOR DEPARTMENT USE ONLY

\*Other minorities are defined as Asians (A) or Native Americans (N).  
Please specify race of each employee shown in Other Minorities column.

**Note: See instructions on page 2**

**RETURN WITH BID**

**Contract No. 63169  
MCHENRY County  
Section 08-00109-00-RS (Woodstock)  
Project M-9003(182)  
Route FAU 33 (South Street)  
District 1 Construction Funds**

**PART II. WORKFORCE PROJECTION - continued**

- B. Included in "Total Employees" under Table A is the total number of **new hires** that would be employed in the event the undersigned bidder is awarded this contract.

The undersigned bidder projects that: (number) \_\_\_\_\_ new hires would be recruited from the area in which the contract project is located; and/or (number) \_\_\_\_\_ new hires would be recruited from the area in which the bidder's principal office or base of operation is located.

- C. Included in "Total Employees" under Table A is a projection of numbers of persons to be employed directly by the undersigned bidder as well as a projection of numbers of persons to be employed by subcontractors.

The undersigned bidder estimates that (number) \_\_\_\_\_ persons will be directly employed by the prime contractor and that (number) \_\_\_\_\_ persons will be employed by subcontractors.

**PART III. AFFIRMATIVE ACTION PLAN**

- A. The undersigned bidder understands and agrees that in the event the foregoing minority and female employee utilization projection included under **PART II** is determined to be an underutilization of minority persons or women in any job category, and in the event that the undersigned bidder is awarded this contract, he/she will, prior to commencement of work, develop and submit a written Affirmative Action Plan including a specific timetable (geared to the completion stages of the contract) whereby deficiencies in minority and/or female employee utilization are corrected. Such Affirmative Action Plan will be subject to approval by the contracting agency and the **Department of Human Rights**.
- B. The undersigned bidder understands and agrees that the minority and female employee utilization projection submitted herein, and the goals and timetable included under an Affirmative Action Plan if required, are deemed to be part of the contract specifications.

Company \_\_\_\_\_

Telephone Number \_\_\_\_\_

Address \_\_\_\_\_

**NOTICE REGARDING SIGNATURE**

The Bidder's signature on the Proposal Signature Sheet will constitute the signing of this form. The following signature block needs to be completed only if revisions are required.

Signature:  \_\_\_\_\_ Title: \_\_\_\_\_ Date: \_\_\_\_\_

- Instructions: All tables must include subcontractor personnel in addition to prime contractor personnel.
- Table A - Include both the number of employees that would be hired to perform the contract work and the total number currently employed (Table B) that will be allocated to contract work, and include all apprentices and on-the-job trainees. The "Total Employees" column should include all employees including all minorities, apprentices and on-the-job trainees to be employed on the contract work.
- Table B - Include all employees currently employed that will be allocated to the contract work including any apprentices and on-the-job trainees currently employed.
- Table C - Indicate the racial breakdown of the total apprentices and on-the-job trainees shown in Table A.

**RETURN WITH BID**

**ADDITIONAL FEDERAL REQUIREMENTS**

In addition to the Required Contract Provisions for Federal-Aid Construction Contracts (FHWA 1273), all bidders make the following certifications.

- A. By the execution of this proposal, the signing bidder certifies that the bidding entity has not, either directly or indirectly, entered into any agreement, participated in any collusion, or otherwise taken any action, in restraint of free competitive bidding in connection with the submitted bid. This statement made by the undersigned bidder is true and correct under penalty of perjury under the laws of the United States.
- B. CERTIFICATION, EQUAL EMPLOYMENT OPPORTUNITY:
1. Have you participated in any previous contracts or subcontracts subject to the equal opportunity clause. YES \_\_\_\_\_ NO \_\_\_\_\_
  2. If answer to #1 is yes, have you filed with the Joint Reporting Committee, the Director of OFCC, any Federal agency, or the former President's Committee on Equal Employment Opportunity, all reports due under the applicable filing requirements of those organizations? YES \_\_\_\_\_ NO \_\_\_\_\_

**RETURN WITH BID**

**Contract No. 63169  
MCHENRY County  
Section 08-00109-00-RS (Woodstock)  
Project M-9003(182)  
Route FAU 33 (South Street)  
District 1 Construction Funds**

PROPOSAL SIGNATURE SHEET

The undersigned bidder hereby makes and submits this bid on the subject Proposal, thereby assuring the Department that all requirements of the Invitation for Bids and rules of the Department have been met, that there is no misunderstanding of the requirements of paragraph 3 of this Proposal, and that the contract will be executed in accordance with the rules of the Department if an award is made on this bid.

(IF AN INDIVIDUAL) Firm Name \_\_\_\_\_  
Signature of Owner \_\_\_\_\_  
Business Address \_\_\_\_\_  
\_\_\_\_\_

(IF A CO-PARTNERSHIP) Firm Name \_\_\_\_\_  
By \_\_\_\_\_  
Business Address \_\_\_\_\_  
Name and Address of All Members of the Firm: \_\_\_\_\_  
\_\_\_\_\_

(IF A CORPORATION) Corporate Name \_\_\_\_\_  
By \_\_\_\_\_  
Signature of Authorized Representative \_\_\_\_\_  
Typed or printed name and title of Authorized Representative \_\_\_\_\_

(IF A JOINT VENTURE, USE THIS SECTION FOR THE MANAGING PARTY AND THE SECOND PARTY SHOULD SIGN BELOW) Attest \_\_\_\_\_  
Signature \_\_\_\_\_  
Business Address \_\_\_\_\_

(IF A JOINT VENTURE) Corporate Name \_\_\_\_\_  
By \_\_\_\_\_  
Signature of Authorized Representative \_\_\_\_\_  
Typed or printed name and title of Authorized Representative \_\_\_\_\_

Attest \_\_\_\_\_  
Signature \_\_\_\_\_  
Business Address \_\_\_\_\_

If more than two parties are in the joint venture, please attach an additional signature sheet.



Return with Bid

Division of Highways
Proposal Bid Bond
(Effective November 1, 1992)

Item No.
Letting Date

KNOW ALL MEN BY THESE PRESENTS, That We

as PRINCIPAL, and

as SURETY, are held jointly, severally and firmly bound unto the STATE OF ILLINOIS in the penal sum of 5 percent of the total bid price, or for the amount specified in Article 102.09 of the "Standard Specifications for Road and Bridge Construction" in effect on the date of invitation for bids, whichever is the lesser sum, well and truly to be paid unto said STATE OF ILLINOIS, for the payment of which we bind ourselves, our heirs, executors, administrators, successors and assigns.

THE CONDITION OF THE FOREGOING OBLIGATION IS SUCH, that whereas, the PRINCIPAL has submitted a bid proposal to the STATE OF ILLINOIS, acting through the Department of Transportation, for the improvement designated by the Transportation Bulletin Item Number and Letting Date indicated above.

NOW, THEREFORE, if the Department shall accept the bid proposal of the PRINCIPAL; and if the PRINCIPAL shall, within the time and as specified in the bidding and contract documents, submit a DBE Utilization Plan that is accepted and approved by the Department; and if, after award by the Department, the PRINCIPAL shall enter into a contract in accordance with the terms of the bidding and contract documents including evidence of the required insurance coverages and providing such bond as specified with good and sufficient surety for the faithful performance of such contract and for the prompt payment of labor and material furnished in the prosecution thereof; or if, in the event of the failure of the PRINCIPAL to make the required DBE submission or to enter into such contract and to give the specified bond, the PRINCIPAL pays to the Department the difference not to exceed the penalty hereof between the amount specified in the bid proposal and such larger amount for which the Department may contract with another party to perform the work covered by said bid proposal, then this obligation shall be null and void, otherwise, it shall remain in full force and effect.

IN THE EVENT the Department determines the PRINCIPAL has failed to comply with any requirement as set forth in the preceding paragraph, then Surety shall pay the penal sum to the Department within fifteen (15) days of written demand therefor. If Surety does not make full payment within such period of time, the Department may bring an action to collect the amount owed. Surety is liable to the Department for all its expenses, including attorney's fees, incurred in any litigation in which it prevails either in whole or in part.

In TESTIMONY WHEREOF, the said PRINCIPAL and the said SURETY have caused this instrument to be signed by

their respective officers this day of A.D.,

PRINCIPAL

SURETY

(Company Name)

(Company Name)

By (Signature & Title)

By: (Signature of Attorney-in-Fact)

Notary Certification for Principal and Surety

STATE OF ILLINOIS,
County of

I, , a Notary Public in and for said County, do hereby certify that
and
(Insert names of individuals signing on behalf of PRINCIPAL & SURETY)

who are each personally known to me to be the same persons whose names are subscribed to the foregoing instrument on behalf of PRINCIPAL and SURETY, appeared before me this day in person and acknowledged respectively, that they signed and delivered said instrument as their free and voluntary act for the uses and purposes therein set forth.

Given under my hand and notarial seal this day of A.D.

My commission expires
Notary Public

In lieu of completing the above section of the Proposal Bid Form, the Principal may file an Electronic Bid Bond. By signing the proposal and marking the check box next to the Signature and Title line below, the Principal is ensuring the identified electronic bid bond has been executed and the Principal and Surety are firmly bound unto the State of Illinois under the conditions of the bid bond as shown above.

Electronic Bid Bond ID# Company / Bidder Name Signature and Title

# PROPOSAL ENVELOPE



# PROPOSALS

for construction work advertised for bids by the  
Illinois Department of Transportation

Item No.	Item No.	Item No.

Submitted By:

Name:
Address:
Phone No.

Bidders should use an IDOT proposal envelope or affix this form to the front of a 10" x 13" envelope for the submittal of bids. If proposals are mailed, they should be enclosed in a second or outer envelope addressed to:

Engineer of Design and Environment - Room 326  
Illinois Department of Transportation  
2300 South Dirksen Parkway  
Springfield, Illinois 62764

## **NOTICE**

**Individual bids, including Bid Bond and/or supplemental information if required, should be securely stapled.**

# CONTRACTOR OFFICE COPY OF CONTRACT SPECIFICATIONS

## NOTICE

None of the following material needs to be returned with the bid package unless the special provisions require documentation and/or other information to be submitted.

**Contract No. 63169  
MCHENRY County  
Section 08-00109-00-RS (Woodstock)  
Project M-9003(182)  
Route FAU 33 (South Street)  
District 1 Construction Funds**



**Illinois Department of Transportation**





## NOTICE TO BIDDERS

- 1. TIME AND PLACE OF OPENING BIDS.** Sealed proposals for the improvement described herein will be received by the Department of Transportation at the Harry R. Hanley Building, 2300 South Dirksen Parkway, in Springfield, Illinois until 10:00 o'clock a.m., June 12, 2009. All bids will be gathered, sorted, publicly opened and read in the auditorium at the Department of Transportation's Harry R. Hanley Building shortly after the 10:00 a.m. cut off time.
- 2. DESCRIPTION OF WORK.** The proposed improvement is identified and advertised for bids in the Invitation for Bids as:

**Contract No. 63169  
MCHENRY County  
Section 08-00109-00-RS (Woodstock)  
Project M-9003(182)  
Route FAU 33 (South Street)  
District 1 Construction Funds**

**Patching, milling and resurfacing, construction of new sidewalk and curb and gutter, remove and replace sidewalks and curb and gutter, installation of storm sewers and the extension of a box culvert from west of Morain Drive to Tara Drive in the city of Woodstock.**

- 3. INSTRUCTIONS TO BIDDERS.** (a) This Notice, the invitation for bids, proposal and letter of award shall, together with all other documents in accordance with Article 101.09 of the Standard Specifications for Road and Bridge Construction, become part of the contract. Bidders are cautioned to read and examine carefully all documents, to make all required inspections, and to inquire or seek explanation of the same prior to submission of a bid.  
  
(b) State law, and, if the work is to be paid wholly or in part with Federal-aid funds, Federal law requires the bidder to make various certifications as a part of the proposal and contract. By execution and submission of the proposal, the bidder makes the certification contained therein. A false or fraudulent certification shall, in addition to all other remedies provided by law, be a breach of contract and may result in termination of the contract.
- 4. AWARD CRITERIA AND REJECTION OF BIDS.** This contract will be awarded to the lowest responsive and responsible bidder considering conformity with the terms and conditions established by the Department in the rules, Invitation for Bids and contract documents. The issuance of plans and proposal forms for bidding based upon a prequalification rating shall not be the sole determinant of responsibility. The Department reserves the right to determine responsibility at the time of award, to reject any or all proposals, to readvertise the proposed improvement, and to waive technicalities.

By Order of the  
Illinois Department of Transportation

Gary Hannig,  
Acting Secretary

INDEX  
FOR  
SUPPLEMENTAL SPECIFICATIONS  
AND RECURRING SPECIAL PROVISIONS

Adopted January 1, 2009

This index contains a listing of SUPPLEMENTAL SPECIFICATIONS and frequently used RECURRING SPECIAL PROVISIONS.

ERRATA Standard Specifications for Road and Bridge Construction (Adopted 1-1-07) (Revised 1-1-09)

SUPPLEMENTAL SPECIFICATIONS

<u>Std. Spec. Sec.</u>	<u>Page No.</u>
201 Clearing, Tree Removal and Protection .....	1
205 Embankment .....	2
251 Mulch .....	3
253 Planting Woody Plants .....	4
280 Temporary Erosion Control .....	6
443 Reflective Crack Control Treatment .....	7
502 Excavation for Structures .....	10
503 Concrete Structures .....	11
504 Precast Concrete Structures .....	12
505 Steel Structures .....	13
540 Box Culverts .....	14
581 Waterproofing Membrane System .....	15
633 Removing and Reerecting Guardrail and Terminals .....	16
669 Removal and Disposal of Regulated Substances .....	17
672 Sealing Abandoned Water Wells .....	18
701 Work Zone Traffic Control and Protection .....	19
733 Overhead Sign Structures .....	20
783 Pavement Marking and Marker Removal .....	21
801 Electrical Requirements .....	22
805 Electrical Service Installation – Traffic Signals .....	23
836 Pole Foundation .....	24
838 Breakaway Devices .....	25
862 Uninterruptable Power Supply .....	26
873 Electric Cable .....	28
878 Traffic Signal Concrete Foundation .....	30
1004 Coarse Aggregates .....	31
1008 Structural Steel Coatings .....	32
1010 Finely Divided Materials .....	33
1020 Portland Cement Concrete .....	34
1022 Concrete Curing Materials .....	43
1024 Nonshrink Grout .....	44
1042 Precast Concrete Products .....	45
1062 Reflective Crack Control System .....	47
1069 Pole and Tower .....	49
1074 Control Equipment .....	52
1076 Wire and Cable .....	57
1081 Materials for Planting .....	58
1083 Elastomeric Bearings .....	60
1094 Overhead Sign Structures .....	61
1101 General Equipment .....	62
1102 Hot-Mix Asphalt Equipment .....	63
1106 Work Zone Traffic Control Devices .....	64

RECURRING SPECIAL PROVISIONS

The following RECURRING SPECIAL PROVISIONS indicated by an "X" are applicable to this contract and are included by reference:

<u>CHECK SHEET #</u>		<u>PAGE NO.</u>
1	<input checked="" type="checkbox"/> Additional State Requirements For Federal-Aid Construction Contracts (Eff. 2-1-69) (Rev. 1-1-07) .....	65
2	<input checked="" type="checkbox"/> Subletting of Contracts (Federal-Aid Contracts) (Eff. 1-1-88) (Rev. 5-1-93) .....	67
3	<input checked="" type="checkbox"/> EEO (Eff. 7-21-78) (Rev. 11-18-80) .....	68
4	<input type="checkbox"/> Specific Equal Employment Opportunity Responsibilities Non Federal-Aid Contracts (Eff. 3-20-69) (Rev. 1-1-94) .....	78
5	<input type="checkbox"/> Required Provisions - State Contracts (Eff. 4-1-65) (Rev. 1-1-07) .....	83
6	<input type="checkbox"/> Reserved .....	88
7	<input type="checkbox"/> Reserved .....	89
8	<input type="checkbox"/> Haul Road Stream Crossings, Other Temporary Stream Crossings, and In-Stream Work Pads (Eff. 1-2-92) (Rev. 1-1-98) .....	90
9	<input type="checkbox"/> Construction Layout Stakes Except for Bridges (Eff. 1-1-99) (Rev. 1-1-07) .....	91
10	<input type="checkbox"/> Construction Layout Stakes (Eff. 5-1-93) (Rev. 1-1-07) .....	94
11	<input type="checkbox"/> Use of Geotextile Fabric for Railroad Crossing (Eff. 1-1-95) (Rev. 1-1-07) .....	97
12	<input type="checkbox"/> Subsealing of Concrete Pavements (Eff. 11-1-84) (Rev. 1-1-07) .....	99
13	<input type="checkbox"/> Hot-Mix Asphalt Surface Correction (Eff. 11-1-87) (Rev. 1-1-09) .....	103
14	<input type="checkbox"/> Pavement and Shoulder Resurfacing (Eff. 2-1-00) (Rev. 1-1-09) .....	105
15	<input type="checkbox"/> PCC Partial Depth Hot-Mix Asphalt Patching (Eff. 1-1-98) (Rev. 1-1-07) .....	106
16	<input type="checkbox"/> Patching with Hot-Mix Asphalt Overlay Removal (Eff. 10-1-95) (Rev. 1-1-07) .....	108
17	<input type="checkbox"/> Polymer Concrete (Eff. 8-1-95) (Rev. 1-1-08) .....	109
18	<input type="checkbox"/> PVC Pipeliner (Eff. 4-1-04) (Rev. 1-1-07) .....	111
19	<input type="checkbox"/> Pipe Underdrains (Eff. 9-9-87) (Rev. 1-1-07) .....	112
20	<input checked="" type="checkbox"/> Guardrail and Barrier Wall Delineation (Eff. 12-15-93) (Rev. 1-1-97) .....	113
21	<input type="checkbox"/> Bicycle Racks (Eff. 4-1-94) (Rev. 1-1-07) .....	117
22	<input type="checkbox"/> Temporary Modular Glare Screen System (Eff. 1-1-00) (Rev. 1-1-07) .....	119
23	<input type="checkbox"/> Temporary Portable Bridge Traffic Signals (Eff. 8-1-03) (Rev. 1-1-07) .....	121
24	<input type="checkbox"/> Work Zone Public Information Signs (Eff. 9-1-02) (Rev. 1-1-07) .....	123
25	<input type="checkbox"/> Night Time Inspection of Roadway Lighting (Eff. 5-1-96) .....	124
26	<input type="checkbox"/> English Substitution of Metric Bolts (Eff. 7-1-96) .....	125
27	<input type="checkbox"/> English Substitution of Metric Reinforcement Bars (Eff. 4-1-96) (Rev. 1-1-03) .....	126
28	<input type="checkbox"/> Calcium Chloride Accelerator for Portland Cement Concrete (Eff. 1-1-01) .....	127
29	<input type="checkbox"/> Reserved .....	128
30	<input type="checkbox"/> Quality Control of Concrete Mixtures at the Plant (Eff. 8-1-00) (Rev. 1-1-09) .....	129
31	<input checked="" type="checkbox"/> Quality Control/Quality Assurance of Concrete Mixtures (Eff. 4-1-92) (Rev. 1-1-09) .....	137
32	<input type="checkbox"/> Asbestos Bearing Pad Removal (Eff. 11-1-03) .....	149
33	<input type="checkbox"/> Asbestos Hot-Mix Asphalt Surface Removal (Eff. 6-1-89) (Rev. 1-1-09) .....	150
LRS 1	Reserved .....	152
LRS 2	<input type="checkbox"/> Furnished Excavation (Eff. 1-1-99) (Rev. 1-1-07) .....	153
LRS 3	<input checked="" type="checkbox"/> Work Zone Traffic Control (Eff. 1-1-99) (Rev. 1-1-07).....	154
LRS 4	<input checked="" type="checkbox"/> Flaggers in Work Zones (Eff. 1-1-99) (Rev 1-1-07).....	155
LRS 5	<input type="checkbox"/> Contract Claims (Eff. 1-1-02) (Rev. 1-1-07).....	156
LRS 6	<input type="checkbox"/> Bidding Requirements and Conditions for Contract Proposals (Eff. 1-1-02).....	157
LRS 7	<input type="checkbox"/> Bidding Requirements and Conditions for Material Proposals (Eff. 1-1-02) (Rev. 1-1-03).....	163
LRS 8	<input type="checkbox"/> Failure to Complete the Work on Time (Eff. 1-1-99).....	169
LRS 9	<input type="checkbox"/> Bituminous Surface Treatments (Eff. 1-1-99) .....	170
LRS 10	<input type="checkbox"/> Reflective Sheeting Type C (Eff. 1-1-99) (Rev. 1-1-02) .....	171
LRS 11	<input type="checkbox"/> Employment Practices (Eff. 1-1-99) .....	172
LRS 12	<input type="checkbox"/> Wages of Employees on Public Works (Eff. 1-1-99) (Rev. 4-1-06).....	174
LRS 13	<input type="checkbox"/> Selection of Labor (Eff. 1-1-99) .....	175
LRS 14	<input type="checkbox"/> Paving Brick and Concrete Paver Pavements and Sidewalks (Eff. 1-1-04) (Rev. 1-1-09).....	176
LRS 15	<input type="checkbox"/> Partial Payments (Eff. 1-1-07) .....	179

CITY OF WOODSTOCK  
McHENRY COUNTY, ILLINOIS

SPECIFICATIONS  
PLANS  
CONTRACT PROPOSAL

FOR

**SOUTH STREET**

FAU ROUTE 033  
SECTION 08-00109-00-RS  
PROJECT M-9003 (182)

Prepared by:

Hampton, Lenzini and Renwick, Inc.  
380 Shepard Drive  
Elgin, Illinois 60123-7010

## INDEX OF SPECIAL PROVISIONS

	<u>PAGE</u>
LOCATION OF PROJECT.....	1
DESCRIPTION OF PROJECT.....	1
COMPLETION DATE.....	1
CONSTRUCTION SEQUENCING AND STAGING.....	1
MAINTENANCE OF ROADWAYS .....	2
CONSTRUCTION NOISE.....	2
EXISTING UTILITY INFORMATION.....	2
INDEMNIFICATION.....	3
EARTH EXCAVATION .....	4
FURNISHED EXCAVATION .....	4
SEEDING, CLASS 1B .....	5
PERIMETER EROSION BARRIER.....	5
INLET FILTERS .....	5
BITUMINOUS MATERIALS (PRIME COAT).....	6
AGGREGATE (PRIME COAT) .....	6
PORTLAND CEMENT CONCRETE SIDEWALK, 5"	
PORTLAND CEMENT CONCRETE SIDEWALK, 7" .....	6
PAVEMENT REMOVAL AND REPLACEMENT .....	7
HOT-MIX ASPHALT SURFACE REMOVAL, VARIABLE DEPTH.....	7
HOT-MIX ASPHALT DRIVEWAY.....	8
REMOVE EXISTING CULVERTS .....	8
SPECIAL FRAMES AND GRATES	
SPECIAL FRAMES AND LIDS .....	8
REMOVE AND RE-ERECT TERMINAL SECTION, SINGLE RAIL .....	9
GUARDRAIL <i>MARKERS</i> .....	9
TRAFFIC CONTROL AND PROTECTION.....	10
TRAFFIC PROTECTION FOR SIDE ROADS AND INTERSECTIONS .....	12
<hr/>	
DISTRICT ONE SPECIAL PROVISIONS.....	<i>13-23</i>
STORM WATER POLLUTION PREVENTION PLAN .....	<i>24</i>
CITY OF WOODSTOCK DETAILS .....	<i>31</i>

INDEX LOCAL ROADS AND STREETS SPECIAL PROVISIONS

LR #	Pg #	Special Provision Title	Effective	Revised
LR SD 12	<input type="checkbox"/>	Slab Movement Detection Device	Nov. 11, 1984	Jan. 1, 2007
LR SD 13	<input type="checkbox"/>	Required Cold Milled Surface Texture	Nov. 1, 1987	Jan. 1, 2007
LR 102	<input type="checkbox"/>	Protests on Local Lettings	Jan. 1, 2007	
LR 105	<input type="checkbox"/>	Cooperation with Utilities	Jan. 1, 1999	Jan. 1, 2007
LR 107-2	<input type="checkbox"/>	Railroad Protective Liability Insurance for Local Lettings	Mar. 1, 2005	Jan. 1, 2006
LR 107-3	<input type="checkbox"/>	Disadvantaged Business Enterprise Participation	Jan. 1, 2007	Nov. 1, 2008
LR 107-4	43 <input checked="" type="checkbox"/>	Insurance	Feb. 1, 2007	Aug. 1, 2007
LR 107-5	<input type="checkbox"/>	Substance Abuse Prevention Program	Jan. 1, 2008	Jan. 8, 2008
LR 108	<input type="checkbox"/>	Combination Bids	Jan. 1, 1994	Mar. 1, 2005
LR 212	<input type="checkbox"/>	Shaping Roadway	Aug. 1, 1969	Jan. 1, 2002
LR 355-1	<input type="checkbox"/>	Asphalt Stabilized Base Course, Road Mix or Traveling Plant Mix	Oct. 1, 1973	Jan. 1, 2007
LR 355-2	<input type="checkbox"/>	Asphalt Stabilized Base Course, Plant Mix	Feb. 2, 1963	Jan. 1, 2007
LR 400-1	<input type="checkbox"/>	Bituminous Treated Earth Surface	Jan. 1, 2008	
LR 400-2	<input type="checkbox"/>	Bituminous Surface Mixture (Class B)	Jan. 1, 2008	
LR 400-3	<input type="checkbox"/>	Pavement Rehabilitation by the Heat-Scarify-Overlay Method	Jan. 1, 2008	
LR 402	<input type="checkbox"/>	Salt Stabilized Surface Course	Feb. 20, 1963	Jan. 1, 2007
LR 403-2	<input type="checkbox"/>	Bituminous Hot Mix Sand Seal Coat	Aug. 1, 1969	Jan. 1, 2007
LR 406	<input type="checkbox"/>	Filling HMA Core Holes with Non-shrink Grout	Jan. 1, 2008	
LR 420	<input type="checkbox"/>	PCC Pavement (Special)	May 12, 1964	Jan. 2, 2007
LR 442	<input type="checkbox"/>	Bituminous Patching Mixtures for Maintenance Use	Jan. 1, 2004	Jun. 1, 2007
LR 451	<input type="checkbox"/>	Crack Filling Bituminous Pavement with Fiber-Asphalt	Oct. 1, 1991	Jan. 1, 2007
LR 503-1	<input type="checkbox"/>	Furnishing Class SI Concrete	Oct. 1, 1973	Jan. 1, 2002
LR 503-2	<input type="checkbox"/>	Furnishing Class SI Concrete (Short Load)	Jan. 1, 1989	Jan. 1, 2002
LR 542	<input type="checkbox"/>	Pipe Culverts, Type _____ (Furnished)	Sep. 1, 1964	Jan. 1, 2007
LR 663	<input type="checkbox"/>	Calcium Chloride Applied	Jun. 1, 1958	Jan. 1, 2007
LR 702	<input type="checkbox"/>	Construction and Maintenance Signs	Jan. 1, 2004	Jun. 1, 2007
LR 1004	<input type="checkbox"/>	Coarse Aggregate for Bituminous Surface Treatment	Jan. 1, 2002	Jan. 1, 2007
LR 1013	<input type="checkbox"/>	Rock Salt (Sodium Chloride)	Aug. 1, 1969	Jan. 1, 2002
LR 1030	<input type="checkbox"/>	Growth Curve	Mar. 1, 2008	
LR 1032-1	<input type="checkbox"/>	Penetrating Emulsions	Jan. 1, 2007	Feb. 1, 2007
LR 1032-2	<input type="checkbox"/>	Multigrade Cold Mix Asphalt	Jan. 1, 2007	Feb. 1, 2007
LR 1102	<input type="checkbox"/>	Road Mix or Traveling Plan Mix Equipment	Jan. 1, 2007	

**BDE SPECIAL PROVISIONS**  
For the April 24 and June 12, 2009 Lettings

The following special provisions indicated by an "X" are applicable to this contract. An \* indicates a new or revised special provision for the letting.

<u>File Name</u>	<u>Pg#</u>		<u>Special Provision Title</u>	<u>Effective</u>	<u>Revised</u>
80099			Accessible Pedestrian Signals (APS)	April 1, 2003	Jan. 1, 2007
80186	44	X	Alkali-Silica Reaction for Cast-in-Place Concrete	Aug. 1, 2007	Jan. 1, 2009
80213	47	X	Alkali-Silica Reaction for Precast and Precast Prestressed Concrete	Jan. 1, 2009	
* 80243			American Recovery and Reinvestment Act Provisions	April 1, 2009	
* 80236			American Recovery and Reinvestment Act Signing	April 1, 2009	April 2, 2009
80207	50	X	Approval of Proposed Borrow Areas, Use Areas, and/or Waste Areas Inside Illinois State Borders	Nov. 1, 2008	
80192			Automated Flagger Assistance Device	Jan. 1, 2008	
* 80173			Bituminous Materials Cost Adjustments	Nov. 2, 2006	April 1, 2009
50261			Building Removal-Case I (Non-Friable and Friable Asbestos)	Sept. 1, 1990	Jan. 1, 2007
50481			Building Removal-Case II (Non-Friable Asbestos)	Sept. 1, 1990	Jan. 1, 2007
50491			Building Removal-Case III (Friable Asbestos)	Sept. 1, 1990	Jan. 1, 2007
50531			Building Removal-Case IV (No Asbestos)	Sept. 1, 1990	Jan. 1, 2007
* 80166	51	X	Cement	Jan. 1, 2007	April 1, 2009
80198			Completion Date (via calendar days)	April 1, 2008	
80199			Completion Date (via calendar days) Plus Working Days	April 1, 2008	
* 80094	54	X	Concrete Admixtures	Jan. 1, 2003	April 1, 2009
80193			Concrete Barrier	Jan. 1, 2008	
80214			Concrete Gutter, Type A	Jan. 1, 2009	
80215			Concrete Joint Sealer	Jan. 1, 2009	
* 80226			Concrete Mix Designs	April 1, 2009	
* 80237			Construction Air Quality – Diesel Vehicle Emissions Control	April 1, 2009	
* 80239			Construction Air Quality – Idling Restrictions	April 1, 2009	
* 80227			Determination of Thickness	April 1, 2009	
80177			Digital Terrain Modeling for Earthwork Calculations	April 1, 2007	
80029	58	X	Disadvantaged Business Enterprise Participation	Sept. 1, 2000	Nov. 1, 2008
80178	58A	X	Dowel Bars	April 1, 2007	Jan. 1, 2008
80179			Engineer's Field Office Type A	April 1, 2007	Aug. 1, 2008
80205			Engineer's Field Office Type B	Aug. 1, 2008	
80175			Epoxy Pavement Markings	Jan. 1, 2007	
80189	66	X	Equipment Rental Rates	Aug. 2, 2007	Jan. 2, 2008
* 80228			Flagger at Side Roads and Entrances	April 1, 2009	
* 80229			Fuel Cost Adjustment	April 1, 2009	
80169			High Tension Cable Median Barrier	Jan. 1, 2007	
80194			HMA – Hauling on Partially Completed Full-Depth Pavement	Jan. 1, 2008	
80181	68	X	Hot-Mix Asphalt – Field Voids in the Mineral Aggregate	April 1, 2007	April 1, 2008
80201	70	X	Hot-Mix Asphalt – Plant Test Frequency	April 1, 2008	
80202	72	X	Hot-Mix Asphalt – Transportation	April 1, 2008	
80136			Hot-Mix Asphalt Mixture IL-4.75	Nov. 1, 2004	Jan. 1, 2008
80195			Hot-Mix Asphalt Mixture IL-9.5L	Jan. 1, 2008	
80109			Impact Attenuators	Nov. 1, 2003	Nov. 1, 2008
80110			Impact Attenuators, Temporary	Nov. 1, 2003	Jan. 1, 2007
* 80230	73	X	Liquidated Damages	April 1, 2009	
80196			Mast Arm Assembly and Pole	Jan. 1, 2008	Jan. 1, 2009
80045			Material Transfer Device	June 15, 1999	Jan. 1, 2009
* 80203	74	X	Metal Hardware Cast into Concrete	April 1, 2008	April 1, 2009
80165			Moisture Cured Urethane Paint System	Nov. 1, 2006	Jan. 1, 2007
* 80238			Monthly Employment Report	April 1, 2009	
80082			Multilane Pavement Patching	Nov. 1, 2002	
80180	75	X	National Pollutant Discharge Elimination System / Erosion and Sediment Control Deficiency Deduction (NOTE: This special provision was previously named "Erosion and Sediment Control Deficiency Deduction".)	April 1, 2007	Nov. 1, 2008
80208			Nighttime Work Zone Lighting	Nov. 1, 2008	
80129			Notched Wedge Longitudinal Joint	July 1, 2004	Jan. 1, 2007
80182			Notification of Reduced Width	April 1, 2007	

File Name	Pg#		Special Provision Title	Effective	Revised
80069			Organic Zinc-Rich Paint System	Nov. 1, 2001	Jan. 1, 2008
80216			Partial Exit Ramp Closure for Freeway/Expressway	Jan. 1, 2009	
* 80231			Pavement Marking Removal	April 1, 2009	
80022	76	X	Payments to Subcontractors	June 1, 2000	Jan. 1, 2006
* 80235	78	X	Payrolls and Payroll Records	Mar. 1, 2009	
80209	80	X	Personal Protective Equipment	Nov. 1, 2008	
* 80232			Pipe Culverts	April 1, 2009	
80134	81	X	Plastic Blockouts for Guardrail	Nov. 1, 2004	Jan. 1, 2007
80119			Polyurea Pavement Marking	April 1, 2004	Jan. 1, 2009
80210			Portland Cement Concrete Inlay or Overlay	Nov. 1, 2008	
80170			Portland Cement Concrete Plants	Jan. 1, 2007	
80217			Post Clips for Extruded Aluminum Signs	Jan. 1, 2009	
80171			Precast Handling Holes	Jan. 1, 2007	
* 80218			Preventive Maintenance – Bituminous Surface Treatment	Jan. 1, 2009	April 1, 2009
* 80219			Preventive Maintenance – Cape Seal	Jan. 1, 2009	April 1, 2009
80220			Preventive Maintenance – Micro-Surfacing	Jan. 1, 2009	
80221			Preventive Maintenance – Slurry Seal	Jan. 1, 2009	
80211			Prismatic Curb Reflectors	Nov. 1, 2008	
80015			Public Convenience and Safety	Jan. 1, 2000	
34261			Railroad Protective Liability Insurance	Dec. 1, 1986	Jan. 1, 2006
80157			Railroad Protective Liability Insurance (5 and 10)	Jan. 1, 2006	
80223			Ramp Closure for Freeway/Expressway	Jan. 1, 2009	
* 80172			Reclaimed Asphalt Pavement (RAP)	Jan. 1, 2007	April 1, 2009
80183	82	X	Reflective Sheeting on Channelizing Devices	April 1, 2007	Nov. 1, 2008
* 80151	83	X	Reinforcement Bars	Nov. 1, 2005	April 1, 2009
* 80206	85	X	Reinforcement Bars – Storage and Protection	Aug. 1, 2008	April 1, 2009
80224			Restoring Bridge Approach Pavements Using High-Density Foam	Jan. 1, 2009	
80184			Retroreflective Sheeting, Nonreflective Sheeting, and Translucent Overlay Film for Highway Signs	April 1, 2007	
* 80233			Right-of-Entry Permit	April 1, 2009	
80131	86	X	Seeding	July 1, 2004	Jan. 1, 2009
80152	88	X	Self-Consolidating Concrete for Cast-In-Place Construction	Nov. 1, 2005	Jan. 1, 2009
80132	93	X	Self-Consolidating Concrete for Precast Products	July 1, 2004	Jan. 1, 2007
80212			Sign Panels and Sign Panel Overlays	Nov. 1, 2008	
80197	95	X	Silt Filter Fence	Jan. 1, 2008	
* 80127			Steel Cost Adjustment	April 2, 2004	April 1, 2009
80153	96	X	Steel Plate Beam Guardrail	Nov. 1, 2005	Aug. 1, 2007
80191			Stone Gradation Testing	Nov. 1, 2007	
* 80234			Storm Sewers	April 1, 2009	
80143	97	X	Subcontractor Mobilization Payments	April 2, 2005	
80075			Surface Testing of Pavements	April 1, 2002	Jan. 1, 2007
80087	98	X	Temporary Erosion Control	Nov. 1, 2002	Jan. 1, 2008
80225			Temporary Raised Pavement Marker	Jan. 1, 2009	
80176	99	X	Thermoplastic Pavement Markings	Jan. 1, 2007	
20338	101	X	Training Special Provisions	Oct. 15, 1975	
80185			Type ZZ Retroreflective Sheeting, Nonreflective Sheeting, and Translucent Overlay Film for Highway Signs	April 1, 2007	
80149			Variable Spaced Tining	Aug. 1, 2005	Jan. 1, 2007
80071			Working Days	Jan. 1, 2002	
80204			Woven Wire Fence	April 1, 2008	

The following special provisions are in the 2009 Supplemental Specifications and Recurring Special Provisions:

File Name	Special Provision Title	New Location	Effective	Revised
80108	Asbestos Bearing Pad Removal	Check Sheet #32	Nov. 1, 2003	
72541	Asbestos Waterproofing Membrane and Asbestos Hot-Mix Asphalt Surface Removal	Check Sheet #33	June 1, 1989	Jan. 2, 2007
80167	Electrical Service Installation – Traffic Signals	Section 805	Jan. 1, 2007	
80164	Removal and Disposal of Regulated Substances	Section 669	Aug. 1, 2006	Jan. 1, 2007
80161	Traffic Signal Grounding	Sections 873 and 1076	April 1, 2006	Jan. 1, 2007
80162	Uninterruptable Power Supply (UPS)	Sections 801, 862 and 1074	April 1, 2006	Jan. 1, 2007



<u>File Name</u>	<u>Special Provision Title</u>	<u>New Location</u>	<u>Effective</u>	<u>Revised</u>
80163	Water Blaster with Vacuum Recovery	Articles 783.02 and 1101.12	April 1, 2006	Jan. 1, 2007

The following special provisions require additional information from the designer. The additional information needs to be included in a separate document attached to this check sheet. The Project Development and Implementation section will then include the information in the applicable special provision. The Special Provisions are:

- Building Removal-Case I
- Building Removal-Case II
- Building Removal-Case III
- Building Removal-Case IV
- Completion Date
- Completion Date Plus Working Days
- DBE Participation
- Material Transfer Device
- Railroad Protective Liability Insurance
- Right-of-Entry Permit
- Training Special Provisions
- Working Days

## **SPECIAL PROVISIONS**

The following Special Provisions supplement the "Standard Specifications for Road and Bridge Construction," adopted January 1, 2007, the "Supplemental Specifications and Recurring Special Provisions," adopted January 1, 2009 (as indicated on the check sheet included herein), the latest edition of the "Standard Specifications for Water and Sewer Main Construction in Illinois," and the latest edition of the "Illinois Manual on Uniform Traffic Control Devices for Streets and Highways" in effect on the date of invitation for bids. These special provisions included herein apply to and govern the proposed improvement designated as South Street Sidewalk Improvements, and in case of conflict with any part or parts of said specifications, said special provisions shall take precedence and shall govern.

## **LOCATION OF PROJECT**

---

The project is located on South Street from Tara Drive/Emricson Park Entrance to just west of Moraine Drive in the City of Woodstock.

## **DESCRIPTION OF PROJECT**

---

The proposed improvement consists of the construction of sidewalk and curb and gutter along the north side of South Street and the resurfacing of South Street. The improvement also includes the removal of existing curbs and sidewalks at selected locations, installation of storm sewers, catch basins, inlets, and manholes, the extension of a box culvert, sanitary sewer installation, guardrail, pavement markings, and other necessary appurtenant construction.

## **COMPLETION DATE**

---

The Contractor shall complete all work on or before the completion date of this contract, which is August 28, 2009.

## **CONSTRUCTION SEQUENCING AND STAGING**

---

South Street shall remain open to traffic at all times. Closure of one lane will be permitted during working hours with the use of certified flaggers to direct traffic.

In order to construct the curb and gutter along the north side of the pavement, the existing pavement markings shall be removed and temporary pavement markings installed to create one 10-foot lane in each direction from the south side of the pavement.

At the preconstruction meeting the Contractor shall submit to the City a progress schedule which details both the utilization of working days and the proposed sequence of work.

---

### **MAINTENANCE OF ROADWAYS**

---

Beginning on the date that work begins on this project, the Contractor shall assume responsibility for normal maintenance of all existing roadways within the limits of the improvement. This normal maintenance shall include all repair work deemed necessary by the Engineer but shall not include snow removal operations. Traffic control and protection for maintenance of roadways will be provided by the Contractor as required by the Engineer.

If items of work have not been provided in the contract or otherwise specified for payment, such items, including the accompanying traffic control and protection required by the Engineer, will be paid for in accordance with Article 109.04 of the Standard Specifications.

---

### **CONSTRUCTION NOISE**

---

In order to minimize the effect of construction noise on the area surrounding the improvement, the Contractor and his subcontractors shall comply with the following requirements:

1. All engines and engine-driven equipment used for hauling or construction shall be equipped with an adequate muffler in constant operation and properly maintained to prevent excessive or unusual noise.

Any machine or device or part thereof which is regulated by or becomes regulated by federal or State of Illinois noise standards shall conform to those standards. Such equipment shall be operated as designated in item 2 below.

2. Construction operations shall be confined to the daylight hours between 7:00 a.m. and 8:00 p.m. Monday through Friday and from 7:00 a.m. to 5:00 p.m. on Saturday. No work of any kind shall be done on Sundays. These time restrictions shall not apply to maintenance or operation of safety and traffic-control devices such as barricades, signs, and lighting, or to construction of an emergency nature. However, starting up of equipment does apply.

---

### **EXISTING UTILITY INFORMATION**

---

The Contractor shall familiarize himself with the location of all utilities and structures that may be found in the vicinity of the construction. The Contractor shall conduct his operation to avoid damage to the above-mentioned utilities or structures. Should any damage occur due to the Contractor's negligence, repairs shall be made at the Contractor's expense in a manner acceptable to the Engineer or owner. The names of the representatives of the utility companies involved are listed below. The Contractor shall notify each of the representatives prior to commencing work and proceed with the work procedures which will not impair the operations of the utility systems.

CABLE TV: Comcast Cable Services  
Mr. Thomas Munar  
688 Industrial Drive  
Elmhurst, IL 60126  
(630) 600-6316

City of Woodstock  
South Street  
Section 08-00109-00-RS  
FAU Route 033

ELECTRIC: ComEd  
Mr. Dave Schact  
123 Energy Drive  
Rockford, IL 61109-1099  
(630) 437-2129

---

GAS: Nicor Gas  
Ms. Beverly Augsburg  
1844 Ferry Road  
Naperville, IL 60563-9600  
(630) 983-8676

---

TELEPHONE: AT&T  
Mr. Bruce Gilbert  
222 W. Jackson Street  
Woodstock, IL 60098  
(815) 337-4374

---

SEWER AND WATER: City of Woodstock  
326 Washington Street  
Woodstock, IL 60098  
(815) 338-6118

The above represents the best information available to the Department and is included for the convenience of the bidder. The applicable portions of Articles 105.07 and 107.31 of the Standard Specifications shall apply.

---

#### **INDEMNIFICATION**

---

Section 107 of the Standard Specifications shall be modified to include the following:

To the fullest extent permitted by law, the Contractor shall indemnify and hold harmless the City of Woodstock, Hampton, Lenzini and Renwick, Inc., and their respective agents and employees (Indemnitees) from and against any and all claims, damages, losses, economic losses, and expenses, including but not limited to attorney's fees arising out of or resulting from performance of the work, provided that such claim, loss, or expense is attributable to bodily injury, sickness, disease, or death, or to injury to or destruction of tangible property (other than the work itself), including loss of use resulting therefrom, but only to the extent caused in whole or in part by negligent acts or omissions of the Contractor, a subcontractor, anyone directly or indirectly employed by them, or anyone for whose acts they may be liable, excluding any proportionate amount of any claim, damage, loss, or expense which is caused by a party indemnified hereunder. Such obligation shall not be construed to negate, abridge, or reduce other rights or obligations of indemnity which would otherwise exist as to a party or person described in this paragraph.

In claims against any person or entity indemnified under this paragraph by an employee of the Contractor, a subcontractor, anyone directly or indirectly employed by them, or anyone for whose acts they may be liable, the indemnification obligation under this paragraph shall not be limited by a limitation on the amount or type of damages, compensation, or benefits payable by or for the Contractor or a subcontractor under workers' or workmen's compensation acts, disability benefit acts, or other employee benefit acts.

The Contractor will obtain and maintain Commercial General Liability Insurance with broad form Property Damage coverage and contractual liability endorsement insuring the indemnity required of the Contractor. The City of Woodstock and Hampton, Lenzini and Renwick, Inc. will be named as additional insureds on the Contractor's Commercial General Liability insurance policy. The additional insured endorsement included on the Contractor's Commercial General Liability policy will provide the following:

1. That the coverage afforded the additional insureds will be primary insurance for the additional insureds with respect to claims arising out of operations performed by or on behalf of the Contractor.
2. That if the additional insureds have other insurance which is applicable to the loss, such other insurance will be on an excess or contingent basis.
3. That the amount of the company's liability under the insurance policy will not be reduced by the existence of such other insurance.
4. That the additional insureds will be given not less than 30 days prior written notice of any cancellation thereof.

---

#### **EARTH EXCAVATION**

**Description.** This work shall consist of the excavation and transportation of suitable excavated material to embankment locations throughout the limits of the contract. The work will be done in accordance with Section 202 of the Standard Specifications and the following.

**Construction Requirements.** Suitable excavated materials shall be placed in areas where sidewalk is to be constructed. Other excavated materials shall be placed in areas that will be covered with topsoil and seeded.

**Basis of Payment.** This work will be paid for at the contract unit price per cubic yard for EARTH EXCAVATION.

---

#### **FURNISHED EXCAVATION**

**Description.** This work shall consist of furnishing, transporting, and placing suitable excavated material obtained from locations approved by the Engineer in accordance with Section 204 of the Standard Specifications.

**Construction Requirements.** Furnished material shall be used for supporting the construction of a sidewalk and for fill at other locations throughout the limits of the project.

**Basis of Payment.** This work will be paid for at the contract unit price per cubic yard for FURNISHED EXCAVATION.

---

### SEEDING, CLASS 1B

---

**Description.** This work shall be in accordance with Section 250 of the Standard Specifications insofar as applicable and the following provisions.

**Construction Requirements.** Fertilizer nutrients shall be applied at 1:1:1 ratio, 90 pounds per acre, for each of the nutrients specified.

**Basis of Payment.** This work will be paid for at the contract unit price per acre for SEEDING, CLASS 1B, which price will be payment in full for all equipment, labor, and materials, including the seed and fertilizer nutrients necessary to complete the work as specified herein.

---

### PERIMETER EROSION BARRIER

---

**Description.** This work shall be in accordance with Section 280 of the Standard Specifications insofar as applicable and the following provisions.

Revise Article 280.08 to read: Maintenance of the perimeter erosion barrier, including repair of the silt filter fence, removal of entrapped sediment, and cleaning of any silt filter fabric will not be paid for separately but shall be included in the contract unit price per foot for Perimeter Erosion Barrier. If the Contractor fails to maintain the perimeter erosion barrier as directed by the Engineer, the Engineer is required to file an Incidental of Non-Compliance (ION) with the Illinois Environmental Protection Agency, as required by the Storm Water Pollution Prevention Plan.

**Basis of Payment.** This work shall be paid for at the contract unit price per foot for PERIMETER EROSION BARRIER.

---

### INLET FILTERS

---

**Description.** This work shall be in accordance with Section 280 of the Standard Specifications insofar as applicable and the following provisions.

Revise Article 280.08 to read: Maintenance of the inlet filters, including repair of the filters or removal of entrapped sediment and cleaning of any silt filter fabric, will not be paid for separately but shall be included in the contract unit price per each for Inlet Filters. If the Contractor fails to maintain the inlet filters as directed by the Engineer, the Engineer is required to file an Incidental of Non-Compliance (ION) with the Illinois Environmental Protection Agency, as required by the Storm Water Pollution Prevention Plan.

**Basis of Payment.** This work will be paid for at the contract unit price per each for INLET FILTERS.

---

**BITUMINOUS MATERIALS (PRIME COAT)**

---

**Description.** This work shall be done in accordance with Section 406 of the Standard Specifications insofar as applicable and the following provisions.

**Construction Requirements.** The prime shall be SS-1 applied at the rate of 0.1 gallon per square yard. Prime will not be required on any aggregate bases.

Shields, covers, or other suitable equipment shall be provided by the Contractor to protect the motoring public, adjoining pavement, curbs, or structures during the application of prime coat. The Contractor will be required to present a weight ticket for the truckload prior to applying the prime coat. After application, the truck shall then be weighed again in order to determine the net weight of prime coat that has been placed. Both tickets shall be stamped by the certified weighmaster.

One *FRESH OIL* sign shall be installed in advance of each street to be primed and on each side street adjacent to the street to be primed. These signs shall be maintained until the prime coat is adequately cured.

**Basis of Payment.** This work will be paid for at the contract unit price per gallon for BITUMINOUS MATERIALS (PRIME COAT).

---

**AGGREGATE (PRIME COAT)**

---

**Description.** This work shall be done in accordance with Section 406 of the Standard Specifications insofar as applicable and the following provisions.

**Construction Requirements.** The aggregate will be spread at the rate of 4 pounds per square yard.

**Basis of Payment.** This work shall be paid for at the contract unit price per ton for AGGREGATE (PRIME COAT).

---

**PORTLAND CEMENT CONCRETE SIDEWALK, 5"**  
**PORTLAND CEMENT CONCRETE SIDEWALK, 7"**

---

**Description.** This work shall consist of constructing Portland cement concrete sidewalk and sidewalk accessibility ramps on an aggregate subbase. The work will be done in accordance with Section 424 of the Standard Specifications and the following.

**Materials.** Materials for the sidewalk shall be as specified in Section 424. Material for the aggregate subbase shall be CA 6 crushed stone.

**Construction Requirements.** Sidewalk shall be constructed on a minimum 2-inch mechanically compacted aggregate subbase.

**Basis of Payment.** This work will be paid for at the contract unit price per square foot for PORTLAND CEMENT CONCRETE SIDEWALK, 5" and PORTLAND CEMENT CONCRETE SIDEWALK, 7".

---

### PAVEMENT REMOVAL AND REPLACEMENT

---

**Description.** This work shall consist of the saw cutting and removal of existing pavement and replacing it with a minimum 7½" hot-mix asphalt base course on a prepared subgrade. The work shall be in accordance with Section 355 of the Standard Specifications insofar as applicable.

**Materials.** Materials shall be according to Section 1030. The mixture composition used shall be IL-19.0.

**Construction Requirements.** The thickness of the hot-mix asphalt base course shall be 7½ inches or match existing, whichever is greater.

**Basis of Payment.** This work will be paid for at the contract unit price per square yard for PAVEMENT REMOVAL AND REPLACEMENT.

---

### HOT-MIX ASPHALT SURFACE REMOVAL, VARIABLE DEPTH

---

**Description.** This work shall be in accordance with the applicable portions of Section 440 of the Standard Specifications and the following.

**Construction Requirements.** In those areas where removal is required to construct a butt joint with the existing surface, the surface shall be removed to a depth of 1½ inches. All butt joints shall be saw cut to a depth of 1½ inches.

At locations where removal is required along a concrete gutter or curb and gutter, the depth shall be tapered from two (2) inches at the gutter or curb and gutter to nothing at a distance seven (7) feet out or as directed by the Engineer.

Any surface removed outside the designated limits will not be considered for payment.

Any butt joints cut deeper than 1½ inches shall be ramped immediately with hot-mix asphalt surface material meeting the specifications for this project. Such material shall be placed and compacted by mechanical means to the satisfaction of the Engineer so that the resulting butt joint is between one (1) and 1½ inches in depth.

**Method of Measurement.** This work will be measured in place and the area computed in square yards without regard for the number of passes required to remove the surface material.

**Basis of Payment.** This work will be paid for at the contract unit price per square yard for HOT-MIX ASPHALT SURFACE REMOVAL, VARIABLE DEPTH, which price will include the cost of any required saw cutting, the furnishing and placing of any required hot-mix asphalt material, and the disposal of the resultant grindings.



---

### HOT-MIX ASPHALT DRIVEWAY

---

**Description.** This work shall consist of constructing a driveway consisting of hot-mix asphalt surface and binder courses. The work will be done in accordance with the applicable portions of Sections 351 and 406 of the Standard Specifications.

**Material.** The material for the binder shall be Hot-Mix Asphalt Binder Course, IL-19.0, N50. The material for the surface course shall be Hot-Mix Asphalt Surface Course, Mix "C", N50.

**Construction Requirements.** The driveway shall be constructed with a minimum 6-inch binder course, and a 2-inch surface.

**Method of Measurement.** This work will be measured for payment in place and the area computed in square yards.

**Basis of Payment.** This work will be paid for at the contract unit price per square yard for HOT-MIX ASPHALT DRIVEWAY.

---

### REMOVE EXISTING CULVERTS

---

**Description.** This work shall be in accordance with the applicable portions of Section 501 of the Standard Specifications and the following:

**Construction Requirements.** Removal of the existing pipe culverts shall include removal of any end sections and backfilling the void created with CA 6 crushed stone.

**Basis of Payment.** This work will be paid for at the contract unit price per each for REMOVE EXISTING CULVERT.

---

### SPECIAL FRAMES AND GRATES SPECIAL FRAMES AND LIDS

---

**Description.** This work shall be in accordance with the applicable portions of Section 604 of the Standard Specifications and the following:

**Materials.** Frames and grates or lids designated as "Special" shall be manufactured by East Jordan Iron Works or approved equals as follows:

<u>Frame and Grate/Lid</u>	<u>East Jordan Catalog Number</u>
Special Frame, Closed Lid (Parkway)	1022 Frame 1020 Type A Lid
Special Frame, Open Lid (Ditch)	1022 Frame 1020 M1 Lid
Special Frame, Open Lid (Paved Area)	1050 Frame 1020 M1 Lid

City of Woodstock  
South Street  
Section 08-00109-00-RS  
FAU Route 033

<u>Frame and Grate/Lid</u>	<u>East Jordan Catalog Number</u>
Special Frame, Closed Lid (Paved Area)	1050 Frame 1020 Type A Lid
Special Frame and Grate No. 1 (Curb)	7000 Frame Type M1 Grate Type T1 Back

All closed lids shall be marked STORM, SANITARY, or WATER, as appropriate for the structure being constructed, reconstructed, or adjusted.

All closed lids used on sanitary manholes shall be watertight.

**Basis of Payment.** This work will be paid for at the contract unit price per each for SPECIAL FRAME AND GRATE NO. 1 or SPECIAL FRAME, CLOSED LID or SPECIAL FRAME, OPEN LID.

---

### **REMOVE AND RE-ERECT TERMINAL SECTION, SINGLE RAIL**

---

**Description.** This work shall consist of removing one section of guardrail with end section and two posts and reinstalling the end section at the location shown on the plans.

**Construction Requirements.** The existing rail, end section, and two posts shall be carefully removed. The rail and posts shall be delivered to the Public Works Department, 326 Washington Street, Woodstock, Illinois. The end section shall be installed at the end of the remaining rail.

Any damage resulting from the removal of the rail, posts, or end section shall be repaired to its original condition to the satisfaction of the Engineer or replaced at the Contractor's expense.

**Basis of Payment.** This work will be paid for at the contract unit price per each for REMOVE AND RE-ERECT TERMINAL SECTION, SINGLE RAIL, which will be payment in full for all materials, labor, and equipment necessary to provide a complete installation.

---

### **GUARDRAIL REFLECTORS**

---

**Description.** This work shall consist of furnishing and installing guardrail reflectors on guardrail.

**Materials.** The reflectors shall be a #567 Guardrail Delineator as manufactured by AKT Corporation, Wauwatosa, Wisconsin, or an approved equal.

The bracket shall have a minimum thickness of 12 gauge and shall have **both sides** faced with white, high-intensity reflective sheeting.

**General.** The reflectors shall be spaced 25 feet on center or as directed by the Engineer.

**Basis of Payment.** This work will be paid for at the contract unit price per each for GUARDRAIL *MARKERS.*

---

### **TRAFFIC CONTROL AND PROTECTION**

---

**Construction Requirements.** Traffic control shall be in accordance with the applicable sections of the Standard Specifications, the Supplemental Specifications, the "Illinois Manual on Uniform Traffic Control Devices for Streets and Highways," any special details and Highway Standards contained in the plans, and the Traffic Specifications and the Special Provisions contained herein.

#### **Standard Drawings**

701001, 701006, 701011, 701301, 701311, 701501, 701901  
Traffic Control and Protection for Side Roads, Intersections and Driveways

#### **Standard Specifications, Supplemental Specifications, and Special Provisions**

Maintenance of Roadways  
Construction Zone Traffic Control (LRS 3)  
Work Zone Traffic Control (Section 701)

At the preconstruction meeting, the Contractor shall furnish the name of the individual in his direct employ who is to be responsible for the installation and maintenance of the traffic control for this project. If the actual installation and maintenance are to be accomplished by a subcontractor, consent shall be requested of the Engineer at the time of the preconstruction meeting in accordance with Article 108.01 of the Standard Specifications. This shall not relieve the Contractor of the foregoing requirement for a responsible individual in his direct employ. The City will provide the Contractor the name of its representative who will be responsible for the administration of the traffic control plan.

The Contractor shall notify the City of Woodstock at least 72 hours in advance of beginning work.

Advance construction signing in accordance with the standards listed above shall be furnished and erected prior to the commencement of construction and shall be maintained until the work is complete.

Any drop-offs up to six inches in either the sidewalk or street pavement shall be protected by barricades or other devices satisfactory to the City.

Any drop-offs greater than six inches that are to be left overnight shall be securely fenced.

At times when the work or equipment used in the work encroaches on the travel lane, certified flaggers will be required in accordance with the standards included herein.

City of Woodstock  
South Street  
Section 08-00109-00-RS  
FAU Route 033

South Street shall remain open to traffic at all times. No detour is planned for this project. Closure of one lane will be permitted during working hours with the use of certified flaggers to direct traffic.

To maintain traffic during the construction along the north side of the pavement, the existing pavement markings shall be removed and temporary pavement marking lines placed to create one ten-foot lane in each direction from the south side of the pavement. The pavement marking removal and the temporary pavement marking lines will be paid for separately.

**Method of Measurement.** This item of work will be measured on a lump-sum basis for furnishing, installing, maintaining, relocating, and removing the traffic control devices required in the plans and these Special Provisions.

**Basis of Payment.** This work will be paid for at the contract lump-sum price for TRAFFIC CONTROL AND PROTECTION (SPECIAL), which price shall be payment in full for all labor, materials, transportation, handling, and incidentals necessary to furnish, install, maintain, and remove all traffic control devices indicated in the plans, specifications, or required by the Engineer, as specified herein. The salvage value of the materials removed shall be reflected in the bid price for this item.

**TRAFFIC PROTECTION FOR SIDE ROADS AND INTERSECTIONS**

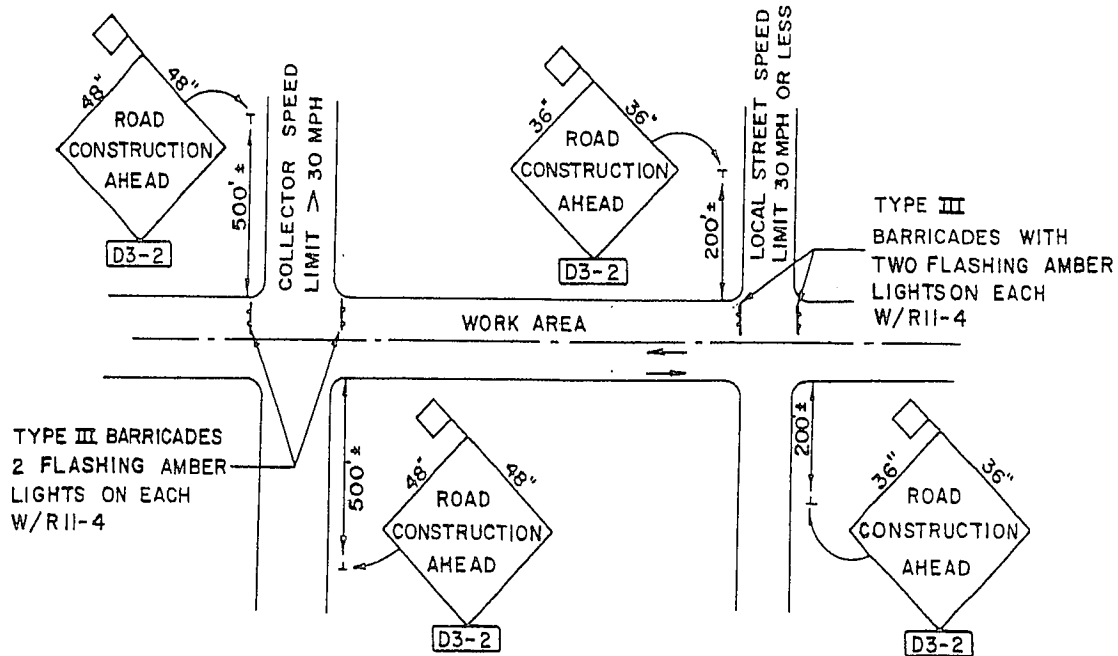

**NOTES**

- A. **FOR A LANE CLOSURE ON A SIDE ROAD:** USE APPLICABLE PORTIONS OF BASIC APPLICATION OF TRAFFIC CONTROL DEVICES (STANDARD 701501). THE SPACING OF SIGN AND BARRICADES SHALL BE ADJUSTED FOR FIELD CONDITIONS AS DIRECTED BY THE ENGINEER.
- B. **FOR NO LANE RESTRICTION ON THE SIDE ROAD:**
  1. **SIDE ROAD WITH A SPEED LIMIT OF 30 M.P.H. OR LESS, AS SHOWN ON THE DRAWING AND AS DIRECTED BY THE ENGINEER:**
    - a. ONE "ROAD CONSTRUCTION AHEAD" SIGN 36" BY 36" WITH A FLASHER AND FLAG MOUNTED ON IT APPROXIMATELY 200 FEET IN ADVANCE OF THE MAIN ROUTE. EACH SIGN SHALL HAVE AN ORANGE FLAG AND AN AMBER FLASHING LIGHT.
    - b. THE CLOSED PORTION OF THE MAIN ROUTE SHOULD BE PROTECTED BY BLOCKING WITH TYPE III BARRICADES, HALF OF THE CROSS SECTION OF THE CLOSED PORTION, PROVIDING TWO FLASHING AMBER LIGHTS ON EACH BARRICADE.
    - c. MOUNTED ON THE POST BELOW THE "ROAD CONSTRUCTION AHEAD" SIGN WILL BE A STREET NAME SIGN (D3-2) INDICATING THE STREET UNDER CONSTRUCTION.
  2. **SIDE ROAD WITH SPEED LIMIT GREATER THAN 30 M.P.H., AS SHOWN ON THE DRAWING AND AS DIRECTED BY THE ENGINEER:**
    - a. ONE "ROAD CONSTRUCTION AHEAD" SIGN 48" BY 48" WITH A FLASHER AND FLAG MOUNTED ON IT APPROXIMATELY 500 FEET IN ADVANCE OF THE MAIN ROUTE. EACH SIGN SHALL HAVE AN ORANGE FLAG AND AN AMBER FLASHING LIGHT.
    - b. THE CLOSED PORTION OF THE MAIN ROUTE SHOULD BE PROTECTED BY BLOCKING WITH TYPE III BARRICADES, HALF OF THE CROSS SECTION OF THE CLOSED PORTION, PROVIDING TWO FLASHING AMBER LIGHTS ON EACH BARRICADE.
    - c. MOUNTED ON THE POST BELOW THE "ROAD CONSTRUCTION AHEAD" SIGN WILL BE A STREET NAME SIGN (D3-2) INDICATING THE STREET UNDER CONSTRUCTION.
    - d. THE TRAFFIC CONTROL AND PROTECTION FOR SIDE ROADS AND INTERSECTIONS WILL BE PAID FOR AT THE CONTRACT LUMP SUM PRICE FOR "TRAFFIC CONTROL AND PROTECTION."

**FINE AGGREGATE FOR HOT-MIX ASPHALT (HMA) (DISTRICT ONE)**

Effective: May 1, 2007

Revise Article 1003.03 (c) of the Standard Specifications to read:

"Gradation. The fine aggregate gradation for all HMA shall be FA1, FA 2, FA 20, or FA 21. When Reclaimed Asphalt Pavement (RAP) is incorporated in the HMA design, the use of FA 21 Gradation will not be permitted.

## HOT MIX ASPHALT – DENSITY TESTING OF LONGITUDINAL JOINTS (D-1)

Effective: January 1, 2007

Revised: January 8, 2009

Description: This work shall consist of testing the density of longitudinal joints as part of the quality control / quality assurance (QC/QA) of hot-mix asphalt (HMA). This work shall be according to Section 1030 of the Standard Specifications except as follows.

### Definitions:

Density Test Location: The station location used for density testing.

Density Test Site: Individual test site where a single density value is determined.

Density Reading: A single, one minute nuclear density reading.

Density Value: The density determined at a given density test site from the average of two "density readings".

### Quality Control / Quality Assurance (QC/QA)

1030.05(d) (3) add the following paragraphs:

Longitudinal joint density testing shall be performed at each random "density test location". Longitudinal joint testing shall be located at a distance equal to the lift thickness, or a minimum of two inches, from each pavement edge. For Example, on a four inch HMA lift the near edge of the nuclear gauge or core barrel shall be within four inches from the edge of pavement. The remaining 3 density test sites shall be equally spaced between the two edge readings. Documentation shall indicate whether the joint was confined or unconfined.

The joint density value shall be determined using either a correlated nuclear gauge or cores. When using a correlated nuclear gauge, two "density readings" shall be taken at the given density test site. The gauge shall be rotated 180 degrees between "density readings". If the two "density readings" are not within 1.5 lb/cu ft (23 kg/cu m) then one additional "density reading" shall be taken. Additional "density readings" taken at a given site shall not be allowed to replace the original "density readings" unless an error has occurred (i.e. the nuclear gauge was sitting on debris).

**Comment [t1]:** You won't need this because there is only one version in the 2008 Manual I combined them to handle both situations.

**Comment [t2]:** Won't need because it is defined above as one minute readings

1030.05(d) (4) Replace the density control limits table with the following:

DENSITY CONTROL LIMITS			
Mixture Composition	Parameter	Individual Test <sup>2/</sup>	Minimum Unconfined Test
IL-9.5, IL-12.5	Ndesign ≥ 90	92.0 – 96.0 %	90.0 %
IL-9.5, IL-9.5L, IL-12.5	Ndesign < 90	92.5 – 97.4 %	90.0 %
IL-19.0, IL-25.0	Ndesign ≥ 90	93.0 – 96.0 %	90.0 %
IL-19.0, IL-19.0L, IL-25.0	Ndesign < 90	93.0 – 97.4 %	90.0 %
All Other	Ndesign = 30	93.0 <sup>1/</sup> - 97.4 %	90.0 %

- 1/ 92.0 % when placed as first lift on an unimproved subgrade.  
2/ "Density values" shall meet the "Individual Test" density control limits specified herein.



## USE OF RAP (DIST 1)

Effective: January 1, 2007

Revised: January 7, 2009

In Article 1030.02(g) of the Standard Specifications, delete the last sentence of the first paragraph in (Note 2).

Revise Section 1031 of the Standard Specifications to read:

### "SECTION 1031. RECLAIMED ASPHALT PAVEMENT

**1031.01 Description.** Reclaimed asphalt pavement (RAP) results from the cold milling or crushing of an existing hot-mix asphalt (HMA) pavement. The Contractor shall supply written documentation that the RAP originated from routes or airfields under federal, state, or local agency jurisdiction. The contractor can also request that a processed pile be tested by the Department to determine the aggregate quality.

**1031.02 Stockpiles.** The Contractor shall construct individual, sealed RAP stockpiles meeting one of the following definitions. No additional RAP shall be added to the pile after the pile has been sealed. Stockpiles shall be sufficiently separated to prevent intermingling at the base. Stockpiles shall be identified by signs indicating the type and size as listed below (i.e. "Homogenous Surface").

Prior to milling or removal of an HMA pavement, the Contractor may request the District to provide verification of the existing mix composition to clarify appropriate stockpile.

- (a) Homogeneous. Homogeneous RAP stockpiles shall consist of RAP from Class I, Superpave (High ESAL), HMA (High ESAL), or equivalent mixtures and represent: 1) the same aggregate quality, but shall be at least C quality; 2) the same type of crushed aggregate (either crushed natural aggregate, ACBF slag, or steel slag); 3) similar gradation; and 4) similar asphalt binder content. If approved by the Engineer, combined single pass surface/binder millings may be considered "homogenous" with a quality rating dictated by the lowest coarse aggregate quality present in the mixture.
- (b) Conglomerate 5/8. Conglomerate 5/8 RAP stockpiles shall consist of RAP from Class I, Superpave (High ESAL), HMA (High ESAL), or equivalent mixtures. The coarse aggregate in this RAP shall be crushed aggregate and may represent more than one aggregate type and/or quality but shall be at least C quality. This RAP may have an inconsistent gradation and/or asphalt binder content prior to processing. All conglomerate 5/8 RAP shall be processed prior to testing by crushing to where all RAP shall pass the 5/8 in. (16 mm) or smaller screen. Conglomerate 5/8 RAP stockpiles shall not contain steel slag or other expansive material as determined by the Department.
- (c) Conglomerate 3/8. Conglomerate 3/8 RAP stockpiles shall consist of RAP from Class I, Superpave (High ESAL), HMA (High ESAL), or equivalent mixtures. The coarse aggregate in this RAP shall be crushed aggregate and may represent more than one aggregate type and/or

quality but shall be at least B quality. This RAP may have an inconsistent gradation and/or asphalt binder content prior to processing. All conglomerate 3/8 RAP shall be processed prior to testing by crushing to where all RAP shall pass the 3/8 in (9.5 mm) or smaller screen. Conglomerate 3/8 RAP stockpiles shall not contain steel slag or other expansive material as determined by the Department.

- (d) Conglomerate Variable Size. Conglomerate variable size RAP shall consist of RAP from Class I, Superpave (High ESAL), HMA (High ESAL), or equivalent mixtures. The coarse aggregate in this RAP shall be crushed aggregate and may represent more than one aggregate type and/or quality but shall be at least B quality. This RAP may have an inconsistent gradation and/or asphalt binder content prior to processing. All conglomerate variable size RAP shall be processed prior to testing by crushing and screening to where all RAP is separated into various sizes. All the conglomerate variable size RAP shall pass the 3/4 in. (19 mm) screen and shall be a minimum of two sizes. Conglomerate variable size RAP stockpiles shall not contain steel slag or other expensive material as determined by the Department.
- (e) Conglomerate "D" Quality (DQ). Conglomerate DQ RAP stockpiles shall consist of RAP from Class I, Superpave (High or Low ESAL), HMA (High or Low Esal), or equivalent mixtures. The coarse aggregate in this RAP may be crushed or round but shall be at least D quality. This RAP may have an inconsistent gradation and/or asphalt binder content. Conglomerate DQ Rap stockpiles shall not contain steel slag or other expansive material as determined by the Department.
- (f) Non-Quality. RAP stockpiles that do not meet the requirements of the stockpile categories listed above shall be classified as "Non-Quality".

RAP containing contaminants, such as earth, brick, sand, concrete, sheet asphalt, bituminous surface treatment (i.e. chip seal), pavement fabric, joint sealants, etc., will be unacceptable unless the contaminants are removed to the satisfaction of the Engineer. Sheet asphalt shall be stockpiled separately.

**1031.03 Testing.** When used in HMA, the RAP shall be sampled and tested either during or after stockpiling.

For testing during stockpiling, washed extraction samples shall be run at the minimum frequency of one sample per 500 tons (450 metric tons) for the first 2000 tons (1800 metric tons) and one sample per 2000 tons (1800 metric tons) thereafter. A minimum of five tests shall be required for stockpiles less than 4000 tons (3600 metric tons).

For testing after stockpiling, the Contractor shall submit a plan for approval to the District proposing a satisfactory method of sampling and testing the RAP pile either in-situ or by restockpiling. The sampling plan shall meet the minimum frequency required above and detail the procedure used to obtain representative samples throughout the pile for testing.

Before extraction, each field sample shall be split to obtain two samples of test sample size. One of the two test samples from the final split shall be labeled and stored for Department use. The Contractor shall extract the other

test sample according to Department procedure. The Engineer reserves the right to test any sample (split or Department-taken) to verify Contractor test results.

- (a) Testing Conglomerate 3/8 and Conglomerate Variable Size. In addition to the requirements above, conglomerate 3/8 and variable size RAP shall be tested for maximum theoretical specific gravity ( $G_{mm}$ ) at a frequency of one sample per 500 tons (450 metric tons) for the first 2000 tons (1800 metric tons) and one sample per 2000 tons (1800 metric tons) thereafter. A minimum of five tests shall be required for stockpiles less than 4000 tons (3600 metric tons).
- (b) Evaluation of Test Results. All of the extraction results shall be compiled and averaged for asphalt binder content and gradation and, when applicable  $G_{mm}$ . Individual extraction test results, when compared to the averages, will be accepted if within the tolerances listed below.

Parameter	Homogeneous/ Conglomerate	Conglomerate "D" Quality
1 in. (25 mm)		± 5 %
3/4 in. (19mm)		
1/2 in. (12.5mm)	± 8 %	± 15 %
No. 4 (4.75 mm)	± 6 %	± 13 %
No. 8 (2.36 mm)	±5 %	
No. 16 (1.18 mm)		± 15 %
No. 30 (600 μm)	± 5. %	
No. 200 (75 μm)	± 2.0 %	± 4.0 %
Asphalt Binder	± 0.4 % <sup>1/</sup>	± 0.5 %
$G_{mm}$	±0.02 % <sup>2/</sup>	
$G_{mm}$	±0.03 % <sup>3/</sup>	

- 1/ The tolerance for conglomerate 3/8 shall be ± 0.3 %.
- 2/ Applies only to conglomerate 3/8. When variation of the  $G_{mm}$  exceeds the ± 0.02 % tolerance, a new conglomerate 3/8 stockpile shall be created which will also require an additional mix design.
- 3/ Applies only to conglomerate variable size. When variation of the  $G_{mm}$  exceeds the ± 0.03 tolerance, a new conglomerate variable size stockpile shall be created which will also require an additional mix design.

If more than 20 percent of the individual sieves are out of the gradation tolerances, or if more than 20 percent of the asphalt binder content test results fall outside the appropriate tolerances, the RAP shall not be used in HMA unless the RAP representing the failing tests is removed from the stockpile. All test data and acceptance ranges shall be sent to the District for evaluation.

With the approval of the Engineer, the ignition oven may be substituted for extractions according to the Illinois Test Procedure, "Calibration of the

Ignition Oven for the Purpose of Characterizing Reclaimed Asphalt Pavement (RAP)".

**1031.04 Quality Designation of Aggregate in RAP.** The quality of the RAP shall be set by the lowest quality of coarse aggregate in the RAP stockpile and are designated as follows.

- (a) RAP from Class I, Superpave (High ESAL), or HMA (High ESAL) surface mixtures are designated as containing Class B quality coarse aggregate.
- (b) RAP from Superpave (Low ESAL)/HMA (Low ESAL) IL-19.0L binder and IL-9.5L surface mixtures are designated as Class D quality coarse aggregate.
- (c) RAP from Class I, Superpave (High ESAL), or HMA (High ESAL) binder mixtures, bituminous base course mixtures, and bituminous base course widening mixtures are designated as containing Class C quality coarse aggregate.
- (d) RAP from bituminous stabilized subbase and BAM shoulders are designated as containing Class D quality coarse aggregate.

**1031.05 Use of RAP in HMA.** The use of RAP in HMA shall be as follows.

- (a) Coarse Aggregate Size. The coarse aggregate in all RAP shall be equal to or less than the nominal maximum size requirement for the HMA mixture to be produced.
- (b) Steel Slag Stockpiles. RAP stockpiles containing steel slag or other expansive material, as determined by the Department, shall be homogeneous and will be approved for use in HMA (High ESAL and Low ESAL) surface mixtures only.
- (c) Use in HMA Surface Mixtures (High and Low ESAL). RAP stockpiles for use in HMA surface mixtures (High and Low ESAL) shall be either homogeneous or conglomerate 3/8 or variable size in which the coarse aggregate is Class B quality or better.
- (d) Use in HMA Binder Mixtures (High and Low ESAL), HMA Base Course, and HMA Base Course Widening. RAP stockpiles for use in HMA binder mixtures (High and Low ESAL), HMA base course, and HMA base course widening shall be homogeneous, conglomerate 5/8, or conglomerate 3/8, conglomerate variable size, in which the coarse aggregate is Class C quality or better.
- (e) Use in Shoulders and Subbase. RAP stockpiles for use in HMA shoulders and stabilized subbase (HMA) shall be homogeneous, conglomerate 5/8, conglomerate 3/8, conglomerate variable size, or conglomerate DQ.
- (f) The use of RAP shall be a contractor's option when constructing HMA in all contracts. When the contractor chooses the RAP option, the percentage of RAP shall not exceed the amounts indicated in the table for a given N Design.

Max Mix Rap Percentage

HMA Mixtures <sup>1/ 3/</sup>		Maximum % Rap	
Ndesign	Binder/Leveling Binder	Surface	Polymer Modified
30	30/40 <sup>2/</sup>	30	10
50	25/40 <sup>2/</sup>	15/25 <sup>2/</sup>	10
70	25/30 <sup>2/</sup>	10/20 <sup>2/</sup>	10
90	10/15 <sup>2/</sup>	10/15 <sup>2/</sup>	10
105	10/15 <sup>2/</sup>	10/15 <sup>2/</sup>	10

- 1/ For HMA Shoulder and Stabilized Sub-Base (HMA) N-30, the amount of RAP shall not exceed 50% of the mixture.
- 2/ Value of Max % RAP If 3/8 Rap or conglomerate variable size RAP is utilized.
- 3/ When RAP exceeds 20% the AC shall be PG58-22. However, when RAP exceeds 20% and is used in full depth HMA pavement the AC shall be PG58-28.

**1031.06 HMA Mix Designs.** At the Contractor's option, HMA mixtures may be constructed utilizing RAP material meeting the above detailed requirements.

RAP designs shall be submitted for volumetric verification. If additional RAP stockpiles are tested and found that no more than 20 percent of the results, as defined under "Testing" herein, are outside of the control tolerances set for the original RAP stockpile and HMA mix design, and meets all of the requirements herein, the additional RAP stockpiles may be used in the original mix design at the percent previously verified.

**1031.07 HMA Production.** The coarse aggregate in all RAP used shall be equal to or less than the nominal maximum size requirement for the HMA mixture being produced.

To remove or reduce agglomerated material, a scalping screen, crushing unit, or comparable sizing device approved by the Engineer shall be used in the RAP feed system to remove or reduce oversized material. If material passing the sizing device adversely affects the mix production or quality of the mix, the sizing device shall be set at a size specified by the Engineer.

If the RAP control tolerances or QC/QA test results require corrective action, the Contractor shall cease production of the mixture containing RAP and either switch to the virgin aggregate design or submit a new RAP design. When producing mixtures containing conglomerate 3/8 or conglomerate variable size RAP, a positive dust control system shall be utilized.

HMA plants utilizing RAP shall be capable of automatically recording and printing the following information.

- (a) Drier Drum Plants

- (1) Date, month, year, and time to the nearest minute for each print.
- (2) HMA Mix number assigned by the Department
- (3) Accumulated weight of dry aggregate (combined or individual) in tons (metric tons) Accumulated weight of dry aggregate (combined or individual) in tons (metric tons) to the nearest 0.1 ton (0.1 metric ton)
- (4) Accumulated dry weight of RAP in tons (metric tons) to the nearest 0.1 ton (0.1 metric ton)
- (5) Accumulated mineral filler in revolutions, tons (metric tons), etc. to the nearest 0.1 unit.
- (6) Accumulated asphalt binder in gallons (liters), tons (metric tons), etc. to the nearest 0.1 unit.
- (7) Residual asphalt binder in the RAP material (per size) as a percent of the total mix to the nearest 0.1 unit.
- (8) Aggregate and RAP moisture compensators in percent as set on the control panel (Required when accumulated or individual aggregate and RAP are printed in wet condition).

(b) Batch Plants

- (1) Date, month, year, and time to the nearest minute for each print.
- (2) HMA mix number assigned by the Department.
- (3) Individual virgin aggregate hot bin batch weights to the nearest pound (kilogram)
- (4) Mineral filler weight to the nearest pound (kilogram).
- (5) Individual RAP Aggregate weight to the nearest pound (kilogram).
- (6) Virgin asphalt binder weight to the nearest pound (kilogram)
- (7) Residual asphalt binder of each RAP size material as a percent of the total mix to the nearest 0.1 percent.

The printouts shall be maintained in a file at the plant for a minimum of one year or as directed by the Engineer and shall be made available upon request. The printing system will be inspected by the Engineer prior to production and verified at the beginning of each construction season thereafter.

**1031.08 RAP in Aggregate Surface Course and Aggregate Shoulders.**  
The use of RAP in aggregate surface course and aggregate shoulders shall be as follows.

- (a) Stockpiles and Testing. RAP stockpiles may be any of those listed in Article 1031.02, except "Other". The testing requirements of Article 1031.03 shall not apply.
- (b) Gradation. One hundred percent of the RAP material shall pass the 1 1/2 in. (37.5 mm) sieve. The RAP material shall be reasonably well graded from coarse to fine. RAP material that is gap-graded or single sized will not be accepted."

S:\WP\MEL\MG 080609a USE of RAP.doc

**TEMPERATURE CONTROL FOR CONCRETE PLACEMENT (DISTRICT ONE)**

Effective: May 1, 2007

Delete the second and third sentences of the second paragraph of Article 1020.14(a) of the Standard Specifications.





Route F.A.U. 033
Section 80-00109-00-RS
County McHenry

Marked Rt. South Street
Project No. M-9003(182)
Contract No.

This plan has been prepared to comply with the provisions of the NPDES Permit Number ILR10, issued by the Illinois Environmental Protection Agency on May 30, 2003 for storm water discharges from Construction Site Activities. This plan has also been prepared to comply with the provisions of NPDES Permit Number ILR40 for discharges from small municipal separate storm sewer systems if checked below.

NPDES permits associated with this project:

- ILR10 Permit No. (if applicable):
ILR40 Permit No. (if applicable):

I certify under penalty of law that this document and all attachments were prepared under my direction or supervision in accordance with a system designed to assure that qualified personnel properly gathered and evaluated the information submitted. Based on my inquiry of the person or persons who manage the system, or those persons directly responsible for gathering the information, the information submitted is, to the best of my knowledge and belief, true, accurate and complete. I am aware that there are significant penalties for submitting false information, including the possibility of fine and imprisonment for knowing violations.

Mark A. Stott, P.E.
Print Name
Vice President
Title
Hampton, Lenzini and Renwick, Inc
Agency

Mark A. Stott
Signature
APRIL 10, 2009
Date

I. Site Description:

A. The following is a description of the project location:

The project is located on South Street from Moraine Drive to Tara Drive in the City of Woodstock.

B. The following is a description of the construction activity which is the subject of this plan:

Construction will include the resurfacing of South Street, construction of a curb and gutter and sidewalk along the north side, storm sewers, drainage structures, and appurtenant work necessary to complete the project as shown in the plans.

C. The following is a description of the intended sequence of major activities which will disturb soils for major portions of the construction site, such as grubbing, excavation, and grading:

Excavation and grading for curb and gutter and sidewalk will be performed.

D. The total area of the construction site is estimated to be 2.9 acres.

The total area of the site that is estimated will be disturbed by excavation, grading or other activities is 1.1 acres.

E. The following is a weighted average of the runoff coefficient for this project after construction activities are completed:

0.83

- F. The following is a description of the soil types found at the project site followed by information regarding their erosivity:

The soils map for McHenry County shows the majority of the native soil to be McHenry silt loam. Erosion of this soil is a problem on steep slopes if not controlled. The area near the bridge is fill material of unknown source.

- G. The following is a description of potentially erosive areas associated with this project:

The existing slopes near the bridge are 2:1 where grading will occur.

- H. The following is a description of soil disturbing activities, their locations, and their erosive factors (e.g. steepness of slopes, length of slopes, etc):

The grading for the sidewalk will disturb parts of the 2:1 slopes.

- I. See the erosion control plans and/or drainage plans for this contract for information regarding drainage patterns, approximate slopes anticipated before and after major grading activities, locations where vehicles enter or exit the site and controls to prevent offsite sediment tracking (to be added after contractor identifies locations), areas of soil disturbance, the location of major structural and non-structural controls identified in the plan, the location of areas where stabilization practices are expected to occur, surface waters (including wetlands) and locations where storm water is discharged to surface water including wetlands.

- J. The following is a list of receiving water(s) and the ultimate receiving water(s), and areal extent of wetland acreage at the site. The location of the receiving waters can be found on the erosion and sediment control plans:

The receiving water from this project is Franklinville Creek.

- K. The following pollutants of concern will be associated with this construction project:

- |   |  |
|---|--|
| <input checked="" type="checkbox"/> Soil Sediment             | <input checked="" type="checkbox"/> Petroleum (gas, diesel, oil, kerosene, hydraulic oil / fluids) |
| <input checked="" type="checkbox"/> Concrete                  | <input checked="" type="checkbox"/> Antifreeze / Coolants  |
| <input checked="" type="checkbox"/> Concrete Truck Waste      | <input checked="" type="checkbox"/> Waste water from cleaning construction equipment               |
| <input checked="" type="checkbox"/> Concrete Curing Compounds | <input type="checkbox"/> Other (specify)   |
| <input checked="" type="checkbox"/> Solid Waste Debris        | <input type="checkbox"/> Other (specify)   |
| <input type="checkbox"/> Paints                               | <input type="checkbox"/> Other (specify)   |
| <input type="checkbox"/> Solvents                             | <input type="checkbox"/> Other (specify)   |
| <input type="checkbox"/> Fertilizers / Pesticides             | <input type="checkbox"/> Other (specify)   |

## II. Controls:

This section of the plan addresses the controls that will be implemented for each of the major construction activities described in I.C. above and for all use areas, borrow sites, and waste sites. For each measure discussed, the contractor will be responsible for its implementation as indicated. The contractor shall provide to the resident engineer a plan for the implementation of the measures indicated. The contractor, and subcontractors, will notify the resident engineer of any proposed changes, maintenance, or modifications to keep construction activities compliant with the permit. Each such contractor has signed the required certification on forms which are attached to, and are a part of, this plan:

### A. Erosion and Sediment Controls

1. **Stabilized Practices:** Provided below is a description of interim and permanent stabilization practices, including site specific scheduling of the implementation of the practices. Site plans will ensure that existing vegetation is preserved where attainable and disturbed portions of the site will be stabilized. Stabilization practices may include but are not limited to: temporary seeding, permanent seeding, mulching, geotextiles, sodding, vegetative buffer strips, protection of trees, preservation of mature vegetation, and other appropriate measures. Except as provided below in II.A.1.a. and II.A.3., stabilization measures shall be initiated as soon as practicable in portions of the site where construction activities have temporarily or permanently ceased, but in no case more than 14 days after the construction activity in that portion of the site has temporarily or permanently ceases on all disturbed portions of the site where construction will not occur for a period of 21 or more calendar days.

- a. Where the initiation of stabilization measures by the 14<sup>th</sup> day after construction activity temporarily or permanently ceases is precluded by snow cover, stabilization measures shall be initiated as soon as practicable thereafter.

The following Stabilization Practices will be used for this project:

- |   |  |
|---|--|
| <input checked="" type="checkbox"/> Preservation of Mature Vegetation | <input checked="" type="checkbox"/> Erosion Control Blanket / Mulching |
| <input type="checkbox"/> Vegetated Buffer Strips                      | <input type="checkbox"/> Sodding                                       |
| <input type="checkbox"/> Protection of Trees                          | <input type="checkbox"/> Geotextiles                                   |
| <input type="checkbox"/> Temporary Erosion Control Seeding            | <input type="checkbox"/> Other (specify)                               |
| <input type="checkbox"/> Temporary Turf (Seeding, Class 7)            | <input type="checkbox"/> Other (specify)                               |
| <input type="checkbox"/> Temporary Mulching                           | <input type="checkbox"/> Other (specify)                               |
| <input checked="" type="checkbox"/> Permanent Seeding                 | <input type="checkbox"/> Other (specify)                               |

Describe how the Stabilization Practices listed above will be utilized:

- (1) Preservation of Mature Vegetation: To the extent possible, as much of the existing grass cover on the slopes by the bridge will be maintained during construction.
- (2) Permanent Seeding: As areas are completed, Seeding Class 1B will be installed per IDOT specifications.
- (3) Erosion Control Blanket: After seeding, Erosion Control Blanket will be installed per IDOT specifications.

- 2. Structural Practices:** Provided below is a description of structural practices that will be implemented, to the degree attainable, to divert flows from exposed soils, store flows or otherwise limit runoff and the discharge of pollutants from exposed areas of the site. Such practices may include but are not limited to: perimeter erosion barrier, earth dikes, drainage swales, sediment traps, ditch checks, subsurface drains, pipe slope drains, level spreaders, storm drain inlet protection, rock outlet protection, reinforced soil retaining systems, gabions, and temporary or permanent sediment basins. The installation of these devices may be subject to Section 404 of the Clean Water Act.

The following Structural Practices will be used for this project:

- |  |  |
|--|--|
| <input checked="" type="checkbox"/> Perimeter Erosion Barrier    | <input type="checkbox"/> Rock Outlet Protection  |
| <input type="checkbox"/> Temporary Ditch Check                   | <input type="checkbox"/> Riprap                  |
| <input checked="" type="checkbox"/> Storm Drain Inlet Protection | <input type="checkbox"/> Gabions                 |
| <input type="checkbox"/> Sediment Trap                           | <input type="checkbox"/> Slope Mattress          |
| <input type="checkbox"/> Temporary Pipe Slope Drain              | <input type="checkbox"/> Retaining Walls         |
| <input type="checkbox"/> Temporary Sediment Basin                | <input type="checkbox"/> Slope Walls             |
| <input type="checkbox"/> Temporary Stream Crossing               | <input type="checkbox"/> Concrete Revetment Mats |
| <input type="checkbox"/> Stabilized Construction Exits           | <input type="checkbox"/> Level Spreaders         |
| <input type="checkbox"/> Turf Reinforcement Mats                 | <input type="checkbox"/> Other (specify)         |
| <input type="checkbox"/> Permanent Check Dams                    | <input type="checkbox"/> Other (specify)         |
| <input type="checkbox"/> Permanent Sediment Basin                | <input type="checkbox"/> Other (specify)         |
| <input type="checkbox"/> Aggregate Ditch                         | <input type="checkbox"/> Other (specify)         |
| <input type="checkbox"/> Paved Ditch                             | <input type="checkbox"/> Other (specify)         |

Describe how the Structural Practices listed above will be utilized:

- a. Perimeter Erosion Barrier: Silt fence will be placed along the right-of-way or as necessary for areas that slope away from the roadway.
  - b. Storm Drain Inlet Protection: Sediment Filters will be placed in all inlets, catch basins and manholes during construction and will be cleaned on a regular basis.
- 3. Storm Water Management:** Provided below is a description of measures that will be installed during the construction process to control pollutants in storm water discharges that will occur after construction operations have been completed. The installation of these devices may be subject to Section 404 of the Clean Water Act.
- a. Such practices may include but are not limited to: storm water detention structures (including wet ponds), storm water retention structures, flow attenuation by use of open vegetated swales and natural depressions, infiltration of runoff on site, and sequential systems (which combine several practices).

The practices selected for implementation were determined on the basis of the technical guidance in Section 59-8 (Erosion and Sediment Control) in Chapter 59 (Landscape Design and Erosion Control) of the Illinois Department of Transportation Bureau of Design and Environment Manual. If practices other than those discussed in Section 59-8 are selected for implementation or if practices are applied to situations different from those covered in Section 59-8, the technical basis for such decisions will be explained below.

- b. Velocity dissipation devices will be placed at discharge locations and along the length of any outfall channel as necessary to provide a non-erosive velocity flow from the structure to a water course so that the natural physical and biological characteristics and functions are maintained and protected (e.g., maintenance of hydrologic conditions such as the hydroperiod and hydrodynamics present prior to the initiation of construction activities).

#### Description of Storm Water Management Controls.

The storm water runoff will continue to drain into the open vegetated swales and natural depressions that existed prior to construction.

#### 4. Other Controls:

- a. Vehicle Entrances and Exits – Stabilized construction entrances and exits must be constructed to prevent tracking of sediments onto roadways.

The contractor will provide the resident engineer with a written plan identifying the location of stabilized entrances and exits and the procedures (s)he will use to construct and maintain them.

- b. Material Delivery, Storage, and Use – The following BMPs shall be implemented to help prevent discharges of construction materials during delivery, storage, and use:
  - All products delivered to the project site must be properly labeled.
  - Water tight shipping containers and/or semi trailers shall be used to store hand tools, small parts, and most construction materials that can be carried by hand, such as paint cans, solvents, and grease.
  - A storage/containment facility should be chosen for larger items such as drums and items shipped or stored on pallets. Such material is to be covered by a tin roof or large sheets of plastic to prevent precipitation from coming in contact with the products being stored.
  - Large items such as light stands, framing materials, and lumber shall be stored in the open in a general storage area. Such material shall be elevated with wood blocks to minimize contact with storm water runoff.
  - Spill clean-up materials, material safety data sheets, an inventory of materials, and emergency contact numbers shall be maintained and stored in one designated area, and each Contractor is to inform his/her employees and the resident engineer of this location.
- c. Stockpile Management – BMPs shall be implemented to reduce or eliminate pollution of storm water from stockpiles of soil and paving materials such as but not limited to portland cement concrete rubble, asphalt concrete, asphalt concrete rubble, aggregate base, aggregate subbase, and pre-mixed aggregate. The following BMPs may be considered:
  - Perimeter Erosion Barrier
  - Temporary Seeding
  - Temporary Mulch
  - Plastic Covers
  - Soil Binders
  - Storm Drain Inlet Protection

The contractor will provide the resident engineer with a written plan of the procedures (s)he will use on the project and how they will be maintained.

- d. Waste Disposal. No materials, including building materials, shall be discharged into Waters of the State, except as authorized by a Section 404 permit.
- e. The provisions of this plan shall ensure and demonstrate compliance with applicable State and/or local waste disposal, sanitary sewer or septic system regulations.
- f. The contractor shall provide a written and graphic plan to the resident engineer identifying where each of the above areas will be located and how they are to be managed.

## 5. Approved State or Local Laws

The management practices, controls and provisions contained in this plan will be in accordance with IDOT specifications, which are at least as protective as the requirements contained in the Illinois Environmental Protection Agency's Illinois Urban Manual, 1995. Procedures and requirements specified in applicable sediment and erosion site plans or storm water management plans approved by local officials shall be described or incorporated by reference in the space provided below. Requirements specified in sediment and erosion site plans, site permits, storm water management site plans or site permits approved by local officials that are applicable to protecting surface water resources are, upon submittal of an NOI, to be authorized to discharge under permit ILR10 incorporated by reference and are enforceable under this permit even if they are not specifically included in the plan.

Description of procedures and requirements specified in applicable sediment and erosion site plans or storm water management plans approved by local officials:

All management practices, controls, and other provisions provided in this plan are in accordance with "IDOT Standard Specifications for Road and Bridge Construction and the Illinois Urban Manual".

### III. Maintenance:

The following is a description of procedures that will be used to maintain, in good and effective operating conditions, the vegetation, erosion and sediment control measures and other protective measures identified in this plan. The resident engineer will provide maintenance guides to the contractor for the practices associated with this project.

- A. Perimeter Erosion Barrier: Sediment will be removed if the integrity of the fencing is in jeopardy and any fencing that is knocked down or damaged will be repaired immediately.
- B. Storm Drain Inlet Protection: Sediment will be removed on a regular basis and damaged inlet filters will be repaired or replaced.

### IV. Inspections:

Qualified personnel shall inspect disturbed areas of the construction site which have not yet been finally stabilized, structural control measures, and locations where vehicles and equipment enter and exit the site. Such inspections shall be conducted at least once every seven (7) calendar days and within 24 hours of the end of a storm that is 0.5 inch or greater or equivalent snowfall.

- A. Disturbed areas, use areas (storage of materials, stockpiles, machine maintenance, fueling, etc.), borrow sites, and waste sites shall be inspected for evidence of, or the potential for, pollutants entering the drainage system. Erosion and sediment control measures identified in the plan shall be observed to ensure that they are operating correctly. Discharge locations or points that are accessible shall be inspected to ascertain whether erosion control measures are effective in preventing significant impacts to receiving waters. Locations where vehicles enter or exit the site shall be inspected for evidence of off-site sediment tracking.
- B. Based on the results of the inspection, the description of potential pollutant sources identified in Section I above and pollution prevention measures identified in Section II above shall be revised as appropriate as soon as practicable after such inspection. Any changes to this plan resulting from the required inspections shall be implemented within ½ hour to 1 week, based on the urgency of the situation. The resident engineer will notify the contractor of the time required to implement such actions through the weekly inspection report.
- C. A report summarizing the scope of the inspection, name(s) and qualifications of personnel making the inspection, the date(s) of the inspection, major observations relating to the implementation of this storm water pollution prevention plan, and actions taken in accordance with Section IV. B. shall be made and retained as part of the plan for at least three (3) years after the date of the inspection. The report shall be signed in accordance with Part VI. G of the general permit.
- D. If any violation of the provisions of this plan is identified during the conduct of the construction work covered by this plan, the resident engineer shall complete and file an "Incidence of Noncompliance" (ION) report for the identified violation. The resident engineer shall use forms provided by the Illinois Environmental Protection Agency and shall include specific information on the cause of noncompliance, actions which were taken to prevent any further causes of noncompliance, and a statement detailing any environmental impact which may have resulted from the noncompliance. All reports of noncompliance shall be signed by a responsible authority in accordance with Part VI. G. of the general permit.

The Incidence of Non-Compliance shall be mailed to the following address:

Illinois Environmental Protection Agency  
Division of Water Pollution Control  
Attn: Compliance Assurance Section  
1021 North Grand East  
Post Office Box 19276  
Springfield, Illinois 62794-9276

#### V. Non-Storm Water Discharges:

Except for flows from fire fighting activities, sources of non-storm water that is combined with storm water discharges associated with the industrial activity addressed in this plan must be described below. Appropriate pollution prevention measures, as described below, will be implemented for the non-storm water component(s) of the discharge.

- A. Spill Prevention and Control – BMPs shall be implemented to contain and clean-up spills and prevent material discharges to the storm drain system. The contractor shall produce a written plan stating how his/her company will prevent, report, and clean up spills and provide a copy to all of his/her employees and the resident engineer. The contractor shall notify all of his/her employees on the proper protocol for reporting spills. The contractor shall notify the resident engineer of any spills immediately.
- B. Concrete Residuals and Washout Wastes – The following BMPs shall be implemented to control residual concrete, concrete sediments, and rinse water:
  - Temporary Concrete Washout Facilities shall be constructed for rinsing out concrete trucks. Signs shall be installed directing concrete truck drivers where designated washout facilities are located.
  - The contractor shall have the location of temporary concrete washout facilities approved by the resident engineer.
  - All temporary concrete washout facilities are to be inspected by the contractor after each use and all spills must be reported to the resident engineer and cleaned up immediately.
  - Concrete waste solids/liquids shall be disposed of properly.
- C. Litter Management – A proper number of dumpsters shall be provided on site to handle debris and litter associated with the project. The Contractor is responsible for ensuring his/her employees place all litter including marking paint cans, soda cans, food wrappers, wood lathe, marking ribbon, construction string, and all other construction related litter in the proper dumpsters.
- D. Vehicle and Equipment Cleaning – Vehicles and equipment are to be cleaned in designated areas only, preferably off site.
- E. Vehicle and Equipment Fueling – A variety of BMPs can be implemented during fueling of vehicles and equipment to prevent pollution. The contractor shall inform the resident engineer as to which BMPs will be used on the project. The contractor shall inform the resident engineer how (s)he will be informing his/her employees of these BMPs (i.e., signs, training, etc.). Below are a few examples of these BMPs:
  - Containment
  - Spill Prevention and Control
  - Use of Drip Pans and Absorbents
  - Automatic Shut-Off Nozzles
  - Topping-Off Restrictions
  - Leak Inspection and Repair
- F. Vehicle and Equipment Maintenance – On-site maintenance must be performed in accordance with all environmental laws such as proper storage and no dumping of old engine oil or other fluids on site.

#### VI. Failure to Comply:

Failure to comply with any provisions of this Storm Water Pollution Prevention Plan will result in the implementation of an Erosion and Sediment Control Deficiency Deduction against the contractor and/or penalties under the NPDES permit which could be passed onto the contractor.



The Resident Engineer is to make copies of this form and every contractor and sub-contractor will be required to complete their own separate form.

This certification statement is part of the Storm Water Pollution Prevention Plan for the project described below, in accordance with General NPDES Permit No. ILR10 issued by the Illinois Environmental Protection Agency.

Route	<u>F.A.U. 033</u>	Marked Route	<u>South Street</u>
Section	<u>08-00109-00-RS</u>	Project No.	<u>M-9003(182)</u>
County	<u>McHenry</u>	Contract No.	<u></u>

I certify under penalty of law that I understand the terms of the general National Pollutant Discharge Elimination System (NPDES) permit (ILR 10) that authorizes the storm water discharges associated with industrial activity from the construction site identified as part of this certification. I have read and understand all of the information and requirements stated in the Storm Water Pollution Prevention Plan for the above mentioned project. I have provided all documentation required to be in compliance with the ILR10 and Storm Water Pollution Prevention Plan and will provide timely updates to these documents as necessary.

- Contractor
- Sub-Contractor

\_\_\_\_\_  
Print Name

\_\_\_\_\_  
Title

\_\_\_\_\_  
Name of Firm

\_\_\_\_\_  
Street Address

\_\_\_\_\_  
Signature

\_\_\_\_\_  
Date

\_\_\_\_\_  
Telephone

\_\_\_\_\_  
City/State/ZIP

TYPE OF STRUCTURE	LOCATION	FRAME	LID AND GRATE
Manhole	Street or paved surface	1050	Solid cover marked with STORM or SANITARY
Water Valve Manhole	Street or paved surface	1050	Solid cover marked with WATER
Manhole	Parkway or yard	1022	Solid cover marked with STORM or SANITARY
Water Valve Manhole	Parkway or yard	1022	Solid cover marked with WATER
Storm Sewer Inlet	Curb	7000	Type I with Type 3 or 4 grate
Storm Sewer Inlet	Street or paved surface	1050	Type M1
Storm Sewer Inlet	Depressed curb at driveway or sidewalk	7000	Type M3 or Type 2
Storm Sewer Inlet	Ditch	1022	Type M1
Manhole	Ditch	1022	Solid with 'O' ring

ALL CASTINGS MUST BE EAST JORDAN IRON WORKS OR APPROVED EQUALS.

FRAMES AND GRATES

**CITY OF WOODSTOCK**



**1020 FRAME & COVER**

Heavy duty  
Machined bearing surfaces

- Options:  
Solid, vented or custom logo covers  
Special lettered covers  
Watertite assembly  
Adjusting risers  
Gasket seal covers  
Stackable frames

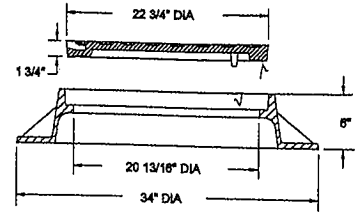
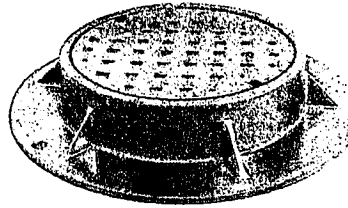

TYPE A Solid Cover

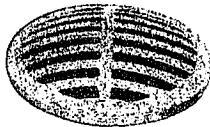

TYPE N Oval Grate  
Height above frame 2 1/2"  
Approx. 135 sq. in. open area



TYPE M1 Radial Flat Grate  
Approx. 120 sq. in. open area  
"DUMP NO WASTE!" lettering  
and trout image

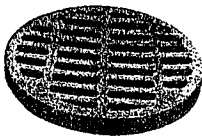

TYPE P Concave Grate  
Depth of concave 5/8"  
Approx. 150 sq. in. open area

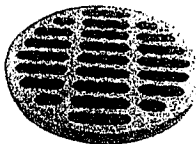

TYPE M2 Flat Bar Grate  
Approx. 150 sq. in. open area

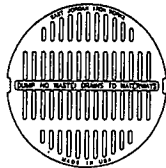

TYPE M3 ADA Grate  
Approx. 120 sq. in. open area  
"DUMP NO WASTE!" lettering

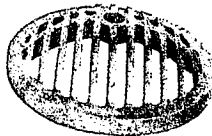

TYPE 01 Beehive Grate  
Height above frame 4"  
Approx. 115 sq. in. open area

TYPE 02 Beehive Grate 7" ht.  
TYPE 03 Beehive Grate 9" ht.

All 1020 covers and grates can be used with the following frames.

Catalog Number	Base Flange Diameter	Frame Height
1037	34	4
1885*	32 1/2	4
1077	36	4
2995	34	4
2996***	34 TF	4 1/2
1020	34	6
1022-1	34	7
1022-2	34	7
1022-3	36	7
1076**	36	7
1550	34	8
1051	34	9
1050Z1	34	9
1050	36	9

\*Special lock bar and mud ring (security)

\*\*Special non-rocking feature

\*\*\*Frame is reversible, can be installed as top flange

Note: All dimensions are in inches.

**1050 FRAME & COVER**

Heavy duty  
Machined bearing surfaces  
Accepts 1020 covers and grates

- Options:  
Solid and vented covers  
Custom logo covers  
Special lettered covers  
Watertite assembly  
Adjusting risers  
Stacking frame

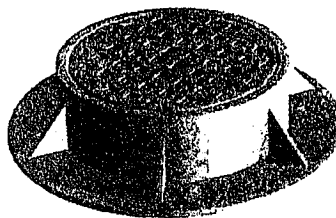

Light weight stacking frame shown.

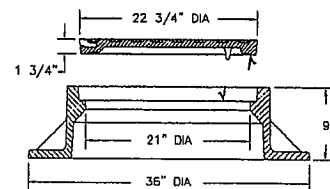

# 7000 CATCH BASIN CURB INLET

Heavy duty  
 With TYPE M1 grate and T1 back  
 Approximate 135 sq. in. open area  
 Curb back height adjusts from 3" to 9"  
 "DUMP NO WASTE!" lettering  
 and fish image on back

Options:  
 Height adjustable

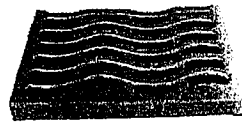
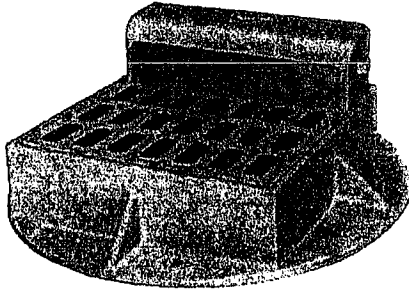
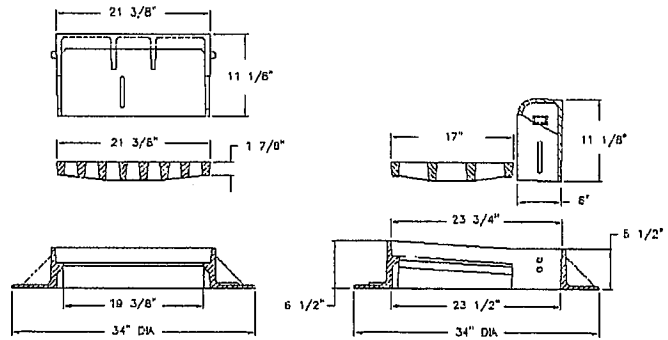

TYPE M2 Sinusoidal Grate  
 Approx. 150 sq. in. open area



TYPE M3 Flat Grate  
 Approx. 195 sq. in. open area  
 To be used without curb back



TYPE M4 Restricted Grate  
 Approx. 6 sq. in. open area per knockout



TYPE T2 Back  
 No Adjustment

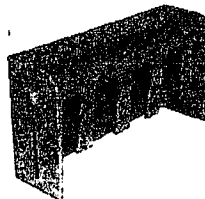

TYPE T3 Strainer Back  
 2" Curb Radius  
 Height Adjusts 3" to 9"



TYPE T4 Back  
 4" Curb Radius  
 Height Adjusts 3 3/4" to 8 1/4"

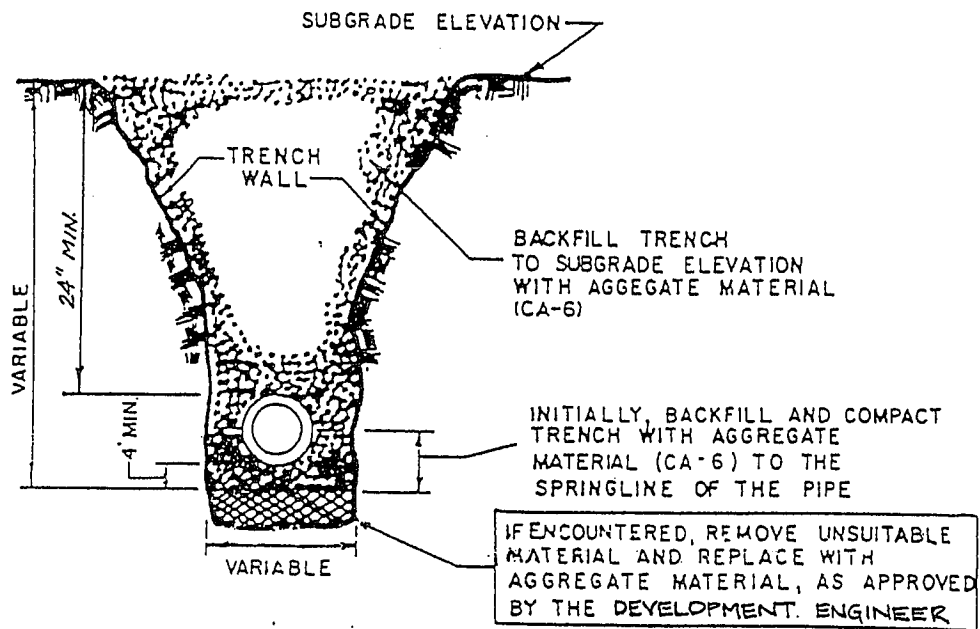

ALL TRENCHES SHALL BE JETTED IN CONFORMANCE WITH SECTION 603.08 (METHOD 3) OF THE STANDARD SPECIFICATIONS FOR ROAD AND BRIDGE CONSTRUCTION.

SANITARY SEWER AND  
STORM SEWER TRENCH SECTION  
(IN PAVED AREAS)

CITY OF  
WOODSTOCK

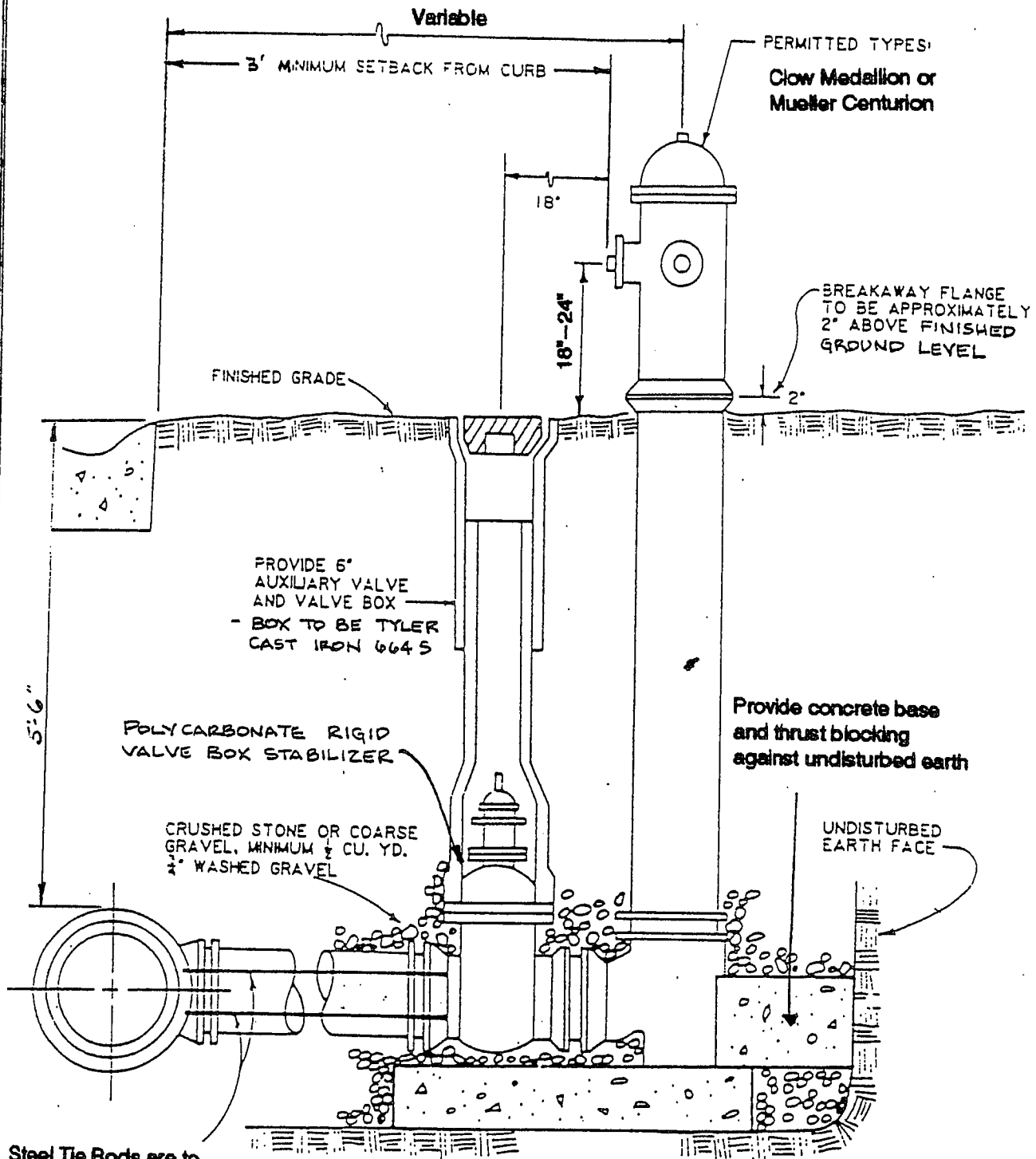

PERMITTED TYPES:  
Clow Medallion or  
Mueller Centurion

BREAKAWAY FLANGE  
TO BE APPROXIMATELY  
2" ABOVE FINISHED  
GROUND LEVEL

FINISHED GRADE

PROVIDE 6"  
AUXILIARY VALVE  
AND VALVE BOX  
- BOX TO BE TYLER  
CAST IRON 6645

POLYCARBONATE RIGID  
VALVE BOX STABILIZER

CRUSHED STONE OR COARSE  
GRAVEL, MINIMUM 1/2 CU. YD.  
3/4" WASHED GRAVEL

Provide concrete base  
and thrust blocking  
against undisturbed earth

UNDISTURBED  
EARTH FACE

Steel Tie Rods are to  
"tie" hydrant to tee

Hydrant must be equipped with a 5 1/4" valve opening, 3 way hose  
connections to include two (2) 2 1/2" nozzles and one (1) 4 1/2" pumper  
nozzle, all nozzles NST and MJ shoe.

**TYPICAL INSTALLATION  
HYDRANT**

**CITY OF  
WOODSTOCK**

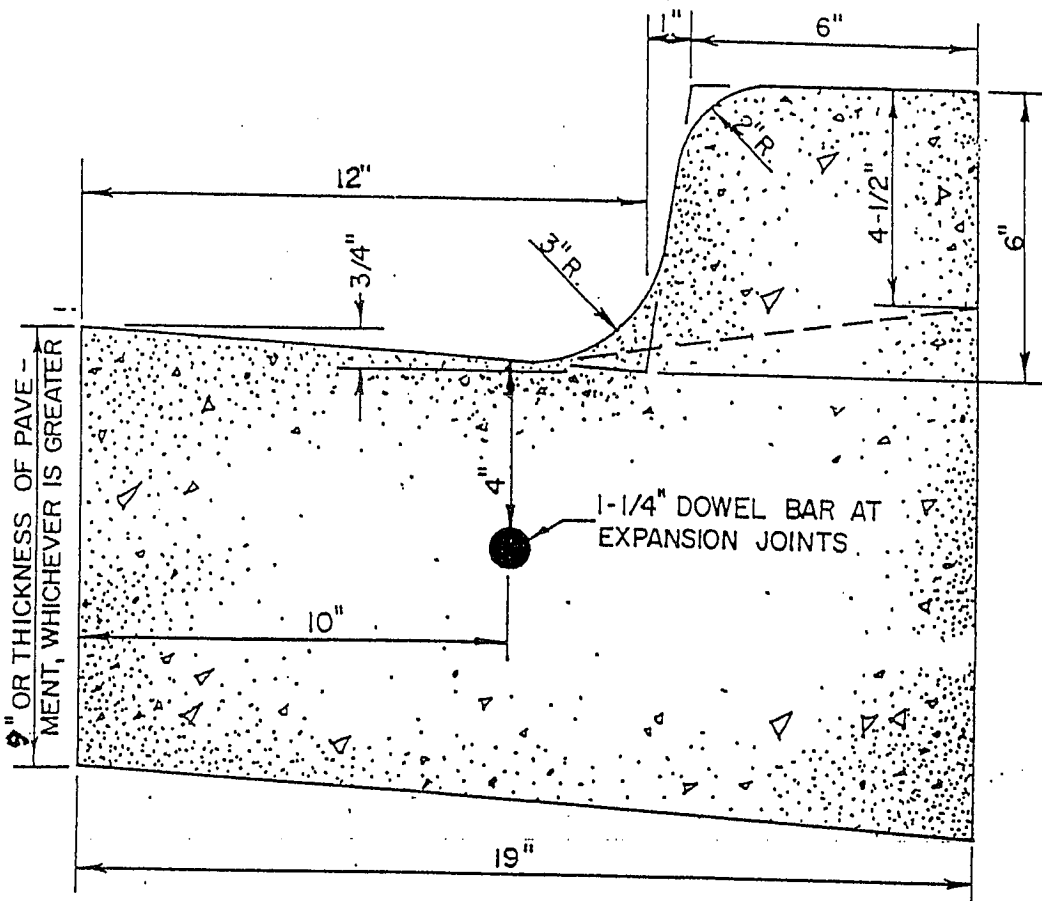

**NOTE:**

1. 1" BITUMINOUS PREFORMED EXPANSION INORGANIC FIBRE JOINT FILLER, CONFORMING TO AASHTO STANDARD M-213, CUT TO THE SHAPE OF THE COMBINATION CURB AND GUTTER SHALL BE PLACED AT 150' INTERVALS AND AT ALL P.C. AND P.T. POINTS. SAWED CONTRACTION JOINTS, 2" DEEP, ARE TO BE PLACED AT 25' INTERVALS BETWEEN EXPANSION JOINTS. ALL EXPANSION AND CONTRACTION JOINTS ARE TO BE FILLED WITH JOINT SEALER CONFORMING TO SECTION 716 OF THE STANDARD SPECIFICATIONS.
2. ONE 1-1/4" EPOXY COATED DOWEL BAR, 18" LONG, WITH A CAP HAVING A PINCHED STOP THAT WILL PROVIDE 1" EXPANSION, SHALL BE PLACED THROUGH EACH EXPANSION JOINT.

**COMBINATION CONCRETE CURB  
AND GUTTER, B-6.12**

**CITY OF  
WOODSTOCK**

TYPICAL  
PLACEMENT IN  
CURB & GUTTER  
SECTION

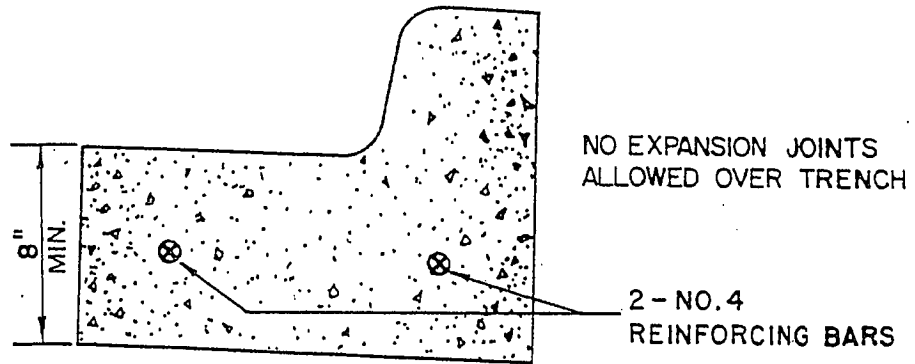

TYPICAL  
PLACEMENT IN  
SIDEWALK  
SECTION

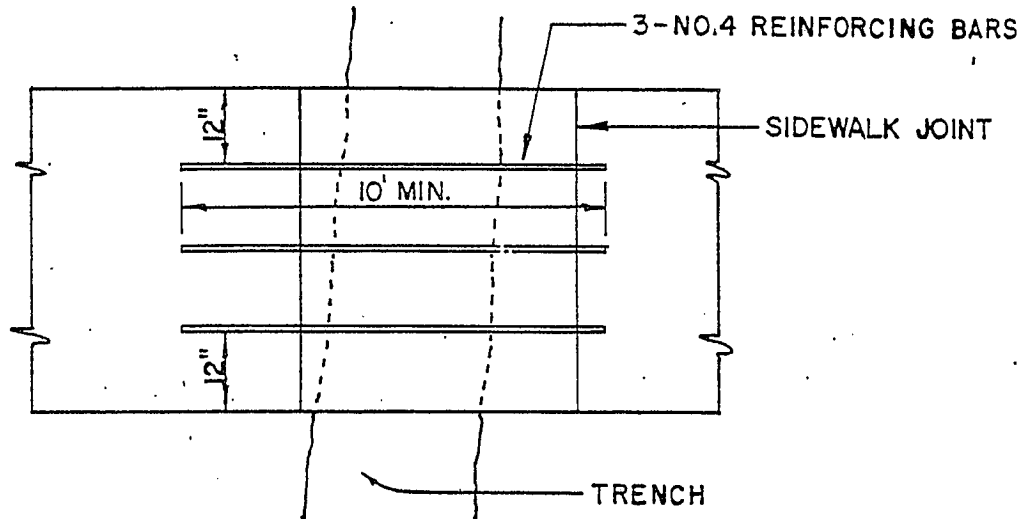

TYPICAL BAR  
LENGTH  
REQUIREMENTS  
OVER TRENCH

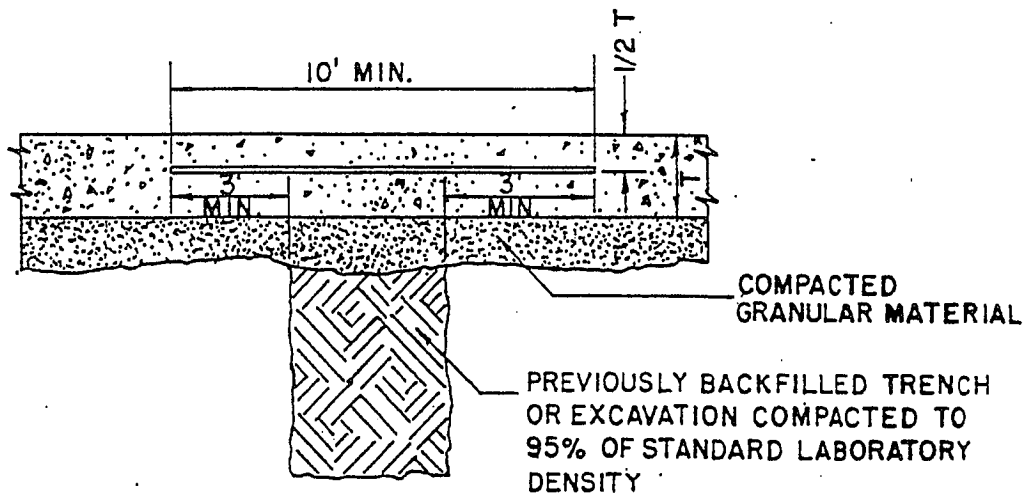

REINFORCING CURB & GUTTER OR  
SIDEWALK INSTALLED OVER A TRENCH

CITY OF  
WOODSTOCK

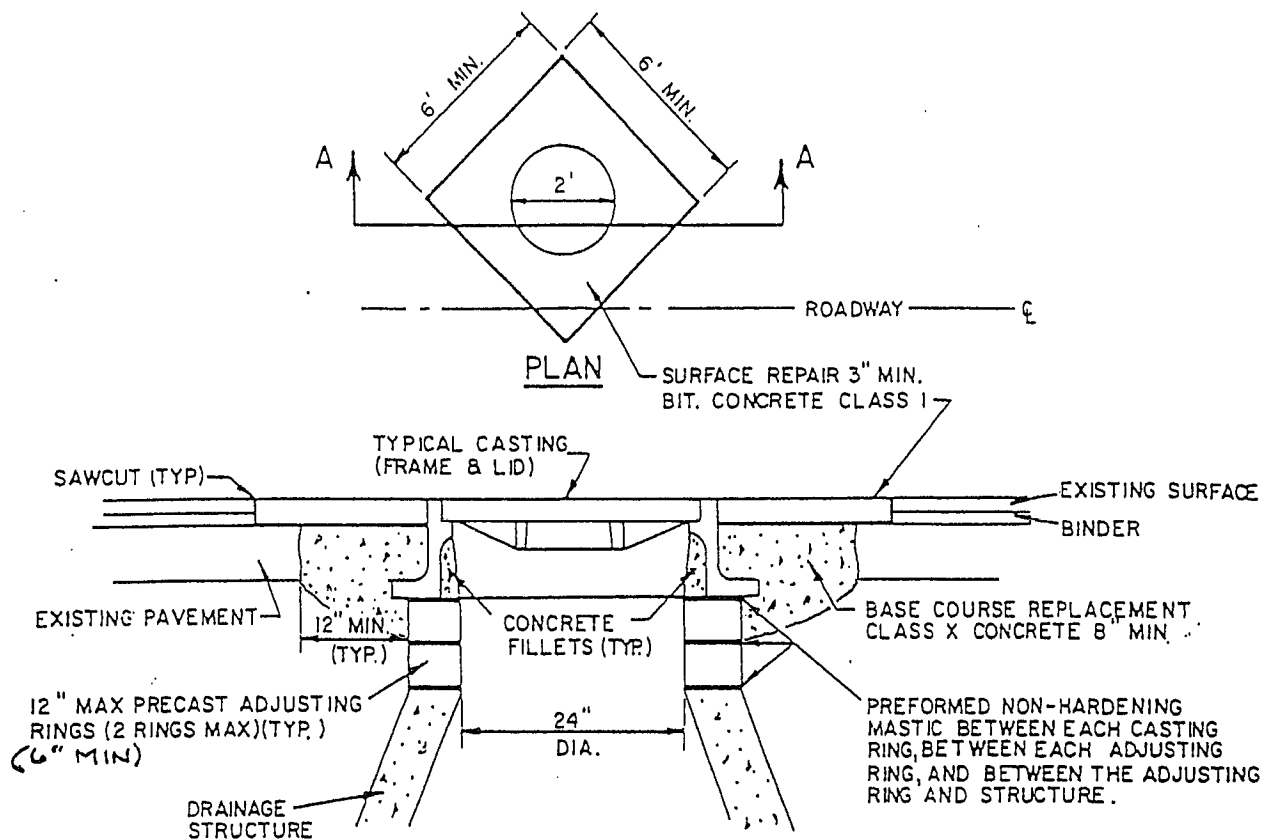

## NOTES

## SECTION A-A

1. Provide select granular backfill CA-II around structure to subgrade elevation.
2. Adjustments shall be performed using a maximum of two precast adjusting rings set in a bed of preformed non-hardening mastic (Rub-R-Nek or approved equal) to a maximum height of twelve (12) inches. *Adjustments less than 3" are not allowed.*
3. No mortar shall be used to dress up inside adjusting rings.
4. Concrete fillets shall be made with non-shrink mortar to provide a smooth transition between the casting and the adjusting ring or top of structure to direct the flow of water down into the structure.
5. Adjustments shall be protected by a barricade with two (2) lights or a one (1) inch steel plate provided and maintained by the contractor at locations where adjustments are located in travel lanes until the surface restoration is complete. The plate shall be protected from sliding and provided with bituminous ramps as required.
6. When adjustments raise a casting above the elevation of the existing pavement surface, a bituminous mixture shall be placed around the casting, transitioned a distance of one (1) foot horizontal for each inch of vertical distance above the existing pavement. Such ramps shall be maintained by the contractor until the completion of the surface restoration.

**CASTING ADJUSTMENTS FOR  
STRUCTURES IN PAVED AREAS**

**CITY OF  
WOODSTOCK**

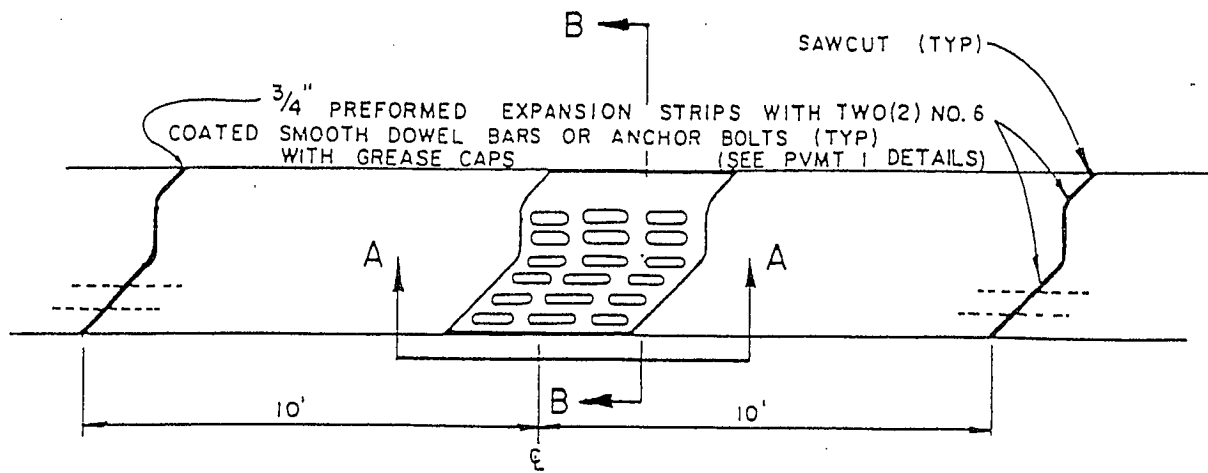

REMOVE & REPLACE CURB A MINIMUM OF 10' EITHER SIDE OF STRUCTURE OR TO NEAREST EXPANSION JOINT (WHICHEVER IS CLOSEST)

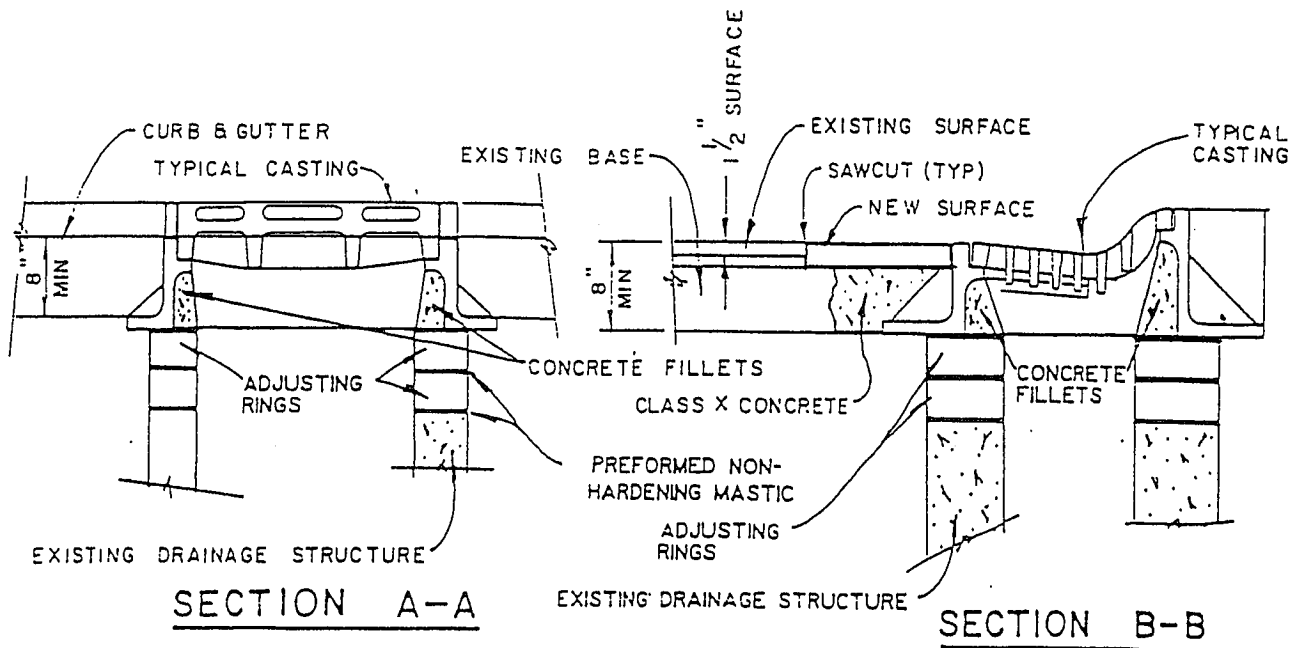

CASTING ADJUSTMENTS FOR  
STRUCTURES WITHIN THE CURB LINE

CITY OF  
WOODSTOCK



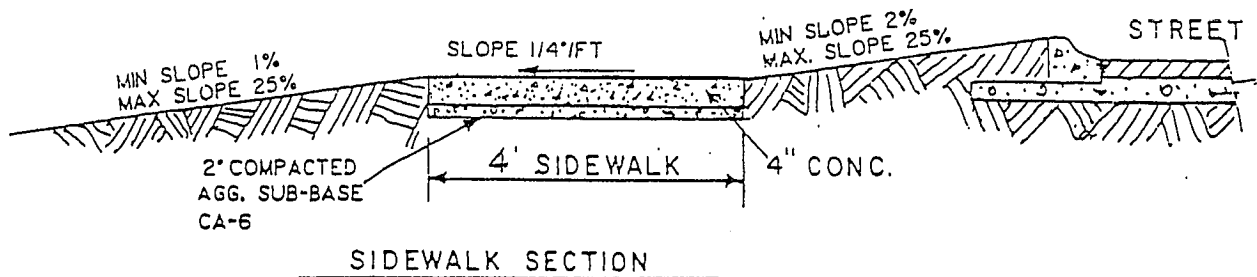
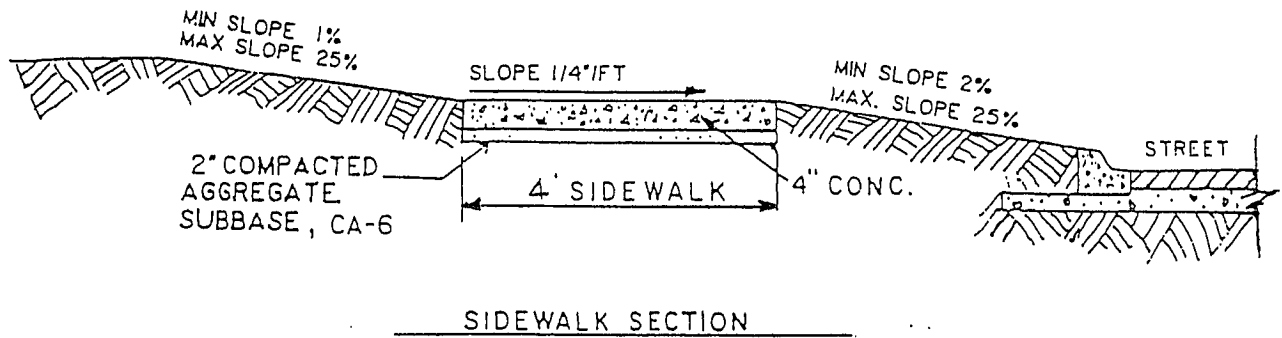

**NOTES:**

1. Concrete shall be IDOT Class X.
2. Minimum sidewalk thickness shall be 4".
3. Sidewalk thickness across driveways shall be minimum 6" for residential driveways and 8" for commercial.
4. Maximum longitudinal slope shall not exceed 6% (1/6').
5. Minimum transverse slope shall be 1/4"/ft (2%) typical. Maximum transverse slope shall be no greater than 1/2"/ft. (4%).
6. A minimum two (2) inch aggregate sub-base (CA-6) shall be provided (4 inch through commercial driveways.)
7. Aggregate sub-base course shall be mechanically compacted.
8. All sidewalks shall be promptly backfilled and protected from damage.

**SIDEWALK**

**CITY OF  
WOODSTOCK**

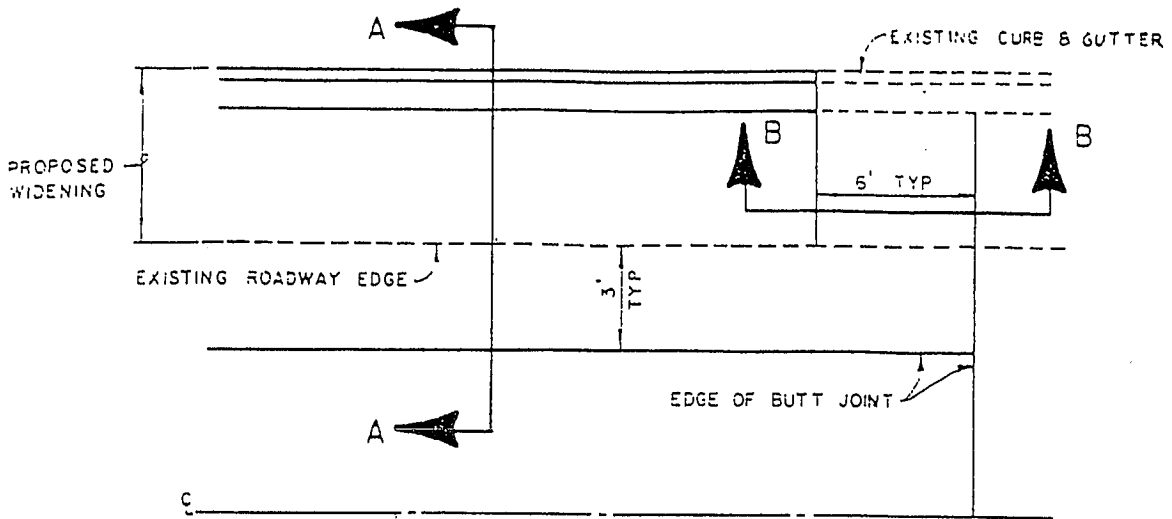

FOR WIDENING LESS THAN 8' WHERE COMPACTION IS DIFFICULT-  
CONCRETE BASE SHALL BE USED.

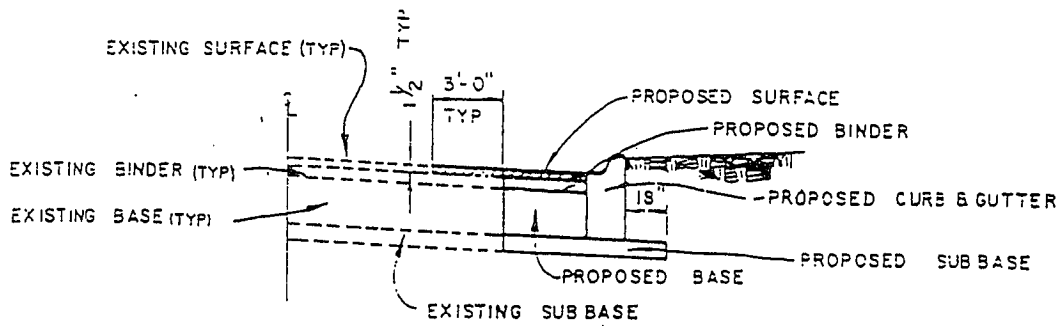

**SECTION A-A**

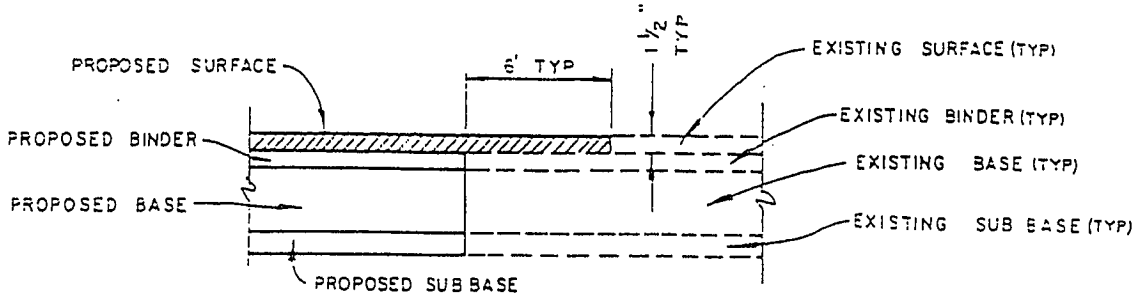

**SECTION B-B**

**BUTT JOINT  
DETAIL**

**CITY OF  
WOODSTOCK**

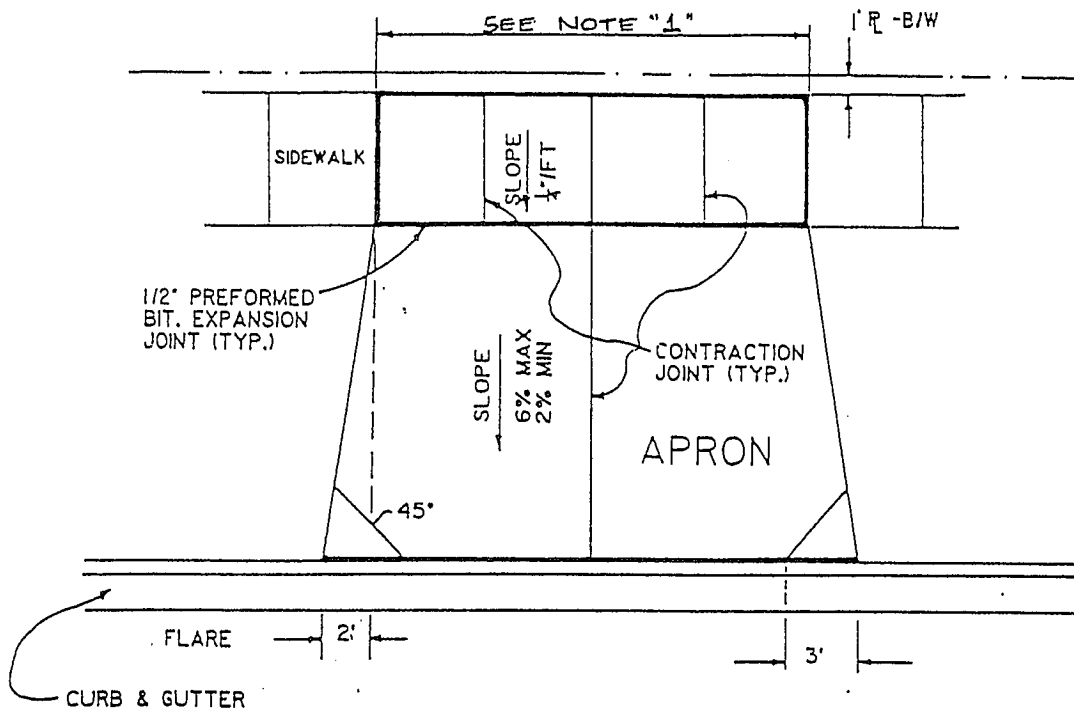

**NOTE:**

- 1.) Driveway width at the right-of-way shall be a maximum of 40' or 40% of the lot width, whichever is less.
- 2.) Existing concrete curb and gutter must be removed and replaced to form the driveway depression or existing concrete curb may be uniformly saw cut to form the depression.

**TYPICAL RESIDENTIAL  
DRIVEWAY DETAIL**

**CITY OF  
WOODSTOCK**

State of Illinois  
Department of Transportation  
Bureau of Local Roads and Streets

SPECIAL PROVISION  
FOR  
INSURANCE

Effective: February 1, 2007  
Revised: August 1, 2007

All references to Sections or Articles in this specification shall be construed to mean specific Section or Article of the Standard Specifications for Road and Bridge Construction, adopted by the Department of Transportation.

The Contractor shall name the following entities as additional insured under the Contractor's general liability insurance policy in accordance with Article 107.27:

City of Woodstock

---

---

---

---

---

---

---

---

The entities listed above and their officers, employees, and agents shall be indemnified and held harmless in accordance with Article 107.26.

## ALKALI-SILICA REACTION FOR CAST-IN-PLACE CONCRETE (BDE)

Effective: August 1, 2007

Revised: January 1, 2009

Description. This special provision is intended to reduce the risk of a deleterious alkali-silica reaction in concrete exposed to humid or wet conditions. The special provision is not intended or adequate for concrete exposed to potassium acetate, potassium formate, sodium acetate or sodium formate. The special provision shall not apply to the dry environment (humidity less than 60 percent) found inside buildings for residential or commercial occupancy. The special provision shall also not apply to precast products or precast prestressed products.

Aggregate Expansion Values. Each coarse and fine aggregate will be tested by the Department for alkali reaction according to ASTM C 1260. The test will be performed with Type I or II cement having a total equivalent alkali content ( $\text{Na}_2\text{O} + 0.658\text{K}_2\text{O}$ ) of 0.90 percent or greater. The Engineer will determine the assigned expansion value for each aggregate, and these values will be made available on the Department's Alkali-Silica Potential Reactivity Rating List. The Engineer may differentiate aggregate based on ledge, production method, gradation number, or other factors. An expansion value of 0.05 percent will be assigned to limestone or dolomite coarse aggregates and 0.03 percent to limestone or dolomite fine aggregates (manufactured stone sand); however the Department reserves the right to perform the ASTM C 1260 test.

Aggregate Groups. Each combination of aggregates used in a mixture will be assigned to an aggregate group. The point at which the coarse aggregate and fine aggregate expansion values intersect in the following table will determine the group.

AGGREGATE GROUPS			
Coarse Aggregate or Coarse Aggregate Blend  ASTM C 1260 Expansion	Fine Aggregate or Fine Aggregate Blend  ASTM C 1260 Expansion		
	$\leq 0.16\%$	$> 0.16\% - 0.27\%$	$> 0.27\%$
$\leq 0.16\%$	Group I	Group II	Group III
$> 0.16\% - 0.27\%$	Group II	Group II	Group III
$> 0.27\%$	Group III	Group III	Group IV

Mixture Options. Based upon the aggregate group, the following mixture options shall be used; however, the Department may prohibit a mixture option if field performance shows a deleterious alkali-silica reaction or Department testing indicates the mixture may experience a deleterious alkali-silica reaction.

- Group I - Mixture options are not applicable. Use any cement or finely divided mineral.
- Group II - Mixture options 1, 2, 3, 4, or 5 shall be used.
- Group III - Mixture options 1, 2 and 3 combined, 4, or 5 shall be used.

Group IV - Mixture options 1, 2 and 4 combined, or 5 shall be used.

For Class PP-3 concrete the mixture options are not applicable, and any cement may be used with the specified finely divided minerals.

- a) Mixture Option 1. The coarse or fine aggregates shall be blended to place the material in a group that will allow the selected cement or finely divided mineral to be used.

When a coarse or fine aggregate is blended, the weighted expansion value shall be calculated separately for the coarse and fine aggregate as follows:

$$\text{Weighted Expansion Value} = (a/100 \times A) + (b/100 \times B) + (c/100 \times C) + \dots$$

Where: a, b, c... = percentage of aggregate in the blend;  
A, B, C... = expansion value for that aggregate.

- b) Mixture Option 2. A finely divided mineral shall be used as described in 1), 2), 3), or 4) that follow. The replacement ratio is defined as "finely divided mineral:portland cement".

1) Class F Fly Ash. For Class PV, BS, MS, DS, SC, and SI concrete and cement aggregate mixture II (CAM II), Class F fly ash shall replace 15 percent of the portland cement at a minimum replacement ratio of 1.5:1.

2) Class C Fly Ash. For Class PV, MS, SC, and SI Concrete, Class C fly ash with 18 percent to less than 26.5 percent calcium oxide content, and less than 2.0 percent loss on ignition, shall replace 20 percent of the portland cement at a minimum replacement ratio of 1:1; or at a minimum replacement ratio of 1.25:1 if the loss on ignition is 2.0 percent or greater. Class C fly ash with less than 18 percent calcium oxide content shall replace 20 percent of the portland cement at a minimum replacement ratio of 1.25:1.

For Class PP-1, RR, BS, and DS concrete and CAM II, Class C fly ash with less than 26.5 percent calcium oxide content shall replace 15 percent of the portland cement at a minimum replacement ratio of 1.5:1.

3) Ground Granulated Blast-Furnace Slag. For Class PV, BS, MS, SI, DS, and SC concrete, ground granulated blast-furnace slag shall replace 25 percent of the portland cement at a minimum replacement ratio of 1:1.

For Class PP-1 and RR concrete, ground granulated blast-furnace slag shall replace 15 percent of the portland cement at a minimum replacement ratio of 1.5:1.

For Class PP-2, ground granulated blast-furnace slag shall replace 25 to 30 percent of the portland cement at a minimum replacement ratio of 1:1.

- 4) Microsilica or High Reactivity Metakaolin. Microsilica solids or high reactivity metakaolin shall be added to the mixture at a minimum 25 lb/cu yd (15 kg/cu m) or 27 lb/cu yd (16 kg/cu m) respectively.
- c) Mixture Option 3. The cement used shall have a maximum total equivalent alkali content ( $\text{Na}_2\text{O} + 0.658\text{K}_2\text{O}$ ) of 0.60 percent. When aggregate in Group II is involved, any finely divided mineral may be used with a portland cement.
- d) Mixture Option 4. The cement used shall have a maximum total equivalent alkali content ( $\text{Na}_2\text{O} + 0.658\text{K}_2\text{O}$ ) of 0.45 percent. When aggregate in Group II or III is involved, any finely divided mineral may be used with a portland cement.
- e) Mixture Option 5. The proposed cement or finely divided mineral may be used if the ASTM C 1567 expansion value is  $\leq 0.16$  percent when performed on the aggregate in the concrete mixture with the highest ASTM C 1260 test result. The ASTM C 1567 test will be valid for two years, unless the Engineer determines the materials have changed significantly. For latex concrete, the ASTM C 1567 test shall be performed without the latex. The 0.20 percent autoclave expansion limit in ASTM C 1567 shall not apply.

If during the two year time period the Contractor needs to replace the cement, and the replacement cement has an equal or lower total equivalent alkali content ( $\text{Na}_2\text{O} + 0.658\text{K}_2\text{O}$ ), a new ASTM C 1567 test will not be required.

Testing. If an individual aggregate has an ASTM C 1260 expansion value  $> 0.16$  percent, an ASTM C 1293 test may be performed by the Contractor to evaluate the Department's ASTM C 1260 test result. The ASTM C 1293 test shall be performed with Type I or II cement having a total equivalent alkali content ( $\text{Na}_2\text{O} + 0.658\text{K}_2\text{O}$ ) of 0.80 percent or greater. The interior vertical wall of the ASTM C 1293 recommended container (pail) shall be half covered with a wick of absorbent material consisting of blotting paper. If the testing laboratory desires to use an alternate container or wick of absorbent material, ASTM C 1293 test results with an alkali-reactive aggregate of known expansion characteristics shall be provided to the Engineer for review and approval. If the expansion is less than 0.040 percent after one year, the aggregate will be assigned an ASTM C 1260 expansion value of 0.08 percent that will be valid for two years, unless the Engineer determines the aggregate has changed significantly.

The Engineer reserves the right to verify a Contractor's ASTM C 1293 or 1567 test result. The Engineer will not accept the result if the precision and bias for the test methods are not met.

The laboratory performing the ASTM C 1567 test shall either be accredited by the AASHTO Materials Reference Laboratory (AMRL) for ASTM C 227 under Portland Cement Concrete or Aggregate; or shall be inspected for Hydraulic Cement - Physical Tests by the Cement and Concrete Reference Laboratory (CCRL) and shall be approved by the Department. The laboratory performing the ASTM C 1293 test shall be inspected for Portland Cement Concrete by CCRL and shall be approved by the Department.

80186

**ALKALI-SILICA REACTION FOR PRECAST AND PRECAST PRESTRESSED CONCRETE (BDE)**

Effective: January 1, 2009

Description. This special provision is intended to reduce the risk of a deleterious alkali-silica reaction in precast and precast prestressed concrete exposed to humid or wet conditions. The special provision is not intended or adequate for concrete exposed to potassium acetate, potassium formate, sodium acetate or sodium formate. The special provision shall not apply to the dry environment (humidity less than 60 percent) found inside buildings for residential or commercial occupancy. The special provision shall also not apply to cast-in-place concrete.

Aggregate Expansion Values. Each coarse and fine aggregate will be tested by the Department for alkali reaction according to ASTM C 1260. The test will be performed with Type I or II cement having a total equivalent alkali content ( $\text{Na}_2\text{O} + 0.658\text{K}_2\text{O}$ ) of 0.90 percent or greater. The Engineer will determine the assigned expansion value for each aggregate, and these values will be made available on the Department's Alkali-Silica Potential Reactivity Rating List. The Engineer may differentiate aggregate based on ledge, production method, gradation number, or other factors. An expansion value of 0.05 percent will be assigned to limestone or dolomite coarse aggregates and 0.03 percent to limestone or dolomite fine aggregates (manufactured stone sand); however the Department reserves the right to perform the ASTM C 1260 test.

Aggregate Groups. Each combination of aggregates used in a mixture will be assigned to an aggregate group. The point at which the coarse aggregate and fine aggregate expansion values intersect in the following table will determine the group.

AGGREGATE GROUPS			
Coarse Aggregate or Coarse Aggregate Blend  ASTM C 1260 Expansion	Fine Aggregate or Fine Aggregate Blend  ASTM C 1260 Expansion		
	≤ 0.16%	> 0.16% - 0.27%	> 0.27%
≤ 0.16%	Group I	Group II	Group III
> 0.16% - 0.27%	Group II	Group II	Group III
> 0.27%	Group III	Group III	Group IV

Mixture Options. Based upon the aggregate group, the following mixture options shall be used; however, the Department may prohibit a mixture option if field performance shows a deleterious alkali-silica reaction or Department testing indicates the mixture may experience a deleterious alkali-silica reaction.

- Group I - Mixture options are not applicable. Use any cement or finely divided mineral.
- Group II - Mixture options 1, 2, 3, 4, or 5 shall be used.
- Group III - Mixture options 1, 2 and 3 combined, 4, or 5 shall be used.



Group IV - Mixture options 1, 2 and 4 combined, or 5 shall be used.

- a) Mixture Option 1. The coarse or fine aggregates shall be blended to place the material in a group that will allow the selected cement or finely divided mineral to be used.

When a coarse or fine aggregate is blended, the weighted expansion value shall be calculated separately for the coarse and fine aggregate as follows:

$$\text{Weighted Expansion Value} = (a/100 \times A) + (b/100 \times B) + (c/100 \times C) + \dots$$

Where: a, b, c... = percentage of aggregate in the blend;  
A, B, C... = expansion value for that aggregate.

- b) Mixture Option 2. A finely divided mineral shall be used as described in 1), 2), 3), or 4) that follow. The replacement ratio is defined as "finely divided mineral:portland cement".
- 1) Class F Fly Ash. For Class PC concrete, precast products, and PS concrete, Class F fly ash shall replace 15 percent of the portland cement at a minimum replacement ratio of 1.5:1.
  - 2) Class C Fly Ash. For Class PC Concrete, precast products, and Class PS concrete, Class C fly ash with 18 percent to less than 26.5 percent calcium oxide content, and less than 2.0 percent loss on ignition, shall replace 20 percent of the portland cement at a minimum replacement ratio of 1:1; or at a minimum replacement ratio of 1.25:1 if the loss on ignition is 2.0 percent or greater. Class C fly ash with less than 18 percent calcium oxide content shall replace 20 percent of the portland cement at a minimum replacement ratio of 1.25:1.
  - 3) Ground Granulated Blast-Furnace Slag. For Class PC concrete, precast products, and Class PS concrete, ground granulated blast-furnace slag shall replace 25 percent of the portland cement at a minimum replacement ratio of 1:1.
  - 4) Microsilica or High Reactivity Metakaolin. Microsilica solids or high reactivity metakaolin shall be added to the mixture at a minimum 25 lb/cu yd (15 kg/cu m) or 27 lb/cu yd (16 kg/cu m) respectively.
- c) Mixture Option 3. The cement used shall have a maximum total equivalent alkali content ( $\text{Na}_2\text{O} + 0.658\text{K}_2\text{O}$ ) of 0.60 percent. When aggregate in Group II is involved, any finely divided mineral may be used with a portland cement.
- d) Mixture Option 4. The cement used shall have a maximum total equivalent alkali content ( $\text{Na}_2\text{O} + 0.658\text{K}_2\text{O}$ ) of 0.45 percent. When aggregate in Group II or III is involved, any finely divided mineral may be used with a portland cement.
- e) Mixture Option 5. The proposed cement or finely divided mineral may be used if the ASTM C 1567 expansion value is  $\leq 0.16$  percent when performed on the aggregate in

the concrete mixture with the highest ASTM C 1260 test result. The ASTM C 1567 test will be valid for two years, unless the Engineer determines the materials have changed significantly. The 0.20 percent autoclave expansion limit in ASTM C 1567 shall not apply.

If during the two year time period the Contractor needs to replace the cement, and the replacement cement has an equal or lower total equivalent alkali content ( $\text{Na}_2\text{O} + 0.658\text{K}_2\text{O}$ ), a new ASTM C 1567 test will not be required.

Testing. If an individual aggregate has an ASTM C 1260 expansion value  $> 0.16$  percent, an ASTM C 1293 test may be performed by the Contractor to evaluate the Department's ASTM C 1260 test result. The ASTM C 1293 test shall be performed with Type I or II cement having a total equivalent alkali content ( $\text{Na}_2\text{O} + 0.658\text{K}_2\text{O}$ ) of 0.80 percent or greater. The interior vertical wall of the ASTM C 1293 recommended container (pail) shall be half covered with a wick of absorbent material consisting of blotting paper. If the testing laboratory desires to use an alternate container or wick of absorbent material, ASTM C 1293 test results with an alkali-reactive aggregate of known expansion characteristics shall be provided to the Engineer for review and approval. If the expansion is less than 0.040 percent after one year, the aggregate will be assigned an ASTM C 1260 expansion value of 0.08 percent that will be valid for two years, unless the Engineer determines the aggregate has changed significantly.

The Engineer reserves the right to verify a Contractor's ASTM C 1293 or 1567 test result. The Engineer will not accept the result if the precision and bias for the test methods are not met.

The laboratory performing the ASTM C 1567 test shall either be accredited by the AASHTO Materials Reference Laboratory (AMRL) for ASTM C 227 under Portland Cement or Aggregate; or shall be inspected for Hydraulic Cement - Physical Tests by the Cement and Concrete Reference Laboratory (CCRL) and shall be approved by the Department. The laboratory performing the ASTM C 1293 test shall be inspected for Portland Cement Concrete by CCRL and shall be approved by the Department.

80213

**APPROVAL OF PROPOSED BORROW AREAS, USE AREAS, AND/OR WASTE AREAS  
INSIDE ILLINOIS STATE BORDERS (BDE)**

Effective: November 1, 2008

Revise the title of Article 107.22 of the Standard Specifications to read:

**"107.22 Approval of Proposed Borrow Areas, Use Areas, and/or Waste Areas Inside  
Illinois State Borders."**

Add the following sentence to the end of the first paragraph of Article 107.22 of the Standard Specifications:

"Proposed borrow areas, use areas, and/or waste areas outside of Illinois shall comply with Article 107.01."

80207

## CEMENT (BDE)

Effective: January 1, 2007

Revised: April 1, 2009

Revise Section 1001 of the Standard Specifications to read:

### "SECTION 1001. CEMENT

**1001.01 Cement Types.** Cement shall be according to the following.

- (a) Portland Cement. Acceptance of portland cement shall be according to the current Bureau of Materials and Physical Research's Policy Memorandum, "Portland or Blended Cement Acceptance Procedure for Qualified and Non-Qualified Plants".

Portland cement shall be according to ASTM C 150, and shall meet the standard physical and chemical requirements. Type I or Type II may be used for cast-in-place, precast, and precast prestressed concrete. Type III may be used according to Article 1020.04, or when approved by the Engineer. All other cements referenced in ASTM C 150 may be used when approved by the Engineer.

The total of all organic processing additions shall be a maximum of 1.0 percent by weight (mass) of the cement. The total of all inorganic processing additions shall be a maximum of 4.0 percent by weight (mass) of the cement. However, a cement kiln dust inorganic processing addition shall be limited to a maximum of 1.0 percent. Organic processing additions shall be limited to grinding aids that improve the flowability of cement, reduce pack set, and improve grinding efficiency. Inorganic processing additions shall be limited to granulated blast-furnace slag according to the chemical requirements of AASHTO M 302, Class C fly ash according to the chemical requirements of AASHTO M 295, and cement kiln dust.

- (b) Portland-Pozzolan Cement. Acceptance of portland-pozzolan cement shall be according to the current Bureau of Materials and Physical Research's Policy Memorandum, "Portland or Blended Cement Acceptance Procedure for Qualified and Non-Qualified Plants".

Portland-pozzolan cement shall be according to ASTM C 595 and shall meet the standard physical and chemical requirements. Type IP may be used for cast-in-place, precast, and precast prestressed concrete, except when Class PP concrete is used. The pozzolan constituent for Type IP shall be a maximum of 21 percent of the weight (mass) of the portland-pozzolan cement.

For cast-in-place construction, portland-pozzolan cement shall not be used in concrete mixtures when the air temperature is below 40 °F (4 °C) without permission of the Engineer. If permission is given, the mix design strength requirement may require the Contractor to increase the cement or eliminate the cement factor reduction for a water-

reducing or high range water-reducing admixture which is permitted according to Article 1020.05(b).

The total of all organic processing additions shall be a maximum of 1.0 percent by weight (mass) of the cement. Organic processing additions shall be limited to grinding aids as defined in (a) above. Inorganic processing additions shall be limited to cement kiln dust at a maximum of 1.0 percent.

- (c) Portland Blast-Furnace Slag Cement. Acceptance of portland blast-furnace slag cement shall be according to the current Bureau of Materials and Physical Research's Policy Memorandum, "Portland or Blended Cement Acceptance Procedure for Qualified and Non-Qualified Plants".

Portland blast-furnace slag cement shall be according to ASTM C 595 and shall meet the standard physical and chemical requirements. Type IS portland blast-furnace slag cement may be used for cast-in-place, precast, and precast prestressed concrete, except when Class PP concrete is used. The blast-furnace slag constituent for Type IS shall be a maximum of 25 percent of the weight (mass) of the portland blast-furnace slag cement.

For cast-in-place construction, portland blast-furnace slag cement shall not be used in concrete mixtures when the air temperature is below 40 °F (4 °C) without permission of the Engineer. If permission is given, the mix design strength requirement may require the Contractor to increase the cement or eliminate the cement factor reduction for a water-reducing or high range water-reducing admixture which is permitted according to Article 1020.05(b).

The total of all organic processing additions shall be a maximum of 1.0 percent by weight (mass) of the cement. Organic processing additions shall be limited to grinding aids as defined in (a) above. Inorganic processing additions shall be limited to cement kiln dust at a maximum of 1.0 percent.

- (d) Rapid Hardening Cement. Rapid hardening cement shall be used according to Article 1020.04 or when approved by the Engineer. The cement shall be on the Department's current "Approved List of Packaged, Dry, Rapid Hardening Cementitious Materials for Concrete Repairs", and shall be according to the following.

- (1) The cement shall have a maximum final set of 25 minutes, according to Illinois Modified ASTM C 191.
- (2) The cement shall have a minimum compressive strength of 2000 psi (13,800 kPa) at 3.0 hours, 3200 psi (22,100 kPa) at 6.0 hours, and 4000 psi (27,600 kPa) at 24.0 hours, according to Illinois Modified ASTM C 109.
- (3) The cement shall have a maximum drying shrinkage of 0.050 percent at seven days, according to Illinois Modified ASTM C 596.

- (4) The cement shall have a maximum expansion of 0.020 percent at 14 days, according to Illinois Modified ASTM C 1038.
- (5) The cement shall have a minimum 80 percent relative dynamic modulus of elasticity; and shall not have a weight (mass) gain in excess of 0.15 percent or a weight (mass) loss in excess of 1.0 percent, after 100 cycles, according to AASHTO T 161, Procedure B.
- (e) Calcium Aluminate Cement. Calcium aluminate cement shall be used only where specified by the Engineer. The cement shall meet the standard physical requirements for Type I cement according to ASTM C 150, except the time of setting shall not apply. The chemical requirements shall be determined according to ASTM C 114 and shall be as follows: minimum 38 percent aluminum oxide ( $Al_2O_3$ ), maximum 42 percent calcium oxide (CaO), maximum 1 percent magnesium oxide (MgO), maximum 0.4 percent sulfur trioxide ( $SO_3$ ), maximum 1 percent loss on ignition, and maximum 3.5 percent insoluble residue.

**1001.02 Uniformity of Color.** Cement contained in single loads or in shipments of several loads to the same project shall not have visible differences in color.

**1001.03 Mixing Brands and Types.** Different brands or different types of cement from the same manufacturing plant, or the same brand or type from different plants shall not be mixed or used alternately in the same item of construction unless approved by the Engineer.

**1001.04 Storage.** Cement shall be stored and protected against damage, such as dampness which may cause partial set or hardened lumps. Different brands or different types of cement from the same manufacturing plant, or the same brand or type from different plants shall be kept separate."

80166

## CONCRETE ADMIXTURES (BDE)

Effective: January 1, 2003

Revised: April 1, 2009

Replace the first paragraph of Article 1020.05(b) of the Standard Specifications to read:

"(b) Admixtures. The use of admixtures to increase the workability or to accelerate the hardening of the concrete will be permitted when approved by the Engineer. Admixture dosages shall result in the mixture meeting the specified plastic and hardened properties. The Department will maintain an Approved List of Corrosion Inhibitors. Corrosion inhibitor dosage rates shall be according to Article 1020.05(b)(12). The Department will also maintain an Approved List of Concrete Admixtures, and an admixture technical representative shall be consulted when determining an admixture dosage from this list. The dosage shall be within the range indicated on the approved list unless the influence by other admixtures, jobsite conditions (such as a very short haul time), or other circumstances warrant a dosage outside the range. The Engineer shall be notified when a dosage is proposed outside the range. To determine an admixture dosage, air temperature, concrete temperature, cement source and quantity, finely divided mineral sources(s) and quantity, influence of other admixtures, haul time, placement conditions, and other factors as appropriate shall be considered. The Engineer may request the Contractor to have a batch of concrete mixed in the lab or field to verify the admixture dosage is correct. An admixture dosage or combination of admixture dosages shall not delay the initial set of concrete by more than one hour. When a retarding admixture is required or appropriate for a bridge deck or bridge deck overlayer pour, the initial set time shall be delayed until the deflections due to the concrete dead load are no longer a concern for inducing cracks in the completed work. However, a retarding admixture shall not be used to further extend the pour time and justify the alteration of a bridge deck pour sequence.

When determining water in admixtures for water/cement ratio, the Contractor shall calculate 70 percent of the admixture dosage as water, except a value of 50 percent shall be used for a latex admixture used in bridge deck latex concrete overlays."

Revise Section 1021 of the Standard Specifications to read:

### "SECTION 1021. CONCRETE ADMIXTURES

**1021.01 General.** Admixtures shall be furnished in liquid form ready for use. The admixtures shall be delivered in the manufacturer's original containers, bulk tank trucks or such containers or tanks as are acceptable to the Engineer. Delivery shall be accompanied by a ticket which clearly identifies the manufacturer and trade name of the material. Containers shall be readily identifiable as to manufacturer and trade name of the material they contain.

Corrosion inhibitors will be maintained on the Department's Approved List of Corrosion Inhibitors. All other concrete admixture products will be maintained on the Department's

Approved List of Concrete Admixtures. For the admixture submittal, a report prepared by an independent laboratory accredited by the AASHTO Materials Reference Laboratory (AMRL) for Portland Cement Concrete shall be provided. The report shall show the results of physical tests conducted no more than five years prior to the time of submittal, according to applicable specifications. However, for corrosion inhibitors the ASTM G 109 test information specified in ASTM C 1582 is not required to be from an independent lab. All other information in ASTM C 1582 shall be from an independent lab.

Tests shall be conducted using materials and methods specified on a "test" concrete and a "reference" concrete, together with a certification that no changes have been made in the formulation of the material since the performance of the tests. Per the manufacturer's option, the cement content for all required tests shall either be according to applicable specifications or 5.65 cwt/cu yd (335 kg/cu m). Compressive strength test results for six months and one year will not be required.

Prior to the approval of an admixture, the Engineer reserves the right to request a sample for testing. The test and reference concrete mixtures tested by the Engineer will contain a cement content of 5.65 cwt/cu yd (335 kg/cu m). For freeze-thaw testing, the Department will perform the test according to AASHTO T 161, Procedure B. The flexural strength test will be performed according to AASHTO T 177. If the Engineer decides to test the admixture, the manufacturer shall submit AASHTO T 197 water content and set time test results on the standard cement used by the Department. The test and reference concrete mixture shall contain a cement content of 5.65 cwt/cu yd (335 kg/cu m). The manufacturer may select their lab or an independent lab to perform this testing. The laboratory is not required to be accredited by AASHTO.

The manufacturer shall include in the submittal the following admixture information: the manufacturing range for specific gravity, the midpoint and manufacturing range for residue by oven drying, and the manufacturing range for pH. The submittal shall also include an infrared spectrophotometer trace no more than five years old.

For air-entraining admixtures according to Article 1021.02, the specific gravity allowable manufacturing range shall be established by the manufacturer and the test method shall be according to ASTM C 494. For residue by oven drying and pH, the allowable manufacturing range and test methods shall be according to ASTM C 260.

For admixtures according to Articles 1021.03, 1021.04, 1021.05, 1021.06, and 1021.07, the pH allowable manufacturing range shall be established by the manufacturer and the test method shall be according to ASTM E 70. For specific gravity and residue by oven drying, the allowable manufacturing range and test methods shall be according to ASTM C 494.

When test results are more than seven years old, the manufacturer shall re-submit the infrared spectrophotometer trace and the report prepared by an independent laboratory accredited by AASHTO.



All admixtures, except chloride-based accelerators, shall contain a maximum of 0.3 percent chloride by weight (mass).

Random field samples may be taken by the Department to verify an admixture meets specification. A split sample will be provided to the manufacturer if requested. Admixtures that do not meet specification requirements or an allowable manufacturing range established by the manufacturer shall be replaced with new material.

**1021.02 Air-Entraining Admixtures.** Air-entraining admixtures shall be according to AASHTO M 154.

**1021.03 Retarding and Water-Reducing Admixtures.** The admixture shall be according to the following.

- (a) The retarding admixture shall be according to AASHTO M 194, Type B (retarding) or Type D (water-reducing and retarding).
- (b) The water-reducing admixture shall be according to AASHTO M 194, Type A.
- (c) The high range water-reducing admixture shall be according to AASHTO M 194, Type F (high range water-reducing) or Type G (high range water-reducing and retarding).

**1021.04 Accelerating Admixtures.** The admixture shall be according to AASHTO M 194, Type C (accelerating) or Type E (water reducing and accelerating).

**1021.05 Self-Consolidating Admixtures.** The self-consolidating admixture system shall consist of either a high range water-reducing admixture only or a high range water-reducing admixture combined with a separate viscosity modifying admixture. The one or two component admixture system shall be capable of producing a concrete mixture that can flow around reinforcement and consolidate under its own weight without additional effort and without segregation.

The high range water-reducing admixture shall be according to AASHTO M 194, Type F.

The viscosity modifying admixture shall be according to ASTM C 494, Type S (specific performance).

**1021.06 Rheology-Controlling Admixture.** The rheology-controlling admixture shall be capable of producing a concrete mixture with a lower yield stress that will consolidate easier for slipform applications used by the Contractor. The rheology-controlling admixture shall be according to ASTM C 494, Type S (specific performance).

**1021.07 Corrosion Inhibitor.** The corrosion inhibitor shall be according to one of the following.

- (a) Calcium Nitrite. The corrosion inhibitor shall contain a minimum 30 percent calcium nitrite by weight (mass) of solution, and shall comply with the requirements of AASHTO M 194, Type C (accelerating).
- (b) Other Materials. The corrosion inhibitor shall be according to ASTM C 1582."

80094

## **DISADVANTAGED BUSINESS ENTERPRISE PARTICIPATION (BDE)**

Effective: September 1, 2000

Revised: November 1, 2008

FEDERAL OBLIGATION. The Department of Transportation, as a recipient of federal financial assistance, is required to take all necessary and reasonable steps to ensure nondiscrimination in the award and administration of contracts. Consequently, the federal regulatory provisions of 49 CFR part 26 apply to this contract concerning the utilization of disadvantaged business enterprises. For the purposes of this Special Provision, a disadvantaged business enterprise (DBE) means a business certified by the Department in accordance with the requirements of 49 CFR part 26 and listed in the Illinois Unified Certification Program (IL UCP) DBE Directory or most recent addendum.

STATE OBLIGATION. This Special Provision will also be used by the Department to satisfy the requirements of the Business Enterprise for Minorities, Females, and Persons with Disabilities Act, 30 ILCS 575. When this Special Provision is used to satisfy state law requirements on 100 percent state-funded contracts, the federal government has no involvement in such contracts (not a federal-aid contract) and no responsibility to oversee the implementation of this Special Provision by the Department on those contracts. DBE participation on 100 percent state-funded contracts will not be credited toward fulfilling the Department's annual overall DBE goal required by the US Department of Transportation to comply with the federal DBE program requirements.

CONTRACTOR ASSURANCE. The Contractor makes the following assurance and agrees to include the assurance in each subcontract that the Contractor signs with a subcontractor:

The Contractor, subrecipient, or subcontractor shall not discriminate on the basis of race, color, national origin, or sex in the performance of this contract. The Contractor shall carry out applicable requirements of 49 CFR part 26 in the award and administration of contracts funded in whole or in part with federal or state funds. Failure by the Contractor to carry out these requirements is a material breach of this contract, which may result in the termination of this contract or such other remedy as the recipient deems appropriate.

OVERALL GOAL SET FOR THE DEPARTMENT. As a requirement of compliance with 49 CFR part 26, the Department has set an overall goal for DBE participation in its federally assisted contracts. That goal applies to all federal-aid funds the Department will expend in its federally assisted contracts for the subject reporting fiscal year. The Department is required to make a good faith effort to achieve the overall goal. The dollar amount paid to all approved DBE companies performing work called for in this contract is eligible to be credited toward fulfillment of the Department's overall goal.

CONTRACT GOAL TO BE ACHIEVED BY THE CONTRACTOR. This contract includes a specific DBE utilization goal established by the Department. The goal has been included because the Department has determined that the work of this contract has subcontracting opportunities that may be suitable for performance by DBE companies. This determination is

**DOWEL BARS (BDE)**

Effective: April 1, 2007

| Revised: January 1, 2008

| Revise the fifth and sixth sentences of Article 1006.11(b) of the Standard Specifications to read:

| "The bars shall be epoxy coated according to AASHTO M 284, except the thickness of the epoxy shall be 7 to 12 mils (0.18 to 0.30 mm) and patching of the ends will not be required. The epoxy coating applicator shall be certified according to the current Bureau of Materials and Physical Research Policy Memorandum, "Epoxy Coating Plant Certification Procedure". The Department will maintain an approved list."

80178

based on an assessment of the type of work, the location of the work, and the availability of DBE companies to do a part of the work. The assessment indicates that, in the absence of unlawful discrimination, and in an arena of fair and open competition, DBE companies can be expected to perform 4 % of the work. This percentage is set as the DBE participation goal for this contract. Consequently, in addition to the other award criteria established for this contract, the Department will award this contract to a bidder who makes a good faith effort to meet this goal of DBE participation in the performance of the work. A bidder makes a good faith effort for award consideration if either of the following is done in accordance with the procedures set forth in this Special Provision:

- (a) The bidder documents that firmly committed DBE participation has been obtained to meet the goal; or
- (b) The bidder documents that a good faith effort has been made to meet the goal, even though the effort did not succeed in obtaining enough DBE participation to meet the goal.

DBE LOCATOR REFERENCES. Bidders may consult the IL UCP DBE Directory as a reference source for DBE-certified companies. In addition, the Department maintains a letting and item specific DBE locator information system whereby DBE companies can register their interest in providing quotes on particular bid items advertised for letting. Information concerning DBE companies willing to quote work for particular contracts may be obtained by contacting the Department's Bureau of Small Business Enterprises at telephone number (217)785-4611, or by visiting the Department's web site at [www.dot.il.gov](http://www.dot.il.gov).

BIDDING PROCEDURES. Compliance with the bidding procedures of this Special Provision is required prior to the award of the contract and the failure of the as-read low bidder to comply will render the bid not responsive.

- (a) In order to assure the timely award of the contract, the as-read low bidder shall submit a Disadvantaged Business Utilization Plan on Department form SBE 2026 within seven working days after the date of letting. To meet the seven day requirement, the bidder may send the Plan by certified mail or delivery service within the seven working day period. If a question arises concerning the mailing date of a Plan, the mailing date will be established by the U.S. Postal Service postmark on the original certified mail receipt from the U.S. Postal Service or the receipt issued by a delivery service. It is the responsibility of the bidder to ensure that the postmark or receipt date is affixed within the seven working days if the bidder intends to rely upon mailing or delivery to satisfy the submission day requirement. The Plan is to be submitted to the Department of Transportation, Bureau of Small Business Enterprises, Contract Compliance Section, 2300 South Dirksen Parkway, Room 319, Springfield, Illinois 62764 (Telefax: (217)785-1524). It is the responsibility of the bidder to obtain confirmation of telefax delivery. The Department will not accept a Utilization Plan if it does not meet the seven day submittal requirement and the bid will be declared not responsive. In the event the bid is declared not responsive due to a failure to submit a Plan or failure to comply with the bidding procedures set forth herein, the Department may elect to cause the forfeiture of the

penal sum of the bidder's proposal guaranty, and may deny authorization to bid the project if re-advertised for bids. The Department reserves the right to invite any other bidder to submit a Utilization Plan at any time for award consideration or to extend the time for award.

- (b) The Utilization Plan shall indicate that the bidder either has obtained sufficient DBE participation commitments to meet the contract goal or has not obtained enough DBE participation commitments in spite of a good faith effort to meet the goal. The Utilization Plan shall further provide the name, telephone number, and telefax number of a responsible official of the bidder designated for purposes of notification of plan approval or disapproval under the procedures of this Special Provision.
- (c) The Utilization Plan shall include a DBE Participation Commitment Statement, Department form SBE 2025, for each DBE proposed for the performance of work to achieve the contract goal. The signatures on these forms must be original signatures. All elements of information indicated on the said form shall be provided, including but not limited to the following:
  - (1) The name and address of each DBE to be used;
  - (2) A description, including pay item numbers, of the commercially useful work to be done by each DBE;
  - (3) The price to be paid to each DBE for the identified work specifically stating the quantity, unit price, and total subcontract price for the work to be completed by the DBE. If partial pay items are to be performed by the DBE, indicate the portion of each item, a unit price where appropriate and the subcontract price amount;
  - (4) A commitment statement signed by the bidder and each DBE evidencing availability and intent to perform commercially useful work on the project; and
  - (5) If the bidder is a joint venture comprised of DBE companies and non-DBE companies, the plan must also include a clear identification of the portion of the work to be performed by the DBE partner(s).
- (d) The contract will not be awarded until the Utilization Plan submitted by the bidder is approved. The Utilization Plan will be approved by the Department if the Plan commits sufficient commercially useful DBE work performance to meet the contract goal. The Utilization Plan will not be approved by the Department if the Plan does not commit sufficient DBE performance to meet the contract goal unless the bidder documents that it made a good faith effort to meet the goal. The good faith procedures of Section VIII of this special provision apply. If the Utilization Plan is not approved because it is deficient in a technical matter, unless waived by the Department, the bidder will be notified and will be allowed no less than a five working day period in order to cure the deficiency.

CALCULATING DBE PARTICIPATION. The Utilization Plan values represent work anticipated to be performed and paid for upon satisfactory completion. The Department is only able to count toward the achievement of the overall goal and the contract goal the value of payments made for the work actually performed by DBE companies. In addition, a DBE must perform a commercially useful function on the contract to be counted. A commercially useful function is generally performed when the DBE is responsible for the work and is carrying out its responsibilities by actually performing, managing, and supervising the work involved. The Department and Contractor are governed by the provisions of 49 CFR part 26.55(c) on questions of commercially useful functions as it affects the work. Specific counting guidelines are provided in 49 CFR part 26.55, the provisions of which govern over the summary contained herein.

- (a) DBE as the Contractor: 100 percent goal credit for that portion of the work performed by the DBE's own forces, including the cost of materials and supplies. Work that a DBE subcontracts to a non-DBE does not count toward the DBE goals.
- (b) DBE as a joint venture Contractor: 100 percent goal credit for that portion of the total dollar value of the contract equal to the distinct, clearly defined portion of the work performed by the DBE's own forces.
- (c) DBE as a subcontractor: 100 percent goal credit for the work of the subcontract performed by the DBE's own forces, including the cost of materials and supplies, excluding the purchase of materials and supplies or the lease of equipment by the DBE subcontractor from the prime Contractor or its affiliates. Work that a DBE subcontractor in turn subcontracts to a non-DBE does not count toward the DBE goal.
- (d) DBE as a trucker: 100 percent goal credit for trucking participation provided the DBE is responsible for the management and supervision of the entire trucking operation for which it is responsible. At least one truck owned, operated, licensed, and insured by the DBE must be used on the contract. Credit will be given for the full value of all such DBE trucks operated using DBE employed drivers. Goal credit will be limited to the value of the reasonable fee or commission received by the DBE if trucks are leased from a non-DBE company.
- (e) DBE as a material supplier:
  - (1) 60 percent goal credit for the cost of the materials or supplies purchased from a DBE regular dealer.
  - (2) 100 percent goal credit for the cost of materials or supplies obtained from a DBE manufacturer.
  - (3) 100 percent credit for the value of reasonable fees and commissions for the procurement of materials and supplies if not a regular dealer or manufacturer.

GOOD FAITH EFFORT PROCEDURES. If the bidder cannot obtain sufficient DBE commitments to meet the contract goal, the bidder must document in the Utilization Plan the good faith efforts made in the attempt to meet the goal. This means that the bidder must show that all necessary and reasonable steps were taken to achieve the contract goal. Necessary and reasonable steps are those which could reasonably be expected to obtain sufficient DBE participation. The Department will consider the quality, quantity, and intensity of the kinds of efforts that the bidder has made. Mere *pro forma* efforts are not good faith efforts; rather, the bidder is expected to have taken those efforts that would be reasonably expected of a bidder actively and aggressively trying to obtain DBE participation sufficient to meet the contract goal.

- (a) The following is a list of types of action that the Department will consider as part of the evaluation of the bidder's good faith efforts to obtain participation. These listed factors are not intended to be a mandatory checklist and are not intended to be exhaustive. Other factors or efforts brought to the attention of the Department may be relevant in appropriate cases, and will be considered by the Department.
- (1) Soliciting through all reasonable and available means (e.g. attendance at pre-bid meetings, advertising and/or written notices) the interest of all certified DBE companies that have the capability to perform the work of the contract. The bidder must solicit this interest within sufficient time to allow the DBE companies to respond to the solicitation. The bidder must determine with certainty if the DBE companies are interested by taking appropriate steps to follow up initial solicitations.
  - (2) Selecting portions of the work to be performed by DBE companies in order to increase the likelihood that the DBE goals will be achieved. This includes, where appropriate, breaking out contract work items into economically feasible units to facilitate DBE participation, even when the prime Contractor might otherwise prefer to perform these work items with its own forces.
  - (3) Providing interested DBE companies with adequate information about the plans, specifications, and requirements of the contract in a timely manner to assist them in responding to a solicitation.
  - (4) a. Negotiating in good faith with interested DBE companies. It is the bidder's responsibility to make a portion of the work available to DBE subcontractors and suppliers and to select those portions of the work or material needs consistent with the available DBE subcontractors and suppliers, so as to facilitate DBE participation. Evidence of such negotiation includes the names, addresses, and telephone numbers of DBE companies that were considered; a description of the information provided regarding the plans and specifications for the work selected for subcontracting; and evidence as to why additional agreements could not be reached for DBE companies to perform the work.
    - b. A bidder using good business judgment would consider a number of factors in negotiating with subcontractors, including DBE subcontractors, and would take a firm's price and capabilities as well as contract goals into consideration. However, the fact that there may be some additional costs involved in finding and



using DBE companies is not in itself sufficient reason for a bidder's failure to meet the contract DBE goal, as long as such costs are reasonable. Also, the ability or desire of a bidder to perform the work of a contract with its own organization does not relieve the bidder of the responsibility to make good faith efforts. Bidders are not, however, required to accept higher quotes from DBE companies if the price difference is excessive or unreasonable.

- (5) Not rejecting DBE companies as being unqualified without sound reasons based on a thorough investigation of their capabilities. The bidder's standing within its industry, membership in specific groups, organizations, or associations and political or social affiliations (for example union vs. non-union employee status) are not legitimate causes for the rejection or non-solicitation of bids in the bidder's efforts to meet the project goal.
  - (6) Making efforts to assist interested DBE companies in obtaining bonding, lines of credit, or insurance as required by the recipient or Contractor.
  - (7) Making efforts to assist interested DBE companies in obtaining necessary equipment, supplies, materials, or related assistance or services.
  - (8) Effectively using the services of available minority/women community organizations; minority/women contractors' groups; local, state, and federal minority/women business assistance offices; and other organizations as allowed on a case-by-case basis to provide assistance in the recruitment and placement of DBE companies.
- (b) If the Department determines that the bidder has made a good faith effort to secure the work commitment of DBE companies to meet the contract goal, the Department will award the contract provided that it is otherwise eligible for award. If the Department determines that a good faith effort has not been made, the Department will notify the bidder of that preliminary determination by contacting the responsible company official designated in the Utilization Plan. The preliminary determination shall include a statement of reasons why good faith efforts have not been found, and may include additional good faith efforts that the bidder could take. The notification will designate a five working day period during which the bidder shall take additional efforts. The bidder is not limited by a statement of additional efforts, but may take other action beyond any stated additional efforts in order to obtain additional DBE commitments. The bidder shall submit an amended Utilization Plan if additional DBE commitments to meet the contract goal are secured. If additional DBE commitments sufficient to meet the contract goal are not secured, the bidder shall report the final good faith efforts made in the time allotted. All additional efforts taken by the bidder will be considered as part of the bidder's good faith efforts. If the bidder is not able to meet the goal after taking additional efforts, the Department will make a pre-final determination of the good faith efforts of the bidder and will notify the designated responsible company official of the reasons for an adverse determination.
- (c) The bidder may request administrative reconsideration of a pre-final determination adverse to the bidder within the five working days after the notification date of the

determination by delivering the request to the Department of Transportation, Bureau of Small Business Enterprises, Contract Compliance Section, 2300 South Dirksen Parkway, Room 319, Springfield, Illinois 62764 (Telefax: (217)785-1524). Deposit of the request in the United States mail on or before the fifth business day shall not be deemed delivery. The pre-final determination shall become final if a request is not made and delivered. A request may provide additional written documentation and/or argument concerning the issue of whether an adequate good faith effort was made to meet the contract goal. In addition, the request shall be considered a consent by the bidder to extend the time for award. The request will be forwarded to the Department's Reconsideration Officer. The Reconsideration Officer will extend an opportunity to the bidder to meet in person in order to consider all issues of whether the bidder made a good faith effort to meet the goal. After the review by the Reconsideration Officer, the bidder will be sent a written decision within ten working days after receipt of the request for reconsideration, explaining the basis for finding that the bidder did or did not meet the goal or make adequate good faith efforts to do so. A final decision by the Reconsideration Officer that a good faith effort was made shall approve the Utilization Plan submitted by the bidder and shall clear the contract for award. A final decision that a good faith effort was not made shall render the bid not responsive.

CONTRACT COMPLIANCE. Compliance with this Special Provision is an essential part of the contract. The Department is prohibited by federal regulations from crediting the participation of a DBE included in the Utilization Plan toward either the contract goal or the Department's overall goal until the amount to be applied toward the goals has been paid to the DBE. The following administrative procedures and remedies govern the compliance by the Contractor with the contractual obligations established by the Utilization Plan. After approval of the Plan and award of the contract, the Utilization Plan and individual DBE Participation Statements become part of the contract. If the Contractor did not succeed in obtaining enough DBE participation to achieve the advertised contract goal, and the Utilization Plan was approved and contract awarded based upon a determination of good faith, the total dollar value of DBE work calculated in the approved Utilization Plan as a percentage of the awarded contract value shall become the amended contract goal.

- (a) No amendment to the Utilization Plan may be made without prior written approval from the Department's Bureau of Small Business Enterprises. All requests for amendment to the Utilization Plan shall be submitted to the Department of Transportation, Bureau of Small Business Enterprises, Contract Compliance Section, 2300 South Dirksen Parkway, Room 319, Springfield, Illinois 62764. Telephone number (217) 785-4611. Telefax number (217) 785-1524.
- (b) All work indicated for performance by an approved DBE shall be performed, managed, and supervised by the DBE executing the Participation Statement. The Contractor shall not terminate for convenience a DBE listed in the Utilization Plan and then perform the work of the terminated DBE with its own forces, those of an affiliate or those of another subcontractor, whether DBE or not, without first obtaining the written consent of the Bureau of Small Business Enterprises to amend the Utilization Plan. If a DBE listed in the Utilization Plan is terminated for reasons other than convenience, or fails to complete its work on the contract for any reason, the Contractor shall make good faith efforts to

find another DBE to substitute for the terminated DBE. The good faith efforts shall be directed at finding another DBE to perform at least the same amount of work under the contract as the DBE that was terminated, but only to the extent needed to meet the contract goal or the amended contract goal. The Contractor shall notify the Bureau of Small Business Enterprises of any termination for reasons other than convenience, and shall obtain approval for inclusion of the substitute DBE in the Utilization Plan. If good faith efforts following a termination of a DBE for cause are not successful, the Contractor shall contact the Bureau of Small Business Enterprises and provide a full accounting of the efforts undertaken to obtain substitute DBE participation. The Bureau of Small Business Enterprises will evaluate the good faith efforts in light of all circumstances surrounding the performance status of the contract, and determine whether the contract goal should be amended.

- (c) The Contractor shall maintain a record of payments for work performed to the DBE participants. The records shall be made available to the Department for inspection upon request. After the performance of the final item of work or delivery of material by a DBE and final payment therefor to the DBE by the Contractor, but not later than thirty calendar days after payment has been made by the Department to the Contractor for such work or material, the Contractor shall submit a DBE Payment Agreement on Department form SBE 2115 to the Regional Engineer. If full and final payment has not been made to the DBE, the DBE Payment Agreement shall indicate whether a disagreement as to the payment required exists between the Contractor and the DBE or if the Contractor believes that the work has not been satisfactorily completed. If the Contractor does not have the full amount of work indicated in the Utilization Plan performed by the DBE companies indicated in the Plan, the Department will deduct from contract payments to the Contractor the amount of the goal not achieved as liquidated and ascertained damages.
- (d) The Department reserves the right to withhold payment to the Contractor to enforce the provisions of this Special Provision. Final payment shall not be made on the contract until such time as the Contractor submits sufficient documentation demonstrating achievement of the goal in accordance with this Special Provision or after liquidated damages have been determined and collected.
- (e) Notwithstanding any other provision of the contract, including but not limited to Article 109.09 of the Standard Specifications, the Contractor may request administrative reconsideration of a decision to deduct the amount of the goal not achieved as liquidated damages. A request to reconsider shall be delivered to the Contract Compliance Section and shall be handled and considered in the same manner as set forth in paragraph (c) of "Good Faith Effort Procedures" of this Special Provision, except a final decision that a good faith effort was not made during contract performance to achieve the goal agreed to in the Utilization Plan shall be the final administrative decision of the Department.

## EQUIPMENT RENTAL RATES (BDE)

Effective: August 2, 2007

Revised: January 2, 2008

Replace the second and third paragraphs of Article 105.07(b)(4)a. of the Standard Specifications with the following:

“Equipment idled which cannot be used on other work, and which is authorized to standby on the project site by the Engineer, will be paid for according to Article 109.04(b)(4).”

Replace Article 109.04(b)(4) of the Standard Specifications with the following:

“(4) Equipment. Equipment used for extra work shall be authorized by the Engineer. The equipment shall be specifically described, be of suitable size and capacity for the work to be performed, and be in good operating condition. For such equipment, the Contractor will be paid as follows.

- a. Contractor Owned Equipment. Contractor owned equipment will be paid for by the hour using the applicable FHWA hourly rate from the “Equipment Watch Rental Rate Blue Book” (Blue Book) in effect when the force account work begins. The FHWA hourly rate is calculated as follows.

FHWA hourly rate = (monthly rate/176) x (model year adj.) x (Illinois adj.) + EOC

Where: EOC = Estimated Operating Costs per hour (from the Blue Book)

The time allowed will be the actual time the equipment is operating on the extra work. For the time required to move the equipment to and from the site of the extra work and any authorized idle (standby) time, payment will be made at the following hourly rate: 0.5 x (FHWA hourly rate - EOC).

All time allowed shall fall within the working hours authorized for the extra work.

The rates above include the cost of fuel, oil, lubrication, supplies, small tools, necessary attachments, repairs, overhaul and maintenance of any kind, depreciation, storage, overhead, profits, insurance, and all incidentals. The rates do not include labor.

The Contractor shall submit to the Engineer sufficient information for each piece of equipment and its attachments to enable the Engineer to determine the proper equipment category. If a rate is not established in the Blue Book for a particular piece of equipment, the Engineer will establish a rate for that piece of equipment that is consistent with its cost and use in the industry.

- b. Rented Equipment. Whenever it is necessary for the Contractor to rent equipment to perform extra work, the rental and transportation costs of the equipment plus five percent for overhead will be paid. In no case shall the rental rates exceed those of established distributors or equipment rental agencies.

All prices shall be agreed to in writing before the equipment is used.”

80189

**HOT-MIX ASPHALT - FIELD VOIDS IN THE MINERAL AGGREGATE (BDE)**

Effective: April 1, 2007

Revised: April 1, 2008

Add the following to the table in Article 1030.05(d)(2)a. of the Standard Specifications:

"Parameter	Frequency of Tests	Frequency of Tests	Test Method See Manual of Test Procedures for Materials
	High ESAL Mixture Low ESAL Mixture	All Other Mixtures	
VMA  Note 5.	Day's production ≥ 1200 tons:  1 per half day of production	N/A	Illinois-Modified AASHTO R 35
	Day's production < 1200 tons:  1 per half day of production for first 2 days and 1 per day thereafter (first sample of the day)		

Note 5. The  $G_{sb}$  used in the voids in the mineral aggregate (VMA) calculation shall be the same average  $G_{sb}$  value listed in the mix design."

Add the following to the Control Limits table in Article 1030.05(d)(4) of the Standard Specifications:

"CONTROL LIMITS			
Parameter	High ESAL Low ESAL	High ESAL Low ESAL	All Other
	Individual Test	Moving Avg. of 4	Individual Test
VMA	-0.7 % <sup>2/</sup>	-0.5 % <sup>2/</sup>	N/A

2/ Allowable limit below minimum design VMA requirement"

Add the following to the table in Article 1030.05(d)(5) of the Standard Specifications:

"CONTROL CHART REQUIREMENTS	High ESAL Low ESAL	All Other
	VMA"	

Revise the heading of Article 1030.05(d)(6)a.1. of the Standard Specifications to read:

"1. Voids, VMA, and Asphalt Binder Content."

Revise the first sentence of the first paragraph of Article 1030.05(d)(6)a.1.(a.) of the Standard Specifications to read:

"If the retest for voids, VMA, or asphalt binder content exceeds control limits, HMA production shall cease and immediate corrective action shall be instituted by the Contractor."

Revise the table in Article 1030.05(e) of the Standard Specifications to read:

"Test Parameter	Acceptable Limits of Precision
% Passing: <sup>1/</sup>	
1/2 in. (12.5 mm)	5.0 %
No. 4 (4.75 mm)	5.0 %
No. 8 (2.36 mm)	3.0 %
No. 30 (600 μm)	2.0 %
Total Dust Content No. 200 (75 μm) <sup>1/</sup>	2.2 %
Asphalt Binder Content	0.3 %
Maximum Specific Gravity of Mixture	0.026
Bulk Specific Gravity	0.030
VMA	1.4 %
Density (% Compaction)	1.0 % (Correlated)

1/ Based on washed ignition."

80181

## HOT-MIX ASPHALT – PLANT TEST FREQUENCY (BDE)

Effective: April 1, 2008

Revise the table in Article 1030.05(d)(2)a. of the Standard Specifications to read:

"Parameter	Frequency of Tests	Frequency of Tests	Test Method See Manual of Test Procedures for Materials
	High ESAL Mixture Low ESAL Mixture	All Other Mixtures	
<p>Aggregate Gradation</p> <p>Hot bins for batch and continuous plants.</p> <p>Individual cold-feed or combined belt-feed for drier drum plants.</p> <p>% passing sieves: 1/2 in. (12.5 mm), No. 4 (4.75 mm), No. 8 (2.36 mm), No. 30 (600 μm) No. 200 (75 μm)</p> <p>Note 1.</p>	<p>1 dry gradation per day of production (either morning or afternoon sample).</p> <p>and</p> <p>1 washed ignition oven test on the mix per day of production (conduct in the afternoon if dry gradation is conducted in the morning or vice versa).</p> <p>Note 3.</p> <p>Note 4.</p>	<p>1 gradation per day of production.</p> <p>The first day of production shall be a washed ignition oven test on the mix. Thereafter, the testing shall alternate between dry gradation and washed ignition oven test on the mix.</p> <p>Note 4.</p>	<p>Illinois Procedure</p>
<p>Asphalt Binder Content by Ignition Oven</p> <p>Note 2.</p>	<p>1 per half day of production</p>	<p>1 per day</p>	<p>Illinois-Modified AASHTO T 308</p>
<p>Air Voids</p> <p>Bulk Specific Gravity of Gyratory Sample</p>	<p>Day's production ≥ 1200 tons: 1 per half day of production</p> <p>Day's production &lt; 1200 tons: 1 per half day of production for first 2 days and 1 per day thereafter (first sample of the day)</p>	<p>1 per day</p>	<p>Illinois-Modified AASHTO T 312</p>



"Parameter	Frequency of Tests	Frequency of Tests All Other Mixtures	Test Method See Manual of Test Procedures for Materials
	High ESAL Mixture Low ESAL Mixture		
Maximum Specific Gravity of Mixture	Day's production $\geq$ 1200 tons:  1 per half day of production	1 per day	Illinois-Modified AASHTO T 209"
	Day's production < 1200 tons:  1 per half day of production for first 2 days and 1 per day thereafter (first sample of the day)		

80201

## HOT-MIX ASPHALT – TRANSPORTATION (BDE)

Effective: April 1, 2008

Revise Article 1030.08 of the Standard Specifications to read:

**“1030.08 Transportation.** Vehicles used in transporting HMA shall have clean and tight beds. The beds shall be sprayed with asphalt release agents from the Department’s approved list. In lieu of a release agent, the Contractor may use a light spray of water with a light scatter of manufactured sand (FA 20 or FA 21) evenly distributed over the bed of the vehicle. After spraying, the bed of the vehicle shall be in a completely raised position and it shall remain in this position until all excess asphalt release agent or water has been drained.

When the air temperature is below 60 °F (15 °C), the bed, including the end, endgate, sides and bottom shall be insulated with fiberboard, plywood or other approved insulating material and shall have a thickness of not less than 3/4 in (20 mm). When the insulation is placed inside the bed, the insulation shall be covered with sheet steel approved by the Engineer. Each vehicle shall be equipped with a cover of canvas or other suitable material meeting the approval of the Engineer which shall be used if any one of the following conditions is present.

- (a) Ambient air temperature is below 60 °F (15 °C).
- (b) The weather is inclement.
- (c) The temperature of the HMA immediately behind the paver screed is below 250 °F (120 °C).

The cover shall extend down over the sides and ends of the bed for a distance of approximately 12 in. (300 mm) and shall be fastened securely. The covering shall be rolled back before the load is dumped into the finishing machine.”

80202

**LIQUIDATED DAMAGES (BDE)**

Effective: April 1, 2009

Revise the table in Article 108.09 of the Standard Specifications to read:

"Schedule of Deductions for Each Day of Overrun in Contract Time			
Original Contract Amount		Daily Charges	
From More Than	To and Including	Calendar Day	Work Day
\$ 0	\$ 100,000	\$ 375	\$ 500
100,000	500,000	625	875
500,000	1,000,000	1,025	1,425
1,000,000	3,000,000	1,125	1,550
3,000,000	5,000,000	1,425	1,950
5,000,000	10,000,000	1,700	2,350
10,000,000	And over	3,325	4,650"

80230

**METAL HARDWARE CAST INTO CONCRETE (BDE)**

Effective: April 1, 2008

Revised: April 1, 2009

Add the following to Article 503.02 of the Standard Specifications:

“(g) Metal Hardware Cast into Concrete..... 1006.13”

Add the following to Article 504.02 of the Standard Specifications:

“(j) Metal Hardware Cast into Concrete..... 1006.13”

Revise Article 1006.13 of the Standard Specifications to read:

“**1006.13 Metal Hardware Cast into Concrete.** Unless otherwise noted, all steel hardware cast into concrete, such as inserts, brackets, cable clamps, metal casings for formed holes, and other miscellaneous items, shall be galvanized according to AASHTO M 232 or AASHTO M 111. Aluminum inserts will not be allowed. Zinc alloy inserts shall be according to ASTM B 86, Alloys 3, 5, or 7.

The inserts shall be UNC threaded type anchorages having the following minimum certified proof load.

Insert Diameter	Proof Load
5/8 in. (16 mm)	6600 lb (29.4 kN)
3/4 in. (19 mm)	6600 lb (29.4 kN)
1 in. (25 mm)	9240 lb (41.1 kN)”

80203

**NATIONAL POLLUTANT DISCHARGE ELIMINATION SYSTEM / EROSION AND SEDIMENT CONTROL DEFICIENCY DEDUCTION (BDE)**

Effective: April 1, 2007

Revised: November 1, 2008

Revise Article 105.03(a) of the Standard Specifications to read:

“(a) National Pollutant Discharge Elimination System (NPDES) / Erosion and Sediment Control Deficiency Deduction. When the Engineer is notified or determines an erosion and/or sediment control deficiency(s) exists, or the Contractor's activities represents a violation of the Department's NPDES permits, the Engineer will notify and direct the Contractor to correct the deficiency within a specified time. The specified time, which begins upon notification to the Contractor, will be from 1/2 hour to 1 week based on the urgency of the situation and the nature of the work effort required. The Engineer will be the sole judge.

A deficiency may be any lack of repair, maintenance, or implementation of erosion and/or sediment control devices included in the contract, or any failure to comply with the conditions of the Department's NPDES permits. A deficiency may also be applied to situations where corrective action is not an option such as the failure to participate in a jobsite inspection of the project, failure to install required measures prior to initiating earth moving operations, disregard of concrete washout requirements, or other disregard of the NPDES permit.

If the Contractor fails to correct a deficiency within the specified time, a daily monetary deduction will be imposed for each calendar day or fraction thereof the deficiency exists. The calendar day(s) will begin with notification to the Contractor and end with the Engineer's acceptance of the correction. The daily monetary deduction will be either \$1000.00 or 0.05 percent of the awarded contract value, whichever is greater. For those deficiencies where corrective action was not an option, the monetary deduction will be immediate and will be valued at one calendar day.”

80180

## **PAYMENTS TO SUBCONTRACTORS (BDE)**

Effective: June 1, 2000

Revised: January 1, 2006

Federal regulations found at 49 CFR §26.29 mandate the Department to establish a contract clause to require Contractors to pay subcontractors for satisfactory performance of their subcontracts and to set the time for such payments.

State law also addresses the timing of payments to be made to subcontractors and material suppliers. Section 7 of the Prompt Payment Act, 30 ILCS 540/7, requires that when a Contractor receives any payment from the Department, the Contractor shall make corresponding, proportional payments to each subcontractor and material supplier performing work or supplying material within 15 calendar days after receipt of the Department payment. Section 7 of the Act further provides that interest in the amount of two percent per month, in addition to the payment due, shall be paid to any subcontractor or material supplier by the Contractor if the payment required by the Act is withheld or delayed without reasonable cause. The Act also provides that the time for payment required and the calculation of any interest due applies to transactions between subcontractors and lower-tier subcontractors and material suppliers throughout the contracting chain.

This Special Provision establishes the required federal contract clause, and adopts the 15 calendar day requirement of the State Prompt Payment Act for purposes of compliance with the federal regulation regarding payments to subcontractors. This contract is subject to the following payment obligations.

When progress payments are made to the Contractor according to Article 109.07 of the Standard Specifications, the Contractor shall make a corresponding payment to each subcontractor and material supplier in proportion to the work satisfactorily completed by each subcontractor and for the material supplied to perform any work of the contract. The proportionate amount of partial payment due to each subcontractor and material supplier throughout the contracting chain shall be determined by the quantities measured or otherwise determined as eligible for payment by the Department and included in the progress payment to the Contractor. Subcontractors and material suppliers shall be paid by the Contractor within 15 calendar days after the receipt of payment from the Department. The Contractor shall not hold retainage from the subcontractors. These obligations shall also apply to any payments made by subcontractors and material suppliers to their subcontractors and material suppliers; and to all payments made to lower tier subcontractors and material suppliers throughout the contracting chain. Any payment or portion of a payment subject to this provision may only be withheld from the subcontractor or material supplier to whom it is due for reasonable cause.

This Special Provision does not create any rights in favor of any subcontractor or material supplier against the State or authorize any cause of action against the State on account of any payment, nonpayment, delayed payment, or interest claimed by application of the State Prompt Payment Act. The Department will not approve any delay or postponement of the 15 day requirement except for reasonable cause shown after notice and hearing pursuant to Section

| 7(b) of the State Prompt Payment Act. State law creates other and additional remedies available to any subcontractor or material supplier, regardless of tier, who has not been paid for work properly performed or material furnished. These remedies are a lien against public funds set forth in Section 23(c) of the Mechanics Lien Act, 770 ILCS 60/23(c), and a recovery on the Contractor's payment bond according to the Public Construction Bond Act, 30 ILCS 550.

80022

## **PAYROLLS AND PAYROLL RECORDS (BDE)**

Effective: March 1, 2009

FEDERAL AID CONTRACTS. Revise the following section of Check Sheet #1 of the Recurring Special Provisions to read:

### **"STATEMENTS AND PAYROLLS**

The payroll records shall include each worker's name, address, telephone number, social security number, classification, rate of pay, number of hours worked each day, starting and ending times of work each day, total hours worked each week, itemized deductions made, and actual wages paid.

The Contractor and each subcontractor shall submit payroll records to the Engineer each week from the start to the completion of their respective work, except that full social security numbers and home addresses shall not be included on weekly transmittals. Instead the payrolls shall include an identification number for each employee (e.g., the last four digits of the employee's social security number.). The submittals shall be on the Department's form SBE 48, or an approved facsimile. When there has been no activity during a work week, a payroll record shall still be submitted with the appropriate box ("No Work", "Suspended", or "Complete") checked on the form."

STATE CONTRACTS. Revise Section IV of Check Sheet #5 of the Recurring Special Provisions to read:

### **"IV.COMPLIANCE WITH THE PREVAILING WAGE ACT**

1. **Prevailing Wages.** All wages paid by the Contractor and each subcontractor shall be in compliance with The Prevailing Wage Act (820 ILCS 130), as amended, except where a prevailing wage violates a federal law, order, or ruling, the rate conforming to the federal law, order, or ruling shall govern. The Contractor shall be responsible to notify each subcontractor of the wage rates set forth in this contract and any revisions thereto. If the Department of Labor revises the wage rates, the Contractor will not be allowed additional compensation on account of said revisions.
2. **Payroll Records.** The Contractor and each subcontractor shall make and keep, for a period of three years from the date of completion of this contract, records of the wages paid to his/her workers. The payroll records shall include each worker's name, address, telephone number, social security number, classification, rate of pay, number of hours worked each day, starting and ending times of work each day, total hours worked each week, itemized deductions made, and actual wages paid. Upon two business days' notice, these records shall be available, at all reasonable hours at a location within the State, for inspection by the Department or the Department of Labor.



3. Submission of Payroll Records. The Contractor and each subcontractor shall submit payroll records to the Engineer each week from the start to the completion of their respective work, except that full social security numbers and home addresses shall not be included on weekly transmittals. Instead the payrolls shall include an identification number for each employee (e.g., the last four digits of the employee's social security number). The submittals shall be on the Department's form SBE 48, or an approved facsimile. When there has been no activity during a work week, a payroll record shall still be submitted with the appropriate box ("No Work", "Suspended", or "Complete") checked on the form.

Each submittal shall be accompanied by a statement signed by the Contractor or subcontractor which avers that: (i) such records are true and accurate; (ii) the hourly rate paid to each worker is not less than the general prevailing rate of hourly wages required by the Act; and (iii) the Contractor or subcontractor is aware that filing a payroll record that he/she knows to be false is a Class B misdemeanor.

4. Employee Interviews. The Contractor and each subcontractor shall permit his/her employees to be interviewed on the job, during working hours, by compliance investigators of the Department or the Department of Labor."

80235

**PERSONAL PROTECTIVE EQUIPMENT (BDE)**

Effective: November 1, 2008

Revise the first sentence of Article 701.12 of the Standard Specifications to read:

"All personnel on foot, excluding flaggers, within the highway right-of-way shall wear a fluorescent orange, fluorescent yellow/green, or a combination of fluorescent orange and fluorescent yellow/green vest meeting the requirements of ANSI/ISEA 107-2004 for Conspicuity Class 2 garments."

80209

**PLASTIC BLOCKOUTS FOR GUARDRAIL (BDE)**

Effective: November 1, 2004

Revised: January 1, 2007

Add the following to Article 630.02 of the Standard Specifications:

“(g) Plastic Blockouts (Note 1.)

Note 1. Plastic blockouts may be used in lieu of wood blockouts for steel plate beam guardrail. The plastic blockouts shall be the minimum dimensions shown on the plans and shall be on the Department’s approved list.”

80134

## REFLECTIVE SHEETING ON CHANNELIZING DEVICES (BDE)

Effective: April 1, 2007

Revised: November 1, 2008

Revise the seventh paragraph of Article 1106.02 of the Standard Specifications to read:

"At the time of manufacturing, the retroreflective prismatic sheeting used on channelizing devices shall meet or exceed the initial minimum coefficient of retroreflection as specified in the following table. Measurements shall be conducted according to ASTM E 810, without averaging. Sheeting used on cones, drums and flexible delineators shall be reboundable as tested according to ASTM D 4956. Prestriped sheeting for rigid substrates on barricades shall be white and orange. The sheeting shall be uniform in color and devoid of streaks throughout the length of each roll. The color shall conform to the latest appropriate standard color tolerance chart issued by the U.S. Department of Transportation, Federal Highway Administration, and to the daytime and nighttime color requirements of ASTM D 4956.

Initial Minimum Coefficient of Retroreflection candelas/foot candle/sq ft (candelas/lux/sq m) of material				
Observation Angle (deg.)	Entrance Angle (deg.)	White	Orange	Fluorescent Orange
0.2	-4	365	160	150
0.2	+30	175	80	70
0.5	-4	245	100	95
0.5	+30	100	50	40"

Revise the first sentence of the first paragraph of Article 1106.02(c) of the Standard Specifications to read:

"Barricades and vertical panels shall have alternating white and orange stripes sloping downward at 45 degrees toward the side on which traffic will pass."

Revise the third sentence of the first paragraph of Article 1106.02(d) of the Standard Specifications to read:

"The bottom panels shall be 8 x 24 in. (200 x 600 mm) with alternating white and orange stripes sloping downward at 45 degrees toward the side on which traffic will pass."

80183

## REINFORCEMENT BARS (BDE)

Effective: November 1, 2005

Revised: April 1, 2009

Revise Article 1006.10(a) of the Standard Specifications to read:

“(a) Reinforcement Bars. Reinforcement bars will be accepted according to the current Bureau of Materials and Physical Research Policy Memorandum, “Reinforcement Bar and/or Dowel Bar Plant Certification Procedure”. The Department will maintain an approved list of producers.

(1) Reinforcement Bars (Non-Coated). Reinforcement bars shall be according to ASTM A 706 (A 706M), Grade 60 (420) for deformed bars and the following.

- a. For straight bars furnished in cut lengths and with a well-defined yield point, the yield point shall be determined as the elastic peak load, identified by a halt or arrest of the load indicator before plastic flow is sustained by the bar and dividing it by the nominal cross-sectional area of the bar.
- b. Tensile strength shall be a minimum of 1.20 times the yield strength.
- c. For bars straightened from coils or bars bent from fabrication, there shall be no upper limit on yield strength; and for bar designation Nos. 3 - 6 (10 - 19), the elongation after rupture shall be at least 9%.
- d. Heat Numbers. Bundles or bars at the construction site shall be marked or tagged with heat identification numbers of the bar producer.
- e. Guided Bend Test. Bars may be subject to a guided bend test across two pins which are free to rotate, where the bending force shall be centrally applied with a fixed or rotating pin of a certain diameter as specified in Table 3 of ASTM A 706 (A 706M). The dimensions and clearances of this guided bend test shall be according to ASTM E 190.
- f. Spiral Reinforcement. Spiral reinforcement shall be deformed or plain bars conforming to the above requirements or cold-drawn steel wire conforming to AASHTO M 32.

(2) Epoxy Coated Reinforcement Bars. Epoxy coated reinforcement bars shall be according to Article 1006.10(a)(1) and shall be epoxy coated according to AASHTO M 284 (M 284M) and the following.

- a. Certification. The epoxy coating applicator shall be certified according to the current Bureau of Materials and Physical Research Policy Memorandum, “Epoxy

Coating Plant Certification Procedure". The Department will maintain an approved list.

- b. Coating Thickness. When spiral reinforcement is coated after fabrication, the thickness of the epoxy coating shall be 7 to 20 mils (0.18 to 0.50 mm).
- c. Cutting Reinforcement. Reinforcement bars may be sheared or sawn to length after coating, providing the end damage to the coating does not extend more than 0.5 in. (13 mm) back and the cut is patched before any visible rusting appears. Flame cutting will not be permitted."

80151

## REINFORCEMENT BARS - STORAGE AND PROTECTION (BDE)

Effective: August 1, 2008

Revised: April 1, 2009

Revise Article 508.03 of the Standard Specifications to read:

**508.03 Storage and Protection.** Reinforcement bars shall be stored off the ground using platforms, skids, or other supports; and shall be protected from mechanical injury and from deterioration by exposure. Epoxy coated bars shall be stored on wooden or padded steel cribbing and all systems for handling shall have padded contact areas. The bars or bundles shall not be dragged or dropped.

When epoxy coated bars are stored in a manner where they will be exposed to the weather more than 60 days prior to use, they shall be protected from deterioration such as that caused by sunlight, salt spray, and weather exposure. The protection shall consist of covering with opaque polyethylene sheeting or other suitable opaque material. The covering shall be secured and allow for air circulation around the bars to minimize condensation under the cover.

Covering of the epoxy coated bars will not be required when the bars are installed and tied, or when they are partially incorporated into the concrete."

80206

**SEEDING (BDE)**

Effective: July 1, 2004

Revised: January 1, 2009

Revise the following seeding mixtures shown in Table 1 of Article 250.07 of the Standard Specifications to read:

"Table 1 - SEEDING MIXTURES		
Class – Type	Seeds	lb/acre (kg/hectare)
2 Roadside Mixture 7/	Tall Fescue (Inferno, Tarheel II, Quest, Blade Runner, or Falcon IV)	100 (110)
	Perennial Ryegrass	50 (55)
	Creeping Red Fescue	40 (50)
	Red Top	10 (10)
2A Salt Tolerant Roadside Mixture 7/	Tall Fescue (Inferno, Tarheel II, Quest, Blade Runner, or Falcon IV)	60 (70)
	Perennial Ryegrass	20 (20)
	Red Fescue (Audubon, Sea Link, or Epic)	30 (20)
	Hard Fescue (Rescue 911, Spartan II, or Reliant IV)	30 (20)
	Fults Salt Grass 1/	60 (70)"

Revise Note 7 of Table 1 – Seeding Mixtures of Article 250.07 of the Standard Specifications to read:

“7/ In Districts 1 through 6, the planting times shall be April 1 to June 15 and August 1 to November 1. In Districts 7 through 9, the planting times shall be March 1 to June 1 and August 1 to November 15. Seeding may be performed outside these dates provided the Contractor guarantees a minimum of 75 percent uniform growth over the entire seeded area(s) after a period of establishment. Inspection dates for the period of establishment will be as follows: Seeding conducted in Districts 1 through 6 between June 16 and July 31 will be inspected after April 15 and seeding conducted between November 2 and March 31 will be inspected after September 15. Seeding conducted in Districts 7 through 9 between June 2 and July 31 will be inspected after April 15 and seeding conducted between November 16 and February 28 will be inspected after September 15. The guarantee shall be submitted to the Engineer in writing prior to performing the work. After the period of establishment, areas not exhibiting 75 percent uniform growth shall be interseeded or reseeded, as determined by the Engineer, at no additional cost to the Department.”



Revise Table II of Article 1081.04(c)(6) of the Standard Specifications to read:

TABLE II						
Variety of Seeds	Hard Seed % Max.	Purity % Min.	Pure Live Seed % Min.	Weed % Max.	Secondary * Noxious Weeds No. per oz (kg) Max. Permitted	Notes
Alfalfa	20	92	89	0.50	6 (211)	1/
Clover, Alsike	15	92	87	0.30	6 (211)	2/
Red Fescue, Audubon	0	97	82	0.10	3 (105)	-
Red Fescue, Creeping	-	97	82	1.00	6 (211)	-
Red Fescue, Epic	-	98	83	0.05	1 (35)	-
Red Fescue, Sea Link	-	98	83	0.10	3 (105)	-
Tall Fescue, Blade Runner	-	98	83	0.10	2 (70)	-
Tall Fescue, Falcon IV	-	98	83	0.05	1 (35)	-
Tall Fescue, Inferno	0	98	83	0.10	2 (70)	-
Tall Fescue, Tarheel II	-	97	82	1.00	6 (211)	-
Tall Fescue, Quest	0	98	83	0.10	2 (70)	-
Fults Salt Grass	0	98	85	0.10	2 (70)	-
Kentucky Bluegrass	-	97	80	0.30	7 (247)	4/
Oats	-	92	88	0.50	2 (70)	3/
Redtop	-	90	78	1.80	5 (175)	3/
Ryegrass, Perennial, Annual	-	97	85	0.30	5 (175)	3/
Rye, Grain, Winter	-	92	83	0.50	2 (70)	3/
Hard Fescue, Reliant IV	-	98	83	0.05	1 (35)	-
Hard Fescue, Rescue 911	0	97	82	0.10	3 (105)	-
Hard Fescue, Spartan II	-	98	83	0.10	3 (105)	-
Timothy	-	92	84	0.50	5 (175)	3/
Wheat, hard Red Winter	-	92	89	0.50	2 (70)	3/

Revise the first sentence of the first paragraph of Article 1081.04(c)(7) of the Standard Specifications to read:

"The seed quantities indicated per acre (hectare) for Prairie Grass Seed in Classes 3, 3A, 4, 4A, 6, and 6A in Article 250.07 shall be the amounts of pure, live seed per acre (hectare) for each species listed."

80131

## **SELF-CONSOLIDATING CONCRETE FOR CAST-IN-PLACE CONSTRUCTION (BDE)**

Effective: November 1, 2005

Revised: January 1, 2009

Definition. Self-consolidating concrete is a flowable mixture that does not require mechanical vibration for consolidation.

Usage. Self-consolidating concrete may be used for cast-in-place concrete construction items involving Class MS, DS, and SI concrete.

Materials. Materials shall be according to Section 1021 of the Standard Specifications.

Mix Design Criteria. Article 1020.04 of the Standard Specifications shall apply, except as follows:

- (a) The cement factor shall be according to Article 1020.04 of the Standard Specifications. If the maximum cement factor is not specified, it shall not exceed 7.05 cwt/cu yd (418 kg/cu m). The cement factor shall not be reduced if a water-reducing, retarding, or high range water-reducing admixture is used.
- (b) The maximum allowable water/cement ratio shall be according to Article 1020.04 of the Standard Specifications or 0.44, whichever is lower.
- (c) The slump requirements shall not apply.
- (d) The coarse aggregate gradations shall be CA 13, CA 14, CA 16, or a blend of these gradations. CA 11 may be used when the Contractor provides satisfactory evidence to the Engineer that the mix will not segregate. The fine aggregate proportion shall be a maximum 50 percent by weight (mass) of the total aggregate used.
- (e) The slump flow range shall be  $\pm 2$  in. ( $\pm 50$  mm) of the Contractor target value, and within the overall Department range of 20 in. (510 mm) minimum to 28 in. (710 mm) maximum.
- (f) The visual stability index shall be a maximum of 1.
- (g) The J-ring value shall be a maximum of 4 in. (100 mm). The Contractor may specify a lower maximum in the mix design.
- (h) The L-box blocking ratio shall be a minimum of 60 percent. The Contractor may specify a higher minimum in the mix design.
- (i) The column segregation index shall be a maximum 15 percent.
- (j) The hardened visual stability index shall be a maximum of 1.

Test Methods. Illinois Test Procedures SCC-1, SCC-2, SCC-3, SCC-4, SCC-5, SCC-6, and Illinois Modified AASHTO T 22, 23, 121, 126, 141, 152, 177, 196, and 309 shall be used for testing of self-consolidating concrete mixtures.

Mix Design Submittal. The Contractor's Level III PCC Technician shall submit a mix design according to the "Portland Cement Concrete Level III Technician" course manual, except target slump information is not applicable and will not be required. However, a slump flow target range shall be submitted. In addition, the design mortar factor may exceed 1.10 and durability test data will be waived.

A J-ring value shall be submitted if a lower mix design maximum will apply. An L-box blocking ratio shall be submitted if a higher mix design minimum will apply. The Contractor shall also indicate applicable construction items for the mix design.

Trial mixture information will be required by the Engineer. A trial mixture is a batch of concrete tested by the Contractor to verify the Contractor's mix design will meet specification requirements. Trial mixture information shall include test results as specified in the "Portland Cement Concrete Level III Technician" course manual. Test results shall also include slump flow, visual stability index, J-ring value, L-box blocking ratio, column segregation index, and hardened visual stability index. For the trial mixture, the slump flow shall be near the midpoint of the proposed slump flow target range.

Trial Batch. A minimum 2 cu yd (1.5 cu m) trial batch shall be produced, and the self-consolidating concrete admixture dosage proposed by the Contractor shall be used. The slump flow shall be within 1.0 in. (25 mm) of the maximum slump flow range specified by the Contractor, and the air content shall be within the top half of the allowable specification range.

The trial batch shall be scheduled a minimum of 21 calendar days prior to anticipated use and shall be performed in the presence of the Engineer.

The Contractor shall provide the labor, equipment, and materials to test the concrete. The mixture will be evaluated by the Engineer for strength, air content, slump flow, visual stability index, J-ring value, L-box blocking ratio, column segregation index, and hardened visual stability index.

Upon review of the test data from the trial batch, the Engineer will verify or deny the use of the mix design and notify the Contractor. Verification by the Engineer will include the Contractor's target slump flow range. If applicable, the Engineer will verify the Contractor's maximum J-ring value and minimum L-box blocking ratio.

A new trial batch will be required whenever there is a change in the source of any component material, proportions beyond normal field adjustments, dosage of the self-consolidating concrete admixture, batch sequence, mixing speed, mixing time, or as determined by the Engineer. The testing criteria for the new trial batch will be determined by the Engineer.

When necessary, the trial batches shall be disposed of according to Article 202.03 of the Standard Specifications.

Mixing Portland Cement Concrete. In addition to Article 1020.11 of the Standard Specifications, the mixing time for central-mixed concrete shall not be reduced as a result of a mixer performance test. Truck-mixed or shrink-mixed concrete shall be mixed in a truck mixer for a minimum of 100 revolutions.

Wash water, if used, shall be completely discharged from the drum or container before the succeeding batch is introduced.

The batch sequence, mixing speed, and mixing time shall be appropriate to prevent cement balls and mix foaming for central-mixed, truck-mixed, and shrink-mixed concrete.

Falsework and Forms. In addition to Articles 503.05 and 503.06 of the Standard Specifications, the Contractor shall ensure the design of the falsework and forms is adequate for the additional form pressure caused by the fluid concrete. Forms shall be tight to prevent leakage of fluid concrete.

When the form height for placing the self-consolidating concrete is greater than 10.0 ft (3.0 m), direct monitoring of form pressure shall be performed according to Illinois Test Procedure SCC-10. The monitoring requirement is a minimum, and the Contractor shall remain responsible for adequate design of the falsework and forms. A minimum of one sensor will be required below each point of concrete placement to measure the maximum pressure. The first sensor below the point of concrete placement shall be approximately 12 in. (300 mm) above the base of the formwork. Additional sensors shall be installed above the bottom sensor when the form height is greater than 10.0 ft (3.0 m) above the bottom sensor. The additional sensors shall be installed at a maximum vertical spacing of 10.0 ft (3.0 m). The Contractor shall record the formwork pressure during concrete placement. This information shall be used by the Contractor to prevent the placement rate from exceeding the maximum formwork pressure allowed, to monitor the thixotropic change in the concrete during the pour, and to make appropriate adjustments to the mix design. This information shall be provided to the Engineer during the pour.

Placing and Consolidating. Concrete placement and consolidation shall be according to Article 503.07 of the Standard Specifications, except as follows:

Revise the third paragraph of Article 503.07 of the Standard Specifications to read:

“Open troughs and chutes shall extend as nearly as practicable to the point of deposit. The drop distance of concrete shall not exceed 5 ft (1.5 m). If necessary, a tremie shall be used to meet this requirement. The maximum distance of horizontal flow from the point of deposit shall be 25 ft (7.6 m), unless approved otherwise by the Engineer. For drilled shafts, free fall placement will not be permitted.”

Delete the seventh, eighth, ninth, and tenth paragraphs of Article 503.07 of the Standard Specifications.

Add to the end of the eleventh paragraph of Article 503.07 of the Standard Specifications the following:

"Concrete shall be rodded with a piece of lumber, conduit, or vibrator if the material has lost its fluidity prior to placement of additional concrete. The vibrator shall be the pencil head type with a maximum diameter or width of 1 in. (25 mm). Any other method for restoring the fluidity of the concrete shall be approved by the Engineer."

Quality Control by Contractor at Plant. The specified test frequencies for aggregate gradation, aggregate moisture, air content, unit weight/yield, and temperature shall be performed as indicated in the contract.

Slump flow, visual stability index, and J-ring or L-box tests shall be performed as needed to control production. The column segregation index test and hardened visual stability index test will not be required to be performed at the plant.

Quality Control by Contractor at Jobsite. The specified test frequencies for air content, strength, and temperature shall be performed as indicated in the contract.

Slump flow, visual stability index, and J-ring or L-box tests shall be performed on the first two truck deliveries of the day, and every 50 cu yd (40 cu m) thereafter. The Contractor shall select either the J-ring or L-box test for jobsite testing.

The column segregation index test will not be required to be performed at the jobsite. The hardened visual stability index test shall be performed on the first truck delivery of the day, and every 300 cu yd (230 cu m) thereafter. Slump flow, visual stability index, J-ring value or L-box blocking ratio, air content, and concrete temperature shall be recorded for each hardened visual stability index test.

The Contractor shall retain all hardened visual stability index cut cylinder specimens until the Engineer notifies the Contractor that the specimens may be discarded.

If mix foaming or other potential detrimental material is observed during placement or at the completion of the pour, the material shall be removed while the concrete is still plastic.

Quality Assurance by Engineer at Plant. For air content and aggregate gradation, quality assurance independent sample testing and split sample testing will be performed as indicated in the contract.

For slump flow, visual stability index, and J-ring or L-box tests, quality assurance independent sample testing and split sample testing will be performed as determined by the Engineer.

Quality Assurance by Engineer at Jobsite. For air content and strength, quality assurance independent sample testing and split sample testing will be performed as indicated in the contract.

For slump flow, visual stability index, J-ring or L-box, and hardened visual stability index tests, quality assurance independent sample testing will be performed as determined by the Engineer.

For slump flow and visual stability index quality assurance split sample testing, the Engineer will perform tests at the beginning of the project on the first three tests performed by the Contractor. Thereafter, a minimum of ten percent of total tests required of the Contractor will be performed per plant, which will include a minimum of one test per mix design. The acceptable limit of precision will be 1.5 in. (40 mm) for slump flow and a limit of precision will not apply to the visual stability index.

For the J-ring or the L-box quality assurance split sample testing, a minimum of 80 percent of the total tests required of the Contractor will be witnessed by the Engineer per plant, which will include a minimum of one witnessed test per mix design. The Engineer reserves the right to conduct quality assurance split sample testing. The acceptable limit of precision will be 1.5 in. (40 mm) for the J-ring value and ten percent for the L-box blocking ratio.

For each hardened visual stability index test performed by the Contractor, the cut cylinders shall be presented to the Engineer for determination of the rating. The Engineer reserves the right to conduct quality assurance split sample testing. A limit of precision will not apply to the hardened visual stability index.

80152

## **SELF-CONSOLIDATING CONCRETE FOR PRECAST PRODUCTS (BDE)**

Effective: July 1, 2004

Revised: January 1, 2007

Definition. Self-consolidating concrete is a flowable mixture that does not require mechanical vibration for consolidation.

Usage. Self-consolidating concrete may be used for precast concrete products.

Materials. Materials shall be according to Section 1021 of the Standard Specifications.

Mix Design Criteria. The mix design criteria shall be as follows:

- (a) The minimum cement factor shall be according to Article 1020.04 of the Standard Specifications. If the maximum cement factor is not specified, it shall not exceed 7.05 cwt/cu yd (418 kg/cu m).
- (b) The maximum allowable water/cement ratio shall be according to Article 1020.04 of the Standard Specifications or 0.44, whichever is lower.
- (c) The slump requirements of Article 1020.04 of the Standard Specifications shall not apply.
- (d) The coarse aggregate gradations shall be CA 13, CA 14, CA 16, or a blend of these gradations. CA 11 may be used when the Contractor provides satisfactory evidence to the Engineer that the mix will not segregate. The fine aggregate proportion shall be a maximum 50 percent by weight (mass) of the total aggregate used.
- (e) The slump flow range shall be  $\pm 2$  in. ( $\pm 50$  mm) of the Contractor target value, and within the overall Department range of 20 in. (510 mm) minimum to 28 in. (710 mm) maximum.
- (f) The visual stability index shall be a maximum of 1.
- (g) The J-ring value shall be a maximum of 4 in. (100 mm). The Contractor may specify a lower maximum in the mix design.
- (h) The L-box blocking ratio shall be a minimum of 60 percent. The Contractor may specify a higher minimum in the mix design.
- (i) The column segregation index shall be a maximum 15 percent.
- (j) The hardened visual stability index shall be a maximum of 1.

Placing and Consolidating. The maximum distance of horizontal flow from the point of deposit shall be 25 ft (7.6 m), unless approved otherwise by the Engineer.

Concrete shall be rodded with a piece of lumber, conduit, or vibrator if the material has lost its fluidity prior to placement of additional concrete. The vibrator shall be the pencil head type with a maximum diameter or width of 1 in. (25 mm). Any other method for restoring the fluidity of the concrete shall be approved by the Engineer.

Mix Design Approval. The Contractor shall obtain mix design approval according to the Department's Policy Memorandum "Quality Control/Quality Assurance Program for Precast Concrete Products".

80132



## **SILT FILTER FENCE (BDE)**

Effective: January 1, 2008

For silt filter fence fabric only, revise Article 1080.02 of the Standard Specifications to read:

**"1080.02 Geotextile Fabric.** The fabric for silt filter fence shall be a woven fabric meeting the requirements of AASHTO M 288 for unsupported silt fence with less than 50 percent geotextile elongation."

Replace the last sentence of Article 1081.15(b) of the Standard Specifications with the following:

"Silt filter fence stakes shall be a minimum of 4 ft (1.2 m) long and made of either wood or metal. Wood stakes shall be 2 in. x 2 in. (50 mm x 50 mm). Metal stakes shall be a standard T or U shape having a minimum weight (mass) of 1.32 lb/ft (600 g/300 mm)."

80197

## STEEL PLATE BEAM GUARDRAIL (BDE)

Effective: November 1, 2005

Revised: August 1, 2007

Revise the first paragraph of Article 1006.25 of the Standard Specifications to read:

**"1006.25 Steel Plate Beam Guardrail.** Steel plate beam guardrail, including bolts, nuts, and washers, shall be according to AASHTO M 180. The guardrail shall be Class A, with a Type II galvanized coating; except the weight (mass) of the coating for each side of the guardrail shall be at least 2.00 oz/sq ft (610 g/sq m). The coating will be determined for each side of the guardrail using the average of at least three non-destructive test readings taken on that side of the guardrail. The minimum average thickness for each side shall be 3.4 mils (86  $\mu$ m)."

80153

## **SUBCONTRACTOR MOBILIZATION PAYMENTS (BDE)**

Effective: April 2, 2005

To account for the preparatory work and operations necessary for the movement of subcontractor personnel, equipment, supplies, and incidentals to the project site and for all other work or operations that must be performed or costs incurred when beginning work approved for subcontracting in accordance with Article 108.01 of the Standard Specifications, the Contractor shall make a mobilization payment to each subcontractor.

This mobilization payment shall be made at least 14 days prior to the subcontractor starting work. The amount paid shall be equal to 3 percent of the amount of the subcontract reported on form BC 260A submitted for the approval of the subcontractor's work.

This provision shall be incorporated directly or by reference into each subcontract approved by the Department.

80143

## **TEMPORARY EROSION CONTROL (BDE)**

Effective: November 1, 2002

Revised: January 1, 2008

Revise the third paragraph of Article 280.03 of the Standard Specifications to read:

"Erosion control systems shall be installed prior to beginning any activities which will potentially create erodible conditions. Erosion control systems for areas outside the limits of construction such as storage sites, plant sites, waste sites, haul roads, and Contractor furnished borrow sites shall be installed prior to beginning soil disturbing activities at each area. These offsite systems shall be designed by the Contractor and be subject to the approval of the Engineer."

Add the following paragraph after the third paragraph of Article 280.03 of the Standard Specifications:

"The temporary erosion and sediment control systems shown on the plans represent the minimum systems anticipated for the project. Conditions created by the Contractor's operations, or for the Contractor's convenience, which are not covered by the plans, shall be protected as directed by the Engineer at no additional cost to the Department. Revisions or modifications of the erosion and sediment control systems shall have the Engineer's written approval."

Add the following paragraph after the ninth paragraph of Article 280.07 of the Standard Specifications:

"Temporary or permanent erosion control systems required for areas outside the limits of construction will not be measured for payment."

Delete the tenth (last) paragraph of Article 280.08 of the Standard Specifications.

80087

## THERMOPLASTIC PAVEMENT MARKINGS (BDE)

Effective: January 1, 2007

Revise Article 1095.01(a)(2) of the Standard Specifications to read:

"(2) Pigment. The pigment used for the white thermoplastic compound shall be a high-grade pure (minimum 93 percent) titanium dioxide (TiO<sub>2</sub>). The white pigment content shall be a minimum of ten percent by weight and shall be uniformly distributed throughout the thermoplastic compound.

The pigments used for the yellow thermoplastic compound shall not contain any hazardous materials listed in the Environmental Protection Agency Code of Federal Regulations (CFR) 40, Section 261.24, Table 1. The combined total of RCRA listed heavy metals shall not exceed 100 ppm when tested by X-ray fluorescence spectroscopy. The pigments shall also be heat resistant, UV stable and color-fast yellows, golds, and oranges, which shall produce a compound which shall match Federal Standard 595 Color No. 33538. The pigment shall be uniformly distributed throughout the thermoplastic compound."

Revise Article 1095.01(b)(1)e. of the Standard Specifications to read:

"e. Daylight Reflectance and Color. The thermoplastic compound after heating for four hours ± five minutes at 425 ± 3 °F (218.3 ± 2 °C) and cooled at 77 °F (25 °C) shall meet the following requirements for daylight reflectance and color, when tested, using a color spectrophotometer with 45 degree circumferential/zero degree geometry, illuminant C, and two degree observer angle. The color instrument shall measure the visible spectrum from 380 to 720 nm with a wavelength measurement interval and spectral bandpass of 10 nm.

White: Daylight Reflectance .....75 percent min.

\*Yellow: Daylight Reflectance .....45 percent min.

\*Shall meet the coordinates of the following color tolerance chart.

x	0.490	0.475	0.485	0.530
y	0.470	0.438	0.425	0.456"

Revise Article 1095.01(b)(1)k. of the Standard Specifications to read:

"k. Accelerated Weathering. After heating the thermoplastic for four hours ± five minutes at 425 ± 3 °F (218.3 ± 2 °C) the thermoplastic shall be applied to a steel wool abraded aluminum alloy panel (Federal Test Std. No. 141, Method 2013) at a film thickness of 30 mils (0.70 mm) and allowed to cool for 24 hours at room temperature. The coated panel shall be subjected to accelerated weathering

using the light and water exposure apparatus (fluorescent UV - condensation type) for 75 hours according to ASTM G 53 (equipped with UVB-313 lamps).

The cycle shall consist of four hours UV exposure at 122 °F (50 °C) followed by four hours of condensation at 104 °F (40 °C). UVB 313 bulbs shall be used. At the end of the exposure period, the panel shall not exceed 10 Hunter Lab Delta E units from the original material."

80176

**TRAINING SPECIAL PROVISIONS (BDE)** This Training Special Provision supersedes Section 7b of the Special Provision entitled "Specific Equal Employment Opportunity Responsibilities," and is in implementation of 23 U.S.C. 140(a).

As part of the contractor's equal employment opportunity affirmative action program, training shall be provided as follows:

The contractor shall provide on-the-job training aimed at developing full journeyman in the type of trade or job classification involved. The number of trainees to be trained under this contract will be 2. In the event the contractor subcontracts a portion of the contract work, he shall determine how many, if any, of the trainees are to be trained by the subcontractor, provided however, that the contractor shall retain the primary responsibility for meeting the training requirements imposed by this special provision. The contractor shall also insure that this Training Special Provision is made applicable to such subcontract. Where feasible, 25 percent of apprentices or trainees in each occupation shall be in their first year of apprenticeship or training.

The number of trainees shall be distributed among the work classifications on the basis of the contractor's needs and the availability of journeymen in the various classifications within the reasonable area of recruitment. Prior to commencing construction, the contractor shall submit to the Illinois Department of Transportation for approval the number of trainees to be trained in each selected classification and training program to be used. Furthermore, the contractor shall specify the starting time for training in each of the classifications. The contractor will be credited for each trainee employed by him on the contract work who is currently enrolled or becomes enrolled in an approved program and will be reimbursed for such trainees as provided hereinafter.

Training and upgrading of minorities and women toward journeyman status is a primary objective of this Training Special Provision. Accordingly, the contractor shall make every effort to enroll minority trainees and women (e.g. by conducting systematic and direct recruitment through public and private sources likely to yield minority and women trainees) to the extent such persons are available within a reasonable area of recruitment. The contractor will be responsible for demonstrating the steps that he has taken in pursuance thereof, prior to a determination as to whether the contractor is in compliance with this Training Special Provision. This training commitment is not intended, and shall not be used, to discriminate against any applicant for training, whether a member of a minority group or not.

No employee shall be employed as a trainee in any classification in which he has successfully completed a training course leading to journeyman status or in which he has been employed as a journeyman. The contractor should satisfy this requirement by including appropriate questions in the employee application or by other suitable means. Regardless of the method used the contractor's records should document the findings in each case.

The minimum length and type of training for each classification will be as established in the training program selected by the contractor and approved by the Illinois Department of Transportation and the Federal Highway Administration. The Illinois Department of Transportation and the Federal Highway Administration shall approve a program, if it is reasonably calculated to meet the equal employment opportunity obligations of the contractor and to qualify the average trainee for journeyman status in the classification concerned by the end of the training period. Furthermore, apprenticeship programs registered with the U.S. Department of Labor, Bureau of Apprenticeship and Training, or with a State apprenticeship agency recognized by the Bureau and training programs approved by not necessarily sponsored by the U.S. Department of Labor, Manpower Administration, Bureau of Apprenticeship and Training shall also be considered acceptable provided it is being administered in a manner consistent with the equal employment obligations of Federal-aid highway construction contracts. Approval or acceptance of a training program shall be obtained from the State prior to commencing work on the classification covered by the program. It is the intention of these provisions that training is to be provided in the construction crafts rather than clerk-typists or secretarial-type positions. Training is permissible in lower level management positions such as office engineers, estimators, timekeepers, etc., where the training is oriented toward construction applications. Training in the laborer classification may be permitted provided that significant and meaningful training is provided and approved by the Illinois Department of Transportation and the Federal Highway Administration. Some offsite training is permissible as long as the training is an integral part of an approved training program and does not comprise a significant part of the overall training.

Except as otherwise noted below, the contractor will be reimbursed 80 cents per hour of training given an employee on this contract in accordance with an approved training program. As approved by the Engineer, reimbursement will be made for training of persons in excess of the number specified herein. This reimbursement will be made even though the contractor receives additional training program funds from other sources, provided such other source does not specifically prohibit the contractor from receiving other reimbursement. Reimbursement for offsite training indicated above may only be made to the contractor where he does one or more of the following and the trainees are concurrently employed on a Federal-aid project; contributes to the cost of the training, provides the instruction to the trainee or pays the trainee's wages during the offsite training period.

No payment shall be made to the contractor if either the failure to provide the required training, or the failure to hire the trainee as a journeyman, is caused by the contractor and evidences a lack of good faith on the part of the contractor in meeting the requirement of this Training Special Provision. It is normally expected that a trainee will begin his training on the project as soon as feasible after start of work utilizing the skill involved and remain on the project as long as training opportunities exist in his work classification or until he has completed his training program.

It is not required that all trainees be on board for the entire length of the contract. A contractor will have fulfilled his responsibilities under this Training Special Provision if he has provided acceptable training to the number of trainees specified. The number trained shall be determined on the basis of the total number enrolled on the contract for a significant period.



Trainees will be paid at least 60 percent of the appropriate minimum journeyman's rate specified in the contract for the first half of the training period, 75 percent for the third quarter of the training period, and 90 percent for the last quarter of the training period, unless apprentices or trainees in an approved existing program are enrolled as trainees on this project. In that case, the appropriate rates approved by the Departments of Labor or Transportation in connection with the existing program shall apply to all trainees being trained for the same classification who are covered by this Training Special Provision.

The contractor shall furnish the trainee a copy of the program he will follow in providing the training. The contractor shall provide each trainee with a certification showing the type and length of training satisfactorily complete.

The contractor will provide for the maintenance of records and furnish periodic reports documenting his performance under this Training Special Provision.

METHOD OF MEASUREMENT The unit of measurement is in hours.

BASIS OF PAYMENT This work will be paid for at the contract unit price of 80 cents per hour for TRAINEES. The estimated total number of hours, unit price and total price have been included in the schedule of prices.

20338

**REQUIRED CONTRACT PROVISIONS  
FEDERAL-AID CONSTRUCTION CONTRACTS**

	Page
I. General .....	1
II. Nondiscrimination .....	1
III. Nonsegregated Facilities .....	3
IV. Payment of Predetermined Minimum Wage.....	3
V. Statements and Payrolls .....	5
VI. Record of Materials, Supplies, and Labor.....	6
VII. Subletting or Assigning the Contract.....	6
VIII. Safety: Accident Prevention .....	7
IX. False Statements Concerning Highway Projects.....	7
X. Implementation of Clean Air Act and Federal Water Pollution Control Act .....	7
XI. Certification Regarding Debarment, Suspension, Ineligibility, and Voluntary Exclusion .....	8
XII. Certification Regarding Use of Contract Funds for Lobbying .....	9

**ATTACHMENTS**

**A. Employment Preference for Appalachian Contracts  
(included in Appalachian contracts only)**

**I. GENERAL**

1. These contract provisions shall apply to all work performed on the contract by the contractor's own organization and with the assistance of workers under the contractor's immediate superintendence and to all work performed on the contract by piecework, station work, or by subcontract.

2. Except as otherwise provided for in each section, the contractor shall insert in each subcontract all of the stipulations contained in these Required Contract Provisions, and further require their inclusion in any lower tier subcontract or purchase order that may in turn be made. The Required Contract Provisions shall not be incorporated by reference in any case. The prime contractor shall be responsible for compliance by any subcontractor or lower tier subcontractor with these Required Contract Provisions.

3. A breach of any of the stipulations contained in these Required Contract Provisions shall be sufficient grounds for termination of the contract.

4. A breach of the following clauses of the Required Contract Provisions may also be grounds for debarment as provided in 29 CFR 5.12:

- Section I, paragraph 2;
- Section IV, paragraphs 1, 2, 3, 4 and 7;
- Section V, paragraphs 1 and 2a through 2g.

5. Disputes arising out of the labor standards provisions of Section IV (except paragraph 5) and Section V of these Required Contract Provisions shall not be subject to the general disputes clause of this contract. Such disputes shall be resolved in accordance with the procedures of the U.S. Department of Labor (DOL) as set forth in 29 CFR 5, 6 and 7. Disputes within the meaning of this clause include disputes between the contractor (or any of its subcontractors) and the contracting agency, the DOL, or the contractor's employees or their representatives.

6. Selection of Labor: During the performance of this contract, the contractor shall not:

- a. Discriminate against labor from any other State, possession, or territory of the United States (except for employment preference for Appalachian contracts, when applicable, as specified in Attachment A), or

- b. Employ convict labor for any purpose within the limits of the project unless it is labor performed by convicts who are on parole, supervised release, or probation.

**II. NONDISCRIMINATION**

(Applicable to all Federal-aid construction contracts and to all related subcontracts of \$10,000 or more.)

**1. Equal Employment Opportunity:** Equal employment opportunity (EEO) requirements not to discriminate and to take affirmative action to assure equal opportunity as set forth under laws, executive orders, rules, regulations (28 CFR 35, 29 CFR 1630 and 41 CFR 60 (and orders of the Secretary of Labor as modified by the provisions prescribed herein, and imposed pursuant to 23 U.S.C. 140 shall constitute the EEO and specific affirmative action standards for the contractor's project activities under this contract. The Equal Opportunity Construction Contract Specifications set forth under 41 CFR 60-4.3 and the provisions of the American Disabilities Act of 1990 (42 U.S.C. 12101 et seq.) set forth under 28 CFR 35 and 29 CFR 1630 are incorporated by reference in this contract. In the execution of this contract, the contractor agrees to comply with the following minimum specific requirement activities of EEO:

- a. The contractor will work with the State highway agency (SHA) and the Federal Government in carrying out EEO obligations and in their

review of his/her activities under the contract.

- b. The contractor will accept as his operating policy the following

statement: "It is the policy of this Company to assure that applicants are employed, and that employees are treated during employment, without regard to their race, religion, sex, color, national origin, age or disability. Such action shall include: employment, upgrading, demotion, or transfer; recruitment or recruitment advertising; layoff or termination; rates of pay or other forms of compensation; and selection for training, including apprenticeship, preapprenticeship, and/or on-the-job-training."

**2. EEO Officer:** The contractor will designate and make known to the SHA contracting officers an EEO Officer who will have the responsibility for an must be capable of effectively administering and promoting an active contractor program of EEO and who must be assigned adequate authority and responsibility to do so.

**3. Dissemination of Policy:** All members of the contractor's staff who are authorized to hire, supervise, promote, and discharge employees, or who recommend such action, or who are substantially involved in such action, will be made fully cognizant of, and will implement, the contractor's EEO policy and contractual responsibilities to provide EEO in each grade and classification of employment. To ensure that the above agreement will be met, the following actions will be taken as a minimum:

- a. Periodic meetings of supervisory and personnel office employees will be conducted before the start of work and then not less often than once every six months, at which time the contractor's EEO policy and its implementation will be reviewed and explained. The meetings will be conducted by the EEO Officer.

- b. All new supervisory or personnel office employees will be given a thorough indoctrination by the EEO Officer, covering all major aspects of the contractor's EEO obligations within thirty days following their reporting for duty with the contractor.

- c. All personnel who are engaged in direct recruitment for the project will be instructed by the EEO Officer in the contractor's procedures for locating and hiring minority group employees.

- d. Notices and posters setting forth the contractor's EEO policy will be placed in areas readily accessible to employees,

applicants for employment and potential employees.

e. The contractor's EEO policy and the procedures to implement such policy will be brought to the attention of employees by means of meetings, employee handbooks, or other appropriate means.

**4. Recruitment:** When advertising for employees, the contractor will include in all advertisements for employees the notation: "An Equal Opportunity Employer." All such advertisements will be placed in publications having a large circulation among minority groups in the area from which the project work force would normally be derived.

a. The contractor will, unless precluded by a valid bargaining agreement, conduct systematic and direct recruitment through public and private employees referral sources likely to yield qualified minority group applicants. To meet this requirement, the contractor will identify sources of potential minority group employees, and establish which such identified sources procedures whereby minority group applicants may be referred to the contractor for employment consideration.

b. In the event the contractor has a valid bargaining agreement providing for exclusive hiring hall referrals, he is expected to observe the provisions of that agreement to the extent that the system permits the contractor's compliance with EEO contract provisions. (The DOL has held that where implementation of such agreements have the effect of discriminating against minorities or women, or obligates the contractor to do the same, such implementation violates Executive Order 11246, as amended.)

c. The contractor will encourage his present employees to refer minority group applicants for employment. Information and procedures with regard to referring minority group applicants will be discussed with employees.

**5. Personnel Actions:** Wages, working conditions, and employee benefits shall be established and administered, and personnel actions of every type, including hiring, upgrading, promotion, transfer, demotion, layoff, and termination, shall be taken without regard to race, color, religion, sex, national origin, age or disability. The following procedures shall be followed:

a. The contractor will conduct periodic inspections of project sites to insure that working conditions and employee facilities do not indicate discriminatory treatment of project site personnel.

b. The contractor will periodically evaluate the spread of wages paid within each classification to determine any evidence of discriminatory wage practices.

c. The contractor will periodically review selected personnel actions in depth to determine whether there is evidence of discrimination. Where evidence is found, the contractor will promptly take corrective action. If the review indicates that the discrimination may extend beyond the actions reviewed, such corrective action shall include all affected persons.

d. The contractor will promptly investigate all complaints of alleged discrimination made to the contractor in connection with his obligations under this contract, will attempt to resolve such complaints, and will take appropriate corrective action within a reasonable time. If the investigation indicates that the discrimination may affect persons other than the complainant, such corrective action shall include such other persons. Upon completion of each investigation, the contractor will inform every complainant of all of his avenues of appeal.

#### **6. Training and Promotion:**

a. The contractor will assist in locating, qualifying, and increasing the skills of minority group and women employees, and applicants for employment.

b. Consistent with the contractor's work force requirements and as permissible under Federal and State regulations, the contractor shall make full use of training programs, i.e., apprenticeship, and on-the-job training programs for the geographical area of contract performance. Where feasible, 25 percent of apprentices or trainees in each occupation shall be

in their first year of apprenticeship or training. In the event a special provision for training is provided under this contract, this subparagraph will be superseded as indicated in the special provision.

c. The contractor will advise employees and applicants for employment of available training programs and entrance requirements for each.

d. The contractor will periodically review the training and promotion potential of minority group and women employees and will encourage eligible employees to apply for such training and promotion.

**7. Unions:** If the contractor relies in whole or in part upon unions as a source of employees, the contractor will use his/her best efforts to obtain the cooperation of such unions to increase opportunities for minority groups and women within the unions, and to effect referrals by such unions of minority and female employees. Actions by the contractor either directly or through a contractor's association acting as agent will include the procedures set forth below:

a. The contractor will use best efforts to develop, in cooperation with the unions, joint training programs aimed toward qualifying more minority group members and women for membership in the unions and increasing the skills of minority group employees and women so that they may qualify for higher paying employment.

b. The contractor will use best efforts to incorporate an EEO clause into each union agreement to the end that such union will be contractually bound to refer applicants without regard to their race, color, religion, sex, national origin, age or disability.

c. The contractor is to obtain information as to the referral practices and policies of the labor union except that to the extent such information is within the exclusive possession of the labor union and such labor union refuses to furnish such information to the contractor, the contractor shall so certify to the SHA and shall set forth what efforts have been made to obtain such information.

d. In the event the union is unable to provide the contractor with a reasonable flow of minority and women referrals within the time limit set forth in the collective bargaining agreement, the contractor will, through independent recruitment efforts, fill the employment vacancies without regard to race, color, religion, sex, national origin, age or disability; making full efforts to obtain qualified and/or qualifiable minority group persons and women. (The DOL has held that it shall be no excuse that the union with which the contractor has a collective bargaining agreement providing for exclusive referral failed to refer minority employees.) In the event the union referral practice prevents the contractor from meeting the obligations pursuant to Executive Order 11246, as amended, and these special provisions, such contractor shall immediately notify the SHA.

**8. Selection of Subcontractors, Procurement of Materials and Leasing of Equipment:** The contractor shall not discriminate on the grounds of race, color, religion, sex, national origin, age or disability in the selection and retention of subcontractors, including procurement of materials and leases of equipment.

a. The contractor shall notify all potential subcontractors and suppliers of his/her EEO obligations under this contract.

b. Disadvantaged business enterprises (DBE), as defined in 49 CFR 23, shall have equal opportunity to compete for and perform subcontracts which the contractor enters into pursuant to this contract. The contractor will use his best efforts to solicit bids from and to utilize DBE subcontractors or subcontractors with meaningful minority group and female representation among their employees.

Contractors shall obtain lists of DBE construction firms from SHA

personnel.

c. The contractor will use his best efforts to ensure subcontractor compliance with their EEO obligations.

**9. Records and Reports:** The contractor shall keep such records as necessary to document compliance with the EEO requirements. Such records shall be retained for a period of three years following completion of the contract work and shall be available at reasonable times and places for inspection by authorized representatives of the SHA and the FHWA.

a. The records kept by the contractor shall document the following:

(1) The number of minority and non-minority group members and women employed in each work classification on the project;

(2) The progress and efforts being made in cooperation with unions, when applicable, to increase employment opportunities for minorities and women;

(3) The progress and efforts being made in locating, hiring, training,

qualifying, and upgrading minority and female employees; and

(4) The progress and efforts being made in securing the services of

DBE subcontractors or subcontractors with meaningful minority and

female representation among their employees.

b. The contractors will submit an annual report to the SHA each July for the duration of the project, indicating the number of minority, women, and non-minority group employees currently engaged in each work classification required by the contract work. This information is to be reported on Form FHWA-1391. If on-the-job training is being required by special provision, the contractor will be required to collect and report training data.

### III. NONSEGREGATED FACILITIES

(Applicable to all Federal-aid construction contracts and to all related subcontracts of \$10,000 or more.)

a. By submission of this bid, the execution of this contract or subcontract, or the consummation of this material supply agreement or purchase order, as appropriate, the bidder, Federal-aid construction contractor, subcontractor, material supplier, or vendor, as appropriate, certifies that the firm does not maintain or provide for its employees any segregated facilities at any of its establishments, and that the firm does not permit its employees to perform their services at any location, under its control, where segregated facilities are maintained. The firm agrees that a breach of this certification is a violation of the EEO provisions of this contract. The firm further certifies that no employee will be denied access to adequate facilities on the basis of sex or disability.

b. As used in this certification, the term "segregated facilities" means any waiting rooms, work areas, restrooms and washrooms, restaurants and other eating areas, timeclocks, locker rooms, and other storage or dressing areas, parking lots, drinking fountains, recreation or entertainment areas, transportation, and housing facilities provided for employees which are segregated by explicit directive, or are, in fact, segregated on the basis of race, color, religion, national origin, age or disability, because of habit, local custom, or otherwise. The only exception will be for the disabled when the demands for accessibility override (e.g. disabled parking).

c. The contractor agrees that it has obtained or will obtain identical certification from proposed subcontractors or material suppliers prior to award of subcontracts or consummation of material supply agreements of \$10,000 or more and that it will retain such certifications in its files.

### IV. PAYMENT OF PREDETERMINED MINIMUM WAGE

(Applicable to all Federal-aid construction contracts exceeding \$2,000 and to all related subcontracts, except for projects located

on roadways classified as local roads or rural minor collectors, which are exempt.)

#### 1. General:

a. All mechanics and laborers employed or working upon the site of the work will be paid unconditionally and not less often than once a week and without subsequent deduction or rebate on any account [except such payroll deductions as are permitted by regulations (29 CFR 3) issued by the Secretary of Labor under the Copeland Act (40 U.S.C. 276c)] the full amounts of wages and bona fide fringe benefits (or cash equivalents thereof) due at time of payment. The payment shall be computed at wage rates not less than those contained in the wage determination of the Secretary of Labor (hereinafter "the wage determination") which is attached hereto and made a part hereof, regardless of any contractual relationship which may be alleged to exist between the contractor or its subcontractors and such laborers and mechanics. The wage determination (including any additional classifications and wage rates conformed under paragraph 2 of this Section IV and the DOL poster (WH-1321) or Form FHWA-1495) shall be posted at all times by the contractor and its subcontractors at the site of the work in a prominent and accessible place where it can be easily seen by the workers. For the purpose of this Section, contributions made or costs reasonably anticipated for bona fide fringe benefits under Section 1(b)(2) of the Davis-Bacon Act (40 U.S.C. 276a) on behalf of laborers or mechanics are considered wages paid to such laborers or mechanics, subject to the provisions of Section IV, paragraph 3b, hereof. Also, for the purpose of this Section, regular contributions made or costs incurred for more than a weekly period (but not less often than quarterly) under plans, funds, or programs, which cover the particular weekly period, are deemed to be constructively made or incurred during such weekly period. Such laborers and mechanics shall be paid the appropriate wage rate and fringe benefits on the wage determination for the classification of work actually performed, without regard to skill, except as provided in paragraphs 4 and 5 of this Section IV.

b. Laborers or mechanics performing work in more than one classification may be compensated at the rate specified for each classification for the time actually worked therein, provided, that the employer's payroll records accurately set forth the time spent in each classification in which work is performed.

c. All rulings and interpretations of the Davis-Bacon Act and related acts contained in 29 CFR 1, 3, and 5 are herein incorporated by reference in this contract.

#### 2. Classification:

a. The SHA contracting officer shall require that any class of laborers or mechanics employed under the contract, which is not listed in the wage determination, shall be classified in conformance with the wage determination.

b. The contracting officer shall approve an additional classification, wage rate and fringe benefits only when the following criteria have been met:

(1) the work to be performed by the additional classification requested is not performed by a classification in the wage determination;

(2) the additional classification is utilized in the area by the construction industry;

(3) the proposed wage rate, including any bona fide fringe benefits, bears a reasonable relationship to the wage rates contained in the wage determination; and

(4) with respect to helpers, when such a classification prevails in the area in which the work is performed.

c. If the contractor or subcontractors, as appropriate, the laborers and mechanics (if known) to be employed in the additional classification or their representatives, and the

contracting officer agree on the classification and wage rate (including the amount designated for fringe benefits where appropriate), a report of the action taken shall be sent by the contracting officer to the DOL, Administrator of the Wage and Hour Division, Employment Standards Administration, Washington, D.C. 20210. The Wage and Hour Administrator, or an authorized representative, will approve, modify, or disapprove every additional classification action within 30 days of receipt and so advise the contracting officer or will notify the contracting officer within the 30-day period that additional time is necessary.

d. In the event the contractor or subcontractors, as appropriate, the laborers or mechanics to be employed in the additional classification or their representatives, and the contracting officer do not agree on the proposed classification and wage rate (including the amount designated for fringe benefits, where appropriate), the contracting officer shall refer the question, including the views of all interested parties and the recommendation of the contracting officer, to the Wage and Hour Administrator for determination. Said Administrator, or an authorized representative, will issue a determination within 30 days of receipt and so advised the contracting officer or will notify the contracting officer within the 30-day period that additional time is necessary.

e. The wage rate (including fringe benefits where appropriate) determined pursuant to paragraph 2c or 2d of this Section IV shall be paid to all workers performing work in the additional classification from the first day on which work is performed in the classification.

### 3. Payment of Fringe Benefits:

a. Whenever the minimum wage rate prescribed in the contract for a class of laborers or mechanics includes a fringe benefit which is not expressed as an hourly rate, the contractor or subcontractors, as appropriate, shall either pay the benefit as stated in the wage determination or shall pay another bona fide fringe benefit or an hourly case equivalent thereof.

b. If the contractor or subcontractor, as appropriate, does not make payments to a trustee or other third person, he/she may consider as a part of the wages of any laborer or mechanic the amount of any cost reasonably anticipated in providing bona fide fringe benefits under a plan or program, provided that the Secretary of Labor has found, upon the written request of the contractor, that the applicable standards of the Davis-Bacon Act have been met. The Secretary of Labor may require the contractor to set aside in a separate account assets for the meeting of obligations under the plan or program.

### 4. Apprentices and Trainees (Programs of the U.S. DOL) and Helpers:

#### a. Apprentices:

(1) Apprentices will be permitted to work at less than the predetermined rate for the work they performed when they are employed pursuant to and individually registered in a bona fide apprenticeship program registered with the DOL, Employment and Training Administration, Bureau of Apprenticeship and Training, or with a State apprenticeship agency recognized by the Bureau, or if a person is employed in his/her first 90 days of probationary employment as an apprentice in such an apprenticeship program, who is not individually registered in the program, but who has been certified by the Bureau of Apprenticeship and Training or a State apprenticeship agency (where appropriate) to be eligible for probationary employment as an apprentice.

(2) The allowable ratio of apprentices to journeyman-level employees on the job site in any craft classification shall not be greater than the ratio permitted to the contractor as to the entire work force under the registered program. Any

employee listed on a payroll at an apprentice wage rate, who is not registered or otherwise employed as stated above, shall be paid not less than the applicable wage rate listed in the wage determination for the classification of work actually performed. In addition, any apprentice performing work on the job site in excess of the ratio permitted under the registered program shall be paid not less than the applicable wage rate on the wage determination for the work actually performed. Where a contractor or subcontractor is performing construction on a project in a locality other than that in which its program is registered, the ratios and wage rates (expressed in percentages of the journeyman-level hourly rate) specified in the contractor's or subcontractor's registered program shall be observed.

(3) Every apprentice must be paid at not less than the rate specified in the registered program for the apprentice's level of progress, expressed as a percentage of the journeyman-level hourly rate specified in the applicable wage determination. Apprentices shall be paid fringe benefits in accordance with the provisions of the apprenticeship program. If the apprenticeship program does not specify fringe benefits, apprentices must be paid

the full amount of fringe benefits listed on the wage determination

for the applicable classification. If the Administrator for the Wage

and Hour Division determines that a different practice prevails for

the applicable apprentice classification, fringes shall be paid in accordance with that determination.

(4) In the event the Bureau of Apprenticeship and Training, or a State apprenticeship agency recognized by the Bureau, withdraws approval of an apprenticeship program, the contractor or subcontractor will no longer be permitted to utilize apprentices at less than the applicable predetermined rate for the comparable work performed by regular employees until an acceptable program is approved.

#### b. Trainees:

(1) Except as provided in 29 CFR 5.16, trainees will not be permitted to work at less than the predetermined rate for the work performed unless they are employed pursuant to and individually registered in a program which has received prior approval, evidenced by formal certification by the DOL, Employment and Training Administration.

(2) The ratio of trainees to journeyman-level employees on the job site shall not be greater than permitted under the plan approved by the Employment and Training Administration. Any employee listed on the payroll at a trainee rate who is not registered and participating in a training plan approved by the Employment and Training Administration shall be paid not less than the applicable wage rate on the wage determination for the classification of work actually performed. In addition, any trainee performing work on the job site in excess of the ratio permitted under the registered program shall be paid not less than the applicable wage rate on the wage determination for the work actually performed.

(3) Every trainee must be paid at not less than the rate specified in the approved program for his/her level of progress, expressed as a percentage of the journeyman-level hourly rate specified in the applicable wage determination. Trainees shall be paid fringe benefits in accordance with the provisions of the trainee program. If the trainee program does not mention fringe benefits, trainees shall be paid the full amount of fringe benefits listed on the wage determination unless the Administrator of the Wage and Hour Division determines that there is an apprenticeship program associated with the corresponding journeyman-level wage rate on the wage determination which provides for less than full fringe benefits for apprentices, in which cases such trainees shall receive the same fringe benefits as apprentices.

(4) In the event the Employment and Training Administration

withdraws approval of a training program, the contractor or subcontractor will no longer be permitted to utilize trainees at less than the applicable predetermined rate for the work performed until an acceptable program is approved.

**c. Helpers:**

Helpers will be permitted to work on a project if the helper classification is specified and defined on the applicable wage determination or is approved pursuant to the conformance procedure set forth in Section IV. 2. Any worker listed on a payroll at a helper wage rate, who is not a helper under a approved definition, shall be paid not less than the applicable wage rate on the wage determination for the classification of work actually performed.

**5. Apprentices and Trainees (Programs of the U.S. DOT):**

Apprentices and trainees working under apprenticeship and skill training programs which have been certified by the Secretary of Transportation as promoting EEO in connection with Federal-aid highway construction programs are not subject to the requirements of paragraph 4 of this Section IV. The straight time hourly wage rates for apprentices and trainees under such programs will be established by the particular programs. The ratio of apprentices and trainees to journeymen shall not be greater than permitted by the terms of the particular program.

**6. Withholding:**

The SHA shall upon its own action or upon written request of an authorized representative of the DOL withhold, or cause to be withheld, from the contractor or subcontractor under this contract or any other Federal contract with the same prime contractor or any other Federally-assisted contract subject to Davis-Bacon prevailing wage requirements which is held by the same prime contractor, as much of the accrued payments or advances as may be considered necessary to pay laborers and mechanics, including apprentices, trainee's and helpers, employed by the contractor or any subcontractor the full amount of wages required by the contract. In the event of failure to pay any laborer or mechanic, including any apprentice, trainee, or helper, employed or working on the site of the work, all or part of the wages required by the contract, the SHA contracting officer may, after written notice to the contractor, take such action as may be necessary to cause the suspension of any further payment, advance, or guarantee of funds until such violations have ceased.

**7. Overtime Requirements:**

No contractor or subcontractor contracting for any part of the contract work which may require or involve the employment of laborers, mechanics, watchmen, or guards (including apprentices, trainees, and helpers described in paragraphs 4 and 5 above) shall require or permit any laborer, mechanic, watchman, or guard in any workweek in which he/she is employed on such work, to work in excess of 40 hours in such workweek unless such laborer, mechanic, watchman, or guard receives compensation at a rate not less than one-and-one-half times his/her basic rate of pay for all hours worked in excess of 40 hours in such workweek.

**8. Violation:**

Liability for Unpaid Wages; Liquidated Damages: In the event of any violation of the clause set forth in paragraph 7 above, the contractor and any subcontractor responsible thereof shall be liable to the affected employee for his/her unpaid wages. In addition, such contractor and subcontractor shall be liable to the United States (in the case of work done under contract for the District of Columbia or a territory, to such District or to such territory) for liquidated damages. Such liquidated damages shall be computed with respect to each individual laborer, mechanic, watchman, or guard employed in violation of the clause set forth in paragraph 7, in the sum of \$10 for each calendar day on which such employee was required or

permitted to work in excess of the standard work week of 40 hours without payment of the overtime wages required by the clause set forth in paragraph 7.

**9. Withholding for Unpaid Wages and Liquidated Damages:**

The SHA shall; upon its own action or upon written request of any authorized representative of the DOL withhold, or cause to be withheld, from any monies payable on account of work performed by the contractor or subcontractor under any such contract or any other Federal contract with the same prime contractor, or any other Federally-assisted contract subject to the Contract Work Hours and Safety Standards Act, which is held by the same prime contractor, such sums as may be determined to be necessary to satisfy any liabilities of such contractor or subcontractor for unpaid wages and liquidated damages as provided in the clause set forth in paragraph 8 above.

**V. STATEMENTS AND PAYROLLS**

(Applicable to all Federal-aid construction contracts exceeding \$2,000 and to all related subcontracts, except for projects located on roadways classified as local roads or rural collectors, which are exempt.)

**1. Compliance with Copeland Regulations (29 CFR 3):**

The contractor shall comply with the Copeland Regulations of the Secretary of Labor which are herein incorporated by reference.

**2. Payrolls and Payroll Records:**

- a. Payrolls and basic records relating thereto shall be maintained by the contractor and each subcontractor during the course of the work and preserved for a period of 3 years from the date of completion of the contract for all laborers, mechanics, apprentices, trainees, watchmen, helpers, and guards working at the site of the work.
- b. The payroll records shall contain the name, social security number, and address of each such employee; his or her correct classification; hourly rates of wages paid (including rates of contributions or costs anticipated for bona fide fringe benefits or cash equivalent thereof the types described in Section 1(b)(2)(B) of the Davis Bacon Act); daily and weekly number of hours worked; deductions made; and actual wages paid. In addition, for Appalachian contracts, the payroll records shall contain a notation indicating whether the employee does, or does not, normally reside in the labor area as defined in Attachment A, paragraph 1. Whenever the Secretary of Labor, pursuant to Section IV, paragraph 3b, has found that the wages of any laborer or mechanic include the amount of any costs reasonably anticipated in providing benefits under a plan or program described in Section 1(b)(2)(B) of the Davis Bacon Act, the contractor and each subcontractor shall maintain records which show that the commitment to provide such benefits is enforceable, that the plan or program is financially responsible, that the plan or program has been communicated in writing to the laborers or mechanics affected, and show the cost anticipated or the actual cost incurred in providing benefits. Contractors or subcontractors employing apprentices or trainees under approved programs shall maintain written evidence of the registration of apprentices and trainees, and ratios and wage rates prescribed in the applicable programs.
- c. Each contractor and subcontractor shall furnish, each week in which any contract work is performed, to the SHA resident engineer a payroll of wages paid each of its employees (including apprentices trainees, and helpers, described in Section IV, paragraphs 4 and 5, and watchmen and guards engaged on work during the preceding weekly payroll period). The payroll submitted shall set out accurately and completely

all of the information required to be maintained under paragraph 2b of this Section V. This information may be submitted in any form desired. Optional Form WH-347 is available for this purpose and may be purchased from the Superintendent of Documents (Federal stock number 029-005-0014-1), U.S. Government Printing Office, Washington, D.C. 20402. The prime contractor is responsible for submitting payroll copies of all subcontractors.

d. Each payroll submitted shall be accompanied by a "Statement of Compliance," signed by the Contractor or subcontractor or his/her agent who pays or supervises the payment of the persons employed under the contract and shall certify the following:

- (1) that the payroll for the payroll period contains the information required to be maintained under paragraph 2b of this Section V and that such information is correct and complete;
- (2) that such laborer or mechanic (including each helper, apprentice, and trainee) employed on the contract during the payroll period has been paid the full weekly wages earned, without rebate, either directly or indirectly, and that no deductions have been made either directly or indirectly from the full wages earned, other than permissible deductions as set forth in the Regulations, 29 CFR 3;
- (3) that each laborer or mechanic has been paid not less than the applicable wage rate and fringe benefits or cash equivalent for the classification of work performed, as specified in the applicable wage determination incorporated into the contract.

e. The weekly submission of a properly executed certification set forth on the reverse side of Optional Form WH-347 shall satisfy the requirement for submission of the "Statement of Compliance" required by paragraph 2d of this Section V.

f. The falsification of any of the above certifications may subject the contractor to civil or criminal prosecution under 18 U.S. C. 1001 and 31 U.S.C. 231.

g. The contractor or subcontractor shall make the records required under paragraph 2b of this Section V available for inspection, copying, or transcription by authorized representatives of the SHA, the FHWA, or the DOL, and shall permit such representatives to interview employees during working hours on the job. If the contractor or subcontractor fails to submit the required records or to make them available, the SHA, the FHWA, the DOL, or all may, after written notice to the contractor, sponsor, applicant, or owner, take such actions as may be necessary to cause the suspension of any further payment, advance, or guarantee of funds. Furthermore, failure to submit the required records upon request or to make such records available may be grounds for debarment action pursuant to 29 CFR 5.12.

## VI. RECORD OF MATERIALS, SUPPLIES, AND LABOR

1. On all federal-aid contracts on the national highway system, except those which provide solely for the installation of protective devices at railroad grade crossings, those which are constructed on a force account or direct labor basis, highway beautification contracts, and contracts for which the total final construction cost for roadway and bridge is less than \$1,000,000 (23 CFR 635) the contractor shall:

- a. Become familiar with the list of specific materials and supplies contained in Form FHWA-47, "Statement of Materials and Labor Used by Contractor of Highway Construction Involving Federal Funds," prior to the commencement of work under this contract.
- b. Maintain a record of the total cost of all materials and supplies purchased for and incorporated in the work, and also of the quantities of those specific materials and supplies listed on Form FHWA-47, and in the units shown on Form FHWA-47.
- c. Furnish, upon the completion of the contract, to the SHA resident engineer on Form FHWA-47 together with the data

required in paragraph 1b relative to materials and supplies, a final labor summary of all contract work indicating the total hours worked and the total amount earned.

2. At the prime contractor's option, either a single report covering all contract work or separate reports for the contractor and for each subcontract shall be submitted.

## VII. SUBLETTING OR ASSIGNING THE CONTRACT

1. The contractor shall perform with its own organization contract work amounting to not less than 30 percent (or a greater percentage if specified elsewhere in the contract) of the total original contract price, excluding any specialty items designated by the State. Specialty items may be performed by subcontract and the amount of any such specialty items performed may be deducted from the total original contract price before computing the amount of work required to be performed by the contractors' own organization (23 CFR 635).

- a. "Its own organization" shall be construed to include only workers employed and paid directly by the prime contractor and equipment owned or rented by the prime contractor, with or without operators. Such term does not include employees or equipment of a subcontractor, assignee, or agent of the prime contractor.
- b. "Specialty Items" shall be construed to be limited to work that requires highly specialized knowledge, abilities, or equipment not ordinarily available in the type of contracting organizations qualified and expected to bid on the contract as a whole and in general are to be limited to minor components of the overall contract.

2. The contract amount upon which the requirements set forth in paragraph 1 of Section VII is computed includes the cost of material and manufactured products which are to be purchased or produced by the contractor under the contract provisions.

3. The contractor shall furnish (a) a competent superintendent or supervisor who is employed by the firm, has full authority to direct performance of the work in accordance with the contract requirements, and is in charge of all construction operations (regardless of who performs the work) and (b) such other of its own organizational resources (supervision, management, and engineering services) as the SHA contracting officer determines is necessary to assure the performance of the contract.

4. No portion of the contract shall be sublet, assigned or otherwise disposed of except with the written consent of the SHA contracting officer, or authorized representative, and such consent when given shall not be construed to relieve the contractor of any responsibility for the fulfillment of the contract. Written consent will be given only after the SHA has assured that each subcontract is evidenced in writing and that it contains all pertinent provisions and requirements of the prime contract.

## VIII. SAFETY: ACCIDENT PREVENTION

1. In the performance of this contract the contractor shall comply with all applicable Federal, State, and local laws governing safety, health, and sanitation (23 CFR 635). The contractor shall provide all safeguards, safety devices and protective equipment and take any other needed actions as it determines, or as the SHA contracting officer may determine, to be reasonably necessary to protect the life and health of employees on the job and the safety of the public and to protect property in connection with the performance of the work covered by the contract.

2. It is a condition of this contract, and shall be made a condition of each subcontract, which the contractor enters into pursuant to this contract, that the contractor and any subcontractor shall not permit any employee, in performance of the contract, to work in

surroundings or under conditions which are unsanitary, hazardous or dangerous to his/her health or safety, as determined under construction safety and health standards (29 CFR 1926) promulgated by the Secretary of Labor, in accordance with Section 107 of the Contract Work Hours and Safety Standards Act (40 U.S.C. 333).

3. Pursuant to 29 CFR 1926.3, it is a condition of this contract that the Secretary of Labor or authorized representative thereof, shall have right of entry to any site of contract performance to inspect or investigate the matter of compliance with the construction safety and health standards and to carry out the duties of the Secretary under Section 107 of the Contract Work Hours and Safety Standards Act (40 U.S.C. 333).

#### **IX. FALSE STATEMENTS CONCERNING HIGHWAY PROJECTS**

In order to assure high quality and durable construction in conformity with approved plans and specifications and a high degree of reliability on statements and representations made by engineers, contractors, suppliers, and workers on Federal-aid highway projects, it is essential that all persons concerned with the project perform their functions as carefully, thoroughly, and honestly as possible. Willful falsification, distortion, or misrepresentation with respect to any facts related to the project is a violation of Federal law. To prevent any misunderstanding regarding the seriousness of these and similar acts, the following notice shall be posted on each Federal-aid highway project (23 CFR 635) in one or more places where it is readily available to all persons concerned with the project:

##### **NOTICE TO ALL PERSONNEL ENGAGED ON FEDERAL-AID HIGHWAY PROJECTS**

18 U.S.C. 1020 reads as follows:

*“Whoever, being an officer, agent or employee of the United States, or of any State or Territory, or whoever, whether a person, association, firm, or corporation, knowingly makes any false statement, false representation, or false report as to the character, quality, quantity, or cost of the material used or to be used, or the quantity or quality of the work performed or to be performed, or the cost thereof in connection with the submission of plans, maps, specifications, contracts, or costs of construction on any highway or related project submitted for approval to the Secretary of Transportation; or*

*Whoever knowingly makes any false statement, false representation, false report or false claim with respect to the character, quality, quantity, or cost of any work performed or to be performed, or materials furnished or to be furnished, in connection with the construction of any highway or related project approved by the Secretary of Transportation; or*

*Whoever knowingly makes any false statement or false representation as to material fact in any statement, certificate, or report submitted pursuant to provisions of the Federal-aid Roads Act approved July 1, 1916, (39 Stat. 355), as amended and supplemented;*

*Shall be fined not more than \$10,000 or imprisoned not more than 5 years or both.”*

#### **X. IMPLEMENTATION OF CLEAN AIR ACT AND FEDERAL WATER POLLUTION CONTROL ACT**

(Applicable to all Federal-aid construction contracts and to all related subcontracts of \$100,000 or more).

By submission of this bid or the execution of this contract, or

subcontract, as appropriate, the bidder, Federal-aid construction contractor, or subcontractor, as appropriate, will be deemed to have stipulated as follows:

1. That any facility that is or will be utilized in the performance of this contract, unless such contract is exempt under the Clean Air Act, as amended (42 U.S.C. 1857 *et seq.*, as amended by Pub.L. 91-604), and under the Federal Water Pollution Control Act, as amended (33 U.S.C. 1251 *et seq.*, as amended by Pub.L. 92-500), Executive Order 11738, and regulations in implementation thereof (40 CFR 15) is not listed, on the date of contract award, on the U.S. Environmental Protection Agency (EPA) List of Violating Facilities pursuant to 40 CFR 15.20.

2. That the firm agrees to comply and remain in compliance with all the requirements of Section 114 of the Clean Air Act and Section 308 of the Federal Water Pollution Control Act and all regulations and guidelines listed thereunder.

3. That the firm shall promptly notify the SHA of the receipt of any communication from the Director, Office of Federal Activities, EPA indicating that a facility that is or will be utilized for the contract is under consideration to be listed on the EPA List of Violating Facilities.

4. That the firm agrees to include or cause to be included the requirements of paragraph 1 through 4 of this Section X in every nonexempt subcontract, and further agrees to take such action as the government may direct as a means of enforcing such requirements.

#### **XI. CERTIFICATION REGARDING DEBARMENT, SUSPENSION, INELIGIBILITY AND VOLUNTARY EXCLUSION**

1. Instructions for Certification - Primary Covered Transactions:

(Applicable to all Federal-aid contracts - 49 CFR 29)

- a. By signing and submitting this proposal, the prospective primary participant is providing the certification set out below.
- b. The inability of a person to provide the certification set out below will not necessarily result in denial of participation in this covered transaction. The prospective participant shall submit an explanation of why it cannot provide the certification set out below. The certification or explanation will be considered in connection with the department or agency's determination whether to enter into this transaction. However, failure of the prospective primary participant to furnish a certification or an explanation shall disqualify such a person from participation in this transaction.
- c. The certification in this clause is a material representation of fact upon which reliance was placed when the department or agency determined to enter into this transaction. If it is later determined that the prospective primary participant knowingly rendered an erroneous certification, in addition to other remedies available to the Federal Government, the department or agency may terminate this transaction for cause of default.
- d. The prospective primary participant shall provide immediate written notice to the department or agency to whom this proposal is submitted if any time the prospective primary participant learns that its certification was erroneous when submitted or has become erroneous by reason of changed circumstances.
- e. The terms "covered transaction," "debarred," "suspended," "ineligible," "lower tier covered transaction," "participant," "person," "primary covered transaction," "principal," "proposal," and "voluntarily excluded," as used in this clause, have the meanings set out in the Definitions and Coverage sections of rules implementing Executive Order 12549. You may contact the department or agency to which this proposal



is submitted for assistance in obtaining a copy of those regulations.

f. The prospective primary participant agrees by submitting this proposal that, should the proposed covered transaction be entered into, it shall not knowingly enter into any lower tier covered transaction with a person who is debarred, suspended, declared ineligible, or voluntarily excluded from participation in this covered transaction, unless authorized by the department or agency entering into this transaction.

g. The prospective primary participant further agrees by submitting this proposal that it will include the clause titled "Certification Regarding Debarment, Suspension, Ineligibility and Voluntary Exclusion-Lower Tier Covered Transaction," provided by the department or agency entering into this covered transaction, without modification in all lower tier covered transactions

and in all solicitations for lower tier covered transactions.

h. A participant in a covered transaction may rely upon a certification of a prospective participant in a lower tier covered transaction that is not debarred, suspended, ineligible, or voluntarily excluded from the covered transaction, unless it knows that the certification is erroneous. A participant may decide the method and frequency by which it determines the eligibility of its principals. Each participant may, but is not required to, check the nonprocurement portion of the "Lists of Parties Excluded from Federal Procurement or Nonprocurement Programs" (Nonprocurement List) which is compiled by the General Services Administration.

i. Nothing contained in the foregoing shall be construed to require establishment of a system of records in order to render in good faith the certification required by this clause. The knowledge and information of participant is not required to exceed that which is normally possessed by a prudent person in the ordinary course of business dealings.

j. Except for transactions authorized under paragraph f of these instructions, if a participant in a covered transaction knowingly enters into a lower tier covered transaction with a person who is suspended, debarred, ineligible, or voluntarily excluded from participation in this transaction, in addition to other remedies available to the Federal Government, the department or agency may terminate this transaction for cause or default.

\*\*\*\*\*

#### **Certification Regarding Debarment, Suspension, Ineligibility and Voluntary Exclusion-Primary Covered Transactions**

1. The prospective primary participant certifies to the best of its knowledge and belief, that it and its principals:

- a. Are not presently debarred, suspended, proposed for debarment, declared ineligible, or voluntarily excluded from covered transactions by any Federal department or agency;
- b. Have not within a 3-year period preceding this proposal been convicted of or had a civil judgment rendered against them for commission of fraud or a criminal offense in connection with obtaining, attempting to obtain, or performing a public (Federal, State or local) transaction or contract under a public transaction; violation of Federal or State antitrust statutes or commission of embezzlement, theft, forgery, bribery, falsification or destruction of records, making false statements, or receiving stolen property;
- c. Are not presently indicted for or otherwise criminally or civilly charged by a governmental entity (Federal, State or local) with commission of any of the offenses enumerated in paragraph 1b of this certification; and
- d. Have not within a 3-year period preceding this application/proposal had one or more public transactions (Federal, State or local) terminated for cause or default.

to any of the statements in this certification, such prospective participant shall attach an explanation to this proposal.

\*\*\*\*\*

#### **2. Instructions for Certification - Lower Tier Covered Transactions:**

(Applicable to all subcontracts, purchase orders and other lower tier transactions of \$25,000 or more - 49 CFR 29)

a. By signing and submitting this proposal, the prospective lower tier is providing the certification set out below.

b. The certification in this clause is a material representation of fact upon which reliance was placed when this transaction was entered into. If it is later determined that the prospective lower tier participant knowingly rendered an erroneous certification, in addition to other remedies available to the Federal Government, the department, or agency with which this transaction originated may pursue available remedies, including suspension and/or debarment.

c. The prospective lower tier participant shall provide immediate written notice to the person to which this proposal is submitted if at any time the prospective lower tier participant learns that its certification was erroneous by reason of changed circumstances.

d. The terms "covered transaction," "debarred," "suspended," "ineligible," "primary covered transaction," "participant," "person," "principal," "proposal," and "voluntarily excluded," as used in this clause, have the meanings set out in the Definitions and Coverage sections of rules implementing Executive Order 12549. You may contact the person to which this proposal is submitted for assistance in obtaining a copy of those regulations.

e. The prospective lower tier participant agrees by submitting this proposal that, should the proposed covered transaction be entered into, it shall not knowingly enter into any lower tier covered transaction with a person who is debarred, suspended, declared ineligible, or voluntarily excluded from participation in this covered transaction, unless authorized by the department or agency with which this transaction originated.

f. The prospective lower tier participant further agrees by submitting this proposal that it will include this clause titled "Certification Regarding Debarment, Suspension, Ineligibility and Voluntary Exclusion-Lower Tier Covered Transaction," without modification, in all lower tier covered transactions and in all solicitations for lower tier covered transactions.

g. A participant in a covered transaction may rely upon a certification of a prospective participant in a lower tier covered transaction that is not debarred, suspended, ineligible, or voluntarily excluded from the covered transaction, unless it knows that the certification is erroneous. A participant may decide the method and frequency by which it determines the eligibility of its principals. Each participant may, but is not required to, check the Nonprocurement List.

h. Nothing contained in the foregoing shall be construed to require establishment of a system of records in order to render in good faith the certification required by this clause. The knowledge and information of participant is not required to exceed that which is normally possessed by a prudent person in the ordinary course of business dealing.

i. Except for transactions authorized under paragraph e of these instructions, if a participant in a covered transaction knowingly enters into a lower tier covered transaction with a person who is suspended, debarred, ineligible, or voluntarily excluded from participation in this transaction, in addition to other remedies available to the Federal Government, the department or agency with which this transaction originated may pursue available remedies, including suspension and/or debarment.

\*\*\*\*\*

2. Where the prospective primary participant is unable to certify

**Certification Regarding Debarment, Suspension, Ineligibility And  
Voluntary Exclusion-Lower Tier Covered Transactions:**

1. The prospective lower tier participant certifies, by submission of this proposal, that neither it nor its principals is presently debarred, suspended, proposed for debarment, declared ineligible, or voluntarily excluded from participation in this transaction by any Federal department or agency.

2. Where the prospective lower tier participant is unable to certify to any of the statements in this certification, such prospective participant shall attach an explanation to this proposal.

\*\*\*\*\*

**XII. CERTIFICATION REGARDING USE OF CONTRACT FUNDS FOR  
LOBBYING**

(Applicable to all Federal-aid construction contracts and to all related subcontracts which exceed \$100,000 - 49 CFR 20)

1. The prospective participant certifies, by signing and submitting this bid or proposal, to the best of his or her knowledge and belief, that:

a. No Federal appropriated funds have been paid or will be paid, by or on behalf of the undersigned, to any person for influencing or attempting to influence an officer or employee of any Federal agency, a Member of Congress, an officer or employee of Congress, or an employee of a Member of Congress in connection with the awarding of any Federal contract, the making of any Federal grant, the making of any Federal loan, the entering into of any cooperative agreement, and the extension, continuation, renewal, amendment, or modification of any Federal contract, grant, loan, or cooperative agreement.

b. If any funds other than Federal appropriated funds have been paid or will be paid to any person for influencing or attempting to influence an officer or employee of any Federal agency, a Member of Congress, an officer or employee of Congress, or an employee of a Member of Congress in connection with this Federal contract, grant, loan, or cooperative agreement, the undersigned shall complete and submit Standard Form-LLL, "Disclosure Form to Report Lobbying," in accordance with its instructions.

2. This certification is a material representation of fact upon which reliance was placed when this transaction was made or entered into. Submission of this certification is a prerequisite for making or entering into this transaction imposed by 31 U.S.C. 1352. Any person who fails to file the required certification shall be subject to a civil penalty of not less than \$10,000 and not more than \$100,000 for each such failure.

3. The prospective participant also agrees by submitting his or her bid or proposal that he or she shall require that the language of this certification be included in all lower tier subcontracts, which exceed \$100,000 and that all such recipients shall certify and disclose accordingly.

**MINIMUM WAGES FOR FEDERAL AND FEDERALLY  
ASSISTED CONSTRUCTION CONTRACTS**

This project is funded, in part, with Federal-aid funds and, as such, is subject to the provisions of the Davis-Bacon Act of March 3, 1931, as amended (46 Sta. 1494, as amended, 40 U.S.C. 276a) and of other Federal statutes referred to in a 29 CFR Part 1, Appendix A, as well as such additional statutes as may from time to time be enacted containing provisions for the payment of wages determined to be prevailing by the Secretary of Labor in accordance with the Davis-Bacon Act and pursuant to the provisions of 29 CFR Part 1. The prevailing rates and fringe benefits shown in the General Wage Determination Decisions issued by the U.S. Department of Labor shall, in accordance with the provisions of the foregoing statutes, constitute the minimum wages payable on Federal and federally assisted construction projects to laborers and mechanics of the specified classes engaged on contract work of the character and in the localities described therein.

General Wage Determination Decisions, modifications and supersedes decisions thereto are to be used in accordance with the provisions of 29 CFR Parts 1 and 5. Accordingly, the applicable decision, together with any modifications issued, must be made a part of every contract for performance of the described work within the geographic area indicated as required by an applicable DBRA Federal prevailing wage law and 29 CFR Part 5. The wage rates and fringe benefits contained in the General Wage Determination Decision shall be the minimum paid by contractors and subcontractors to laborers and mechanics.

**NOTICE**

The most current **General Wage Determination Decisions** (wage rates) are available on the IDOT web site. They are located on the Letting and Bidding page at <http://www.dot.state.il.us/desenv/delett.html>.

In addition, ten (10) days prior to the letting, the applicable Federal wage rates will be e-mailed to subscribers. It is recommended that all contractors subscribe to the Federal Wage Rates List or the Contractor's Packet through IDOT's subscription service.

PLEASE NOTE: if you have already subscribed to the Contractor's Packet you will automatically receive the Federal Wage Rates.

The instructions for subscribing are at <http://www.dot.state.il.us/desenv/subsc.html>.

If you have any questions concerning the wage rates, please contact IDOT's Chief Contract Official at 217-782-7806.