

RETURN WITH BID

State of _____)
) ss.
County of _____)

AFFIDAVIT

_____ (name of affiant), of _____,

_____, being first duly sworn upon oath, states as follows:

1. That I am the _____ (officer or position) of _____ (bidder) and have personal knowledge of the facts herein stated.
2. That, if selected under this proposal, _____ (bidder) will maintain a business office in the State of Illinois which will be located in _____ County, Illinois.
3. That this business office will serve as the primary place of employment for any persons employed in the construction contemplated by this proposal.
4. That this Affidavit is given as a requirement of state law as provided in Section 30-22(8) of the Illinois Procurement Code.

Signature

Print Name of Affiant

This instrument was acknowledged before me on the _____ day of _____, 20__ by _____.

Notary Public

(SEAL)

INSTRUCTIONS

ABOUT IDOT PROPOSALS: All proposals are potential bidding proposals. Each proposal contains all certifications and affidavits, a proposal signature sheet and a proposal bid bond.

PREQUALIFICATION

Any contractor who desires to become pre-qualified to bid on work advertised by IDOT must submit the properly completed pre-qualification forms to the Bureau of Construction no later than 4:30 p.m. prevailing time twenty-one days prior to the letting of interest. This pre-qualification requirement applies to first time contractors, contractors renewing expired ratings, contractors maintaining continuous pre-qualification or contractors requesting revised ratings. To be eligible to bid, existing pre-qualification ratings must be effective through the date of letting.

WHO CAN BID ?

Bids will be accepted from only those companies that request and receive written Authorization to Bid from IDOT's Central Bureau of Construction.

REQUESTS FOR AUTHORIZATION TO BID

Contractors wanting to bid on items included in a particular letting must submit the properly completed "Request for Authorization to Bid/or Not For Bid Status" (BDE 124) and the ORIGINAL "Affidavit of Availability" (BC 57) to the proper office no later than 4:30 p.m. prevailing time, three (3) days prior to the letting date.

WHAT CONSTITUTES WRITTEN AUTHORIZATION TO BID?: When a prospective prime bidder submits a "Request for Authorization to Bid/or Not For Bid Status"(BDE 124) he/she must indicate at that time which items are being requested For Bidding purposes. Only those items requested For Bidding will be analyzed. After the request has been analyzed, the bidder will be issued an **Authorization to Bid or Not for Bid Report**, approved by the Central Bureau of Construction and the Chief Procurement Officer that indicates which items have been approved For Bidding. If **Authorization to Bid** cannot be approved, the **Authorization to Bid or Not for Bid Report** will indicate the reason for denial.

ABOUT AUTHORIZATION TO BID: Firms that have not received an Authorization to Bid or Not For Bid Report within a reasonable time of complete and correct original document submittal should contact the department as to the status. Firms unsure as to authorization status should call the Prequalification Section of the Bureau of Construction at the number listed at the end of these instructions. These documents must be received three days before the letting date.

ADDENDA AND REVISIONS: It is the bidder's responsibility to determine which, if any, addenda or revisions pertain to any project they may be bidding. Failure to incorporate all relevant addenda or revisions may cause the bid to be declared unacceptable.

Each addendum or revision will be included with the Electronic Plans and Proposals. Addenda and revisions will also be placed on the Addendum/Revision Checklist and each subscription service subscriber will be notified by e-mail of each addendum and revision issued.

The Internet is the Department's primary way of doing business. The subscription service emails are an added courtesy the Department provides. It is suggested that bidders check IDOT's website at <http://www.dot.il.gov/desenv/delett.html> before submitting final bid information.

IDOT IS NOT RESPONSIBLE FOR ANY E-MAIL FAILURES.

Addenda questions may be directed to the Contracts Office at (217)782-7806 or D&Econtracts@dot.il.gov

Technical questions about downloading these files may be directed to Tim Garman at (217)524-1642 or Timothy.Garman@illinois.gov.

BID SUBMITTAL GUIDELINES AND CHECKLIST

In an effort to eliminate confusion and standardize the bid submission process the Contracts Office has created the following guidelines and checklist for submitting bids.

This information has been compiled from questions received from contractors and from inconsistencies noted on submitted bids. If you have additional questions please refer to the contact information listed below.

ABOUT SUBMITTING BIDS: It is recommended that bidders deliver bid proposals in person to ensure they arrive at the proper location prior to the time specified for the receipt of bids. Any proposals received at the place of letting after the time specified will not be read.

STANDARD GUIDELINES FOR SUBMITTING BIDS

- All pages should be single sided.
- Use the Cover Page that is provided in the Bid Proposal (posted on the IDOT Web Site) as the first page of your submitted bid. This page has the Item number in the upper left-hand corner and lines provided for your company name and address in the upper right-hand corner.
- Do not use report covers, presentation folders or special bindings and do not staple multiple times on left side like a book. Use only 1 staple in the upper left hand corner. Make sure all elements of your bid are stapled together including the bid bond or guaranty check (if required).
- Do not include any certificates of eligibility, your authorization to bid, Addendum Letters or affidavit of availability.
- Do not include the Subcontractor Documentation with your bid (pages i – iii and pages a – g). This documentation is required only after you are awarded the contract.
- Use the envelope cover sheet (provided with the proposal) as the cover for the proposal envelope.
- Do not rely on overnight services to deliver your proposal prior to 10 AM on letting day. It will not be read if it is delivered after 10 AM.
- Do not submit your Substance Abuse Prevention Program (SAPP) with your bid. If you are awarded the contract this form is to be submitted to the district engineer at the pre-construction conference.

Use the following checklist to ensure completeness and the correct order in assembling your bid

Illinois Office Affidavit (Not applicable to federally funded projects) insert your affidavit after page 4 along with your Cost Adjustments for Steel, Bituminous and Fuel (if applicable).

Cover page (the sheet that has the item number on it) **followed by your bid (the Pay Items)**. If you are using special software or CBID to generate your schedule of prices, do not include the blank pages of the schedule of prices that came with the proposal package.

Page 4 (Item 9) – Check “YES” if you will use a subcontractor(s). Include the subcontractor(s) name, address, general type of work to be performed and the dollar amount (if over \$50,000). If you will use subcontractor(s) but are uncertain who or the dollar amount; check “YES” but leave the lines blank.

Page 10 (Paragraph J) – Check “YES” or “NO” whether your company has any business in Iran.

Page 10 (Paragraph K) – (Not applicable to federally funded projects) List the Union Local Name and number or certified training programs that you have in place. **Your bid will not be read if this is not completed.** Do not include certificates with your bid. Keep the certificates in your office in case they are requested by IDOT.

Page 11 (Paragraph L) - A copy of your State Board of Elections certificate of registration is no longer required with your bid.

Page 11 (Paragraph M) – Indicate if your company has hired a lobbyist in connection with the job for which you are submitting the bid proposal.

Page 12 (Paragraph C) – This is a work sheet to determine if a completed Form A is required. It is not part of the form and you do not need to make copies for each Form A that is filled out.

Pages 14-17 (Form A) – One Form A (4 pages) is required for each applicable person in your company. Copies of the Forms can be used and only need to be changed when the financial information changes. The certification signature and date must be original for each letting. Do not staple the forms together.

If you answered “NO” to all of the questions in Paragraph C (page 12), complete the first section (page 14) with your company information and then sign and date the Not Applicable statement on page 17.

Page 18 (Form B) - If you check “YES” to having other current or pending contracts it is acceptable to use the phrase, “See Affidavit of Availability on file”. **Ownership Certification** (at the bottom of the page) - Check N/A if the Form A you submitted accounts for 100 percent of the company ownership. Check YES if any percentage of ownership falls outside of the parameters that require reporting on the Form A. Checking NO indicates that the Form A you submitted is not correct and you will be required to submit a revised Form A.

Page 20 (Workforce Projection) – Be sure to include the Duration of the Project. It is acceptable to use the phrase “Per Contract Specifications”.

Bid Bond – Submit your bid bond using the current Bid Bond Form provided in the proposal package. The Power of Attorney page should be stapled to the Bid Bond. If you are using an electronic bond, include your bid bond number on the form and attach the Proof of Insurance printed from the electronic bond Web Site.

Disadvantaged Business Utilization Plan and/or Good Faith Effort – The last item in your bid should be the DBE Utilization Plan (SBE 2026), followed by the DBE Participation Statement (SBE 2025) and supporting paperwork. If you have documentation for a Good Faith Effort, it should follow the SBE Forms.

The Bid Letting is now available in streaming Audio/Video from the IDOT Web Site. A link to the stream will be placed on the main page of the current letting on the day of the Letting. The stream will not begin until 10 AM. The actual reading of the bids does not begin until approximately 10:20 AM.

Following the Letting, the As-Read Tabulation of Bids will be posted by the end of the day. You will find the link on the main page of the current letting.

QUESTIONS: pre-letting up to execution of the contract

Contractor/Subcontractor pre-qualification -----217-782-3413
Small Business, Disadvantaged Business Enterprise (DBE) -----217-785-4611
Contracts, Bids, Letting process or Internet downloads-----217-782-7806
Estimates Unit -----217-785-3483
Aeronautics -----217-785-8515
IDNR (Land Reclamation, Water Resources, Natural Resources) -----217-782-6302

QUESTIONS: following contract execution

Including Subcontractor documentation, payments -----217-782-3413
Railroad Insurance -----217-785-0275

57

RETURN WITH BID

Proposal Submitted By
Name
Address
City

Letting May 24, 2013

NOTICE TO PROSPECTIVE BIDDERS

This proposal can be used for bidding purposes by only those companies that request and receive written **AUTHORIZATION TO BID** from IDOT's Central Bureau of Construction.
BIDDERS NEED NOT RETURN THE ENTIRE PROPOSAL

Notice to Bidders, Specifications, Proposal, Contract and Contract Bond



**Illinois Department
of Transportation**

Springfield, Illinois 62764

**Contract No. 78342
JEFFERSON-POPE-WHITE Counties
Section D9 SCOUR REPAIR 2013-1
Various Routes
District 9 Construction Funds**

PLEASE MARK THE APPROPRIATE BOX BELOW:

- A Bid Bond is included.
- A Cashier's Check or a Certified Check is included.

Plans Included
Herein

Prepared by

S

Checked by

(Printed by authority of the State of Illinois)

Page intentionally left blank

RETURN WITH BID



PROPOSAL

TO THE DEPARTMENT OF TRANSPORTATION

1. Proposal of _____

Taxpayer Identification Number (Mandatory) _____ a

For the improvement identified and advertised for bids in the Invitation for Bids as:

**Contract No. 78342
JEFFERSON-POPE-WHITE Counties
Section D9 SCOUR REPAIR 2013-1
Various Routes
District 9 Construction Funds**

This project consists of placing riprap for scour mitigation at four structures (S.N. 041-0019) carrying Illinois Route 15 over Rayse Creek in Jefferson County, (S.N. 076-0001) carrying Illinois Route 34 over Gibbons Creek in Pope County, (S.N. 097-0013) carrying U.S. Route 45 over Bear Creek in White County and (S.N. 097-0030) carrying Illinois Route 141 over Little Wabash River in White County.

2. The undersigned bidder will furnish all labor, material and equipment to complete the above described project in a good and workmanlike manner as provided in the contract documents provided by the Department of Transportation. This proposal will become part of the contract and the terms and conditions contained in the contract documents shall govern performance and payments.

RETURN WITH BID

- 3. **ASSURANCE OF EXAMINATION AND INSPECTION/WAIVER.** The undersigned further declares that he/she has carefully examined the proposal, plans, specifications, addenda, form of contract and contract bond, and special provisions, and that he/she has inspected in detail the site of the proposed work, and that he/she has familiarized themselves with all of the local conditions affecting the contract and the detailed requirements of construction, and understands that in making this proposal he/she waives all right to plead any misunderstanding regarding the same.
- 4. **EXECUTION OF CONTRACT AND CONTRACT BOND.** The undersigned further agrees to execute a contract for this work and present the same to the department within fifteen (15) days after the contract has been mailed to him/her. The undersigned further agrees that he/she and his/her surety will execute and present within fifteen (15) days after the contract has been mailed to him/her contract bond satisfactory to and in the form prescribed by the Department of Transportation, in the penal sum of the full amount of the contract, guaranteeing the faithful performance of the work in accordance with the terms of the contract.
- 5. **PROPOSAL GUARANTY.** Accompanying this proposal is either a bid bond on the department form, executed by a corporate surety company satisfactory to the department, or a proposal guaranty check consisting of a bank cashier's check or a properly certified check for not less than 5 per cent of the amount bid or for the amount specified in the following schedule:

<u>Amount of Bid</u>	<u>Proposal Guaranty</u>	<u>Amount of Bid</u>	<u>Proposal Guaranty</u>
Up to \$5,000	to \$150	\$2,000,000	to \$100,000
\$5,000 to \$10,000	to \$300	\$3,000,000 to \$5,000,000	to \$150,000
\$10,000 to \$50,000	to \$1,000	\$5,000,000 to \$7,500,000	to \$250,000
\$50,000 to \$100,000	to \$3,000	\$7,500,000 to \$10,000,000	to \$400,000
\$100,000 to \$150,000	to \$5,000	\$10,000,000 to \$15,000,000	to \$500,000
\$150,000 to \$250,000	to \$7,500	\$15,000,000 to \$20,000,000	to \$600,000
\$250,000 to \$500,000	to \$12,500	\$20,000,000 to \$25,000,000	to \$700,000
\$500,000 to \$1,000,000	to \$25,000	\$25,000,000 to \$30,000,000	to \$800,000
\$1,000,000 to \$1,500,000	to \$50,000	\$30,000,000 to \$35,000,000	to \$900,000
\$1,500,000 to \$2,000,000	to \$75,000	over \$35,000,000	to \$1,000,000

Bank cashier's checks or properly certified checks accompanying proposals shall be made payable to the Treasurer, State of Illinois, when the state is awarding authority; the county treasurer, when a county is the awarding authority; or the city, village, or town treasurer, when a city, village, or town is the awarding authority.

If a combination bid is submitted, the proposal guaranties which accompany the individual proposals making up the combination will be considered as also covering the combination bid.

The amount of the proposal guaranty check is _____ \$(_____). If this proposal is accepted and the undersigned shall fail to execute a contract bond as required herein, it is hereby agreed that the amount of the proposal guaranty shall become the property of the State of Illinois, and shall be considered as payment of damages due to delay and other causes suffered by the State because of the failure to execute said contract and contract bond; otherwise, the bid bond shall become void or the proposal guaranty check shall be returned to the undersigned.

Attach Cashier's Check or Certified Check Here	
In the event that one proposal guaranty check is intended to cover two or more proposals, the amount must be equal to the sum of the proposal guaranties which would be required for each individual proposal. If the guaranty check is placed in another proposal, state below where it may be found.	
The proposal guaranty check will be found in the proposal for:	Item _____
	Section No. _____
	County _____

Mark the proposal cover sheet as to the type of proposal guaranty submitted.

RETURN WITH BID

6. **COMBINATION BIDS.** The undersigned further agrees that if awarded the contract for the sections contained in the following combination, he/she will perform the work in accordance with the requirements of each individual proposal comprising the combination bid specified in the schedule below, and that the combination bid shall be prorated against each section in proportion to the bid submitted for the same. If an error is found to exist in the gross sum bid for one or more of the individual sections included in a combination, the combination bid shall be corrected as provided in the specifications.

When a combination bid is submitted, the schedule below must be completed in each proposal comprising the combination.

If alternate bids are submitted for one or more of the sections comprising the combination, a combination bid must be submitted for each alternate.

Schedule of Combination Bids

Combination No.	Sections Included in Combination	Combination Bid	
		Dollars	Cents

7. **SCHEDULE OF PRICES.** The undersigned bidder submits herewith, in accordance with the rules and instructions, a schedule of prices for the items of work for which bids are sought. The unit prices bid are in U.S. dollars and cents, and all extensions and summations have been made. The bidder understands that the quantities appearing in the bid schedule are approximate and are provided for the purpose of obtaining a gross sum for the comparison of bids. If there is an error in the extension of the unit prices, the unit prices shall govern. Payment to the contractor awarded the contract will be made only for actual quantities of work performed and accepted or materials furnished according to the contract. The scheduled quantities of work to be done and materials to be furnished may be increased, decreased or omitted as provided elsewhere in the contract.

8. **AUTHORITY TO DO BUSINESS IN ILLINOIS.** Section 20-43 of the Illinois Procurement Code (the Code) (30 ILCS 500/20-43) provides that a person (other than an individual acting as a sole proprietor) must be a legal entity authorized to do business in the State of Illinois prior to submitting the bid.

9. **The services of a subcontractor will be used.**

Check box Yes
 Check box No

For known subcontractors with subcontracts with an annual value of more than \$50,000, the contract shall include their name, address, general type of work to be performed, and the dollar allocation for each subcontractor.
 (30 ILCS 500/20-120)

10. **EXECUTION OF CONTRACT:** The Department of Transportation will, in accordance with the rules governing Department procurements, execute the contract and shall be the sole entity having the authority to accept performance and make payments under the contract. Execution of the contract by the Chief Procurement Officer (CPO) or the State Purchasing Officer (SPO) is for approval of the procurement process and execution of the contract by the Department. Neither the CPO nor the SPO shall be responsible for administration of the contract or determinations respecting performance or payment there under except as otherwise permitted in the Code.

RETURN WITH BID

STATE REQUIRED ETHICAL STANDARDS GOVERNING CONTRACT PROCUREMENT: ASSURANCES, CERTIFICATIONS AND DISCLOSURES

I. GENERAL

A. Article 50 of the Code establishes the duty of all State CPOs, SPOs, and their designees to maximize the value of the expenditure of public moneys in procuring goods, services, and contracts for the State of Illinois and to act in a manner that maintains the integrity and public trust of State government. In discharging this duty, they are charged by law to use all available information, reasonable efforts, and reasonable actions to protect, safeguard, and maintain the procurement process of the State of Illinois.

B. In order to comply with the provisions of Article 50 and to carry out the duty established therein, all bidders are to adhere to ethical standards established for the procurement process, and to make such assurances, disclosures and certifications required by law. Except as otherwise required in subsection III, paragraphs J-M, by execution of the Proposal Signature Sheet, the bidder indicates that each of the mandated assurances have been read and understood, that each certification is made and understood, and that each disclosure requirement has been understood and completed.

C. In addition to all other remedies provided by law, failure to comply with any assurance, failure to make any disclosure or the making of a false certification shall be grounds for the CPO to void the contract, and may result in the suspension or debarment of the bidder or subcontractor. If a false certification is made by a subcontractor the contractor's submitted bid and the executed contract may not be declared void unless the contractor refuses to terminate the subcontract upon the State's request after a finding that the subcontractor's certification was false.

II. ASSURANCES

The assurances hereinafter made by the bidder are each a material representation of fact upon which reliance is placed should the Department enter into the contract with the bidder.

A. Conflicts of Interest

1. The Code provides in pertinent part:

Section 50-13. Conflicts of Interest.

(a) Prohibition. It is unlawful for any person holding an elective office in this State, holding a seat in the General Assembly, or appointed to or employed in any of the offices or agencies of state government and who receives compensation for such employment in excess of 60% of the salary of the Governor of the State of Illinois, or who is an officer or employee of the Capital Development Board or the Illinois Toll Highway Authority, or who is the spouse or minor child of any such person to have or acquire any contract, or any direct pecuniary interest in any contract therein, whether for stationery, printing, paper, or any services, materials, or supplies, that will be wholly or partially satisfied by the payment of funds appropriated by the General Assembly of the State of Illinois or in any contract of the Capital Development Board or the Illinois Toll Highway authority.

(b) Interests. It is unlawful for any firm, partnership, association or corporation, in which any person listed in subsection (a) is entitled to receive (i) more than 7 1/2% of the total distributable income or (ii) an amount in excess of the salary of the Governor, to have or acquire any such contract or direct pecuniary interest therein.

(c) Combined interests. It is unlawful for any firm, partnership, association, or corporation, in which any person listed in subsection (a) together with his or her spouse or minor children is entitled to receive (i) more than 15%, in the aggregate, of the total distributable income or (ii) an amount in excess of 2 times the salary of the Governor, to have or acquire any such contract or direct pecuniary interest therein.

(d) Securities. Nothing in this Section invalidates the provisions of any bond or other security previously offered or to be offered for sale or sold by or for the State of Illinois.

(e) Prior interests. This Section does not affect the validity of any contract made between the State and an officer or employee of the State or member of the General Assembly, his or her spouse, minor child or any combination of those persons if that contract was in existence before his or her election or employment as an officer, member, or employee. The contract is voidable, however, if it cannot be completed within 365 days after the officer, member, or employee takes office or is employed.

The current salary of the Governor is \$177,412.00. Sixty percent of the salary is \$106,447.20.

RETURN WITH BID

2. The bidder assures the Department that the award and execution of the contract would not cause a violation of Section 50-13, or that an effective exemption has been issued by the Board of Ethics to any individual subject to the Section 50-13 prohibitions pursuant to the provisions of Section 50-20 of the Code and Executive Order Number 3 (1998). Information concerning the exemption process is available from the Department upon request.

B. Negotiations

1. The Code provides in pertinent part:

Section 50-15. Negotiations.

(a) It is unlawful for any person employed in or on a continual contractual relationship with any of the offices or agencies of State government to participate in contract negotiations on behalf of that office or agency with any firm, partnership, association, or corporation with whom that person has a contract for future employment or is negotiating concerning possible future employment.

2. The bidder assures the Department that the award and execution of the contract would not cause a violation of Section 50-15, and that the bidder has no knowledge of any facts relevant to the kinds of acts prohibited therein.

C. Inducements

1. The Code provides:

Section 50-25. Inducement. Any person who offers or pays any money or other valuable thing to any person to induce him or her not to bid for a State contract or as recompense for not having bid on a State contract is guilty of a Class 4 felony. Any person who accepts any money or other valuable thing for not bidding for a State contract or who withholds a bid in consideration of the promise for the payment of money or other valuable thing is guilty of a Class 4 felony.

2. The bidder assures the Department that the award and execution of the contract would not cause a violation of Section 50-25, and that the bidder has no knowledge of any facts relevant to the kinds of acts prohibited therein.

D. Revolving Door Prohibition

1. The Code provides:

Section 50-30. Revolving door prohibition. CPOs, SPOs, procurement compliance monitors, their designees whose principal duties are directly related to State procurement, and executive officers confirmed by the Senate are expressly prohibited for a period of 2 years after terminating an affected position from engaging in any procurement activity relating to the State agency most recently employing them in an affected position for a period of at least 6 months. The prohibition includes, but is not limited to: lobbying the procurement process; specifying; bidding; proposing bid, proposal, or contract documents; on their own behalf or on behalf of any firm, partnership, association, or corporation. This Section applies only to persons who terminate an affected position on or after January 15, 1999.

2. The bidder assures the Department that the award and execution of the contract would not cause a violation of Section 50-30, and that the bidder has no knowledge of any facts relevant to the kinds of acts prohibited therein.

E. Reporting Anticompetitive Practices

1. The Code provides:

Section 50-40. Reporting anticompetitive practices. When, for any reason, any vendor, bidder, contractor, CPO, SPO, designee, elected official, or State employee suspects collusion or other anticompetitive practice among any bidders, offerors, contractors, proposers, or employees of the State, a notice of the relevant facts shall be transmitted to the Attorney General and the CPO.

2. The bidder assures the Department that it has not failed to report any relevant facts concerning the practices addressed in Section 50-40 which may involve the contract for which the bid is submitted.

F. Confidentiality

1. The Code provides:

Section 50-45. Confidentiality. Any CPO, SPO, designee, or executive officer who willfully uses or allows the use of specifications, competitive bid documents, proprietary competitive information, proposals, contracts, or selection information to compromise the fairness or integrity of the procurement, bidding, or contract process shall be subject to immediate dismissal, regardless of the Personnel code, any contract, or any collective bargaining agreement, and may in addition be subject to criminal prosecution.

2. The bidder assures the Department that it has no knowledge of any fact relevant to the practices addressed in Section 50-45 which may involve the contract for which the bid is submitted.

RETURN WITH BID

G. Insider Information

1. The Code provides:

Section 50-50. Insider information. It is unlawful for any current or former elected or appointed State official or State employee to knowingly use confidential information available only by virtue of that office or employment for actual or anticipated gain for themselves or another person.

2. The bidder assures the Department that it has no knowledge of any facts relevant to the practices addressed in Section 50-50 which may involve the contract for which the bid is submitted.

III. CERTIFICATIONS

The certifications hereinafter made by the bidder are each a material representation of fact upon which reliance is placed should the Department enter into the contract with the bidder. Section 50-2 of the Code provides that every person that has entered into a multi-year contract and every subcontractor with a multi-year subcontract shall certify, by July 1 of each fiscal year covered by the contract after the initial fiscal year, to the responsible CPO whether it continues to satisfy the requirements of Article 50 pertaining to the eligibility for a contract award. If a contractor or subcontractor is not able to truthfully certify that it continues to meet all requirements, it shall provide with its certification a detailed explanation of the circumstances leading to the change in certification status. A contractor or subcontractor that makes a false statement material to any given certification required under Article 50 is, in addition to any other penalties or consequences prescribed by law, subject to liability under the Whistleblower Reward and Protection Act for submission of a false claim.

A. Bribery

1. The Code provides:

Section 50-5. Bribery.

(a) Prohibition. No person or business shall be awarded a contract or subcontract under this Code who:

(1) has been convicted under the laws of Illinois or any other state of bribery or attempting to bribe an officer or employee of the State of Illinois or any other state in that officer's or employee's official capacity; or

(2) has made an admission of guilt of that conduct that is a matter of record but has not been prosecuted for that conduct.

(b) Businesses. No business shall be barred from contracting with any unit of State or local government, or subcontracting under such a contract, as a result of a conviction under this Section of any employee or agent of the business if the employee or agent is no longer employed by the business and:

(1) the business has been finally adjudicated not guilty; or

(2) the business demonstrates to the governmental entity with which it seeks to contract, or which is signatory to the contract which the subcontract relates, and that entity finds that the commission of the offense was not authorized, requested, commanded, or performed by a director, officer, or high managerial agent on behalf of the business as provided in paragraph (2) of subsection (a) of Section 5-4 of the Criminal Code of 1961.

(c) Conduct on behalf of business. For purposes of this Section, when an official, agent, or employee of a business committed the bribery or attempted bribery on behalf of the business and in accordance with the direction or authorization of a responsible official of the business, the business shall be chargeable with the conduct.

(d) Certification. Every bid submitted to and contract executed by the State, and every subcontract subject to Section 20-120 of the Code shall contain a certification by the contractor or the subcontractor, respectively, that the contractor or subcontractor is not barred from being awarded a contract or subcontract under this Section and acknowledges that the CPO may declare the related contract void if any certifications required by this Section are false. A contractor who makes a false statement, material to the certification, commits a Class 3 felony.

2. The contractor or subcontractor certifies that it is not barred from being awarded a contract under Section 50.5.

B. Felons

1. The Code provides:

Section 50-10. Felons. Unless otherwise provided, no person or business convicted of a felony shall do business with the State of Illinois or any State agency, or enter into a subcontract, from the date of conviction until 5 years after the date of completion of the sentence for that felony, unless no person held responsible by a prosecutorial office for the facts upon which the conviction was based continues to have any involvement with the business.

2. Certification. Every bid submitted to and contract executed by the State and every subcontract subject to Section 20-120 of the Code shall contain a certification by the bidder or contractor or subcontractor, respectively, that the bidder, contractor, or subcontractor is not barred from being awarded a contract or subcontract under this Section and acknowledges that the CPO may declare the related contract void if any of the certifications required by this Section are false.

RETURN WITH BID

C. Debt Delinquency

1. The Code provides:

Section 50-11 and 50-12. Debt Delinquency.

The contractor or bidder or subcontractor, respectively, certifies that it, or any affiliate, is not barred from being awarded a contract or subcontract under the Code. Section 50-11 prohibits a person from entering into a contract with a State agency, or entering into a subcontract, if it knows or should know that it, or any affiliate, is delinquent in the payment of any debt to the State as defined by the Debt Collection Board. Section 50-12 prohibits a person from entering into a contract with a State agency, or entering into a subcontract, if it, or any affiliate, has failed to collect and remit Illinois Use Tax on all sales of tangible personal property into the State of Illinois in accordance with the provisions of the Illinois Use Tax Act. The bidder or contractor or subcontractor, respectively, further acknowledges that the CPO may declare the related contract void if this certification is false or if the bidder, contractor, or subcontractor, or any affiliate, is determined to be delinquent in the payment of any debt to the State during the term of the contract.

D. Prohibited Bidders, Contractors and Subcontractors

1. The Code provides:

Section 50-10.5 and 50-60(c). Prohibited bidders, contractors and subcontractors.

The bidder or contractor or subcontractor, respectively, certifies in accordance with 30 ILCS 500/50-10.5 that no officer, director, partner or other managerial agent of the contracting business has been convicted of a felony under the Sarbanes-Oxley Act of 2002 or a Class 3 or Class 2 felony under the Illinois Securities Law of 1953 or if in violation of Subsection (c) for a period of five years from the date of conviction. Every bid submitted to and contract executed by the State and every subcontract subject to Section 20-120 of the Code shall contain a certification by the bidder, contractor, or subcontractor, respectively, that the bidder, contractor, or subcontractor is not barred from being awarded a contract or subcontract under this Section and acknowledges that the CPO shall declare the related contract void if any of the certifications completed pursuant to this Section are false.

E. Section 42 of the Environmental Protection Act

The bidder or contractor or subcontractor, respectively, certifies in accordance with 30 ILCS 500/50-14 that the bidder, contractor, or subcontractor, is not barred from being awarded a contract or entering into a subcontract under this Section which prohibits the bidding on or entering into contracts with the State of Illinois or a State agency, or entering into any subcontract, that is subject to the Code by a person or business found by a court or the Pollution Control Board to have committed a willful or knowing violation of Section 42 of the Environmental Protection Act for a period of five years from the date of the order. The bidder or contractor or subcontractor, respectively, acknowledges that the CPO may declare the contract void if this certification is false.

F. Educational Loan

1. Section 3 of the Educational Loan Default Act provides:

§ 3. No State agency shall contract with an individual for goods or services if that individual is in default, as defined in Section 2 of this Act, on an educational loan. Any contract used by any State agency shall include a statement certifying that the individual is not in default on an educational loan as provided in this Section.

2. The bidder, if an individual as opposed to a corporation, partnership or other form of business organization, certifies that the bidder is not in default on an educational loan as provided in Section 3 of the Act.

G. Bid-Rigging/Bid Rotating

1. Section 33E-11 of the Criminal Code of 1961 provides:

§ 33E-11. (a) Every bid submitted to and public contract executed pursuant to such bid by the State or a unit of local government shall contain a certification by the prime contractor that the prime contractor is not barred from contracting with any unit of State or local government as a result of a violation of either Section 33E-3 or 33E-4 of this Article. The State and units of local government shall provide the appropriate forms for such certification.

- (b) A contractor who makes a false statement, material to the certification, commits a Class 3 felony.

A violation of Section 33E-3 would be represented by a conviction of the crime of bid-rigging which, in addition to Class 3 felony sentencing, provides that any person convicted of this offense or any similar offense of any state or the United States which contains the same elements as this offense shall be barred for 5 years from the date of conviction from contracting with any unit of State or local government. No corporation shall be barred from contracting with any unit of State or local government as a result of a conviction under this Section of any employee or agent of such corporation if the employee so convicted is no longer employed by the corporation and: (1) it has been finally adjudicated not guilty or (2) if it demonstrates to the governmental entity with which it seeks to contract and that entity finds that the commission of the offense was neither authorized, requested, commanded, nor performed by a director, officer or a high managerial agent in behalf of the corporation.

RETURN WITH BID

A violation of Section 33E-4 would be represented by a conviction of the crime of bid-rotating which, in addition to Class 2 felony sentencing, provides that any person convicted of this offense or any similar offense of any state or the United States which contains the same elements as this offense shall be permanently barred from contracting with any unit of State or local government. No corporation shall be barred from contracting with any unit of State or local government as a result of a conviction under this Section of any employee or agent of such corporation if the employee so convicted is no longer employed by the corporation and: (1) it has been finally adjudicated not guilty or (2) if it demonstrates to the governmental entity with which it seeks to contract and that entity finds that the commission of the offense was neither authorized, requested, commanded, nor performed by a director, officer or a high managerial agent in behalf of the corporation.

2. The bidder certifies that it is not barred from contracting with the Department by reason of a violation of either Section 33E-3 or Section 33E-4.

H. International Anti-Boycott

1. Section 5 of the International Anti-Boycott Certification Act provides:

§ 5. State contracts. Every contract entered into by the State of Illinois for the manufacture, furnishing, or purchasing of supplies, material, or equipment or for the furnishing of work, labor, or services, in an amount exceeding the threshold for small purchases according to the purchasing laws of this State or \$10,000.00, whichever is less, shall contain certification, as a material condition of the contract, by which the contractor agrees that neither the contractor nor any substantially-owned affiliated company is participating or shall participate in an international boycott in violation of the provisions of the U.S. Export Administration Act of 1979 or the regulations of the U.S. Department of Commerce promulgated under that Act.

2. The bidder makes the certification set forth in Section 5 of the Act.

I. Drug Free Workplace

1. The Illinois "Drug Free Workplace Act" applies to this contract and it is necessary to comply with the provisions of the "Act" if the contractor is a corporation, partnership, or other entity (including a sole proprietorship) which has 25 or more employees.

2. The bidder certifies that if awarded a contract in excess of \$5,000 it will provide a drug free workplace by:

(a) Publishing a statement notifying employees that the unlawful manufacture, distribution, dispensation, possession or use of a controlled substance, including cannabis, is prohibited in the contractor's workplace; specifying the actions that will be taken against employees for violations of such prohibition; and notifying the employee that, as a condition of employment on such contract, the employee shall abide by the terms of the statement, and notify the employer of any criminal drug statute conviction for a violation occurring in the workplace no later than five (5) days after such conviction.

(b) Establishing a drug free awareness program to inform employees about the dangers of drug abuse in the workplace; the contractor's policy of maintaining a drug free workplace; any available drug counseling, rehabilitation, and employee assistance programs; and the penalties that may be imposed upon employees for drug violations.

(c) Providing a copy of the statement required by subparagraph (1) to each employee engaged in the performance of the contract and to post the statement in a prominent place in the workplace.

(d) Notifying the Department within ten (10) days after receiving notice from an employee or otherwise receiving actual notice of the conviction of an employee for a violation of any criminal drug statute occurring in the workplace.

(e) Imposing or requiring, within 30 days after receiving notice from an employee of a conviction or actual notice of such a conviction, an appropriate personnel action, up to and including termination, or the satisfactory participation in a drug abuse assistance or rehabilitation program approved by a federal, state or local health, law enforcement or other appropriate agency.

(f) Assisting employees in selecting a course of action in the event drug counseling, treatment, and rehabilitation is required and indicating that a trained referral team is in place.

(g) Making a good faith effort to continue to maintain a drug free workplace through implementation of the actions and efforts stated in this certification.

RETURN WITH BID

J. Disclosure of Business Operations in Iran

Section 50-36 of the Code, 30ILCS 500/50-36 provides that each bid, offer, or proposal submitted for a State contract shall include a disclosure of whether or not the Company acting as the bidder, offeror, or proposing entity, or any of its corporate parents or subsidiaries, within the 24 months before submission of the bid, offer, or proposal had business operations that involved contracts with or provision of supplies or services to the Government of Iran, companies in which the Government of Iran has any direct or indirect equity share, consortiums or projects commissioned by the Government of Iran, or companies involved in consortiums or projects commissioned by the Government of Iran and either of the following conditions apply:

- (1) More than 10% of the Company's revenues produced in or assets located in Iran involve oil-related activities or mineral-extraction activities; less than 75% of the Company's revenues produced in or assets located in Iran involve contracts with or provision of oil-related or mineral-extraction products or services to the Government of Iran or a project or consortium created exclusively by that government; and the Company has failed to take substantial action.
- (2) The Company has, on or after August 5, 1996, made an investment of \$20 million or more, or any combination of investments of at least \$10 million each that in the aggregate equals or exceeds \$20 million in any 12-month period, which directly or significantly contributes to the enhancement of Iran's ability to develop petroleum resources of Iran.

The terms "Business operations", "Company", "Mineral-extraction activities", "Oil-related activities", "Petroleum resources", and "Substantial action" are all defined in the Code.

Failure to make the disclosure required by the Code shall cause the bid, offer or proposal to be considered not responsive. The disclosure will be considered when evaluating the bid, offer, or proposal or awarding the contract. The name of each Company disclosed as doing business or having done business in Iran will be provided to the State Comptroller.

Check the appropriate statement:

Company has no business operations in Iran to disclose.

Company has business operations in Iran as disclosed the attached document.

K. Apprenticeship and Training Certification (Does not apply to federal aid projects)

In accordance with the provisions of Section 30-22 (6) of the Code, the bidder certifies that it is a participant, either as an individual or as part of a group program, in the approved apprenticeship and training programs applicable to each type of work or craft that the bidder will perform with its own forces. The bidder further certifies for work that will be performed by subcontract that each of its subcontractors submitted for approval either (a) is, at the time of such bid, participating in an approved, applicable apprenticeship and training program; or (b) will, prior to commencement of performance of work pursuant to this contract, begin participation in an approved apprenticeship and training program applicable to the work of the subcontract. The Department, at any time before or after award, may require the production of a copy of each applicable Certificate of Registration issued by the United States Department of Labor evidencing such participation by the contractor and any or all of its subcontractors. Applicable apprenticeship and training programs are those that have been approved and registered with the United States Department of Labor. The bidder shall list in the space below, the official name of the program sponsor holding the Certificate of Registration for all of the types of work or crafts in which the bidder is a participant and that will be performed with the bidder's forces. Types of work or craft work that will be subcontracted shall be included and listed as subcontract work. The list shall also indicate any type of work or craft job category that does not have an applicable apprenticeship or training program. **The bidder is responsible for making a complete report and shall make certain that each type of work or craft job category that will be utilized on the project as reported on the Construction Employee Workforce Projection (Form BC-1256) and returned with the bid is accounted for and listed.**

The requirements of this certification and disclosure are a material part of the contract, and the contractor shall require this certification provision to be included in all approved subcontracts. In order to fulfill this requirement, it shall not be necessary that an applicable program sponsor be currently taking or that it will take applications for apprenticeship, training or employment during the performance of the work of this contract.

TO BE RETURNED WITH BID

L. Political Contributions and Registration with the State Board of Elections

Sections 20-160 and 50-37 of the Code regulate political contributions from business entities and any affiliated entities or affiliated persons bidding on or contracting with the state. Generally under Section 50-37, any business entity, and any affiliated entity or affiliated person of the business entity, whose current year contracts with all state agencies exceed an awarded value of \$50,000, are prohibited from making any contributions to any political committees established to promote the candidacy of the officeholder responsible for the awarding of the contracts or any other declared candidate for that office for the duration of the term of office of the incumbent officeholder or a period 2 years after the termination of the contract, whichever is longer. Any business entity and affiliated entities or affiliated persons whose state contracts in the current year do not exceed an awarded value of \$50,000, but whose aggregate pending bids and proposals on state contracts exceed \$50,000, either alone or in combination with contracts not exceeding \$50,000, are prohibited from making any political contributions to any political committee established to promote the candidacy of the officeholder responsible for awarding the pending contract during the period beginning on the date the invitation for bids or request for proposals is issued and ending on the day after the date of award or selection if the entity was not awarded or selected. Section 20-160 requires certification of registration of affected business entities in accordance with procedures found in Section 9-35 of The Election Code.

By submission of a bid, the contractor business entity acknowledges and agrees that it has read and understands Sections 20-160 and 50-37 of the Code, and that it makes the following certification:

The undersigned business entity certifies that it has registered as a business with the State Board of Elections and acknowledges a continuing duty to update the registration in accordance with the above referenced statutes. If the business entity is required to register, the CPO shall verify that it is in compliance on the date the bid or proposal is due. The CPO shall not accept a bid or proposal if the business entity is not in compliance with the registration requirements.

These requirements and compliance with the above referenced statutory sections are a material part of the contract, and any breach thereof shall be cause to void the contract under Section 50-60 of the Code. This provision does not apply to Federal-aid contracts.

M. Lobbyist Disclosure

Section 50-38 of the Code requires that any bidder or offeror on a State contract that hires a person required to register under the Lobbyist Registration Act to assist in obtaining a contract shall:

- (i) Disclose all costs, fees, compensation, reimbursements, and other remunerations paid or to be paid to the lobbyist related to the contract,
- (ii) Not bill or otherwise cause the State of Illinois to pay for any of the lobbyist's costs, fees, compensation, reimbursements, or other remuneration, and
- (iii) Sign a verification certifying that none of the lobbyist's costs, fees, compensation, reimbursements, or other remuneration were billed to the State.

This information, along with all supporting documents, shall be filed with the agency awarding the contract and with the Secretary of State. The CPO shall post this information, together with the contract award notice, in the online Procurement Bulletin.

Pursuant to Subsection (c) of this Section, no person or entity shall retain a person or entity to attempt to influence the outcome of a procurement decision made under the Code for compensation contingent in whole or in part upon the decision or procurement. Any person who violates this subsection is guilty of a business offense and shall be fined not more than \$10,000.

Bidder acknowledges that it is required to disclose the hiring of any person required to register pursuant to the Illinois Lobbyist Registration Act (25 ILCS 170) in connection with this contract.

Bidder has not hired any person required to register pursuant to the Illinois Lobbyist Registration Act in connection with this contract.

Or

Bidder has hired the following persons required to register pursuant to the Illinois Lobbyist Registration Act in connection with the contract:

Name and address of person: _____
All costs, fees, compensation, reimbursements and other remuneration paid to said person: _____

RETURN WITH BID

IV. DISCLOSURES

- A. The disclosures hereinafter made by the bidder are each a material representation of fact upon which reliance is placed should the Department enter into the contract with the bidder. The bidder further certifies that the Department has received the disclosure forms for each bid.

The CPO may void the bid, or contract, respectively, if it is later determined that the bidder or subcontractor rendered a false or erroneous disclosure. A contractor or subcontractor may be suspended or debarred for violations of the Code. Furthermore, the CPO may void the contract and the surety providing the performance bond shall be responsible for completion of the contract.

B. Financial Interests and Conflicts of Interest

1. Section 50-35 of the Code provides that all bids of more than \$25,000 shall be accompanied by disclosure of the financial interests of the bidder. This disclosed information for the successful bidder, will be maintained as public information subject to release by request pursuant to the Freedom of Information Act, filed with the Procurement Policy Board, and shall be incorporated as a material term of the contract. Furthermore, pursuant to Section 5-5, the Procurement Policy Board may review a proposal, bid, or contract and issue a recommendation to void a contract or reject a proposal or bid based on any violation of the Code or the existence of a conflict of interest as provided in subsections (b) and (d) of Section 50-35.

The financial interests to be disclosed shall include ownership or distributive income share that is in excess of 5%, or an amount greater than 60% of the annual salary of the Governor, of the bidding entity or its parent entity, whichever is less, unless the contractor or bidder is a publicly traded entity subject to Federal 10K reporting, in which case it may submit its 10K disclosure in place of the prescribed disclosure. If a bidder is a privately held entity that is exempt from Federal 10K reporting, but has more than 200 shareholders, it may submit the information that Federal 10K companies are required to report, and list the names of any person or entity holding any ownership share that is in excess of 5%. The disclosure shall include the names, addresses, and dollar or proportionate share of ownership of each person making the disclosure, their instrument of ownership or beneficial relationship, and notice of any potential conflict of interest resulting from the current ownership or beneficial interest of each person making the disclosure having any of the relationships identified in Section 50-35 and on the disclosure form.
The current annual salary of the Governor is \$177,412.00

In addition, all disclosures shall indicate any other current or pending contracts, proposals, leases, or other ongoing procurement relationships the bidding entity has with any other unit of state government and shall clearly identify the unit and the contract, proposal, lease, or other relationship.

2. Disclosure Forms. Disclosure Form A is attached for use concerning the individuals meeting the above ownership or distributive share requirements. A separate Disclosure Form A must be submitted with the bid for each individual meeting the above requirements. In addition, a second form (Disclosure Form B) provides for the disclosure of current or pending procurement relationships with other (non-IDOT) state agencies and a total ownership certification. **The forms must be included with each bid.**

C. Disclosure Form Instructions

Form A Instructions for Financial Information & Potential Conflicts of Interest

If the bidder is a publicly traded entity subject to Federal 10K reporting, the 10K Report may be submitted to meet the requirements of Form A. If a bidder is a privately held entity that is exempt from Federal 10K reporting, but has more than 200 shareholders, it may submit the information that Federal 10K companies are required to report, and list the names of any person or entity holding any ownership share that is in excess of 5%. If a bidder is not subject to Federal 10K reporting, the bidder must determine if any individuals are required by law to complete a financial disclosure form. To do this, the bidder should answer each of the following questions. A "YES" answer indicates Form A must be completed. If the answer to each of the following questions is "NO", then the NOT APPLICABLE STATEMENT on Form A must be signed and dated by a person that is authorized to execute contracts for the bidding company. Note: These questions are for assistance only and are not required to be completed.

1. Does anyone in your organization have a direct or beneficial ownership share of greater than 5% of the bidding entity or parent entity? YES ___ NO ___
2. Does anyone in your organization have a direct or beneficial ownership share of less than 5%, but which has a value greater than 60% of the annual salary of the Governor? YES ___ NO ___
3. Does anyone in your organization receive more than 60% of the annual salary of the Governor of the bidding entity's or parent entity's distributive income? YES ___ NO ___

(Note: Distributive income is, for these purposes, any type of distribution of profits. An annual salary is not distributive income.)

4. Does anyone in your organization receive greater than 5% of the bidding entity's or parent entity's total distributive income, but which is less than 60% of the annual salary of the Governor? YES ___ NO ___

(Note: Only one set of forms needs to be completed per person per bid even if a specific individual would require a yes answer to more than one question.)

A "YES" answer to any of these questions requires the completion of Form A. The bidder must determine each individual in the bidding entity or the bidding entity's parent company that would cause the questions to be answered "Yes". Each form must be signed and dated by a person that is authorized to execute contracts for your organization. **Photocopied or stamped signatures are not acceptable.** The person signing can be, but does not have to be, the person for which the form is being completed. The bidder is responsible for the accuracy of any information provided.

If the answer to each of the above questions is "NO", then the NOT APPLICABLE STATEMENT of Form A must be signed and dated by a person that is authorized to execute contracts for your company.

RETURN WITH BID

Form B: Instructions for Identifying Other Contracts & Procurement Related Information

Disclosure Form B must be completed for each bid submitted by the bidding entity. *Note: Checking the NOT APPLICABLE STATEMENT on Form A does not allow the bidder to ignore Form B. Form B must be completed, checked, and dated or the bidder may be considered nonresponsive and the bid will not be accepted.*

The Bidder shall identify, by checking Yes or No on Form B, whether it has any pending contracts (including leases), bids, proposals, or other ongoing procurement relationship with any other (non-IDOT) State of Illinois agency. If "No" is checked, the bidder only needs to complete the check box on the bottom of Form B. If "Yes" is checked, the bidder must do one of the following:

Option I: If the bidder did not submit an Affidavit of Availability to obtain authorization to bid, the bidder must list all non-IDOT State of Illinois agency pending contracts, leases, bids, proposals, and other ongoing procurement relationships. These items may be listed on Form B or on an attached sheet(s). Do not include IDOT contracts. Contracts with cities, counties, villages, etc. are not considered State of Illinois agency contracts and are not to be included. Contracts with other State of Illinois agencies such as the Department of Natural Resources or the Capital Development Board must be included. Bidders who submit Affidavits of Availability are suggested to use Option II.

Option II: If the bidder is required and has submitted an Affidavit of Availability in order to obtain authorization to bid, the bidder may write or type "See Affidavit of Availability" which indicates that the Affidavit of Availability is incorporated by reference and includes all non-IDOT State of Illinois agency pending contracts, leases, bids, proposals, and other ongoing procurement relationships. For any contracts that are not covered by the Affidavit of Availability, the bidder must identify them on Form B or on an attached sheet(s). These might be such things as leases.

**ILLINOIS DEPARTMENT
OF TRANSPORTATION**

**Form A
Financial Information &
Potential Conflicts of Interest
Disclosure**

Contractor Name		
Legal Address		
City, State, Zip		
Telephone Number	Email Address	Fax Number (if available)

Disclosure of the information contained in this Form is required by the Section 50-35 of the Code (30 ILCS 500). Vendors desiring to enter into a contract with the State of Illinois must disclose the financial information and potential conflict of interest information as specified in this Disclosure Form. This information shall become part of the publicly available contract file. This Form A must be completed for bids in excess of \$25,000, and for all open-ended contracts. **A publicly traded company may submit a 10K disclosure (or equivalent if applicable) in satisfaction of the requirements set forth in Form A. See Disclosure Form Instructions.**

The current annual salary of the Governor is \$177,412.00.

DISCLOSURE OF FINANCIAL INFORMATION

1. Disclosure of Financial Information. The individual named below has an interest in the BIDDER (or its parent) in terms of ownership or distributive income share in excess of 5%, or an interest which has a value of more than 60% of the annual salary of the Governor. **(Make copies of this form as necessary and attach a separate Disclosure Form A for each individual meeting these requirements)**

FOR INDIVIDUAL (type or print information)	
NAME:	_____
ADDRESS	_____
Type of ownership/distributable income share:	
stock _____ sole proprietorship _____ Partnership _____ other: (explain on separate sheet):	
% or \$ value of ownership/distributable income share:	_____

2. Disclosure of Potential Conflicts of Interest. Check "Yes" or "No" to indicate which, if any, of the following potential conflict of interest relationships apply. If the answer to any question is "Yes", please attach additional pages and describe.

- (a) State employment, currently or in the previous 3 years, including contractual employment of services. Yes ___ No ___

If your answer is yes, please answer each of the following questions.

- Are you currently an officer or employee of either the Capitol Development Board or the Illinois State Toll Highway Authority? Yes ___ No ___
- Are you currently appointed to or employed by any agency of the State of Illinois? If you are currently appointed to or employed by any agency of the State of Illinois, and your annual salary exceeds 60% of the annual salary of the Governor, provide the name the State agency for which you are employed and your annual salary. _____

RETURN WITH BID

3. If you are currently appointed to or employed by any agency of the State of Illinois, and your annual salary exceeds 60% of the annual salary of the Governor, are you entitled to receive (i) more than 7 1/2% of the total distributable income of your firm, partnership, association or corporation, or (ii) an amount in excess of 100% of the annual salary of the Governor?
Yes ___ No ___

4. If you are currently appointed to or employed by any agency of the State of Illinois, and your annual salary exceeds 60% of the annual salary of the Governor, are you and your spouse or minor children entitled to receive (i) more than 15 % in the aggregate of the total distributable income of your firm, partnership, association or corporation, or (ii) an amount in excess of two times the salary of the Governor?
Yes ___ No ___

(b) State employment of spouse, father, mother, son, or daughter, including contractual employment for services in the previous 2 years.
Yes ___ No ___

If your answer is yes, please answer each of the following questions.

1. Is your spouse or any minor children currently an officer or employee of the Capitol Development Board or the Illinois State Toll Highway Authority?
Yes ___ No ___

2. Is your spouse or any minor children currently appointed to or employed by any agency of the State of Illinois? If your spouse or minor children is/are currently appointed to or employed by any agency of the State of Illinois, and his/her annual salary exceeds 60% of the annual salary of the Governor, provide the name of your spouse and/or minor children, the name of the State agency for which he/she is employed and his/her annual salary. _____

3. If your spouse or any minor children is/are currently appointed to or employed by any agency of the State of Illinois, and his/her annual salary exceeds 60% of the annual salary of the Governor, are you entitled to receive (i) more than 7 1/2% of the total distributable income of your firm, partnership, association or corporation, or (ii) an amount in excess of 100% of the annual salary of the Governor?
Yes ___ No ___

4. If your spouse or any minor children are currently appointed to or employed by any agency of the State of Illinois, and his/her annual salary exceeds 60% of the annual salary of the Governor, are you and your spouse or minor children entitled to receive (i) more than 15 % in the aggregate of the total distributable income of your firm, partnership, association or corporation, or (ii) an amount in excess of two times the salary of the Governor?
Yes ___ No ___

(c) Elective status; the holding of elective office of the State of Illinois, the government of the United States, any unit of local government authorized by the Constitution of the State of Illinois or the statutes of the State of Illinois currently or in the previous 3 years.
Yes ___ No ___

(d) Relationship to anyone holding elective office currently or in the previous 2 years; spouse, father, mother, son, or daughter.
Yes ___ No ___

(e) Appointive office; the holding of any appointive government office of the State of Illinois, the United States of America, or any unit of local government authorized by the Constitution of the State of Illinois or the statutes of the State of Illinois, which office entitles the holder to compensation in excess of the expenses incurred in the discharge of that office currently or in the previous 3 years.
Yes ___ No ___

(f) Relationship to anyone holding appointive office currently or in the previous 2 years; spouse, father, mother, son, or daughter.
Yes ___ No ___

(g) Employment, currently or in the previous 3 years, as or by any registered lobbyist of the State government.
Yes ___ No ___

RETURN WITH BID

(h) Relationship to anyone who is or was a registered lobbyist in the previous 2 years; spouse, father, mother, son, or daughter. Yes ___ No ___

(i) Compensated employment, currently or in the previous 3 years, by any registered election or reelection committee registered with the Secretary of State or any county clerk of the State of Illinois, or any political action committee registered with either the Secretary of State or the Federal Board of Elections. Yes ___ No ___

(j) Relationship to anyone; spouse, father, mother, son, or daughter; who was a compensated employee in the last 2 years by any registered election or re-election committee registered with the Secretary of State or any county clerk of the State of Illinois, or any political action committee registered with either the Secretary of State or the Federal Board of Elections. Yes ___ No ___

3. Communication Disclosure.

Disclose the name and address of each lobbyist and other agent of the bidder or offeror who is not identified in Section 2 of this form, who is has communicated, is communicating, or may communicate with any State officer or employee concerning the bid or offer. This disclosure is a continuing obligation and must be promptly supplemented for accuracy throughout the process and throughout the term of the contract. If no person is identified, enter "None" on the line below:

Name and address of person(s): _____

RETURN WITH BID

4. Debarment Disclosure. For each of the persons identified under Sections 2 and 3 of this form, disclose whether any of the following has occurred within the previous 10 years: debarment from contracting with any governmental entity; professional licensure discipline; bankruptcies; adverse civil judgments and administrative findings; and criminal felony convictions. This disclosure is a continuing obligation and must be promptly supplemented for accuracy throughout the procurement process and term of the contract. If no person is identified, enter "None" on the line below:

Name of person(s): _____

Nature of disclosure: _____

APPLICABLE STATEMENT

This Disclosure Form A is submitted on behalf of the INDIVIDUAL named on previous page. Under penalty of perjury, I certify the contents of this disclosure to be true and accurate to the best of my knowledge.

Completed by: _____ Date _____
Signature of Individual or Authorized Representative

NOT APPLICABLE STATEMENT

Under penalty of perjury, I have determined that no individuals associated with this organization meet the criteria that would require the completion of this Form A.

This Disclosure Form A is submitted on behalf of the CONTRACTOR listed on the previous page.

_____ Date _____
Signature of Authorized Representative

The bidder has a continuing obligation to supplement these disclosures under Sec. 50-35 of the Code.

RETURN WITH BID

ILLINOIS DEPARTMENT OF TRANSPORTATION

Form B Other Contracts & Financial Related Information Disclosure

Contractor Name, Legal Address, City, State, Zip, Telephone Number, Email Address, Fax Number (if available)

Disclosure of the information contained in this Form is required by the Section 50-35 of the Code (30 ILCS 500). This information shall become part of the publicly available contract file. This Form B must be completed for bids in excess of \$25,000, and for all open-ended contracts.

DISCLOSURE OF OTHER CONTRACTS AND PROCUREMENT RELATED INFORMATION

1. Identifying Other Contracts & Procurement Related Information. The BIDDER shall identify whether it has any pending contracts (including leases), bids, proposals, or other ongoing procurement relationship with any other State of Illinois agency: Yes ___ No ___

If "No" is checked, the bidder only needs to complete the signature box on the bottom of this page.

2. If "Yes" is checked. Identify each such relationship by showing State of Illinois agency name and other descriptive information such as bid or project number (attach additional pages as necessary). SEE DISCLOSURE FORM INSTRUCTIONS:

THE FOLLOWING STATEMENT MUST BE CHECKED

Signature of Authorized Representative, Date

OWNERSHIP CERTIFICATION

Please certify that the following statement is true if the individuals for all submitted Form A disclosures do not total 100% of ownership.

Any remaining ownership interest is held by individuals receiving less than \$106,447.20 of the bidding entity's or parent entity's distributive income or holding less than a 5% ownership interest.

Yes No N/A (Form A disclosure(s) established 100% ownership)

RETURN WITH BID

SPECIAL NOTICE TO CONTRACTORS

The following requirements of the Illinois Department of Human Rights' Rules and Regulations are applicable to bidders on all construction contracts advertised by the Illinois Department of Transportation:

CONSTRUCTION EMPLOYEE UTILIZATION PROJECTION

- (a) All bidders on construction contracts shall complete and submit, along with and as part of their bids, a Bidder's Employee Utilization Form (Form BC-1256) setting forth a projection and breakdown of the total workforce intended to be hired and/or allocated to such contract work by the bidder including a projection of minority and female employee utilization in all job classifications on the contract project.
- (b) The Department of Transportation shall review the Employee Utilization Form, and workforce projections contained therein, of the contract awardee to determine if such projections reflect an underutilization of minority persons and/or women in any job classification in accordance with the Equal Employment Opportunity Clause and Section 7.2 of the Illinois Department of Human Rights' Rules and Regulations for Public Contracts adopted as amended on September 17, 1980. If it is determined that the contract awardee's projections reflect an underutilization of minority persons and/or women in any job classification, it shall be advised in writing of the manner in which it is underutilizing and such awardee shall be considered to be in breach of the contract unless, prior to commencement of work on the contract project, it submits revised satisfactory projections or an acceptable written affirmative action plan to correct such underutilization including a specific timetable geared to the completion stages of the contract.
- (c) The Department of Transportation shall provide to the Department of Human Rights a copy of the contract awardee's Employee Utilization Form, a copy of any required written affirmative action plan, and any written correspondence related thereto. The Department of Human Rights may review and revise any action taken by the Department of Transportation with respect to these requirements.

RETURN WITH BID



Contract No. 78342
JEFFERSON-POPE-WHITE Counties
Section D9 SCOUR REPAIR 2013-1
Various Routes
District 9 Construction Funds

PART I. IDENTIFICATION

Dept. Human Rights # _____ Duration of Project: _____

Name of Bidder: _____

PART II. WORKFORCE PROJECTION

A. The undersigned bidder has analyzed minority group and female populations, unemployment rates and availability of workers for the location in which this contract work is to be performed, and for the locations from which the bidder recruits employees, and hereby submits the following workforce projection including a projection for minority and female employee utilization in all job categories in the workforce to be allocated to this contract:

TABLE A

TOTAL Workforce Projection for Contract														
JOB CATEGORIES	TOTAL EMPLOYEES		MINORITY EMPLOYEES						TRAINEES					
			BLACK		HISPANIC		*OTHER MINOR.		APPRENTICES		ON THE JOB TRAINEES			
	M	F	M	F	M	F	M	F	M	F	M	F		
OFFICIALS (MANAGERS)														
SUPERVISORS														
FOREMEN														
CLERICAL														
EQUIPMENT OPERATORS														
MECHANICS														
TRUCK DRIVERS														
IRONWORKERS														
CARPENTERS														
CEMENT MASONS														
ELECTRICIANS														
PIPEFITTERS, PLUMBERS														
PAINTERS														
LABORERS, SEMI-SKILLED														
LABORERS, UNSKILLED														
TOTAL														

TABLE B

CURRENT EMPLOYEES TO BE ASSIGNED TO CONTRACT			
TOTAL EMPLOYEES		MINORITY EMPLOYEES	
M	F	M	F

TABLE C

TOTAL Training Projection for Contract								
EMPLOYEES IN TRAINING	TOTAL EMPLOYEES		BLACK		HISPANIC		*OTHER MINOR.	
	M	F	M	F	M	F	M	F
APPRENTICES								
ON THE JOB TRAINEES								

FOR DEPARTMENT USE ONLY

* Other minorities are defined as Asians (A) or Native Americans (N).
Please specify race of each employee shown in Other Minorities column.

Note: See instructions on page 2

RETURN WITH BID

**Contract No. 78342
JEFFERSON-POPE-WHITE Counties
Section D9 SCOUR REPAIR 2013-1
Various Routes
District 9 Construction Funds**

PART II. WORKFORCE PROJECTION - continued

- B. Included in "Total Employees" under Table A is the total number of **new hires** that would be employed in the event the undersigned bidder is awarded this contract.

The undersigned bidder projects that: (number) _____ new hires would be recruited from the area in which the contract project is located; and/or (number) _____ new hires would be recruited from the area in which the bidder's principal office or base of operation is located.

- C. Included in "Total Employees" under Table A is a projection of numbers of persons to be employed directly by the undersigned bidder as well as a projection of numbers of persons to be employed by subcontractors.

The undersigned bidder estimates that (number) _____ persons will be directly employed by the prime contractor and that (number) _____ persons will be employed by subcontractors.

PART III. AFFIRMATIVE ACTION PLAN

- A. The undersigned bidder understands and agrees that in the event the foregoing minority and female employee utilization projection included under **PART II** is determined to be an underutilization of minority persons or women in any job category, and in the event that the undersigned bidder is awarded this contract, he/she will, prior to commencement of work, develop and submit a written Affirmative Action Plan including a specific timetable (geared to the completion stages of the contract) whereby deficiencies in minority and/or female employee utilization are corrected. Such Affirmative Action Plan will be subject to approval by the contracting agency and the **Department of Human Rights**.
- B. The undersigned bidder understands and agrees that the minority and female employee utilization projection submitted herein, and the goals and timetable included under an Affirmative Action Plan if required, are deemed to be part of the contract specifications.

Company _____ Telephone Number _____

Address _____

NOTICE REGARDING SIGNATURE

The Bidder's signature on the Proposal Signature Sheet will constitute the signing of this form. The following signature block needs to be completed if revisions are required.

Signature: _____ Title: _____ Date: _____

Instructions: All tables must include subcontractor personnel in addition to prime contractor personnel.

Table A - Include both the number of employees that would be hired to perform the contract work and the total number currently employed (Table B) that will be allocated to contract work, and include all apprentices and on-the-job trainees. The "Total Employees" column should include all employees including all minorities, apprentices and on-the-job trainees to be employed on the contract work.

Table B - Include all employees currently employed that will be allocated to the contract work including any apprentices and on-the-job trainees currently employed.

Table C - Indicate the racial breakdown of the total apprentices and on-the-job trainees shown in Table A.

RETURN WITH BID
Contract No. 78342
JEFFERSON-POPE-WHITE Counties
Section D9 SCOUR REPAIR 2013-1
Various Routes
District 9 Construction Funds

PROPOSAL SIGNATURE SHEET

The undersigned bidder hereby makes and submits this bid on the subject Proposal, thereby assuring the Department that all requirements of the Invitation for Bids and rules of the Department have been met, that there is no misunderstanding of the requirements of paragraph 3 of this Proposal, and that the contract will be executed in accordance with the rules of the Department if an award is made on this bid.

Firm Name _____

(IF AN INDIVIDUAL) Signature of Owner _____

Business Address _____

Firm Name _____

By _____

(IF A CO-PARTNERSHIP) Business Address _____

Name and Address of All Members of the Firm:

Corporate Name _____

By _____

Signature of Authorized Representative

Typed or printed name and title of Authorized Representative

(IF A CORPORATION)

Attest _____

(IF A JOINT VENTURE, USE THIS SECTION
FOR THE MANAGING PARTY AND THE
SECOND PARTY SHOULD SIGN BELOW) Signature

Business Address _____

Corporate Name _____

By _____

Signature of Authorized Representative

Typed or printed name and title of Authorized Representative

(IF A JOINT VENTURE)

Attest _____

Signature

Business Address _____

If more than two parties are in the joint venture, please attach an additional signature sheet.



Return with Bid

Division of Highways
Proposal Bid Bond
(Effective November 1, 1992)

Item No.
Letting Date

KNOW ALL MEN BY THESE PRESENTS, That We

as PRINCIPAL, and

as SURETY, are held jointly, severally and firmly bound unto the STATE OF ILLINOIS in the penal sum of 5 percent of the total bid price, or for the amount specified in the bid proposal under "Proposal Guaranty" in effect on the date of the Invitation for Bids, whichever is the lesser sum, well and truly to be paid unto said STATE OF ILLINOIS, for the payment of which we bind ourselves, our heirs, executors, administrators, successors and assigns.

THE CONDITION OF THE FOREGOING OBLIGATION IS SUCH, that whereas, the PRINCIPAL has submitted a bid proposal to the STATE OF ILLINOIS, acting through the Department of Transportation, for the improvement designated by the Transportation Bulletin Item Number and Letting Date indicated above.

NOW, THEREFORE, if the Department shall accept the bid proposal of the PRINCIPAL; and if the PRINCIPAL shall, within the time and as specified in the bidding and contract documents, submit a DBE Utilization Plan that is accepted and approved by the Department; and if, after award by the Department, the PRINCIPAL shall enter into a contract in accordance with the terms of the bidding and contract documents including evidence of the required insurance coverages and providing such bond as specified with good and sufficient surety for the faithful performance of such contract and for the prompt payment of labor and material furnished in the prosecution thereof; or if, in the event of the failure of the PRINCIPAL to make the required DBE submission or to enter into such contract and to give the specified bond, the PRINCIPAL pays to the Department the difference not to exceed the penalty hereof between the amount specified in the bid proposal and such larger amount for which the Department may contract with another party to perform the work covered by said bid proposal, then this obligation shall be null and void, otherwise, it shall remain in full force and effect.

IN THE EVENT the Department determines the PRINCIPAL has failed to comply with any requirement as set forth in the preceding paragraph, then Surety shall pay the penal sum to the Department within fifteen (15) days of written demand therefor. If Surety does not make full payment within such period of time, the Department may bring an action to collect the amount owed. Surety is liable to the Department for all its expenses, including attorney's fees, incurred in any litigation in which it prevails either in whole or in part.

In TESTIMONY WHEREOF, the said PRINCIPAL and the said SURETY have caused this instrument to be signed by their respective officers this day of A.D.,

PRINCIPAL SURETY
(Company Name) (Company Name)
By (Signature & Title) By: (Signature of Attorney-in-Fact)

Notary Certification for Principal and Surety

STATE OF ILLINOIS,
County of
I, a Notary Public in and for said County, do hereby certify that
and
(Insert names of individuals signing on behalf of PRINCIPAL & SURETY)

who are each personally known to me to be the same persons whose names are subscribed to the foregoing instrument on behalf of PRINCIPAL and SURETY, appeared before me this day in person and acknowledged respectively, that they signed and delivered said instrument as their free and voluntary act for the uses and purposes therein set forth.

Given under my hand and notarial seal this day of A.D.

My commission expires Notary Public

In lieu of completing the above section of the Proposal Bid Form, the Principal may file an Electronic Bid Bond. By signing the proposal and marking the check box next to the Signature and Title line below, the Principal is ensuring the identified electronic bid bond has been executed and the Principal and Surety are firmly bound unto the State of Illinois under the conditions of the bid bond as shown above.

Electronic Bid Bond ID# Company / Bidder Name Signature and Title

(1) Policy

It is public policy that disadvantageded businesses as defined in 49 CFR Part 26 and the Special Provision shall have the maximum opportunity to participate in the performance of contracts financed in whole or in part with Federal or State funds. Consequently the requirements of 49 CFR Part 26 apply to this contract.

(2) Obligation

The contractor agrees to ensure that disadvantageded businesses as defined in 49 CFR Part 26 and the Special Provision have the maximum opportunity to participate in the performance of contracts or subcontracts financed in whole or in part with Federal or State funds. The contractor shall take all necessary and reasonable steps in accordance with 49 CFR Part 26 and the Special Provision to ensure that said businesses have the maximum opportunity to compete for and perform under this contract. The contractor shall not discriminate on the basis of race, color, national origin or sex in the award and performance of contracts.

(3) Project and Bid Identification

Complete the following information concerning the project and bid:

Route _____	Total Bid _____
Section _____	Contract DBE Goal _____ (Percent) (Dollar Amount)
Project _____	
County _____	
Letting Date _____	
Contract No. _____	
Letting Item No. _____	

(4) Assurance

I, acting in my capacity as an officer of the undersigned bidder (or bidders if a joint venture), hereby assure the Department that on this project my company : (check one)

Meets or exceeds contract award goals and has provided documented participation as follows:
Disadvantaged Business Participation _____ percent

Attached are the signed participation statements, forms SBE 2025, required by the Special Provision evidencing availability and use of each business participating in this plan and assuring that each business will perform a commercially useful function in the work of the contract.

Failed to meet contract award goals and has included good faith effort documentation to meet the goals and that my company has provided participation as follows:

Disadvantaged Business Participation _____ percent

The contract goals should be accordingly modified or waived. Attached is all information required by the Special Provision in support of this request including good faith effort. Also attached are the signed participation statements, forms SBE 2025, required by the Special Provision evidencing availability and use of each business participating in this plan and assuring that each business will perform a commercially useful function in the work of the contract.

Company

By _____

Title _____

Date _____

The "as read" Low Bidder is required to comply with the Special Provision.

Submit only one utilization plan for each project. The utilization plan shall be submitted in accordance with the special provision.

Bureau of Small Business Enterprises **Local Let Projects**
2300 South Dirksen Parkway Submit forms to the
Springfield, Illinois 62764 Local Agency



Illinois Department of Transportation

DBE Participation Statement

Subcontractor Registration _____

Letting _____

Participation Statement

Item No. _____

(1) Instructions

Contract _____

This form must be completed for each disadvantaged business participating in the Utilization Plan. This form shall be submitted in accordance with the special provision and will be attached to the Utilization Plan form. If additional space is needed complete an additional form for the firm.

(2) Work

Pay Item No.	Description	Quantity	Unit Price	Total
Total				

(3) Partial Payment Items

For any of the above items which are partial pay items, specifically describe the work and subcontract dollar amount:

(4) Commitment

The undersigned certify that the information included herein is true and correct, and that the DBE firm listed below has agreed to perform a commercially useful function in the work of the contract item(s) listed above and to execute a contract with the prime contractor. The undersigned further understand that no changes to this statement may be made without prior approval from the Department's Bureau of Small Business Enterprises and that complete and accurate information regarding actual work performed on this project and the payment therefore must be provided to the Department.

Signature for Prime Contractor

Signature for DBE Firm

Title _____

Title _____

Date _____

Date _____

Contact _____

Contact _____

Phone _____

Phone _____

Firm Name _____

Firm Name _____

Address _____

Address _____

City/State/Zip _____

City/State/Zip _____

E _____

WC _____

The Department of Transportation is requesting disclosure of information that is necessary to accomplish the statutory purpose as outlined under the state and federal law. Disclosure of this information is **REQUIRED**. Failure to provide any information will result in the contract not being awarded. This form has been approved by the State Forms Management Center.

PROPOSAL ENVELOPE



PROPOSALS

for construction work advertised for bids by the
Illinois Department of Transportation

Item No.	Item No.	Item No.

Submitted By:

Name:
Address:
Phone No.

Bidders should use an IDOT proposal envelope or affix this form to the front of a 10" x 13" envelope for the submittal of bids. If proposals are mailed, they should be enclosed in a second or outer envelope addressed to:

Engineer of Design and Environment - Room 326
Illinois Department of Transportation
2300 South Dirksen Parkway
Springfield, Illinois 62764

NOTICE

Individual bids, including Bid Bond and/or supplemental information if required, should be securely stapled.

CONTRACTOR OFFICE COPY OF CONTRACT SPECIFICATIONS

NOTICE

None of the following material needs to be returned with the bid package unless the special provisions require documentation and/or other information to be submitted.

Contract No. 78342
JEFFERSON-POPE-WHITE Counties
Section D9 SCOUR REPAIR 2013-1
Various Routes
District 9 Construction Funds



Illinois Department of Transportation

SUBCONTRACTOR DOCUMENTATION

Public Acts 96-0795, 96-0920, and 97-0895 enacted substantial changes to the provisions of the Code (30 ILCS 500). Among the changes are provisions affecting subcontractors. The Contractor awarded this contract will be required as a material condition of the contract to implement and enforce the contract requirements applicable to subcontractors that entered into a contractual agreement with a total value of \$50,000 or more with a person or entity who has a contract subject to the Code and approved in accordance with article 108.01 of the Standard Specifications for Road and Bridge Construction.

If the Contractor seeks approval of subcontractors to perform a portion of the work, and approval is granted by the Department, the Contractor shall provide a copy of the subcontract to the Illinois Department of Transportation's CPO upon request within 15 calendar days after execution of the subcontract.

Financial disclosures required pursuant to Sec. 50-35 of the Code must be submitted for all applicable subcontractors. The subcontract shall contain the certifications required to be made by subcontractors pursuant to Article 50 of the Code. This Notice to Bidders includes a document incorporating all required subcontractor certifications and disclosures for use by the Contractor in compliance with this mandate. The document is entitled State Required Ethical Standards Governing Subcontractors.

RETURN WITH SUBCONTRACT

STATE ETHICAL STANDARDS GOVERNING SUBCONTRACTORS

Article 50 of the Code establishes the duty of all State CPOs, SPOs, and their designees to maximize the value of the expenditure of public moneys in procuring goods, services, and contracts for the State of Illinois and to act in a manner that maintains the integrity and public trust of State government. In discharging this duty, they are charged by law to use all available information, reasonable efforts, and reasonable actions to protect, safeguard, and maintain the procurement process of the State of Illinois.

The certifications hereinafter made by the subcontractor are each a material representation of fact upon which reliance is placed should the Department approve the subcontractor. The CPO may terminate or void the contract approval if it is later determined that the bidder or subcontractor rendered a false or erroneous certification. If a false certification is made by a subcontractor the contractor's submitted bid and the executed contract may not be declared void unless the contractor refuses to terminate the subcontract upon the State's request after a finding that the subcontractor's certification was false.

Section 50-2 of the Code provides that every person that has entered into a multi-year contract and every subcontractor with a multi-year subcontract shall certify, by July 1 of each fiscal year covered by the contract after the initial fiscal year, to the responsible CPO whether it continues to satisfy the requirements of Article 50 pertaining to the eligibility for a contract award. If a contractor or subcontractor is not able to truthfully certify that it continues to meet all requirements, it shall provide with its certification a detailed explanation of the circumstances leading to the change in certification status. A contractor or subcontractor that makes a false statement material to any given certification required under Article 50 is, in addition to any other penalties or consequences prescribed by law, subject to liability under the Whistleblower Reward and Protection Act for submission of a false claim.

A. Bribery

1. The Code provides:

Section 50-5. Bribery.

(a) Prohibition. No person or business shall be awarded a contract or subcontract under this Code who:

(1) has been convicted under the laws of Illinois or any other state of bribery or attempting to bribe an officer or employee of the State of Illinois or any other state in that officer's or employee's official capacity; or

(2) has made an admission of guilt of that conduct that is a matter of record but has not been prosecuted for that conduct.

(b) Businesses. No business shall be barred from contracting with any unit of State or local government, or subcontracting under such a contract, as a result of a conviction under this Section of any employee or agent of the business if the employee or agent is no longer employed by the business and:

(1) the business has been finally adjudicated not guilty; or

(2) the business demonstrates to the governmental entity with which it seeks to contract, or which is signatory to the contract to which the subcontract relates, and that entity finds that the commission of the offense was not authorized, requested, commanded, or performed by a director, officer, or high managerial agent on behalf of the business as provided in paragraph (2) of subsection (a) of Section 5-4 of the Criminal Code of 1961.

(c) Conduct on behalf of business. For purposes of this Section, when an official, agent, or employee of a business committed the bribery or attempted bribery on behalf of the business and in accordance with the direction or authorization of a responsible official of the business, the business shall be chargeable with the conduct.

(d) Certification. Every bid submitted to and contract executed by the State, and every subcontract subject to Section 20-120 of the Code shall contain a certification by the contractor or the subcontractor, respectively, that the contractor or subcontractor is not barred from being awarded a contract or subcontract under this Section and acknowledges that the CPO may declare the related contract void if any certifications required by this Section are false. A contractor who makes a false statement, material to the certification, commits a Class 3 felony.

2. The contractor or subcontractor certifies that it is not barred from being awarded a contract under Section 50.5.

B. Felons

1. The Code provides:

Section 50-10. Felons. Unless otherwise provided, no person or business convicted of a felony shall do business with the State of Illinois or any State agency, or enter into a subcontract, from the date of conviction until 5 years after the date of completion of the sentence for that felony, unless no person held responsible by a prosecutorial office for the facts upon which the conviction was based continues to have any involvement with the business.

2. Certification. Every bid submitted to and contract executed by the State and every subcontract subject to Section 20-120 of the Code shall contain a certification by the bidder or contractor or subcontractor, respectively, that the bidder, contractor, or subcontractor is not barred from being awarded a contract or subcontract under this Section and acknowledges that the CPO may declare the related contract void if any of the certifications required by this Section are false.

RETURN WITH SUBCONTRACT

C. Debt Delinquency

1. The Code provides:

Section 50-11 and 50-12. Debt Delinquency.

The contractor or bidder or subcontractor, respectively, certifies that it, or any affiliate, is not barred from being awarded a contract or subcontract under the Code. Section 50-11 prohibits a person from entering into a contract with a State agency, or entering into a subcontract, if it knows or should know that it, or any affiliate, is delinquent in the payment of any debt to the State as defined by the Debt Collection Board. Section 50-12 prohibits a person from entering into a contract with a State agency, or entering into a subcontract, if it, or any affiliate, has failed to collect and remit Illinois Use Tax on all sales of tangible personal property into the State of Illinois in accordance with the provisions of the Illinois Use Tax Act. The bidder or contractor or subcontractor, respectively, further acknowledges that the CPO may declare the related contract void if this certification is false or if the bidder, contractor, or subcontractor, or any affiliate, is determined to be delinquent in the payment of any debt to the State during the term of the contract.

D. Prohibited Bidders, Contractors and Subcontractors

1. The Code provides:

Section 50-10.5 and 50-60(c). Prohibited bidders, contractors and subcontractors.

The bidder or contractor or subcontractor, respectively, certifies in accordance with 30 ILCS 500/50-10.5 that no officer, director, partner or other managerial agent of the contracting business has been convicted of a felony under the Sarbanes-Oxley Act of 2002 or a Class 3 or Class 2 felony under the Illinois Securities Law of 1953 or if in violation of Subsection (c) for a period of five years from the date of conviction. Every bid submitted to and contract executed by the State and every subcontract subject to Section 20-120 of the Code shall contain a certification by the bidder, contractor, or subcontractor, respectively, that the bidder, contractor, or subcontractor is not barred from being awarded a contract or subcontract under this Section and acknowledges that the CPO shall declare the related contract void if any of the certifications completed pursuant to this Section are false.

E. Section 42 of the Environmental Protection Act

The bidder or contractor or subcontractor, respectively, certifies in accordance with 30 ILCS 500/50-12 that the bidder, contractor, or subcontractor, is not barred from being awarded a contract or entering into a subcontract under this Section which prohibits the bidding on or entering into contracts with the State of Illinois or a State agency, or entering into any subcontract, that is subject to the Code by a person or business found by a court or the Pollution Control Board to have committed a willful or knowing violation of Section 42 of the Environmental Protection Act for a period of five years from the date of the order. The bidder or contractor or subcontractor, respectively, acknowledges that the CPO may declare the contract void if this certification is false.

The undersigned, on behalf of the subcontracting company, has read and understands the above certifications and makes the certifications as required by law.

Name of Subcontracting Company

Authorized Officer

Date

RETURN WITH SUBCONTRACT
SUBCONTRACTOR DISCLOSURES

I. DISCLOSURES

- A.** The disclosures hereinafter made by the subcontractor are each a material representation of fact upon which reliance is placed. The subcontractor further certifies that the Department has received the disclosure forms for each subcontract.

The CPO may void the bid, contract, or subcontract, respectively, if it is later determined that the bidder or subcontractor rendered a false or erroneous disclosure. A contractor or subcontractor may be suspended or debarred for violations of the Code. Furthermore, the CPO may void the contract.

B. Financial Interests and Conflicts of Interest

1. Section 50-35 of the Code provides that all subcontracts with a total value of \$50,000 or more from subcontractors identified in Section 20-120 of the Code, shall be accompanied by disclosure of the financial interests of the subcontractor. This disclosed information for the subcontractor, will be maintained as public information subject to release by request pursuant to the Freedom of Information Act, filed with the Procurement Policy Board, and shall be incorporated as a material term of the Prime Contractor's contract. Furthermore, pursuant to this Section, the Procurement Policy Board may recommend to allow or void a contract or subcontract based on a potential conflict of interest.

The financial interests to be disclosed shall include ownership or distributive income share that is in excess of 5%, or an amount greater than 60% of the annual salary of the Governor, of the subcontracting entity or its parent entity, whichever is less, unless the subcontractor is a publicly traded entity subject to Federal 10K reporting, in which case it may submit its 10K disclosure in place of the prescribed disclosure. If a subcontractor is a privately held entity that is exempt from Federal 10K reporting, but has more than 200 shareholders, it may submit the information that Federal 10K companies are required to report, and list the names of any person or entity holding any ownership share that is in excess of 5%. The disclosure shall include the names, addresses, and dollar or proportionate share of ownership of each person making the disclosure, their instrument of ownership or beneficial relationship, and notice of any potential conflict of interest resulting from the current ownership or beneficial interest of each person making the disclosure having any of the relationships identified in Section 50-35 and on the disclosure form.

The current annual salary of the Governor is \$177,412.00.

In addition, all disclosures shall indicate any other current or pending contracts, subcontracts, proposals, leases, or other ongoing procurement relationships the subcontracting entity has with any other unit of state government and shall clearly identify the unit and the contract, subcontract, proposal, lease, or other relationship.

2. Disclosure Forms. Disclosure Form A is attached for use concerning the individuals meeting the above ownership or distributive share requirements. A separate Disclosure Form A must be submitted with the bid for each individual meeting the above requirements. In addition, a second form (Disclosure Form B) provides for the disclosure of current or pending procurement relationships with other (non-IDOT) state agencies and a total ownership certification. **The forms must be included with each bid.**

C. Disclosure Form Instructions

Form A Instructions for Financial Information & Potential Conflicts of Interest

If the subcontractor is a publicly traded entity subject to Federal 10K reporting, the 10K Report may be submitted to meet the requirements of Form A. If a subcontractor is a privately held entity that is exempt from Federal 10K reporting, but has more than 200 shareholders, it may submit the information that Federal 10K companies are required to report, and list the names of any person or entity holding any ownership share that is in excess of 5%. If a subcontractor is not subject to Federal 10K reporting, the subcontractor must determine if any individuals are required by law to complete a financial disclosure form. To do this, the subcontractor should answer each of the following questions. A "YES" answer indicates Form A must be completed. If the answer to each of the following questions is "NO", then the **NOT APPLICABLE STATEMENT** on the second page of Form A must be signed and dated by a person that is authorized to execute contracts for the subcontracting company. Note: These questions are for assistance only and are not required to be completed.

1. Does anyone in your organization have a direct or beneficial ownership share of greater than 5% of the bidding entity or parent entity? YES ___ NO ___
2. Does anyone in your organization have a direct or beneficial ownership share of less than 5%, but which has a value greater than 60% of the annual salary of the Governor? YES ___ NO ___
3. Does anyone in your organization receive more than 60% of the annual salary of the Governor of the subcontracting entity's or parent entity's distributive income? YES ___ NO ___

(Note: Distributive income is, for these purposes, any type of distribution of profits. An annual salary is not distributive income.)

4. Does anyone in your organization receive greater than 5% of the subcontracting entity's or parent entity's total distributive income, but which is less than 60% of the annual salary of the Governor? YES ___ NO ___

(Note: Only one set of forms needs to be completed per person per subcontract even if a specific individual would require a yes answer to more than one question.)

A "YES" answer to any of these questions requires the completion of Form A. The subcontractor must determine each individual in the subcontracting entity or the subcontracting entity's parent company that would cause the questions to be answered "Yes". Each form must be signed and dated by a person that is authorized to execute contracts for your organization. **Photocopied or stamped signatures are not acceptable.** The person signing can be, but does not have to be, the person for which the form is being completed. The subcontractor is responsible for the accuracy of any information provided.

If the answer to each of the above questions is "NO", then the **NOT APPLICABLE STATEMENT** on page 2 of Form A must be signed and dated by a person that is authorized to execute contracts for your company.

RETURN WITH SUBCONTRACT

Form B: Instructions for Identifying Other Contracts & Procurement Related Information

Disclosure Form B must be completed for each subcontract submitted by the subcontracting entity. *Note: Checking the NOT APPLICABLE STATEMENT on Form A does not allow the subcontractor to ignore Form B. Form B must be completed, checked, and dated or the subcontract will not be approved.*

The Subcontractor shall identify, by checking Yes or No on Form B, whether it has any pending contracts, subcontracts, leases, bids, proposals, or other ongoing procurement relationship with any other (non-IDOT) State of Illinois agency. If "No" is checked, the subcontractor only needs to complete the check box on the bottom of Form B. If "Yes" is checked, the subcontractor must list all non-IDOT State of Illinois agency pending contracts, subcontracts, leases, bids, proposals, and other ongoing procurement relationships. These items may be listed on Form B or on an attached sheet(s). Contracts with cities, counties, villages, etc. are not considered State of Illinois agency contracts and are not to be included. Contracts or subcontracts with other State of Illinois agencies such as the Department of Natural Resources or the Capital Development Board must be included.

**ILLINOIS DEPARTMENT
OF TRANSPORTATION**

**Form A
Subcontractor: Financial
Information & Potential Conflicts
of Interest Disclosure**

Subcontractor Name		
Legal Address		
City, State, Zip		
Telephone Number	Email Address	Fax Number (if available)

Disclosure of the information contained in this Form is required by the Section 50-35 of the Code (30 ILCS 500). Subcontractors desiring to enter into a subcontract of a State of Illinois contract must disclose the financial information and potential conflict of interest information as specified in this Disclosure Form. This information shall become part of the publicly available contract file. This Form A must be completed for subcontracts with a total value of \$50,000 or more, from subcontractors identified in Section 20-120 of the Code, and for all open-ended contracts. **A publicly traded company may submit a 10K disclosure (or equivalent if applicable) in satisfaction of the requirements set forth in Form A. See Disclosure Form Instructions.**

The current annual salary of the Governor is \$177,412.00.

DISCLOSURE OF FINANCIAL INFORMATION

1. Disclosure of Financial Information. The individual named below has an interest in the SUBCONTRACTOR (or its parent) in terms of ownership or distributive income share in excess of 5%, or an interest which has a value of more than 60% of the annual salary of the Governor. **(Make copies of this form as necessary and attach a separate Disclosure Form A for each individual meeting these requirements)**

FOR INDIVIDUAL (type or print information)	
NAME:	_____
ADDRESS	_____
Type of ownership/distributable income share:	
stock _____ sole proprietorship _____ Partnership _____ other: (explain on separate sheet):	
% or \$ value of ownership/distributable income share:	_____

2. Disclosure of Potential Conflicts of Interest. Check "Yes" or "No" to indicate which, if any, of the following potential conflict of interest relationships apply. If the answer to any question is "Yes", please attach additional pages and describe.

(a) State employment, currently or in the previous 3 years, including contractual employment of services. Yes ___ No ___

If your answer is yes, please answer each of the following questions.

1. Are you currently an officer or employee of either the Capitol Development Board or the Illinois State Toll Highway Authority? Yes ___ No ___

2. Are you currently appointed to or employed by any agency of the State of Illinois? If you are currently appointed to or employed by any agency of the State of Illinois, and your annual salary exceeds 60% of the annual salary of the Governor, provide the name the State agency for which you are employed and your annual salary. _____

RETURN WITH SUBCONTRACT

3. If you are currently appointed to or employed by any agency of the State of Illinois, and your annual salary exceeds 60% of the annual salary of the Governor, are you entitled to receive (i) more than 7 1/2% of the total distributable income of your firm, partnership, association or corporation, or (ii) an amount in excess of 100% of the annual salary of the Governor?
Yes ___ No ___

4. If you are currently appointed to or employed by any agency of the State of Illinois, and your annual salary exceeds 60% of the annual salary of the Governor, are you and your spouse or minor children entitled to receive (i) more than 15 % in the aggregate of the total distributable income of your firm, partnership, association or corporation, or (ii) an amount in excess of two times the salary of the Governor?
Yes ___ No ___

(b) State employment of spouse, father, mother, son, or daughter, including contractual employment services in the previous 2 years.

Yes ___ No ___

If your answer is yes, please answer each of the following questions.

1. Is your spouse or any minor children currently an officer or employee of the Capitol Development Board or the Illinois Toll Highway Authority?
Yes ___ No ___

2. Is your spouse or any minor children currently appointed to or employed by any agency of the State of Illinois? If your spouse or minor children is/are currently appointed to or employed by any agency of the State of Illinois, and his/her annual salary exceeds 60% of the annual salary of the Governor, provide the name of your spouse and/or minor children, the name of the State agency for which he/she is employed and his/her annual salary. _____

3. If your spouse or any minor children is/are currently appointed to or employed by any agency of the State of Illinois, and his/her annual salary exceeds 60% of the annual salary of the Governor, as of 7/1/07) are you entitled to receive (i) more then 7 1/2% of the total distributable income of your firm, partnership, association or corporation, or (ii) an amount in excess of 100% of the annual salary of the Governor?
Yes ___ No ___

4. If your spouse or any minor children are currently appointed to or employed by any agency of the State of Illinois, and his/her annual salary exceeds 60% of the annual salary of the Governor, are you and your spouse or minor children entitled to receive (i) more than 15 % in the aggregate of the total distributable income of your firm, partnership, association or corporation, or (ii) an amount in excess of two times the annual salary of the Governor?
Yes ___ No ___

(c) Elective status; the holding of elective office of the State of Illinois, the government of the United States, any unit of local government authorized by the Constitution of the State of Illinois or the statutes of the State of Illinois currently or in the previous 3 years.
Yes ___ No ___

(d) Relationship to anyone holding elective office currently or in the previous 2 years; spouse, father, mother, son, or daughter.
Yes ___ No ___

(e) Appointive office; the holding of any appointive government office of the State of Illinois, the United States of America, or any unit of local government authorized by the Constitution of the State of Illinois or the statutes of the State of Illinois, which office entitles the holder to compensation in excess of the expenses incurred in the discharge of that office currently or in the previous 3 years.
Yes ___ No ___

(f) Relationship to anyone holding appointive office currently or in the previous 2 years; spouse, father, mother, son, or daughter.
Yes ___ No ___

(g) Employment, currently or in the previous 3 years, as or by any registered lobbyist of the State government.
Yes ___ No ___

RETURN WITH SUBCONTRACT

(h) Relationship to anyone who is or was a registered lobbyist in the previous 2 years; spouse, father, mother, son, or daughter. Yes ___ No ___

(i) Compensated employment, currently or in the previous 3 years, by any registered election or reelection committee registered with the Secretary of State or any county clerk of the State of Illinois, or any political action committee registered with either the Secretary of State or the Federal Board of Elections. Yes ___ No ___

(j) Relationship to anyone; spouse, father, mother, son, or daughter; who was a compensated employee in the last 2 years by any registered election or re-election committee registered with the Secretary of State or any county clerk of the State of Illinois, or any political action committee registered with either the Secretary of State or the Federal Board of Elections. Yes ___ No ___

3 Communication Disclosure.

Disclose the name and address of each lobbyist and other agent of the bidder or offeror who is not identified in Section 2 of this form, who is has communicated, is communicating, or may communicate with any State officer or employee concerning the bid or offer. This disclosure is a continuing obligation and must be promptly supplemented for accuracy throughout the process and throughout the term of the contract. If no person is identified, enter "None" on the line below:

Name and address of person(s): _____

RETURN WITH SUBCONTRACT

4. Debarment Disclosure. For each of the persons identified under Sections 2 and 3 of this form, disclose whether any of the following has occurred within the previous 10 years: debarment from contracting with any governmental entity; professional licensure discipline; bankruptcies; adverse civil judgments and administrative findings; and criminal felony convictions. This disclosure is a continuing obligation and must be promptly supplemented for accuracy throughout the procurement process and term of the contract. If no person is identified, enter "None" on the line below:

Name of person(s): _____

Nature of disclosure: _____

APPLICABLE STATEMENT

This Disclosure Form A is submitted on behalf of the INDIVIDUAL named on previous page. Under penalty of perjury, I certify the contents of this disclosure to be true and accurate to the best of my knowledge.

Completed by: _____ Date _____
Signature of Individual or Authorized Officer

NOT APPLICABLE STATEMENT

Under penalty of perjury, I have determined that no individuals associated with this organization meet the criteria that would require the completion of this Form A.

This Disclosure Form A is submitted on behalf of the SUBCONTRACTOR listed on the previous page.

_____ Date _____
Signature of Authorized Officer

RETURN WITH SUBCONTRACT

ILLINOIS DEPARTMENT OF TRANSPORTATION

Form B
Subcontractor: Other Contracts & Financial Related Information Disclosure

Form with fields: Subcontractor Name, Legal Address, City, State, Zip, Telephone Number, Email Address, Fax Number (if available)

Disclosure of the information contained in this Form is required by the Section 50-35 of the Code (30 ILCS 500). This information shall become part of the publicly available contract file. This Form B must be completed for subcontracts with a total value of \$50,000 or more, from subcontractors identified in Section 20-120 of the Code, and for all open-ended contracts.

DISCLOSURE OF OTHER CONTRACTS, SUBCONTRACTS, AND PROCUREMENT RELATED INFORMATION

1. Identifying Other Contracts & Procurement Related Information. The SUBCONTRACTOR shall identify whether it has any pending contracts, subcontracts, including leases, bids, proposals, or other ongoing procurement relationship with any other State of Illinois agency: Yes ___ No ___

If "No" is checked, the subcontractor only needs to complete the signature box on the bottom of this page.

2. If "Yes" is checked. Identify each such relationship by showing State of Illinois agency name and other descriptive information such as bid or project number (attach additional pages as necessary). SEE DISCLOSURE FORM INSTRUCTIONS:

THE FOLLOWING STATEMENT MUST BE CHECKED

Signature box with fields: Signature of Authorized Representative, Date

OWNERSHIP CERTIFICATION

Please certify that the following statement is true if the individuals for all submitted Form A disclosures do not total 100% of ownership

Any remaining ownership interest is held by individuals receiving less than \$106,447.20 of the bidding entity's or parent entity's distributive income or holding less than a 5% ownership interest.

Yes No N/A (Form A disclosure(s) established 100% ownership)



NOTICE TO BIDDERS

- 1. TIME AND PLACE OF OPENING BIDS.** Sealed proposals for the improvement described herein will be received by the Department of Transportation at the Harry R. Hanley Building, 2300 South Dirksen Parkway, in Springfield, Illinois until 10:00 o'clock a.m., May 24, 2013. All bids will be gathered, sorted, publicly opened and read in the auditorium at the Department of Transportation's Harry R. Hanley Building shortly after the 10:00 a.m. cut off time.
- 2. DESCRIPTION OF WORK.** The proposed improvement is identified and advertised for bids in the Invitation for Bids as:

**Contract No. 78342
JEFFERSON-POPE-WHITE Counties
Section D9 SCOUR REPAIR 2013-1
Various Routes
District 9 Construction Funds**

This project consists of placing riprap for scour mitigation at four structures (S.N. 041-0019) carrying Illinois Route 15 over Rayse Creek in Jefferson County, (S.N. 076-0001) carrying Illinois Route 34 over Gibbons Creek in Pope County, (S.N. 097-0013) carrying U.S. Route 45 over Bear Creek in White County and (S.N. 097-0030) carrying Illinois Route 141 over Little Wabash River in White County.

- 3. INSTRUCTIONS TO BIDDERS.** (a) This Notice, the invitation for bids, proposal and letter of award shall, together with all other documents in accordance with Article 101.09 of the Standard Specifications for Road and Bridge Construction, become part of the contract. Bidders are cautioned to read and examine carefully all documents, to make all required inspections, and to inquire or seek explanation of the same prior to submission of a bid.

(b) State law, and, if the work is to be paid wholly or in part with Federal-aid funds, Federal law requires the bidder to make various certifications as a part of the proposal and contract. By execution and submission of the proposal, the bidder makes the certification contained therein. A false or fraudulent certification shall, in addition to all other remedies provided by law, be a breach of contract and may result in termination of the contract.
- 4. AWARD CRITERIA AND REJECTION OF BIDS.** This contract will be awarded to the lowest responsive and responsible bidder considering conformity with the terms and conditions established by the Department in the rules, Invitation for Bids and contract documents. The issuance of plans and proposal forms for bidding based upon a prequalification rating shall not be the sole determinant of responsibility. The Department reserves the right to determine responsibility at the time of award, to reject any or all proposals, to readvertise the proposed improvement, and to waive technicalities.

By Order of the
Illinois Department of Transportation

Ann L. Schneider,
Secretary

INDEX
FOR
SUPPLEMENTAL SPECIFICATIONS
AND RECURRING SPECIAL PROVISIONS

Adopted January 1, 2013

This index contains a listing of SUPPLEMENTAL SPECIFICATIONS, frequently used RECURRING SPECIAL PROVISIONS, and LOCAL ROADS AND STREETS RECURRING SPECIAL PROVISIONS.

ERRATA Standard Specifications for Road and Bridge Construction (Adopted 1-1-12) (Revised 1-1-13)

SUPPLEMENTAL SPECIFICATIONS

<u>Std. Spec. Sec.</u>	<u>Page No.</u>
105 Control of Work	1
107 Legal Regulations and Responsibility to Public	2
202 Earth and Rock Excavation	4
211 Topsoil and Compost	5
407 Hot-Mix Asphalt Pavement (Full-Depth)	6
420 Portland Cement Concrete Pavement	10
424 Portland Cement Concrete Sidewalk	12
503 Concrete Structures	13
504 Precast Concrete Structures	14
540 Box Culverts	15
603 Adjusting Frames and Grates of Drainage and Utility Structures	16
610 Shoulder Inlets with Curb	18
642 Shoulder Rumble Strips	19
643 Impact Attenuators	20
701 Work Zone Traffic Control and Protection	22
706 Impact Attenuators, Temporary	24
780 Pavement Striping	26
860 Master Controller	27
1006 Metals	28
1042 Precast Concrete Products	29
1073 Controller	30
1083 Elastomeric Bearings	31
1101 General Equipment	32
1106 Work Zone Traffic Control Devices	34

RECURRING SPECIAL PROVISIONS

The following RECURRING SPECIAL PROVISIONS indicated by an "X" are applicable to this contract and are included by reference:

<u>CHECK SHEET #</u>	<u>PAGE NO.</u>
1	35
2	38
3	39
4	49
5	54
6	59
7	60
8	61
9	62
10	65
11	68
12	70
13	74
14	76
15	77
16	79
17	80
18	82
19	83
20	84
21	88
22	90
23	92
24	94
25	95
26	96
27	97
28	98
29	99
30	102
31	110
32	122

TABLE OF CONTENTS

LOCATION OF PROJECT	1
DESCRIPTION OF PROJECT	1
UTILITIES	1
TRAFFIC CONTROL PLAN	2
AUTOMATED FLAGGER ASSISTANCE DEVICES (BDE)	3
DISADVANTAGED BUSINESS ENTERPRISE PARTICIPATION (BDE)	4
LIQUIDATED DAMAGES (BDE)	14
PAYMENTS TO SUBCONTRACTORS (BDE)	14
REMOVAL AND DISPOSAL OF REGULATED SUBSTANCES (BDE)	15
REMOVAL AND DISPOSAL OF SURPLUS MATERIALS (BDE)	19
SUBCONTRACTOR MOBILIZATION PAYMENTS (BDE)	20
TRACKING THE USE OF PESTICIDES (BDE)	21
TRAFFIC CONTROL DEFICIENCY DEDUCTION (BDE)	21
UTILITY COORDINATION AND CONFLICTS (BDE)	21
WEEKLY DBE TRUCKING REPORTS (BDE)	27
WORKING DAYS (BDE)	27
404 PERMIT	28

STATE OF ILLINOIS

SPECIAL PROVISIONS

The following Special Provisions supplement the "Standard Specifications for Road and Bridge Construction," adopted January 1, 2012, the latest edition of the "Manual on Uniform Traffic Control Devices for Streets and Highways," and the "Manual of Test Procedures for Materials" in effect on the date of invitation for bids, and the Supplemental Specifications and Recurring Special Provisions indicated on the Check Sheet included herein which apply to and govern the construction of Various Routes, Section D9 SCOUR REPAIR 2013-1 in Jefferson, Pope & White Counties, Contract No. 78342 and in case of conflict with any part or parts of said Specifications, the said Special Provisions shall take precedence and shall govern.

LOCATION OF PROJECT

Structure 041-0019 carries FAP 821 (IL 15) over Faysse Creek at 3.6 miles east of Washington County in Jefferson County. Structure 076-0001 carries FAP 778 (IL 34) over Gibbons Creek at 1.6 miles west of Hardin County in Pope County. Structure 097-0013 carries FAP 332 (US 45) over Bear Creek at 2 miles south of the IL 1/US 45 junction in White County. Structure 097-0030 carries FAP 877 (IL 141) over the Little Wabash River at the north city limit of New Haven in White County.

DESCRIPTION OF PROJECT

The project consists of installing filter fabric, bedding material and stone riprap for the purpose of scour mitigation.

UTILITIES

Effective 1984 Revised 1/2/97

Add the following after the first paragraph of Article 105.07 of the Standard Specifications:

Verification of locations of underground utilities, shown or not shown, will be the responsibility of the Contractor.

A telephone line is attached to Structure 076-0001.

Additional utility information may be obtained by calling the "Joint Utility Location Information for Excavators" phone number, 800-892-0123 or 811. This project is located in Casner Township at T2S R1E Sec. 34; County Unit Road District at T11S R7E Sec. 9; Indian Creek Township at T7S R8E SEC 5; and Emma Township at T7S R10E Sec. 17.

TRAFFIC CONTROL PLAN

Effective 1985 Revised 2/17/99

Traffic control shall be in accordance with the applicable sections of the Standard Specifications for Road and Bridge Construction, the guidelines contained in the National Manual on Uniform Traffic Control Devices for Streets and Highways, the Supplemental Specifications, these Special Provisions, and any special details and highway standards contained herein and in the plans.

Special attention is called to Articles 107.09 and 107.14 of the Standard Specifications for Road and Bridge Construction and the following traffic control related (1) Highway Standards; (2) Supplemental Specifications and Recurring Special Provisions; (3) other Special Provisions; and (4) Plan Details which are included in this contract:

1. Standards: 701201, 701301, 701901
2. Supplemental Specifications and Recurring Special Provisions: None
3. Special Provisions: Traffic Control Deficiency Deduction (BDE)
4. Plan Details: None

Traffic control standards shall be applied as directed by the Engineer. Suggested applications for each standard are as follow:

701201 This standard should be applied during operations which require encroachment of any equipment, vehicles, or workers within 2' of the edge of pavement.

701301 This standard will apply when short time work operations are being performed.

During the entire construction period, the road shall be kept open to traffic as follows:

Access to all public roads and private entrances shall be maintained at all times.

If at any time the signs are in place but not applicable, they shall be turned from the view of motorists or covered as directed by the Engineer.

AUTOMATED FLAGGER ASSISTANCE DEVICES (BDE)

Effective: January 1, 2008

Description. This work shall consist of furnishing and operating automated flagger assistance devices (AFADs) as part of the work zone traffic control and protection for two-lane highways where two-way traffic is maintained over one lane of pavement. Use of these devices shall be at the option of the Contractor.

Equipment. AFADs shall be according to the FHWA memorandum, "MUTCD - Revised Interim Approval for the use of Automated Flagger Assistance Devices in Temporary Traffic Control Zones (IA-4R)", dated January 28, 2005. The devices shall be mounted on a trailer or a moveable cart and shall meet the requirements of NCHRP 350, Category 4.

The AFAD shall be the Stop/Slow type. This device uses remotely controlled "STOP" and "SLOW" signs to alternately control right-of-way.

Signs for the AFAD shall be according to Article 701.03 of the Standard Specifications and the MUTCD. The signs shall be 24 x 24 in. (600 x 600 mm) having an octagon shaped "STOP" sign on one side and a diamond shaped "SLOW" sign on the opposite side. The letters on the signs shall be 8 in. (200 mm) high. If the "STOP" sign has louvers, the full sign face shall be visible at a distance of 50 ft (15 m) and greater.

The signs shall be supplemented with one of the following types of lights.

- (a) Flashing Lights. When flashing lights are used, white or red flashing lights shall be mounted within the "STOP" sign face and white or yellow flashing lights within the "SLOW" sign face.
- (b) Stop and Warning Beacons. When beacons are used, a stop beacon shall be mounted 24 in. (600 mm) or less above the "STOP" sign face and a warning beacon mounted 24 in. (600 mm) or less above, below, or to the side of the "SLOW" sign face. As an option, a Type B warning light may be used in lieu of the warning beacon.

A "WAIT ON STOP" sign shall be placed on the right hand side of the roadway at a point where drivers are expected to stop. The sign shall be 24 x 30 in. (600 x 750 mm) with a black legend and border on a white background. The letters shall be at least 6 in. (150 mm) high.

This device may include a gate arm or mast arm that descends to a horizontal position when the "STOP" sign is displayed and rises to a vertical position when the "SLOW" sign is displayed. When included, the end of the arm shall reach at least to the center of the lane being controlled. The arm shall have alternating red and white retroreflective stripes, on both sides, sloping downward at 45 degrees toward the side on which traffic will pass. The stripes shall be 6 in. (150 mm) in width and at least 2 in. (50 mm) in height.

Flagging Requirements. Flaggers and flagging requirements shall be according to Article 701.13 of the Standard Specifications and the following.

AFADs shall be placed at each end of the traffic control, where a flagger is shown on the plans. The flaggers shall be able to view the face of the AFAD and approaching traffic during operation.

To stop traffic, the "STOP" sign shall be displayed, the corresponding lights/beacon shall flash, and when included, the gate arm shall descend to a horizontal position. To permit traffic to move, the "SLOW" sign shall be displayed, the corresponding lights/beacon shall flash, and when included, the gate arm shall rise to a vertical position.

If used at night, the AFAD location shall be illuminated according to Section 701 of the Standard Specifications.

When not in use, AFADs will be considered nonoperating equipment and shall be stored according to Article 701.11 of the Standard Specifications.

Basis of Payment. This work will not be paid for separately but shall be considered as included in the cost of the various traffic control items included in the contract.

DISADVANTAGED BUSINESS ENTERPRISE PARTICIPATION (BDE)

Effective: September 1, 2000

Revised: August 2, 2011

FEDERAL OBLIGATION. The Department of Transportation, as a recipient of federal financial assistance, is required to take all necessary and reasonable steps to ensure nondiscrimination in the award and administration of contracts. Consequently, the federal regulatory provisions of 49 CFR Part 26 apply to this contract concerning the utilization of disadvantaged business enterprises. For the purposes of this Special Provision, a disadvantaged business enterprise (DBE) means a business certified by the Department in accordance with the requirements of 49 CFR Part 26 and listed in the Illinois Unified Certification Program (IL UCP) DBE Directory.

STATE OBLIGATION. This Special Provision will also be used by the Department to satisfy the requirements of the Business Enterprise for Minorities, Females, and Persons with Disabilities Act, 30 ILCS 575. When this Special Provision is used to satisfy state law requirements on 100 percent state-funded contracts, the federal government has no involvement in such contracts (not a federal-aid contract) and no responsibility to oversee the implementation of this Special Provision by the Department on those contracts. DBE participation on 100 percent state-funded contracts will not be credited toward fulfilling the Department's annual overall DBE goal required by the US Department of Transportation to comply with the federal DBE program requirements.

CONTRACTOR ASSURANCE. The Contractor makes the following assurance and agrees to include the assurance in each subcontract that the Contractor signs with a subcontractor.

The Contractor, subrecipient, or subcontractor shall not discriminate on the basis of race, color, national origin, or sex in the performance of this contract. The Contractor shall carry out applicable requirements of 49 CFR Part 26 in the award and administration of contracts funded in whole or in part with federal or state funds. Failure by the Contractor to carry out these requirements is a material breach of this contract, which may result in the termination of this contract or such other remedy as the recipient deems appropriate.

OVERALL GOAL SET FOR THE DEPARTMENT. As a requirement of compliance with 49 CFR Part 26, the Department has set an overall goal for DBE participation in its federally assisted contracts. That goal applies to all federal-aid funds the Department will expend in its federally assisted contracts for the subject reporting fiscal year. The Department is required to make a good faith effort to achieve the overall goal. The dollar amount paid to all approved DBE companies performing work called for in this contract is eligible to be credited toward fulfillment of the Department's overall goal.

CONTRACT GOAL TO BE ACHIEVED BY THE CONTRACTOR. This contract includes a specific DBE utilization goal established by the Department. The goal has been included because the Department has determined that the work of this contract has subcontracting opportunities that may be suitable for performance by DBE companies. The determination is based on an assessment of the type of work, the location of the work, and the availability of DBE companies to do a part of the work. The assessment indicates that, in the absence of unlawful discrimination, and in an arena of fair and open competition, DBE companies can be expected to perform 0.00% of the work. This percentage is set as the DBE participation goal for this contract. Consequently, in addition to the other award criteria established for this contract, the Department will only award this contract to a bidder who makes a good faith effort to meet this goal of DBE participation in the performance of the work. A bidder makes a good faith effort for award consideration if either of the following is done in accordance with the procedures set for in this Special Provision:

- (a) The bidder documents that enough DBE participation has been obtained to meet the goal: or
- (b) The bidder documents that a good faith effort has been made to meet the goal, even though the effort did not succeed in obtaining enough DBE participation to meet the goal.

DBE LOCATOR REFERENCES. Bidders shall consult the IL UCP DBE Directory as a reference source for DBE-certified companies. In addition, the Department maintains a letting and item specific DBE locator information system whereby DBE companies can register their interest in providing quotes on particular bid items advertised for letting. Information concerning DBE companies willing to quote work for particular contracts may be obtained by contacting the Department's Bureau of Small Business Enterprises at telephone number (217)785-4611, or by visiting the Department's website at www.dot.il.gov.

BIDDING PROCEDURES. Compliance with this Special Provision is a material bidding requirement. The failure of the bidder to comply will render the bid not responsive.

- (a) The bidder shall submit a Disadvantaged Business Utilization Plan on Department forms SBE 2025 and 2026 with the bid.
- (b) The Utilization Plan shall indicate that the bidder either has obtained sufficient DBE participation commitments to meet the contract goal or has not obtained enough DBE participation commitments in spite of a good faith effort to meet the goal. The Utilization Plan shall further provide the name, telephone number, and telefax number of a responsible official of the bidder designated for purposes of notification of plan approval or disapproval under the procedures of this Special Provision.
- (c) The Utilization Plan shall include a DBE Participation Commitment Statement, Department form SBE 2025, for each DBE proposed for the performance of work to achieve the contract goal. For bidding purposes, submission of the completed SBE 2025 forms, signed by the DBEs and faxed to the bidder will be acceptable as long as the original is available and provided upon request. All elements of information indicated on the said form shall be provided, including but not limited to the following:
 - (1) The names and addresses of DBE firms that will participate in the contract;
 - (2) A description, including pay item numbers, of the work each DBE will perform;
 - (3) The dollar amount of the participation of each DBE firm participating. The dollar amount of participation for identified work shall specifically state the quantity, unit price, and total subcontract price for the work to be completed by the DBE. If partial pay items are to be performed by the DBE, indicate the portion of each item, a unit price where appropriate and the subcontract price amount;
 - (4) DBE Participation Commitment Statements, form SBE 2025, signed by the bidder and each participating DBE firm documenting the commitment to use the DBE subcontractors whose participation is submitted to meet the contract goal;
 - (5) if the bidder is a joint venture comprised of DBE companies and non-DBE companies, the plan must also include a clear identification of the portion of the work to be performed by the DBE partner(s); and,
 - (6) If the contract goal if not met, evidence of good faith efforts.

GOOD FAITH EFFORT PROCEDURES. The contract will not be awarded until the Utilization Plan submitted by the apparent successful bidder is approved. All information submitted by the bidder must be complete, accurate and adequately document that enough DBE participation has been obtained or document that good faith efforts of the bidder, in the event enough DBE participation has not been obtained, before the Department will commit to the performance of the contract by the bidder. The Utilization Plan will be approved by the Department if the Utilization Plan documents sufficient commercially useful DBE work performance to meet the contract goal or the bidder submits sufficient documentation of a good faith effort to meet the contract goal pursuant to 49 CFR Part 26, Appendix A. The Utilization Plan will not be approved by the Department if the Utilization Plan does not document sufficient DBE participation to meet the contract goal unless the apparent successful bidder documented in the Utilization Plan that it made a good faith effort to meet the goal. This means that the bidder must show that all necessary and reasonable steps were taken to achieve the contract goal. Necessary and reasonable steps are those which, by their scope, intensity and appropriateness to the objective, could reasonably be expected to obtain sufficient DBE participation, even if they were not successful. The Department will consider the quality, quantity, and intensity of the kinds of efforts that the bidder has made. Mere *pro forma* efforts, in other words, efforts done as a matter of form, are not good faith efforts; rather, the bidder is expected to have taken genuine efforts that would be reasonably expected of a bidder actively and aggressively trying to obtain DBE participation sufficient to meet the contract goal.

- (a) The following is a list of types of action that the Department will consider as part of the evaluation of the bidder's good faith efforts to obtain participation. These listed factors are not intended to be a mandatory checklist and are not intended to be exhaustive. Other factors or efforts brought to the attention of the Department may be relevant in appropriate cases, and will be considered by the Department.
 - (1) Soliciting through all reasonable and available means (e.g. attendance at pre-bid meetings, advertising and/or written notices) the interest of all certified DBE companies that have the capability to perform the work of the contract. The bidder must solicit this interest within sufficient time to allow the DBE companies to respond to the solicitation. The bidder must determine with certainty if the DBE companies are interested by taking appropriate steps to follow up initial solicitations.
 - (2) Selecting portions of the work to be performed by DBE companies in order to increase the likelihood that the DBE goals will be achieved. This includes, where appropriate, breaking out contract work items into economically feasible units to facilitate DBE participation, even when the prime Contractor might otherwise prefer to perform these work items with its own forces.
 - (3) Providing interested DBE companies with adequate information about the plans, specifications, and requirements of the contract in a timely manner to assist them in responding to a solicitation.

- (4) a. Negotiating in good faith with interested DBE companies. It is the bidder's responsibility to make a portion of the work available to DBE subcontractors and suppliers and to select those portions of the work or material needs consistent with the available DBE subcontractors and suppliers, so as to facilitate DBE participation. Evidence of such negotiation includes the names, addresses, and telephone numbers of DBE companies that were considered; a description of the information provided regarding the plans and specifications for the work selected for subcontracting; and evidence as to why additional agreements could not be reached for DBE companies to perform the work.
 - b. A bidder using good business judgment would consider a number of factors in negotiating with subcontractors, including DBE subcontractors, and would take a firm's price and capabilities as well as contract goals into consideration. However, the fact that there may be some additional costs involved in finding and using DBE companies is not in itself sufficient reason for a bidder's failure to meet the contract DBE goal, as long as such costs are reasonable. Also the ability or desire of a bidder to perform the work of a contract with its own organization does not relieve the bidder of the responsibility to make good faith efforts. Bidders are not, however, required to accept higher quotes from DBE companies if the price difference is excessive or unreasonable.
 - (5) Not rejecting DBE companies as being unqualified without sound reasons based on a thorough investigation of their capabilities. The bidder's standing within its industry, membership in specific groups, organizations, or associations and political or social affiliations (for example union vs. non-union employee status) are not legitimate causes for the rejection or non-solicitation of bids in the bidder's efforts to meet the project goal.
 - (6) Making efforts to assist interested DBE companies in obtaining bonding, lines of credit, or insurance as required by the recipient or Contractor.
 - (7) Making efforts to assist interested DBE companies in obtaining necessary equipment, supplies, materials, or related assistance or services.
 - (8) Effectively using the services of available minority/women community organizations; minority/women contractors' groups; local, state, and federal minority/women business assistance offices; and other organizations as allowed on a case-by-case basis to provide assistance in the recruitment and placement of DBE companies.
- (b) If the Department determines that the apparent successful bidder has made a good faith effort to secure the work commitment of DBE companies to meet the contract goal, the Department will award the contract provided that it is otherwise eligible for award. If the Department determines that the bidder has failed to meet the requirements of this Special Provision or that a good faith effort has not been made, the Department will notify the responsible company official designated in the Utilization Plan that the bid is not responsive. The notification shall include a statement of reasons for the determination.

- (c) The bidder may request administrative reconsideration of a determination adverse to the bidder within the five working days after the receipt of the notification date of the determination by delivering the request to the Department of Transportation, Bureau of Small Business Enterprises, Contract Compliance Section, 2300 South Dirksen Parkway, Room 319, Springfield, Illinois 62764 (Telefax: (217)785-1524). Deposit of the request in the United States mail on or before the fifth business day shall not be deemed delivery. The determination shall become final if a request is not made and delivered. A request may provide additional written documentation and/or argument concerning the issues raised in the determination statement of reasons, provided the documentation and arguments address efforts made prior to submitting the bid. The request will be forwarded to the Department's Reconsideration Officer. The Reconsideration Officer will extend an opportunity to the bidder to meet in person in order to consider all issues of documentation and whether the bidder made a good faith effort to meet the goal. After the review by the Reconsideration Officer, the bidder will be sent a written decision within ten working days after receipt of the request for consideration, explaining the basis for finding that the bidder did or did not meet the goal or make adequate good faith efforts to do so. A final decision by the Reconsideration Officer that a good faith effort was made shall approve the Utilization Plan submitted by the bidder and shall clear the contract for award. A final decision that a good faith effort was not made shall render the bid not responsive.

CALCULATING DBE PARTICIPATION. The Utilization Plan values represent work anticipated to be performed and paid for upon satisfactory completion. The Department is only able to count toward the achievement of the overall goal and the contract goal the value of payments made for the work actually performed by DBE companies. In addition, a DBE must perform a commercially useful function on the contract to be counted. A commercially useful function is generally performed when the DBE is responsible for the work and is carrying out its responsibilities by actually performing, managing, and supervising the work involved. The Department and Contractor are governed by the provisions of 49 CFR Part 26.55(c) on questions of commercially useful functions as it affects the work. Specific counting guidelines are provided in 49 CFR Part 26.55, the provisions of which govern over the summary contained herein.

- (a) DBE as the Contractor: 100 percent goal credit for that portion of the work performed by the DBE's own forces, including the cost of materials and supplies. Work that a DBE subcontracts to a non-DBE does not count toward the DBE goals.
- (b) DBE as a joint venture Contractor: 100 percent goal credit for that portion of the total dollar value of the contract equal to the distinct, clearly defined portion of the work performed by the DBE's own forces.
- (c) DBE as a subcontractor: 100 percent goal credit for the work of the subcontract performed by the DBE's own forces, including the cost of materials and supplies, excluding the purchase of materials and supplies or the lease of equipment by the DBE subcontractor from the prime Contractor or its affiliates. Work that a DBE subcontractor in turn subcontracts to a non-DBE does not count toward the DBE goal.

- (d) DBE as a trucker: 100 percent goal credit for trucking participation provided the DBE is responsible for the management and supervision of the entire trucking operation for which it is responsible. At least one truck owned, operated, licensed, and insured by the DBE must be used on the contract. Credit will be given for the following:
- (1) The DBE may lease trucks from another DBE firm, including an owner-operator who is certified as a DBE. The DBE who leases trucks from another DBE receives credit for the total value of the transportation services the lessee DBE provides on the contract.
 - (2) The DBE may also lease trucks from a non-DBE firm, including from an owner-operator. The DBE who leases trucks from a non-DBE is entitled to credit only for the fee or commission is receives as a result of the lease arrangement.
- (e) DBE as a material supplier:
- (1) 60 percent goal credit for the cost of the materials or supplies purchased from a DBE regular dealer.
 - (2) 100 percent goal credit for the cost of materials of supplies obtained from a DBE manufacturer.
 - (3) 100 percent credit for the value of reasonable fees and commissions for the procurement of materials and supplies if not a regular dealer or manufacturer.

CONTRACT COMPLIANCE. Compliance with this Special Provision is an essential part of the contract. The Department is prohibited by federal regulations from crediting the participation of a DBE included in the Utilization Plan toward either the contract goal or the Department's overall goal until the amount to be applied toward the goals has been paid to the DBE. The following administrative procedures and remedies govern the compliance by the Contractor with the contractual obligations established by the Utilization Plan. After approval of the Utilization Plan and award of the contract, the Utilization Plan and individual DBE Participation Statements become part of the contract. If the Contractor did not succeed in obtaining enough DBE participation to achieve the advertised contract goal, and the Utilization Plan was approved and contract awarded based upon a determination of good faith, the total dollar value of DBE work calculated in the approved Utilization Plan as a percentage of the awarded contract value shall become the amended contract goal. All work indicated for performance by an approved DBE shall be performed, managed, and supervised by the DBE executing the Participation Statement.

- (a) **NO AMENDMENT.** No amendment to the Utilization Plan may be made without prior written approval from the Department's Bureau of Small Business Enterprises. All requests for amendment to the Utilization Plan shall be submitted to the Department of Transportation, Bureau of Small Business Enterprises, Contract Compliance Section, 2300 South Dirksen Parkway, Room 319, Springfield, Illinois 62764. Telephone number (217)785-4611. Telefax number (217)785-1524.

- (b) TERMINATION OR REPLACEMENT. The Contractor shall not terminate or replace a DBE listed on the approved Utilization Plan, or perform with other forces work designated for a listed DBE except as provided in the Special Provision.
- (c) CHANGES TO WORK. Any deviation from the DBE condition-of-award or contract plans, specifications, or special provisions must be approved, in writing, by the Department as provided elsewhere in the Contract. The Contractor shall notify affected DBEs in writing of any changes in the scope of work which result in a reduction in the dollar amount condition-of-award to the contract. Where the revision includes work committed to a new DBE subcontractor, not previously involved in the project, then a Request for Approval of Subcontractor, Department form BC 260A, must be signed and submitted. If the commitment of work is in the form of additional tasks assigned to an existing subcontract, then a new Request for Approval of Subcontractor shall not be required. However, the Contractor must document efforts to assure that the existing DBE subcontractor is capable of performing the additional work and has agreed in writing to the change.
- (d) ALTERNATIVE WORK METHODS. In addition to the above requirements for reductions in the condition of award, additional requirements apply to the two cases of Contractor-initiated work substitution proposals. Where the contract allows alternate work methods which serve to delete or create underruns in condition of award DBE work, and the Contractor selects that alternate method or, where the Contractor proposes a substitute work method or material that serves to diminish or delete work committed to a DBE and replace it with other work, then the Contractor must demonstrate one of the following:
- (1) That the replacement work will be performed by the same DBE (as long as the DBE is certified in the respective item of work) in a modification of the condition of award; or
 - (2) That the DBE is aware that its work will be deleted or will experience underruns and has agreed in writing to the change. If this occurs, the Contractor shall substitute other work of equivalent value to a certified DBE or provide documentation of good faith efforts to do so; or
 - (3) That the DBE is not capable of performing the replacement work or has declined to perform the work at a reasonable competitive price. If this occurs, the Contractor shall substitute other work of equivalent value to a certified DBE or provide documentation of good faith efforts to do so.

(e) TERMINATION AND REPLACEMENT PROCEDURES. The Contractor shall not terminate or replace a DBE subcontractor listed in the approved Utilization Plan without prior written consent. This includes, but is not limited to, instances in which the Contractor seeks to perform work originally designated for a DBE subcontractor with its own forces or those of an affiliate, a non-DBE firm, or with another DBE firm. Written consent will be granted only if the Bureau of Small Business Enterprises agrees, for reasons stated in its concurrence document, that the Contractor has good cause to terminate or replace the DBE firm. Before transmitting to the Bureau of Small Business Enterprises any request to terminate and/or substitute a DBE subcontractor, the Contractor shall give notice in writing to the DBE subcontractor, with a copy to the Bureau, of its intent to request to terminate and/or substitute, and the reason for the request. The Contractor shall give the DBE five days to respond to the Contractor's notice. The DBE so notified shall advise the Bureau and the Contractor of the reasons, if any, why it objects to the proposed termination of its subcontract and why the Bureau should not approve the Contractor's action. If required in a particular case as a matter of public necessity, the Bureau may provide a response period shorter than five days.

For purposes of this paragraph, good cause includes the following circumstances:

- (1) The listed DBE subcontractor fails or refuses to execute a written contract;
- (2) The listed DBE subcontractor fails or refuses to perform the work of its subcontract in a way consistent with normal industry standards. Provided, however, that good cause does not exist if the failure or refusal of the DBE subcontractor to perform its work on the subcontract results from the bad faith or discriminatory action of the prime contractor;
- (3) The listed DBE subcontractor fails or refuses to meet the prime Contractor's reasonable, nondiscriminatory bond requirements;
- (4) The listed DBE subcontractor becomes bankrupt, insolvent, or exhibits credit unworthiness;
- (5) The listed DBE subcontractor is ineligible to work on public works projects because of suspension and debarment proceedings pursuant 2 CFR Parts 180, 215 and 1,200 or applicable state law.
- (6) You have determined that the listed DBE subcontractor is not a responsible contractor;
- (7) The listed DBE subcontractor voluntarily withdraws from the projects and provides to you written notice of its withdrawal;
- (8) The listed DBE is ineligible to receive DBE credit for the type of work required;
- (9) A DBE owner dies or becomes disabled with the result that the listed DBE contractor is unable to complete its work on the contract;

- (10) Other documented good cause that compels the termination of the DBE subcontractor. Provided, that good cause does not exist if the prime Contractor seeks to terminate a DBE it relied upon to obtain the contract so that the prime Contractor can self-perform the work for which the DBE contractor was engaged or so that the prime Contractor can substitute another DBE or non-DBE contractor after contract award.

When a DBE is terminated, or fails to complete its work on the Contract for any reason the Contractor shall make a good faith effort to find another DBE to substitute for the original DBE to perform at least the same amount of work under the contract as the terminated DBE to the extent needed to meet the established Contract goal.

- (f) PAYMENT RECORDS. The Contractor shall maintain a record of payments for work performed to the DBE participants. The records shall be made available to the Department for inspection upon request. After the performance of the final item of work or delivery of material by a DBE and final payment therefore to the DBE by the Contractor, but not later than thirty calendar days after payment has been made by the Department to the Contractor for such work or material, the Contractor shall submit a DBE Payment Agreement on Department form SBE 2115 to the Regional Engineer. If full and final payment has not been made to the DBE, the DBE Payment Agreement shall indicate whether a disagreement as to the payment required exists between the Contractor and the DBE or if the Contractor believes that the work has not been satisfactorily completed. If the Contractor does not have the full amount of work indicated in the Utilization Plan performed by the BDE companies indicated in the Utilization Plan and after good faith efforts are reviewed, the Department may deduct from contract payments to the Contractor the amount of the goal not achieved as liquidated and ascertained damages. The Contractor may request an administrative reconsideration of any amount deducted as damages pursuant to subsection (h) of this part.
- (g) ENFORCEMENT. The Department reserves the right to withhold payment to the Contractor to enforce the provisions of this Special Provision. Final payment shall not be made on the contract until such time as the Contractor submits sufficient documentation demonstrating achievement of the goal in accordance with this Special Provision or after liquidated damages have been determined and collected.
- (h) RECONSIDERATION. Notwithstanding any other provision of the contract, including but not limited to Article 109.09 of the Standard Specifications, the Contractor may request administrative reconsideration of a decision to deduct the amount of the goal not achieved as liquidated damages. A request to reconsider shall be delivered to the Contract Compliance Section and shall be handled and considered in the same manner as set forth in paragraph (c) of "Good Faith Effort Procedures" of this Special Provision, except a final decision that a good faith effort was not made during contract performance to achieve the goal agreed to in the Utilization Plan shall be the final administrative decision of the Department.

LIQUIDATED DAMAGES (BDE)

Effective: April 1, 2013

Revise the table in Article 108.09 of the Standard Specifications to read:

"Schedule of Deductions for Each Day of Overrun in Contract Time			
Original Contract Amount		Daily Charges	
From More Than	To and Including	Calendar Day	Work Day
\$ 0	\$ 100,000	\$ 475	\$ 675
100,000	500,000	750	1,050
500,000	1,000,000	1,025	1,425
1,000,000	3,000,000	1,275	1,725
3,000,000	6,000,000	1,425	2,000
6,000,000	12,000,000	2,300	3,450
12,000,000	And over	6,775	9,525"

PAYMENTS TO SUBCONTRACTORS (BDE)

Effective: June 1, 2000

Revised: January 1, 2006

Federal regulations found at 49 CFR §26.29 mandate the Department to establish a contract clause to require Contractors to pay subcontractors for satisfactory performance of their subcontracts and to set the time for such payments.

State law also addresses the timing of payments to be made to subcontractors and material suppliers. Section 7 of the Prompt Payment Act, 30 ILCS 540/7, requires that when a Contractor receives any payment from the Department, the Contractor shall make corresponding, proportional payments to each subcontractor and material supplier performing work or supplying material within 15 calendar days after receipt of the Department payment. Section 7 of the Act further provides that interest in the amount of two percent per month, in addition to the payment due, shall be paid to any subcontractor or material supplier by the Contractor if the payment required by the Act is withheld or delayed without reasonable cause. The Act also provides that the time for payment required and the calculation of any interest due applies to transactions between subcontractors and lower-tier subcontractors and material suppliers throughout the contracting chain.

This Special Provision establishes the required federal contract clause, and adopts the 15 calendar day requirement of the State Prompt Payment Act for purposes of compliance with the federal regulation regarding payments to subcontractors. This contract is subject to the following payment obligations.

When progress payments are made to the Contractor according to Article 109.07 of the Standard Specifications, the Contractor shall make a corresponding payment to each subcontractor and material supplier in proportion to the work satisfactorily completed by each subcontractor and for the material supplied to perform any work of the contract. The proportionate amount of partial payment due to each subcontractor and material supplier throughout the contracting chain shall be determined by the quantities measured or otherwise determined as eligible for payment by the Department and included in the progress payment to the Contractor. Subcontractors and material suppliers shall be paid by the Contractor within 15 calendar days after the receipt of payment from the Department. The Contractor shall not hold retainage from the subcontractors. These obligations shall also apply to any payments made by subcontractors and material suppliers to their subcontractors and material suppliers; and to all payments made to lower tier subcontractors and material suppliers throughout the contracting chain. Any payment or portion of a payment subject to this provision may only be withheld from the subcontractor or material supplier to whom it is due for reasonable cause.

This Special Provision does not create any rights in favor of any subcontractor or material supplier against the State or authorize any cause of action against the State on account of any payment, nonpayment, delayed payment, or interest claimed by application of the State Prompt Payment Act. The Department will not approve any delay or postponement of the 15 day requirement except for reasonable cause shown after notice and hearing pursuant to Section 7(b) of the State Prompt Payment Act. State law creates other and additional remedies available to any subcontractor or material supplier, regardless of tier, who has not been paid for work properly performed or material furnished. These remedies are a lien against public funds set forth in Section 23(c) of the Mechanics Lien Act, 770 ILCS 60/23(c), and a recovery on the Contractor's payment bond according to the Public Construction Bond Act, 30 ILCS 550.

REMOVAL AND DISPOSAL OF REGULATED SUBSTANCES (BDE)

Effective: January 1, 2012

Revised: November 2, 2012

Revise Article 669.01 of the Standard Specifications to read:

“669.01 Description. This work shall consist of the transportation and proper disposal of contaminated soil and water. This work shall also consist of the removal, transportation, and proper disposal of underground storage tanks (UST), their content and associated underground piping to the point where the piping is above the ground, including determining the content types and estimated quantities.”

Revise Article 669.08 of the Standard Specifications to read:

“669.08 Contaminated Soil and/or Groundwater Monitoring. The Contractor shall hire a qualified environmental firm to monitor the area containing the regulated substances. The affected area shall be monitored with a photoionization detector (PID) utilizing a lamp of 10.6eV or greater or a flame ionization detector (FID). Any field screen reading on the PID or FID in excess of background levels indicates the potential presence of contaminated material requiring handling as a non-special waste, special waste, or hazardous waste. No excavated soils can be taken to a clean construction and demolition debris (CCDD) facility or an uncontaminated soil fill operation with detectable PID or FID meter readings that are above background. The PID or FID meter shall be calibrated on-site and background level readings taken and recorded daily. All testing shall be done by a qualified engineer/technician. Such testing and monitoring shall be included in the work. The Contractor shall identify the exact limits of removal of non-special waste, special waste, or hazardous waste. All limits shall be approved by the Engineer prior to excavation. The Contractor shall take all necessary precautions.

Based upon the land use history of the subject property and/or PID or FID readings indicating contamination, a soil or groundwater sample shall be taken from the same location and submitted to an approved laboratory. Soil or groundwater samples shall be analyzed for the contaminants of concern, including pH, based on the property's land use history or the parameters listed in the maximum allowable concentration (MAC) for chemical constituents in uncontaminated soil established pursuant to Subpart F of 35 Illinois Administrative Code 1100.605. The analytical results shall serve to document the level of soil contamination. Soil and groundwater samples may be required at the discretion of the Engineer to verify the level of soil and groundwater contamination.

Samples shall be grab samples (not combined with other locations). The samples shall be taken with decontaminated or disposable instruments. The samples shall be placed in sealed containers and transported in an insulated container to the laboratory. The container shall maintain a temperature of 39 °F (4 °C). All samples shall be clearly labeled. The labels shall indicate the sample number, date sampled, location and elevation, and any other observations.

The laboratory shall use analytical methods which are able to meet the lowest appropriate practical quantitation limits (PQL) or estimated quantitation limit (EQL) specified in "Test Methods for Evaluating Solid Wastes, Physical/Chemical Methods", EPA Publication No. SW-846 and "Methods for the Determination of Organic Compounds in Drinking Water", EPA, EMSL, EPA-600/4-88/039. For parameters where the specified cleanup objective is below the acceptable detection limit (ADL), the ADL shall serve as the cleanup objective. For other parameters the ADL shall be equal to or below the specified cleanup objective.”

Replace the first two paragraphs of Article 669.09 of the Standard Specifications with the following:

“669.09 Contaminated Soil and/or Groundwater Management and Disposal. The management and disposal of contaminated soil and/or groundwater shall be according to the following:

- (a) Soil Analytical Results Exceed Most Stringent MAC. When the soil analytical results indicate that detected levels exceed the most stringent maximum allowable concentration (MAC) for chemical constituents in uncontaminated soil established pursuant to Subpart F of 35 Illinois Administrative Code 1100.605, the soil shall be managed as follows:
 - (1) When analytical results indicate inorganic chemical constituents exceed the most stringent MAC but they are still considered within area background levels by the Engineer, the excavated soil can be utilized within the construction limits as fill, when suitable. Such soil excavated for storm sewers can be placed back into the excavated trench as backfill, when suitable, unless trench backfill is specified. If the soils cannot be utilized within the construction limits, they shall be managed and disposed of off-site as a non-special waste, special waste, or hazardous waste as applicable.
 - (2) When analytical results indicate chemical constituents exceed the most stringent MAC but do not exceed the MAC for a Metropolitan Statistical Area (MSA) County, the excavated soil can be utilized within the construction limits as fill, when suitable, or managed and disposed of off-site as “uncontaminated soil” at a CCDD facility or an uncontaminated soil fill operation within an MSA County provided the pH of the soil is within the range of 6.25 - 9.0, inclusive.
 - (3) When analytical results indicate chemical constituents exceed the most stringent MAC but do not exceed the MAC for an MSA County excluding Chicago, or the MAC within the Chicago corporate limits, the excavated soil can be utilized within the construction limits as fill, when suitable, or managed and disposed of off-site as “uncontaminated soil” at a CCDD facility or an uncontaminated soil fill operation within an MSA County excluding Chicago or within the Chicago corporate limits provided the pH of the soil is within the range of 6.25 - 9.0, inclusive.
 - (4) When analytical results indicate chemical constituents exceed the most stringent MAC but do not exceed the MAC for an MSA County excluding Chicago, the excavated soil can be utilized within the construction limits as fill, when suitable, or managed and disposed of off-site as “uncontaminated soil” at a CCDD facility or an uncontaminated soil fill operation within an MSA County excluding Chicago provided the pH of the soil is within the range of 6.25 - 9.0, inclusive.
 - (5) When the Engineer determines soil cannot be managed according to Articles 669.09(a)(1) through (a)(4) above, the soil shall be managed and disposed of off-site as a non-special waste, special waste, or hazardous waste as applicable.

- (b) Soil Analytical Results Do Not Exceed Most Stringent MAC. When the soil analytical results indicate that detected levels do not exceed the most stringent MAC but the pH of the soil is less than 6.25 or greater than 9.0, the excavated soil can be utilized within the construction limits or managed and disposed of off-site as “uncontaminated soil” according to Article 202.03. However the excavated soil cannot be taken to a CCDD facility or an uncontaminated soil fill operation.
- (c) Groundwater. When groundwater analytical results indicate the detected levels are above Appendix B, Table E of 35 Illinois Administrative Code 742, the most stringent Tier 1 Groundwater Remediation Objectives for Groundwater Component of the Groundwater Ingestion Route for Class 1 groundwater, the groundwater shall be managed off-site as a special waste.

All groundwater encountered within lateral trenches may be managed within the trench and allowed to infiltrate back into the ground. If the groundwater cannot be managed within the trench it must be removed as a special or hazardous waste. The Contractor is prohibited from managing groundwater within the trench by discharging it through any existing or new storm sewer. The Contractor shall install backfill plugs within the area of groundwater contamination.

One backfill plug shall be placed down gradient to the area of groundwater contamination. Backfill plugs shall be installed at intervals not to exceed 50 ft (15 m). Backfill plugs are to be 4 ft (1.2 m) long, measured parallel to the trench, full trench width and depth. Backfill plugs shall not have any fine aggregate bedding or backfill, but shall be entirely cohesive soil or any class of concrete. The Contractor shall provide test data that the material has a permeability of less than 10^{-7} cm/sec according to ASTM D 5084, Method A or per another test method approved by the Engineer.”

Revise Article 669.14 of the Standard Specifications to read:

“669.14 Final Environmental Construction Report. At the end of the project, the Contractor will prepare and submit three copies of the Environmental Construction Report on the activities conducted during the life of the project, one copy shall be submitted to the Resident Engineer, one copy shall be submitted to the District's Environmental Studies Unit, and one copy shall be submitted with an electronic copy in Adode.pdf format to the Geologic and Waste Assessment Unit, Bureau of Design and Environment, IDOT, 2300 South Dirksen Parkway, Springfield, Illinois 62764. The technical report shall include all pertinent information regarding the project including, but not limited to:

- (a) Measures taken to identify, monitor, handle, and dispose of soil or groundwater containing regulated substances, to prevent further migration of regulated substances, and to protect workers,
- (b) Cost of identifying, monitoring, handling, and disposing of soil or groundwater containing regulated substances, the cost of preventing further migration of regulated substances, and the cost for worker protection from the regulated substances. All cost should be in the format of the contract pay items listed in the contract plans (identified by the preliminary environmental site investigation (PESA) site number),

- (c) Plan sheets showing the areas containing the regulated substances,
- (d) Field sampling and testing results used to identify the nature and extent of the regulated substances,
- (e) Waste manifests (identified by the preliminary environmental site investigation (PESA) site number) for special or hazardous waste disposal, and
- (f) Landfill tickets (identified by the preliminary environmental site investigation (PESA) site number) for non-special waste disposal.”

Revise the second paragraph of Article 669.16 of the Standard Specifications to read:

“The transportation and disposal of soil and other materials from an excavation determined to be contaminated will be paid for at the contract unit price per cubic yard (cubic meter) for NON-SPECIAL WASTE DISPOSAL, SPECIAL WASTE DISPOSAL, or HAZARDOUS WASTE DISPOSAL.”

REMOVAL AND DISPOSAL OF SURPLUS MATERIALS (BDE)

Effective: November 2, 2012

Revise the first four paragraphs of Article 202.03 of the Standard Specifications to read:

“202.03 Removal and Disposal of Surplus, Unstable, Unsuitable, and Organic Materials. Suitable excavated materials shall not be wasted without permission of the Engineer. The Contractor shall dispose of all surplus, unstable, unsuitable, and organic materials, in such a manner that public or private property will not be damaged or endangered.

Suitable earth, stones and boulders naturally occurring within the right-of-way may be placed in fills or embankments in lifts and compacted according to Section 205. Broken concrete without protruding metal bars, bricks, rock, stone, reclaimed asphalt pavement with no expansive aggregate, or uncontaminated dirt and sand generated from construction or demolition activities may be used in embankment or in fill. If used in fills or embankments, these materials shall be placed and compacted to the satisfaction of the Engineer; shall be buried under a minimum of 2 ft (600 mm) of earth cover (except when the materials include only uncontaminated dirt); and shall not create an unsightly appearance or detract from the natural topographic features of an area. Broken concrete without protruding metal bars, bricks, rock, or stone may be used as riprap as approved by the Engineer. If the materials are used for fill in locations within the right-of-way but outside project construction limits, the Contractor must specify to the Engineer, in writing, how the landscape restoration of the fill areas will be accomplished. Placement of fill in such areas shall not commence until the Contractor's landscape restoration plan is approved by the Engineer.

Aside from the materials listed above, all other construction and demolition debris or waste shall be disposed of in a licensed landfill, recycled, reused, or otherwise disposed of as allowed by State or Federal laws and regulations. When the Contractor chooses to dispose of uncontaminated soil at a clean construction and demolition debris (CCDD) facility or at an uncontaminated soil fill operation, it shall be the Contractor's responsibility to have the pH of the material tested to ensure the value is between 6.25 and 9.0, inclusive. A copy of the pH test results shall be provided to the Engineer.

A permit shall be obtained from IEPA and made available to the Engineer prior to open burning of organic materials (i.e., plant refuse resulting from pruning or removal of trees or shrubs) or other construction or demolition debris. Organic materials originating within the right-of-way limits may be chipped or shredded and placed as mulch around landscape plantings within the right-of-way when approved by the Engineer. Chipped or shredded material to be placed as mulch shall not exceed a depth of 6 in. (150 mm)."

SUBCONTRACTOR MOBILIZATION PAYMENTS (BDE)

Effective: April 2, 2005

Revised: April 1, 2011

To account for the preparatory work and operations necessary for the movement of subcontractor personnel, equipment, supplies, and incidentals to the project site and for all other work or operations that must be performed or costs incurred when beginning work approved for subcontracting according to Article 108.01 of the Standard Specifications, the Contractor shall make a mobilization payment to each subcontractor.

This mobilization payment shall be made at least 14 days prior to the subcontractor starting work. The amount paid shall be equal to 3 percent of the amount of the subcontract reported on form BC 260A submitted for the approval of the subcontractor's work.

The mobilization payment to the subcontractor is an advance payment of the reported amount of the subcontract and is not a payment in addition to the amount of the subcontract; therefore, the amount of the advance payment will be deducted from future progress payments.

This provision shall be incorporated directly or by reference into each subcontract approved by the Department.

TRACKING THE USE OF PESTICIDES (BDE)

Effective: August 1, 2012

Add the following paragraph after the first paragraph of Article 107.23 of the Standard Specifications:

“Within 48 hours of the application of pesticides, including but not limited to herbicides, insecticides, algacides, and fungicides, the Contractor shall complete and return to the Engineer, Operations form “OPER 2720”.”

TRAFFIC CONTROL DEFICIENCY DEDUCTION (BDE)

Effective: August 1, 2011

Revise the third sentence of the third paragraph of Article 105.03(b) of the Standard Specifications to read:

“The daily monetary deduction will be \$2,500.”

UTILITY COORDINATION AND CONFLICTS (BDE)

Effective: April 1, 2011

Revised: January 1, 2012

Revise Article 105.07 of the Standard Specifications to read:

“105.07 Cooperation with Utilities. The Department reserves the right at any time to allow work by utilities on or near the work covered by the contract. The Contractor shall conduct his/her work so as not to interfere with or hinder the progress or completion of the work being performed by utilities. The Contractor shall also arrange the work and shall place and dispose of the materials being used so as not to interfere with the operations of utility work in the area.

The Contractor shall cooperate with the owners of utilities in their removal and rearrangement operations so work may progress in a reasonable manner, duplication or rearrangement of work may be reduced to a minimum, and services rendered by those parties will not be unnecessarily interrupted.

The Contractor shall coordinate with any planned utility adjustment or new installation and the Contractor shall take all precautions to prevent disturbance or damage to utility facilities. Any failure on the part of the utility owner, or their representative, to proceed with any planned utility adjustment or new installation shall be reported promptly by the Contractor to the Engineer.”

Revise the first sentence of the last paragraph of Article 107.19 of the Standard Specifications to read:

“When the Contractor encounters unexpected regulated substances due to the presence of utilities in unanticipated locations, the provisions of Article 107.40 shall apply; otherwise, if the Engineer does not direct a resumption of operations, the provisions of Article 108.07 shall apply.”

Revise Article 107.31 of the Standard Specification to read:

“107.31 Reserved.”

Add the following four Articles to Section 107 of the Standard Specifications:

“107.37 Locations of Utilities within the Project Limits. All known utilities existing within the limits of construction are either indicated on the plans or visible above ground. For the purpose of this Article, the limits of proposed construction are defined as follows:

(a) Limits of Proposed Construction for Utilities Paralleling the Roadway.

- (1) The horizontal limits shall be a vertical plane, outside of, parallel to, and 2 ft (600 mm) distant at right angles from the plan or revised slope limits.

In cases where the limits of excavation for structures are not shown on the plans, the horizontal limits shall be a vertical plane 4 ft (1.2 m) outside the edges of structure footings or the structure where no footings are required.

- (2) The upper vertical limits shall be the regulations governing the roadbed clearance for the specific utility involved.
- (3) The lower vertical limits shall be either the top of the utility at the depth below the proposed grade as prescribed by the governing agency or the limits of excavation, whichever is less.

(b) Limits of Proposed Construction for Utilities Crossing the Roadway in a Generally Transverse Direction.

- (1) Utilities crossing excavations for structures that are normally made by trenching such as sewers, underdrains, etc. and all minor structures such as manholes, inlets, foundations for signs, foundations for traffic signals, etc., the limits shall be the space to be occupied by the proposed permanent construction, unless otherwise required by the regulations governing the specific utility involved.
- (2) For utilities crossing the proposed site of major structures such as bridges, sign trusses, etc., the limits shall be as defined above for utilities extending in the same general direction as the roadway.

It is understood and agreed that the Contractor has considered in the bid all of the permanent and temporary utilities in their present and/or adjusted positions as indicated in the contract. It is further understood the actual location of the utilities may be located anywhere within the tolerances provided in 220 ILCS 50/2.8 or Administrative Code Title 92 Part 530.40(c), and the proximity of some utilities to construction may require extraordinary measures by the Contractor to protect those utilities.

No additional compensation will be allowed for any delays, inconveniences, or damages sustained by the Contractor due to the presence of or any claimed interference from known utility facilities or any adjustment of them, except as specifically provided in the contract.

107.38 Adjustments of Utilities within the Project Limits. The adjustment of utilities consists of the relocation, removal, replacement, rearrangements, reconstruction, improvement, disconnection, connection, shifting, new installation, or altering of an existing utility facility in any manner.

Utilities which are to be adjusted shall be adjusted by the utility owner or the owner's representative or by the Contractor as a contract item. Generally, arrangements for adjusting known utilities will be made by the Department prior to project construction; however, utilities will not necessarily be adjusted in advance of project construction and, in some cases, utilities will not be removed from the proposed construction limits as described in Article 107.37. When utility adjustments must be performed in conjunction with construction, the utility adjustment work will be indicated in the contract.

The Contractor may make arrangements for adjustment of utilities indicated in the contract, but not scheduled by the Department for adjustment, provided the Contractor furnishes the Department with a signed agreement with the utility owner covering the adjustments to be made. The cost of any such adjustments shall be the responsibility of the Contractor.

107.39 Contractor's Responsibility for Locating and Protecting Utility Property and Services. At points where the Contractor's operations are adjacent to properties or facilities of utility companies, or are adjacent to other property, damage to which might result in considerable expense, loss, or inconvenience, work shall not be commenced until all arrangements necessary for the protection thereof have been made.

Within the State of Illinois, a State-Wide One Call Notice System has been established for notifying utilities. Outside the city limits of the City of Chicago, the system is known as the Joint Utility Locating Information for Excavators (JULIE) System. Within the city limits of the City of Chicago the system is known as DIGGER. All utility companies and municipalities which have buried utility facilities in the State of Illinois are a part of this system.

The Contractor shall call JULIE (800-892-0123) or DIGGER (312-744-7000), a minimum of 48 hours in advance of work being done in the area, and they will notify all member utility companies involved their respective utility should be located.

For utilities which are not members of JULIE or DIGGER, the Contractor shall contact the owners directly. The plan general notes will indicate which utilities are not members of JULIE or DIGGER.

The following table indicates the color of markings required of the State-Wide One Call Notification System.

Utility Service	Color
Electric Power, Distribution and Transmission	Safety Red
Municipal Electric Systems	Safety Red
Gas Distribution and Transmission	High Visibility Safety Yellow
Oil Distribution and Transmission	High Visibility Safety Yellow
Telephone and Telegraph System	Safety Alert Orange
Community Antenna Television Systems	Safety Alert Orange
Water Systems	Safety Precaution Blue
Sewer Systems	Safety Green
Non-Potable Water and Slurry Lines	Safety Purple
Temporary Survey	Safety Pink
Proposed Excavation	Safety White (Black when snow is on the ground)

The State-Wide One Call Notification System will provide for horizontal locations of utilities. When it is determined that the vertical location of the utility is necessary to facilitate construction, the Engineer may make the request for location from the utility after receipt of notice from the Contractor. If the utility owner does not field locate their facilities to the satisfaction of the Engineer, the Engineer will authorize the Contractor in writing to proceed to locate the facilities in the most economical and reasonable manner, subject to the approval of the Engineer, and be paid according to Article 109.04.

The Contractor shall be responsible for maintaining the excavations or markers provided by the utility owners.

The Contractor shall take all necessary precautions for the protection of the utility facilities. The Contractor shall be responsible for any damage or destruction of utility facilities resulting from neglect, misconduct, or omission in the Contractor's manner or method of execution or nonexecution of the work, or caused by defective work or the use of unsatisfactory materials. Whenever any damage or destruction of a utility facility occurs as a result of work performed by the Contractor, the utility company will be immediately notified. The utility company will make arrangements to restore such facility to a condition equal to that existing before any such damage or destruction was done.

In the event of interruption of utility services as a result of accidental breakage or as a result of being exposed or unsupported, the Contractor shall promptly notify the proper authority and shall cooperate with the said authority in the restoration of service. If water service is interrupted, repair work shall be continuous until the service is restored. No work shall be undertaken around fire hydrants until provisions for continued service have been approved by the local fire authority.

107.40 Conflicts with Utilities. Except as provided hereinafter, the discovery of a utility in an unanticipated location will be evaluated according to Article 104.03. It is understood and agreed that the Contractor has considered in the bid all facilities not meeting the definition of a utility in an unanticipated location and no additional compensation will be allowed for any delays, inconveniences, or damages sustained by the Contractor due to the presence of or any claimed interference from such facilities.

When the Contractor discovers a utility in an unanticipated location, the Contractor shall not interfere with said utility, shall take proper precautions to prevent damage or interruption of the utility, and shall promptly notify the Engineer of the nature and location of said utility.

- (a) Definition. A utility in an unanticipated location is defined as an active or inactive utility, which is either:
- (1) Located underground and (a) not shown in any way in any location on the contract documents; (b) not identified in writing by the Department to the Contractor prior to the letting; or (c) not located relative to the location shown in the contract within the tolerances provided in 220 ILCS 50/2.8 or Administrative Code Title 92 Part 530.40(c); or
 - (2) Located above ground or underground and not relocated as provided in the contract.

Service connections shall not be considered to be utilities in unanticipated locations.

- (b) Compensation. Compensation will not be allowed for delays, inconveniences, or damages sustained by the Contractor from conflicts with facilities not meeting the above definition; or if a conflict with a utility in an unanticipated location does not cause a shutdown of the work applicable to the utility or a documentable reduction in the rate of progress exceeding the limits set herein. The provisions of Article 104.03 notwithstanding, compensation for delays caused by a utility in an unanticipated location will be paid according to the provisions of this Article governing minor and major delays or reduced rate of production which are defined as follows:
- (1) Minor Delay. A minor delay occurs when the Contractor's operation is completely stopped by a utility in an unanticipated location for more than two hours, but not to exceed three weeks.
 - (2) Major Delay. A major delay occurs when the Contractor's operation is completely stopped by a utility in an unanticipated location for more than three weeks.
 - (3) Reduced Rate of Production Delay. A reduced rate of production delay occurs when the contractor's rate of production decreases by more than 25 percent and lasts longer than seven days.
- (c) Payment. Payment for Minor, Major and Reduced Rate of Production Delays will be made as follows.

- (1) Minor Delay. Labor idled which cannot be used on other work will be paid for according to Article 109.04(b)(1) and (2) for the time between start of the delay and the minimum remaining hours in the work shift required by the prevailing practice in the area.

Equipment idled which cannot be used on other work, and which is authorized to standby on the project site by the Engineer, will be paid for according to Article 109.04(b)(4).

- (2) Major Delay. Labor will be the same as for a minor delay.

Equipment will be the same as for a minor delay, except Contractor-owned equipment will be limited to three weeks plus the cost of move-out to either the Contractor's yard or another job, whichever is less. Rental equipment may be paid for longer than three weeks provided the Contractor presents adequate support to the Department (including lease agreement) to show retaining equipment on the job is the most economical course to follow and in the public interest.

- (3) Reduced Rate of Production Delay. The Contractor will be compensated for the reduced productivity for labor and equipment time in excess of the 25 percent threshold for that portion of the delay in excess of seven days. Determination of compensation will be in accordance with Article 104.02, except labor and material additives will not be permitted.

Whether covered by (1), (2) or (3) above, additional traffic control required as a result of the operation(s) delayed will be paid for according to Article 109.04 for the total length of the delay.

If the delay is clearly shown to have caused work, which would have otherwise been completed, to be done after material or labor costs have increased, such increases may be paid. Payment for materials will be limited to increased cost substantiated by documentation furnished by the Contractor. Payment for increased labor rates will include those items in Article 109.04(b)(1) and (2), except the 35 percent and ten percent additives will not be permitted. On a working day contract, a delay occurring between November 30 and May 1, when work has not started, will not be considered as eligible for payment of measured labor and material costs.

Project overhead (not including interest) will be allowed when all progress on the contract has been delayed, and will be calculated as 15 percent of the delay claim.

- (d) Other Obligations of Contractor. Upon payment of a claim under this provision, the Contractor shall assign subrogation rights to the Department for the Department's efforts of recovery from any other party for monies paid by the Department as a result of any claim under this Provision. The Contractor shall fully cooperate with the Department in its efforts to recover from another party any money paid to the Contractor for delay damages under this Provision."

WEEKLY DBE TRUCKING REPORTS (BDE)

Effective: June 2, 2012

The Contractor shall provide a weekly report of Disadvantaged Business Enterprise (DBE) trucks hired by the Contractor or subcontractors (i.e. not owned by the Contractor or subcontractors) that are used on the jobsite; or used for the delivery and/or removal of equipment/material to and from the jobsite. The jobsite shall also include offsite locations, such as plant sites or storage sites, when those locations are used solely for this contract.

The report shall be submitted on the form provided by the Department within ten business days following the reporting period. The reporting period shall be Monday through Sunday for each week reportable trucking activities occur. The report shall be submitted to the Engineer and a copy shall be provided to the district EEO Officer.

Any costs associated with providing weekly DBE trucking reports shall be considered as included in the contract unit prices bid for the various items of work involved and no additional compensation will be allowed.

WORKING DAYS (BDE)

Effective: January 1, 2002

The Contractor shall complete the work within **45** working days.

404 PERMIT



404 PERMIT

Route FAP 821, FAP 778, FAP 332, FAP 877 Marked Rte. IL 15, IL 34, US 45, IL 141
Section D9 Scour Repair 2013-1 Stream Name: Fayse Cr., Gibbons Cr., Bear Cr., Lit. Wabash Riv.
County Jefferson, Pope, White Location: T2S R1E Sec. 34; T11S R7E Sec. 9;
T7S R8E Sec. 5; T7S R10E Sec. 17

The Division of Highways, District Nine, has determined that the plans as prepared for letting are authorized under the provisions of 33 CFR 330 Nationwide Permit (NWP) No. 3, Maintenance, as published in the Federal Register February 21, 2012. Under the provisions of the authorization, the following attachments must be complied with:

1. Terms for Nationwide Permit No. 3.
2. Nationwide Permit General Conditions.
3. Illinois EPA Water Quality Certification Regional Conditions.

You are reminded that the permit determination is based upon plans as prepared for letting. Variation from these plans may result in the revocation of the permit.



U.S. Army Corps
Of Engineers
Louisville District

Nationwide Permit Summary

No. 3, MAINTENANCE (NWP Final Notice, 72 FR 11181)

(a) The repair, rehabilitation, or replacement of any previously authorized, currently serviceable, structure, or fill, or of any currently serviceable structure or fill authorized by 33 CFR 330.3, provided that the structure or fill is not to be put to uses differing from those uses specified or contemplated for it in the original permit or the most recently authorized modification. Minor deviations in the structure's configuration or filled area, including those due to changes in materials, construction techniques, or current construction codes or safety standards that are necessary to make the repair, rehabilitation, or replacement are authorized. This NWP authorizes the repair, rehabilitation, or replacement of those structures or fills destroyed or damaged by storms, floods, fire or other discrete events, provided the repair, rehabilitation, or replacement is commenced, or is under contract to commence, within two years of the date of their destruction or damage. In cases of catastrophic events, such as hurricanes or tornadoes, this two-year limit may be waived by the district engineer, provided the permittee can demonstrate funding, contract, or other similar delays. (b) This NWP also authorizes the removal of accumulated sediments and debris in the vicinity of and within existing structures (e.g., bridges, culverted road crossings, water intake structures, etc.) and the placement of new or additional riprap to protect the structure. The removal of sediment is limited to the minimum necessary to restore the waterway in the immediate vicinity of the structure to the approximate dimensions that existed when the structure was built, but cannot extend further than 200 feet in any direction from the structure. This 200 foot limit does not apply to maintenance dredging to remove accumulated sediments blocking or restricting outfall and intake structures or to maintenance dredging to remove accumulated sediments from canals associated with outfall and intake structures. All dredged or excavated materials must be deposited and retained in an upland area unless otherwise specifically approved by the district engineer under separate authorization. The placement of riprap must be the minimum necessary to protect the structure or to ensure the safety of the structure. Any bank stabilization measures not directly associated with the structure will require a separate authorization from the district engineer.

(c) This NWP also authorizes temporary structures, fills, and work necessary to conduct the maintenance activity. Appropriate measures must be taken to maintain normal downstream flows and minimize flooding to the maximum extent practicable. When temporary structures, work, and discharges, including cofferdams, are necessary for construction activities, access fills, or dewatering of construction sites, temporary fills must

consist of materials, and be placed in a manner, that will not be eroded by expected high flows. Temporary fills must be removed in their entirety and the affected areas returned to pre-construction elevations. The areas affected by temporary fills must be revegetated, as appropriate.

(d) This NWP does not authorize maintenance dredging for the primary purpose of navigation or beach restoration. This NWP does not authorize new stream channelization or stream relocation projects. Notification: For activities authorized by paragraph (b) of this NWP, the permittee must submit a pre-construction notification to the district engineer prior to commencing the activity (see general condition 27). Where maintenance dredging is proposed, the pre-construction notification must include information regarding the original design capacities and configurations of the outlets, intakes, small impoundments, and canals. (Sections 10 and 404)

Note: This NWP authorizes the repair, rehabilitation, or replacement of any previously authorized structure or fill that does not qualify for the Clean Water Act Section 404(b) exemption for maintenance.

NATIONWIDE PERMIT CONDITIONS

General Conditions: Note: To qualify for NWP authorization, the prospective permittee must comply with the following general conditions, as appropriate, in addition to any regional or case-specific conditions imposed by the division engineer or district engineer. Prospective permittees should contact the appropriate Corps district office to determine if regional conditions have been imposed on an NWP. Prospective permittees should also contact the appropriate Corps district office to determine the status of Clean Water Act Section 401 water quality certification and/or Coastal Zone Management Act consistency for an NWP.

1. Navigation. (a) No activity may cause more than a minimal adverse effect on navigation.

(b) Any safety lights and signals prescribed by the U.S. Coast Guard, through regulations or otherwise, must be installed and maintained at the permittee's expense on authorized facilities in navigable waters of the United States.

(c) The permittee understands and agrees that, if future operations by the United States require the removal, relocation, or other alteration, of the structure or work herein authorized, or if, in the opinion of the Secretary of the Army or his authorized representative, said structure or work shall cause unreasonable obstruction to the free navigation of the navigable waters, the permittee will be required, upon due notice from the Corps of Engineers, to remove, relocate, or alter the structural work or obstructions caused thereby, without expense to the United States. No claim shall be made against the United States on account of any such removal or alteration.

2. Aquatic Life Movements. No activity may substantially disrupt the necessary life cycle movements of those species of aquatic life indigenous to the waterbody, including those species that normally migrate through the area, unless the activity's primary purpose is to impound water. Culverts placed in streams must be installed to maintain low flow conditions.

3. Spawning Areas. Activities in spawning areas during spawning seasons must be avoided to the maximum extent practicable. Activities that result in the physical destruction (e.g., through excavation, fill, or downstream smothering by substantial turbidity) of an important spawning area are not authorized.

4. Migratory Bird Breeding Areas. Activities in waters of the United States that serve as breeding areas for migratory birds must be avoided to the maximum extent practicable.

5. Shellfish Beds. No activity may occur in areas of concentrated shellfish populations, unless the activity is directly related to a shellfish harvesting activity authorized by NWP's 4 and 4B.

6. Suitable Material. No activity may use unsuitable material (e.g., trash, debris, car bodies, asphalt, etc.). Material used for construction or discharged must be free from toxic pollutants in toxic amounts (see Section 307 of the Clean Water Act).

7. Water Supply Intakes. No activity may occur in the proximity of a public water supply intake, except where the activity is for the repair or improvement of public water supply intake structures or adjacent bank stabilization.

8. Adverse Effects From Impoundments. If the activity creates an impoundment of water, adverse effects to the aquatic system due to accelerating the passage of water, and/or restricting its flow must be minimized to the maximum extent practicable.

9. Management of Water Flows. To the maximum extent practicable, the pre-construction course, condition, capacity, and location of open waters must be maintained for each activity, including stream channelization and storm water management activities, except as provided below. The activity must be constructed to withstand expected high flows. The activity must not restrict or impede the passage of normal or high flows, unless the primary purpose of the activity is to impound water or manage high flows. The activity may alter the pre-construction course, condition, capacity, and location of open waters if it benefits the aquatic environment (e.g., stream restoration or relocation activities).

10. Fills Within 100-Year Floodplains. The activity must comply with applicable FEMA-approved state or local floodplain management requirements.

11. Equipment. Heavy equipment working in wetlands or mudflats must be placed on mats, or other measures must be taken to minimize soil disturbance.

12. Soil Erosion and Sediment Controls. Appropriate soil erosion and sediment controls must be used and maintained in effective operating condition during construction, and all exposed soil and other fills, as well as any work below the ordinary high water mark or high tide line, must be permanently stabilized at the earliest practicable date. Permittees are encouraged to perform work within waters of the United States during periods of low-flow or no-flow.

13. Removal of Temporary Fills. Temporary fills must be removed in their entirety and the affected areas returned to pre-construction elevations. The affected areas must be revegetated, as appropriate.

14. Proper Maintenance. Any authorized structure or fill shall be properly maintained, including maintenance to ensure public safety.

15. Wild and Scenic Rivers. No activity may occur in a component of the National Wild and Scenic River System, or in a river officially designated by Congress as a "study river" for possible inclusion in the system while the river is in an official study status, unless the appropriate Federal agency with direct management responsibility for such river, has determined in writing that the proposed activity will not adversely affect the Wild and Scenic River designation or study status. Information on Wild and Scenic Rivers may be obtained from the appropriate Federal land management agency in the area (e.g., National Park Service, U.S. Forest Service, Bureau of Land Management, U.S. Fish and Wildlife Service).

16. Tribal Rights. No activity or its operation may impair reserved tribal rights, including, but not limited to, reserved water rights and treaty fishing and hunting rights.

17. Endangered Species. (a) No activity is authorized under any NWP which is likely to jeopardize the continued existence of a threatened or endangered species or a species proposed for such designation, as identified under the Federal Endangered Species Act (ESA), or which will destroy or adversely modify the critical habitat of such species. No activity is authorized under any NWP which "may affect" a listed species or critical habitat, unless Section 7 consultation addressing the effects of the proposed activity has been completed.

(b) Federal agencies should follow their own procedures for complying with the requirements of the ESA. Federal permittees must provide the district engineer with the appropriate documentation to demonstrate compliance with those requirements.

(c) Non-federal permittees shall notify the district engineer if any listed species or designated critical habitat might be affected or is in the vicinity of the project, or if the project is located in designated critical habitat, and shall not begin work on the activity until notified by the district engineer that the requirements of the ESA have been satisfied and that the activity is authorized. For activities that might affect Federally-listed endangered or threatened species or designated critical habitat, the pre-construction notification must include the name(s) of the endangered or threatened species that may be affected by the proposed work or that utilize the designated critical habitat that may be affected by the proposed work. The district engineer will determine whether the proposed activity "may affect" or will have "no effect" on listed species and designated critical habitat and will notify the non-Federal applicant of the Corps' determination within 45 days of receipt of a complete pre-construction notification. In cases where the non-Federal applicant has identified listed species or critical habitat that might be affected or is in the vicinity of the project, and has so notified the Corps, the applicant shall not begin work until the Corps has provided notification the proposed activities will have "no effect" on listed species or critical habitat, or until Section 7 consultation has been completed.

(d) As a result of formal or informal consultation with the FWS or NMFS the district engineer may add species-specific regional endangered species conditions to the NWPs.

(e) Authorization of an activity by a NWP does not authorize the "take" of a threatened or endangered species as defined under the ESA, in the absence of separate authorization (e.g., an ESA Section 10 Permit, a Biological Opinion with "incidental take" provisions, etc.) from the U.S. FWS or the NMFS, both lethal and non-lethal "takes" of protected species are in violation of the ESA. Information on the location of threatened and endangered species and their critical habitat can be obtained directly from the offices of the U.S. FWS and NMFS or their world wide Web pages at <http://www.fws.gov/> and <http://www.noaa.gov/fisheries.html> respectively.

18. **Historic Properties.** (a) In cases where the district engineer determines that the activity may affect properties listed, or eligible for listing, in the National Register of Historic Places, the activity is not authorized, until the requirements of Section 106 of the National Historic Preservation Act (NHPA) have been satisfied.

(b) Federal permittees should follow their own procedures for complying with the requirements of Section 106 of the National Historic Preservation Act. Federal permittees must provide the district engineer with the appropriate documentation to demonstrate compliance with those requirements.

(c) Non-federal permittees must submit a pre-construction notification to the district engineer if the authorized activity may have the potential to cause effects to any historic properties listed, determined to be eligible for listing on, or potentially eligible for listing on the National Register of Historic Places, including previously unidentified properties. For such activities, the pre-construction notification must state which historic properties may be affected by the proposed work or include a vicinity map indicating the location of the historic properties or the potential for the presence of historic properties. Assistance regarding information on the location of or potential for the presence of historic resources can be sought from the State Historic Preservation Officer or Tribal Historic Preservation Officer, as appropriate, and the National Register of Historic Places (see 33 CFR 320.44g). The district engineer shall make a reasonable and good faith effort to carry out appropriate identification efforts, which may include background research, consultation, oral history interviews, sample field investigation, and field survey. Based on the information submitted and these efforts, the district engineer shall determine whether the proposed activity has the potential to cause an effect on the historic properties. Where the non-federal applicant has identified historic properties which the activity may have the potential to cause effects and so notified the Corps, the non-Federal applicant shall not begin the activity until notified by the district engineer either that the activity has no potential to cause effects or that consultation under Section 106 of the NHPA has been completed.

(d) The district engineer will notify the prospective permittee within 45 days of receipt of a complete pre-construction notification whether NHPA Section 106 consultation is required.

19. **Designated Critical Resource Waters.** Critical resource waters include: NOAA-designated marine sanctuaries, National Estuarine Research Reserves, state natural heritage sites, and outstanding national resource waters or other waters officially designated by a state as having particular environmental or ecological significance and identified by the district engineer after notice and opportunity for public comment. The district engineer may also designate additional critical resource waters after notice and opportunity for comment.

(a) Discharges of dredged or fill material into waters of the United States are not authorized by NHPA 7, 12, 14, 16, 17, 21, 29, 31, 35, 39, 40, 42, 43, 44, 49, and 50 for any activity within, or directly affecting, critical resource waters, including wetlands adjacent to such waters.

(b) For NHPA 3, 8, 10, 13, 15, 18, 19, 22, 23, 25, 27, 28, 30, 33, 34, 36, 37, and 38, notification is required in accordance with general condition 27, for any activity proposed in the designated critical resource waters including wetlands adjacent to those waters. The district engineer may authorize activities under those NHPAs only after it is determined that the impacts to the critical resource waters will be no more than minimal.

20. **Mitigation.** The district engineer will consider the following factors when determining appropriate and practicable mitigation necessary to ensure that adverse effects on the aquatic environment are minimal:

(a) The activity must be designed and constructed to avoid and minimize adverse effects, both temporary and permanent, to waters of the United States to the maximum extent practicable at the project site

(i.e., on site).

(b) Mitigation in all its forms (avoiding, minimizing, rectifying, reducing, or compensating) will be required to the extent necessary to ensure that the adverse effects to the aquatic environment are minimal.

(c) Compensatory mitigation at a minimum one-for-one ratio will be required for all wetland losses that exceed 1/10 acre and require pre-construction notification, unless the district engineer determines in writing that some other form of mitigation would be more environmentally appropriate and provides a project-specific waiver of this requirement. For wetland losses of 1/10 acre or less that require pre-construction notification, the district engineer may determine on a case-by-case basis that compensatory mitigation is required to ensure that the activity results in minimal adverse effects on the aquatic environment, since the likelihood of success is greater and the impacts to potentially valuable uplands are reduced; wetland restoration should be the first compensatory mitigation option considered.

(d) For losses of streams or other open waters that require pre-construction notification, the district engineer may require compensatory mitigation, such as stream restoration, to ensure that the activity results in minimal adverse effects on the aquatic environment.

(e) Compensatory mitigation will not be used to increase the acreage losses allowed by the acreage limits of the NHPAs. For example, if an NHPA has an acreage limit of 1/2 acre, it cannot be used to authorize any project resulting in the loss of greater than 1/2 acre of waters of the United States, even if compensatory mitigation is provided that replaces or restores some of the lost waters. However, compensatory mitigation can and should be used, as necessary, to ensure that a project already meeting the established acreage limits also satisfies the minimal impact requirement associated with the NHPAs.

(f) Compensatory mitigation plans for projects in or near streams or other open waters will normally include a requirement for the establishment, maintenance, and legal protection (e.g., conservation easements) of riparian areas next to open waters. In some cases, riparian areas may be the only compensatory mitigation required. Riparian areas should consist of native species. The width of the required riparian area will address documented water quality or aquatic habitat loss concerns. Normally, the riparian area will be 25 to 50 feet wide on each side of the stream, but the district engineer may require slightly wider riparian areas to address documented water quality or habitat loss concerns. Where both wetlands and open waters exist on the project site, the district engineer will determine the appropriate compensatory mitigation (e.g., riparian areas and/or wetlands compensation) based on what is best for the aquatic environment on a watershed basis. In cases where riparian areas are determined to be the most appropriate form of compensatory mitigation, the district engineer may waive or reduce the requirement to provide wetland compensatory mitigation for wetland losses.

(g) Permittees may propose the use of mitigation banks, in-lieu fee arrangements or separate activity-specific compensatory mitigation. In all cases, the mitigation providers will specify the party responsible for accomplishing and/or complying with the mitigation plan.

(h) Where certain functions and services of waters of the United States are permanently adversely affected, such as the conversion of a forested or scrub-shrub wetland to a herbaceous wetland or a permanently maintained utility line right-of-way, mitigation may be required to reduce the adverse effects of the project to the minimal level.

21. **Water Quality.** Where States and authorized Tribes, or EPA where applicable, have not previously certified compliance of an NHPA with CWA Section 401, individual 401 Water Quality Certification must

be obtained or waived (see 33 CFR 320.4(c)). The district engineer or

be obtained or waived (see 33 CFR 330.4(c)). The district engineer or State or Tribe may require additional water quality management measures to ensure that the authorized activity does not result in more than minimal degradation of water quality.

22. Coastal Zone Management. In coastal states where an NWP has not previously received a state coastal zone management consistency concurrence, an individual state coastal zone management consistency concurrence must be obtained, or a presumption of concurrence must occur (see 33 CFR 330.4(d)). The district engineer or a State may require additional measures to ensure that the authorized activity is consistent with state coastal zone management requirements.

23. Regional and Case-By-Case Conditions. The activity must comply with any regional conditions that may have been added by the Division Engineer (see 33 CFR 330.4(e)) and with any case specific conditions added by the Corps or by the state, Indian Tribe, or U.S. EPA in its section 401 Water Quality Certification, or by the state in its Coastal Zone Management Act consistency determination.

24. Use of Multiple Nationwide Permits. The use of more than one NWP for a single and complete project is prohibited, except when the average loss of waters of the United States authorized by the NWPs does not exceed the acreage limit of the NWP with the highest specified acreage limit. For example, if a road crossing over tidal waters is constructed under NWP 14, with associated bank stabilization authorized by NWP 13, the maximum acreage loss of waters of the United States for the total project cannot exceed 1/3-acre.

25. Transfer of Nationwide Permit Verifications. If the permittee sells the property associated with a nationwide permit verification, the permittee may transfer the nationwide permit verification to the new owner by submitting a letter to the appropriate Corps district office to validate the transfer. A copy of the nationwide permit verification must be attached to the letter, and the letter must contain the following statement and signature: "When the structures or work authorized by this nationwide permit are still in existence at the time the property is transferred, the terms and conditions of this nationwide permit, including any special conditions, will continue to be binding on the new owner(s) of the property. To validate the transfer of this nationwide permit and the associated liabilities associated with compliance with its terms and conditions, have the transferee sign and date below."

26. Compliance Certification. Each permittee who received an NWP verification from the Corps must submit a signed certification regarding the completed work and any required mitigation. The certification form must be forwarded by the Corps with the NWP verification letter and will include:

- (a) A statement that the authorized work was done in accordance with the NWP authorization, including any general or specific conditions;
- (b) A statement that any required mitigation was completed in accordance with the permit conditions; and
- (c) The signature of the permittee certifying the completion of the work and mitigation.

27. Pre-Construction Notification. (a) **Timing.** Where required by the terms of the NWP, the prospective permittee must notify the district engineer by submitting a pre-construction notification (PCN) as early as possible. The district engineer must determine if the PCN is complete within 30 calendar days of the date of receipt and, as a general rule, will request additional information necessary to make the PCN complete only once. However, if the prospective permittee does

not provide all of the requested information, then the district engineer will notify the prospective permittee that the PCN is still incomplete and the PCN review process will not commence until all of the requested information has been received by the district engineer. The prospective permittee shall not begin the activity until either:

(1) He or she is notified in writing by the district engineer that the activity may proceed under the NWP with any special conditions imposed by the district or division engineer; or

(2) Forty-five calendar days have passed from the district engineer's receipt of the complete PCN and the prospective permittee has not received written notice from the district or division engineer. However, if the permittee was required to notify the Corps pursuant to general condition 17 that listed species or critical habitat might be affected or in the vicinity of the project, or to notify the Corps pursuant to general condition 18 that the activity may have the potential to cause effects to historic properties, the permittee cannot begin the activity until receiving written notification from the Corps that is "no effect" on listed species or "no potential to cause effects" on historic properties, or that any consultation required under Section 7 of the Endangered Species Act (see 33 CFR 330.4(f)) and/or Section 106 of the National Historic Preservation Act (see 33 CFR 330.4(g)) is completed. Also, work cannot begin under NWPs 21, 49, or 50 until the permittee has received written approval from the Corps. If the proposed activity requires a written waiver to exceed specified limits of an NWP, the permittee cannot begin the activity until the district engineer issues the waiver. If the district or division engineer notifies the permittee in writing that an individual permit is required within 45 calendar days of receipt of a complete PCN, the permittee cannot begin the activity until an individual permit has been obtained. Subsequently, the permittee's right to proceed under the NWP may be modified, suspended, or revoked only in accordance with the procedure set forth in 33 CFR 330.5(d)(2).

(b) **Contents of Pre-Construction Notification:** The PCN must be in writing and include the following information:

- (1) Name, address, and telephone numbers of the prospective permittee;
- (2) Location of the proposed project;
- (3) A description of the proposed project; the project's purpose; direct and indirect adverse environmental effects the project would cause; any other NWP(s), regional general permit(s), or individual permit(s) used or intended to be used to authorize any part of the proposed project or any related activity. The description should be sufficiently detailed to allow the district engineer to determine the adverse effects of the project will be minimal and to determine the need for compensatory mitigation. Sketches should be provided when necessary to show that the activity complies with the terms of the NWP. (Sketches usually clarify the project and when provided result in a quicker decision.);
- (4) The PCN must include a delineation of special aquatic sites and other waters of the United States on the project site. Wetland delineations must be prepared in accordance with the current methods required by the Corps. The permittee may ask the Corps to delineate the special aquatic sites and other waters of the United States, but there may be a delay if the Corps does the delineation, especially if the project site is large or contains many waters of the United States. Furthermore, the 45 day period will not start until the delineation has been submitted to or completed by the Corps, where appropriate;
- (5) If the proposed activity will result in the loss of greater than 1/10 acre of wetlands and a PCN is required, the prospective permittee must submit a statement describing how the mitigation requirement will be satisfied. As an alternative, the prospective permittee may submit a conceptual or detailed mitigation plan.
- (6) If any listed species or designated critical habitat might be affected or is in the vicinity of the project, or if the project is located in designated critical habitat, for non-Federal applicants the PCN must include the name(s) of those endangered or threatened species that

critical habitat that may be affected by the proposed work. Federal applicants must provide documentation demonstrating compliance with the Endangered Species Act, and

(7) For an activity that may affect a historic property listed on, determined to be eligible for listing on, or potentially eligible for listing on, the National Register of Historic Places, for non-Federal applicants the PCN must state which historic property may be affected by the proposed work or include a vicinity map indicating the location of the historic property. Federal applicants must provide documentation demonstrating compliance with Section 106 of the National Historic Preservation Act.

(b) **Form of the Construction Notification:** The standard individual permit application form (Form EHQ 4344) may be used, but the completed application form must clearly indicate that it is a PCN and must include all of the information required in paragraphs B(1) through (7) of this general condition. A letter containing the required information may also be used.

(c) **Agency Coordination:** (1) The district engineer will consider any comments from Federal and state agencies concerning the proposed activity's compliance with the terms and conditions of the NWP and the need for mitigation to reduce the project's adverse environmental effects to a minimal level.

(2) For all NWP 48 activities requiring pre-construction notification and for other NWP activities requiring pre-construction notification to the district engineer that result in the loss of greater than 1/2-acre of waters of the United States, the district engineer will immediately provide (e.g., via facsimile transmission, overnight mail, or other expeditious manner) a copy of the PCN to the appropriate Federal or state office (U.S. FWS, 9906 national resource or water quality agency, EPA, State Historic Preservation Office (SHPO) or Tribal Historic Preservation Office (THPO), and, if appropriate, the NMFS). With the exception of NWP 37, these agencies will then have 10 calendar days from the date the material is transmitted to telephonically or fax the district engineer notice that they intend to provide substantive, site-specific comments. If so contacted by an agency, the district engineer will wait an additional 10 calendar days before making a decision on the pre-construction notification. The district engineer will fully consider agency comments received within the specified time frame, but will provide no response to the resource agency, except as provided below. The district engineer will indicate in the administrative record associated with each pre-construction notification that the resource agencies' concerns were considered. For NWP 37, the emergency watershed protection and rehabilitation activity may proceed immediately in cases where there is an unacceptable hazard to life or a significant loss of property or economic hardship will occur. The district engineer will consider any comments received to decide whether the NWP 37 authorization should be modified, suspended, or revoked in accordance with the procedures at 33 CFR 330.6.

(3) In cases of where the prospective permittee is not a Federal agency, the district engineer will provide a response to NMFS within 30 calendar days of receipt of any Essential Fish Habitat conservation recommendations, as required by Section 306(b)(A)(3) of the Magnuson-Stevens Fishery Conservation and Management Act.

(4) Applicants are encouraged to provide the Corps multiple copies of pre-construction notifications to expedite agency coordination.

(5) For NWP 48 activities that require reporting, the district engineer will provide a copy of each report within 10 calendar days of receipt to the appropriate regional office of the NMFS.

(6) **District Engineer's Decision:** In reviewing the PCN for the proposed activity, the district engineer will determine whether the activity authorized by the NWP will result in more than minimal individual or cumulative adverse environmental effects or may be contrary to the public interest. If the proposed activity requires a PCN and will result in a loss of greater than 1/10 acre of wetlands, the

prospective permittee should submit a mitigation proposal with the PCN. Applicants may also propose compensatory mitigation for projects with another impacts. The district engineer will consider any proposed compensatory mitigation the applicant has included in the proposal in determining whether the net adverse environmental effects to the aquatic environment of the proposed work are minimal. The compensatory mitigation proposal may be either conceptual or detailed. If the district engineer determines that the activity complies with the terms and conditions of the NWP and that the adverse effects on the aquatic environment are minimal after considering mitigation, the district engineer will notify the permittee and include any conditions the district engineer deems necessary. The district engineer must approve any compensatory mitigation proposal before the permittee commences work. If the prospective permittee elects to submit a compensatory mitigation plan with the PCN, the district engineer will expeditiously review the proposed compensatory mitigation plan. The district engineer must review the plan within 45 calendar days of receiving a complete PCN and determine whether the proposed mitigation would ensure no more than minimal adverse effects on the aquatic environment. If the net adverse effects of the project on the aquatic environment (after consideration of the compensatory mitigation proposal) are determined by the district engineer to be minimal, the district engineer will provide a timely written response to the applicant. The response will state that the project can proceed under the terms and conditions of the NWP. If the district engineer determines that the adverse effects of the proposed work are more than minimal, then the district engineer will notify the applicant either: (1) that the project does not qualify for authorization under the NWP and instruct the applicant on the procedures to seek authorization under an individual permit; (2) that the project is authorized under the NWP subject to the applicant's submission of a mitigation plan that would reduce the adverse effects on the aquatic environment to the minimal level; or (3) that the project is authorized under the NWP with specific modifications or conditions. Where the district engineer determines that mitigation is required to ensure no more than minimal adverse effects occur to the aquatic environment, the activity will be authorized within the 45-day PCN period. The authorization will include the necessary conceptual or specific mitigation or a requirement that the applicant submit a mitigation plan that would reduce the adverse effects on the aquatic environment to the minimal level. When mitigation is required, no work in waters of the United States may occur until the district engineer has approved a specific mitigation plan.

38. **Single and Complete Project.** The activity must be a single and complete project. The same NWP cannot be used more than once for the same single and complete project.

FURTHER INFORMATION

1. District Engineers have authority to determine if an activity complies with the terms and conditions of an NWP.
2. NWPs do not obviate the need to obtain other federal, state, or local permits, approvals, or authorizations required by law.
3. NWPs do not grant any property rights or exclusive privileges.
4. NWPs do not authorize any injury to the property or rights of others.
5. NWPs do not authorize interference with any existing or proposed Federal project.

DEFINITIONS

DEFINITIONS

Best management practices (BMPs): Policies, practices, procedures, or structures implemented to mitigate the adverse environmental effects on surface water quality resulting from development. BMPs are categorized as structural or non-structural.

Compensatory mitigation: The restoration, establishment (creation), enhancement, or preservation of aquatic resources for the purpose of compensating for unavoidable adverse impacts which remain after all appropriate and practicable avoidance and minimization has been achieved.

Currently serviceable: Useable as is or with some maintenance, but not so degraded as to essentially require reconstruction.

Discharge: The term "discharge" means any discharge of dredged or fill material.

Enhancement: The manipulation of the physical, chemical, or biological characteristics of an aquatic resource to heighten, intensify, or improve a specific aquatic resource function(s). Enhancement results in the gain of selected aquatic resource function(s), but may also lead to a decline in other aquatic resource function(s). Enhancement does not result in a gain in aquatic resource area.

Ephemeral stream: An ephemeral stream has flowing water only during, and for a short duration after, precipitation events in a typical year. Ephemeral stream beds are located above the water table year-round. Groundwater is not a source of water for the stream. Runoff from rainfall is the primary source of water for stream flow.

Establishment (creation): The manipulation of the physical, chemical, or biological characteristics present to develop an aquatic resource that did not previously exist at an upland site. Establishment results in a gain in aquatic resource area.

Historic Property: Any prehistoric or historic district, site (including archaeological site), building, structure, or other object included in, or eligible for inclusion in, the National Register of Historic Places maintained by the Secretary of the Interior. This term includes artifacts, records, and remains that are related to and located within such properties. The term includes properties of traditional religious and cultural importance to an Indian tribe or Native Hawaiian organization and that meet the National Register criteria (36 CFR part 60).

Independent utility: A test to determine what constitutes a single and complete project in the Corps regulatory program. A project is considered to have independent utility if it would be constructed absent the construction of other projects in the project area. Portions of a multi-phase project that depend upon other phases of the project do not have independent utility. Phases of a project that would be constructed even if the other phases were not built can be considered as separate single and complete projects with independent utility.

Intermittent stream: An intermittent stream has flowing water during certain times of the year, when groundwater provides water for stream flow. During dry periods, intermittent streams may not have flowing water. Runoff from rainfall is a supplemental source of water for stream flow.

Loss of waters of the United States: Waters of the United States that are permanently adversely affected by filling, flooding, excavation, or drainage because of the regulated activity. Permanent adverse effects include permanent discharges of dredged or fill material that change an aquatic area to dry land, increase the bottom elevation of a waterbody, or change the use of a waterbody. The acreage of loss of waters of the United States is a threshold measurement of the impact to jurisdictional waters for determining whether a project may qualify for an NWP; it is not a net threshold that is calculated after considering compensatory mitigation that may be used to offset losses of aquatic functions and services. The loss of stream bed includes the linear feet

of stream bed that is filled or excavated. Waters of the United States temporarily filled, flooded, excavated, or drained, but restored to pre-construction contours and elevations after construction, are not included in the measurement of loss of waters of the United States. Impacts resulting from activities eligible for exemptions under Section 404(f) of the Clean Water Act are not considered when calculating the loss of waters of the United States.

Non-tidal wetland: A non-tidal wetland is a wetland that is not subject to the ebb and flow of tidal waters. The definition of a wetland can be found at 33 CFR 328.3(b). Non-tidal wetlands contiguous to tidal waters are located landward of the high tide line (i.e., spring high tide line).

Open water: For purposes of the NWPs, an open water is any area that in a year with normal patterns of precipitation has water flowing or standing above ground to the extent that an ordinary high water mark can be determined. Aquatic vegetation within the area of standing or flowing water is either non-emergent, sparse, or absent. Vegetated shallows are considered to be open waters. Examples of "open waters" include rivers, streams, lakes, and ponds.

Ordinary High Water Mark: An ordinary high water mark is a line on the shore established by the fluctuations of water and indicated by physical characteristics, or by other appropriate means that consider the characteristics of the surrounding areas (see 33 CFR 328.3(e)).

Perennial stream: A perennial stream has flowing water year-round during a typical year. The water table is located above the stream bed for most of the year. Groundwater is the primary source of water for stream flow. Runoff from rainfall is a supplemental source of water for stream flow.

Practicable: Available and capable of being done after taking into consideration cost, existing technology, and logistics in light of overall project purposes.

Pre-construction notification: A request submitted by the project proponent to the Corps for confirmation that a particular activity is authorized by nationwide permit. The request may be a permit application, letter, or similar document that includes information about the proposed work and its anticipated environmental effects. Pre-construction notification may be required by the terms and conditions of a nationwide permit, or by regional conditions. A pre-construction notification may be voluntarily submitted in cases where pre-construction notification is not required and the project proponent wants confirmation that the activity is authorized by nationwide permit.

Preservation: The removal of a threat to, or preventing the decline of, aquatic resources by an action in or near those aquatic resources. This term includes activities commonly associated with the protection and maintenance of aquatic resources through the implementation of appropriate legal and physical mechanisms. Preservation does not result in a gain of aquatic resource area or functions.

Re-establishment: The manipulation of the physical, chemical, or biological characteristics of a site with the goal of returning natural/historic functions to a former aquatic resource. Re-establishment results in rebuilding a former aquatic resource and results in a gain in aquatic resource area.

Rehabilitation: The manipulation of the physical, chemical, or biological characteristics of a site with the goal of repairing natural/historic functions to a degraded aquatic resource. Rehabilitation results in a gain in aquatic resource function, but does not result in a gain in aquatic resource area.

Restoration: The manipulation of the physical, chemical, or biological characteristics of a site with the goal of returning natural/historic functions to a former or degraded aquatic resource. For the purpose of tracking net gains in aquatic resource area, restoration is divided into two categories: re-establishment and rehabilitation.

Riffle and pool complex: Riffle and pool complexes are special aquatic sites under the 404(b)(1) Guidelines. Riffle and pool complexes sometimes characterize steep gradient sections of

streams. Such stream sections are recognizable by their hydraulic characteristics. The rapid movement of water over a coarse substrate in riffles results in a rough flow, a turbulent surface, and high dissolved oxygen levels in the water. Pools are deeper areas associated with riffles. A slower stream velocity, a streaming flow, a smooth surface, and a finer substrate characterize pools.

Riparian areas: Riparian areas are lands adjacent to streams, lakes, and estuarine-marine shorelines. Riparian areas are transitional between terrestrial and aquatic ecosystems, through which surface and subsurface hydrology connects waterbodies with their adjacent uplands. Riparian areas provide a variety of ecological functions and services and help improve or maintain local water quality. (See general condition 20.)

Shellfish seeding: The placement of shellfish seed and/or suitable substrate to increase shellfish production. Shellfish seed consists of immature individual shellfish or individual shellfish attached to shells or shell fragments (i.e., spat on shell). Suitable substrate may consist of shellfish shells, shell fragments, or other appropriate materials placed into waters for shellfish habitat.

Single and complete project: The term "single and complete project" is defined at 33 CFR 328.2) as the total project proposed or accomplished by one owner/developer or partnership or other association of owner/developers. A single and complete project must have independent utility (see definition). For linear projects, a "single and complete project" is all crossings of a single water of the United States (i.e., a single waterbody) at a specific location. For linear projects crossing a single waterbody several times at separate and distant locations, each crossing is considered a single and complete project. However, individual channels in a braided stream or river, or individual arms of a large, irregularly shaped wetland or lake, etc., are not separate waterbodies, and crossings of such features cannot be considered separately.

Stormwater management: Stormwater management is the mechanism for controlling stormwater runoff for the purposes of reducing downstream erosion, water quality degradation, and flooding and mitigating the adverse effects of changes in land use on the aquatic environment.

Stormwater management facilities: Stormwater management facilities are those facilities, including but not limited to, stormwater retention and detention ponds and best management practices, which retain water for a period of time to control runoff and/or improve the quality (i.e., by reducing the concentration of nutrients, sediments, hazardous substances and other pollutants) of stormwater runoff.

Stream bed: The substrate of the stream channel between the ordinary high water marks. The substrate may be bedrock or inorganic particles that range in size from clay to boulders. Wetlands contiguous to the stream bed, but outside of the ordinary high water marks, are not considered part of the stream bed.

Stream channelization: The manipulation of a stream's course, condition, capacity, or location that causes more than minimal interruption of normal stream processes. A channelized stream remains a water of the United States.

Structure: An object that is arranged in a definite pattern of organization. Examples of structures include, without limitation, any pier, boat dock, boat ramp, wharf, dolphin, weir, boom, breakwater, bulkhead, seawall, dike, jetty, artificial island, artificial reef, permanent mooring structure, power transmission line, permanently moored floating vessel, piling, aid to navigation, or any other manmade obstacle or obstruction.

Tidal wetland: A tidal wetland is a wetland (i.e., water of the United States) that is inundated by tidal waters. The definitions of a wetland and tidal waters can be found at 33 CFR 328.3(a) and 33 CFR 328.3(f), respectively. Tidal waters rise and fall in a predictable and measurable rhythm or cycle due to the gravitational pull of the moon and sun. Tidal waters end where the rise and fall of the water surface

can no longer be practically measured in a predictable rhythm due to masking by other waves, wind, or other effects. Tidal wetlands are located channelward of the high tide line, which is defined at 33 CFR 328.3(d).

Vegetated shallows: Vegetated shallows are special aquatic sites under the 404(b)(1) Guidelines. They are areas that are permanently inundated and under normal circumstances have rooted aquatic vegetation, such as seagrasses in marine and estuarine systems and a variety of vascular rooted plants in freshwater systems.

Waterbody: For purposes of the NWPP, a waterbody is a jurisdictional water of the United States that, during a year with normal patterns of precipitation, has water flowing or standing above ground to the extent that an ordinary high water mark (OHWM) or other indicators of jurisdiction can be determined, as well as any wetland areas (see 33 CFR 328.3(h)). If a jurisdictional wetland is adjacent—meaning bordering, contiguous, or neighboring—to a jurisdictional waterbody displaying an OHWM or other indicators of jurisdiction, that waterbody and its adjacent wetlands are considered together as a single aquatic unit (see 33 CFR 328.4(c)(2)). Examples of "waterbodies" include streams, rivers, lakes, ponds, and wetlands.

STATE OF ILLINOIS
CLEAN WATER ACT SECTION 401 WATER QUALITY CERTIFICATION
2012 GENERAL AND SPECIFIC CONDITIONS
NWP 3 - MAINTENANCE

These conditions ensure that the activities carried out under Nationwide Permits (NWPs) do not violate the Water Quality Standards of the State of Illinois resulting in permanent damage to habitat, increased turbidity, reduced bank and channel stability, and/or impacts to the biological and chemical integrity of the waters. These conditions are in addition to, not a replacement for, those conditions included by the federal authorities. Proposed projects authorized by the NWPs listed above that cannot be conducted within the conditions listed below must apply for individual Clean Water Act Section 401 Water Quality Certification.

Applications for certification should be sent to the Illinois Environmental Protection Agency, Division of Water Pollution Control, 1021 North Grand Avenue East, P.O. Box 19276, Springfield, Illinois, 62794-9276. An issued certification becomes part of the Clean Water Act Section 404 Permit. Therefore, it expires with the 404 Permit unless explicitly stated otherwise.

GENERAL CONDITIONS FOR ALL NWPs

1. An individual 401 water quality certification will be required for any activities permitted under these Nationwide Permits for discharges to waters designated by the State of Illinois as Outstanding Resource Waters under 35 Ill. Adm. Code 302.105(b).
2. Projects requiring authorization under Section 404 of the Clean Water Act must implement Best Management Practices (BMPs) to protect water quality, preserve natural hydrology and minimize the overall impacts to aquatic resources during and after construction. If the project involves a water with an approved Total Maximum Daily Load (TMDL) allocation for any parameter, measures which ensure consistency with the assumption and requirements of the TMDL shall be included. TMDL program information and water listings are available at www.epa.state.il.us/water/tmdl/. If the project involves an impaired water listed on the Illinois Environmental Protection Agency's Section 303(d) list for suspended solids, turbidity, or siltation, measures designed for at least a 25-year, 24-hour rainfall event shall be incorporated. Impaired waters are identified at www.epa.state.il.us/water/tmdl/303d-list.html.
3. Prior to proceeding with any work in accordance with any Nationwide Permit, potential impacts to threatened or endangered species shall be identified through use of the State's Ecological Compliance Assessment Tool (EcoCAT) at <http://dnrecocat.state.il.us/ecopublic/>. If potential impacts to State threatened or endangered species are identified, the Illinois Department of Natural Resources shall be consulted with.

SPECIFIC CONDITIONS FOR NWP 3 – Maintenance

1. The applicant shall not cause:
 - A. violation of applicable provisions of the Illinois Environmental Protection Act;
 - B. water pollution defined and prohibited by the Illinois Environmental Protection Act;
 - C. violation of applicable water quality standards of the Illinois Pollution Control Board, Title 35, Subtitle C: Water Pollution Rules and Regulation; or
 - D. interference with water use practices near public recreation areas or water supply intakes.

2. Any spoil material excavated, dredged or otherwise produced must not be returned to the waterway but must be deposited in a self-contained area in compliance with all state statutes, as determined by the Illinois EPA.
3. Any backfilling must be done with clean material and placed in a manner to prevent violation of applicable water quality standards.
4. The applicant for Nationwide Permit 3 shall provide adequate planning and supervision during the project construction period for implementing construction methods, processes and cleanup procedures necessary to prevent water pollution and control erosion.
5. All areas affected by construction shall be mulched and seeded as soon after construction as possible. The applicant for Nationwide 3 shall undertake necessary measures and procedures to reduce erosion during construction. Interim measures to prevent erosion during construction shall be taken and may include the installation of sedimentation basins and temporary mulching. All construction within the waterway shall be conducted during zero or low flow conditions. The applicant for Nationwide 3 shall be responsible for obtaining an NPDES Storm Water Permit prior to initiating construction if the construction activity associated with the project will result in the disturbance of 1 (one) or more acres, total land area. An NPDES Storm Water Permit may be obtained by submitting a properly completed Notice of Intent (NOI) form by certified mail to the Agency's Division of Water Pollution Control, Permit Section.
6. The applicant for Nationwide 3 shall implement erosion control measures consistent with the "Illinois Urban Manual" (IEPA/USDA, NRCS; 2011).
7. Temporary work pads, cofferdams, access roads and other temporary fills shall be constructed of clean coarse aggregate or non-erodible non-carthen fill material that will not cause siltation. Sandbags, pre-fabricated rigid materials, sheet piling, inflatable bladders and fabric lined basins may be used for temporary facilities.
8. The applicant for Nationwide 3 that uses temporary work pads, cofferdams, access roads and other temporary fills in order to perform work in creeks, streams, or rivers shall maintain flow in these waters by utilizing dam and pumping, fluming, culverts or other such techniques.

STATE OF ILLINOIS
DEPARTMENT OF TRANSPORTATION
DIVISION OF HIGHWAYS

**PROPOSED
HIGHWAY PLANS**

VARIOUS ROUTES
SECTION D9 SCOUR REPAIR 2013-1
JEFFERSON, POPE, WHITE COUNTIES
C-99-003-13

VARIOUS ROUTES
D9 SCOUR REPAIR 2013-1
VARIOUS COUNTIES
CONTRACT NO. 78342
SHEET 1 OF 19

D-99-003-13

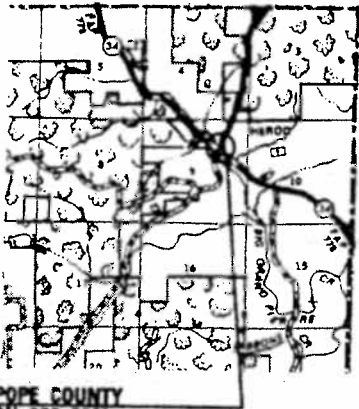
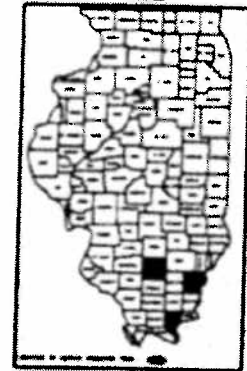

POPE COUNTY
SN: 075-0001
(ILL 34) OVER GIBBONS CREEK

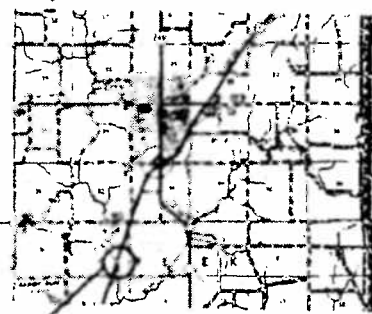

WHITE COUNTY
SN: 097-0013
FAP 332 (US 45) OVER BEAR CREEK

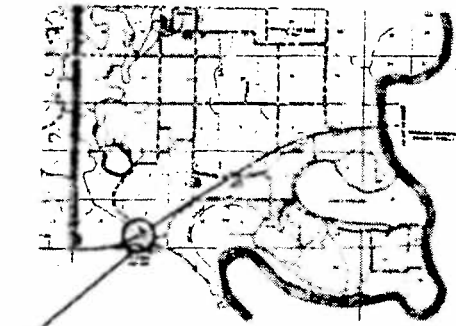

WHITE COUNTY
SN: 097-0030
FAP 077 (ILL 141) OVER LITTLE WABASH RIVER

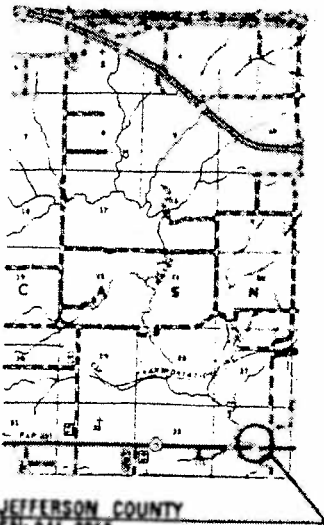

JEFFERSON COUNTY
SN: 041-0019
FAP 021 (ILL 15) OVER RAYSE CREEK

STRUCTURE NO. 041-0019
2011 ADT = 2550
% TRUCKS = 8
HS INV RATING: 14.6
HS OPER RATING: 24.4
LEGAL LOADS ONLY
TOWNSHIP: CASNER

STRUCTURE NO. 078-0001
2011 ADT = 2850
% TRUCKS = 27
HS INV RATING: 25.1
HS OPER RATING: 41.0
NO POSTING
TOWNSHIP: ROAD DIST #02

STRUCTURE NO. 097-0013
2011 ADT = 3250
% TRUCKS = 12
HS INV RATING: 15.0
HS OPER RATING: 26.4
NO POSTING
TOWNSHIP: INDIAN CREEK

STRUCTURE NO. 097-0030
2011 ADT = 3150
% TRUCKS = 14
HS INV RATING: 34.0
HS OPER RATING: 55
NO POSTING
TOWNSHIP: EMMA

PROJECT ENGINEER: DAVID POPE 549-2171 CONTRACT: 782-0054
DESIGNER: RITA GAUTNEY



FOR SIGNATURE SHEET, SEE SHEET NO. 2
FOR INDEX OF SHEETS, SEE SHEET NO. 3
FOR SUMMARY OF QUANTITIES, SEE SHEET NO. 5

JULIE 1-800-892-0123 OR 811

STATE OF ILLINOIS
DEPARTMENT OF TRANSPORTATION
DIVISION OF HIGHWAYS

SUBMITTED 3/29 2013

Jeffrey L. Kain
DEPUTY DIRECTOR OF HIGHWAYS, REGION ENGINEER





ENGINEER OF DESIGN AND ENVIRONMENT

DIRECTOR OF HIGHWAYS, CHIEF ENGINEER

PRINTED BY THE AUTHORITY
OF THE STATE OF ILLINOIS

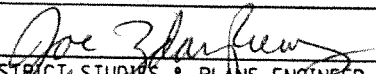
CONTRACT NO. 78342

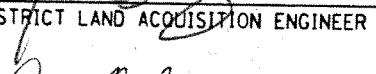
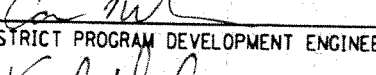
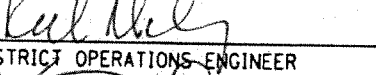
SIGNATURE SHEET

Prepared By:	 DISTRICT STUDIES & PLANS ENGINEER
Examined By:	 DISTRICT LAND ACQUISITION ENGINEER
Examined By:	 DISTRICT PROGRAM DEVELOPMENT ENGINEER
Examined By:	 DISTRICT OPERATIONS ENGINEER
Examined By:	 DISTRICT PROJECT IMPLEMENTATION ENGINEER
Examined By:	 DISTRICT CONSTRUCTION ENGINEER
Examined By:	 DISTRICT MATERIALS ENGINEER

INDEX OF SHEETS

<u>SHEET NO.</u>	<u>DESCRIPTION</u>
1	COVER SHEET
2	SIGNATURES
3	INDEX OF SHEETS, STANDARDS
4	GENERAL NOTES
5	SUMMARY OF QUANTITIES
6	SN 041-0019 PLAN
7	SN 041-0019 CHANNEL SECTION
8	SN 041-0019 SECTION E-E NEAR WING
9	SN 041-0019 R.O.W.
10	SN 076-0001 PLAN
11	SN 076-0001 CHANNEL SECTION
12	SN 076-0001 SECTION F-F NEAR WING
13	SN 076-0001 R.O.W.
14	SN 097-0013 PLAN
15	SN 097-0013 CHANNEL SECTION
16	SN 097-0030 PLAN
17	SN 097-0030 CHANNEL SECTION
18	SN 097-0030 PIER SECTIONS
19	RIPRAP DETAILS

STANDARDS

701201-04	LANE CLOSURE, 2L, 2W, DAY ONLY
701301-04	LANE CLOSURE, 2L, 2W, SHORT-TIME OPERATIONS
701901-02	TRAFFIC CONTROL DEVICES

GENERAL NOTES

COST OF REMOVAL OF EXISTING RIPRAP AND DEBRIS IS INCLUDED IN THE CONTRACT UNIT PRICE FOR STONE RIPRAP.

EACH RIPRAP INSTALLATION SHALL MEET THE EXISTING FLOWLINE BOTH UPSTREAM AND DOWNSTREAM. NO REDUCTION IN WATERWAY OPENING SHALL OCCUR UNDER THAT ORIGINALLY PERMITTED.

PLAN DIMENSIONS AND DETAILS RELATIVE TO EXISTING PLANS ARE SUBJECT TO NOMINAL CONSTRUCTION VARIATIONS. THE CONTRACTOR SHALL FIELD VERIFY EXISTING DIMENSIONS AND DETAILS AFFECTING NEW CONSTRUCTION AND MAKE NECESSARY APPROVED ADJUSTMENTS PRIOR TO CONSTRUCTION OR ORDERING OF MATERIALS. SUCH VARIATIONS SHALL NOT BE CAUSE FOR ADDITIONAL COMPENSATION FOR A CHANGE IN THE SCOPE OF THE WORK; HOWEVER, THE CONTRACTOR WILL BE PAID FOR THE QUANTITY ACTUALLY FURNISHED AT THE UNIT PRICE BID FOR THE WORK.

IN ACCORDANCE WITH SECTIONS 250 AND 251 OF THE STANDARD SPECIFICATIONS, AREAS OF VEGETATION WHICH ARE DISTURBED SHALL BE GRADED, FERTILIZED, SEEDED WITH CLASS 3A SOUTHERN ILLINOIS SLOPE MIXTURE, AND MULCHED. COST IS INCLUDED IN THE COST OF STONE RIPRAP.

ONLY THE CHANNEL EXCAVATION THAT EXCEEDS THE VOLUME OF PROPOSED RIPRAP AND BEDDING IS PAID SEPARATELY. THE QUANTITIES OF CHANNEL EXCAVATION ARE ESTIMATES. THE ENGINEER SHALL DETERMINE THE EXACT QUANTITIES IN THE FIELD.

THE ELEVATIONS OF FOOTINGS AND OTHER STRUCTURAL ELEMENTS SHOWN ON THE PLANS ARE TAKEN FROM EXISTING STRUCTURE PLANS. CHANNEL SECTIONS AND RIPRAP ELEVATIONS ARE AVERAGE ELEVATIONS CALCULATED FROM UPSTREAM AND DOWNSTREAM CROSS-SECTIONS. THE ENGINEER SHALL DETERMINE THE EXACT LIMITS OF THE INSTALLATION.

COMMITMENTS:

STRUCTURE NO. 041-0019

- a) THE CONTRACTOR SHALL NOT STORE EQUIPMENT EAST OF THE CREEK ON THE NORTH SIDE OF THE ROAD FOR MORE THAN 5 CALENDAR DAYS WITHOUT THE PRIOR CONSENT OF THE PROPERTY OWNER.
- b) THE CONTRACTOR SHALL GRADE AND SEED DISTURBED VEGETATION IN PREVIOUSLY MOWED AREAS TO A CONDITION SUITABLE FOR FUTURE MOWING, AS DIRECTED BY THE ENGINEER.

SUMMARY OF QUANTITIES

				CONSTRUCTION TYPE: 0014			
				FUNDING: 100% STATE			
				RURAL/URBAN:		RURAL	
				RURAL	RURAL	RURAL	RURAL
				ROUTE:			
				IL 15	IL 34	US 45	IL 141
				COUNTY:			
				JEFFERSON	POPE	WHITE	WHITE
CODE NO.	PAY ITEM DESCRIPTION	UNIT	TOTAL QUANTITY	041-0019	076-0001	097-0013	097-0030
20300100	CHANNEL EXCAVATION	CU. YD.	37.1	2.9	10.4		23.8
28100109	STONE RIPRAP, CLASS A5	SQ. YD.	904	387	223	294	
28100111	STONE RIPRAP, CLASS A6	SQ. YD.	391				391
28200200	FILTER FABRIC	SQ. YD.	1066	387	185	294	200
67100100	MOBILIZATION	L. SUM	1	0.25	0.25	0.25	0.25
70100450	TRAFFIC CONTROL AND PROTECTION, STANDARD 701201	L. SUM	1	0.25	0.25	0.25	0.25

6

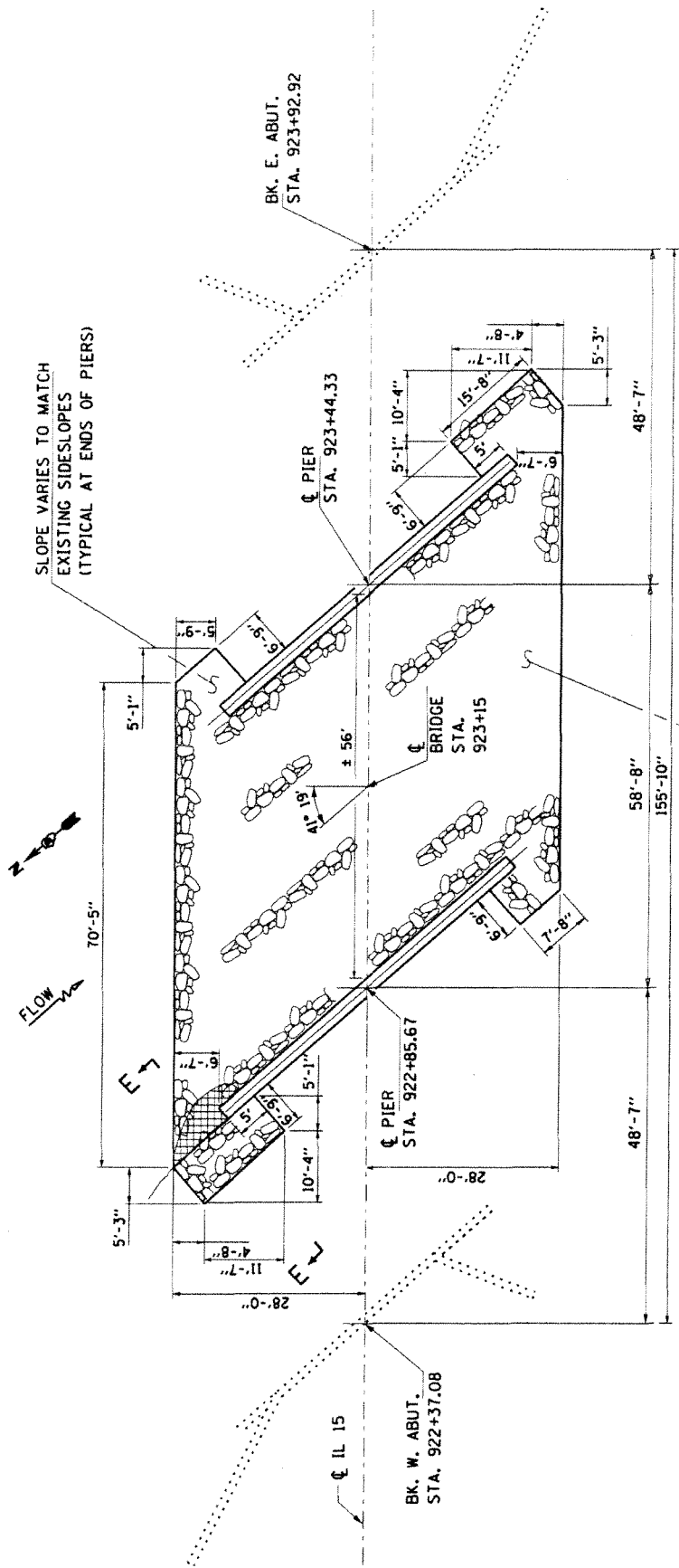

CHANNEL EXCAVATION

STONE RIPRAP
 CLASS A5
 (22" MIN.)

PLAN

SEE SECTION E-E ON SHEET 8 OF 19.
 USE FLANK DETAIL ON UPSTREAM RIPRAP TERMINUS.
 SEE FLANK DETAIL ON SHEET 19 OF 19.

BILL OF MATERIAL

ITEM	UNIT	QUANTITY
CHANNEL EXCAVATION	CU. YD.	2.9
STONE RIPRAP, CLASS A5	SO. YD.	387
FILTER FABRIC	SO. YD.	387

SEE SHEET 9 OF 19 FOR EXISTING RIGHT OF WAY LIMITS AND
 PROPOSED TEMPORARY EASEMENT LIMITS.

041-0019

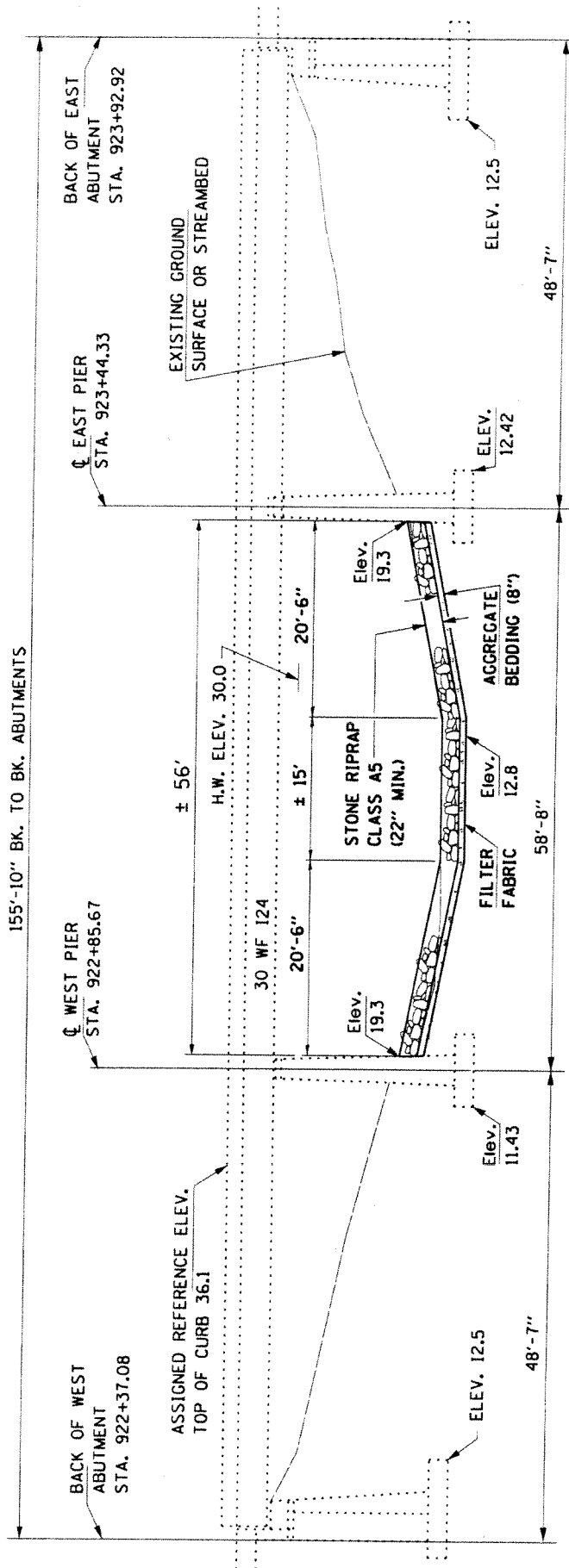

CHANNEL SECTION

DIMENSIONS PARALLEL TO TRAFFIC

041-0019

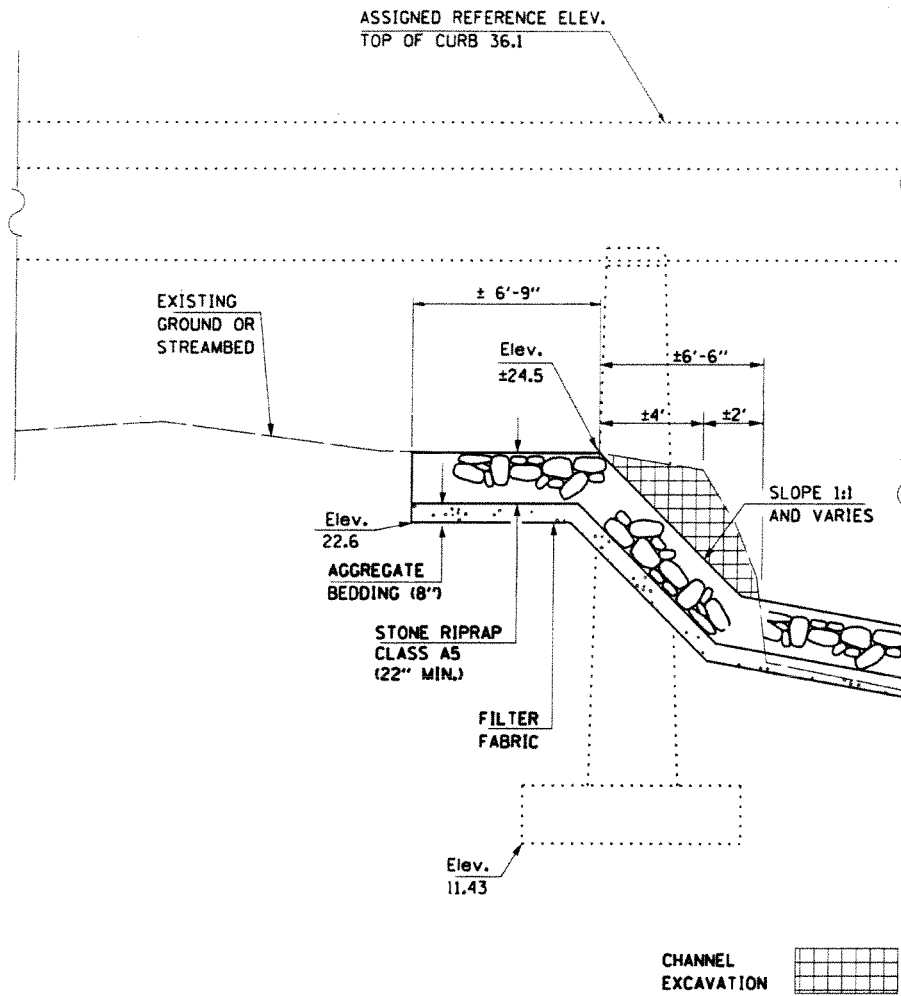

SECTION E-E

DIMENSIONS PARALLEL TO TRAFFIC

041-0019

PARCEL NO.	NAME	PURPOSE	ACREAGE
9034012	KELLY L. & SCOTT A. OWENS, TRUSTEES	TEMP. EASEMENT	±0.16
9034112	PATRICK & JEAN KUJAWA	TEMP. EASEMENT	±0.13

S 1/2 OF SW QTR NE QTR
SECTION 34
T2S, R1E, 3RD PM

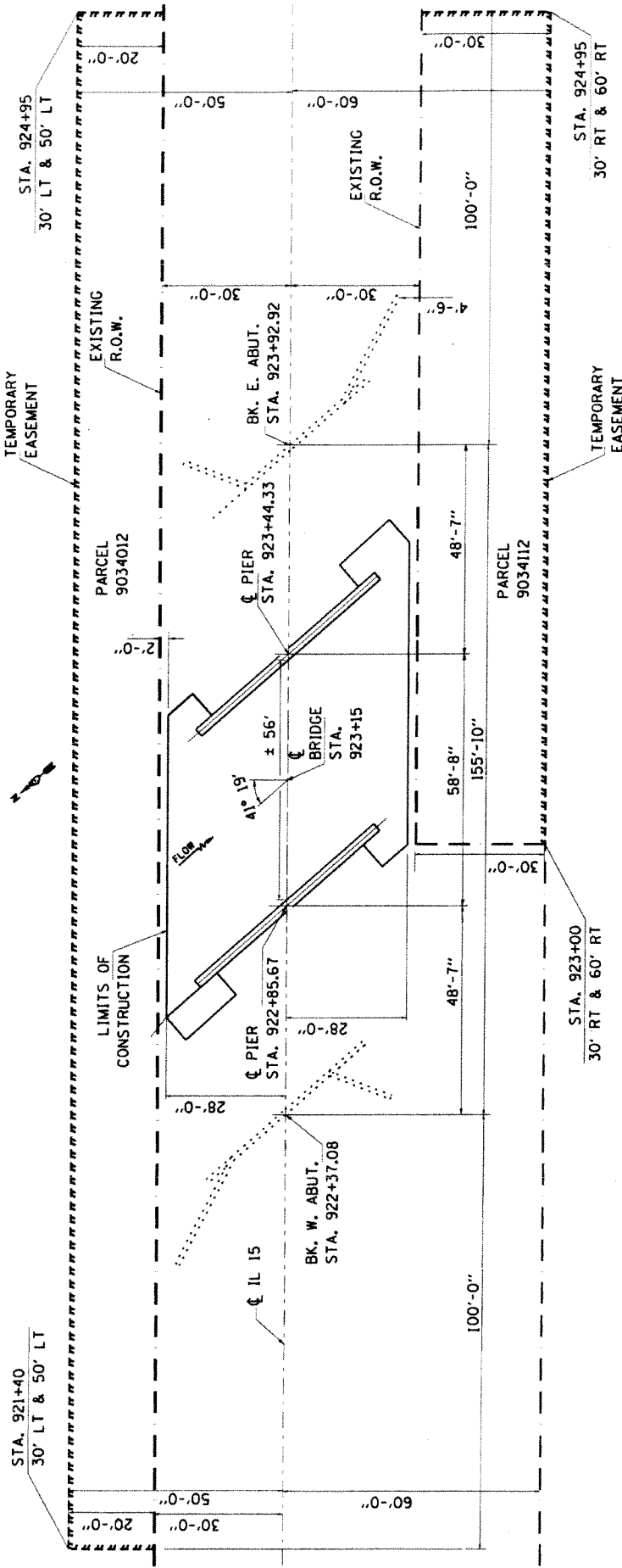

W 1/2 OF SE QTR
SECTION 34
T2S, R1E, 3RD PM

041-0019

VARIOUS ROUTES
D9 SCOUR REPAIR 2013-1
VARIOUS COUNTIES
CONTRACT NO. 78342
SHEET 9 of 19

R.O.W. PLAN R-99-023-12
JEFFERSON COUNTY

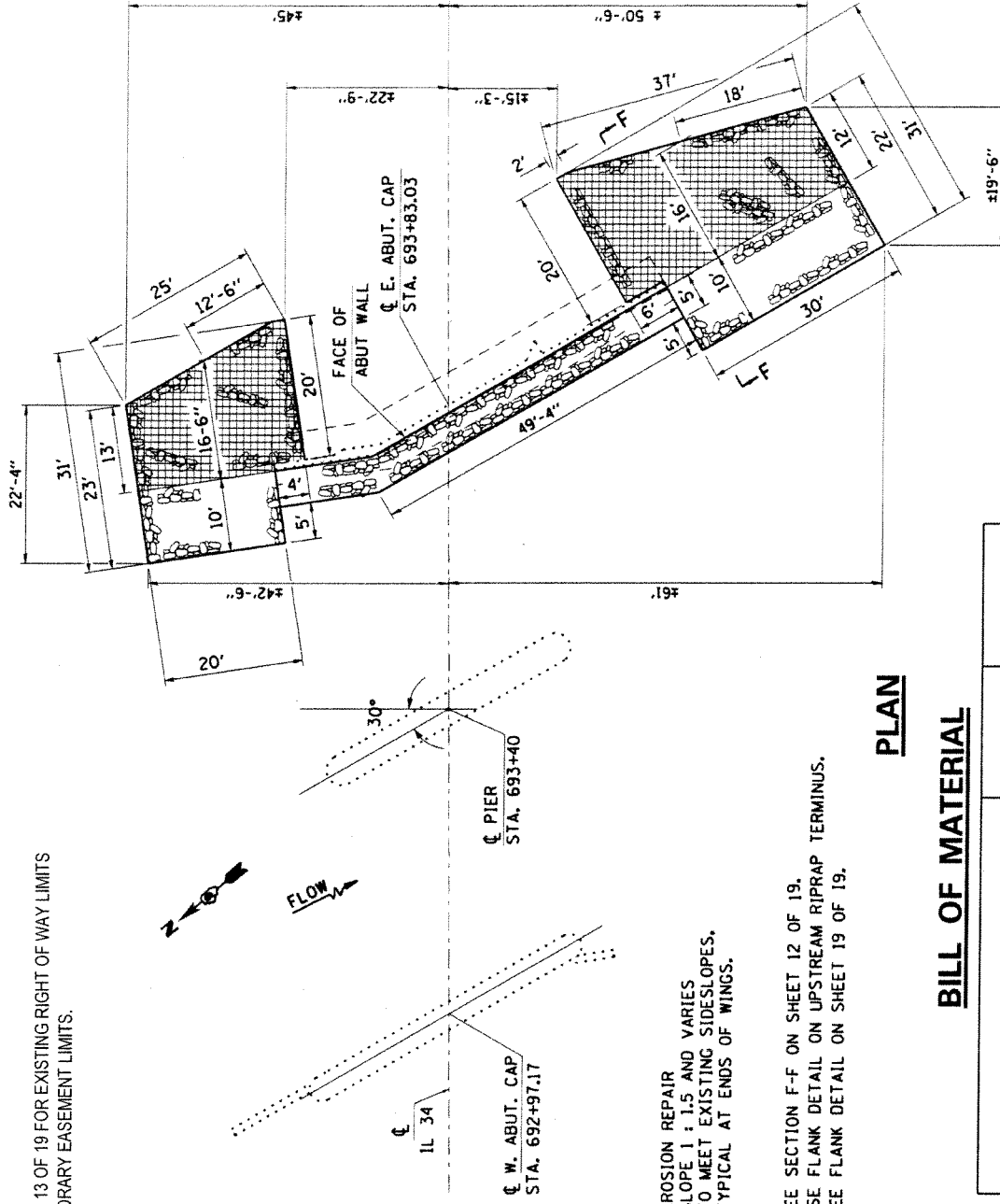

CHANNEL EXCAVATION
 STONE RIPRAP CLASS A5 (22" MIN.)

076-0001

SEE SHEET 13 OF 19 FOR EXISTING RIGHT OF WAY LIMITS AND TEMPORARY EASEMENT LIMITS.

EROSION REPAIR
 SLOPE 1 : 1.5 AND VARIES TO MEET EXISTING SIDESLOPES, TYPICAL AT ENDS OF WINGS.

SEE SECTION F-F ON SHEET 12 OF 19.
 USE FLANK DETAIL ON UPSTREAM RIPRAP TERMINUS.
 SEE FLANK DETAIL ON SHEET 19 OF 19.

PLAN

BILL OF MATERIAL

ITEM	UNIT	QUANTITY
CHANNEL EXCAVATION	CU. YD.	10.4
STONE RIPRAP, CLASS A5	SO. YD.	223
FILTER FABRIC	SO. YD.	185

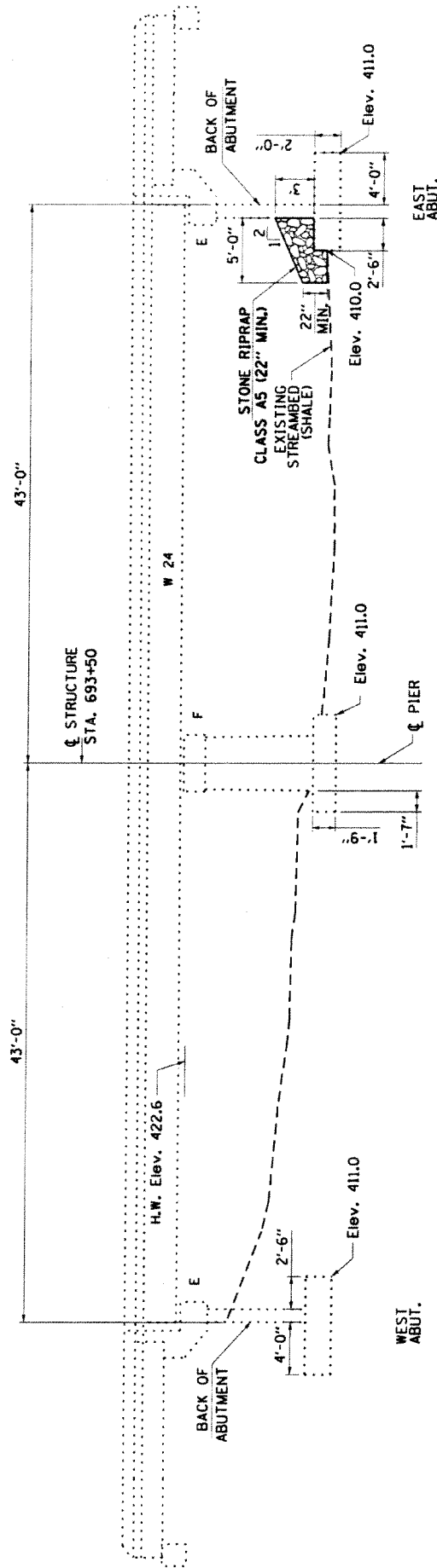

CHANNEL SECTION

LOOKING NORTH
 DIMENSIONS ALONG ϵ

076-0001

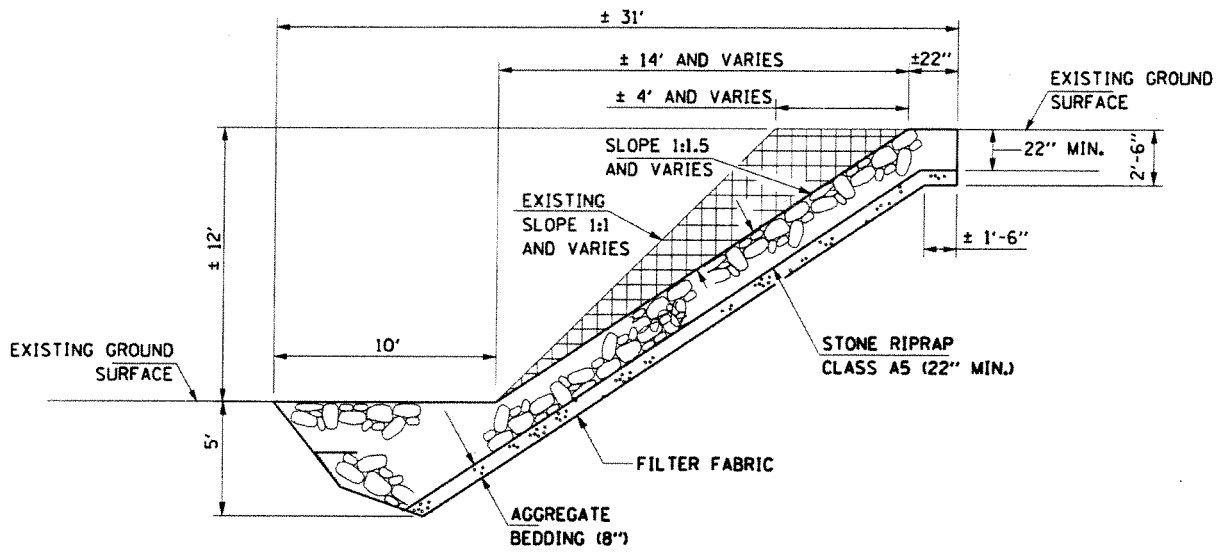

SECTION F-F



SEE TOE DETAIL (A) ON SHEET 19 OF 19.

076-0001

PARCEL NO.	NAME	PURPOSE	ACREAGE
9033512	R.E. & ALDIE P. FERRELL	TEMP. EASEMENT	±0.033
9033612	JOSEPH B. HARRISON	PERM. EASEMENT	±0.136

NW QTR, NE QTR
SECTION 9
T11S, R7E, 3RD PM

STA. 693+40.00
50' LT & 70' LT

TEMPORARY
EASEMENT

EXISTING
R.O.W.

PARCEL NO.
9033512

STA. 694+05.00
70' LT

STA. 694+18.00
50' LT

LIMITS OF
CONSTRUCTION

30'-0"

STA. 694+93.64
30' LT

50'-0"

30'-0"

40'-0"

70'-0"

STA. 694+85.00
30' RT & 70' RT

FACE OF
ABUT WALL

¢ E. ABUT. CAP
STA. 693+83.03

FLOW

30°

¢ PIER
STA. 693+40.00

¢ W. ABUT. CAP
STA. 692+97.17

STA. 693+27.09
30' RT

PARCEL NO.
9033612

PERMANENT
EASEMENT

STA. 693+42.90
70' RT

EXISTING
R.O.W.

SW QTR, NE QTR
SECTION 9
T11S, R7E, 3RD PM

076-0001

R.O.W. PLAN R-99-023-12

POPE COUNTY

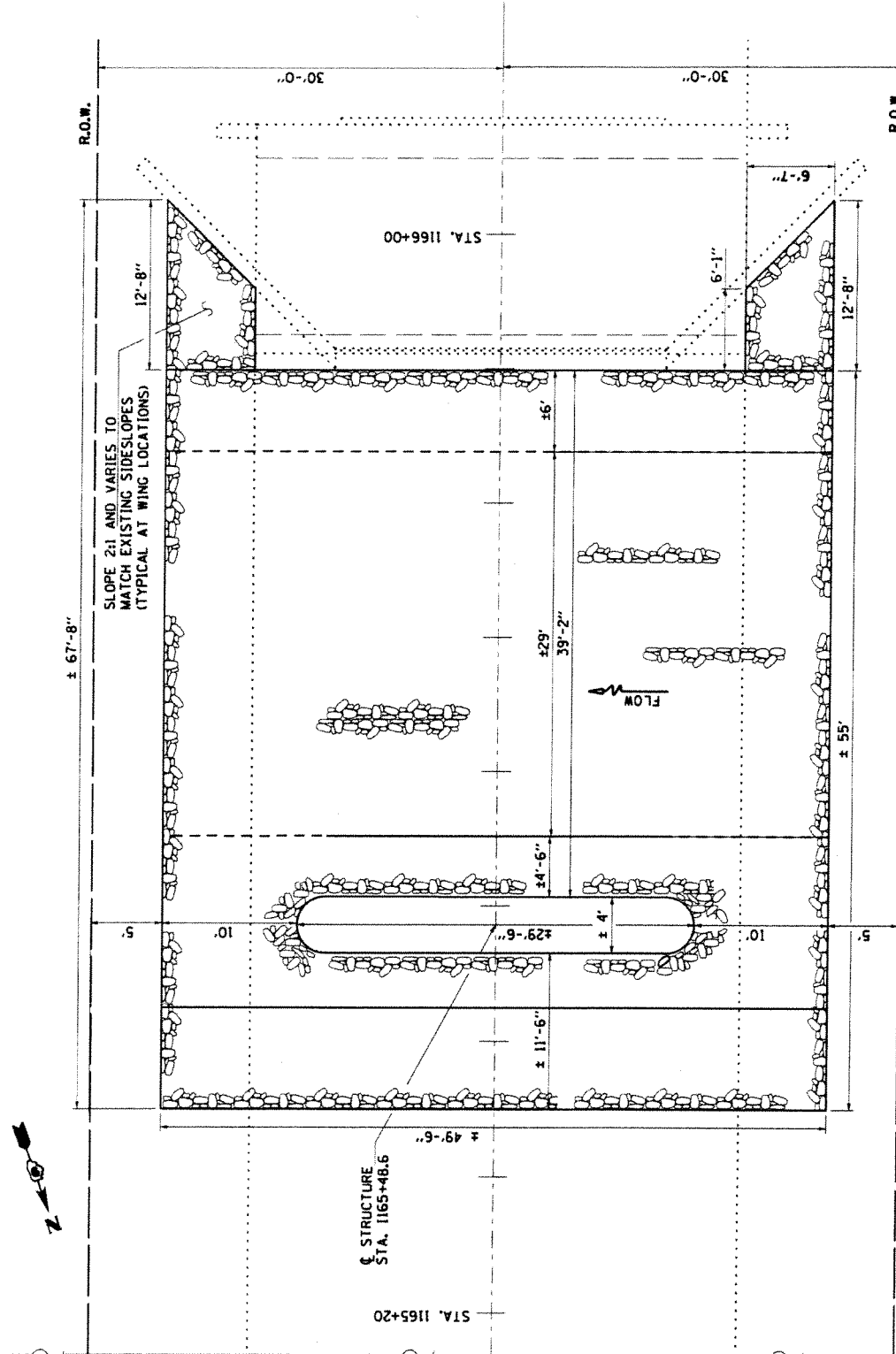

PARTIAL PLAN

BILL OF MATERIAL

ITEM	UNIT	QUANTITY
STONE RIPRAP, CLASS A5	SO. YD.	294
FILTER FABRIC	SO. YD.	294

STONE RIPRAP, CLASS A5 (22" MIN.)

097-0013

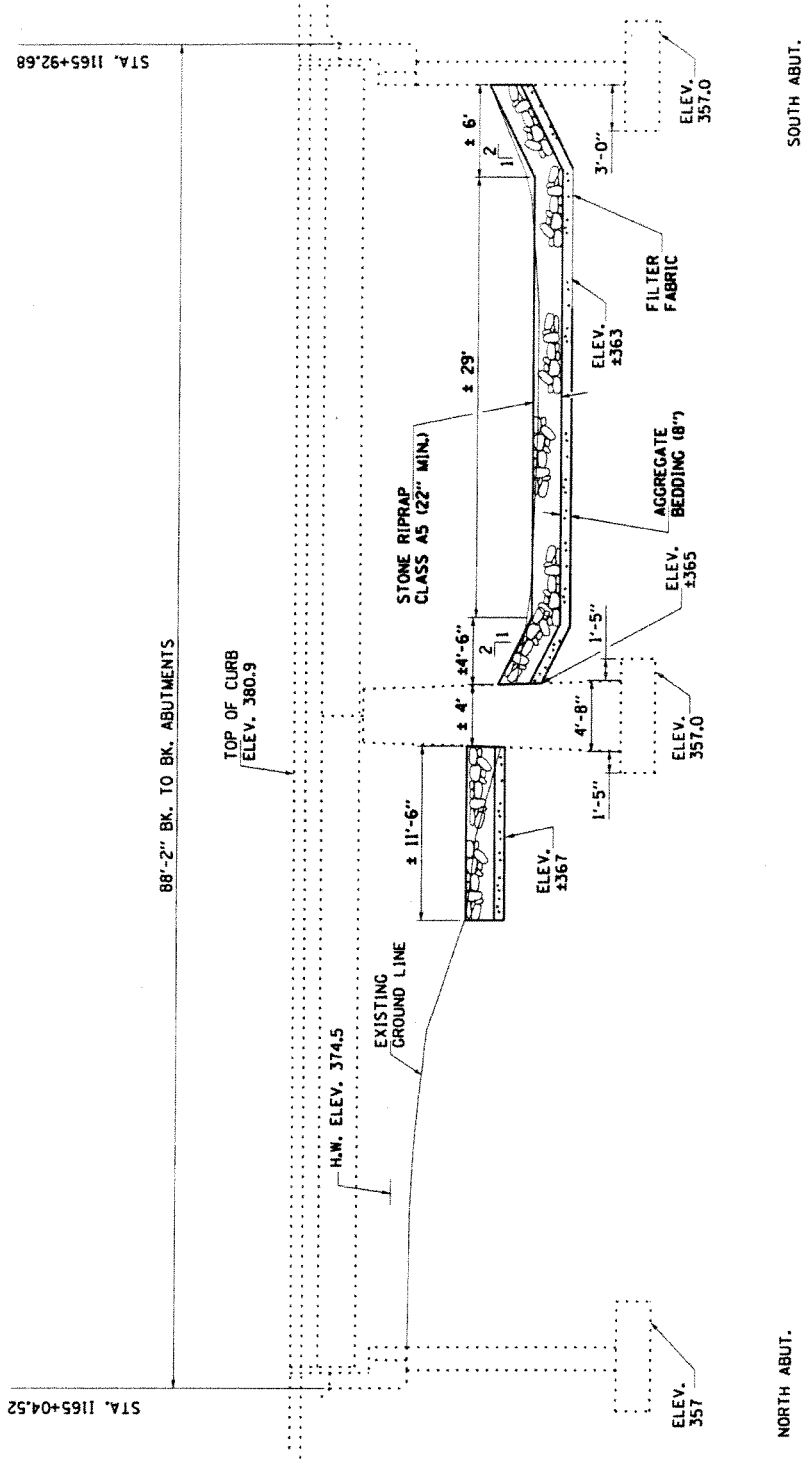

097-0013
CHANNEL SECTION

USE FLANK DETAIL ON UPSTREAM RIPRAP TERMINUS.
 SEE ON SHEET 19 OF 19.

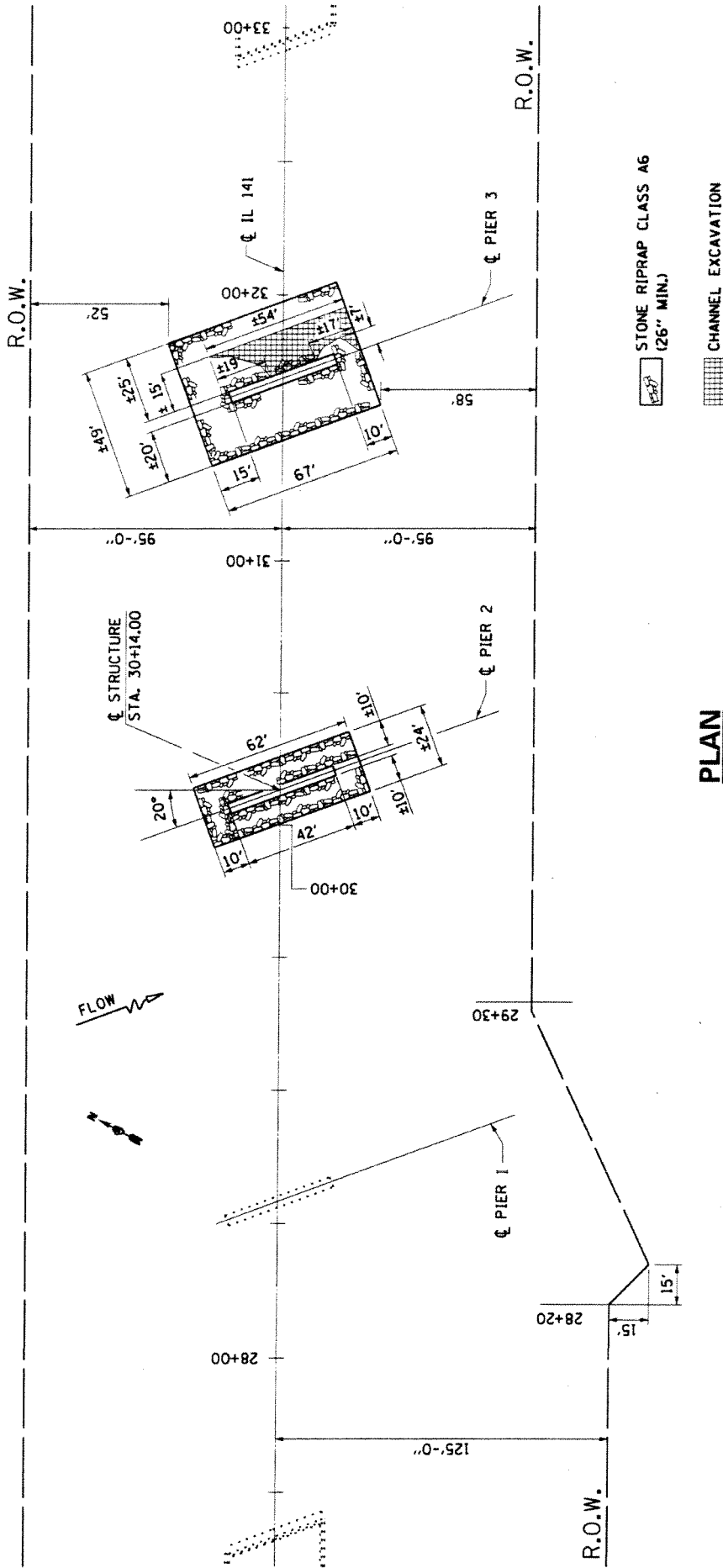

PLAN

BILL OF MATERIAL

ITEM	UNIT	QUANTITY
CHANNEL EXCAVATION	CU. YD.	23.8
STONE RIPRAP, CLASS A6	SO. YD.	391
FILTER FABRIC	SQ. YD.	200

097-0030

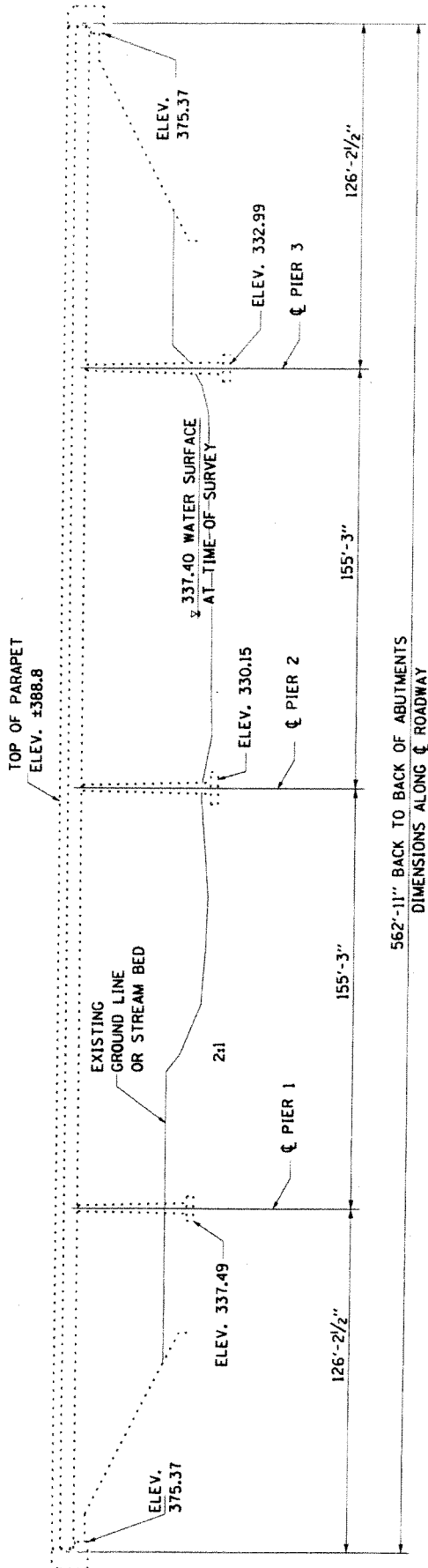

GENERAL CHANNEL SECTION

097-0030

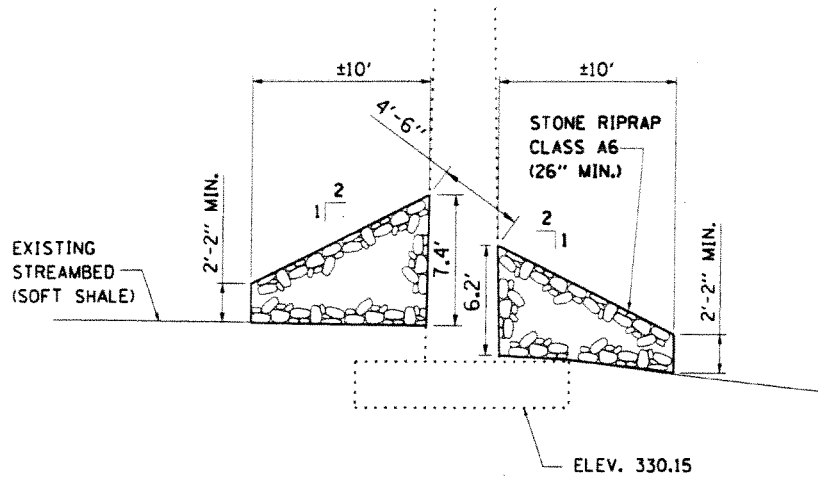

PIER 2
LOOKING NORTH
DIMENSIONS PARALLEL TO TRAFFIC

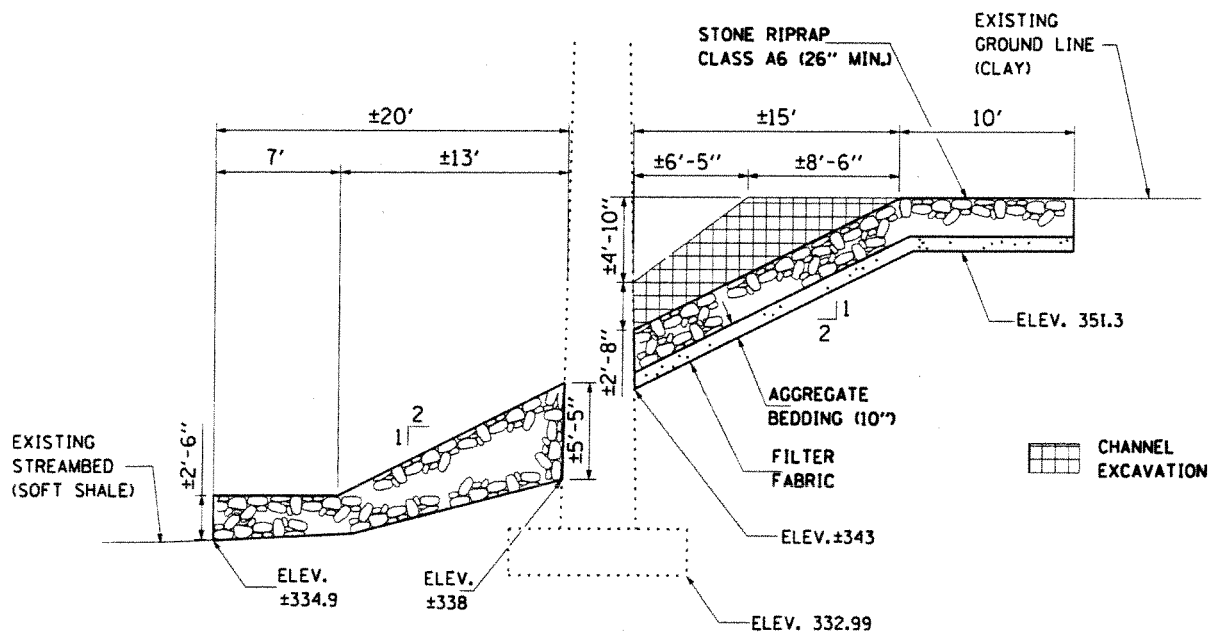

USE FLANK DETAIL ON UPSTREAM RIPRAP TERMINUS ON EAST SIDE OF PIER.
SEE DETAIL ON SHEET 19 OF 19.

PIER 3
LOOKING NORTH
DIMENSIONS PARALLEL TO TRAFFIC

097-0030

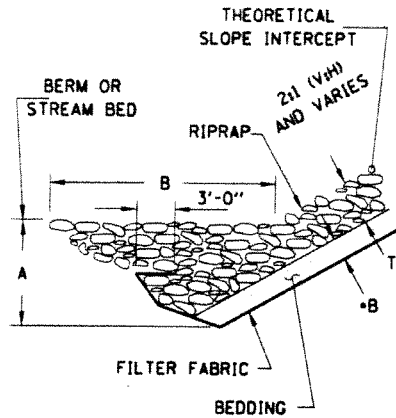

RIPRAP CLASS A	T	•B	A	B
RR4	16"	6"	4'	8'
RR5	22"	8"	5'	10'
RR6	26"	10"	6'	12'
RR7	30"	12"	7'	14'

TOE DETAIL (A)

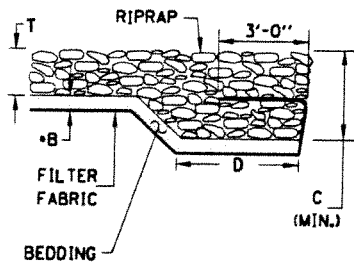

RIPRAP CLASS A	T	•B	C	D
RR4	16"	6"	2'-8"	4'-0"
RR5	22"	8"	3'-8"	5'-6"
RR6	26"	10"	4'-4"	6'-6"
RR7	30"	12"	5'-0"	7'-6"

FLANK OR TOE DETAIL (B)

STONE RIPRAP DETAILS

ILLINOIS DEPARTMENT OF LABOR

**PREVAILING WAGES FOR
>9 : : 9FGCBžDCD9 / 'K < #9 COUNT-9G
EFFECTIVE MAY 2013**

The Prevailing rates of wages are included in the Contract proposals which are subject to Check Sheet #5 of the Supplemental Specifications and Recurring Special Provisions. The rates have been ascertained and certified by the Illinois Department of Labor for the locality in which the work is to be performed and for each craft or type of work or mechanic needed to execute the work of the Contract. As required by Prevailing Wage Act (820 ILCS 130/0.01, et seq.) and Check Sheet #5 of the Contract, not less than the rates of wages ascertained by the Illinois Department of Labor and as revised during the performance of a Contract shall be paid to all laborers, workers and mechanics performing work under the Contract. Post the scale of wages in a prominent and easily accessible place at the site of work.

If the Illinois Department of Labor revises the prevailing rates of wages to be paid as listed in the specification of rates, the contractor shall post the revised rates of wages and shall pay not less than the revised rates of wages. Current wage rate information shall be obtained by visiting the Illinois Department of Labor web site at <http://www.state.il.us/agency/idol/> or by calling 312-793-2814. It is the responsibility of the contractor to review the rates applicable to the work of the contract at regular intervals in order to insure the timely payment of current rates. Provision of this information to the contractor by means of the Illinois Department of Labor web site satisfies the notification of revisions by the Department to the contractor pursuant to the Act, and the contractor agrees that no additional notice is required. The contractor shall notify each of its subcontractors of the revised rates of wages.

Jefferson County Prevailing Wage for May 2013

(See explanation of column headings at bottom of wages)

Trade Name	RG	TYP	C	Base	FRMAN	M-F>8	OSA	OSH	H/W	Pensn	Vac	Trng
=====	==	===	=	=====	=====	=====	===	===	=====	=====	=====	=====
ASBESTOS ABT-GEN		ALL		25.300	25.750	1.5	1.5	2.0	5.750	10.35	0.000	0.900
ASBESTOS ABT-MEC		BLD		29.860	30.860	1.5	1.5	2.0	6.950	3.000	0.000	0.000
BOILERMAKER		BLD		31.500	34.000	1.5	1.5	2.0	7.070	18.73	1.000	0.350
BRICK MASON		BLD		28.620	30.120	1.5	1.5	2.0	8.200	7.030	0.000	0.430
CARPENTER		BLD		31.890	33.390	1.5	1.5	2.0	6.550	6.750	0.000	0.400
CARPENTER		HWY		31.890	33.640	1.5	1.5	2.0	6.550	6.750	0.000	0.400
CEMENT MASON		BLD		28.200	29.700	1.5	1.5	2.0	6.600	5.400	0.000	0.500
CEMENT MASON		HWY		27.080	28.580	1.5	1.5	2.0	6.600	5.800	0.000	0.300
CERAMIC TILE FNSHER		BLD		27.120	0.000	1.5	1.5	2.0	8.200	7.030	0.000	0.430
ELECTRIC PWR EQMT OP		ALL	1	35.570	0.000	1.5	1.5	2.0	5.000	9.960	0.000	0.360
ELECTRIC PWR EQMT OP		ALL	2	31.740	0.000	1.5	1.5	2.0	5.000	8.880	0.000	0.320
ELECTRIC PWR GRNDMAN		ALL		26.100	0.000	1.5	1.5	2.0	5.000	7.310	0.000	0.260
ELECTRIC PWR LINEMAN		ALL		44.630	47.650	1.5	1.5	2.0	5.000	12.50	0.000	0.450
ELECTRICIAN		ALL		39.350	41.600	1.5	1.5	2.0	6.140	9.440	0.000	0.790
ELECTRONIC SYS TECH		BLD		32.570	34.320	1.5	1.5	2.0	6.000	4.240	0.000	0.400
FLOOR LAYER		BLD		29.330	30.080	1.5	1.5	2.0	6.550	6.750	0.000	0.400
GLAZIER		BLD		26.780	28.030	1.5	1.5	2.0	6.120	5.200	0.000	0.300
HT/FROST INSULATOR		BLD		37.260	38.260	1.5	1.5	2.0	7.850	11.16	0.000	0.500
IRON WORKER		ALL		31.500	33.500	1.5	1.5	2.0	7.610	13.33	0.000	0.420
LABORER		BLD		25.300	25.750	1.5	1.5	2.0	5.750	10.35	0.000	0.800
LABORER		HWY		25.300	25.750	1.5	1.5	2.0	5.750	10.35	0.000	0.800
MACHINIST		BLD		43.550	46.050	1.5	1.5	2.0	6.130	8.950	1.850	0.000
MARBLE FINISHERS		BLD		27.120	0.000	1.5	1.5	2.0	8.200	7.030	0.000	0.430
MARBLE MASON		BLD		28.620	30.120	1.5	1.5	2.0	8.200	7.030	0.000	0.430
MILLWRIGHT		BLD		31.890	33.390	1.5	1.5	2.0	6.550	6.750	0.000	0.400
MILLWRIGHT		HWY		32.390	34.140	1.5	1.5	2.0	6.550	6.750	0.000	0.400
OPERATING ENGINEER		BLD	1	34.200	37.200	1.5	1.5	2.0	9.000	17.00	0.000	1.000
OPERATING ENGINEER		BLD	2	33.070	37.200	1.5	1.5	2.0	9.000	17.00	0.000	1.000
OPERATING ENGINEER		BLD	3	28.590	37.200	1.5	1.5	2.0	9.000	17.00	0.000	1.000
OPERATING ENGINEER		BLD	4	28.650	37.200	1.5	1.5	2.0	9.000	17.00	0.000	1.000
OPERATING ENGINEER		BLD	5	28.320	37.200	1.5	1.5	2.0	9.000	17.00	0.000	1.000
OPERATING ENGINEER		BLD	6	35.750	37.200	1.5	1.5	2.0	9.000	17.00	0.000	1.000
OPERATING ENGINEER		BLD	7	36.050	37.200	1.5	1.5	2.0	9.000	17.00	0.000	1.000
OPERATING ENGINEER		BLD	8	36.330	37.200	1.5	1.5	2.0	9.000	17.00	0.000	1.000
OPERATING ENGINEER		BLD	9	35.650	37.200	1.5	1.5	2.0	9.000	17.00	0.000	1.000
OPERATING ENGINEER		HWY	1	32.700	35.700	1.5	1.5	2.0	9.000	17.00	0.000	1.000
OPERATING ENGINEER		HWY	2	31.570	35.700	1.5	1.5	2.0	9.000	17.00	0.000	1.000
OPERATING ENGINEER		HWY	3	27.090	35.700	1.5	1.5	2.0	9.000	17.00	0.000	1.000
OPERATING ENGINEER		HWY	4	27.150	35.700	1.5	1.5	2.0	9.000	17.00	0.000	1.000
OPERATING ENGINEER		HWY	5	26.820	35.700	1.5	1.5	2.0	9.000	17.00	0.000	1.000
OPERATING ENGINEER		HWY	6	34.250	35.700	1.5	1.5	2.0	9.000	17.00	0.000	1.000
OPERATING ENGINEER		HWY	7	34.550	35.700	1.5	1.5	2.0	9.000	17.00	0.000	1.000
OPERATING ENGINEER		HWY	8	34.830	35.700	1.5	1.5	2.0	9.000	17.00	0.000	1.000
OPERATING ENGINEER		HWY	9	34.150	35.700	1.5	1.5	2.0	9.000	17.00	0.000	1.000
PAINTER		ALL		23.190	23.690	1.5	1.5	2.0	5.000	6.840	0.000	0.480
PAINTER OVER 30FT		ALL		26.290	26.790	1.5	1.5	2.0	5.000	6.840	0.000	0.480
PAINTER PWR EQMT		ALL		26.290	26.790	1.5	1.5	2.0	5.000	6.840	0.000	0.480
PILEDRIVER		BLD		31.890	33.390	1.5	1.5	2.0	6.550	6.750	0.000	0.400
PILEDRIVER		HWY		32.390	34.140	1.5	1.5	2.0	6.550	6.750	0.000	0.400
PIPEFITTER		BLD		37.000	40.700	1.5	1.5	2.0	8.500	9.300	0.000	1.350
PLASTERER		BLD		28.200	29.700	1.5	1.5	2.0	6.600	5.400	0.000	0.500
PLUMBER		BLD		37.000	40.700	1.5	1.5	2.0	8.500	9.300	0.000	1.350
ROOFER		BLD		23.900	24.900	1.5	1.5	2.0	8.650	3.800	0.000	0.000
SHEETMETAL WORKER		ALL		31.690	33.190	1.5	1.5	2.0	7.130	6.730	1.910	0.360
SPRINKLER FITTER		BLD		36.390	39.140	1.5	1.5	2.0	8.420	8.500	0.000	0.450
STONE MASON		BLD		28.620	30.120	1.5	1.5	2.0	8.200	7.030	0.000	0.430
TERRAZZO FINISHER		BLD		27.120	0.000	1.5	1.5	2.0	8.200	7.030	0.000	0.430

TERRAZZO MASON	BLD	28.620	30.120	1.5	1.5	2.0	8.200	7.030	0.000	0.430
TRUCK DRIVER	ALL 1	31.340	0.000	1.5	1.5	2.0	10.30	5.010	0.000	0.250
TRUCK DRIVER	ALL 2	31.780	0.000	1.5	1.5	2.0	10.30	5.010	0.000	0.250
TRUCK DRIVER	ALL 3	32.020	0.000	1.5	1.5	2.0	10.30	5.010	0.000	0.250
TRUCK DRIVER	ALL 4	32.280	0.000	1.5	1.5	2.0	10.30	5.010	0.000	0.250
TRUCK DRIVER	ALL 5	33.130	0.000	1.5	1.5	2.0	10.30	5.010	0.000	0.250
TRUCK DRIVER	O&C 1	25.070	0.000	1.5	1.5	2.0	10.30	5.010	0.000	0.250
TRUCK DRIVER	O&C 2	25.420	0.000	1.5	1.5	2.0	10.30	5.010	0.000	0.250
TRUCK DRIVER	O&C 3	25.620	0.000	1.5	1.5	2.0	10.30	5.010	0.000	0.250
TRUCK DRIVER	O&C 4	25.820	0.000	1.5	1.5	2.0	10.30	5.010	0.000	0.250
TRUCK DRIVER	O&C 5	26.500	0.000	1.5	1.5	2.0	10.30	5.010	0.000	0.250
TUCKPOINTER	BLD	28.620	30.120	1.5	1.5	2.0	8.200	7.030	0.000	0.430

Legend:

RG (Region)

TYP (Trade Type - All,Highway,Building,Floating,Oil & Chip,Rivers)

C (Class)

Base (Base Wage Rate)

FRMAN (Foreman Rate)

M-F>8 (OT required for any hour greater than 8 worked each day, Mon through Fri.)

OSA (Overtime (OT) is required for every hour worked on Saturday)

OSH (Overtime is required for every hour worked on Sunday and Holidays)

H/W (Health & Welfare Insurance)

Pensn (Pension)

Vac (Vacation)

Trng (Training)

Explanations

JEFFERSON COUNTY

The following list is considered as those days for which holiday rates of wages for work performed apply: New Years Day, Memorial Day, Fourth of July, Labor Day, Thanksgiving Day, Christmas Day and Veterans Day in some classifications/counties. Generally, any of these holidays which fall on a Sunday is celebrated on the following Monday. This then makes work performed on that Monday payable at the appropriate overtime rate for holiday pay. Common practice in a given local may alter certain days of celebration. If in doubt, please check with IDOL.

Oil and chip resealing (O&C) means the application of road oils and liquid asphalt to coat an existing road surface, followed by application of aggregate chips or gravel to coated surface, and subsequent rolling of material to seal the surface.

EXPLANATION OF CLASSES

ASBESTOS - GENERAL - removal of asbestos material/mold and hazardous materials from any place in a building, including mechanical systems where those mechanical systems are to be removed. This includes the removal of asbestos materials/mold and hazardous materials from ductwork or pipes in a building when the building is to be demolished at the time or at some close future date.

ASBESTOS - MECHANICAL - removal of asbestos material from mechanical systems, such as pipes, ducts, and boilers, where the mechanical systems are to remain.

CERAMIC TILE FINISHER, MARBLE FINISHER, TERRAZZO FINISHER

Assisting, helping or supporting the tile, marble and terrazzo mechanic by performing their historic and traditional work assignments required to complete the proper installation of the work covered by said crafts. The term "Ceramic" is used for naming the classification only, and is in no a limitation of the product handled. Ceramic takes into consideration most hard tiles.

ELECTRIC POWER LINEMAN

Construction, maintenance and dismantling of overhead and underground electric power lines, including high voltage pipe type cable work, and associated structures and equipment.

ELECTRIC POWER EQUIPMENT OPERATOR - CLASS 1

Operation of all crawler type equipment D-4 and larger from the ground to assist the Electric Power Linemen in performing their duties.

ELECTRIC POWER EQUIPMENT OPERATORS - CLASS 2

Operation of all other equipment from the ground to assist the Electric Power Linemen in performing their duties.

ELECTRIC POWER GROUNDMAN

Applies to workers who assist the Electric Power Lineman from the ground.

ELECTRONIC SYSTEMS TECHNICIAN

Installation, service and maintenance of low-voltage systems which utilizes the transmission and/or transference of voice, sound, vision, or digital for commercial, education, security and entertainment purposes for the following: TV monitoring and surveillance, background/foreground music, intercom and telephone interconnect, field programming, inventory control systems, microwave transmission, multi-media, multiplex, radio page, school, intercom and sound burglar alarms and low voltage master clock systems.

Excluded from this classification are energy management systems, life safety systems, supervisory controls and data acquisition systems not intrinsic with the above listed systems, fire alarm systems, nurse call systems and raceways exceeding fifteen feet in length.

OPERATING ENGINEER - BUILDING

GROUP I. Cranes, Dragline, Shovels, Skimmer Scoops, Clamshells or Derrick Boats, Pile Drivers, Crane-Type Backhoes, Asphalt Plant Operators, Concrete Plant Operators, Dredges, Asphalt Spreading

Machines, All Locomotives, Cable Ways or Tower Machines, Hoists, Hydraulic Backhoes, Ditching Machines or Backfiller, Cherrypickers, Overhead Cranes, Roller - Steam or Gas, Concrete Pavers, Excavators, Concrete Breakers, Concrete Pumps, Bulk Cement Plants, Cement Pumps, Derrick-Type Drills, Boat Operators, Motor Graders or Pushcats, Scoops or Tournapulls, Bulldozers, Endloaders or Fork Lifts, Power Blade or Elevating Graders, Winch Cats, Boom or Winch Trucks or Boom Tractors, Pipe Wrapping or Painting Machines, Asphalt Plant Engineer, Journeyman Lubricating Engineer, Drills (other than Derrick Type), Mud Jacks, or Well Drilling Machines, Boring Machines or Track Jacks, Mixers, Conveyors (Two), Air Compressors (Two), Water Pumps regardless of size (Two), Welding Machines (Two), Siphons or Jets (Two), Winch Heads or Apparatuses (Two), Light Plants (Two), All Tractors regardless of size (straight tractor only), Fireman on Stationary Boilers, Automatic Elevators, Form Grading Machines, Finishing Machines, Power Sub-Grader or Ribbon Machines, Longitudinal Floats, Distributor Operators on Trucks, Winch Heads or Apparatuses (One), Mobil Track air and heaters (two to five), Heavy Equipment Greaser, Relief Operator, Assistant Master Mechanic and Heavy Duty Mechanic, self-propelled concrete saws of all types and sizes with their attachments, gob-hoppers, excavators all sizes, the repair and greasing of all diesel hammers, the operation and set-up of bidwells, water blasters of all sizes and their clutches, hydraulic jacks where used for hoisting, operation of log skidders, iceolators used on and off of pipeline, condor cranes, bow boats, survey boats, bobcats and all their attachments, skid steer loaders and all their attachments, creter cranes, batch plants, operator (all sizes), self propelled roto mills, operation of conveyor systems of any size and any configuration, operation, repair and service of all vibratory hammers, all power pacs and their controls regardless of location, curtains or brush burning machines, stump cutter machines, Nail launchers when mounted on a machine or self-propelled, operation of con-cover machines, and all Operators except those listed below).

GROUP II. Assistant Operators.

GROUP III. Air Compressors (One), Water Pumps, regardless of Size (One), Waterblasters (one), Welding Machine (One), Mixers (One Bag), Conveyor (One), Siphon or Jet (One), Light Plant (One), Heater (One), Immobile Track Air (One), and Self Propelled Walk-Behind Rollers.

GROUP IV. Asphalt Spreader Oilers, Fireman on Whirlies and Heavy Equipment Oilers, Truck Cranes, Dredges, Monigans, Large Cranes - (Over 65-ton rated capacity) Concrete Plant Oiler, Blacktop Plant Oiler, and Creter Crane Oiler (when required).

GROUP V. Oiler.

GROUP VI. Operators on equipment with Booms, including jibs, 100 feet and over, and less than 150 feet long.

GROUP VII. Operators on equipment with Booms, including jibs, 150 feet and over, and less than 200 feet long.

GROUP VIII. Operators on Equipment with Booms, including jibs, 200 feet and over; Tower Cranes; and Whirlie Cranes.

GROUP IX. Master Mechanic

OPERATING ENGINEERS - Highway

GROUP I. Cranes, Dragline, Shovels, Skimmer Scoops, Clamshells or Derrick Boats, Pile Drivers, Crane-Type Backhoes, Asphalt Plant

Operators, Concrete Plant Operators, Dredges, Asphalt Spreading Machines, All Locomotives, Cable Ways or Tower Machines, Hoists, Hydraulic Backhoes, Ditching Machines or Backfiller, Cherrypickers, Overhead Cranes, Roller - Steam or Gas, Concrete Pavers, Excavators, Concrete Breakers, Concrete Pumps, Bulk Cement Plants, Cement Pumps, Derrick-Type Drills, Boat Operators, Motor Graders or Pushcats, Scoops or Tournapulls, Bulldozers, Endloaders or Fork Lifts, Power Blade or Elevating Graders, Winch Cats, Boom or Winch Trucks or Boom Tractors, Pipe Wrapping or Painting Machines, Asphalt Plant Engineer, Journeyman Lubricating Engineer, Drills (other than Derrick Type), Mud Jacks, Well Drilling Machines, Boring Machines, Track Jacks, Mixers, Conveyors (Two), Air Compressors (Two), Water Pumps regardless of size (Two), Welding Machines (Two), Siphons or Jets (Two), Winch Heads or Apparatuses (Two), Light Plants (Two), All Tractors regardless of size (straight tractor only), Fireman on Stationary Boilers, Automatic Elevators, Form Grading Machines, Finishing Machines, Power Sub-Grader or Ribbon Machines, Longitudinal Floats, Distributor Operators on Trucks, Winch Heads or Apparatuses (One), Mobil Track air and heaters (two to five), Heavy Equipment Greaser, Relief Operator, Assistant Master Mechanic and Heavy Duty Mechanic, self-propelled concrete saws of all types and sizes with their attachments, gob-hoppers, excavators all sizes, the repair and greasing of all diesel hammers, the operation and set-up of bidwells, water blasters of all sizes and their clutches, hydraulic jacks where used for hoisting, operation of log skidders, iceolators used on and off of pipeline, condor cranes, bow boats, survey boats, bobcats and all their attachments, skid steer loaders and all their attachments, creter cranes, batch plants, operator (all sizes), self propelled roto mills, operation of conveyor systems of any size and any configuration, operation, repair and service of all vibratory hammers, all power pacs and their controls regardless of location, curtains or brush burning machines, stump cutter machines, Nail launchers when mounted on a machine or self-propelled, operation of con-cover machines, and all Operators (except those listed below).

GROUP II. Assistant Operators.

GROUP III. Air Compressors (One), Water Pumps, regardless of Size (One), Waterblasters (one), Welding Machine (One), Mixers (One Bag), Conveyor (One), Siphon or Jet (One), Light Plant (One), Heater (One), Immobile Track Air (One), and Self Propelled Walk-Behind Rollers.

GROUP IV. Asphalt Spreader Oilers, Fireman on Whirlies and Heavy Equipment Oilers, Truck Cranes, Dredges, Monigans, Large Cranes - (Over 65-ton rated capacity) Concrete Plant Oiler, Blacktop Plant Oiler, and Creter Crane Oiler (when required).

GROUP V. Oiler.

GROUP VI. Operators on equipment with Booms, including jibs, 100 feet and over, and less than 150 feet long.

GROUP VII. Operators on equipment with Booms, including jibs, 150 feet and over, and less than 200 feet long.

GROUP VIII. Operators on Equipment with Booms, including jibs, 200 feet and over; Tower Cranes; and Whirlie Cranes.

GROUP IX. Mechanic

TRUCK DRIVER - BUILDING, HEAVY AND HIGHWAY CONSTRUCTION

Class 1. Drivers on 2 axle trucks hauling less than 9 ton. Air compressor and welding machines and brooms, including those pulled by separate units, truck driver helpers, warehouse employees, mechanic helpers, greasers and tiremen, pickup trucks when hauling materials, tools, or workers to and from and on-the-job site, and fork lifts up to 6,000 lb. capacity.

Class 2. Two or three axle trucks hauling more than 9 ton but hauling less than 16 ton. A-frame winch trucks, hydrolift trucks, vactor trucks or similar equipment when used for transportation purposes. Fork lifts over 6,000 lb. capacity, winch trucks, four axle combination units, and ticket writers.

Class 3. Two, three or four axle trucks hauling 16 ton or more. Drivers on water pulls, articulated dump trucks, mechanics and working forepersons, and dispatchers. Five axle or more combination units.

Class 4. Low Boy and Oil Distributors.

Class 5. Drivers who require special protective clothing while employed on hazardous waste work.

TRUCK DRIVER - OIL AND CHIP RESEALING ONLY.

This shall encompass laborers, workers and mechanics who drive contractor or subcontractor owned, leased, or hired pickup, dump, service, or oil distributor trucks. The work includes transporting materials and equipment (including but not limited to, oils, aggregate supplies, parts, machinery and tools) to or from the job site; distributing oil or liquid asphalt and aggregate; stock piling material when in connection with the actual oil and chip contract. The Truck Driver (Oil & Chip Resealing) wage classification does not include supplier delivered materials.

Other Classifications of Work:

For definitions of classifications not otherwise set out, the Department generally has on file such definitions which are available. If a task to be performed is not subject to one of the classification of pay set out, the Department will upon being contacted state which neighboring county has such a classification and provide such rate, such rate being deemed to exist by reference in this document. If no neighboring county rate applies to the task, the Department shall undertake a special determination, such special determination being then deemed to have existed under this determination. If a project requires these, or any classification not listed, please contact IDOL at 217-782-1710 for wage rates or clarifications.

LANDSCAPING

Landscaping work falls under the existing classifications for laborer, operating engineer and truck driver. The work performed by landscape plantsman and landscape laborer is covered by the existing classification of laborer. The work performed by landscape operators (regardless of equipment used or its size) is covered by the classifications of operating engineer. The work performed by landscape truck drivers (regardless of size of truck driven) is covered by the classifications of truck driver.

Pope County Prevailing Wage for May 2013

(See explanation of column headings at bottom of wages)

Trade Name	RG	TYP	C	Base	FRMAN	M-F>8	OSA	OSH	H/W	Pensn	Vac	Trng
=====	==	===	=	=====	=====	=====	===	===	=====	=====	=====	=====
ASBESTOS ABT-GEN		ALL		25.300	25.750	1.5	1.5	2.0	5.750	10.35	0.000	0.900
ASBESTOS ABT-MEC		BLD		21.150	22.150	1.5	1.5	2.0	6.400	5.150	0.000	0.650
BOILERMAKER		BLD		31.500	34.000	1.5	1.5	2.0	7.070	18.73	1.000	0.350
BRICK MASON		BLD		28.620	30.120	1.5	1.5	2.0	8.200	7.030	0.000	0.430
CARPENTER		BLD		31.890	33.390	1.5	1.5	2.0	6.550	6.750	0.000	0.400
CARPENTER		HWY		31.840	33.340	1.5	1.5	2.0	6.550	6.750	0.000	0.400
CEMENT MASON		BLD		28.200	29.700	1.5	1.5	2.0	6.600	5.400	0.000	0.500
CEMENT MASON		HWY		27.290	28.290	1.5	1.5	2.0	6.600	5.160	0.000	0.400
CERAMIC TILE FNSHER		BLD		27.120	0.000	1.5	1.5	2.0	8.200	7.030	0.000	0.430
ELECTRIC PWR EQMT OP		ALL	1	35.570	0.000	1.5	1.5	2.0	5.000	9.960	0.000	0.360
ELECTRIC PWR EQMT OP		ALL	2	31.740	0.000	1.5	1.5	2.0	5.000	8.880	0.000	0.320
ELECTRIC PWR GRNDMAN		ALL		26.100	0.000	1.5	1.5	2.0	5.000	7.310	0.000	0.260
ELECTRIC PWR LINEMAN		ALL		44.630	47.650	1.5	1.5	2.0	5.000	12.50	0.000	0.450
ELECTRICIAN		ALL		39.350	41.600	1.5	1.5	2.0	6.140	9.440	0.000	0.790
ELECTRONIC SYS TECH		BLD		32.570	34.320	1.5	1.5	2.0	6.000	4.240	0.000	0.400
FLOOR LAYER		BLD		29.330	30.080	1.5	1.5	2.0	6.550	6.750	0.000	0.400
GLAZIER		BLD		26.780	28.030	1.5	1.5	2.0	6.120	5.200	0.000	0.300
HT/FROST INSULATOR		BLD		29.450	30.450	1.5	1.5	2.0	5.050	9.730	0.000	0.280
IRON WORKER		ALL		27.730	29.730	1.5	1.5	2.0	7.010	11.41	0.000	0.500
LABORER		BLD		25.300	25.750	1.5	1.5	2.0	5.750	10.35	0.000	0.800
LABORER		HWY		25.300	25.750	1.5	1.5	2.0	5.750	10.35	0.000	0.800
LABORER		O&C		17.740	18.190	1.5	1.5	2.0	5.450	8.450	0.000	0.800
MACHINIST		BLD		43.550	46.050	1.5	1.5	2.0	6.130	8.950	1.850	0.000
MARBLE FINISHERS		BLD		27.120	0.000	1.5	1.5	2.0	8.200	7.030	0.000	0.430
MARBLE MASON		BLD		28.620	30.120	1.5	1.5	2.0	8.200	7.030	0.000	0.430
MILLWRIGHT		BLD		31.890	33.390	1.5	1.5	2.0	6.550	6.750	0.000	0.400
MILLWRIGHT		HWY		31.840	33.340	1.5	1.5	2.0	6.550	6.750	0.000	0.400
OE RIVER 1		RIV	1	33.550	34.550	1.5	1.5	2.0	7.000	8.800	0.000	1.450
OE RIVER 2		RIV	2	30.100	34.550	1.5	1.5	2.0	7.000	8.800	0.000	1.450
OPERATING ENGINEER		ALL	1	33.450	34.450	1.5	1.5	2.0	7.000	8.800	0.000	1.450
OPERATING ENGINEER		ALL	2	31.550	34.450	1.5	1.5	2.0	7.000	8.800	0.000	1.450
OPERATING ENGINEER		ALL	3	24.150	34.450	1.5	1.5	2.0	7.000	8.800	0.000	1.450
OPERATING ENGINEER		ALL	4	21.400	27.800	1.5	1.5	2.0	5.650	6.100	0.000	1.100
OPERATING ENGINEER		O&C	1	25.090	26.090	1.5	1.5	2.0	7.000	8.800	0.000	1.450
OPERATING ENGINEER		O&C	2	23.660	26.090	1.5	1.5	2.0	7.000	8.800	0.000	1.450
OPERATING ENGINEER		O&C	3	18.120	26.090	1.5	1.5	2.0	7.000	8.800	0.000	1.450
OPERATING ENGINEER		O&C	4	16.050	21.100	1.5	1.5	2.0	5.650	6.100	0.000	1.100
PAINTER		BLD		26.260	27.760	1.5	1.5	2.0	6.630	7.070	0.000	0.500
PAINTER		HWY		30.560	32.060	1.5	1.5	2.0	6.630	7.070	0.000	0.500
PAINTER OVER 30FT		BLD		27.260	28.760	1.5	1.5	2.0	6.630	7.070	0.000	0.500
PAINTER PWR EQMT		BLD		27.260	28.760	1.5	1.5	2.0	6.630	7.070	0.000	0.500
PAINTER PWR EQMT		HWY		31.560	33.060	1.5	1.5	2.0	6.630	7.070	0.000	0.500
PILEDRIVER		BLD		31.890	33.390	1.5	1.5	2.0	6.550	6.750	0.000	0.400
PILEDRIVER		HWY		31.840	33.340	1.5	1.5	2.0	6.550	6.750	0.000	0.400
PIPEFITTER		BLD		41.470	45.620	1.5	2.0	2.0	8.450	5.780	0.000	1.250
PLASTERER		BLD		28.200	29.700	1.5	1.5	2.0	6.600	5.400	0.000	0.500
PLUMBER		BLD		41.470	45.620	1.5	2.0	2.0	8.450	5.780	0.000	1.250
ROOFER		BLD		23.900	24.900	1.5	1.5	2.0	8.650	3.800	0.000	0.000
SHEETMETAL WORKER		ALL		31.690	33.190	1.5	1.5	2.0	7.130	6.730	1.910	0.360
SPRINKLER FITTER		BLD		36.390	39.140	1.5	1.5	2.0	8.420	8.500	0.000	0.450
STONE MASON		BLD		28.620	30.120	1.5	1.5	2.0	8.200	7.030	0.000	0.430
TERRAZZO FINISHER		BLD		27.120	0.000	1.5	1.5	2.0	8.200	7.030	0.000	0.430
TRUCK DRIVER		ALL	1	30.070	0.000	1.5	1.5	2.0	10.30	6.100	0.000	0.250
TRUCK DRIVER		ALL	2	30.520	0.000	1.5	1.5	2.0	10.30	6.100	0.000	0.250
TRUCK DRIVER		ALL	3	30.740	0.000	1.5	1.5	2.0	10.30	6.100	0.000	0.250
TRUCK DRIVER		ALL	4	31.030	0.000	1.5	1.5	2.0	10.30	6.100	0.000	0.250
TRUCK DRIVER		ALL	5	31.850	0.000	1.5	1.5	2.0	10.30	6.100	0.000	0.250

TRUCK DRIVER	O&C 1	22.750	0.000	1.5	1.5	2.0	2.920	6.700	0.000	0.250
TRUCK DRIVER	O&C 2	19.150	0.000	1.5	1.5	2.0	2.920	6.700	0.000	0.250
TRUCK DRIVER	O&C 3	19.650	0.000	1.5	1.5	2.0	2.920	6.700	0.000	0.250
TUCKPINTER	BLD	28.620	30.120	1.5	1.5	2.0	8.200	7.030	0.000	0.430

Legend :

RG (Region)

TYP (Trade Type - All,Highway,Building,Floating,Oil & Chip,Rivers)

C (Class)

Base (Base Wage Rate)

FRMAN (Foreman Rate)

M-F>8 (OT required for any hour greater than 8 worked each day, Mon through Fri.

OSA (Overtime (OT) is required for every hour worked on Saturday)

OSH (Overtime is required for every hour worked on Sunday and Holidays)

H/W (Health & Welfare Insurance)

Pensn (Pension)

Vac (Vacation)

Trng (Training)

Explanations

POPE COUNTY

The following list is considered as those days for which holiday rates of wages for work performed apply: New Years Day, Memorial Day, Fourth of July, Labor Day, Thanksgiving Day, Christmas Day and Veterans Day in some classifications/counties. Generally, any of these holidays which fall on a Sunday is celebrated on the following Monday. This then makes work performed on that Monday payable at the appropriate overtime rate for holiday pay. Common practice in a given local may alter certain days of celebration. If in doubt, please check with IDOL.

Oil and chip resealing (O&C) means the application of road oils and liquid asphalt to coat an existing road surface, followed by application of aggregate chips or gravel to coated surface, and subsequent rolling of material to seal the surface.

EXPLANATION OF CLASSES

ASBESTOS - GENERAL - removal of asbestos material/mold and hazardous materials from any place in a building, including mechanical systems where those mechanical systems are to be removed. This includes the removal of asbestos materials/mold and hazardous materials from ductwork or pipes in a building when the building is to be demolished at the time or at some close future date.

ASBESTOS - MECHANICAL - removal of asbestos material from mechanical systems, such as pipes, ducts, and boilers, where the mechanical systems are to remain.

LABORER - OIL AND CHIP RESEALING ONLY

Hook and unhook chip box from aggregate truck; distribute material within chip box; perform flagging work related to oil and chip resealing; hand spray oil fluids; handle traffic control, including setting-up and maintaining barricades, drums, cones, delineators, signs and other such items, as well as laying-out and applying or removing temporary roadway markings used to control traffic in job site related to oil and chip resealing; and perform clean-up related to oil and chip resealing.

CERAMIC TILE FINISHER, MARBLE FINISHER, TERRAZZO FINISHER

Assisting, helping or supporting the tile, marble and terrazzo mechanic by performing their historic and traditional work assignments required to complete the proper installation of the work covered by said crafts. The term "Ceramic" is used for naming the classification only, and is in no a limitation of the product handled. Ceramic takes into consideration most hard tiles.

ELECTRIC POWER LINEMAN

Construction, maintenance and dismantling of overhead and underground electric power lines, including high voltage pipe type cable work, and associated structures and equipment.

ELECTRIC POWER EQUIPMENT OPERATOR - CLASS 1

Operation of all crawler type equipment D-4 and larger from the ground to assist the Electric Power Linemen in performing their duties.

ELECTRIC POWER EQUIPMENT OPERATORS - CLASS 2

Operation of all other equipment from the ground to assist the Electric Power Linemen in performing their duties.

ELECTRIC POWER GROUNDMAN

Applies to workers who assist the Electric Power Lineman from the ground.

ELECTRONIC SYSTEMS TECHNICIAN

Installation, service and maintenance of low-voltage systems which utilizes the transmission and/or transference of voice, sound, vision, or digital for commercial, education, security and entertainment purposes for the following: TV monitoring and surveillance, background/foreground music, intercom and telephone interconnect, field programming, inventory control systems, microwave transmission, multi-media, multiplex, radio page, school, intercom and sound burglar alarms and low voltage master clock systems.

Excluded from this classification are energy management systems, life safety systems, supervisory controls and data acquisition systems not intrinsic with the above listed systems, fire alarm systems, nurse call systems and raceways exceeding fifteen feet in length.

TRUCK DRIVER - BUILDING, HEAVY AND HIGHWAY CONSTRUCTION

Class 1. Drivers on 2 axle trucks hauling less than 9 ton. Air compressor and welding machines and brooms, including those pulled by separate units, truck driver helpers, warehouse employees, mechanic helpers, greasers and tiremen, pickup trucks when hauling materials, tools, or workers to and from and on-the-job site, and fork lifts up to 6,000 lb. capacity.

Class 2. Two or three axle trucks hauling more than 9 ton but hauling less than 16 ton. A-frame winch trucks, hydrolift trucks, vactor trucks or similar equipment when used for transportation purposes. Fork lifts over 6,000 lb. capacity, winch trucks, four axle combination units, and ticket writers.

Class 3. Two, three or four axle trucks hauling 16 ton or more. Drivers on water pulls, articulated dump trucks, mechanics and working forepersons, and dispatchers. Five axle or more combination units.

Class 4. Low Boy and Oil Distributors.

Class 5. Drivers who require special protective clothing while employed on hazardous waste work.

TRUCK DRIVER - O & C (Oil and Chip Resealing ONLY)

It involves driving of contractor or subcontractor owned, leased, or hired pickup, dump, service, or oil distributor trucks. Includes transporting materials and equipment (including, but not limited to oils, aggregate supplies, parts, machinery and tools) to or from the job site; distributing oil or liquid asphalt and aggregate; stock piling material; and maintaining trucks at job site related to oil and chip resealing.

Class 1. Distributors, liquid asphalt hauling and hauling of asphalt rubber-tired rollers.

Class 2. Stockpiling.

Class 3. Tandem hauling to job site.

OPERATING ENGINEERS - BUILDING, HEAVY AND HIGHWAY CONSTRUCTION

Class 1. APSCO or Equal Spreading Machine, Backhoe, Backfiller, Boom or Winch Cat, Bituminous Mixplane Machine, Blacksmith, Bituminous Surfacing Machine, Bull-Dozer, Crane, Shovel, Dragline, Truck Crane, Pile Driver, Concrete Breaker, Concrete or Pumpcrete Pumps, Dinky or Standard Locomotives, Well or Caisson Drills, Elevating Grader, Fork Lifts, Flexplane, Gradeall, Hi-Lift Hoists, Guy-Derricks, Hysters, Mechanic Motor Patrol, Mixers-21 cu. ft. or over, Push Cats, Pulls and Scrapers, Two Well Point Pumps, Pulverizer or Tiller, PugMill, Rubber-Tired Farm Type Tractor with Bulldozer/Blade/Auger or hi-lift over 1/2 yd., Jersey Spreader, Tract-Air used with Drill or Hi-Lift, Trenching or Ditching Machines, Wood Chipper w/Tractor, Self-Propelled Roller w/Blade, Equipment Greaser, Self-Propelled Bump Grinder on Concrete pavement, Boat Operator, Skid-Loaders, Tuggers, Lazer Screed, and Self-Propelled Chip Spreader (when others run conveyors).

Class 2. Any type tractor pulling any type roller or disc, Two Air Compressors (220 cu. ft. capacity or over), Two AirTract Drills, Air-Track Drill w/Compressor, Automatic Bins or Scales w/Compressor or Generator, Pipeline Boring Machine, Bulk Cement Plant w/Separate Compressor, Power Operated Bull Float, Hydra-Lift w/Single Motor, Straw Mulcher Blower w/Spout, Self-Propelled Roller/Compactor, Back-End man on Bituminous Surfacing Machine, oiler on milling

machine.

Class 3. Air Compressor w/Valve driving piling, Boom or Winch Type Truck, Two Conveyors, Self-Propelled Concrete Saw, Form Grader, Truck Crane Oiler, Self-Propelled Vibrator, Rubber Tired Farm Type Tractor w/Blade/Bulldozer/Auger/hi-lift - 1/2 yd. or less, Elevator Operator, Man Lift (scissor lift) when lifting materials.

Class 4. Air-Track Drill (one), Belt Drag Machine, Power Broom, Mechanical Plasterer Applicator, Trac-Air, Air Compressor (220 cu. ft. or over) One, Air Compressor (under 220 cu. ft) four, Automatic Bin, Bulk Cement Plant w/Built-in Compressor running off same motor or electric motor, Fireman or Switchman, Self-Propelled Form Tamper, Light Plants (4), Welding Machines (4), Pumps (4), or Combination of four (4) Pumps, Light Plants, Welding Machines, Air-Compressors (under 220 cu. ft.), Mudjacks or Wood Chipper, Mixers - less than 21 cu. ft. Mortar Mixer w/Skip or Pump, Pipeline Tract Jack. One Operating Engineer may operate and maintain any combination of the following pieces of equipment, not to exceed four (4) which shall be within a reasonable distance, such combination may include any equipment in this classification: (Compressors, Light Plants, Generators, Welding Machines, Pumps or Conveyors), One Well- Point Pump, Two Motor Driven Heaters, One Air Compressor (under 220 cu. ft.), One Engine-Driven Conveyor, One Motor Driven Heater, One Light Plant, One Pump, One Welding Machine, One Ulmac or Equal Spreader, Oilers, and one Generator 10 kw or greater.

OPERATING ENGINEER - O & C (Oil and Chip Resealing ONLY). Includes the operation of all motorized heavy equipment used in oil and chip resealing, including but not limited to operating self-propelled chip spreaders, and all types of rollers (both hard and rubber tired); and other duties pertaining to the operation or maintenance of heavy equipment related to oil and chip resealing.

Class 1. See Class 1 above for types of equipment operated.

Class 2. See Class 2 above for types of equipment operated.

Class 3. See Class 3 above for types of equipment operated.

Class 4. See Class 4 above for types of equipment operated.

OPERATING ENGINEER RIVER WORK 1 - operate the following machines when working on River Work and Levee Work on the Mississippi and Ohio Rivers, Lakes and Tributaries: Crane, Shovel, Drageline, Scrapers, Dredge, Derrick, Pile-Driver, Push Boat, all power boat operators, Mechanic, Engineman on Dredge, Leverman on Dredge, All Bituminous Spreader machines, Backhoe, Backfiller, Boom, or Winch Cat, Bituminous Mixplane Machine, Blacksmith, Bituminous Surfacing Machine, Bulldozer, Truck Cranes, Hydraulic Truck Mounted Boom/Crane, Concrete Finishing Machine, or Spreader Machine, Concrete Breaker, Concrete or Pumpcrete Machines, Concrete Plant Operator, All Off Road Material Hauling Equipment, Dinky or Standard Locomotives, Well Drill, Elevating Grader, Fork-Lifts, Flexplane, Gradeall, Hi-Lift, Power Handblade Tugger type Hoist, Hoist Two Drum (or over one), Gyderrick, Hyster, Motor Patrol, Mixers - 21 Cu. Ft. or over, Push Cat, Pulls, & Scrapers, Pumps-Two Well Points, Equipment Greaser, P & H Pulverizer or Pulverizer equal to Pugmill, Pugmill, Rubber-Tired farm type tractor w/Bulldozer/Blade/Auger or Hi-Lift over 1/2 yard, Skimmer Scoops, Seaman Tiller, Jersey Spreader, Tract-Air used with Drill or Hi-Lift, Trenching or Ditching Machine, Wood Chipper w/Tractor, self-propelled roller w/Blade, Concrete Pumps and Small Equipment Operators.

OPERATING ENGINEER RIVER 2 - when working on River Work and Levee Work on the Mississippi and Ohio Rivers, Lakes and Tributaries shall be employed as the Oiler or Fireman on Crane, Dragline, Shovel, Dredge, Truck Crane, Pile Driver, Gradeall, Dinky or Standard Locomotive, Guy Derrick, Trenching Machine or Ditching Machine 80 H.P. and over, All Terrain (cherry-picker) with over 40 ton Lifting Capacity, Deck Oiler and Deckhands.

Other Classifications of Work:

For definitions of classifications not otherwise set out, the Department generally has on file such definitions which are available. If a task to be performed is not subject to one of the classifications of pay set out, the Department will upon being contacted state which neighboring county has such a classification and provide such rate, such rate being deemed to exist by reference in this document. If no neighboring county rate applies to the task, the Department shall undertake a special determination, such special determination being then deemed to have existed under this determination. If a project requires these, or any classification not listed, please contact IDOL at 217-782-1710 for wage rates or clarifications.

LANDSCAPING

Landscaping work falls under the existing classifications for laborer, operating engineer and truck driver. The work performed by landscape plantsman and landscape laborer is covered by the existing classification of laborer. The work performed by landscape operators (regardless of equipment used or its size) is covered by the classifications of operating engineer. The work performed by landscape truck drivers (regardless of size of truck driven) is covered by the classifications of truck driver.

White County Prevailing Wage for May 2013

(See explanation of column headings at bottom of wages)

Trade Name	RG	TYP	C	Base	FRMAN	M-F>8	OSA	OSH	H/W	Pensn	Vac	Trng
=====	==	===	=	=====	=====	=====	===	===	=====	=====	=====	=====
ASBESTOS ABT-GEN		ALL		25.300	25.750	1.5	1.5	2.0	5.750	10.35	0.000	0.900
ASBESTOS ABT-MEC		BLD		21.150	22.150	1.5	1.5	2.0	6.400	5.150	0.000	0.650
BOILERMAKER		BLD		31.500	34.000	1.5	1.5	2.0	7.070	18.73	1.000	0.350
BRICK MASON		BLD		28.620	30.120	1.5	1.5	2.0	8.200	7.030	0.000	0.430
CARPENTER		BLD		31.890	33.390	1.5	1.5	2.0	6.550	6.750	0.000	0.400
CARPENTER		HWY		31.890	33.640	1.5	1.5	2.0	6.550	6.750	0.000	0.400
CEMENT MASON		BLD		28.200	29.700	1.5	1.5	2.0	6.600	5.400	0.000	0.500
CEMENT MASON		HWY		27.080	28.580	1.5	1.5	2.0	6.600	5.800	0.000	0.300
CERAMIC TILE FNSHER		BLD		27.120	0.000	1.5	1.5	2.0	8.200	7.030	0.000	0.430
ELECTRIC PWR EQMT OP		ALL	1	35.570	0.000	1.5	1.5	2.0	5.000	9.960	0.000	0.360
ELECTRIC PWR EQMT OP		ALL	2	31.740	0.000	1.5	1.5	2.0	5.000	8.880	0.000	0.320
ELECTRIC PWR GRNDMAN		ALL		26.100	0.000	1.5	1.5	2.0	5.000	7.310	0.000	0.260
ELECTRIC PWR LINEMAN		ALL		44.630	47.650	1.5	1.5	2.0	5.000	12.50	0.000	0.450
ELECTRICIAN		ALL		39.350	41.600	1.5	1.5	2.0	6.140	9.440	0.000	0.790
ELECTRONIC SYS TECH		BLD		32.570	34.320	1.5	1.5	2.0	6.000	4.240	0.000	0.400
FLOOR LAYER		BLD		29.330	30.080	1.5	1.5	2.0	6.550	6.750	0.000	0.400
GLAZIER		BLD		26.780	28.030	1.5	1.5	2.0	6.120	5.200	0.000	0.300
HT/FROST INSULATOR		BLD		29.450	30.450	1.5	1.5	2.0	5.050	9.730	0.000	0.280
IRON WORKER		ALL		27.020	28.270	1.5	1.5	2.0	7.010	9.200	0.000	0.345
LABORER		BLD		25.300	25.750	1.5	1.5	2.0	5.750	10.35	0.000	0.800
LABORER		HWY		25.300	25.750	1.5	1.5	2.0	5.750	10.35	0.000	0.800
MACHINIST		BLD		43.550	46.050	1.5	1.5	2.0	6.130	8.950	1.850	0.000
MARBLE FINISHERS		BLD		27.120	0.000	1.5	1.5	2.0	8.200	7.030	0.000	0.430
MARBLE MASON		BLD		28.620	30.120	1.5	1.5	2.0	8.200	7.030	0.000	0.430
MILLWRIGHT		BLD		31.890	33.390	1.5	1.5	2.0	6.550	6.750	0.000	0.400
MILLWRIGHT		HWY		32.390	34.140	1.5	1.5	2.0	6.550	6.750	0.000	0.400
OE RIVER 1		RIV	1	33.550	34.550	1.5	1.5	2.0	7.000	8.800	0.000	1.450
OE RIVER 2		RIV	2	30.100	34.550	1.5	1.5	2.0	7.000	8.800	0.000	1.450
OPERATING ENGINEER		ALL	1	33.450	34.450	1.5	1.5	2.0	7.000	8.800	0.000	1.450
OPERATING ENGINEER		ALL	2	31.550	34.450	1.5	1.5	2.0	7.000	8.800	0.000	1.450
OPERATING ENGINEER		ALL	3	24.150	34.450	1.5	1.5	2.0	7.000	8.800	0.000	1.450
OPERATING ENGINEER		ALL	4	21.400	27.800	1.5	1.5	2.0	5.650	6.100	0.000	1.100
OPERATING ENGINEER		O&C	1	25.090	26.090	1.5	1.5	2.0	7.000	8.800	0.000	1.450
OPERATING ENGINEER		O&C	2	23.660	26.090	1.5	1.5	2.0	7.000	8.800	0.000	1.450
OPERATING ENGINEER		O&C	3	18.120	26.090	1.5	1.5	2.0	7.000	8.800	0.000	1.450
OPERATING ENGINEER		O&C	4	16.050	21.100	1.5	1.5	2.0	5.650	6.100	0.000	1.100
PAINTER		BLD		24.450	25.450	1.5	1.5	2.0	6.250	5.550	0.000	0.300
PAINTER		HWY		25.600	26.600	1.5	1.5	2.0	6.250	5.550	0.000	0.300
PAINTER OVER 30FT		BLD		25.200	26.200	1.5	1.5	2.0	6.250	5.550	0.000	0.300
PAINTER PWR EQMT		BLD		25.450	26.450	1.5	1.5	2.0	6.250	5.550	0.000	0.300
PAINTER PWR EQMT		HWY		26.600	27.600	1.5	1.5	2.0	6.250	5.550	0.000	0.300
PILEDRIIVER		BLD		31.890	33.390	1.5	1.5	2.0	6.550	6.750	0.000	0.400
PILEDRIIVER		HWY		32.390	34.140	1.5	1.5	2.0	6.550	6.750	0.000	0.400
PIPEFITTER		BLD		33.640	35.660	1.5	1.5	2.0	6.100	8.310	0.000	0.800
PLASTERER		BLD		28.200	29.700	1.5	1.5	2.0	6.600	5.400	0.000	0.500
PLUMBER		BLD		33.640	35.660	1.5	1.5	2.0	6.100	8.310	0.000	0.800
ROOFER		BLD		27.240	29.240	1.5	1.5	2.0	7.200	5.250	0.000	0.540
SHEETMETAL WORKER		ALL		31.690	33.190	1.5	1.5	2.0	7.130	6.730	1.910	0.360
SPRINKLER FITTER		BLD		36.390	39.140	1.5	1.5	2.0	8.420	8.500	0.000	0.450
STONE MASON		BLD		28.620	30.120	1.5	1.5	2.0	8.200	7.030	0.000	0.430
TERRAZZO FINISHER		BLD		27.120	0.000	1.5	1.5	2.0	8.200	7.030	0.000	0.430
TRUCK DRIVER		ALL	1	30.070	0.000	1.5	1.5	2.0	10.30	6.100	0.000	0.250
TRUCK DRIVER		ALL	2	30.520	0.000	1.5	1.5	2.0	10.30	6.100	0.000	0.250
TRUCK DRIVER		ALL	3	30.740	0.000	1.5	1.5	2.0	10.30	6.100	0.000	0.250
TRUCK DRIVER		ALL	4	31.030	0.000	1.5	1.5	2.0	10.30	6.100	0.000	0.250
TRUCK DRIVER		ALL	5	31.850	0.000	1.5	1.5	2.0	10.30	6.100	0.000	0.250
TUCKPOINTER		BLD		28.620	30.120	1.5	1.5	2.0	8.200	7.030	0.000	0.430

Legend :

RG (Region)

TYP (Trade Type - All,Highway,Building,Floating,Oil & Chip,Rivers)

C (Class)

Base (Base Wage Rate)

FRMAN (Foreman Rate)

M-F>8 (OT required for any hour greater than 8 worked each day, Mon through Fri.

OSA (Overtime (OT) is required for every hour worked on Saturday)

OSH (Overtime is required for every hour worked on Sunday and Holidays)

H/W (Health & Welfare Insurance)

Pensn (Pension)

Vac (Vacation)

Trng (Training)

Explanations

WHITE COUNTY

The following list is considered as those days for which holiday rates of wages for work performed apply: New Years Day, Memorial Day, Fourth of July, Labor Day, Thanksgiving Day, Christmas Day and Veterans Day in some classifications/counties. Generally, any of these holidays which fall on a Sunday is celebrated on the following Monday. This then makes work performed on that Monday payable at the appropriate overtime rate for holiday pay. Common practice in a given local may alter certain days of celebration. If in doubt, please check with IDOL.

EXPLANATION OF CLASSES

ASBESTOS - GENERAL - removal of asbestos material/mold and hazardous materials from any place in a building, including mechanical systems where those mechanical systems are to be removed. This includes the removal of asbestos materials/mold and hazardous materials from ductwork or pipes in a building when the building is to be demolished at the time or at some close future date.

ASBESTOS - MECHANICAL - removal of asbestos material from mechanical systems, such as pipes, ducts, and boilers, where the mechanical systems are to remain.

CERAMIC TILE FINISHER, MARBLE FINISHER, TERRAZZO FINISHER

Assisting, helping or supporting the tile, marble and terrazzo mechanic by performing their historic and traditional work assignments

required to complete the proper installation of the work covered by said crafts. The term "Ceramic" is used for naming the classification only, and is in no a limitation of the product handled. Ceramic takes into consideration most hard tiles.

ELECTRIC POWER LINEMAN

Construction, maintenance and dismantling of overhead and underground electric power lines, including high voltage pipe type cable work, and associated structures and equipment.

ELECTRIC POWER EQUIPMENT OPERATOR - CLASS 1

Operation of all crawler type equipment D-4 and larger from the ground to assist the Electric Power Linemen in performing their duties.

ELECTRIC POWER EQUIPMENT OPERATORS - CLASS 2

Operation of all other equipment from the ground to assist the Electric Power Linemen in performing their duties.

ELECTRIC POWER GROUNDMAN

Applies to workers who assist the Electric Power Lineman from the ground.

ELECTRONIC SYSTEMS TECHNICIAN

Installation, service and maintenance of low-voltage systems which utilizes the transmission and/or transference of voice, sound, vision, or digital for commercial, education, security and entertainment purposes for the following: TV monitoring and surveillance, background/foreground music, intercom and telephone interconnect, field programming, inventory control systems, microwave transmission, multi-media, multiplex, radio page, school, intercom and sound burglar alarms and low voltage master clock systems.

Excluded from this classification are energy management systems, life safety systems, supervisory controls and data acquisition systems not intrinsic with the above listed systems, fire alarm systems, nurse call systems and raceways exceeding fifteen feet in length.

TRUCK DRIVER - BUILDING, HEAVY AND HIGHWAY CONSTRUCTION

Class 1. Drivers on 2 axle trucks hauling less than 9 ton. Air compressor and welding machines and brooms, including those pulled by separate units, truck driver helpers, warehouse employees, mechanic helpers, greasers and tiremen, pickup trucks when hauling materials, tools, or workers to and from and on-the-job site, and fork lifts up to 6,000 lb. capacity.

Class 2. Two or three axle trucks hauling more than 9 ton but hauling less than 16 ton. A-frame winch trucks, hydrolift trucks, vector trucks or similar equipment when used for transportation purposes. Fork lifts over 6,000 lb. capacity, winch trucks, four axle combination units, and ticket writers.

Class 3. Two, three or four axle trucks hauling 16 ton or more. Drivers on water pulls, articulated dump trucks, mechanics and working forepersons, and dispatchers. Five axle or more combination units.

Class 4. Low Boy and Oil Distributors.

Class 5. Drivers who require special protective clothing while

employed on hazardous waste work.

OPERATING ENGINEERS - BUILDING, HEAVY AND HIGHWAY CONSTRUCTION

Class 1. APSCO or Equal Spreading Machine, Backhoe, Backfiller, Boom or Winch Cat, Bituminous Mixplane Machine, Blacksmith, Bituminous Surfacing Machine, Bull-Dozer, Crane, Shovel, Dragline, Truck Crane, Pile Driver, Concrete Breaker, Concrete or Pumpcrete Pumps, Dinky or Standard Locomotives, Well or Caisson Drills, Elevating Grader, Fork Lifts, Flexplane, Gradeall, Hi-Lift Hoists, Guy-Derricks, Hysters, Mechanic Motor Patrol, Mixers-21 cu. ft. or over, Push Cats, Pulls and Scrapers, Two Well Point Pumps, Pulverizer or Tiller, PugMill, Rubber-Tired Farm Type Tractor with Bulldozer/Blade/Auger or hi-lift over 1/2 yd., Jersey Spreader, Tract-Air used with Drill or Hi-Lift, Trenching or Ditching Machines, Wood Chipper w/Tractor, Self-Propelled Roller w/Blade, Equipment Greaser, Self-Propelled Bump Grinder on Concrete pavement, Boat Operator, Skid-Loaders, Tuggers, Lazer Screed, and Self-Propelled Chip Spreader (when others run conveyors).

Class 2. Any type tractor pulling any type roller or disc, Two Air Compressors (220 cu. ft. capacity or over), Two AirTract Drills, Air-Track Drill w/Compressor, Automatic Bins or Scales w/Compressor or Generator, Pipeline Boring Machine, Bulk Cement Plant w/Separate Compressor, Power Operated Bull Float, Hydra-Lift w/Single Motor, Straw Mulcher Blower w/Spout, Self-Propelled Roller/Compactor, Back-End man on Bituminous Surfacing Machine, oiler on milling machine.

Class 3. Air Compressor w/Valve driving piling, Boom or Winch Type Truck, Two Conveyors, Self-Propelled Concrete Saw, Form Grader, Truck Crane Oiler, Self-Propelled Vibrator, Rubber Tired Farm Type Tractor w/Blade/Bulldozer/Auger/hi-lift - 1/2 yd. or less, Elevator Operator, Man Lift (scissor lift) when lifting materials.

Class 4. Air-Track Drill (one), Belt Drag Machine, Power Broom, Mechanical Plasterer Applicator, Trac-Air, Air Compressor (220 cu. ft. or over) One, Air Compressor (under 220 cu. ft) four, Automatic Bin, Bulk Cement Plant w/Built-in Compressor running off same motor or electric motor, Fireman or Switchman, Self-Propelled Form Tamper, Light Plants (4), Welding Machines (4), Pumps (4), or Combination of four (4) Pumps, Light Plants, Welding Machines, Air-Compressors (under 220 cu. ft.), Mudjacks or Wood Chipper, Mixers - less than 21 cu. ft. Mortar Mixer w/Skip or Pump, Pipeline Tract Jack. One Operating Engineer may operate and maintain any combination of the following pieces of equipment, not to exceed four (4) which shall be within a reasonable distance, such combination may include any equipment in this classification: (Compressors, Light Plants, Generators, Welding Machines, Pumps or Conveyors), One Well-Point Pump, Two Motor Driven Heaters, One Air Compressor (under 220 cu. ft.), One Engine-Driven Conveyor, One Motor Driven Heater, One Light Plant, One Pump, One Welding Machine, One Ulmac or Equal Spreader, Oilers, and one Generator 10 kw or greater.

OPERATING ENGINEER RIVER WORK 1 - operate the following machines when working on River Work and Levee Work on the Mississippi and Ohio Rivers, Lakes and Tributaries: Crane, Shovel, Drageline, Scrapers, Dredge, Derrick, Pile-Driver, Push Boat, all power boat operators, Mechanic, Engineman on Dredge, Leverman on Dredge, All Bituminous Spreader machines, Backhoe, Backfiller, Boom, or Winch Cat, Bituminous Mixplane Machine, Blacksmith, Bituminous Surfacing Machine, Bulldozer, Truck Cranes, Hydraulic Truck Mounted Boom/Crane, Concrete Finishing Machine, or Spreader Machine, Concrete Breaker, Concrete or Pumpcrete Machines, Concrete Plant Operator, All Off Road Material Hauling Equipment, Dinky or Standard Locomotives, Well Drill,

Elevating Grader, Fork-Lifts, Flexplane, Gradeall, Hi-Lift, Power Handblade Tugger type Hoist, Hoist Two Drum (or over one), Gyderrick, Hyster, Motor Patrol, Mixers - 21 Cu. Ft. or over, Push Cat, Pulls, & Scrapers, Pumps-Two Well Points, Equipment Greaser, P & H Pulverizer or Pulverizer equal to Pugmill, Pugmill, Rubber-Tired farm type tractor w/Bulldozer/Blade/Auger or Hi-Lift over ½ yard, Skimmer Scoops, Seaman Tiller, Jersey Spreader, Tract-Air used with Drill or Hi-Lift, Trenching or Ditching Machine, Wood Chipper w/Tractor, self-propelled roller w/Blade, Concrete Pumps and Small Equipment Operators.

OPERATING ENGINEER RIVER 2 - when working on River Work and Levee Work on the Mississippi and Ohio Rivers, Lakes and Tributaries shall be employed as the Oiler or Fireman on Crane, Dragline, Shovel, Dredge, Truck Crane, Pile Driver, Gradeall, Dinky or Standard Locomotive, Guy Derrick, Trenching Machine or Ditching Machine 80 H.P. and over, All Terrain (cherry-picker) with over 40 ton Lifting Capacity, Deck Oiler and Deckhands.

Other Classifications of Work:

For definitions of classifications not otherwise set out, the Department generally has on file such definitions which are available. If a task to be performed is not subject to one of the classifications of pay set out, the Department will upon being contacted state which neighboring county has such a classification and provide such rate, such rate being deemed to exist by reference in this document. If no neighboring county rate applies to the task, the Department shall undertake a special determination, such special determination being then deemed to have existed under this determination. If a project requires these, or any classification not listed, please contact IDOL at 217-782-1710 for wage rates or clarifications.

LANDSCAPING

Landscaping work falls under the existing classifications for laborer, operating engineer and truck driver. The work performed by landscape plantsman and landscape laborer is covered by the existing classification of laborer. The work performed by landscape operators (regardless of equipment used or its size) is covered by the classifications of operating engineer. The work performed by landscape truck drivers (regardless of size of truck driven) is covered by the classifications of truck driver.