

**If you plan to submit a bid directly to the Department of Transportation**

**PREQUALIFICATION**

Any contractor who desires to become pre-qualified to bid on work advertised by IDOT must submit the properly completed pre-qualification forms to the Bureau of Construction no later than 4:30 p.m. prevailing time twenty-one days prior to the letting of interest. This pre-qualification requirement applies to first time contractors, contractors renewing expired ratings, contractors maintaining continuous pre-qualification or contractors requesting revised ratings. To be eligible to bid, existing pre-qualification ratings must be effective through the date of letting.

**REQUESTS FOR AUTHORIZATION TO BID**

Contractors downloading and/or ordering CD-ROM's and are wanting to bid on items included in a particular letting must submit the properly completed "Request for Authorization to Bid/or Not For Bid Status" (BDE 124INT) and the ORIGINAL, signed and notarized, "Affidavit of Availability" (BC 57) to the proper office no later than 4:30 p.m. prevailing time, three (3) days prior to the letting date.

**WHO CAN BID ?**

Bids will be accepted from only those companies that request and receive written **Authorization to Bid** from IDOT's Central Bureau of Construction.

**WHAT CONSTITUTES WRITTEN AUTHORIZATION TO BID?** When a prospective prime bidder submits a "Request for Authorization to Bid/or Not For Bid Status"(BDE 124INT) he/she must indicate at that time which items are being requested For Bidding purposes. Only those items requested For Bidding will be analyzed. After the request has been analyzed, the bidder will be issued a **Proposal Denial and/or Authorization Form**, approved by the Central Bureau of Construction, that indicates which items have been approved For Bidding. If **Authorization to Bid** cannot be approved, the **Proposal Denial and/or Authorization Form** will indicate the reason for denial.

**ABOUT AUTHORIZATION TO BID:** Firms that have not received an authorization form within a reasonable time of complete and correct original document submittal should contact the department as to status. This is critical in the week before the letting. These documents must be received three days before the letting date. Firms unsure as to authorization status should call the Prequalification Section of the Bureau of Construction at the number listed at the end of these instructions.

**ADDENDA AND REVISIONS:** It is the contractor's responsibility to determine which, if any, addenda or revisions pertain to any project they may be bidding. Failure to incorporate all relevant addenda or revisions may cause the bid to be declared unacceptable.

Each addendum will be placed with the contract number. Addenda and revisions will also be placed on the Addendum/Revision Checklist and each subscription service subscriber will be notified by e-mail of each addendum and revision issued.

The Internet is the Department's primary way of doing business. The subscription server e-mails are an added courtesy the Department provides. It is suggested that bidder check IDOT's website <http://www.dot.il.gov/desenv/delett.html> before submitting final bid information.

**IDOT is not responsible for any e-mail related failures.**

Addenda Questions may be directed to the Contracts Office at (217)782-7806 or [D&Econtracts@dot.il.gov](mailto:D&Econtracts@dot.il.gov)

Technical Questions about downloading these files may be directed to Tim Garman (217)524-1642 or [garmantr@dot.il.gov](mailto:garmantr@dot.il.gov).

**WHAT MUST BE INCLUDED WHEN BIDS ARE SUBMITTED?:** Bidders need not return the entire proposal when bids are submitted. That portion of the proposal that must be returned includes the following:

1. All documents from the Proposal Cover Sheet through the Proposal Bid Bond
2. Other special documentation and/or information that may be required by the contract special provisions

All proposal documents, including Proposal Guaranty Checks or Proposal Bid Bonds, should be stapled together to prevent loss when bids are processed by IDOT personnel.

**ABOUT SUBMITTING BIDS:** It is recommended that bidders deliver bids in person to insure they arrive at the proper location prior to the time specified for the receipt of bids. Any bid received at the place of letting after the time specified will not be accepted.

**WHO SHOULD BE CALLED IF ASSISTANCE IS NEEDED?**

<b>Questions Regarding</b>	<b>Call</b>
Prequalification and/or Authorization to Bid	(217)782-3413
Preparation and submittal of bids	(217)782-7806
Mailing of plans and proposals	(217)782-7806
Electronic plans and proposals	(217)524-1642

**ADDENDUMS AND REVISIONS TO THE PROPOSAL FORMS**

Planholders should verify that they have received and incorporated the addendum and/or revision prior to submitting their bid. Failure by the bidder to include an addendum could result in a bid being rejected as irregular.

RETURN WITH BID

2

Proposal Submitted By
Name
Address
City

Letting April 15, 2005

BIDDERS NEED NOT RETURN THE ENTIRE PROPOSAL  
(See instructions inside front cover)

**NOTICE TO PROSPECTIVE BIDDERS**  
 This proposal can be used for bidding purposes  
 by only those companies that request and receive  
 written AUTHORIZATION TO BID from IDOT's  
 Central Bureau of Construction.  
 (SEE INSTRUCTIONS ON THE INSIDE OF COVER)

# Notice To Bidders, Specifications, Proposal, Contract and Contract Bond



Illinois Department  
of Transportation

Springfield, Illinois 62764

Contract No. 64775  
HENRY-BUREAU Counties  
Section (6CS,26CS,7)RS-2&8RS-5  
District 2 Construction Funds  
Route FAP 613

PLEASE MARK THE APPROPRIATE BOX BELOW:

A Bid Bond is included.

A Cashier's Check or a Certified Check is included.

Plans Included  
Herein

Prepared by	S
Checked by	

(Printed by authority of the State of Illinois)

---

---

## INSTRUCTIONS

**ABOUT IDOT PROPOSALS:** All proposals issued by IDOT are potential bidding proposals. Each proposal contains all Certifications and Affidavits, a Proposal Signature Sheet and a Proposal Bid Bond required for Prime Contractors to submit a bid after written **Authorization to Bid** has been issued by IDOT's Central Bureau of Construction.

**WHO CAN BID?:** Bids will be accepted from only those companies that request and receive written **Authorization to Bid** from IDOT's Central Bureau of Construction. To request authorization, a potential bidder must complete and submit Part B of the Request for Authorization to Bid/or Not For Bid Status form (BDE 124 INT) and submit an original Affidavit of Availability (BC 57).

**WHAT CONSTITUTES WRITTEN AUTHORIZATION TO BID?:** When a prospective prime bidder submits a "Request for Proposal Forms and Plans" he/she must indicate at that time which items are being requested For Bidding purposes. Only those items requested For Bidding will be analyzed. After the request has been analyzed, the bidder will be issued a **Proposal Denial and/or Authorization Form**, approved by the Central Bureau of Construction, that indicates which items have been approved For Bidding. If **Authorization to Bid** cannot be approved, the **Proposal Denial and/or Authorization Form** will indicate the reason for denial. If a contractor has requested to bid but has not received a **Proposal Denial and/or Authorization Form**, they should contact the Central Bureau of Construction in advance of the letting date.

**WHAT MUST BE INCLUDED WHEN BIDS ARE SUBMITTED?:** Bidders need not return the entire proposal when bids are submitted. That portion of the proposal that must be returned includes the following:

1. All documents from the Proposal Cover Sheet through the Proposal Bid Bond
2. Other special documentation and/or information that may be required by the contract special provisions

All proposal documents, including Proposal Guaranty Checks or Proposal Bid Bonds, should be stapled together to prevent loss when bids are processed by IDOT personnel.

**ABOUT SUBMITTING BIDS:** It is recommended that bidders deliver bids in person to insure they arrive at the proper location prior to the time specified for the receipt of bids. Any bid received at the place of letting after the time specified will not be accepted.

### WHO SHOULD BE CALLED IF ASSISTANCE IS NEEDED?

Questions Regarding	Call
Prequalification and/or Authorization to Bid	217/782-3413
Preparation and submittal of bids	217/782-7806
Mailing of CD-ROMS	217/782-7806

RETURN WITH BID



PROPOSAL

TO THE DEPARTMENT OF TRANSPORTATION

1. Proposal of \_\_\_\_\_

\_\_\_\_\_

for the improvement identified and advertised for bids in the Invitation for Bids as:

**Contract No. 64775  
HENRY-BUREAU Counties  
Section (6CS,26CS,7)RS-2&8RS-5  
Route FAP 613  
District 2 Construction Funds**

**13.6 miles of 44 feet and variable width bituminous resurfacing and patching along U.S. Route 34 from Illinois Route 78 in Kewanee to U.S. Route 6 near Sheffield.**

2. The undersigned bidder will furnish all labor, material and equipment to complete the above described project in a good and workmanlike manner as provided in the contract documents provided by the Department of Transportation. This proposal will become part of the contract and the terms and conditions contained in the contract documents shall govern performance and payments.

**RETURN WITH BID**

3. **ASSURANCE OF EXAMINATION AND INSPECTION/WAIVER.** The undersigned further declares that he/she has carefully examined the proposal, plans, specifications, form of contract and contract bond, and special provisions, and that he/she has inspected in detail the site of the proposed work, and that he/she has familiarized themselves with all of the local conditions affecting the contract and the detailed requirements of construction, and understands that in making this proposal he/she waives all right to plead any misunderstanding regarding the same.
  
4. **EXECUTION OF CONTRACT AND CONTRACT BOND.** The undersigned further agrees to execute a contract for this work and present the same to the department within fifteen (15) days after the contract has been mailed to him/her. The undersigned further agrees that he/she and his/her surety will execute and present within fifteen (15) days after the contract has been mailed to him/her contract bond satisfactory to and in the form prescribed by the Department of Transportation, in the penal sum of the full amount of the contract, guaranteeing the faithful performance of the work in accordance with the terms of the contract.
  
5. **PROPOSAL GUARANTY.** Accompanying this proposal is either a bid bond on the department form, executed by a corporate surety company satisfactory to the department, or a proposal guaranty check consisting of a bank cashier's check or a properly certified check for not less than 5 per cent of the amount bid or for the amount specified in the following schedule:

<u>Amount of Bid</u>		<u>Proposal Guaranty</u>	<u>Amount of Bid</u>		<u>Proposal Guaranty</u>	
Up to	\$5,000 .....	\$150	\$2,000,000	to	\$3,000,000 .....	\$100,000
\$5,000	to \$10,000 .....	\$300	\$3,000,000	to	\$5,000,000 .....	\$150,000
\$10,000	to \$50,000 .....	\$1,000	\$5,000,000	to	\$7,500,000 .....	\$250,000
\$50,000	to \$100,000 .....	\$3,000	\$7,500,000	to	\$10,000,000 .....	\$400,000
\$100,000	to \$150,000 .....	\$5,000	\$10,000,000	to	\$15,000,000 .....	\$500,000
\$150,000	to \$250,000 .....	\$7,500	\$15,000,000	to	\$20,000,000 .....	\$600,000
\$250,000	to \$500,000 .....	\$12,500	\$20,000,000	to	\$25,000,000 .....	\$700,000
\$500,000	to \$1,000,000 .....	\$25,000	\$25,000,000	to	\$30,000,000 .....	\$800,000
\$1,000,000	to \$1,500,000 .....	\$50,000	\$30,000,000	to	\$35,000,000 .....	\$900,000
\$1,500,000	to \$2,000,000 .....	\$75,000	over		\$35,000,000 .....	\$1,000,000

Bank cashier's checks or properly certified checks accompanying proposals shall be made payable to the Treasurer, State of Illinois, when the state is awarding authority; the county treasurer, when a county is the awarding authority; or the city, village, or town treasurer, when a city, village, or town is the awarding authority.

If a combination bid is submitted, the proposal guaranties which accompany the individual proposals making up the combination will be considered as also covering the combination bid.

The amount of the proposal guaranty check is \_\_\_\_\_ \$( \_\_\_\_\_ ). If this proposal is accepted and the undersigned shall fail to execute a contract bond as required herein, it is hereby agreed that the amount of the proposal guaranty shall become the property of the State of Illinois, and shall be considered as payment of damages due to delay and other causes suffered by the State because of the failure to execute said contract and contract bond; otherwise, the bid bond shall become void or the proposal guaranty check shall be returned to the undersigned.

**Attach Cashier's Check or Certified Check Here**

In the event that one proposal guaranty check is intended to cover two or more proposals, the amount must be equal to the sum of the proposal guaranties which would be required for each individual proposal. If the guaranty check is placed in another proposal, state below where it may be found.

The proposal guaranty check will be found in the proposal for:

Item \_\_\_\_\_

Section No. \_\_\_\_\_

County \_\_\_\_\_

Mark the proposal cover sheet as to the type of proposal guaranty submitted.

**RETURN WITH BID**

6. **COMBINATION BIDS.** The undersigned further agrees that if awarded the contract for the sections contained in the following combination, he/she will perform the work in accordance with the requirements of each individual proposal comprising the combination bid specified in the schedule below, and that the combination bid shall be prorated against each section in proportion to the bid submitted for the same. If an error is found to exist in the gross sum bid for one or more of the individual sections included in a combination, the combination bid shall be corrected as provided in the specifications.

**When a combination bid is submitted, the schedule below must be completed in each proposal comprising the combination.**

**If alternate bids are submitted for one or more of the sections comprising the combination, a combination bid must be submitted for each alternate.**

**Schedule of Combination Bids**

Combination No.	Sections Included in Combination	Combination Bid	
		Dollars	Cents

7. **SCHEDULE OF PRICES.** The undersigned bidder submits herewith, in accordance with the rules and instructions, a schedule of prices for the items of work for which bids are sought. The unit prices bid are in U.S. dollars and cents, and all extensions and summations have been made. The bidder understands that the quantities appearing in the bid schedule are approximate and are provided for the purpose of obtaining a gross sum for the comparison of bids. If there is an error in the extension of the unit prices, the unit prices shall govern. Payment to the contractor awarded the contract will be made only for actual quantities of work performed and accepted or materials furnished according to the contract. The scheduled quantities of work to be done and materials to be furnished may be increased, decreased or omitted as provided elsewhere in the contract.

8. **CERTIFICATE OF AUTHORITY.** The undersigned bidder, if a business organized under the laws of another State, assures the Department that it will furnish a copy of its certificate of authority to do business in the State of Illinois with the return of the executed contract and bond. Failure to furnish the certificate within the time provided for execution of an awarded contract may be cause for cancellation of the award and forfeiture of the proposal guaranty to the State.

ILLINOIS DEPARTMENT OF TRANSPORTATION  
 SCHEDULE OF PRICES  
 CONTRACT  
 NUMBER - 64775

State Job # - C-92-010-05  
 PPS NBR - 2-15090-0000  
 County Name - BUREAU- HENRY-  
 Code - 11 - 73 -  
 District - 2 - 2 -  
 Section Number - (6CS,26CS,7)RS-2 & 8RS-5

Project Number

Route  
 FAP 613

Item Number	Pay Item Description	Unit of Measure	Quantity	x	Unit Price	=	Total Price
X0323973	SED CONT SILT FENCE	FOOT	587.000				
X0324855	SLOP MET ES W/GR 36	EACH	2.000				
X0324856	SLOP MET ES W/GR 48	EACH	1.000				
X4066414	BC SC SUPER "C" N50	TON	71.000				
X4066424	BC SC SUPER "D" N50	TON	13,331.400				
X4066735	LEV BIND HM SUPER N50	TON	5.000				
X4066765	LEV BIND MM SUPER N50	TON	1,069.000				
Z0028415	GEOTECHNICAL REINF	SQ YD	126.000				
Z0028700	GRAN SUBGRADE REPL	CU YD	21.000				
Z0040315	PILOT CAR	DAY	7.000				
Z0048665	RR PROT LIABILITY INS	L SUM	1.000				
20200520	EARTH EXC WID	UNIT	25.000				
20400800	FURNISHED EXCAV	CU YD	1,391.000				
28000250	TEMP EROS CONTR SEED	POUND	20.000				
40600200	BIT MATLS PR CT	TON	97.000				



ILLINOIS DEPARTMENT OF TRANSPORTATION  
 SCHEDULE OF PRICES  
 CONTRACT  
 NUMBER - 64775

State Job # - C-92-010-05  
 PPS NBR - 2-15090-0000  
 County Name - BUREAU- HENRY-  
 Code - 11 - 73 -  
 District - 2 - 2 -  
 Section Number - (6CS,26CS,7)RS-2 & 8RS-5

Project Number

Route  
 FAP 613

Item Number	Pay Item Description	Unit of Measure	Quantity	x	Unit Price	=	Total Price
40600300	AGG PR CT	TON	255.000				
40600895	CONSTRUC TEST STRIP	EACH	1.000				
40600980	BIT SURF REM BUTT JT	SQ YD	5,073.000				
40600985	PCC SURF REM BUTT JT	SQ YD	99.000				
40600990	TEMPORARY RAMP	SQ YD	873.000				
40601000	BIT REPL OVER PATCH	TON	843.300				
40800040	INCIDENTAL BIT SURF	TON	1,000.000				
44000007	BIT SURF REM 2	SQ YD	20,562.000				
44000128	BIT RM OV PATCH 7	SQ YD	2,151.800				
44002000	CONC CURB REMOV	FOOT	47.000				
44200180	PAVT PATCH T2 15	SQ YD	68.000				
44200184	PAVT PATCH T3 15	SQ YD	26.000				
44200186	PAVT PATCH T4 15	SQ YD	32.000				
44300100	AREA REF CR CON TREAT	SQ YD	57,000.000				
48101200	AGGREGATE SHLDS B	TON	7,288.900				

ILLINOIS DEPARTMENT OF TRANSPORTATION  
 SCHEDULE OF PRICES  
 CONTRACT  
 NUMBER - 64775

State Job # - C-92-010-05  
 PPS NBR - 2-15090-0000  
 County Name - BUREAU- HENRY-  
 Code - 11 - 73 -  
 District - 2 - 2 -  
 Section Number - (6CS,26CS,7)RS-2 & 8RS-5

Project Number

Route  
 FAP 613

Item Number	Pay Item Description	Unit of Measure	Quantity	x	Unit Price	=	Total Price
48202315	BIT SHLD SUPER 5 3/4	SQ YD	566.000				
50104400	CONC HDWL REM	EACH	1.000				
50105200	REM EXIST CULVERTS	EACH	1.000				
542A0253	P CUL CL A 1 48	FOOT	3.000				
542D0220	P CUL CL D 1 15	FOOT	56.000				
542D0241	P CUL CL D 1 36	FOOT	11.000				
542D0253	P CUL CL D 1 48	FOOT	8.000				
54213450	END SECTIONS 15	EACH	2.000				
54247190	GRATING-C FL END S 48	EACH	1.000				
56109210	WATER VALVES ADJUST	EACH	18.000				
60228400	MAN SPL	EACH	1.000				
60255800	MAN ADJ NEW T1F CL	EACH	24.000				
60260100	INLETS ADJUST	EACH	22.000				
60600605	CONC CURB TB	FOOT	81.000				
63200310	GUARDRAIL REMOV	FOOT	327.000				

ILLINOIS DEPARTMENT OF TRANSPORTATION  
 SCHEDULE OF PRICES  
 CONTRACT  
 NUMBER -

64775

State Job # - C-92-010-05  
 PPS NBR - 2-15090-0000  
 County Name - BUREAU- HENRY-  
 Code - 11 - 73 -  
 District - 2 - 2 -  
 Section Number - (6CS,26CS,7)RS-2 & 8RS-5

Project Number

Route  
 FAP 613

Item Number	Pay Item Description	Unit of Measure	Quantity	x	Unit Price	=	Total Price
67100100	MOBILIZATION	L SUM	1.000				
70100450	TRAF CONT-PROT 701201	L SUM	1.000				
70100460	TRAF CONT-PROT 701306	L SUM	1.000				
70100500	TRAF CONT-PROT 701326	L SUM	1.000				
70100600	TRAF CONT-PROT 701336	L SUM	1.000				
70102620	TR CONT & PROT 701501	L SUM	1.000				
70103815	TR CONT SURVEILLANCE	CAL DA	65.000				
70300100	SHORT-TERM PAVT MKING	FOOT	11,855.300				
70301000	WORK ZONE PAVT MK REM	SQ FT	1,321.500				
78000200	THPL PVT MK LINE 4	FOOT	12,844.000				
78000500	THPL PVT MK LINE 8	FOOT	710.000				
78000600	THPL PVT MK LINE 12	FOOT	97.000				
78000650	THPL PVT MK LINE 24	FOOT	104.000				
78001110	PAINT PVT MK LINE 4	FOOT	298,692.000				
78001140	PAINT PVT MK LINE 8	FOOT	108.000				

ILLINOIS DEPARTMENT OF TRANSPORTATION  
 SCHEDULE OF PRICES  
 CONTRACT  
 NUMBER - 64775

State Job # - C-92-010-05  
 PPS NBR - 2-15090-0000  
 County Name - BUREAU- HENRY-  
 Code - 11 - 73 -  
 District - 2 - 2 -  
 Section Number - (6CS,26CS,7)RS-2 & 8RS-5

Project Number

Route

FAP 613

Item Number	Pay Item Description	Unit of Measure	Quantity	x	Unit Price	=	Total Price
78100100	RAISED REFL PAVT MKR	EACH	200.000				
78300200	RAISED REF PVT MK REM	EACH	243.000				

**CONTRACT NUMBER**

**64775**

**THIS IS THE TOTAL BID**

**\$ \_\_\_\_\_**

**NOTES:**

1. Each PAY ITEM should have a UNIT PRICE and a TOTAL PRICE.
2. The UNIT PRICE shall govern if no TOTAL PRICE is shown or if there is a discrepancy between the product of the UNIT PRICE multiplied by the QUANTITY.
3. If a UNIT PRICE is omitted, the TOTAL PRICE will be divided by the QUANTITY in order to establish a UNIT PRICE.
4. A bid may be declared UNACCEPTABLE if neither a unit price nor a total price is shown.

## RETURN WITH BID

### **STATE REQUIRED ETHICAL STANDARDS GOVERNING CONTRACT PROCUREMENT: ASSURANCES, CERTIFICATIONS AND DISCLOSURES**

#### **I. GENERAL**

**A.** Article 50 of the Illinois Procurement Code establishes the duty of all State chief procurement officers, State purchasing officers, and their designees to maximize the value of the expenditure of public moneys in procuring goods, services, and contracts for the State of Illinois and to act in a manner that maintains the integrity and public trust of State government. In discharging this duty, they are charged by law to use all available information, reasonable efforts, and reasonable actions to protect, safeguard, and maintain the procurement process of the State of Illinois.

**B.** In order to comply with the provisions of Article 50 and to carry out the duty established therein, all bidders are to adhere to ethical standards established for the procurement process, and to make such assurances, disclosures and certifications required by law. By execution of the Proposal Signature Sheet, the bidder indicates that each of the mandated assurances has been read and understood, that each certification is made and understood, and that each disclosure requirement has been understood and completed.

**C.** In addition to all other remedies provided by law, failure to comply with any assurance, failure to make any disclosure or the making of a false certification shall be grounds for termination of the contract and the suspension or debarment of the bidder.

#### **II. ASSURANCES**

**A.** The assurances hereinafter made by the bidder are each a material representation of fact upon which reliance is placed should the Department enter into the contract with the bidder. The Department may terminate the contract if it is later determined that the bidder rendered a false or erroneous assurance, and the surety providing the performance bond shall be responsible for the completion of the contract.

##### **B. Felons**

1. The Illinois Procurement Code provides:

Section 50-10. Felons. Unless otherwise provided, no person or business convicted of a felony shall do business with the State of Illinois or any state agency from the date of conviction until 5 years after the date of completion of the sentence for that felony, unless no person held responsible by a prosecutorial office for the facts upon which the conviction was based continues to have any involvement with the business.

2. The bidder assures the Department that the award and execution of the contract would not cause a violation of Section 50-10.

##### **C. Conflicts of Interest**

1. The Illinois Procurement Code provides in pertinent part:

Section 50-13. Conflicts of Interest.

(a) Prohibition. It is unlawful for any person holding an elective office in this State, holding a seat in the General Assembly, or appointed to or employed in any of the offices or agencies of state government and who receives compensation for such employment in excess of 60% of the salary of the Governor of the State of Illinois, or who is an officer or employee of the Capital Development Board or the Illinois Toll Highway Authority, or who is the spouse or minor child of any such person to have or acquire any contract, or any direct pecuniary interest in any contract therein, whether for stationery, printing, paper, or any services, materials, or supplies, that will be wholly or partially satisfied by the payment of funds appropriated by the General Assembly of the State of Illinois or in any contract of the Capital Development Board or the Illinois Toll Highway authority.

(b) Interests. It is unlawful for any firm, partnership, association or corporation, in which any person listed in subsection (a) is entitled to receive (i) more than 7 1/2% of the total distributable income or (ii) an amount in excess of the salary of the Governor, to have or acquire any such contract or direct pecuniary interest therein.

(c) Combined interests. It is unlawful for any firm, partnership, association, or corporation, in which any person listed in subsection (a) together with his or her spouse or minor children is entitled to receive (i) more than 15%, in the aggregate, of the total distributable income or (ii) an amount in excess of 2 times the salary of the Governor, to have or acquire any such contract or direct pecuniary interest therein.

(d) Securities. Nothing in this Section invalidates the provisions of any bond or other security previously offered or to be offered for sale or sold by or for the State of Illinois.

(e) Prior interests. This Section does not affect the validity of any contract made between the State and an officer or employee of the State or member of the General Assembly, his or her spouse, minor child or any combination of those persons if that contract was in existence before his or her election or employment as an officer, member, or employee. The contract is voidable, however, if it cannot be completed within 365 days after the officer, member, or employee takes office or is employed.

The current salary of the Governor is \$150,700.00. Sixty percent of the salary is \$90,420.00.

## RETURN WITH BID

2. The bidder assures the Department that the award and execution of the contract would not cause a violation of Section 50-13, or that an effective exemption has been issued by the Board of Ethics to any individual subject to the Section 50-13 prohibitions pursuant to the provisions of Section 50-20 of the Code and Executive Order Number 3 (1998). Information concerning the exemption process is available from the Department upon request.

### **D. Negotiations**

1. The Illinois Procurement Code provides in pertinent part:

Section 50-15. Negotiations.

(a) It is unlawful for any person employed in or on a continual contractual relationship with any of the offices or agencies of State government to participate in contract negotiations on behalf of that office or agency with any firm, partnership, association, or corporation with whom that person has a contract for future employment or is negotiating concerning possible future employment.

2. The bidder assures the Department that the award and execution of the contract would not cause a violation of Section 50-15, and that the bidder has no knowledge of any facts relevant to the kinds of acts prohibited therein.

### **E. Inducements**

1. The Illinois Procurement Code provides:

Section 50-25. Inducement. Any person who offers or pays any money or other valuable thing to any person to induce him or her not to bid for a State contract or as recompense for not having bid on a State contract is guilty of a Class 4 felony. Any person who accepts any money or other valuable thing for not bidding for a State contract or who withholds a bid in consideration of the promise for the payment of money or other valuable thing is guilty of a Class 4 felony.

2. The bidder assures the Department that the award and execution of the contract would not cause a violation of Section 50-25, and that the bidder has no knowledge of any facts relevant to the kinds of acts prohibited therein.

### **F. Revolving Door Prohibition**

1. The Illinois Procurement Code provides:

Section 50-30. Revolving door prohibition. Chief procurement officers, associate procurement officers, State purchasing officers, their designees whose principal duties are directly related to State procurement, and executive officers confirmed by the Senate are expressly prohibited for a period of 2 years after terminating an affected position from engaging in any procurement activity relating to the State agency most recently employing them in an affected position for a period of at least 6 months. The prohibition includes, but is not limited to: lobbying the procurement process; specifying; bidding; proposing bid, proposal, or contract documents; on their own behalf or on behalf of any firm, partnership, association, or corporation. This Section applies only to persons who terminate an affected position on or after January 15, 1999.

2. The bidder assures the Department that the award and execution of the contract would not cause a violation of Section 50-30, and that the bidder has no knowledge of any facts relevant to the kinds of acts prohibited therein.

### **G. Reporting Anticompetitive Practices**

1. The Illinois Procurement Code provides:

Section 50-40. Reporting anticompetitive practices. When, for any reason, any vendor, bidder, contractor, chief procurement officer, State purchasing officer, designee, elected official, or State employee suspects collusion or other anticompetitive practice among any bidders, offerors, contractors, proposers, or employees of the State, a notice of the relevant facts shall be transmitted to the Attorney General and the chief procurement officer.

2. The bidder assures the Department that it has not failed to report any relevant facts concerning the practices addressed in Section 50-40 which may involve the contract for which the bid is submitted.

### **H. Confidentiality**

1. The Illinois Procurement Code provides:

Section 50-45. Confidentiality. Any chief procurement officer, State purchasing officer, designee, or executive officer who willfully uses or allows the use of specifications, competitive bid documents, proprietary competitive information, proposals, contracts, or selection information to compromise the fairness or integrity of the procurement, bidding, or contract process shall be subject to immediate dismissal, regardless of the Personnel code, any contract, or any collective bargaining agreement, and may in addition be subject to criminal prosecution.

2. The bidder assures the Department that it has no knowledge of any fact relevant to the practices addressed in Section 50-45 which may involve the contract for which the bid is submitted.

## RETURN WITH BID

### **I. Insider Information**

1. The Illinois Procurement Act provides:

Section 50-50. Insider information. It is unlawful for any current or former elected or appointed State official or State employee to knowingly use confidential information available only by virtue of that office or employment for actual or anticipated gain for themselves or another person.

2. The bidder assures the Department that it has no knowledge of any facts relevant to the practices addressed in Section 50-50 which may involve the contract for which the bid is submitted.

### **III. CERTIFICATIONS**

**A.** The certifications hereinafter made by the bidder are each a material representation of fact upon which reliance is placed should the Department enter into the contract with the bidder. The Department may terminate the contract if it is later determined that the bidder rendered a false or erroneous certification, and the surety providing the performance bond shall be responsible for completion of the contract.

#### **B. Bribery**

1. The Illinois Procurement Code provides:

Section 50-5. Bribery.

(a) Prohibition. No person or business shall be awarded a contract or subcontract under this Code who:

(1) has been convicted under the laws of Illinois or any other state of bribery or attempting to bribe an officer or employee of the State of Illinois or any other state in that officer's or employee's official capacity; or

(2) has made an admission of guilt of that conduct that is a matter of record but has not been prosecuted for that conduct.

(b) Businesses. No business shall be barred from contracting with any unit of State or local government as a result of a conviction under this Section of any employee or agent of the business if the employee or agent is no longer employed by the business and:

(1) the business has been finally adjudicated not guilty; or

(2) the business demonstrates to the governmental entity with which it seeks to contract, and that entity finds that the commission of the offense was not authorized, requested, commanded, or performed by a director, officer, or high managerial agent on behalf of the business as provided in paragraph (2) of subsection (a) of Section 5-4 of the Criminal Code of 1961.

(c) Conduct on behalf of business. For purposes of this Section, when an official, agent, or employee of a business committed the bribery or attempted bribery on behalf of the business and in accordance with the direction or authorization of a responsible official of the business, the business shall be chargeable with the conduct.

(d) Certification. Every bid submitted to and contract executed by the State shall contain a certification by the contractor that the contractor is not barred from being awarded a contract or subcontract under this Section. A contractor who makes a false statement, material to the certification, commits a Class 3 felony.

2. The bidder certifies that it is not barred from being awarded a contract under Section 50.5.

#### **C. Educational Loan**

1. Section 3 of the Educational Loan Default Act provides:

§ 3. No State agency shall contract with an individual for goods or services if that individual is in default, as defined in Section 2 of this Act, on an educational loan. Any contract used by any State agency shall include a statement certifying that the individual is not in default on an educational loan as provided in this Section.

2. The bidder, if an individual as opposed to a corporation, partnership or other form of business organization, certifies that the bidder is not in default on an educational loan as provided in Section 3 of the Act.

#### **D. Bid-Rigging/Bid Rotating**

1. Section 33E-11 of the Criminal Code of 1961 provides:

§ 33E-11. (a) Every bid submitted to and public contract executed pursuant to such bid by the State or a unit of local government shall contain a certification by the prime contractor that the prime contractor is not barred from contracting with any unit of State or local government as a result of a violation of either Section 33E-3 or 33E-4 of this Article. The State and units of local government shall provide the appropriate forms for such certification.



## RETURN WITH BID

(b) A contractor who makes a false statement, material to the certification, commits a Class 3 felony.

A violation of Section 33E-3 would be represented by a conviction of the crime of bid-rigging which, in addition to Class 3 felony sentencing, provides that any person convicted of this offense or any similar offense of any state or the United States which contains the same elements as this offense shall be barred for 5 years from the date of conviction from contracting with any unit of State or local government. No corporation shall be barred from contracting with any unit of State or local government as a result of a conviction under this Section of any employee or agent of such corporation if the employee so convicted is no longer employed by the corporation and: (1) it has been finally adjudicated not guilty or (2) if it demonstrates to the governmental entity with which it seeks to contract and that entity finds that the commission of the offense was neither authorized, requested, commanded, nor performed by a director, officer or a high managerial agent in behalf of the corporation.

A violation of Section 33E-4 would be represented by a conviction of the crime of bid-rotating which, in addition to Class 2 felony sentencing, provides that any person convicted of this offense or any similar offense of any state or the United States which contains the same elements as this offense shall be permanently barred from contracting with any unit of State or local government. No corporation shall be barred from contracting with any unit of State or local government as a result of a conviction under this Section of any employee or agent of such corporation if the employee so convicted is no longer employed by the corporation and: (1) it has been finally adjudicated not guilty or (2) if it demonstrates to the governmental entity with which it seeks to contract and that entity finds that the commission of the offense was neither authorized, requested, commanded, nor performed by a director, officer or a high managerial agent in behalf of the corporation.

2. The bidder certifies that it is not barred from contracting with the Department by reason of a violation of either Section 33E-3 or Section 33E-4.

### **E. International Anti-Boycott**

1. Section 5 of the International Anti-Boycott Certification Act provides:

§ 5. State contracts. Every contract entered into by the State of Illinois for the manufacture, furnishing, or purchasing of supplies, material, or equipment or for the furnishing of work, labor, or services, in an amount exceeding the threshold for small purchases according to the purchasing laws of this State or \$10,000.00, whichever is less, shall contain certification, as a material condition of the contract, by which the contractor agrees that neither the contractor nor any substantially-owned affiliated company is participating or shall participate in an international boycott in violation of the provisions of the U.S. Export Administration Act of 1979 or the regulations of the U.S. Department of Commerce promulgated under that Act.

2. The bidder makes the certification set forth in Section 5 of the Act.

### **F. Drug Free Workplace**

1. The Illinois "Drug Free Workplace Act" applies to this contract and it is necessary to comply with the provisions of the "Act" if the contractor is a corporation, partnership, or other entity (including a sole proprietorship) which has 25 or more employees.

2. The bidder certifies that if awarded a contract in excess of \$5,000 it will provide a drug free workplace by:

(a) Publishing a statement notifying employees that the unlawful manufacture, distribution, dispensation, possession or use of a controlled substance, including cannabis, is prohibited in the contractor's workplace; specifying the actions that will be taken against employees for violations of such prohibition; and notifying the employee that, as a condition of employment on such contract, the employee shall abide by the terms of the statement, and notify the employer of any criminal drug statute conviction for a violation occurring in the workplace no later than five (5) days after such conviction.

(b) Establishing a drug free awareness program to inform employees about the dangers of drug abuse in the workplace; the contractor's policy of maintaining a drug free workplace; any available drug counseling, rehabilitation, and employee assistance programs; and the penalties that may be imposed upon employees for drug violations.

(c) Providing a copy of the statement required by subparagraph (1) to each employee engaged in the performance of the contract and to post the statement in a prominent place in the workplace.

(d) Notifying the Department within ten (10) days after receiving notice from an employee or otherwise receiving actual notice of the conviction of an employee for a violation of any criminal drug statute occurring in the workplace.

(e) Imposing or requiring, within 30 days after receiving notice from an employee of a conviction or actual notice of such a conviction, an appropriate personnel action, up to and including termination, or the satisfactory participation in a drug abuse assistance or rehabilitation program approved by a federal, state or local health, law enforcement or other appropriate agency.

(f) Assisting employees in selecting a course of action in the event drug counseling, treatment, and rehabilitation is required and indicating that a trained referral team is in place.

(g) Making a good faith effort to continue to maintain a drug free workplace through implementation of the actions and efforts stated in this certification.

**G. Debt Delinquency**

1. The Illinois Procurement Code provides:

Section 50-11 and 50-12. Debt Delinquency.

The contractor or bidder certifies that it, or any affiliate, is not barred from being awarded a contract under 30 ILCS 500. Section 50-11 prohibits a person from entering into a contract with a State agency if it knows or should know that it, or any affiliate, is delinquent in the payment of any debt to the State as defined by the Debt Collection Board. Section 50-12 prohibits a person from entering into a contract with a State agency if it, or any affiliate, has failed to collect and remit Illinois Use Tax on all sales of tangible personal property into the State of Illinois in accordance with the provisions of the Illinois Use Tax Act. The contractor further acknowledges that the contracting State agency may declare the contract void if this certification is false or if the contractor, or any affiliate, is determined to be delinquent in the payment of any debt to the State during the term of the contract.

**H. Sarbanes-Oxley Act of 2002**

1. The Illinois Procurement Code provides:

Section 50-60(c).

The contractor certifies in accordance with 30 ILCS 500/50-10.5 that no officer, director, partner or other managerial agent of the contracting business has been convicted of a felony under the Sarbanes-Oxley Act of 2002 or a Class 3 or Class 2 felony under the Illinois Securities Law of 1953 for a period of five years prior to the date of the bid or contract. The contractor acknowledges that the contracting agency shall declare the contract void if this certification is false.

**I. ADDENDA**

The contractor or bidder certifies that all relevant addenda have been incorporated in to this contract. Failure to do so may cause the bid to be declared unacceptable.

**J. Section 42 of the Environmental Protection Act**

The contractor certifies in accordance with 30 ILCS 500/50-12 that the bidder or contractor is not barred from being awarded a contract under this Section which prohibits the bidding on or entering into contracts with the State of Illinois or a State agency by a person or business found by a court or the Pollution Control Board to have committed a willful or knowing violation of Section 42 of the Environmental Protection Act for a period of five years from the date of the order. The contractor acknowledges that the contracting agency may declare the contract void if this certification is false.

**K. Apprenticeship and Training Certification (Does not apply to federal aid projects)**

In accordance with the provisions of Section 30-22 (6) of the Illinois Procurement Code, the bidder certifies that it is a participant, either as an individual or as part of a group program, in the approved apprenticeship and training programs applicable to each type of work or craft that the bidder will perform with its own forces. The bidder further certifies for work that will be performed by subcontract that each of its subcontractors submitted for approval either (a) is, at the time of such bid, participating in an approved, applicable apprenticeship and training program; or (b) will, prior to commencement of performance of work pursuant to this contract, begin participation in an approved apprenticeship and training program applicable to the work of the subcontract. The Department, at any time before or after award, may require the production of a copy of each applicable Certificate of Registration issued by the United States Department of Labor evidencing such participation by the contractor and any or all of its subcontractors. Applicable apprenticeship and training programs are those that have been approved and registered with the United States Department of Labor. The bidder shall list in the space below, the official name of the program sponsor holding the Certificate of Registration for all of the types of work or crafts in which the bidder is a participant and that will be performed with the bidder's forces. Types of work or craft work that will be subcontracted shall be included and listed as subcontract work. The list shall also indicate any type of work or craft job category that does not have an applicable apprenticeship or training program. **The bidder is responsible for making a complete report and shall make certain that each type of work or craft job category that will be utilized on the project as reported on the Construction Employee Workforce Projection (Form BC-1256) and returned with the bid is accounted for and listed.**

---

---

---

The requirements of this certification and disclosure are a material part of the contract, and the contractor shall require this certification provision to be included in all approved subcontracts. In order to fulfill this requirement, it shall not be necessary that an applicable program sponsor be currently taking or that it will take applications for apprenticeship, training or employment during the performance of the work of this contract.

## TO BE RETURNED WITH BID

### IV. DISCLOSURES

A. The disclosures hereinafter made by the bidder are each a material representation of fact upon which reliance is placed should the Department enter into the contract with the bidder. The Department may terminate the contract if it is later determined that the bidder rendered a false or erroneous disclosure, and the surety providing the performance bond shall be responsible for completion of the contract.

#### B. Financial Interests and Conflicts of Interest

1. Section 50-35 of the Illinois Procurement Code provides that all bids of more than \$10,000 shall be accompanied by disclosure of the financial interests of the bidder. This disclosed information for the successful bidder, will be maintained as public information subject to release by request pursuant to the Freedom of Information Act.

The financial interests to be disclosed shall include ownership or distributive income share that is in excess of 5%, or an amount greater than 60% of the annual salary of the Governor, of the bidding entity or its parent entity, whichever is less, unless the contractor or bidder is a publicly traded entity subject to Federal 10K reporting, in which case it may submit its 10K disclosure in place of the prescribed disclosure. If a bidder is a privately held entity that is exempt from Federal 10K reporting, but has more than 400 shareholders, it may submit the information that Federal 10K companies are required to report, and list the names of any person or entity holding any ownership share that is in excess of 5%. The disclosure shall include the names, addresses, and dollar or proportionate share of ownership of each person making the disclosure, their instrument of ownership or beneficial relationship, and notice of any potential conflict of interest resulting from the current ownership or beneficial interest of each person making the disclosure having any of the relationships identified in Section 50-35 and on the disclosure form.

In addition, all disclosures shall indicate any other current or pending contracts, proposals, leases, or other ongoing procurement relationships the bidding entity has with any other unit of state government and shall clearly identify the unit and the contract, proposal, lease, or other relationship.

2. Disclosure Forms. Disclosure Form A is attached for use concerning the individuals meeting the above ownership or distributive share requirements. Subject individuals should be covered each by one form. In addition, a second form (Disclosure Form B) provides for the disclosure of current or pending procurement relationships with other (non-IDOT) state agencies. **The forms must be included with each bid or incorporated by reference.**

#### C. Disclosure Form Instructions

##### Form A: For bidders that have previously submitted the information requested in Form A

The Department has retained the Form A disclosures submitted by all bidders responding to these requirements for the April 24, 1998 or any subsequent letting conducted by the Department. The bidder has the option of submitting the information again or the bidder may sign the following certification statement indicating that the information previously submitted by the bidder is, as of the date of signature, current and accurate. The Certification must be signed and dated by a person who is authorized to execute contracts for the bidding company. Before signing this certification, the bidder should carefully review its prior submissions to ensure the Certification is correct. If the Bidder signs the Certification, the Bidder should proceed to Form B instructions.

### CERTIFICATION STATEMENT

**I have determined that the Form A disclosure information previously submitted is current and accurate, and all forms are hereby incorporated by reference in this bid. Any necessary additional forms or amendments to previously submitted forms are attached to this bid.**

\_\_\_\_\_  
(Bidding Company)

\_\_\_\_\_  
Name of Authorized Representative (type or print)

\_\_\_\_\_  
Title of Authorized Representative (type or print)

\_\_\_\_\_  
Signature of Authorized Representative

\_\_\_\_\_  
Date

**Form A: For bidders who have NOT previously submitted the information requested in Form A**

If the bidder is a publicly traded entity subject to Federal 10K reporting, the 10K Report may be submitted to meet the requirements of Form A. If a bidder is a privately held entity that is exempt from Federal 10K reporting, but has more than 400 shareholders, it may submit the information that Federal 10K companies are required to report, and list the names of any person or entity holding any ownership share that is in excess of 5%. If a bidder is not subject to Federal 10K reporting, the bidder must determine if any individuals are required by law to complete a financial disclosure form. To do this, the bidder should answer each of the following questions. A "YES" answer indicates Form A must be completed. If the answer to each of the following questions is "NO", then the NOT APPLICABLE STATEMENT on the second page of Form A must be signed and dated by a person that is authorized to execute contracts for the bidding company. Note: These questions are for assistance only and are not required to be completed.

1. Does anyone in your organization have a direct or beneficial ownership share of greater than 5% of the bidding entity or parent entity? YES \_\_\_ NO \_\_\_
2. Does anyone in your organization have a direct or beneficial ownership share of less than 5%, but which has a value greater than \$90,420.00? YES \_\_\_ NO \_\_\_
3. Does anyone in your organization receive more than \$90,420.00 of the bidding entity's or parent entity's distributive income? (Note: Distributive income is, for these purposes, any type of distribution of profits. An annual salary is not distributive income.) YES \_\_\_ NO \_\_\_
4. Does anyone in your organization receive greater than 5% of the bidding entity's or parent entity's total distributive income, but which is less than \$90,420.00? YES \_\_\_ NO \_\_\_

(Note: Only one set of forms needs to be completed per person per bid even if a specific individual would require a yes answer to more than one question.)

A "YES" answer to any of these questions requires the completion of Form A. The bidder must determine each individual in the bidding entity or the bidding entity's parent company that would cause the questions to be answered "Yes". Each form must be signed and dated by a person that is authorized to execute contracts for your organization. **Photocopied or stamped signatures are not acceptable.** The person signing can be, but does not have to be, the person for which the form is being completed. The bidder is responsible for the accuracy of any information provided.

If the answer to each of the above questions is "NO", then the NOT APPLICABLE STATEMENT on page 2 of Form A must be signed and dated by a person that is authorized to execute contracts for your company.

**Form B: Identifying Other Contracts & Procurement Related Information** Disclosure Form B must be completed for each bid submitted by the bidding entity. It must be signed by an individual who is authorized to execute contracts for the bidding entity. *Note: Signing the NOT APPLICABLE STATEMENT on Form A does not allow the bidder to ignore Form B. Form B must be completed, signed and dated or the bidder may be considered nonresponsive and the bid will not be accepted.*

The Bidder shall identify, by checking Yes or No on Form B, whether it has any pending contracts (including leases), bids, proposals, or other ongoing procurement relationship with any other (non-IDOT) State of Illinois agency. If "No" is checked, the bidder only needs to complete the signature box on the bottom of Form B. If "Yes" is checked, the bidder must do one of the following:

Option I: If the bidder did not submit an Affidavit of Availability to obtain authorization to bid, the bidder must list all non-IDOT State of Illinois agency pending contracts, leases, bids, proposals, and other ongoing procurement relationships. These items may be listed on Form B or on an attached sheet(s). Do not include IDOT contracts. Contracts with cities, counties, villages, etc. are not considered State of Illinois agency contracts and are not to be included. Contracts with other State of Illinois agencies such as the Department of Natural Resources or the Capital Development Board must be included. Bidders who submit Affidavits of Availability are suggested to use Option II.

Option II: If the bidder is required and has submitted an Affidavit of Availability in order to obtain authorization to bid, the bidder may write or type "See Affidavit of Availability" which indicates that the Affidavit of Availability is incorporated by reference and includes all non-IDOT State of Illinois agency pending contracts, leases, bids, proposals, and other ongoing procurement relationships. For any contracts that are not covered by the Affidavit of Availability, the bidder must identify them on Form B or on an attached sheet(s). These might be such things as leases.

**D. Bidders Submitting More Than One Bid**

Bidders submitting multiple bids may submit one set of forms consisting of all required Form A disclosures and one Form B for use with all bids. Please indicate in the space provided below the bid item that contains the original disclosure forms and the bid items which incorporate the forms by reference.

- The bid submitted for letting item \_\_\_\_\_ contains the Form A disclosures or Certification Statement and the Form B disclosures. The following letting items incorporate the said forms by reference:

---



---

**ILLINOIS DEPARTMENT  
OF TRANSPORTATION**

**Form A  
Financial Information &  
Potential Conflicts of Interest  
Disclosure**

Contractor Name		
Legal Address		
City, State, Zip		
Telephone Number	Email Address	Fax Number (if available)

Disclosure of the information contained in this Form is required by the Section 50-35 of the Illinois Procurement Code (30 ILCS 500). Vendors desiring to enter into a contract with the State of Illinois must disclose the financial information and potential conflict of interest information as specified in this Disclosure Form. This information shall become part of the publicly available contract file. This Form A must be completed for bids in excess of \$10,000, and for all open-ended contracts. **A publicly traded company may submit a 10K disclosure (or equivalent if applicable) in satisfaction of the requirements set forth in Form A. See Disclosure Form Instructions.**

**DISCLOSURE OF FINANCIAL INFORMATION**

**1. Disclosure of Financial Information.** The individual named below has an interest in the BIDDER (or its parent) in terms of ownership or distributive income share in excess of 5%, or an interest which has a value of more than \$90,420.00 (60% of the Governor's salary as of 7/1/01). **(Make copies of this form as necessary and attach a separate Disclosure Form A for each individual meeting these requirements)**

**FOR INDIVIDUAL (type or print information)**

**NAME:** \_\_\_\_\_

**ADDRESS** \_\_\_\_\_

**Type of ownership/distributable income share:**

stock \_\_\_\_\_ sole proprietorship \_\_\_\_\_ Partnership \_\_\_\_\_ other: (explain on separate sheet):  
% or \$ value of ownership/distributable income share: \_\_\_\_\_

**2. Disclosure of Potential Conflicts of Interest.** Check "Yes" or "No" to indicate which, if any, of the following potential conflict of interest relationships apply. If the answer to any question is "Yes", please attach additional pages and describe.

(a) State employment, currently or in the previous 3 years, including contractual employment of services. Yes \_\_\_ No \_\_\_

If your answer is yes, please answer each of the following questions.

1. Are you currently an officer or employee of either the Capitol Development Board or the Illinois Toll Highway Authority? Yes \_\_\_ No \_\_\_

2. Are you currently appointed to or employed by any agency of the State of Illinois? If you are currently appointed to or employed by any agency of the State of Illinois, and your annual salary exceeds \$90,420.00, (60% of the Governor's salary as of 7/1/01) provide the name the State agency for which you are employed and your annual salary. \_\_\_\_\_

**RETURN WITH BID/OFFER**

- 3. If you are currently appointed to or employed by any agency of the State of Illinois, and your annual salary exceeds \$90,420.00, (60% of the Governor's salary as of 7/1/01) are you entitled to receive (i) more than 7 1/2% of the total distributable income of your firm, partnership, association or corporation, or (ii) an amount in excess of the salary of the Governor? Yes \_\_\_ No \_\_\_
- 4. If you are currently appointed to or employed by any agency of the State of Illinois, and your annual salary exceeds \$90,420.00, (60% of the Governor's salary as of 7/1/01) are you and your spouse or minor children entitled to receive (i) more than 15 % in the aggregate of the total distributable income of your firm, partnership, association or corporation, or (ii) an amount in excess of 2 times the salary of the Governor? Yes \_\_\_ No \_\_\_

---

(b) State employment of spouse, father, mother, son, or daughter, including contractual employment services in the previous 2 years.

Yes \_\_\_ No \_\_\_

If your answer is yes, please answer each of the following questions.

- 1. Is your spouse or any minor children currently an officer or employee of the Capitol Development Board or the Illinois Toll Highway Authority? Yes \_\_\_ No \_\_\_
- 2. Is your spouse or any minor children currently appointed to or employed by any agency of the State of Illinois? If your spouse or minor children is/are currently appointed to or employed by any agency of the State of Illinois, and his/her annual salary exceeds \$90,420.00, (60 % of the Governor's salary as of 7/1/01) provide the name of your spouse and/or minor children, the name of the State agency for which he/she is employed and his/her annual salary. \_\_\_\_\_  
\_\_\_\_\_
- 3. If your spouse or any minor children is/are currently appointed to or employed by any agency of the State of Illinois, and his/her annual salary exceeds \$90,420.00, (60% of the salary of the Governor as of 7/1/01) are you entitled to receive (i) more then 71/2% of the total distributable income of your firm, partnership, association or corporation, or (ii) an amount in excess of the salary of the Governor? Yes \_\_\_ No \_\_\_
- 4. If your spouse or any minor children are currently appointed to or employed by any agency of the State of Illinois, and his/her annual salary exceeds \$90,420.00, (60% of the Governor's salary as of 7/1/01) are you and your spouse or minor children entitled to receive (i) more than 15 % in the aggregate of the total distributable income of your firm, partnership, association or corporation, or (ii) an amount in excess of 2 times the salary of the Governor? Yes \_\_\_ No \_\_\_

---

(c) Elective status; the holding of elective office of the State of Illinois, the government of the United States, any unit of local government authorized by the Constitution of the State of Illinois or the statutes of the State of Illinois currently or in the previous 3 years.

Yes \_\_\_ No \_\_\_

---

(d) Relationship to anyone holding elective office currently or in the previous 2 years; spouse, father, mother, son, or daughter.

Yes \_\_\_ No \_\_\_

---

(e) Appointive office; the holding of any appointive government office of the State of Illinois, the United States of America, or any unit of local government authorized by the Constitution of the State of Illinois or the statutes of the State of Illinois, which office entitles the holder to compensation in excess of the expenses incurred in the discharge of that office currently or in the previous 3 years.

Yes \_\_\_ No \_\_\_

---

(f) Relationship to anyone holding appointive office currently or in the previous 2 years; spouse, father, mother, son, or daughter.

Yes \_\_\_ No \_\_\_

---

(g) Employment, currently or in the previous 3 years, as or by any registered lobbyist of the State government.

Yes \_\_\_ No \_\_\_

---

**RETURN WITH BID/OFFER**

(h) Relationship to anyone who is or was a registered lobbyist in the previous 2 years; spouse, father, mother, son, or daughter. Yes \_\_\_ No \_\_\_

(i) Compensated employment, currently or in the previous 3 years, by any registered election or reelection committee registered with the Secretary of State or any county clerk of the State of Illinois, or any political action committee registered with either the Secretary of State or the Federal Board of Elections. Yes \_\_\_ No \_\_\_

(j) Relationship to anyone; spouse, father, mother, son, or daughter; who was a compensated employee in the last 2 years by any registered election or re-election committee registered with the Secretary of State or any county clerk of the State of Illinois, or any political action committee registered with either the Secretary of State or the Federal Board of Elections. Yes \_\_\_ No \_\_\_

**APPLICABLE STATEMENT**

**This Disclosure Form A is submitted on behalf of the INDIVIDUAL named on previous page.**

Completed by: \_\_\_\_\_  
Name of Authorized Representative (type or print)

Completed by: \_\_\_\_\_  
Title of Authorized Representative (type or print)

Completed by: \_\_\_\_\_ Date \_\_\_\_\_  
Signature of Individual or Authorized Representative

**NOT APPLICABLE STATEMENT**

**I have determined that no individuals associated with this organization meet the criteria that would require the completion of this Form A.**

**This Disclosure Form A is submitted on behalf of the CONTRACTOR listed on the previous page.**

\_\_\_\_\_  
Name of Authorized Representative (type or print)

\_\_\_\_\_  
Title of Authorized Representative (type or print)

\_\_\_\_\_  
Signature of Authorized Representative Date \_\_\_\_\_

RETURN WITH BID/OFFER

ILLINOIS DEPARTMENT  
OF TRANSPORTATION

Form B  
Other Contracts &  
Procurement Related Information  
Disclosure

Contractor Name		
Legal Address		
City, State, Zip		
Telephone Number	Email Address	Fax Number (if available)

Disclosure of the information contained in this Form is required by the Section 50-35 of the Illinois Procurement Act (30 ILCS 500). This information shall become part of the publicly available contract file. This Form B must be completed for bids in excess of \$10,000, and for all open-ended contracts.

**DISCLOSURE OF OTHER CONTRACTS AND PROCUREMENT RELATED INFORMATION**

**1. Identifying Other Contracts & Procurement Related Information.** The BIDDER shall identify whether it has any pending contracts (including leases), bids, proposals, or other ongoing procurement relationship with any other State of Illinois agency: Yes \_\_\_ No \_\_\_

If **“No” is checked**, the bidder only needs to complete the signature box on the bottom of this page.

**2. If “Yes” is checked.** Identify each such relationship by showing State of Illinois agency name and other descriptive information such as bid or project number (attach additional pages as necessary). SEE DISCLOSURE FORM INSTRUCTIONS:

**THE FOLLOWING STATEMENT MUST BE SIGNED**

_____	
Name of Authorized Representative (type or print)	
_____	
Title of Authorized Representative (type or print)	
_____	_____
Signature of Authorized Representative	Date



## **RETURN WITH BID**

### **SPECIAL NOTICE TO CONTRACTORS**

The following requirements of the Illinois Department of Human Rights' Rules and Regulations are applicable to bidders on all construction contracts advertised by the Illinois Department of Transportation:

#### **CONSTRUCTION EMPLOYEE UTILIZATION PROJECTION**

- (a) All bidders on construction contracts shall complete and submit, along with and as part of their bids, a Bidder's Employee Utilization Form (Form BC-1256) setting forth a projection and breakdown of the total workforce intended to be hired and/or allocated to such contract work by the bidder including a projection of minority and female employee utilization in all job classifications on the contract project.
- (b) The Department of Transportation shall review the Employee Utilization Form, and workforce projections contained therein, of the contract awardee to determine if such projections reflect an underutilization of minority persons and/or women in any job classification in accordance with the Equal Employment Opportunity Clause and Section 7.2 of the Illinois Department of Human Rights' Rules and Regulations for Public Contracts adopted as amended on September 17, 1980. If it is determined that the contract awardee's projections reflect an underutilization of minority persons and/or women in any job classification, it shall be advised in writing of the manner in which it is underutilizing and such awardee shall be considered to be in breach of the contract unless, prior to commencement of work on the contract project, it submits revised satisfactory projections or an acceptable written affirmative action plan to correct such underutilization including a specific timetable geared to the completion stages of the contract.
- (c) The Department of Transportation shall provide to the Department of Human Rights a copy of the contract awardee's Employee Utilization Form, a copy of any required written affirmative action plan, and any written correspondence related thereto. The Department of Human Rights may review and revise any action taken by the Department of Transportation with respect to these requirements.

RETURN WITH BID



Contract No. 64775
HENRY-BUREAU Counties
Section (6CS,26CS,7)RS-2&8RS-5
Route FAP 613
District 2 Construction Funds

PART I. IDENTIFICATION

Dept. Human Rights # \_\_\_\_\_ Duration of Project: \_\_\_\_\_

Name of Bidder: \_\_\_\_\_

PART II. WORKFORCE PROJECTION

A. The undersigned bidder has analyzed minority group and female populations, unemployment rates and availability of workers for the location in which this contract work is to be performed, and for the locations from which the bidder recruits employees, and hereby submits the following workforce projection including a projection for minority and female employee utilization in all job categories in the workforce to be allocated to this contract:

TABLE A

Table with columns: JOB CATEGORIES, TOTAL EMPLOYEES (M, F), MINORITY EMPLOYEES (BLACK, HISPANIC, \*OTHER MINOR. (M, F)), and TRAINEES (APPRENTICES, ON THE JOB TRAINEES (M, F)). Rows include OFFICIALS (MANAGERS), SUPERVISORS, FOREMEN, CLERICAL EQUIPMENT OPERATORS, MECHANICS, TRUCK DRIVERS, IRONWORKERS, CARPENTERS, CEMENT MASONS, ELECTRICIANS, PIPEFITTERS, PLUMBERS, PAINTERS, LABORERS SEMI-SKILLED, LABORERS UNSKILLED, and TOTAL.

TABLE B

Table with columns: TOTAL EMPLOYEES (M, F) and MINORITY EMPLOYEES (M, F). Rows correspond to job categories listed in Table A.

TABLE C

Table with columns: EMPLOYEES IN TRAINING, TOTAL EMPLOYEES (M, F), MINORITY EMPLOYEES (BLACK, HISPANIC, \*OTHER MINOR. (M, F)). Rows include APPRENTICES and ON THE JOB TRAINEES.

FOR DEPARTMENT USE ONLY

\*Other minorities are defined as Asians (A) or Native Americans (N).

Please specify race of each employee shown in Other Minorities column.

Note: See instructions on the next page

**RETURN WITH BID**

**Contract No. 64775  
HENRY-BUREAU Counties  
Section (6CS,26CS,7)RS-2&8RS-5  
Route FAP 613  
District 2 Construction Funds**

**PART II. WORKFORCE PROJECTION - continued**

B. Included in "Total Employees" under Table A is the total number of **new hires** that would be employed in the event the undersigned bidder is awarded this contract.

The undersigned bidder projects that: (number) \_\_\_\_\_ new hires would be recruited from the area in which the contract project is located; and/or (number) \_\_\_\_\_ new hires would be recruited from the area in which the bidder's principal office or base of operation is located.

C. Included in "Total Employees" under Table A is a projection of numbers of persons to be employed directly by the undersigned bidder as well as a projection of numbers of persons to be employed by subcontractors.

The undersigned bidder estimates that (number) \_\_\_\_\_ persons will be directly employed by the prime contractor and that (number) \_\_\_\_\_ persons will be employed by subcontractors.

**PART III. AFFIRMATIVE ACTION PLAN**

A. The undersigned bidder understands and agrees that in the event the foregoing minority and female employee utilization projection included under **PART II** is determined to be an underutilization of minority persons or women in any job category, and in the event that the undersigned bidder is awarded this contract, he/she will, prior to commencement of work, develop and submit a written Affirmative Action Plan including a specific timetable (geared to the completion stages of the contract) whereby deficiencies in minority and/or female employee utilization are corrected. Such Affirmative Action Plan will be subject to approval by the contracting agency and the **Department of Human Rights**.

B. The undersigned bidder understands and agrees that the minority and female employee utilization projection submitted herein, and the goals and timetable included under an Affirmative Action Plan if required, are deemed to be part of the contract specifications.

Company \_\_\_\_\_ Telephone Number \_\_\_\_\_  
\_\_\_\_\_  
Address \_\_\_\_\_

**NOTICE REGARDING SIGNATURE**

The Bidder's signature on the Proposal Signature Sheet will constitute the signing of this form. The following signature block needs to be completed only if revisions are required.

Signature: \_\_\_\_\_ Title: \_\_\_\_\_ Date: \_\_\_\_\_

- Instructions: All tables must include subcontractor personnel in addition to prime contractor personnel.
- Table A - Include both the number of employees that would be hired to perform the contract work and the total number currently employed (Table B) that will be allocated to contract work, and include all apprentices and on-the-job trainees. The "Total Employees" column should include all employees including all minorities, apprentices and on-the-job trainees to be employed on the contract work.
- Table B - Include all employees currently employed that will be allocated to the contract work including any apprentices and on-the-job trainees currently employed.
- Table C - Indicate the racial breakdown of the total apprentices and on-the-job trainees shown in Table A.

**RETURN WITH BID**

**Contract No. 64775  
HENRY-BUREAU Counties  
Section (6CS,26CS,7)RS-2&8RS-5  
Route FAP 613  
District 2 Construction Funds**

PROPOSAL SIGNATURE SHEET

The undersigned bidder hereby makes and submits this bid on the subject Proposal, thereby assuring the Department that all requirements of the Invitation for Bids and rules of the Department have been met, that there is no misunderstanding of the requirements of paragraph 3 of this Proposal, and that the contract will be executed in accordance with the rules of the Department if an award is made on this bid.

(IF AN INDIVIDUAL) Firm Name \_\_\_\_\_  
Signature of Owner \_\_\_\_\_  
Business Address \_\_\_\_\_  
\_\_\_\_\_

(IF A CO-PARTNERSHIP) Firm Name \_\_\_\_\_  
By \_\_\_\_\_  
Business Address \_\_\_\_\_  
Name and Address of All Members of the Firm:  
\_\_\_\_\_  
\_\_\_\_\_

(IF A CORPORATION)  
(IF A JOINT VENTURE, USE THIS SECTION FOR THE MANAGING PARTY AND THE SECOND PARTY SHOULD SIGN BELOW)

Corporate Name \_\_\_\_\_  
By \_\_\_\_\_  
Signature of Authorized Representative \_\_\_\_\_  
Typed or printed name and title of Authorized Representative \_\_\_\_\_  
Attest \_\_\_\_\_  
Signature \_\_\_\_\_  
Business Address \_\_\_\_\_  
\_\_\_\_\_

(IF A JOINT VENTURE)

Corporate Name \_\_\_\_\_  
By \_\_\_\_\_  
Signature of Authorized Representative \_\_\_\_\_  
Typed or printed name and title of Authorized Representative \_\_\_\_\_  
Attest \_\_\_\_\_  
Signature \_\_\_\_\_  
Business Address \_\_\_\_\_  
\_\_\_\_\_

If more than two parties are in the joint venture, please attach an additional signature sheet.



RETURN WITH BID

Division of Highways
Proposal Bid Bond
(Effective November 1, 1992)

Item No.
Letting Date

KNOW ALL MEN BY THESE PRESENTS, That We
as PRINCIPAL, and

held jointly, severally and firmly bound unto the STATE OF ILLINOIS in the penal sum of 5 percent of the total bid price, or for the amount specified in Article 102.09 of the "Standard Specifications for Road and Bridge Construction" in effect on the date of invitation for bids, whichever is the lesser sum, well and truly to be paid unto said STATE OF ILLINOIS, for the payment of which we bind ourselves, our heirs, executors, administrators, successors and assigns.

THE CONDITION OF THE FOREGOING OBLIGATION IS SUCH, That Whereas, the PRINCIPAL has submitted a bid proposal to the STATE OF ILLINOIS, acting through the Department of Transportation, for the improvement designated by the Transportation Bulletin Item Number and Letting Date indicated above.

NOW, THEREFORE, if the Department shall accept the bid proposal of the PRINCIPAL; and if the PRINCIPAL shall, within the time and as specified in the bidding and contract documents, submit a DBE Utilization Plan that is accepted and approved by the Department; and if, after award by the Department, the PRINCIPAL shall enter into a contract in accordance with the terms of the bidding and contract documents including evidence of the required insurance coverages and providing such bond as specified with good and sufficient surety for the faithful performance of such contract and for the prompt payment of labor and material furnished in the prosecution thereof; or if, in the event of the failure of the PRINCIPAL to make the required DBE submission or to enter into such contract and to give the specified bond, the PRINCIPAL pays to the Department the difference not to exceed the penalty hereof between the amount specified in the bid proposal and such larger amount for which the Department may contract with another party to perform the work covered by said bid proposal, then this obligation shall be null and void, otherwise, it shall remain in full force and effect.

IN THE EVENT the Department determines the PRINCIPAL has failed to comply with any requirement as set forth in the preceding paragraph, then Surety shall pay the penal sum to the Department within fifteen (15) days of written demand therefor. If Surety does not make full payment within such period of time, the Department may bring an action to collect the amount owed. Surety is liable to the Department for all its expenses, including attorney's fees, incurred in any litigation in which it prevails either in whole or in part.

In TESTIMONY WHEREOF, the said PRINCIPAL and the said SURETY have caused this instrument to be signed by their respective officers this day of A.D.,

PRINCIPAL SURETY
(Company Name) (Company Name)
By: (Signature & Title) By: (Signature of Attorney-in-Fact)

Notary Certification for Principal and Surety

STATE OF ILLINOIS,
COUNTY OF

I, a Notary Public in and for said County, do hereby certify that
and

(Insert names of individuals signing on behalf of PRINCIPAL & SURETY)

who are each personally known to me to be the same persons whose names are subscribed to the foregoing instrument on behalf of PRINCIPAL and SURETY, appeared before me this day in person and acknowledged respectively, that they signed and delivered said instrument as their free and voluntary act for the uses and purposes therein set forth.

Given under my hand and notarial seal this day of A.D.

My commission expires Notary Public

In lieu of completing the above section of the Proposal Bid Form, the Principal may file an Electronic Bid Bond. By signing below the Principal is ensuring the identified electronic bid bond has been executed and the Principal and Surety are firmly bound unto the State of Illinois under the conditions of the bid bond as shown above.

Electronic Bid Bond ID# Company/Bidder Name Signature and Title

# PROPOSAL ENVELOPE



# PROPOSALS

for construction work advertised for bids by the  
Illinois Department of Transportation

Item No.	Item No.	Item No.

Submitted By:

Name:
Address:
Phone No.

Bidders should use an IDOT proposal envelope or affix this form to the front of a 10" x 13" envelope for the submittal of bids. If proposals are mailed, they should be enclosed in a second or outer envelope addressed to:

Engineer of Design and Environment - Room 323  
Illinois Department of Transportation  
2300 South Dirksen Parkway  
Springfield, Illinois 62764

## **NOTICE**

**Individual bids, including Bid Bond and/or supplemental information if required, should be securely stapled.**

# CONTRACTOR OFFICE COPY OF CONTRACT SPECIFICATIONS

---

## NOTICE

None of the following material needs to be returned with the bid package unless the special provisions require documentation and/or other information to be submitted.

**Contract No. 64775  
HENRY-BUREAU Counties  
Section (6CS,26CS,7)RS-2&8RS-5  
Route FAP 613  
District 2 Construction Funds**



**Illinois Department of Transportation**



## NOTICE TO BIDDERS

**1. TIME AND PLACE OF OPENING BIDS.** Sealed proposals for the improvement described herein will be received by the Department of Transportation at the Harry R. Hanley Building, 2300 South Dirksen Parkway, in Springfield, Illinois until 10:00 o'clock a.m., April 15, 2005. All bids will be gathered, sorted, publicly opened and read in the auditorium at the Department of Transportation's Harry R. Hanley Building shortly after the 10:00 a.m. cut off time.

**2. DESCRIPTION OF WORK.** The proposed improvement is identified and advertised for bids in the Invitation for Bids as:

**Contract No. 64775  
HENRY-BUREAU Counties  
Section (6CS,26CS,7)RS-2&8RS-5  
Route FAP 613  
District 2 Construction Funds**

**13.6 miles of 44 feet and variable width bituminous resurfacing and patching along U.S. Route 34 from Illinois Route 78 in Kewanee to U.S. Route 6 near Sheffield.**

**3. INSTRUCTIONS TO BIDDERS.** (a) This Notice, the invitation for bids, proposal and letter of award shall, together with all other documents in accordance with Article 101.09 of the Standard Specifications for Road and Bridge Construction, become part of the contract. Bidders are cautioned to read and examine carefully all documents, to make all required inspections, and to inquire or seek explanation of the same prior to submission of a bid.

(b) State law, and, if the work is to be paid wholly or in part with Federal-aid funds, Federal law requires the bidder to make various certifications as a part of the proposal and contract. By execution and submission of the proposal, the bidder makes the certification contained therein. A false or fraudulent certification shall, in addition to all other remedies provided by law, be a breach of contract and may result in termination of the contract.

**4. AWARD CRITERIA AND REJECTION OF BIDS.** This contract will be awarded to the lowest responsive and responsible bidder considering conformity with the terms and conditions established by the Department in the rules, Invitation for Bids and contract documents. The issuance of plans and proposal forms for bidding based upon a prequalification rating shall not be the sole determinant of responsibility. The Department reserves the right to determine responsibility at the time of award, to reject any or all proposals, to readvertise the proposed improvement, and to waive technicalities.

By Order of the  
Illinois Department of Transportation

Timothy W. Martin, Secretary

BD 351 (Rev. 01/2003)



INDEX  
FOR  
SUPPLEMENTAL SPECIFICATIONS AND RECURRING SPECIAL PROVISIONS  
Adopted March 1, 2005

This index contains a listing of SUPPLEMENTAL SPECIFICATIONS and frequently used RECURRING SPECIAL PROVISIONS.

ERRATA Standard Specifications for Road and Bridge Construction (Adopted 1-1-02) (Revised 3-1-05)

SUPPLEMENTAL SPECIFICATIONS

<u>Std. Spec. Sec.</u>		<u>Page No.</u>
101	Definition of Terms .....	1
105	Control of Work .....	2
205	Embankment .....	3
251	Mulch .....	4
281	Riprap.....	5
282	Filter Fabric for Use With Riprap .....	8
285	Concrete Revetment Mats.....	10
311	Granular Subbase .....	14
351	Aggregate Base Course.....	15
440	Removal of Existing Pavement and Appurtenances .....	16
442	Pavement Patching .....	17
449	Removal and Replacement of Preformed Elastomeric Compression Joint Seal .....	18
481	Aggregate Shoulders .....	19
501	Removal of Existing Structures .....	20
503	Concrete Structures .....	21
505	Steel Structures .....	22
506	Cleaning and Painting Metal Structures .....	25
508	Reinforcement Bars .....	26
512	Piling .....	27
540	Box Culverts.....	28
589	Elastic Joint Sealer .....	30
602	Catch Basin, Manhole, Inlet, Drainage Structures and Valve Vault Construction, Adjustment and Reconstruction .....	31
603	Adjusting Frames and Grates of Drainage and Utility Structures .....	32
610	Shoulder Inlets with Curb .....	33
665	Woven Wire Fence .....	34
669	Removal and Disposal of Regulated Substances .....	35
671	Mobilization .....	36
702	Work Zone Traffic Control Devices .....	37
1003	Fine Aggregates .....	38
1004	Coarse Aggregate .....	39
1005	Stone, Concrete Blocks and Broken Concrete for Erosion Protection, Sediment Control and Rockfill .....	42
1006	Metals .....	46
1007	Timber and Preservative Treatment .....	49
1012	Hydrated Lime .....	50
1020	Portland Cement Concrete .....	51
1021	Concrete Admixtures .....	58
1022	Concrete Curing Materials .....	59
1024	Nonshrink Grout .....	61
1041	Brick .....	63
1043	Precast Reinforced Concrete Manhole Sections and Adjusting Rings.....	64
1056	Preformed Flexible Gaskets and Mastic Joint Sealer for Sewer and Culvert Pipe .....	66
1059	Elastic Joint Sealers .....	67
1060	Waterproofing Materials .....	68
1069	Pole and Tower .....	69
1070	Foundation and Breakaway Devices .....	70
1077	Post and Foundation .....	72
1080	Fabric Materials .....	73
1081	Materials For Planting .....	76
1083	Elastomeric Bearings .....	77
1094	Overhead Sign Structures .....	78
1103	Portland Cement Concrete Equipment .....	79

RECURRING SPECIAL PROVISIONS

The following RECURRING SPECIAL PROVISIONS indicated by an "X" are applicable to this contract and are included by reference:

<u>CHECK SHEET #</u>	<u>PAGE NO.</u>
1 State Required Contract Provisions All Federal-aid Construction Contracts (Eff. 2-1-69) (Rev. 10-1-83) ....	80
2 Subletting of Contracts (Federal-aid Contracts) (Eff. 1-1-88) (Rev. 5-1-93).....	82
3 X EEO (Eff. 7-21-78) (Rev. 11-18-80) .....	83
4 X Specific Equal Employment Opportunity Responsibilities NonFederal-aid Contracts (Eff. 3-20-69) (Rev. 1-1-94) .....	94
5 X Required Provisions - State Contracts (Eff. 4-1-65) (Rev. 4-1-93).....	100
6 Reserved .....	105
7 X Asphalt Quantities and Cost Reviews (Eff. 7-1-88).....	106
8 National Pollutant Discharge Elimination System Permit (Eff. 7-1-94) (Rev. 1-1-03).....	107
9 Haul Road Stream Crossings, Other Temporary Stream Crossings and In-Stream Work Pads (Eff. 1-2-92) (Rev. 1-1-98) .....	108
10 Construction Layout Stakes Except for Bridges (Eff. 1-1-99) (Rev. 1-1-02).....	109
11 Construction Layout Stakes (Eff. 5-1-93) (Rev. 1-1-02).....	112
12 Use of Geotextile Fabric for Railroad Crossing (Eff. 1-1-95) (Rev. 1-1-97).....	115
13 Asphaltic Emulsion Slurry Seal and Fibrated Asphaltic Emulsion Slurry Seal (Eff. 8-1-89) (Rev. 2-1-97) ....	117
14 Bituminous Surface Treatments Half-Smart (Eff. 7-1-93) (Rev. 1-1-97) .....	123
15 X Quality Control/Quality Assurance of Bituminous Concrete Mixtures (Eff. 1-1-00) (Rev. 3-1-05) .....	129
16 Subsealing of Concrete Pavements (Eff. 11-1-84) (Rev. 2-1-95).....	148
17 Bituminous Surface Removal (Cold Milling) (Eff. 11-1-87) (Rev. 10-15-97).....	152
18 X Resurfacing of Milled Surfaces (Eff. 10-1-95) .....	154
19 PCC Partial Depth Bituminous Patching (Eff. 1-1-98).....	155
20 X Patching with Bituminous Overlay Removal (Eff. 10-1-95) (Rev. 7-1-99) .....	157
21 Reserved .....	159
22 Protective Shield System (Eff. 4-1-95) (Rev. 1-1-03).....	160
23 Polymer Concrete (Eff. 8-1-95) (Rev. 3-1-05).....	162
24 Controlled Low-Strength Material (CLSM) (Eff. 1-1-90) (Rev. 3-1-05).....	164
25 Pipe Underdrains (Eff. 9-9-87) (Rev. 1-1-98).....	169
26 X Guardrail and Barrier Wall Delineation (Eff. 12-15-93) (Rev. 1-1-97) .....	170
27 Bicycle Racks (Eff. 4-1-94) (Rev. 1-1-97) .....	175
28 Reserved .....	177
29 Reserved .....	178
30 Reserved .....	179
31 Night Time Inspection of Roadway Lighting (Eff. 5-1-96).....	180
32 Reserved .....	181
33 English Substitution of Metric Bolts (Eff. 7-1-96).....	182
34 English Substitution of Metric Reinforcement Bars (Eff. 4-1-96) (Rev. 1-1-03).....	183
35 Polymer Modified Emulsified Asphalt (Eff. 5-15-89) (Rev. 1-1-04).....	185
36 Corrosion Inhibitor (Eff. 3-1-80) (Rev. 7-1-99) .....	187
37 Quality Control of Concrete Mixtures at the Plant-Single A (Eff. 8-1-00) (Rev. 1-1-04) .....	188
38 Quality Control of Concrete Mixtures at the Plant-Double A (Eff. 8-1-00) (Rev. 1-1-04) .....	194
39 Quality Control/Quality Assurance of Concrete Mixtures (Eff. 4-1-92) (Rev. 3-1-05) .....	202
40 X Traffic Barrier Terminal Type 1, Special (Eff. 8-1-94) (Rev. 1-1-03) .....	215
41 Reserved .....	216
42 X Segregation Control of Bituminous Concrete (Eff. 7-15-97).....	217
43 Reserved .....	220

## TABLE OF CONTENTS

LOCATION OF PROJECT .....	1
DESCRIPTION OF PROJECT .....	1
TRAFFIC CONTROL PLAN .....	1
GUARDRAIL REMOVAL.....	3
SEEDING, CLASS 6 (MODIFIED) .....	3
GEOTECHNICAL REINFORCEMENT .....	3
FURNISHED EXCAVATION .....	6
REMOVE EXISTING CULVERTS .....	6
AUTHORITY OF RAILROAD ENGINEER (BDE) .....	6
BITUMINOUS CONCRETE SURFACE COURSE (BDE).....	7
BITUMINOUS EQUIPMENT, SPREADING AND FINISHING MACHINE (BDE) .....	7
BUTT JOINTS (BDE) .....	8
CONCRETE ADMIXTURES (BDE) .....	8
CORRUGATED METAL PIPE CULVERTS (BDE) .....	12
CURING AND PROTECTION OF CONCRETE CONSTRUCTION (BDE) .....	13
DISADVANTAGED BUSINESS ENTERPRISE PARTICIPATION (BDE) .....	19
EPOXY COATING ON REINFORCEMENT (BDE) .....	27
EROSION AND SEDIMENT CONTROL DEFICIENCY DEDUCTION (BDE) .....	27
FLAGGER VESTS (BDE) .....	28
FREEZE-THAW RATING (BDE).....	28
HAND VIBRATOR (BDE).....	28
MULCHING SEEDED AREAS (BDE) .....	28
PARTIAL PAYMENTS (BDE).....	29
PAYMENTS TO SUBCONTRACTORS (BDE) .....	30
PERSONAL PROTECTIVE EQUIPMENT (BDE) .....	31
PLASTIC BLOCKOUTS FOR GUARDRAIL (BDE) .....	31
PORTLAND CEMENT (BDE).....	31
PORTLAND CEMENT CONCRETE (BDE) .....	32
PORTLAND CEMENT CONCRETE PATCHING (BDE) .....	32
PRECAST CONCRETE PRODUCTS (BDE).....	35
RAILROAD PROTECTIVE LIABILITY INSURANCE (BDE) .....	36
RAP FOR USE IN BITUMINOUS CONCRETE MIXTURES (BDE).....	37
SEEDING AND SODDING (BDE).....	40
SELF-CONSOLIDATING CONCRETE FOR PRECAST PRODUCTS (BDE).....	42
SHOULDER STABILIZATION AT GUARDRAIL (BDE).....	44
STABILIZED SUBBASE AND BITUMINOUS SHOULDERS SUPERPAVE (BDE).....	44
TEMPORARY EROSION CONTROL (BDE) .....	49
TRAFFIC CONTROL DEFICIENCY DEDUCTION (BDE) .....	51

TRUCK BED RELEASE AGENT (BDE) ..... 51  
WEIGHT CONTROL DEFICIENCY DEDUCTION..... 51  
WORK ZONE TRAFFIC CONTROL DEVICES (BDE) ..... 53  
WORKING DAYS (BDE) ..... 54  
SUPERPAVE BITUMINOUS CONCRETE MIXTURES (BDE)..... 54  
SUBCONTRACTOR MOBILIZATION PAYMENTS (BDE) ..... 60  
PROJECT LABOR AGREEMENT ..... 61  
STEEL COST ADJUSTMENT (BDE)..... 74

## STATE OF ILLINOIS

### SPECIAL PROVISIONS

The following Special Provisions supplement the "Standard Specifications for Road and Bridge Construction," adopted January 1, 2002, the latest edition of the "Manual on Uniform Traffic Control Devices for Streets and Highways," and the "Manual of Test Procedures for Materials" in effect on the date of invitation for bids, and the Supplemental Specifications and Recurring Special Provisions indicated on the Check Sheet included herein which apply to and govern the construction of FAP Route 613 (US 34), Section (6CS, 26CS, 7)RS-2 & 8RS-5, Henry/Bureau Counties, Contract #64775, and in case of conflict with any part or parts of said Specifications, the said Special Provisions shall take precedence and shall govern.

#### LOCATION OF PROJECT

US 34 from IL 78 (Main Street) in Kewanee to US 6 near Sheffield.

#### DESCRIPTION OF PROJECT

Bituminous resurfacing and patching of approximately 10.70 miles along US 34 from IL 78 (Main Street) in Kewanee to US 6 near Sheffield.

#### TRAFFIC CONTROL PLAN

Effective January 14, 1999

Traffic Control shall be according to the applicable sections of the Standard Specifications for Road and Bridge Construction, the applicable guidelines contained in the National Manual on Uniform Traffic Control Devices for Streets and Highways, Illinois Supplement to the National Manual on Uniform Traffic Control Devices, these special provisions, and any special details and Highway Standards contained herein and in the plans.

Special attention is called to Articles 107.09 and 107.14 of the Standard Specifications for Road and Bridge Construction and the following Highway Standards relating to traffic control.

Standards:

701006	701011	701201	701301	701306	701311
	701326	701336	701501	702001	

Details:

District Standard 91.2 Rough Grooved Surface Sign

A minimum of 3 drums spaced at 1.2 meters (4 feet) shall be placed at each return when the sideroad is open.

BUMP (W8-1(O)48) signs shall be installed as directed by the Engineer.

Uneven Pavement Signs: "UNEVEN LANES" W8-11(O)48 signs shall be installed as directed by the Engineer.

The cost of furnishing, erecting, maintaining, covering and removing the signs shall be included in the cost of TRAFFIC CONTROL AND PROTECTION STANDARD 701306 and TRAFFIC CONTROL AND PROTECTION STANDARD 701501.

Low Shoulder Signs: "LOW SHOULDER" W8-9(O)48 signs shall be installed as directed by the Engineer.

The cost of furnishing, erecting, maintaining, covering and removing the signs shall be included in the cost of TRAFFIC CONTROL AND PROTECTION STANDARD 701306 and TRAFFIC CONTROL AND PROTECTION STANDARD 701501.

Pilot Car: During the bituminous priming operation, the Contractor shall be required to provide a pilot car to lead the traffic through the areas primed.

The pilot car shall be a pickup truck, carrying the Contractor's company insignia, equipped with "PILOT CAR - FOLLOW ME" (G-20-4(0)) signs. Two signs shall be mounted on the vehicle so as to be clearly visible from both directions. The bottom of the sign shall be mounted at least 300 mm (one foot) above the top of the cab. The pilot car shall be equipped with a two-way radio so normal communication with the flagger at each end of the work area can be maintained.

The pilot car shall be paid for by the day. If the pilot car is used less than four hours, the operation will be counted as a half day.

This work will be paid for at the contract unit price Per Day for PILOT CAR for each car required by the Engineer.

Maintenance of Traffic: The Contractor shall be required to notify the Henry/Bureau County Highway Department and/or corresponding Township Commissioner for any sideroad closure or opening.

The sawing of patches, resurfacing and placing of shoulder aggregate shall be completed using Traffic Control and Protection Standard 701306 and in urban areas Traffic Control and Protection Standard 701501.

Guardrail work shall be completed using Traffic Control and Protection Standard 701006 and Article 701.05(f).

The mainline shall be kept open to one-way traffic at all times during working hours and two-way traffic during non-working hours.

For earthwork at guardrail and manhole special locations use TRAFFIC CONTROL AND PROTECTION STANDARD 701201.

The removal and replacement of widening on the inside of curves shall be completed using Traffic Control and Protection Standard 701326.

The pavement patch removal and replacement shall be completed using Traffic Control and Protection Standard 701201.

The Contractor shall have all lanes open on weekends, unless prior approval is obtained from the Resident Engineer.

The pavement striping shall be completed using Traffic Control and Protection Standard 701311.

The installation of curb shall be completed using Traffic Control and Protection Standard 701501.

**GUARDRAIL REMOVAL**

Effective August 20, 1990

Revised August 26, 1997

This work shall be done in accordance with Section 632 of the Standard Specifications except that all removed guardrail will become the property of the Contractor.

This work will be paid for at the contract unit price per meter (foot) for GUARDRAIL REMOVAL, measured from center-to-center of end post.

**SEEDING, CLASS 6 (MODIFIED)**

Effective January 5, 2000

This work shall be done according to Section 250 of the Standard Specifications and the following seeding mixture.

TYPE	SEEDS	KG/Hectare ((lbs./Acre)
Conservation Mixture Modified	Smooth Brome Grass	70 (60)
	Vernal Alfalfa 2	25 (20)
	Perennial Ryegrass	45 (40)
	Oats, Spring	55 (48)

This work will be paid for at the contract unit price per hectare (acre) for SEEDING, CLASS 6 (MODIFIED).

**GEOTECHNICAL REINFORCEMENT**

Revised September 1, 2004

Biaxial Geogrid Flat Installation

This work consists of furnishing and installing an integrally-formed polypropylene geotechnical grid reinforcement material. The grid shall have an aperture, rib and junction cross section sufficient to permit significant mechanical interlock with the material being reinforced. There shall be a high continuity of tensile strength through all ribs and junctions of the grid material to reinforce the embankment or subgrade as shown on the plans and specifications.

Materials: Each layer of geogrid shall conform to the property requirements listed below. Multiple layers of lesser strength materials will not be accepted.

**Reinforcement and Interlock**

<b><u>Property</u></b>	<b><u>Test Method</u></b>	<b><u>Value</u></b>
<b><u>Tensile Modulus:</u></b>		
▪ True Tensile Modulus	ASTMD 6637	17,000 lb./ft. (Min.)
▪ True Tensile Strength @ 2% Strain		280 lb./ft. (Min.)
▪ True Tensile Strength @5% Strain		580 lb./ft. (Min.)
<b><u>Apertures:</u></b>		
▪ Aperture Stability	USACE*	2.7 in. – lb./deg. (min.)
▪ Open Area	COE Method Modified**	70% (Nom.)
* Resistance to in-plane rotational movement measured by applying a 20 kg-cm moment to the central junction of a 9 inch x 9 inch specimen restrained at its perimeter (U.S. Army Corps of Engineers Methodology for measurement of Torsional Rigidity).		
** Percent open area measured without magnification by Corps of Engineers method as specified in CW 02215 Civil Works Construction Guide, November, 1977.		
<b><u>Structural Integrity:</u></b>		
▪ Flexural Stiffness	ASTM D-5732-95 ***	0.2 in.-lb. (Min.)
▪ Junction Efficiency	GRI GG2-87****	90% (Min.)
*** Resistance to bending force measured via ASTM D-5732-95, using specimens of width two ribs wide, with transverse ribs cut flush with exterior edges of longitudinal ribs (as a “ladder), and of length sufficiently long to enable measurement of the overhang dimension. The overall Flexural Stiffness is calculated as the square root of the product of machine-and cross-machine-direction Flexural Stiffness values.		
**** Load transfer capability measured via GRI-GG2-87. Expressed as a percentage of ultimate tensile strength.		

	<b><u>Material</u></b>	
Polypropylene	ASTM D 1401 Group I/Class 1/Grade 2	98% (Min.)
Carbon Black	ASTM 4218	0.5% (Min.)

The supplier should provide a certification that their product meets the above requirements.

The geotechnical reinforcement shall be placed as described herein or as shown on the cross sections.

Geogrid shall be delivered to the jobsite in such a manner as to facilitate handling and incorporation into the work without damage. Material shall be stored in such a manner as to prevent exposure to direct sunlight and damage by other construction activities.



Prior to the installation of the geogrid, the application surface shall be cleared of debris, sharp objects and trees. Tree stumps shall be cut to the level of the ground surface. If the stumps cannot be cut to the ground level, they shall be completely removed. In the case of subgrades, all wheel tracks or ruts in excess of 75 mm (3 inches) in depth shall be graded smooth or otherwise filled with soil to provide a reasonably smooth surface.

The geotechnical reinforcement shall be placed with the "roll length" parallel to the pavement. Fabric of insufficient width or length to fully cover the specified area shall be lapped a minimum of 600 mm (24 inches).

Installation:

The granular blanket shall be constructed to the width and depth required on the plans. Unless otherwise specified, the material shall be back-dumped on the Geogrid in a sequence of operations beginning at the outer edges of the treatment area with subsequent placement towards the middle.

Placement of material on the Geogrid shall be accomplished by spreading dumped material off of previously placed material with a bulldozer blade or endloader, in such a manner as to prevent tearing or shoving of the Geogrid. Dumping of material directly on the Geogrid will only be permitted to establish an initial working platform. No construction equipment shall be allowed on the Geogrid prior to placement of the granular blanket.

Unless otherwise specified in the plans or Special Provisions, the granular material, shall be placed to the full required thickness and compacted to the satisfaction of the Engineer.

Geogrid which is damaged during installation or subsequent placement of granular material, due to failure of the Contractor to comply with these provisions, shall be repaired or replaced at his expense, including costs of removal and replacement of the granular material.

Torn Geogrid may be patched in-place by cutting and placing a piece of the same Geogrid over the tear. The dimensions of the patch shall be at least 600 mm (2 feet) larger than the largest dimension of the tear and it shall be weighted or otherwise secured to prevent the granular material from causing lap separation.

Method of Measurement:

Geotechnical Reinforcement will be measured in square meters (square yards) for the surface area placed. The excavation, replacement and compaction of the granular layer shall be paid for separately. Each layer of geogrid will be paid for separately.

Basis of Payment:

This work will be measured in place and the area computed in square yards. The work will be paid for at the contract unit price per Square Meter (Square Yard) for GEOTECHNICAL REINFORCEMENT.

**FURNISHED EXCAVATION**

Effective July 1, 1994

Revised May 16, 1995

The Furnished Excavation shall be measured by the truck load method. Prior to the start of work the Contractor and the Engineer shall agree to standard volume for the trucks utilized by the Contractor.

Suitable excavated materials from the project shall not be wasted without permission of the Engineer. Embankment and mechanical compaction will not be measured for payment.

This work shall be paid for at the contract unit price per Cubic Meter (Cubic Yard) for FURNISHED EXCAVATION.

**REMOVE EXISTING CULVERTS**

Effective August 24, 1995

This work shall consist of the removal and satisfactory disposal of existing culverts at locations shown in the plans. These culverts may be concrete or clay, with or without concrete headwalls, or metal pipes with concrete headwalls. Metal pipes without headwalls will not be paid for with this pay item, but shall be removed as specified in the General Notes.

If materials resulting from the removal of the concrete culverts and headwalls are to be used in the embankment, they shall conform to, and be placed and compacted in accordance with Section 205 of the Standard Specifications.

All corrugated metal pipe culverts in condition for re-use shall be cleaned and stored along the right of way. Any re-usable pipe damaged by the Contractor shall be replaced by him at his expense.

All unusable material shall be disposed of by the Contractor at his expense.

All costs incurred in conforming with this special provision shall be included in the contract unit price Each for REMOVE EXISTING CULVERTS.

**AUTHORITY OF RAILROAD ENGINEER (BDE)**

Effective: July 1, 2004

Revise Article 105.02 of the Standard Specifications to read:

**“105.02 Authority of Railroad Engineer.** Whenever the safety of railroad traffic is concerned, the Railroad Engineer will have jurisdiction over safety measures to be taken and his/her decision as to the methods, procedures, and measures used shall be final, and any and all Contractors performing work near or about the railroad shall be governed by such decision. Instructions to the Contractor by the Railroad Engineer will be given through the Engineer. Work ordered as specified herein will be classified and paid for according to Article 104.02. Work performed for the Contractor’s convenience will not be paid for separately but shall be considered as included in the contract.”

**BITUMINOUS CONCRETE SURFACE COURSE (BDE)**

Effective: April 1, 2001

Revised: April 1, 2003

Replace the fourth paragraph of Article 406.23(b) of the Standard Specifications with the following:

“Mixture for cracks, joints, flangeways, leveling binder (machine method), leveling binder (hand method) and binder course in excess of 103 percent of the quantity specified by the Engineer will not be measured for payment.

Surface course mixture in excess of 103 percent of adjusted plan quantity will not be measured for payment. The adjusted plan quantity for surface course mixtures will be calculated as follows:

Adjusted Plan Quantity = C x quantity shown on the plans or as specified by the Engineer.

where C =      metric:  $C = \frac{G_{mb} \times 24.99}{U}$               English:  $C = \frac{G_{mb} \times 46.8}{U}$

and where:

$G_{mb}$  = average bulk specific gravity from approved mix design.

U = Unit weight of surface course shown on the plans in kg/sq m/25 mm (lb/sq yd/in.), used to estimate plan quantity.

24.99 = metric constant.

46.8 = English constant.

If project circumstances warrant a new surface course mix design, the above equations shall be used to calculate the adjusted plan quantity for each mix design using its respective average bulk specific gravity.”

**BITUMINOUS EQUIPMENT, SPREADING AND FINISHING MACHINE (BDE)**

Effective: January 1, 2005

Revise the fourth paragraph of Article 1102.03 of the Standard Specifications to read:

“The paver shall be equipped with a receiving hopper having sufficient capacity for a uniform spreading operation. The hopper shall be equipped with a distribution system to uniformly place a non-segregated mixture in front of the screed. The distribution system shall have chain curtains, deflector plates, and/or other devices designed and built by the paver manufacturer to prevent segregation during distribution of the mixture from the hopper to the paver screed. The Contractor shall submit a written certification that the devices recommended by the paver manufacturer to prevent segregation have been installed and are operational. Prior to paving, the Contractor, in the presence of the Engineer, shall visually inspect paver parts specifically identified by the manufacturer for excessive wear and the need for replacement. The Contractor shall supply a completed check list to the Engineer noting the condition of the parts. Worn parts shall be replaced. The Engineer may require an additional inspection prior to the placement of a surface course or at other times throughout the work.”

**BUTT JOINTS (BDE)**

Effective: April 1, 2004

Revised: April 1, 2005

Revise Article 406.18 of the Standard Specifications to read:

**“406.18 Butt Joints.** Butt joints shall be constructed according to the details shown on the plans. The surface removal shall be performed according to Section 440. Construction of butt joints shall not begin prior to beginning general operations on the project.

When butt joints are to be constructed under traffic, temporary ramps shall be constructed and maintained at both the upstream and downstream ends of the surface removal areas immediately upon completion of the surface removal operation. The temporary ramps shall be constructed by the following methods.

- (a) Temporary Bituminous Ramps. Temporary bituminous ramps shall have a minimum taper rate of 1:40 (V:H). The bituminous material used shall meet the approval of the Engineer. Cold-milled bituminous tailings will not be acceptable.
- (b) Temporary Rubber Ramps. Temporary rubber ramps shall only be used on roadways with permanent posted speeds of 55 mph or less. The ramps shall have a minimum taper rate of 1:30 (V:H). The leading edge of the rubber ramp shall have a maximum thickness of 6 mm (1/4 in.) and the trailing edge shall match the height of the adjacent pavement  $\pm$  6 mm (1/4 in.).

The rubber material shall conform to the following.

Property	Test Method	Requirement
Durometer Hardness, Shore A	ASTM D 2240	80 $\pm$ 10
Tensile Strength	ASTM D 412	5500 kPa (800 psi) min.
Elongation, percent	ASTM D 412	100 min.
Specific Gravity	ASTM D 297	1.1-1.3
Brittleness	ASTM D 746	-40 °C (-40 °F)

The rubber ramps shall be installed according to the manufacturer’s specifications and fastened with the anchors provided. Rubber ramps that fail to stay in place or create a traffic hazard shall be replaced immediately with temporary bituminous ramps at the Contractor’s expense.

The temporary ramps shall be removed just prior to placing the proposed surface course. If work is suspended for the winter season prior to completion of surface course construction, precut butt joints shall be filled to the elevation of the existing pavement surface with compacted bituminous concrete surface course or binder course.”

80118

**CONCRETE ADMIXTURES (BDE)**

Effective: January 1, 2003

Revised: July 1, 2004

Revise Article 1020.05(b) of the Standard Specifications to read:

“(b) Admixtures. Except as specified, the use of admixtures to increase the workability or to accelerate the hardening of the concrete will be permitted only when approved in writing

by the Engineer. The Department will maintain an Approved List of Concrete Admixtures. When the Department permits the use of a calcium chloride accelerator, it shall be according to Article 442.02, Note 5.

When the atmosphere or concrete temperature is 18 °C (65 °F) or higher, a retarding admixture meeting the requirements of Article 1021.03 shall be used in the Class BD Concrete and portland cement concrete bridge deck overlays. The amount of retarding admixture to be used will be determined by the Engineer. The proportions of the ingredients of the concrete shall be the same as without the retarding admixture except that the amount of mixing water shall be reduced, as may be necessary, in order to maintain the consistency of the concrete as required. In addition, a high range water-reducing admixture shall be used in Class BD Concrete. The amount of high range water-reducing admixture will be determined by the Engineer. At the option of the Contractor, a water-reducing admixture may be used. Type I cement shall be used.

For Class PC and PS Concrete, a retarding admixture may be added to the concrete mixture when the concrete temperature is 18 °C (65 °F) or higher. Other admixtures may be used when approved by the Engineer, or if specified by the contract. If an accelerating admixture is permitted by the Engineer, it shall be the non-chloride type.

At the Contractor's option, admixtures in addition to an air-entraining admixture may be used for Class PP-1 concrete. The accelerator shall be the non-chloride type. If a water-reducing or retarding admixture is used, the cement factor may be reduced a maximum 18 kg/cu m (0.30 hundredweight/cu yd). If a high range water-reducing admixture is used, the cement factor may be reduced a maximum 36 kg/cu m (0.60 hundredweight/cu yd). Cement factor reductions shall not be cumulative when using multiple admixtures. An accelerator shall always be added prior to a high range water-reducing admixture, if both are used.

If Class C fly ash or ground granulated blast-furnace slag is used in Class PP-1 concrete, a water-reducing or high range water-reducing admixture shall be used. However, the cement factor shall not be reduced if a water-reducing, retarding, or high range water-reducing admixture is used. In addition, an accelerator shall not be used.

For Class PP-2 or PP-3 concrete, a non-chloride accelerator followed by a high range water-reducing admixture shall be used, in addition to the air-entraining admixture. For Class PP-3 concrete, the non-chloride accelerator shall be calcium nitrite.

For Class PP-2 or PP-3 concrete, the Contractor has the option to use a water-reducing admixture. A retarding admixture shall not be used unless approved by the Engineer. A water-reducing, retarding, or high range water-reducing admixture shall not be used to reduce the cement factor.

When the air temperature is less than 13 °C (55 °F) for Class PP-1 or PP-2 concrete, the non-chloride accelerator shall be calcium nitrite.

For Class PP-4 concrete, a high range water-reducing admixture shall be used in addition to the air-entraining admixture. The Contractor has the option to use a water-reducing admixture. An accelerator shall not be used. For stationary or truck mixed concrete, a retarding admixture shall be used to allow for haul time. The Contractor has the option to use a mobile portland cement concrete plant according to Article 1103.04,

but a retarding admixture shall not be used unless approved by the Engineer. A water-reducing, retarding, or high range water-reducing admixture shall not be used to reduce the cement factor.

If the Department specifies a calcium chloride accelerator for Class PP-1 concrete, the maximum chloride dosage shall be 1.0 L (1.0 quart) of solution per 45 kg (100 lb) of cement. The dosage may be increased to a maximum 2.0 L (2.0 quarts) per 45 kg (100 lb) of cement if approved by the Engineer. If the Department specifies a calcium chloride accelerator for Class PP-2 concrete, the maximum chloride dosage shall be 1.3 L (1.3 quarts) of solution per 45 kg (100 lb) of cement. The dosage may be increased to a maximum 2.6 L (2.6 quarts) per 45 kg (100 lb) of cement if approved by the Engineer.

For Class PV, MS, SI, RR, SC and SH concrete, at the option of the Contractor, or when specified by the Engineer, a water-reducing admixture or a retarding admixture may be used. The amount of water-reducing admixture or retarding admixture permitted will be determined by the Engineer. The air-entraining admixture and other admixtures shall be added to the concrete separately, and shall be permitted to intermingle only after they have separately entered the concrete batch. The sequence, method and equipment for adding the admixtures shall be approved by the Engineer. The water-reducing admixture shall not delay the initial set of the concrete by more than one hour. Type I cement shall be used.

When a water-reducing admixture is added, a cement factor reduction of up to 18 kg/cu m (0.30 hundredweight/cu yd), from the concrete designed for a specific slump without the admixture, will be permitted for Class PV, MS, SI, RR, SC and SH concrete. When an approved high range water-reducing admixture is used, a cement factor reduction of up to 36 kg/cu m (0.60 hundredweight/cu yd), from a specific water cement/ratio without the admixture, will be permitted based on a 14 percent minimum water reduction. This is applicable to Class PV, MS, SI, RR, SC and SH concrete. A cement factor below 320 kg/cu m (5.35 hundredweight/cu yd) will not be permitted for Class PV, MS, SI, RR, SC and SH concrete. A cement factor reduction will not be allowed for concrete placed underwater. Cement factor reductions shall not be cumulative when using multiple admixtures.

For use of admixtures to control concrete temperature, refer to Articles 1020.14(a) and 1020.14(b).

The maximum slumps given in Table 1 may be increased to 175 mm (7 in.) when a high range water-reducing admixture is used for all classes of concrete except Class PV and PP."

Revise Section 1021 of the Standard Specifications to read:

#### **"SECTION 1021. CONCRETE ADMIXTURES"**

**1021.01 General.** Admixtures shall be furnished in liquid form ready for use. The admixtures may be delivered in the manufacturer's original containers, bulk tank trucks or such containers or tanks as are acceptable to the Engineer. Delivery shall be accompanied by a ticket which clearly identifies the manufacturer and trade name of the material. Containers shall be readily identifiable to the satisfaction of the Engineer as to manufacturer and trade name of the material they contain.

Prior to inclusion of a product on the Department's Approved List of Concrete Admixtures, the manufacturer shall submit a report prepared by an independent laboratory accredited by the AASHTO Accreditation Program. The report shall show the results of physical tests conducted no more than five years prior to the time of submittal, according to applicable specifications.

Tests shall be conducted using materials and methods specified on a "test" concrete and a "reference" concrete, together with a certification that no changes have been made in the formulation of the material since the performance of the tests. Per the manufacturer's option, the cement content for all required tests shall either be according to applicable specifications or 335 kg/cu m (5.65 cwt/cu yd). Compressive strength test results for six months and one year will not be required.

In addition to the report, the manufacturer shall submit AASHTO T 197 water content and set time test results on the standard cement used by the Department. The test and reference concrete mixture shall contain a cement content of 335 kg/cu m (5.65 cwt/cu yd). The manufacturer may select their lab or an independent lab to perform this testing. The laboratory is not required to be accredited by the AASHTO Accreditation Program.

Prior to the approval of an admixture, the Engineer may conduct all or part of the applicable tests on a sample that is representative of the material to be furnished. The test and reference concrete mixtures tested by the Engineer will contain a cement content of 335 kg/cu m (5.65 cwt/cu yd). For freeze-thaw testing, the Department will perform the test according to Illinois Modified AASHTO T 161, Procedure B.

The manufacturer shall include in the submittal the following information according to ASTM C 494; the average and manufacturing range of specific gravity, the average and manufacturing range of solids in the solution, and the average and manufacturing range of pH. The submittal shall also include an infrared spectrophotometer trace no more than five years old.

When test results are more than seven years old, the manufacturer shall re-submit the infrared spectrophotometer trace and the report prepared by an independent laboratory accredited by the AASHTO Accreditation Program.

All admixtures, except chloride-based accelerators, shall contain no more than 0.3 percent chloride by mass (weight).

**1021.02 Air-Entraining Admixtures.** Air-entraining admixtures shall conform to the requirements of AASHTO M 154.

If the manufacturer certifies that the air-entraining admixture is an aqueous solution of Vinsol resin that has been neutralized with sodium hydroxide (caustic soda), testing for compliance with the requirements may be waived by the Engineer. In the certification, the manufacturer shall show complete information with respect to the formulation of the solution, including the number of parts of Vinsol resin to each part of sodium hydroxide. Before the approval of its use is granted, the Engineer will test the solution for its air-entraining quality in comparison with a solution prepared and kept for that purpose.

**1021.03 Retarding and Water-Reducing Admixtures.** The admixture shall comply with the following requirements:

- (a) The retarding admixture shall comply with the requirements of AASHTO M 194, Type B (retarding) or Type D (water-reducing and retarding).
- (b) The water-reducing admixture shall comply with the requirements of AASHTO M 194, Type A.
- (c) The high range water-reducing admixture shall comply with the requirements of AASHTO M 194, Type F (high range water-reducing) or Type G (high range water-reducing and retarding).

When a Type F or Type G high range water-reducing admixture is used, water-cement ratios shall be a minimum of 0.32.

Type F or Type G admixtures may be used, subject to the following restrictions:

For Class MS, SI, RR, SC and SH concrete, the water-cement ratio shall be a maximum of 0.44.

The Type F or Type G admixture shall be added at the jobsite unless otherwise directed by the Engineer. The initial slump shall be a minimum of 40 mm (1 1/2 in.) prior to addition of the Type F or Type G admixture, except as approved by the Engineer.

When a Type F or Type G admixture is used, retempering with water or with a Type G admixture will not be allowed. An additional dosage of a Type F admixture, not to exceed 40 percent of the original dosage, may be used to retemper concrete once, provided set time is not unduly affected. A second retempering with a Type F admixture may be used for all classes of concrete except Class PP and SC, provided that the dosage does not exceed the dosage used for the first retempering, and provided that the set time is not unduly affected. No further retempering will be allowed.

Air tests shall be performed after the addition of the Type F or Type G admixture.

**1021.04 Set Accelerating Admixtures.** The admixture shall comply with the requirements of AASHTO M 194, Type C (accelerating) or Type E (water reducing and accelerating)”

#### **CORRUGATED METAL PIPE CULVERTS (BDE)**

Effective: August 1, 2003

Revised: July 1, 2004

Revise the fourth paragraph of Article 542.04(d) of the Standard Specifications to read:

“When corrugated steel or aluminum alloy culvert pipe (including bituminous coated steel or aluminum and pre-coated steel) is used, the pipe shall be placed such that the longitudinal lap is placed at the sides and separate sections of pipe shall be joined with a hugger-type band. When the pipes are fabricated with a smooth sleeve-type coupler, the gasket shall meet the requirements of Article 1006.01.”

Add the following paragraph after the first paragraph of Article 1006.01 of the Standard Specifications:



“Round pipes 1200 mm (48 in.) in diameter and smaller may be fabricated with a smooth sleeve-type coupler. Gasket material on the smooth sleeve-type coupler shall be polyisoprene or equal with a durometer hardness of 45±5 (ASTM D 2240, Shore A). Pipe used with smooth sleeve-type couplers shall contain a homing mark that indicates when the joint is tight. The homing mark shall consist of a painted stripe around the circumference of the male end of the pipe.”

Delete the last sentence of the first paragraph of Article 1006.01(a) of the Standard Specifications.

Add the following paragraph after the first paragraph of Article 1006.03 of the Standard Specifications:

“Round pipes 1200 mm (48 in.) in diameter and smaller may be fabricated with a smooth sleeve-type coupler. Gasket material on the smooth sleeve-type coupler shall be polyisoprene or equal with a durometer hardness of 45±5 (ASTM D 2240, Shore A). Pipe used with smooth sleeve-type couplers shall contain a homing mark that indicates when the joint is tight. The homing mark shall consist of a painted stripe around the circumference of the male end of the pipe.”

**CURING AND PROTECTION OF CONCRETE CONSTRUCTION (BDE)**

Effective: January 1, 2004

Revise the second and third sentences of the eleventh paragraph of Article 503.06 of the Standard Specifications to read:

“Forms on substructure units shall remain in place at least 24 hours. The method of form removal shall not result in damage to the concrete.”

Delete the twentieth paragraph of Article 503.22 of the Standard Specifications.

Revise the “Unit Price Adjustments” table of Article 503.22 of the Standard Specifications to read:

“UNIT PRICE ADJUSTMENTS	
Type of Construction	Percent Adjustment in Unit Price
For concrete in substructures, culverts (having a waterway opening of more than 1 sq m (10 sq ft)), pump houses, and retaining walls (except concrete pilings, footings and foundation seals): When protected by:	
Protection Method II	115%
Protection Method I	110%
For concrete in superstructures: When protected by:	
Protection Method II	123%
Protection Method I	115%
For concrete in footings: When protected by:	
Protection Method I, II or III	107%
For concrete in slope walls: When protected by:	
Protection Method I	107%”

Delete the fourth paragraph of Article 504.05(a) of the Standard Specifications.

Revise the second and third sentences of the fifth paragraph of Article 504.05(a) of the Standard Specifications to read:

“All test specimens shall be cured with the units according to Article 1020.13.”

Revise the first paragraph of Article 504.06(c)(6) of the Standard Specifications to read:

“Curing and Low Air Temperature Protection. The curing and protection for precast, prestressed concrete members shall be according to Article 1020.13 and this Article.”

Revise the first sentence of the second paragraph of Article 504.06(c)(6) of the Standard Specifications to read:

“For curing, air vents shall be in place, and shall be so arranged that no water can enter the void tubes during the curing of the members.”

Revise the first sentence of the third paragraph of Article 504.06(c)(6) of the Standard Specifications to read:

“As soon as each member is finished, the concrete shall be covered with curing material according to Article 1020.13.”

Revise the eighth paragraph of Article 504.06(c)(6) of the Standard Specifications to read:

“The prestressing force shall not be transferred to any member before the concrete has attained the compressive strength of 28,000 kPa (4000 psi) or other higher compressive release strength specified on the plans, as determined from tests of 150 mm (6 in.) by 300 mm (12 in.) cylinders cured with the member according to Article 1020.13. Members shall not be shipped until 28-day strengths have been attained and members have a yard age of at least 4 days.”

Delete the third paragraph of Article 512.03(a) of the Standard Specifications.

Delete the last sentence of the second paragraph of Article 512.04(d) of the Standard Specifications.

Revise the “Index Table of Curing and Protection of Concrete Construction” table of Article 1020.13 of the Standard Specifications to read:

"INDEX TABLE OF CURING AND PROTECTION OF CONCRETE CONSTRUCTION			
TYPE OF CONSTRUCTION	CURING METHODS	CURING PERIOD DAYS	LOW AIR TEMPERATURE PROTECTION METHODS
<b>Cast-in-Place Concrete:</b> <sup>11/</sup>			
Pavement			
Shoulder	1020.13(a)(1)(2)(3)(4)(5) <sup>3/ 5/</sup>	3	1020.13(c)
Base Course			
Base Course Widening	1020.13(a)(1)(2)(3)(4)(5) <sup>1/ 2/</sup>	3	1020.13(c)
Driveway			
Median			
Curb			
Gutter	1020.13(a)(1)(2)(3)(4)(5) <sup>4/ 5/</sup>	3	1020.13(c) <sup>16/</sup>
Curb and Gutter			
Sidewalk			
Slope Wall			
Paved Ditch			
Catch Basin			
Manhole	1020.13(a)(1)(2)(3)(4)(5) <sup>4/</sup>	3	1020.13(c)
Inlet			
Valve Vault			
Pavement Patching	1020.13(a)(1)(2)(3)(4)(5) <sup>2/</sup>	3 <sup>12/</sup>	1020.13(c)
Pavement Replacement	1020.13(a)(1)(2)(3)(4)(5) <sup>1/ 2/</sup>	3	442.06(h) and 1020.13(c)
Railroad Crossing	1020.13(a)(3)(5)	1	1020.13(c)
Piles	1020.13(a)(3)(5)	7	1020.13(e)(1)(2)(3)
Footings			
Foundation Seals	1020.13(a)(1)(2)(3)(4)(5) <sup>4/6/</sup>	7	1020.13(e)(1)(2)(3)
Substructure	1020.13(a)(1)(2)(3)(4)(5) <sup>1/7/</sup>	7	1020.13(e)(1)(2)(3)
Superstructure (except deck)	1020.13(a)(1)(2)(3)(5) <sup>8/</sup>	7	1020.13(e)(1)(2)
Deck	1020.13(a)(5)	7	1020.13(e)(1)(2) <sup>17/</sup>
Retaining Walls	1020.13(a)(1)(2)(3)(4)(5) <sup>1/7/</sup>	7	1020.13(e)(1)(2)
Pump Houses	1020.13(a)(1)(2)(3)(4)(5) <sup>1/</sup>	7	1020.13(e)(1)(2)
Culverts	1020.13(a)(1)(2)(3)(4)(5) <sup>4/6/</sup>	7	1020.13(e)(1)(2) <sup>18/</sup>
Other Incidental Concrete	1020.13(a)(1)(2)(3)(5)	3	1020.13(c)
<b>Precast Concrete:</b> <sup>11/</sup>			
Bridge Beams			
Piles			
Bridge Slabs	1020.13(a)(3)(5) <sup>9/10/</sup>	As required.	<sup>13/</sup> 504.06(c)(6), 1020.13(e)(2) <sup>19/</sup>
Nelson Type Structural Member			
All Other Precast Items	1020.13(a)(3)(4)(5) <sup>2/9/10/</sup>	As required.	<sup>14/</sup> 504.06(c)(6), 1020.13(e)(2) <sup>19/</sup>
<b>Precast, Prestressed Concrete:</b> <sup>11/</sup>			
All Items	1020.13(a)(3)(5) <sup>9/10/</sup>	Until strand tensioning is released.	<sup>15/</sup> 504.06(c)(6), 1020.13(e)(2) <sup>19/</sup>

Notes-General:

- 1/ Type I, membrane curing only
- 2/ Type II, membrane curing only
- 3/ Type III, membrane curing only
- 4/ Type I, II and III membrane curing
- 5/ Membrane curing will not be permitted between November 1 and April 15.

- 6/ The use of water to inundate footings, foundation seals or the bottom slab of culverts is permissible when approved by the Engineer, provided the water temperature can be maintained at 7 °C ( 45 °F) or higher.
- 7/ Asphalt Emulsion for Waterproofing may be used in lieu of other curing methods when specified and permitted according to Article 503.18.
- 8/ On non-traffic surfaces which receive protective coat according to Article 503.19, a linseed oil emulsion curing compound may be used as a substitute for protective coat and other curing methods. The linseed emulsion curing compound will be permitted between April 16 and October 31 of the same year, provided it is applied with a mechanical sprayer according to Article 1101.09 (b), and meets the material requirements of Article 1022.07.
- 9/ Steam curing (heat and moisture) is acceptable and shall be accomplished by the method specified in Article 504.06(c)(6).
- 10/ A moist room according to AASHTO M 201 is acceptable for curing.
- 11/ If curing is required and interrupted because of form removal for cast-in-place concrete items, precast concrete products, or precast prestressed concrete products, the curing shall be resumed within two hours from the start of the form removal.
- 12/ Curing maintained only until opening strength is attained, with a maximum curing period of three days.
- 13/ The curing period shall end when the concrete has attained the mix design strength. The producer has the option to discontinue curing when the concrete has attained 80 percent of the mix design strength or after seven days. All strength test specimens shall remain with the units and shall be subjected to the same curing method and environmental condition as the units, until the time of testing.
- 14/ The producer shall determine the curing period or may elect to not cure the product. All strength test specimens shall remain with the units and shall be subjected to the same curing method and environmental condition as the units, until the time of testing.
- 15/ The producer has the option to continue curing after strand release.
- 16/ When structural steel or structural concrete is in place above slope wall, Article 1020.13(c) shall not apply. The protection method shall be according to Article 1020.13(e)(1).
- 17/ When Article 1020.13(e)(2) is used to protect the deck, the housing may enclose only the bottom and sides. The top surface shall be protected according to Article 1020.13(e)(1).
- 18/ For culverts having a waterway opening of 1 sq m (10 sq ft) or less, the culverts may be protected according to Article 1020.13(e)(3).
- 19/ The seven day protection period in the first paragraph of Article 1020.13(e)(2) shall not apply. The protection period shall end when curing is finished. For the third paragraph of Article 1020.13(e)(2), the decrease in temperature shall be according to Article 504.06(c)(6)."

Add the following to Article 1020.13(a) of the Standard Specifications:

“(5) Wetted Cotton Mat Method. After the surface of concrete has been textured or finished, it shall be covered immediately with dry cotton mats. The cotton mats shall be placed in a manner which will not mar the concrete surface. A texture resulting from the cotton mat material is acceptable. The cotton mats shall then be wetted immediately and thoroughly soaked with a gentle spray of water. For bridge decks, a foot bridge shall be used to place and wet the cotton mats.

The cotton mats shall be maintained in a wetted condition until the concrete has hardened sufficiently to place soaker hoses without marring the concrete surface.

The soaker hoses shall be placed on top of the cotton mats at a maximum 1.2 m (4 ft) spacing. The cotton mats shall be kept wet with a continuous supply of water for the remainder of the curing period. Other continuous wetting systems may be used if approved by the Engineer.

After placement of the soaker hoses, the cotton mats shall be covered with white polyethylene sheeting or burlap-polyethylene blankets.

For construction items other than bridge decks, soaker hoses or a continuous wetting system will not be required if the alternative method keeps the cotton mats wet. Periodic wetting of the cotton mats is acceptable.

For areas inaccessible to the cotton mats on bridge decks, curing shall be according to Article 1020.13(a)(3)."

Revise the first paragraph of Article 1020.13(c) of the Standard Specifications to read:

"Protection of Portland Cement Concrete, Other Than Structures, From Low Air Temperatures. When the official National Weather Service forecast for the construction area predicts a low of 0 °C (32 °F), or lower, or if the actual temperature drops to 0 °C (32 °F), or lower, concrete less than 72 hours old shall be provided at least the following protection:"

Delete Article 1020.13(d) and Articles 1020.13(d)(1),(2),(3),(4) of the Standard Specifications.

Revise the first five paragraphs of Article 1020.13(e) of the Standard Specifications to read:

"Protection of Portland Cement Concrete Structures From Low Air Temperatures. When the official National Weather Service Forecast for the construction area predicts a low below 7 °C (45 °F), or if the actual temperature drops below 7 °C (45 °F), concrete less than 72 hours old shall be provided protection. Concrete shall also be provided protection when placed during the winter period of December 1 through March 15. Concrete shall not be placed until the materials, facilities and equipment for protection are approved by the Engineer.

When directed by the Engineer, the Contractor may be required to place concrete during the winter period. If winter construction is specified, the Contractor shall proceed with the construction, including concrete, excavation, pile driving, steel erection and all appurtenant work required for the complete construction of the item, except at times when weather conditions make such operations impracticable.

Regardless of the precautions taken, the Contractor shall be responsible for protection of the concrete placed and any concrete damaged by cold temperatures shall be removed and replaced by the Contractor at his/her own expense."

Add the following at the end of the third paragraph of Article 1020.13(e)(1) of the Standard Specifications:

"The Contractor shall provide means for checking the temperature of the surface of the concrete during the protection period."

Revise the second sentence of the first paragraph of Article 1020.13(e)(2) of the Standard Specifications to read:

“The Contractor shall provide means for checking the temperature of the surface of the concrete or air temperature within the housing during the protection period.”

Delete the last sentence of the first paragraph of Article 1020.13(e)(3) of the Standard Specifications.

Add the following Article to Section 1022 of the Standard Specifications:

**“1022.06 Cotton Mats.** Cotton mats shall consist of a cotton fill material, minimum 400 g/sq m (11.8 oz/sq yd), covered with unsized cloth or burlap, minimum 200 g/sq m (5.9 oz/sq yd), and be tufted or stitched to maintain stability.

Cotton mats shall be in a condition satisfactory to the Engineer. Any tears or holes in the mats shall be repaired.

Add the following Article to Section 1022 of the Standard Specifications:

**“1022.07 Linseed Oil Emulsion Curing Compound.** Linseed oil emulsion curing compound shall be composed of a blend of boiled linseed oil and high viscosity, heavy bodied linseed oil emulsified in a water solution. The curing compound shall meet the requirements of a Type I, II, or III according to Article 1022.01, except the drying time requirement will be waived. The oil phase shall be  $50 \pm 4$  percent by volume. The oil phase shall consist of 80 percent by mass (weight) boiled linseed oil and 20 percent by mass (weight ) Z-8 viscosity linseed oil. The water phase shall be  $50 \pm 4$  percent by volume.”

Revise Article 1020.14 of the Standard Specifications to read:

**“1020.14 Temperature Control for Placement.** Temperature control for concrete placement shall conform to the following requirements:

- (a) Temperature Control other than Structures. The temperature of concrete immediately before placing, shall be not less than 10 °C (50 °F) nor more than 32 °C (90 °F). Aggregates and/or water shall be heated or cooled as necessary to produce concrete within these temperature limits.

When the temperature of the plastic concrete reaches 30 °C (85 °F), an approved retarding admixture shall be used or the approved water reducing admixture in use shall have its dosage increased by 50 percent over the dosage recommended on the Department’s Approved List of Concrete Admixtures for the temperature experienced. The amount of retarding admixture to be used will be determined by the Engineer. This requirement may be waived by the Engineer when fly ash compensated mixtures are used.

Plastic concrete temperatures up to 35 °C (96 °F), as placed, may be permitted provided job site conditions permit placement and finishing without excessive use of water on and/or overworking of the surface. The occurrence within 24 hours of unusual surface distress shall be cause to revert to a maximum 32 °C (90 °F) plastic concrete temperature.

Concrete shall not be placed when the air temperature is below 5 °C (40 °F) and falling or below 2 °C (35 °F), without permission of the Engineer. When placing of concrete is authorized during cold weather, the Engineer may require the water and/or the aggregates to be heated to not less than 20 °C (70 °F) nor more than 65 °C (150 °F). The aggregates may be heated by either steam or dry heat prior to being placed in the mixer. The apparatus used shall heat the mass uniformly and shall be so arranged as to preclude the possible occurrence of overheated areas which might damage the materials. No frozen aggregates shall be used in the concrete.

For pavement patching, refer to Article 442.06(e) for additional information on temperature control for placement.

- (b) Temperature Control for Structures. The temperature of concrete as placed in the forms shall be not less than 10 °C (50 °F) nor more than 32 °C (90 °F). Aggregates and/or water shall be heated or cooled as necessary to produce concrete within these temperature limits. When insulated forms are used, the temperature of the concrete mixture shall not exceed 25 °C (80 °F). If the Engineer determines that heat of hydration might cause excessive temperatures in the concrete, the concrete shall be placed at a temperature between 10 °C (50 °F) and 15 °C (60 °F), per the Engineer's instructions. When concrete is placed in contact with previously placed concrete, the temperature of the concrete may be increased as required to offset anticipated heat loss.

Concrete shall not be placed when the air temperature is below 7 °C (45 °F) and falling or below 4 °C (40 °F), without permission of the Engineer. When placing of concrete is authorized during cold weather, the Engineer may require the water and/or the aggregates to be heated to not less than 20 °C (70 °F) nor more than 65 °C (150 °F). The aggregates may be heated by either steam or dry heat prior to being placed in the mixer. The apparatus used shall heat the mass uniformly and shall be so arranged as to preclude the possible occurrence of overheated areas which might damage the materials. No frozen aggregates shall be used in the concrete.

When the temperature of the plastic concrete reaches 30 °C (85 °F), an approved retarding admixture shall be used or the approved water reducing admixture in use shall have its dosage increased by 50 percent over the dosage recommended on the Department's Approved List of Concrete Admixtures for the temperature experienced. The amount of retarding admixture to be used will be determined by the Engineer. This requirement may be waived by the Engineer when fly ash compensated mixtures are used.

- (c) Temperature. The concrete temperature shall be determined according to ASTM C 1064."

**DISADVANTAGED BUSINESS ENTERPRISE PARTICIPATION (BDE)**

Effective: September 1, 2000

Revised: June 1, 2004

FEDERAL OBLIGATION. The Department of Transportation, as a recipient of federal financial assistance, is required to take all necessary and reasonable steps to ensure nondiscrimination in the award and administration of contracts. Consequently, the federal regulatory provisions of 49 CFR part 26 apply to this contract concerning the utilization of disadvantaged business

enterprises. This Special Provision will also be used by the Department to satisfy the requirements of the Business Enterprise for Minorities, Females, and Persons with Disabilities Act, 30 ILCS 575. For the purposes of this Special Provision, a disadvantaged business enterprise (DBE) means a business certified by the Department in accordance with the requirements of 49 CFR part 26 and listed in the DBE Directory or most recent addendum.

**CONTRACTOR ASSURANCE.** The Contractor makes the following assurance and agrees to include the assurance in each subcontract that the Contractor signs with a subcontractor:

The contractor, subrecipient or subcontractor shall not discriminate on the basis of race, color, national origin, or sex in the performance of this contract. The contractor shall carry out applicable requirements of 49 CFR part 26 in the award and administration of federally-assisted contracts. Failure by the contractor to carry out these requirements is a material breach of this contract, which may result in the termination of this contract or such other remedy as the recipient deems appropriate.

**OVERALL GOAL SET FOR THE DEPARTMENT.** As a requirement of compliance with 49 CFR part 26, the Department has set an overall goal for DBE participation in its federally assisted contracts. That goal applies to all federal-aid funds the Department will expend in its federally assisted contracts for the subject reporting fiscal year. The Department is required to make a good faith effort to achieve the overall goal. The dollar amount paid to all approved DBE firms performing work called for in this contract is eligible to be credited toward fulfillment of the Department's overall goal.

**CONTRACT GOAL TO BE ACHIEVED BY THE CONTRACTOR.** This contract includes a specific DBE utilization goal established by the Department. The goal has been included because the Department has determined that the work of this contract has subcontracting opportunities that may be suitable for performance by DBE companies. This determination is based on an assessment of the type of work, the location of the work, and the availability of DBE companies to do a part of the work. The assessment indicates that, in the absence of unlawful discrimination, and in an arena of fair and open competition, DBE companies can be expected to perform 6.00% of the work. This percentage is set as the DBE participation goal for this contract. Consequently, in addition to the other award criteria established for this contract, the Department will award this contract to a bidder who makes a good faith effort to meet this goal of DBE participation in the performance of the work. A bidder makes a good faith effort for award consideration if either of the following is done in accordance with the procedures set forth in this Special Provision:

- (a) The bidder documents that firmly committed DBE participation has been obtained to meet the goal; or
- (b) The bidder documents that a good faith effort has been made to meet the goal, even though the effort did not succeed in obtaining enough DBE participation to meet the goal.

**DBE LOCATOR REFERENCES.** Bidders may consult the DBE Directory as a reference source for DBE companies certified by the Department. In addition, the Department maintains a letting and item specific DBE locator information system whereby DBE companies can register their interest in providing quotes on particular bid items advertised for letting. Information concerning DBE companies willing to quote work for particular contracts may be obtained by contacting the Department's Bureau of Small Business Enterprises at telephone number (217)785-4611, or by visiting the Department's web site at [www.dot.state.il.us](http://www.dot.state.il.us).



**BIDDING PROCEDURES.** Compliance with the bidding procedures of this Special Provision is required prior to the award of the contract and the failure of the as-read low bidder to comply will render the bid nonresponsive.

- (a) In order to assure the timely award of the contract, the as-read low bidder must submit a Disadvantaged Business Utilization Plan on Department form SBE 2026 within seven (7) working days after the date of letting. To meet the seven (7) day requirement, the bidder may send the Plan by certified mail or delivery service within the seven (7) working day period. If a question arises concerning the mailing date of a Plan, the mailing date will be established by the U.S. Postal Service postmark on the original certified mail receipt from the U.S. Postal Service or the receipt issued by a delivery service. It is the responsibility of the as-read low bidder to ensure that the postmark or receipt date is affixed within the seven (7) working days if the bidder intends to rely upon mailing or delivery to satisfy the submission day requirement. The Plan is to be submitted to the Department of Transportation, Bureau of Small Business Enterprises, Contract Compliance Section, 2300 South Dirksen Parkway, Room 319, Springfield, Illinois 62764 (Telefax: (217)785-1524). It is the responsibility of the bidder to obtain confirmation of telefax delivery. The Department will not accept a Utilization Plan if it does not meet the seven (7) day submittal requirement, and the bid will be declared nonresponsive. In the event the bid is declared nonresponsive due to a failure to submit a Plan or failure to comply with the bidding procedures set forth herein, the Department may elect to cause the forfeiture of the penal sum of the bidder's proposal guaranty, and may deny authorization to bid the project if re-advertised for bids. The Department reserves the right to invite any other bidder to submit a Utilization Plan at any time for award consideration or to extend the time for award.
- (b) The Utilization Plan shall indicate that the bidder either has obtained sufficient DBE participation commitments to meet the contract goal or has not obtained enough DBE participation commitments in spite of a good faith effort to meet the goal. The Utilization Plan shall further provide the name, telephone number and telefax number of a responsible official of the bidder designated for purposes of notification of plan approval or disapproval under the procedures of this Special Provision.
- (c) The Utilization Plan shall include a DBE Participation Commitment Statement, Department form SBE 2025, for each DBE proposed for the performance of work to achieve the contract goal. The signatures on these forms must be original signatures. All elements of information indicated on the said form shall be provided, including but not limited to the following:
  - (1) The name and address of each DBE to be used;
  - (2) A description, including pay item numbers, of the commercially useful work to be done by each DBE;
  - (3) The price to be paid to each DBE for the identified work specifically stating the quantity, unit price and total subcontract price for the work to be completed by the DBE. If partial pay items are to be performed by the DBE, indicate the portion of each item, a unit price where appropriate and the subcontract price amount;
  - (4) A commitment statement signed by the bidder and each DBE evidencing availability and intent to perform commercially useful work on the project; and

- (5) If the bidder is a joint venture comprised of DBE firms and non-DBE firms, the plan must also include a clear identification of the portion of the work to be performed by the DBE partner(s).
- (d) The contract will not be awarded until the Utilization Plan submitted by the bidder is approved. The Utilization Plan will be approved by the Department if the Plan commits sufficient commercially useful DBE work performance to meet the contract goal. The Utilization Plan will not be approved by the Department if the Plan does not commit sufficient DBE performance to meet the contract goal unless the bidder documents that it made a good faith effort to meet the goal. The good faith procedures of Section VIII of this special provision apply. If the Utilization Plan is not approved because it is deficient in a technical matter, unless waived by the Department, the bidder will be notified and will be allowed no less than a five (5) working day period in order to cure the deficiency.

CALCULATING DBE PARTICIPATION. The Utilization Plan values represent work anticipated to be performed and paid for upon satisfactory completion. The Department is only able to count toward the achievement of the overall goal and the contract goal the value of payments made for the work actually performed by DBE companies. In addition, a DBE must perform a commercially useful function on the contract to be counted. A commercially useful function is generally performed when the DBE is responsible for the work and is carrying out its responsibilities by actually performing, managing, and supervising the work involved. The Department and Contractor are governed by the provisions of 49 CFR part 26.55(c) on questions of commercially useful functions as it affects the work. Specific counting guidelines are provided in 49 CFR part 26.55, the provisions of which govern over the summary contained herein.

- (a) DBE as the Contractor: 100% goal credit for that portion of the work performed by the DBE's own forces, including the cost of materials and supplies. Work that a DBE subcontracts to a non-DBE firm does not count toward the DBE goals.
- (b) DBE as a joint venture Contractor: 100% goal credit for that portion of the total dollar value of the contract equal to the distinct, clearly defined portion of the work performed by the DBE's own forces.
- (c) DBE as a subcontractor: 100% goal credit for the work of the subcontract performed by the DBE's own forces, including the cost of materials and supplies, excluding the purchase of materials and supplies or the lease of equipment by the DBE subcontractor from the prime contractor or its affiliates. Work that a DBE subcontractor in turn subcontracts to a non-DBE firm does not count toward the DBE goal.
- (d) DBE as a trucker: 100% goal credit for trucking participation provided the DBE is responsible for the management and supervision of the entire trucking operation for which it is responsible. At least one truck owned, operated, licensed and insured by the DBE must be used on the contract. Credit will be given for the full value of all such DBE trucks operated using DBE employed drivers. Goal credit will be limited to the value of the reasonable fee or commission received by the DBE if trucks are leased from a non-DBE company.
- (e) DBE as a material supplier:
  - (1) 60% goal credit for the cost of the materials or supplies purchased from a DBE regular dealer.

- (2) 100% goal credit for the cost of materials or supplies obtained from a DBE manufacturer.
- (3) 100% credit for the value of reasonable fees and commissions for the procurement of materials and supplies if not a regular dealer or manufacturer.

GOOD FAITH EFFORT PROCEDURES. If the bidder cannot obtain sufficient DBE commitments to meet the contract goal, the bidder must document in the Utilization Plan the good faith efforts made in the attempt to meet the goal. This means that the bidder must show

that all necessary and reasonable steps were taken to achieve the contract goal. Necessary and reasonable steps are those which could reasonably be expected to obtain sufficient DBE participation. The Department will consider the quality, quantity and intensity of the kinds of efforts that the bidder has made. Mere *pro forma* efforts are not good faith efforts; rather, the bidder is expected to have taken those efforts that would be reasonably expected of a bidder actively and aggressively trying to obtain DBE participation sufficient to meet the contract goal.

- (a) The following is a list of types of action that the Department will consider as part of the evaluation of the bidder's good faith efforts to obtain participation. These listed factors are not intended to be a mandatory checklist and are not intended to be exhaustive. Other factors or efforts brought to the attention of the Department may be relevant in appropriate cases, and will be considered by the Department.
- (1) Soliciting through all reasonable and available means (e.g. attendance at pre-bid meetings, advertising and/or written notices) the interest of all certified DBE companies that have the capability to perform the work of the contract. The bidder must solicit this interest within sufficient time to allow the DBE companies to respond to the solicitation. The bidder must determine with certainty if the DBE companies are interested by taking appropriate steps to follow up initial solicitations.
  - (2) Selecting portions of the work to be performed by DBE companies in order to increase the likelihood that the DBE goals will be achieved. This includes, where appropriate, breaking out contract work items into economically feasible units to facilitate DBE participation, even when the prime contractor might otherwise prefer to perform these work items with its own forces.
  - (3) Providing interested DBE companies with adequate information about the plans, specifications, and requirements of the contract in a timely manner to assist them in responding to a solicitation.
  - (4) a. Negotiating in good faith with interested DBE companies. It is the bidder's responsibility to make a portion of the work available to DBE subcontractors and suppliers and to select those portions of the work or material needs consistent with the available DBE subcontractors and suppliers, so as to facilitate DBE participation. Evidence of such negotiation includes the names, addresses, and telephone numbers of DBE companies that were considered; a description of the information provided regarding the plans and specifications for the work selected for subcontracting; and evidence as to why additional agreements could not be reached for DBE companies to perform the work.
    - b. A bidder using good business judgment would consider a number of factors in negotiating with subcontractors, including DBE subcontractors, and would take a firm's price and capabilities as well as contract goals into consideration. However, the fact that there may be some additional costs involved in finding and using DBE companies is not in itself sufficient reason for a bidder's failure to meet the contract DBE goal, as long as such costs are reasonable. Also, the ability or desire of a prime contractor to perform the work of a contract with its own organization does not relieve the bidder of the responsibility to make good faith efforts. Prime contractors are not, however, required to accept higher quotes from DBE companies if the price difference is excessive or unreasonable.

- (5) Not rejecting DBE companies as being unqualified without sound reasons based on a thorough investigation of their capabilities. The contractor's standing within its industry, membership in specific groups, organizations, or associations and political or social affiliations (for example union vs. non-union employee status) are not legitimate causes for the rejection or non-solicitation of bids in the contractor's efforts to meet the project goal.
  - (6) Making efforts to assist interested DBE companies in obtaining bonding, lines of credit, or insurance as required by the recipient or contractor.
  - (7) Making efforts to assist interested DBE companies in obtaining necessary equipment, supplies, materials, or related assistance or services.
  - (8) Effectively using the services of available minority/women community organizations; minority/women contractors' groups; local, state, and Federal minority/women business assistance offices; and other organizations as allowed on a case-by-case basis to provide assistance in the recruitment and placement of DBE companies.
- (b) If the Department determines that the Contractor has made a good faith effort to secure the work commitment of DBE companies to meet the contract goal, the Department will award the contract provided that it is otherwise eligible for award. If the Department determines that a good faith effort has not been made, the Department will notify the bidder of that preliminary determination by contacting the responsible company official designated in the Utilization Plan. The preliminary determination shall include a statement of reasons why good faith efforts have not been found, and may include additional good faith efforts that the bidder could take. The notification will designate a five (5) working day period during which the bidder shall take additional efforts. The bidder is not limited by a statement of additional efforts, but may take other action beyond any stated additional efforts in order to obtain additional DBE commitments. The bidder shall submit an amended Utilization Plan if additional DBE commitments to meet the contract goal are secured. If additional DBE commitments sufficient to meet the contract goal are not secured, the bidder shall report the final good faith efforts made in the time allotted. All additional efforts taken by the bidder will be considered as part of the bidder's good faith efforts. If the bidder is not able to meet the goal after taking additional efforts, the Department will make a pre-final determination of the good faith efforts of the bidder and will notify the designated responsible company official of the reasons for an adverse determination.
- (c) The bidder may request administrative reconsideration of a pre-final determination adverse to the bidder within the five (5) working days after the notification date of the determination by delivering the request to the Department of Transportation, Bureau of Small Business Enterprises, Contract Compliance Section, 2300 South Dirksen Parkway, Room 319, Springfield, Illinois 62764 (Telefax: (217)785-1524). Deposit of the request in the United States mail on or before the fifth business day shall not be deemed delivery. The pre-final determination shall become final if a request is not made and delivered. A request may provide additional written documentation and/or argument concerning the issue of whether an adequate good faith effort was made to meet the contract goal. In addition, the request shall be considered a consent by the bidder to extend the time for award. The request will be forwarded to the Department's

Reconsideration Officer. The Reconsideration Officer will extend an opportunity to the bidder to meet in person in order to consider all issues of whether the bidder made a good faith effort to meet the goal. After the review by the Reconsideration Officer, the bidder will be sent a written decision within ten (10) working days after receipt of the request for reconsideration, explaining the basis for finding that the bidder did or did not meet the goal or make adequate good faith efforts to do so. A final decision by the Reconsideration Officer that a good faith effort was made shall approve the Utilization Plan submitted by the bidder and shall clear the contract for award. A final decision that a good faith effort was not made shall render the bid nonresponsive.

CONTRACT COMPLIANCE. Compliance with this Special Provision is an essential part of the contract. The Department is prohibited by federal regulations from crediting the participation of a DBE included in the Utilization Plan toward either the contract goal or the Department's overall goal until the amount to be applied toward the goals has been paid to the DBE. The following administrative procedures and remedies govern the compliance by the Contractor with the contractual obligations established by the Utilization Plan. After approval of the Plan and award of the contract, the Utilization Plan and individual DBE Participation Statements become part of the contract. If the contractor did not succeed in obtaining enough DBE participation to achieve the advertised contract goal, and the Utilization Plan was approved and contract awarded based upon a determination of good faith, the total dollar value of DBE work calculated in the approved Utilization Plan as a percentage of the awarded contract value shall become the amended contract goal.

- (a) No amendment to the Utilization Plan may be made without prior written approval from the Department's Bureau of Small Business Enterprises. All requests for amendment to the Utilization Plan shall be submitted to the Department of Transportation, Bureau of Small Business Enterprises, Contract Compliance Section, 2300 South Dirksen Parkway, Room 319, Springfield, Illinois 62764. Telephone number (217) 785-4611. Telefax number (217) 785-1524.
- (b) All work indicated for performance by an approved DBE shall be performed, managed and supervised by the DBE executing the Participation Statement. The Contractor shall not terminate for convenience a DBE listed in the Utilization Plan and then perform the work of the terminated DBE with its own forces, those of an affiliate or those of another subcontractor, whether DBE or not, without first obtaining the written consent of the Bureau of Small Business Enterprises to amend the Utilization Plan. If a DBE listed in the Utilization Plan is terminated for reasons other than convenience, or fails to complete its work on the contract for any reason, the Contractor shall make good faith efforts to find another DBE to substitute for the terminated DBE. The good faith efforts shall be directed at finding another DBE to perform at least the same amount of work under the contract as the DBE that was terminated, but only to the extent needed to meet the contract goal or the amended contract goal. The Contractor shall notify the Bureau of Small Business Enterprises of any termination for reasons other than convenience, and shall obtain approval for inclusion of the substitute DBE in the Utilization Plan. If good faith efforts following a termination of a DBE for cause are not successful, the Contractor shall contact the Bureau and provide a full accounting of the efforts undertaken to obtain substitute DBE participation. The Bureau will evaluate the good faith efforts in light of all circumstances surrounding the performance status of the contract, and determine whether the contract goal should be amended.

- (c) The Contractor shall maintain a record of payments for work performed to the DBE participants. The records shall be made available to the Department for inspection upon request. After the performance of the final item of work or delivery of material by a DBE and final payment therefor to the DBE by the Contractor, but not later than thirty (30) calendar days after payment has been made by the Department to the Contractor for such work or material, the Contractor shall submit a DBE Payment Report on Department form SBE 2115 to the District Engineer. If full and final payment has not been made to the DBE, the Report shall indicate whether a disagreement as to the payment required exists between the Contractor and the DBE or if the Contractor believes that the work has not been satisfactorily completed. If the Contractor does not have the full amount of work indicated in the Utilization Plan performed by the DBE companies indicated in the Plan, the Department will deduct from contract payments to the Contractor the amount of the goal not achieved as liquidated and ascertained damages.
- (d) The Department reserves the right to withhold payment to the Contractor to enforce the provisions of this Special Provision. Final payment shall not be made on the contract until such time as the Contractor submits sufficient documentation demonstrating achievement of the goal in accordance with this Special Provision or after liquidated damages have been determined and collected.

#### **EPOXY COATING ON REINFORCEMENT (BDE)**

Effective: April 1, 1997

Revised: January 1, 2003

For work outside the limits of bridge approach pavement, all references to epoxy coating in the Highway Standards and Standard Specifications for reinforcement, tie bars and chair supports will not apply for pavement, shoulders, curb, gutter, combination curb and gutter and median.

#### **EROSION AND SEDIMENT CONTROL DEFICIENCY DEDUCTION (BDE)**

Effective: August 1, 2001

Revised: November 1, 2001

When the Engineer is notified or determines an erosion and/or sediment control deficiency(s) exists, he/she will direct the Contractor in writing to correct the deficiency. The Contractor shall then correct the deficiency within 24 hours. The deficiency may be any lack of repair, maintenance, or implementation of erosion and/or sediment control devices included in the contract, or any failure to comply with the conditions of the National Pollutant Discharge Elimination System (NPDES) Storm Water Permit for Construction Site Activities.

If the Contractor fails to correct the deficiency(s) within 24 hours, a daily monetary deduction will be imposed for each calendar day or fraction thereof the deficiency exists. The time period will begin with the initial written notification to the Contractor and end with the Engineer's acceptance of the corrected work. The per calendar day deduction will be either \$1000.00 or 0.05 percent of the awarded contract value, whichever is greater.

If the Contractor fails to respond, the Engineer may correct the deficiencies and deduct the cost from monies due or which may become due the Contractor. This corrective action shall in no way relieve the Contractor of his/her contractual requirements or responsibilities.

**FLAGGER VESTS (BDE)**

Effective: April 1, 2003

Revised: April 1, 2005

Revise the first sentence of Article 701.04(c)(1) of the Standard Specifications to read:

“The flagger shall be stationed to the satisfaction of the Engineer and be equipped with a fluorescent orange, fluorescent yellow/green or a combination of fluorescent orange and fluorescent yellow/green vest meeting the requirements of the American National Standards Institute specification ANSI/ISEA 107-1999 for Conspicuity Class 2 garments and approved flagger traffic control signs conforming to Standard 702001 and Article 702.05(e).”

Revise Article 701.04(c)(6) of the Standard Specifications to read:

“(6) Nighttime Flagging. The flagger station shall be lit by additional overhead lighting other than streetlights. The flagger shall be equipped with a fluorescent orange, fluorescent yellow/green, or a combination of fluorescent orange and fluorescent yellow/green garment meeting the requirements of the American National Standards Institute specification ANSI/ISEA 107-1999 for Conspicuity Class 3 garments.”

80101

**FREEZE-THAW RATING (BDE)**

Effective: November 1, 2002

Revise the first sentence of Article 1004.02(f) of the Standard Specifications to read:

“When coarse aggregate is used to produce portland cement concrete for base course, base course widening, pavement, driveway pavement, sidewalk, shoulders, curb, gutter, combination curb and gutter, median, paved ditch or their repair using concrete, the gradation permitted will be determined from the results of the Department’s Freeze-Thaw Test.”

**HAND VIBRATOR (BDE)**

Effective: November 1, 2003

Add the following paragraph to Article 1103.17(a) of the Standard Specifications:

“The vibrator shall have a non-metallic head for areas containing epoxy coated reinforcement. The head shall be coated by the manufacturer. The hardness of the non-metallic head shall be less than the epoxy coated reinforcement, resulting in no damage to the epoxy coating. Slip-on covers will not be allowed.”

**MULCHING SEEDED AREAS (BDE)**

Effective: January 1, 2005

Delete Article 251.02(a) of the Standard Specifications.

Add the following to Article 251.02 of the Standard Specifications:

“(h) Compost ..... 1081.05(b)”



Delete Article 251.03(b)(1) of the Standard Specifications.

Add the following to Article 251.03 of the Standard Specifications:

“(d) Method 4. This method shall consist of applying compost combined with a performance additive designed to bind/stabilize the compost. The compost/performance additive mixture shall be applied to the surface of the slope using a pneumatic blower at a depth of 50 mm (2 in.)”

Revise the first sentence of the first paragraph of Article 251.06(b) of the Standard Specifications to read:

“Mulch Methods 1, 2, 3, and 4 will be measured for payment in hectares (acres) of surface area mulched.”

Revise Article 251.07 of the Standard Specifications to read:

“**251.07 Basis of Payment.** This work will be paid for at the contract unit price per hectare (acre) for MULCH, METHOD 1; MULCH, METHOD 2; MULCH, METHOD 3; or MULCH, METHOD 4; and at the contract unit price per square meter (square yard) for EROSION CONTROL BLANKET or HEAVY DUTY EROSION CONTROL BLANKET.”

Add the following after the second paragraph of Article 1081.05(b) of the Standard Specifications:

“Chemical Compost Binder. Chemical compost binder shall be a commercially available product specifically recommended by the manufacturer for use as a compost stabilizer.

The compost binder shall be nonstaining and nontoxic to vegetation and the environment. It shall disperse evenly and rapidly and remain in suspension when agitated in water.

Prior to use of the compost binder, the Contractor shall submit a notarized certification by the manufacturer stating that it meets these requirements. Chemical compost binder shall be packaged, stored, and shipped according to the manufacturer's recommendations with the net quantity plainly shown on each package or container.”

## **PARTIAL PAYMENTS (BDE)**

Effective: September 1, 2003

Revise Article 109.07 of the Standard Specifications to read:

“**109.07 Partial Payments.** Partial payments will be made as follows:

- (a) Progress Payments. At least once each month, the Engineer will make a written estimate of the amount of work performed in accordance with the contract, and the value thereof at the contract unit prices. The amount of the estimate approved as due for payment will be vouchered by the Department and presented to the State Comptroller for payment. No amount less than \$1000.00 will be approved for payment other than the final payment.

The failure to perform any requirement, obligation, or term of the contract by the Contractor shall be reason for withholding any progress payments until the Department determines that compliance has been achieved. Furthermore, progress payments may be reduced by liens filed pursuant to Section 23(c) of the Mechanics Lien Act, 770 ILCS 60/23(c).

- (b) **Material Allowances.** At the discretion of the Department, payment may be made for materials, prior to their use in the work, when satisfactory evidence is presented by the Contractor. Satisfactory evidence includes justification for the allowance (to expedite the work, meet project schedules, regional or national material shortages, etc.), documentation of material and transportation costs, and evidence that such material is properly stored on the project or at a secure location acceptable and accessible to the Department.

Material allowances will be considered only for nonperishable materials when the cost, including transportation, exceeds \$10,000 and such materials are not expected to be utilized within 60 days of the request for the allowance. For contracts valued under \$500,000, the minimum \$10,000 requirement may be met by combining the principal (material) product of no more than two contract items. An exception to this two item limitation may be considered for any contract regardless of value for items in which material (products) are similar except for type and/or size.

Material allowances shall not exceed the value of the contract items in which used and shall not include the cost of installation or related markups. Amounts paid by the Department for material allowances will be deducted from estimates due the Contractor as the material is used. Two-sided copies of the Contractor's cancelled checks for materials and transportation must be furnished to the Department within 60 days of payment of the allowances or the amounts will be reclaimed by the Department."

## **PAYMENTS TO SUBCONTRACTORS (BDE)**

Effective: June 1, 2000

Revised: September 1, 2003

Federal regulations found at 49 CFR §26.29 mandate the Department to establish a contract clause to require Contractors to pay subcontractors for satisfactory performance of their subcontracts no later than 30 days from the receipt of each payment made to the Contractor.

State law addresses the timing of payments to be made to subcontractors. Section 7 of the Prompt Payment Act, 30 ILCS 540/7, generally requires that when a Contractor receives any payment from the Department, the Contractor is required to make corresponding, proportional payments to each subcontractor performing work within 15 calendar days after receipt of the state payment. Section 7 of the State Prompt Payment Act further provides that interest in the amount of 2% per month, in addition to the payment due, shall be paid to any subcontractor by the Contractor if the payment required by the Act is withheld or delayed without reasonable cause. The Act also provides that the time for payment required and the calculation of any interest due applies to transactions between subcontractors and lower-tier subcontractors throughout the contracting chain.

This Special Provision establishes the required federal contract clause, and adopts the 15 calendar day requirement of the Act for purposes of compliance with the federal regulation regarding payments to subcontractors. This contract is subject to the following payment obligations.

As progress payments are made to the Contractor in accordance with Article 109.07 of the Standard Specifications for Road and Bridge Construction, the Contractor shall make a corresponding partial payment within 15 calendar days to each subcontractor in proportion to the work satisfactorily completed by each subcontractor. The proportionate amount of partial payment due to each subcontractor shall be determined by the quantities measured or otherwise determined as eligible for payment by the Department and included in the progress payment to the Contractor. Subcontractors shall be paid in full within 15 calendar days after the subcontractor's work has been satisfactorily completed. The Contractor shall hold no retainage from the subcontractors.

This Special Provision does not create any rights in favor of any subcontractor against the State of Illinois or authorize any cause of action against the State of Illinois on account of any payment, nonpayment, delayed payment or interest claimed by application of the State Prompt Payment Act. The Department will neither determine the reasonableness of any cause for delay of payment nor enforce any claim to payment, including interest. Moreover, the Department will not approve any delay or postponement of the 15 day requirement. State law creates remedies available to any subcontractor or material supplier, regardless of tier, who has not been paid for work properly performed or material furnished. These remedies are a lien against public funds set forth in Section 23(c) of the Mechanics Lien Act, 770 ILCS 60/23(c), and a recovery on the Contractor's payment bond in accordance with the Public Construction Bond Act, 30 ILCS 550.

#### **PERSONAL PROTECTIVE EQUIPMENT (BDE)**

Effective: July 1, 2004

All personnel, excluding flaggers, working outside of a vehicle (car or truck) within 7.6 m (25 ft) of pavement open to traffic shall wear a fluorescent orange, fluorescent yellow/green or a combination of fluorescent orange and fluorescent yellow/.green vest meeting the requirements of the American National Standards Institute specification ANSI/ISEA 107-1999 for Conspicuity Class 2 garments. Other types of garments may be substituted for the vest as long as the garments have manufacturers tags identifying them as meeting the ANSI Class 2 requirement.

#### **PLASTIC BLOCKOUTS FOR GUARDRAIL (BDE)**

Effective: November 1, 2004

Add the following to Article 630.02 of the Standard Specifications:

“(h) Plastic Blockouts (Note 1.)

Note 1. Plastic blockouts, 150 mm (6 in.) deep, may be used in lieu of 150 mm (6 in.) deep wood block-outs for steel plate beam guardrail. The plastic blockouts shall be on the Department's approved list.”

#### **PORTLAND CEMENT (BDE)**

Effective: January 1, 2005

Replace the first sentence of the second paragraph of Article 1001.01 of the Standard Specifications with the following:

“For portland cement according to ASTM C 150, the addition of up to 5.0 percent limestone by mass (weight) to the cement will not be permitted. Also, the total of all organic processing additions shall not exceed 1.0 percent by mass (weight) of the cement and the total of all inorganic processing additions shall not exceed 4.0 percent by mass (weight) of the cement.”

**PORTLAND CEMENT CONCRETE (BDE)**

Effective: November 1, 2002

Add the following paragraph after the fourth paragraph of Article 1103.01(b) of the Standard Specifications:

“The truck mixer shall be approved before use according to the Bureau of Materials and Physical Research’s Policy Memorandum, “Approval of Concrete Plants and Delivery Trucks”.”

Add the following paragraph after the first paragraph of Article 1103.01(c) of the Standard Specifications:

“The truck agitator shall be approved before use according to the Bureau of Materials and Physical Research’s Policy Memorandum, “Approval of Concrete Plants and Delivery Trucks”.”

Add the following paragraph after the first paragraph of Article 1103.01(d) of the Standard Specifications:

“The nonagitator truck shall be approved before use according to the Bureau of Materials and Physical Research’s Policy Memorandum, “Approval of Concrete Plants and Delivery Trucks”.”

Revise the first sentence of the first paragraph of Article 1103.02 of the Standard Specifications to read:

“The plant shall be approved before production begins according to the Bureau of Materials and Physical Research’s Policy Memorandum, “Approval of Concrete Plants and Delivery Trucks”.”

**PORTLAND CEMENT CONCRETE PATCHING (BDE)**

Effective: January 1, 2001

Revised: January 1, 2004

Revise Note 1 of Article 442.02 of the Standard Specifications, to read:

"Note 1. When patching ramp pavements and two lane pavements with two way traffic, Class PP-2, PP-3, or PP-4 concrete shall be used for Class A, Class B and Class C patching. For all other pavements, Class PP-1, PP-2, PP-3, or PP-4 concrete shall be used, at the Contractor’s option, for Class A, Class B and Class C patching."

Delete Note 2 of Article 442.02 of the Standard Specifications.

Add the following to Article 442.02 of the Standard Specifications:

“(l) Calcium Chloride (Note 5)..... 1013.01

Note 5. The calcium chloride accelerator, when permitted by the Department, shall be Type L (Liquid) with a minimum of 32.0 percent by mass (weight) of calcium chloride.”

Revise the first paragraph of Article 442.06(e) of the Standard Specifications to read:

"(e) Concrete Placement. For Class A, Class B and Class C Patches, concrete shall be placed according to Article 420.07 and governed by the limitations set forth in Article 1020.14, except that the maximum temperature of the mixed concrete immediately before placing shall be 35 °C (96 °F), the required use of an approved retarding admixture when the plastic concrete reaches 30 °C (85 °F) shall not apply."

Revise the first paragraph of Article 442.06(h) of the Standard Specifications to read:

"(h) Curing and Protection. In addition to Article 1020.13, when the air temperature is less than 13 °C (55 °F), the Contractor shall cover the patch with minimum R12 insulation until opening strength is reached. Insulation is optional when the air temperature is 13 °C - 35 °C (55 °F - 96 °F). Insulation shall not be placed when the air temperature is greater than 35 °C (96 °F)."

Revise the second paragraph of Article 701.05(e)(1)d.1. of the Standard Specifications to read:

"No open holes, broken pavement, or partially filled holes shall remain overnight for bituminous patching or when the Department specifies only Class PP-2, PP-3, or PP-4 concrete be used. The only exception is conditions beyond the control of the Contractor."

Revise Article 701.05(e)(2)b. of the Standard Specifications to read:

"b. Strength Tests. For patches constructed with Class PP-1, PP-2, PP-3, or PP-4 concrete, the pavement may be opened to traffic when test specimens cured with the patches have obtained a minimum flexural strength of 4150 kPa (600 psi) or a minimum compressive strength of 22,100 kPa (3200 psi) according to Article 1020.09.

For patches constructed with Class PP-2, PP-3, or PP-4 concrete which can obtain a minimum flexural strength of 4150 kPa (600 psi) or a minimum of compressive strength of 22,100 kPa (3200 psi) in 16 hours, the pavement may be opened to traffic at a lower opening strength. The specimens cured with the patches shall have obtained a minimum flexural strength of 2050 kPa (300 psi) or a minimum compressive strength of 11,000 kPa (1600 psi) according to Article 1020.09, to permit opening pavement to traffic.

With the approval of the Engineer, concrete strength may be determined according to AASHTO T 276. The strength-maturity relationship shall be developed from concrete which has an air content near the upper specification limit. The strength-maturity relationship shall be re-established if the mix design or materials are changed."

Revise Article 701.05(e)(2)c. of the Standard Specifications to read:

- "c. Construction Operations. For Class PP-2, PP-3, or PP-4 concrete used on ramp pavements and two lane pavements with two way traffic, or when the Department specifies only Class PP-2, PP-3, or PP-4 concrete be used for other pavements, Contractor construction operations shall be performed in a manner which allows the patches to be opened the same day and before nightfall. If patches are not opened before nightfall, the additional traffic control shall be at the Contractor's expense. Any time patches cannot be opened before nightfall, the Contractor shall change subsequent construction operations or the mix design. The changes shall be at no additional cost to the Department."

Revise Table 1 of Article 1020.04 of the Standard Specifications by replacing Class PP concrete with the following:

"TABLE 1. CLASSES OF PORTLAND CEMENT CONCRETE AND MIX DESIGN CRITERIA				
Class of Concrete	Use	Specification Section Reference	Cement Factor kg/cu m (cwt/cu yd)	Max. Water/Cement Ratio kg/kg (lb/lb)
PP-1	PCC Pavement Patching Bridge Deck Patching	442	Type I Cement 385 to 445 (6.50 to 7.50) Type III Cement 365 to 425 (6.20 to 7.20)	0.44
PP-2	PCC Pavement Patching Bridge Deck Patching	442	Type I Cement 435 (7.35)	0.38
PP-3	PCC Pavement Patching Bridge Deck Patching	442	Type III Cement 435 (7.35)	0.35
PP-4	PCC Pavement Patching Bridge Deck Patching	442	Rapid Hardening Cement 355 to 370 (6.00 to 6.25)	0.50

For PP-1, the Contractor has the option to replace the Type I Cement with Class C fly ash or ground granulated blast-furnace slag. The amount of cement replaced shall not exceed 15 percent by mass (weight), at a minimum replacement ratio of 1.5:1.

For PP-2, the Contractor has the option to replace the Type I cement with ground granulated blast-furnace slag. The amount of cement replaced shall not exceed 30 percent by mass (weight), at a minimum replacement ratio of 1:1.

For PP-3, in addition to the cement, 60 kg/cu m (100 lb/cu yd) of ground granulated blast-furnace slag and 30 kg/cu m (50 lb/cu yd) of microsilica are required. For an air temperature greater than 30 °C (85 °F), the Contractor has the option to replace the Type III cement with Type I cement.

For PP-4, the cement shall be from the Department's "Approved List of Packaged, Dry, Rapid Hardening Cementitious Materials for Concrete Repairs".

TABLE 1. (CONT'D) CLASSES OF PORTLAND CEMENT CONCRETE AND MIX DESIGN CRITERIA					
Class of Concrete	Slump, mm (in.)	Mix Design Compressive Strength, kPa (psi)	Mix Design Flexural Strength, kPa (psi)	Air Content, %	Coarse Aggregate Gradations Permitted
		Hours	Hours		
		48	48		
PP – 1	100 (4) Max	22,100 (3200)	4150 (600)	4.0 – 7.0	CA-7, CA-11, CA-13, CA14, or CA-16
PP – 2	150 (6) Max	22,100 (3200)	4150 (600)	4.0 – 6.0	CA-7, CA-11, CA-13, CA14, or CA-16
PP – 3	100 (4) Max	22,100 (3200)	4150 (600)	4.0 – 6.0	CA-7, CA-11, CA-13, CA14, or CA-16
PP – 4	150 (6) Max	22,100 (3200)	4150 (600)	4.0 – 6.0	CA-7, CA-11, CA-13, CA14, or CA-16

For PP-1, PP-2, PP-3 or PP-4; only CA-13, CA-14, or CA-16 may be used for bridge deck patching. In addition, the mix design strength at 48 hours shall be increased to 27,500 kPa (4,000 psi) compressive or 4,650 kPa (675 psi) flexural for bridge deck patching.

For PP-1, the slump may be increased to 150 mm (6 in.) Max if a high range water-reducing admixture is used.”

Delete Article 1020.05(g) of the Standard Specifications.

**PRECAST CONCRETE PRODUCTS (BDE)**

Effective: July 1, 1999

Revised: November 1, 2004

Product Approval. Precast concrete products shall be produced according to the Department's current Policy Memorandum, "Quality Control/Quality Assurance Program for Precast Concrete Products". The Policy Memorandum applies to precast concrete products listed under the Products Key of the "Approved List of Certified Precast Concrete Producers".

Precast Concrete Box Culverts. Add the following sentence to the end of the fourth paragraph of Article 540.06:

“After installation, the interior and exterior joint gap between precast concrete box culvert sections shall not exceed 38 mm (1 1/2 in.).”

Portland Cement Replacement. For precast concrete products using Class PC concrete or other mixtures, portland cement replacement with fly ash or ground granulated blast-furnace (GGBF) slag shall be governed by the AASHTO or ASTM standard specification referenced in the Standard Specifications.

For all other precast concrete products using Class PC concrete or other mixtures, portland cement replacement with fly ash or GGBF slag shall be approved by the Engineer. Class F fly ash shall not exceed 15 percent by mass (weight) of the total portland cement and Class F fly ash. Class C fly ash shall not exceed 20 percent by mass (weight) of the total portland cement and Class C fly ash. GGBF slag shall not exceed 25 percent by mass (weight) of the total portland cement and GGBF slag.

Concrete mix designs, for precast concrete products, shall not consist of portland cement, fly ash and GGBF slag.

Ready-Mixed Concrete. Delete the last paragraph of Article 1020.11(a) of the Standard Specifications.

Shipping. When a precast concrete product has attained the specified strength, the earliest the product may be loaded, shipped, and used is on the fifth calendar day. The first calendar day shall be the date casting was completed.

Acceptance. Products which have been lot or piece inspected and approved by the Department prior to July 1, 1999, will be accepted for use on this contract.

#### **RAILROAD PROTECTIVE LIABILITY INSURANCE (BDE)**

The contractor will be required to carry Railroad Protective Liability and Property Damage Liability Insurance in accordance with Article 107.11 of the Standard Specifications. The limits of liability shall be in accordance with Article 107.11 of the Standard Specifications unless otherwise noted. A separate policy is required for each railroad indicated below unless otherwise noted.

---

#### **NAME, ADDRESS PHONE OF RAILROAD**

Burlington Northern &  
4515 Kansas Avenue  
Kansas City, Kansas 66106

Cheryl Townlian 1-417-829-4954

#### **DOT/AAR CROSSING NUMBER AND LOCATION**

This project includes patching and resurfacing US 34 from IL 78 (Main Street) in Kewanee to US 6 in Sheffield, approximately 13.1 miles. There are several areas where US 34 parallels these BNSF Railroad double mainline tracks and there is a common ditch between them.

---

#### **NUMBER & SPEED OF PASSENGER TRAINS**

6 per day at 79 MPH

#### **NUMBER & SPEED OF FREIGHT TRAINS**

26 per day at 60 MPH

---

FOR FREIGHT/PASSENGER INFORMATION CONTACT: Duane Schoonover PHONE: 1-309-345-6445

FOR INSURANCE INFORMATION CONTACT: Jamie Johnson PHONE: 1-817-352-3485

---



Basis of Payment: The costs for providing insurance, as noted above, will be paid for at the contract unit price per Lump Sum for RAILROAD PROTECTIVE LIABILITY INSURANCE.

APPROVAL OF INSURANCE: The ORIGINAL and one CERTIFIED copy of each required policy shall be submitted to ENGINEER OF DESIGN, ILLINOIS DEPARTMENT OF TRANSPORTATION, 2300 SOUTH DIRKSEN PARKWAY, SPRINGFIELD, ILLINOIS 62764 for approval. The contractor will be advised when the Department has received approval of the insurance from the railroad(s). Before any work begins on railroad right-of-way, the Contractor shall submit to the Resident Engineer evidence that the required railroad protective liability insurance has been approved by the railroad(s). The Contractor shall also provide the Resident Engineer with expiration date of each required policy.

### **RAP FOR USE IN BITUMINOUS CONCRETE MIXTURES (BDE)**

Effective: January 1, 2000

Revised: April 1, 2002

Revise Article 1004.07 to read:

**“1004.07 RAP Materials.** RAP is reclaimed asphalt pavement resulting from cold milling or crushing of an existing dense graded hot-mix asphalt pavement. RAP must originate from routes or airfields under federal, state or local agency jurisdiction. The Contractor shall supply documentation that the RAP meets these requirements.

(a) Stockpiles. The Contractor shall construct individual, sealed RAP stockpiles meeting one of the following definitions. No additional RAP will be allowed on top of the pile after the pile has been sealed.

(1) Homogeneous. Homogeneous RAP stockpiles shall consist of RAP from Class I/ Superpave, or equivalent mixtures only and represent the same aggregate quality, but shall be at least C quality or better, the same type of crushed aggregate (either crushed natural aggregate, ACBF slag, or steel slag), similar gradation and similar AC content. If approved by the Engineer, combined single pass surface/binder millings may be considered “homogenous”, with a quality rating dictated by the lowest coarse aggregate quality present in the mixture. Homogenous stockpiles shall meet the requirements of Article 1004.07(d). Homogeneous RAP stockpiles not meeting these requirements may be processed (crushing and screening) and retested.

(2) Conglomerate. Conglomerate RAP stockpiles shall consist of RAP from Class I/ Superpave, or equivalent mixtures only. The coarse aggregate in this RAP shall be crushed aggregate only and may represent more than one aggregate type and/or quality but shall be at least C quality or better. This RAP may have an inconsistent gradation and/or asphalt cement content prior to processing. All conglomerate RAP shall be processed prior to testing by crushing to where all RAP shall pass the 16 mm (5/8 in.) or smaller screen. Conglomerate RAP stockpiles shall not contain steel slag or other expansive material as determined by the Department. Conglomerate RAP stockpiles shall meet the requirements of Article 1004.07(d).

(3) Conglomerate “D” Quality (DQ). Conglomerate DQ RAP stockpiles shall consist of RAP containing coarse aggregate (crushed or round) that is at least D quality or better. This RAP may have an inconsistent gradation and/or asphalt content.

Conglomerate DQ RAP stockpiles shall not contain steel slag or other expansive material as determined by the Department. Conglomerate DQ RAP shall meet the requirements of Article 1004.07(d).

Reclaimed Superpave Low ESAL IL-9.5L surface mixtures shall only be placed in conglomerate DQ RAP stockpiles due to the potential for rounded aggregate.

- (4) Other. RAP stockpiles that do not meet the requirements of the stockpile categories listed above shall be classified as "Other". "Other" RAP stockpiles shall not be used in any of the Department's bituminous mixtures.
- (b) Use. The allowable use of a RAP stockpile shall be set by the lowest quality of coarse aggregate in the RAP stockpile. Class I/Superpave surface mixtures are designated as containing Class B quality coarse aggregate only. Superpave Low ESAL IL-19.0L binder and IL-9.5L surface mixtures are designated as Class C quality coarse aggregate only. Class I/Superpave binder mixtures, bituminous base course mixtures, and bituminous base course widening mixtures are designated as containing Class C quality coarse aggregate only. Bituminous stabilized subbase and BAM shoulders are designated as containing Class D quality coarse aggregate only. Any mixture not listed above shall have the designated quality determined by the Department.

RAP containing steel slag or other expansive material, as determined by the Department, shall be homogeneous and will be approved for use in Class I/Superpave (including Low ESAL) surface mixtures only. RAP stockpiles for use in Class I/Superpave mixtures (including Low ESAL), base course, base course widening and Class B mixtures shall be either homogeneous or conglomerate RAP stockpiles except conglomerate RAP stockpiles shall not be used in Superpave surface mixture Ndesign 50 or greater. RAP for use in bituminous aggregate mixtures (BAM) shoulders and BAM stabilized subbase shall be from homogeneous, conglomerate, or conglomerate DQ stockpiles.

Additionally, RAP used in Class I/Superpave surface mixtures shall originate from milled or crushed mixtures only, in which the coarse aggregate is of Class B quality or better. RAP stockpiles for use in Class I/Superpave (including Low ESAL) binder mixes as well as base course, base course widening and Class B mixtures shall originate from milled or processed surface mixture, binder mixture, or a combination of both mixtures uniformly blended to the satisfaction of the Engineer, in which the coarse aggregate is of Class C quality or better.

- (c) Contaminants. RAP containing contaminants, such as earth, brick, sand, concrete, sheet asphalt, bituminous surface treatment (i.e. chip seal), pavement fabric, etc., will be unacceptable unless the contaminants are removed to the satisfaction of the Engineer. Sheet asphalt shall be stockpiled separately.
- (d) Testing. All RAP shall be sampled and tested either during or after stockpiling.

For testing during stockpiling, washed extraction samples shall be run at the minimum frequency of one sample per 450 metric tons (500 tons) for the first 1800 metric tons (2,000 tons) and one sample per 1800 metric tons (2,000 tons) thereafter. A minimum of five tests shall be required for stockpiles less than 3600 metric tons (4,000 tons).

For testing existing stockpiles, the Contractor shall submit a plan for approval to the District proposing a satisfactory method of sampling and testing the RAP pile either in-situ or by restockpiling. The sampling plan shall meet the minimum frequency required above and detail the procedure used to extract representative samples throughout the pile for testing.

Before extraction, each field sample shall be split to test sample size. One of the two test samples from the final split shall be labeled and stored for Department use. The Contractor shall extract the other test sample according to Department procedure. The Engineer reserves the right to test any sample (split or Department-taken) to verify Contractor test results.

All of the extraction results shall be compiled and averaged for asphalt content and gradation. Individual extraction test results, when compared to the averages, will be accepted if within the tolerances listed below.

Parameter	Homogeneous / Conglomerate	Conglomerate "D" Quality
25 mm (1 in.)		± 5%
12.5 mm (1/2 in.)	± 8%	± 15%
4.75 mm (No. 4)	± 6%	± 13%
2.36 mm (No. 8)	± 5%	
1.18 mm (No. 16)		± 15%
600 μm (No. 30)	± 5%	
75 μm (No. 200)	± 2.0%	± 4.0%
AC	± 0.4%	± 0.5%

If more than 20 percent of the individual sieves are out of the gradation tolerances, or if more than 20 percent of the asphalt content test results fall outside the appropriate tolerances, the RAP will not be allowed to be used in the Department's bituminous concrete mixtures unless the RAP representing the failing tests is removed from the stockpile to the satisfaction of the Engineer. All test data and acceptance ranges shall be sent to the District for evaluation.

With the approval of the Engineer, the ignition oven may be substituted for extractions according to the Illinois Test Procedure, "Calibration of the Ignition Oven for the Purpose of Characterizing Reclaimed Asphalt Pavement (RAP)".

- (e) Designs. At the Contractor's option, bituminous concrete mixtures may be constructed utilizing RAP material meeting the above detailed requirements. The amount of RAP included in the mixture shall not exceed the percentages specified in the plans.

RAP designs shall be submitted for volumetric verification. If additional RAP stockpiles are tested and found that no more than 20 percent of the results, as defined under "Testing" herein, are outside of the control tolerances set for the original RAP stockpile and design, and meets all of the requirements herein, the additional RAP stockpiles may be used in the original mix design at the percent previously verified.

- (f) Production. The coarse aggregate in all RAP used shall be equal to or less than the nominal maximum size requirement for the bituminous mixture being produced.

To remove or reduce agglomerated material, a scalping screen, crushing unit or comparable sizing device approved by the Engineer shall be used in the RAP feed system to remove or reduce oversized material. If material passing the sizing device adversely affects the mix production or quality of the mix, the sizing device shall be set at a size specified by the Engineer.

If the RAP control tolerances or QC/QA test results require corrective action, the Contractor shall cease production of the mixture containing RAP and either switch to the virgin aggregate design or submit a new RAP design.

**SEEDING AND SODDING (BDE)**

Effective: July 1, 2004

Revised: November 1, 2004

Revise Class 1A and 2A seeding mixtures shown in Table 1 of Article 250.07 of the Standard Specifications to read:

"Table 1 - SEEDING MIXTURES		
Class – Type	Seeds	kg/hectare (lb/acre)
1A Salt Tolerant Lawn Mixture 7/	Bluegrass	70 (60)
	Perennial Ryegrass	20 (20)
	Audubon Red Fescue	20 (20)
	Rescue 911 Hard Fescue	20 (20)
	Fults Salt Grass*	70 (60)
2A Salt Tolerant Roadside Mixture 7/	Alta Fescue or Ky 31	70 (60)
	Perennial Ryegrass	20 (20)
	Audubon Red Fescue	20 (30)
	Rescue 911 Hard Fescue	20 (30)
	Fults Salt Grass 1/	70 (60)"

Revise Note 7 of Article 250.07 of the Standard Specifications to read:

"Note 7. In Districts 1 through 6, the planting times shall be April 1 to June 15 and August 1 to November 1. In Districts 7 through 9, the planting times shall be March 1 to June 1 and August 1 to November 15. Seeding may be performed outside these dates provided the Contractor guarantees a minimum of 75 percent coverage over the entire seeded area(s) after one growing season. The guarantee shall be submitted to the Engineer in writing prior to performing the work. After one growing season, areas not sustaining 75 percent growth shall be interseeded or reseeded, as determined by the Engineer, at the Contractor's expense."

Add the following sentence to Article 252.04 of the Standard Specifications:

"Sod shall not be placed during the months of July and August."

Revise the first paragraph of Article 252.08 of the Standard Specifications to read:

**“252.08 Sod Watering.** Within two hours after the sod has been placed, water shall be applied at a rate of 25 L/sq m (5 gal/sq yd). Additional water shall be applied every other day at a rate of 15 L/sq m (3 gal/sq yd) for a total of 15 additional waterings. During periods exceeding 26 °C (80 °F) or subnormal rainfall, the schedule of additional waterings may be altered with the approval of the Engineer.”

Revise Article 252.09 of the Standard Specifications to read:

**“252.09 Supplemental Watering.** During periods exceeding 26 °C (80 °F) or subnormal rainfall, supplemental watering may be required after the initial and additional waterings. Supplemental watering shall be performed when directed by the Engineer. Water shall be applied at the rate specified by the Engineer within 24 hours of notice.”

Revise the first and third paragraphs of Article 252.12 of the Standard Specifications to read:

**“252.12 Method of Measurement.** Sodding will be measured for payment in place and the area computed in square meters (square yards). To be acceptable for final payment, the sod shall be growing in place for a minimum of 30 days in a live, healthy condition. When directed by the Engineer, any defective or unacceptable sod shall be removed, replaced and watered by the Contractor at his/her own expense.”

“Supplemental watering will be measured for payment in units of 1000 L (1000 gal) of water applied on the sodded areas. Waterings performed in addition to those required by Article 252.08 or after the 30 day establishment period will be considered as supplemental watering.”

Replace the first paragraph of Article 252.13 of the Standard Specifications with the following:

**“252.13 Basis of Payment.** Sodding will be paid for at the contract unit price per square meter (square yard) for SODDING or SODDING, SALT TOLERANT according to the following schedule.

- (a) Initial Payment. Upon placement of sod, 25 percent of the pay item will be paid.
- (b) Final Payment. Upon acceptance of sod, the remaining 75 percent of the pay item will be paid.”

Revise Article 1081.03(b) of the Standard Specifications to read:

“(b) Salt Tolerant Sod.

Variety	Percent by Weight
Buffalo Grass	30%
Buchloe Dactyloides	
Amigo Fineleaf Tall Fescue	20%
Audubon Red Fescue	15%
Rescue 911 Hard Fescue	15%
Rugby Kentucky Bluegrass	5%
Fults Pucinnellia Distans	15%”

Revise Table II of Article 1081.04(c)(6) of the Standard Specifications to read:

TABLE II						
Variety of Seeds	Hard Seed Percent Maximum	Purity Percent Minimum	Pure, Live Seed Percent Minimum	Weed Percent Maximum	Secondary Noxious Weeds No. per kg (oz) Max. Permitted*	Remarks
Alfalfa	20	92	89	0.50	211 (6)	1/
Brome Grass	-	90	75	0.50	175 (5)	-
Clover, Alsike	15	92	87	0.30	211 (6)	2/
Clover, Crimson	15	92	83	0.50	211 (6)	-
Clover, Ladino	15	92	87	0.30	211 (6)	-
Clover, Red	20	92	87	0.30	211 (6)	-
Clover, White Dutch	30	92	87	0.30	211 (6)	3/
Audubon Red Fescue	0	97	82	0.10	105 (3)	-
Fescue, Alta or Ky. 31	-	97	82	1.00	105 (3)	-
Fescue, Creeping Red	-	97	82	1.00	105 (3)	-
Fults Salt Grass	0	98	85	0.10	70 (2)	-
Kentucky Bluegrass	-	97	80	0.30	247 (7)	5/
Lespedeza, Korean	20	92	84	0.50	211 (6)	3/
Oats	-	92	88	0.50	70 (2)	4/
Orchard Grass	-	90	78	1.50	175 (5)	4/
Redtop	-	90	78	1.80	175 (5)	4/
Ryegrass, Perennial, Annual	-	97	85	0.30	175 (5)	4/
Rye, Grain, Winter	-	92	83	0.50	70 (2)	4/
Rescue 911 Hard Fescue	0	97	82	0.10	105 (3)	-
Timothy	-	92	84	0.50	175 (5)	4/
Vetch, Crown	30	92	67	1.00	211 (6)	3/ & 6/
Vetch, Spring	30	92	88	1.00	70 (2)	4/
Vetch, Winter	15	92	83	1.00	105 (3)	4/
Wheat, hard Red Winter	-	92	89	0.50	70 (2)	4/

**SELF-CONSOLIDATING CONCRETE FOR PRECAST PRODUCTS (BDE)**

Effective: July 1, 2004

Definition. Self-consolidating concrete is a flowable mixture that does not require mechanical vibration for consolidation.

Usage. Self-consolidating concrete may be used for precast concrete products. The design and testing of a self-consolidating concrete mixture shall be according to Section 1020 of the Standard Specifications except as modified herein.

Materials. Materials shall conform to the following requirements:

- (a) Self-Consolidating Admixtures. The self-consolidating admixture system shall consist of either a high range water-reducing admixture only or a high range water-reducing admixture combined with a separate viscosity modifying admixture. The one or two component admixture system shall be capable of producing a flowable concrete that does not require mechanical vibration.

The high range water-reducing admixture shall comply with the requirements of AASHTO M 194, Type F.

The viscosity modifying admixture will be evaluated according to the test methods and mix design proportions referenced in AASHTO M 194, except the following physical requirements shall be met:

- (1) For initial and final set times, the allowable deviation of the test concrete from the reference concrete shall not be more than 1.0 hour earlier or 1.5 hours later.
  - (2) For compressive and flexural strengths, the test concrete shall be a minimum of 90 percent of the reference concrete at 3, 7 and 28 days.
  - (3) The length change of the test concrete shall be a maximum 135 percent of the reference concrete. However, if the length change of the reference concrete is less than 0.030 percent, the length change of the test concrete shall be a maximum 0.010 percentage units greater than the reference concrete.
  - (4) The relative durability factor of the test concrete shall be a minimum 80 percent.
- (b) Fine Aggregate. A fine aggregate used alone in the mix design shall not have an expansion greater than 0.30 percent per ASTM C 1260. For a blend of two or more fine aggregates, the resulting blend shall not have an expansion greater than 0.30 percent.

The aggregate blend expansion will be calculated as follows:

$$\text{Aggregate Blend Expansion} = (a/100 \times A) + (b/100 \times B) + (c/100 \times C) + \dots \text{etc.}$$

Where: a, b, c, ... = percent of aggregate blend  
A, B, C, ... = aggregate expansion according to ASTM C 1260

Mix Design Criteria. The slump requirements of Article 1020.04 of the Standard Specifications shall not apply. In addition, the allowable coarse aggregate gradations shall be CA 11, CA 13, CA 14, CA 16, or a blend of these gradations. The fine aggregate proportion shall be a maximum 50 percent by mass (weight) of the total aggregate used.

Trail Batch. A minimum 1 cu m (1 cu yd) trial batch shall be produced. The mixture will be evaluated for air content, slump flow, visual stability index, compressive strength, passing ability, and static/dynamic segregation resistance.

The trial batch shall be scheduled and performed in the presence of the Engineer. Testing shall be performed per the Department's test method or as approved by the Engineer.

For the trial batch, the air content shall be within the top half of the allowable specification range. The slump flow range shall be 510 mm (20 in.) minimum to 710 mm (28 in.) maximum. The visual stability index shall be a maximum of 1. Strength shall be determined at 28 days. At the Contractor's option, strength may be determined for additional days.

Passing ability and static/dynamic segregation resistance shall be determined by tests selected by the Contractor and approved by the Engineer. The visual stability index shall not be used as the sole criteria for evaluating static segregation resistance.

After an acceptable mixture has been batched and tested, the mixture shall also be evaluated for robustness. Robustness shall be evaluated by varying the dosage of the self-consolidating admixture system and water separately. Additional trial batches may be necessary to accomplish this.

When necessary, the trial batches shall be disposed of according to Article 202.03 of the Standard Specifications.

Quality Control. Once testing is completed and acceptable results have been attained, production test frequencies and allowable test ranges for slump flow, visual stability index, passing ability, and static/dynamic segregation resistance shall be proposed. The production test frequencies and allowable test ranges will be approved by the Engineer.

The slump flow range shall be  $\pm 50$  mm ( $\pm 2$  in.) of the target value, and within the overall range of 510 mm (20 in.) minimum to 710 mm (28 in.) maximum. The visual stability index shall be a maximum of 1. The approved test ranges for passing ability and static/dynamic segregation resistance will be based on recommended guidelines determined by the Engineer.

### **SHOULDER STABILIZATION AT GUARDRAIL (BDE)**

Effective: January 1, 2005

Revise the last sentence of the second paragraph of Article 630.06 of the Standard Specifications to read:

“The void around each post shall be backfilled with earth or aggregate and capped with 75 mm (3 in.) of bituminous mixture or grout.”

Replace the last sentence of the third paragraph of Article 630.06 of the Standard Specifications with the following:

“Guardrail posts shall be driven through holes cored in the completed shoulder stabilization. The void around each post shall be backfilled with earth or aggregate and capped with 75 mm (3 in.) of bituminous mixture or grout.”

Add the following paragraph to the end of Article 630.06 of the Standard Specifications:

“When driving guardrail posts through existing shoulders, shoulder stabilization, or other paved areas, the posts shall be driven through cored holes. The void around each post shall be backfilled with earth or aggregate and capped with 75 mm (3 in.) of bituminous mixture or grout.”

### **STABILIZED SUBBASE AND BITUMINOUS SHOULDERS SUPERPAVE (BDE)**

Effective: April 1, 2002

Revised: July 1, 2004

Description. This work shall consist of constructing stabilized subbase and bituminous shoulders Superpave according to Sections 312 and 482 respectively, of the Standard Specifications and the special provision, “Quality Control/Quality Assurance of Bituminous Concrete Mixtures” except as modified herein.

Revise Article 312.03(b) of the Standard Specifications to read:

“(b) RAP Material (Note 3)”



Revise Note 2 of Article 312.03 of the Standard Specifications to read:

“Note 2. Gradation CA 6, CA 10, or CA 12 shall be used.”

Revise Note 3 of Article 312.03 of the Standard Specifications to read:

"Note 3. RAP shall meet the requirements of the special provision "RAP for Use in Bituminous Concrete Mixtures". RAP containing steel slag shall be permitted for use in top-lift surface mixtures only."

Revise Note 4 of Article 312.03 of the Standard Specifications to read:

"Note 4. Unless otherwise specified on the plans, the bituminous material shall be performance graded asphalt cement, PG58-22. When more than 15 percent RAP is used, a softer PG binder may be required as determined by the Engineer."

Revise Article 312.06 of the Standard Specifications to read:

**"312.06 Mixture Design.** The Contractor shall submit mix designs for approval, for each required mixture. Mix designs shall be developed by Level III personnel who have completed the course, "Superpave Mix Design Upgrade". The mixtures shall be designed according to the respective Illinois Modified AASHTO references listed below:

- AASHTO MP 2 Standard Specification for Superpave Volumetric Mix Design
- AASHTO R 30 Standard Practice for Mixture Conditioning of Hot-Mix Asphalt (HMA)
- AASHTO PP 28 Standard Practice for Designing Superpave HMA
- AASHTO T 209 Theoretical Maximum Specific Gravity and Density of Bituminous Paving Mixtures
- AASHTO T 312 Preparing and Determining the Density of Hot Mix Asphalt (HMA) Specimens by Means of the Superpave Gyrotory Compactor
- AASHTO T 308 Determining the Asphalt Content of Hot Mix Asphalt (HMA) by the Ignition Method

(a) Job Mix Formula (JMF). The JMF shall be according to the following limits:

<u>Ingredient</u>	<u>Percent by Dry Weight</u>
Aggregate.....	94.0 to 96.0
Asphalt Cement.....	4.0 to 6.0*
Dust/AC Ratio .....	1.4

\*Upper limit may be raised for the lower or top lifts if the Contractor elects to use a highly absorptive coarse and/or fine aggregate requiring more than six percent asphalt. The additional asphalt shall be furnished at no cost to the Department.

When RAP material is being used, the JMF shall be according to the following limits:

<u>Ingredient</u>	<u>Percent by Dry Weight</u>
Virgin Aggregate(s) .....	46.0 to 96.0
RAP Material(s) (Note 1) .....	0 to 50
Mineral Filler (if required) .....	0 to 5.0
Asphalt Cement.....	4.0 to 7.0
Dust/AC Ratio .....	1.4

Note 1. If specified on the plans, the maximum percentage of RAP shall be as specified therein.

It is recommended that the selected combined aggregate gradation not pass through the restricted zones specified in Illinois Modified AASHTO MP 2.

(b) Volumetric Requirements.

Design Compactive Effort	Design Air Voids Target (%)
N <sub>DES</sub> =30	2.0

(c) Determination of Need for Anti-Stripping Additive. The mixture designer shall determine if an additive is needed in the mix to prevent stripping. The determination will be made on the basis of tests performed according to Illinois Modified AASHTO T 283 using 4 in. Marshall bricks. To be considered acceptable by the Engineer as a mixture not susceptible to stripping, the ratio of conditioned to unconditioned split tensile strengths (TSR) shall be equal to or greater than 0.75. Mixtures, either with or without an additive, with TSR values less than 0.75 will be considered unacceptable.

If it is determined that an additive is required, the additive may be hydrated lime, slaked quicklime, or a liquid additive, at the Contractor's option. The liquid additive shall be selected from the Department's list of approved additives and may be limited to those which have exhibited satisfactory performance in similar mixes.

Dry hydrated lime shall be added at a rate of 1.0 to 1.5 percent by weight of total dry aggregate. Slurry shall be added in such quantity as to provide the required amount of hydrated lime solids by weight of total dry aggregate. The exact rate of application for all anti-stripping additives will be determined by the Engineer. The method of application shall be according to Article 406.12 of the Standard Specifications."

Revise Article 312.08 of the Standard Specifications to read:

**"312.08 Mixture Production.** When a hot-mix plant conforming to Article 1102.01 is used, the aggregate shall be dried and heated in the revolving dryer to a temperature of 120 °C (250 °F) to 175 °C (350 °F).

The aggregate and bituminous material used in the bituminous aggregate mixture shall be measured separately and accurately by weight or by volume. When the aggregate is in the mixer, the bituminous material shall be added and mixing continued for a minimum of 35 seconds and until a homogeneous mixture is produced in which all particles of the aggregate are coated. The mixing period, size of the batch and the production rate shall be approved by the Engineer.

The ingredients shall be heated and combined in such a manner as to produce a mixture which, when discharged from the mixer, shall be workable and vary not more 10 °C (20 °F) from the temperature set by the Engineer.

When RAP material(s) is used in the bituminous aggregate mixture, the virgin aggregate(s) shall be dried and heated in the dryer to a temperature that will produce the specified resultant mix temperature when combined with the RAP material.

The heated virgin aggregates and mineral filler shall be combined with RAP material in such a manner as to produce a bituminous mixture which when discharged from the mixer shall not vary more than 15 °C (30 °F) from the temperature set by the Engineer. The combined ingredients shall be mixed for a minimum of 35 seconds and until a homogeneous mixture as to composition and temperature is obtained. The total mixing time shall be a minimum of 45 seconds consisting of dry and wet mixing. Variation in wet and dry mixing times may be permitted, depending on the moisture content and amount of salvaged material used. The mix temperature shall not exceed 175 °C (350 °F). Wide variations in the mixture temperature will be cause for rejection of the mix.

- (a) Personnel. The QC Manager and Level I Technician shall have successfully completed the Department's "Superpave Field Control Course".
- (b) Required Tests. Testing for stabilized subbase and bituminous shoulders shall be conducted to control the production of the bituminous mixture using the test methods identified and performed at a frequency not less than indicated in the following table.

Parameter	Frequency of Tests Non-Class I Mixtures	Test Method
Aggregate Gradation  Hot bins for batch and continuous plants.  Individual cold-feeds or combined belt-feed for drier-drum plants.  (% passing sieves: 12.5 mm (1/2 In.), 4.75 mm (No. 4), 75 µm (No. 200))	1 gradation per day of production.  The first day of production shall be washed ignition oven test on the mix. Thereafter, the testing shall alternate between dry gradation and washed ignition oven test on the mix.  The dry gradation and the washed ignition oven test results shall be plotted on the same control chart.	Illinois Procedure (See Manual of Test Procedures for Materials).
Asphalt Content by ignition oven (Note 1.)	1 per day	Illinois-Modified AASHTO T 308
Air Voids		
Bulk Specific Gravity of Gyratory Sample	1 per day	Illinois-Modified AASHTO T 312
Maximum Specific Gravity of Mixture	1 per day	Illinois-Modified AASHTO T 209

Note 1. The Engineer may waive the ignition oven requirement for AC content if the aggregates to be used are known to have ignition AC content calibration factors which exceed 1.5 percent. If the ignition oven requirement is waived, other Department approved methods shall be used to determine the AC content.

During production, the ratio of minus 75 µm (#200) sieve material to total asphalt cement shall be not less than 0.6 nor more than 1.6, and the moisture content of the mixture at discharge from the mixer shall not exceed 0.5 percent. If at any time the ratio of minus 75 µm (#200) material to asphalt or moisture content of the mixture falls outside the stated limits, production of the mix shall cease. The cause shall be determined and corrective action satisfactory to the Engineer shall be initiated prior to resumption of production.

During production, mixture containing an anti-stripping additive will be tested by the Engineer for stripping according to Illinois Modified AASHTO T 283. If the mixture fails to meet the TSR criteria for acceptance, no further mixture will be accepted until the Contractor takes such action as is necessary to furnish a mixture meeting the criteria.

- (c) Control Charts/Limits. Control charts/limits shall be according to QC/QA requirements for Non-Class I Mixtures except air voids shall be plotted on the control charts within the following control limits:

Air Void Control Limits	
Mixture	Individual Test
Shoulders	± 1.2 %
Others	± 1.2 %"

Replace the first paragraph of Article 312.10 of the Standard Specifications with the following:

**“312.10 Placing and Compacting.** After the subgrade has been compacted and is acceptable to the Engineer, the bituminous aggregate mixture shall be spread upon it with a mechanical spreader. The maximum compacted thickness of each lift shall be 150 mm (6 in.) provided the required density is obtained. The minimum compacted thickness of each lift shall be according to the following table:

Nominal Maximum Aggregate Size of Mixture	Minimum Compacted Lift Thickness
CA 12 – 12.5 mm (1/2 in.)	38 mm (1 1/2 in.)
CA 10 - 19 mm (3/4 in.)	57 mm (2 1/4 in.)
CA 6 – 25 mm (1 in.)	76 mm (3 in.)

The surface of each lift shall be clean and dry before succeeding lifts are placed.”

Revise Article 482.02 of the Standard Specifications to read:

**“482.02 Materials.** Materials shall meet the requirements of Article 312.03. For the top lift, the aggregate used shall meet the gradation requirements for a CA 10 or CA 12. Blending of aggregates to meet these gradation requirements will be permitted.”

Revise the first paragraph of Article 482.04 of the Standard Specifications to read:

**“482.04 General.** For pavement and shoulder resurfacing projects, Superpave binder and surface course mixtures may be used in lieu of bituminous aggregate mixture for the resurfacing of shoulders, at the option of the Contractor, or shall be used when specified on the plans.”

Revise Article 482.04(c) of the Standard Specifications to read:

“(c) Mixture Production .....312.08”

Revise Article 482.05 of the Standard Specifications to read:

“**482.05 Composition of Bituminous Aggregate Mixture.** The composition of the mixture shall be according to Article 312.06, except that the amount of asphalt cement used in the top lift shall be increased up to 0.5 percent more than that required in the lower lifts. For resurfacing projects when the Superpave binder and surface course mixtures option is used, the asphalt cement used in the top lift shall not be increased. Superpave mixtures used on the top lift of such shoulders shall meet the gradation requirements of the special provision “Superpave Bituminous Concrete Mixtures”.

For shoulder and strip construction, the composition of the Superpave binder and surface course shall be the same as that specified for the mainline pavement.”

In the following locations of Section 482 of the Standard Specifications, change “Class I” to “Superpave”:

- the second paragraph of Article 482.04
- the first sentence of the second paragraph of Article 482.06
- the first sentence of the fourth paragraph of Article 482.06
- the second sentence of the fourth paragraph of Article 482.06
- the first sentence of the third paragraph of Article 482.08(b)

Revise the first paragraph of Article 482.06 of the Standard Specifications to read:

“**482.06 Placing and Compacting.** This work shall be according to Article 312.10. The mechanical spreader for the top lift of shoulders shall meet the requirements of Article 1102.03 when the shoulder width is 3 m (10 ft) or greater.”

Revise Article 482.09 of the Standard Specifications to read:

"**482.09 Basis of Payment.** When bituminous shoulders are constructed along the edges of the completed pavement structure, this work will be paid for at the contract unit price per square meter (square yard) for BITUMINOUS SHOULDERS SUPERPAVE of the thickness specified. The specified thickness shall be the thickness shown on the plans at the edge of the pavement.

On pavement and shoulder resurfacing projects, the shoulder resurfacing will be paid for at the contract unit price per metric ton (ton) for BITUMINOUS SHOULDERS SUPERPAVE.

The construction of shoulder strips for resurfacing pavements will be paid according to the special provision, “Superpave Bituminous Concrete Mixtures”.

**TEMPORARY EROSION CONTROL (BDE)**

Effective: November 1, 2002

Revise the fifth sentence of the third paragraph of Article 280.04(a) of the Standard Specifications to read:

“This work may be constructed of hay or straw bales, extruded UV resistant high density polyethylene panels, erosion control blanket, mulch barrier, aggregate barriers, excavation, seeding, or mulch used separately or in combination, as approved, by the Engineer.”

Add the following paragraphs after the fifth paragraph of Article 280.04(a) of the Standard Specifications.

“A ditch check constructed of extruded, UV resistant, high density polyethylene panels, “M” pins and erosion control blanket shall consist of the following materials:

Extruded, UV resistant, high density polyethylene panels shall have a minimum height of 250 mm (10 in.) and minimum length of 1.0 m (39.4 in.). The panels shall have a 51 mm (2 in.) lip along the bottom of the panel. Each panel shall have a single rib thickness of 4 mm (5/32 in.) with a 12 mm (1/2 in.) distance between the ribs. The panels shall have an average apparent opening size equal to 4.75 mm (No. 4) sieve, with an average of 30 percent open area. The tensile strength of each panel shall be 26.27 kN/m (1800 lb/ft) in the machine direction and 7.3 kN/m (500 lb/ft) in the transverse direction when tested according to ASTM D 4595.

“M” pins shall be at least 76 mm (3 in.) by 686 mm (27 in.), constructed out of deformed grade C1008 D3.5 rod (0.211 in. diameter). The rod shall have a minimum tensile strength of 55 MPa (8000 psi).

Erosion control blanket shall conform to Article 251.04.

A section of erosion control blanket shall be placed transverse to the flowline direction of the ditch prior to the construction of the polyethylene ditch check. The length of the section shall extend from the top of one side of the ditch to the top of the opposite side of the ditch, while the width of the section shall be one roll width of the blanket. The upstream edge of the erosion control blanket shall be secured in a 100 mm (4 in.) trench. The blanket shall be secured in the trench with 200 mm (8 in.) staples placed at 300 mm (1 ft) intervals along the edge before the trench is backfilled. Once the upstream edge of the blanket is secured, the downstream edge shall be secured with 200 mm (8 in.) staples placed at 300 mm (1 ft) intervals along the edge. The polyethylene ditch check shall be installed in the middle of the erosion control blanket, with the lip of each panel facing outward.

The ditch check shall consist of two panels placed back to back forming a single row. Placement of the first two panels shall be at the toe of the backslope or sideslope, with the panels extending across the bottom of the ditch. Subsequent panels shall extend both across the bottom of the ditch and up the opposite sideslope, as well as up the original backslope or sideslope at the distance determined by the Engineer.

The M pins shall be driven through the panel lips to secure the panels to the ground. M pins shall be installed in the center of the panels with adjacent panels overlapping the ends a minimum of 50 mm (2 in.). The pins shall be placed through both sets of panels at each overlap. They shall be installed at an interval of three M pins per one meter (39 in.) length of ditch check. The panels shall be wedged into the M pins at the top to ensure firm contact between the entire bottom of the panels and the soil.”

**TRAFFIC CONTROL DEFICIENCY DEDUCTION (BDE)**

Effective: April 1, 1992

Revised: January 1, 2005

To ensure a prompt response to incidents involving the integrity of work zone traffic control, the Contractor shall provide a telephone number where a responsible individual can be contacted 24 hours-a-day.

When the Engineer is notified, or determines a traffic control deficiency exists, he/she will notify and direct the Contractor to correct the deficiency within a specified time. The specified time, which begins upon notification to the Contractor, will be from 1/2 hour to 12 hours based upon the urgency of the situation and the nature of the deficiency. The Engineer shall be the sole judge.

A deficiency may be any lack of repair, maintenance, or non-compliance with the traffic control plan. A deficiency may also be applied to situations where corrective action is not an option such as the use of non-certified flaggers for short term operations; working with lane closures beyond the time allowed in the contract; or failure to perform required contract obligations such as traffic control surveillance.

If the Contractor fails to correct a deficiency within the specified time, a daily monetary deduction will be imposed for each calendar day or fraction thereof the deficiency exists. The calendar day(s) will begin with notification to the Contractor and end with the Engineer's acceptance of the correction. The daily monetary deduction will be either \$1,000 or 0.05 percent of the awarded contract value, whichever is greater. For those deficiencies where corrective action was not an option this monetary deduction will be immediate.

In addition, if the Contractor fails to respond, the Engineer may correct the deficiency and the cost thereof will be deducted from monies due or which may become due the Contractor. This corrective action will in no way relieve the Contractor of his/her contractual requirements or responsibilities.

**TRUCK BED RELEASE AGENT (BDE)**

Effective: April 1, 2004

Add the following sentence after the third sentence of the first paragraph of Article 406.14 of the Standard Specifications.

"In addition to the release agent, the Contractor may use a light scatter of manufactured sand (FA 20 or FA 21) evenly distributed over the bed of the vehicle."

**WEIGHT CONTROL DEFICIENCY DEDUCTION**

Effective: April 1, 2001

Revised: August 1, 2002

The Contractor shall provide accurate weights of materials delivered to the contract for incorporation into the work (whether temporary or permanent) and for which the basis of payment is by weight. These weights shall be documented on delivery tickets which shall identify the source of the material, type of material, the date and time the material was loaded, the contract number, the net weight, the tare weight when applicable and the identification of the transporting vehicle. For aggregates, the Contractor shall have the driver of the vehicle furnish

or establish an acceptable alternative to provide the contract number and a copy of the material order to the source for each load. The source is defined as that facility that produces the final material product that is to be incorporated into the contract pay items.

The Department will conduct random, independent vehicle weight checks for material sources according to the procedures outlined in the Documentation Section Policy Statement of the Department's Construction Manual and hereby incorporated by reference. The results of the independent weight checks shall be applicable to all contracts containing this Special Provision. Should the vehicle weight check for a source result in the net weight of material on the vehicle exceeding the net weight of material shown on the delivery ticket by 0.50% (0.70% for aggregates) or more, the Engineer will document the independent vehicle weight check and immediately furnish a copy of the results to the Contractor. No adjustment in pay quantity will be made. Should the vehicle weight check for a source result in the net weight of material shown on the delivery ticket exceeding the net weight of material on the vehicle by 0.50% (0.70% for aggregates) or more, the Engineer will document the independent vehicle weight check and immediately furnish a copy of the results to the Contractor. The Engineer will adjust the net weight shown on the delivery ticket to the checked delivered net weight as determined by the independent vehicle weight check.

The Engineer will also adjust the method of measurement for all contracts for subsequent deliveries of all materials from the source based on the independent weight check. The net weight of all materials delivered to all contracts containing this Special Provision from this source, for which the basis of payment is by weight, will be adjusted by applying a correction factor "A" as determined by the following formula:

$$A = 1.0 - \left( \frac{B - C}{B} \right); \text{ Where } A \leq 1.0; \left( \frac{B - C}{C} \right) > 0.50\% \text{ (0.70\% for aggregates)}$$

Where A = Adjustment factor  
B = Net weight shown on delivery ticket  
C = Net weight determined from independent weight check

The adjustment factor will be applied as follows:

$$\text{Adjusted Net Weight} = A \times \text{Delivery Ticket Net Weight}$$

The adjustment factor will be imposed until the cause of the deficient weight is identified and corrected by the Contractor to the satisfaction of the Engineer. If the cause of the deficient weight is not identified and corrected within seven (7) calendar days, the source shall cease delivery of all materials to all contracts containing this Special Provision for which the basis of payment is by weight.

Should the Contractor elect to challenge the results of the independent weight check, the Engineer will continue to document the weight of material for which the adjustment factor would be applied. However, provided the Contractor furnishes the Engineer with written documentation that the source scale has been calibrated within seven (7) calendar days after the date of the independent weight check, adjustments in the weight of material paid for will not be applied unless the scale calibration demonstrates that the source scale was not within the specified Department of Agriculture tolerance.



At the Contractor's option, the vehicle may be weighed on a second independent Department of Agriculture certified scale to verify the accuracy of the scale used for the independent weight check.

### **WORK ZONE TRAFFIC CONTROL DEVICES (BDE)**

Effective: January 1, 2003

Revised: November 1, 2004

Add the following to Article 702.01 of the Standard Specifications:

"All devices and combinations of devices shall meet the requirements of the National Cooperative Highway Research Program (NCHRP) Report 350 for their respective categories. The categories are as follows:

Category 1 includes small, lightweight, channelizing and delineating devices that have been in common use for many years and are known to be crashworthy by crash testing of similar devices or years of demonstrable safe performance. These include cones, tubular markers, flexible delineators and plastic drums with no attachments. Category 1 devices shall be crash tested and accepted or may be self-certified by the manufacturer.

Category 2 includes devices that are not expected to produce significant vehicular velocity change but may otherwise be hazardous. These include drums and vertical panels with lights, barricades and portable sign supports. Category 2 devices shall be crash tested and accepted for Test Level 3.

Category 3 includes devices that are expected to cause significant velocity changes or other potentially harmful reactions to impacting vehicles. These include crash cushions, truck mounted attenuators and other devices not meeting the definitions of Category 1 or 2. Category 3 devices shall be crash tested and accepted for either Test Level 3 or the test level specified.

Category 4 includes portable or trailer-mounted devices such as arrow boards, changeable message signs, temporary traffic signals and area lighting supports. Currently, there is no implementation date set for this category and it is exempt from the NCHRP 350 compliance requirement.

The Contractor shall provide a manufacturer's self-certification letter for each Category 1 device and an FHWA acceptance letter for each Category 2 and Category 3 device used on the contract. The letters shall state the device meets the NCHRP 350 requirements for its respective category and test level, and shall include a detail drawing of the device."

Delete the third, fourth and fifth paragraphs of Article 702.03(b) of the Standard Specifications.

Delete the third sentence of the first paragraph of Article 702.03(c) of the Standard Specifications.

Revise the first sentence of the first paragraph of Article 702.03(e) of the Standard Specifications to read:

"Drums shall be nonmetallic and have alternating reflectorized Type AA or Type AP fluorescent orange and reflectorized white horizontal, circumferential stripes."

Add the following to Article 702.03 of the Standard Specifications:

“(h) Vertical Barricades. Vertical barricades may be used in lieu of cones, drums or Type II barricades to channelize traffic.”

Delete the fourth paragraph of Article 702.05(a) of the Standard Specifications.

Revise the sixth paragraph of Article 702.05(a) of the Standard Specifications to read:

“When the work operations exceed four days, all signs shall be post mounted unless the signs are located on the pavement or define a moving or intermittent operation. When approved by the Engineer, a temporary sign stand may be used to support a sign at 1.2 m (5 ft) minimum where posts are impractical. Longitudinal dimensions shown on the plans for the placement of signs may be increased up to 30 m (100 ft) to avoid obstacles, hazards or to improve sight distance, when approved by the Engineer. “ROAD CONSTRUCTION AHEAD” signs will also be required on side roads located within the limits of the mainline “ROAD CONSTRUCTION AHEAD” signs.”

Delete all references to “Type 1A barricades” and “wing barricades” throughout Section 702 of the Standard Specifications.

#### **WORKING DAYS (BDE)**

Effective: January 1, 2002

The Contractor shall complete the work within 65 working days.

#### **SUPERPAVE BITUMINOUS CONCRETE MIXTURES (BDE)**

Effective: January 1, 2000

Revised: April 1, 2004

Description. This work shall consist of designing, producing and constructing Superpave bituminous concrete mixtures using Illinois Modified Strategic Highway Research Program (SHRP) Superpave criteria. This work shall be according to Sections 406 and 407 of the Standard Specifications and the special provision, “Quality Control/Quality Assurance of Bituminous Concrete Mixtures”, except as follows.

#### Materials.

- (a) Fine Aggregate Blend Requirement. The Contractor may be required to provide FA 20 manufactured sand to meet the design requirements. For mixtures with  $N_{design} \geq 90$ , at least 50 percent of the required fine aggregate fraction shall consist of either stone sand, slag sand, or steel slag sand meeting the FA/FM 20 gradation.
- (b) Reclaimed Asphalt Pavement (RAP). If the Contractor is allowed to use more than 15 percent RAP, as specified in the plans, a softer performance-graded binder may be required as determined by the Engineer.

RAP shall meet the requirements of the special provision, “RAP for Use in Bituminous Concrete Mixtures”.

RAP will not be permitted in mixtures containing polymer modifiers.

RAP containing steel slag will be permitted for use in top-lift surface mixtures only.

- (c) Bituminous Material. The asphalt cement (AC) shall be performance-graded (PG) or polymer modified performance-graded (SBS-PG or SBR-PG) meeting the requirements of Article 1009.05 of the Standard Specifications for the grade specified on the plans.

The following additional guidelines shall be used if a polymer modified asphalt is specified:

- (1) The polymer modified asphalt cement shall be shipped, maintained, and stored at the mix plant according to the manufacturer's requirements. Polymer modified asphalt cement shall be placed in an empty tank and shall not be blended with other asphalt cements.
- (2) The mixture shall be designed using a mixing temperature of  $163 \pm 3 \text{ }^\circ\text{C}$  ( $325 \pm 5 \text{ }^\circ\text{F}$ ) and a gyratory compaction temperature of  $152 \pm 3 \text{ }^\circ\text{C}$  ( $305 \pm 5 \text{ }^\circ\text{F}$ ).
- (3) Pneumatic-tired rollers will not be allowed unless otherwise specified by the Engineer. A vibratory roller meeting the requirements of Article 406.16 of the Standard Specifications shall be required in the absence of the pneumatic-tired roller.

#### Laboratory Equipment.

- (a) Superpave Gyratory Compactor. The superpave gyratory compactor (SGC) shall be used for all QC/QA testing.
- (b) Ignition Oven. The ignition oven shall be used to determine the AC content. The ignition oven shall also be used to recover aggregates for all required washed gradations.

The Engineer may waive the ignition oven requirement for AC content if the aggregates to be used are known to have ignition AC content calibration factors which exceed 1.5 percent. If the ignition oven requirement is waived, other Department approved methods shall be used to determine the AC content.

Mixture Design. The Contractor shall submit mix designs, for approval, for each required mixture. Mix designs shall be developed by Level III personnel who have successfully completed the course, "Superpave Mix Design Upgrade". Articles 406.10 and 406.13 of the Standard Specifications shall not apply. The mixtures shall be designed according to the respective Illinois Modified AASHTO references listed below.

AASHTO MP 2	Standard Specification for Superpave Volumetric Mix Design
AASHTO R 30	Standard Practice for Mixture Conditioning of Hot-Mix Asphalt (HMA)
AASHTO PP 28	Standard Practice for Designing Superpave HMA
AASHTO T 209	Theoretical Maximum Specific Gravity and Density of Bituminous Paving Mixtures

AASHTO T 312 Preparing and Determining the Density of Hot Mix Asphalt (HMA) Specimens by Means of the Superpave Gyratory Compactor

AASHTO T 308 Determining the Asphalt Content of Hot Mix Asphalt (HMA) by the Ignition Method

- (a) Mixture Composition. The ingredients of the bituminous mixture shall be combined in such proportions as to produce a mixture conforming to the composition limits by weight. The gradation mixture specified on the plans shall produce a mixture falling within the limits specified in Table 1.

TABLE 1. MIXTURE COMPOSITION (% PASSING) <sup>1/</sup>								
Sieve Size	IL-25.0 mm		IL-19.0 mm		IL-12.5 mm <sup>4/</sup>		IL-9.5 mm <sup>4/</sup>	
	min	max	min	max	Min	max	min	max
37.5 mm (1 1/2 in.)		100						
25 mm (1 in.)	90	100		100				
19 mm (3/4 in.)		90	82	100		100		
12.5 mm (1/2 in.)	45	75	50	85	90	100		100
9.5 mm (3/8 in.)						89	90	100
4.75 mm (#4)	24	42 <sup>2/</sup>	24	50 <sup>2/</sup>	28	65	28	65
2.36 mm (#8)	16	31	20	36	28	48 <sup>3/</sup>	28	48 <sup>3/</sup>
1.18 mm (#16)	10	22	10	25	10	32	10	32
600 µm (#30)								
300 µm (#50)	4	12	4	12	4	15	4	15
150 µm (#100)	3	9	3	9	3	10	3	10
75 µm (#200)	3	6	3	6	4	6	4	6

1/ Based on percent of total aggregate weight.

2/ The mixture composition shall not exceed 40 percent passing the 4.75 mm (#4) sieve for binder courses with N<sub>design</sub> ≥ 90.

3/ The mixture composition shall not exceed 40 percent passing the 2.36 mm (#8) sieve for surface courses with N<sub>design</sub> ≥ 90.

4/ The mixture composition for surface courses shall be according to IL-12.5 mm or IL-9.5 mm, unless otherwise specified by the Engineer.

One of the above gradations shall be used for leveling binder as specified in the plans and according to Article 406.04 of the Standard Specifications.

It is recommended that the selected combined aggregate gradation not pass through the restricted zones specified in Illinois Modified AASHTO MP 2.

- (b) Dust/AC Ratio for Superpave. The ratio of material passing the 75 µm (#200) sieve to total asphalt cement shall not exceed 1.0 for mixture design (based on total weight of mixture).
- (c) Volumetric Requirements. The target value for the air voids of the hot mix asphalt (HMA) shall be 4.0 percent at the design number of gyrations. The VMA and VFA of the HMA design shall be based on the nominal maximum size of the aggregate in the mix and shall conform to the requirements listed in Table 2.

<b>TABLE 2. VOLUMETRIC REQUIREMENTS</b>					
<b>Ndesign</b>	<b>Voids in the Mineral Aggregate (VMA), % minimum</b>				<b>Voids Filled with Asphalt (VFA), %</b>
	<b>IL-25.0</b>	<b>IL-19.0</b>	<b>IL-12.5</b>	<b>IL-9.5</b>	
<b>50</b>	12.0	13.0	14.0	15	65 - 78
<b>70</b>					65 - 75
<b>90</b>					
<b>105</b>					

- (d) Determination of Need for Anti-Stripping Additive. The mixture designer shall determine if an additive is needed in the mix to prevent stripping. The determination will be made on the basis of tests performed according to Illinois Modified T 283 using 4 in. Marshall bricks. To be considered acceptable by the Department as a mixture not susceptible to stripping, the ratio of conditioned to unconditioned split tensile strengths (TSRs) shall be equal to or greater than 0.75. Mixtures, either with or without an additive, with TSRs less than 0.75 will be considered unacceptable.

If it is determined that an additive is required, the additive may be hydrated lime, slaked quicklime, or a liquid additive, at the Contractor's option. The liquid additive shall be selected from the Department's list of approved additives and may be limited to those which have exhibited satisfactory performance in similar mixes.

Dry hydrated lime shall be added at a rate of 1.0 to 1.5 percent by weight of total dry aggregate. Slurry shall be added in such quantity as to provide the required amount of hydrated lime solids by weight of total dry aggregate. The exact rate of application for all anti-stripping additives will be determined by the Department. The method of application shall be according to Article 406.12 of the Standard Specifications.

Personnel. The QC Manager and Level I Technician shall have successfully completed the Department's "Superpave Field Control Course".

Required Plant Tests. Testing shall be conducted to control the production of the bituminous mixture. The Contractor shall use the test methods identified to perform the following mixture tests at a frequency not less than that indicated in Table 3.

TABLE 3. REQUIRED PLANT TESTS for SUPERPAVE		
Parameter	Frequency of Tests	Test Method
Aggregate Gradation  Hot bins for batch and continuous plants  Individual cold-feeds or combined belt-feed for drier drum plants.  (% passing sieves: 12.5 mm (1/2 in.), 4.75 mm (No. 4), 2.36 mm (No. 8), 600 µm (No. 30), 75 µm (No. 200))	1 dry gradation per day of production (either morning or afternoon sample).  And  1 washed ignition oven test on the mix per day of production (conduct in afternoon if dry gradation is conducted in the morning or vice versa).  NOTE. The order in which the above tests are conducted shall alternate from the previous production day (example: a dry gradation conducted in the morning will be conducted in the afternoon on the next production day and so forth).  The dry gradation and washed ignition oven test results shall be plotted on the same control chart.	Illinois Procedure (See Manual of Test Procedures for Materials).
Asphalt Content by Ignition Oven (Note 1.)	1 per half day of production	Illinois Modified AASHTO T 308
Air Voids	Bulk Specific Gravity of Gyratory Sample	1 per half day of production for first 2 days and 1 per day thereafter (first sample of the day)
	Maximum Specific Gravity of Mixture	Illinois Modified AASHTO T 209

Note 1. The Engineer may waive the ignition oven requirement for AC content if the aggregates to be used are known to have ignition AC content calibration factors which exceed 1.5 percent. If the ignition oven requirement is waived, other Department approved methods shall be used to determine the AC content.

During production, the ratio of minus 75 µm (#200) sieve material to total asphalt cement shall be not less than 0.6 nor more than 1.2 and the moisture content of the mixture at discharge from the mixer shall not exceed 0.5 percent. If at any time the ratio of minus 75 µm (#200) material to asphalt or moisture content of the mixture falls outside the stated limits, production of the mix shall cease. The cause shall be determined and corrective action satisfactory to the Engineer shall be initiated prior to resuming production.

During production, mixtures containing an anti-stripping additive will be tested by the Department for stripping according to Illinois Modified T 283. If the mixture fails to meet the TSR criteria for acceptance, no further mixture will be accepted until the Contractor takes such action as is necessary to furnish a mixture meeting the criteria.

Construction Requirements

Lift Thickness.

- (a) Binder and Surface Courses. The minimum compacted lift thickness for constructing bituminous concrete binder and surface courses shall be according to Table 4:

<b>TABLE 4 – MINIMUM COMPACTED LIFT THICKNESS</b>	
Mixture	Thickness, mm (in.)
IL-9.5	32 (1 1/4)
IL-12.5	38 (1 1/2)
IL-19.0	57 (2 1/4)
IL-25.0	76 (3)

- (b) Leveling Binder. Mixtures used for leveling binder shall be as follows:

<b>TABLE 5 – LEVELING BINDER</b>	
Nominal, Compacted, Leveling Binder Thickness, mm (in.)	Mixture
≤ 32 (1 1/4)	IL-9.5
32 (1 1/4) to 50 (2)	IL 9.5 or IL-12.5

Density requirements shall apply for leveling binder when the nominal, compacted thickness is 32 mm (1 1/4 in.) or greater for IL-9.5 mixtures and 38 mm (1 1/2 in.) or greater for IL-12.5 mixtures.

- (c) Full-Depth Pavement. The compacted thickness of the initial lift of binder course shall be 100 mm (4 in.). The compacted thickness of succeeding lifts shall meet the minimums specified in Table 4 but not exceed 100 mm (4 in.).

If a vibratory roller is used for breakdown, the compacted thickness of the binder lifts, excluding the top lift, may be increased to 150 mm (6 in.) provided the required density is obtained.

- (d) Bituminous Patching. The minimum compacted lift thickness for constructing bituminous patches shall be according to Table 4.

Control Charts/Limits. Control charts/limits shall be according to QC/QA Class I requirements, except density shall be plotted on the control charts within the following control limits:

<b>TABLE 6. DENSITY CONTROL LIMITS</b>		
Mixture	Parameter	Individual Test
12.5 mm / 9.5 mm	Ndesign ≥ 90	92.0 – 96.0%
12.5 mm / 9.5 mm	Ndesign < 90	92.5 – 97.4%
19.0 mm / 25.0 mm	Ndesign ≥ 90	93.0 – 96.0%
19.0 mm / 25.0 mm	Ndesign < 90	93.0 – 97.4%

Basis of Payment. On resurfacing projects, this work will be paid for at the contract unit price per metric ton (ton) for BITUMINOUS CONCRETE SURFACE COURSE, SUPERPAVE, of the friction aggregate mixture and Ndesign specified, LEVELING BINDER (HAND METHOD),

SUPERPAVE, of the Ndesign specified, LEVELING BINDER (MACHINE METHOD), SUPERPAVE, of the Ndesign specified, and BITUMINOUS CONCRETE BINDER COURSE, SUPERPAVE, of the mixture composition and Ndesign specified.

On resurfacing projects in which polymer modifiers are required, this work will be paid for at the contract unit price per metric ton (ton) for POLYMERIZED BITUMINOUS CONCRETE SURFACE COURSE, SUPERPAVE, of the friction aggregate mixture and Ndesign specified, POLYMERIZED LEVELING BINDER (HAND METHOD), SUPERPAVE, of the Ndesign specified, POLYMERIZED LEVELING BINDER (MACHINE METHOD), SUPERPAVE, of the Ndesign specified, and POLYMERIZED BITUMINOUS CONCRETE BINDER COURSE, SUPERPAVE, of the mixture composition and Ndesign specified.

On full-depth pavement projects, this work will be paid for at the contract unit price per square meter (square yard) for BITUMINOUS CONCRETE PAVEMENT, (FULL-DEPTH), SUPERPAVE, of the thickness specified.

On projects where widening is constructed and the entire pavement is then resurfaced, the binder for the widening will be paid for at the contract unit price per square meter (square yard) for BITUMINOUS CONCRETE BINDER COURSE, SUPERPAVE, of the mixture composition, Ndesign, and thickness specified. The surface and binder used to resurface the entire pavement will be paid for according to the paragraphs above for resurfacing projects.

#### **SUBCONTRACTOR MOBILIZATION PAYMENTS (BDE)**

Effective: April 2, 2005

To account for the preparatory work and operations necessary for the movement of subcontractor personnel, equipment, supplies, and incidentals to the project site and for all other work or operations that must be performed or costs incurred when beginning work approved for subcontracting in accordance with Article 108.01 of the Standard Specifications, the Contractor shall make a mobilization payment to each subcontractor.

This mobilization payment shall be made at least 14 days prior to the subcontractor starting work. The amount paid shall be equal to 3 percent of the amount of the subcontract reported on form BC 260A submitted for the approval of the subcontractor's work.

This provision shall be incorporated directly or by reference into each subcontract approved by the Department.

80143



Illinois Department of Transportation  
**PROJECT LABOR AGREEMENT**

This Project Labor Agreement ("PLA") is entered into this \_\_\_\_\_ day of \_\_\_\_\_, 2004, by and between the Illinois Department of Transportation ("IDOT" or "Department") in its proprietary capacity, and each relevant Illinois AFL-CIO Building Trades Council signatory hereto on behalf of itself and each of its affiliated members (individually and collectively, the "Union"). This PLA shall apply to Construction Work (as defined herein) to be performed by IDOT's Prime Contractor and each of its relevant subcontractors of whatever tier ("Subcontractor" or "Subcontractors") on the Project Name (hereinafter, the "Project").

**ARTICLE 1 - INTENT AND PURPOSES**

- 1.1. This PLA is entered into in furtherance of Illinois Executive Order No. 2003-13. It is mutually understood and agreed that the terms and conditions of this PLA are intended to promote the public interest in obtaining timely and economical completion of the Project by encouraging productive and efficient construction operations; by establishing a spirit of harmony and cooperation among the parties; and by providing for peaceful and prompt settlement of any and all labor grievances or jurisdictional disputes of any kind without strikes, lockouts, slowdowns, delays or other disruptions to the prosecution of the work.
- 1.2. As a condition of the award of the contract for performance of work on the Project, IDOT's Prime Contractor and each of its Subcontractors shall be required to sign a "Contractor Letter of Assent", in the form attached hereto as Exhibit A, prior to commencing Construction Work on the Project. Each Union affiliate and separate local representing workers engaged in Construction Work on the Project in accordance with this PLA shall be required to sign the "Union Letter of Assent", in the form attached hereto as Exhibit B; provided, however, that the failure of any Union affiliate or local to sign such Union Letter of Assent prior to commencement of Construction Work shall not diminish the applicability of this PLA through the relevant Building Trades Council. Upon their signing the Letter of Assent, the Prime Contractor, each Subcontractor, and the individual Unions shall thereafter be deemed a party to this PLA. No party signatory to this PLA shall, contract or subcontract, nor permit any other person, firm, company or entity to contract or subcontract for the performance of Construction Work for the Project to any person, firm, company or entity that does not agree in writing to become bound by the terms of this PLA prior to commencing such work.
- 1.3. It is understood that the Prime Contractor(s) and each Subcontractor will be considered and accepted by the Unions as separate employers for the purposes of collective bargaining, and it is further agreed that the employees working under this PLA shall constitute a bargaining unit separate and distinct from all others. The Parties hereto also agree that this PLA shall be applicable solely with respect to this Project, and shall have no bearing on the interpretation of any other collective bargaining agreement or as to the recognition of any bargaining unit other than for the specific purposes of this Project.

- 1.4. In the event of a variance or conflict, whether explicit or implicit, between the terms and conditions of this PLA and the provisions of any other applicable national, area, or local collective bargaining agreement, the terms and conditions of this PLA shall supercede and control. For any work performed under the NTL Articles of Agreement, the National Stack/Chimney Agreement, the National Cooling Tower Agreement, the National Agreement of the International Union of Elevator Constructors, and for any instrument calibration work and loop checking performed under the UA/IBEW Joint National Agreement for Instrument and Control Systems Technicians, the preceding sentence shall apply only with respect to Articles I, II, V, VI, and VII.
- 1.5. Subject to the provisions of paragraph 1.4 of this Article, it is the parties' intent to respect the provisions of any other collective bargaining agreements that may now or hereafter pertain, whether between the Prime Contractor and one or more of the Unions or between a Subcontractor and one or more of the Unions. Accordingly, except and to the extent of any contrary provision set forth in this PLA, the Prime Contractor and each of its Subcontractors agrees to be bound and abide by the terms of the following in order of precedence: (a) the applicable collective bargaining agreement between the Prime Contractor and one or more of the Unions signatory hereto; (b) the applicable collective bargaining agreement between a Subcontractor and one or more of the Unions signatory hereto; or (c) the current applicable area collective bargaining agreement for the relevant Union that is the agreement certified by the Illinois Department of Labor for purposes of establishing the Prevailing Wage applicable to the Project. Copies of the potentially applicable collective bargaining agreements pursuant to part (c) of the preceding sentence are attached hereto as Exhibits 1 through \_\_\_. Assignments by the Contractors amongst the trades shall be consistent with area practices; in the event of unresolved disagreements as to the propriety of such assignments, the provisions of Article VI shall apply.
- 1.6. Subject to the limitations of paragraphs 1.4 and 1.5 of this Article, the terms of each applicable collective bargaining agreement as determined in accordance with paragraph 1.5 are incorporated herein by reference, and the terms of this PLA shall be deemed incorporated into such other applicable collective bargaining agreements only for purposes of their application to the Project.
- 1.7. To the extent necessary to comply with the requirements of any fringe benefit fund to which the Prime Contractor or Subcontractor is required to contribute under the terms of an applicable collective bargaining agreement pursuant to the preceding paragraph, the Prime Contractor or Subcontractor shall execute all "Participation Agreements" as may be reasonably required by the Union to accomplish such purpose; provided, however, that such Participation Agreements shall, when applicable to the Prime Contractor or Subcontractor solely as a result of this PLA, be amended as reasonably necessary to reflect such fact. Upon written notice from any applicable fringe benefit fund, IDOT will withhold from the Prime Contractor payment of any delinquencies arising from this Project.

- 1.8. In the event that the applicable collective bargaining agreement between a Prime Contractor and the Union or between the Subcontractor and the Union expires prior to the completion of this Project, the expired applicable contract's terms will be maintained until a new applicable collective bargaining agreement is ratified. The wages and fringe benefits included in any new applicable collective bargaining agreement will apply on and after the effective date of the newly negotiated collective bargaining agreement, except to the extent wage and fringe benefit retroactivity is specifically agreed upon by the relevant bargaining parties.

## ARTICLE II – APPLICABILITY, RECOGNITION, AND COMMITMENTS

- 2.1 The term Construction Work as used herein shall include all “construction, prosecution, completion, or repair” work performed by a “laborer or mechanic” at the “site of the work” for the purpose of “building” the specific structures and improvements that constitute the Project. Terms appearing within quotation marks in the preceding sentence shall have the meaning ascribed to them pursuant to 29 CFR Part 5.
- 2.2 By executing the Letters of Assent, Prime Contractor and each of its Subcontractors recognizes the Unions signatory to this PLA as the sole and exclusive bargaining representatives for their craft employees employed on the jobsite for this Project. Unions who are signatory to this PLA will have recognition on the Project for their craft.
- 2.3 The Prime Contractor and each of its Subcontractors retains and shall be permitted to exercise full and exclusive authority and responsibility for the management of its operations, except as expressly limited by the terms of this PLA or by the terms and conditions of the applicable collective bargaining agreement.
- 2.4 Except to the extent contrary to an express provision of the relevant collective bargaining agreement, equipment or materials used in the Project may be pre-assembled or pre-fabricated, and there shall be no refusal by the Union to handle, transport, install, or connect such equipment or materials. Equipment or materials delivered to the job-site will be unloaded and handled promptly without regard to potential jurisdictional disputes; any such disputes shall be handled in accordance with the provisions of this PLA.
- 2.5 Unions commit to furnishing qualified and skilled craft persons as required by the Prime Contractor and its Subcontractors in fulfillment of their obligations to complete the Project. In order to promote the long-term development of a skilled and knowledgeable work force, the parties are encouraged to utilize apprentices to the maximum extent permitted by the applicable collective bargaining agreement.
- 2.6 The parties are mutually committed to promoting a safe working environment for all personnel at the job site. It shall be the responsibility of each employer to which this PLA applies to provide and maintain safe working conditions for its employees, and to comply with all applicable federal, state, and local health and safety laws and regulations.

- 2.7 The use or furnishing of alcohol or drugs and the conduct of any other illegal activity at the job-site is strictly prohibited. The parties shall take every practical measure consistent with the terms of applicable collective bargaining agreements to ensure that the job-site is free of alcohol and drugs.
- 2.8 All parties to this PLA agree that they shall not discriminate against any employee based on race, creed, color, national origin, union activity, age, or gender as required by all applicable federal, state, and local laws.
- 2.9 The Parties hereto agree that engineering consultants and materials testing employees, to the extent subject to the terms of this PLA, shall be fully expected to objectively and responsibly perform their duties and obligations owed to the Department without regard to the potential union affiliation of such employees or of other employees on the Project.

### ARTICLE III - ADMINISTRATION OF AGREEMENT

- 3.1 In order to assure that all parties have a clear understanding of the PLA and to promote harmony, a post-award pre-job conference will be held among the Prime Contractor, all Subcontractors and Union representatives prior to the start of any Construction Work on the Project. No later than the conclusion of such pre-job conference, the parties shall, among other matters, provide to one another contact information for their respective representatives (including name, address, phone number, facsimile number, e-mail). Nothing herein shall be construed to limit the right of the Department to discuss or explain the purpose and intent of this PLA with prospective bidders or other interested parties prior to or following its award of the job.
- 3.2 Representatives of the Prime Contractor and the Unions shall meet as often as reasonably necessary following award until completion of the Project to assure the effective implementation of this PLA.
- 3.3 Not less than once per month, Prime Contractor and all Subcontractors shall make available in writing to the Unions a Project status report that shall include, though not necessarily be limited to, planned activities for the next 30 day period and estimated numbers of employees by craft required for the next 30 day period. The purpose of this Project status report is to promote effective workforce planning and to facilitate resolution of any potential jurisdictional or other problems.
- 3.4 Not later than the earlier of (a) five business days following the pre-job conference, or (b) commencement of Construction Work, the Unions and Prime Contractor (on behalf of itself and all its subcontractors of whatever tier) shall confer and jointly designate a slate of three (3) permanent arbitrators (each a "Permanent Arbitrator") for the purpose of hearing disputes pursuant to Articles V and VII of this PLA. The slate of Permanent Arbitrators shall be selected from among the following individuals: Jack P. Cerone,

Thomas F. Gibbons, Thomas G. Pagan, Robert Perkovich, Byron Yaffee, and Glenn A. Zipp. In the event that the Unions and Prime Contractor are not able to agree on a full slate of three Permanent Arbitrators, the Department, after consultation with the Unions and Prime Contractor, shall designate such additional Permanent Arbitrators as may be necessary to establish the full slate. A single Permanent Arbitrator shall be selected from the slate of three on a rotating basis to adjudicate each arbitrable matter as it arises. In the event a Permanent Arbitrator is not available to adjudicate a particular matter in the order of rotation, the arbitration assignment shall pass to the next available Permanent Arbitrator.

#### ARTICLE IV - HOURS OF WORK AND GENERAL CONDITIONS

- 4.1 The standard work day for Construction Work on the Project shall be an established consecutive eight (8) hour period between the hours of 7:00 a.m. and 5:00 p.m. with one-half hour designated as unpaid period for lunch. The standard work week shall be five (5) consecutive days of work commencing on Monday. Starting time shall be established at the pre-job conference, and shall be applicable to all craft employees on the Project unless otherwise expressly agreed in writing. In the event Project site or other job conditions dictate a change in the established starting time and/or a staggered lunch period for portions of the Project or for specific crafts, the Prime Contractor, relevant Subcontractors and business managers of the specific crafts involved shall confer and mutually agree to such changes as appropriate. If proposed work schedule changes cannot be mutually agreed upon between the parties, the hours fixed at the time of the pre-job meeting shall prevail.
- 4.2 Shift work may be established and directed by the Prime Contractor or relevant Subcontractor as reasonably necessary or appropriate to fulfill the terms of its contract with the Department. If used, shift hours, rates and conditions shall be as provided in the applicable collective bargaining agreement.
- 4.3 The parties agree that chronic and/or unexcused absenteeism is undesirable and must be controlled in accordance with procedures established by the applicable collective bargaining agreement. Any employee disciplined for absenteeism in accordance with such procedures shall be suspended from all work on the Project for not less than the maximum period permitted under the applicable collective bargaining agreement.
- 4.4 Except as may be otherwise expressly provided by the applicable collective bargaining agreement, employment begins and ends at the Project site; employees shall be at their place of work at the starting time; and employees shall remain at their place of work until quitting time.
- 4.5 Except as may be otherwise expressly provided by the applicable collective bargaining agreement, there shall be no limit on production by workmen, no restrictions on the full use of tools or equipment, and no restrictions on efficient use of manpower or techniques of construction other than as may be required by safety regulations.

- 4.6 The parties recognize that specialized or unusual equipment may be installed on the Project. In such cases, the Union recognizes the right of the Prime Contractor or Subcontractor to involve the equipment supplier or vendor's personnel in supervising the setting up of the equipment, making modifications and final alignment, and performing similar activities that may be reasonably necessary prior to and during the start-up procedure in order to protect factory warranties. The Prime Contractor or Subcontractor shall notify the Union representatives in advance of any work at the job-site by such vendor personnel in order to promote a harmonious relationship between the equipment vendor's personnel and other Project employees.
- 4.7 For the purpose of promoting full and effective implementation of this PLA, authorized Union representatives shall have access to the Project job-site during scheduled work hours. Such access shall be conditioned upon adherence to all reasonable visitor and security rules of general applicability that may be established for the Project site at the pre-job conference or from time to time thereafter.

#### ARTICLE V - GRIEVANCE AND ARBITRATION PROCEDURES

- 5.1 Except as provided in Articles VI or VII, it is specifically agreed among the parties that any grievance or dispute arising out of the interpretation or application of this PLA shall be settled by means of the expedited arbitration process set forth in Paragraph 5.2 below. No such grievance or dispute shall be recognized unless called to the attention of the Prime Contractor and relevant Subcontractor by the Union or to the Union by the Prime Contractor or relevant Subcontractor within five (5) working days after the alleged violation was committed or discovered by the grieving party.
- 5.2 Grievances shall be settled according to the following procedure:
- 5.2.A. Step 1. The dispute shall be referred to the Steward of the craft union involved and a representative of the Prime Contractor and relevant Subcontractor at the job-site.
- 5.2.B. Step 2. In the event that the Steward and the contractors' representatives at the job-site cannot reach agreement within two (2) working days after a meeting is arranged and held, the matter shall be referred to the Union Business Manager and to executive representatives of the Prime Contractor and relevant Subcontractor.
- 5.2.C. Step 3. In the event the dispute is not resolved within five (5) working days after completion of Step 2, the relevant parties shall request a Permanent Arbitrator as determined in accordance with paragraph 3.4 of this PLA, who shall, within ten (10) working days, hear the grievance and make a written decision. Such decisions shall be final and binding on all parties. The parties shall each pay the expense of their own representative. The expense of the Permanent Arbitrator shall be divided equally between (1) the Prime Contractor and/or relevant Subcontractor, and (2) the involved Union.

- 5.3 Any failure of a party to comply fully with such final and binding decision of the Permanent Arbitrator may result in removal of the non-complying party from the site, in a holdback from the Prime Contractor or Subcontractor of any amounts awarded, or in such other relief as the Department may reasonably determine is necessary to promote final resolution of the dispute.
- 5.4 In the event any dispute or grievance should arise, the parties expressly agree that it shall be resolved without occurrence of any strike, work stoppage, slow-down or other prohibited activities as provided in Article VII of this PLA. Individuals or parties violating this section shall be subject to immediate discharge or other discipline.

#### ARTICLE VI - JURISDICTIONAL DISPUTES

- 6.1 As used in this PLA, the term "jurisdictional dispute" shall be defined as any dispute, difference or disagreement involving the assignment of particular work to one class or craft of employees rather than to a different class or craft of employees, regardless of the Prime Contractor's or relevant Subcontractor's contractual relationship to any other employer, contractor, or organization on the site.
- 6.2 It is agreed by and between the parties to this Agreement that any and all jurisdictional disputes, whether between or among different Unions, employees, or other parties to this PLA, shall be settled and adjusted according to the present "Plan for Settlement of Jurisdictional Disputes in the Construction Industry" as established by the AFL-CIO Building and Construction Trades Department or any other plan or method of procedure that may be adopted in the future by the Building and Construction Trades Department for such purpose. Decisions rendered shall be final, binding and conclusive on the parties for purposes of this PLA.
- 6.3 The parties to this PLA agree that jurisdictional disputes cannot and shall not interfere with the efficient and continuous operations required for the proper completion of the Project and the successful application of this PLA. In the event a jurisdictional dispute arises, it shall be resolved without occurrence of any strike, work stoppage, slow-down or other prohibited activities as provided in Article VII of this PLA. The Prime Contractor's or relevant Subcontractor's assignment shall be adhered to until the dispute is resolved. Individuals violating this section shall be subject to immediate discharge.

#### ARTICLE VII - WORK STOPPAGES AND LOCKOUTS

- 7.1 During the term of this PLA, no Union or any of its members, officers, stewards, employees, agents or representatives shall instigate, support, sanction, maintain, or participate in any strike, picketing, walkout, work stoppage, slow down or other activity that interferes with the routine and timely prosecution of work at the Project site or at any other contractor's or supplier's facility that is necessary to performance of work at the Project site. Hand billing at the Project site during the designated lunch period and before

commencement or following conclusion of the established standard workday shall not, in itself, be deemed an activity that interferes with the routine and timely prosecution of work on the Project.

- 7.2 Should any activity prohibited by paragraph 7.1 of this Article occur, the Union shall undertake all steps reasonably necessary to promptly end such prohibited activities. No Union complying with its obligations under this Article shall be liable for acts of employees for which it has no responsibility or for the unauthorized acts of employees it represents. Any employee who participates in or encourages any activity prohibited by paragraph 7.1 shall be immediately suspended from all work on the Project for a period equal to the greater of (a) 60 days; or (b) the maximum disciplinary period allowed under the applicable collective bargaining agreement for engaging in comparable unauthorized or prohibited activity.
- 7.3 During the term of this PLA, the Prime Contractor and its Subcontractors shall not engage in any lockout at the Project site of employees covered by this Agreement.
- 7.4 Upon notification of violations of this Article, the principal officer or officers of the local area Building and Construction Trades Council, as appropriate, will immediately instruct, order and use the best efforts of his or her office to cause the affiliated union or unions to cease any violations of this Article. A Trades Council in compliance with its obligations under this paragraph shall not be liable for unauthorized acts of its affiliates.
- 7.5 In the event that activities in violation of this Article are not immediately halted through the efforts of the parties, any aggrieved party may invoke the special arbitration provisions set forth in paragraph 7.6 of this Article.
- 7.6 Upon written notice to the other involved parties by the most expeditious means available, any aggrieved party may institute the following special arbitration procedure when a breach of this Article is alleged:
  - 7.6.A The party invoking this procedure shall notify the individual designated as the Permanent Arbitrator pursuant to Article III of the nature of the alleged violation; such notice shall be by the most expeditious means possible. The initiating party may also furnish such additional factual information as may be reasonably necessary for the Permanent Arbitrator to understand the relevant circumstances. Copies of any written materials provided to the arbitrator shall also be contemporaneously provided by the most expeditious means possible to the party alleged to be in violation and to all other involved parties.
  - 7.6.B Upon receipt of said notice the Permanent Arbitrator shall set and hold a hearing within twenty-four (24) hours if it is contended the violation is ongoing, but not before twenty-four (24) hours after the written notice to all parties involved as required above.



- 7.6.C The Permanent Arbitrator shall notify the parties by facsimile or any other effective written means, of the place and time chosen by the Permanent Arbitrator for this hearing. Said hearing shall be completed in one session. A failure of any party or parties to attend said hearing shall not delay the hearing of evidence or issuance of an Award by the Permanent Arbitrator.
- 7.6.D The sole issue at the hearing shall be whether a violation of this Article has, in fact, occurred. An Award shall be issued in writing within three (3) hours after the close of the hearing, and may be issued without a written opinion. If any party desires a written opinion, one shall be issued within fifteen (15) days, but its issuance shall not delay compliance with, or enforcement of, the Award. The Permanent Arbitrator may order cessation of the violation of this Article, and such Award shall be served on all parties by hand or registered mail upon issuance.
- 7.6.E Such Award may be enforced by any court of competent jurisdiction upon the filing of the Award and such other relevant documents as may be required. Facsimile or other hardcopy written notice of the filing of such enforcement proceedings shall be given to the other relevant parties. In a proceeding to obtain a temporary order enforcing the Permanent Arbitrator's Award as issued under this Article, all parties waive the right to a hearing and agree that such proceedings may be ex parte. Such agreement does not waive any party's right to participate in a hearing for a final order of enforcement. The Court's order or orders enforcing the Permanent Arbitrator's Award shall be served on all parties by hand or by delivery to their last known address or by registered mail.
- 7.7 Individuals found to have violated the provisions of this Article are subject to immediate termination. In addition, IDOT reserves the right to terminate this PLA as to any party found to have violated the provisions of this Article.
- 7.8 Any rights created by statute or law governing arbitration proceedings inconsistent with the above procedure or which interfere with compliance therewith are hereby waived by parties to whom they accrue.
- 7.9 The fees and expenses of the Permanent Arbitrator shall be borne by the party or parties found in violation, or in the event no violation is found, such fees and expenses shall be borne by the moving party.

#### ARTICLE VIII – MISCELLANEOUS

- 8.1 If any Article or provision of this PLA shall be declared invalid, inoperative or unenforceable by operation of law or by final non-appealable order of any tribunal of competent jurisdiction, such provision shall be deemed severed or limited, but only to the extent required to render the remaining provisions of this PLA enforceable consistent with the intent of the parties. The remainder of this PLA or the application of such

Article or provision to persons or circumstances other than those as to which it has been held invalid, inoperative or unenforceable shall not be affected thereby.

- 8.2 The term of this PLA shall commence as of and from the date of the notice of award to the Prime Contractor and shall end upon final acceptance by IDOT of all work on the Project by the parties hereto.
- 8.3 This PLA may not be changed or modified except by the subsequent written agreement of the parties. All parties represent that they have the full legal authority to enter into this PLA. This PLA may be executed by the parties in one or more counterparts.
- 8.4 Any liability arising out of this PLA shall be several and not joint. IDOT shall not be liable to any person or other party for any violation of this PLA by any other party, and no Contractor or Union shall be liable for any violation of this PLA by any other Contractor or Union.
- 8.5 The failure or refusal of a party to exercise its rights hereunder in one or more instances shall not be deemed a waiver of any such rights in respect of a separate instance of the same or similar nature.

[The Balance of This Page Intentionally Left Blank]

**Execution Page**

**Illinois Department of Transportation**

\_\_\_\_\_  
Victor Modeer, Director of Highways

\_\_\_\_\_  
Robert Millette, Director Finance & Administration

\_\_\_\_\_  
~~Samuel Ach~~, Chief Counsel (as to form)  
Ellen Schanzle-Haskins, Acting Chief Counsel

\_\_\_\_\_  
Timothy Martin, Secretary

\_\_\_\_\_  
(Date)

**Building Trades Councils**

\_\_\_\_\_  
\_\_\_\_\_  
(Date)

**Execution Page**

**Illinois Department of Transportation**



Victor Modeer, Director of Highways

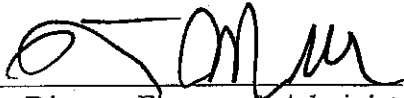

Robert Millette, Director Finance & Administration



Ellen Schanzle-Haskins, Chief Counsel

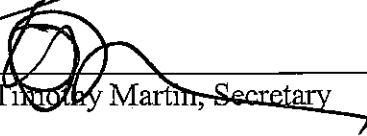

Timothy Martin, Secretary

4/21/05  
(Date)

**Building Trades Councils**

See Attached

3/18/05  
(Date)



# ILLINOIS VALLEY BUILDING AND CONSTRUCTION TRADES COUNCIL

Affiliated with the  
Building and Construction Trades Department  
A. F. of L. - C. I. O.

740 E. U.S. ROUTE 6, UTICA, IL 61373

Tel. 815/667-3036



Fax. 815/667-4195

Dan Aussem, *President*  
Randy Hill, *Sec. Secretary*

March 18, 2005

**Affiliated Organizations**

- Asbestos Workers L.U. 17
- Boilermakers L.U. 60
- Bricklayers L.U. 6
- Carpenter's Local 195
- Cement Masons L.U. 11
- Electricians L.U. 178
- Electricians L.U. 601
- Glaziers L.U. 1164
- Ironworkers L.U. 386
- Labor L.U. 393
- Labor L.U. 811
- Lathers L.U. 74-L
- Millwrights Local 2158
- Operating Engineers L.U. 150
- Painters L.U. 465
- Pipefitters L.U. 587
- Plumbers & Pipefitters L.U. 422
- Roofers L.U. 11
- Sheet Metal Wrks. L.U. 1
- Teamsters L.U. 722
- Technical Engineers L.U. 130

Mr. Jim Duncan  
Illinois Department of Labor  
2300 South Dirksen Parkway  
Springfield, Illinois 62764

VIA FACSIMILE & REGULAR MAIL

Re: FAP Route 613 (US 34)  
Section (6CS, 26CS, 7)RS-2 & 8RS-5  
Henry/Bureau Counties  
#64775  
73

Dear Mr. Duncan,

In accordance with the terms and conditions of the contract for Construction Work on the above referenced project, this Union Letter of Assent hereby confirms that the undersigned Union agrees to be bound by the terms and conditions of the Project Labor Agreement established and entered into by the Illinois Department of Transportation in connection with said Project.

It is the understanding and intent of the undersigned party that this Project Labor Agreement shall pertain only to the identified Project. In the event it is necessary for a Contractor party to this PLA to become signatory to a collective bargaining agreement to which it is not otherwise a party in order that it may lawfully make certain required contributions to applicable fringe benefit funds benefiting the undersigned Union, the undersigned party hereby expressly acknowledges that such Contractor's participation in such collective bargaining agreement is limited to its work on the Project.

Daniel F. Aussem, President  
Illinois Valley Building Trades Council

## Exhibit A – Contractor Letter of Assent

\_\_\_\_\_  
(Date)

To All Parties:

In accordance with the terms and conditions of the contract for Construction Work on [], this Letter of Assent hereby confirms that the undersigned Prime Contractor or Subcontractor agrees to be bound by the terms and conditions of the Project Labor Agreement established and entered into by the Illinois Department of Transportation in connection with said Project.

It is the understanding and intent of the undersigned party that this Project Labor Agreement shall pertain only to the identified Project. In the event it is necessary for the undersigned party to become signatory to a collective bargaining agreement to which it is not otherwise a party in order that it may lawfully make certain required contributions to applicable fringe benefit funds, the undersigned party hereby expressly conditions its acceptance of and limits its participation in such collective bargaining agreement to its work on the Project.

\_\_\_\_\_  
(Authorized Company Officer)

\_\_\_\_\_  
(Company)

## Exhibit B – Union Letter of Assent

\_\_\_\_\_  
(Date)

To All Parties:

In accordance with the terms and conditions of the contract for Construction Work on [], this Union Letter of Assent hereby confirms that the undersigned Union agrees to be bound by the terms and conditions of the Project Labor Agreement established and entered into by the Illinois Department of Transportation in connection with said Project.

It is the understanding and intent of the undersigned party that this Project Labor Agreement shall pertain only to the identified Project. In the event it is necessary for a Contractor party to this PLA to become signatory to a collective bargaining agreement to which it is not otherwise a party in order that it may lawfully make certain required contributions to applicable fringe benefit funds benefiting the undersigned Union, the undersigned party hereby expressly acknowledges that such Contractor's participation in such collective bargaining agreement is limited to its work on the Project.

\_\_\_\_\_  
(Authorized Union Representative)

\_\_\_\_\_  
(Local)

**STEEL COST ADJUSTMENT (BDE)**

Effective: April 2, 2004

Revised: July 1, 2004

Description. At the bidder's option, a steel cost adjustment will be made to provide additional compensation to the Contractor or a credit to the Department for fluctuations in steel prices. The bidder must indicate on the attached form whether or not steel cost adjustments will be part of this contract. This attached form shall be submitted with the bid. Failure to submit the form shall make this contract exempt of steel cost adjustments.

Types of Steel Products. An adjustment will be made for fluctuations in the cost of steel used in the manufacture of the following items:

- Metal Piling (excluding temporary sheet piling)
- Structural Steel
- Reinforcing Steel

Other steel materials such as dowel bars, tie bars, mesh reinforcement, guardrail, steel traffic signal and light poles, towers and mast arms, metal railings (excluding wire fence), frames and grates, and other miscellaneous items will be subject to a steel cost adjustment when the pay item they are used in has a contract value of \$10,000 or greater.

Documentation. Sufficient documentation shall be furnished to the Engineer to verify the following:

- (a) Evidence that increased or decreased steel costs have been passed on to the Contractor.
- (b) The dates and quantity of steel, in kg (lb), shipped from the mill to the fabricator.
- (c) The quantity of steel, in kg (lb), incorporated into the various items of work covered by this special provision. The Department reserves the right to verify submitted quantities.

Method of Adjustment. Steel cost adjustments will be computed as follows:

$$SCA = Q \times D$$

Where: SCA = steel cost adjustment, in dollars  
Q = quantity of steel incorporated into the work, in kg (lb)  
D = price factor, in dollars per kg (lb)

$$D = CBP_M - CBP_L$$



Where:  $CBP_M$  = The average of the Consumer Buying Price indices for Shredded Auto Scrap (Chicago) and No. 1 Heavy Melt (Chicago) as published by the American Metal Market (AMM) for the day the steel is shipped from the mill. The indices will be converted from dollars per ton to dollars per kg (lb).

$CBP_L$  = The average of the Consumer Buying Price indices for Shredded Auto Scrap (Chicago) and No. 1 Heavy Melt (Chicago) as published by the AMM for the day the contract is let. The indices will be converted from dollars per ton to dollars per kg (lb).

The unit masses (weights) of steel that will be used to calculate the steel cost adjustment for the various items are shown in the attached table.

No steel cost adjustment will be made for any products manufactured from steel having a mill shipping date prior to the letting date.

If the Contractor fails to provide the required documentation, the method of adjustment will be calculated as described above; however, the  $CBP_M$  will be based on the date the steel arrives at the job site. In this case, an adjustment will only be made when there is a decrease in steel costs.

Basis of Payment. Steel cost adjustments may be positive or negative but will only be made when there is a difference between the  $CBP_L$  and  $CBP_M$  in excess of five percent, as calculated by:

$$\text{Percent Difference} = \{(CBP_L - CBP_M) \div CBP_L\} \times 100$$

Steel cost adjustments will be calculated by the Engineer and will be paid or deducted when all other contract requirements for the steel items are satisfied. Adjustments will only be made for fluctuations in the cost of the steel as described herein. No adjustment will be made for changes in the cost of manufacturing, fabrication, shipping, storage, etc.

**Attachment**

Item	Unit Mass (Weight)
Metal Piling (excluding temporary sheet piling)	
Furnishing Metal Pile Shells 305 mm (12 in.), 3.80 mm (0.179 in.) wall thickness)	34 kg/m (23 lb/ft)
Furnishing Metal Pile Shells 305 mm (12 in.), 6.35 mm (0.250 in.) wall thickness)	48 kg/m (32 lb/ft)
Furnishing Metal Pile Shells 356 mm (14 in.), 6.35 mm (0.250 in.) wall thickness)	55 kg/m (37 lb/ft)
Other piling	See plans
Structural Steel	See plans for weights
Reinforcing Steel	See plans for weights
Dowel Bars and Tie Bars	3 kg (6 lb) each
Mesh Reinforcement	310 kg/sq m (63 lb/100 sq ft)
Guardrail	
Steel Plate Beam Guardrail, Type A w/steel posts	30 kg/m (20 lb/ft)
Steel Plate Beam Guardrail, Type B w/steel posts	45 kg/m (30 lb/ft)
Steel Plate Beam Guardrail, Types A and B w/wood posts	12 kg/m (8 lb/ft)
Steel Plate Beam Guardrail, Type 2	140 kg (305 lb) each
Steel Plate Beam Guardrail, Type 6	570 kg (1260 lb) each
Traffic Barrier Terminal, Type 1 Special (Tangent)	330 kg (730 lb) each
Traffic Barrier Terminal, Type 1 Special (Flared)	185 kg (410 lb) each
Steel Traffic Signal and Light Poles, Towers and Mast Arms	
Traffic Signal Post	16 kg/m (11 lb/ft)
Light Pole, Tenon Mount and Twin Mount, 9 m – 12 m (30 - 40 ft)	21 kg/m (14 lb/ft)
Light Pole, Tenon Mount and Twin Mount, 13.5 m – 16.5 m (45 - 55 ft)	31 kg/m (21 lb/ft)
Light Pole w/Mast Arm, 9 m – 15.2 m (30 - 50 ft)	19 kg/m (13 lb/ft)
Light Pole w/Mast Arm, 16.5 m – 18 m (55 - 60 ft)	28 kg/m (19 lb/ft)
Light Tower w/Luminaire Mount, 24 m – 33.5 m (80 - 110 ft)	46 kg/m (31 lb/ft)
Light Tower w/Luminaire Mount, 36.5 m – 42.5 m (120 - 140 ft)	97 kg/m (65 lb/ft)
Light Tower w/Luminaire Mount, 45.5 m – 48.5 m (150 - 160 ft)	119 kg/m (80 lb/ft)
Metal Railings (excluding wire fence)	
Steel Railing, Type SM	95 kg/m (64 lb/ft)
Steel Railing, Type S-1	58 kg/m (39 lb/ft)
Steel Railing, Type T-1	79 kg/m (53 lb/ft)
Steel Bridge Rail	77 kg/m (52 lb/ft)
Frames and Grates	
Frame	115 kg (250 lb)
Lids and Grates	70 kg (150 lb)

**RETURN WITH BID**

**ILLINOIS DEPARTMENT  
OF TRANSPORTATION**

**OPTION FOR  
STEEL COST ADJUSTMENT**

The bidder shall submit this form with his/her bid. Failure to submit the form shall make this contract exempt of steel cost adjustments. After award, this form, when submitted shall become part of the contract.

**Contract No.:** \_\_\_\_\_

**Company Name:** \_\_\_\_\_

**Contractor's Option:**

Is your company opting to include this special provision as part of the contract plans?

Yes  No

**Signature:** \_\_\_\_\_ **Date:** \_\_\_\_\_

80127

PROJECT ENGINEER: BOB WAGNER

SENIOR SQUAD LEADER: SAMEER ABDULLAH (815) 284-5935

FOR INDEX OF SHEETS, SEE SHEET NO. 2  
FOR STATE STANDARDS, SEE SHEET NO. 3.

KEMANEE TOWNSHIP SECTION 23,24,25,27,28,33 & 34  
NEPONSET TOWNSHIP SECTION 1,2,9,10,11,15,17,18 & 19

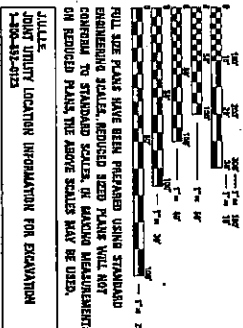

CONTRACT NO. 64775

F&P ROUTE 613 (US 34)

SECTION (6CS, 26CS, 7) RS-2 & BR-5

HENRY/BUREAU COUNTY

STATE OF ILLINOIS

DEPARTMENT OF TRANSPORTATION

DIVISION OF HIGHWAYS

# PROPOSED HIGHWAY PLANS

F&P ROUTE 613 (US 34)  
SECTION (6CS, 26CS, 7) RS - 2 & BR - 5  
PROJECT  
HENRY/BUREAU COUNTY  
C-92-010-05

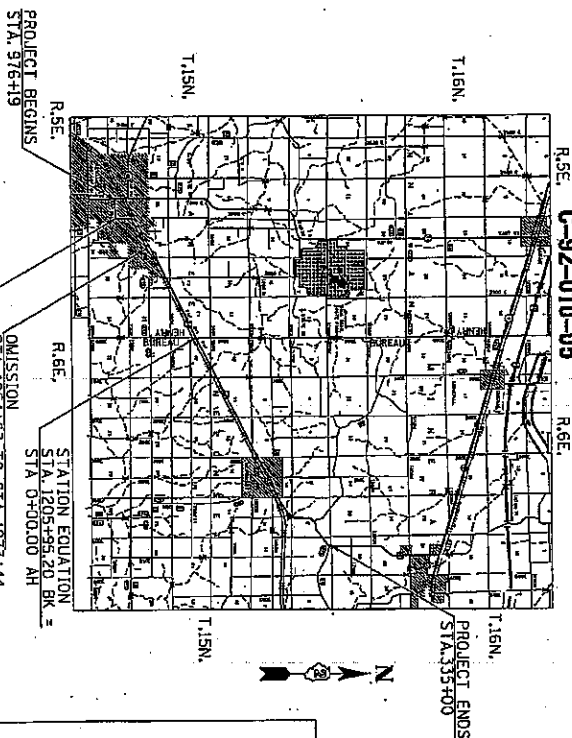

NET LENGTH OF PROJECT = 5408.2 FEET = 10.25 MILES  
GROSS LENGTH OF PROJECT = 56476.2 FEET = 10.70 MILES  
OMISSION LENGTH OF PROJECT = 2368 FEET = 0.45 MILES

OMISSION STA. 1000+34 TO 1005+25  
OMISSION STA. 1054+67 TO STA. 1073+44

STATION EQUATION  
STA. 0+00=0.00 AH

...projects\200502\200502cvr.dgn 1/10/2005 11:46:10 AM

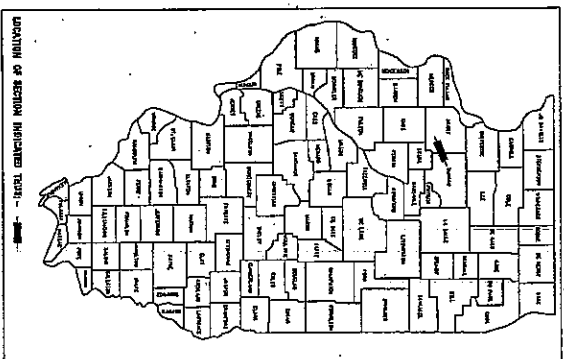

CONTRACT NO. 64775			
F&P	SECTION	COUNTY	TOWNSHIP
613	7	HENRY / BUREAU	1
* 6CS, 26CS, 7) RS - 2 & BR - 5			
** HENRY / BUREAU			

STATE OF ILLINOIS  
DEPARTMENT OF TRANSPORTATION  
DIVISION OF HIGHWAYS

SUBMITTED 1/10 20 05  
*Sameer Abdullah*  
PROJECT ENGINEER

ENGINEER OF DESIGN AND ENVIRONMENT  
20 \_\_\_\_\_

DIRECTOR, DIVISION OF HIGHWAYS

PRINTED BY THE AUTHORITY  
OF THE STATE OF ILLINOIS

ROUTE NO.	SEC.	COUNTY	TOTAL SHEET
F.A.P.	*	HENRY/BUREAU	SHEETS NO. 84
CONTRACT# 94776			2

## INDEX OF SHEETS

1	COVER SHEET
2	INDEX OF SHEETS
3	STATE STANDARDS
4 - 7	SUMMARY OF QUANTITIES
8	GENERAL NOTES
9 - 15	TYPICAL SECTIONS
16 - 23	SCHEDULE OF QUANTITIES
24	PAVEMENT MARKING DETAILS FOR OMISSION AT 2ND STREET AND EAST STREET
25 - 26	BITUMINOUS SCHEDULE
27 - 28	ENTRANCE SCHEDULE
29	PATCHING SCHEDULE HENRY COUNTY
30	PATCHING SCHEDULE BUREAU COUNTY
31 - 45	HORIZONTAL & VERTICAL CONTROL
46 - 69	PLAN SHEETS
70	MANHOLE SPECIAL PLAN VIEW
71	MANHOLES, SPECIAL
72	MANHOLES, SPECIAL
73	CATCH BASIN OR INLETS TO BE ADJUSTED OR RECONSTRUCTED (17.4A)
74	BITUMINOUS SHOULDER (23.4A)
75	PAVEMENT PATCHING FOR BITUMINOUS SURFACED PAVEMENT (32.4)
76	SUBGRADE REPLACEMENT (97.4)
77	EROSION CONTROL DETAILS FOR SILT FENCE (29.2)
78	BITUMINOUS APPROACHES & MAILBOX RETURNS FOR SINGLE LIFT (SMART) RESURFACING PROJECTS (46.2)
79	BITUMINOUS APPROACHES & MAILBOX RETURNS FOR TWO LIFT (3P) RESURFACING PROJECTS (47.2)
80	ROUGH GROOVED SURFACE SIGN (91.2)
81	CONCRETE COLLARS FOR PIPE OR BOX CULVERT EXTENSIONS (33.1)
82	SLOPED METAL END SECTIONS WITH GRATE (35.1)
83 - 84	TYPICAL PAVEMENT MARKINGS (41.1)

# STATE STANDARDS

- 001001 Areas of Reinforcement Bars
- 001006 Decimal of an Inch and of a Foot
- 420001 - 05 Pavement Joints
- 442201 - 01 Class C and D Patches
- 542311 Grating for Concrete Flared End Sections ( For 600mm(24") Thru 1350mm(54") Pipe)
- 542401 Metal end Sections for Pipe Culverts
- 606001 - 02 Concrete Curb Type B and Combination Concrete Curb and Gutter
- 701006 - 02 Typical Application of Traffic Control Standard
- 701011 - 01 Typical Application of Traffic Control Standard
- 701201 - 02 Typical Application of Traffic Control Standard
- 701301 - 02 Typical Application of Traffic Control Standard
- 701306 - 01 Typical Application of Traffic Control Standard
- 701311 - 02 Typical Application of Traffic Control Standard
- 701326 - 02 Typical Application of Traffic Control Standard
- 701336 - 04 Typical Application of Traffic Control Standard
- 701501 - 03 Typical Application of Traffic Control Standard
- 702001 - 05 Traffic Control Devices
- 780001 - 01 Typical Pavement Markings
- 781001 - 02 Typical Applications Raised Reflective Pavement Markers

ROUTE NO.	SEC.	COUNTY	TOTAL SHEET
F.A.P.	*	HENRY/BUREAU	SHEETS
(62) 2054 / 10-248-8		CONTRACTOR 8476	84
			3

# SUMMARY OF QUANTITIES

ROUTE NO.	SEC.	COUNTY	TOTAL SHEET
F.A.P.	*	HENRY/BUREAU	SHEETS NO.
			84 4

Code No.	Item	Units	Total Quantity	Bureau County		Henry County	
				Rural 1000 Sta 0+00- Sta 497+67	Urban 100% City Y060 Henry County	Urban 1000 Sta 976+19- Sta 1116+00	Rural 1000 Sta 1116+00- Sta 1205+95.20
20200620	EARTH EXCAVATION ( WIDENING )	UNIT	25	25			
20400800	FURNISHED EXCAVATION	CU YD	1391	233			1158
28000250	TEMPORARY EROSION CONTROL SEEDING	POUND	20	10			10
40600200	BITUMINOUS MATERIALS (PRIME COAT)	TON	97.0	58.3		23.8	14.9
40600300	AGGREGATE (PRIME COAT)	TON	255	153		62	40
40600695	CONSTRUCTING TEST STRIP	EACH	1	1			
40600980	BITUMINOUS SURFACE REMOVAL - BUTT JOINT	SQ YD	5073	3283		1194	596
40600985	PORTLAND CEMENT CONCRETE SURFACE REMOVAL - BUTT JOINT	SQ YD	99	99			
40600990	TEMPORARY RAMP	SQ YD	873	23		850	
40601000	BITUMINOUS REPLACEMENT OVER PATCHES	TON	843.2	314.4		401	127.9
40800040	INCIDENTAL BITUMINOUS SURFACING	TON	1000	548		379	73
44000007	BITUMINOUS SURFACE REMOVAL 2"	SQ YD	20,562			20,562	
44000128	BITUMINOUS REMOVAL OVER PATCHES 7"	SQ YD	2151.8	801.9		1023.9	326
44002000	CONCRETE CURB REMOVAL	FOOT	47			47	
44200180	PAVEMENT PATCHING, TYPE II, 15 INCH	SQ YD	68	29		25	14
44200184	PAVEMENT PATCHING, TYPE III, 15 INCH	SQ YD	26	11		10	5
44200186	PAVEMENT PATCHING, TYPE IV, 15 INCH	SQ YD	32	7		16	9.0
44300100	AREA REFLECTIVE CRACK CONTROL TREATMENT	SQ YD	57,000	41,500		5000	10,500

# SUMMARY OF QUANTITIES

ROUTE NO.	SEC.	COUNTY	TOTAL SHEETS
F.A.P.	*	HENRY/BUREAU	34
CONTRACT# 94775			5

Code No.	Item	Units	Total Quantity	Bureau County		Henry County	
				Rural 1000 Sta 0+00- Sta 497+67	Urban 100% City Y060 Henry County	Urban 1000 Sta 976+19- Sta 1116+00	Rural 1000 Sta 1116+00- Sta 1205+95.20
48101200	AGGREGATE SHOULDERS, TYPE B	TON	7,282.9	4923.5		1301.6	1063.8
48202315	BITUMINOUS SHOULDERS, SUPERPAVE 5-3/4"	SQ YD	566	566			
50104400	CONCRETE HEADWALL REMOVAL	EACH	1				1
50106200	REMOVE EXISTING CULVERTS	EACH	1	1			
542A0253	PIPE CULVERTS, CLASS A, TYPE 1 - 48"	FOOT	3				3
542D0220	PIPE CULVERTS, CLASS D, TYPE 1 - 15"	FOOT	56	56			
542D0241	PIPE CULVERTS, CLASS D, TYPE 1 - 36"	FOOT	11				11
542D0253	PIPE CULVERTS, CLASS D, TYPE 1 - 48"	FOOT	8				8
54213450	END SECTIONS - 15"	EACH	2	2			
54247190	GRATING FOR CONCRETE FLARED END SECTION - 48"	EACH	1	1			
56109210	WATER VALVES TO BE ADJUSTED	EACH	18		18		
60228400	MANHOLES, SPECIAL	EACH	1				1
60255800	MANHOLES TO BE ADJUSTED WITH NEW TYPE 1 FRAME, CLOSED LID	EACH	24		24		
60260100	INLETS TO BE ADJUSTED	EACH	22			22	
60600605	CONCRETE CURB, TYPE B	FOOT	81			81	
63200310	GUARD RAIL REMOVAL	FOOT	327	125			202
67100100	MOBILIZATION	L SUM	1	0.7			0.3
70100450	TRAFFIC CONTROL AND PROTECTION STANDARD 701201	L SUM	1	0.3			0.7



# SUMMARY OF QUANTITIES

Code No.	Item	Units	Total Quantity	Bureau County		Henry County		TOTAL SHEET	
				Rural 1000 Sta 0+00-497+67	Urban 100% City Y060 Sta 1116+00-1116+00	Urban 1000 Sta 976+19-1116+00	Rural 1000 Sta 1205+95.20-1205+95.20	SHEET NO. 84	SHEET NO. 6
70100460	TRAFFIC CONTROL AND PROTECTION STANDARD 701306	L SUM	1	0.7				0.3	
70100500	TRAFFIC CONTROL AND PROTECTION STANDARD 701326	L SUM	1	0.7				0.3	
70100600	TRAFFIC CONTROL AND PROTECTION STANDARD 701336	L SUM	1	0.7				0.3	
70102620	TRAFFIC CONTROL AND PROTECTION STANDARD 701501	L SUM	1	0.7				0.3	
70103815	TRAFFIC CONTROL SURVEILLANCE	CAL DAY	65	35		15		15	
70300100	SHORT-TERM PAVEMENT MARKING	FOOT	11,855.5	6700.4		3355.9		1799.0	
70301000	WORK ZONE PAVEMENT MARKING REMOVAL	SQ FT	1,321.5	736.5		387.0		198.0	
78000200	THERMOPLASTIC PAVEMENT MARKING - LINE 4"	FOOT	12,844			12,844			
78000500	THERMOPLASTIC PAVEMENT MARKING - LINE 8"	FOOT	710			710			
78000600	THERMOPLASTIC PAVEMENT MARKING - LINE 12"	FOOT	97			97			
78000650	THERMOPLASTIC PAVEMENT MARKING - LINE 24"	FOOT	104			104			
78001110	PAINT PAVEMENT MARKING - LINE 4"	FOOT	298,692	207,185		32,392		59,115	
78001140	PAINT PAVEMENT MARKING - LINE 8"	FOOT	108			108			
78100100	RAISED REFLECTIVE PAVEMENT MARKER	EACH	200	157		43			
78300200	RAISED REFLECTIVE PAVEMENT MARKER REMOVAL	EACH	243	200		43			
X0323973	SEDIMENT CONTROL, SILT FENCE	FOOT	587	279				308	
X4066414	BITUMINOUS CONCRETE SURFACE COURSE, SUPERPAVE, MIX "C", N50	TON	71	71					
X4066424	BITUMINOUS CONCRETE SURFACE COURSE, SUPERPAVE, MIX "D", N50	TON	13,331.4	7,999.4		3,182		2,150	

\* SPECIFICITY ITEMS

ROUTE NO.	SEC.	COUNTY	TOTAL SHEET
F.A.P. *	HENRY/BUREAU	SHEET NO. 84	SHEET NO. 6
CONTRACT NO. 710-246-5			

# SUMMARY OF QUANTITIES

Code No.	Item	Units	Total Quantity	Bureau County		Henry County	
				Rural 1000 Sta 0+00- Sta 497+67	Urban 100% City Y060 Henry County	Urban 1000 Sta 976+19- Sta 1116+00	Rural 1000 Sta 1116+00- Sta 1205+95.20
X4066735	LEVELING BINDER (HAND METHOD), SUPERPAVE N50	TON	5			5.0	
X4066765	LEVELING BINDER (MACHINE METHOD), SUPERPAVE, N50	TON	1,069			1069.0	
Z0028415	GEOTECHNICAL REINFORCEMENT	SQ YD	126	47		51	28
Z0028700	GRANULAR SUBGRADE REPLACEMENT	CU YD	21	8		8	5
Z0040315	PILOT CAR	DAY	7	4			3
Z0048665	RAILROAD PROTECTIVE LIABILITY INSURANCE	L SUM	1	0.5			0.5
X0324855	SLOPED METAL END SECTION WITH GRATE, 36 INCH	EACH	2				2
X0324856	SLOPED METAL END SECTION WITH GRATE, 48 INCH	EACH	1				1

\* SPECIALTY ITEMS

ROUTE NO.	SEC.	COUNTY	TOTAL SHEET NO.
F.A.P. 218m-5	*	HENRY/BUREAU	84
CONTRACT/SECTION			7

# GENERAL NOTES

NO.	DATE	BY	REVISION
1	06/05/2005	Henry	ISSUED FOR BIDDING
2	08/22/2005	Henry	REVISED PER COMMENTS
3	09/05/2005	Henry	REVISED PER COMMENTS

The final top (four inches) of soil in any right-of-way area disturbed by the Contractor must be capable of supporting vegetation. The soil must be from the A horizon (zero to 2' deep) of soil profiles of local soils.

The Contractor shall seed all disturbed areas within the project limits. Seeding Class 4 or 6 (modified) shall be used, except in front of properties where the grass will be mowed, then use Seeding Class 1 (modified). Class 6 (modified) shall be used on front slopes and ditch bottoms. Class 4 shall be used behind Type A gutters, on all backstops and areas behind the backstops, and beyond the toe of front slope on fill sections without ditches. This work will be included in the contract unit price per Cubic Meter (Cubic Yard) for FURNISHED EXCAVATION.

Fertilizer shall be applied to all disturbed areas and incorporated into the seedbed prior to seeding or placement of soil at the rate specified in Sections 250 and 252 of the Standard Specifications. This work shall be included in the cost of FURNISHED EXCAVATION.

Mulch Method II shall be applied over all seeded areas. This shall be included in the cost of the FURNISHED EXCAVATION.

When mulch with emulsified asphalt is applied, it will be the contractor's responsibility to cover or protect all traffic signs, guardrail and curbs. Any signs, guardrail or curbs which become covered with asphaltic material shall be cleaned by the Contractor at his own expense.

When laying out for patching, the minimum distance between new patches (saw cut to saw cut) shall be 4.6 m (15 feet). When patch spacing is less than 4.6 m (15 feet), the pavement between patches shall also be removed and replaced.

The minimum patch dimension for full-depth patches will be as shown on State Standard 442201.

The existing bituminous surface on private and commercial entrances shall be bladed off or milled and disposed of outside the project limits. The cost of the blading, milling, rolling, and disposal is included in the contract unit price for INCIDENTAL BITUMINOUS SURFACING.

Milling machines on this project shall be capable of removing a layer of bituminous a minimum 12" wide and 1-1/2" inches in depth in a single pass, or using a 7" milling machine with electronic grade control.

The following Mixture Requirements are applicable for this project:

Mixture Uses(s):	Surface & Incidental	Level Binder	Bit. Repl. Over Patches Add Binder
PG:	PG 64-22	PG 64-22	PG 64-22
RAP%: (Max)	15%	25%	25%
Design Air Voids	4.2 @ NSD	4.2 @ NSD	4.2 @ NSD
Mixture Composition (Gradation Mixture)	IL 9.6 or 12.5	IL 9.5	IL 19.0
Friction Aggregate	D	N/A	N/A
20 Year ESAL	1.2		

The Contractor will be required to furnish 140 mm (5 1/2") high brass stencils as approved by the Engineer and install stationing at 250' intervals. Stationing shall be placed on both lanes of 2-lane highways and on the outside lanes in both directions on 4-lane highways. The stations shall be placed 150 mm (6") inside the pavement marking edges so they can be read from the shoulder. This work will be included in the cost of the final pavement surface.

Reflective Crack Control shall be placed on the existing surface prior to any resurfacing, unless pavement is milled then it will be placed on the binder course.

The removal and replacement of guardrail or rail at the location of Concrete Curb, Type B shall be included in the contract unit price for CONCRETE CURB, TYPE B.

If, during the grinding or resurfacing operations, the existing manholes become a hindrance, the Contractor shall be required to carefully remove and reinstall the manholes as directed by the Engineer. This work shall be included in the contract unit price for the INCIDENTAL BITUMINOUS SURFACING.

The proposed pipes for entrances and side roads shall be placed in line with the existing or proposed ditch line.

The frame and grate of the inlet to be adjusted at Station 1006+45, 13 foot (right) shall be replaced. The new frame and grate is to be obtained from the City of Kewanee, contact Mike Furon at (309) 855-5956. This work shall be included in the contract unit price for INLETS TO BE ADJUSTED.

The new manhole lids on this project shall have the word "STORM", "SANITARY", or "WATER" on the lid. The word to be used is noted on the plans. It will be the Contractor's responsibility to determine the word to be used on other lids not noted on the plans. No additional compensation will be allowed for this work.

All proposed manholes on this project shall be cast in place or precast. This work will be paid for at the contract unit price Each for MANHOLES, SPECIAL of the type and size specified.

Pavement Marking shall be done according to Standard 780001, except as follows:

- The distance between yellow no-passing lines shall be 200 mm (8"), not 180 mm (7") as shown in the detail of Typical Lane and Edge Lines.

The cost of the removal of the existing bituminous shoulder as shown in the plans shall be included in the contract unit price for EARTH EXCAVATION (WIDENING).

The cost of milling the concrete patches located within the project limits shall be included in the contract unit price for BITUMINOUS SURFACE REMOVAL, 2.

All milling material resulting from milling the existing pavement shall be transported to the Langley Yard located at the interchange of IL 40 and 140. The cost involved in conforming to this general note shall be included in the contract unit price for BITUMINOUS SURFACE REMOVAL, 2.

The Contractor shall be responsible for protecting utility property during construction operations as outlined in Article 107.31 of the Standard Specifications. A minimum of 48 hours advance notice is required for non-emergency work. The JULIE number is 800-892-0123. The following listed utilities located within the project limits or immediately adjacent to the project construction limits are members of JULIE:

Verizon	SBC/Ameritech Telephone Co.
Illinois Power Co.	Corn Belt Energy Corp.
Insight Communications of Kewanee	Medacom
MCI World Com	City of Kewanee

Following are the known utilities located within the project limits or immediately adjacent to the project construction limits which are not members of JULIE and should be notified individually by the contractor:

Mr. Dennis Schultz  
IDOT - Dist. 2  
819 Depot Ave.  
Dixon, IL 61021

# TYPICAL SECTION

STA. 976+94 TO STA. 1025+25  
 WITH OMISSION STA. 1000+34 TO STA. 1005+25

± US 34

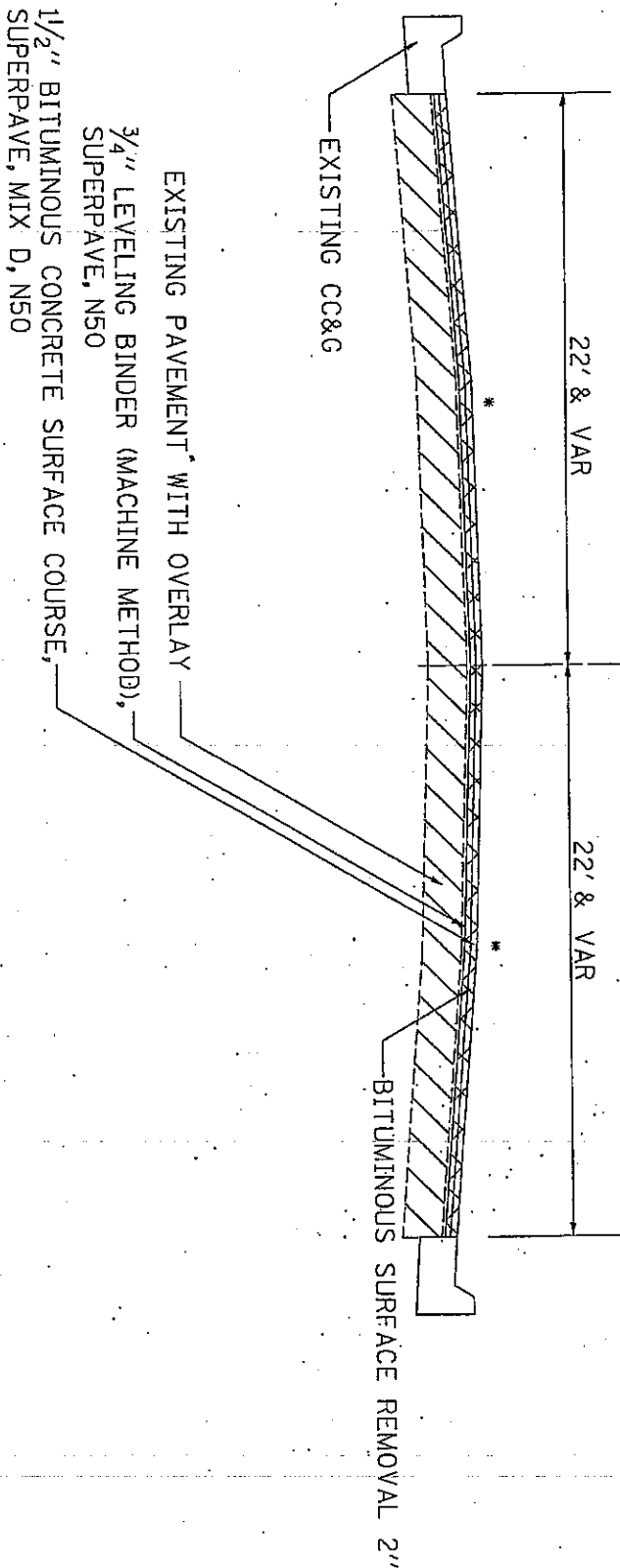

\* MATCH EXISTING SLOPE  
 (MIN. 1/8" / FT CROSS SLOPE)

NOTE:  
 BINDER & SURFACE COURSES  
 (112 LB/SY/IN)

REVISIONS	DATE	ILLINOIS DEPARTMENT OF TRANSPORTATION

SCALE: VERT. \_\_\_\_\_  
 DATE: \_\_\_\_\_

TYPICAL SECTION

CONTRACT NO. 88115  
 COUNTY: JEFFERSON  
 DISTRICT: 15  
 STA. 976+94 TO STA. 1025+25  
 ILLINOIS DEPARTMENT OF TRANSPORTATION  
 DIVISION OF DESIGN & CONSTRUCTION  
 PROJECT NO. 88115-15  
 DESIGN NO. 88115-15-15-15  
 DATE: 1/10/2005

# TYPICAL SECTION

STA. 1054+22 TO STA. 1054+67  
 STA. 334+55 TO STA. 335+00  
 BUTT JOINT TAPER

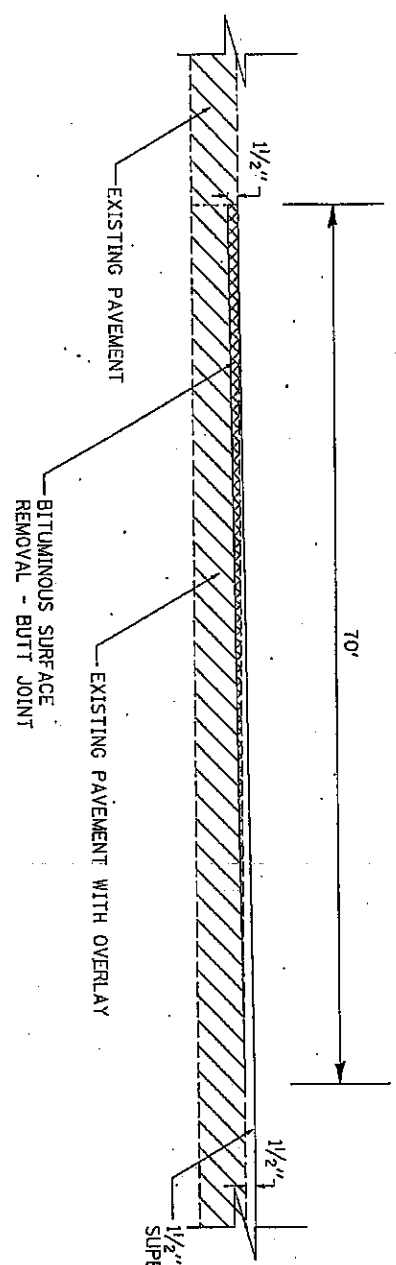

CONTRACT NO. 6175	SECTION	COUNTY	ROUTE
STA. 1054+22 TO STA. 1054+67	1054+22 TO 1054+67	ILLINOIS	1054+22 TO 1054+67
DESIGNED BY	DRAWN BY	CHECKED BY	DATE
ILLINOIS DEPARTMENT OF TRANSPORTATION			

1/2" BITUMINOUS CONCRETE SURFACE COURSE, SUPERPAVE, MIX "D", NSO

PLT DATE: 1 Nov 2005 10:47:52 AM  
 FILE NAME: ...projects\12005021\d005021yp.dgn  
 PLOT DATE: 11/10/2005 11:47:52 AM  
 PLOT SCALE: 1"=20'

REVISIONS	DATE	BY	DESCRIPTION

ILLINOIS DEPARTMENT OF TRANSPORTATION  
 SCALE: VERT. 1"=20'  
 HORIZ. 1"=40'  
 DATE: 11/10/2005  
 DRAWN BY: [Name]  
 CHECKED BY: [Name]

TYPICAL SECTION

# TYPICAL SECTION

STA. 1073+44 TO STA. 1081+59

± US 34

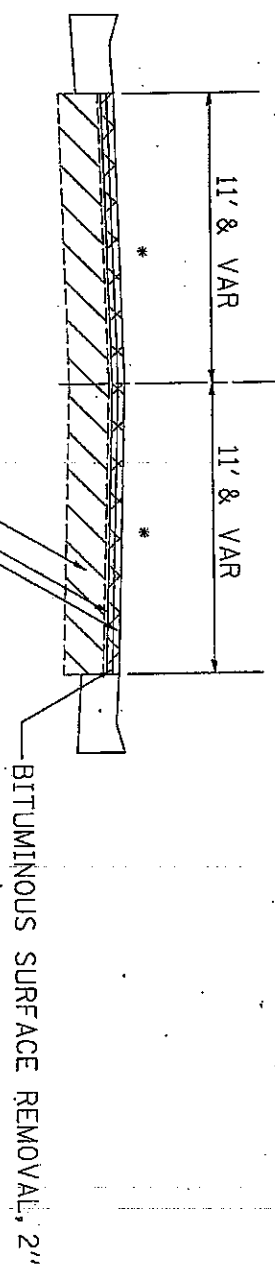

\* MATCH EXISTING SLOPE (MIN. 1/8" / FT CROSS SLOPE)

NOTE:  
BINDER & SURFACE COURSES  
(112 LB/SY/IN)

REVISIONS	DATE	BY	CHKD

ILLINOIS DEPARTMENT OF TRANSPORTATION

SCALE: HORIZ. 1" = 40'

VERT. 1" = 4'

DATE: 11/10/2005

DESIGNED BY: [ ]

CHECKED BY: [ ]

CONTRACT NO. 04/05	SECTION	QUANTITY	UNIT

CONTRACT NO. 04/05  
SECTION  
QUANTITY  
UNIT

# TYPICAL SECTION

STA. 1025+25 TO STA. 1054+67  
 STA. 1081+59 TO STA. 335+00

± US 34

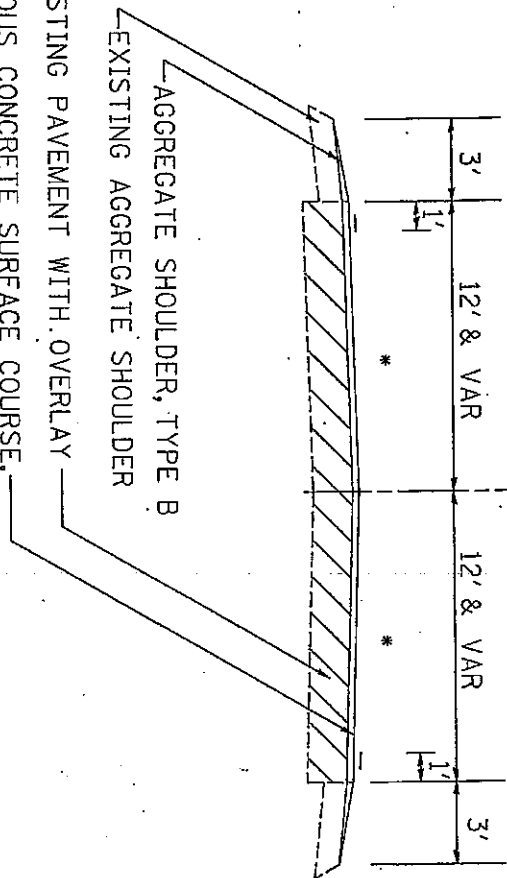

1/2" BITUMINOUS CONCRETE SURFACE COURSE,  
 SUPERPAVE, MIX D, N50

\* MATCH EXISTING SLOPE  
 (MIN. 1/8" / FT CROSS SLOPE)

NOTE:  
 SURFACE COURSE  
 (112 LB/SY/IN)

CONTRACT NO. 84115	
SECTION	COUNTY
DATE	SCALE
BY	CHECKED
DATE	DATE

REVISIONS	DATE

ALABAMA DEPARTMENT OF TRANSPORTATION

SCALE: VERT. 1"=10'  
 HORIZ. 1"=40'

DRAWN BY: \_\_\_\_\_  
 CHECKED BY: \_\_\_\_\_

TYPICAL SECTION

# TYPICAL SECTION

(BITUMINOUS SHOULDER ON INSIDE OF CURVES)  
 RT STA. 258+41 TO RT STA. 267+52  
 LT STA. 295+61 TO LT STA. 311+53

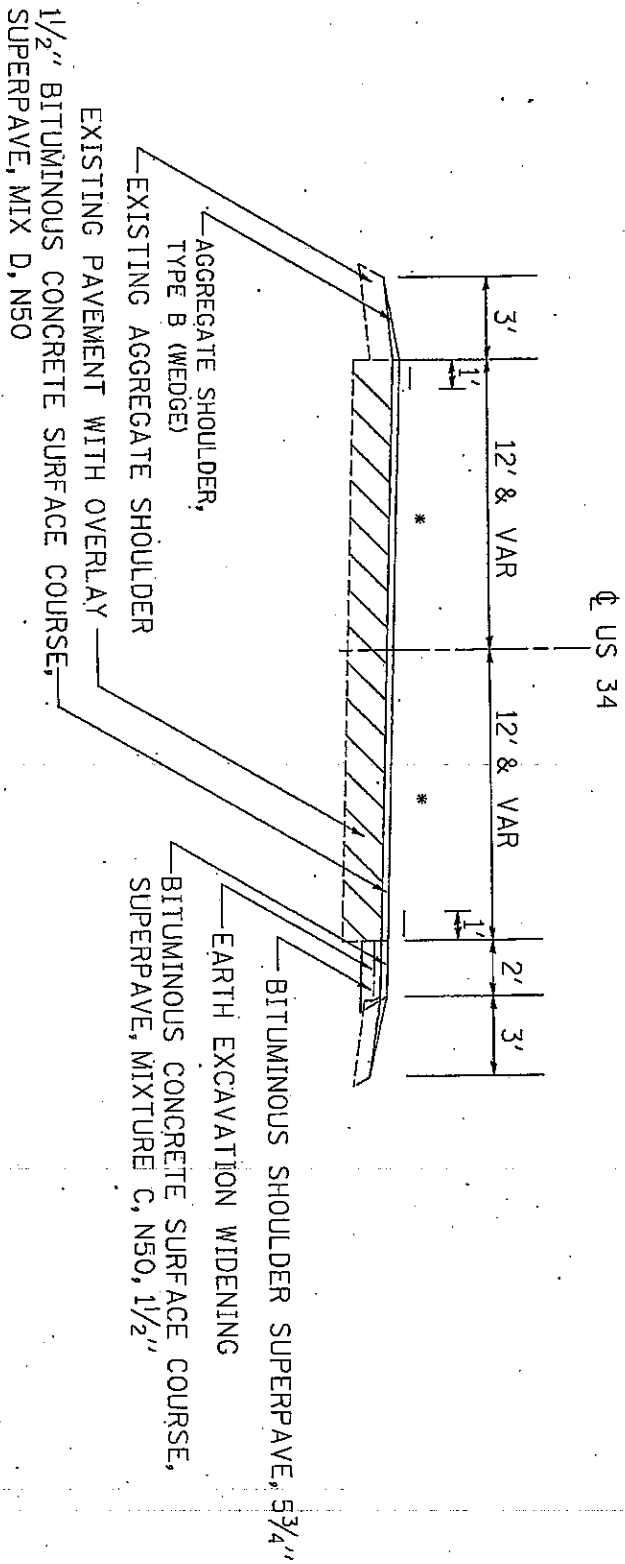

\* MATCH EXISTING SLOPE  
 (MIN. 1/8" / FT CROSS SLOPE)

NOTE:  
 SURFACE COURSE  
 (112 LB/SY/IN)

REVISIONS	DATE	BY	CHKD.

ILLINOIS DEPARTMENT OF TRANSPORTATION

SCALE: VERT. 1" = 10'

DATE: \_\_\_\_\_

DESIGNED BY: \_\_\_\_\_

CHECKED BY: \_\_\_\_\_

TYPICAL SECTION

CONTRACT NO. 011111	SECTION 011111
COUNTY	NO. 1111
DATE	11/11/11
TO STA.	1111
FROM STA.	1111
SCALE	1" = 10'
DATE	11/11/11

DESIGNED BY: \_\_\_\_\_

CHECKED BY: \_\_\_\_\_



# TYPICAL SECTION

SMART JOB SECTION TYPICAL TAPER FOR  
SIDE ROADS

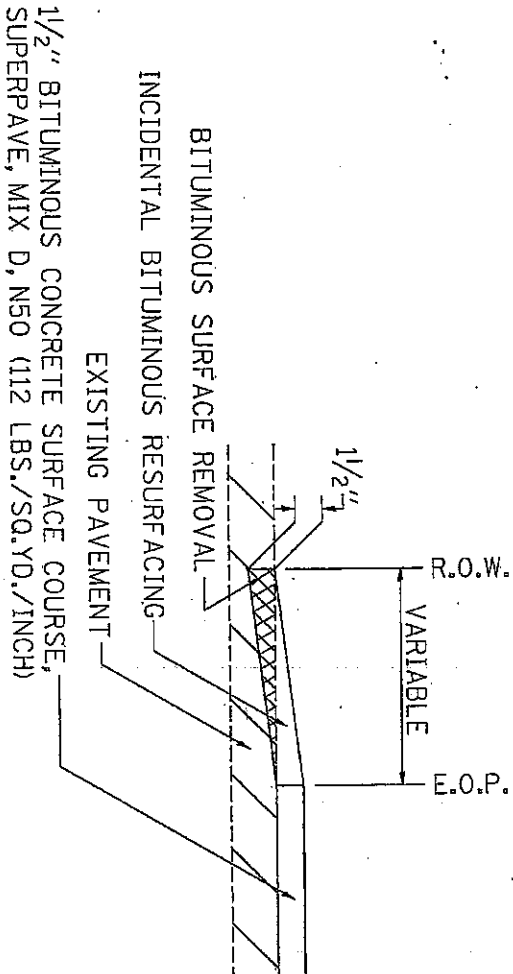

CONTRACT NO. 6478

SECTION	QUANTITY	UNIT	EST. PRICE
1/2" BITUMINOUS CONCRETE SURFACE COURSE, SUPERPAVE, MIX D, N50 (112 LBS./SQ.YD./INCH)		SQ. YD.	
TOTAL			

REVISED PER: AUTHORIZED BY PROJECT  
 \* (55-455, 755-3 & 505-3  
 \*\* (REVISED) (NEW)

REVISIONS	DATE

ILLINOIS DEPARTMENT OF TRANSPORTATION

SCALE: 1/4" = 1'-0"

DRAWN BY: \_\_\_\_\_

CHECKED BY: \_\_\_\_\_

## TYPICAL SECTION

PLT DATE: 11/10/2005 11:53:32 AM  
 FILE NAME: ...  
 FILE SCALE: 1/4" = 1'-0"  
 PROJECT: ...

# TYPICAL SECTION

TYPICAL TAPER  
SIDE ROADS

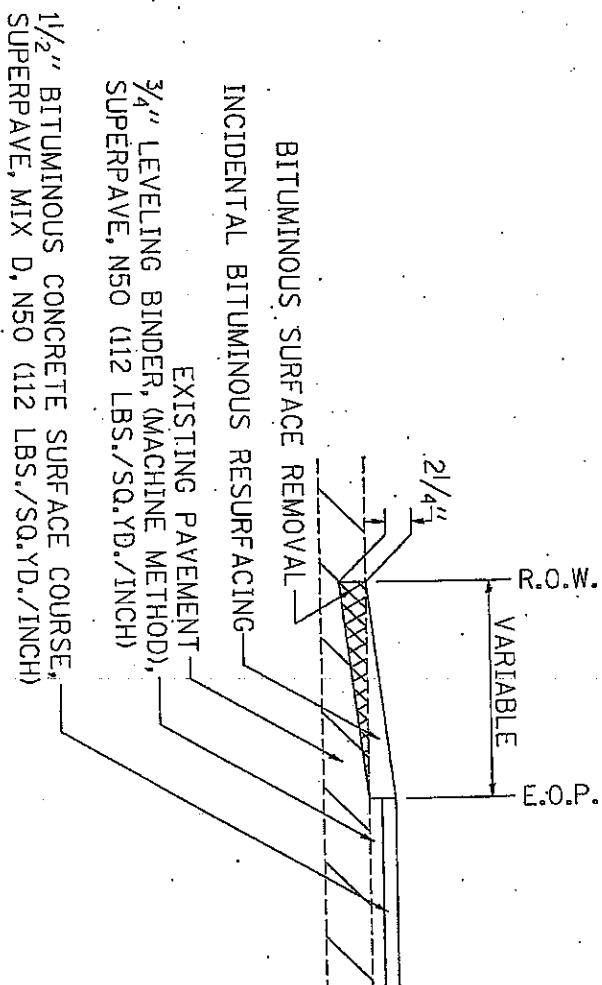

CONTRACT NO. 01/03	SECTION	DATE
NO. 1	NO. 1	NO. 1
NO. 1	NO. 1	NO. 1
NO. 1	NO. 1	NO. 1

REVISION	DATE

TYPICAL SECTION

# Schedule of Quantities

ROUTE NO.	SEC.	COUNTY	TOTAL SHEET	SHEETS NO.	TOTAL SHEET
			84	16	
F.A.P. * HENRY/BUREAU					
CONTRACT#476					
(see also 1/26/85)					

## 20200520 EARTH EXCAVATION (WIDENING)

UNIT LOCATION

	LT Sta	258+41	-	267+52	
	RT Sta	296+61	-	311+53	
	TOTAL				25.0

## 20400800 FURNISHED EXCAVATION

CU YD LOCATION

	LT STA	1116 + 00	-	1117 + 70	1158.0
	LT STA	182 + 00	-	184 + 79	233.0
	TOTAL				1391

## 28000250 TEMPORARY EROSION CONTROL SEEDING

POUND LOCATION

	LT STA	1116 + 00	-	1117 + 70	10.0
	LT STA	182 + 00	-	184 + 79	10.0
	TOTAL				20.00

## 44002000 CONCRETE CURB REMOVAL

FOOT LOCATION

	RT Sta	1074 + 53	-	1074 + 72	19
	LT Sta	1074 + 07	-	1074 + 35	28
	TOTAL				47

## 44300100 AREA REFLECTIVE CRACK CONTROL TREATMENT

SQ YD LOCATION

	Sta	62000		TOTAL	62000
--	-----	-------	--	-------	-------

Various Location Through Out Job

# Schedule of Quantities

ROUTE NO.	SEC.	COUNTY	TOTAL SHEET
F.A.P.	*	HENRY/BUREAU	84
CONTRACT#64775			17

50104400 CONCRETE HEADWALL REMOVAL

EACH	LOCATION	LT STA	1.0	1116 + 46
		TOTAL	1	

50105200 REMOVE EXISTING CULVERTS

EACH	LOCATION	LT STA	1.0	184 + 78
		TOTAL	1	185 + 17

54213450 END SECTIONS 15"

EACH	LOCATION	LT STA	1.0	184 + 61
		LT STA	1.0	185 + 17
		TOTAL	2	

54247190 GRATING FOR CONCRETE FLARED END SECTION 48"

EACH	LOCATION	LT STA	1.0	183 + 75
		TOTAL	1	

542A0253 PIPE CULVERTS, CLASS A, TYPE 1 48"

FOOT	LOCATION	LT STA	3.0	1116 + 46
		TOTAL	3	

542D0220 PIPE CULVERTS, CLASS D, TYPE 1 15"

FOOT	LOCATION	LT STA	56.0	184 + 78
		TOTAL	56	185 + 17

542D0241 PIPE CULVERTS, CLASS D, TYPE 1 36"

FOOT	LOCATION	LT STA	11.0	1116 + 46
		TOTAL	11	

542D0253 PIPE CULVERTS, CLASS D, TYPE 1 48"

FOOT	LOCATION	LT STA	8.0	1116 + 46
		TOTAL	8	

# Schedule of Quantities

ROUTE NO.	SEC.	COUNTY	TOTAL SHEETS
F.A.P.	*	HENRY/BUREAU	84
CONTRACT#4475			18

56109210 WATER VALVES TO BE ADJUSTED

EACH LOCATION OFFSET

LOCATION	OFFSET	TOTAL
Lt Sta	976 + 57	17
Rt Sta	977 + 24	19
Rt Sta	977 + 90	21
Rt Sta	978 + 54	20
Rt Sta	978 + 57	20
Lt Sta	979 + 17	19
Lt Sta	979 + 40	20
Lt Sta	979 + 80	18
Lt Sta	979 + 83	13
Lt Sta	979 + 87	37
Lt Sta	987 + 78	32
Lt Sta	987 + 81	16
Rt Sta	991 + 40	12
Lt Sta	1010 + 24	30
Rt Sta	1043 + 34	22
Rt Sta	1051 + 81	49
Rt Sta	1051 + 91	25
Rt Sta	1051 + 95	25
<b>TOTAL</b>		<b>18</b>

60228400 MANHOLES, SPECIAL

EACH LOCATION

LOCATION	OFFSET	TOTAL
Lt Sta	1116 + 40	1
<b>TOTAL</b>		<b>1</b>

60255800 MANHOLES TO BE ADJUSTED WITH NEW TYPE 1 FRAME, CLOSED LID

EACH LOCATION OFFSET

LOCATION	OFFSET	TOTAL
Lt Sta	978+03	1
Lt Sta	981+95	1
Sta	984+12	1
Lt Sta	985+94	1
Lt Sta	987+54	1
Lt Sta	987+74	20
Rt Sta	991+99	1
Lt Sta	993+72	1
Rt Sta	996+05	1
Lt Sta	996+73	1
Lt Sta	999+56	1
Lt Sta	1006+45	1
Rt Sta	1010+24	1
Lt Sta	1010+35	1
Lt Sta	1010+71	1
Lt Sta	1015+40	1
Rt Sta	1018+85	1
Lt Sta	1018+91	1
Lt Sta	1019+07	1
Lt Sta	1019+07	1
Rt Sta	1019+07	1
Lt Sta	1021+89	1
Rt Sta	1022+06	1
Rt Sta	1032+66	1
Rt Sta	1037+02	1
<b>TOTAL</b>		<b>24</b>

# Schedule of Quantities

60260100 INLETS TO BE ADJUSTED

EACH LOCATION OFFSET

LOCATION	OFFSET
Lt Sta 976 + 93	18'
Lt Sta 979 + 87	22'
Rt Sta 979 + 87	22'
Lt Sta 983 + 83	18'
Lt Sta 983 + 83	18'
Rt Sta 983 + 83	18'
Lt Sta 984 + 23	18'
Lt Sta 984 + 81	14'
Rt Sta 984 + 83	14'
Lt Sta 987 + 65	18'
Lt Sta 991 + 56	18'
Rt Sta 991 + 56	18'
Lt Sta 991 + 96	18'
Lt Sta 996 + 88	13'
Rt Sta 996 + 88	13'
Rt Sta 1006 + 37	29'
Rt Sta 1006 + 72	27'
Rt Sta 1006 + 95	13'
Lt Sta 1006 + 97	11'
Rt Sta 1010 + 71	14'
Lt Sta 1010 + 71	10'
Lt Sta 1018 + 45	13'
Rt Sta 1018 + 43	14'
<b>TOTAL</b>	<b>22</b>

60600605 CONCRETE CURB, TYPE B

FOOT LOCATION

LOCATION	FOOT
Rt Sta 1074 + 83	30
Lt Sta 1074 + 07	51
<b>TOTAL</b>	<b>81</b>

63200310 GUARD RAIL REMOVAL

FOOT LOCATION

LOCATION	FOOT
Lt Sta 1116 + 76	100
Lt Sta 1115 + 98	102
Lt Sta 1117 + 17	125
<b>TOTAL</b>	<b>327</b>

ROUTE NO.	SEC.	COUNTY	TOTAL SHEETS	SHEET NO.
F.A.P.	*	HENRY/BUREAU	84	19
CONTRACT#4475				
(See sheet #2489-5)				

# Schedule of Quantities

ROUTE NO.	SEC.	COUNTY	TOTAL SHEET
F.A.P.	*	HENRY/BUREAU	84
CONTRACT#4775			20
(Sec. 26a, 7a-289e-5)			

## 78000200 THERMOPLASTIC PAVEMENT MARKING - LINE 4\*

LOCATION	FOOT	TOTAL
Sta	605	976 + 19
Sta	289	1005 + 25
Sta	2422	1016 + 79
Sta	886	1028 + 90
Sta	467	1035 + 99
Lt & Rt Sta	7134	1054 + 67
Omitted	1041	1054 + 67
TOTAL	12844	Refer to Pavement Marking Detail Sheet

## 78000500 THERMOPLASTIC PAVEMENT MARKING - LINE 8\*

LOCATION	FOOT	TOTAL
Lt & Rt Sta	134	976 + 48
Rt Sta	60	977 + 08
Rt Sta	43	1014 + 19
Lt & Rt Sta	64	1014 + 49
Omitted	409	Refer to Pavement Marking Detail Sheet
TOTAL	710	

## 78000600 THERMOPLASTIC PAVEMENT MARKING - LINE 12\*

LOCATION	FOOT	TOTAL
Rt Sta	39	977 + 08
Rt Sta	58	977 + 64
Omission	97	Refer to Pavement Marking Detail Sheet
TOTAL	97	

## 78000650 THERMOPLASTIC PAVEMENT MARKING - LINE 24\*

LOCATION	FOOT	TOTAL
Rt Sta	11	1014 + 19
Omission	93	Refer to Pavement Marking Detail Sheet
TOTAL	104	

# Schedule of Quantities

78001110 PAINT PAVEMENT MARKING - LINE 4 ( 2 COATS APPLIED )

FOOT LOCATION

DESCRIPTION	QUANTITY	UNIT	TOTAL QUANTITY	LOCATION	TOTAL
White Edge Line	335 + 00	-	1073 + 44	Lt & Rt Sta	187004
Double Yellow	1103 + 86	-	1073 + 44	Lt & Rt Sta	12168
Solid Yellow, No Passing	1114 + 90	-	1103 + 86	Lt Sta	2760
Double Yellow	1117 + 87	-	1114 + 90	Lt & Rt Sta	1188
Solid Yellow, No Passing	1128 + 42	-	1117 + 87	Rt Sta	2638
Double Yellow	1160 + 47	-	1128 + 42	Lt & Rt Sta	12820
Solid Yellow, No Passing	1167 + 92	-	1160 + 47	Lt Sta	1864
Yellow Skip Dash	1175 + 86	-	1167 + 92	Sta	398
Solid Yellow, No Passing	1183 + 61	-	1175 + 86	Rt Sta	1938
Solid Yellow, No Passing	1191 + 66	-	1183 + 61	Lt Sta	2014
Yellow Skip Dash	9 + 13	-	1191 + 66	Sta	1172
Solid Yellow, No Passing	16 + 61	-	9 + 13	Rt Sta	1870
Double Yellow	19 + 23	-	16 + 61	Lt & Rt Sta	1048
Solid Yellow, No Passing	28 + 97	-	19 + 23	Lt Sta	2436
Double Yellow	42 + 91	-	28 + 97	Lt & Rt Sta	5576
Solid Yellow, No Passing	48 + 96	-	42 + 91	Lt Sta	1514
Yellow Skip Dash	52 + 26	-	48 + 96	Sta	166
Solid Yellow, No Passing	58 + 78	-	52 + 26	Rt Sta	1630
Double Yellow	73 + 91	-	58 + 78	Lt & Rt Sta	6052
Solid Yellow, No Passing	83 + 86	-	73 + 91	Lt Sta	2488
Yellow Skip Dash	92 + 02	-	83 + 86	Sta	408
Solid Yellow, No Passing	98 + 83	-	92 + 02	Rt Sta	1704
Yellow Skip Dash	99 + 67	-	98 + 83	Sta	42
Solid Yellow, No Passing	108 + 91	-	99 + 67	Lt Sta	2310
Double Yellow	118 + 36	-	108 + 91	Rt Sta	2364
Solid Yellow, No Passing	120 + 94	-	118 + 36	Lt & Rt Sta	1032
Solid Yellow, No Passing	128 + 75	-	120 + 94	Lt Sta	1954
Yellow Skip Dash	129 + 47	-	128 + 75	Sta	1850
Solid Yellow, No Passing	174 + 41	-	129 + 47	Rt Sta	2170
Double Yellow	179 + 27	-	174 + 41	Lt & Rt Sta	1944
Solid Yellow, No Passing	184 + 09	-	179 + 27	Lt Sta	1206
Yellow Skip Dash	220 + 27	-	184 + 09	Sta	1810
Solid Yellow, No Passing	229 + 47	-	220 + 27	Rt Sta	2300
Yellow Skip Dash	230 + 32	-	229 + 47	Sta	44
Solid Yellow, No Passing	238 + 06	-	230 + 32	Lt Sta	1936
Yellow Skip Dash	242 + 28	-	238 + 06	Sta	212
Solid Yellow, No Passing	250 + 43	-	242 + 28	Rt Sta	2038
Yellow Skip Dash	258 + 78	-	250 + 43	Lt Sta	2088
Solid Yellow, No Passing	277 + 20	-	258 + 78	Sta	922
Double Yellow	287 + 24	-	277 + 20	Rt Sta	2510
TOTAL	287 + 24	-	287 + 24	Lt & Rt Sta	19104

ROUTE NO.	SEC.	COUNTY	TOTAL SHEETS	SHEETS NO.	TOTAL SHEET
F.A.P.	*	HENRY/BUREAU	84	21	
CONTRACT#6475					



# Schedule of Quantities

78001140 PAINT PAVEMENT MARKING - LINE 8" (2 COATS APPLIED)

White Cross Walk

FOOT LOCATION

108  
108  
TOTAL

78100100 RAISED REFLECTIVE PAVEMENT MARKER

EACH LOCATION

43.0  
157.0  
200  
TOTAL

78300200 RAISED REFLECTIVE PAVEMENT MARKER REMOVAL

EACH LOCATION

43.0  
200.0  
243  
TOTAL

X0323973 SEDIMENT CONTROL SILT FENCE

FOOT LOCATION

167  
141  
279  
587  
TOTAL

#2001278 SLOPED METAL END SECTION WITH GRATE 36 INCH

EACH LOCATION

1.0  
1.0  
2  
TOTAL

#2001279 SLOPED METAL END SECTION WITH GRATE 48 INCH

EACH LOCATION

1.0  
1.0  
1  
TOTAL

ROUTE NO.	SEC.	COUNTY	TOTAL SHEETS
F.A.P.	*	HENRY/BUREAU	84
CONTRACT#04175			22

# SCHEDULE OF QUANTITIES

ROUTE NO.	SEC.	COUNTY	TOTAL SHEET NO.
F.A.P.	*	HENRY/BUREAU	84
CONTRACT NO. 78			23

### 78000800 THERMOPLASTIC PAVEMENT MARKING - 12 INCH

FOOT	LOCATION	DESCRIPTION
21	SOUTH SIDE OF ISLAND	(Diagonals - White)
27	STA. 100+41 to STA. 101+20	(Median Diagonals - Yellow)
58	TOTAL	

### 78000200 THERMOPLASTIC PAVEMENT MARKING - 4 INCH

FOOT	LOCATION	DESCRIPTION
312	2ND STREET STA. 33+88 to STA. 35+65	(Double - Yellow)
81	EAST STREET SOUTH SIDE OF ISLAND	(White)
318	STA. 100+41 to STA. 101+20	(Median - Yellow)
340	STA. 101+20 to STA. 102+90	(Double - Yellow)
1051	TOTAL	

### 78000850 THERMOPLASTIC PAVEMENT MARKING - 24 INCH

FOOT	LOCATION	DESCRIPTION
18	2ND STREET RT. STA. 33+88	(Stopbar - White)
19	LT. STA. 38+40	(Stopbar - White)
18	EAST STREET RT. STA. 88+65	(Stopbar - White)
12	LT. STA. 100+42	(Stopbar - White)
28	LT. STA. 100+46 in turn lane	(Stopbar - White)
93	TOTAL	

### 78000900 THERMOPLASTIC PAVEMENT MARKING - 8 INCH

FOOT	LOCATION	DESCRIPTION
88	2ND STREET STA. 33+84	(Crosswalk - White)
94	STA. 38+22	(Crosswalk - White)
95	EAST STREET STA. 88+74	(Crosswalk - White)
85	STA. 100+31	(Crosswalk - White)
47	LT. STA. 100+40	(Crosswalk - White)
408	TOTAL	

DISTRICT NO. 2 DIXON  
 DRAWN BY DATE  
 CHECKED BY SCALE

# PAVEMENT MARKING DETAILS

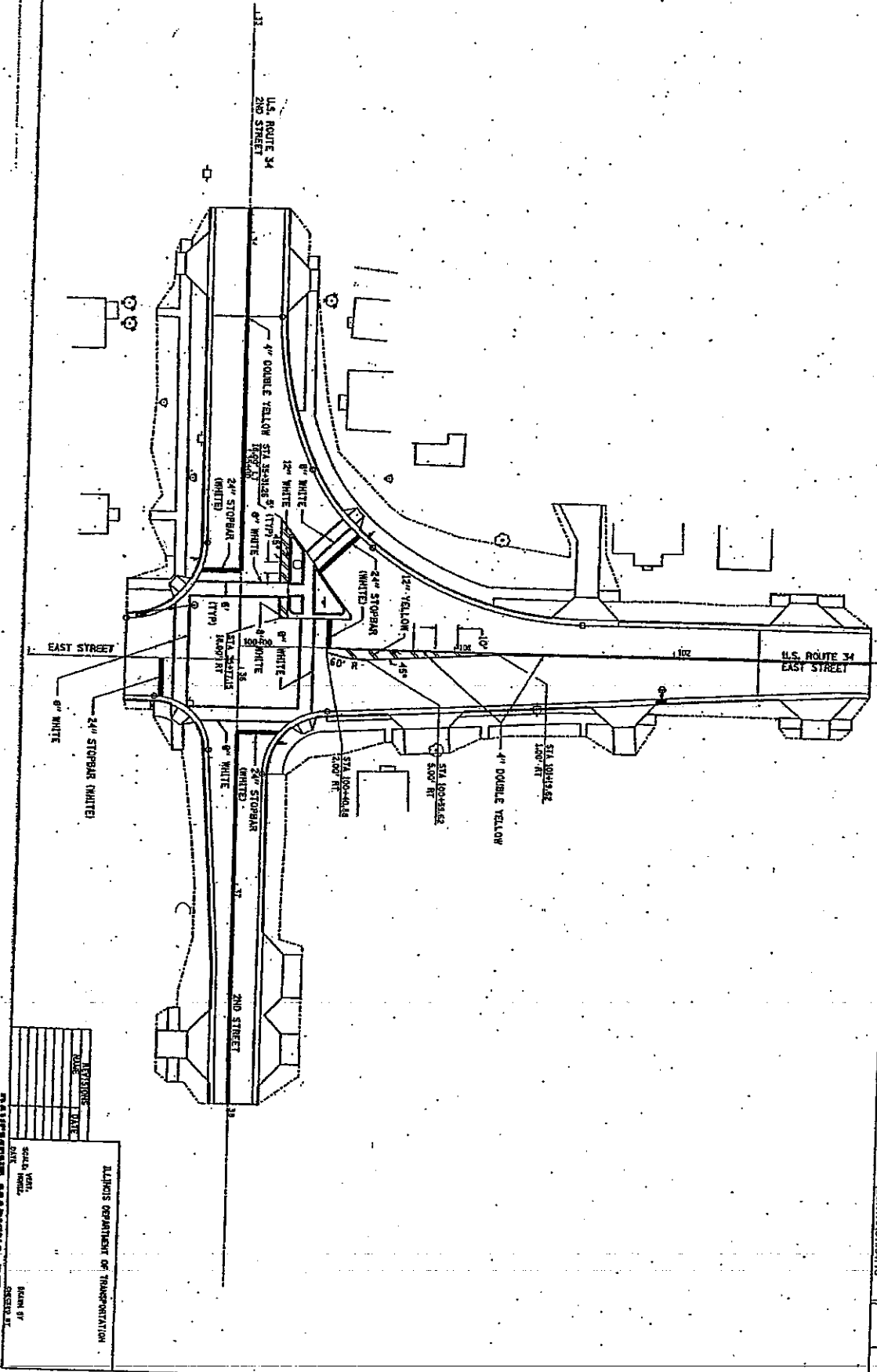

ROUTE NO.	SEC.	COUNTY	TOTAL SHEET SHEETS NO.
F.A.P.	4	HENRY/BUREAU	84
CONTRACT NO. 64776			24

ILLINOIS DEPARTMENT OF TRANSPORTATION

DESIGNED BY	DATE
CHECKED BY	DATE
SCALE	VERT. HORIZ.
DRAWN BY	
REVISIONS	



ROUTE NO.	SEC.	COUNTY	TOTAL SHEETS NO.
F.A.P.	*	HENRY/BUREAU	84
CONTRACT# 84775			26

**BITUMINOUS SCHEDULE**

Location	Remarks	Length	Proposed Surface	Sq Yd	4800000		4800000		4800000		4800000		4800000		4800000		4800000		4800000	
					Bill	Material	Prime Coat	Agg	Surf	Temp	Inst	Bitum	2-1/2	Bit	Sheet	Water	Bit	Lat	Lat	Lat
2337E	without joint	45	Var	220	0.1	0.3	220													
2338E	without joint	30	Var	179	0.1	0.3	179													
DOE	without joint	28	Var	181	0.1	0.2	181													
N. L&K	without joint	28	Var	187	0.1	0.3	187													
S. L&K	without joint	28	Var	108	0.1	0.2	108													
1008	without joint	45	Var	216	0.1	0.3	216													
200E	without joint	38	Var	187	0.1	0.2	187													
N. L&K	without joint	30	Var	178	0.1	0.3	178													
S. L&K	without joint	30	Var	205	0.1	0.3	205													
Center Street	without joint	50	Var	98	0.1	0.1	98													
7TH Street	without joint	28	Var	98	0.1	0.1	98													
Commercial Street	without joint	70	Var	184	0.1	0.2	184													
5TH Street	without joint	28	Var	232	0.1	0.2	232													
7TH Street	without joint	45	Var	184	0.1	0.3	184													
3RD Street	without joint	25	Var	191	0.1	0.2	191													
3RD Street	without joint	45	Var	105	0.1	0.2	105													
4TH Street	without joint	30	Var	207	0.1	0.3	207													
Marion Place	without joint	45	Var	174	0.1	0.3	174													
15TH Street	without joint	45	Var	174	0.1	0.3	174													
49TH	without joint	30	Var	179	0.1	0.3	179													
48TH	without joint	45	Var	215	0.1	0.3	215													
TOTALS					94.0	248.8	803.3	873	642	20,582	7,265.8	588	11,855	1,327	71	13,391	5	1,009		

ROUTE NO.	SEC.	COUNTY	TOTAL SHEETS NO.
F.A.P.	*	HENRY/BUREAU	84
CONTRACT#4475			27

### ENTRANCE SCHEDULE

Location	Remarks	Length	Width	Sq Yd	Pcc Surface Removal	Sq Yd Butt-Joint	Bit Materials Prime Coat	Agg Prime Coat	Incidental Bituminous Surfacing	Agg Shoulder, Type B
US 34	CE	12	130	188.0	13.0		0.11	0.3	15.8	
1025 + 25	CE	8	8	13.0	13.0		0.01	0.0	1.1	
1026 + 83	PE	8	8	13.0	13.0		0.01	0.0	1.1	
1027 + 17	PE	8	8	13.0	13.0		0.01	0.0	1.1	
1027 + 72	PE	8	8	13.0	13.0		0.01	0.0	1.1	
1029 + 18	PE	8	8	13.0	13.0		0.01	0.0	1.1	
1029 + 47	PE	8	8	13.0	13.0		0.01	0.0	1.1	
1030 + 94	PE	8	8	13.0	13.0		0.01	0.0	1.1	
1031 + 59	PE	8	8	13.0	13.0		0.01	0.0	1.1	
1034 + 16	PE	8	8	13.0	13.0		0.01	0.0	1.1	
1034 + 00	ALLEY	8	8	13.0	13.0		0.01	0.0	1.1	
1035 + 00	PE Parking	13	177	247.0	13.0	0.14	0.4	20.7		
1037 + 97	PE	8	8	13.0	13.0		0.01	0.0	1.1	
1039 + 49	PE	8	8	13.0	13.0		0.01	0.0	1.1	
1040 + 35	PE	8	8	13.0	13.0		0.01	0.0	1.1	
1041 + 9	PE	8	8	13.0	13.0		0.01	0.0	1.1	
1045 + 43	PE	8	8	13.0	13.0		0.01	0.0	1.1	
1046 + 14	PE	8	8	13.0	13.0		0.01	0.0	1.1	
1046 + 92	PE	8	8	13.0	13.0		0.01	0.0	1.1	
1049 + 13	CE	19	272	374.0	13.0	0.21	0.6	41.9		
1054 + 1	CE	17	32	81.0	13.0	0.05	0.1	6.8		
1081 + 60	PE	14	15	64.0	13.0	0.04	0.1	5.4		
1082 + 10	MB	17	14	37.0	13.0	0.02	0.1	3.1		
1082 + 65	PE	14	14	64.0	13.0	0.04	0.1	5.4		
1082 + 55	PE	17	17	64.0	13.0	0.04	0.1	5.4		
1082 + 58	PE	14	14	64.0	13.0	0.04	0.1	5.4		
1160 + 92	FE	58	9	40.0	13.0	0.02	0.1	3.4		
1160 + 38	PE	53	10	102.0	13.0	0.04	0.1	6.6		
1175 + 79	FE	9	15	23.0	13.0	0.01	0.0	1.9		
1184 + 40	MB			24.0	13.0	0.01	0.0	2.0		
1184 + 79	PE	53	11	124.0	13.0	0.07	0.2	10.4		
1197 + 5	FE	11	16	28.0	13.0	0.02	0.0	2.4		
0 + 00								0		
14 + 18	FE	10	15	27.0	13.0	0.02	0.0	2.3		
30 + 00	FE	11	19	27.0	13.0	0.02	0.0	2.3		
40 + 38	FE	10	12	24.0	13.0	0.01	0.0	2.0		
51 + 17	PE	58	17	195.0	13.0	0.11	0.3	16.4		
69 + 26	PE	58	12	91.0	13.0	0.05	0.1	7.6		

ROUTE NO.	SEC.	COUNTY	TOTAL SHEETS
F.A.P.	HENRY/BUREAU	84	28
CONTRACT NO. 106-2052/MS-2891-5			

### ENTRANCE SCHEDULE

Location	Remarks	Length	Width	SqYd	Pcc	Surface Removal	Bit Materials	Agg Prime Coat	Incidental Bituminous Surfacing	Agg Shoulder, Type B
				Sq Yd			Ton	Ton	Ton	Ton
Lt Sta 72 + 24	PE	58	14	135.0			0.08	0.2		11.3
Lt Sta 89 + 18	FE	30	12	57.0			0.03	0.1		4.8
Rt Sta 96 + 86	FE	19	14	69.0			0.04	0.1		5.8
Lt Sta 102 + 25	FE	14	13	30.0			0.02	0.0		2.5
Lt Sta 115 + 37	PE	58	12	89.0			0.05	0.1		7.5
Lt Sta 136 + 22	FE	17	7	36.0			0.02	0.1		3.0
Lt Sta 138 + 66	PE	58	16	152.0			0.09	0.2		12.8
Lt Sta 139 + 15	FE	18	14	44.0			0.03	0.1		3.7
Rt Sta 151 + 76	PE	18	15	64.0			0.04	0.1		5.4
Lt Sta 152 + 79	MB			43.0			0.02	0.1		3.6
Lt Sta 184 + 98	CE	21	17	56.0			0.03	0.1		4.7
Lt Sta 186 + 81	CE	21	21	206.0			0.12	0.3		17.3
Rt Sta 201 + 63	CE	24	26	135.0			0.08	0.2		11.3
Rt Sta 205 + 10	CE	18	11	39.0	50.0		0.02	0.1		3.3
Lt Sta 206 + 42	CE	5	83	50.0		50.0	0.03	0.1		4.2
Rt Sta 206 + 70	CE	9	26	31.0			0.02	0.0		2.6
Lt Sta 208 + 43	CE	5	83	49.0	49.0		0.03	0.1		4.1
Rt Sta 208 + 87	CE	33	180	517.0			0.30	0.8		43.4
Rt Sta 212 + 50	PE	26	19	75.0			0.04	0.1		6.3
Lt Sta 213 + 58	CE	42	30	304.0			0.17	0.5	25.5	
Lt Sta 235 + 61	FE	3	10	18.0			0.01	0.0		
Lt Sta 249 + 12	FE	3	10	9.0			0.01	0.0		
Lt Sta 274 + 38	FE	3	17	11.0			0.01	0.0		
Rt Sta 275 + 00	FE	3	13	14.0			0.01	0.0		
Rt Sta 276 + 59	PE	53	16	156.0			0.09	0.2		13.1
Lt Sta 280 + 23	PE	45	9	72.0			0.04	0.1		6.0
Rt Sta 280 + 61	MB			34.0			0.02	0.1		2.9
Rt Sta 286 + 47	FE	3	12	10.0			0.01	0.0		
Lt Sta 288 + 70	FE	47	16	115.0			0.07	0.2		9.7
Rt Sta 311 + 94	FE	3	16	8.0			0.00	0.0		
Rt Sta 313 + 58	PE	46	12	101.0			0.06	0.2		8.5
Lt Sta 313 + 58	PE	46	14	88.0			0.05	0.1		9.9
Lt Sta 316 + 28	FE	3	21	17.0			0.01	0.0		
Lt Sta 316 + 86	PE	47	13	110.0			0.06	0.2		9.2
Lt Sta 317 + 18	PE	47	13	88.0			0.05	0.1		7.4
Rt Sta 317 + 77	PE	60	11	73.0			0.04	0.1		8.2
Rt Sta 330 + 9	FE	3	19	21.0			0.01	0.0		
Totals 2-Lane										
				99			3	8	458	23

PAVEMENT PATCHING HENRY COUNTY

01/10/05

ROUTE NO.	SEC.	COUNTY	TOTAL SHEET
F.A.P.		HENRY/BUREAU	84
CONTRACT#BR2775			29

STATION	REMARKS (LANE WIDTH)	LENGTH OF PATCH		AREA OF PATCHES								44000128 Over Patches (yd <sup>2</sup> )	40801000 Bl. Replacement Over Patches (ton)
		LT LANE (feet)	RT LANE (feet)	TYPE 1		TYPE 2		TYPE 3		TYPE 4			
				LT LANE (yd <sup>2</sup> )	RT LANE (yd <sup>2</sup> )	LT LANE (yd <sup>2</sup> )	RT LANE (yd <sup>2</sup> )	LT LANE (yd <sup>2</sup> )	RT LANE (yd <sup>2</sup> )	LT LANE (yd <sup>2</sup> )	RT LANE (yd <sup>2</sup> )	Bl. Removal (yd <sup>2</sup> )	
977 + 93		22	8										
978 + 86		22	6			14.7	14.7					34.2	13.4
979 + 76		22	20									102.7	40.3
980 + 34		22	6			14.7	14.7					34.2	13.4
982 + 00		22	8							19.6	19.6	44.0	17.2
982 + 67		22	6			14.7	14.7					34.2	13.4
985 + 70		22	6			14.7	14.7					34.2	13.4
987 + 51		22	6			14.7	14.7					63.6	24.9
993 + 57		22	12									74.7	29.3
1007 + 8		16	20									24.9	9.8
1008 + 1		16	6			10.7	10.7					24.9	9.8
1009 + 87		16	25							44.4	26.7	24.9	9.8
1024 + 58		16	6			10.7	10.7					21.0	8.2
1026 + 68		13.5	6			9.0	9.0					21.0	8.2
1030 + 15		13.5	6			9.0	9.0					27.0	10.6
1032 + 10		13.5	8			12.0	12.0					21.0	8.2
1034 + 80		13.5	6			9.0	9.0					21.0	8.2
1035 + 20		13.5	6			9.0	9.0					21.0	8.2
1038 + 32		13.5	6			9.0	9.0					21.0	8.2
1039 + 10		13.5	15							22.5	22.5	48.0	18.8
1039 + 85		13.5	6			9.0	9.0					21.0	8.2
1042 + 28		13.5	6			9.0	9.0					21.0	8.2
1042 + 76		13.5	6			9.0	9.0					21.0	8.2
1045 + 93		13.5	6			9.0	9.0					21.0	8.2
1049 + 11		13.5	6			9.0	9.0					27.0	10.6
1050 + 79		13.5	8			12.0	12.0					21.0	8.2
1052 + 39		13.5	6			9.0	9.0					20.2	7.9
1081 + 95		13	6			8.7	8.7					20.2	7.9
1094 + 78		13	6			8.7	8.7					26.0	10.2
1104 + 4		13	8									31.8	12.5
1128 + 7		13	10			14.4	14.4					20.2	7.9
1138 + 74		13	6			8.7	8.7					20.2	7.9
1143 + 51		13	6			8.7	8.7					20.2	7.9
1147 + 19		13	6			8.7	8.7					20.2	7.9
1150 + 18		13	6			8.7	8.7					20.2	7.9
1152 + 28		13	6			8.7	8.7					26.0	10.2
1154 + 94		13	8			11.6	11.6					20.2	7.9
1159 + 41		13	8			8.7	8.7					26.0	10.2
1162 + 58		13	8			11.6	11.6					20.2	7.9
1163 + 22		13	6			8.7	8.7					20.2	7.9
1170 + 85		13	6			8.7	8.7					20.2	7.9
1170 + 85		13	6			8.7	8.7					20.2	7.9
1194 + 17		13	6			8.7	8.7					20.2	7.9
1196 + 78		13	6			8.7	8.7					10.1	4.0
1200 + 78		13	6			8.7	8.7					10.1	4.0
1201 + 22		13	6			8.7	8.7					10.1	4.0
1202 + 56		13	6			8.7	8.7					10.1	4.0
1203 + 16		13	6			8.7	8.7					10.1	4.0
<b>TOTAL</b>				0.0	0.0	370.8	405.4	61.6	61.6	158.2	140.4	1350.1	528.9
PAVEMENT PATCHING (FULL DEPTH), SQ YD				0.0	0.0	778.2	778.2	123.2	123.2	298.7	250	1350.1	528.9



PAVEMENT PATCHING BUREAU COUNTY

01/10/05

STATION	REMARKS (LANE WIDTH)	LENGTH OF PATCH		AREA OF PATCHES								Bit Removal (yd <sup>2</sup> )	Over Patches (yd <sup>2</sup> )	Replacement Bk. (ton)				
		LT LANE (feet)	RT LANE (feet)	TYPE 1 (yd <sup>2</sup> )	TYPE 2 (yd <sup>2</sup> )	TYPE 3 (yd <sup>2</sup> )	TYPE 4 (yd <sup>2</sup> )	TYPE 1 (yd <sup>2</sup> )	TYPE 2 (yd <sup>2</sup> )	TYPE 3 (yd <sup>2</sup> )	TYPE 4 (yd <sup>2</sup> )							
8 + 49	12.5	6	6															
18 + 41	12.5	6	6															
24 + 60	12.5	6	6															
25 + 23	12.5																	
28 + 81	12.5																	
32 + 88	12.5																	
45 + 3	12.5																	
45 + 56	12.5	6	6															
52 + 10	12.5	8	8															
63 + 18	12.5	6	6															
64 + 25	12.5	6	6															
67 + 62	12.5	6	6															
79 + 2	12.5	6	6															
80 + 29	12.5	6	6															
90 + 75	12.5	6	6															
95 + 29	12.5	6	6															
102 + 38	12.5	6	6															
106 + 56	12.5	6	6															
107 + 00	12.5	6	6															
112 + 34	12.5	6	6															
118 + 18	12.5	20	20															
121 + 35	12.5	6	6															
126 + 16	12.5	6	6															
129 + 6	12.5	6	6															
135 + 23	12.5	10	10															
138 + 8	12.5	8	8															
140 + 39	12.5	6	6															
145 + 16	12.5	8	8															
145 + 91	12.5	12	12															
146 + 78	12.5	6	6															
150 + 59	12.5	8	8															
153 + 85	12.5	6	6															
157 + 46	12.5	6	6															
169 + 79	12.5	10	10															
175 + 90	12.5	6	6															
187 + 65	12.5	6	6															
216 + 62	12.5	8	8															
226 + 85	12.5	12	12															
230 + 95	12.5	10	10															
292 + 14	12.5	6	6															
324 + 86	12.5	6	6															
<b>TOTAL</b>																		
PAVEMENT PATCHING (FULL DEPTH), SQ. YD.				0.0	0.0	241.7	333.3	16.7	60.0	33.3	27.8	83.3	55.6	801.9	314.4			
				0.0	0.0	576.0	333.3	11.0			7.0							

ROUTE NO.	SEC.	COUNTY	TOTAL SHEET NO.
F.A.P.	*	HENRY/BUREAU	84
CONTRACT # 44776			30

PLOT DATE: 10-Jan-10 11:04:43 2005  
 FILE NAME: ...\  
 PLOT SCALE: ...  
 REFERENCE: ...

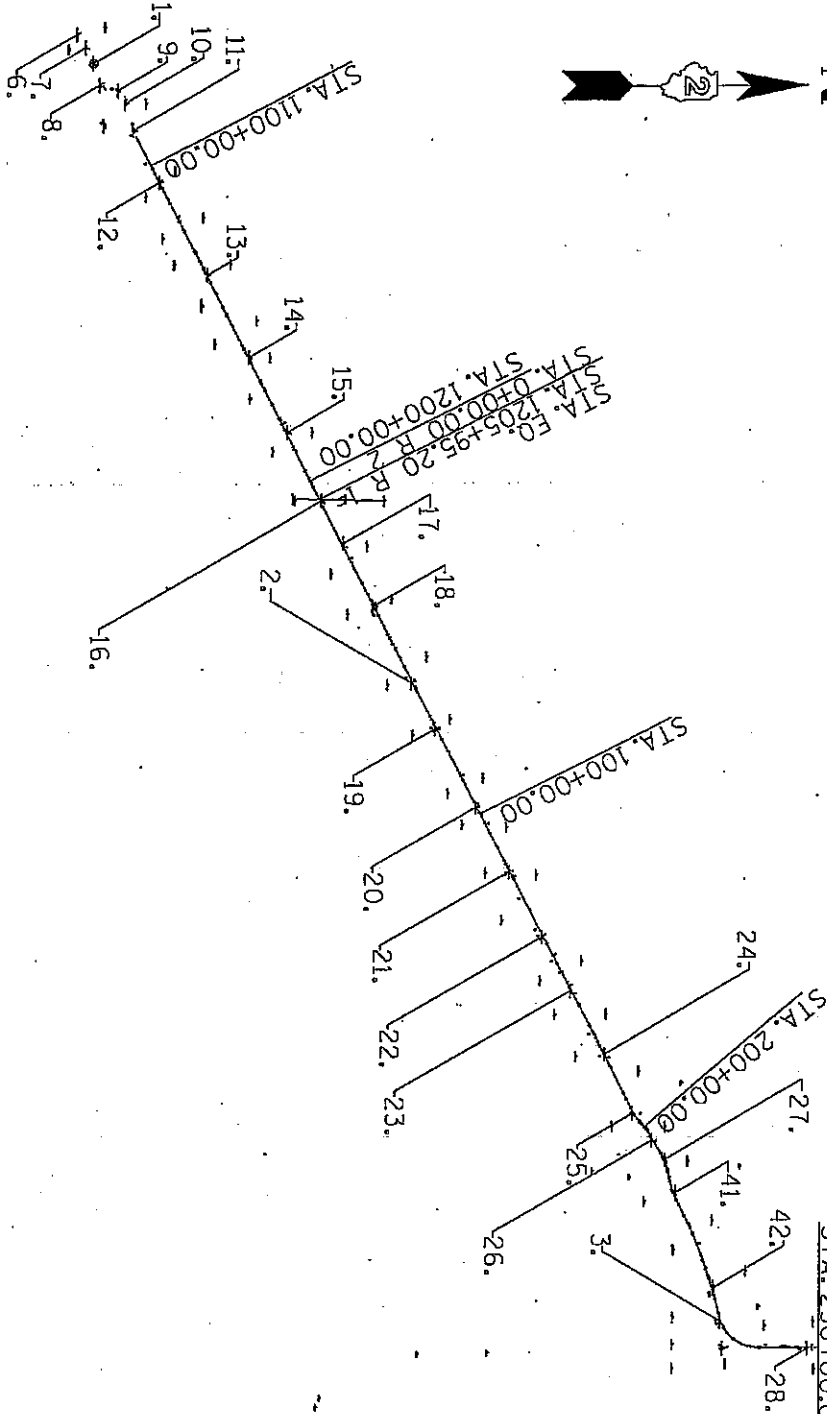

CONTRACT NO. 44712	
SECTION	COMMIT
DATE	BY
NO. STA.	NO. STA.
CONTRACT NO. 44712	
SECTION	
COMMIT	
DATE	
BY	
NO. STA.	
NO. STA.	
CONTRACT NO. 44712	
SECTION	
COMMIT	
DATE	
BY	
NO. STA.	
NO. STA.	
CONTRACT NO. 44712	
SECTION	
COMMIT	
DATE	
BY	
NO. STA.	
NO. STA.	

HORIZONTAL VERTICAL CONTROL

PLOT DATE: Mon Jan 18 11:55:11 AM  
 FILE NAME: \\projects\200502\hvc.dgn  
 PLOT SCALE: 1/8" = 1'-0"  
 REVISION: 1

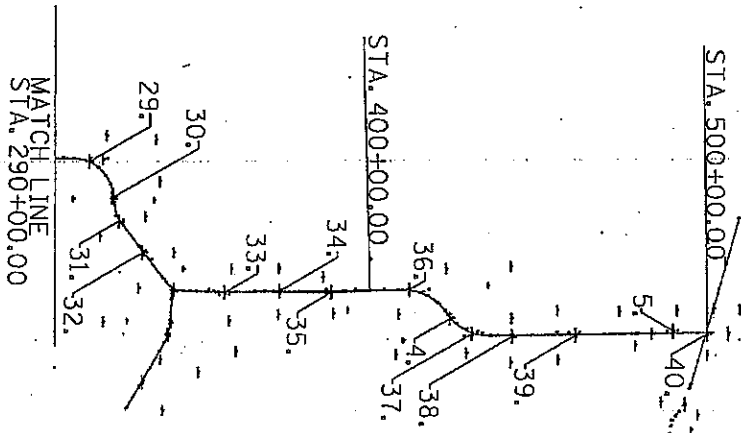

CONTRACT NO. 64116	
DATE	SECTION
01/18/06	SECTION 2
STA. 290+00.00	TO STA. 500+00.00
1/18/06	28
1/18/06	29

\* REVISIONS & WORK  
 \*\* SORT & REVERSE

HORIZONTAL VERTICAL CONTROL

PLT DATE: 11/10/2005 11:55:58 AM  
 FILE: .../projects/d2005021/d00602hvc.dgn  
 PLOT DATE: 11/10/2005 11:55:58 AM  
 PLOT FILE: .../projects/d2005021/d00602hvc.dgn

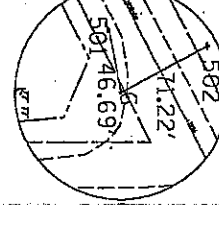
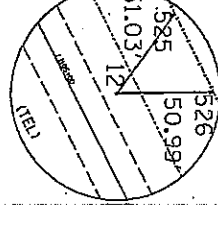
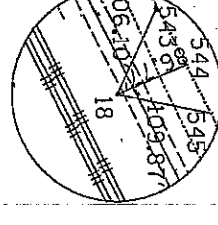
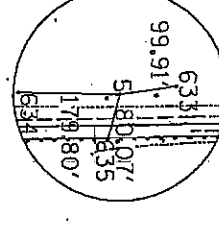
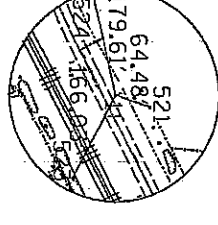
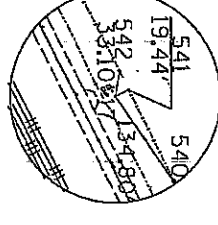
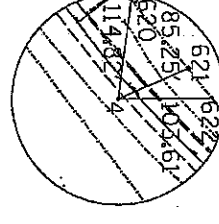
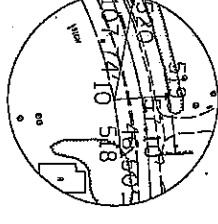
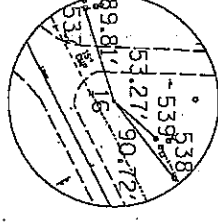
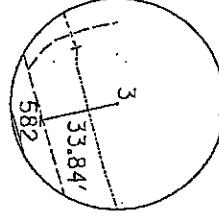
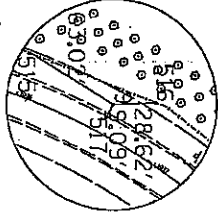
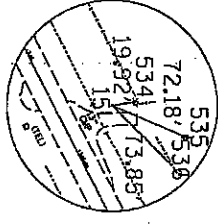
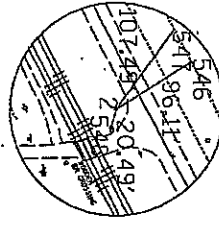
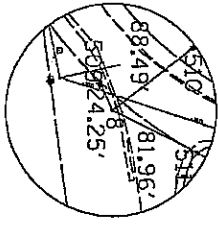
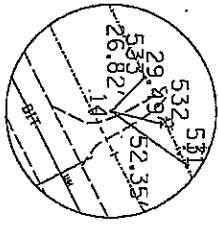
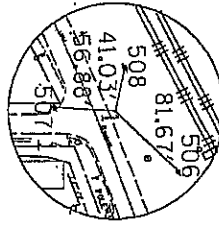
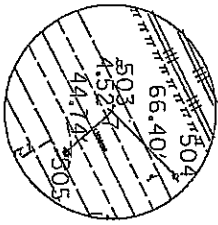
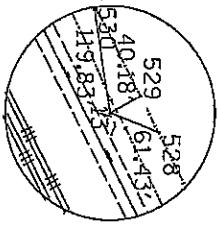

CONTRACT NO.	4445
SHEET NO.	1
DATE	11/10/2005
BY	...
CHECKED	...
APPROVED	...
PROJECT	...
SCALE	...
DATE PLOTTED	11/10/2005
PLT FILE	...
PLT DATE	11/10/2005 11:55:58 AM

HORIZONTAL VERTICAL CONTROL

.../projects/d2005021/d00602hvc.dgn 1/10/2005 11:55:58 AM

PLOT DATE: Sun Jun 26 11:52:24 2005  
 FILE NAME: I:\projects\200502\hvc\hvc.dgn  
 PLOT SCALE: 1/8" = 1'-0"  
 PLOT DEVICE: HPGL

..\projects\200502\hvc\hvc.dgn 1/10/2005 11:56:24 AM

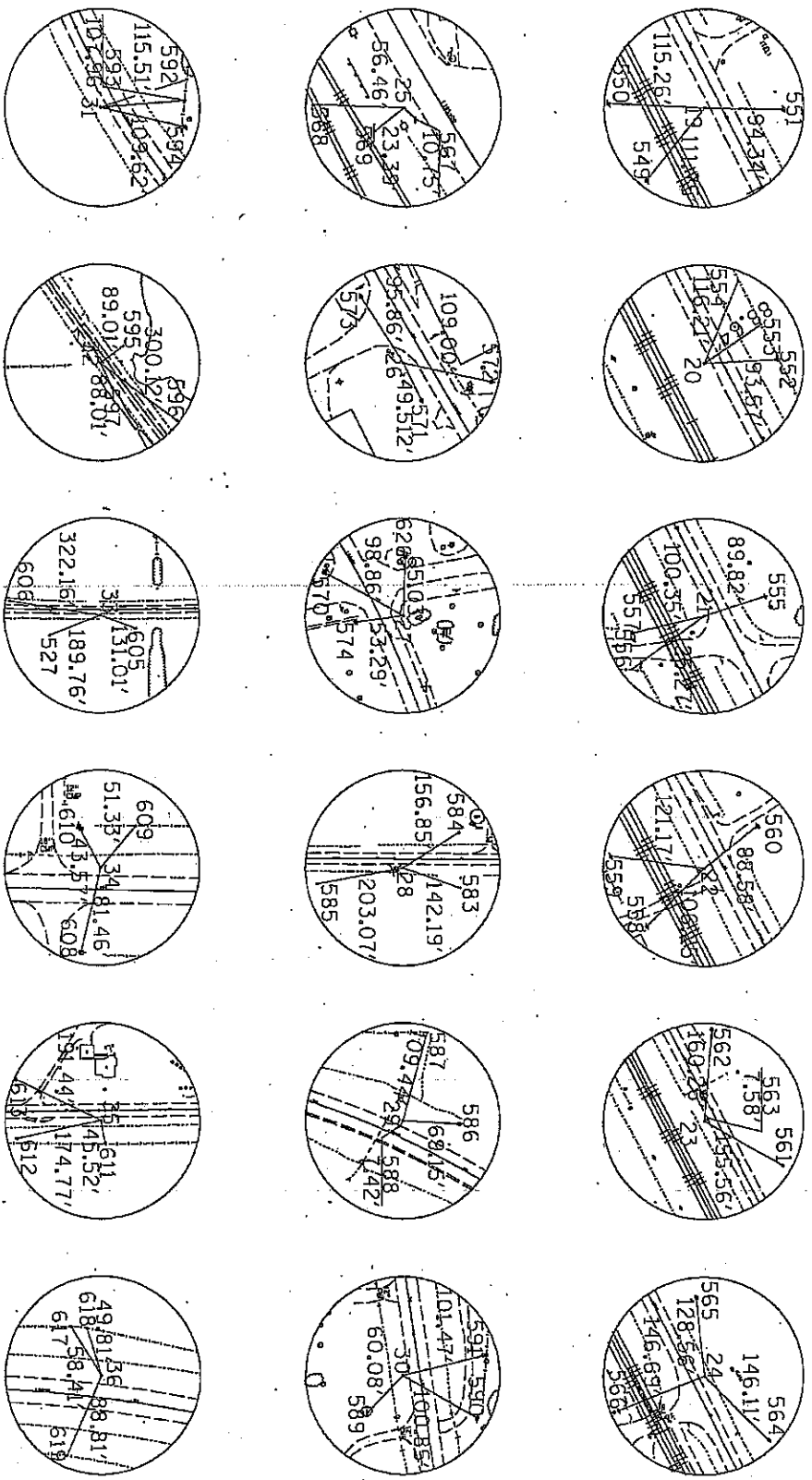

HORIZONTAL VERTICAL CONTROL

CONTRACT NO. 54114	
DATE	SECTION
COUNTY	TO STATE
DATE	DATE
DATE	DATE
DATE	DATE

PLT DATE = Nov 14 10 56:58 AM  
PLT BY =  
PLT SCALE = 1/8"=1'-0"  
NOTICE = 4/07/1

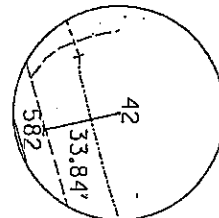
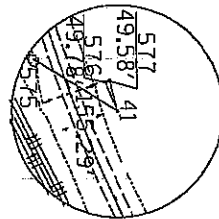
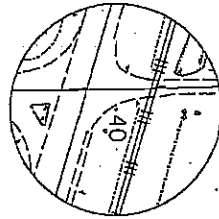
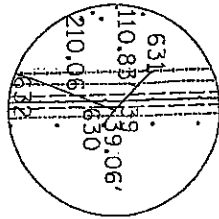
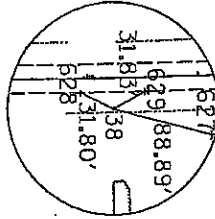
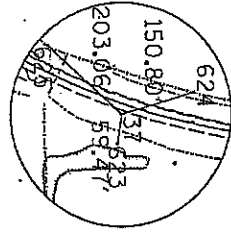

DATE	SECTION	CONTRACT NO.	NO. OF SHEETS
11/14/05		5123	10
11/14/05			
11/14/05			

DESIGNED BY: [blank] DRAWN BY: [blank] CHECKED BY: [blank]  
IN CHARGE: [blank]  
DATE: [blank]

HORIZONTAL VERTICAL CONTROL

HORIZONTAL CONTROL POINTS

POINT	NORTH	EAST	ELEVATION	CHAIN	STATION	OFFSET	DESCRIPTION
90I03	1671427.7250	2369352.2860	823.2780	new34	1064+88.4433	18.4860' LT	GPS CONTROL POINT, PIN
90I24	1680444.5760	2386872.6580	809.8620	new34	56+30.1959	29.9343' RT	GPS CONTROL POINT, PIN
90I50	1689142.8150	2404892.7930	796.7650	new34	259+12.4143	22.0500' RT	GPS CONTROL POINT, PIN
90I83	1703119.8780	2410185.0150	726.7920	new34	425+04.1494	18.6686' RT	GPS CONTROL POINT, PIN
90I97	1709470.4820	2410547.5380	703.0260	new34	469+89.6336	55.1719' LT	GPS CONTROL POINT, PIN
90I111	1670965.9880	2368543.5200	830.1020	new34	1055+59.5505	32.7407' RT	GPS CONTROL POINT, PIN
90I112	1671208.6640	2368907.3920	833.7180	new34	1059+93.8375	19.1173' LT	GPS CONTROL POINT, PIN
90I114	1671608.5830	2369957.4870	808.2530	new34	1071+31.4372	12.6888' RT	GPS CONTROL POINT, PIN
90I115	1672120.1110	2370096.8800	812.7640	new34	1076+57.8474	20.2600' LT	GPS CONTROL POINT, PIN
90I116	1672327.5700	2370458.1760	827.9220	new34	1080+90.1228	29.3650' RT	GPS CONTROL POINT, PIN
90I117	1672554.9570	2371216.2410	834.8310	new34	1088+93.5316	20.6214' LT	GPS CONTROL POINT, PIN
90I118	1673298.8210	2372675.8390	827.0280	new34	1105+31.7325	20.4826' LT	GPS CONTROL POINT, PIN
90I119	1674632.9080	2375289.3770	821.2000	new34	1134+66.0380	25.3611' LT	GPS CONTROL POINT, PIN
90I120	1675829.8500	2377615.7890	819.5500	new34	1160+82.2553	40.8642' LT	GPS CONTROL POINT, PIN
90I121	1676917.3950	2379750.3540	809.8540	new34	1184+77.9088	45.7855' LT	GPS CONTROL POINT, PIN
90I122	1677903.0320	2381689.9000	816.6200	new34	0+58.3274	47.4694' LT	GPS CONTROL POINT, PIN
90I123	1678521.7650	2382913.2250	814.8580	new34	14+29.2221	45.9136' LT	GPS CONTROL POINT, PIN
90I124	1679351.7560	2384695.1020	811.4970	new34	33+93.8188	19.8929' RT	GPS CONTROL POINT, PIN
90I125	1681110.9090	2388163.1180	818.6010	new34	72+82.4535	19.0530' RT	GPS CONTROL POINT, PIN
90I126	1682240.7390	2390393.6300	803.7040	new34	97+82.8198	21.6628' RT	GPS CONTROL POINT, PIN
90I127	1683166.8380	2392222.0730	809.5420	new34	118+32.4059	23.2974' RT	GPS CONTROL POINT, PIN
90I128	1684101.1970	2394060.1430	815.7590	new34	138+94.3303	23.4168' RT	GPS CONTROL POINT, PIN
90I129	1684685.5860	2395594.0800	814.7590	new34	156+17.1227	19.7163' RT	GPS CONTROL POINT, PIN
90I130	1685838.8950	2397383.5290	819.4120	new34	176+44.2102	20.5954' LT	GPS CONTROL POINT, PIN
90I131	1686633.0200	2399052.0410	824.6120	new34	194+90.1115	21.0254' RT	GPS CONTROL POINT, PIN
90I132	1687188.2730	2399802.3500	827.5940	new34	204+26.5049	25.9155' RT	GPS CONTROL POINT, PIN
90I133	1687570.4950	2400349.9330	829.5490	new34	210+90.6814	23.9625' LT	GPS CONTROL POINT, PIN
90I136	1691601.5440	2405660.2220	810.9280	new34	286+65.9237	21.7478' RT	GPS CONTROL POINT, PIN
90I137	1692941.0860	2405726.2930	821.3230	new34	300+11.6517	19.6835' LT	GPS CONTROL POINT, PIN
90I138	1693594.9240	2406755.9020	845.2840	new34	312+90.7847	19.9886' RT	GPS CONTROL POINT, PIN
90I139	1693781.7780	2407416.0500	841.4660	new34	319+74.8663	20.0428' RT	GPS CONTROL POINT, PIN
90I140	1694446.7570	2408320.0270	812.6390	new34	330+95.1639	19.6923' RT	GPS CONTROL POINT, PIN
90I142	1696748.3330	2409450.4130	782.6070	new34	358+24.7622	19.8075' RT	GPS CONTROL POINT, PIN
90I143	1698326.2670	2409401.7070	749.4200	new34	374+02.5072	20.4335' LT	GPS CONTROL POINT, PIN
90I144	1699798.4130	2409442.5010	751.5360	new34	388+74.8777	19.5303' RT	GPS CONTROL POINT, PIN
90I145	1701991.5330	2409364.7080	725.5640	new34	410+66.5216	22.5252' LT	GPS CONTROL POINT, PIN
90I146	1703747.8850	2410615.3390	732.0210	new34	432+64.0611	20.5494' RT	GPS CONTROL POINT, PIN
90I147	1704907.9310	2410689.3530	743.6830	new34	444+25.8499	26.5674' RT	GPS CONTROL POINT, PIN
90I148	1706707.2830	2410658.4160	701.5550	new34	462+25.3946	19.5968' RT	GPS CONTROL POINT, PIN
90I149	1710430.2010	2410619.9790	671.1040	new34	499+48.6474	27.1856' RT	GPS CONTROL POINT, PIN
65722950	1687869.8450	2401286.5680	820.8760	new34	220+78.1029	60.3271' LT	D2-NETWORK MONUMENT, DISK
65722951	1688963.4550	2403943.8420	804.9930	new34	249+51.9673	45.3617' LT	D2-NETWORK MONUMENT, DISK

HORIZONTAL VERTICAL CONTROL

CONTRACT NO. 05111  
 SHEET NO. 11  
 DATE: 11/02/2005  
 PROJECT: HORIZONTAL CONTROL POINTS  
 DRAWN BY: J. B. BROWN  
 CHECKED BY: J. B. BROWN  
 APPROVED BY: J. B. BROWN

...projects\id200502\id00502hvc.dgn 1/10/2005 12:59:16 PM

PLT DATE: 1/10/2005  
 FILE NAME: hvc.dgn  
 PLOT SCALE: 1"=50'-0"  
 PLOT DATE: 1/10/2005  
 PLOT TIME: 1:11:19 PM

CHAIN NEW34 CONTAINS:  
 5 1370 CUR 1380 CUR 60340 60200 CUR 60350 CUR 60360 1004 200 1009 210 1014 136-  
 0 1022 1026 1028 1029 1031 1034 CUR 220 230 CUR 240 CUR 250 CUR 260 CUR 270 CUR-  
 280 CUR 290 CUR 300 CUR 310 CUR 320 330 CUR 340 CUR 350 1037 CUR 70200 CUR 370-  
 1040 CUR 380 CUR 390 CUR 1200 CUR 1210 CUR 1220 CUR 1230 CUR 1240 CUR 1250 104-  
 3 1260 CUR 1270 171 173

Beginning chain NEW34 description

Point 5 N 1.667,351,0076 E 2.363,070,6717 Sta 915+88.7252  
 Course from 5 to 1370 90° 00' 05.2553" Dist 2,666,6054'

Point 1370 N 1.667,350,9401 E 2.365,717,2770 Sta 1002+35.1306  
 Course from 1370 to PC 1380 0° 08' 59.2156" Dist 2,012,0987'

Curve Data

Curve 1380  
 P.I. Station 1024+45.7669 N 1.669,572,3689 E 2.365,723,0843  
 Delta = 62° 57' 33.3224" RTI  
 Degree = 16° 45' 32.3581"  
 Tangent = 2091.3177'  
 Length = 375.6745'  
 Radius = 34188.08'  
 External = 58.5992'  
 Long Chord = 351.0572'  
 Mid. Ord. = 50.3160'  
 P.C. Station 1022+47.4292 N 1.665,363,0319 E 2.365,722,5370  
 P.T. Station 1026+23.1057 N 1.665,667,0511 E 2,365,909,7860  
 C.C. N 1.665,352,1582 E 2,366,064,4181  
 Course from PC 1380 to PC 60340 63° 06' 32.5366" Dist 3,728,1207'

Curve Data

Curve 60340  
 P.I. Station 1055+48.7669 N 1.671,461,1491 E 2.369,447,5295  
 Delta = 3° 08' 42.4652"  
 Degree = 07' 42.4652"  
 Tangent = 238.5424'  
 Length = 474.3889'  
 Radius = 14821.3305'  
 External = 15.5513'  
 Long Chord = 473.0467'  
 Mid. Ord. = 15.4917'  
 P.C. Station 1063+41.2244 N 1.671,353,2578 E 2.369,234,7609  
 P.T. Station 1068+25.6103 N 1.671,510,6284 E 2,369,680,8884  
 C.C. N 1.669,728,5129 E 2,370,058,7386  
 Course from PT 60340 to 60200 78° 07' 44.8335" Dist 254,2098'  
 Point 60200 N 1.671,563,3531 E 2,369,923,5659 Sta 1070+79.8201  
 Course from 60200 to PC 60350 17° 52' 56.3225" Dist 488,4416'

Curve Data

Curve 60350  
 P.I. Station 1079+04.1751 N 1.672,341,9074 E 2,370,182,6187  
 Delta = 69° 22' 11.1954" RTI  
 Degree = 17° 48' 14.3064"  
 Tangent = 335.9134'  
 Length = 587.6815'  
 Radius = 483,3340'  
 External = 104,8384'  
 Long Chord = 592.4392'  
 Mid. Ord. = 86.2513'  
 P.C. Station 1075+48.8218 N 1.672,028,2123 E 2,370,079,5031  
 P.T. Station 1081+25.9452 N 1.672,454,0441 E 2,370,518,1482  
 C.C. N 1.671,073,2105 E 2,370,941,4811  
 Course from PT 60350 to PC 60360 87° 14' 47.6537" Dist 171,4854'

Curve Data

Curve 60360  
 P.I. Station 1085+63.9985 N 1.672,283,6463 E 2,370,925,7283  
 Delta = 24° 16' 10.8528" (LTI)  
 Degree = 5° 12' 27.3489"  
 Tangent = 236.5697'  
 Length = 466,0438'  
 Radius = 1,100,2345'  
 External = 25,1460'  
 Long Chord = 462.5674'  
 Mid. Ord. = 24.3881'  
 P.C. Station 1083+27.4287 N 1.672,372,2819 E 2,370,688,4317  
 P.T. Station 1081+25.9452 N 1.672,454,0441 E 2,370,518,1482  
 C.C. N 1.673,112,4502 E 2,370,656,5793  
 Course from PT 60360 to 1004 62° 58' 53.8857" Dist 1,457,8166'

Curve Data

Point 1004 N 1.673,153,3830 E 2,372,435,8820 Sta 1102+61.2891  
 Course from 1004 to 200 63° 07' 52.0919" Dist 2,687,7815'  
 Point 200 N 1.674,326,9579 E 2,374,741,5601 Sta 1128+39.0704  
 Course from 200 to 1009 63° 08' 11.7367" Dist 557,4011'  
 Point 1009 N 1.674,578,8280 E 2,375,238,8000 Sta 1133+96.4715  
 Course from 1009 to 210 63° 06' 45.8665" Dist 2,401,3707'  
 Point 210 N 1.675,664,8150 E 2,377,380,5775 Sta 1157+97.8417  
 Course from 210 to 1014 63° 07' 15.6080" Dist 2,398,7068'  
 Point 1014 N 1.676,749,2890 E 2,379,520,1360 Sta 1181+86.5485  
 Course from 1014 to 1360 63° 06' 20.2158" Dist 2,398,5615'

DATE	SECTION	COUNT	NO. STATION
1/10/2005	1102+61.2891	1	1102
1/10/2005	1128+39.0704	1	1128
1/10/2005	1133+96.4715	1	1133
1/10/2005	1157+97.8417	1	1157
1/10/2005	1181+86.5485	1	1181
1/10/2005	1197+86.5485	1	1197
1/10/2005	1210+86.5485	1	1210
1/10/2005	1220+86.5485	1	1220
1/10/2005	1230+86.5485	1	1230
1/10/2005	1240+86.5485	1	1240
1/10/2005	1250+86.5485	1	1250
1/10/2005	1260+86.5485	1	1260
1/10/2005	1270+86.5485	1	1270
1/10/2005	1280+86.5485	1	1280
1/10/2005	1290+86.5485	1	1290
1/10/2005	1300+86.5485	1	1300
1/10/2005	1310+86.5485	1	1310
1/10/2005	1320+86.5485	1	1320
1/10/2005	1330+86.5485	1	1330
1/10/2005	1340+86.5485	1	1340
1/10/2005	1350+86.5485	1	1350
1/10/2005	1360+86.5485	1	1360
1/10/2005	1370+86.5485	1	1370
1/10/2005	1380+86.5485	1	1380
1/10/2005	1390+86.5485	1	1390
1/10/2005	1400+86.5485	1	1400
1/10/2005	1410+86.5485	1	1410
1/10/2005	1420+86.5485	1	1420
1/10/2005	1430+86.5485	1	1430
1/10/2005	1440+86.5485	1	1440
1/10/2005	1450+86.5485	1	1450
1/10/2005	1460+86.5485	1	1460
1/10/2005	1470+86.5485	1	1470
1/10/2005	1480+86.5485	1	1480
1/10/2005	1490+86.5485	1	1490
1/10/2005	1500+86.5485	1	1500

HORIZONTAL VERTICAL CONTROL



DATE	SECTION	COMPET	DATE	TIME
11/10/2005	11/10/2005	11/10/2005	11/10/2005	11/10/2005
11/10/2005	11/10/2005	11/10/2005	11/10/2005	11/10/2005
11/10/2005	11/10/2005	11/10/2005	11/10/2005	11/10/2005
11/10/2005	11/10/2005	11/10/2005	11/10/2005	11/10/2005

End Region 1  
Begin Region 2

Equation:  $Std\ 1205+95.2000\ (Bk1) = Std\ 0+00.0000\ (A4)$

Point 1350 N 1,671,834.3125 E 2,381,659.3538  $Std\ 0+00.0000$   
 Course from 1350 to 1022 63° 08' 20.2158" Dist 4,403.7125'  
 Point 1022 N 1,679,826.3200 E 2,385,586.7690  $Std\ 44+03.1125$   
 Course from 1022 to 1026 63° 07' 10.4621" Dist 2,901.1123'  
 Point 1026 N 1,681,138.0000 E 2,388,114.4220  $Std\ 73+04.8248$   
 Course from 1026 to 1028 63° 04' 19.5146" Dist 1,459.0954'  
 Point 1028 N 1,681,816.8940 E 2,389,510.9810  $Std\ 88+03.9202$   
 Course from 1028 to 1029 63° 04' 55.9221" Dist 999.7743'  
 Point 1029 N 1,682,269.5050 E 2,390,402.4360  $Std\ 98+103.6845$   
 Course from 1029 to 1031 63° 05' 42.8383" Dist 1,898.5615'  
 Point 1031 N 1,683,128.6210 E 2,392,095.4970  $Std\ 117+02.2560$   
 Course from 1031 to 1034 63° 03' 02.7589" Dist 3,403.4312'  
 Point 1034 N 1,684,852.3420 E 2,395,485.9130  $Std\ 155+05.6932$   
 Course from 1034 to PC 220 62° 52' 54.0413" Dist 1,258.8358'

Curve Data

Curve 220  
 P.L. Station 159+47.5567 N 1,685,509.7456 E 2,396,769.1976  
 Delta = 0° 41' 04.2459" (RT)  
 Degree = 0° 41' 04.2459"  
 Length = 1,831.0171'  
 Tangent = 1,831.0171'  
 Radius = 1,020,124.56'  
 External = 0.5467'  
 Long Chord = 366.0588'  
 Mid. Ord. = 0.5467'  
 P.C. Station 157+64.8290 N 1,685,426.1565 E 2,395,606.3613  
 P.T. Station 171+50.6000 N 1,685,591.3833 E 2,396,433.0209  
 C.C. N 1,685,156.7009 E 2,410,599.5027

Course from PI 220 to 230 63° 30' 41.5321" Dist 1,745.3740'  
 Point 230 N 1,686,369.8478 E 2,399,495.1744  $Std\ 188+75.5740$   
 Course from 230 to PC 240 63° 18' 52.1895" Dist 476.5890'

Curve 240  
 P.L. Station 195+94.2385 N 1,686,688.2925 E 2,399,127.8131  
 Delta = 15° 05' 18.6761" (LT)  
 Degree = 15° 05' 18.6761"  
 Length = 2,229.6757'  
 Tangent = 456.3291'  
 Radius = 1,625.115'  
 External = 16.1497'  
 Long Chord = 454.8314'  
 Mid. Ord. = 15.9908'  
 P.C. Station 193+45.5630 N 1,686,585.0275 E 2,398,922.6614  
 P.T. Station 198+10.9921 N 1,686,844.3855 E 2,399,296.3128  
 C.C. N 1,688,036.6154 E 2,399,191.9906

Course from PI 240 to PC 250 47° 11' 33.3134" Dist 51.2358'

Curve Data

Curve 250  
 P.L. Station 201+02.1619 N 1,687,042.2938 E 2,399,510.0005  
 Delta = 11° 43' 27.2455" (RT)  
 Degree = 11° 43' 27.2455"  
 Length = 2,000.0340'  
 Tangent = 200.0340'  
 Radius = 1,904.6467'  
 External = 10.42881'  
 Long Chord = 104.2881'  
 Mid. Ord. = 10.42881'  
 P.C. Station 199+02.1279 N 1,686,905.3635 E 2,399,363.2472  
 P.T. Station 203+00.7989 N 1,687,145.6677 E 2,399,681.3133  
 C.C. N 1,686,577.0191 E 2,400,687.1782

Course from PI 250 to PC 260 58° 55' 00.5930" Dist 682.1068'

Curve Data

Curve 260  
 P.L. Station 211+73.5524 N 1,687,596.1546 E 2,400,428.7557  
 Delta = 19° 08' 50.1468" (RT)  
 Degree = 19° 08' 50.1468"  
 Length = 1,906.6467'  
 Tangent = 377.7383'  
 Radius = 1,130.3344'  
 External = 15.9649'  
 Long Chord = 375.9830'  
 Mid. Ord. = 15.74252'  
 P.C. Station 209+02.9056 N 1,687,497.7271 E 2,400,265.4823  
 P.T. Station 213+00.6435 N 1,687,653.8837 E 2,400,615.2806  
 C.C. N 1,686,523.8876 E 2,400,049.0535

Course from PI 260 to PC 270 78° 03' 50.7057" Dist 350.1170'

Curve Data

Curve 270  
 P.L. Station 219+95.0353 N 1,687,766.7871 E 2,401,235.9571  
 Delta = 15° 12' 00.3665" (LT)  
 Degree = 15° 12' 00.3665"  
 Length = 2,731.6154'  
 Tangent = 544.1365'  
 Radius = 2,051.0972'  
 External = 18.1176'  
 Long Chord = 542.5426'  
 Mid. Ord. = 18.0179'  
 P.C. Station 217+42.3609 N 1,687,701.8662 E 2,400,868.1987  
 P.T. Station 222+59.4878 N 1,687,881.8171 E 2,401,179.5080  
 C.C. N 1,688,716.5279 E 2,400,245.3919

Course from PI 270 to PC 280 62° 51' 50.3192" Dist 520.5515'

HORIZONTAL VERTICAL CONTROL

FILE NAME: ...  
 PROJECT: ...

SECTION		DATE		BY	
NO.	DESCRIPTION	NO.	DATE	NAME	INITIALS
1	SECTION 1	01	11/01/05	JMC	
2	SECTION 2	02	11/01/05	JMC	

```

Curve Data
*****
Curve 280
P.I. Station 230+45.5318      N 1,688,250.1254      E 2,402,179.0204
Delta = 3° 34' 41.8880" (RT)
Degree = 0° 40' 26.5156"
Tangent = 265,4825'
Length = 530.7928'
Radius = 6,499,0514'
External = 4,1454'
Long Chord = 530,7063'
Mid. Ord. = 4,1434'
P.C. Station 227+46.0492      N 1,688,129.0376      E 2,401,342,7504
P.T. Station 233+45.6418      N 1,688,356.2315      E 2,402,422,3771
C.C. N 1,680,565,5088      E 2,405,819,2161

Course from PT 280 to PC 290 65+ 26' 32.2072" Dist 29,7335'

*****
Curve Data

Curve 290
P.I. Station 235+45.8740      N 1,688,481,7367      E 2,402,723,9870
Delta = 2° 38' 27.0283" (RT)
Degree = 0° 29' 16.3503"
Tangent = 227,9178'
Length = 524,2971'
Radius = 11,535,7753'
External = 3,8817'
Long Chord = 528,3928'
Mid. Ord. = 3,8804'
P.C. Station 233+45.5789      N 1,688,368,1158      E 2,402,449,6340
P.T. Station 239+45.0369      N 1,688,592,9712      E 2,403,004,1734
C.C. N 1,677,792,8395      E 2,407,060,5684

Course from PT 290 to PC 300 69+ 24' 52.0098" Dist 196,2098'

*****
Curve Data

Curve 300
P.I. Station 243+46.7644      N 1,688,741,9562      E 2,403,400,8453
Delta = 2° 13' 11.0637" (RT)
Degree = 0° 29' 16.3503"
Tangent = 227,9178'
Length = 454,9174'
Radius = 11,743,9174'
External = 2,2037'
Long Chord = 454,9501'
Mid. Ord. = 2,2033'
P.C. Station 241+41.2467      N 1,688,661,9597      E 2,403,187,9549
P.T. Station 249+46.2233      N 1,688,913,6432      E 2,403,616,1742
C.C. N 1,671,861,9497      E 2,407,917,0681

Course from PT 300 to PC 310 71+ 38' 03.0735" Dist 68,9657'

*****
Curve Data

Curve 310
P.I. Station 249+46.6701      N 1,688,914,4208      E 2,403,920,3274
Delta = 4° 19' 39.1281" (RT)
Degree = 0° 51' 46.3843"
Tangent = 250,8797'
Length = 501,5197'
Radius = 6,640,0267'
External = 4,1738'
Long Chord = 501,4005'
Mid. Ord. = 4,1734'
P.C. Station 246+45.1909      N 1,688,835,3131      E 2,403,682,2271
P.T. Station 251+46.7106      N 1,688,975,2769      E 2,404,163,1138
C.C. N 1,682,333,3397      E 2,405,174,1899

Course from PT 310 to PC 320 75+ 57' 42.2016" Dist 613,7091'

*****
Curve Data

Curve 320
P.I. Station 266+46.3988      N 1,689,330,5411      E 2,405,620,5523
Delta = 7° 29' 22.3964" (LT)
Degree = 4° 59' 42,4145'
Tangent = 881,9790'
Length = 1,011,0336'
Radius = 1,511,2336'
External = 303,3408'
Long Chord = 803,3292'
Mid. Ord. = 240,0072'
P.C. Station 263+40.0272      N 1,689,124,1440      E 2,404,759,0938
P.T. Station 272+48,7133      N 1,690,227,4900      E 2,405,627,6676
C.C. N 1,690,216,9395      E 2,404,480,86529

Course from PT 320 to PC 330 0+ 28' 31,2585" Dist 1,112,2752'

*****
Curve Data

Point 330 N 1,691,339,7269      E 2,405,637,0594      Stc 284+03,9884
Course from 330 to PC 340 0+ 18' 05,9726" Dist 1,128,7361'

*****
Curve Data

Curve 340
P.I. Station 305+42,1538      N 1,693,447,8630      E 2,405,648,1947
Delta = 81° 06' 39,3205" (RT)
Degree = 5° 00' 21,9622"
Tangent = 379,4292'
Length = 1,620,2416'
Radius = 1,144,9197'
External = 361,8692'
Long Chord = 1,488,2955'
Mid. Ord. = 274,2339'
P.C. Station 292+32,7246      N 1,692,468,4474      E 2,405,643,0381
P.T. Station 320+48,9861      N 1,693,594,1097      E 2,406,616,6439
C.C. N 1,692,462,4218      E 2,406,787,5413

Course from PT 340 to PC 350 81+ 24' 45,2331" Dist 379,5350'

*****
Curve Data

Curve 350
P.I. Station 318+45,8832      N 1,693,693,2446      E 2,407,273,1179
Delta = 28° 07' 45,0546" (LT)
Degree = 5° 07' 32,4533"
Tangent = 284,3811'
Length = 551,3874'
Radius = 1,140,0599'
External = 34,9334'
Long Chord = 551,8529'
Mid. Ord. = 33,8946'
P.C. Station 315+32,5021      N 1,693,650,7813      E 2,406,991,9249
P.T. Station 320+48,9895      N 1,693,862,7994      E 2,407,501,4242
C.C. N 1,694,778,0502      E 2,406,821,6932

Course from PT 350 to 1037 53+ 24' 00,2384" Dist 905,1038'

Point 1037 N 1,694,402,4440      E 2,408,228,0580      Stc 329+94,9333
Course from 1037 to PC 70200 53+ 09' 07,9803" Dist 730,6117'

```

HORIZONTAL VERTICAL CONTROL

PLI Station 368+45.5121 N 1.697,868,8875 E 2,409,412,7713  
 Delta = 0° 09' 55.1786" (RT)  
 Degree = 0° 24' 52.7491"  
 Tangent = 280,4636"  
 Length = 520,8655"  
 Radius = 13,817,8480"  
 External = 2,4546"  
 Long Chord = 520,8347"  
 Mid. Ord. = 2,4542"  
 P.C. Station 366+86.0485 N 1.697,608,4625 E 2,409,417,2521  
 P.T. Station 372+05.9141 N 1.698,128,2965 E 2,409,418,1081  
 C.C. N 1.697,846,1732 E 2,423,233,0552  
 Course from PT 380 to PC 390 1° 10' 26.5957" Dist 291,5796"

Curve 380  
 P.L. Station 356+50.7374 N 1.696,574,4109 E 2,409,435,0488  
 Delta = 3° 12' 46.1372" (LT)  
 Degree = 0° 28' 05.8928"  
 Tangent = 359,4113"  
 Length = 738,6289"  
 Radius = 13,172,3451"  
 External = 5,1790"  
 Long Chord = 738,5322"  
 Mid. Ord. = 5,1769"  
 P.C. Station 352+48.3261 N 1.695,204,3786 E 2,409,420,6933  
 P.T. Station 360+19.9550 N 1.696,943,4674 E 2,409,428,6538  
 C.C. N 1.696,716,8614 E 2,356,258,2990  
 Course from PT 370 to 1040 359° 00' 51,4172" Dist 126,5913"  
 Point 1040 N 1,697,070,0400 E 2,409,426,5160 Sta 361+46,5463  
 Course from 1040 to PC 380 359° 00' 51,4172" Dist 338,5022"

Curve 370  
 P.L. Station 317+29.6050 N 1.693,392,8921 E 2,403,412,0481  
 Delta = 50° 55' 30.4299" (LT)  
 Degree = 3° 49' 10.9971"  
 Tangent = 714,2605"  
 Length = 1,333,2165"  
 Radius = 1,500,0000"  
 External = 161,3753"  
 Long Chord = 1,289,7638"  
 Mid. Ord. = 149,1004"  
 P.C. Station 337+28.6050 N 1.694,840,5854 E 2,408,812,7165  
 P.T. Station 330+59.9219 N 1.693,392,8921 E 2,403,412,0481  
 C.C. N 1.693,040,3327 E 2,407,311,1791  
 Course from PT 1200 to PC 370 2° 13' 37.5544" Dist 222,5046"

Curve 1200  
 P.L. Station 381+59,4561 N 1.699,123,4579 E 2,409,426,3200  
 Delta = 0° 19' 11,2567" (RT)  
 Degree = 0° 34' 48,9710"  
 Tangent = 27,5557"  
 Length = 55,1112"  
 Radius = 9,873,9911"  
 External = 0,0385"  
 Long Chord = 55,1111"  
 Mid. Ord. = 0,0385"  
 P.C. Station 381+42,3004 N 1.699,095,6023 E 2,409,426,3562  
 P.T. Station 382+27,4116 N 1.699,150,7153 E 2,409,426,4377  
 C.C. N 1.699,108,5445 E 2,419,300,3388  
 Course from PT 1200 to PC 1210 0° 14' 40,8967" Dist 123,6495"

Curve 1210  
 P.L. Station 386+45,1574 N 1.699,438,4565 E 2,409,427,6666  
 Delta = 0° 58' 32,3038" (LT)  
 Degree = 0° 18' 08,5049"  
 Tangent = 164,0963"  
 Length = 328,1844"  
 Radius = 18,949,3691"  
 External = 0,7105"  
 Long Chord = 328,1803"  
 Mid. Ord. = 0,7105"  
 P.C. Station 383+51,0611 N 1.699,274,3617 E 2,409,426,3658  
 P.T. Station 386+79,2455 N 1.699,602,5389 E 2,409,425,5255  
 C.C. N 1.699,355,2885 E 2,390,471,7705  
 Course from PT 1210 to PC 1220 359° 15' 09,5929" Dist 190,6208"

Curve 330  
 P.L. Station 376+42,3636 N 1.698,565,6544 E 2,409,427,0580  
 Delta = 1° 14' 56,2597" (LT)  
 Degree = 0° 42' 23,6217"  
 Tangent = 14,4310"  
 Length = 269,1285"  
 Radius = 13,269,1651"  
 External = 0,1939"  
 Long Chord = 142,9722"  
 Mid. Ord. = 7,6587"  
 P.C. Station 374+49,4817 N 1.698,420,8149 E 2,409,424,0894  
 P.T. Station 377+47,2221 N 1.698,710,5243 E 2,409,426,8609  
 C.C. N 1.698,693,1056 E 2,396,131,7072  
 Course from PT 390 to PC 1200 359° 55' 28,6400" Dist 385,0783"

Curve 390  
 P.L. Station 317+49,4817 N 1.698,420,8149 E 2,409,424,0894  
 Delta = 1° 14' 56,2597" (LT)  
 Degree = 0° 42' 23,6217"  
 Tangent = 14,4310"  
 Length = 269,1285"  
 Radius = 13,269,1651"  
 External = 0,1939"  
 Long Chord = 142,9722"  
 Mid. Ord. = 7,6587"  
 P.C. Station 317+49,4817 N 1.698,420,8149 E 2,409,424,0894  
 P.T. Station 317+47,2221 N 1.698,710,5243 E 2,409,426,8609  
 C.C. N 1.698,693,1056 E 2,396,131,7072  
 Course from PT 390 to PC 1200 359° 55' 28,6400" Dist 385,0783"

Curve 350  
 P.L. Station 376+42,3636 N 1.698,565,6544 E 2,409,427,0580  
 Delta = 1° 14' 56,2597" (LT)  
 Degree = 0° 42' 23,6217"  
 Tangent = 14,4310"  
 Length = 269,1285"  
 Radius = 13,269,1651"  
 External = 0,1939"  
 Long Chord = 142,9722"  
 Mid. Ord. = 7,6587"  
 P.C. Station 374+49,4817 N 1.698,420,8149 E 2,409,424,0894  
 P.T. Station 377+47,2221 N 1.698,710,5243 E 2,409,426,8609  
 C.C. N 1.698,693,1056 E 2,396,131,7072  
 Course from PT 390 to PC 1200 359° 55' 28,6400" Dist 385,0783"

Curve 370  
 P.L. Station 317+29,6050 N 1.693,392,8921 E 2,403,412,0481  
 Delta = 50° 55' 30,4299" (LT)  
 Degree = 3° 49' 10,9971"  
 Tangent = 714,2605"  
 Length = 1,333,2165"  
 Radius = 1,500,0000"  
 External = 161,3753"  
 Long Chord = 1,289,7638"  
 Mid. Ord. = 149,1004"  
 P.C. Station 337+28,6050 N 1.694,840,5854 E 2,408,812,7165  
 P.T. Station 330+59,9219 N 1.693,392,8921 E 2,403,412,0481  
 C.C. N 1.693,040,3327 E 2,407,311,1791  
 Course from PT 1200 to PC 370 2° 13' 37,5544" Dist 222,5046"

DATE	SECTION	COUNT	PERCENT
1/10/2005	1	1	100.00
TOTAL		1	100.00
REVISIONS:			
NO.	DATE	BY	REASON

HORIZONTAL VERTICAL CONTROL

CONTRACT NO.	4115
COUNTY	BRUCE
DISTRICT	15
SECTION	10
TO STA.	210
FROM STA.	100
DATE	11/10/2005
BY	XXXXXX
CHECKED BY	XXXXXX
DATE	11/10/2005
SCALE	AS SHOWN
PROJECT	HORIZONTAL CONTROL

Curve Data  
 Curve 1220  
 P.I. Station 391+45.7312 N 1,700.066,9850 E 2,409,419.4649  
 Delta = 1° 13' 52.8349" (L1)  
 Degree = 0° 13' 29.3486"  
 Tangent = 273,8649'  
 Length = 547.7088'  
 Radius = 25,485,5076'  
 External = 1,4174'  
 Long Chord = 547,6983'  
 Mid. Ord. = 1,4173'  
 P.I. Station 389+49.8653 N 1,599,793,1434 E 2,409,423,0383  
 P.I. Station 387+47.5751 N 1,700,340,6865 E 2,409,410,0077  
 C.C. N 1,700,460,8100 E 2,383,959,7002

Curve Data  
 Curve 1230  
 P.I. Station 395+51.3921 N 1,700,454,4357 E 2,409,406,0773  
 Delta = 0° 44' 03.2739" (RT)  
 Degree = 0° 19' 21.2107"  
 Tangent = 113,8170'  
 Length = 227,6309'  
 Radius = 17,762,9098'  
 External = 0,3646'  
 Long Chord = 227,6293'  
 Mid. Ord. = 0,3646'  
 P.I. Station 394+47.5751 N 1,700,340,6866 E 2,409,410,0077  
 P.I. Station 396+45.2059 N 1,700,568,2258 E 2,409,403,6049  
 C.C. N 1,700,954,0831 E 2,427,182,3233

Curve Data  
 Curve 1240  
 P.I. Station 416+03.2964 N 1,702,625,8543 E 2,409,361,0700  
 Delta = 54° 34' 59.6027" (RT)  
 Degree = 3° 59' 48,4558"  
 Tangent = 739,6413'  
 Length = 1,385,5734'  
 Radius = 1,259,5234'  
 External = 1,793,8541'  
 Long Chord = 1,314,6154'  
 Mid. Ord. = 159,5759'  
 P.I. Station 408+63,6551 N 1,701,786,3975 E 2,409,377,1370  
 P.I. Station 422+29,3305 N 1,702,987,4838 E 2,409,954,9394  
 C.C. N 1,701,817,5278 E 2,410,810,3424

Curve Data  
 Curve 1250  
 P.I. Station 431+41.7867 N 1,703,512,2988 E 2,410,686,3449  
 Delta = 54° 18' 30,4708" (L1)  
 Degree = 4° 00' 35,8175"  
 Tangent = 732,8820'  
 Length = 1,354,3429'  
 Radius = 1,428,8405'  
 External = 176,9930'  
 Long Chord = 1,304,2094'  
 Mid. Ord. = 151,4891'  
 P.I. Station 424+08,9047 N 1,703,074,7051 E 2,410,098,4437  
 P.I. Station 437+63,2476 N 1,704,246,0758 E 2,410,673,9386  
 C.C. N 1,704,220,8883 E 2,409,249,3028

Course from PT 1250 to 1043 359° 01' 48.1637" Dist 645,5887'  
 Point 1043 N 1,704,890,5720 E 2,410,663,0109 Sta 444+08,8363  
 Course from 1043 to 1260 359° 15' 06,6729" Dist 1,659,2836'  
 Point 1260 N 1,706,550,0142 E 2,410,641,3404 Sta 460+58,4199  
 Course from 1260 to PC 1270 359° 04' 50,3080" Dist 1,726,1173'

Curve Data  
 Curve 1270  
 P.I. Station 478+49,5372 N 1,708,370,8970 E 2,410,612,1203  
 Delta = 0° 25' 44,8777" (RT)  
 Degree = 0° 13' 33,0973"  
 Tangent = 85,0000'  
 Length = 189,9997'  
 Radius = 25,367,7683'  
 External = 0,1779'  
 Long Chord = 189,9987'  
 Mid. Ord. = 0,1779'  
 P.I. Station 477+94,5372 N 1,708,276,9092 E 2,410,613,6446  
 P.I. Station 479+44,5363 N 1,708,465,9935 E 2,410,611,3075  
 C.C. N 1,708,682,9392 E 2,435,978,1673

Course from PT 1270 to 171 359° 30' 35,1857" Dist 1,070,8897'  
 Point 171 N 1,709,556,7440 E 2,410,602,1480 Sta 490+55,4280  
 Course from 171 to 173 359° 24' 00,8122" Dist 1,034,4057'  
 Point 173 N 1,710,571,0930 E 2,410,591,3170 Sta 500+99,8317

HORIZONTAL VERTICAL CONTROL





NET DATE: 4 Nov 2005 10:23:58 AM  
 FILE NAME: 4 columns 11x17.dwg  
 NET SCALE: 1/16"=1' 0"  
 NET PLOT: 11x17" PL  
 PLOT DATE: 4 Nov 2005

...projects\200502\id005021\nc.dgn 1/10/2005 1:11:08 PM

REFERENCE TIES

POINT	CHAIN	STATION	OFFSET	DESCRIPTION
501	new34	1055+14.6769	13.8430' RT	POWER POLE, SHINER
502	new34	1055+58.2002	38.4623' LT	TELEGRAPH POLE, SHINER
503	new34	1059+90.8241	72.4922' LT	GUY POLE, SHINER
504	new34	1060+56.7706	40.2984' LT	TELEGRAPH POLE, SHINER
505	new34	1060+04.6351	24.3013' RT	POWER POLE WITH TRANSFORMER, SHINER
506	new34	1065+61.2998	52.4620' LT	TELEGRAPH POLE, SHINER
507	new34	1064+62.8709	32.3761' RT	POWER POLE WITH LIGHT, SHINER
508	new34	1064+56.0751	42.9634' LT	TELEGRAPH POLE, SHINER
509	new34	1071+15.0564	5.1889' LT	POWER POLE WITH LIGHT, SHINER
510	new34	1071+82.5984	55.5100' LT	GUY POLE, SHINER
511	new34	1072+12.5525	24.4466' RT	SIGN, SHINER
515	new34	1075+98.2856	28.3360' LT	FENCE, SHINER
516	new34	1076+80.5305	35.2294' LT	FENCE, SHINER
517	new34	1076+57.9161	11.1741' LT	FLOWLINE OF GUTTER, CROSS CUT
518	new34	1081+39.6744	30.1497' RT	TELEPHONE SPLICE BOX, SHINER
519	new34	1080+96.1519	27.4145' LT	POWER POLE WITH TRANSFORMER, SHINER
520	new34	1079+93.3950	20.4111' LT	POWER POLE, SHINER
521	new34	1089+39.8046	65.5299' LT	POWER POLE, SHINER
524	new34	1087+15.0226	62.5947' LT	TELEGRAPH POLE, SHINER
525	new34	1105+09.4385	66.3814' LT	FENCE, SHINER
526	new34	1105+54.2752	66.2224' LT	FENCE, SHINER
527	new34	356+48.7596	88.9366' RT	POWER POLE, SHINER
528	new34	1135+11.9168	66.2076' LT	FENCE, SHINER
529	new34	1134+65.4513	65.5342' LT	FENCE, SHINER
530	new34	1133+52.3911	63.4315' LT	POWER POLE, SHINER
531	new34	1161+28.4322	65.5312' LT	FENCE, SHINER
532	new34	1161+01.5507	63.1616' LT	POWER POLE, SHINER
533	new34	1180+74.0295	86.3910' LT	FENCE, SHINER
534	new34	1184+84.1282	64.7155' LT	POWER POLE, SHINER
535	new34	1185+33.2360	92.1412' LT	POWER POLE, SHINER
536	new34	1185+47.9732	69.1288' LT	FENCE, SHINER
537	new34	1205+65.0294	62.7713' LT	POWER POLE, SHINER
538	new34	1447.3259	65.0810' LT	POWER POLE, SHINER
539	new34	1407.7364	67.3922' LT	FENCE, SHINER
540	new34	15+62.7289	64.5431' LT	POWER POLE, SHINER
541	new34	14+29.4832	65.3942' LT	FENCE, SHINER
542	new34	14+02.8639	68.9307' LT	FENCE, SHINER
543	new34	33+29.2899	64.3311' LT	POWER POLE, SHINER
544	new34	34+00.4899	66.6194' LT	FENCE, SHINER
545	new34	34+61.6816	66.5097' LT	FENCE, SHINER
546	new34	58+21.8197	65.8102' LT	FENCE, SHINER
547	new34	57+61.3933	65.8400' LT	FENCE, SHINER
548	new34	58+45.1546	43.8400' RT	SIGN, CORNER
551	new34	73+27.0298	64.1257' LT	POWER POLE, SHINER
552	new34	98+21.0753	63.7280' LT	POWER POLE, SHINER
553	new34	97+71.0827	66.1935' LT	FENCE, SHINER
554	new34	97+06.4977	65.9708' LT	FENCE, SHINER
555	new34	118+46.1844	65.4566' LT	POWER POLE, SHINER
560	new34	136+75.5935	63.1652' LT	POWER POLE WITH TRANSFORMER, SHINER
561	new34	157+47.9461	64.4479' LT	POWER POLE, SHINER
562	new34	154+80.6597	64.5604' LT	POWER POLE, SHINER
563	new34	156+14.9065	12.4663' RT	PAVEMENT STATION NUMBER, PAINTED
564	new34	177+82.8128	66.8288' LT	POWER POLE, SHINER
565	new34	175+23.7547	65.5272' LT	POWER POLE, SHINER
567	new34	195+00.4131	18.4223' RT	POWER POLE, SHINER
568	new34	194+60.2888	68.4470' RT	POWER POLE WITH LIGHT, SHINER
569	new34	194+92.7701	44.2548' RT	GUARDRAIL STEEL PLATE BEAM, END
570	new34	210+07.9749	30.6201' RT	POWER POLE, SHINER
571	new34	204+75.8886	28.8920' RT	POWER POLE, SHINER
572	new34	205+00.6913	53.5414' LT	POWER POLE, SHINER
573	new34	203+30.7294	29.8164' RT	POWER POLE, SHINER
574	new34	210+73.8254	26.5981' RT	POWER POLE, SHINER
575	new34	219+55.0534	35.4304' RT	FENCE, SHINER
576	new34	220+26.8508	58.9017' LT	SIGN, SHINER
577	new34	220+27.2466	65.6615' LT	SIGN, SHINER
582	new34	249+49.7219	11.5966' LT	PAVEMENT - EDGE, SHINER

HORIZONTAL VERTICAL CONTROL

CONTRACT NO. 5513	SECTION
NO. 44	DATE
11/10/05	BY
11/10/05	CHK
11/10/05	APP
11/10/05	DES
11/10/05	DRAWN
11/10/05	CHECKED
11/10/05	PROJECT

...projects\2005021\000602hvc.dgn 1/10/2005 1:11:13 PM

PLT DATE: 1/10/2005 11:23:13 AM  
 FILE NAME: ...  
 PLOT SCALE: 1/8" = 1'-0"  
 PLOT AREA: 11.75' x 17.5'

REFERENCE TIES

POINT	CHAIN	STATION	OFFSET	DESCRIPTION
583	new34	288+00.8173	66.7172' RT	POWER POLE, SHINER
584	new34	287+98.3339	62.3305' LT	POWER POLE, SHINER
585	new34	284+66.3515	59.2751' RT	POWER POLE, SHINER
586	new34	300+73.7052	46.2774' LT	POWER POLE, SHINER
588	new34	300+10.8880	12.3037' LT	PAVEMENT - EDGE, SHINER
589	new34	313+26.5078	68.2973' RT	24" TREE DECIDUOUS, SHINER
590	new34	313+52.2560	59.9559' LT	POWER POLE, SHINER
591	new34	312+82.0014	81.0992' LT	FENCE, SHINER
592	new34	320+03.2426	92.1557' LT	FENCE, SHINER
593	new34	320+25.9071	75.7719' LT	FENCE, SHINER
594	new34	320+54.6465	56.5327' LT	POWER POLE, SHINER
595	new34	330+96.3498	63.3117' LT	POWER POLE, SHINER
596	new34	333+83.4916	63.6004' LT	POWER POLE, SHINER
597	new34	331+81.7053	35.6903' RT	12" TREE DECIDUOUS, SHINER
604	new34	356+48.7656	88.9366' RT	POWER POLE, SHINER
605	new34	359+47.1933	65.3799' RT	POWER POLE, SHINER
606	new34	355+05.9145	26.9538' LT	SIGN
607	new34	355+05.9145	26.9538' LT	SIGN
608	new34	373+85.2910	59.1900' RT	POWER POLE, SHINER
609	new34	374+34.8362	60.2973' LT	FENCE, SHINER
610	new34	373+81.2851	58.4836' LT	POWER POLE, SHINER
611	new34	388+81.6920	64.5317' RT	POWER POLE, SHINER
612	new34	387+03.4675	53.5931' RT	POWER POLE, SHINER
613	new34	387+02.8846	64.5235' LT	POWER POLE, SHINER
617	new34	410+30.9488	67.9716' LT	FENCE, SHINER
618	new34	410+46.7471	67.9726' LT	FENCE, SHINER
619	new34	410+39.2798	62.3298' RT	FENCE, SHINER
620	new34	424+23.6903	64.5491' LT	7" TREE DECIDUOUS, SHINER
621	new34	425+30.1749	62.6471' LT	7" TREE DECIDUOUS, SHINER
622	new34	425+74.5783	58.2465' LT	FENCE, SHINER
623	new34	432+74.9416	78.9416' RT	27" TREE DECIDUOUS, SHINER
624	new34	433+93.2236	60.3392' LT	FENCE, SHINER
625	new34	430+70.9003	48.1253' LT	FENCE, SHINER
626	new34	210+35.5962	55.2570' LT	POWER POLE, SHINER
627	new34	445+41.2586	51.1887' RT	4" TREE DECIDUOUS, SHINER
628	new34	443+87.3699	12.2737' RT	PAVEMENT - EDGE, SHINER
629	new34	444+54.1671	12.0319' RT	PAVEMENT - EDGE, SHINER
630	new34	462+00.7383	49.8931' RT	4" TREE DECIDUOUS, SHINER
631	new34	463+03.7059	56.8228' LT	POWER POLE, SHINER
632	new34	460+30.2781	58.5534' LT	POWER POLE, SHINER
633	new34	490+88.8692	67.7616' LT	POWER POLE, SHINER
634	new34	486+09.9358	61.3396' LT	POWER POLE, SHINER
635	new34	489+68.2506	21.9919' RT	GUARDRAIL STEEL PLATE BEAM, SHINER

HORIZONTAL VERTICAL CONTROL

CONTRACT NO. 6425  
 SHEET NO. 10  
 DATE: 1/10/2005  
 DRAWN BY: [Name]  
 CHECKED BY: [Name]  
 APPROVED BY: [Name]



PLOT DATE: 1/10/2005  
 FILE NAME: ...  
 PLOT SCALE: 1"=200'  
 REFERENCE: 1:100'

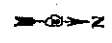
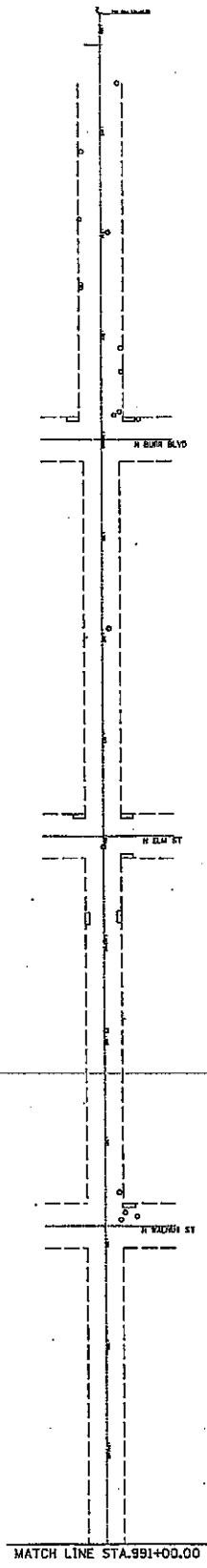

CONTRACT NO. 41715

SECTION	DATE	NO. OF SHEETS
1	1/10/2005	1

DESIGNED BY: ...  
 DRAWN BY: ...  
 CHECKED BY: ...

ILLINOIS DEPARTMENT OF TRANSPORTATION

REVISIONS	DATE	BY	DESCRIPTION

SCALE: NONE  
 DATE: ...  
 DESIGNED BY: ...  
 CHECKED BY: ...

US 34

PLOT DATE: 4 Nov 2004 10:23:45 AM  
 FILE NAME: \\d200502\ad00502\pin1.dgn  
 PLOT SCALE: 1/8"=1'-0"  
 REFERENCE: 1:16:18 PM

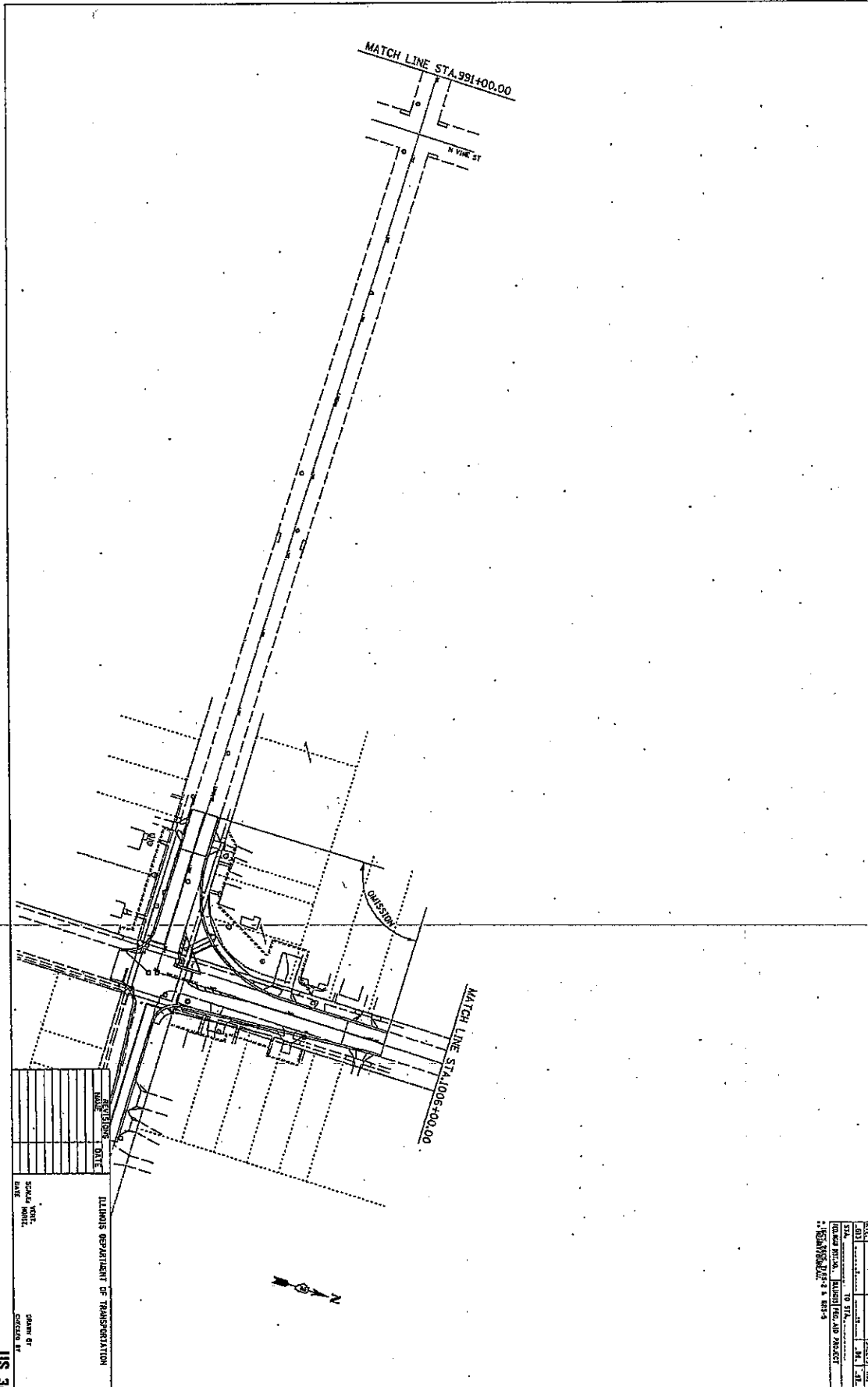

CONTRACT NO. 4418

SECTION	COUNTY	SHEET NO.	TOTAL SHEETS
101	ILLINOIS	34	34

DESIGNED BY: [Name] TO STA. [Stationing]

CHECKED BY: [Name] FROM STA. [Stationing]

DATE: [Date]

PROJECT: [Project Name]

NO.	REVISION	DATE

ILLINOIS DEPARTMENT OF TRANSPORTATION

SCALE: HORIZ. 1"=40'

VERT. 1"=20'

DATE: [Date]

DESIGNED BY: [Name]

CHECKED BY: [Name]

US 34

PLT DATE: Mon Jan 10 12:42:51 2005  
 PLOT NAME: c:\temp\600502\600502.plt.dgn  
 PLOT SCALE: 1/8"=1'-0"  
 PLOT DEVICE: HPGL

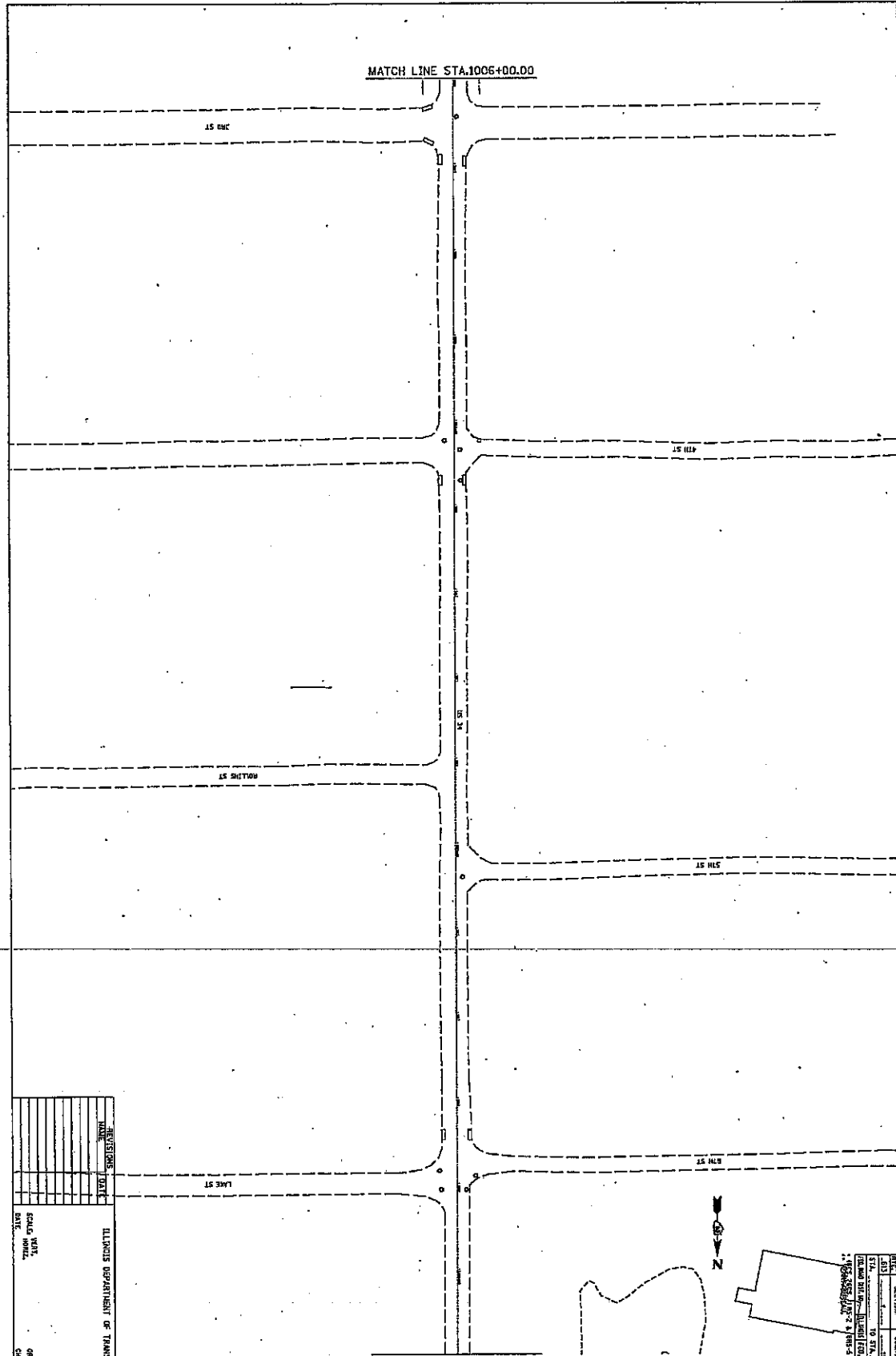

DATE	REVISION

ILLINOIS DEPARTMENT OF TRANSPORTATION

SCALE: HORIZ. 1"=40'

SCALE: VERT. 1"=10'

DESIGNED BY: [ ]

CHECKED BY: [ ]

CONTRACT NO. 04175	
DATE	SECTION
01/10/05	04
TO STA.	FROM STA.
1006+00.00	1021+00.00
DRAWN BY: [ ]	
CHECKED BY: [ ]	
DATE: 01/10/05	

PLOT DATE: 8 Nov 2005 15:16:32  
 FILE NAME: c:\p0502\1d00502p1.dgn  
 PLOT SCALE: 1"=100'-0"  
 REFERENCE: 44921

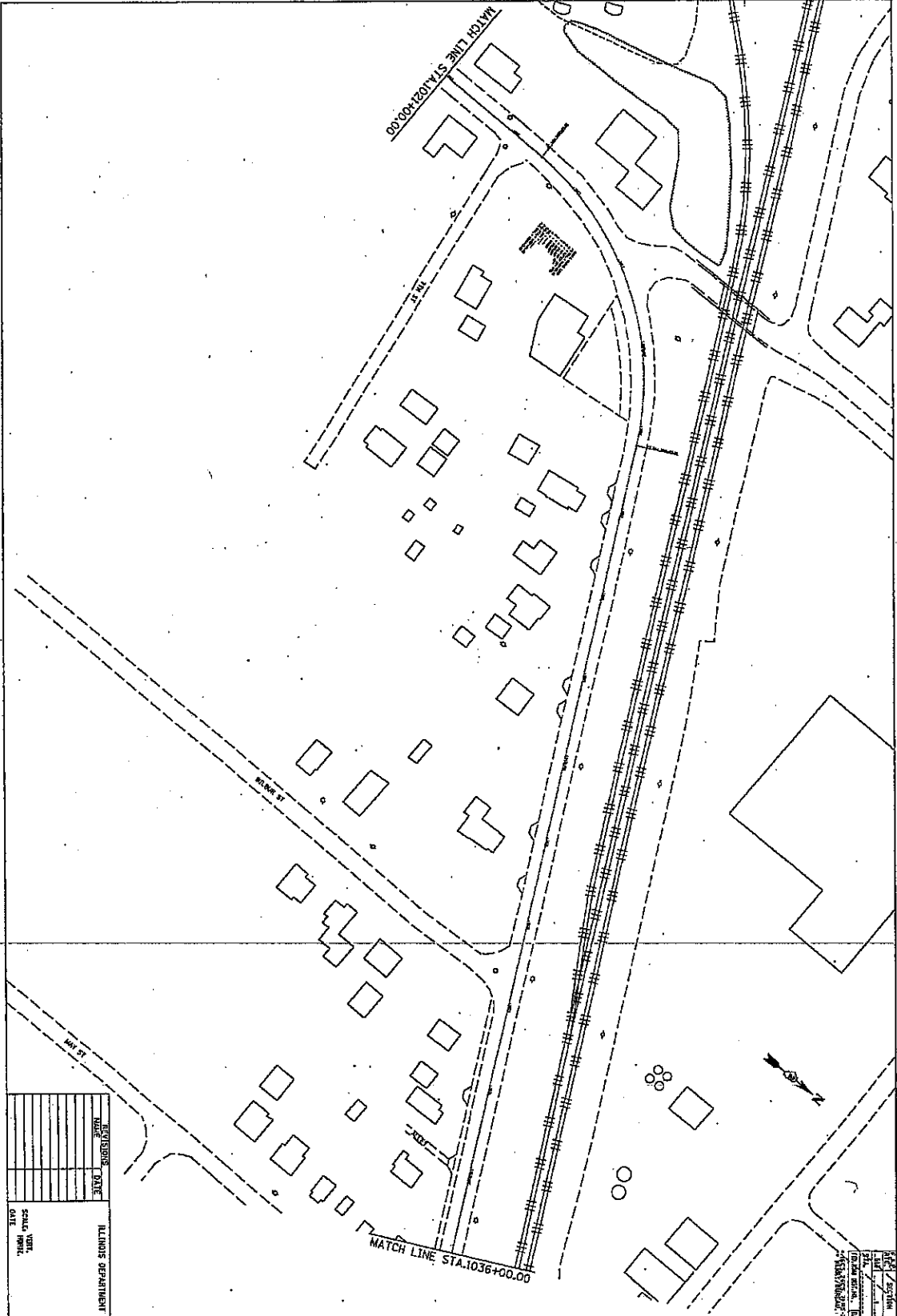

CONTRACT NO. 6418

DATE	SECTION	COUNTY	SECTION
NO.	NO.	NO.	NO.
1	1	1	1

DRAWN BY: [Name]  
 CHECKED BY: [Name]  
 DATE: [Date]

REVISIONS	DATE	DESCRIPTION

ILLINOIS DEPARTMENT OF TRANSPORTATION  
 SCALE: VERT. 1"=40'-0"  
 DATE: [Date]  
 DRAWN BY: [Name]  
 CHECKED BY: [Name]

US 34

PLT DATE: 1/10/2005  
 PLOT NAME: \\d2005021\d00502\p1.dgn  
 PLOT SCALE: 1/8" = 1'-0"  
 PLOT ORIENT: WEST

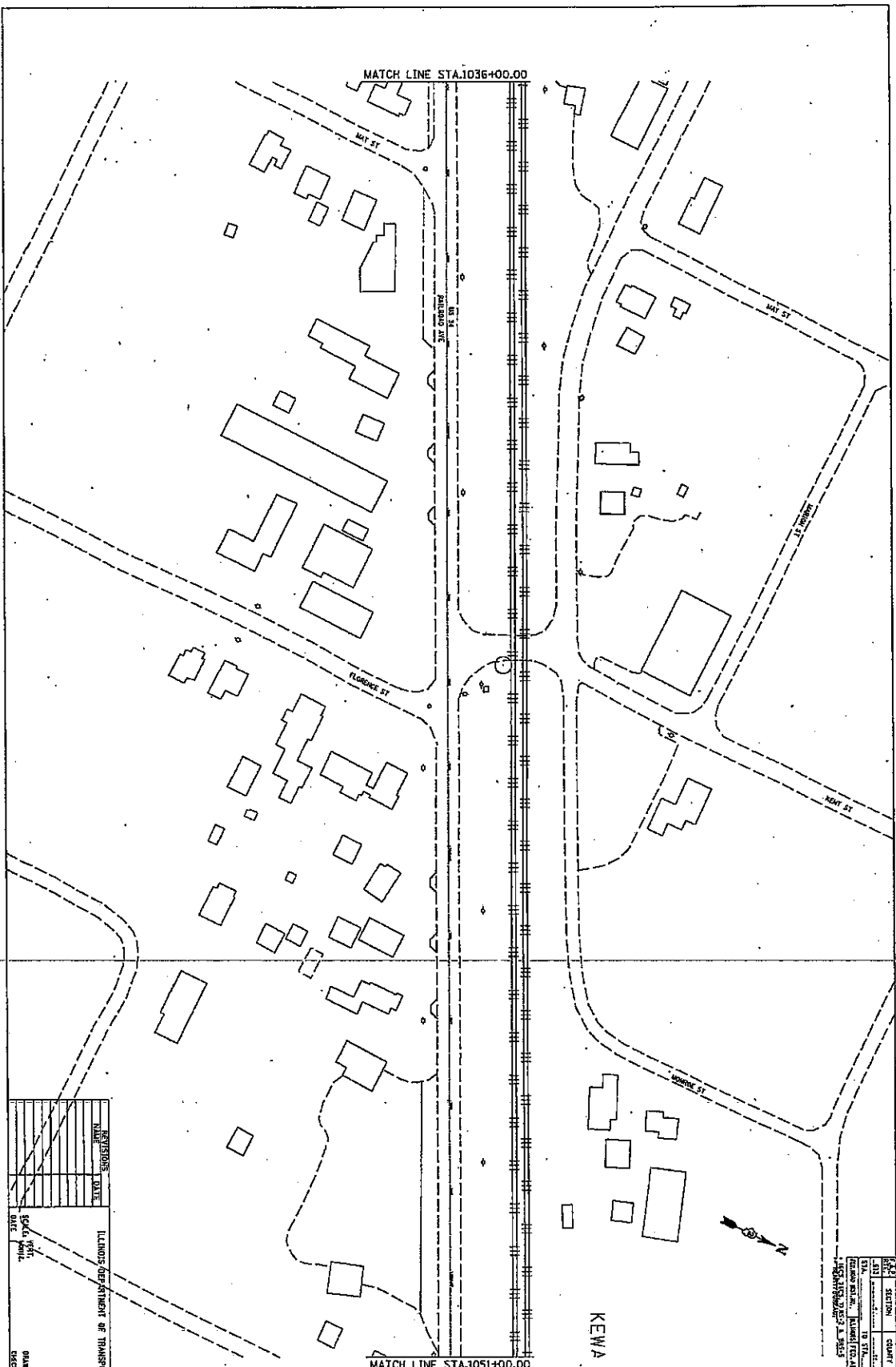

NO.	REVISIONS	DATE
1	ISSUED FOR PERMIT	1/10/2005
2	REVISED	1/10/2005
3	REVISED	1/10/2005
4	REVISED	1/10/2005
5	REVISED	1/10/2005
6	REVISED	1/10/2005
7	REVISED	1/10/2005
8	REVISED	1/10/2005
9	REVISED	1/10/2005
10	REVISED	1/10/2005

DESIGNED BY: [Name]  
 CHECKED BY: [Name]  
 DATE: [Date]

ISLAND DEPARTMENT OF TRANSPORTATION  
 US 34

CONTRACT NO. 3411	SHEET NO. 1036
SECTION NO. 1036	DATE: 1/10/2005
PROJECT NO. 3411	SCALE: 1/8" = 1'-0"
DESIGNED BY: [Name]	CHECKED BY: [Name]
DATE: [Date]	DATE: [Date]

PLAT DATE: 10 Nov 2004 10:23:42 AM  
 FILE NAME: C:\p000502\A000502.plt1.dgn  
 PLOT SCALE: 1/8" = 1'-0"  
 PLOT DEVICE: HPGL

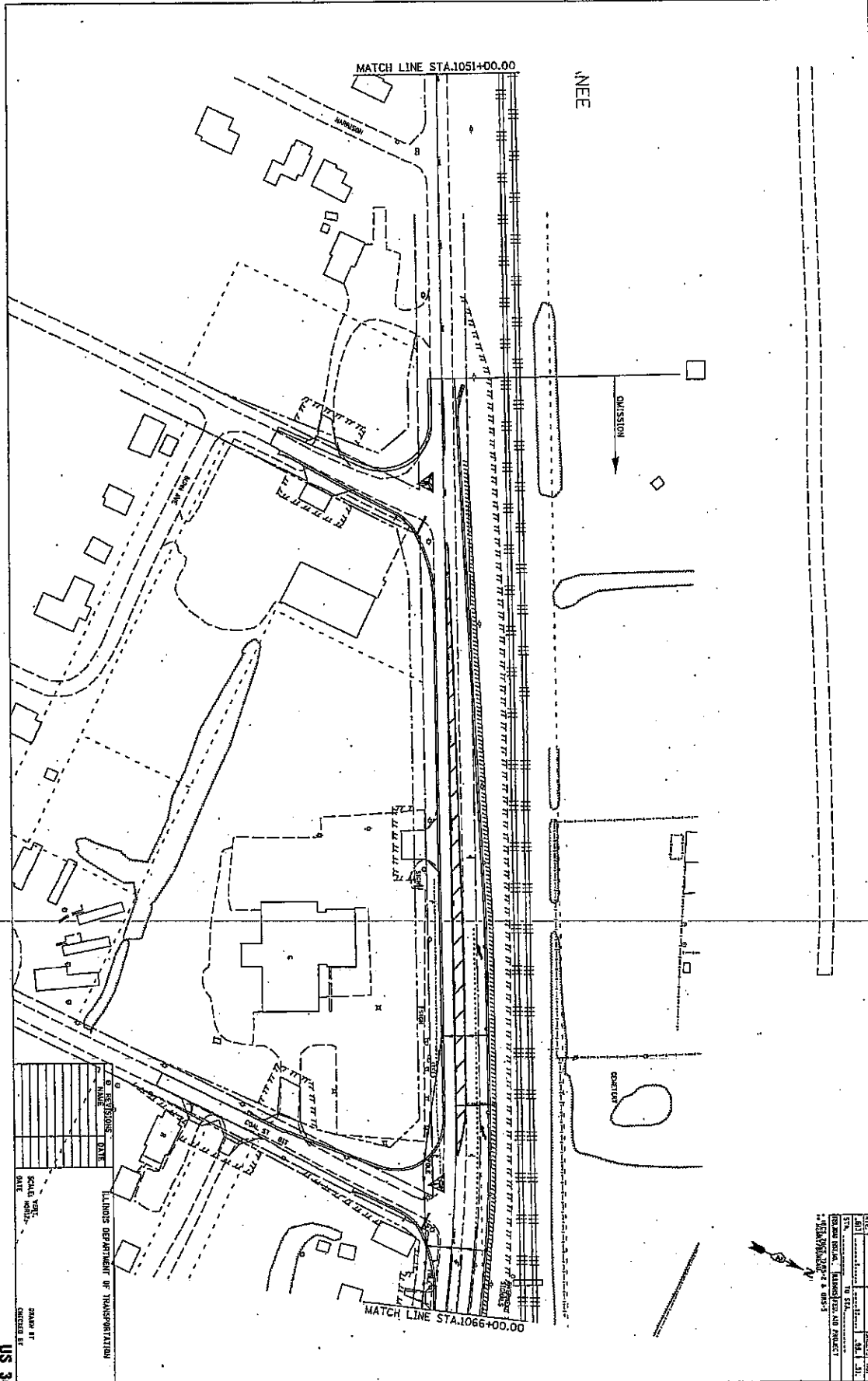

NO.	REVISIONS	DATE	BY	CHKD.

LANDS DEPARTMENT OF TRANSPORTATION  
 SCALE: AS SHOWN  
 DATE: 10/20/04  
 DRAWN BY: J. J. JONES  
 CHECKED BY: J. J. JONES

US 34

CONTRACT NO. 04173

DATE	SECTION	COMMIT	ISSUE NO.
01/10/2005			
01/10/2005			
01/10/2005			

PROJECT NO. 04173  
 PROJECT NAME: I-95/US 34  
 PROJECT LOCATION: I-95/US 34

...d2005021d00502p1.dgn 1/10/2005 1:16:48 PM

PLOT DATE: 10-Nov-05 10:12:41 AM  
 FILE NAME: d:\projects\2005021d00502p1.dgn  
 PLOT SCALE: 1"=100'  
 REFERENCE: SHEET 1

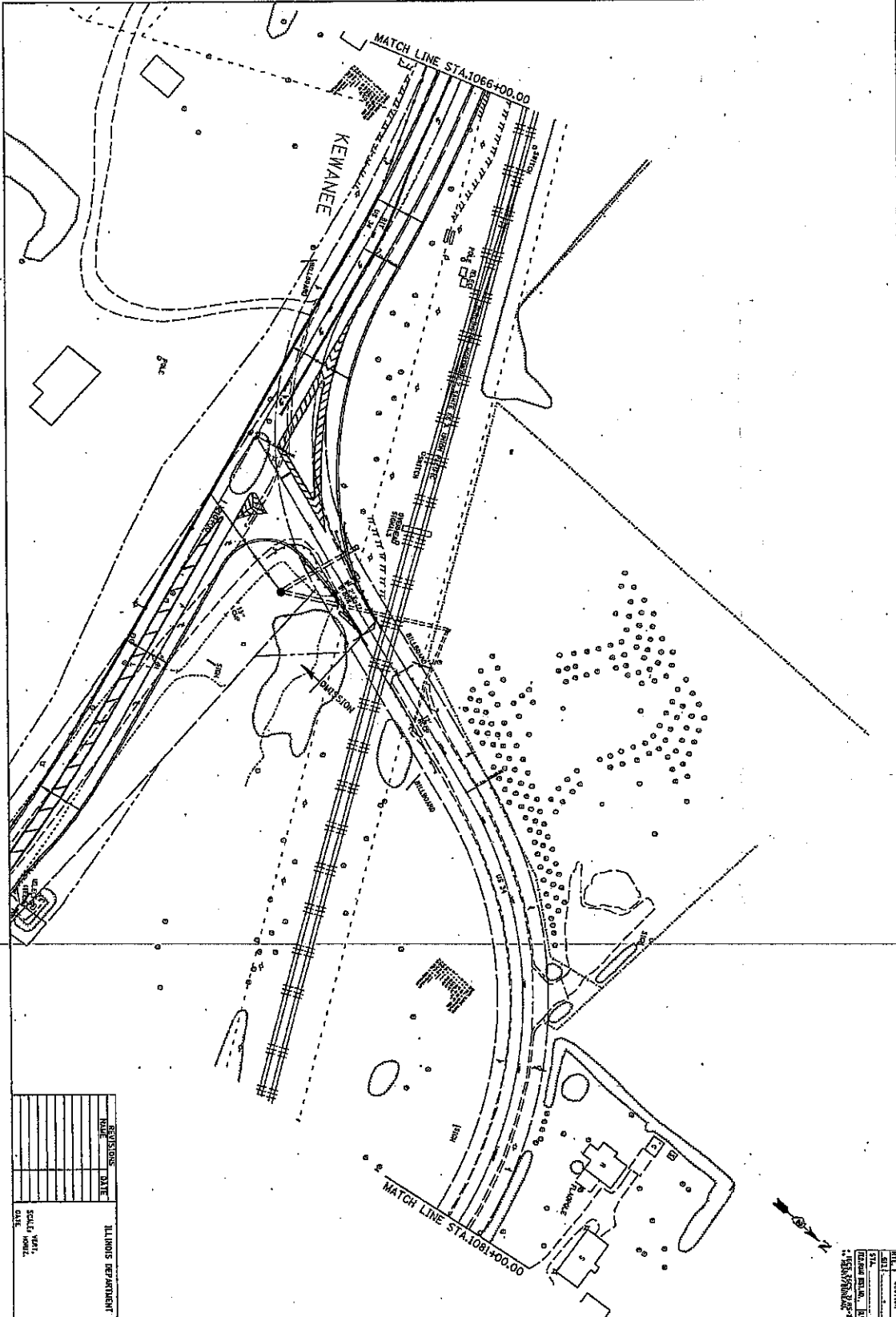

REVISIONS	DATE	BY	CHKD	APP'D

ALIENS DEPARTMENT OF TRANSPORTATION  
 ROAD NO. 10  
 COUNTY OF ...  
 STATE OF ...  
 DRAWN BY: ...  
 CHECKED BY: ...  
 DATE: ...

CONTRACT NO. 04115  
 COUNTY OF ...  
 SECTION ...  
 TO STA. ...  
 FROM STA. ...  
 DRAWN BY: ...  
 CHECKED BY: ...  
 DATE: ...

US 34

PLOT DATE: 1/10/2005 1:21:55 PM  
 FILE NAME: D:\200502\100502\pin2.dgn  
 PLOT SCALE: 1/8"=1'-0"  
 REFERENCE: 10052

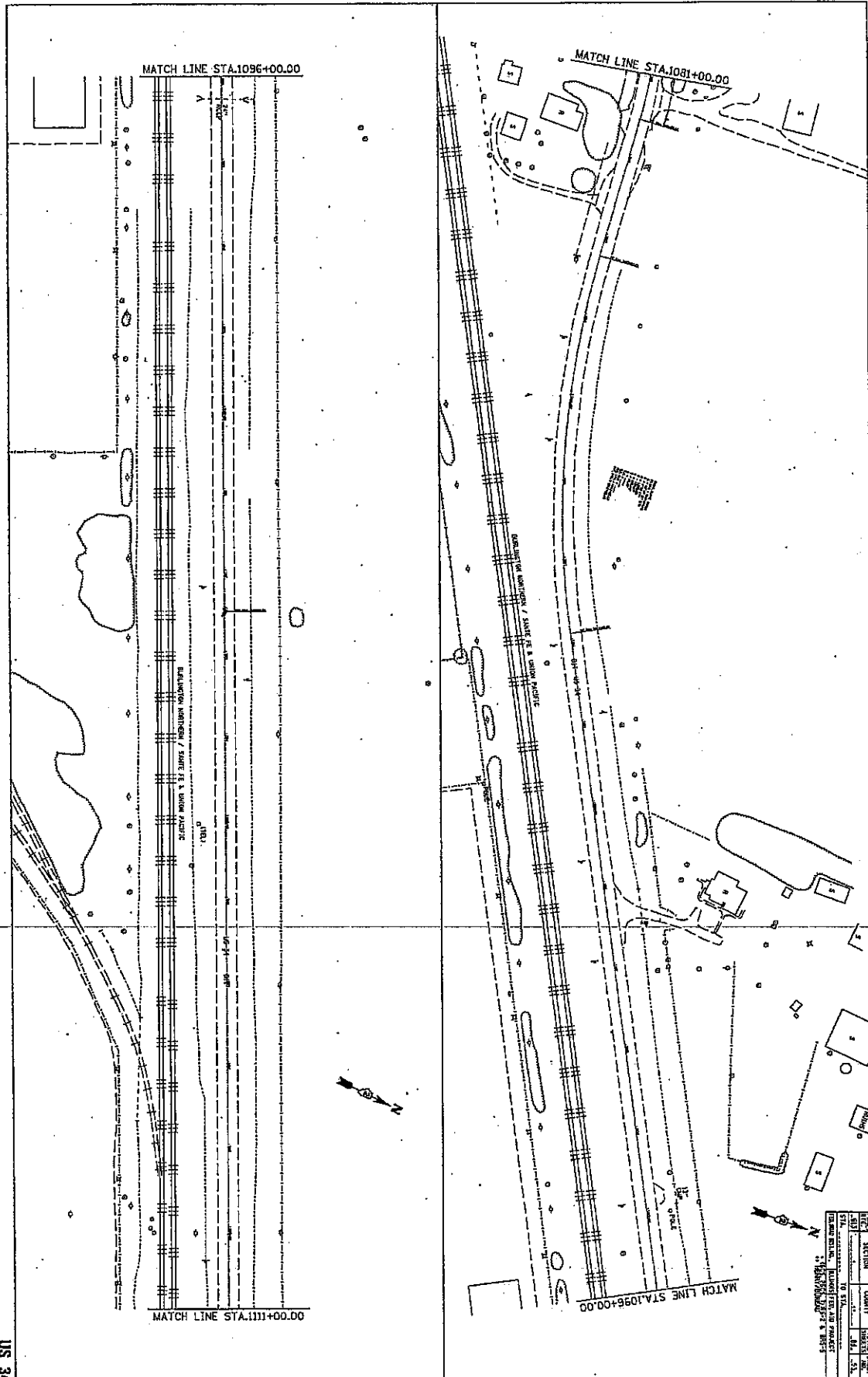

CONTRACT NO. 8473

LINE	SECTION	COUNTY	PROJECT SHEET
100	100	100	100
100	100	100	100
100	100	100	100

DRAWN BY: [Name]  
 CHECKED BY: [Name]  
 DATE: 1/10/2005

...d200502\100502\pin2.dgn 1/10/2005 1:21:55 PM



...d200502\d00502pln2.dgn 1/10/2005 1:22:03 PM

PLT DATE = 1/10/2005 1:22:03 PM  
 PLOT SCALE = 1/8" = 1'-0"  
 PLOT SHEET = 1126-00  
 PROJECT = 0502

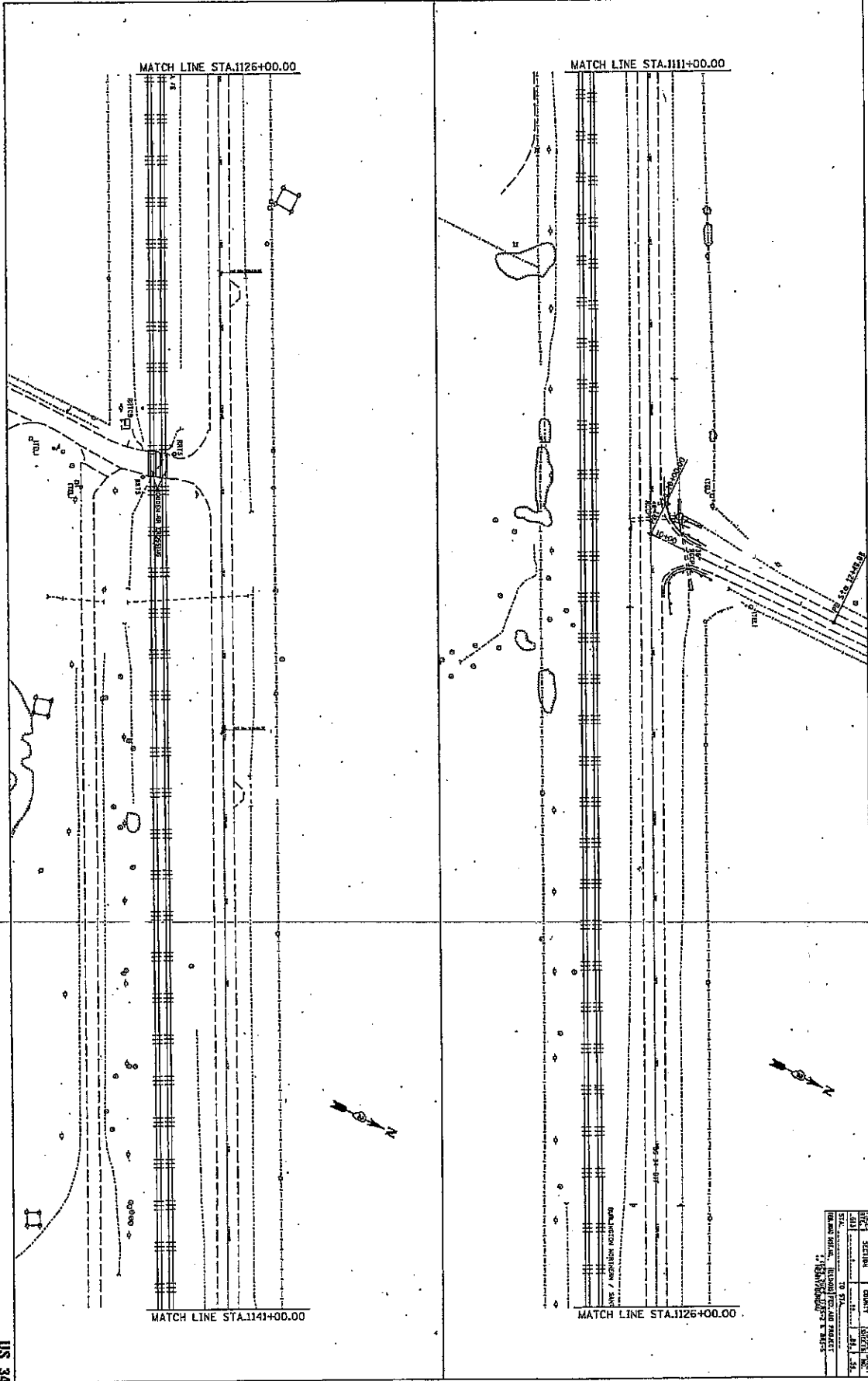

CONTRACT NO. 0502		SHEET NO. 1126-00	
SECTION	DATE	DATE	DATE
1126-00	1/10/2005	1/10/2005	1/10/2005
DESIGNED BY: [Name]		CHECKED BY: [Name]	
DRAWN BY: [Name]		SCALE: 1/8" = 1'-0"	

US 34

...d200502\d00502.pln2.dgn 1/10/2005 1:22:08 PM

PLOT DATE: Mon, Jan 10 11:22:08 AM  
FILE NAME: c:\p200502\d00502.pln2.dgn  
PLOT SCALE: 1/4"=1'-0"  
PLOT DEVICE: HPGL

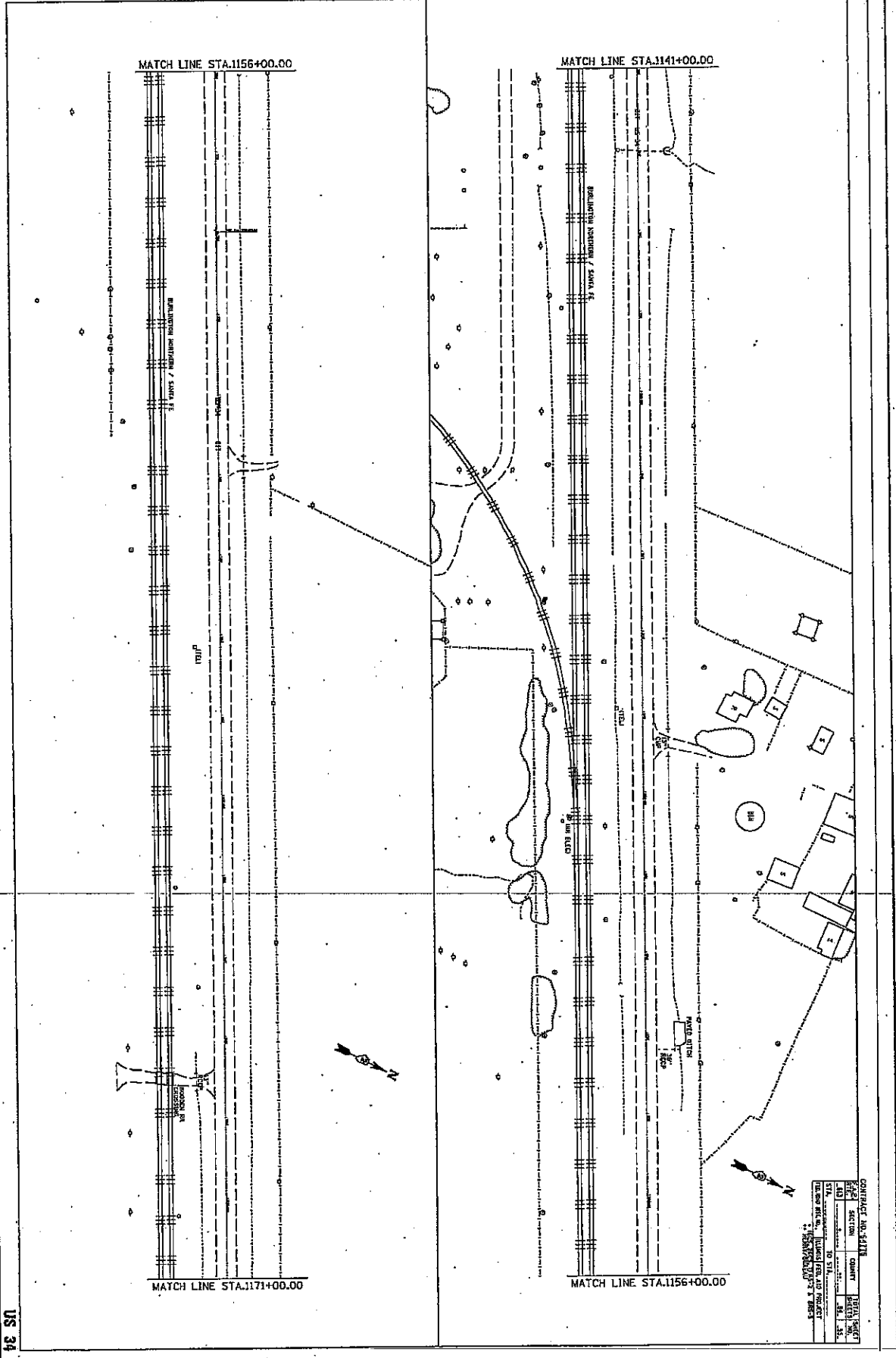

CONTRACT NO. 34178

DATE	SECTION	COUNTY	TOWNSHIP	RANGE
1/10/2005	1141-1171	...	...	...
DRAWN BY: ...				
CHECKED BY: ...				
DATE PLOTTED: 1/10/2005				

US 34

...\\d200502\p00502pin2.dgn 1/10/2005 1:22:16 PM

PLT DATE : Mon Jan 10 10:22:16 2005  
FILE NAME : \\d200502\p00502pin2.dgn  
PLT SCALE : 1:2000  
PLOT DEVICE : HPGL

MATCH LINE STA.1186+00.00

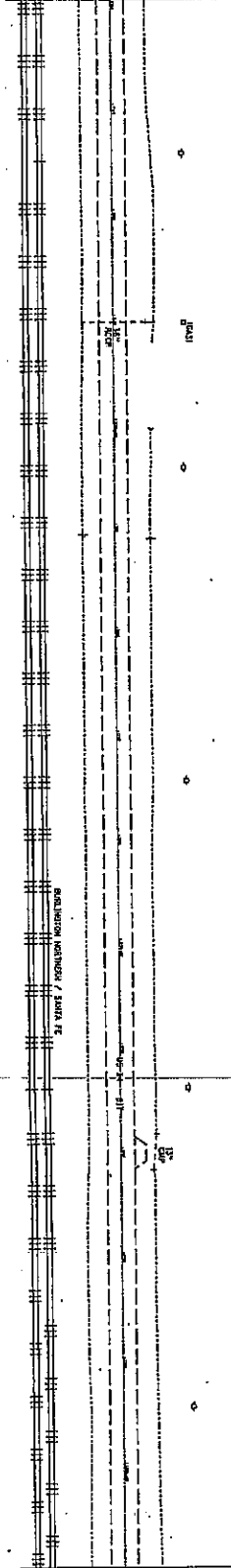

MATCH LINE STA.1201+00.00

MATCH LINE STA.1171+00.00

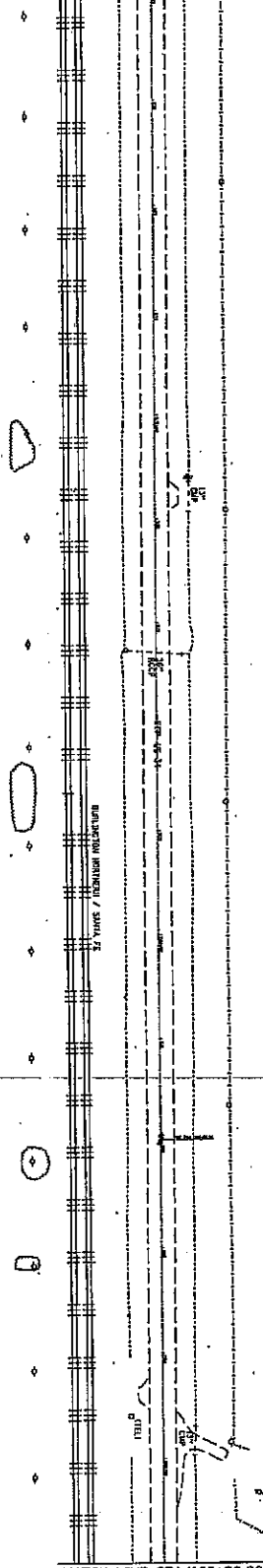

MATCH LINE STA.1186+00.00

CONTRACT NO. 64115		COUNTY		TOWNSHIP	
DATE	SECTION	TO STA.	FROM STA.	NO.	BY
01/10/05		1171+00.00	1186+00.00	18	JK

DESIGNED BY: J. K. JENSEN  
CHECKED BY: J. K. JENSEN  
DATE: 01/10/05

US 34

PLOT DATE: Mon, Jun 18 12:22:20 2005  
 FILE NAME: \\p00502\p00502pin2.dgn  
 PLOT SCALE: 1/8" = 1'-0"  
 PLOT DEVICE: HPGL

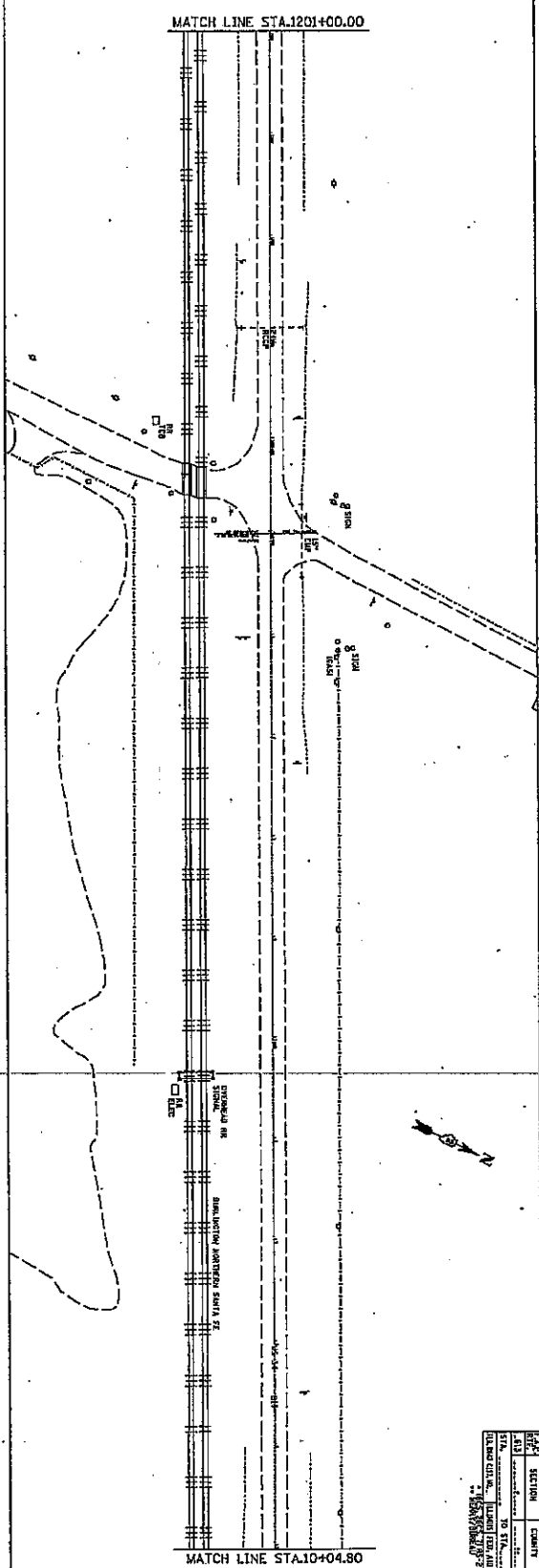

CONTRACT NO. 84715

SECTION	COUNTY	ROUTE	POST MILE
101	...	...	...
STA. 10+04.80	...	...	...
TO STA. 10+04.80	...	...	...
DATE OF THIS PLAN	...	...	...
BY	...	...	...
CHECKED BY	...	...	...
DATE OF THIS PROJECT	...	...	...

US 34

...\\p00502\p00502pin2.dgn 1/10/2005 1:22:20 PM

PLOT DATE = Sun Jun 14 12:22:25 2005  
 FILE NAME = \\snp\proj\1205\1205\1205\1205.dwg  
 PLOT SCALE = 1:10000  
 PLOT DEVICE = HPGL

MATCH LINE STA.15+00.00

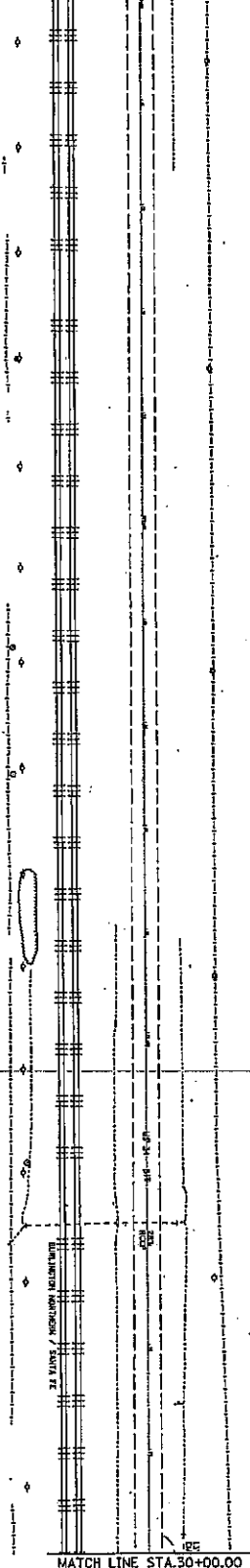

MATCH LINE STA.30+00.00

MATCH LINE STA.1205+95.20

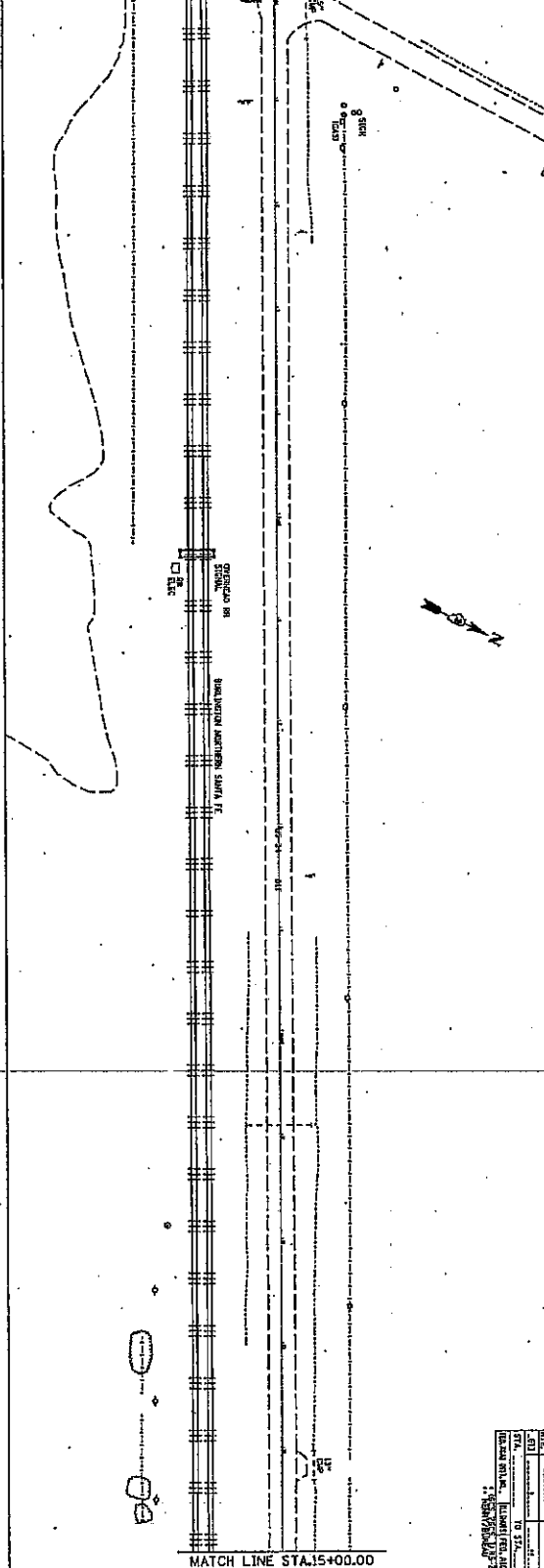

MATCH LINE STA.15+00.00

CONTRACT NO. 64718	
DATE	12/15/04
SECTION	SECTION 1
COUNTY	CLATSOP
TOWN	TO TOWN
PROJECT	BURLINGTON AVENUE PROJECT
DATE	12/15/04
BY	12/15/04

\\d200502\id00502pin2.dgn 1/10/2005 1:22:30 PM

PLOT DATE: 1/10/2005 1:22:30 PM  
 FILE NAME: \\d200502\id00502pin2.dgn  
 PLOT SCALE: 1/8" = 1'-0"  
 PLOT DEVICE: HPGL

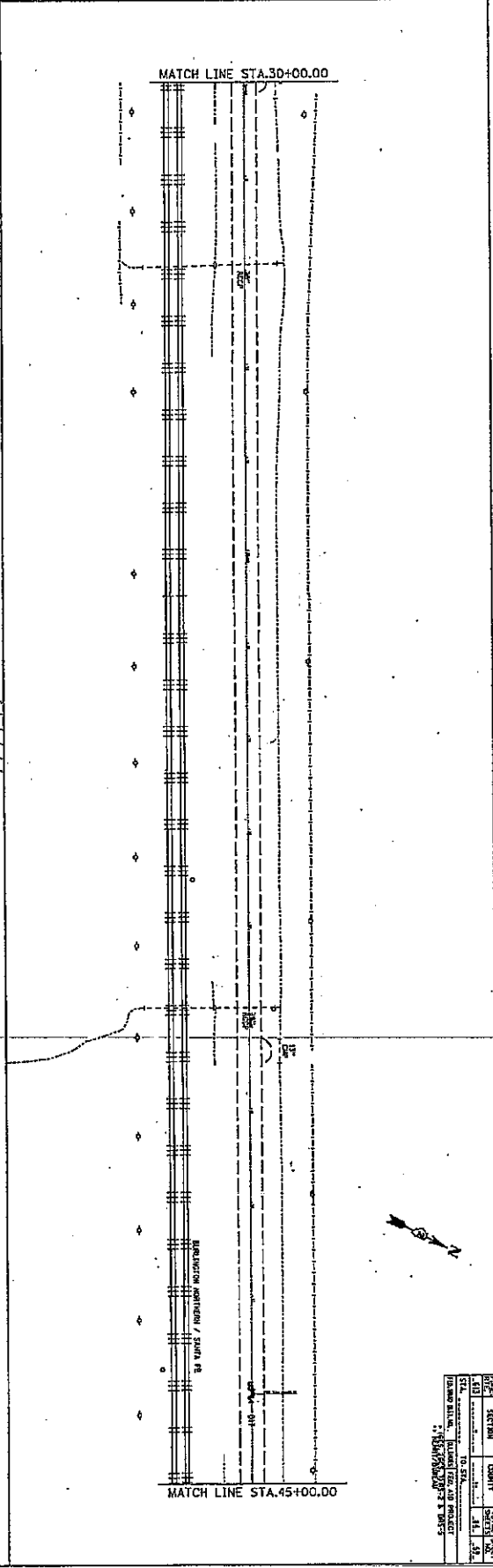
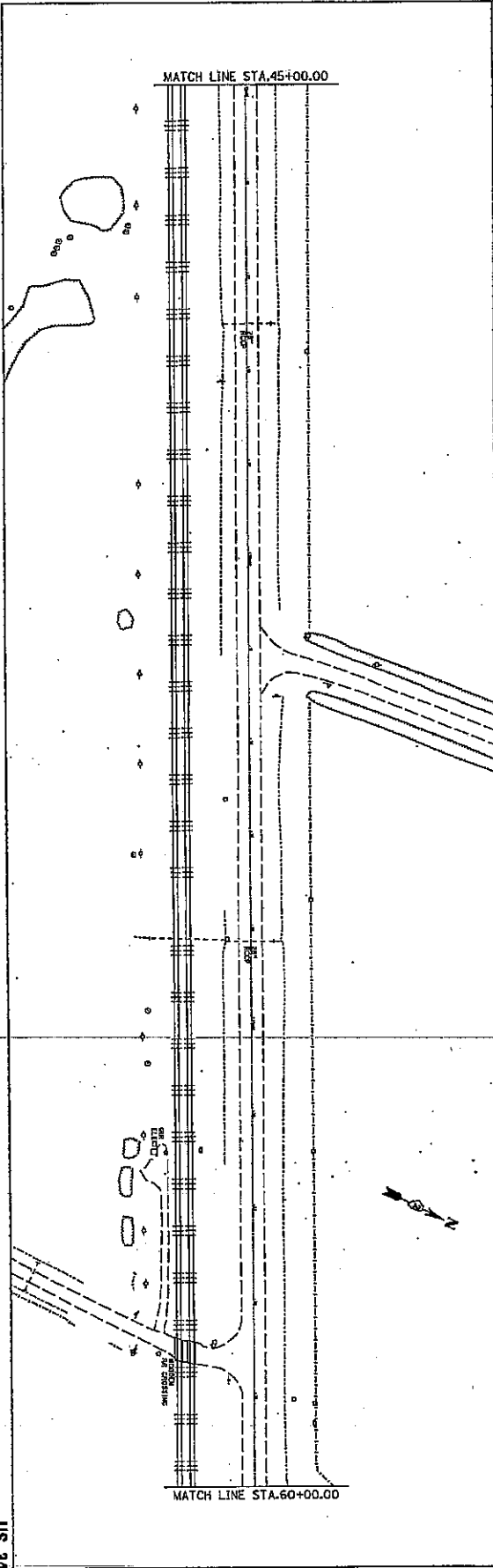

CONTRACT NO. 6112

SECTION	DATE	BY	CHKD.
SECTION	DATE	BY	CHKD.
SECTION	DATE	BY	CHKD.

DESIGNED BY: [Name]  
 DRAWN BY: [Name]  
 CHECKED BY: [Name]  
 APPROVED BY: [Name]

US 34

PLOT DATE: 1/10/2005 1:22:35 PM  
 PLOT SCALE: 1/8" = 1'-0"  
 PLOT SIZE: 11.0" x 17.0"  
 PLOT DEVICE: HPGL

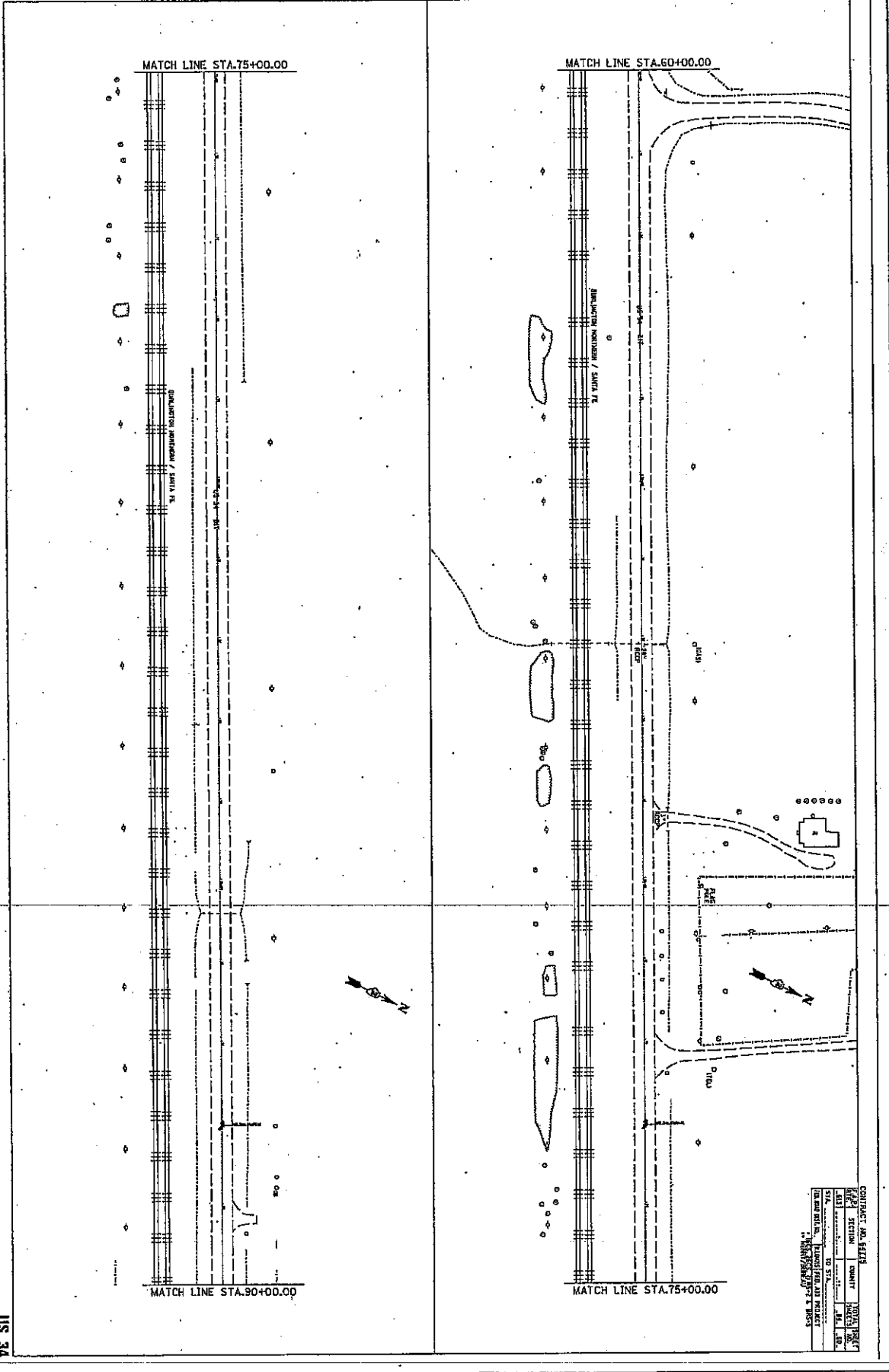

CONTRACT NO. 0415		SHEET NO. 34	
DATE	SECTION	OWNER	PROJECT
1/10/2005	1	STATE OF TEXAS	HOUSTON AIRPORT
BY	DATE	BY	DATE
...	...	...	...

...\\d200502\d00502pln2.dgn 1/10/2005 1:22:39 PM

PLT DATE = Sun Jan 16 13:25:11 2005  
FILE NAME = ...\\d200502\d00502pln2.dgn  
PLT SCALE = 1:10000  
REFERENCE = W079

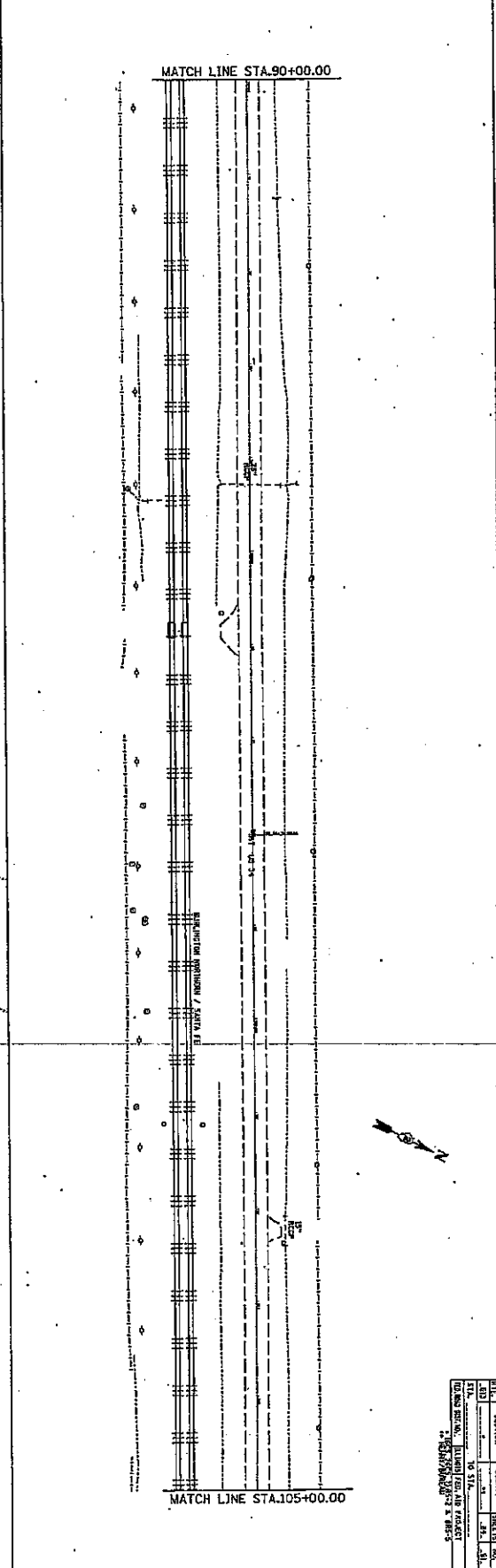
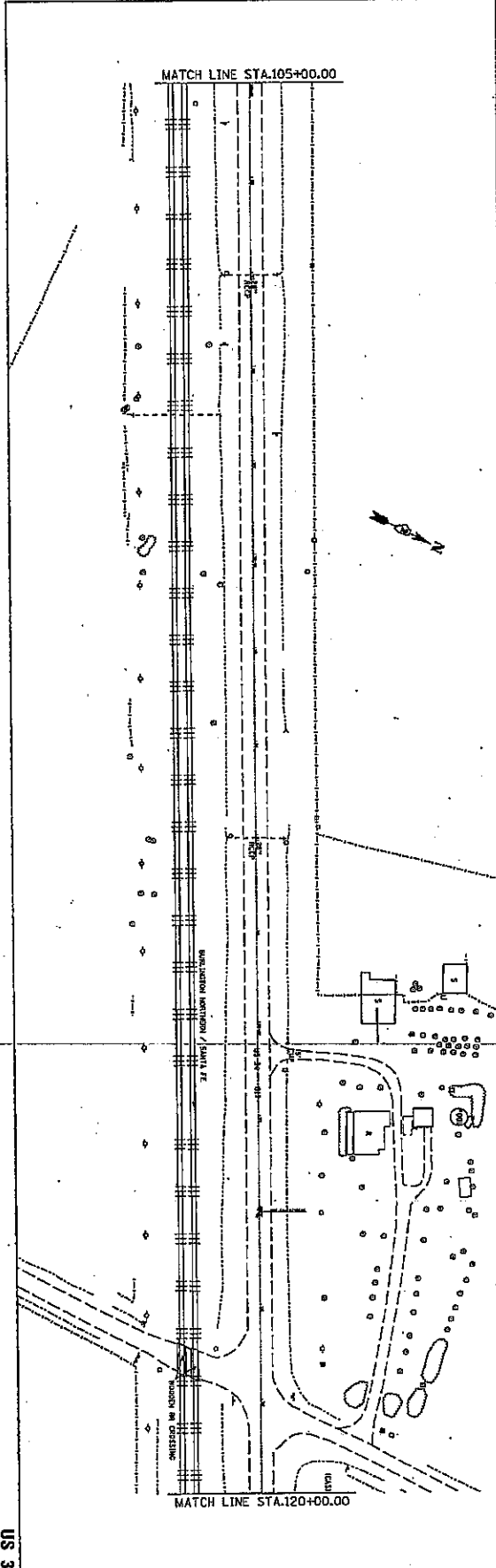

CONTRACT NO. 84118			
SECTION	COUNTY	ROUTE	POST-MILE
105+00.00 TO 120+00.00	...	...	...
DRAWN BY: ...			
CHECKED BY: ...			
DATE: ...			

US 34



PLT DATE = Nov 20 11 52:45 2003  
FILE NAME = ..\\id00502\id00502pin2.dgn  
PLT SCALE = 1/8"=1'-0"  
REFERENCE = SHEET

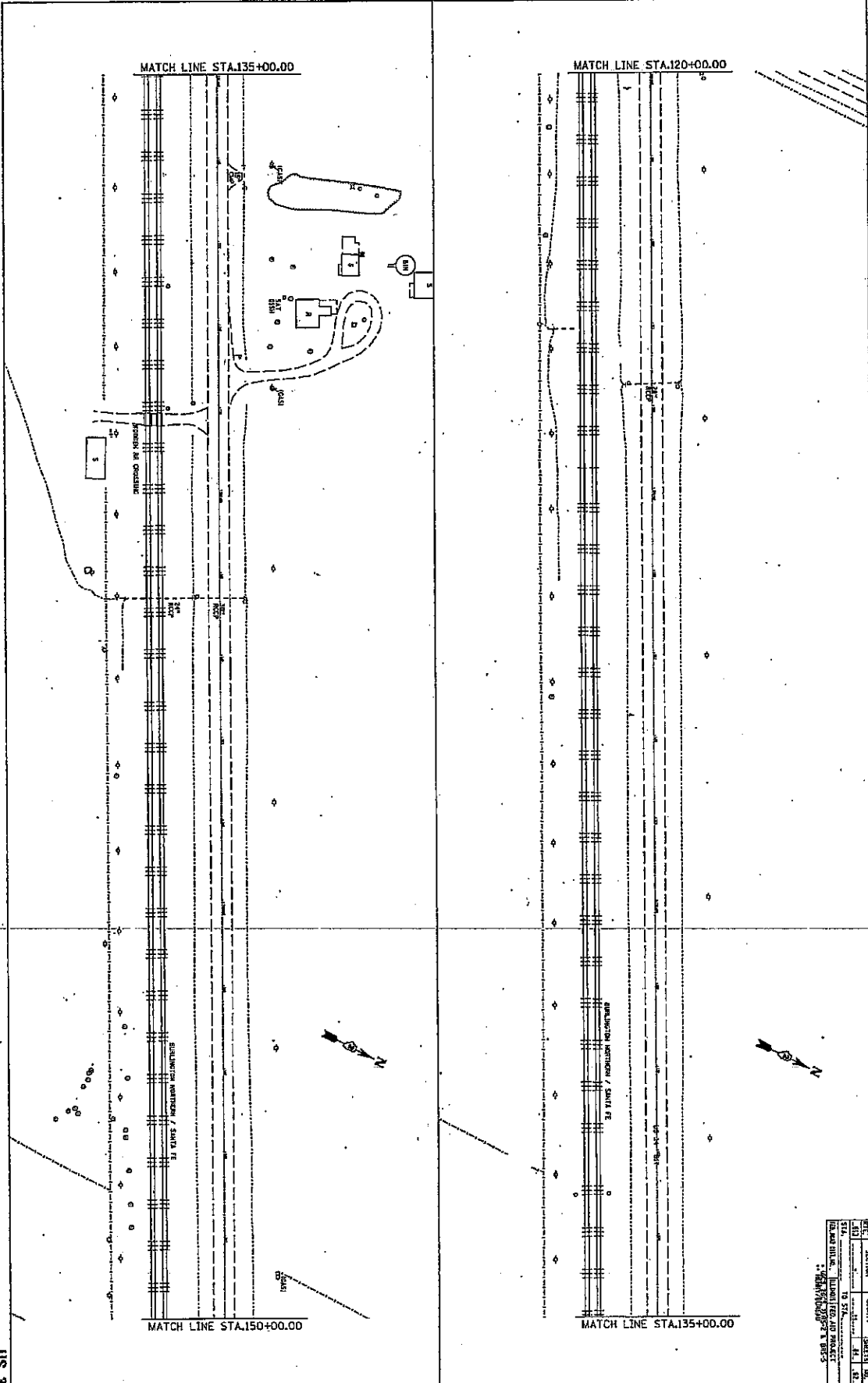

CONTRACT NO. 87115			
SECTION	COUNTY	SHEET NO.	TOTAL SHEETS
120	1	1	1
SANTA FE COUNTY, NEW MEXICO			
SANTA FE COUNTY, NEW MEXICO			
SANTA FE COUNTY, NEW MEXICO			

...\\d200502\id00502\p1n2.dgn 1/10/2005 1:22:50 PM

PLOT DATE: 1/10/2005 1:22:50 PM  
FILE NAME: \\d200502\id00502\p1n2.dgn  
PLOT SCALE: 1/8" = 1'-0"  
PLOT DEVICE: HPGL

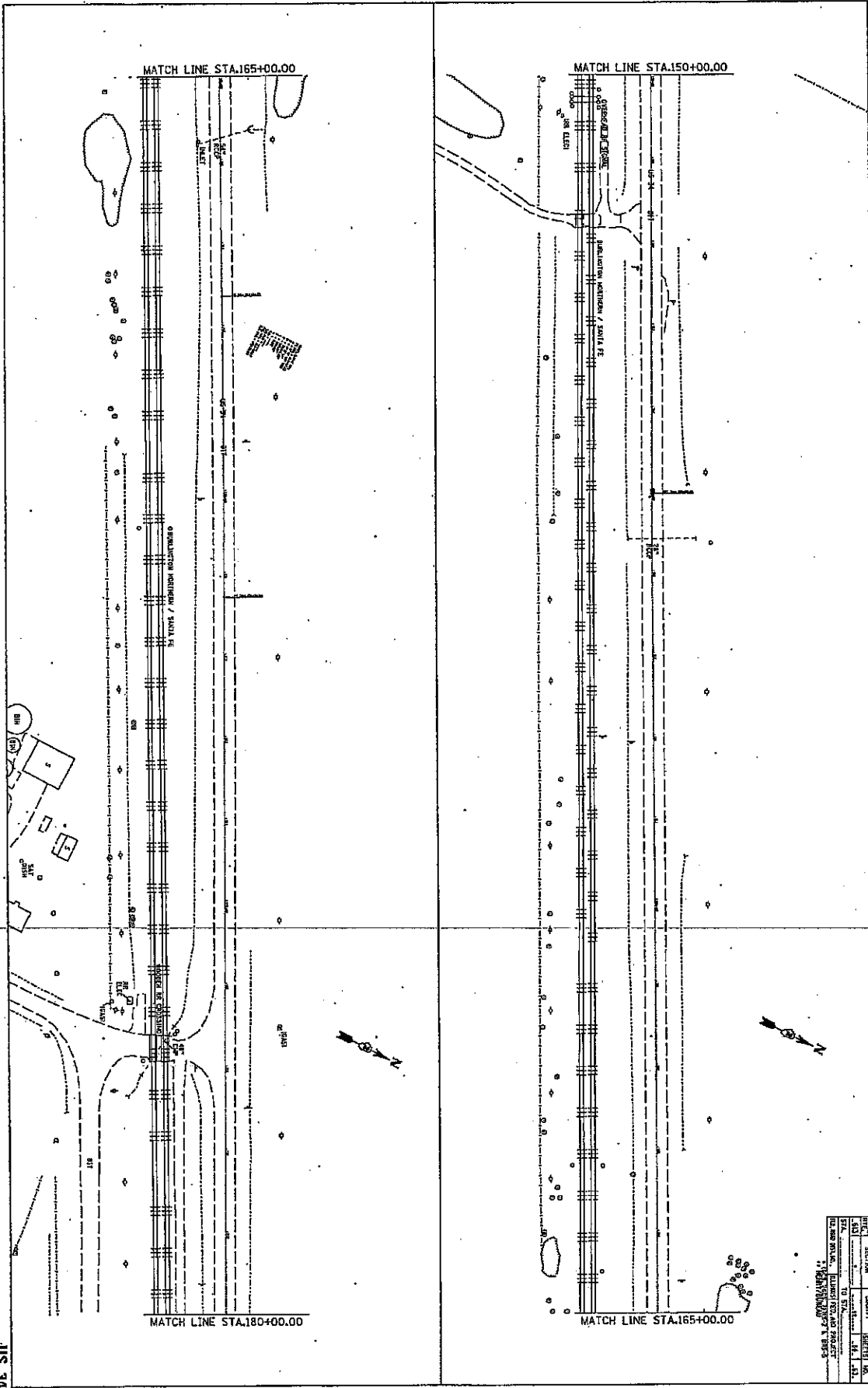

PROJECT NO. 04715		CONTRACT NO.	
SECTION	DATE	SCALE	BY
1/10/2005	1/10/2005	1/8" = 1'-0"	JL
DRAWN BY: JL			
CHECKED BY: JL			
DATE: 1/10/2005			
PROJECT: 04715			
DRAWING: 1/10/2005			

US 34

...:\d200502a600502pin2.dgn 1/10/2005 1:25:51 PM

PLT DATE: 1/10/2005 1:25:51 PM  
FILE NAME: ...:\d200502a600502pin2.dgn  
PLOT SCALE: 1/8" = 1'-0"  
REFERENCE: ...

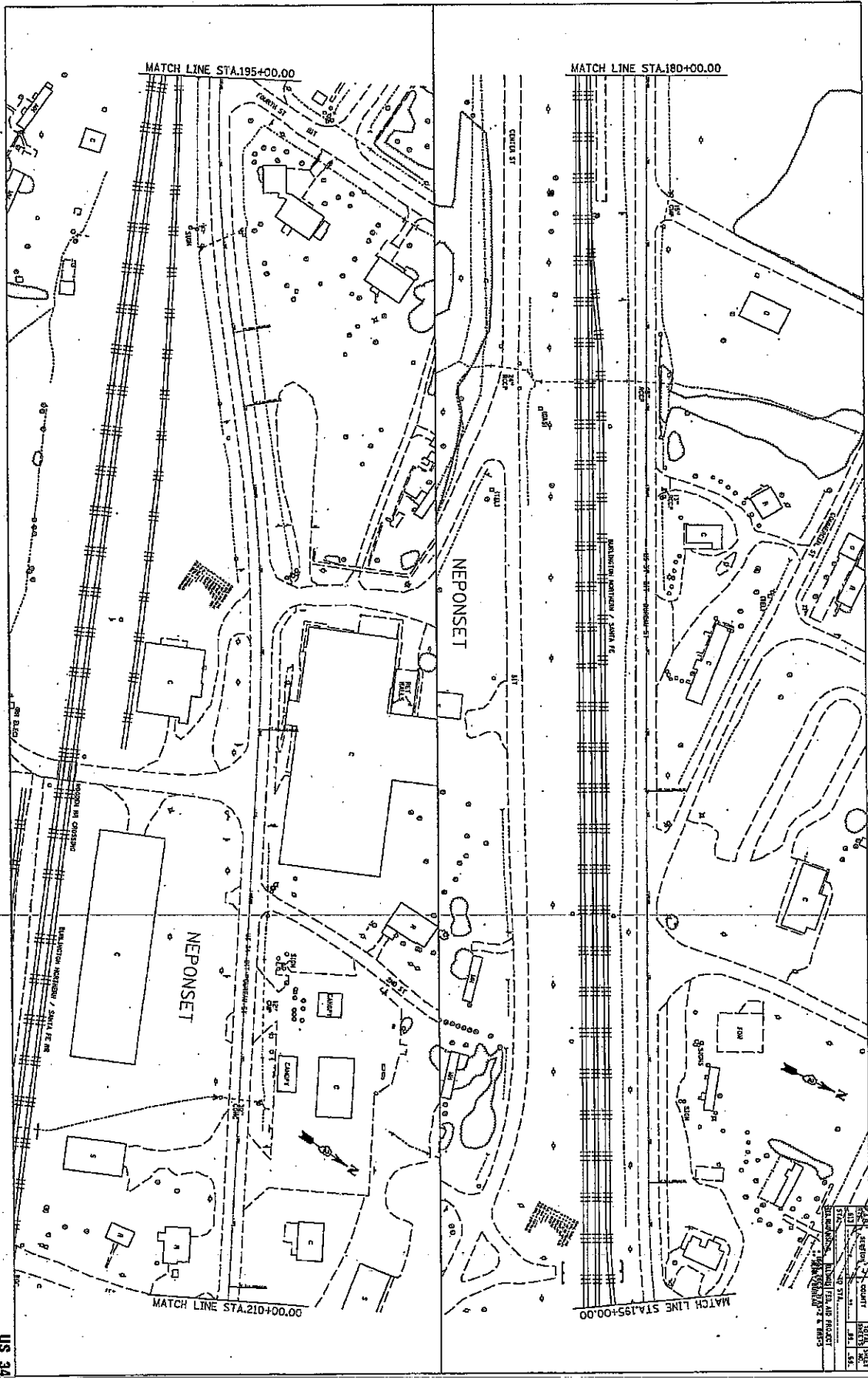

CONTRACT NO. 44113

DATE	DESCRIPTION	BY
1/10/2005	ISSUED FOR PERMITS	JL
1/10/2005	ISSUED FOR PERMITS	JL
1/10/2005	ISSUED FOR PERMITS	JL
1/10/2005	ISSUED FOR PERMITS	JL

1. PLAN, PROFILE, AND ELEVATION  
2. GENERAL NOTES  
3. SPECIFICATIONS

US 3A

PLOT DATE: \* Mon Jun 08 13:26:35 2005  
 FILE NAME: \* s:\m\p\2005\200502\200502.dwg  
 PLOT SCALE: \* 1/8" = 1' @  
 REFERENCE: \* NCP

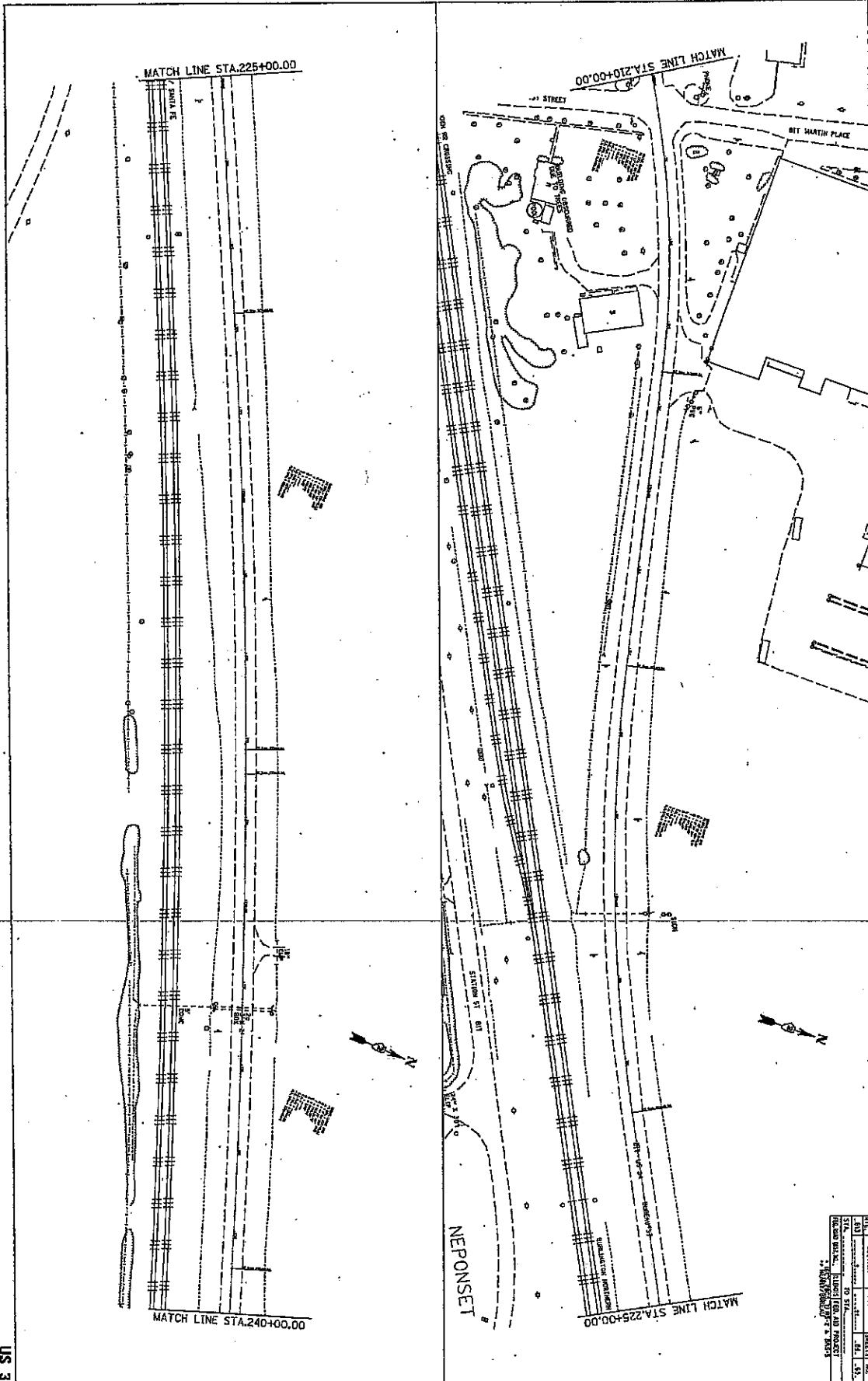

CONTRACT NO. 5413

DATE	SECTION	COUNTY	TOWN	SHEET
STA. 225+00.00	TO STA. 240+00.00	ESSEX	NEPONSET	34

DRAWN BY: [Name]  
 CHECKED BY: [Name]  
 DATE: 6/8/05

..\\d200502\200502\p1n2.dgn 1/10/2005 1:22:59 PM

...ld200502\ld00502pln2.dgn 1/10/2005 1:23:06 PM

PLT DATE: 1/10/2005 1:23:06 PM  
FILE NAME: ...ld200502\ld00502pln2.dgn  
PLOT SCALE: 1/8"=1'-0"  
NO. SHEETS: 1 OF 1

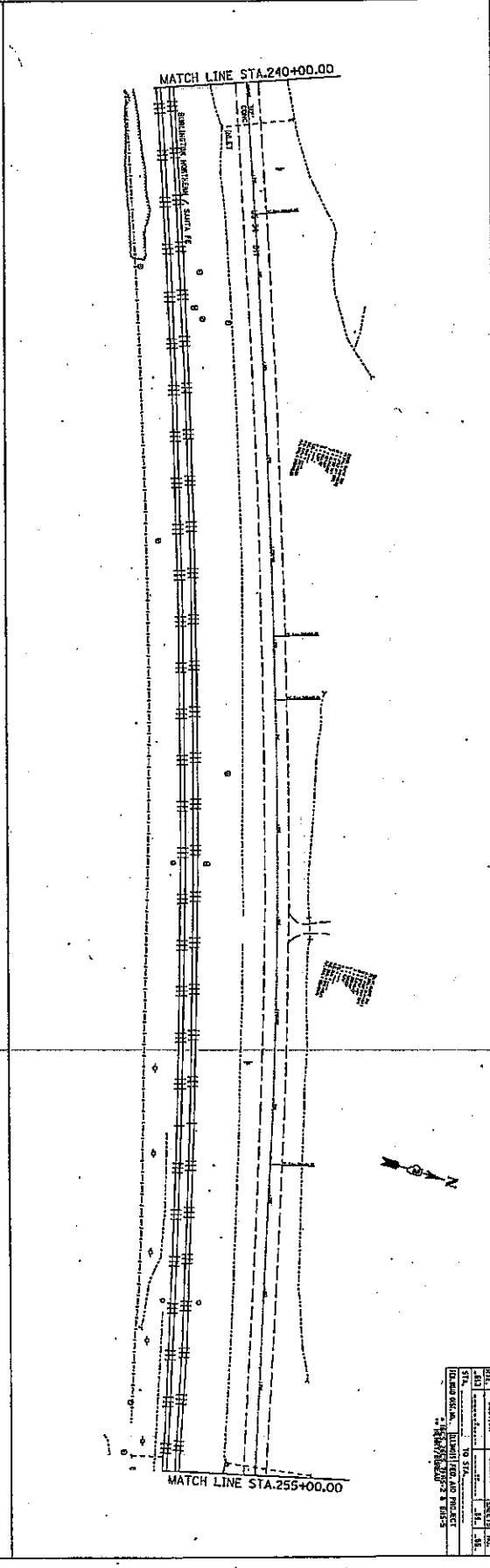
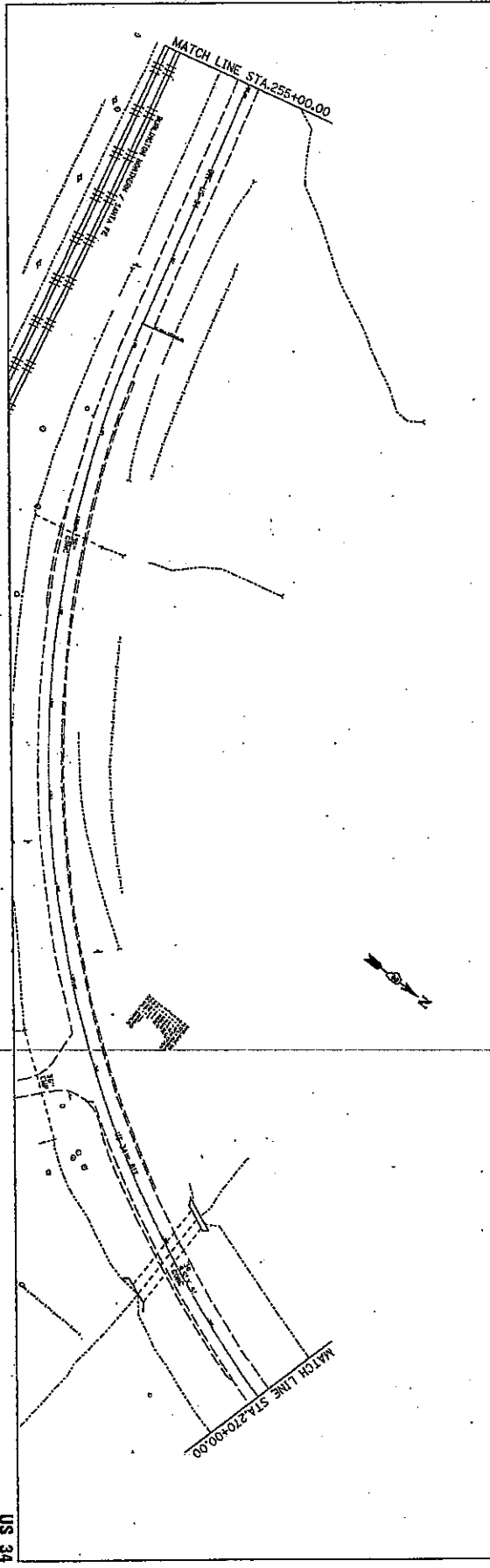

CONTRACT NO. 5412			
SECTION	SECTION	SECTION	SECTION
1	2	3	4
STA.	TO STA.	PROJECT	PROJECT
255+00.00	285+00.00	US 34	US 34

US 34

...\\d200502ad00502pin2.dgn 1/10/2005 1:23:13 PM

PLT DATE = Nov 26 10 12:34 2005  
PLT FILE = C:\PROGRA~1\BENTLEY\BIN\PLT\PLT2005.dgn  
PLT SCALE = 1/8" = 1' 0"  
REFERENCE = VERT

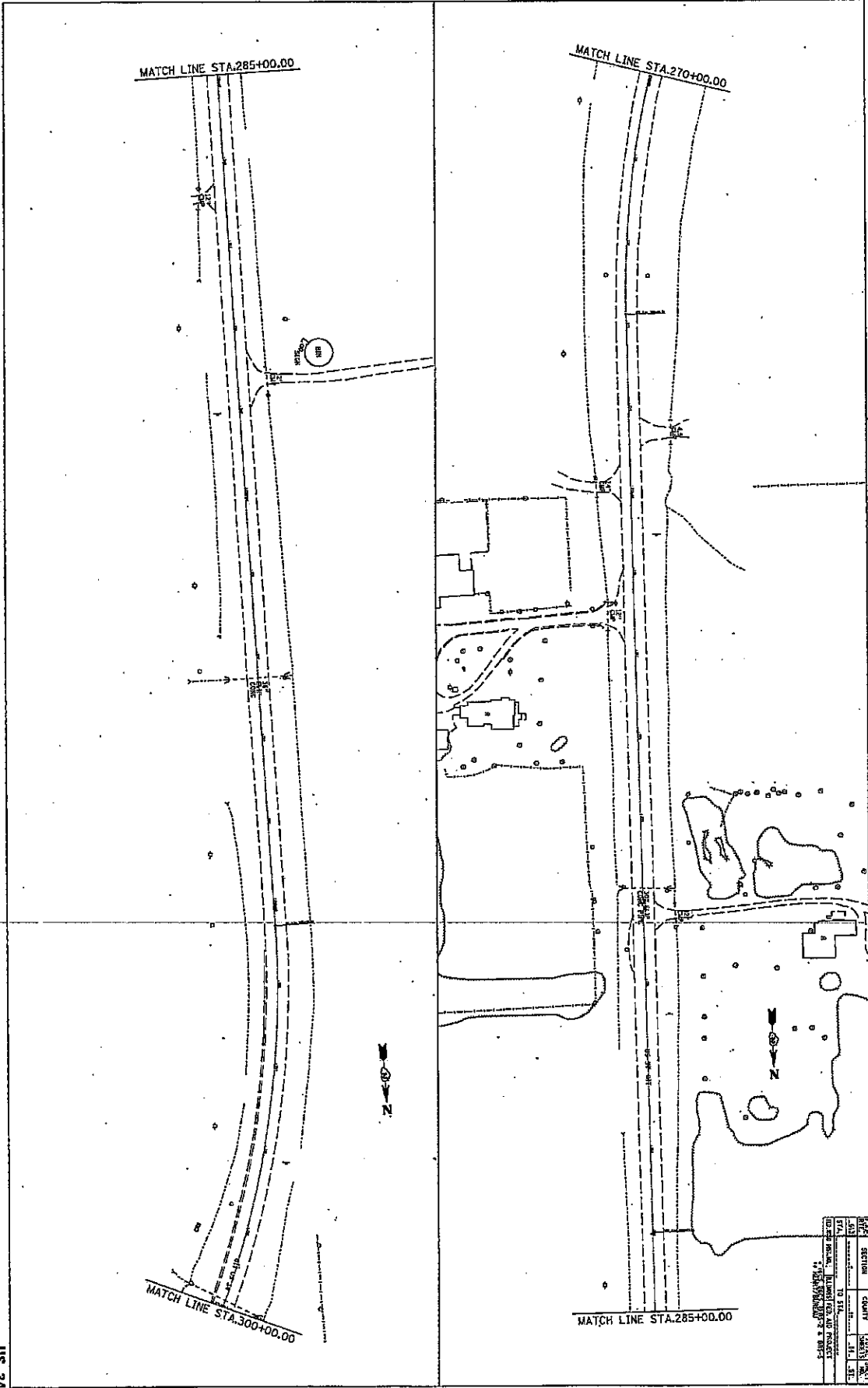

CONTRACT NO. 54113

DATE	SECTION	COUNTY	TOWN	SCALE
STA.				
TO STA.				
BY				
FOR				

DESIGNED BY: [Name]  
CHECKED BY: [Name]  
DATE: [Date]

US 34

PLT 011 - Plan 2005 12 23 18 2005  
 FILE NAME - \\snp\proj\2005\12\23\18\2005.dwg  
 PLOT SCALE = 1/8"=1'-0"  
 PLOT DATE = 1/10/2005

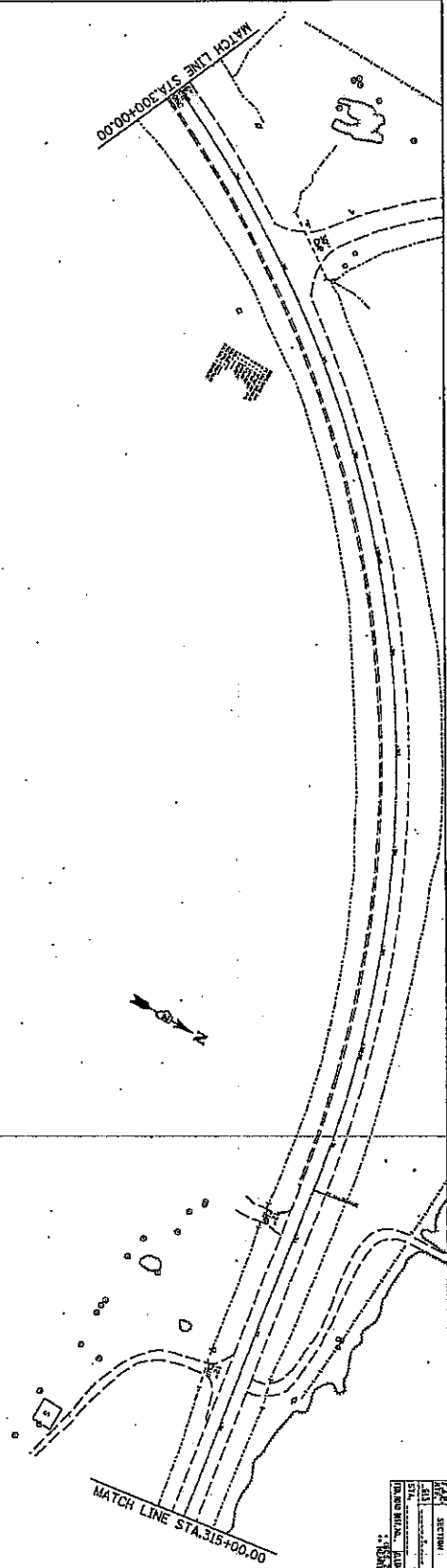
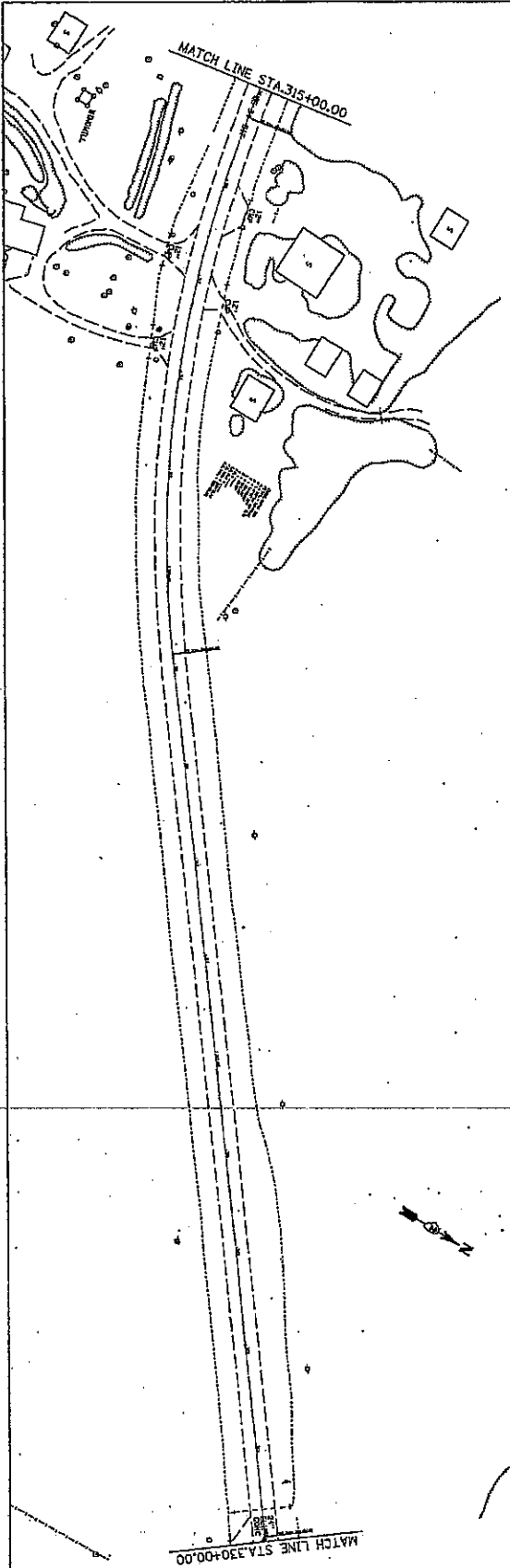

CONTRACT NO. 4418

DATE	SECTION	COUNTY	SHEET NO.
1/10/2005	1	US 34	1

ROAD NO. 4418  
 PROJECT NO. 4418  
 SHEET 1 OF 1

US 34

...\\d200502\ad00502pin2.dgn 1/10/2005 1:23:18 PM

...\\d200602\ad00502pin2.dgn 1/10/2005 1:23:25 PM

PLOT DATE = Mon Jun 18 12:22:21 2005  
FILE NAME = \\d200602\ad00502pin2.dgn  
PLOT SCALE = 1:1000  
PLOT DEVICE = HPGL

US 34

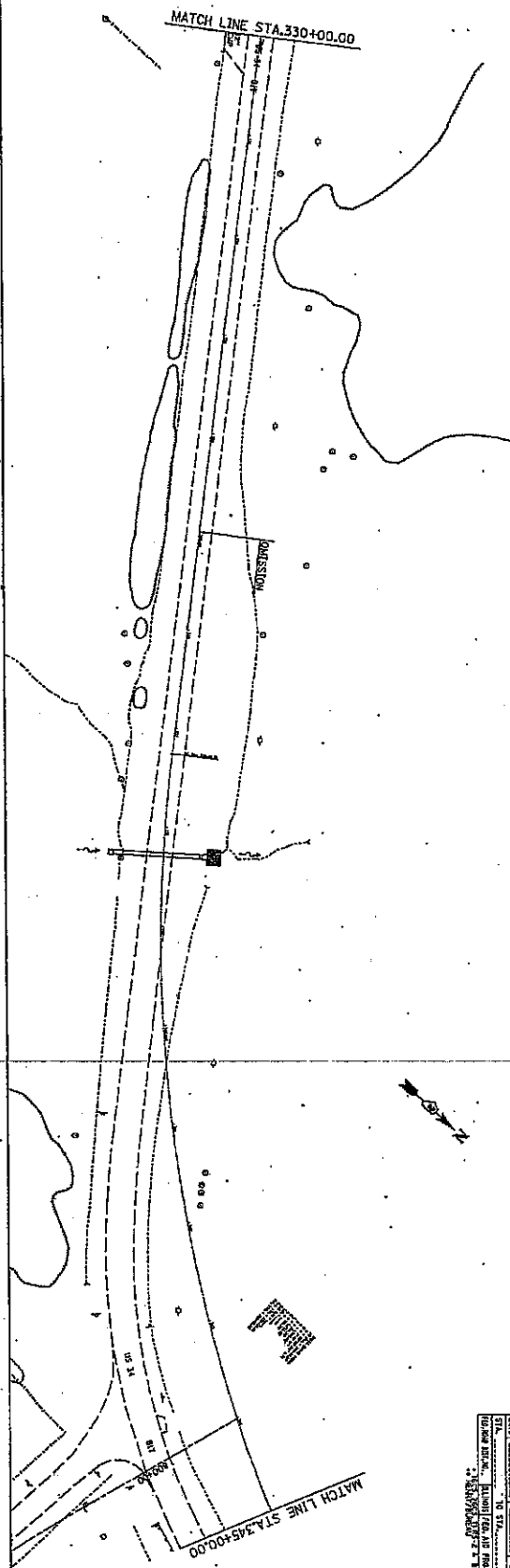

CONTRACT NO. 4412			
SECTION	COUNTY	LENGTH	DATE
101	101	1.00	10/10/05
102	102	1.00	10/10/05
103	103	1.00	10/10/05
104	104	1.00	10/10/05
105	105	1.00	10/10/05
106	106	1.00	10/10/05
107	107	1.00	10/10/05
108	108	1.00	10/10/05
109	109	1.00	10/10/05
110	110	1.00	10/10/05
111	111	1.00	10/10/05
112	112	1.00	10/10/05
113	113	1.00	10/10/05
114	114	1.00	10/10/05
115	115	1.00	10/10/05
116	116	1.00	10/10/05
117	117	1.00	10/10/05
118	118	1.00	10/10/05
119	119	1.00	10/10/05
120	120	1.00	10/10/05



NOTE: THE CONTRACTOR SHALL BE RESPONSIBLE TO  
 DETERMINE THE EXISTING UTILITIES AND  
 CONDITIONS AT THE CONSTRUCTION SITE AND  
 VERIFY THE ACCURACY OF THE INFORMATION  
 CONTAINED ON THIS PLAN. THE CONTRACTOR SHALL BE  
 RESPONSIBLE FOR OBTAINING ALL NECESSARY  
 PERMITS AND TO OBTAIN ALL NECESSARY  
 UTILITY CROSSING PERMITS AND TO OBTAIN ALL  
 NECESSARY INFORMATION REGARDING THE  
 CONDITIONS OF THE EXISTING UTILITIES AND THEIR  
 DEPTHS.

# MANHOLE SPECIAL PLAN VIEW

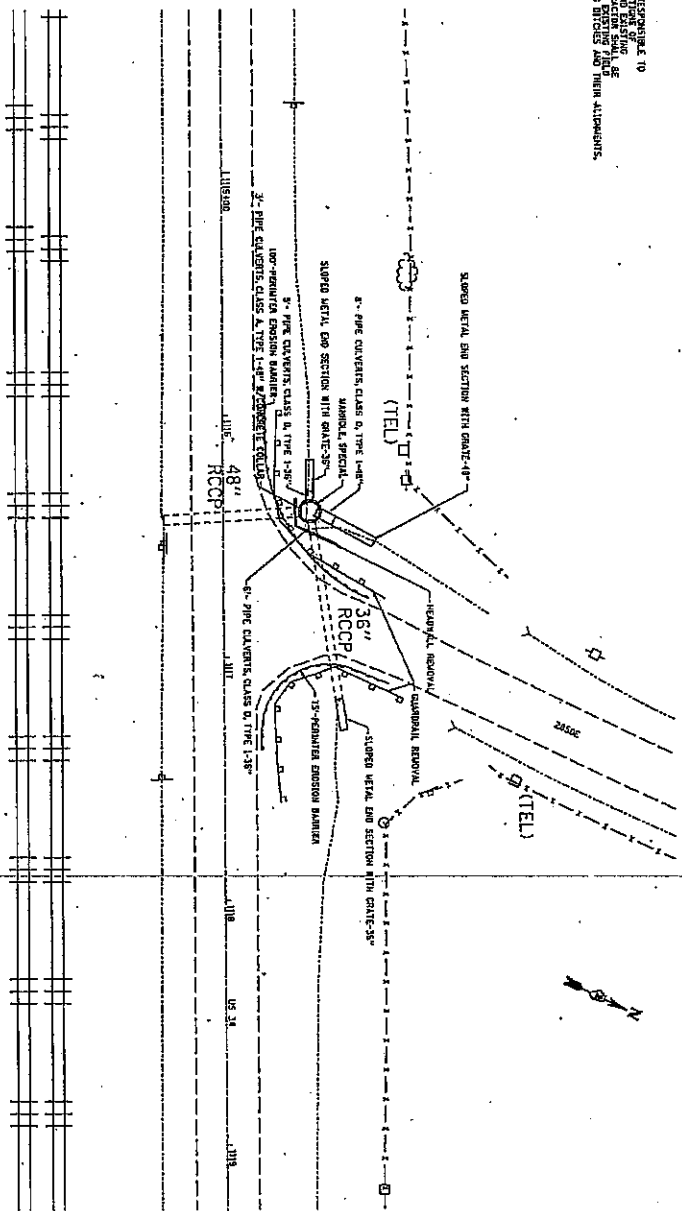

NOTED: See item 10 of SPEC. 2015  
 FILE NO. 2015-10-10-10-10-10  
 DATE 12/11/10  
 BY 1010/2005  
 1010/2005

CONTRACT NO. 6182			
DATE	SECTION	COUNTY	DISTRICT
12/11/10	1010/2005	1010	1010
DRAWN BY: JENNIFER L. HARTZ CHECKED BY: JENNIFER L. HARTZ IN CHARGE: JENNIFER L. HARTZ			

REVISIONS	
NO.	DATE
DRAWN BY: JENNIFER L. HARTZ	
CHECKED BY: JENNIFER L. HARTZ	
IN CHARGE: JENNIFER L. HARTZ	

GENERAL NOTES

THE MANHOLES, SPECIAL SHALL BE CONSTRUCTED ACCORDING TO SECTION 602 OF THE STANDARD SPECIFICATION AND AS SPECIFIED HEREIN.

THE MANHOLES, SPECIAL SHALL BE PAID FOR AT THE CONTRACT UNIT PRICE PER EACH MANHOLE, SPECIAL, WHICH PRICE SHALL INCLUDE ALL FRAMES, LIDS, CLASS SI CONCRETE, REINFORCEMENT BARS, SAND CUSHION, FLAT SLAB TOPS AND ALL EXCAVATION AND BACKFILLING.

\*THE CONTRACTOR SHALL USE AN INVERTED PIPE CULVERT CLASS A, TYPE 1, 96" TO CONSTRUCT THE MANHOLES, SPECIAL.

\*THE BOTTOM SLAB SHALL BE REINFORCED WITH A MINIMUM OF 0.46 SQ IN/FT IN BOTH DIRECTIONS.

\*THE TOP SLAB SHALL BE CONSTRUCTED OF CLASS SI CONCRETE WITH A MINIMUM OF 1.495 SQ IN/FT OF REINFORCEMENT.

\*LIFTING DEVICES SHALL BE APPROVED BY THE ENGINEER.

\*CONCRETE COLLAR FOR PIPE EXTENSION SHALL BE INCLUDED IN THE CONTRACT UNIT PRICE FOR CULVERT CLASS A, TYPE 1 - 48"

MANHOLES, SPECIAL

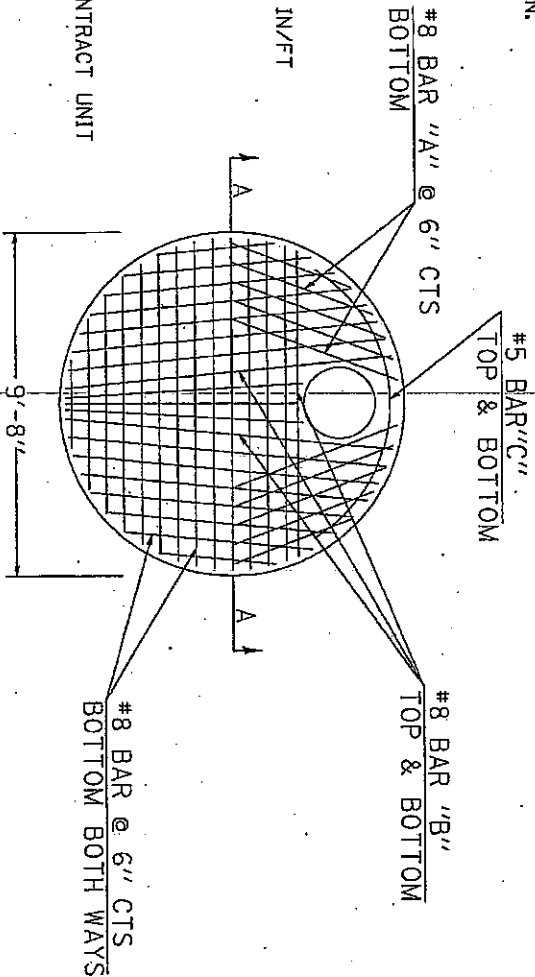

PLAN

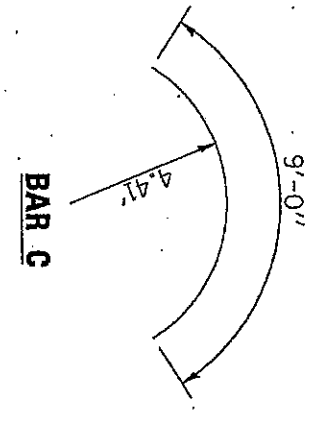

BAR C

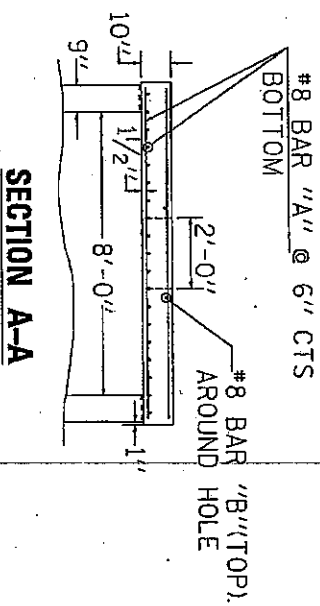

SECTION A-A

CONTRACT NO. 6473			
SECTION	COUNT	SHEET NO.	TOTAL SHEETS
MANHOLE, SPECIAL	1	11	11
TOTAL	1	11	11

REVISIONS		DATE	BY	CHECKED BY	SCALE	DATE
NO.	DESCRIPTION					

ILLINOIS DEPARTMENT OF TRANSPORTATION  
 DRAWN BY: \_\_\_\_\_  
 CHECKED BY: \_\_\_\_\_

CONTRACT NO. 4473

NO.	SECTION	DATE	BY	CHECKED	APPROVED
1	1				
2	2				
3	3				
4	4				
5	5				

SCALE: VERT. 1" = 4'-0"  
HORIZ. AS SHOWN

DATE: \_\_\_\_\_

DESIGNED BY: \_\_\_\_\_

DRAWN BY: \_\_\_\_\_

# MANHOLES, SPECIAL

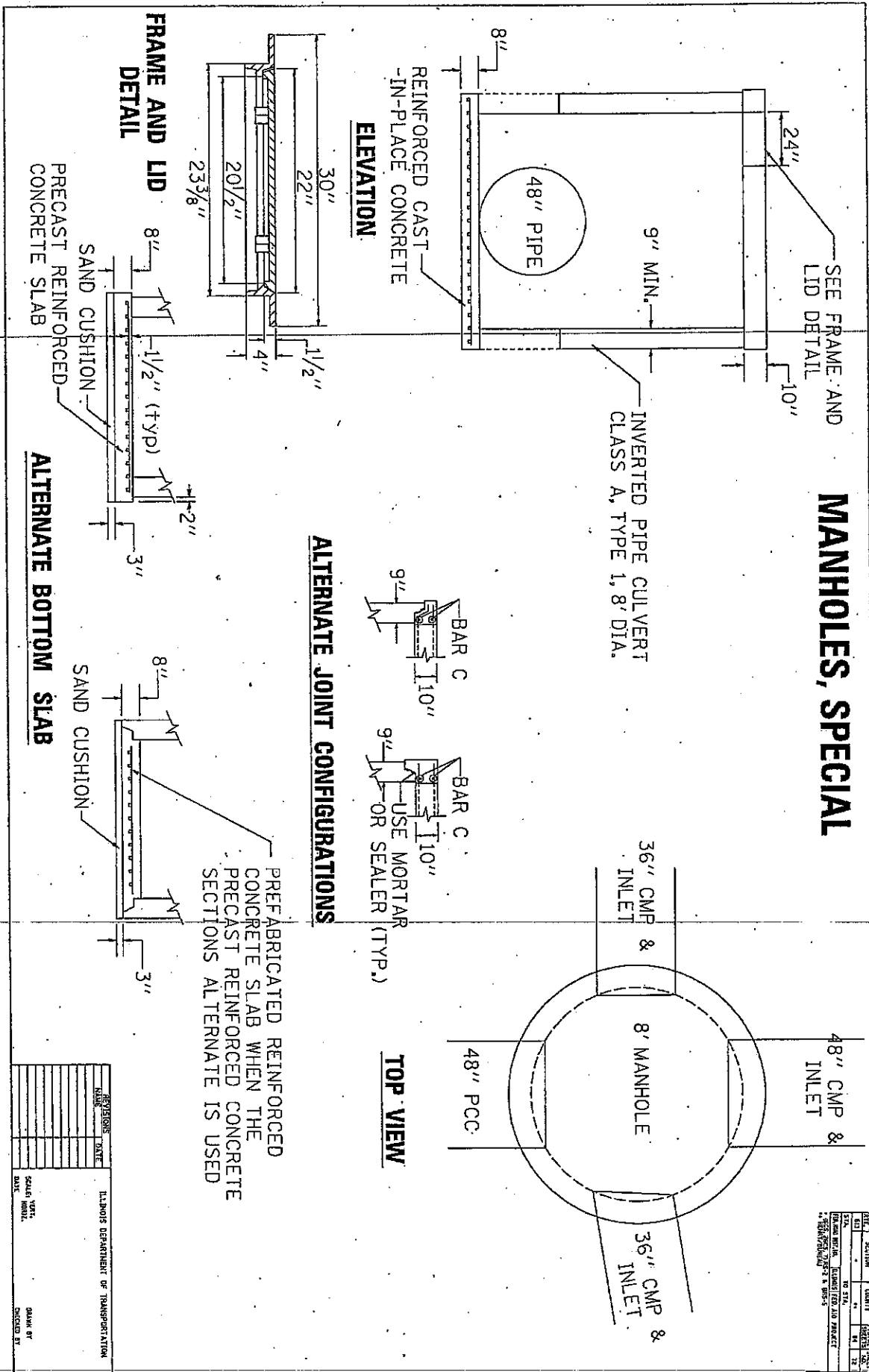

PLG DATE: 11/19/2004  
 DESIGNED BY: [Signature]  
 DRAWN BY: [Signature]  
 CHECKED BY: [Signature]

# CATCH BASIN OR INLETS TO BE ADJUSTED OR RECONSTRUCTED (DETAILS FOR CURB & GUTTER REPLACEMENT)

CONCRETE CURB AND GUTTER SHALL BE CONSTRUCTED IN ACCORDANCE WITH SECTION 606 OF THE STANDARD SPECIFICATIONS, SUPPLEMENTAL SPECIFICATIONS, STANDARD 606001 AND THIS DRAWING.

CLASS SI CONCRETE SHALL BE USED THROUGHOUT. A HOLE 40 (1 1/2) IN DIAMETER AND 225(9) DEEP SHALL BE DRILLED IN THE EXISTING CONCRETE CURB AS SHOWN. A 32x450(1 1/4 X 18) SMOOTH DOWEL BAR SHALL BE GROUTED IN THE HOLE LONGITUDINALLY.

JOINTS OF A TYPE SIMILAR TO THAT IN THE UNDERLYING PAVEMENT (EXPANSION OR CONTRACTION) SHALL BE INSTALLED IN THE CONCRETE CURB IN ALIGNMENT WITH THE JOINTS IN THE PAVEMENT.

THE PROPOSED CONFIGURATION OF THE CURB AND GUTTER SHALL MATCH THAT REMOVED.

THE LOCATION OF THE DOWEL BAR SHALL BE DETERMINED BY THE ENGINEER.

ALL EXISTING TIE BARS IN EDGE OF PAVEMENT SLAB THRU REPLACEMENT AREA SHALL BE CUT OFF.

THE WORK SHALL BE DONE IN ACCORDANCE WITH SECTION 602 OF THE STANDARD SPECIFICATIONS AND INCLUDES THE REMOVAL AND REPLACEMENT OF SOD, CONCRETE PAVEMENT AND/OR CURB AND GUTTER ADJACENT TO CATCH BASINS OR INLETS TO BE ADJUSTED OR RECONSTRUCTED AND SHALL BE INCLUDED IN THE PAY ITEM OF CATCH BASINS OR INLETS TO BE ADJUSTED OR RECONSTRUCTED AS SPECIFIED.

ALL DIMENSIONS ARE IN MILLIMETERS (INCHES) UNLESS OTHERWISE NOTED.

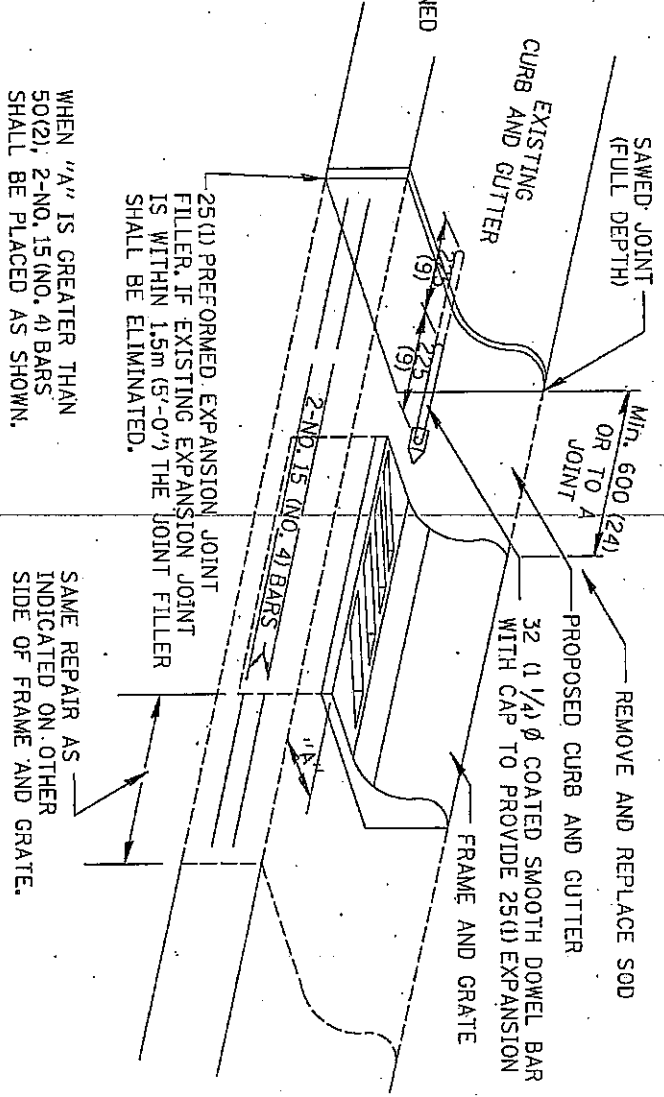

CONTRACT NO. 64115			
NO.	SECTION	QUANTITY	UNIT PRICE
603			
TOTAL AMOUNT ESTIMATED BY PROJECT			
* 11/10/2005			

REVISED 5-4-94 17.4A

# BITUMINOUS SHOULDER

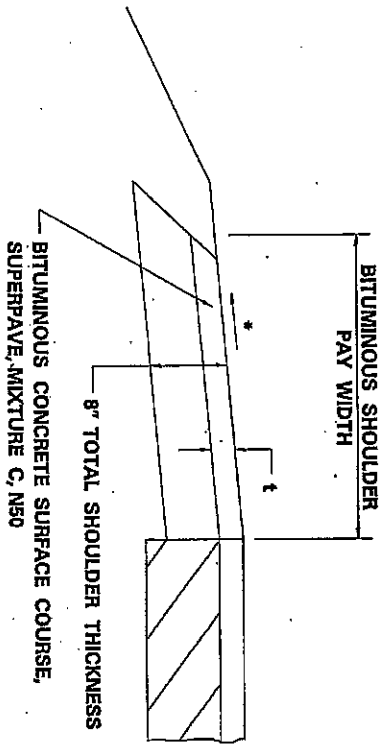

ALL DIMENSIONS ARE IN INCHES (MILLIMETERS)  
UNLESS OTHERWISE NOTED.

t = SEE TYPICAL SECTIONS  
FOR THICKNESS

## GENERAL NOTES

THE BITUMINOUS SHOULDER SHALL BE CONSTRUCTED IN ACCORDANCE WITH SECTION 482 EXCEPT THE TOP LIFT SHALL BE BITUMINOUS CONCRETE SURFACE COURSE, SUPERPAVE MIXTURE C, NSO. THE WORK WILL BE PAID FOR AT THE CONTRACT UNIT PRICE PER TON FOR BITUMINOUS CONCRETE SURFACE COURSE, SUPERPAVE MIXTURE C, NSO, AND SQUARE YARD FOR BITUMINOUS SHOULDERS SUPERPAVE OF THE THICKNESS SPECIFIED.

USE BITUMINOUS CONCRETE SURFACE COURSE, SUPERPAVE MIXTURE C, NSO, WHEN RESURFACING EXISTING BITUMINOUS SHOULDERS. THE THICKNESS IS SHOWN ON THE TYPICAL SECTIONS. THIS WORK WILL BE PAID FOR AT THE CONTRACT UNIT PRICE PER TON FOR BITUMINOUS CONCRETE SURFACE COURSE, SUPERPAVE MIXTURE C, NSO.

REMOVAL OF MATERIAL FOR PLACEMENT OF THE BITUMINOUS SHOULDER TO BE PAID FOR IN UNITS FOR EXCAVATING AND GRADING EXISTING SHOULDERS OR FOR EARTH EXCAVATION OR EARTH EXCAVATION WIDENING.

\* 4% WHEN MAINLINE IS ON TANGENT, FOR CROSS SLOPE ON SUPERELEVATION SECTION, SEE HIGHWAY STANDARD 482001 OR 482006.

CONTRACT NO. 4475

REV.	SECTION	DATE	BY	CHK.
1		10/11/05		

DESIGNED BY: J. M. HARRIS  
CHECKED BY: J. M. HARRIS  
DATE: 10/11/05

REV.	DATE	BY	CHK.

ILLINOIS DEPARTMENT OF TRANSPORTATION

DESIGN BY: J. M. HARRIS  
CHECKED BY: J. M. HARRIS  
DATE: 10/11/05

REV. 5-30-03 23.40

# PAVEMENT PATCHING FOR BITUMINOUS SURFACED PAVEMENT

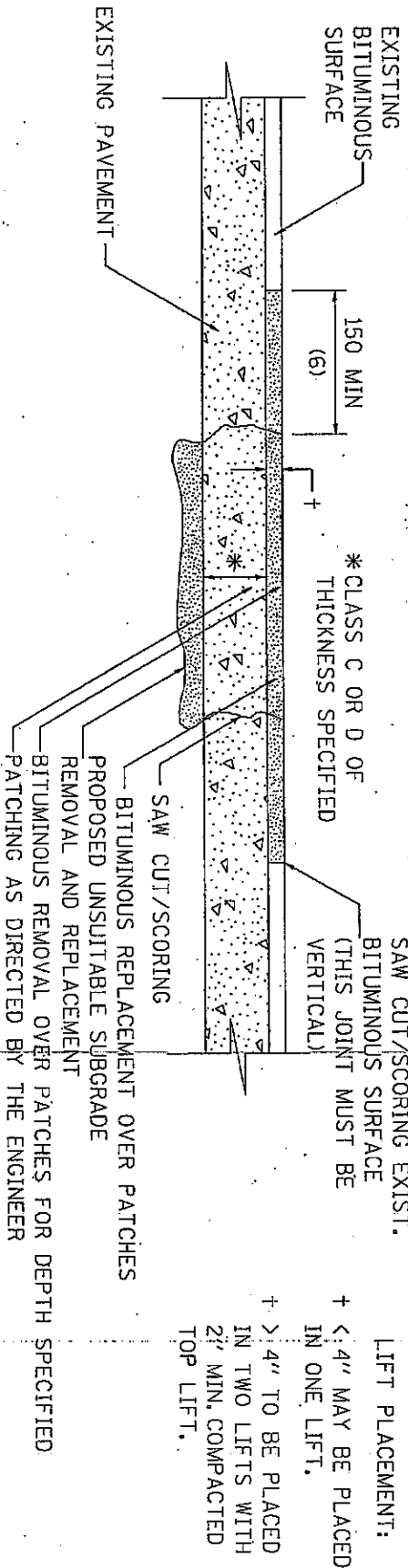

**SEQUENCE OF CONSTRUCTION:**

1. REMOVE THE EXISTING BITUMINOUS SURFACE.
2. RESIDENT ENGINEER WILL DETERMINE IF LOCATION IS TO BE PATCHED OR TO ONLY REPLACE BITUMINOUS SURFACE.
3. REMOVE AND REPLACE FULL DEPTH PATCHES AT LOCATIONS DIRECTED BY THE ENGINEER.
4. REPLACE BITUMINOUS SURFACE OVER FULL DEPTH PATCHES AND AT LOCATIONS OF BITUMINOUS SURFACE REMOVAL.

**GENERAL NOTES:**

1. THE WIDTH OF THE FULL DEPTH PATCH OVER A TRENCH SHALL BE 300 (12) WIDER ON EACH SIDE OF THE TRENCH.
2. FOR BASIS OF PAYMENT: SEE SPECIAL PROVISION "PATCHING WITH BITUMINOUS OVERLAY REMOVAL".

ALL DIMENSIONS ARE IN MILLIMETERS (INCHES) UNLESS OTHERWISE NOTED

CONTRACT NO. 64175		100% PAID	
DATE	SECTION	CONTRACT	DATE

DESIGNED BY: LUDWIG PERNO PROJECT  
\* REVISIONS: 2 & 3, 6/24/01

REVISIONS		ILLUSTRATION DEPARTMENT OF TRANSPORTATION	
NO.	DATE	SCALE	DATE

Scale: VERT. 1" = 4' HORIZ. 1" = 40'  
DATE: 6-21-01  
PROJECT NO. 32.4

# SUBGRADE REPLACEMENT

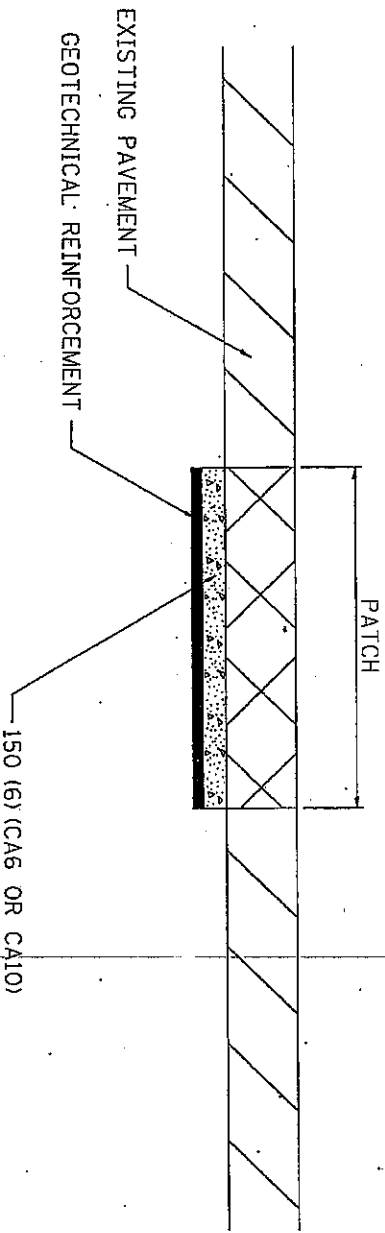

**NOTES:**

The Engineer will determine which patches will require Subgrade Replacement, generally when the  $Q_u$  of the Subgrade  $< 0.3TSF$  or if patch density is questionable. UNSTABLE SUBGRADE MATERIAL SHALL BE REMOVED AND DISPOSED OF BY THE CONTRACTOR.

This work will be paid for at the contract unit price per  $m^3$  (CU. YD.) for GRANULAR SUBGRADE REPLACEMENT and per  $m^2$  (SQ. YD.) for GEOTECHNICAL REINFORCEMENT.

ALL DIMENSIONS ARE IN MILLIMETERS (INCHES) UNLESS OTHERWISE NOTED.

**CONTRACT NO. 4473**

SECTION	DATE	BY	FOR

DATE: 1/10/2005  
 TIME: 1:53:56 PM

**ALABAMA DEPARTMENT OF TRANSPORTATION**

NO.	DATE	BY	FOR

SCALE: VERT. 1" = 8' HORIZ. 1" = 40'

DATE: 1/10/2005  
 TIME: 1:53:56 PM

...projects\200502\00502s.dgn 1/10/2005 1:54:09 PM

PLOT DATE: 4 Nov 2005 10:54:09 AM  
 FILE NAME: c:\projects\200502\00502s.dgn  
 PLOT SCALE: 1:1000  
 REFERENCE: 1:1000

## EROSION CONTROL DETAILS FOR SILT FENCE

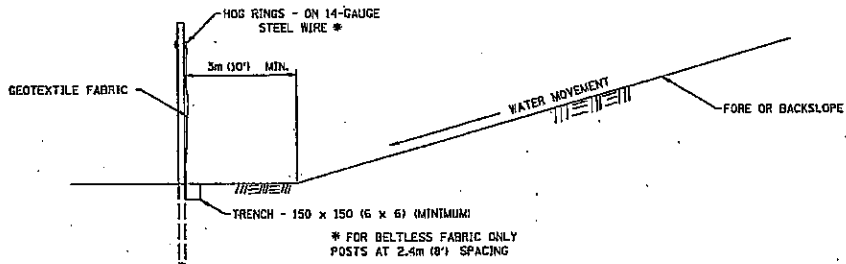
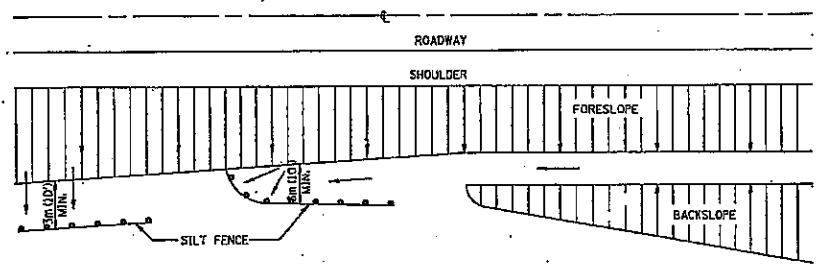

DETAILS OF SILT FENCE

REVISED 10-22-01

29.2

CONTRACT NO. 04115		SHEET NO.	
DATE	SECTION	COUNTY	LENGTH
05/11/05	TO STA.	MI.	FT.
STA.	TO STA.	MI.	FT.
DRAINAGE DISTRICT PROJECT			
* SEE PLAN SHEET FOR DETAILS			



...:\projects\200502\200502std.dgn 1/10/2005 1:54:26 PM

PLT DATE: 1/10/2005  
 FILE NAME: 200502std.dgn  
 PLOT SCALE: 1/8" = 1'-0"  
 PLOT DEVICE: HP-GL/2

## BITUMINOUS APPROACHES & MAILBOX RETURNS FOR SINGLE LIFT (SMART) RESURFACING PROJECTS

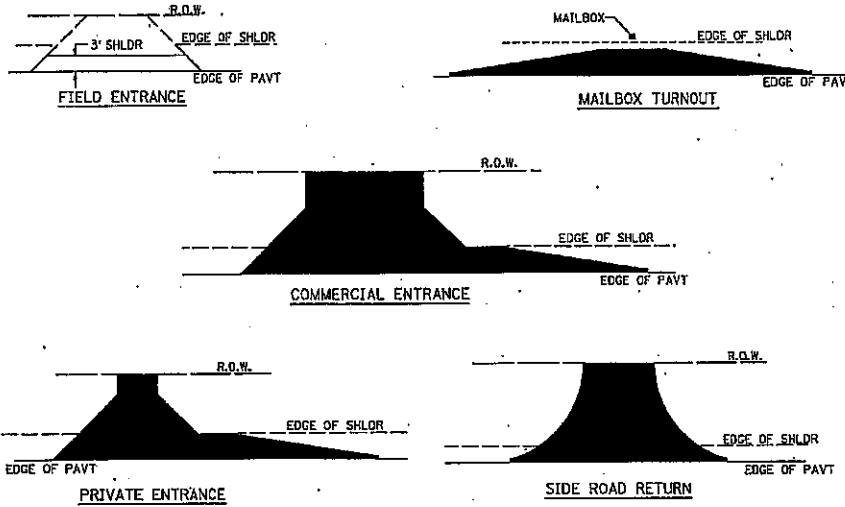

**NOTE:** EXISTING BIT PE's, CE's, SR's, & MB TURNOUTS  
 Place 1/2" Incidental Bituminous Surfacing on entrance to conform to the existing configuration.

EXISTING AGG. PE's & CE's  
 Place 2" Incidental Bituminous Surfacing on existing entrance to conform to the present configuration.

EXISTING AGG. SIDEROADS  
 Place 3" Incidental Bituminous Surfacing on sideroad to conform to the present configuration.

EXISTING AGG. MAILBOX TURNOUTS  
 Existing Agg. Mailbox Turnouts shall be constructed as shown below.

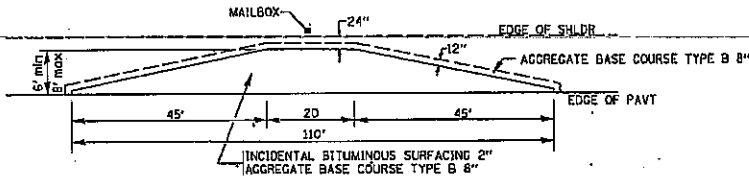

	6'	8'
AGG BASE CSE T-B (TON)	24.5	31.1
INC BIT SURF 2" (TON)	5.8	7.8
BIT PRIME COAT (TON)	0.06	0.08

REVISED 12-19-02

REVISIONS	DATE	BY	REASON

ILLINOIS DEPARTMENT OF TRANSPORTATION

SCALE: VERT. 1" = 10'

DATE: 1/10/2005

ISSUED BY: [Signature]

46.2

CONTRACT NO. 0378  
 SHEET NO. 46.2  
 TOTAL SHEETS 46  
 DATE: 1/10/2005  
 BY: [Signature]  
 CHECKED BY: [Signature]  
 APPROVED BY: [Signature]

...projects\id200502\id00502std.dgn 1/10/2005 1:54:34 PM

PLT DATE = Nov 10 10 15:54:34 2005  
FILE NAME = I:\projects\id200502\id00502std.dgn  
PLT SCALE = 1/8"=1'-0"  
REFERENCE = SHEET 7 OF 7

# BITUMINOUS APPROACHES & MAILBOX RETURNS FOR TWO LIFT (3P) RESURFACING PROJECTS

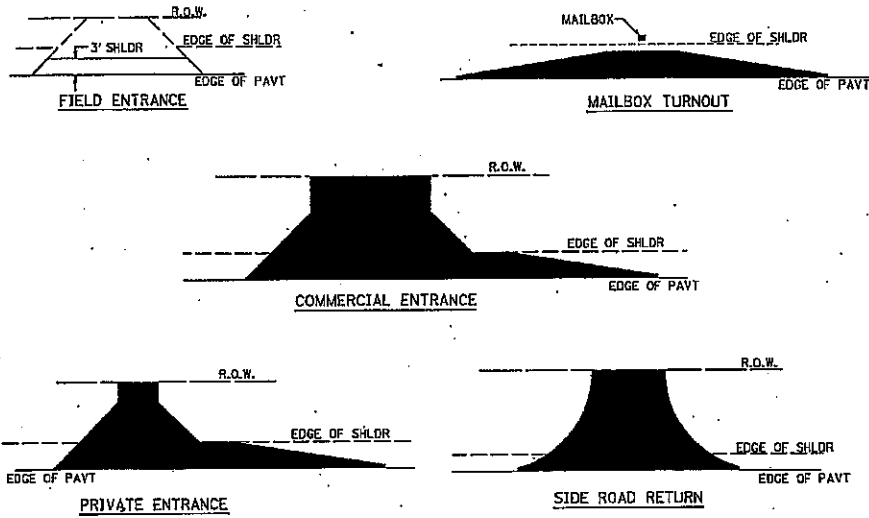

**NOTE:** EXISTING BIT PE's, CE's, SR's, & MB TURNOUTS  
Place 2<sup>3</sup>/<sub>4</sub>" Incidental Bituminous Surfacing on entrance to conform to the existing configuration.

EXISTING AGG. PE's & CE's  
Place 2" Incidental Bituminous Surfacing on existing entrance to conform to the present configuration.

EXISTING AGG. SIDEROADS  
Place 3" Incidental Bituminous Surfacing on sideroad to conform to the present configuration.

EXISTING AGG. MAILBOX TURNOUTS  
Existing Agg. Mailbox Turnouts shall be constructed as shown below.

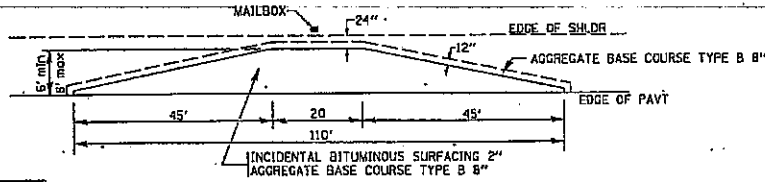

	6'	8'
AGG BASE CSE T-B (TON)	24.5	31.1
INC BIT SURF 2" (TON)	5.8	7.8
BIT PRIME COAT (TON)	0.06	0.08

REVISED 12-19-02 47.2

NO.	DATE	BY	REVISIONS	DATE

SCALE: VERT. 1/4"=1'-0" HORIZ. 1"=20'-0"

DRAWN BY: [REDACTED]  
CHECKED BY: [REDACTED]

ILLINOIS DEPARTMENT OF TRANSPORTATION

CONTRACT NO. 0472E  
SHEET NO. 1  
SECTION 1  
CANT  
RIDGE

PLT FILE - Plot File M:1346432.DWG  
 FILE NAME - M:\Projects\id200502\id00502sfd.dwg  
 PLOT SCALE - 1:1  
 REFERENCE - 0001

## ROUGH GROOVED SURFACE SIGN

ILLINOIS STANDARD W8-II07

SIGN PANEL TYPE 1

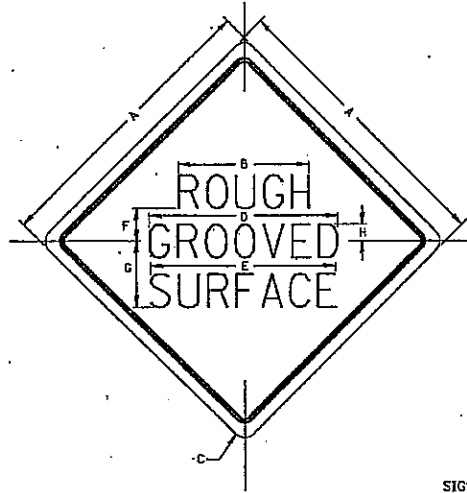

COLOR: LEGEND AND BORDER - BLACK NON-REFLECTIVE  
 BACKGROUND - ORANGE REFLECTORIZED.

SIGN SIZE	DIMENSIONS							
	A	B	C	D	E	F	G	H
1200x1200 (48x48)	1200 (48.0)	800 (24.1)	75 (3.0)	850 (34.0)	825 (33.0)	150 (6.0)	325 (13.0)	88 (3.5)

SIGN SIZE	SERIES			MARGIN	BORDER	BLANK STD.
	LINES					
	1	2	3			
1200x1200 (48x48)	7C	7C	7C	20 (0.8)	30 (1.2)	B4-48D

ALL DIMENSIONS IN INCHES.

### GENERAL NOTES

SIGN PANELS AND FACE MATERIALS SHALL BE ACCORDING TO SECTION 720 OF THE STANDARD SPECIFICATIONS. METAL POSTS SHALL BE IN ACCORDANCE WITH STD. 720011.

ALL MOUNTING HARDWARE SHALL BE ALUMINUM, STAINLESS STEEL, ZINC OR CADMIUM PLATED STEEL AND SHALL BE INCIDENTAL TO THE COST OF THE INSTALLATION.

ALL DIMENSIONS ARE IN MILLIMETERS (INCHES) UNLESS OTHERWISE NOTED.

REVISIONS 1-27-00

NO.	DATE	BY	REVISIONS
1			
2			
3			

DESIGNED BY	ILLINOIS DEPARTMENT OF TRANSPORTATION
CHECKED BY	
DRAWN BY	
SCALE	AS SHOWN
DATE	

91.2

CONTRACT NO. 04775					
STATE	SECTION	COUNTY	TOWNSHIP	RANGE	SECTION
TO BE FILLED IN BY CONTRACTOR					
DATE OF CONTRACT	DATE OF COMPLETION	DATE OF ASSESSMENT	DATE OF REVIEW	DATE OF INSPECTION	DATE OF SIGNATURE

# CONCRETE COLLARS FOR PIPE OR BOX CULVERT EXTENSIONS

CONTRACT NO. 48775					
DATE	SECTION	COUNTY	TOWNSHIP	SHEET	NO.
1949		ILLINOIS		331	1
DESIGNED BY					ILLINOIS DEPARTMENT OF TRANSPORTATION
CHECKED BY					ILLINOIS DEPARTMENT OF TRANSPORTATION

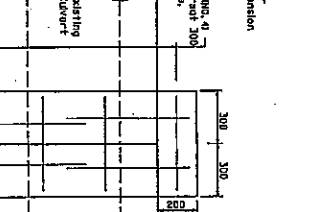
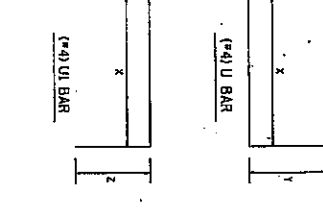
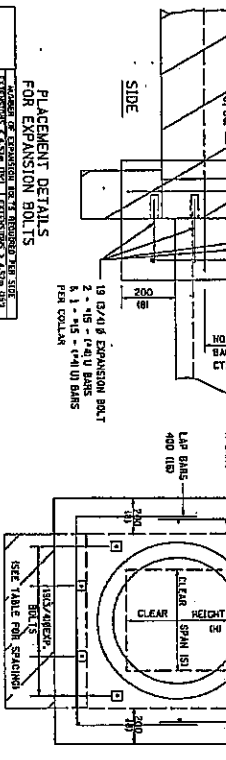
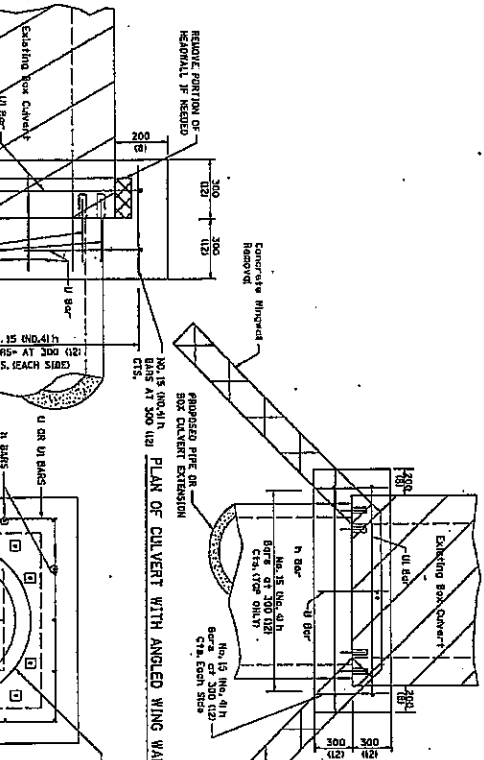

**PLACEMENT DETAILS FOR EXPANSION BOLTS**

CLASS	TYPE	SIZE	SPACING	DEPTH
1	EXP.	1/2"	24"	4"
2	EXP.	3/8"	24"	4"
3	EXP.	1/2"	24"	4"
4	EXP.	1/2"	24"	4"
5	EXP.	1/2"	24"	4"
6	EXP.	1/2"	24"	4"
7	EXP.	1/2"	24"	4"
8	EXP.	1/2"	24"	4"
9	EXP.	1/2"	24"	4"
10	EXP.	1/2"	24"	4"
11	EXP.	1/2"	24"	4"
12	EXP.	1/2"	24"	4"
13	EXP.	1/2"	24"	4"
14	EXP.	1/2"	24"	4"
15	EXP.	1/2"	24"	4"
16	EXP.	1/2"	24"	4"
17	EXP.	1/2"	24"	4"
18	EXP.	1/2"	24"	4"
19	EXP.	1/2"	24"	4"
20	EXP.	1/2"	24"	4"
21	EXP.	1/2"	24"	4"
22	EXP.	1/2"	24"	4"
23	EXP.	1/2"	24"	4"
24	EXP.	1/2"	24"	4"
25	EXP.	1/2"	24"	4"
26	EXP.	1/2"	24"	4"
27	EXP.	1/2"	24"	4"
28	EXP.	1/2"	24"	4"
29	EXP.	1/2"	24"	4"
30	EXP.	1/2"	24"	4"
31	EXP.	1/2"	24"	4"
32	EXP.	1/2"	24"	4"
33	EXP.	1/2"	24"	4"
34	EXP.	1/2"	24"	4"
35	EXP.	1/2"	24"	4"
36	EXP.	1/2"	24"	4"
37	EXP.	1/2"	24"	4"
38	EXP.	1/2"	24"	4"
39	EXP.	1/2"	24"	4"
40	EXP.	1/2"	24"	4"

**EXPANSION BOLTS FOR CONNECTION WITHOUT EXISTING HEADWALL**

STATION	CLASS	TYPE	SIZE	SPACING	DEPTH
1	EXP.	1/2"	24"	4"	
2	EXP.	3/8"	24"	4"	
3	EXP.	1/2"	24"	4"	
4	EXP.	1/2"	24"	4"	
5	EXP.	1/2"	24"	4"	
6	EXP.	1/2"	24"	4"	
7	EXP.	1/2"	24"	4"	
8	EXP.	1/2"	24"	4"	
9	EXP.	1/2"	24"	4"	
10	EXP.	1/2"	24"	4"	
11	EXP.	1/2"	24"	4"	
12	EXP.	1/2"	24"	4"	
13	EXP.	1/2"	24"	4"	
14	EXP.	1/2"	24"	4"	
15	EXP.	1/2"	24"	4"	
16	EXP.	1/2"	24"	4"	
17	EXP.	1/2"	24"	4"	
18	EXP.	1/2"	24"	4"	
19	EXP.	1/2"	24"	4"	
20	EXP.	1/2"	24"	4"	
21	EXP.	1/2"	24"	4"	
22	EXP.	1/2"	24"	4"	
23	EXP.	1/2"	24"	4"	
24	EXP.	1/2"	24"	4"	
25	EXP.	1/2"	24"	4"	
26	EXP.	1/2"	24"	4"	
27	EXP.	1/2"	24"	4"	
28	EXP.	1/2"	24"	4"	
29	EXP.	1/2"	24"	4"	
30	EXP.	1/2"	24"	4"	
31	EXP.	1/2"	24"	4"	
32	EXP.	1/2"	24"	4"	
33	EXP.	1/2"	24"	4"	
34	EXP.	1/2"	24"	4"	
35	EXP.	1/2"	24"	4"	
36	EXP.	1/2"	24"	4"	
37	EXP.	1/2"	24"	4"	
38	EXP.	1/2"	24"	4"	
39	EXP.	1/2"	24"	4"	
40	EXP.	1/2"	24"	4"	

**GENERAL NOTES**

Concrete Collars shall be constructed of Class 85 Concrete in accordance with Section 503 of the Standard Specifications for Road and Bridge Construction.

Reinforcement bars shall conform to Section 508 of the Standard Specifications.

The concrete will be paid for at the contract unit price per cubic meter. Reinforcement bars will be paid for at the contract unit price per kilogram (pound) for reinforcement bars. Expansion bolts will be paid for at the contract unit price per each. Expansion bolts of the size indicated shall be used. These bolts shall extend at least 200 lb inches into the new concrete.

ILLINOIS DEPARTMENT OF TRANSPORTATION

STATE ENGINEER

CHIEF CLERK

DATE

331

# SLOPED METAL END SECTIONS WITH GRATE

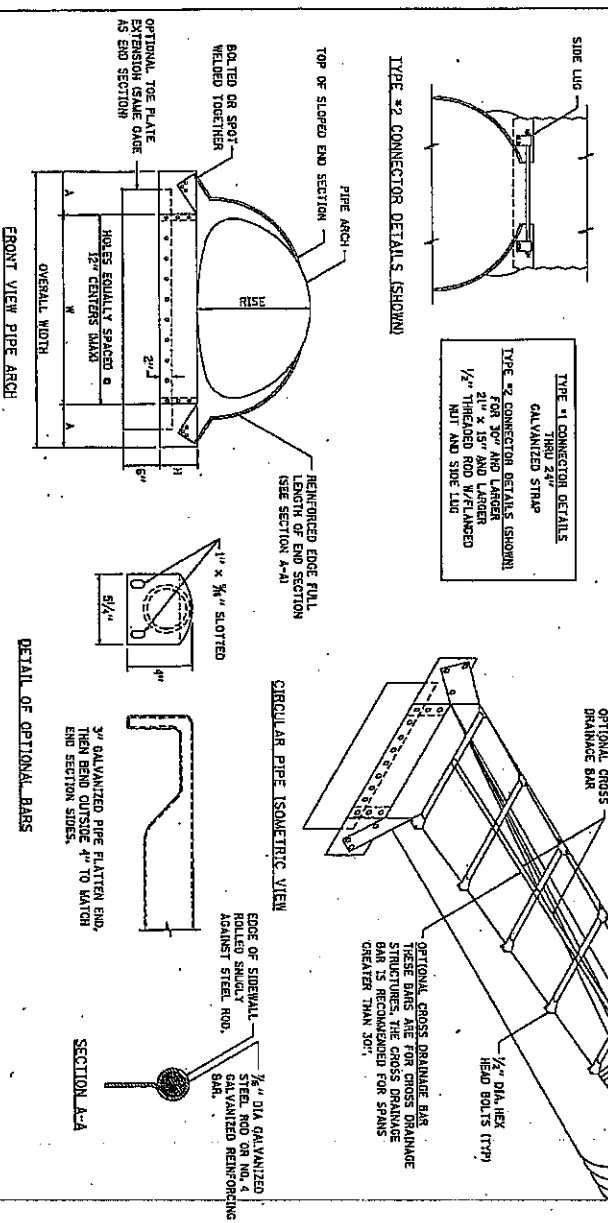
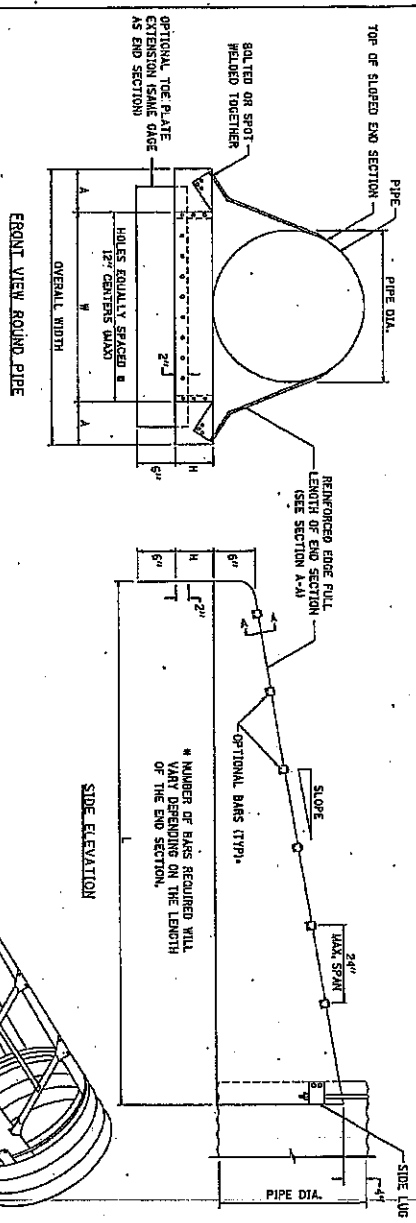

### GENERAL NOTES

- CONNECTORS - ROUND SIZES THRU 24" ATTACH TO PIPE WITH THE "I" STRAP, ALL OTHER SIZES ATTACH WITH THE "Z" RODS AND LUGS.
- TOE PLATE EXTENSIONS - WHEN REQUIRED, THE TOE PLATE EXTENSIONS ARE TO BE THE SAME GAGE AS END SECTION. DIMENSIONS SHALL BE OVERALL WITH LESS 8 INCHES BY 8 INCHES HIGH.
- OPTIONAL BARS - BARS WHEN SPECIFIED, SHALL BE SCHEDULE 40 GALVANIZED STEEL PIPE.
- TYPICALLY PARALLEL BARS ARE PLACED ON 24" CENTERS.
- TYPICALLY THE CROSS BARS ARE USED ON CROSS DRAIN APPLICATIONS.
- HOLDS FOR BAR ATTACHMENTS SHALL BE PROVIDED ON ALL END SECTIONS.
- DIMENSIONS ARE SUBJECT TO MANUFACTURING TOLERANCES.
- THESE END SECTIONS WILL BE PAID FOR AT THE CONTRACT UNIT PRICE PER EACH FOR SLOPED METAL END SECTIONS WITH GRATE OF THE DIAMETER SPECIFIED, WHICH SHALL INCLUDE FURNISHING AND INSTALLING THE END SECTION COMPLETE IN PLACE, INCLUDING THE TOE PLATE, THE STRAP, THE BOLT AND CROSS DRAINAGE BARS, CONNECTED TO THE PIPE AND CROSS DRAINAGE BARS.

METAL END SECTIONS FOR ROUND PIPE

PIPE DIA. IN.	MAX. THICK. IN.	DIMENSIONS (INCHES)			L. DIMENSIONS			
		A	K	W	SLOPE	LENGTH		
12	0.063	16	8	31	37	51	41	20
14	0.063	16	8	31	37	51	41	20
16	0.063	16	8	31	37	51	41	20
18	0.063	16	8	31	37	51	41	20
20	0.063	16	8	31	37	51	41	20
22	0.063	16	8	31	37	51	41	20
24	0.063	16	8	31	37	51	41	20
26	0.063	16	8	31	37	51	41	20
28	0.063	16	8	31	37	51	41	20
30	0.063	16	8	31	37	51	41	20
32	0.063	16	8	31	37	51	41	20
34	0.063	16	8	31	37	51	41	20
36	0.063	16	8	31	37	51	41	20
38	0.063	16	8	31	37	51	41	20
40	0.063	16	8	31	37	51	41	20
42	0.063	16	8	31	37	51	41	20
44	0.063	16	8	31	37	51	41	20
46	0.063	16	8	31	37	51	41	20
48	0.063	16	8	31	37	51	41	20
50	0.063	16	8	31	37	51	41	20

METAL END SECTIONS FOR PIPE ARCH

PIPE DIA. IN.	SPAN	LENGTH	DIMENSIONS (INCHES)			L. DIMENSIONS			
			A	H	W	SLOPE	LENGTH		
12	18	48	16	8	31	37	51	41	20
14	18	48	16	8	31	37	51	41	20
16	18	48	16	8	31	37	51	41	20
18	18	48	16	8	31	37	51	41	20
20	18	48	16	8	31	37	51	41	20
22	18	48	16	8	31	37	51	41	20
24	18	48	16	8	31	37	51	41	20
26	18	48	16	8	31	37	51	41	20
28	18	48	16	8	31	37	51	41	20
30	18	48	16	8	31	37	51	41	20
32	18	48	16	8	31	37	51	41	20
34	18	48	16	8	31	37	51	41	20
36	18	48	16	8	31	37	51	41	20
38	18	48	16	8	31	37	51	41	20
40	18	48	16	8	31	37	51	41	20
42	18	48	16	8	31	37	51	41	20
44	18	48	16	8	31	37	51	41	20
46	18	48	16	8	31	37	51	41	20
48	18	48	16	8	31	37	51	41	20
50	18	48	16	8	31	37	51	41	20

# TYPICAL PAVEMENT MARKINGS

TYPICAL PAVEMENT MARKING FOR FLUSH MEDIAN

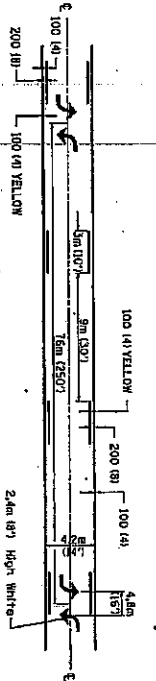
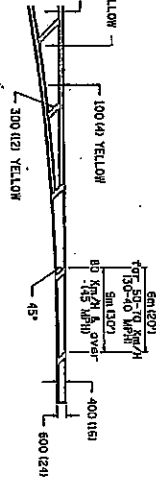
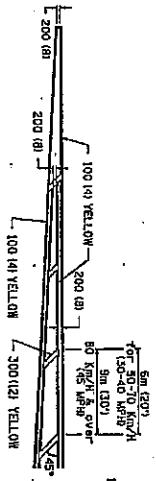

MEDIAN PAVEMENT MARKING

TYPICAL ISLAND  
OFFSET SHOULDER WIDTH

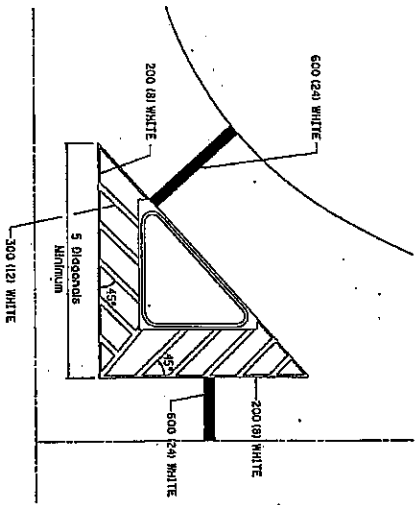

TYPICAL PARKING SPACING

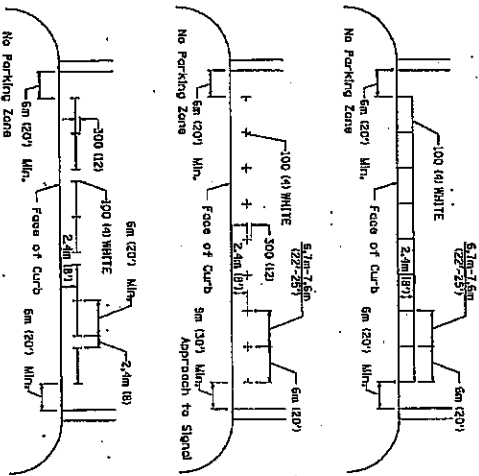

STANDARD CROSSWALK MARKING  
See Schedules for Locations

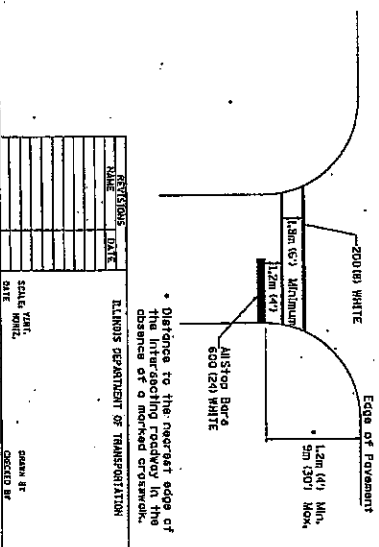

PROJECTS\200502\00502std.dgn 1/10/2005 1:55:15 PM

CONTRACT NO. 0413  
SHEET NO. 41.1  
DATE  
SCALE  
SHEET TITLE  
DRAWN BY  
CHECKED BY

TYPICAL PAVEMENT MARKINGS 41.1 SHEET 1 OF 2

NO.	SECTION	DATE	TOTAL SHEETS
001			1
002			1
003			1
004			1
005			1
006			1
007			1
008			1
009			1
010			1
011			1
012			1
013			1
014			1
015			1
016			1
017			1
018			1
019			1
020			1
021			1
022			1
023			1
024			1
025			1
026			1
027			1
028			1
029			1
030			1
031			1
032			1
033			1
034			1
035			1
036			1
037			1
038			1
039			1
040			1
041			1
042			1
043			1
044			1
045			1
046			1
047			1
048			1
049			1
050			1
051			1
052			1
053			1
054			1
055			1
056			1
057			1
058			1
059			1
060			1
061			1
062			1
063			1
064			1
065			1
066			1
067			1
068			1
069			1
070			1
071			1
072			1
073			1
074			1
075			1
076			1
077			1
078			1
079			1
080			1
081			1
082			1
083			1
084			1
085			1
086			1
087			1
088			1
089			1
090			1
091			1
092			1
093			1
094			1
095			1
096			1
097			1
098			1
099			1
100			1

ILLINOIS DEPARTMENT OF TRANSPORTATION  
DISTANCE TO THE NEAREST EDGE OF THE INTERSECTING ROADWAY IN THE CASE OF A MEDIAN CROSSWALK.  
SCALE VERT.  
DATE  
SHEET TITLE  
DRAWN BY  
CHECKED BY

1:56:23 PM 1/10/2005

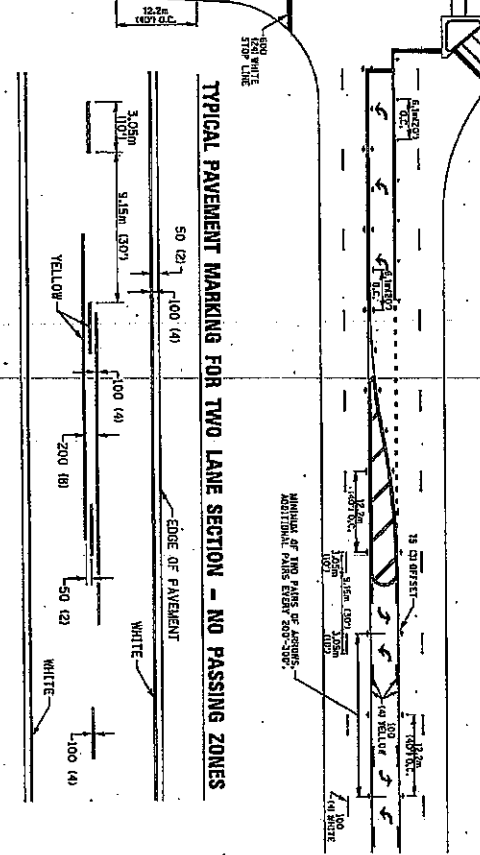
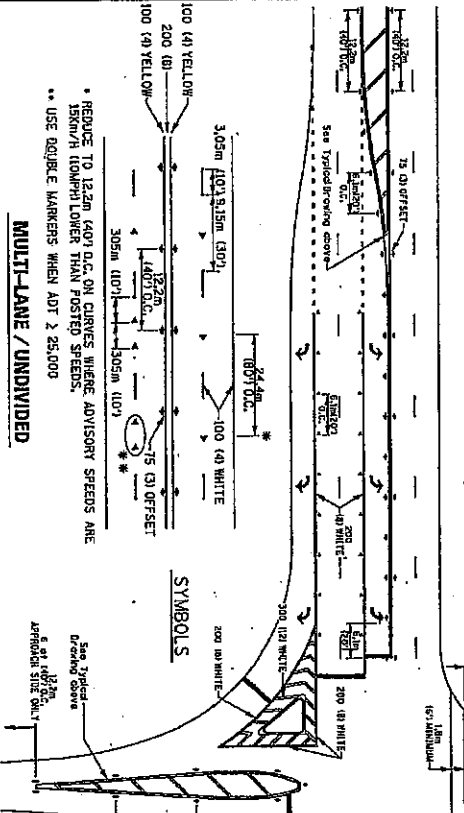
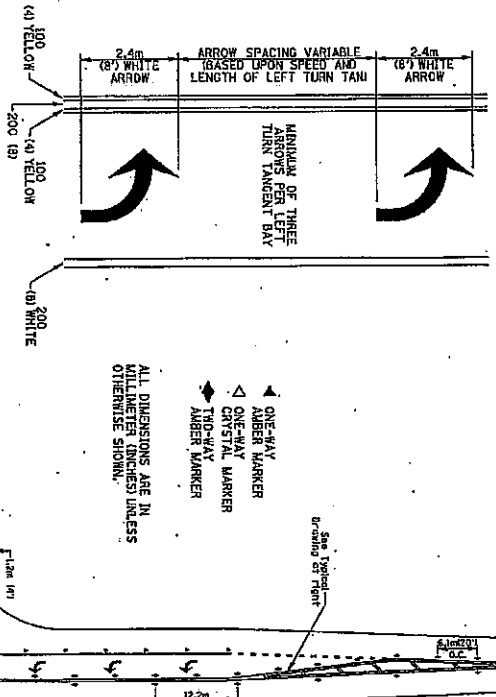

RECOMMENDED SPACING BETWEEN DIAGONALS (IN FEET)

Speed Limit Range	Continuous Median	Intersection Diversion	Diagonal Reversal
less than 50km/h (30MPH)	15.3m (50')	4.53m (15')	3.05m (10')
50-60km/h (30-40MPH)	22.9m (75')	5.1m (17')	4.53m (15')
70km/h (45MPH) & over	22.9m (75')	5.05m (16')	6.1m (20')

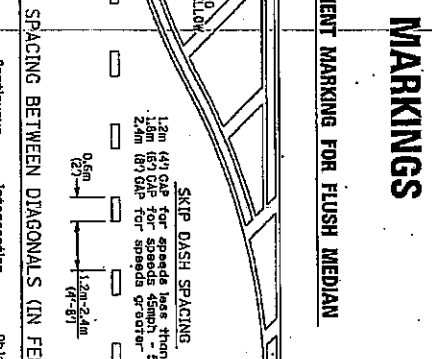

NOTES: If the spacing recommended in the table does not apply at least one spacing from the next lowest speed range should be used. The recommended spacing is measured from offset to the pavement center line.

TYPICAL PAVEMENT MARKINGS 41.1 SHEET 2 OF 2

CONTRACT NO. 4473 CONTRACT NO. 4473

DATE	SECTION	REVISION	SHEET NO.	TOTAL SHEETS
01/10/2005	41.1	1	2	2

DESIGNED BY: [Name]  
CHECKED BY: [Name]  
DATE: 01/10/2005

## ILLINOIS DEPARTMENT OF LABOR

### PREVAILING WAGES FOR HENRY AND BUREAU COUNTIES EFFECTIVE APRIL 2005

The Prevailing rates of wages are included in the Contract proposals which are subject to Check Sheet #5 of the Supplemental Specifications and Recurring Special Provisions. The rates have been ascertained and certified by the Illinois Department of Labor for the locality in which the work is to be performed and for each craft or type of work or mechanic needed to execute the work of the Contract. As required by Prevailing Wage Act (820 ILCS 130/0.01, et seq.) and Check Sheet #5 of the Contract, not less than the rates of wages ascertained by the Illinois Department of Labor and as revised during the performance of a Contract shall be paid to all laborers, workers and mechanics performing work under the Contract. Post the scale of wages in a prominent and easily accessible place at the site of work.

If the Illinois Department of Labor revises the prevailing rates of wages to be paid as listed in the specification of rates, the contractor shall post the revised rates of wages and shall pay not less than the revised rates of wages. Current wage rate information shall be obtained by visiting the Illinois Department of Labor web site at <http://www.state.il.us/agency/idol/> or by calling 312-793-2814. It is the responsibility of the contractor to review the rates applicable to the work of the contract at regular intervals in order to insure the timely payment of current rates. Provision of this information to the contractor by means of the Illinois Department of Labor web site satisfies the notification of revisions by the Department to the contractor pursuant to the Act, and the contractor agrees that no additional notice is required. The contractor shall notify each of its subcontractors of the revised rates of wages.



# Bureau County Prevailing Wage for April 2005

Trade Name	RG	TYP	C	Base	FRMAN	*M-F>8	OSA	OSH	H/W	Pensn	Vac	Trng
=====	==	==	=	=====	=====	=====	==	==	=====	=====	=====	=====
ASBESTOS ABT-GEN		ALL		23.390	24.140	1.5	1.5	2.0	5.000	4.500	0.000	0.500
ASBESTOS ABT-MEC		BLD		23.300	24.800	1.5	1.5	2.0	3.640	5.520	0.000	0.000
BOILERMAKER		BLD		28.970	31.970	2.0	2.0	2.0	7.020	6.600	0.000	0.210
BRICK MASON		BLD		26.780	27.780	1.5	1.5	2.0	4.870	5.750	0.000	0.340
CARPENTER		BLD		24.970	26.470	1.5	1.5	2.0	5.560	6.670	0.000	0.570
CARPENTER		HWY		23.760	25.510	1.5	1.5	2.0	5.560	6.670	0.000	0.500
CEMENT MASON		ALL		27.000	28.000	2.0	2.0	2.0	4.800	6.590	0.000	0.050
CERAMIC TILE FNSHER		BLD		22.930	0.000	1.5	1.5	2.0	4.800	3.500	0.000	0.300
COMMUNICATION TECH		BLD		26.820	28.320	1.5	1.5	2.0	5.910	8.600	0.000	0.270
ELECTRIC PWR EQMT OP		ALL		27.180	31.060	1.5	1.5	2.0	3.250	7.070	0.000	0.000
ELECTRIC PWR GRNDMAN		ALL		18.650	31.060	1.5	1.5	2.0	3.250	4.850	0.000	0.000
ELECTRIC PWR LINEMAN		ALL		29.180	31.060	1.5	1.5	2.0	3.250	7.590	0.000	0.000
ELECTRIC PWR TRK DRV		ALL		19.570	31.060	1.5	1.5	2.0	3.250	5.090	0.000	0.000
ELECTRICIAN		BLD		32.460	35.380	1.5	1.5	2.0	6.260	10.06	0.000	0.320
ELEVATOR CONSTRUCTOR		BLD		30.090	33.850	2.0	2.0	2.0	7.275	3.420	1.810	0.000
GLAZIER		BLD		24.520	25.270	1.5	1.5	2.0	4.850	5.550	0.000	0.300
HT/FROST INSULATOR		BLD		31.650	33.400	1.5	1.5	2.0	7.260	8.360	0.000	0.230
IRON WORKER		ALL		25.650	27.650	1.5	1.5	2.0	6.440	9.410	0.000	0.570
LABORER		ALL		22.390	23.140	1.5	1.5	2.0	5.000	4.500	0.000	0.500
LABORER, SKILLED		BLD		22.790	23.540	1.5	1.5	2.0	5.000	4.500	0.000	0.500
LABORER, SKILLED		HWY		22.790	23.540	1.5	1.5	2.0	5.000	4.500	0.000	0.500
LATHER		BLD		24.970	26.470	1.5	1.5	2.0	5.560	6.670	0.000	0.570
MACHINIST		BLD		34.540	36.290	2.0	2.0	2.0	3.200	4.100	2.380	0.000
MARBLE FINISHERS		BLD		22.930	0.000	1.5	1.5	2.0	4.800	3.500	0.000	0.300
MARBLE MASON		BLD		25.530	25.780	1.5	1.5	2.0	4.800	5.000	0.000	0.320
MILLWRIGHT		BLD		30.820	33.900	1.5	1.5	2.0	6.100	8.930	0.000	0.560
OPERATING ENGINEER	E	BLD	1	35.800	39.800	2.0	2.0	2.0	6.050	4.850	1.800	0.600
OPERATING ENGINEER	E	BLD	2	34.500	39.800	2.0	2.0	2.0	6.050	4.850	1.800	0.600
OPERATING ENGINEER	E	BLD	3	31.950	39.800	2.0	2.0	2.0	6.050	4.850	1.800	0.600
OPERATING ENGINEER	E	BLD	4	30.200	39.800	2.0	2.0	2.0	6.050	4.850	1.800	0.600
OPERATING ENGINEER	E	HWY	1	35.800	39.800	1.5	1.5	2.0	6.050	4.850	1.800	0.600
OPERATING ENGINEER	E	HWY	2	35.250	39.800	1.5	1.5	2.0	6.050	4.850	1.800	0.600
OPERATING ENGINEER	E	HWY	3	33.200	39.800	1.5	1.5	2.0	6.050	4.850	1.800	0.600
OPERATING ENGINEER	E	HWY	4	31.800	39.800	1.5	1.5	2.0	6.050	4.850	1.800	0.600
OPERATING ENGINEER	E	HWY	5	30.600	39.800	1.5	1.5	2.0	6.050	4.850	1.800	0.600
OPERATING ENGINEER	W	BLD	1	26.410	28.160	1.5	1.5	2.0	4.250	7.500	0.000	0.700
OPERATING ENGINEER	W	BLD	2	24.590	28.160	1.5	1.5	2.0	4.250	7.500	0.000	0.700
OPERATING ENGINEER	W	BLD	3	23.270	28.160	1.5	1.5	2.0	4.250	7.500	0.000	0.700
OPERATING ENGINEER	W	HWY	1	26.690	26.690	1.5	1.5	2.0	4.250	7.500	0.000	0.700
OPERATING ENGINEER	W	HWY	2	24.630	26.690	1.5	1.5	2.0	4.250	7.500	0.000	0.700
OPERATING ENGINEER	W	HWY	3	21.240	26.690	1.5	1.5	2.0	4.250	7.500	0.000	0.700
PAINTER		ALL		25.300	26.300	1.5	1.5	1.5	4.850	4.200	0.000	0.250
PAINTER SIGNS		BLD		25.150	28.240	1.5	1.5	1.5	2.600	2.010	0.000	0.000
PILEDRIVER		BLD		25.220	26.720	1.5	1.5	2.0	5.560	6.670	0.000	0.570
PILEDRIVER		HWY		23.760	25.510	1.5	1.5	2.0	5.560	6.670	0.000	0.500
PIPEFITTER		BLD		35.000	37.000	1.5	1.5	2.0	6.410	5.600	0.000	0.650
PLASTERER		BLD		27.000	28.000	2.0	2.0	2.0	4.800	6.590	0.000	0.050
PLUMBER		BLD		34.960	36.960	1.5	1.5	2.0	4.600	7.490	0.000	0.520
ROOFER		BLD		23.760	24.760	1.5	1.5	2.0	4.120	2.460	0.000	0.320
SHEETMETAL WORKER		BLD		29.740	30.990	1.5	1.5	2.0	5.170	5.430	0.000	0.200
SPRINKLER FITTER		BLD		29.390	30.890	1.5	1.5	2.0	6.100	4.950	0.000	0.250
STONE MASON		BLD		26.780	27.780	1.5	1.5	2.0	4.870	5.750	0.000	0.340
TERRAZZO FINISHER		BLD		22.930	0.000	1.5	1.5	2.0	4.800	3.500	0.000	0.300
TILE LAYER		BLD		24.970	26.470	1.5	1.5	2.0	5.560	6.670	0.000	0.570
TILE MASON		BLD		25.530	25.780	1.5	1.5	2.0	4.800	5.000	0.000	0.320
TRUCK DRIVER		ALL	1	24.235	0.000	1.5	1.5	2.0	6.500	2.750	0.000	0.000
TRUCK DRIVER		ALL	2	24.635	0.000	1.5	1.5	2.0	6.500	2.750	0.000	0.000
TRUCK DRIVER		ALL	3	24.835	0.000	1.5	1.5	2.0	6.500	2.750	0.000	0.000

TRUCK DRIVER	ALL	4	25.085	0.000	1.5	1.5	2.0	6.500	2.750	0.000	0.000
TRUCK DRIVER	ALL	5	25.835	0.000	1.5	1.5	2.0	6.500	2.750	0.000	0.000
TRUCK DRIVER	O&C	1	19.388	0.000	1.5	1.5	2.0	6.500	2.750	0.000	0.000
TRUCK DRIVER	O&C	2	19.708	0.000	1.5	1.5	2.0	6.500	2.750	0.000	0.000
TRUCK DRIVER	O&C	3	19.868	0.000	1.5	1.5	2.0	6.500	2.750	0.000	0.000
TRUCK DRIVER	O&C	4	20.068	0.000	1.5	1.5	2.0	6.500	2.750	0.000	0.000
TRUCK DRIVER	O&C	5	20.668	0.000	1.5	1.5	2.0	6.500	2.750	0.000	0.000
TUCKPOINTER	BLD		26.780	27.780	1.5	1.5	2.0	4.870	5.750	0.000	0.340

Legend:

M-F>8 (Overtime is required for any hour greater than 8 worked each day, Monday through Friday.)

OSA (Overtime is required for every hour worked on Saturday)

OSH (Overtime is required for every hour worked on Sunday and Holidays)

H/W (Health & Welfare Insurance)

Pensn (Pension)

Vac (Vacation)

Trng (Training)

## Explanations

BUREAU COUNTY

OPERATING ENGINEERS (EAST) - That part of the county East of Route 26.

The following list is considered as those days for which holiday rates of wages for work performed apply: New Years Day, Memorial/Decoration Day, Fourth of July, Labor Day, Veterans Day, Thanksgiving Day, Christmas Day. Generally, any of these holidays which fall on a Sunday is celebrated on the following Monday. This then makes work performed on that Monday payable at the appropriate overtime rate for holiday pay. Common practice in a given local may alter certain days of celebration such as the day after Thanksgiving for Veterans Day. If in doubt, please check with IDOL.

Oil and chip resealing (O&C) means the application of road oils and liquid asphalt to coat an existing road surface, followed by application of aggregate chips or gravel to coated surface, and subsequent rolling of material to seal the surface.

EXPLANATION OF CLASSES

ASBESTOS - GENERAL - removal of asbestos material/mold and hazardous materials from any place in a building, including mechanical systems where those mechanical systems are to be removed. This includes the removal of asbestos materials/mold and hazardous materials from ductwork or pipes in a building when the building is to be demolished at the time or at some close future date.

ASBESTOS - MECHANICAL - removal of asbestos material from mechanical systems, such as pipes, ducts, and boilers, where the mechanical systems are to remain.

## CERAMIC TILE FINISHER, MARBLE FINISHER, TERRAZO FINISHER

Assisting, helping or supporting the tile, marble and terrazzo mechanic by performing their historic and traditional work assignments required to complete the proper installation of the work covered by said crafts. The term "Ceramic" is used for naming the classification only and is in no way a limitation of the product handled. Ceramic takes into consideration most hard tiles.

## COMMUNICATION TECHNICIAN

Installation, operation, inspection, maintenance, repair and service of radio, television, recording, voice, sound and vision production and reproduction, telephone and telephone interconnect, facsimile, equipment and appliances used for domestic, commercial, educational and entertainment purposes, pulling of wire through conduit but not the installation of conduit.

## LABORER, SKILLED - BUILDING AND HIGHWAY

The skilled laborer building (BLD) and heavy & highway (HWY) classification shall encompass the following types of work, irrespective of the site of the work: flagging, caisson worker plus depth, gunnite nozzle men, lead man on sewer work, welders, cutter burners and torchmen, chain saw operator, paving breaker, jackhammer and drill operators, layout man and/or drainage tile layer, steel form setter - street and highway, air tamping hammerman, signal man on crane, concrete saw operator, concrete saw operator walk behind, screenman on asphalt pavers, front end man on chip spreader, laborers tending masons with hot material or where foreign materials are used, multiple concrete duct - leadman, luteman, asphalt raker, curb asphalt machine operator, ready mix scalemen (permanent, portable or temporary plant), laborers handling masterplate or similar materials, laser beam operator, coring machine operator, plaster tenders, underpinning and shoring of buildings, material selector when working with fire-brick or castable material, fire watch, signaling of all power equipment, tree topper or trimmer when in connection with construction, and diver tender.

## TRUCK DRIVER - BUILDING, HEAVY AND HIGHWAY CONSTRUCTION

Class 1. Drivers on 2 axle trucks hauling less than 9 ton. Air compressor and welding machines and brooms, including those pulled by separate units, truck driver helpers, warehouse employees, mechanic helpers, greasers and tiremen, pickup trucks when hauling materials, tools, or workers to and from and on-the-job site, and fork lifts up to 6,000 lb. capacity.

Class 2. Two or three axle trucks hauling more than 9 ton but hauling less than 16 ton. A-frame winch trucks, hydrolift trucks, vector trucks or similar equipment when used for transportation purposes. Fork lifts over 6,000 lb. capacity, winch trucks, four axle combination units, and ticket writers.

Class 3. Two, three or four axle trucks hauling 16 ton or more. Drivers on water pulls, articulated dump trucks, mechanics and working forepersons, and dispatchers. Five axle or more combination units.

Class 4. Low Boy and Oil Distributors.

Class 5. Drivers who require special protective clothing while employed on hazardous waste work.

TRUCK DRIVER - OIL AND CHIP RESEALING ONLY.

This shall encompass laborers, workers and mechanics who drive contractor or subcontractor owned, leased, or hired pickup, dump, service, or oil distributor trucks. The work includes transporting materials and equipment (including but not limited to, oils, aggregate supplies, parts, machinery and tools) to or from the job site; distributing oil or liquid asphalt and aggregate; stock piling material when in connection with the actual oil and chip contract. The Truck Driver (Oil & Chip Resealing) wage classification does not include supplier delivered materials.

OPERATING ENGINEERS - BUILDING - EAST

Class 1. Assistant Craft Foreman; Craft Foreman; Mechanic; Asphalt Plant; Asphalt Spreader; Autograde; Backhoes w/Caisson attachment; Batch Plant; Benoto; Boiler and Throttle Valve; Caisson Rigs; Central Redi-Mix Plant; Combination Back Hoe Front End-loader Machine; Compressor and Throttle Valve; Concrete Breaker (Truck Mounted); Concrete Conveyor; Concrete Paver; Concrete Placer; Concrete Pump (Truck Mounted); Concrete Tower; Cranes, All; Cranes, Hammerhead; Creter Crane; Crusher, Stone, etc.; Derricks, All; Derricks, Traveling; Formless Curb and Gutter Machine; Grader, Elevating; Grouting Machines; Highlift Shovels or Front Endloader 2-1/4 yd. and over; Hoists, Elevators, outside type rack and pinion and similar machines; Hoists, one, two and three Drum; Hoists, Two tigger One Floor; Hydraulic Backhoes; Hydraulic Boom Trucks; Hydro Vac (and similar equipment.); Locomotives, All; Motor Patrol; Pile Drivers and Skid Rig; Post Hole Digger; Pre-Stress Machine; Pump Cretes; Squeeze Cretes-screw Type Pumps; Gypsum Bulker and Pump; Roto Mill Grinder; Scoops - Tractor Drawn; Slip-form Paver; Straddle Buggies; Tournapull; Tractor with Boom and Side Boom; Trenching Machines.

Class 2. Boilers; Broom, All Power Propelled; Bulldozers; Concrete Mixer (Two Bag and Over); Conveyor, Portable; Forklift Trucks; Greaser Engineer; Highlift Shovels or Front Endloaders under 2-1/4 yd.; Hoists, Automatic; Hoists, inside Freight Elevators; Hoists, Sewer Dragging Machine; Hoists, Tigger Single Drum; Laser Screed; Rock Drill (self-propelled); Rock Drill (Truck mounted); Rollers, All; Steam Generators; Tractors, All; Tractor Drawn Vibratory Roller; Winch Trucks with "A" Frame.

Class 3. Air Compressors; Combination - Small Equipment Operator; Generators; Heaters, Mechanical; Hoists, Inside Elevators - (Rheostat Manual Controlled); Hoists, Inside Elevators; Hydraulic Power Units (Pile Driving and Extracting); Vibratory Roller; Lowboys; Pumps, over 3" (1 to 3 not to exceed a total of 300 ft.); Pumps, Well Points; Welding Machines (2 through 5); Winches, 4 small Electric Drill Winches.

Class 4. Bobcat/Skid Steer Loader; Brick Forklift; Hoists, Inside Elevators push button with automatic doors; Oilers.

OPERATING ENGINEERS - HEAVY AND HIGHWAY CONSTRUCTION - EAST

Class 1. Craft Foreman; Asphalt Plant; Asphalt Heater and Planer Combination; Asphalt Heater Scarfire; Asphalt Spreader; Autograder; ABC Paver; Backhoes with Caisson Attachment; Belt Loader; Caisson Rigs; Car Dumper; Central Redi-Mix Plant; Combination Backhoe Front Endloader Machine, (1 cu. yd. Backhoe Bucket or over or with attachments); Concrete Breaker (Truck Mounted); Concrete Conveyor; Concrete Paver over 27E cu. ft.; Concrete Placer; Concrete Tube Float;

Cranes, all attachments; Cranes, Hammerhead, Linden, Peco & Machines of a like nature; Creter Crane; Crusher, Stone, etc.; Derricks, All; Derrick Boats; Derricks, Traveling; Dowell Machine; Dredges; Field Mechanic-Welder; Formless Curb and Gutter Machine; Gradall and Machines of a like nature; Grader, Elevating; Grader, Motor Grader, Motor Patrol, Auto Patrol, Form Grader, Pull Grader, Subgrader; Guard Rail Post Driver Truck Mounted; Hoists, One, Two and Three Drum; Hydraulic Backhoes; Mucking Machine; Pile Drivers and Skid Rig; Pre-Stress Machine; Pump Cretes Dual Ram; Rock/Track Tamper; Rock Drill - Truck Mounted; Roto Mill Grinder; Slip-Form Paver; Soil Test Drill Rig (Truck Mounted); Straddle Buggies; Hydraulic Telescoping form (Tunnel); Tractor Drawn Belt Loader with attached pusher; Tractor with Boom; Tractaire with Attachments; Trenching Machine; Truck Mounted Concrete Pump with Boom; Raised or Blind Hole; Drills (Tunnel Shaft); Underground Boring and/or Mining Machines; Wheel Excavator; Widener (APSCO).

Class 2. Batch Plant; Bituminous Mixer; Boiler and Throttle Valve; Bulldozers; Car Loader Trailing Conveyors; Combination Backhoe Front Endloader Machine (less than 1 cu. yd. Backhoe Bucket or over or with attachments); Compressor and Throttle Valve; Compressor, Common Receiver (3); Concrete Breaker or Hydro Hammer; Concrete Grinding Machine; Concrete Mixer or Paver 7S Series to and including 27 cu. ft.; Concrete Spreader; Concrete Curing Machine, Burlap Machine, Belting Machine and Sealing Machine; Concrete Wheel Saw; Conveyor Muck Cars (Haglund or Similar Type); Drills, All; Finishing Machine - Concrete; Greaser Engine; Highlift Shovels or Front Endloader; Hoist - Sewer Dragging Machine; Hydraulic Boom Trucks (All Attachments); Hydro-Blaster; Locomotives, Dinky; Laser Screed; Pump Cretes; Squeeze Cretes-Screw Type Pumps, Gypsum Bulker and Pump; Rock Drill - Crawler or Skid Rig; Rock Drill - Truck Mounted; Roller, Asphalt; Rotary Snow Plows; Rototiller, Seaman, etc., self-propelled; Scoops - Tractor Drawn; Self-Propelled Compactor; Spreader - Chip - Stone, etc.; Scraper; Scraper - Prime Mover in Tandem; Tank Car Heater; Tractors, Push, Pulling Sheeps Foot, Disc, Compactor, etc. Tug Boats.

Class 3. Boilers; Brooms, All Power Propelled; Cement Supply Tender; Compressor, Common Receiver (2); Concrete Mixer (Two Bag and Over); Conveyor, Portable; Farm-Type Tractors Used for Mowing, Seeding, etc.; Fireman on Boilers; Forklift Trucks; Grouting Machine; Hoists, Automatic; Hoists, All Elevators; Hoists, Tugger Single Drum; Jeep Diggers; Pipe Jacking Machines; Post-Hole Digger; Power Saw, Concrete Power Driven; Pug Mills; Rollers, other than asphalt; Seed and Straw Blower; Steam Generators; Stump Machine; Winch Trucks with "A" Frame; Work Boats; Tamper - Form-Motor Driven.

Class 4. Air Compressor; Combination - Small Equipment Operator; Directional Boring Machine; Generators; Heaters, Mechanical; Hydraulic Power Unit (Pile Driving, Extracting, or Drilling); Hydro-Blaster; Light Plants, All (1 through 5); Pumps, over 3" (1 to 3 not to exceed a total of 300 ft.); Pumps; Tractaire; Welding Machines (2 through 5); Winches.

Class 5. Bobcats (All); Brick Forklifts; Oilers.

#### OPERATING ENGINEERS - BUILDING - WEST

Class 1. Cranes; Overhead Cranes; Gradall; All Cherry Pickers; Mechanics; Central Concrete Mixing Plant Operator; Road Pavers (27E - Dual Drum - Tri Batchers); Blacktop Plant Operators and Plant Engineers; 3 Drum Hoist; Derricks; Hydro Cranes; Shovels; Skimmer Scoops; Koehring Scooper; Drag Lines; Backhoe; Derrick Boats; Pile Drivers and Skid Rigs; Clamshells; Locomotive Cranes; Dredge (all

types) Motor Patrol; Power Blades - Dumore - Elevating and similar types; Tower Cranes (Crawler-Mobile) and Stationary; Crane-type Backfiller; Drott Yumbo and similar types considered as Cranes; Caisson Rigs; Dozer; Tournadozer; Work Boats; Ross Carrier; Helicopter; Tournapulls - all and similar types; Scoops (all sizes); Pushcats; Endloaders (all types); Asphalt Surfacing Machine; Slip Form Paver; Rock Crusher; Heavy Equipment Greaser; CMI, CMI Belt Placer, Auto Grade & 3 Track and similar types; Side Booms; Multiple Unit Earth Movers; Creter Crane; Trench Machine; Pump-crete-Belt Crete-Squeeze Cretes-Screw-type Pumps and Gypsum; Bulker & Pump - Operator will clean; Formless Finishing Machine; Flaherty Spreader or similar types; Screed Man on Laydown Machine; Wheel Tractors (industrial or Farm-type w/Dozer-Hoe-Endloader or other attachments); F.W.D. & Similar Types; Vermeer Concrete Saw.

Class 2. Dinkeys; Power Launches; PH One-pass Soil Cement Machine (and similar types); Pugmill with Pump; Backfillers; Euclid Loader; Forklifts; Jeeps w/Ditching Machine or other attachments; Tuneluger; Automatic Cement and Gravel Batching Plants; Mobile Drills (Soil Testing) and similar types; Gurries and Similar Types; (1) and (2) Drum Hoists (Buck Hoist and Similar Types); Chicago Boom; Boring Machine & Pipe Jacking Machine; Hydro Boom; Dewatering System; Straw Blower; Hydro Seeder; Assistant Heavy Equipment Greaser on Spread; Tractors (Track type) without Power Unit pulling Rollers; Rollers on Asphalt -- Brick Macadem; Concrete Breakers; Concrete Spreaders; Mule Pulling Rollers; Center Stripper; Cement Finishing Machines & CMI Texture & Reel Curing Machines; Cement Finishing Machine; Barber Green or similar loaders; Vibro Tamper (All similar types) Self-propelled; Winch or Boom Truck; Mechanical Bull Floats; Mixers over 3 Bag to 27E; Tractor pulling Power Blade or Elevating Grader; Porter Rex Rail; Clary Screed; Truck Type Hoptoe Oilers; Fireman; Spray Machine on Paving; Curb Machines; Truck Crane Oilers; Oil Distributor; Truck-Mounted Saws; Directional boring machine.

Class 3. Air Compressor; Power Subgrader; Straight Tractor; Trac Air without attachments; Herman Nelson Heater, Dravo, Warner, Silent Glo, and similar types; Roller: Five (5) Ton and under on Earth or Gravel; Form Grader; Crawler Crane & Skid Rig Oilers; Freight Elevators - permanently installed; Pump; Light Plant; Generator; Conveyor (1) or (2) - Operator will clean; Welding Machine; Mixer (3) Bag and Under (Standard Capacity with skip); Bulk Cement Plant; Oiler on Central Concrete Mixing Plant; Straight framed articulating end dump vehicle; Truck mounted vac unit (separately powered).

#### OPERATING ENGINEERS - HEAVY AND HIGHWAY CONSTRUCTION - WEST

Class 1. Cranes; Hydro Crane; Shovels; Crane Type Backfiller; Tower Cranes - Mobile & Crawler & Stationary; Derricks & Hoists (3 Drum); Draglines; Drott Yumbo & similar types considered as Cranes; Back Hoe; Derrick Boats; Pile Driver and Skid Rigs; Clam Shell; Locomotive - Cranes; Road Pavers - Single Drum - Dual Drum - Tri Batcher; Motor Patrols & Power Blades - Dumore - Elevating & Similar Types; Mechanics; Central Concrete Mixing Plant Operator; Asphalt Batch Plant Operators and Plant Engineers; Gradall; Caisson Rigs; Skimmer Scoop - Koering Scooper; Dredges (all types); Hoptoe; All Cherry Pickers; Work Boat; Ross Carrier; Helicopter; Dozer; Tournadozer; Tournapulls - all and similar types; Multiple Unit Earth Movers; Scoops (all sizes); Pushcats; Endloaders (all types); Asphalt Surfacing Machine; Slip Form Paver; Rock Crusher; Heavy Equipment Greaser (top greaser on spread); CMI, Auto Grade, CMI Belt Placer & 3 Track and similar types; Side Booms; Starting Engineer on Pipeline; Asphalt Heater & Planer Combination (used to plane streets); Wheel Tractors (with dozer, hoe or endloader attachments); F.W.D. and Similar types; Blaw Knox

Spreader and Similar types; Trench Machines; Pump Crete - Belt Crete - Squeeze Crete - screw type pumps and gypsum (operator will clean); Formless Finishing Machines; Flaherty Spreader or similar types; Screed Man on Laydown Machine; Vermeer Concrete Saw.

Class 2. Bulker & Pump; Power Launches; Boring Machine & Pipe Jacking Machine; Dinkeys; P-H One Pass Soil Cement Machines and similar types; Wheel Tractors (Industry or farm type - other); Back Fillers; Euclid Loader; Fork Lifts; Jeep w/Ditching Machine or other attachments; Tunneluger; Automatic Cement & Gravel Batching Plants; Mobile Drills - Soil Testing and similar types; Pugmill with pump; All (1) and (2) Drum Hoists; Dewatering System; Straw Blower; Hydro-Seeder; Boring Machine; Hydro-Boom; Bump Grinders (self-propelled); Assistant Heavy Equipment Greaser; Apsco Spreader; Tractors (track-type) without Power Units Pulling Rollers on Asphalt - Brick or Macadam; Concrete Breakers; Concrete Spreaders; Cement Strippers; Cement Finishing Machines & CMI Texture & Reel Curing Machines; Vibro-Tampers (all similar types self-propelled); Mechanical Bull Floats; Self-propelled Concrete Saws; Mixers-over three (3) bags to 27E; Winch and Boom Trucks; Tractor Pulling Power Blade or Elevating Grader; Porter Rex Rail; Clary Screed; Mule Pulling Rollers; Pugmill without Pump; Barber Greene or similar Loaders; Track Type Tractor w/Power Unit attached (minimum); Fireman; Spray Machine on Paving; Curb Machines; Paved Ditch Machine; Power Broom; Self-Propelled Conveyors; Power Subgrader; Oil Distributor; Straight Tractor; Truck Crane Oiler; Truck Type Oilers.

Class 3. Trac Air Machine (without attachments); Herman Nelson Heater, Dravo Warner, Silent Glo & similar types; Rollers - five ton and under on earth and gravel; Form Graders; Pumps; Light Plant; Generator; Air Compressor (1) or (2); Conveyor; Welding Machine; Mixer - 3 bags and under; Bulk Cement Plant; Oilers.

#### Other Classifications of Work:

For definitions of classifications not otherwise set out, the Department generally has on file such definitions which are available. If a task to be performed is not subject to one of the classifications of pay set out, the Department will upon being contacted state which neighboring county has such a classification and provide such rate, such rate being deemed to exist by reference in this document. If no neighboring county rate applies to the task, the Department shall undertake a special determination, such special determination being then deemed to have existed under this determination. If a project requires these, or any classification not listed, please contact IDOL at 618/993-7271 for wage rates or clarifications.

#### LANDSCAPING

Landscaping work falls under the existing classifications for laborer, operating engineer and truck driver. The work performed by landscape plantsman and landscape laborer is covered by the existing classification of laborer. The work performed by landscape operators (regardless of equipment used or its size) is covered by the classifications of operating engineer. The work performed by landscape truck drivers (regardless of size of truck driven) is covered by the classifications of truck driver.

# Henry County Prevailing Wage for April 2005

Trade Name	RG	TYP	C	Base	FRMAN	*M-F>8	OSA	OSH	H/W	Pensn	Vac	Trng
=====	==	==	=	=====	=====	=====	==	==	=====	=====	=====	=====
ASBESTOS ABT-GEN		BLD		22.270	23.020	1.5	1.5	2.0	5.000	5.980	0.000	0.500
ASBESTOS ABT-GEN		HWY		21.870	22.320	1.5	1.5	2.0	5.000	5.650	0.000	0.500
ASBESTOS ABT-MEC		BLD		18.260	19.010	1.5	1.5	2.0	3.750	1.650	0.000	0.000
BOILERMAKER		BLD		28.970	31.970	2.0	2.0	2.0	7.020	6.600	0.000	0.210
BRICK MASON		BLD		26.780	27.780	1.5	1.5	2.0	4.870	5.750	0.000	0.340
CARPENTER		BLD		24.000	25.200	1.5	1.5	2.0	5.140	4.470	0.000	0.400
CARPENTER		HWY		24.920	26.670	1.5	1.5	2.0	5.600	4.510	0.000	0.400
CEMENT MASON		BLD		27.270	28.270	1.5	1.5	2.0	4.800	6.820	0.000	0.050
CEMENT MASON		HWY		27.000	28.000	1.5	1.5	2.0	4.800	6.590	0.000	0.050
CERAMIC TILE FNSHER		BLD		22.930	0.000	1.5	1.5	2.0	4.800	3.500	0.000	0.300
COMMUNICATION TECH	SE	BLD		26.820	28.320	1.5	1.5	2.0	5.910	8.600	0.000	0.270
ELECTRIC PWR EQMT OP		ALL		27.180	31.060	1.5	1.5	2.0	3.250	7.070	0.000	0.000
ELECTRIC PWR GRNDMAN		ALL		18.650	31.060	1.5	1.5	2.0	3.250	4.850	0.000	0.000
ELECTRIC PWR LINEMAN		ALL		29.180	31.060	1.5	1.5	2.0	3.250	7.590	0.000	0.000
ELECTRIC PWR TRK DRV		ALL		19.570	31.060	1.5	1.5	2.0	3.250	5.090	0.000	0.000
ELECTRICIAN	NW	BLD		26.520	28.520	1.5	1.5	2.0	5.230	6.970	0.000	0.310
ELECTRICIAN	SE	BLD		32.460	35.380	1.5	1.5	2.0	6.260	10.06	0.000	0.320
ELECTRONIC SYS TECH	NW	BLD		19.800	20.750	1.5	1.5	2.0	2.800	3.770	0.000	0.310
ELEVATOR CONSTRUCTOR		BLD		30.090	33.850	2.0	2.0	2.0	7.275	3.420	1.810	0.000
GLAZIER		BLD		22.470	23.820	1.5	1.5	2.0	3.900	3.450	0.000	0.000
HT/FROST INSULATOR		BLD		25.860	27.060	1.5	1.5	2.0	4.300	6.850	0.000	0.300
IRON WORKER		ALL		22.380	24.170	1.5	1.5	2.0	6.440	8.090	0.000	0.360
LABORER		BLD		21.270	22.020	1.5	1.5	2.0	5.000	5.980	0.000	0.500
LABORER		HWY		20.870	21.320	1.5	1.5	2.0	5.000	5.650	0.000	0.500
LABORER, SKILLED		BLD		21.270	22.020	1.5	1.5	2.0	5.000	5.980	0.000	0.500
LABORER, SKILLED		HWY		21.170	21.620	1.5	1.5	2.0	5.000	5.650	0.000	0.500
LATHER		BLD		24.000	25.200	1.5	1.5	2.0	5.140	4.470	0.000	0.400
MACHINIST		BLD		34.540	36.290	2.0	2.0	2.0	3.200	4.100	2.380	0.000
MARBLE FINISHERS		BLD		22.930	0.000	1.5	1.5	2.0	4.800	3.500	0.000	0.300
MARBLE MASON		BLD		25.530	25.780	1.5	1.5	2.0	4.800	5.000	0.000	0.320
MILLWRIGHT	N	BLD		29.820	32.800	1.5	1.5	2.0	4.300	8.730	0.000	0.560
MILLWRIGHT	S	BLD		24.390	26.090	1.5	1.5	2.0	5.550	7.090	0.000	0.560
OPERATING ENGINEER	E	BLD	1	26.410	28.160	1.5	1.5	2.0	4.250	7.500	0.000	0.700
OPERATING ENGINEER	E	BLD	2	24.590	28.160	1.5	1.5	2.0	4.250	7.500	0.000	0.700
OPERATING ENGINEER	E	BLD	3	23.270	28.160	1.5	1.5	2.0	4.250	7.500	0.000	0.700
OPERATING ENGINEER	E	HWY	1	26.690	26.690	1.5	1.5	2.0	4.250	7.500	0.000	0.700
OPERATING ENGINEER	E	HWY	2	24.630	26.690	1.5	1.5	2.0	4.250	7.500	0.000	0.700
OPERATING ENGINEER	E	HWY	3	21.240	26.690	1.5	1.5	2.0	4.250	7.500	0.000	0.700
OPERATING ENGINEER	W	BLD	1	24.800	0.000	1.5	1.5	2.0	5.400	5.050	1.400	0.400
OPERATING ENGINEER	W	BLD	2	24.800	0.000	1.5	1.5	2.0	5.400	5.050	1.400	0.400
OPERATING ENGINEER	W	BLD	3	22.150	0.000	1.5	1.5	2.0	5.400	5.050	1.400	0.400
OPERATING ENGINEER	W	BLD	4	22.150	0.000	1.5	1.5	2.0	5.400	5.050	1.400	0.400
OPERATING ENGINEER	W	BLD	5	21.100	0.000	1.5	1.5	2.0	5.400	5.050	1.400	0.400
OPERATING ENGINEER	W	HWY	1	24.800	25.800	1.5	1.5	2.0	5.400	5.050	1.400	0.400
OPERATING ENGINEER	W	HWY	2	24.800	25.800	1.5	1.5	2.0	5.400	5.050	1.400	0.400
OPERATING ENGINEER	W	HWY	3	23.200	25.800	1.5	1.5	2.0	5.400	5.050	1.400	0.400
OPERATING ENGINEER	W	HWY	4	23.200	25.800	1.5	1.5	2.0	5.400	5.050	1.400	0.400
OPERATING ENGINEER	W	HWY	5	22.050	25.800	1.5	1.5	2.0	5.400	5.050	1.400	0.400
PAINTER		ALL		22.570	23.570	1.5	1.5	1.5	3.900	4.850	0.000	0.600
PAINTER OVER 30FT		ALL		23.820	24.820	1.5	1.5	1.5	3.900	4.850	0.000	0.600
PAINTER PWR EQMT		ALL		23.070	24.070	1.5	1.5	1.5	3.900	4.850	0.000	0.600
PILEDRIVER		BLD		24.000	25.200	1.5	1.5	2.0	5.140	4.470	0.000	0.400
PILEDRIVER		HWY		24.920	26.670	1.5	1.5	2.0	5.600	4.510	0.000	0.400
PIPEFITTER		ALL		29.720	32.690	1.5	1.5	2.0	4.450	6.780	0.000	0.490
PLASTERER		BLD		27.000	28.000	1.5	1.5	2.0	4.800	6.590	0.000	0.050
PLUMBER		ALL		29.720	32.690	1.5	1.5	2.0	4.450	6.780	0.000	0.490
ROOFER		BLD		22.000	23.250	1.5	1.5	2.0	4.890	4.820	0.000	0.190
SHEETMETAL WORKER		BLD		25.970	27.560	1.5	1.5	2.0	5.040	6.860	0.000	0.380



SPRINKLER FITTER	BLD	29.390	30.890	1.5	1.5	2.0	6.100	4.950	0.000	0.250
STONE MASON	BLD	26.780	27.780	1.5	1.5	2.0	4.870	5.750	0.000	0.340
TERRAZZO FINISHER	BLD	22.930	0.000	1.5	1.5	2.0	4.800	3.500	0.000	0.300
TILE LAYER	BLD	24.000	25.200	1.5	1.5	2.0	5.140	4.470	0.000	0.400
TILE MASON	BLD	25.530	25.780	1.5	1.5	2.0	4.800	5.000	0.000	0.320
TRUCK DRIVER	ALL 1	23.535	0.000	1.5	1.5	2.0	6.500	3.200	0.000	0.000
TRUCK DRIVER	ALL 2	23.935	0.000	1.5	1.5	2.0	6.500	3.200	0.000	0.000
TRUCK DRIVER	ALL 3	24.135	0.000	1.5	1.5	2.0	6.500	3.200	0.000	0.000
TRUCK DRIVER	ALL 4	24.385	0.000	1.5	1.5	2.0	6.500	3.200	0.000	0.000
TRUCK DRIVER	ALL 5	25.135	0.000	1.5	1.5	2.0	6.500	3.200	0.000	0.000
TRUCK DRIVER	O&C 1	18.828	0.000	1.5	1.5	2.0	6.500	3.200	0.000	0.000
TRUCK DRIVER	O&C 2	19.148	0.000	1.5	1.5	2.0	6.500	3.200	0.000	0.000
TRUCK DRIVER	O&C 3	19.308	0.000	1.5	1.5	2.0	6.500	3.200	0.000	0.000
TRUCK DRIVER	O&C 4	19.508	0.000	1.5	1.5	2.0	6.500	3.200	0.000	0.000
TRUCK DRIVER	O&C 5	20.108	0.000	1.5	1.5	2.0	6.500	3.200	0.000	0.000
TUCKPOINTER	BLD	26.780	27.780	1.5	1.5	2.0	4.870	5.750	0.000	0.340

Legend:

M-F>8 (Overtime is required for any hour greater than 8 worked each day, Monday through Friday.)

OSA (Overtime is required for every hour worked on Saturday)

OSH (Overtime is required for every hour worked on Sunday and Holidays)

H/W (Health & Welfare Insurance)

Pensn (Pension)

Vac (Vacation)

Trng (Training)

## Explanations

### HENRY COUNTY

COMMUNICATIONS TECHNICIAN (SE) - Townships of Annawan, Cambridge, Burns, Kewanee, Weller, Galva, and Wethersfield.

ELECTRICIANS AND ELECTRONIC SYSTEMS TECHNICIAN (NW) - That portion North and West of Annawan, Burns, Cambridge, and Weller Townships.

MILLWRIGHT (NORTH) - North of interstate 80.

OPERATING ENGINEERS (EAST) - The eastern half of the county divided by highway 82 excluding Geneseo.

The following list is considered as those days for which holiday rates of wages for work performed apply: New Years Day, Memorial/Decoration Day, Fourth of July, Labor Day, Veterans Day, Thanksgiving Day, Christmas Day. Generally, any of these holidays which fall on a Sunday is celebrated on the following Monday. This then makes work performed on that Monday payable at the appropriate overtime rate for holiday pay. Common practice in a given local may alter certain days of celebration such as the day after Thanksgiving for Veterans Day. If in doubt, please check with IDOL.

Oil and chip resealing (O&C) means the application of road oils and

liquid asphalt to coat an existing road surface, followed by application of aggregate chips or gravel to coated surface, and subsequent rolling of material to seal the surface.

#### EXPLANATION OF CLASSES

ASBESTOS - GENERAL - removal of asbestos material/mold and hazardous materials from any place in a building, including mechanical systems where those mechanical systems are to be removed. This includes the removal of asbestos materials/mold and hazardous materials from ductwork or pipes in a building when the building is to be demolished at the time or at some close future date.

ASBESTOS - MECHANICAL - removal of asbestos material from mechanical systems, such as pipes, ducts, and boilers, where the mechanical systems are to remain.

#### CERAMIC TILE FINISHER, MARBLE FINISHER, TERRAZO FINISHER

Assisting, helping or supporting the tile, marble and terrazzo mechanic by performing their historic and traditional work assignments required to complete the proper installation of the work covered by said crafts. The term "Ceramic" is used for naming the classification only and is in no way a limitation of the product handled. Ceramic takes into consideration most hard tiles.

#### COMMUNICATIONS TECHNICIAN - Southeast

Installation, operation, inspection, maintenance, repair and service of radio, television, recording, voice, sound and vision production and reproduction, telephone and telephone interconnect, facsimile, equipment and appliances used for domestic, commercial, educational and entertainment purposes, pulling of wire through conduit but not the installation of conduit.

#### ELECTRONIC SYSTEMS TECHNICIAN - Northwest

Installing, assembling and maintaining sound and intercom, protection alarm (security), master antenna television, closed circuit television, computer hardware and software programming and installation to the network's outlet and input (EXCLUDING all cabling, power and cable termination work historically performed by wiremen), door monitoring and control, nurse and emergency call programming and installation to the system's outlet and input (EXCLUDING all cabling, power and cable termination work historically performed by wiremen), clock and timing; and the installation and maintenance of transmit and receive antennas, transmitters, receivers, and associated apparatus which operates in conjunction with the above systems. All work associated with these system installations will be included EXCEPT (1) installation of protective metallic conduit, excluding less than ten-foot runs strictly for protection of cable, and (2) 120 volt AC (or higher) power wiring and associated hardware.

#### LABORER, SKILLED - BUILDING

The skilled laborer building (BLD) classification shall encompass the following types of work, irrespective of the site of the work: tending of carpenters in unloading, handling, stockpiling and distribution operations, also other building crafts, mixing, handling, and conveying of all materials used by masons, plasterers and other building construction crafts, whether done by hand or by any process. The drying of plastering when done by salamander heat, and the cleaning and clearing of all debris. All work pertaining to and in

preparation of asbestos abatement and removal. The building of scaffolding and staging for masons and plasterers. The excavations for buildings and all other construction, digging, of trenches, piers, foundations and holes, digging, lagging, sheeting, cribbing, bracing and propping of foundations, holes, caissons, cofferdams, and dikes, the setting of all guidelines for machine or hand excavation and subgrading. The mixing, handling, conveying, pouring, vibrating, gunniting and otherwise applying of concrete, whether by hand or other method of concrete for any walls, foundations, floors, or for other construction concrete sealant men. The wrecking, stripping, dismantling, and handling of concrete forms and false work, and the building of centers for fireproofing purposes. Boring machine, gas, electric or air in preparation for shoving pipe, telephone cable, and so forth, under highways, roads, streets and alleys. All hand and power operating cross cut saws when used for clearing. All work in compressed air construction. All work on acetylene burners in salvaging. The blocking and tamping of concrete. The laying of sewer tile and conduit, and pre-cast materials. The assembling and dismantling of all jacks and sectional scaffolding, including elevator construction and running of slip form jacks. The work of drill running and blasting, including wagon drills. The wrecking, stripping, dismantling, cleaning, moving and oiling of forms. The cutting off of concrete piles. The loading, unloading, handling and carrying to place of installation of all rods, (and materials for use in reinforcing) concrete and the hoisting of same and all signaling where hoist is used in this type of construction coming under the jurisdiction of the Laborers' Union. And, all other labor work not awarded to any other craft. Mortar mixers, kettlemen and carrier of hot stuff, tool crib men, watchmen (Laborer), firemen or salamander tenders, flagmen, deck hands, installation and maintenance of temporary gas-fired heating units, gravel box men, dumpmen and spotters, fencing Laborers, cleaning lumber, pit men, material checkers, dispatchers, unloading explosives, asphalt plant laborers, writer of scale tickets, fireproofing laborers, janitors, asbestos abatement and removal laborers, handling of materials treated with oil, creosote, chloride, asphalt, and/or foreign material harmful to skin or clothing, Laborers with de-watering systems, gunnite nozzle men, laborers tending masons with hot material or where foreign materials are used, Laborers handling masterplate or similar materials, laser beam operator, concrete burning machine operator, material selector men working with firebrick or combustible material, dynamite men, track laborers, cement handlers, chloride handlers, the unloading and laborers with steel workers and re-bars, concrete workers (wet), luteman, asphalt raker, curb asphalt machine operator, ready mix scalemen, permanent, portable or temporary plant drilling machine operator, plaster tenders, underpinning and shoring of buildings, fire watch, signaling of all power equipment, to include trucks excavating equipment, etc., tree topper or trimmer when in connection to construction, tunnel helpers in free air, batch dumpers, kettle and tar men, tank cleaners, plastic installers, scaffold workers, motorized buggies or motorized unit used for wet concrete or handling of building materials, sewer workers, rod and chain men, vibrator operators, mortar mixer operator, cement silica, clay, fly ash, lime and plasters, handlers (bulk or bag), cofferdam workers, on concrete paving, placing, cutting and tying of reinforcing, deck hand, dredge hand and shore laborers, bankmen on floating plant, asphalt workers with machine & layers, grade checker, power tools, caisson workers, lead man on sewer work, welders, cutters, burners and torch men, chain saw operators, paving breaker, jackhammer and drill operator, layout man and/or drainage tile layer, steel form setters -- street and highway, air tamping hammerman, signal man on crane, concrete saw operator, screen man on asphalt pavers, front end man on chip spreader, multiple concrete duct -- lead man.

#### LABORER, SKILLED - HIGHWAY

The skilled laborer heavy and highway (HWY) classification shall encompass the following types of work, irrespective of the site of the work: handling of materials treated with oil, creosote, asphalt and/or any foreign materials harmful to skin or clothing, track laborers, chloride handlers, the unloading and loading with steel workers and re-bars, concrete workers (wet), tunnel helpers in free air, batch dumpers, mason tenders, kettle and tar men, plastic installers, scaffold workers, motorized buggies or motorized unit used for wet concrete or handling of building materials, laborers with de-watering systems, sewer workers plus depth, rod and chainmen, vibrator operators, mortar mixer operators, cement silica, clay, fly ash, lime and plasters, handlers (bulk or bag), cofferdam workers plus depth, on concrete paving, placing, cutting and tying or reinforcing, deck hand, dredge hand shore laborers, bankmen on floating plant, asphalt workers with machine, and layers, grade checker, power tools, stripping of all concrete forms excluding paving forms, dumpmen and spotters, when necessary, caisson workers plus depth, gunnite nozzle men, welders, cutters, burners and torchmen, chain saw operators, paving breaker, jackhammer and drill operators, layout man and/or drainage tile layer, steel form setters - street and highway, air tamping hammerman, signal man on crane, concrete saw operator, screedman on asphalt pavers, front end man on chip spreader, multiple concrete duct, luteman, asphalt raker, curb asphalt machine operator, ready mix scalemen (portable or temporary plant), laser beam operator, concrete burning machine operator, and coring machine operator.

#### TRUCK DRIVER - BUILDING, HEAVY AND HIGHWAY CONSTRUCTION

Class 1. Drivers on 2 axle trucks hauling less than 9 ton. Air compressor and welding machines and brooms, including those pulled by separate units, truck driver helpers, warehouse employees, mechanic helpers, greasers and tiremen, pickup trucks when hauling materials, tools, or workers to and from and on-the-job site, and fork lifts up to 6,000 lb. capacity.

Class 2. Two or three axle trucks hauling more than 9 ton but hauling less than 16 ton. A-frame winch trucks, hydrolift trucks, vector trucks or similar equipment when used for transportation purposes. Fork lifts over 6,000 lb. capacity, winch trucks, four axle combination units, and ticket writers.

Class 3. Two, three or four axle trucks hauling 16 ton or more. Drivers on water pulls, articulated dump trucks, mechanics and working forepersons, and dispatchers. Five axle or more combination units.

Class 4. Low Boy and Oil Distributors.

Class 5. Drivers who require special protective clothing while employed on hazardous waste work.

#### TRUCK DRIVER - OIL AND CHIP RESEALING ONLY.

This shall encompass laborers, workers and mechanics who drive contractor or subcontractor owned, leased, or hired pickup, dump, service, or oil distributor trucks. The work includes transporting materials and equipment (including but not limited to, oils, aggregate supplies, parts, machinery and tools) to or from the job site; distributing oil or liquid asphalt and aggregate; stock piling material when in connection with the actual oil and chip contract. The Truck Driver (Oil & Chip Resealing) wage classification does not include supplier delivered materials.

OPERATING ENGINEERS - BUILDING - EAST

Class 1. Cranes; Overhead Cranes; Gradall; All Cherry Pickers; Mechanics; Central Concrete Mixing Plant Operator; Road Pavers (27E - Dual Drum - Tri Batchers); Blacktop Plant Operators and Plant Engineers; 3 Drum Hoist; Derricks; Hydro Cranes; Shovels; Skimmer Scoops; Koehring Scooper; Drag Lines; Backhoe; Derrick Boats; Pile Drivers and Skid Rigs; Clamshells; Locomotive Cranes; Dredge (all types) Motor Patrol; Power Blades - Dumore - Elevating and similar types; Tower Cranes (Crawler-Mobile) and Stationary; Crane-type Backfiller; Drott Yumbo and similar types considered as Cranes; Caisson Rigs; Dozer; Tournadozer; Work Boats; Ross Carrier; Helicopter; Tournapulls - all and similar types; Scoops (all sizes); Pushcats; Endloaders (all types); Asphalt Surfacing Machine; Slip Form Paver; Rock Crusher; Heavy Equipment Greaser; CMI, CMI Belt Placer, Auto Grade & 3 Track and similar types; Side Booms; Multiple Unit Earth Movers; Creter Crane; Trench Machine; Pump-crete-Belt Crete-Squeeze Cretes-Screw-type Pumps and Gypsum; Bulker & Pump - Operator will clean; Formless Finishing Machine; Flaherty Spreader or similar types; Screed Man on Laydown Machine; Wheel Tractors (industrial or Farm-type w/Dozer-Hoe-Endloader or other attachments); F.W.D. & Similar Types; Vermeer Concrete Saw.

Class 2. Dinkeys; Power Launches; PH One-pass Soil Cement Machine (and similar types); Pugmill with Pump; Backfillers; Euclid Loader; Forklifts; Jeeps w/Ditching Machine or other attachments; Tuneluger; Automatic Cement and Gravel Batching Plants; Mobile Drills (Soil Testing) and similar types; Gurries and Similar Types; (1) and (2) Drum Hoists (Buck Hoist and Similar Types); Chicago Boom; Boring Machine & Pipe Jacking Machine; Hydro Boom; Dewatering System; Straw Blower; Hydro Seeder; Assistant Heavy Equipment Greaser on Spread; Tractors (Track type) without Power Unit pulling Rollers; Rollers on Asphalt -- Brick Macadem; Concrete Breakers; Concrete Spreaders; Mule Pulling Rollers; Center Stripper; Cement Finishing Machines & CMI Texture & Reel Curing Machines; Cement Finishing Machine; Barber Green or similar loaders; Vibro Tamper (All similar types) Self-propelled; Winch or Boom Truck; Mechanical Bull Floats; Mixers over 3 Bag to 27E; Tractor pulling Power Blade or Elevating Grader; Porter Rex Rail; Clary Screed; Truck Type Hoptoe Oilers; Fireman; Spray Machine on Paving; Curb Machines; Truck Crane Oilers; Oil Distributor; Truck-Mounted Saws.

Class 3. Air Compressor; Power Subgrader; Straight Tractor; Trac Air without attachments; Herman Nelson Heater, Dravo, Warner, Silent Glo, and similar types; Roller: Five (5) Ton and under on Earth or Gravel; Form Grader; Crawler Crane & Skid Rig Oilers; Freight Elevators - permanently installed; Pump; Light Plant; Generator; Conveyor (1) or (2) - Operator will clean; Welding Machine; Mixer (3) Bag and Under (Standard Capacity with skip); Bulk Cement Plant; Oiler on Central Concrete Mixing Plant.

OPERATING ENGINEERS - HEAVY AND HIGHWAY CONSTRUCTION - EAST

Class 1. Cranes; Hydro Crane; Shovels; Crane Type Backfiller; Tower Cranes - Mobile & Crawler & Stationary; Derricks & Hoists (3 Drum); Draglines; Drott Yumbo & similar types considered as Cranes; Back Hoe; Derrick Boats; Pile Driver and Skid Rigs; Clam Shell; Locomotive - Cranes; Road Pavers - Single Drum - Dual Drum - Tri Batcher; Motor Patrols & Power Blades - Dumore - Elevating & Similar Types; Mechanics; Central Concrete Mixing Plant Operator; Asphalt Batch Plant Operators and Plant Engineers; Gradall; Caisson Rigs; Skimmer Scoop - Koehring Scooper; Dredges (all types); Hoptoe; All Cherry Pickers; Work

Boat; Ross Carrier; Helicopter; Dozer; Tournadozer; Tournapulls - all and similar types; Multiple Unit Earth Movers; Scoops (all sizes); Pushcats; Endloaders (all types); Asphalt Surfacing Machine; Slip Form Paver; Rock Crusher; Heavy Equipment Greaser (top greaser on spread); CMI, Auto Grade, CMI Belt Placer & 3 Track and similar types; Side Booms; Starting Engineer on Pipeline; Asphalt Heater & Planer Combination (used to plane streets); Wheel Tractors (with dozer, hoe or endloader attachments); F.W.D. and Similar types; Blaw Knox Spreader and Similar types; Trench Machines; Pump Crete - Belt Crete - Squeeze Crete - screw type pumps and gypsum (operator will clean); Formless Finishing Machines; Flaherty Spreader or similar types; Screed Man on Laydown Machine; Vermeer Concrete Saw.

Class 2. Bulker & Pump; Power Launches; Boring Machine & Pipe Jacking Machine; Dinkeys; P-H One Pass Soil Cement Machines and similar types; Wheel Tractors (Industry or farm type - other); Back Fillers; Euclid Loader; Fork Lifts; Jeep w/Ditching Machine or other attachments; Tunneluger; Automatic Cement & Gravel Batching Plants; Mobile Drills - Soil Testing and similar types; Pugmill with pump; All (1) and (2) Drum Hoists; Dewatering System; Straw Blower; Hydro-Seeder; Boring Machine; Hydro-Boom; Bump Grinders (self-propelled); Assistant Heavy Equipment Greaser; Apsco Spreader; Tractors (track-type) without Power Units Pulling Rollers on Asphalt - Brick or Macadam; Concrete Breakers; Concrete Spreaders; Cement Strippers; Cement Finishing Machines & CMI Texture & Reel Curing Machines; Vibro-Tampers (all similar types self-propelled); Mechanical Bull Floats; Self-propelled Concrete Saws; Mixers-over three (3) bags to 27E; Winch and Boom Trucks; Tractor Pulling Power Blade or Elevating Grader; Porter Rex Rail; Clary Screed; Mule Pulling Rollers; Pugmill without Pump; Barber Greene or similar Loaders; Track Type Tractor w/Power Unit attached (minimum); Fireman; Spray Machine on Paving; Curb Machines; Paved Ditch Machine; Power Broom; Self-Propelled Conveyors; Power Subgrader; Oil Distributor; Straight Tractor; Truck Crane Oiler; Truck Type Oilers; Directional boring machine; Horizontal directional drill.

Class 3. Straight framed articulating end dump vehicles and Truck mounted vac unit (separately powered); Trac Air Machine (without attachments); Herman Nelson Heater, Dravo Warner, Silent Glo & similar types; Rollers - five ton and under on earth and gravel; Form Graders; Pumps; Light Plant; Generator; Air Compressor (1) or (2); Conveyor; Welding Machine; Mixer - 3 bags and under; Bulk Cement Plant; Oilers.

#### OPERATING ENGINEERS - BUILDING, HEAVY AND HIGHWAY CONSTRUCTION - WEST

Class 1. An engineer on Crane, Shovel, Clamshell, Dragline, Backhoe, Derrick, Tower Crane, Cable Way, Concrete Spreader (servicing two pavers), Asphalt Spreader, Asphalt Mixer, Plant Engineer, Dipper Dredge Operator, Dipper Dredge Craneman, Dual Purpose Truck (boom or winch), Leverman or Engineman (hydraulic dredge), Mechanic, Paving Mixer with tower attached, Pile Driver, Boom Tractor, Stationary, Portable or Floating Mixing Plant, Trenching Machine (over 40 H.P.), Building Hoist (two drums), Hot Paint Wrapping Machine, Cleaning and Priming Machine, Backfiller (throw bucket), Locomotive Engineer, Qualified Welder, Tow or Push Boat, Concrete Paver, Seaman Trav-L-Plant or similar machines, CMI Autograder or similar machines, Slip Form Paver, Caisson Augering Machine, Mucking Machine, Asphalt Heater-Planer Unit, Hydraulic Cranes, Mine Hoists.

Class 2. An engineer on Athey, Barber-Green, Euclid or Haiss Loader, Asphalt Pug Mill, Fireman and Drier, Concrete Pump, Concrete Spreader (servicing one paver) Bulldozer, Endloader, Log Chippers or similar

machines, Elevating Grader, Group Equipment Greaser, LeTourneaupul and similar machines, off-road haul units, DW-10 Hyster Winch and similar machines, Motor Patrol, Power Blade, Push Cat, Tractor Pulling elevating Grader or Power Blade, Tractor Operating Scoop or Scraper, Tractor with Power Attachment, Roller on Asphalt or Blacktop, Single Drum Hoist, Jaeger Mix and Place Machine, Pipe Bending Machine, Flexaplane or similar machines, Automatic Curbing Machines, Automatic Cement and Gravel Batch Plants (one stop set-up), Seaman Pulvi-Mixer or similar machines, Blastholer Self-propelled Rotary Drill or similar machines, Work Boat, Combination Concrete Finishing Machine and Float, Self-propelled Sheep Foot Roller or Compactor (used in conjunction with a Grading Spread), Asphalt Spreader Screed Operator, Apsco spreader or similar machine, Slusher, Forklift (over 6000 lb. cap. or working at heights above 28 ft.) Concrete Conveyors, Chip Spreader, Underground Boring Machine (BUILDING ONLY), Straddle Carrier, Hydro-Hammer (BUILDING ONLY), Hydraulic Pumps or Power Units Driven by any power source (except manually), used to hoist or lift machinery or material.

Class 3. An engineer on Asphalt Booster, Fireman and Pump Operator at Asphalt Plant, Mud Jack, Underground Boring Machine (HIGHWAY ONLY), Concrete Finishing Machine, Form Grader with Roller on Earth, Mixers (3 bag to 16E), Power Operated Bull Float, Tractor without Power attachment, Dope Pot (agitating motor), Dope Chop Machine, Distributor (back end), Straddle Carrier, Portable Machine Fireman, Hydro-Hammer (HIGHWAY ONLY), Power Winch on Paving Work, Self-propelled Roller or Compactor (other than provided for above), Pump Operator (more than one well-point pump), Portable Crusher Operator, Trench Machine (under 40 H.P.), Power Subgrader (on forms) or similar machines, Forklift (6000 or less cap.) Gypsum Pump, Conveyor over 20 H.P., Fuller Kenyon Cement Pump or similar machines.

Class 4. An engineer on Air Compressor (400 c.f.m. or over HIGHWAY ONLY), Light Plant, Mixers (1 or 2 bag), Power Batching Machine (Cement Auger or Conveyor), Boiler (Engineer or Fireman), Water Pumps (HIGHWAY ONLY), Mechanical Broom, Automatic Cement and Gravel Batch Plants (two or three stop set-up), Small Rubber-tired Tractors (not including backhoes or endloaders), Self-propelled Curing Machine, Brush Chipper, Driver on Truck Crane or similar machines.

Class 5. Oiler, Mechanic's Helper, Mechanical Heater (other than steam boiler), Belt Machine, Small Outboard Motor Boats (Safety Boat and Life Boat), Engine Driven Welding Machine, and Small Tractors (used to unroll or roll wire mesh), Water pumps (BUILDING ONLY), Air Compressors (BUILDING ONLY), Permanent Automatic Elevators.

#### Other Classifications of Work:

For definitions of classifications not otherwise set out, the Department generally has on file such definitions which are available. If a task to be performed is not subject to one of the classifications of pay set out, the Department will upon being contacted state which neighboring county has such a classification and provide such rate, such rate being deemed to exist by reference in this document. If no neighboring county rate applies to the task, the Department shall undertake a special determination, such special determination being then deemed to have existed under this determination. If a project requires these, or any classification not listed, please contact IDOL at 618/993-7271 for wage rates or clarifications.

#### LANDSCAPING

Landscaping work falls under the existing classifications for laborer,

operating engineer and truck driver. The work performed by landscape plantsman and landscape laborer is covered by the existing classification of laborer. The work performed by landscape operators (regardless of equipment used or its size) is covered by the classifications of operating engineer. The work performed by landscape truck drivers (regardless of size of truck driven) is covered by the classifications of truck driver.