

If you plan to submit a bid directly to the Department of Transportation

PREQUALIFICATION

Any contractor who desires to become pre-qualified to bid on work advertised by IDOT must submit the properly completed pre-qualification forms to the Bureau of Construction no later than 4:30 p.m. prevailing time twenty-one days prior to the letting of interest. This pre-qualification requirement applies to first time contractors, contractors renewing expired ratings, contractors maintaining continuous pre-qualification or contractors requesting revised ratings. To be eligible to bid, existing pre-qualification ratings must be effective through the date of letting.

REQUESTS FOR AUTHORIZATION TO BID

Contractors wanting to bid on items included in a particular letting must submit the properly completed "Request for Authorization to Bid/or Not For Bid Status" (BDE 124INT) and the ORIGINAL "Affidavit of Availability" (BC 57) to the proper office no later than 4:30 p.m. prevailing time, three (3) days prior to the letting date.

WHO CAN BID ?

Bids will be accepted from only those companies that request and receive written **Authorization to Bid** from IDOT's Central Bureau of Construction.

WHAT CONSTITUTES WRITTEN AUTHORIZATION TO BID?: When a prospective prime bidder submits a "Request for Authorization to Bid/or Not For Bid Status"(BDE 124INT) he/she must indicate at that time which items are being requested For Bidding purposes. Only those items requested For Bidding will be analyzed. After the request has been analyzed, the bidder will be issued a **Proposal Denial and/or Authorization Form**, approved by the Central Bureau of Construction, that indicates which items have been approved For Bidding. If **Authorization to Bid** cannot be approved, the **Proposal Denial and/or Authorization Form** will indicate the reason for denial.

ABOUT AUTHORIZATION TO BID: Firms that have not received an authorization form within a reasonable time of complete and correct original document submittal should contact the department as to status. This is critical in the week before the letting. These documents must be received three days before the letting date. Firms unsure as to authorization status should call the Prequalification Section of the Bureau of Construction at the number listed at the end of these instructions.

ADDENDA AND REVISIONS: It is the contractor's responsibility to determine which, if any, addenda or revisions pertain to any project they may be bidding. Failure to incorporate all relevant addenda or revisions may cause the bid to be declared unacceptable.

Each addendum will be placed with the contract number. Addenda and revisions will also be placed on the Addendum/Revision Checklist and each subscription service subscriber will be notified by e-mail of each addendum and revision issued.

The Internet is the Department's primary way of doing business. The subscription server e-mails are an added courtesy the Department provides. It is suggested that bidders check IDOT's website at <http://www.dot.il.gov/desenv/delett.html> before submitting final bid information.

IDOT IS NOT RESPONSIBLE FOR ANY E-MAIL FAILURES.

Addenda Questions may be directed to the Contracts Office at (217)782-7806 or D&Econtracts@dot.il.gov

Technical Questions about downloading these files may be directed to Tim Garman (217)524-1642 or Timothy.Garman@illinois.gov.

WHAT MUST BE INCLUDED WHEN BIDS ARE SUBMITTED?: Bidders need not return the entire proposal when bids are submitted. That portion of the proposal that must be returned includes the following:

1. All documents from the Proposal Cover Sheet through the Proposal Bid Bond
2. Other special documentation and/or information that may be required by the contract special provisions

All proposal documents, including Proposal Guaranty Checks or Proposal Bid Bonds, should be stapled together to prevent loss when bids are processed by IDOT personnel.

ABOUT SUBMITTING BIDS: It is recommended that bidders deliver bids in person to insure they arrive at the proper location prior to the time specified for the receipt of bids. Any bid received at the place of letting after the time specified will not be accepted.

WHO SHOULD BE CALLED IF ASSISTANCE IS NEEDED?

Questions Regarding	Call
Prequalification and/or Authorization to Bid	217/782-3413
Preparation and submittal of bids	217/782-7806
Mailing of plans and proposals	217/782-7806

ADDENDUMS AND REVISIONS TO THE PROPOSAL FORMS

Planholders should verify that they have received and incorporated any addendum and/or revision prior to submitting their bid. Failure by the bidder to include an addendum or revision could result in a bid being rejected as irregular.

RETURN WITH BID

156

Proposal Submitted By
Name
Address
City

Letting April 3, 2009

BIDDERS NEED NOT RETURN THE ENTIRE PROPOSAL
(See instructions inside front cover)

NOTICE TO PROSPECTIVE BIDDERS

This proposal can be used for bidding purposes by only those companies that request and receive written AUTHORIZATION TO BID from IDOT's Central Bureau of Construction.
(SEE INSTRUCTIONS ON THE INSIDE OF COVER)

**Notice To Bidders,
Specifications,
Proposal, Contract
and Contract Bond**



**Illinois Department
of Transportation**

Springfield, Illinois 62764

Contract No. 68561
WOODFORD County
Section 107RS-5 & 108RS-4
Route FAP 673
Project ESP-0673(024)
District 4 Construction Funds

PLEASE MARK THE APPROPRIATE BOX BELOW:

- A Bid Bond is included.
- A Cashier's Check or a Certified Check is included

Plans Included
Herein

Prepared by
Checked by F

(Printed by authority of the State of Illinois)

INSTRUCTIONS

ABOUT IDOT PROPOSALS: All proposals issued by IDOT are potential bidding proposals. Each proposal contains all Certifications and Affidavits, a Proposal Signature Sheet and a Proposal Bid Bond required for Prime Contractors to submit a bid after written **Authorization to Bid** has been issued by IDOT's Central Bureau of Construction.

WHO CAN BID?: Bids will be accepted from only those companies that request and receive written **Authorization to Bid** from IDOT's Central Bureau of Construction. To request authorization, a potential bidder must complete and submit Part B of the Request for Authorization to Bid/or Not For Bid Status form (BDE 124 INT) and submit an original Affidavit of Availability (BC 57).

WHAT CONSTITUTES WRITTEN AUTHORIZATION TO BID?: When a prospective prime bidder submits a "Request for Proposal Forms and Plans" he/she must indicate at that time which items are being requested For Bidding purposes. Only those items requested For Bidding will be analyzed. After the request has been analyzed, the bidder will be issued a **Proposal Denial and/or Authorization Form**, approved by the Central Bureau of Construction, that indicates which items have been approved For Bidding. If **Authorization to Bid** cannot be approved, the **Proposal Denial and/or Authorization Form** will indicate the reason for denial. If a contractor has requested to bid but has not received a **Proposal Denial and/or Authorization Form**, they should contact the Central Bureau of Construction in advance of the letting date.

WHAT MUST BE INCLUDED WHEN BIDS ARE SUBMITTED?: Bidders need not return the entire proposal when bids are submitted. That portion of the proposal that must be returned includes the following:

1. All documents from the Proposal Cover Sheet through the Proposal Bid Bond
2. Other special documentation and/or information that may be required by the contract special provisions

All proposal documents, including Proposal Guaranty Checks or Proposal Bid Bonds, should be stapled together to prevent loss when bids are processed by IDOT personnel.

ABOUT SUBMITTING BIDS: It is recommended that bidders deliver bids in person to insure they arrive at the proper location prior to the time specified for the receipt of bids. Any bid received at the place of letting after the time specified will not be accepted.

WHO SHOULD BE CALLED IF ASSISTANCE IS NEEDED?

Questions Regarding	Call
Prequalification and/or Authorization to Bid	217/782-3413
Preparation and submittal of bids	217/782-7806
Mailing of CD-ROMS	217/782-7806

RETURN WITH BID



PROPOSAL

TO THE DEPARTMENT OF TRANSPORTATION

1. Proposal of _____

Taxpayer Identification Number (Mandatory) _____

for the improvement identified and advertised for bids in the Invitation for Bids as:

**Contract No. 68561
WOODFORD County
Section 107RS-5 & 108RS-4
Project ESP-0673(024)
Route FAP 673
District 4 Construction Funds**

5.90 miles of resurfacing on IL Routes 116 and 117 from the west city limits of Roanoke to the IL Route 116/117 juncton.

2. The undersigned bidder will furnish all labor, material and equipment to complete the above described project in a good and workmanlike manner as provided in the contract documents provided by the Department of Transportation. This proposal will become part of the contract and the terms and conditions contained in the contract documents shall govern performance and payments.

RETURN WITH BID

6. **COMBINATION BIDS.** The undersigned further agrees that if awarded the contract for the sections contained in the following combination, he/she will perform the work in accordance with the requirements of each individual proposal comprising the combination bid specified in the schedule below, and that the combination bid shall be prorated against each section in proportion to the bid submitted for the same. If an error is found to exist in the gross sum bid for one or more of the individual sections included in a combination, the combination bid shall be corrected as provided in the specifications.

When a combination bid is submitted, the schedule below must be completed in each proposal comprising the combination.

If alternate bids are submitted for one or more of the sections comprising the combination, a combination bid must be submitted for each alternate.

Schedule of Combination Bids

Combination No.	Sections Included in Combination	Combination Bid	
		Dollars	Cents

7. **SCHEDULE OF PRICES.** The undersigned bidder submits herewith, in accordance with the rules and instructions, a schedule of prices for the items of work for which bids are sought. The unit prices bid are in U.S. dollars and cents, and all extensions and summations have been made. The bidder understands that the quantities appearing in the bid schedule are approximate and are provided for the purpose of obtaining a gross sum for the comparison of bids. If there is an error in the extension of the unit prices, the unit prices shall govern. Payment to the contractor awarded the contract will be made only for actual quantities of work performed and accepted or materials furnished according to the contract. The scheduled quantities of work to be done and materials to be furnished may be increased, decreased or omitted as provided elsewhere in the contract.

8. **CERTIFICATE OF AUTHORITY.** The undersigned bidder, if a business organized under the laws of another State, assures the Department that it will furnish a copy of its certificate of authority to do business in the State of Illinois with the return of the executed contract and bond. Failure to furnish the certificate within the time provided for execution of an awarded contract may be cause for cancellation of the award and forfeiture of the proposal guaranty to the State.

ILLINOIS DEPARTMENT OF TRANSPORTATION
 SCHEDULE OF PRICES
 CONTRACT
 NUMBER - 68561

State Job # - C-94-033-06
 PPS NBR - 4-43650-0000
 County Name - WOODFORD- -
 Code - 203 - -
 District - 4 - -
 Section Number - 107RS-5&108RS-4

Project Number
 ESP-0673/024/

Route
 FAP 673

Item Number	Pay Item Description	Unit of Measure	Quantity	x	Unit Price	=	Total Price
X0301512	GDRL AGG EROS CONT	TON	312.000				
X0322729	MATL TRANSFER DEVICE	TON	8,673.000				
X2503100	MOWING	UNIT	312.000				
X4067107	POL LB MM IL4.75 N50	TON	4,324.000				
20200500	EARTH EXC WID	CU YD	1,753.000				
35600700	HMA BC WID 6	SQ YD	10,520.000				
40600215	P BIT MATLS PR CT	TON	55.000				
40600300	AGG PR CT	TON	318.000				
40600895	CONSTRUC TEST STRIP	EACH	1.000				
40600982	HMA SURF REM BUTT JT	SQ YD	2,998.000				
40600990	TEMPORARY RAMP	SQ YD	1,310.000				
40603335	HMA SC "D" N50	TON	8,673.000				
40800050	INCIDENTAL HMA SURF	TON	238.000				
44000155	HMA SURF REM 1 1/2	SQ YD	68,314.000				
44000158	HMA SURF REM 2 1/4	SQ YD	23,425.000				

ILLINOIS DEPARTMENT OF TRANSPORTATION
 SCHEDULE OF PRICES
 CONTRACT
 NUMBER - 68561

State Job # - C-94-033-06
 PPS NBR - 4-43650-0000
 County Name - WOODFORD- -
 Code - 203 - -
 District - 4 - -
 Section Number - 107RS-5&108RS-4

Project Number
 ESP-0673/024/

Route
 FAP 673

Item Number	Pay Item Description	Unit of Measure	Quantity	x	Unit Price	=	Total Price
44000500	COMB CURB GUTTER REM	FOOT	810.000				
44201815	CL D PATCH T2 14	SQ YD	1,910.000				
44201819	CL D PATCH T3 14	SQ YD	70.000				
44201821	CL D PATCH T4 14	SQ YD	288.000				
48101200	AGGREGATE SHLDS B	TON	2,396.000				
60605000	COMB CC&G TB6.24	FOOT	810.000				
63000001	SPBGR TY A 6FT POSTS	FOOT	1,253.000				
63100167	TR BAR TRM T1 SPL TAN	EACH	16.000				
63200310	GUARDRAIL REMOV	FOOT	2,053.000				
67000400	ENGR FIELD OFFICE A	CAL MO	3.000				
67100100	MOBILIZATION	L SUM	1.000				
70100460	TRAF CONT-PROT 701306	L SUM	1.000				
70100600	TRAF CONT-PROT 701336	L SUM	1.000				
70300100	SHORT-TERM PAVT MKING	FOOT	31,175.000				
70300220	TEMP PVT MK LINE 4	FOOT	72,421.000				

RETURN WITH BID

STATE REQUIRED ETHICAL STANDARDS GOVERNING CONTRACT PROCUREMENT: ASSURANCES, CERTIFICATIONS AND DISCLOSURES

I. GENERAL

A. Article 50 of the Illinois Procurement Code establishes the duty of all State chief procurement officers, State purchasing officers, and their designees to maximize the value of the expenditure of public moneys in procuring goods, services, and contracts for the State of Illinois and to act in a manner that maintains the integrity and public trust of State government. In discharging this duty, they are charged by law to use all available information, reasonable efforts, and reasonable actions to protect, safeguard, and maintain the procurement process of the State of Illinois.

B. In order to comply with the provisions of Article 50 and to carry out the duty established therein, all bidders are to adhere to ethical standards established for the procurement process, and to make such assurances, disclosures and certifications required by law. By execution of the Proposal Signature Sheet, the bidder indicates that each of the mandated assurances has been read and understood, that each certification is made and understood, and that each disclosure requirement has been understood and completed.

C. In addition to all other remedies provided by law, failure to comply with any assurance, failure to make any disclosure or the making of a false certification shall be grounds for termination of the contract and the suspension or debarment of the bidder.

II. ASSURANCES

A. The assurances hereinafter made by the bidder are each a material representation of fact upon which reliance is placed should the Department enter into the contract with the bidder. The Department may terminate the contract if it is later determined that the bidder rendered a false or erroneous assurance, and the surety providing the performance bond shall be responsible for the completion of the contract.

B. Felons

1. The Illinois Procurement Code provides:

Section 50-10. Felons. Unless otherwise provided, no person or business convicted of a felony shall do business with the State of Illinois or any state agency from the date of conviction until 5 years after the date of completion of the sentence for that felony, unless no person held responsible by a prosecutorial office for the facts upon which the conviction was based continues to have any involvement with the business.

2. The bidder assures the Department that the award and execution of the contract would not cause a violation of Section 50-10.

C. Conflicts of Interest

1. The Illinois Procurement Code provides in pertinent part:

Section 50-13. Conflicts of Interest.

(a) Prohibition. It is unlawful for any person holding an elective office in this State, holding a seat in the General Assembly, or appointed to or employed in any of the offices or agencies of state government and who receives compensation for such employment in excess of 60% of the salary of the Governor of the State of Illinois, or who is an officer or employee of the Capital Development Board or the Illinois Toll Highway Authority, or who is the spouse or minor child of any such person to have or acquire any contract, or any direct pecuniary interest in any contract therein, whether for stationery, printing, paper, or any services, materials, or supplies, that will be wholly or partially satisfied by the payment of funds appropriated by the General Assembly of the State of Illinois or in any contract of the Capital Development Board or the Illinois Toll Highway authority.

(b) Interests. It is unlawful for any firm, partnership, association or corporation, in which any person listed in subsection (a) is entitled to receive (i) more than 7 1/2% of the total distributable income or (ii) an amount in excess of the salary of the Governor, to have or acquire any such contract or direct pecuniary interest therein.

(c) Combined interests. It is unlawful for any firm, partnership, association, or corporation, in which any person listed in subsection (a) together with his or her spouse or minor children is entitled to receive (i) more than 15%, in the aggregate, of the total distributable income or (ii) an amount in excess of 2 times the salary of the Governor, to have or acquire any such contract or direct pecuniary interest therein.

(d) Securities. Nothing in this Section invalidates the provisions of any bond or other security previously offered or to be offered for sale or sold by or for the State of Illinois.

(e) Prior interests. This Section does not affect the validity of any contract made between the State and an officer or employee of the State or member of the General Assembly, his or her spouse, minor child or any combination of those persons if that contract was in existence before his or her election or employment as an officer, member, or employee. The contract is voidable, however, if it cannot be completed within 365 days after the officer, member, or employee takes office or is employed.

The current salary of the Governor is \$177,412.00. Sixty percent of the salary is \$106,447.20.

RETURN WITH BID

2. The bidder assures the Department that the award and execution of the contract would not cause a violation of Section 50-13, or that an effective exemption has been issued by the Board of Ethics to any individual subject to the Section 50-13 prohibitions pursuant to the provisions of Section 50-20 of the Code and Executive Order Number 3 (1998). Information concerning the exemption process is available from the Department upon request.

D. Negotiations

1. The Illinois Procurement Code provides in pertinent part:

Section 50-15. Negotiations.

(a) It is unlawful for any person employed in or on a continual contractual relationship with any of the offices or agencies of State government to participate in contract negotiations on behalf of that office or agency with any firm, partnership, association, or corporation with whom that person has a contract for future employment or is negotiating concerning possible future employment.

2. The bidder assures the Department that the award and execution of the contract would not cause a violation of Section 50-15, and that the bidder has no knowledge of any facts relevant to the kinds of acts prohibited therein.

E. Inducements

1. The Illinois Procurement Code provides:

Section 50-25. Inducement. Any person who offers or pays any money or other valuable thing to any person to induce him or her not to bid for a State contract or as recompense for not having bid on a State contract is guilty of a Class 4 felony. Any person who accepts any money or other valuable thing for not bidding for a State contract or who withholds a bid in consideration of the promise for the payment of money or other valuable thing is guilty of a Class 4 felony.

2. The bidder assures the Department that the award and execution of the contract would not cause a violation of Section 50-25, and that the bidder has no knowledge of any facts relevant to the kinds of acts prohibited therein.

F. Revolving Door Prohibition

1. The Illinois Procurement Code provides:

Section 50-30. Revolving door prohibition. Chief procurement officers, associate procurement officers, State purchasing officers, their designees whose principal duties are directly related to State procurement, and executive officers confirmed by the Senate are expressly prohibited for a period of 2 years after terminating an affected position from engaging in any procurement activity relating to the State agency most recently employing them in an affected position for a period of at least 6 months. The prohibition includes, but is not limited to: lobbying the procurement process; specifying; bidding; proposing bid, proposal, or contract documents; on their own behalf or on behalf of any firm, partnership, association, or corporation. This Section applies only to persons who terminate an affected position on or after January 15, 1999.

2. The bidder assures the Department that the award and execution of the contract would not cause a violation of Section 50-30, and that the bidder has no knowledge of any facts relevant to the kinds of acts prohibited therein.

G. Reporting Anticompetitive Practices

1. The Illinois Procurement Code provides:

Section 50-40. Reporting anticompetitive practices. When, for any reason, any vendor, bidder, contractor, chief procurement officer, State purchasing officer, designee, elected official, or State employee suspects collusion or other anticompetitive practice among any bidders, offerors, contractors, proposers, or employees of the State, a notice of the relevant facts shall be transmitted to the Attorney General and the chief procurement officer.

2. The bidder assures the Department that it has not failed to report any relevant facts concerning the practices addressed in Section 50-40 which may involve the contract for which the bid is submitted.

H. Confidentiality

1. The Illinois Procurement Code provides:

Section 50-45. Confidentiality. Any chief procurement officer, State purchasing officer, designee, or executive officer who willfully uses or allows the use of specifications, competitive bid documents, proprietary competitive information, proposals, contracts, or selection information to compromise the fairness or integrity of the procurement, bidding, or contract process shall be subject to immediate dismissal, regardless of the Personnel code, any contract, or any collective bargaining agreement, and may in addition be subject to criminal prosecution.

2. The bidder assures the Department that it has no knowledge of any fact relevant to the practices addressed in Section 50-45 which may involve the contract for which the bid is submitted.

RETURN WITH BID

I. Insider Information

1. The Illinois Procurement Act provides:

Section 50-50. Insider information. It is unlawful for any current or former elected or appointed State official or State employee to knowingly use confidential information available only by virtue of that office or employment for actual or anticipated gain for themselves or another person.

2. The bidder assures the Department that it has no knowledge of any facts relevant to the practices addressed in Section 50-50 which may involve the contract for which the bid is submitted.

III. CERTIFICATIONS

A. The certifications hereinafter made by the bidder are each a material representation of fact upon which reliance is placed should the Department enter into the contract with the bidder. The Department may terminate the contract if it is later determined that the bidder rendered a false or erroneous certification, and the surety providing the performance bond shall be responsible for completion of the contract.

B. Bribery

1. The Illinois Procurement Code provides:

Section 50-5. Bribery.

- (a) Prohibition. No person or business shall be awarded a contract or subcontract under this Code who:

- (1) has been convicted under the laws of Illinois or any other state of bribery or attempting to bribe an officer or employee of the State of Illinois or any other state in that officer's or employee's official capacity; or

- (2) has made an admission of guilt of that conduct that is a matter of record but has not been prosecuted for that conduct.

- (b) Businesses. No business shall be barred from contracting with any unit of State or local government as a result of a conviction under this Section of any employee or agent of the business if the employee or agent is no longer employed by the business and:

- (1) the business has been finally adjudicated not guilty; or

- (2) the business demonstrates to the governmental entity with which it seeks to contract, and that entity finds that the commission of the offense was not authorized, requested, commanded, or performed by a director, officer, or high managerial agent on behalf of the business as provided in paragraph (2) of subsection (a) of Section 5-4 of the Criminal Code of 1961.

- (c) Conduct on behalf of business. For purposes of this Section, when an official, agent, or employee of a business committed the bribery or attempted bribery on behalf of the business and in accordance with the direction or authorization of a responsible official of the business, the business shall be chargeable with the conduct.

- (d) Certification. Every bid submitted to and contract executed by the State shall contain a certification by the contractor that the contractor is not barred from being awarded a contract or subcontract under this Section. A contractor who makes a false statement, material to the certification, commits a Class 3 felony.

2. The bidder certifies that it is not barred from being awarded a contract under Section 50.5.

C. Educational Loan

1. Section 3 of the Educational Loan Default Act provides:

§ 3. No State agency shall contract with an individual for goods or services if that individual is in default, as defined in Section 2 of this Act, on an educational loan. Any contract used by any State agency shall include a statement certifying that the individual is not in default on an educational loan as provided in this Section.

2. The bidder, if an individual as opposed to a corporation, partnership or other form of business organization, certifies that the bidder is not in default on an educational loan as provided in Section 3 of the Act.

D. Bid-Rigging/Bid Rotating

1. Section 33E-11 of the Criminal Code of 1961 provides:

§ 33E-11. (a) Every bid submitted to and public contract executed pursuant to such bid by the State or a unit of local government shall contain a certification by the prime contractor that the prime contractor is not barred from contracting with any unit of State or local government as a result of a violation of either Section 33E-3 or 33E-4 of this Article. The State and units of local government shall provide the appropriate forms for such certification.

RETURN WITH BID

(b) A contractor who makes a false statement, material to the certification, commits a Class 3 felony.

A violation of Section 33E-3 would be represented by a conviction of the crime of bid-rigging which, in addition to Class 3 felony sentencing, provides that any person convicted of this offense or any similar offense of any state or the United States which contains the same elements as this offense shall be barred for 5 years from the date of conviction from contracting with any unit of State or local government. No corporation shall be barred from contracting with any unit of State or local government as a result of a conviction under this Section of any employee or agent of such corporation if the employee so convicted is no longer employed by the corporation and: (1) it has been finally adjudicated not guilty or (2) if it demonstrates to the governmental entity with which it seeks to contract and that entity finds that the commission of the offense was neither authorized, requested, commanded, nor performed by a director, officer or a high managerial agent in behalf of the corporation.

A violation of Section 33E-4 would be represented by a conviction of the crime of bid-rotating which, in addition to Class 2 felony sentencing, provides that any person convicted of this offense or any similar offense of any state or the United States which contains the same elements as this offense shall be permanently barred from contracting with any unit of State or local government. No corporation shall be barred from contracting with any unit of State or local government as a result of a conviction under this Section of any employee or agent of such corporation if the employee so convicted is no longer employed by the corporation and: (1) it has been finally adjudicated not guilty or (2) if it demonstrates to the governmental entity with which it seeks to contract and that entity finds that the commission of the offense was neither authorized, requested, commanded, nor performed by a director, officer or a high managerial agent in behalf of the corporation.

2. The bidder certifies that it is not barred from contracting with the Department by reason of a violation of either Section 33E-3 or Section 33E-4.

E. International Anti-Boycott

1. Section 5 of the International Anti-Boycott Certification Act provides:

§ 5. State contracts. Every contract entered into by the State of Illinois for the manufacture, furnishing, or purchasing of supplies, material, or equipment or for the furnishing of work, labor, or services, in an amount exceeding the threshold for small purchases according to the purchasing laws of this State or \$10,000.00, whichever is less, shall contain certification, as a material condition of the contract, by which the contractor agrees that neither the contractor nor any substantially-owned affiliated company is participating or shall participate in an international boycott in violation of the provisions of the U.S. Export Administration Act of 1979 or the regulations of the U.S. Department of Commerce promulgated under that Act.

2. The bidder makes the certification set forth in Section 5 of the Act.

F. Drug Free Workplace

1. The Illinois "Drug Free Workplace Act" applies to this contract and it is necessary to comply with the provisions of the "Act" if the contractor is a corporation, partnership, or other entity (including a sole proprietorship) which has 25 or more employees.

2. The bidder certifies that if awarded a contract in excess of \$5,000 it will provide a drug free workplace by:

(a) Publishing a statement notifying employees that the unlawful manufacture, distribution, dispensation, possession or use of a controlled substance, including cannabis, is prohibited in the contractor's workplace; specifying the actions that will be taken against employees for violations of such prohibition; and notifying the employee that, as a condition of employment on such contract, the employee shall abide by the terms of the statement, and notify the employer of any criminal drug statute conviction for a violation occurring in the workplace no later than five (5) days after such conviction.

(b) Establishing a drug free awareness program to inform employees about the dangers of drug abuse in the workplace; the contractor's policy of maintaining a drug free workplace; any available drug counseling, rehabilitation, and employee assistance programs; and the penalties that may be imposed upon employees for drug violations.

(c) Providing a copy of the statement required by subparagraph (1) to each employee engaged in the performance of the contract and to post the statement in a prominent place in the workplace.

(d) Notifying the Department within ten (10) days after receiving notice from an employee or otherwise receiving actual notice of the conviction of an employee for a violation of any criminal drug statute occurring in the workplace.

(e) Imposing or requiring, within 30 days after receiving notice from an employee of a conviction or actual notice of such a conviction, an appropriate personnel action, up to and including termination, or the satisfactory participation in a drug abuse assistance or rehabilitation program approved by a federal, state or local health, law enforcement or other appropriate agency.

(f) Assisting employees in selecting a course of action in the event drug counseling, treatment, and rehabilitation is required and indicating that a trained referral team is in place.

(g) Making a good faith effort to continue to maintain a drug free workplace through implementation of the actions and efforts stated in this certification.

RETURN WITH BID

G. Debt Delinquency

1. The Illinois Procurement Code provides:

Section 50-11 and 50-12. Debt Delinquency.

The contractor or bidder certifies that it, or any affiliate, is not barred from being awarded a contract under 30 ILCS 500. Section 50-11 prohibits a person from entering into a contract with a State agency if it knows or should know that it, or any affiliate, is delinquent in the payment of any debt to the State as defined by the Debt Collection Board. Section 50-12 prohibits a person from entering into a contract with a State agency if it, or any affiliate, has failed to collect and remit Illinois Use Tax on all sales of tangible personal property into the State of Illinois in accordance with the provisions of the Illinois Use Tax Act. The contractor further acknowledges that the contracting State agency may declare the contract void if this certification is false or if the contractor, or any affiliate, is determined to be delinquent in the payment of any debt to the State during the term of the contract.

H. Sarbanes-Oxley Act of 2002

1. The Illinois Procurement Code, Section 50-60(c), provides:

The contractor certifies in accordance with 30 ILCS 500/50-10.5 that no officer, director, partner or other managerial agent of the contracting business has been convicted of a felony under the Sarbanes-Oxley Act of 2002 or a Class 3 or Class 2 felony under the Illinois Securities Law of 1953 for a period of five years prior to the date of the bid or contract. The contractor acknowledges that the contracting agency shall declare the contract void if this certification is false.

I. Addenda

The contractor or bidder certifies that all relevant addenda have been incorporated in to this contract. Failure to do so may cause the bid to be declared unacceptable.

J. Section 42 of the Environmental Protection Act

The contractor certifies in accordance with 30 ILCS 500/50-12 that the bidder or contractor is not barred from being awarded a contract under this Section which prohibits the bidding on or entering into contracts with the State of Illinois or a State agency by a person or business found by a court or the Pollution Control Board to have committed a willful or knowing violation of Section 42 of the Environmental Protection Act for a period of five years from the date of the order. The contractor acknowledges that the contracting agency may declare the contract void if this certification is false.

K. Apprenticeship and Training Certification (Does not apply to federal aid projects)

In accordance with the provisions of Section 30-22 (6) of the Illinois Procurement Code, the bidder certifies that it is a participant, either as an individual or as part of a group program, in the approved apprenticeship and training programs applicable to each type of work or craft that the bidder will perform with its own forces. The bidder further certifies for work that will be performed by subcontract that each of its subcontractors submitted for approval either (a) is, at the time of such bid, participating in an approved, applicable apprenticeship and training program; or (b) will, prior to commencement of performance of work pursuant to this contract, begin participation in an approved apprenticeship and training program applicable to the work of the subcontract. The Department, at any time before or after award, may require the production of a copy of each applicable Certificate of Registration issued by the United States Department of Labor evidencing such participation by the contractor and any or all of its subcontractors. Applicable apprenticeship and training programs are those that have been approved and registered with the United States Department of Labor. The bidder shall list in the space below, the official name of the program sponsor holding the Certificate of Registration for all of the types of work or crafts in which the bidder is a participant and that will be performed with the bidder's forces. Types of work or craft work that will be subcontracted shall be included and listed as subcontract work. The list shall also indicate any type of work or craft job category that does not have an applicable apprenticeship or training program. **The bidder is responsible for making a complete report and shall make certain that each type of work or craft job category that will be utilized on the project as reported on the Construction Employee Workforce Projection (Form BC-1256) and returned with the bid is accounted for and listed.**

NA - FEDERAL

The requirements of this certification and disclosure are a material part of the contract, and the contractor shall require this certification provision to be included in all approved subcontracts. In order to fulfill this requirement, it shall not be necessary that an applicable program sponsor be currently taking or that it will take applications for apprenticeship, training or employment during the performance of the work of this contract.

L. Executive Order Number 1 (2007) Regarding Lobbying on Government Procurements

The bidder hereby warrants and certifies that they have complied and will comply with the requirements set forth in this Order. The requirements of this warrant and certification are a material part of the contract, and the contractor shall require this warrant and certification provision to be included in all approved subcontracts.

RETURN WITH BID

M. Disclosure of Business Operations in Iran

Public Act 95-0616 provides that each bid, offer, or proposal submitted for a State contract shall include a disclosure of whether or not the Company acting as the bidder, offer or, or proposing entity, or any of its corporate parents or subsidiaries, within the 24 months before submission of the bid, offer, or proposal had business operations that involved contracts with or provision of supplies or services to the Government of Iran, companies in which the Government of Iran has any direct or indirect equity share, consortiums or projects commissioned by the Government of Iran, or companies involved in consortiums or projects commissioned by the Government of Iran and either of the following conditions apply:

- (1) More than 10% of the Company's revenues produced in or assets located in Iran involve oil-related activities or mineral-extraction activities; less than 75% of the Company's revenues produced in or assets located in Iran involve contracts with or provision of oil-related or mineral-extraction products or services to the Government of Iran or a project or consortium created exclusively by that government; and the Company has failed to take substantial action.
- (2) The Company has, on or after August 5, 1996, made an investment of \$20 million or more, or any combination of investments of at least \$10 million each that in the aggregate equals or exceeds \$20 million in any 12-month period, which directly or significantly contributes to the enhancement of Iran's ability to develop petroleum resources of Iran.

The terms "Business operations", "Company", "Mineral-extraction activities", "Oil-related activities", "Petroleum resources", and "Substantial action" are all defined in the Act.

Failure to make the disclosure required by the Act shall cause the bid, offer or proposal to be considered not responsive. The disclosure will be considered when evaluating the bid, offer, or proposal or awarding the contract. The name of each Company disclosed as doing business or having done business in Iran will be provided to the State Comptroller.

Check the appropriate statement:

Company has no business operations in Iran to disclose.

Company has business operations in Iran as disclosed the attached document.

N. Registration with the State Board of Elections.

Public Act 95-0971, amending the Illinois Procurement Code, 30 ILCS 500, adding new sections 20-160 and 50-37, and Executive Order 3 (2008) establish new requirements affecting contributions that contractors, consultants, vendors and bidders, including affiliated persons and entities, may make to state officeholders, declared candidates for state offices and political organizations established to benefit such officeholders and candidates. These provisions do not apply to federal-aid contracts.

By submission of a bid, the bidder acknowledges and agrees that it has read and understands the requirements of PA 95-0971 and Executive Order 3 (2008), including but not limited to, all reporting requirements and all restrictions on soliciting and making contributions to state officeholders, declared candidates for state offices and covered political organizations that promote the candidacy of an officeholder or declared candidate for office. In addition, the bidder makes the following certifications:

- (1) As to Executive Order 3 (2008), the bidder certifies that no contribution will be made that would violate the order, and that the bidder will report all contributions as required by the order.
- (2) As to PA 95-0971, the bidder shall check either of the following certifications that apply:

The bidder is not required to register as a business entity with the State Board of Elections.

The bidder has registered as a business entity with the State Board of Elections, and acknowledges a continuing duty to update the registration as required the Act. **A copy of the time-stamped certificate of registration is enclosed with the bid. The Department will not award this contract without the submission of a certificate of registration.**

In accordance with Article 101.09 of the Standard Specifications for Road and Bridge Construction, this certification shall be part of the contract. Compliance with PA 95-0971 and Executive Order 3 (2008) is a material part of the contract and any breach shall be cause to void the contract under Section 50-60 of the Illinois Procurement Code.

TO BE RETURNED WITH BID

IV. DISCLOSURES

A. The disclosures hereinafter made by the bidder are each a material representation of fact upon which reliance is placed should the Department enter into the contract with the bidder. The Department may terminate the contract if it is later determined that the bidder rendered a false or erroneous disclosure, and the surety providing the performance bond shall be responsible for completion of the contract.

B. Financial Interests and Conflicts of Interest

1. Section 50-35 of the Illinois Procurement Code provides that all bids of more than \$10,000 shall be accompanied by disclosure of the financial interests of the bidder. This disclosed information for the successful bidder, will be maintained as public information subject to release by request pursuant to the Freedom of Information Act.

The financial interests to be disclosed shall include ownership or distributive income share that is in excess of 5%, or an amount greater than 60% of the annual salary of the Governor, of the bidding entity or its parent entity, whichever is less, unless the contractor or bidder is a publicly traded entity subject to Federal 10K reporting, in which case it may submit its 10K disclosure in place of the prescribed disclosure. If a bidder is a privately held entity that is exempt from Federal 10K reporting, but has more than 400 shareholders, it may submit the information that Federal 10K companies are required to report, and list the names of any person or entity holding any ownership share that is in excess of 5%. The disclosure shall include the names, addresses, and dollar or proportionate share of ownership of each person making the disclosure, their instrument of ownership or beneficial relationship, and notice of any potential conflict of interest resulting from the current ownership or beneficial interest of each person making the disclosure having any of the relationships identified in Section 50-35 and on the disclosure form.

In addition, all disclosures shall indicate any other current or pending contracts, proposals, leases, or other ongoing procurement relationships the bidding entity has with any other unit of state government and shall clearly identify the unit and the contract, proposal, lease, or other relationship.

2. Disclosure Forms. Disclosure Form A is attached for use concerning the individuals meeting the above ownership or distributive share requirements. Subject individuals should be covered each by one form. In addition, a second form (Disclosure Form B) provides for the disclosure of current or pending procurement relationships with other (non-IDOT) state agencies. **The forms must be included with each bid or incorporated by reference.**

C. Disclosure Form Instructions

Form A: For bidders that have previously submitted the information requested in Form A

The Department has retained the Form A disclosures submitted by all bidders responding to these requirements for the April 24, 1998 or any subsequent letting conducted by the Department. The bidder has the option of submitting the information again or the bidder may check the following certification statement indicating that the information previously submitted by the bidder is, as of the date of submission, current and accurate. Before checking this certification, the bidder should carefully review its prior submissions to ensure the Certification is correct. If the Bidder checks the Certification, the Bidder should proceed to Form B instructions.

CERTIFICATION STATEMENT

I have determined that the Form A disclosure information previously submitted is current and accurate, and all forms are hereby incorporated by reference in this bid. Any necessary additional forms or amendments to previously submitted forms are attached to this bid.

(Bidding Company)



Signature of Authorized Representative

Date

Form A: For bidders who have NOT previously submitted the information requested in Form A

If the bidder is a publicly traded entity subject to Federal 10K reporting, the 10K Report may be submitted to meet the requirements of Form A. If a bidder is a privately held entity that is exempt from Federal 10K reporting, but has more than 400 shareholders, it may submit the information that Federal 10K companies are required to report, and list the names of any person or entity holding any ownership share that is in excess of 5%. If a bidder is not subject to Federal 10K reporting, the bidder must determine if any individuals are required by law to complete a financial disclosure form. To do this, the bidder should answer each of the following questions. A "YES" answer indicates Form A must be completed. If the answer to each of the following questions is "NO", then the NOT APPLICABLE STATEMENT on the second page of Form A must be signed and dated by a person that is authorized to execute contracts for the bidding company. Note: These questions are for assistance only and are not required to be completed.

1. Does anyone in your organization have a direct or beneficial ownership share of greater than 5% of the bidding entity or parent entity? YES ___ NO ___
2. Does anyone in your organization have a direct or beneficial ownership share of less than 5%, but which has a value greater than \$102,600.00? YES ___ NO ___
3. Does anyone in your organization receive more than \$106,447.20 of the bidding entity's or parent entity's distributive income? (Note: Distributive income is, for these purposes, any type of distribution of profits. An annual salary is not distributive income.) YES ___ NO ___
4. Does anyone in your organization receive greater than 5% of the bidding entity's or parent entity's total distributive income, but which is less than \$106,447.20? YES ___ NO ___
(Note: Only one set of forms needs to be completed per person per bid even if a specific individual would require a yes answer to more than one question.)

A "YES" answer to any of these questions requires the completion of Form A. The bidder must determine each individual in the bidding entity or the bidding entity's parent company that would cause the questions to be answered "Yes". Each form must be signed and dated by a person that is authorized to execute contracts for your organization. **Photocopied or stamped signatures are not acceptable.** The person signing can be, but does not have to be, the person for which the form is being completed. The bidder is responsible for the accuracy of any information provided.

If the answer to each of the above questions is "NO", then the NOT APPLICABLE STATEMENT on page 2 of Form A must be signed and dated by a person that is authorized to execute contracts for your company.

Form B: Identifying Other Contracts & Procurement Related Information Disclosure Form B must be completed for each bid submitted by the bidding entity. Note: *Checking the NOT APPLICABLE STATEMENT on Form A does not allow the bidder to ignore Form B. Form B must be completed, checked, and dated or the bidder may be considered nonresponsive and the bid will not be accepted.*

The Bidder shall identify, by checking Yes or No on Form B, whether it has any pending contracts (including leases), bids, proposals, or other ongoing procurement relationship with any other (non-IDOT) State of Illinois agency. If "No" is checked, the bidder only needs to complete the check box on the bottom of Form B. If "Yes" is checked, the bidder must do one of the following:

Option I: If the bidder did not submit an Affidavit of Availability to obtain authorization to bid, the bidder must list all non-IDOT State of Illinois agency pending contracts, leases, bids, proposals, and other ongoing procurement relationships. These items may be listed on Form B or on an attached sheet(s). Do not include IDOT contracts. Contracts with cities, counties, villages, etc. are not considered State of Illinois agency contracts and are not to be included. Contracts with other State of Illinois agencies such as the Department of Natural Resources or the Capital Development Board must be included. Bidders who submit Affidavits of Availability are suggested to use Option II.

Option II: If the bidder is required and has submitted an Affidavit of Availability in order to obtain authorization to bid, the bidder may write or type "See Affidavit of Availability" which indicates that the Affidavit of Availability is incorporated by reference and includes all non-IDOT State of Illinois agency pending contracts, leases, bids, proposals, and other ongoing procurement relationships. For any contracts that are not covered by the Affidavit of Availability, the bidder must identify them on Form B or on an attached sheet(s). These might be such things as leases.

D. Bidders Submitting More Than One Bid

Bidders submitting multiple bids may submit one set of forms consisting of all required Form A disclosures and one Form B for use with all bids. Please indicate in the space provided below the bid item that contains the original disclosure forms and the bid items which incorporate the forms by reference.

- The bid submitted for letting item _____ contains the Form A disclosures or Certification Statement and the Form B disclosures. The following letting items incorporate the said forms by reference:

RETURN WITH BID/OFFER

ILLINOIS DEPARTMENT OF TRANSPORTATION

Form A Financial Information & Potential Conflicts of Interest Disclosure

Contractor Name, Legal Address, City, State, Zip, Telephone Number, Email Address, Fax Number (if available)

Disclosure of the information contained in this Form is required by the Section 50-35 of the Illinois Procurement Code (30 ILCS 500). Vendors desiring to enter into a contract with the State of Illinois must disclose the financial information and potential conflict of interest information as specified in this Disclosure Form. This information shall become part of the publicly available contract file. This Form A must be completed for bids in excess of \$10,000, and for all open-ended contracts. A publicly traded company may submit a 10K disclosure (or equivalent if applicable) in satisfaction of the requirements set forth in Form A. See Disclosure Form Instructions.

DISCLOSURE OF FINANCIAL INFORMATION

1. Disclosure of Financial Information. The individual named below has an interest in the BIDDER (or its parent) in terms of ownership or distributive income share in excess of 5%, or an interest which has a value of more than \$106,447.20 (60% of the Governor's salary as of 3/1/09). (Make copies of this form as necessary and attach a separate Disclosure Form A for each individual meeting these requirements)

FOR INDIVIDUAL (type or print information)

NAME:

ADDRESS

Type of ownership/distributable income share:

stock _____ sole proprietorship _____ Partnership _____ other: (explain on separate sheet): % or \$ value of ownership/distributable income share: _____

2. Disclosure of Potential Conflicts of Interest. Check "Yes" or "No" to indicate which, if any, of the following potential conflict of interest relationships apply. If the answer to any question is "Yes", please attach additional pages and describe.

(a) State employment, currently or in the previous 3 years, including contractual employment of services. Yes ___ No ___

If your answer is yes, please answer each of the following questions.

1. Are you currently an officer or employee of either the Capitol Development Board or the Illinois Toll Highway Authority? Yes ___ No ___

2. Are you currently appointed to or employed by any agency of the State of Illinois? If you are currently appointed to or employed by any agency of the State of Illinois, and your annual salary exceeds \$106,447.20, (60% of the Governor's salary as of 3/1/09) provide the name the State agency for which you are employed and your annual salary. _____

RETURN WITH BID/OFFER

- 3. If you are currently appointed to or employed by any agency of the State of Illinois, and your annual salary exceeds \$106,447.20, (60% of the Governor's salary as of 3/1/09) are you entitled to receive (i) more than 7 1/2% of the total distributable income of your firm, partnership, association or corporation, or (ii) an amount in excess of the salary of the Governor? Yes ___ No ___

- 4. If you are currently appointed to or employed by any agency of the State of Illinois, and your annual salary exceeds \$106,447.20, (60% of the Governor's salary as of 3/1/09) are you and your spouse or minor children entitled to receive (i) more than 15% in aggregate of the total distributable income of your firm, partnership, association or corporation, or (ii) an amount in excess of 2 times the salary of the Governor? Yes ___ No ___

(b) State employment of spouse, father, mother, son, or daughter, including contractual employment for services in the previous 2 years.

Yes ___ No ___

If your answer is yes, please answer each of the following questions.

- 1. Is your spouse or any minor children currently an officer or employee of the Capitol Development Board or the Illinois Toll Highway Authority? Yes ___ No ___

- 2. Is your spouse or any minor children currently appointed to or employed by any agency of the State of Illinois? If your spouse or minor children is/are currently appointed to or employed by any agency of the State of Illinois, and his/her annual salary exceeds \$106,447.20, (60% of the Governor's salary as of 3/1/09) provide the name of the spouse and/or minor children, the name of the State agency for which he/she is employed and his/her annual salary. _____

- 3. If your spouse or any minor children is/are currently appointed to or employed by any agency of the State of Illinois, and his/her annual salary exceeds \$106,447.20.00, (60% of the salary of the Governor as of 3/1/09) are you entitled to receive (i) more than 7 1/2% of the total distributable income of your firm, partnership, association or corporation, or (ii) an amount in excess of the salary of the Governor? Yes ___ No ___

- 4. If your spouse or any minor children are currently appointed to or employed by any agency of the State of Illinois, and his/her annual salary exceeds \$106,447.20, (60% of the Governor's salary as of 3/1/09) are you and your spouse or any minor children entitled to receive (i) more than 15% in the aggregate of the total distributable income from your firm, partnership, association or corporation, or (ii) an amount in excess of 2 times the salary of the Governor? Yes ___ No ___

(c) Elective status; the holding of elective office of the State of Illinois, the government of the United States, any unit of local government authorized by the Constitution of the State of Illinois or the statutes of the State of Illinois currently or in the previous 3 years.

Yes ___ No ___

(d) Relationship to anyone holding elective office currently or in the previous 2 years; spouse, father, mother, son, or daughter.

Yes ___ No ___

(e) Appointive office; the holding of any appointive government office of the State of Illinois, the United State of America, or any unit of local government authorized by the Constitution of the State of Illinois or the statutes of the State of Illinois, which office entitles the holder to compensation in excess of the expenses incurred in the discharge of that office currently or in the previous 3 years.

Yes ___ No ___

(f) Relationship to anyone holding appointive office currently or in the previous 2 years; spouse, father, mother, son, or daughter.

Yes ___ No ___

(g) Employment, currently or in the previous 3 years, as or by any registered lobbyist of the State government.

Yes ___ No ___

RETURN WITH BID/OFFER

(h) Relationship to anyone who is or was a registered lobbyist in the previous 2 years; spouse, father, mother, son, or daughter. Yes ___ No ___

(i) Compensated employment, currently or in the previous 3 years, by any registered election or reelection committee registered with the Secretary of State or any county clerk of the State of Illinois, or any political action committee registered with either the Secretary of State or the Federal Board of Elections. Yes ___ No ___

(j) Relationship to anyone; spouse, father, mother, son, or daughter; who was a compensated employee in the last 2 years by any registered election or re-election committee registered with the Secretary of State or any county clerk of the State of Illinois, or any political action committee registered with either the Secretary of State or the Federal Board of Elections. Yes ___ No ___

APPLICABLE STATEMENT

This Disclosure Form A is submitted on behalf of the INDIVIDUAL named on previous page.

Completed by: _____ Date _____
Signature of Individual or Authorized Representative

NOT APPLICABLE STATEMENT

I have determined that no individuals associated with this organization meet the criteria that would require the completion of this Form A.

This Disclosure Form A is submitted on behalf of the CONTRACTOR listed on the previous page.

_____ Date _____
Signature of Authorized Representative

RETURN WITH BID/OFFER

**ILLINOIS DEPARTMENT
OF TRANSPORTATION**

**Form B
Other Contracts &
Procurement Related Information
Disclosure**

Contractor Name		
Legal Address		
City, State, Zip		
Telephone Number	Email Address	Fax Number (if available)

Disclosure of the information contained in this Form is required by the Section 50-35 of the Illinois Procurement Act (30 ILCS 500). This information shall become part of the publicly available contract file. This Form B must be completed for bids in excess of \$10,000, and for all open-ended contracts.

DISCLOSURE OF OTHER CONTRACTS AND PROCUREMENT RELATED INFORMATION

1. Identifying Other Contracts & Procurement Related Information. The BIDDER shall identify whether it has any pending contracts (including leases), bids, proposals, or other ongoing procurement relationship with any other State of Illinois agency: Yes ___ No ___

If "No" is checked, the bidder only needs to complete the signature box on the bottom of this page.

2. If "Yes" is checked. Identify each such relationship by showing State of Illinois agency name and other descriptive information such as bid or project number (attach additional pages as necessary). SEE DISCLOSURE FORM INSTRUCTIONS:

THE FOLLOWING STATEMENT MUST BE CHECKED

<input type="checkbox"/>	_____	_____
	Signature of Authorized Representative	Date

RETURN WITH BID

SPECIAL NOTICE TO CONTRACTORS

The following requirements of the Illinois Department of Human Rights' Rules and Regulations are applicable to bidders on all construction contracts advertised by the Illinois Department of Transportation:

CONSTRUCTION EMPLOYEE UTILIZATION PROJECTION

- (a) All bidders on construction contracts shall complete and submit, along with and as part of their bids, a Bidder's Employee Utilization Form (Form BC-1256) setting forth a projection and breakdown of the total workforce intended to be hired and/or allocated to such contract work by the bidder including a projection of minority and female employee utilization in all job classifications on the contract project.
- (b) The Department of Transportation shall review the Employee Utilization Form, and workforce projections contained therein, of the contract awardee to determine if such projections reflect an underutilization of minority persons and/or women in any job classification in accordance with the Equal Employment Opportunity Clause and Section 7.2 of the Illinois Department of Human Rights' Rules and Regulations for Public Contracts adopted as amended on September 17, 1980. If it is determined that the contract awardee's projections reflect an underutilization of minority persons and/or women in any job classification, it shall be advised in writing of the manner in which it is underutilizing and such awardee shall be considered to be in breach of the contract unless, prior to commencement of work on the contract project, it submits revised satisfactory projections or an acceptable written affirmative action plan to correct such underutilization including a specific timetable geared to the completion stages of the contract.
- (c) The Department of Transportation shall provide to the Department of Human Rights a copy of the contract awardee's Employee Utilization Form, a copy of any required written affirmative action plan, and any written correspondence related thereto. The Department of Human Rights may review and revise any action taken by the Department of Transportation with respect to these requirements.

RETURN WITH BID

**Contract No. 68561
WOODFORD County
Section 107RS-5 & 108RS-4
Project ESP-0673(024)
Route FAP 673
District 4 Construction Funds**

PART II. WORKFORCE PROJECTION - continued

- B. Included in "Total Employees" under Table A is the total number of **new hires** that would be employed in the event the undersigned bidder is awarded this contract.

The undersigned bidder projects that: (number) _____ new hires would be recruited from the area in which the contract project is located; and/or (number) _____ new hires would be recruited from the area in which the bidder's principal office or base of operation is located.

- C. Included in "Total Employees" under Table A is a projection of numbers of persons to be employed directly by the undersigned bidder as well as a projection of numbers of persons to be employed by subcontractors.

The undersigned bidder estimates that (number) _____ persons will be directly employed by the prime contractor and that (number) _____ persons will be employed by subcontractors.

PART III. AFFIRMATIVE ACTION PLAN

- A. The undersigned bidder understands and agrees that in the event the foregoing minority and female employee utilization projection included under **PART II** is determined to be an underutilization of minority persons or women in any job category, and in the event that the undersigned bidder is awarded this contract, he/she will, prior to commencement of work, develop and submit a written Affirmative Action Plan including a specific timetable (geared to the completion stages of the contract) whereby deficiencies in minority and/or female employee utilization are corrected. Such Affirmative Action Plan will be subject to approval by the contracting agency and the **Department of Human Rights**.
- B. The undersigned bidder understands and agrees that the minority and female employee utilization projection submitted herein, and the goals and timetable included under an Affirmative Action Plan if required, are deemed to be part of the contract specifications.

Company _____ Telephone Number _____

Address _____

NOTICE REGARDING SIGNATURE

The Bidder's signature on the Proposal Signature Sheet will constitute the signing of this form. The following signature block needs to be completed only if revisions are required.

Signature: _____ Title: _____ Date: _____

- Instructions: All tables must include subcontractor personnel in addition to prime contractor personnel.
- Table A - Include both the number of employees that would be hired to perform the contract work and the total number currently employed (Table B) that will be allocated to contract work, and include all apprentices and on-the-job trainees. The "Total Employees" column should include all employees including all minorities, apprentices and on-the-job trainees to be employed on the contract work.
 - Table B - Include all employees currently employed that will be allocated to the contract work including any apprentices and on-the-job trainees currently employed.
 - Table C - Indicate the racial breakdown of the total apprentices and on-the-job trainees shown in Table A.

RETURN WITH BID

ADDITIONAL FEDERAL REQUIREMENTS

In addition to the Required Contract Provisions for Federal-Aid Construction Contracts (FHWA 1273), all bidders make the following certifications.

- A. By the execution of this proposal, the signing bidder certifies that the bidding entity has not, either directly or indirectly, entered into any agreement, participated in any collusion, or otherwise taken any action, in restraint of free competitive bidding in connection with the submitted bid. This statement made by the undersigned bidder is true and correct under penalty of perjury under the laws of the United States.
- B. **CERTIFICATION, EQUAL EMPLOYMENT OPPORTUNITY:**
1. Have you participated in any previous contracts or subcontracts subject to the equal opportunity clause. YES _____ NO _____
 2. If answer to #1 is yes, have you filed with the Joint Reporting Committee, the Director of OFCC, any Federal agency, or the former President's Committee on Equal Employment Opportunity, all reports due under the applicable filing requirements of those organizations? YES _____ NO _____

RETURN WITH BID

**Contract No. 68561
WOODFORD County
Section 107RS-5 & 108RS-4
Project ESP-0673(024)
Route FAP 673
District 4 Construction Funds**

PROPOSAL SIGNATURE SHEET

The undersigned bidder hereby makes and submits this bid on the subject Proposal, thereby assuring the Department that all requirements of the Invitation for Bids and rules of the Department have been met, that there is no misunderstanding of the requirements of paragraph 3 of this Proposal, and that the contract will be executed in accordance with the rules of the Department if an award is made on this bid.

(IF AN INDIVIDUAL) Firm Name _____
Signature of Owner _____
Business Address _____

(IF A CO-PARTNERSHIP) Firm Name _____
By _____
Business Address _____
Name and Address of All Members of the Firm: _____

(IF A CORPORATION) Corporate Name _____
By _____
Signature of Authorized Representative _____
Typed or printed name and title of Authorized Representative _____

(IF A JOINT VENTURE, USE THIS SECTION FOR THE MANAGING PARTY AND THE SECOND PARTY SHOULD SIGN BELOW) Attest _____
Signature _____
Business Address _____

(IF A JOINT VENTURE) Corporate Name _____
By _____
Signature of Authorized Representative _____
Typed or printed name and title of Authorized Representative _____

Attest _____
Signature _____
Business Address _____

If more than two parties are in the joint venture, please attach an additional signature sheet.



Return with Bid

Division of Highways
Proposal Bid Bond
(Effective November 1, 1992)

Item No. _____

Letting Date _____

KNOW ALL MEN BY THESE PRESENTS, That We _____

as PRINCIPAL, and _____

_____ as SURETY, are held jointly, severally and firmly bound unto the STATE OF ILLINOIS in the penal sum of 5 percent of the total bid price, or for the amount specified in Article 102.09 of the "Standard Specifications for Road and Bridge Construction" in effect on the date of invitation for bids, whichever is the lesser sum, well and truly to be paid unto said STATE OF ILLINOIS, for the payment of which we bind ourselves, our heirs, executors, administrators, successors and assigns.

THE CONDITION OF THE FOREGOING OBLIGATION IS SUCH, that whereas, the PRINCIPAL has submitted a bid proposal to the STATE OF ILLINOIS, acting through the Department of Transportation, for the improvement designated by the Transportation Bulletin Item Number and Letting Date indicated above.

NOW, THEREFORE, if the Department shall accept the bid proposal of the PRINCIPAL; and if the PRINCIPAL shall, within the time and as specified in the bidding and contract documents, submit a DBE Utilization Plan that is accepted and approved by the Department; and if, after award by the Department, the PRINCIPAL shall enter into a contract in accordance with the terms of the bidding and contract documents including evidence of the required insurance coverages and providing such bond as specified with good and sufficient surety for the faithful performance of such contract and for the prompt payment of labor and material furnished in the prosecution thereof; or if, in the event of the failure of the PRINCIPAL to make the required DBE submission or to enter into such contract and to give the specified bond, the PRINCIPAL pays to the Department the difference not to exceed the penalty hereof between the amount specified in the bid proposal and such larger amount for which the Department may contract with another party to perform the work covered by said bid proposal, then this obligation shall be null and void, otherwise, it shall remain in full force and effect.

IN THE EVENT the Department determines the PRINCIPAL has failed to comply with any requirement as set forth in the preceding paragraph, then Surety shall pay the penal sum to the Department within fifteen (15) days of written demand therefor. If Surety does not make full payment within such period of time, the Department may bring an action to collect the amount owed. Surety is liable to the Department for all its expenses, including attorney's fees, incurred in any litigation in which it prevails either in whole or in part.

In TESTIMONY WHEREOF, the said PRINCIPAL and the said SURETY have caused this instrument to be signed by

their respective officers this _____ day of _____ A.D., _____ .

PRINCIPAL

(Company Name) (Company Name)

By _____ By: _____
(Signature & Title) (Signature of Attorney-in-Fact)

Notary Certification for Principal and Surety

STATE OF ILLINOIS,

County of _____

I, _____, a Notary Public in and for said County, do hereby certify that

_____ and _____
(Insert names of individuals signing on behalf of PRINCIPAL & SURETY)

who are each personally known to me to be the same persons whose names are subscribed to the foregoing instrument on behalf of PRINCIPAL and SURETY, appeared before me this day in person and acknowledged respectively, that they signed and delivered said instrument as their free and voluntary act for the uses and purposes therein set forth.

Given under my hand and notarial seal this _____ day of _____ A.D. _____

My commission expires _____

Notary Public

In lieu of completing the above section of the Proposal Bid Form, the Principal may file an Electronic Bid Bond. By signing the proposal and marking the check box next to the Signature and Title line below, the Principal is ensuring the identified electronic bid bond has been executed and the Principal and Surety are firmly bound unto the State of Illinois under the conditions of the bid bond as shown above.



Electronic Bid Bond ID# _____ Company / Bidder Name _____ Signature and Title _____

PROPOSAL ENVELOPE



PROPOSALS

for construction work advertised for bids by the
Illinois Department of Transportation

Item No.	Item No.	Item No.

Submitted By:

Name:
Address:
Phone No.

Bidders should use an IDOT proposal envelope or affix this form to the front of a 10" x 13" envelope for the submittal of bids. If proposals are mailed, they should be enclosed in a second or outer envelope addressed to:

Engineer of Design and Environment - Room 326
Illinois Department of Transportation
2300 South Dirksen Parkway
Springfield, Illinois 62764

NOTICE

Individual bids, including Bid Bond and/or supplemental information if required, should be securely stapled.

CONTRACTOR OFFICE COPY OF CONTRACT SPECIFICATIONS

NOTICE

None of the following material needs to be returned with the bid package unless the special provisions require documentation and/or other information to be submitted.

**Contract No. 68561
WOODFORD County
Section 107RS-5 & 108RS-4
Project ESP-0673(024)
Route FAP 673
District 4 Construction Funds**



Illinois Department of Transportation



NOTICE TO BIDDERS

- 1. TIME AND PLACE OF OPENING BIDS.** Sealed proposals for the improvement described herein will be received by the Department of Transportation at the Harry R. Hanley Building, 2300 South Dirksen Parkway, in Springfield, Illinois until 10:00 o'clock a.m., April 3, 2009. All bids will be gathered, sorted, publicly opened and read in the auditorium at the Department of Transportation's Harry R. Hanley Building shortly after the 10:00 a.m. cut off time.
- 2. DESCRIPTION OF WORK.** The proposed improvement is identified and advertised for bids in the Invitation for Bids as:

**Contract No. 68561
WOODFORD County
Section 107RS-5 & 108RS-4
Project ESP-0673(024)
Route FAP 673
District 4 Construction Funds**

5.90 miles of resurfacing on IL Routes 116 and 117 from the west city limits of Roanoke to the IL Route 116/117 juncton.

- 3. INSTRUCTIONS TO BIDDERS.** (a) This Notice, the invitation for bids, proposal and letter of award shall, together with all other documents in accordance with Article 101.09 of the Standard Specifications for Road and Bridge Construction, become part of the contract. Bidders are cautioned to read and examine carefully all documents, to make all required inspections, and to inquire or seek explanation of the same prior to submission of a bid.

(b) State law, and, if the work is to be paid wholly or in part with Federal-aid funds, Federal law requires the bidder to make various certifications as a part of the proposal and contract. By execution and submission of the proposal, the bidder makes the certification contained therein. A false or fraudulent certification shall, in addition to all other remedies provided by law, be a breach of contract and may result in termination of the contract.
- 4. AWARD CRITERIA AND REJECTION OF BIDS.** This contract will be awarded to the lowest responsive and responsible bidder considering conformity with the terms and conditions established by the Department in the rules, Invitation for Bids and contract documents. The issuance of plans and proposal forms for bidding based upon a prequalification rating shall not be the sole determinant of responsibility. The Department reserves the right to determine responsibility at the time of award, to reject any or all proposals, to readvertise the proposed improvement, and to waive technicalities.

By Order of the
Illinois Department of Transportation

Gary Hannig,
Acting Secretary

INDEX
 FOR
 SUPPLEMENTAL SPECIFICATIONS
 AND RECURRING SPECIAL PROVISIONS

Adopted January 1, 2009

This index contains a listing of SUPPLEMENTAL SPECIFICATIONS and frequently used RECURRING SPECIAL PROVISIONS.

ERRATA Standard Specifications for Road and Bridge Construction (Adopted 1-1-07) (Revised 1-1-09)

SUPPLEMENTAL SPECIFICATIONS

<u>Std. Spec. Sec.</u>	<u>Page No.</u>
201 Clearing, Tree Removal and Protection	1
205 Embankment	2
251 Mulch	3
253 Planting Woody Plants	4
280 Temporary Erosion Control	6
443 Reflective Crack Control Treatment	7
502 Excavation for Structures	10
503 Concrete Structures	11
504 Precast Concrete Structures	12
505 Steel Structures	13
540 Box Culverts	14
581 Waterproofing Membrane System	15
633 Removing and Reerecting Guardrail and Terminals	16
669 Removal and Disposal of Regulated Substances	17
672 Sealing Abandoned Water Wells	18
701 Work Zone Traffic Control and Protection	19
733 Overhead Sign Structures	20
783 Pavement Marking and Marker Removal	21
801 Electrical Requirements	22
805 Electrical Service Installation – Traffic Signals	23
836 Pole Foundation	24
838 Breakaway Devices	25
862 Uninterruptable Power Supply	26
873 Electric Cable	28
878 Traffic Signal Concrete Foundation	30
1004 Coarse Aggregates	31
1008 Structural Steel Coatings	32
1010 Finely Divided Materials	33
1020 Portland Cement Concrete	34
1022 Concrete Curing Materials	43
1024 Nonshrink Grout	44
1042 Precast Concrete Products	45
1062 Reflective Crack Control System	47
1069 Pole and Tower	49
1074 Control Equipment	52
1076 Wire and Cable	57
1081 Materials for Planting	58
1083 Elastomeric Bearings	60
1094 Overhead Sign Structures	61
1101 General Equipment	62
1102 Hot-Mix Asphalt Equipment	63
1106 Work Zone Traffic Control Devices	64

RECURRING SPECIAL PROVISIONS

The following RECURRING SPECIAL PROVISIONS indicated by an "X" are applicable to this contract and are included by reference:

<u>CHECK SHEET #</u>	<u>PAGE NO.</u>
1 X Additional State Requirements For Federal-Aid Construction Contracts (Eff. 2-1-69) (Rev. 1-1-07)	65
2 X Subletting of Contracts (Federal-Aid Contracts) (Eff. 1-1-88) (Rev. 5-1-93)	67
3 X EEO (Eff. 7-21-78) (Rev. 11-18-80)	68
4 Specific Equal Employment Opportunity Responsibilities Non Federal-Aid Contracts (Eff. 3-20-69) (Rev. 1-1-94)	78
5 Required Provisions - State Contracts (Eff. 4-1-65) (Rev. 1-1-07)	83
6 Reserved	88
7 Reserved	89
8 Haul Road Stream Crossings, Other Temporary Stream Crossings, and In-Stream Work Pads (Eff. 1-2-92) (Rev. 1-1-98)	90
9 Construction Layout Stakes Except for Bridges (Eff. 1-1-99) (Rev. 1-1-07)	91
10 Construction Layout Stakes (Eff. 5-1-93) (Rev. 1-1-07)	94
11 Use of Geotextile Fabric for Railroad Crossing (Eff. 1-1-95) (Rev. 1-1-07)	97
12 Subsealing of Concrete Pavements (Eff. 11-1-84) (Rev. 1-1-07)	99
13 Hot-Mix Asphalt Surface Correction (Eff. 11-1-87) (Rev. 1-1-09)	103
14 Pavement and Shoulder Resurfacing (Eff. 2-1-00) (Rev. 1-1-09)	105
15 PCC Partial Depth Hot-Mix Asphalt Patching (Eff. 1-1-98) (Rev. 1-1-07)	106
16 Patching with Hot-Mix Asphalt Overlay Removal (Eff. 10-1-95) (Rev. 1-1-07)	108
17 Polymer Concrete (Eff. 8-1-95) (Rev. 1-1-08)	109
18 PVC Pipeliner (Eff. 4-1-04) (Rev. 1-1-07)	111
19 Pipe Underdrains (Eff. 9-9-87) (Rev. 1-1-07)	112
20 X Guardrail and Barrier Wall Delineation (Eff. 12-15-93) (Rev. 1-1-97)	113
21 Bicycle Racks (Eff. 4-1-94) (Rev. 1-1-07)	117
22 Temporary Modular Glare Screen System (Eff. 1-1-00) (Rev. 1-1-07)	119
23 Temporary Portable Bridge Traffic Signals (Eff. 8-1-03) (Rev. 1-1-07)	121
24 Work Zone Public Information Signs (Eff. 9-1-02) (Rev. 1-1-07)	123
25 Night Time Inspection of Roadway Lighting (Eff. 5-1-96)	124
26 English Substitution of Metric Bolts (Eff. 7-1-96)	125
27 English Substitution of Metric Reinforcement Bars (Eff. 4-1-96) (Rev. 1-1-03)	126
28 Calcium Chloride Accelerator for Portland Cement Concrete (Eff. 1-1-01)	127
29 Reserved	128
30 Quality Control of Concrete Mixtures at the Plant (Eff. 8-1-00) (Rev. 1-1-09)	129
31 Quality Control/Quality Assurance of Concrete Mixtures (Eff. 4-1-92) (Rev. 1-1-09)	137
32 Asbestos Bearing Pad Removal (Eff. 11-1-03)	149
33 Asbestos Hot-Mix Asphalt Surface Removal (Eff. 6-1-89) (Rev. 1-1-09)	150

TABLE OF CONTENTS

LOCATION OF PROJECT	1
DESCRIPTION OF PROJECT	1
TEMPERATURE CONTROL FOR CONCRETE PLACEMENT	1
SEEDING, MINOR AREAS.....	1
MOWING.....	2
HOT-MIX ASPHALT SURFACE COURSE SURFACE TESTS.....	2
HOT-MIX ASPHALT SURFACE REMOVAL, 1½"	3
HOT-MIX ASPHALT SURFACE REMOVAL, 2¼"	5
PAVEMENT DRAINAGE AFTER COLD MILLING	7
HOT-MIX ASPHALT SHOULDER RESURFACING CONSTRUCTED SIMULTANEOUSLY WITH MAINLINE PAVING.....	8
GUARDRAIL AGGREGATE EROSION CONTROL.....	8
TRAFFIC BARRIER TERMINALS	8
TRAFFIC CONTROL PLAN	9
HOT MIX ASPHALT – DENSITY TESTING OF LONGITUDINAL JOINTS (BMPR).....	9
AMERICAN RECOVERY AND REINVESTMENT ACT SIGNING (BDE)	10
ALKALI-SILICA REACTION FOR CAST-IN-PLACE CONCRETE (BDE)	14
APPROVAL OF PROPOSED BORROW AREAS, USE AREAS, AND/OR WASTE AREAS INSIDE ILLINOIS STATE BORDERS (BDE).....	16
AUTOMATED FLAGGER ASSISTANCE DEVICES (BDE).....	17
CEMENT (BDE)	18
CONCRETE ADMIXTURES (BDE)	20
CONSTRUCTION AIR QUALITY – DIESEL VEHICLE EMISSIONS CONTROL (BDE).....	23
CONSTRUCTION AIR QUALITY - IDLING RESTRICTIONS (BDE).....	25
DISADVANTAGED BUSINESS ENTERPRISE PARTICIPATION (BDE)	26
ENGINEER’S FIELD OFFICE TYPE A (BDE).....	33
EPOXY PAVEMENT MARKINGS (BDE).....	36
EQUIPMENT RENTAL RATES (BDE).....	37
FLAGGER AT SIDE ROADS AND ENTRANCES (BDE)	38
HOT-MIX ASPHALT - FIELD VOIDS IN THE MINERAL AGGREGATE (BDE).....	38
HOT-MIX ASPHALT – PLANT TEST FREQUENCY (BDE).....	40
HOT-MIX ASPHALT – TRANSPORTATION (BDE)	41
HOT-MIX ASPHALT MIXTURE IL-4.75 (BDE)	42
LIQUIDATED DAMAGES (BDE).....	47
MATERIAL TRANSFER DEVICE (BDE)	47
MONTHLY EMPLOYMENT REPORT (BDE)	48
NATIONAL POLLUTANT DISCHARGE ELIMINATION SYSTEM / EROSION AND SEDIMENT CONTROL DEFICIENCY DEDUCTION (BDE)	51

PAYMENTS TO SUBCONTRACTORS (BDE)	51
PAYROLLS AND PAYROLL RECORDS (BDE)	52
PERSONAL PROTECTIVE EQUIPMENT (BDE)	54
PLASTIC BLOCKOUTS FOR GUARDRAIL (BDE)	54
PORTLAND CEMENT CONCRETE PLANTS (BDE)	54
RECLAIMED ASPHALT PAVEMENT (RAP) (BDE)	55
REFLECTIVE SHEETING ON CHANNELIZING DEVICES (BDE)	62
STEEL PLATE BEAM GUARDRAIL (BDE)	62
SUBCONTRACTOR MOBILIZATION PAYMENTS (BDE)	63
WORKING DAYS (BDE)	63
BITUMINOUS MATERIALS COST ADJUSTMENTS (BDE) (RETURN FORM WITH BID)	63
STEEL COST ADJUSTMENT (BDE) (RETURN FORM WITH BID)	66

STATE OF ILLINOIS

SPECIAL PROVISIONS

The following Special Provisions supplement the "Standard Specifications for Road and Bridge Construction," adopted January 1, 2007, the latest edition of the "Manual on Uniform Traffic Control Devices for Streets and Highways," and the "Manual of Test Procedures for Materials" in effect on the date of invitation for bids, and the Supplemental Specifications and Recurring Special Provisions indicated on the Check Sheet included herein which apply to and govern the construction of FAP Route 613 (IL 116/IL 117), Project ESP-0673(024), Section 108RS-5,107RS-4 in Woodford County, Contract No. 68561, and in case of conflict with any part or parts of said Specifications, the said Special Provisions shall take precedence and shall govern.

LOCATION OF PROJECT

This project is located on Illinois Route 116/Illinois Route 117. It starts at the west side of the town of Roanoke. It extends easterly for 5.9 miles. It ends just west of the Illinois Route 116/Illinois Route 117 junction. This project is located in Woodford County.

DESCRIPTION OF PROJECT

This project consists of patching, milling and resurfacing of Illinois route 116/Illinois Route 117 in Roanoke. It also includes the construction of two-foot (2') safety shoulders in the rural section.

TEMPERATURE CONTROL FOR CONCRETE PLACEMENT

Effective: August 3, 2007

Delete the second and third sentences of the second paragraph of Article 1020.14(a) of the Standard Specifications.

SEEDING, MINOR AREAS

Seeding, fertilizing, and mulching shall be done in accordance with Article 250 of the Standard Specifications except for the following revisions:

All areas disturbed by the work performed including the installation of guardrail and concrete curb and gutter shall be seeded, fertilized, and mulched in accordance with Article 251.03(a). The materials may be purchased locally and placed as directed by the engineer.

The estimated area is approximately 0.1 acres. The seed mixture shall be applied at 100 pounds/acre (110 kg/ha). The mixture shall be one that contains a high percentage of Kentucky

Blue Grass. All seeds shall meet the purity and noxious weed requirements of Article 1081.04 of the Standard Specifications, and be approved by the engineer.

The fertilizer nutrients shall be applied at a rate of 270 lbs. (300 kg) of actual nutrients per acre (hectare). The fertilizer furnished shall be ready mixed material having a ratio of (1-1-1).

The contractor shall provide the engineer with the test results from the seed container and the chemical analysis of the fertilizer nutrients.

The seed, fertilizer, and mulch will not be measured for payment but will be considered included in the cost of corresponding items.

MOWING

Effective December 11, 2001

Revised January 1, 2007

This work shall consist of mowing the roadway foreslopes to the ditchline or for a width of 15' (4.572 meters) from both edges of pavement or paved shoulder, whichever is less. At intersecting roadways, the mowing shall extend to the proposed right of way for a distance of 150' (45 m) on either side of the intersection. The height of the mowing shall not be more than 6" (150 mm). Equipment used shall be capable of completely severing all growth at the cutting height and distributing it evenly over the mowed area. The Contractor will not be required to mow continuously wet ditches and drainage ways, slopes greater than 1:3 (V:H), or areas which may be designated by the Engineer as not mowable. Mowing shall be done within the project limits during the construction of the project as directed by the Engineer and prior to the final inspection of the project. Any subsequent mowing required to disperse mowed material shall be considered as included in the cost of the mowing. Debris encountered during mowing, which interferes with the mowing operation or is visible from the roadway shall be removed and disposed of according to Article 250.05.

Method of Measurement: Mowing will be measured for payment in units of 100' (30 m) in horizontal distances along the roadway centerline. For purposes of measurement, the quantity of units to be paid for each individual mowing is defined as the net length of the project as shown on the cover sheet of the construction plans divided by 100' (30 m) which includes the left and right sides of the roadway. No allowances will be made for variations in width of mowing.

Basis of Payment: This work will be paid for at the contract unit price per unit for MOWING.

HOT-MIX ASPHALT SURFACE COURSE SURFACE TESTS

Effective: November 1, 2003

Revised January 1, 2007

The Contractor shall provide a person to operate the straight edge in accordance with Article 406.11 of the Standard Specifications and communicate with IDOT personnel to minimize the surface course bumps. If surface course bumps cannot be removed at this time, IDOT personnel will record the locations and provide deductions as stated in Article 406.11.

HOT-MIX ASPHALT SURFACE REMOVAL, 1½"

Effective March 1, 1993

Revised April 24, 2009

Description: This work shall consist of removing a portion of the existing hot-mix asphalt concrete surface course in accordance with the applicable portions of Section 440 and 1101 of the Standard Specifications, this special provision, details in the plans and as directed by the Engineer. The cold milled salvaged aggregate resulting from this operation shall become the property of the Contractor.

Equipment: The machine used for milling and planing shall be a self-propelled grinding machine having a minimum 12' (3.6 m) wide drum at least 28" (710 mm) in diameter. The grinding machine shall be capable of accurately and automatically establishing profile grades by referencing from either the existing pavement or from an independent grade control and shall have a positive means for controlling cross slope elevations. It shall also have an effective means for removing excess material from the surface and for preventing dust resulting from the operation from escaping into the air. When a milling width in excess of 12' is required and the Contractor's milling machine is less than the required width shown in the plans, the remaining area shall be milled with a machine capable of meeting the requirements of this special provision. Milling attachments used with skid steer tractors will not be allowed for longitudinal areas to mill additional widths.

The cutting teeth used in the milling operation shall be the GTE AM722, or an approved equivalent. When the teeth become worn so that they do not produce a uniform surface texture, they shall all be changed at the same time (as a unit). Occasionally, individual teeth may be changed if they lock up or break, but this method shall not be used to avoid changing the set of teeth as a unit.

The moldboard is critical in obtaining the desired surface texture. It shall be straight, true, and free of excessive nicks or wear, and it shall be replaced as necessary to uniformly produce the required surface texture. Gouging of the pavement by more than 1/4 inch (6 mm) shall be sufficient cause to require replacement of all teeth.

Occasional gouges, due to deteriorated pavement condition, or separation of lifts will not be cause to replace all teeth. The Engineer will be the sole judge of the cause of the pavement gouging and the corrective work required. Corrective work due to negligence or poor workmanship shall be at the Contractor's expense.

Construction Requirements

General: The temperature at which the work is performed, the nature and condition of the equipment, and the manner of performing the work shall be such that the milled and planed surface is not torn, gouged, shoved, or otherwise injured by the grinding operation. Sufficient cutting passes shall be made so that all irregularities or high spots are eliminated.

Weather conditions, when milling work is performed, must be such that short term or temporary pavement markings can be placed the day the surface is milled in accordance with Section 703 "Work Zone Pavement Markings".

An automatic grade control device shall be used when milling mainline pavement and shall be

capable of controlling the elevation of the drum relative to either a preset grade control stringline or a grade reference device traveling on the adjacent pavement surface. The automatic grade control device may be utilized only on one side of the machine with a automatic slope control device controlling the opposite side. The traveling grade reference device shall not be less than 30 feet (9 m) in length. When milling cross roads, turn lanes, intersections, crossovers, or other miscellaneous areas, the Engineer may permit the matching shoe. The Contractor, at his option, may also substitute an approved 6' wide (1.8 m) machine for areas other than mainline pavement.

The Contractor shall mill 1½" inch at the centerline, except when the milling at the outer edge of the lane would exceed 1.5 inches (40 mm); then the Contractor shall reduce the cut at the centerline to provide the maximum cut of 1.5 inches (40 mm) at the edge of pavement. If deemed necessary, the Contractor may reduce the cross slope from normal 1.5% to 1%. A drawing labeled "Hot-Mix Asphalt Surface Removal" is included in the plans.

Surface tests will be performed in accordance with Article 407.09(a) of the Standard Specifications. The longitudinal profile will be taken 3 ft. (0.9 m) from and parallel to each edge of pavement and 3 ft. (0.9 m) from and parallel to the centerline on each side. If a shadow area is found at the 3 ft. (0.9 m) points the pavement smoothness tester will be moved sufficient distance either side to measure the Contractor's milling efforts. Any surface variations exceeding the tolerance of Table 1 of Article 407.09 shall be corrected by reprofiling at no additional expense to the Department. In addition, the Contractor shall be responsible for refilling with approved hot-mix asphalt mixtures any area that lowered the pavement profile as a result of faulty milling operations if directed by the Engineer. The Contractor shall be responsible for providing the pavement smoothness tester described elsewhere to retest the pavement profile obtained.

If the milling depth is intended to expose the original concrete pavement, then additional hand or machine work may be necessary to remove any remaining veneer of bituminous pavement which may be left in place behind the milling machine. Such work will be at the direction of the Engineer and at no extra cost to the Department.

The Contractor shall provide a 10 foot (3 m) straightedge equipped with a carpenter's level or a 7 foot (2.1 m) electronic straightedge to check the cross slope of the roadway at regular intervals as directed by the Engineer.

Surface Texture: Each tooth on the cutting drum shall produce a series of discontinuous longitudinal striations. There shall be 16 to 20 striations (tooth marks) for each tooth for each 6 feet (1.8 m) in the longitudinal direction, and each striation shall be 1.7 inches \pm 0.2 inch (43 \pm 5 mm) in length after the area is planed by the moldboard. Thus, the planed length between each pair of striations shall be 2.3 inches \pm 0.2 inch (58 \pm 5 mm). There shall be 80 to 96 rows of discontinuous longitudinal striations for each 5 feet (1.5 m) in the transverse dimension. The areas between the striations in both the longitudinal and transverse directions shall be flat topped and coplaner. The moldboard shall be used to cut this plane; and any time the operation fails to produce this flat plane interspersed with a uniform pattern of discontinuous longitudinal striations, the operation shall be stopped and the cause determined and corrected before recommencing. Other similar patterns of uniform discontinuous longitudinal striations interspersed on a flat plane may be approved by the Engineer. The drawing titled "Hot-Mix Asphalt Surface Removal" showing the desired surface texture is included in the plans.

The start-up milling speed shall be limited to a maximum of 50 foot (15 m) per minute. The Contractor shall limit his operations to this speed to demonstrate his ability to obtain the striations and ride ability as described above. If the Contractor is able to demonstrate that he can consistently obtain the desired striations and ride ability at a greater speed he will be permitted to run at the increased speed.

Cleanup: After cold milling a traffic lane and before opening the lane to traffic, the pavement shall be swept by a mechanical broom to prevent compaction of the cuttings onto the pavement. All loose material shall be removed from the roadway. Before the prime coat is placed, the pavement shall be cleaned of all foreign material to the satisfaction of the Engineer.

This cleanup work shall be considered included in the contract unit price per square meter (square yard) for HOT-MIX ASPHALT SURFACE REMOVAL of the depth specified, and no additional compensation will be allowed.

Method of Measurement:

- (a) Contract Quantities. The requirements for the use of Contract Quantities shall be Article 202.07(a) of the Standard Specifications.
- (b) Measured Quantities. Cold milling and planing will be measured and the area computed in square yards (square meters) of surface.

Areas not milled (shadowed areas) due to rutting in the existing pavement surface will be included in the area measured for payment.

Basis of Payment: The cold milling and planing will be paid for at the contract unit price per square yard (square meter) for HOT-MIX ASPHALT SURFACE REMOVAL of the depth specified. Payment as specified will include variations in depth of cuts due to rutting, superelevations, and pavement crown and no additional compensation will be allowed.

HOT-MIX ASPHALT SURFACE REMOVAL, 2¼"

Effective February 5, 1993

Revised January 1, 2007

Add the following to Article 440.04:

Weather conditions, when milling work is performed, must be such that short term or temporary pavement markings can be placed the day the surface is milled in accordance with Section 703 "Work Zone Pavement Markings".

The cutting teeth used in the milling operation shall be the GTE AM722, or an approved equivalent. When the teeth become worn so that they do not produce a uniform surface texture, they shall all be changed at the same time (as a unit). Occasionally, individual teeth may be changed if they lock up or break, but this method shall not be used to avoid changing the set of teeth as a unit.

The moldboard is critical in obtaining the desired surface texture. It shall be straight, true, and

free of excessive nicks or wear, and it shall be replaced as necessary to uniformly produce the required surface texture. Gouging of the pavement by more than 1/4 inch (6 mm) shall be sufficient cause to require replacement of all teeth, occasional gouges, due to deteriorated pavement condition, or separation of lifts will not be cause to replace all teeth. The Engineer will be the sole judge of the cause of the pavement gouging and the corrective work required. Corrective work due to negligence or poor workmanship will be at the Contractor's expense.

The Contractor shall mill 2¼" inch at the centerline, except when the milling at the outer edge of the lane would exceed 1.5 inches (40 mm); then the Contractor shall reduce the cut at the centerline to provide the maximum cut of 1.5 inches (40 mm) at the edge of pavement. If deemed necessary, the Contractor may reduce the cross slope from normal to 1.5% to 1%. A drawing labeled "Hot-Mix Asphalt Surface Removal" is included in the plans.

An automatic grade control device shall be used when milling mainline pavement and shall be capable of controlling the elevation of the drum relative to either a preset grade control stringline or a grade reference device traveling on the adjacent pavement surface. The automatic grade control device may be utilized on only one side of the machine with an automatic slope control device controlling the opposite side. The traveling grade reference device shall not be less than 30 feet (9 m) in length for rural areas. For urban areas, a device not less than 20 feet (6 m) in length will be required. When milling cross roads, turn lanes, intersections, crossovers, or other miscellaneous areas, the Engineer may permit the use of a matching shoe.

Surface tests will be performed according to Article 407.09(a) of the Standard Specifications. The profile will be taken 3 ft. (0.9 m) from and parallel to each edge of pavement and 3 ft. (0.9 m) from and parallel to the centerline on each side. If a shadow area is found at the 3 ft. (0.9 m) points, the pavement smoothness tester will be moved sufficient distance either side to measure the Contractor's milling efforts. If any (milled) surface variations found to be over 1/4" in 10' (6 mm in 3 m), then the roadway shall be reprofiled at no additional cost. In addition, the Contractor shall be responsible for refilling, with approved hot-mix asphalt mixtures, any area that lowered the pavement profile as a result of his faulty milling operations if directed by the Engineer. The Contractor shall be responsible for providing the pavement smoothness tester described elsewhere to retest the pavement profile obtained.

If the milling depth is intended to expose the original concrete pavement, then additional hand or machine work may be necessary to remove any remaining veneer of bituminous pavement which may be left in place behind the milling machine. Such work will be at the direction of the Engineer and at no extra cost to the State.

The Contractor shall provide a 10' (3 m) straightedge equipped with a carpenter's level or a 7' (2.1 m) electronic straightedge to check the cross slope of the roadway at regular intervals as directed by the Engineer.

Surface Texture: Each tooth on the cutting drum shall produce a series of discontinuous longitudinal striations. There shall be 16 to 20 striations (tooth marks) for each tooth for each 6' (1.8 m) in the longitudinal direction, and each striation shall be 1.7 inches +/- 0.2 inch (43 +/- 5 mm) in length after the area is planed by the moldboard. Thus, the planed length between each pair of striations shall be 2.3 inches +/- 0.2 inch (58 +/- 5 mm). There shall be 80 to 96 rows of discontinuous longitudinal striations for each 5' (1.5 m) in the transverse dimension. The areas

between the striations in both the longitudinal and transverse directions shall be flat topped and coplaner. The moldboard shall be used to cut this plane; and any time the operation fails to produce this flat plane interspersed with a uniform pattern of discontinuous longitudinal striations, the operation shall be stopped and the cause determined and corrected before recommencing. Other similar patterns of uniform discontinuous longitudinal striations interspersed on a flat plane may be approved by the Engineer. A drawing entitled "Hot-Mix Asphalt_Surface Removal" showing the desired surface texture is included in the plans.

The startup milling speed shall be limited to a maximum of 50' (15 m) per minute. The Contractor shall limit his operations to this speed to demonstrate his ability to obtain the striations and rideability as described above. If the Contractor is able to demonstrate that he can consistently obtain the desired striations and rideability at a greater speed he will be permitted to run at the increased speed.

Cleanup: After cold milling a traffic lane and before opening the lane to traffic, the pavement shall be swept by a self-propelled street sweeper with power vacuum capability to prevent compaction of the cuttings onto the pavement. All loose material shall be removed from the roadway. Before the prime coat is placed, the pavement shall be cleaned of all foreign material to the satisfaction of the Engineer.

This cleanup work shall be considered included in the contract unit price per square yard (square meter) for HOT-MIX ASPHALT SURFACE REMOVAL of the depth specified, and no additional compensation will be allowed.

Method of Measurement

- (a) Contract Quantities. The requirements for the use of Contract Quantities shall be Article 202.07(a) of the Standard Specifications.
- (b) Measured Quantities. Cold milling and planing will be measured and the area computed in square yards (square meters) of surface.

Areas not milled (shadow areas) due to rutting in the existing pavement surface will be included in the area measured for payment.

Basis of Payment: The cold milling and planing will be paid for at the contract unit price per square yard (square meter) for HOT-MIX ASPHALT SURFACE REMOVAL of the depth specified. Payment as specified will include variations in depth of cuts due to rutting, superelevations, and pavement crown and no additional compensation will be allowed.

PAVEMENT DRAINAGE AFTER COLD MILLING

Effective March 15, 1996

Revised January 1, 2007

This work shall consist of cold milling a 1.5" (40 mm) deep and 2' (0.6 m) wide drainage channel through the existing shoulder at locations as directed by the Engineer and replacing the mix after the surface has been placed.

To prevent pooling of water in the milled surface, a drainage channel shall be cut in the shoulder at low spots in superelevated curves and other locations where pooling of water may occur as specified by the Engineer.

After the surface has been placed on the adjacent through lane, the drainage channel shall be primed and then filled with a hot-mix asphalt shoulder mix approved by the Engineer and compacted to the satisfaction of the Engineer.

This work shall be paid for under the provisions of Article 109.04.

HOT-MIX ASPHALT SHOULDER RESURFACING CONSTRUCTED SIMULTANEOUSLY WITH MAINLINE PAVING

Effective January 22, 2001

Revised January 1, 2007

If the Department allows resurfacing hot-mix asphalt shoulders simultaneously with the mainline pavement resurfacing, a roller meeting the requirements of Article 1101.01 shall be required. This roller will be in addition to any rollers required for compaction of the mainline roadway resurfacing. This additional roller will not be paid for separately, but shall be included in the contract unit price bid for the mainline bituminous material being placed.

GUARDRAIL AGGREGATE EROSION CONTROL

Effective February 1, 1993

Revised January 1, 2007

This work shall consist of furnishing, placing, and shaping crushed aggregate placed around and behind guardrail posts in accordance with plan details.

Method of Measurement: The aggregate for constructing the Guardrail Aggregate Erosion Control will be measured in tons (metric tons).

The Geotextile Fabric will not be measured for payment.

Basis of Payment: Guardrail Aggregate Erosion Control will be paid for at the contract unit price per ton (metric ton) for GUARDRAIL AGGREGATE EROSION CONTROL measured as specified herein. The Geotextile Fabric will not be measured for payment, but shall be included in the cost per ton (metric ton) for GUARDRAIL AGGREGATE EROSION CONTROL.

TRAFFIC BARRIER TERMINALS

Effective February 1, 1996

Revised November 5, 2004

Widening of existing shoulders/slopes for the construction of Traffic Barrier Terminals shall be completed as directed by the Engineer and paid for as specified in Article 109.04 of the Standard Specifications.

TRAFFIC CONTROL PLAN

Effective February 11, 2009

Traffic control shall be in accordance with the applicable sections of the "Standard Specifications for Road and Bridge Construction," the applicable guidelines contained in the "Illinois Manual on Uniform Traffic Control Devices for Streets and Highways," these Special Provisions, and any special details and Highway Standards contained herein and in the plans. Special attention is called to Section 701 and Articles 107.09 and 107.14 of the "Standard Specifications for Road and Bridge Construction" and the following Highway Standards relating to traffic control:

701001	701006	701011	701201	701206
701301	701306	701311	701336	701901

The Contractor shall be responsible for the proper location, installation and arrangement of all traffic control devices. Special attention shall be given to existing warning signs, speed and guide signs during the construction operation. Warning signs and existing guide signs shall be kept consistent with the barricade placement at all times. The Contractor shall immediately remove, completely cover or turn from motorists view all signs which are inconsistent with lane assignment patterns and traffic speed.

Roadway Restrictions

Staggered intermittent lane closures in either the northbound or southbound lanes will not be allowed.

No lane closures or lane width reduction of any section of lane in either the northbound or southbound direction will be allowed to remain when workers are not present and working in the lane. This restriction does not apply to the curing time required for the pavement patching operation.

Complete lane closure in either the northbound or southbound lane will not be permitted.

Overnight lane closures in either the northbound or southbound lane will not be permitted.

Unless otherwise specified all labor, equipment, and materials required to provide the traffic control, including removal after work completion, as shown in the plans and as directed by the Engineer, in accordance with the applicable Standards, and as specified herein shall be considered as included in the cost of the Traffic Control and Protection items used for the project.

HOT MIX ASPHALT – DENSITY TESTING OF LONGITUDINAL JOINTS (BMPT)

Effective: January 1, 2007

Revised: February 1, 2009

Description: This work shall consist of testing the density of longitudinal joints as part of the quality control / quality assurance (QC/QA) of hot-mix asphalt (HMA). This work shall be according to Section 1030 of the Standard Specifications except as follows.

Quality Control / Quality Assurance (QC/QA):

1030.05(d)(3) Add the following paragraphs:

“Longitudinal joint density testing shall be performed at each random density test location. Longitudinal joint testing shall be located at a distance equal to the lift thickness, or a minimum of 2 inches, from each pavement edge (i.e. For a four inch lift the near edge of the density gauge or core barrel shall be within four inches from the edge of pavement.).

The joint density value shall be determined using either a correlated nuclear gauge or cores. When using a correlated nuclear gauge, two one-minute density readings shall be taken at the given density test site. The gauge shall be rotated 180 degrees between readings. If the two readings are not within 1.5 lb/cu ft (23 kg/cu m) then one additional reading shall be taken. Additional density readings taken at a given site shall not be allowed to replace the original density readings unless an obvious error has occurred (i.e. the nuclear gauge was sitting on debris).

1030.05(d)(4) Replace the density control limits table with the following:

DENSITY CONTROL LIMITS				
Mixture Composition	Parameter	Individual Test	Confined Edge	Unconfined Edge
IL-9.5, IL-12.5	Ndesign ≥ 90	92.0 – 96.0%	92.0 – 96.0%	90.0%
IL-9.5,IL-9.5L, IL-12.5	Ndesign < 90	92.5 – 97.4%	92.5 – 97.4%	90.0%
IL-19.0, IL-25.0	Ndesign ≥ 90	93.0 – 96.0%	93.0 – 96.0%	90.0%
IL-19.0, IL-19.0L, IL-25.0	Ndesign < 90	93.0 – 97.4%	93.0 – 97.4%	90.0%
SMA	Ndesign = 50 & 80	93.5 – 97.4%	93.5 – 97.4%	91.0%
All Other	Ndesign = 30	93.0 - 97.4%	93.0 - 97.4%	90.0%

AMERICAN RECOVERY AND REINVESTMENT ACT SIGNING (BDE)

Effective: April 1, 2009

Description. This work shall consist of furnishing, fabricating and installing sign panels, complete with sign faces, legend, and supplemental panels according to Section 720 of the Standard Specifications and as specified herein.

Materials. The “Putting America to Work” sign shall be fabricated using Type AP fluorescent orange sheeting for the background material with black vinyl or black opaque ink legend, symbol and borders. The “American Recovery and Reinvestment Act” sign shall be fabricated using Type AP green sheeting for the background with Type AP white sheeting for the legend and border. A green translucent overlay film may also be used over white Type AP sheeting to fabricate the “American Recovery and Reinvestment Act” sign.

Sign Layout. See following attachment.

General. The signs shall be erected to applicable portions of Article 701.14 of the Standard Specifications. These signs shall be erected midway between the first and second warning signs as required by the traffic control plan and standards utilized for this project. If the second warning sign is defining a moving or intermittent operation, the sign may be maintained at a distance of 500 ft (150 m) beyond the first post mounted ROAD CONSTRUCTION AHEAD sign. The signs shall remain in place for the duration of the project. Upon completion of the project, the signs and posts shall be removed and shall remain the property of the Contractor.

Basis of Payment. This work will not be paid for separately but shall be included in the cost of Traffic Control items as shown on the plans.

Attachment

**PROJECT FUNDING SOURCE SIGN ASSEMBLY
AMERICAN RECOVERY AND REINVESTMENT ACT
SIGN LAYOUT DETAILS**



PROJECT FUNDING SOURCE
SIGN ASSEMBLY

(Note: Outline of small rectangle on plaque shall be removed.)

ALKALI-SILICA REACTION FOR CAST-IN-PLACE CONCRETE (BDE)

Effective: August 1, 2007

Revised: January 1, 2009

Description. This special provision is intended to reduce the risk of a deleterious alkali-silica reaction in concrete exposed to humid or wet conditions. The special provision is not intended or adequate for concrete exposed to potassium acetate, potassium formate, sodium acetate or sodium formate. The special provision shall not apply to the dry environment (humidity less than 60 percent) found inside buildings for residential or commercial occupancy. The special provision shall also not apply to precast products or precast prestressed products.

Aggregate Expansion Values. Each coarse and fine aggregate will be tested by the Department for alkali reaction according to ASTM C 1260. The test will be performed with Type I or II cement having a total equivalent alkali content ($\text{Na}_2\text{O} + 0.658\text{K}_2\text{O}$) of 0.90 percent or greater. The Engineer will determine the assigned expansion value for each aggregate, and these values will be made available on the Department's Alkali-Silica Potential Reactivity Rating List. The Engineer may differentiate aggregate based on ledge, production method, gradation number, or other factors. An expansion value of 0.05 percent will be assigned to limestone or dolomite coarse aggregates and 0.03 percent to limestone or dolomite fine aggregates (manufactured stone sand); however the Department reserves the right to perform the ASTM C 1260 test.

Aggregate Groups. Each combination of aggregates used in a mixture will be assigned to an aggregate group. The point at which the coarse aggregate and fine aggregate expansion values intersect in the following table will determine the group.

AGGREGATE GROUPS			
Coarse Aggregate or Coarse Aggregate Blend ASTM C 1260 Expansion	Fine Aggregate or Fine Aggregate Blend ASTM C 1260 Expansion		
	$\leq 0.16\%$	$> 0.16\% - 0.27\%$	$> 0.27\%$
$\leq 0.16\%$	Group I	Group II	Group III
$> 0.16\% - 0.27\%$	Group II	Group II	Group III
$> 0.27\%$	Group III	Group III	Group IV

Mixture Options. Based upon the aggregate group, the following mixture options shall be used; however, the Department may prohibit a mixture option if field performance shows a deleterious alkali-silica reaction or Department testing indicates the mixture may experience a deleterious alkali-silica reaction.

- Group I - Mixture options are not applicable. Use any cement or finely divided mineral.
- Group II - Mixture options 1, 2, 3, 4, or 5 shall be used.
- Group III - Mixture options 1, 2 and 3 combined, 4, or 5 shall be used.
- Group IV - Mixture options 1, 2 and 4 combined, or 5 shall be used.

For Class PP-3 concrete the mixture options are not applicable, and any cement may be used with the specified finely divided minerals.

- a) Mixture Option 1. The coarse or fine aggregates shall be blended to place the material in a group that will allow the selected cement or finely divided mineral to be used.

When a coarse or fine aggregate is blended, the weighted expansion value shall be calculated separately for the coarse and fine aggregate as follows:

$$\text{Weighted Expansion Value} = (a/100 \times A) + (b/100 \times B) + (c/100 \times C) + \dots$$

Where: a, b, c... = percentage of aggregate in the blend;
A, B, C...= expansion value for that aggregate.

- b) Mixture Option 2. A finely divided mineral shall be used as described in 1), 2), 3), or 4) that follow. The replacement ratio is defined as “finely divided mineral:portland cement”.

1) Class F Fly Ash. For Class PV, BS, MS, DS, SC, and SI concrete and cement aggregate mixture II (CAM II), Class F fly ash shall replace 15 percent of the portland cement at a minimum replacement ratio of 1.5:1.

2) Class C Fly Ash. For Class PV, MS, SC, and SI Concrete, Class C fly ash with 18 percent to less than 26.5 percent calcium oxide content, and less than 2.0 percent loss on ignition, shall replace 20 percent of the portland cement at a minimum replacement ratio of 1:1; or at a minimum replacement ratio of 1.25:1 if the loss on ignition is 2.0 percent or greater. Class C fly ash with less than 18 percent calcium oxide content shall replace 20 percent of the portland cement at a minimum replacement ratio of 1.25:1.

For Class PP-1, RR, BS, and DS concrete and CAM II, Class C fly ash with less than 26.5 percent calcium oxide content shall replace 15 percent of the portland cement at a minimum replacement ratio of 1.5:1.

3) Ground Granulated Blast-Furnace Slag. For Class PV, BS, MS, SI, DS, and SC concrete, ground granulated blast-furnace slag shall replace 25 percent of the portland cement at a minimum replacement ratio of 1:1.

For Class PP-1 and RR concrete, ground granulated blast-furnace slag shall replace 15 percent of the portland cement at a minimum replacement ratio of 1.5:1.

For Class PP-2, ground granulated blast-furnace slag shall replace 25 to 30 percent of the portland cement at a minimum replacement ratio of 1:1.

4) Microsilica or High Reactivity Metakaolin. Microsilica solids or high reactivity metakaolin shall be added to the mixture at a minimum 25 lb/cu yd (15 kg/cu m) or 27 lb/cu yd (16 kg/cu m) respectively.

- c) Mixture Option 3. The cement used shall have a maximum total equivalent alkali content ($\text{Na}_2\text{O} + 0.658\text{K}_2\text{O}$) of 0.60 percent. When aggregate in Group II is involved, any finely divided mineral may be used with a portland cement.

- d) Mixture Option 4. The cement used shall have a maximum total equivalent alkali content

($\text{Na}_2\text{O} + 0.658\text{K}_2\text{O}$) of 0.45 percent. When aggregate in Group II or III is involved, any finely divided mineral may be used with a portland cement.

- e) Mixture Option 5. The proposed cement or finely divided mineral may be used if the ASTM C 1567 expansion value is ≤ 0.16 percent when performed on the aggregate in the concrete mixture with the highest ASTM C 1260 test result. The ASTM C 1567 test will be valid for two years, unless the Engineer determines the materials have changed significantly. For latex concrete, the ASTM C 1567 test shall be performed without the latex. The 0.20 percent autoclave expansion limit in ASTM C 1567 shall not apply.

If during the two year time period the Contractor needs to replace the cement, and the replacement cement has an equal or lower total equivalent alkali content ($\text{Na}_2\text{O} + 0.658\text{K}_2\text{O}$), a new ASTM C 1567 test will not be required.

Testing. If an individual aggregate has an ASTM C 1260 expansion value > 0.16 percent, an ASTM C 1293 test may be performed by the Contractor to evaluate the Department's ASTM C 1260 test result. The ASTM C 1293 test shall be performed with Type I or II cement having a total equivalent alkali content ($\text{Na}_2\text{O} + 0.658\text{K}_2\text{O}$) of 0.80 percent or greater. The interior vertical wall of the ASTM C 1293 recommended container (pail) shall be half covered with a wick of absorbent material consisting of blotting paper. If the testing laboratory desires to use an alternate container or wick of absorbent material, ASTM C 1293 test results with an alkali-reactive aggregate of known expansion characteristics shall be provided to the Engineer for review and approval. If the expansion is less than 0.040 percent after one year, the aggregate will be assigned an ASTM C 1260 expansion value of 0.08 percent that will be valid for two years, unless the Engineer determines the aggregate has changed significantly.

The Engineer reserves the right to verify a Contractor's ASTM C 1293 or 1567 test result. The Engineer will not accept the result if the precision and bias for the test methods are not met.

The laboratory performing the ASTM C 1567 test shall either be accredited by the AASHTO Materials Reference Laboratory (AMRL) for ASTM C 227 under Portland Cement Concrete or Aggregate; or shall be inspected for Hydraulic Cement - Physical Tests by the Cement and Concrete Reference Laboratory (CCRL) and shall be approved by the Department. The laboratory performing the ASTM C 1293 test shall be inspected for Portland Cement Concrete by CCRL and shall be approved by the Department.

APPROVAL OF PROPOSED BORROW AREAS, USE AREAS, AND/OR WASTE AREAS INSIDE ILLINOIS STATE BORDERS (BDE)

Effective: November 1, 2008

Revise the title of Article 107.22 of the Standard Specifications to read:

"107.22 Approval of Proposed Borrow Areas, Use Areas, and/or Waste Areas Inside Illinois State Borders."

Add the following sentence to the end of the first paragraph of Article 107.22 of the Standard Specifications:

“Proposed borrow areas, use areas, and/or waste areas outside of Illinois shall comply with Article 107.01.”

AUTOMATED FLAGGER ASSISTANCE DEVICES (BDE)

Effective: January 1, 2008

Description. This work shall consist of furnishing and operating automated flagger assistance devices (AFADs) as part of the work zone traffic control and protection for two-lane highways where two-way traffic is maintained over one lane of pavement. Use of these devices shall be at the option of the Contractor.

Equipment. AFADs shall be according to the FHWA memorandum, “MUTCD - Revised Interim Approval for the use of Automated Flagger Assistance Devices in Temporary Traffic Control Zones (IA-4R)”, dated January 28, 2005. The devices shall be mounted on a trailer or a moveable cart and shall meet the requirements of NCHRP 350, Category 4.

The AFAD shall be the Stop/Slow type. This device uses remotely controlled “STOP” and “SLOW” signs to alternately control right-of-way.

Signs for the AFAD shall be according to Article 701.03 of the Standard Specifications and the MUTCD. The signs shall be 24 x 24 in. (600 x 600 mm) having an octagon shaped “STOP” sign on one side and a diamond shaped “SLOW” sign on the opposite side. The letters on the signs shall be 8 in. (200 mm) high. If the “STOP” sign has louvers, the full sign face shall be visible at a distance of 50 ft (15 m) and greater.

The signs shall be supplemented with one of the following types of lights.

- (a) Flashing Lights. When flashing lights are used, white or red flashing lights shall be mounted within the “STOP” sign face and white or yellow flashing lights within the “SLOW” sign face.
- (b) Stop and Warning Beacons. When beacons are used, a stop beacon shall be mounted 24 in. (600 mm) or less above the “STOP” sign face and a warning beacon mounted 24 in. (600 mm) or less above, below, or to the side of the “SLOW” sign face. As an option, a Type B warning light may be used in lieu of the warning beacon.

A “WAIT ON STOP” sign shall be placed on the right hand side of the roadway at a point where drivers are expected to stop. The sign shall be 24 x 30 in. (600 x 750 mm) with a black legend and border on a white background. The letters shall be at least 6 in. (150 mm) high.

This device may include a gate arm or mast arm that descends to a horizontal position when the “STOP” sign is displayed and rises to a vertical position when the “SLOW” sign is displayed. When included, the end of the arm shall reach at least to the center of the lane being controlled. The arm shall have alternating red and white retroreflective stripes, on both sides, sloping downward at 45 degrees toward the side on which traffic will pass. The stripes shall be 6 in. (150 mm) in width and at least 2 in. (50 mm) in height.

Flagging Requirements. Flaggers and flagging requirements shall be according to Article 701.13 of the Standard Specifications and the following.

AFADs shall be placed at each end of the traffic control, where a flagger is shown on the plans. The flaggers shall be able to view the face of the AFAD and approaching traffic during operation.

To stop traffic, the "STOP" sign shall be displayed, the corresponding lights/beacon shall flash, and when included, the gate arm shall descend to a horizontal position. To permit traffic to move, the "SLOW" sign shall be displayed, the corresponding lights/beacon shall flash, and when included, the gate arm shall rise to a vertical position.

If used at night, the AFAD location shall be illuminated according to Section 701 of the Standard Specifications.

When not in use, AFADs will be considered nonoperating equipment and shall be stored according to Article 701.11 of the Standard Specifications.

Basis of Payment. This work will not be paid for separately but shall be considered as included in the cost of the various traffic control items included in the contract.

CEMENT (BDE)

Effective: January 1, 2007

Revised: April 1, 2009

Revise Section 1001 of the Standard Specifications to read:

"SECTION 1001. CEMENT

1001.01 Cement Types. Cement shall be according to the following.

- (a) Portland Cement. Acceptance of portland cement shall be according to the current Bureau of Materials and Physical Research's Policy Memorandum, "Portland or Blended Cement Acceptance Procedure for Qualified and Non-Qualified Plants".

Portland cement shall be according to ASTM C 150, and shall meet the standard physical and chemical requirements. Type I or Type II may be used for cast-in-place, precast, and precast prestressed concrete. Type III may be used according to Article 1020.04, or when approved by the Engineer. All other cements referenced in ASTM C 150 may be used when approved by the Engineer.

The total of all organic processing additions shall be a maximum of 1.0 percent by weight (mass) of the cement. The total of all inorganic processing additions shall be a maximum of 4.0 percent by weight (mass) of the cement. However, a cement kiln dust inorganic processing addition shall be limited to a maximum of 1.0 percent. Organic processing additions shall be limited to grinding aids that improve the flowability of cement, reduce pack set, and improve grinding efficiency. Inorganic processing additions shall be limited to granulated blast-furnace slag according to the chemical

requirements of AASHTO M 302, Class C fly ash according to the chemical requirements of AASHTO M 295, and cement kiln dust.

- (b) Portland-Pozzolan Cement. Acceptance of portland-pozzolan cement shall be according to the current Bureau of Materials and Physical Research's Policy Memorandum, "Portland or Blended Cement Acceptance Procedure for Qualified and Non-Qualified Plants".

Portland-pozzolan cement shall be according to ASTM C 595 and shall meet the standard physical and chemical requirements. Type IP may be used for cast-in-place, precast, and precast prestressed concrete, except when Class PP concrete is used. The pozzolan constituent for Type IP shall be a maximum of 21 percent of the weight (mass) of the portland-pozzolan cement.

For cast-in-place construction, portland-pozzolan cement shall not be used in concrete mixtures when the air temperature is below 40 °F (4 °C) without permission of the Engineer. If permission is given, the mix design strength requirement may require the Contractor to increase the cement or eliminate the cement factor reduction for a water-reducing or high range water-reducing admixture which is permitted according to Article 1020.05(b).

The total of all organic processing additions shall be a maximum of 1.0 percent by weight (mass) of the cement. Organic processing additions shall be limited to grinding aids as defined in (a) above. Inorganic processing additions shall be limited to cement kiln dust at a maximum of 1.0 percent.

- (c) Portland Blast-Furnace Slag Cement. Acceptance of portland blast-furnace slag cement shall be according to the current Bureau of Materials and Physical Research's Policy Memorandum, "Portland or Blended Cement Acceptance Procedure for Qualified and Non-Qualified Plants".

Portland blast-furnace slag cement shall be according to ASTM C 595 and shall meet the standard physical and chemical requirements. Type IS portland blast-furnace slag cement may be used for cast-in-place, precast, and precast prestressed concrete, except when Class PP concrete is used. The blast-furnace slag constituent for Type IS shall be a maximum of 25 percent of the weight (mass) of the portland blast-furnace slag cement.

For cast-in-place construction, portland blast-furnace slag cement shall not be used in concrete mixtures when the air temperature is below 40 °F (4 °C) without permission of the Engineer. If permission is given, the mix design strength requirement may require the Contractor to increase the cement or eliminate the cement factor reduction for a water-reducing or high range water-reducing admixture which is permitted according to Article 1020.05(b).

The total of all organic processing additions shall be a maximum of 1.0 percent by weight (mass) of the cement. Organic processing additions shall be limited to grinding aids as defined in (a) above. Inorganic processing additions shall be limited to cement kiln dust at a maximum of 1.0 percent.

- (d) Rapid Hardening Cement. Rapid hardening cement shall be used according to Article 1020.04 or when approved by the Engineer. The cement shall be on the Department's current "Approved List of Packaged, Dry, Rapid Hardening Cementitious Materials for Concrete Repairs", and shall be according to the following.
- (1) The cement shall have a maximum final set of 25 minutes, according to Illinois Modified ASTM C 191.
 - (2) The cement shall have a minimum compressive strength of 2000 psi (13,800 kPa) at 3.0 hours, 3200 psi (22,100 kPa) at 6.0 hours, and 4000 psi (27,600 kPa) at 24.0 hours, according to Illinois Modified ASTM C 109.
 - (3) The cement shall have a maximum drying shrinkage of 0.050 percent at seven days, according to Illinois Modified ASTM C 596.
 - (4) The cement shall have a maximum expansion of 0.020 percent at 14 days, according to Illinois Modified ASTM C 1038.
 - (5) The cement shall have a minimum 80 percent relative dynamic modulus of elasticity; and shall not have a weight (mass) gain in excess of 0.15 percent or a weight (mass) loss in excess of 1.0 percent, after 100 cycles, according to AASHTO T 161, Procedure B.
- (e) Calcium Aluminate Cement. Calcium aluminate cement shall be used only where specified by the Engineer. The cement shall meet the standard physical requirements for Type I cement according to ASTM C 150, except the time of setting shall not apply. The chemical requirements shall be determined according to ASTM C 114 and shall be as follows: minimum 38 percent aluminum oxide (Al_2O_3), maximum 42 percent calcium oxide (CaO), maximum 1 percent magnesium oxide (MgO), maximum 0.4 percent sulfur trioxide (SO_3), maximum 1 percent loss on ignition, and maximum 3.5 percent insoluble residue.

1001.02 Uniformity of Color. Cement contained in single loads or in shipments of several loads to the same project shall not have visible differences in color.

1001.03 Mixing Brands and Types. Different brands or different types of cement from the same manufacturing plant, or the same brand or type from different plants shall not be mixed or used alternately in the same item of construction unless approved by the Engineer.

1001.04 Storage. Cement shall be stored and protected against damage, such as dampness which may cause partial set or hardened lumps. Different brands or different types of cement from the same manufacturing plant, or the same brand or type from different plants shall be kept separate."

CONCRETE ADMIXTURES (BDE)

Effective: January 1, 2003

Revised: April 1, 2009

Replace the first paragraph of Article 1020.05(b) of the Standard Specifications to read:

“(b) Admixtures. The use of admixtures to increase the workability or to accelerate the hardening of the concrete will be permitted when approved by the Engineer. Admixture dosages shall result in the mixture meeting the specified plastic and hardened properties. The Department will maintain an Approved List of Corrosion Inhibitors. Corrosion inhibitor dosage rates shall be according to Article 1020.05(b)(12). The Department will also maintain an Approved List of Concrete Admixtures, and an admixture technical representative shall be consulted when determining an admixture dosage from this list. The dosage shall be within the range indicated on the approved list unless the influence by other admixtures, jobsite conditions (such as a very short haul time), or other circumstances warrant a dosage outside the range. The Engineer shall be notified when a dosage is proposed outside the range. To determine an admixture dosage, air temperature, concrete temperature, cement source and quantity, finely divided mineral sources(s) and quantity, influence of other admixtures, haul time, placement conditions, and other factors as appropriate shall be considered. The Engineer may request the Contractor to have a batch of concrete mixed in the lab or field to verify the admixture dosage is correct. An admixture dosage or combination of admixture dosages shall not delay the initial set of concrete by more than one hour. When a retarding admixture is required or appropriate for a bridge deck or bridge deck overlayer pour, the initial set time shall be delayed until the deflections due to the concrete dead load are no longer a concern for inducing cracks in the completed work. However, a retarding admixture shall not be used to further extend the pour time and justify the alteration of a bridge deck pour sequence.

When determining water in admixtures for water/cement ratio, the Contractor shall calculate 70 percent of the admixture dosage as water, except a value of 50 percent shall be used for a latex admixture used in bridge deck latex concrete overlays.”

Revise Section 1021 of the Standard Specifications to read:

“SECTION 1021. CONCRETE ADMIXTURES

1021.01 General. Admixtures shall be furnished in liquid form ready for use. The admixtures shall be delivered in the manufacturer's original containers, bulk tank trucks or such containers or tanks as are acceptable to the Engineer. Delivery shall be accompanied by a ticket which clearly identifies the manufacturer and trade name of the material. Containers shall be readily identifiable as to manufacturer and trade name of the material they contain.

Corrosion inhibitors will be maintained on the Department's Approved List of Corrosion Inhibitors. All other concrete admixture products will be maintained on the Department's Approved List of Concrete Admixtures. For the admixture submittal, a report prepared by an independent laboratory accredited by the AASHTO Materials Reference Laboratory (AMRL) for Portland Cement Concrete shall be provided. The report shall show the results of physical tests conducted no more than five years prior to the time of submittal, according to applicable specifications. However, for corrosion inhibitors the ASTM G 109 test information specified in ASTM C 1582 is not required to be from and independent lab. All other information in ASTM C 1582 shall be from and independent lab.

Tests shall be conducted using materials and methods specified on a "test" concrete and a "reference" concrete, together with a certification that no changes have been made in the

formulation of the material since the performance of the tests. Per the manufacturer's option, the cement content for all required tests shall either be according to applicable specifications or 5.65 cwt/cu yd (335 kg/cu m). Compressive strength test results for six months and one year will not be required.

Prior to the approval of an admixture, the Engineer reserves the right to request a sample for testing. The test and reference concrete mixtures tested by the Engineer will contain a cement content of 5.65 cwt/cu yd (335 kg/cu m). For freeze-thaw testing, the Department will perform the test according to AASHTO T 161, Procedure B. The flexural strength test will be performed according to AASHTO T 177. If the Engineer decides to test the admixture, the manufacturer shall submit AASHTO T 197 water content and set time test results on the standard cement used by the Department. The test and reference concrete mixture shall contain a cement content of 5.65 cwt/cu yd (335 kg/cu m). The manufacturer may select their lab or an independent lab to perform this testing. The laboratory is not required to be accredited by AASHTO.

The manufacturer shall include in the submittal the following admixture information: the manufacturing range for specific gravity, the midpoint and manufacturing range for residue by oven drying, and the manufacturing range for pH. The submittal shall also include an infrared spectrophotometer trace no more than five years old.

For air-entraining admixtures according to Article 1021.02, the specific gravity allowable manufacturing range shall be established by the manufacturer and the test method shall be according to ASTM C 494. For residue by oven drying and pH, the allowable manufacturing range and test methods shall be according to ASTM C 260.

For admixtures according to Articles 1021.03, 1021.04, 1021.05, 1021.06, and 1021.07, the pH allowable manufacturing range shall be established by the manufacturer and the test method shall be according to ASTM E 70. For specific gravity and residue by oven drying, the allowable manufacturing range and test methods shall be according to ASTM C 494.

When test results are more than seven years old, the manufacturer shall re-submit the infrared spectrophotometer trace and the report prepared by an independent laboratory accredited by AASHTO.

All admixtures, except chloride-based accelerators, shall contain a maximum of 0.3 percent chloride by weight (mass).

Random field samples may be taken by the Department to verify an admixture meets specification. A split sample will be provided to the manufacturer if requested. Admixtures that do not meet specification requirements or an allowable manufacturing range established by the manufacturer shall be replaced with new material.

1021.02 Air-Entraining Admixtures. Air-entraining admixtures shall be according to AASHTO M 154.

1021.03 Retarding and Water-Reducing Admixtures. The admixture shall be according to the following.

- (a) The retarding admixture shall be according to AASHTO M 194, Type B (retarding) or Type D (water-reducing and retarding).
- (b) The water-reducing admixture shall be according to AASHTO M 194, Type A.
- (c) The high range water-reducing admixture shall be according to AASHTO M 194, Type F (high range water-reducing) or Type G (high range water-reducing and retarding).

1021.04 Accelerating Admixtures. The admixture shall be according to AASHTO M 194, Type C (accelerating) or Type E (water reducing and accelerating).

1021.05 Self-Consolidating Admixtures. The self-consolidating admixture system shall consist of either a high range water-reducing admixture only or a high range water-reducing admixture combined with a separate viscosity modifying admixture. The one or two component admixture system shall be capable of producing a concrete mixture that can flow around reinforcement and consolidate under its own weight without additional effort and without segregation.

The high range water-reducing admixture shall be according to AASHTO M 194, Type F.

The viscosity modifying admixture shall be according to ASTM C 494, Type S (specific performance).

1021.06 Rheology-Controlling Admixture. The rheology-controlling admixture shall be capable of producing a concrete mixture with a lower yield stress that will consolidate easier for slipform applications used by the Contractor. The rheology-controlling admixture shall be according to ASTM C 494, Type S (specific performance).

1021.07 Corrosion Inhibitor. The corrosion inhibitor shall be according to one of the following.

- (a) Calcium Nitrite. The corrosion inhibitor shall contain a minimum 30 percent calcium nitrite by weight (mass) of solution, and shall comply with the requirements of AASHTO M 194, Type C (accelerating).
- (b) Other Materials. The corrosion inhibitor shall be according to ASTM C 1582.”

CONSTRUCTION AIR QUALITY – DIESEL VEHICLE EMISSIONS CONTROL (BDE)

Effective: April 1, 2009

Diesel Vehicle Emissions Control. The reduction of construction air emissions shall be accomplished by using cleaner burning diesel fuel. The term “equipment” refers to any and all diesel fuel powered devices rated at 50 hp and above, to be used on the project site in excess of seven calendar days over the course of the construction period on the project site (including any “rental” equipment).

All equipment on the jobsite, with engine ratings of 50 hp and above, shall be required to: use Ultra Low Sulfur Diesel fuel (ULSD) exclusively (15 ppm sulfur content or less).

In addition, all construction motor vehicles (both on-road and off-road, gasoline or diesel fuel powered) shall comply with all pertinent State and Federal regulations relative to exhaust emission controls and safety, including opacity. Frequently Asked Questions (FAQ's) regarding Illinois Environmental Protection Agency (IEPA) emissions testing for gasoline powered vehicles can be accessed at (<http://www.epa.state.il.us/air/vim/faqs.html>) . Regulations regarding diesel powered vehicles over 16,000 lb (7260 kg), and the Diesel Emission Inspection Program (Title 92: Transportation Part 460, Diesel Emission Inspection Program, Subpart A: General) can be accessed at (<http://www.ilga.gov/commission/jcar/admincode/092/09200460sections.html>). Diesel powered vehicles less than 16,000 lb (7260 kg) are exempt from testing by the Department. All diesel powered equipment used on the project site shall be subject to reasonable, random spot checks for compliance with the required emissions controls and proper diesel fuel usage. The Secretary of State, Illinois State Police and other law enforcement officers will enforce Part 460. For additional information concerning Illinois diesel emission inspection requirements, please call the Illinois Department of Transportation, Diesel Emission Inspections Unit, at 217-557-6081.

Diesel powered equipment in non-compliance will not be allowed to be used on the project site, and is also subject to a notice of non-compliance as outlined below.

The Contractor shall submit copies of monthly summary reports and include certified copies of the ULSD diesel fuel delivery slips for diesel fuel delivered to the jobsite for the reporting time period, noting the quantity of diesel fuel used with each piece of diesel powered equipment. The addition or deletion of any diesel powered equipment shall be included in the summary and noted on the monthly report.

If any diesel powered equipment is found to be in non-compliance with any portion of this specification, the Engineer will issue the Contractor a notice of non-compliance and identify an appropriate period of time, as outlined below under environmental deficiency deduction, in which to bring the equipment into compliance or remove it from the project site.

Any costs associated with bringing any diesel powered equipment into compliance with these diesel vehicle emissions controls shall be considered as included in the contract unit prices bid for the various items of work involved and no additional compensation will be allowed. The Contractor's compliance with this notice and any associated regulations shall also not be grounds for a claim.

Environmental Deficiency Deduction. When the Engineer is notified, or determines that an environmental control deficiency exists, he/she will notify the Contractor in writing, and direct the Contractor to correct the deficiency within a specified time period. The specified time-period, which begins upon Contractor notification, will be from 1/2 hour to 24 hours long, based on the urgency of the situation and the nature of the deficiency. The Engineer shall be the sole judge regarding the time period.

The deficiency will be based on lack of repair, maintenance and diesel vehicle emissions control.

If the Contractor fails to correct the deficiency within the specified time frame, a daily monetary deduction will be imposed for each calendar day or fraction thereof the deficiency continues to

exist. The calendar day(s) will begin when the time period for correction is exceeded and end with the Engineer's written acceptance of the correction. The daily monetary deduction will be \$1,000.00 for each deficiency identified.

If a Contractor or subcontractor accumulates three environmental deficiency deductions in a contract period, the Contractor will be shutdown until the deficiency is corrected. Such a shutdown will not be grounds for any extension of contract time, waiver of penalties, or be grounds for any claim.

CONSTRUCTION AIR QUALITY - IDLING RESTRICTIONS (BDE)

Effective: April 1, 2009

Idling Restrictions. The Contractor shall establish truck-staging areas for all diesel powered vehicles that are waiting to load or unload material at the jobsite. Staging areas shall be located where the diesel emissions from the equipment will have a minimum impact on adjacent sensitive receptors. The Department will review the selection of staging areas, whether within or outside the existing highway right-of-way, to avoid locations near sensitive areas or populations to the extent possible. Sensitive receptors include, but are not limited to, hospitals, schools, residences, motels, hotels, daycare facilities, elderly housing and convalescent facilities. Diesel powered engines shall also be located as far away as possible from fresh air intakes, air conditioners, and windows. The Engineer will approve staging areas before implementation.

Diesel powered vehicle operators may not cause or allow the motor vehicle, when it is not in motion, to idle for more than a total of 10 minutes within any 60 minute period, except under any of the following circumstances:

- 1) The motor vehicle has a gross vehicle weight rating of less than 8000 lb (3630 kg).
- 2) The motor vehicle idles while forced to remain motionless because of on-highway traffic, an official traffic control device or signal, or at the direction of a law enforcement official.
- 3) The motor vehicle idles when operating defrosters, heaters, air conditioners, or other equipment solely to prevent a safety or health emergency.
- 4) A police, fire, ambulance, public safety, other emergency or law enforcement motor vehicle, or any motor vehicle used in an emergency capacity, idles while in an emergency or training mode and not for the convenience of the vehicle operator.
- 5) The primary propulsion engine idles for maintenance, servicing, repairing, or diagnostic purposes if idling is necessary for such activity.
- 6) A motor vehicle idles as part of a government inspection to verify that all equipment is in good working order, provided idling is required as part of the inspection.
- 7) When idling of the motor vehicle is required to operate auxiliary equipment to accomplish the intended use of the vehicle (such as loading, unloading, mixing, or processing cargo; controlling cargo temperature; construction operations, lumbering operations; oil or gas well servicing; or farming operations), provided that this exemption does not apply when the vehicle is idling solely for cabin comfort or to operate non-essential equipment such as air conditioning, heating, microwave ovens, or televisions.
- 8) When the motor vehicle idles due to mechanical difficulties over which the operator has no control.

9) The outdoor temperature is less than 32 °F (0 °C) or greater than 80 °F (26 °C).

When the outdoor temperature is greater than or equal to 32 °F (0 °C) or less than or equal to 80 °F (26 °C), a person who operates a motor vehicle operating on diesel fuel shall not cause or allow the motor vehicle to idle for a period greater than 30 minutes in any 60 minute period while waiting to weigh, load, or unload cargo or freight, unless the vehicle is in a line of vehicles that regularly and periodically moves forward.

The above requirements do not prohibit the operation of an auxiliary power unit or generator set as an alternative to idling the main engine of a motor vehicle operating on diesel fuel.

Environmental Deficiency Deduction. When the Engineer is notified, or determines that an environmental control deficiency exists based on non-compliance with the idling restrictions, he/she will notify the Contractor, and direct the Contractor to correct the deficiency.

If the Contractor fails to correct the deficiency a monetary deduction will be imposed. The monetary deduction will be \$1,000.00 for each deficiency identified.

DISADVANTAGED BUSINESS ENTERPRISE PARTICIPATION (DBE)

Effective: September 1, 2000

Revised: November 1, 2008

FEDERAL OBLIGATION. The Department of Transportation, as a recipient of federal financial assistance, is required to take all necessary and reasonable steps to ensure nondiscrimination in the award and administration of contracts. Consequently, the federal regulatory provisions of 49 CFR part 26 apply to this contract concerning the utilization of disadvantaged business enterprises. For the purposes of this Special Provision, a disadvantaged business enterprise (DBE) means a business certified by the Department in accordance with the requirements of 49 CFR part 26 and listed in the Illinois Unified Certification Program (IL UCP) DBE Directory or most recent addendum.

STATE OBLIGATION. This Special Provision will also be used by the Department to satisfy the requirements of the Business Enterprise for Minorities, Females, and Persons with Disabilities Act, 30 ILCS 575. When this Special Provision is used to satisfy state law requirements on 100 percent state-funded contracts, the federal government has no involvement in such contracts (not a federal-aid contract) and no responsibility to oversee the implementation of this Special Provision by the Department on those contracts. DBE participation on 100 percent state-funded contracts will not be credited toward fulfilling the Department's annual overall DBE goal required by the US Department of Transportation to comply with the federal DBE program requirements.

CONTRACTOR ASSURANCE. The Contractor makes the following assurance and agrees to include the assurance in each subcontract that the Contractor signs with a subcontractor:

The Contractor, subrecipient, or subcontractor shall not discriminate on the basis of race, color, national origin, or sex in the performance of this contract. The Contractor shall carry out applicable requirements of 49 CFR part 26 in the award and administration of contracts funded in whole or in part with federal or state funds. Failure by the Contractor to carry out

these requirements is a material breach of this contract, which may result in the termination of this contract or such other remedy as the recipient deems appropriate.

OVERALL GOAL SET FOR THE DEPARTMENT. As a requirement of compliance with 49 CFR part 26, the Department has set an overall goal for DBE participation in its federally assisted contracts. That goal applies to all federal-aid funds the Department will expend in its federally assisted contracts for the subject reporting fiscal year. The Department is required to make a good faith effort to achieve the overall goal. The dollar amount paid to all approved DBE companies performing work called for in this contract is eligible to be credited toward fulfillment of the Department's overall goal.

CONTRACT GOAL TO BE ACHIEVED BY THE CONTRACTOR. This contract includes a specific DBE utilization goal established by the Department. The goal has been included because the Department has determined that the work of this contract has subcontracting opportunities that may be suitable for performance by DBE companies. This determination is based on an assessment of the type of work, the location of the work, and the availability of DBE companies to do a part of the work. The assessment indicates that, in the absence of unlawful discrimination, and in an arena of fair and open competition, DBE companies can be expected to perform **7.0 %** of the work. This percentage is set as the DBE participation goal for this contract. Consequently, in addition to the other award criteria established for this contract, the Department will award this contract to a bidder who makes a good faith effort to meet this goal of DBE participation in the performance of the work. A bidder makes a good faith effort for award consideration if either of the following is done in accordance with the procedures set forth in this Special Provision:

- (a) The bidder documents that firmly committed DBE participation has been obtained to meet the goal; or
- (b) The bidder documents that a good faith effort has been made to meet the goal, even though the effort did not succeed in obtaining enough DBE participation to meet the goal.

DBE LOCATOR REFERENCES. Bidders may consult the IL UCP DBE Directory as a reference source for DBE-certified companies. In addition, the Department maintains a letting and item specific DBE locator information system whereby DBE companies can register their interest in providing quotes on particular bid items advertised for letting. Information concerning DBE companies willing to quote work for particular contracts may be obtained by contacting the Department's Bureau of Small Business Enterprises at telephone number (217)785-4611, or by visiting the Department's web site at www.dot.il.gov.

BIDDING PROCEDURES. Compliance with the bidding procedures of this Special Provision is required prior to the award of the contract and the failure of the as-read low bidder to comply will render the bid not responsive.

- (a) In order to assure the timely award of the contract, the as-read low bidder shall submit a Disadvantaged Business Utilization Plan on Department form SBE 2026 within seven working days after the date of letting. To meet the seven day requirement, the bidder may send the Plan by certified mail or delivery service within the seven working day period. If a question arises concerning the mailing date of a Plan, the mailing date will

be established by the U.S. Postal Service postmark on the original certified mail receipt from the U.S. Postal Service or the receipt issued by a delivery service. It is the responsibility of the bidder to ensure that the postmark or receipt date is affixed within the seven working days if the bidder intends to rely upon mailing or delivery to satisfy the submission day requirement. The Plan is to be submitted to the Department of Transportation, Bureau of Small Business Enterprises, Contract Compliance Section, 2300 South Dirksen Parkway, Room 319, Springfield, Illinois 62764 (Telefax: (217)785-1524). It is the responsibility of the bidder to obtain confirmation of telefax delivery. The Department will not accept a Utilization Plan if it does not meet the seven day submittal requirement and the bid will be declared not responsive. In the event the bid is declared not responsive due to a failure to submit a Plan or failure to comply with the bidding procedures set forth herein, the Department may elect to cause the forfeiture of the penal sum of the bidder's proposal guaranty, and may deny authorization to bid the project if re-advertised for bids. The Department reserves the right to invite any other bidder to submit a Utilization Plan at any time for award consideration or to extend the time for award.

- (b) The Utilization Plan shall indicate that the bidder either has obtained sufficient DBE participation commitments to meet the contract goal or has not obtained enough DBE participation commitments in spite of a good faith effort to meet the goal. The Utilization Plan shall further provide the name, telephone number, and telefax number of a responsible official of the bidder designated for purposes of notification of plan approval or disapproval under the procedures of this Special Provision.
- (c) The Utilization Plan shall include a DBE Participation Commitment Statement, Department form SBE 2025, for each DBE proposed for the performance of work to achieve the contract goal. The signatures on these forms must be original signatures. All elements of information indicated on the said form shall be provided, including but not limited to the following:
 - (1) The name and address of each DBE to be used;
 - (2) A description, including pay item numbers, of the commercially useful work to be done by each DBE;
 - (3) The price to be paid to each DBE for the identified work specifically stating the quantity, unit price, and total subcontract price for the work to be completed by the DBE. If partial pay items are to be performed by the DBE, indicate the portion of each item, a unit price where appropriate and the subcontract price amount;
 - (4) A commitment statement signed by the bidder and each DBE evidencing availability and intent to perform commercially useful work on the project; and
 - (5) If the bidder is a joint venture comprised of DBE companies and non-DBE companies, the plan must also include a clear identification of the portion of the work to be performed by the DBE partner(s).
- (d) The contract will not be awarded until the Utilization Plan submitted by the bidder is

approved. The Utilization Plan will be approved by the Department if the Plan commits sufficient commercially useful DBE work performance to meet the contract goal. The Utilization Plan will not be approved by the Department if the Plan does not commit sufficient DBE performance to meet the contract goal unless the bidder documents that it made a good faith effort to meet the goal. The good faith procedures of Section VIII of this special provision apply. If the Utilization Plan is not approved because it is deficient in a technical matter, unless waived by the Department, the bidder will be notified and will be allowed no less than a five working day period in order to cure the deficiency.

CALCULATING DBE PARTICIPATION. The Utilization Plan values represent work anticipated to be performed and paid for upon satisfactory completion. The Department is only able to count toward the achievement of the overall goal and the contract goal the value of payments made for the work actually performed by DBE companies. In addition, a DBE must perform a commercially useful function on the contract to be counted. A commercially useful function is generally performed when the DBE is responsible for the work and is carrying out its responsibilities by actually performing, managing, and supervising the work involved. The Department and Contractor are governed by the provisions of 49 CFR part 26.55(c) on questions of commercially useful functions as it affects the work. Specific counting guidelines are provided in 49 CFR part 26.55, the provisions of which govern over the summary contained herein.

- (a) DBE as the Contractor: 100 percent goal credit for that portion of the work performed by the DBE's own forces, including the cost of materials and supplies. Work that a DBE subcontracts to a non-DBE does not count toward the DBE goals.
- (b) DBE as a joint venture Contractor: 100 percent goal credit for that portion of the total dollar value of the contract equal to the distinct, clearly defined portion of the work performed by the DBE's own forces.
- (c) DBE as a subcontractor: 100 percent goal credit for the work of the subcontract performed by the DBE's own forces, including the cost of materials and supplies, excluding the purchase of materials and supplies or the lease of equipment by the DBE subcontractor from the prime Contractor or its affiliates. Work that a DBE subcontractor in turn subcontracts to a non-DBE does not count toward the DBE goal.
- (d) DBE as a trucker: 100 percent goal credit for trucking participation provided the DBE is responsible for the management and supervision of the entire trucking operation for which it is responsible. At least one truck owned, operated, licensed, and insured by the DBE must be used on the contract. Credit will be given for the full value of all such DBE trucks operated using DBE employed drivers. Goal credit will be limited to the value of the reasonable fee or commission received by the DBE if trucks are leased from a non-DBE company.
- (e) DBE as a material supplier:
 - (1) 60 percent goal credit for the cost of the materials or supplies purchased from a DBE regular dealer.

- (2) 100 percent goal credit for the cost of materials or supplies obtained from a DBE manufacturer.
- (3) 100 percent credit for the value of reasonable fees and commissions for the procurement of materials and supplies if not a regular dealer or manufacturer.

GOOD FAITH EFFORT PROCEDURES. If the bidder cannot obtain sufficient DBE commitments to meet the contract goal, the bidder must document in the Utilization Plan the good faith efforts made in the attempt to meet the goal. This means that the bidder must show that all necessary and reasonable steps were taken to achieve the contract goal. Necessary and reasonable steps are those which could reasonably be expected to obtain sufficient DBE participation. The Department will consider the quality, quantity, and intensity of the kinds of efforts that the bidder has made. Mere *pro forma* efforts are not good faith efforts; rather, the bidder is expected to have taken those efforts that would be reasonably expected of a bidder actively and aggressively trying to obtain DBE participation sufficient to meet the contract goal.

- (a) The following is a list of types of action that the Department will consider as part of the evaluation of the bidder's good faith efforts to obtain participation. These listed factors are not intended to be a mandatory checklist and are not intended to be exhaustive. Other factors or efforts brought to the attention of the Department may be relevant in appropriate cases, and will be considered by the Department.
 - (1) Soliciting through all reasonable and available means (e.g. attendance at pre-bid meetings, advertising and/or written notices) the interest of all certified DBE companies that have the capability to perform the work of the contract. The bidder must solicit this interest within sufficient time to allow the DBE companies to respond to the solicitation. The bidder must determine with certainty if the DBE companies are interested by taking appropriate steps to follow up initial solicitations.
 - (2) Selecting portions of the work to be performed by DBE companies in order to increase the likelihood that the DBE goals will be achieved. This includes, where appropriate, breaking out contract work items into economically feasible units to facilitate DBE participation, even when the prime Contractor might otherwise prefer to perform these work items with its own forces.
 - (3) Providing interested DBE companies with adequate information about the plans, specifications, and requirements of the contract in a timely manner to assist them in responding to a solicitation.
 - (4) a. Negotiating in good faith with interested DBE companies. It is the bidder's responsibility to make a portion of the work available to DBE subcontractors and suppliers and to select those portions of the work or material needs consistent with the available DBE subcontractors and suppliers, so as to facilitate DBE participation. Evidence of such negotiation includes the names, addresses, and telephone numbers of DBE companies that were considered; a description of the information provided regarding the plans and specifications for the work selected for subcontracting; and evidence as to why additional agreements could not be reached for DBE companies to perform the work.

- b. A bidder using good business judgment would consider a number of factors in negotiating with subcontractors, including DBE subcontractors, and would take a firm's price and capabilities as well as contract goals into consideration. However, the fact that there may be some additional costs involved in finding and using DBE companies is not in itself sufficient reason for a bidder's failure to meet the contract DBE goal, as long as such costs are reasonable. Also, the ability or desire of a bidder to perform the work of a contract with its own organization does not relieve the bidder of the responsibility to make good faith efforts. Bidders are not, however, required to accept higher quotes from DBE companies if the price difference is excessive or unreasonable.
- (5) Not rejecting DBE companies as being unqualified without sound reasons based on a thorough investigation of their capabilities. The bidder's standing within its industry, membership in specific groups, organizations, or associations and political or social affiliations (for example union vs. non-union employee status) are not legitimate causes for the rejection or non-solicitation of bids in the bidder's efforts to meet the project goal.
- (6) Making efforts to assist interested DBE companies in obtaining bonding, lines of credit, or insurance as required by the recipient or Contractor.
- (7) Making efforts to assist interested DBE companies in obtaining necessary equipment, supplies, materials, or related assistance or services.
- (8) Effectively using the services of available minority/women community organizations; minority/women contractors' groups; local, state, and federal minority/women business assistance offices; and other organizations as allowed on a case-by-case basis to provide assistance in the recruitment and placement of DBE companies.
- (b) If the Department determines that the bidder has made a good faith effort to secure the work commitment of DBE companies to meet the contract goal, the Department will award the contract provided that it is otherwise eligible for award. If the Department determines that a good faith effort has not been made, the Department will notify the bidder of that preliminary determination by contacting the responsible company official designated in the Utilization Plan. The preliminary determination shall include a statement of reasons why good faith efforts have not been found, and may include additional good faith efforts that the bidder could take. The notification will designate a five working day period during which the bidder shall take additional efforts. The bidder is not limited by a statement of additional efforts, but may take other action beyond any stated additional efforts in order to obtain additional DBE commitments. The bidder shall submit an amended Utilization Plan if additional DBE commitments to meet the contract goal are secured. If additional DBE commitments sufficient to meet the contract goal are not secured, the bidder shall report the final good faith efforts made in the time allotted. All additional efforts taken by the bidder will be considered as part of the bidder's good faith efforts. If the bidder is not able to meet the goal after taking additional efforts, the Department will make a pre-final determination of the good faith efforts of the bidder and will notify the designated responsible company official of the reasons for an adverse determination.

- (c) The bidder may request administrative reconsideration of a pre-final determination adverse to the bidder within the five working days after the notification date of the determination by delivering the request to the Department of Transportation, Bureau of Small Business Enterprises, Contract Compliance Section, 2300 South Dirksen Parkway, Room 319, Springfield, Illinois 62764 (Telefax: (217)785-1524). Deposit of the request in the United States mail on or before the fifth business day shall not be deemed delivery. The pre-final determination shall become final if a request is not made and delivered. A request may provide additional written documentation and/or argument concerning the issue of whether an adequate good faith effort was made to meet the contract goal. In addition, the request shall be considered a consent by the bidder to extend the time for award. The request will be forwarded to the Department's Reconsideration Officer. The Reconsideration Officer will extend an opportunity to the bidder to meet in person in order to consider all issues of whether the bidder made a good faith effort to meet the goal. After the review by the Reconsideration Officer, the bidder will be sent a written decision within ten working days after receipt of the request for reconsideration, explaining the basis for finding that the bidder did or did not meet the goal or make adequate good faith efforts to do so. A final decision by the Reconsideration Officer that a good faith effort was made shall approve the Utilization Plan submitted by the bidder and shall clear the contract for award. A final decision that a good faith effort was not made shall render the bid not responsive.

CONTRACT COMPLIANCE. Compliance with this Special Provision is an essential part of the contract. The Department is prohibited by federal regulations from crediting the participation of a DBE included in the Utilization Plan toward either the contract goal or the Department's overall goal until the amount to be applied toward the goals has been paid to the DBE. The following administrative procedures and remedies govern the compliance by the Contractor with the contractual obligations established by the Utilization Plan. After approval of the Plan and award of the contract, the Utilization Plan and individual DBE Participation Statements become part of the contract. If the Contractor did not succeed in obtaining enough DBE participation to achieve the advertised contract goal, and the Utilization Plan was approved and contract awarded based upon a determination of good faith, the total dollar value of DBE work calculated in the approved Utilization Plan as a percentage of the awarded contract value shall become the amended contract goal.

- (a) No amendment to the Utilization Plan may be made without prior written approval from the Department's Bureau of Small Business Enterprises. All requests for amendment to the Utilization Plan shall be submitted to the Department of Transportation, Bureau of Small Business Enterprises, Contract Compliance Section, 2300 South Dirksen Parkway, Room 319, Springfield, Illinois 62764. Telephone number (217) 785-4611. Telefax number (217) 785-1524.
- (b) All work indicated for performance by an approved DBE shall be performed, managed, and supervised by the DBE executing the Participation Statement. The Contractor shall not terminate for convenience a DBE listed in the Utilization Plan and then perform the work of the terminated DBE with its own forces, those of an affiliate or those of another subcontractor, whether DBE or not, without first obtaining the written consent of the Bureau of Small Business Enterprises to amend the Utilization Plan. If a DBE listed in the Utilization Plan is terminated for reasons other than convenience, or fails to complete its work on the contract for any reason, the Contractor shall make good faith efforts to

find another DBE to substitute for the terminated DBE. The good faith efforts shall be directed at finding another DBE to perform at least the same amount of work under the contract as the DBE that was terminated, but only to the extent needed to meet the contract goal or the amended contract goal. The Contractor shall notify the Bureau of Small Business Enterprises of any termination for reasons other than convenience, and shall obtain approval for inclusion of the substitute DBE in the Utilization Plan. If good faith efforts following a termination of a DBE for cause are not successful, the Contractor shall contact the Bureau of Small Business Enterprises and provide a full accounting of the efforts undertaken to obtain substitute DBE participation. The Bureau of Small Business Enterprises will evaluate the good faith efforts in light of all circumstances surrounding the performance status of the contract, and determine whether the contract goal should be amended.

- (c) The Contractor shall maintain a record of payments for work performed to the DBE participants. The records shall be made available to the Department for inspection upon request. After the performance of the final item of work or delivery of material by a DBE and final payment therefore to the DBE by the Contractor, but not later than thirty calendar days after payment has been made by the Department to the Contractor for such work or material, the Contractor shall submit a DBE Payment Agreement on Department form SBE 2115 to the Regional Engineer. If full and final payment has not been made to the DBE, the DBE Payment Agreement shall indicate whether a disagreement as to the payment required exists between the Contractor and the DBE or if the Contractor believes that the work has not been satisfactorily completed. If the Contractor does not have the full amount of work indicated in the Utilization Plan performed by the DBE companies indicated in the Plan, the Department will deduct from contract payments to the Contractor the amount of the goal not achieved as liquidated and ascertained damages.
- (d) The Department reserves the right to withhold payment to the Contractor to enforce the provisions of this Special Provision. Final payment shall not be made on the contract until such time as the Contractor submits sufficient documentation demonstrating achievement of the goal in accordance with this Special Provision or after liquidated damages have been determined and collected.
- (e) Notwithstanding any other provision of the contract, including but not limited to Article 109.09 of the Standard Specifications, the Contractor may request administrative reconsideration of a decision to deduct the amount of the goal not achieved as liquidated damages. A request to reconsider shall be delivered to the Contract Compliance Section and shall be handled and considered in the same manner as set forth in paragraph (c) of "Good Faith Effort Procedures" of this Special Provision, except a final decision that a good faith effort was not made during contract performance to achieve the goal agreed to in the Utilization Plan shall be the final administrative decision of the Department.

ENGINEER'S FIELD OFFICE TYPE A (BDE)

Effective: April 1, 2007

Revised: August 1, 2008

Revise Article 670.02 of the Standard Specifications to read:

“670.02 Engineer's Field Office Type A. Type A field offices shall have a minimum ceiling height of 7 ft (2 m) and a minimum floor space 450 sq ft (42 sq m). The office shall be provided with sufficient heat, natural and artificial light, and air conditioning.

The office shall have an electronic security system that will respond to any breach of exterior doors and windows. Doors and windows shall be equipped with locks. Doors shall also be equipped with dead bolt locks or other secondary locking device.

Windows shall be equipped with exterior screens to allow adequate ventilation. All windows shall be equipped with interior shades, curtains, or blinds. Adequate all-weather parking space shall be available to accommodate a minimum of ten vehicles.

Suitable on-site sanitary facilities meeting Federal, State, and local health department requirements shall be provided, maintained clean and in good working condition, and shall be stocked with lavatory and sanitary supplies at all times.

Sanitary facilities shall include hot and cold potable running water, lavatory and toilet as an integral part of the office where available. Solid waste disposal consisting of two waste baskets and an outside trash container of sufficient size to accommodate a weekly provided pick-up service.

In addition, the following furniture and equipment shall be furnished.

- (a) Four desks with minimum working surface 42 x 30 in. (1.1 m x 750 mm) each and five non-folding chairs with upholstered seats and backs.
- (b) One desk with minimum working surface 48 x 72 in. (1.2 x 1.8 m) with height adjustment of 23 to 30 in. (585 to 750 mm).
- (c) One four-post drafting table with minimum top size of 37 1/2 x 48 in. (950 mm x 1.2 m). The top shall be basswood or equivalent and capable of being tilted through an angle of 50 degrees. An adjustable height drafting stool with upholstered seat and back shall also be provided.
- (d) Two free standing four drawer legal size file cabinet with lock and an underwriters' laboratories insulated file device 350 degrees one hour rating.
- (e) One 6 ft (1.8 m) folding table with six folding chairs.
- (f) One equipment cabinet of minimum inside dimension of 44 in. (1100 mm) high x 24 in. (600 mm) wide x 30 in. (750 mm) deep with lock. The walls shall be of steel with a 3/32 in. (2 mm) minimum thickness with concealed hinges and enclosed lock constructed in such a manner as to prevent entry by force. The cabinet assembly shall be permanently attached to a structural element of the field office in a manner to prevent theft of the entire cabinet.
- (g) One refrigerator with a minimum size of 16 cu ft (0.45 cu m) with a freezer unit.
- (h) One electric desk type tape printing calculator.

- (i) A minimum of two communication paths. The configuration shall include:
 - (1) Internet Connection. An internet service connection using telephone DSL, cable broadband, or CDMA wireless technology. Additionally, an 802.11g/N wireless router shall be provided, which will allow connection by the Engineer and up to four Department staff.
 - (2) Telephone Lines. Three separate telephone lines.
- (j) One plain paper copy machine capable of reproducing prints up to 11 x 17 in. (280 x 432 mm) with an automatic feed tray capable of storing 30 sheets of paper. Letter size and 11 x 17 in. (280 x 432 mm) paper shall be provided.
- (k) One plain paper fax machine with paper.
- (l) Two telephones, with touch tone, where available, and a digital telephone answering machine, for exclusive use by the Engineer.
- (m) One electric water cooler dispenser.
- (n) One first-aid cabinet fully equipped.
- (o) One microwave oven, 1 cu ft (0.03 cu m) minimum capacity.
- (p) One fire-proof safe, 0.5 cu ft (0.01 cu m) minimum capacity.
- (q) One electric paper shredder.
- (r) One post mounted rain gauge, located on the project site for each 5 miles (8 km) of project length.”

Revise the first sentence of the first paragraph of Article 670.07 of the Standard Specifications to read:

“The building or buildings fully equipped as specified will be paid for on a monthly basis until the building or buildings are released by the Engineer.”

Revise the last sentence of the first paragraph of Article 670.07 of the Standard Specifications to read:

“This price shall include all utility costs and shall reflect the salvage value of the building or buildings, equipment, and furniture which become the property of the Contractor after release by the Engineer, except that the Department will pay that portion of the monthly long distance telephone bills that, when combined, exceed \$150.”

EPOXY PAVEMENT MARKINGS (BDE)

Effective: January 1, 2007

Revise Article 1095.04(a) of the Standard Specifications to read:

“(a) The epoxy marking material shall consist of a 100 percent solid two part system formulated and designed to provide a simple volumetric mixing ratio of two components (must be two volumes of Part A and one volume of Part B). No volatile solvents or fillers will be allowed. Total solids shall not be less than 99 percent when determined, on the mixed material, according to ASTM D 2369, excluding the solvent dispersion.”

Revise Article 1095.04(d) of the Standard Specifications to read:

“(d) Composition by Weight of Component A as Determined by Low Temperature Ashing. A 0.5 gram sample of component A shall be dispersed with a paperclip on the bottom of an aluminum dish, weighed and then heated in a muffle furnace at 1000 °F (538 °C) for one hour and weighed again. No solvents shall be used for dispersion. The difference in the weights shall be calculated and meet the following.

Pigment*	White	Yellow
Titanium Dioxide ASTM D 476 Type II	21-24%	
Organic Yellow, Titanium Dioxide, Other		± 2%**
Epoxy Resin	76-79%	± 2%**

* No extender pigments are permitted.

** From the pigment and epoxy resin content determined on qualification samples.”

Revise Article 1095.04(f) of the Standard Specifications to read:

“(f) The daylight directional reflectance of the paint (without glass spheres) applied at 14 to 16 mils (0.35 to 0.41 mm) shall meet the following requirements when tested, using a color spectrophotometer with 45 degree circumferential/zero degree geometry, illuminant C, and two degree observer angle. The color instrument shall measure the visible spectrum from 380 to 720 nm with a wavelength measurement interval and spectral bandpass of 10 nm.

White: Daylight Reflectance 80 % min.
 Yellow:* Daylight Reflectance 50 % min.

*Shall meet the coordinates of the following color tolerance chart.

x	0.490	0.475	0.485	0.530
y	0.470	0.438	0.425	0.456”

Revise Article 1095.04(h) of the Standard Specifications to read:

“(h) The epoxy pavement marking material, when mixed in the proper mix ratio and tested according to ASTM D 7234 shall have a degree of adhesion which results in a 100 percent concrete failure in the performance of this test.”

Revise Article 1095.04(n) of the Standard Specifications to read:

“(n) The epoxy paint shall be applied to an aluminum alloy panel (Federal Test Std. No. 141, Method 2013) at a film thickness of 14 to 16 mils (0.35 to 0.41 mm) and allowed to cure for 72 hours at room temperature. Subject the coated panel for 75 hours to accelerated weathering using the light and water exposure apparatus (fluorescent UV - condensation type) as specified in ASTM G 53 (equipped with UVB-313 lamps).

The cycle shall consist of four hours UV exposure at 122 °F (50 °C) followed by four hours of condensation at 104 °F (40 °C). UVB 313 bulbs shall be used. At the end of the exposure period, the panel shall show no more than 10 Hunter Lab Delta E units or substantial change in gloss from the original, non-exposed paint.”

EQUIPMENT RENTAL RATES (BDE)

Effective: August 2, 2007

Revised: January 2, 2008

Replace the second and third paragraphs of Article 105.07(b)(4)a. of the Standard Specifications with the following:

“Equipment idled which cannot be used on other work, and which is authorized to standby on the project site by the Engineer, will be paid for according to Article 109.04(b)(4).”

Replace Article 109.04(b)(4) of the Standard Specifications with the following:

“(4) Equipment. Equipment used for extra work shall be authorized by the Engineer. The equipment shall be specifically described, be of suitable size and capacity for the work to be performed, and be in good operating condition. For such equipment, the Contractor will be paid as follows.

- a. Contractor Owned Equipment. Contractor owned equipment will be paid for by the hour using the applicable FHWA hourly rate from the “Equipment Watch Rental Rate Blue Book” (Blue Book) in effect when the force account work begins. The FHWA hourly rate is calculated as follows.

$$\text{FHWA hourly rate} = (\text{monthly rate}/176) \times (\text{model year adj.}) \times (\text{Illinois adj.}) + \text{EOC}$$

Where: EOC = Estimated Operating Costs per hour (from the Blue Book)

The time allowed will be the actual time the equipment is operating on the extra work. For the time required to move the equipment to and from the site of the extra work and any authorized idle (standby) time, payment will be made at the following hourly rate: $0.5 \times (\text{FHWA hourly rate} - \text{EOC})$.

All time allowed shall fall within the working hours authorized for the extra work.

The rates above include the cost of fuel, oil, lubrication, supplies, small tools, necessary attachments, repairs, overhaul and maintenance of any kind,

depreciation, storage, overhead, profits, insurance, and all incidentals. The rates do not include labor.

The Contractor shall submit to the Engineer sufficient information for each piece of equipment and its attachments to enable the Engineer to determine the proper equipment category. If a rate is not established in the Blue Book for a particular piece of equipment, the Engineer will establish a rate for that piece of equipment that is consistent with its cost and use in the industry.

- b. Rented Equipment. Whenever it is necessary for the Contractor to rent equipment to perform extra work, the rental and transportation costs of the equipment plus five percent for overhead will be paid. In no case shall the rental rates exceed those of established distributors or equipment rental agencies.

All prices shall be agreed to in writing before the equipment is used.”

FLAGGER AT SIDE ROADS AND ENTRANCES (BDE)

Effective: April 1, 2009

Revise the second paragraph of Article 701.13(a) of the Standard Specifications to read:

“The Engineer will determine when a side road or entrance shall be closed to traffic. A flagger will be required at each side road or entrance remaining open to traffic within the operation where two-way traffic is maintained on one lane of pavement. The flagger shall be positioned as shown on the plans or as directed by the Engineer.”

Revise the first and second paragraph of Article 701.20(i) of the Standard Specifications to read:

“Signs, barricades, or other traffic control devices required by the Engineer over and above those specified will be paid for according to Article 109.04. All flaggers required at side roads and entrances remaining open to traffic including those that are shown on the Highway Standards and/or additional barricades required by the Engineer to close side roads and entrances will be paid for according to Article 109.04.”

HOT-MIX ASPHALT - FIELD VOIDS IN THE MINERAL AGGREGATE (BDE)

Effective: April 1, 2007

Revised: April 1, 2008

Add the following to the table in Article 1030.05(d)(2)a. of the Standard Specifications:

"Parameter	Frequency of Tests	Frequency of Tests	Test Method See Manual of Test Procedures for Materials
	High ESAL Mixture Low ESAL Mixture	All Other Mixtures	
VMA	Day's production ≥ 1200 tons: 1 per half day of production	N/A	Illinois-Modified AASHTO R 35
Note 5.	Day's production < 1200 tons: 1 per half day of production for first 2 days and 1 per day thereafter (first sample of the day)		

Note 5. The G_{sb} used in the voids in the mineral aggregate (VMA) calculation shall be the same average G_{sb} value listed in the mix design."

Add the following to the Control Limits table in Article 1030.05(d)(4) of the Standard Specifications:

"CONTROL LIMITS			
Parameter	High ESAL Low ESAL	High ESAL Low ESAL	All Other
	Individual Test	Moving Avg. of 4	Individual Test
VMA	-0.7 % ^{2/}	-0.5 % ^{2/}	N/A

2/ Allowable limit below minimum design VMA requirement"

Add the following to the table in Article 1030.05(d)(5) of the Standard Specifications:

"CONTROL CHART REQUIREMENTS	High ESAL Low ESAL	All Other
	VMA"	

Revise the heading of Article 1030.05(d)(6)a.1. of the Standard Specifications to read:

"1. Voids, VMA, and Asphalt Binder Content."

Revise the first sentence of the first paragraph of Article 1030.05(d)(6)a.1.(a.) of the Standard Specifications to read:

"If the retest for voids, VMA, or asphalt binder content exceeds control limits, HMA production shall cease and immediate corrective action shall be instituted by the Contractor."

Revise the table in Article 1030.05(e) of the Standard Specifications to read:

"Test Parameter	Acceptable Limits of Precision
% Passing: ^{1/}	
1/2 in. (12.5 mm)	5.0 %
No. 4 (4.75 mm)	5.0 %
No. 8 (2.36 mm)	3.0 %
No. 30 (600 μm)	2.0 %
Total Dust Content No. 200 (75 μm) ^{1/}	2.2 %
Asphalt Binder Content	0.3 %
Maximum Specific Gravity of Mixture	0.026
Bulk Specific Gravity	0.030
VMA	1.4 %
Density (% Compaction)	1.0 % (Correlated)

1/ Based on washed ignition."

HOT-MIX ASPHALT – PLANT TEST FREQUENCY (BDE)

Effective: April 1, 2008

Revise the table in Article 1030.05(d)(2)a. of the Standard Specifications to read:

"Parameter	Frequency of Tests	Frequency of Tests	Test Method
	High ESAL Mixture Low ESAL Mixture	All Other Mixtures	See Manual of Test Procedures for Materials
Aggregate Gradation Hot bins for batch and continuous plants. Individual cold-feed or combined belt- feed for drier drum plants. % passing sieves: 1/2 in. (12.5 mm), No. 4 (4.75 mm), No. 8 (2.36 mm), No. 30 (600 μm) No. 200 (75 μm) Note 1.	1 dry gradation per day of production (either morning or afternoon sample). and 1 washed ignition oven test on the mix per day of production (conduct in the afternoon if dry gradation is conducted in the morning or vice versa). Note 3. Note 4.	1 gradation per day of production. The first day of production shall be a washed ignition oven test on the mix. Thereafter, the testing shall alternate between dry gradation and washed ignition oven test on the mix. Note 4.	Illinois Procedure
Asphalt Binder Content by Ignition Oven Note 2.	1 per half day of production	1 per day	Illinois-Modified AASHTO T 308

Air Voids Bulk Specific Gravity of Gyratory Sample	Day's production \geq 1200 tons: 1 per half day of production	1 per day	Illinois-Modified AASHTO T 312
	Day's production < 1200 tons: 1 per half day of production for first 2 days and 1 per day thereafter (first sample of the day)		
Maximum Specific Gravity of Mixture	Day's production \geq 1200 tons: 1 per half day of production	1 per day	Illinois-Modified AASHTO T 209"
	Day's production < 1200 tons: 1 per half day of production for first 2 days and 1 per day thereafter (first sample of the day)		

HOT-MIX ASPHALT – TRANSPORTATION (BDE)

Effective: April 1, 2008

Revise Article 1030.08 of the Standard Specifications to read:

“1030.08 Transportation. Vehicles used in transporting HMA shall have clean and tight beds. The beds shall be sprayed with asphalt release agents from the Department’s approved list. In lieu of a release agent, the Contractor may use a light spray of water with a light scatter of manufactured sand (FA 20 or FA 21) evenly distributed over the bed of the vehicle. After spraying, the bed of the vehicle shall be in a completely raised position and it shall remain in this position until all excess asphalt release agent or water has been drained.

When the air temperature is below 60 °F (15 °C), the bed, including the end, endgate, sides and bottom shall be insulated with fiberboard, plywood or other approved insulating material and shall have a thickness of not less than 3/4 in (20 mm). When the insulation is placed inside the bed, the insulation shall be covered with sheet steel approved by the Engineer. Each vehicle shall be equipped with a cover of canvas or other suitable material meeting the approval of the Engineer which shall be used if any one of the following conditions is present.

- (a) Ambient air temperature is below 60 °F (15 °C).
- (b) The weather is inclement.

- (c) The temperature of the HMA immediately behind the paver screed is below 250 °F (120 °C).

The cover shall extend down over the sides and ends of the bed for a distance of approximately 12 in. (300 mm) and shall be fastened securely. The covering shall be rolled back before the load is dumped into the finishing machine.”

HOT-MIX ASPHALT MIXTURE IL-4.75 (BDE)

Effective: November 1, 2004

Revised: January 1, 2008

Description. This work shall consist of constructing hot-mix asphalt (HMA) surface course or leveling binder with an IL-4.75 mixture. Work shall be according to Sections 406 and 1030 of the Standard Specifications, except as modified herein.

Materials.

Revise the first paragraph of Article 1003.03(c) of the Standard Specifications to read:

- “(c) Gradation. The fine aggregate gradation for High ESAL, Low ESAL, and All Other HMA shall be FA 1, FA 2, FA 20, or FA 21; except FA 21 will not be permitted for mixture IL-4.75.”

Revise the third sentence of Note 2 of Article 1030.02 of the Standard Specifications to read:

“The maximum percentage of RAP in any mixtures containing a polymer modified asphalt binder shall be ten percent.”

Revise the second sentence of Note 3 of Article 1030.02 of the Standard Specifications to read:

“For mixtures with an $N_{design} \geq 90$ and for mixture IL-4.75, at least 50 percent of the required fine aggregate fraction shall consist of either stone sand, slag sand, or steel slag meeting the FA/FM 20 gradation.”

Add the following note after Table 1 and after Table 2 of Article 1032.05(b) of the Standard Specifications:

“Note. When SBS/SBR PG76-22 or SBS/SBR PG76-28 are specified for mixture IL-4.75, the elastic recovery shall be a minimum of 80.”

Equipment.

Add the following paragraph after the second paragraph of Article 1102.01(a)(6) of the Standard Specifications:

“IL-4.75 mixtures which contain aggregate having absorptions greater than or equal to 2.5 percent, or which contain steel slag sand, shall have a minimum silo storage plus haul time of 1.5 hours.”

Add the following to Article 1102.01(a) of the Standard Specifications:

- “(13) For mixture IL-4.75, mineral filler and collected dust (baghouse) shall be proportioned according to the following.
- a. Mineral filler shall not be stored in the same silo as collected dust (baghouse).
 - b. Additional minus 200 material needed to meet the JMF may be entirely manufactured mineral filler.
 - c. Collected dust (baghouse) may be used in lieu of manufactured mineral filler according to the following.
 1. Sufficient collected dust (baghouse) is available for production of the IL-4.75 mixture for the entire project.
 2. A mix design was prepared based on collected dust (baghouse).
 - d. A combination of collected dust (baghouse) and manufactured mineral filler may be used according to the following.
 1. The amount (proportion) of each shall be established and not varied.
 2. A mix design was prepared based on the established proportions.”

Mixture Design.

Add the following to the list of Illinois Modified AASHTO references in Article 1030.04 of the Standard Specifications:

“AASHTO T 305 Standard Method of Test for Determination of Draindown Characteristics in Uncompacted Asphalt Mixtures”

Add the following to Article 1030.04(a) of the Standard Specifications:

“(4) IL-4.75 Mixture. The Job Mix Formula (JMF) shall fall within the following limits.

IL-4.75, MIXTURE COMPOSITION	
Sieve	Percent Passing
1/2 in. (12.5 mm)	100
3/8 in. (9.5 mm)	100
No. 4 (4.75 mm)	90-100
No. 8 (2.36 mm)	70-90
No. 16 (1.18 mm)	50-65
No. 30 (600 μm)	35-55
No. 50 (300 μm)	15-30

No. 100 (150 μm)	10-18
No. 200 (75 μm)	7-9
AB Content	7% to 9%”

Add the following to Article 1030.04(b) of the Standard Specifications:

“(4) IL-4.75 Mixture.

VOLUMETRIC REQUIREMENTS IL-4.75	
Volumetric Parameter	Requirement
Design Air Voids	4.0 % at Ndesign 50
Voids in the Mineral Aggregate (VMA)	18.5 % minimum
Voids Filled with Asphalt (VFA)	78-88 %
Maximum Dust/AC Ratio	1.0
Maximum Draindown	0.3%”

Control Limits.

Add the following to the tables in Article 1030.05(d)(4) of the Standard Specifications:

“CONTROL LIMITS		
Parameter	IL-4.75 Individual Test	IL-4.75 Moving Ave. of 4
% Passing: ^{1/}		
1/2 in. (12.5 mm)		
No. 4 (4.75 mm)		
No. 8 (2.36 mm)		
No. 16 (1.18 mm)	± 4 %	± 3 %
No. 30 (600 μm)		
Total Dust Content No. 200 (75 μm)	± 1.5 %	± 1.0 %
Asphalt Binder Content	± 0.3 %	± 0.2 %
Voids	± 1.2 %	± 1.0 %

DENSITY CONTROL LIMITS		
Mixture Composition	Parameter	Individual Test
IL-4.75	Ndesign = 50	93.0% - 97.4% ^{2/}

2/ Density shall be determined by cores or by correlated, approved thin lift nuclear gauge.”

CONSTRUCTION REQUIREMENTS

Leveling.

Revise the table and the second paragraph of Article 406.05(c) of the Standard Specifications to read:

"Leveling Binder"	
Nominal, Compacted, Leveling Binder Thickness, in. (mm)	Mixture Composition
≤ 1 1/4 (32)	IL-4.75, IL-9.5, or IL-9.5L
> 1 1/4 to 2 (32 to 50)	IL-9.5, IL-12.5, or IL-9.5L

The density requirements of Article 406.07(c) shall apply for leveling binder, machine method, when the nominal compacted thickness is: 3/4 in. (19 mm) or greater for IL-4.75 mixtures; 1 1/4 in. (32 mm) or greater for IL-9.5 and IL-9.5L mixtures; and 1 1/2 in. (38 mm) or greater for IL-12.5 mixtures."

Placing.

Revise Article 406.06(b) of the Standard Specifications to read:

"(b) Placement Conditions. Placement of HMA shall be under the following conditions.

(1) General Conditions. HMA shall be placed on a clean, dry base and when weather conditions are suitable. The leveling binder and binder courses shall be placed only when the temperature in the shade is at least 40 °F (5 °C) and the forecast is for rising temperatures. The surface course shall be placed only when the air temperature in the shade is at least 45 °F (8 °C) and the forecast is for rising temperatures.

The HMA shall be delivered at a temperature of 250 to 350 °F (120 to 175 °C).

Intermingling of different mixture compositions at any one paver will not be permitted.

(2) Special Conditions for mixture IL-4.75.

- a. The surface shall be dry for at least 24 hours, and clean, prior to placement of the mixture.
- b. Work shall not begin when local conditions indicate rain is imminent.
- c. The mixture shall be placed only when the temperature in the shade is at least 50 °F (10 °C) and the forecast is for rising temperatures.
- d. The mixture temperature shall be 310 to 350 °F (155 to 175 °C) and shall be measured in the truck just prior to placement.

- e. When used as leveling binder, the mixture shall be overlaid within five days of being placed.”

Add the following paragraph to the end of Article 406.06(d) of the Standard Specifications:

“The minimum and maximum compacted lift thickness for mixture IL-4.75 shall be 3/4 in. (19 mm) and 1 1/4 in. (32 mm) respectively.”

Compaction.

Revise Table 1 of Article 406.07 of the Standard Specifications to read:

"TABLE 1 - MINIMUM ROLLER REQUIREMENTS FOR HMA				
	Breakdown Roller (one of the following)	Intermediate Roller	Final Roller (one or more of the following)	Density Requirement
Level Binder: (When the density requirements of Article 406.05(c) do not apply.)	P ^{3/}	--	V _S , P, T _B , T _F , 3W	To the satisfaction of the Engineer.
Binder and Surface ^{1/} Level Binder ^{1/} : (When the density requirements of Article 406.05(c) apply.)	V _D , P, T _B , 3W	P ^{3/}	V _S , T _B , T _F	As specified in Articles: 1030.05(d)(3), (d)(4), and (d)(7).
Bridge Decks ^{2/}	T _B	--	T _F	As specified in Articles: 582.05 and 582.06.

- 1/ If the average delivery at the job site is 85 ton/hr (75 metric ton/hr) or less, any roller combination may be used provided it includes a steel wheeled roller and the required density and smoothness is obtained.
- 2/ One T_B roller may be used for both breakdown and final rolling on bridge decks 300 ft (90 m) or less in length, except when the air temperature is less than 60 °F (15 °C).
- 3/ A V_D roller may be used in lieu of the P roller on mixtures containing polymer modified asphalt binder.
- 4/ For mixture IL-4.75, a minimum of two T_B rollers and one T_F roller shall be provided. P and V rollers will not be permitted.”

Basis of Payment.

Add the following paragraph after the third paragraph of Article 406.14 of the Standard Specifications:

“Mixture IL-4.75 will be paid for at the contract unit price per ton (metric ton) for POLYMERIZED LEVELING BINDER (MACHINE METHOD), IL-4.75, N50; and POLYMERIZED HOT-MIX ASPHALT SURFACE COURSE, IL-4.75, N50.”

LIQUIDATED DAMAGES (BDE)

Effective: April 1, 2009

Revise the table in Article 108.09 of the Standard Specifications to read:

"Schedule of Deductions for Each Day of Overrun in Contract Time			
Original Contract Amount		Daily Charges	
From More Than	To and Including	Calendar Day	Work Day
\$ 0	\$ 100,000	\$ 375	\$ 500
100,000	500,000	625	875
500,000	1,000,000	1,025	1,425
1,000,000	3,000,000	1,125	1,550
3,000,000	5,000,000	1,425	1,950
5,000,000	10,000,000	1,700	2,350
10,000,000	And over	3,325	4,650"

MATERIAL TRANSFER DEVICE (BDE)

Effective Date: June 15, 1999

Revised Date: January 1, 2009

Description. This work shall consist of placing hot-mix asphalt surface course, Mix "D", N50, except that these materials shall be placed using a material transfer device.

Materials and Equipment. The material transfer device shall have a minimum surge capacity of 15 tons (13.5 metric tons), shall be self-propelled and capable of moving independent of the paver, and shall be equipped with the following:

- (a) Front-Dump Hopper and Conveyor. The conveyor shall provide a positive restraint along the sides of the conveyor to prevent material spillage. Material Transfer devices having paver style hoppers shall have a horizontal bar restraint placed across the foldable wings which prevents the wings from being folded.
- (b) Paver Hopper Insert. The paver hopper insert shall have a minimum capacity of 14 tons (12.7 metric tons).
- (c) Mixer/Agitator Mechanism. This re-mixing mechanism shall consist of a segmented, anti-segregation, re-mixing auger or two full-length longitudinal paddle mixers designed for the purpose of re-mixing the hot-mix asphalt (HMA). The longitudinal paddle mixers shall be located in the paver hopper insert.

CONSTRUCTION REQUIREMENTS

General. The material transfer device shall be used for the placement of hot-mix asphalt surface course, Mix "D", N50. The material transfer device speed shall be adjusted to the speed of the paver to maintain a continuous, non-stop paving operation.

Use of a material transfer device with a roadway contact pressure exceeding 20 psi (138 kPa) will be limited to partially completed segments of full-depth HMA pavement where the thickness of binder in place is 10 in. (250 mm) or greater.

Structures. The material transfer device may be allowed to travel over structures under the following conditions:

- (a) Approval will be given by the Engineer.
- (b) The vehicle shall be emptied of HMA material prior to crossing the structure and shall travel at crawl speed across the structure.
- (c) The tires of the vehicle shall travel on or in close proximity and parallel to the beam and/or girder lines of the structure.

Method of Measurement. This work will be measured for payment in tons (metric tons) for hot-mix asphalt surface course, Mix "D", N50, materials placed with a material transfer device.

Basis of Payment. This work will be paid for at the contract unit price per ton (metric ton) for MATERIAL TRANSFER DEVICE.

The various HMA mixtures placed with the material transfer device will be paid for as specified in their respective specifications. The Contractor may choose to use the material transfer device for other applications on this project; however, no additional compensation will be allowed.

MONTHLY EMPLOYMENT REPORT (BDE)

Effective: April 1, 2009

In addition to any other reporting required by the contract, the Contractor shall provide to the Engineer an employment summary for all employees working on the contract from the contract execution date to the last full pay period each month for the duration of the contract. The report may include but is not limited to:

- a) A listing of the total number of employees.
- b) The employee job classification.
- c) The total hours worked and payroll for each employee.

The report shall be completed by the Contractor and each subcontractor. Employee hours worked from home office or other off-site office hours worked related directly to this contract shall be included. Engineering consulting firms performing construction layout and material testing for the Contractor shall also be included.

Hours worked for material suppliers, services provided by purchase orders, Department employees or consulting firms performing inspection or testing for the Department shall not be included in the report.

The report shall contain all hours worked under the contract from the start of the month to the last full pay period each month and shall be submitted no later than 10 business days after the end of each month.

The report shall be submitted electronically in a format determined by the Engineer. See attachment for potential reporting format.

Any costs associated with complying with this provision shall be considered as included in the contract unit prices bid for the various items of work involved and no additional compensation will be allowed.

Attachment

MONTHLY PRIME AND SUBCONTRACTOR EMPLOYMENT REPORT AMERICAN RECOVERY AND REINVESTMENT ACT			
1. First day of reporting period (mm/dd/yyyy)	2. Last day of reporting period (mm/dd/yyyy)	3. Notice to Proceed Date (mm/dd/yyyy)	
4. NAME AND ADDRESS OF FIRM		5. FEDERAL AID PROJECT NUMBER	
		5. State Project Number (if D)	
7. CONTRACTING AGENCY		8. STATE (or Federal Lands Region)	
Employment Data			
Direct, On-Project Jobs	TOTAL EMP. CYCLES	TOTAL HOURS	TOTAL PAYROLL
CONSTRUCTION	NEW HIRES		
	EXISTING EMPLOYEES		
NON-CONSTRUCTION	NEW HIRES		
	EXISTING EMPLOYEES		
TOTAL			
10. PREPARED BY (Signature and Title)			DATE
11. REVIEWED BY (Signature and Title of State Highway Official)			DATE

This form is issued in association with the American Recovery and Reinvestment Act of 2009

NATIONAL POLLUTANT DISCHARGE ELIMINATION SYSTEM / EROSION AND SEDIMENT CONTROL DEFICIENCY DEDUCTION (BDE)

Effective: April 1, 2007

Revised: November 1, 2008

Revise Article 105.03(a) of the Standard Specifications to read:

“(a) National Pollutant Discharge Elimination System (NPDES) / Erosion and Sediment Control Deficiency Deduction. When the Engineer is notified or determines an erosion and/or sediment control deficiency(s) exists, or the Contractor’s activities represents a violation of the Department’s NPDES permits, the Engineer will notify and direct the Contractor to correct the deficiency within a specified time. The specified time, which begins upon notification to the Contractor, will be from 1/2 hour to 1 week based on the urgency of the situation and the nature of the work effort required. The Engineer will be the sole judge.

A deficiency may be any lack of repair, maintenance, or implementation of erosion and/or sediment control devices included in the contract, or any failure to comply with the conditions of the Department’s NPDES permits. A deficiency may also be applied to situations where corrective action is not an option such as the failure to participate in a jobsite inspection of the project, failure to install required measures prior to initiating earth moving operations, disregard of concrete washout requirements, or other disregard of the NPDES permit.

If the Contractor fails to correct a deficiency within the specified time, a daily monetary deduction will be imposed for each calendar day or fraction thereof the deficiency exists. The calendar day(s) will begin with notification to the Contractor and end with the Engineer’s acceptance of the correction. The daily monetary deduction will be either \$1000.00 or 0.05 percent of the awarded contract value, whichever is greater. For those deficiencies where corrective action was not an option, the monetary deduction will be immediate and will be valued at one calendar day.”

PAYMENTS TO SUBCONTRACTORS (BDE)

Effective: June 1, 2000

Revised: January 1, 2006

Federal regulations found at 49 CFR §26.29 mandate the Department to establish a contract clause to require Contractors to pay subcontractors for satisfactory performance of their subcontracts and to set the time for such payments.

State law also addresses the timing of payments to be made to subcontractors and material suppliers. Section 7 of the Prompt Payment Act, 30 ILCS 540/7, requires that when a Contractor receives any payment from the Department, the Contractor shall make corresponding, proportional payments to each subcontractor and material supplier performing work or supplying material within 15 calendar days after receipt of the Department payment. Section 7 of the Act further provides that interest in the amount of two percent per month, in addition to the payment due, shall be paid to any subcontractor or material supplier by the Contractor if the payment required by the Act is withheld or delayed without reasonable cause. The Act also provides that the time for payment required and the calculation of any interest due

applies to transactions between subcontractors and lower-tier subcontractors and material suppliers throughout the contracting chain.

This Special Provision establishes the required federal contract clause, and adopts the 15 calendar day requirement of the State Prompt Payment Act for purposes of compliance with the federal regulation regarding payments to subcontractors. This contract is subject to the following payment obligations.

When progress payments are made to the Contractor according to Article 109.07 of the Standard Specifications, the Contractor shall make a corresponding payment to each subcontractor and material supplier in proportion to the work satisfactorily completed by each subcontractor and for the material supplied to perform any work of the contract. The proportionate amount of partial payment due to each subcontractor and material supplier throughout the contracting chain shall be determined by the quantities measured or otherwise determined as eligible for payment by the Department and included in the progress payment to the Contractor. Subcontractors and material suppliers shall be paid by the Contractor within 15 calendar days after the receipt of payment from the Department. The Contractor shall not hold retainage from the subcontractors. These obligations shall also apply to any payments made by subcontractors and material suppliers to their subcontractors and material suppliers; and to all payments made to lower tier subcontractors and material suppliers throughout the contracting chain. Any payment or portion of a payment subject to this provision may only be withheld from the subcontractor or material supplier to whom it is due for reasonable cause.

This Special Provision does not create any rights in favor of any subcontractor or material supplier against the State or authorize any cause of action against the State on account of any payment, nonpayment, delayed payment, or interest claimed by application of the State Prompt Payment Act. The Department will not approve any delay or postponement of the 15 day requirement except for reasonable cause shown after notice and hearing pursuant to Section 7(b) of the State Prompt Payment Act. State law creates other and additional remedies available to any subcontractor or material supplier, regardless of tier, who has not been paid for work properly performed or material furnished. These remedies are a lien against public funds set forth in Section 23(c) of the Mechanics Lien Act, 770 ILCS 60/23(c), and a recovery on the Contractor's payment bond according to the Public Construction Bond Act, 30 ILCS 550.

PAYROLLS AND PAYROLL RECORDS (BDE)

Effective: March 1, 2009

FEDERAL AID CONTRACTS. Revise the following section of Check Sheet #1 of the Recurring Special Provisions to read:

"STATEMENTS AND PAYROLLS

The payroll records shall include each worker's name, address, telephone number, social security number, classification, rate of pay, number of hours worked each day, starting and ending times of work each day, total hours worked each week, itemized deductions made, and actual wages paid.

The Contractor and each subcontractor shall submit payroll records to the Engineer each week from the start to the completion of their respective work, except that full social security numbers and home addresses shall not be included on weekly transmittals. Instead the payrolls shall include an identification number for each employee (e.g., the last four digits of the employee's social security number.). The submittals shall be on the Department's form SBE 48, or an approved facsimile. When there has been no activity during a work week, a payroll record shall still be submitted with the appropriate box ("No Work", "Suspended", or "Complete") checked on the form."

STATE CONTRACTS. Revise Section IV of Check Sheet #5 of the Recurring Special Provisions to read:

"IV.COMPLIANCE WITH THE PREVAILING WAGE ACT

1. Prevailing Wages. All wages paid by the Contractor and each subcontractor shall be in compliance with The Prevailing Wage Act (820 ILCS 130), as amended, except where a prevailing wage violates a federal law, order, or ruling, the rate conforming to the federal law, order, or ruling shall govern. The Contractor shall be responsible to notify each subcontractor of the wage rates set forth in this contract and any revisions thereto. If the Department of Labor revises the wage rates, the Contractor will not be allowed additional compensation on account of said revisions.
2. Payroll Records. The Contractor and each subcontractor shall make and keep, for a period of three years from the date of completion of this contract, records of the wages paid to his/her workers. The payroll records shall include each worker's name, address, telephone number, social security number, classification, rate of pay, number of hours worked each day, starting and ending times of work each day, total hours worked each week, itemized deductions made, and actual wages paid. Upon two business days' notice, these records shall be available, at all reasonable hours at a location within the State, for inspection by the Department or the Department of Labor.
3. Submission of Payroll Records. The Contractor and each subcontractor shall submit payroll records to the Engineer each week from the start to the completion of their respective work, except that full social security numbers and home addresses shall not be included on weekly transmittals. Instead the payrolls shall include an identification number for each employee (e.g., the last four digits of the employee's social security number). The submittals shall be on the Department's form SBE 48, or an approved facsimile. When there has been no activity during a work week, a payroll record shall still be submitted with the appropriate box ("No Work", "Suspended", or "Complete") checked on the form.

Each submittal shall be accompanied by a statement signed by the Contractor or subcontractor which avers that: (i) such records are true and accurate; (ii) the hourly rate paid to each worker is not less than the general prevailing rate of hourly wages required by the Act; and (iii) the Contractor or subcontractor is aware that filing a payroll record that he/she knows to be false is a Class B misdemeanor.

4. Employee Interviews. The Contractor and each subcontractor shall permit his/her employees to be interviewed on the job, during working hours, by compliance investigators of the Department or the Department of Labor."

PERSONAL PROTECTIVE EQUIPMENT (BDE)

Effective: November 1, 2008

Revise the first sentence of Article 701.12 of the Standard Specifications to read:

“All personnel on foot, excluding flaggers, within the highway right-of-way shall wear a fluorescent orange, fluorescent yellow/green, or a combination of fluorescent orange and fluorescent yellow/green vest meeting the requirements of ANSI/ISEA 107-2004 for Conspicuity Class 2 garments.”

PLASTIC BLOCKOUTS FOR GUARDRAIL (BDE)

Effective: November 1, 2004

Revised: January 1, 2007

Add the following to Article 630.02 of the Standard Specifications:

“(g) Plastic Blockouts (Note 1.)

Note 1. Plastic blockouts may be used in lieu of wood blockouts for steel plate beam guardrail. The plastic blockouts shall be the minimum dimensions shown on the plans and shall be on the Department’s approved list.”

PORTLAND CEMENT CONCRETE PLANTS (BDE)

Effective: January 1, 2007

Add the following to Article 1020.11(a) of the Standard Specifications.

“(9) Use of Multiple Plants in the Same Construction Item. The Contractor may simultaneously use central-mixed, truck-mixed, and shrink-mixed concrete from more than one plant, for the same construction item, on the same day, and in the same pour. However, the following criteria shall be met.

- a. Each plant shall use the same cement, finely divided minerals, aggregates, admixtures, and fibers.
- b. Each plant shall use the same mix design. However, material proportions may be altered slightly in the field to meet slump and air content criteria. Field water adjustments shall not result in a difference that exceeds 0.02 between plants for water/cement ratio. The required cement factor for central-mixed concrete shall be increased to match truck-mixed or shrink-mixed concrete, if the latter two types of mixed concrete are used in the same pour.
- c. The maximum slump difference between deliveries of concrete shall be 3/4 in. (19 mm) when tested at the jobsite. If the difference is exceeded, but test results are within specification limits, the concrete may be used. The Contractor shall take immediate corrective action and shall test subsequent deliveries of concrete until the slump difference is corrected. For each day, the first three truck loads of

delivered concrete from each plant shall be tested for slump by the Contractor. Thereafter, when a specified test frequency for slump is to be performed, it shall be conducted for each plant at the same time.

- d. The maximum air content difference between deliveries of concrete shall be 1.5 percent when tested at the jobsite. If the difference is exceeded, but test results are within specification limits, the concrete may be used. The Contractor shall take immediate corrective action and shall test subsequent deliveries of concrete until the air content difference is corrected. For each day, the first three truck loads of delivered concrete from each plant shall be tested for air content by the Contractor. Thereafter, when a specified test frequency for air content is to be performed, it shall be conducted for each plant at the same time.
- e. Strength tests shall be performed and taken at the jobsite for each plant. When a specified strength test is to be performed, it shall be conducted for each plant at the same time. The difference between plants for their mean strength shall not exceed 450 psi (3100 kPa) compressive and 80 psi (550 kPa) flexural. The strength standard deviation for each plant shall not exceed 650 psi (4480 kPa) compressive and 110 psi (760 kPa) flexural. The mean and standard deviation requirements shall apply to the test of record. If the strength difference requirements are exceeded, the Contractor shall take corrective action.
- f. The maximum haul time difference between deliveries of concrete shall be 15 minutes. If the difference is exceeded, but haul time is within specification limits, the concrete may be used. The Contractor shall take immediate corrective action and check subsequent deliveries of concrete until the haul time difference is corrected.”

RECLAIMED ASPHALT PAVEMENT (RAP) (BDE)

Effective: January 1, 2007

Revised: April 1, 2009

In Article 1030.02(g), delete the last sentence of the first paragraph in (Note 2).

Revise Section 1031 of the Standard Specifications to read:

“SECTION 1031. RECLAIMED ASPHALT PAVEMENT

1031.01 Description. Reclaimed asphalt pavement (RAP) is reclaimed asphalt pavement resulting from cold milling or crushing of an existing dense graded hot-mix asphalt (HMA) pavement. The Contractor shall supply written documentation that the RAP originated from routes or airfields under federal, state, or local agency jurisdiction.

1031.02 Stockpiles. The Contractor shall construct individual, sealed RAP stockpiles meeting one of the following definitions. No additional RAP shall be added to the pile after the pile has been sealed. Stockpiles shall be sufficiently separated to prevent intermingling at the base. Stockpiles shall be identified by signs indicating the type as listed below (i.e. “Homogeneous Surface”).

Prior to milling, the Contractor shall request the District to provide verification of the quality of the RAP to clarify appropriate stockpile.

- (a) Homogeneous. Homogeneous RAP stockpiles shall consist of RAP from Class I, Superpave (High ESAL), HMA (High ESAL), or equivalent mixtures and represent: 1) the same aggregate quality, but shall be at least C quality; 2) the same type of crushed aggregate (either crushed natural aggregate, ACBF slag, or steel slag); 3) similar gradation; and 4) similar asphalt binder content. If approved by the Engineer, combined single pass surface/binder millings may be considered "homogenous" with a quality rating dictated by the lowest coarse aggregate quality present in the mixture.
- (b) Conglomerate. Conglomerate RAP stockpiles shall consist of RAP from Class I, Superpave (High ESAL), HMA (High ESAL), or equivalent mixtures. The coarse aggregate in this RAP shall be crushed aggregate and may represent more than one aggregate type and/or quality but shall be at least C quality. This RAP may have an inconsistent gradation and/or asphalt binder content prior to processing. All conglomerate RAP shall be processed prior to testing by crushing to where all RAP shall pass the 5/8 in. (16 mm) or smaller screen. Conglomerate RAP stockpiles shall not contain steel slag or other expansive material as determined by the Department.
- (c) Conglomerate "D" Quality (DQ). Conglomerate DQ RAP stockpiles shall consist of RAP from Class I, Superpave (High or Low ESAL), HMA (High or Low ESAL), or equivalent mixtures. The coarse aggregate in this RAP may be crushed or round but shall be at least D quality. This RAP may have an inconsistent gradation and/or asphalt binder content. Conglomerate DQ RAP stockpiles shall not contain steel slag or other expansive material as determined by the Department.
- (d) Non-Quality. RAP stockpiles that do not meet the requirements of the stockpile categories listed above shall be classified as "Non-Quality".

RAP containing contaminants, such as earth, brick, sand, concrete, sheet asphalt, bituminous surface treatment (i.e. chip seal), pavement fabric, joint sealants, etc., will be unacceptable unless the contaminants are removed to the satisfaction of the Engineer. Sheet asphalt shall be stockpiled separately.

1031.03 Testing. When used in HMA, the RAP shall be sampled and tested either during or after stockpiling.

For testing during stockpiling, washed extraction samples shall be run at the minimum frequency of one sample per 500 tons (450 metric tons) for the first 2000 tons (1800 metric tons) and one sample per 2000 tons (1800 metric tons) thereafter. A minimum of five tests shall be required for stockpiles less than 4000 tons (3600 metric tons).

For testing after stockpiling, the Contractor shall submit a plan for approval to the District proposing a satisfactory method of sampling and testing the RAP pile either in-situ or by restockpiling. The sampling plan shall meet the minimum frequency required above and detail the procedure used to obtain representative samples throughout the pile for testing.

Before extraction, each field sample shall be split to obtain two samples of test sample size. One of the two test samples from the final split shall be labeled and stored for Department use. The Contractor shall extract the other test sample according to Department procedure. The Engineer reserves the right to test any sample (split or Department-taken) to verify Contractor test results.

Evaluation of Test Results. All of the extraction results shall be compiled and averaged for asphalt binder content and gradation and, when applicable G_{mm} . Individual extraction test results, when compared to the averages, will be accepted if within the tolerances listed below.

Parameter	Homogeneous / Conglomerate	Conglomerate "D" Quality
1 in. (25 mm)		± 5 %
1/2 in. (12.5 mm)	± 8 %	± 15 %
No. 4 (4.75 mm)	± 6 %	± 13 %
No. 8 (2.36 mm)	± 5 %	
No. 16 (1.18 mm)		± 15 %
No. 30 (600 μm)	± 5 %	
No. 200 (75 μm)	± 2.0 %	± 4.0 %
Asphalt Binder	± 0.4 % ^{1/}	± 0.5 %

1/ The tolerance for fractionated reclaimed asphalt pavement (FRAP) shall be ± 0.3 %.

If more than 20 percent of the individual sieves are out of the gradation tolerances, or if more than 20 percent of the asphalt binder content test results fall outside the appropriate tolerances, the RAP shall not be used in HMA unless the RAP representing the failing tests is removed from the stockpile. All test data and acceptance ranges shall be sent to the District for evaluation.

With the approval of the Engineer, the ignition oven may be substituted for extractions according to the Illinois Test Procedure, "Calibration of the Ignition Oven for the Purpose of Characterizing Reclaimed Asphalt Pavement (RAP)".

1031.04 Quality Designation of Aggregate in RAP. The quality of the RAP shall be set by the lowest quality of coarse aggregate in the RAP stockpile and are designated as follows.

- (a) RAP from Class I, Superpave (High ESAL), or HMA (High ESAL) surface mixtures are designated as containing Class B quality coarse aggregate.
- (b) RAP from Superpave (Low ESAL)/HMA (Low ESAL) IL-19.0L binder and IL-9.5L surface mixtures are designated as Class D quality coarse aggregate.
- (c) RAP from Class I, Superpave (High ESAL), or HMA (High ESAL) binder mixtures, bituminous base course mixtures, and bituminous base course widening mixtures are designated as containing Class C quality coarse aggregate.
- (d) RAP from bituminous stabilized subbase and BAM shoulders are designated as containing Class D quality coarse aggregate.

1031.05 Use of RAP in HMA. The use of RAP shall be a Contractor's option when constructing HMA in all contracts. The use of RAP in HMA shall be as follows.

- (a) Coarse Aggregate Size. The coarse aggregate in all RAP shall be equal to or less than the nominal maximum size requirement for the HMA mixture to be produced.
- (b) Steel Slag Stockpiles. RAP stockpiles containing steel slag or other expansive material, as determined by the Department, shall be homogeneous and will be approved for use in HMA (High ESAL and Low ESAL) surface mixtures only.
- (c) Use in HMA Surface Mixtures (High and Low ESAL). RAP stockpiles for use in HMA surface mixtures (High and Low ESAL) shall be homogeneous in which the coarse aggregate is Class B quality or better.
- (d) Use in HMA Binder Mixtures (High and Low ESAL), HMA Base Course, and HMA Base Course Widening. RAP stockpiles for use in HMA binder mixtures (High and Low ESAL), HMA base course, and HMA base course widening shall be homogeneous, or conglomerate, in which the coarse aggregate is Class C quality or better.
- (e) Use in Shoulders and Subbase. RAP stockpiles for use in HMA shoulders and stabilized subbase (HMA) shall be homogeneous, conglomerate, or conglomerate DQ.
- (f) When the Contractor chooses the RAP option, the percentage of RAP shall not exceed the amounts indicated in the table below for a given N Design.

Max RAP Percentage

HMA Mixtures ^{1/, 3/}	Maximum % RAP			
	Ndesign	Binder/Leveling Binder	Surface	Polymer Modified
30	30	30	10	10
50	25	15	10	10
70	15 / 25 ^{2/}	10 / 15 ^{2/}	10	10
90	10	10	10	10
105	10	10	10	10

1/ For HMA shoulder and stabilized subbase (HMA) N-30, the amount of RAP shall not exceed 50% of the mixture.

2/ Value of Max % RAP if homogeneous RAP stockpile of IL-9.5 RAP is utilized.

3/ When RAP exceeds 20 percent, the high and low virgin asphalt binder grades shall each be reduced by one grade (i.e. 25 percent RAP would require a virgin asphalt binder grade of PG64-22 to be reduced to a PG58-28). If warm mix asphalt (WMA) technology is utilized, and production temperatures do not exceed 275°F (135 °C) the grades shall be reduced as follows:

Overlays:

When WMA contains between 20 and 30 percent RAP the high temperature shall be reduced by one grade (i.e. 25 percent RAP would require a virgin asphalt binder grade of PG64-22 to be reduced to a PG58-22). When WMA contains 30 percent or more RAP the high and low temperature grades shall each be reduced by one grade (i.e. 35 percent RAP would require a virgin asphalt binder grade of PG64-22 to be reduced to a PG58-28).

Full Depth:

When WMA contains between 20 and 30 percent RAP, the low temperature shall be reduced by one grade (i.e. 25 percent RAP would require a virgin asphalt binder grade of PG64-22 to be reduced to a PG64-28). When the WMA contains 30 percent or more RAP the high and low temperature grades shall each be reduced by one grade (i.e. 35 percent RAP would require a virgin asphalt binder grade of PG64-22 to be reduced to a PG58-28).

- (g) When the Contractor chooses the FRAP option, the percentage of FRAP shall not exceed the amounts indicated in the table below for a given N Design.

Max FRAP Percentage^{1/}

HMA Mixtures ^{2/, 3/}	Maximum % FRAP		
	Ndesign	Binder/Leveling Binder	Surface
30	35	35	10
50	30	25	10
70	25	20	10
90	20	15	10
105	10	10	10

- 1/ Minimum of two fractions for surface and binder applications.
- 2/ For HMA shoulder and stabilized subbase (HMA) N30, the amount of RAP shall not exceed 50 percent of the mixture.
- 3/ When FRAP exceeds 20 percent, the high and low virgin asphalt binder grades shall each be reduced by one grade (i.e. 25 percent RAP would require a virgin asphalt binder grade of PG64-22 to be reduced to a PG58-28). If warm mix asphalt (WMA) technology is utilized, and production temperatures do not exceed 275°F (135 °C) the grades shall be reduced as follows:

Overlays:

When WMA contains between 20 and 30 percent FRAP the high temperature shall be reduced by one grade (i.e. 25 percent FRAP would require a virgin asphalt binder grade of PG64-22 to be reduced to a PG58-22). When WMA contains 30 percent or more FRAP the high and low temperature grades shall each be reduced by one grade (i.e. 35 percent FRAP would require a virgin asphalt binder grade of PG64-22 to be reduced to a PG58-28).

Full Depth:

When WMA contains between 20 and 30 percent FRAP, the low temperature shall be reduced by one grade (i.e. 25 percent FRAP would require a virgin asphalt binder grade of PG64-22 to be reduced to a PG64-28). When the WMA contains 30 percent or more FRAP the high and low temperature grades shall each be reduced by one grade (i.e. 35 percent FRAP would require a virgin asphalt binder grade of PG64-22 to be reduced to a PG58-28).

1031.06 HMA Mix Designs. At the Contractor's option, HMA mixtures may be constructed utilizing RAP material meeting the above detailed requirements.

RAP designs shall be submitted for volumetric verification. If additional RAP stockpiles are tested and found that no more than 20 percent of the results, as defined under "Testing" herein, are outside of the control tolerances set for the original RAP stockpile and HMA mix design, and meets all of the requirements herein, the additional RAP stockpiles may be used in the original mix design at the percent previously verified.

1031.07 HMA Production. The coarse aggregate in all RAP used shall be equal to or less than the nominal maximum size requirement for the HMA mixture being produced.

To remove or reduce agglomerated material, a scalping screen, crushing unit, or comparable sizing device approved by the Engineer shall be used in the RAP feed system to remove or reduce oversized material. If material passing the sizing device adversely affects the mix production or quality of the mix, the sizing device shall be set at a size specified by the Engineer.

If the RAP control tolerances or QC/QA test results require corrective action, the Contractor shall cease production of the mixture containing RAP and either switch to the virgin aggregate design or submit a new RAP design.

HMA plants utilizing RAP shall be capable of automatically recording and printing the following information.

(a) Dryer Drum Plants.

- (1) Date, month, year, and time to the nearest minute for each print.
- (2) HMA mix number assigned by the Department.
- (3) Accumulated weight of dry aggregate (combined or individual) in tons (metric tons) to the nearest 0.1 ton (0.1 metric ton).
- (4) Accumulated dry weight of RAP in tons (metric tons) to the nearest 0.1 ton (0.1 metric ton).
- (5) Accumulated mineral filler in revolutions, tons (metric tons), etc. to the nearest 0.1 unit.

- (6) Accumulated asphalt binder in gallons (liters), tons (metric tons), etc. to the nearest 0.1 unit.
- (7) Residual asphalt binder in the RAP material as a percent of the total mix to the nearest 0.1 percent.
- (8) Aggregate and RAP moisture compensators in percent as set on the control panel. (Required when accumulated or individual aggregate and RAP are printed in wet condition.)

(b) Batch Plants.

- (1) Date, month, year, and time to the nearest minute for each print.
- (2) HMA mix number assigned by the Department.
- (3) Individual virgin aggregate hot bin batch weights to the nearest pound (kilogram).
- (4) Mineral filler weight to the nearest pound (kilogram).
- (5) RAP weight to the nearest pound (kilogram).
- (6) Virgin asphalt binder weight to the nearest pound (kilogram).
- (7) Residual asphalt binder in the RAP material as a percent of the total mix to the nearest 0.1 percent.

The printouts shall be maintained in a file at the plant for a minimum of one year or as directed by the Engineer and shall be made available upon request. The printing system will be inspected by the Engineer prior to production and verified at the beginning of each construction season thereafter.

1031.08 RAP in Aggregate Surface Course and Aggregate Shoulders. The use of RAP in aggregate surface course and aggregate shoulders shall be as follows.

- (a) Stockpiles and Testing. RAP stockpiles may be any of those listed in Article 1031.02, except "Other". The testing requirements of Article 1031.03 shall not apply.
- (b) Gradation. One hundred percent of the RAP material shall pass the 1 1/2 in. (37.5 mm) sieve. The RAP material shall be reasonably well graded from coarse to fine. RAP material that is gap-graded or single sized will not be accepted."

REFLECTIVE SHEETING ON CHANNELIZING DEVICES (BDE)

Effective: April 1, 2007

Revised: November 1, 2008

Revise the seventh paragraph of Article 1106.02 of the Standard Specifications to read:

“At the time of manufacturing, the retroreflective prismatic sheeting used on channelizing devices shall meet or exceed the initial minimum coefficient of retroreflection as specified in the following table. Measurements shall be conducted according to ASTM E 810, without averaging. Sheeting used on cones, drums and flexible delineators shall be reboundable as tested according to ASTM D 4956. Prestriped sheeting for rigid substrates on barricades shall be white and orange. **The sheeting shall be uniform in color and devoid of streaks throughout the length of each roll. The color shall conform to the latest appropriate standard color tolerance chart issued by the U.S. Department of Transportation, Federal Highway Administration, and to the daytime and nighttime color requirements of ASTM D 4956.**

Initial Minimum Coefficient of Retroreflection candelas/foot candle/sq ft (candelas/lux/sq m) of material				
Observation Angle (deg.)	Entrance Angle (deg.)	White	Orange	Fluorescent Orange
0.2	-4	365	160	150
0.2	+30	175	80	70
0.5	-4	245	100	95
0.5	+30	100	50	40”

Revise the first sentence of the first paragraph of Article 1106.02(c) of the Standard Specifications to read:

“Barricades and vertical panels shall have alternating white and orange stripes sloping downward at 45 degrees toward the side on which traffic will pass.”

Revise the third sentence of the first paragraph of Article 1106.02(d) of the Standard Specifications to read:

“The bottom panels shall be 8 x 24 in. (200 x 600 mm) with alternating white and orange stripes sloping downward at 45 degrees toward the side on which traffic will pass.”

STEEL PLATE BEAM GUARDRAIL (BDE)

Effective: November 1, 2005

Revised: August 1, 2007

Revise the first paragraph of Article 1006.25 of the Standard Specifications to read:

"1006.25 Steel Plate Beam Guardrail. Steel plate beam guardrail, including bolts, nuts, and washers, shall be according to AASHTO M 180. The guardrail shall be Class A, with a Type II galvanized coating; except the weight (mass) of the coating for each side of the guardrail shall be at least 2.00 oz/sq ft (610 g/sq m). The coating will be determined for each side of the guardrail using the average of at least three non-destructive test readings taken on that side of the guardrail. The minimum average thickness for each side shall be 3.4 mils (86 µm).”

SUBCONTRACTOR MOBILIZATION PAYMENTS (BDE)

Effective: April 2, 2005

To account for the preparatory work and operations necessary for the movement of subcontractor personnel, equipment, supplies, and incidentals to the project site and for all other work or operations that must be performed or costs incurred when beginning work approved for subcontracting in accordance with Article 108.01 of the Standard Specifications, the Contractor shall make a mobilization payment to each subcontractor.

This mobilization payment shall be made at least 14 days prior to the subcontractor starting work. The amount paid shall be equal to 3 percent of the amount of the subcontract reported on form BC 260A submitted for the approval of the subcontractor's work.

This provision shall be incorporated directly or by reference into each subcontract approved by the Department.

WORKING DAYS (BDE)

Effective: January 1, 2002

The Contractor shall complete the work within **60** working days.

BITUMINOUS MATERIALS COST ADJUSTMENTS (BDE) (RETURN FORM WITH BID)

Effective: November 2, 2006

Revised: April 1, 2009

Description. Bituminous material cost adjustments will be made to provide additional compensation to the Contractor, or credit to the Department, for fluctuations in the cost of bituminous materials when optioned by the Contractor. The adjustments shall apply to permanent and temporary hot-mix asphalt (HMA) mixtures, bituminous surface treatments (cover and seal coats), and pavement preservation type surface treatments. The adjustments shall not apply to bituminous prime coats, tack coats, crack filling/sealing, or joint filling/sealing.

The bidder shall indicate on the attached form whether or not this special provision will be part of the contract and submit the completed form with his/her bid. Failure to submit the form, or failure to fill out the form completely, shall make this contract exempt of bituminous materials cost adjustments.

Method of Adjustment. Bituminous materials cost adjustments will be computed as follows.

$$CA = (BPI_P - BPI_L) \times (\%AC_V / 100) \times Q$$

Where: CA = Cost Adjustment, \$.

BPI_P = Bituminous Price Index, as published by the Department for the month the work is performed, \$/ton (\$/metric ton).

BPI_L = Bituminous Price Index, as published by the Department for the month prior to the letting, \$/ton (\$/metric ton).

%AC_V = Percent of virgin Asphalt Cement in the Quantity being adjusted. For HMA

mixtures, the % AC_V will be determined from the adjusted job mix formula. For bituminous materials applied, a performance graded or cutback asphalt will be considered to be 100% AC_V and undiluted emulsified asphalt will be considered to be 65% AC_V.

Q = Authorized construction Quantity, tons (metric tons) (see below).

For HMA mixtures measured in square yards: $Q, \text{ tons} = A \times D \times (G_{mb} \times 46.8) / 2000$. For HMA mixtures measured in square meters: $Q, \text{ metric tons} = A \times D \times (G_{mb} \times 24.99) / 1000$. When computing adjustments for full-depth HMA pavement, separate calculations will be made for the binder and surface courses to account for their different G_{mb} and % AC_V.

For bituminous materials measured in gallons: $Q, \text{ tons} = V \times 8.33 \text{ lb/gal} \times SG / 2000$

For bituminous materials measured in liters: $Q, \text{ metric tons} = V \times 1.0 \text{ kg/L} \times SG / 1000$

Where: A = Area of the HMA mixture, sq yd (sq m).

D = Depth of the HMA mixture, in. (mm).

G_{mb} = Average bulk specific gravity of the mixture, from the approved mix design.

V = Volume of the bituminous material, gal (L).

SG = Specific Gravity of bituminous material as shown on the bill of lading.

Basis of Payment. Bituminous materials cost adjustments may be positive or negative but will only be made when there is a difference between the BPI_L and BPI_P in excess of five percent, as calculated by:

$$\text{Percent Difference} = \{(BPI_L - BPI_P) \div BPI_L\} \times 100$$

Bituminous materials cost adjustments will be calculated for each calendar month in which applicable bituminous material is placed; and will be paid or deducted when all other contract requirements for the work placed during the month are satisfied. The adjustments shall not apply during contract time subject to liquidated damages for completion of the entire contract.

RETURN WITH BID

ILLINOIS DEPARTMENT OF TRANSPORTATION

OPTION FOR BITUMINOUS MATERIALS COST ADJUSTMENTS

The bidder shall submit this completed form with his/her bid. Failure to submit the form, or failure to fill out the form completely, shall make this contract exempt of bituminous materials cost adjustments. After award, this form, when submitted, shall become part of the contract.

Contract No.: _____

Company Name: _____

Contractor's Option:

Is your company opting to include this special provision as part of the contract?

Yes No

Signature: _____ **Date:** _____

STEEL COST ADJUSTMENT (BDE) (RETURN FORM WITH BID)

Effective: April 2, 2004

Revised: April 1, 2009

Description. Steel cost adjustments will be made to provide additional compensation to the Contractor, or a credit to the Department, for fluctuations in steel prices when optioned by the Contractor. The bidder shall indicate on the attached form whether or not this special provision will be part of the contract and submit the completed form with his/her bid. Failure to submit the form or failure to indicate contract number, company name, and sign and date the form shall make this contract exempt of steel cost adjustments for all items of steel. Failure to indicate "Yes" for any item of work will make that item of steel exempt from steel cost adjustment.

Types of Steel Products. An adjustment will be made for fluctuations in the cost of steel used in the manufacture of the following items:

- Metal Piling (excluding temporary sheet piling)
- Structural Steel
- Reinforcing Steel

Other steel materials such as dowel bars, tie bars, mesh reinforcement, guardrail, steel traffic signal and light poles, towers and mast arms, metal railings (excluding wire fence), and frames and grates will be subject to a steel cost adjustment when the pay items they are used in has a contract value of \$10,000 or greater.

Documentation. Sufficient documentation shall be furnished to the Engineer to verify the following:

- (a) The dates and quantity of steel, in lb (kg), shipped from the mill to the fabricator.
- (b) The quantity of steel, in lb (kg), incorporated into the various items of work covered by this special provision. The Department reserves the right to verify submitted quantities.

Method of Adjustment. Steel cost adjustments will be computed as follows:

$$SCA = Q \times D$$

- Where: SCA = steel cost adjustment, in dollars
Q = quantity of steel incorporated into the work, in lb (kg)
D = price factor, in dollars per lb (kg)

$$D = MPI_M - MPI_L$$

Where: MPI_M = The Materials Cost Index for steel as published by the Engineering News-Record for the month the steel is shipped from the mill. The indices will be converted from dollars per 100 lb to dollars per lb (kg).

MPI_L = The Materials Cost Index for steel as published by the Engineering News-Record for the month prior to the letting. The indices will be converted from dollars per 100 lb to dollars per lb (kg).

The unit weights (masses) of steel that will be used to calculate the steel cost adjustment for the various items are shown in the attached table.

No steel cost adjustment will be made for any products manufactured from steel having a mill shipping date prior to the letting date.

If the Contractor fails to provide the required documentation, the method of adjustment will be calculated as described above; however, the MPI_M will be based on the date the steel arrives at the job site. In this case, an adjustment will only be made when there is a decrease in steel costs.

Basis of Payment. Steel cost adjustments may be positive or negative but will only be made when there is a difference between the MPI_L and MPI_M in excess of five percent, as calculated by:

$$\text{Percent Difference} = \{(MPI_L - MPI_M) \div MPI_L\} \times 100$$

Steel cost adjustments will be calculated by the Engineer and will be paid or deducted when all other contract requirements for the items of work are satisfied. Adjustments will only be made for fluctuations in the cost of the steel as described herein. No adjustment will be made for changes in the cost of manufacturing, fabrication, shipping, storage, etc.

The adjustments shall not apply during contract time subject to liquidated damages for completion of the entire contract.

Attachment

Item	Unit Mass (Weight)
Metal Piling (excluding temporary sheet piling)	
Furnishing Metal Pile Shells 12 in. (305 mm), 0.179 in. (3.80 mm) wall thickness)	23 lb/ft (34 kg/m)
Furnishing Metal Pile Shells 12 in. (305 mm), 0.250 in. (6.35 mm) wall thickness)	32 lb/ft (48 kg/m)
Furnishing Metal Pile Shells 14 in. (356 mm), 0.250 in. (6.35 mm) wall thickness)	37 lb/ft (55 kg/m)
Other piling	See plans
Structural Steel	See plans for weights (masses)
Reinforcing Steel	See plans for weights (masses)
Dowel Bars and Tie Bars	6 lb (3 kg) each
Mesh Reinforcement	63 lb/100 sq ft (310 kg/sq m)
Guardrail	
Steel Plate Beam Guardrail, Type A w/steel posts	20 lb/ft (30 kg/m)
Steel Plate Beam Guardrail, Type B w/steel posts	30 lb/ft (45 kg/m)
Steel Plate Beam Guardrail, Types A and B w/wood posts	8 lb/ft (12 kg/m)
Steel Plate Beam Guardrail, Type 2	305 lb (140 kg) each
Steel Plate Beam Guardrail, Type 6	1260 lb (570 kg) each
Traffic Barrier Terminal, Type 1 Special (Tangent)	730 lb (330 kg) each
Traffic Barrier Terminal, Type 1 Special (Flared)	410 lb (185 kg) each
Steel Traffic Signal and Light Poles, Towers and Mast Arms	
Traffic Signal Post	11 lb/ft (16 kg/m)
Light Pole, Tenon Mount and Twin Mount, 30 - 40 ft (9 - 12 m)	14 lb/ft (21 kg/m)
Light Pole, Tenon Mount and Twin Mount, 45 - 55 ft (13.5 - 16.5 m)	21 lb/ft (31 kg/m)
Light Pole w/Mast Arm, 30 - 50 ft (9 - 15.2 m)	13 lb/ft (19 kg/m)
Light Pole w/Mast Arm, 55 - 60 ft (16.5 - 18 m)	19 lb/ft (28 kg/m)
Light Tower w/Luminaire Mount, 80 - 110 ft (24 - 33.5 m)	31 lb/ft (46 kg/m)
Light Tower w/Luminaire Mount, 120 - 140 ft (36.5 - 42.5 m)	65 lb/ft (97 kg/m)
Light Tower w/Luminaire Mount, 150 - 160 ft (45.5 - 48.5 m)	80 lb/ft (119 kg/m)
Metal Railings (excluding wire fence)	
Steel Railing, Type SM	64 lb/ft (95 kg/m)
Steel Railing, Type S-1	39 lb/ft (58 kg/m)
Steel Railing, Type T-1	53 lb/ft (79 kg/m)
Steel Bridge Rail	52 lb/ft (77 kg/m)
Frames and Grates	
Frame	250 lb (115 kg)
Lids and Grates	150 lb (70 kg)

RETURN WITH BID

ILLINOIS DEPARTMENT OF TRANSPORTATION

OPTION FOR STEEL COST ADJUSTMENT

The bidder shall submit this completed form with his/her bid. Failure to submit the form or properly complete contract number, company name, and sign and date the form shall make this contract exempt of steel cost adjustments for all items of steel. Failure to indicate "Yes" for any item of work will make that item of steel exempt from steel cost adjustment. After award, this form, when submitted shall become part of the contract.

Contract No.: _____

Company Name: _____

Contractor's Option:

Is your company opting to include this special provision as part of the contract plans for the following items of work?

- | | | |
|--|-----|--------------------------|
| Metal Piling | Yes | <input type="checkbox"/> |
| Structural Steel | Yes | <input type="checkbox"/> |
| Reinforcing Steel | Yes | <input type="checkbox"/> |
| Dowel Bars, Tie Bars and Mesh Reinforcement | Yes | <input type="checkbox"/> |
| Guardrail | Yes | <input type="checkbox"/> |
| Steel Traffic Signal and Light Poles, Towers and Mast Arms | Yes | <input type="checkbox"/> |
| Metal Railings (excluding wire fence) | Yes | <input type="checkbox"/> |
| Frames and Grates | Yes | <input type="checkbox"/> |

Signature: _____ **Date:** _____

SIGNATURE BLOCK ON SHEET 2



STATE OF ILLINOIS
DEPARTMENT OF TRANSPORTATION
DIVISION OF HIGHWAYS
FAP 673 (IL 116 /117)
SECTION: 107RS-5 & 108RS-4
WOODFORD COUNTY
C-94-033-06
PROJECT ESP-0673(024)

INDEX OF SHEETS

1. COVER SHEET
2. SIGNATURE SHEET
- 3-6. GENERAL NOTES
- 7-10. SUMMARY OF QUANTITIES
- 11-12. TYPICAL SECTIONS
13. LINE DIAGRAM
- 14-20. SCHEDULE OF QUANTITIES
21. MILLING DETAILS
- 22-28. CADD STANDARDS

STATE STANDARDS

- 000001-05 635011-02 701306-02
- 442201-03 701001-02 701311-03
- 482011-03 701006-03 701336-05
- 606001-04 701011-02 701901-01
- 630001-08 701201-03 781001-03
- 630301-05 701208-02
- 635006-03 701301-03

CADD STANDARDS	
440001-D4	630101-D4
406101-D4	780001-D4

DESIGN DESIGNATION	
IL 116 /117	
OTHER PRINCIPLE ARTERIAL	
ADT =	5200 YEAR 2007
PV =	4,575 (88.0 %)
SU =	200 (4.0 %)
MU =	425 (8.0 %)

CONTRACT NO. 68561
CATALOG NO. 033187 -- 00D

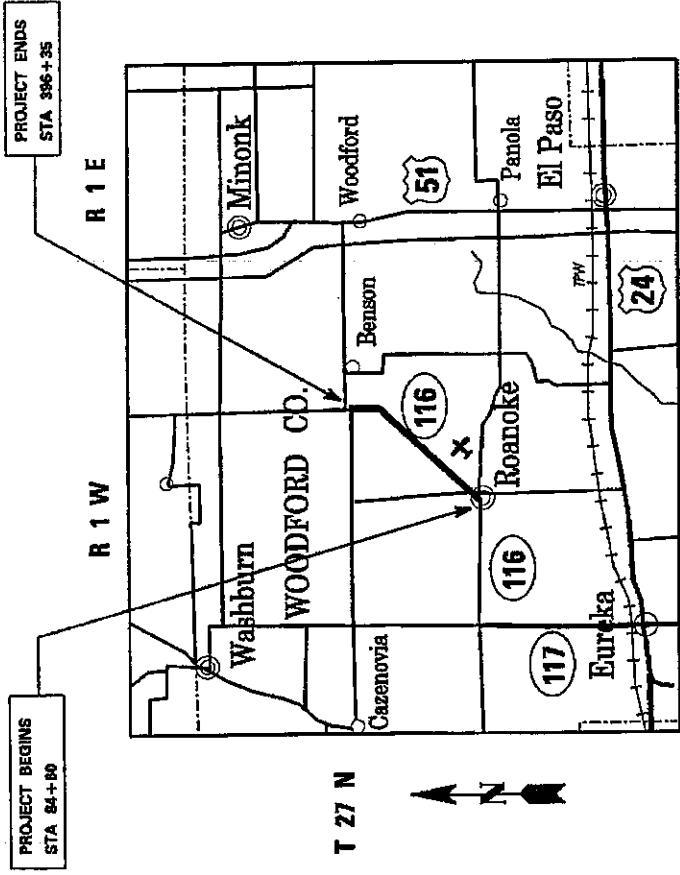

PROJECT BEGINS
STA 84+80

PROJECT ENDS
STA 396+35

DESCRIPTION OF WORK

THIS PROJECT CONSISTS OF PATCHING, MILLING, AND RESURFACING OF IL 116/117 FROM THE TOWN OF ROANOKE TO THE INTERSECTION OF IL 116 & IL 117 IN WOODFORD COUNTY. IT ALSO INCLUDES THE CONSTRUCTION OF 2' SAFETY SHOULDERS.

JULIE
JOINT UTILITY LOCATION
INFORMATION FOR EXCAVATION
CALL 1-800-882-0123

3RD PM

GROSS LENGTH OF IMPROVEMENT = 31,175 FT (5.90 MILES)
NET LENGTH OF IMPROVEMENT = 31,175 FT (5.90 MILES)

ROUTE		SECTION	COUNTY	SHEET	
F.A.	673			TOTAL	NO.
MKD.	IL 116/117	120RS-2	WOODFORD	28	2

CONTRACT NO. 68561

COMMITMENTS

COMMITMENTS ARE NOT TO BE ALTERED WITHOUT THE WRITTEN APPROVAL OF ALL PARTIES TO WHICH THE COMMITMENT WAS MADE.

NO COMMITMENTS HAVE BEEN MADE FOR THIS PROJECT.

STATE OF ILLINOIS
DEPARTMENT OF TRANSPORTATION
DIVISION OF HIGHWAYS

SUBMITTED Feb 6 2009

 _____
DEPUTY DIRECTOR OF HIGHWAYS, REGION ENGINEER

ENGINEER OF DESIGN AND ENVIRONMENT

DIRECTOR OF HIGHWAYS, CHIEF ENGINEER

**PRINTED BY THE AUTHORITY
OF THE STATE OF ILLINOIS**

COMMITMENTS,
SIGNATURE BLOCK

ROUTE		SECTION	COUNTY	SHEET	
F.A.	673			TOTAL	NO.
MKD.	IL 116/117	12ORS-2	WOODFORD	28	3

CONTRACT NO. 68561

GENERAL NOTES

ENVIRONMENTAL REVIEWS

Prior to the use of any proposed borrow areas, use areas (temporary access roads, detours, run-arounds, etc.) and/or waste areas, the Contractor shall file the required environmental resource request surveys according to Section 107.11 of the Standard Specifications. These surveys are required in order for the Department to conduct cultural and biological resource surveys for the proposed site.

Prior to any waste materials being removed from the construction site the required environmental resource surveys will need to be obtained and filed by the Contractor. Excess waste products removed from the construction site shall be disposed of as required in Section 202.03 of the Standard Specifications.

Any protruding metal bars shall be removed prior to the disposal of broken concrete at approved disposal sites.

The required environmental resource documentation shall include the following :

- BDE Form 2289 (Environmental Survey Request)
- A location map showing the size limits and location of the use area
- Signed property owner agreement form
- Color photographs depicting the use area

Please note that a minimum of two weeks shall be allowed for the District to obtain the required environmental clearances.

GENERAL
NOTES

GENERAL NOTES

PAVING SURFACE COURSE

Continuous paving operations on the main roadway shall be maintained at all times during the construction of the Hot-Mix Asphalt surface. No interruptions for side roads, entrances, turn lanes, ETC... will be allowed.

BUTT JOINT CUTTING RESTRICTION

Butt joints shall not be milled more than three (3) days prior to placement of the Hot-Mix Asphalt surface course.

ENGINEERING FIELD OFFICE

ALL OF THE TELEPHONE LINES PROVIDED SHALL HAVE UNPUBLISHED NUMBERS.

AGGREGATE SHOULDERS TYPE B

Aggregate shoulders type B shall be required for all granular construction of side roads, entrances, and mailboxes. Wether or not portions of the surfaces thus constructed are to be covered with hot-mix asphalt surfaces, except where noted differently on the plans.

PROPERTY OWNER ACCESS REQUIREMENT.

Access must be maintained to all existing properties during construction as per article 107.09 unless arrangement are made in writing by the contractor with the property owners with a copy to the Resident for short - term closures

EARTH EXCAVATION BACKFILL AND GRADING:

The cost of earth excavation , backfill, and the necessary grading, for curb and gutter and guardrail work, shall be included in the unit price of the corresponding item.

ROUTE		SECTION	COUNTY	SHEET	
F.A.	673	12ORS-2	WOODFORD	TOTAL	NO.
MKD.	IL 116/117			28	4

CONTRACT NO. 68561

GENERAL
NOTES

GENERAL NOTES

PAVEMENT STATION NUMBERS & PLACEMENT

The Contractor shall provide labor and materials required to imprint pavement station numbers in the finished surface of the pavement and/or overlay. The numbers shall be approximately 20 mm (3/4 inch) wide, 125 mm (5 inches) high and 15 mm (5/8 inch) deep.

The pavement station numbers shall be installed as specified herein:

Interval - 100 meters (200 feet)

Bottom of Numbers - 150 mm (6 inches) from the inside edge of the pavement marking Location:

-2, 3, & 5 Lane Pavements - right edge of pavement in direction of increasing stations

-Multi-Lane Divided Roadways - outside edge of pavement in both directions

-Ramps - along baseline edge of pavement

Position - stations shall be placed so they can be read from the adjacent shoulder

Format - Metric (English) pavement stations shall use this format (XX+X00" (XXX")), where X represents the pavement station

This work will not be paid for separately, but will be considered included in the cost of the associated pavement and/or overlay pay items.

ROUTE		SECTION	COUNTY	SHEET	
F.A.	673			TOTAL	NO.
MKD.	IL 116/117	12ORS-2	WOODFORD	28	5

CONTRACT NO. 68561

GENERAL
NOTES

ROUTE		SECTION	COUNTY	SHEET
F.A.	673			
MKD.	IL 116/117	12ORS-2	WOODFORD	TOTAL
				28
				6

CONTRACT NO. 68561

GENERAL NOTES

HOT - MIX ASPHALT REQUIREMENTS

Mixture Use(s)	HOT MIX ASPHALT SURFACE COURSE	POLYMERIZED LEVELING BINDER CSE	INCIDENTAL H.M.A SURF CSE	CLASS "D" PATCHES	HOT MIX ASPHALT BASE COURSE WIDENING 6"
AC/PG	PG 64 - 22	SBS OR SBR PG 70 - 22	PG 64 - 22	PG 64-22	PG 64-22
RAP % (MAX)**	15 %	0 %	15 %	25 %	30 %
Design Air Voids	4.0 % @ N = 50	3.0 % @ N = 50	4.0 % @ N = 50	4.0 % @ N = 50	4.0 % @ N = 30
Mixture Composition (Gradation Mixture)	IL 9.5 or IL 12.5	IL 4.75	IL 9.5 or IL 12.5	IL 19.0	IL 19.0 L
Friction Aggregate	MIXTURE "D"	N.A.	MIXTURE "D"	N.A.	N.A.

** If the RAP option is selected, the asphalt grade may need to be adjusted, this will be determined by the Materials Engineer.

RATES:

FOR ALL HOT MIXES, 112 lbs/Sq.Yd.in.

FOR AGGREGATE SHOULDERS TYPE B 2.05 ton/cu.yd

FOR BIT MATLS (PRIME COAT): 0.004 ton/gal FOR AGG (PRIME COAT):

-ON GRANULAR BASE: 0.5 GAL/SQ. YD.

-ON EXIST. PVT.: 0.05 GAL/SQ.YD.

-ON COLD MILLED AREA: 0.1 GAL/SQ.YD.

-ON NEW PAVT: 0.03 GAL/SQ.YD.

-ON EXIST PVT: 4 LBS/SQ. YD.

-ON COLD MILLED SURF: 4 LBS/SQ.YD.

-ON NEW PVT: 2 LBS/SQ.YD.

GENERAL NOTES

Summary of Quantities

Code Order

ROUTE		SECTION	COUNTY	SHEET	
FAP	673	107RS-5 & 108RS-4	WOODFORD	TOTAL	NO.
IL	116			28	7
			CONTRACT NO.	68561	

CONSTRUCTION TYPE CODE	
ROADWAY	
1000	
100% FED	

CODE No.	ITEM	UNIT		Tot.QTY
20200500	EARTH EXCAVATION (WIDENING)	CU YD	1753	1753
35600700	HOT - MIX ASPHALT BASE COURSE WIDENING, 6"	SQ YD	10520	10520
40600215	POLYMERIZED BITUMINOUS MATERIALS (PRIME COAT)	TON	55	55
40600300	AGGREGATE (PRIME COAT)	TON	318	318
40600895	CONSTRUCTING TEST STRIP	EACH	1	1
40600982	HOT - MIX ASPHALT SURFACE REMOVAL - BUTT JOINT	SQ YD	2998	2998
40600990	TEMPORARY RAMP	SQ YD	1310	1310
40603335	HOT - MIX ASPHALT SURFACE COURSE, MIX "D", N50	TON	8673	8673
40800050	INCIDENTAL HOT - MIX ASPHALT SURFACING	TON	238	238
44000155	HOT - MIX ASPHALT SURFACE REMOVAL, 1 1/2"	SQ YD	68314	68314

(X)Specialty Item

Summary of Quantities

Code Order

ROUTE		SECTION		COUNTY		SHEET	
FAP	673	107RS-5 & 108RS-4		WOODFORD		TOTAL	NO.
IL	116					28	8
				CONTRACT NO. 68561			

CODE No.		ITEM		UNIT	Tot.QTY	CONSTRUCTION TYPE CODE	
						ROADWAY	
						1000	
						100% FED	

44000158	HOT - MIX ASPHALT SURFACE REMOVAL, 2 1/4"	SQ YD	23425	23425			
44000500	COMBINATION CURB AND GUTTER REMOVAL	FOOT	810	810			
44201815	CLASS D PATCHES, TYPE II, 14 INCH	SQ YD	1910	1910			
44201819	CLASS D PATCHES, TYPE III, 14 INCH	SQ YD	70	70			
44201821	CLASS D PATCHES, TYPE IV, 14 INCH	SQ YD	288	288			
48101200	AGGREGATE SHOULDERS, TYPE B CONCRETE	TON	2396	2396			
60605000	COMBINATION CURB AND GUTTER, TYPE B-6.24	FOOT	810	810			
X 63000001	STEEL PLATE BEAM GUARD RAIL, TYPE A, 6 FOOT POSTS	FOOT	1253	1253			
X 63100167	TRAFFIC BARRIER TERMINAL, TYPE 1(SPECIAL) TANGENT	EACH	16	16			
63200310	GUARDRAIL REMOVAL	FOOT	2053	2053			

Summary of Quantities

Code Order

ROUTE		SECTION		COUNTY		SHEET	
FAP	673	107RS-5 & 108RS-4		WOODFORD		TOTAL	NO.
IL	116					28	9
				CONTRACT NO. 68561			

CONSTRUCTION TYPE CODE	
ROADWAY	
1000	
100% FED	

CODE No.	ITEM	UNIT	Tot.QTY
67000400	ENGINEER'S FIELD OFFICE, TYPE A	CAL MO	3
67100100	MOBILIZATION	L SUM	1
70100460	TRAFFIC CONTROL AND PROTECTION, STANDARD 701306	L SUM	1
70100600	TRAFFIC CONTROL AND PROTECTION, STANDARD 701336	L SUM	1
70300100	SHORT-TERM PAVEMENT MARKING	FOOT	31175
70300220	TEMPORARY PAVEMENT MARKING - LINE 4"	FOOT	72421
70301000	WORK ZONE PAVEMENT MARKING REMOVAL	SQ FT	10392
X 78005110	EPOXY PAVEMENT MARKING - LINE 4"	FOOT	72421
X 78100100	RAISED REFLECTIVE PAVEMENT MARKER	EACH	389
X 78200410	GUARDRAIL MARKERS, TYPE A	EACH	38

(X)Specialty Item

Summary of Quantities

Code Order

ROUTE		SECTION	COUNTY	SHEET	
FAP	673	107RS-5 & 108RS-4	WOODFORD	TOTAL	NO.
IL	116			28	10
			CONTRACT NO.	68561	

CONSTRUCTION TYPE CODE	
ROADWAY	
1000	
100% FED	

CODE No.	ITEM	UNIT	Tot.QTY
78201000	TERMINAL MARKER - DIRECT APPLIED	EACH	16
78300200	RAISED REFLECTIVE PAVEMENT MARKER REMOVAL	EACH	389
X0301512	GUARDRAIL AGGREGATE EROSION CONTROL	TON	312
X0322729	MATERIAL TRANSFER DEVICE	TON	8673
<input type="checkbox"/> X2503100	MOWING	UNIT	312
X4067107	POLYMERIZED LEVELING BINDER (MACHINE METHOD), IL-4.75, N50	TON	4324

NON-PARTICIPATING 100% STATE

ROUTE		SECTION	COUNTY	SHEET	
F.A.	673	12ORS-2	WOODFORD	TOTAL	NO.
MKD.	IL 116/117			28	11

CONTRACT NO. 68561

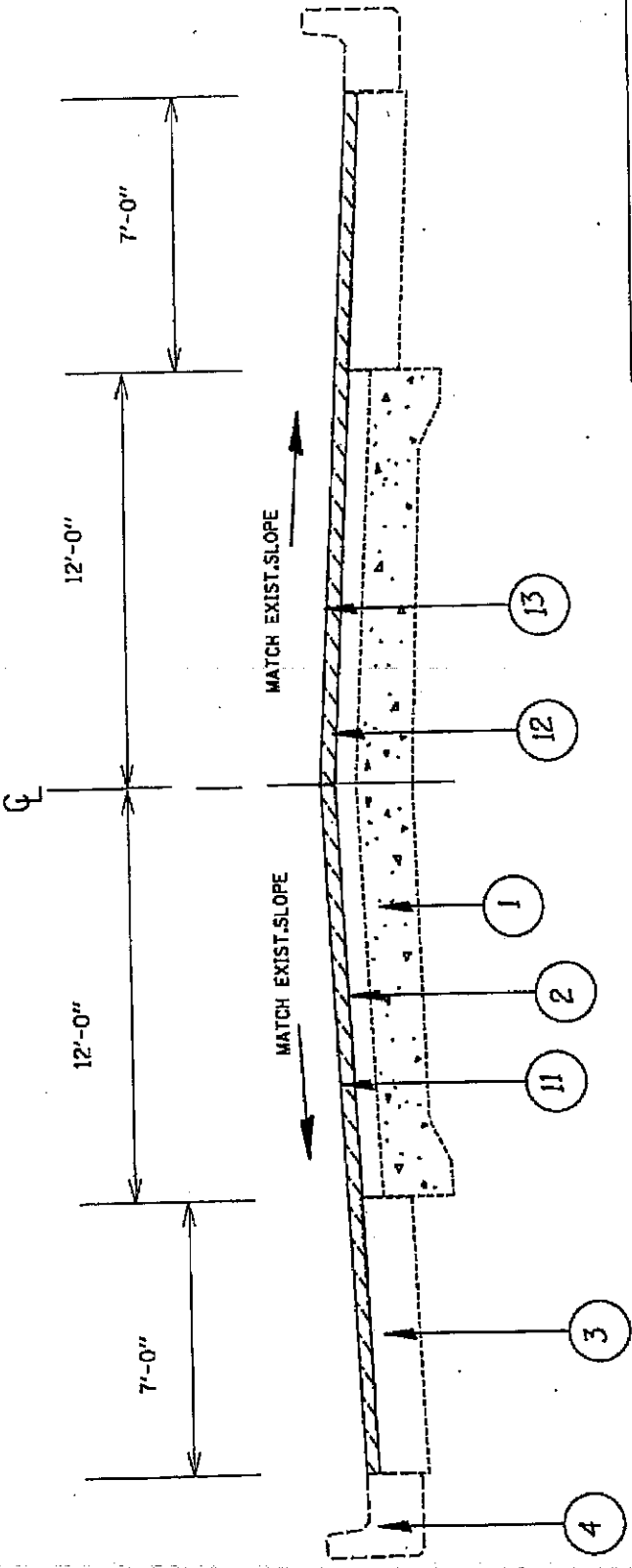

FOR CCC & G REMOVAL AND
PROP. CCC & G SEE SCHEDULES

STA. 84+60 TO 140+95

LEGEND

- 1 EXIST. PCC PAVEMENT
- 2 EXIST. HOT MIX ASPHALT OVERLAY
- 3 EXIST. HOT MIX ASPHALT SHOULDERS
- 4 EXIST. C C C & GUTTER B-6.24
- 11 PROP. HOT-MIX ASPHALT SURF REMOVAL 2 1/4"
- 12 PROP. LEV BIND (M M) 3/4"
- 13 PROP. HOT-MIX ASPHALT SURF CSE 1 1/2"

IL 116
TYPICAL
SECTION

DRAWING NOT TO SCALE

ROUTE		SECTION	COUNTY	SHEET
F.A.	673	12ORS-2	WOODFORD	TOTAL
MKD.	IL 116/117			28
				NO.
				12

CONTRACT NO. 68561

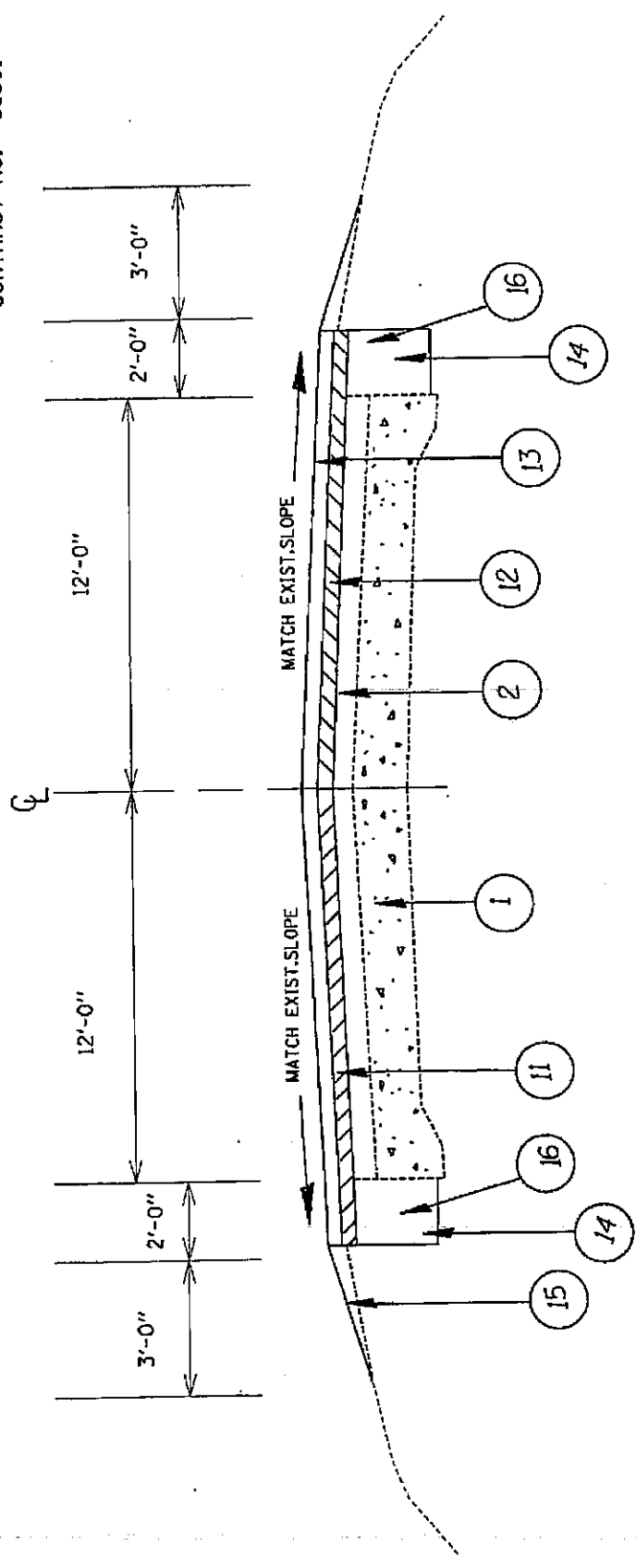

STA. 140+95 TO 396+35

LEGEND

- 1 EXIST. PCC PAVEMENT
- 2 EXIST. HOT MIX ASPHALT OVERLAY
- 11 PROP. HOT-MIX ASPHALT SURF REMOVAL 3/4"
- 12 PROP. LEV BIND (M M) 3/4"
- 13 PROP. HOT-MIX ASPHALT SURF CSE 1/2"
- 14 PROP HMA BASE COURSE WIDENING 6"
- 15 PROP. AGG SHOULDERS
- 16 PROP. EARTH EXCAVATION WIDENING

IL 116
TYPICAL
SECTION
DRAWING NOT TO SCALE

ROUTE		SECTION	COUNTY	SHEET	
F.A.	673	12ORS-2	WOODFORD	TOTAL	NO.
MKD.	IL 116/117			28	13

CONTRACT NO. 68561

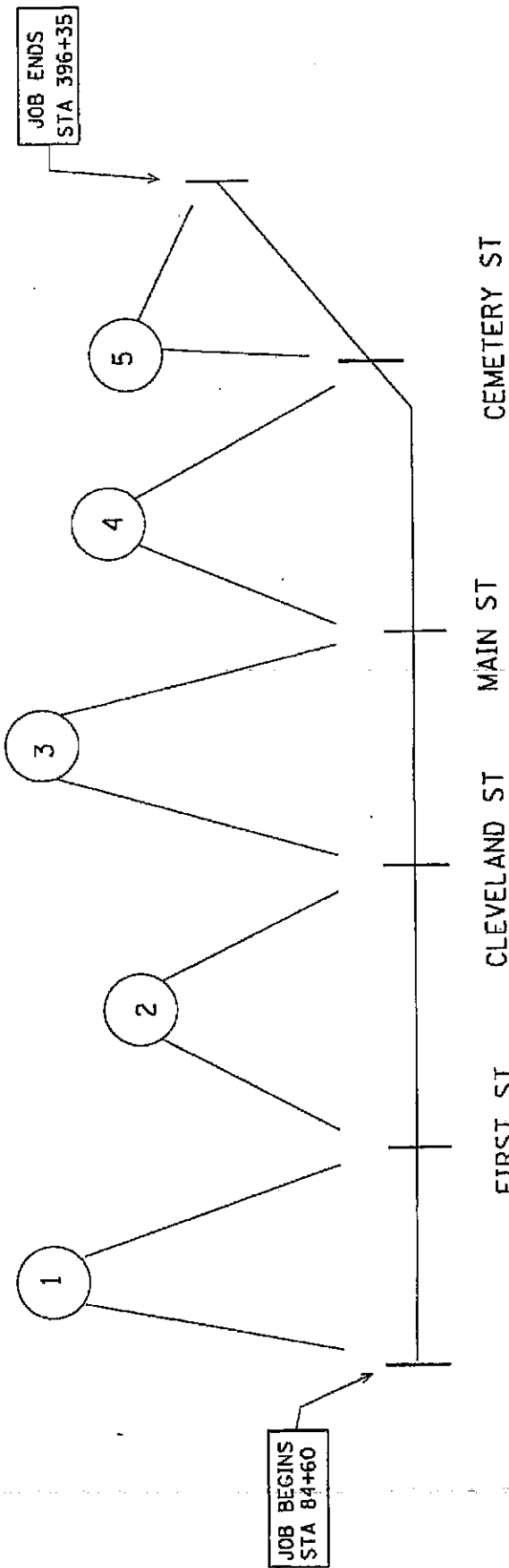

LINE DIAGRAM
IL 116/117
(NOT TO SCALE)

PATCHING SCHEDULE

CONTRACT : 68561

ROUTE		SECTION	COUNTY	SHEET	
F.A.P.	673			107RS-5	WOODFORD
IL	116/117	108RS-4		28	14

PATCH UNITS	CLD PATCH TY II - 14"		CLD PATCH TY III - 14"		CLD PATCH TY IV - 14"	
	NO.	SQ. YD	NO.	SQ. YD	NO.	SQ. YD
E.B						
1	11	101	1	21	0	0
2	13	115	1	21	4	133
3	19	181	1	16	0	0
4	15	128	0	0	1	27
5	36	328	0	0	1	27
W.B						
1	30	283	0	0	1	27
2	11	104	0	0	0	0
3	6	53	0	0	0	0
4	2	16	0	0	0	0
5	30	283	0	0	1	27
SUBTOTAL	173	1,592	3	59	8	240
20% BREAK-UP		318.4		11.7		48.0
TOTAL		1,910		70		288

PATCHING
QUANTITIES

CONTRACT: 68561

STATION TO STATION		BIT SURF REMOVAL BUTT-JOINT	TEMP RAMPS
		SQ YD	SQ YD
84+60	TO 84+90	80	13
SIDE STREETS AND SIDEROADS		2,838	1,283
396+05	TO 396+35	80	13
TOTAL		2,998	1,310

STATION TO STATION		RAISED REF PAVEMENT MAKERS	RAISED REF PVT MKRS REMOVAL
		EACH	EACH
84+60	TO 140+27	70	70
140+27	TO 140+95	BRIDGE	BRIDGE
140+95	TO 396+35	319	319
TOTAL		389	389

ROUTE		SECTION	COUNTY	SHEET
F.A.P.	673	107RS-5	WOODFORD	TOTAL
IL	116/117	108RS-4		28
				16

AGG SHOULDERS TYPE B		TON	
		LT	RT
140+95	TO 324+00	927	927
342+70	TO 396+35	272	272
SUB-TOTAL		1,198	1,198
TOTAL		2,396	

STATION TO STATION		MOWING
		UNIT
84+60	TO 396+35	312
TOTAL		312

SCHEDULE
OF
QUANTITIES

ROUTE	SECTION	COUNTY	SHEET
F.A.P 673	108RS-4	WOODFORD	TOTAL
IL 116/117			28
			17

CONSTRUCTING TEST STRIP	EACH
SURFACE COURSE	1
TOTAL	1

ENGINEER FIELD OFFICE TYPE A	CAL MO
JOBSITE	3
TOTAL	3

MOBILIZATION	L SUM
JOBSITE	1
TOTAL	1

TRAF CONT & PROT STD 701306	L SUM
JOBSITE	1
TOTAL	1

TRAF CONT & PROT STD 701336	L SUM
JOBSITE	1
TOTAL	1

STATION TO STATION	EARTH EXCAVATION (WIDENING)		HOT MIX ASPHALT BASE COURSE WIDENING 6"	
	CU YD	SQ YD	CU YD	SQ YD
140+95 TO 324+00	LT	678	4,068	
140+95 TO 324+00	RT	678	4,068	
342+70 TO 396+35	LT	199	1,192	
342+70 TO 396+35	RT	199	1,192	
TOTAL		1,753	10,520	

STATION TO STATION	SHORT - TERM PAVEMENT MARKING		WORK ZONE	
	FT	REMOVAL	PVT. MRK.	REMOVAL
84+80 TO 396+35	31,175		10,392	
TOTAL	31,175		10,392	

STATION TO STATION	CCC & G REMOVAL		CCC & G TYPE B-6-24	
	FOOT	REMOVAL	FOOT	REMOVAL
IL 116/117 (Roanoke)				
86+00 - 86+50	LT	50	50	
87+40 - 87+80	LT	40	40	
89+00 - 89+20	RT	20	20	
89+70 - 90+00	LT	30	30	
90+00 - 90+40	RT	40	40	
106+00 - 108+30	LT, RT	230	230	
121+00 - 122+00	RT	100	100	
125+00 - 126+00	LT	100	100	
130+00 - 132+00	LT, RT	200	200	
TOTAL		810	810	

SCHEDULE OF QUANTITIES

ROUTE		SECTION	COUNTY	SHEET
F.A.P.	673	107RS-5	WOODFORD	TOTAL
IL	116/117	108RS-4		28
				18

CONTRACT : 68561

LOCATION	CENTER LINE			FT
	LT EDGE OF PVT SOLID (WHITE)	SOLID (YELLOW)	SKIP - DASH (YELLOW)	
84+60 TO 86+00	140		35	140
86+00 TO 147+50	6,150		1,538	6,150
147+50 TO 155+20	770	770	193	770
155+20 TO 156+68	148		37	148
156+68 TO 166+00	932		233	932
166+00 TO 392+00	22,600		5,650	22,600
392+00 TO 396+35	435	435	109	435
TOTALS	31,175		10,071	31,175
			72,421	

PAVT MKNG
QUANTITIES

CONTRACT NO. 68561

GUARDRAIL REMOVAL		FT
LT	139+44 TO 140+34	90
RT	137+99 TO 140+14	215
LT	141+10 TO 142+22	112
RT	140+86 TO 141+62	76
LT	178+00 TO 180+92	292
RT	177+80 TO 180+70	290
LT	279+68 TO 281+94	226
RT	279+14 TO 281+40	226
LT	327+30 TO 329+60	230
RT	326+70 TO 329+66	296
TOTAL		2,053

S P B GUARDRAIL TYPE A 6 FOOT POSTS		FT
LT	139+94 TO 140+34	40
RT	138+49 TO 140+14	165
LT	141+10 TO 141+72	62
RT	140+86 TO 141+12	26
LT	178+50 TO 180+42	192
RT	178+30 TO 180+20	190
LT	280+18 TO 281+44	126
RT	279+64 TO 280+90	126
LT	327+80 TO 329+10	130
RT	327+20 TO 329+16	196
TOTAL		1253

ROUTE		SECTION	COUNTY	SHEET	
F.A.P.	673	107RS-5	WOODFORD	TOTAL	28
MKD	IL 116/117	108RS-4			

**GUARDRAIL
QUANTITIES**

CONTRACT NO. 68561

ROUTE		SECTION	COUNTY	SHEET
F.A.P.	673			
MKD	IL 116/117	108RS-4	WOODFORD	TOTAL
				28
				20

GUARDRAIL AGG EROSION CONTROL		TON
LT	139+44 TO 140+34	13.7
RT	137+99 TO 140+14	32.7
LT	141+10 TO 142+22	17.0
RT	140+86 TO 141+62	11.6
LT	178+00 TO 180+92	44.4
RT	177+80 TO 180+70	44.1
LT	279+68 TO 281+94	34.4
RT	279+14 TO 281+40	34.4
LT	327+30 TO 329+60	35.0
RT	326+70 TO 329+66	45.0
TOTAL		312

GUARDRAIL MARKERS TYPE A		EACH
LT	139+94 TO 140+34	2
RT	138+49 TO 140+14	4
LT	141+10 TO 141+72	2
RT	140+86 TO 141+12	2
LT	178+50 TO 180+42	5
RT	178+30 TO 180+20	5
LT	280+18 TO 281+44	4
RT	279+64 TO 280+90	4
LT	327+80 TO 329+10	5
RT	327+20 TO 329+16	5
TOTAL		38

STATION TO STATION		TRAFFIC BAR TERM TY 1 SPL TANGENT EACH	TERMINAL MARK DIRECT APPLIED EACH	
LT	139+44 TO 139+94		1	
RT	137+99 TO 138+49	1		1
LT	141+72 TO 142+22	1		1
RT	141+12 TO 141+62	1		1
LT	178+00 TO 178+50	1		1
RT	177+80 TO 178+30	1		1
LT	180+42 TO 180+92	1		1
RT	180+20 TO 180+70	1		1
LT	279+68 TO 280+18	1		1
RT	279+14 TO 279+64	1		1
LT	281+44 TO 281+94	1		1
RT	280+90 TO 281+40	1		1
LT	327+30 TO 327+80	1		1
RT	326+70 TO 327+20	1		1
LT	329+10 TO 329+60	1		1
RT	329+16 TO 329+66	1		1
TOTAL		16		16

GUARDRAIL
QUANTITIES

ROUTE		SECTION	COUNTY	SHEET	
F.A.	673	12ORS-2	WOODFORD	TOTAL	NO.
MKD.	IL 116/117			28	21

CONTRACT NO. 68561

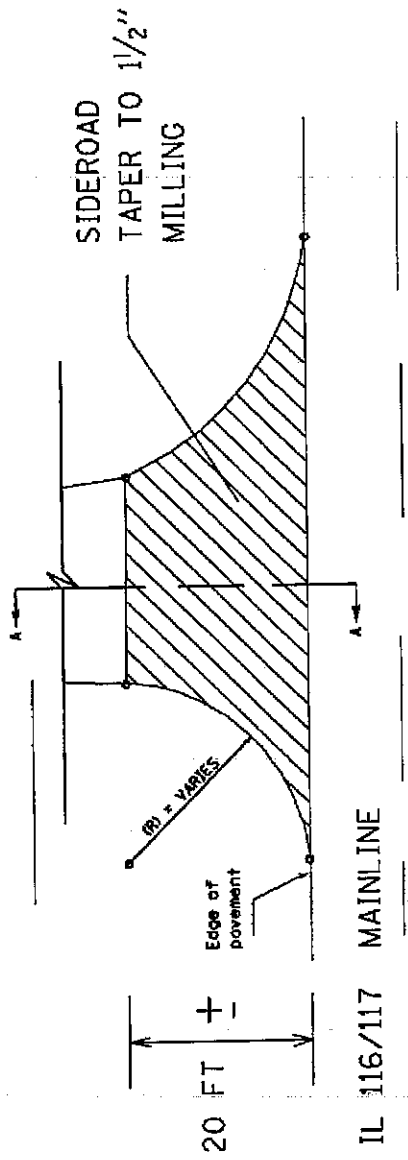

PLAN VIEW

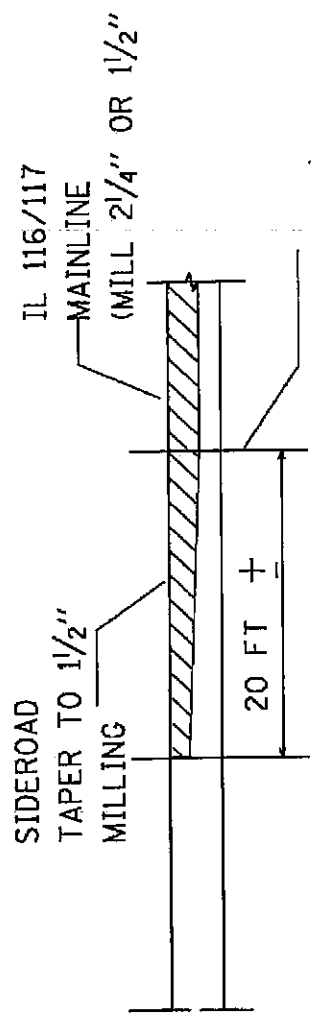

SECTION A-A
EXISTING PCC OR BITUMINOUS SIDEROAD

**BUTT JOINT DETAIL
FOR SIDE SREETS
AND SIDE ROADS
(NOT TO SCALE)**

ROUTE		SECTION	COUNTY	SHEET
F.A.	673	12ORS-2	WOODFORD	TOTAL NO.
MKD.	IL 116/117			28
				22

CONTRACT NO. 68561

- General notes:
1. Coldchilling shall consist of two processes: cutting with carbide teeth mounted on a rotating drum, and planing with a moldboard mounted immediately behind the cutting drum.
 2. Other similar patterns will be acceptable if they consist of a smooth, flat, planed surface interspersed with a pattern of discontinuous longitudinal striations.

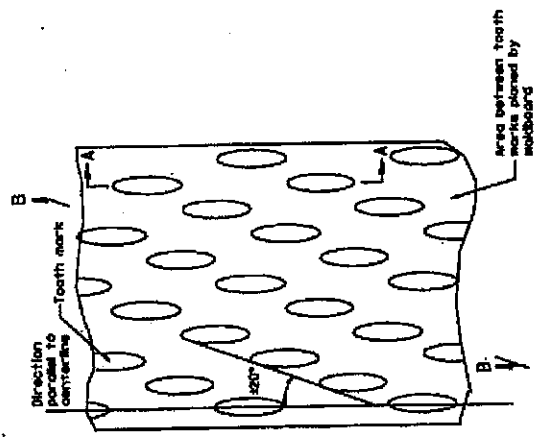

PLAN

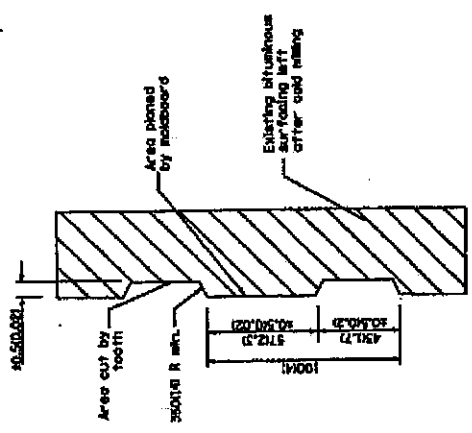

SECTION A-A

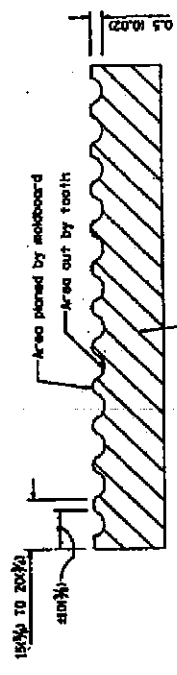

SECTION B-B PROJECTED PERPENDICULAR TO CENTERLINE

As shown on any in addition to
 District Engineer, District Office

DISTRICT CAD STANDARD
 BITUMINOUS SURFACE REMOVAL
 COLD MILLING

CAD STD. NO. 440001-04
 MADE BY: MADE IN: DATE: 1988
 CHECKED BY: 1988

ROUTE		SECTION	COUNTY	SHEET
F.A.	673	12ORS-2	WOODFORD	TOTAL
MKD.	IL 116/117			28
				24

CONTRACT NO. 58561

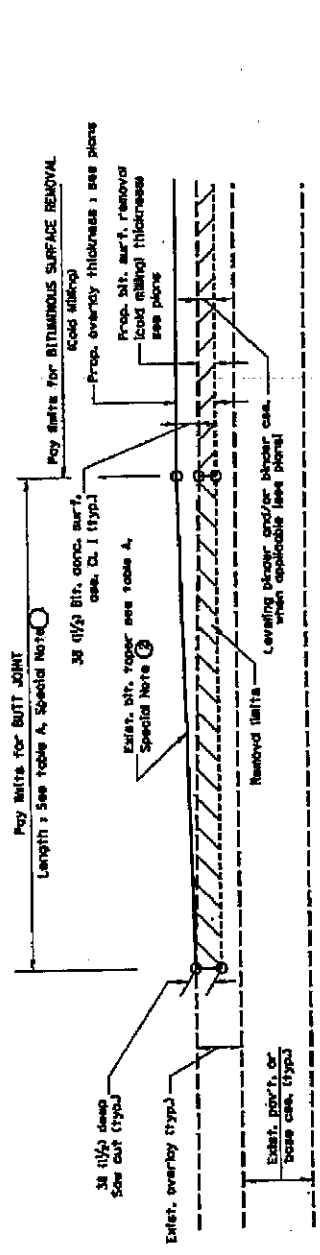

**CASE 3 : WITH BITUMINOUS SURFACE REMOVAL (COLD MILLING)
TIE-IN TO EXISTING BITUMINOUS TAPER**

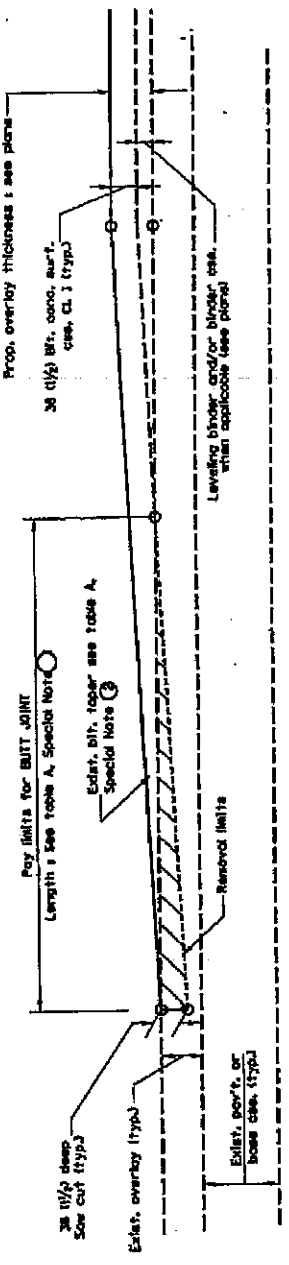

**CASE 4 : NO BITUMINOUS SURFACE REMOVAL (COLD MILLING)
TIE-IN TO EXISTING BITUMINOUS TAPER**

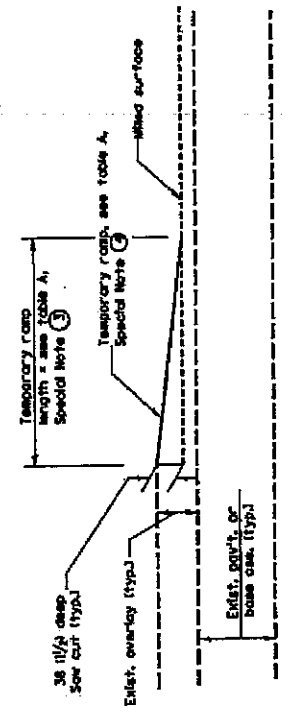

DETAIL TEMPORARY RAMP

BUTT JOINTS
DISTRICT CADD STANDARD

ROUTE		SECTION	COUNTY	SHEET
F.A.	673			
MKD.	IL 116/117	12ORS-2	WOODFORD	TOTAL NO.
				28
				26

CONTRACT NO. 68561

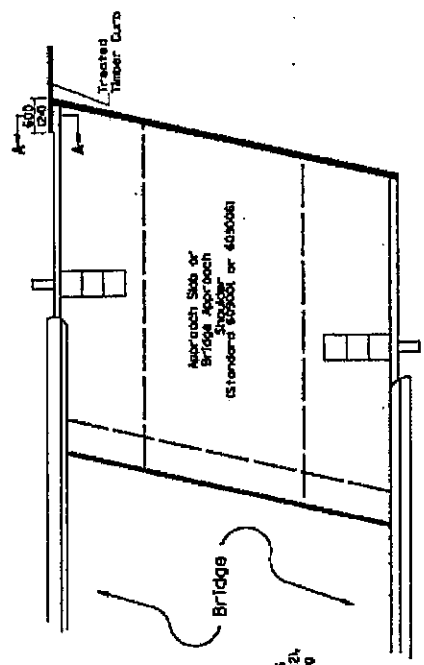

PLAN VIEW
 APPROACH SLAB OR BRIDGE APPROACH SHOULDER
 (STANDARD 609001 OR 609006)

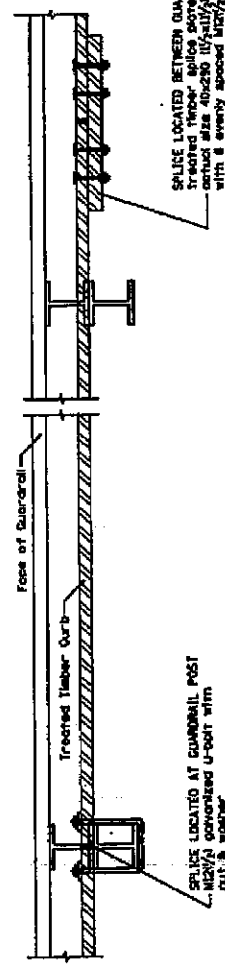

DETAIL A
 Typical Treated Timber Splices

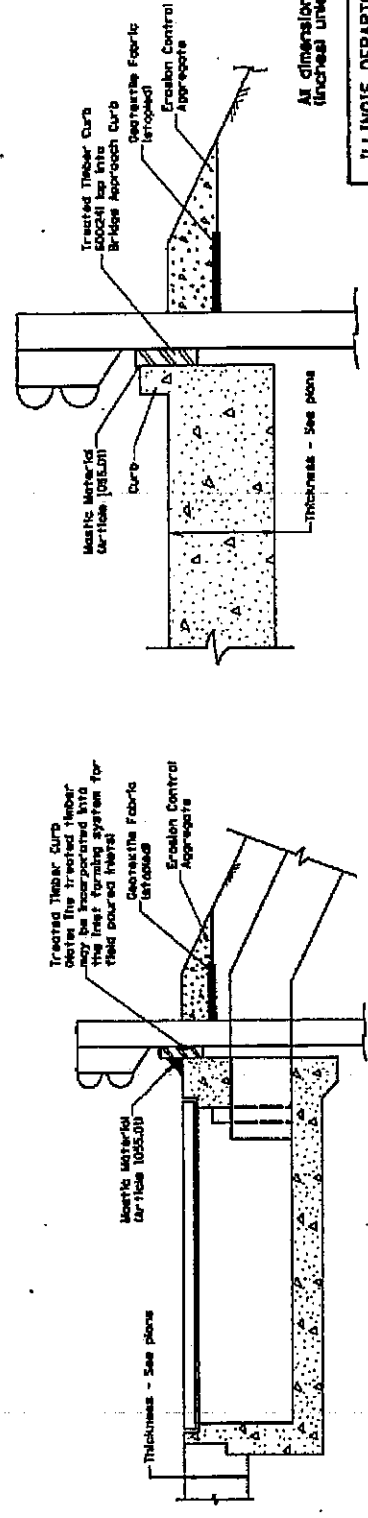

SECTION A-A
 TYPICAL SECTION WITH EROSION CONTROL CURB
 AT BRIDGE APPROACH CURB
 (STANDARD 603001 OR 603006)

**TYPICAL SECTION WITH EROSION CONTROL CURB
 AT INLETS, TYPE E. & F. (STANDARD 610001)**

All dimensions are in millimeters (inches unless otherwise noted).

ILLINOIS DEPARTMENT OF TRANSPORTATION
 DISTRICT CADD STANDARD
GUARDRAIL EROSION CONTROL TREATMENTS
 SHEET 2 OF 2
 CADD STANDARD NO. 630101-D4
 DRAWN BY CADD
 CHECKED BY

630101-D4(2)

ROUTE		SECTION	COUNTY	SHEET
F.A.	673	12ORS-2	WOODFORD	TOTAL
MKD.	IL 116/117			28
				27

CONTRACT NO. 68561

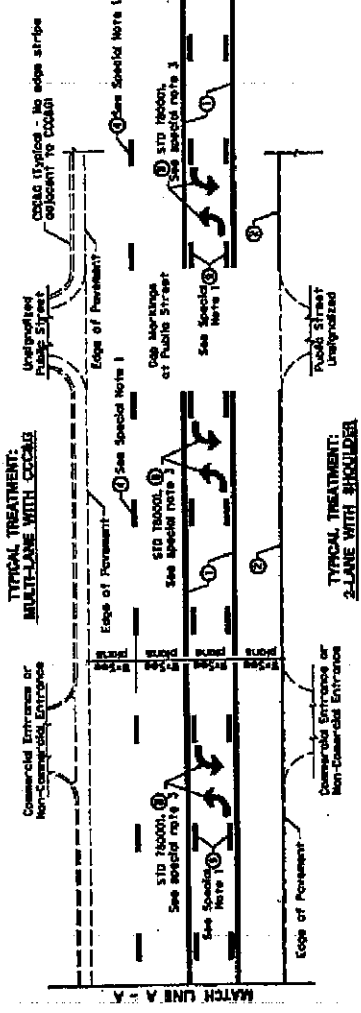
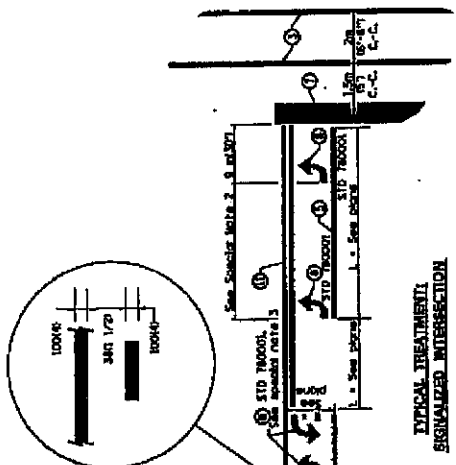

FLUSH PAVED MEDIAN: TWO-WAY LEFT TURN LANE WITH ONE-WAY LEFT TURN LANE AT SIGNALIZED INTERSECTION

- GENERAL NOTES**
- Refer to State Standard 70000 for additional Pavement Markings including letters & arrows.
 - See Plans for Pavement Markings adjacent to curbed islands and medians, and through lane reductions.

SPECIAL NOTES

- Sub-down markings will be centered between both ends of city blocks and not be placed in alignment transversely across the pavement.
 - Arrows shall be evenly spaced if three (3) or more are required.
- The following shall apply to arrows located in one-way left turn lanes:
 - The minimum spacing between arrows is 24 m (80').
 - Arrows shall be evenly spaced if three (3) or more are required.
- The following shall apply to arrow pairs located in two-way left turn lanes:
 - The minimum spacing between arrow pairs is 61 m (200').
 - Arrow pairs shall be evenly spaced if three (3) or more are required.
 - The spacing between BI Directional Left Turn arrows is 10 m (33').

TYPICAL PAVEMENT MARKING LEGEND

Notes: This is a District Standard Legend. Some elements may not apply to specific projects.

- 10004 Solid Yellow
- 10009 Solid White
- 2-50088 6-ribbed 8 2 m 16'-0" wide C-C. (Metric)
- 10048 3/8" Dia. (Metric)
- 20048 3/8" Dia. (Metric)
- 20049 3/8" Dia. (Metric)
- 20052 Diagonal Metal (Type 2) as shown on Std. 70000
- 65004 Strip Bar (Metric)
- Letters & Arrows (See Std. 70000 and Special Notes 2 & 3)
- 10046 3/8" Dia. (Metric)
- 20047 3/8" Dia. (Metric)
- 20048 3/8" Dia. (Metric)
- 10048 Double Solid (Metric)
- 20047 3/8" Dia. (Metric)
- 20048 3/8" Dia. (Metric)

All dimensions are in millimeters (inches) unless otherwise noted.

TYPICAL PAVEMENT MARKINGS

CADD STANDARD NO. T60001-04
 SHEET 1 OF 2
 DRAWN BY CADD
 CHECKED BY

ROUTE		SECTION	COUNTY	SHEET
F.A.	673	12ORS-2	WOODFORD	TOTAL
MKD.	IL 116/117			28
				NO. 28

CONTRACT NO. 68561

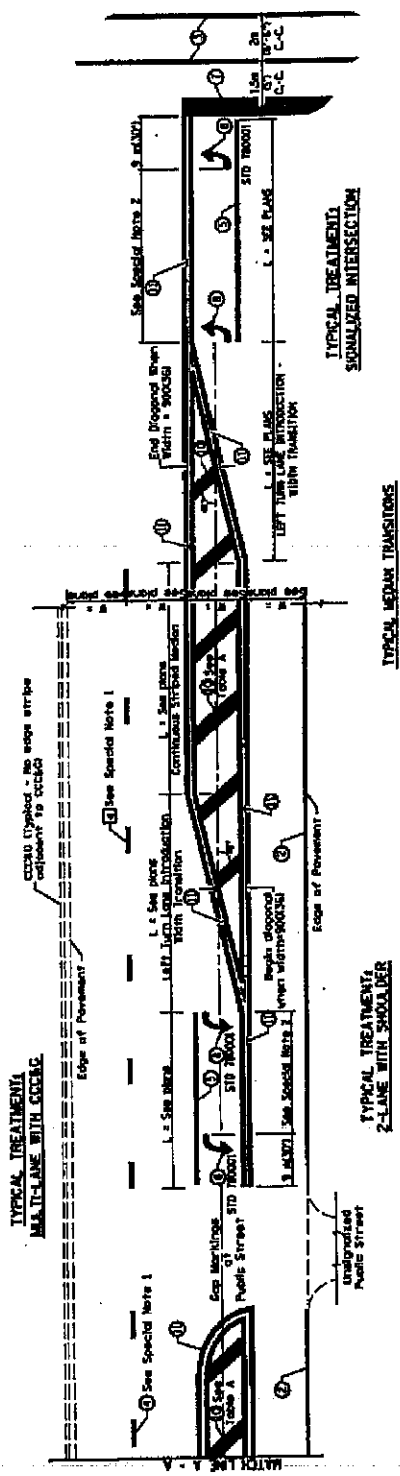

TYPICAL TREATMENT: MULTI-LANE WITH CONC

TYPICAL TREATMENT: 2-LANE WITH SHOULDER

FLUSH PAVED MEDIAN RESTRICTED LEFT TURN LANE

TABLE A

RECOMMENDED SPACING BETWEEN DIAGONAL LINES

SPEED LIMIT RANGE	CONTINUOUS	INTERSECTION DIMENSIONALIZATION (includes both Transitions for Median and Left Turn Lane Introductory)
Less Than 50 km/h (30 mph)	15 m (50')	5 m (15')
50 - 70 km/h (30 - 45 mph)	23 m (75')	5 m (15')
Over 70 km/h (45 mph)	46 m (150')	9 m (30')

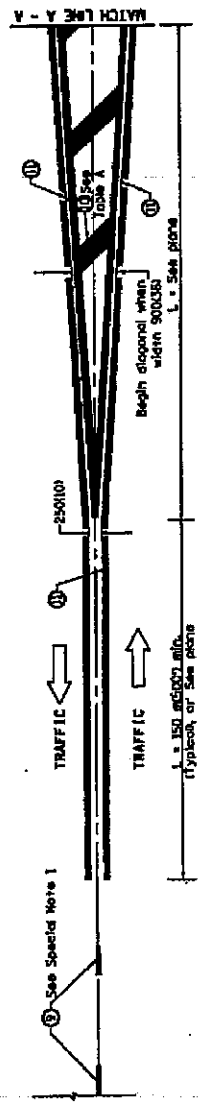

TYPICAL TREATMENT: MEDIAN INTRODUCTION WITH TRANSITIONS

TYPICAL PAVEMENT MARKINGS

ALL DIMENSIONS ARE IN MILLIMETERS (INCHES UNLESS OTHERWISE NOTED)

CADD STANDARD NO. TPO001-04
 SCALE: NOT DRAWN TO SCALE
 SHEET 2 OF 2
 DRAWN BY: CUD
 CHECKED BY:

**REQUIRED CONTRACT PROVISIONS
FEDERAL-AID CONSTRUCTION CONTRACTS**

	Page
I. General	1
II. Nondiscrimination	1
III. Nonsegregated Facilities	3
IV. Payment of Predetermined Minimum Wage.....	3
V. Statements and Payrolls	5
VI. Record of Materials, Supplies, and Labor.....	6
VII. Subletting or Assigning the Contract.....	6
VIII. Safety: Accident Prevention	7
IX. False Statements Concerning Highway Projects.....	7
X. Implementation of Clean Air Act and Federal Water Pollution Control Act	7
XI. Certification Regarding Debarment, Suspension, Ineligibility, and Voluntary Exclusion	8
XII. Certification Regarding Use of Contract Funds for Lobbying	9

ATTACHMENTS

- A. Employment Preference for Appalachian Contracts (included in Appalachian contracts only)

I. GENERAL

1. These contract provisions shall apply to all work performed on the contract by the contractor's own organization and with the assistance of workers under the contractor's immediate superintendence and to all work performed on the contract by piecework, station work, or by subcontract.
2. Except as otherwise provided for in each section, the contractor shall insert in each subcontract all of the stipulations contained in these Required Contract Provisions, and further require their inclusion in any lower tier subcontract or purchase order that may in turn be made. The Required Contract Provisions shall not be incorporated by reference in any case. The prime contractor shall be responsible for compliance by any subcontractor or lower tier subcontractor with these Required Contract Provisions.
3. A breach of any of the stipulations contained in these Required Contract Provisions shall be sufficient grounds for termination of the contract.
4. A breach of the following clauses of the Required Contract Provisions may also be grounds for debarment as provided in 29 CFR 5.12:
 - Section I, paragraph 2;
 - Section IV, paragraphs 1, 2, 3, 4 and 7;
 - Section V, paragraphs 1 and 2a through 2g.
5. Disputes arising out of the labor standards provisions of Section IV (except paragraph 5) and Section V of these Required Contract Provisions shall not be subject to the general disputes clause of this contract. Such disputes shall be resolved in accordance with the procedures of the U.S. Department of Labor (DOL) as set forth in 29 CFR 5, 6 and 7. Disputes within the meaning of this clause include disputes between the contractor (or any of its subcontractors) and the contracting agency, the DOL, or the contractor's employees or their representatives.
6. Selection of Labor: During the performance of this contract, the contractor shall not:
 - a. Discriminate against labor from any other State, possession, or territory of the United States (except for employment preference for Appalachian contracts, when applicable, as specified in Attachment A), or
 - b. Employ convict labor for any purpose within the limits of the project unless it is labor performed by convicts who are on parole, supervised release, or probation.

II. NONDISCRIMINATION

(Applicable to all Federal-aid construction contracts and to all related subcontracts of \$10,000 or more.)

1. Equal Employment Opportunity: Equal employment opportunity (EEO) requirements not to discriminate and to take affirmative action to assure equal opportunity as set forth under laws, executive orders, rules, regulations (28 CFR 35, 29 CFR 1630 and 41 CFR 60 (and orders of the Secretary of Labor as modified by the provisions prescribed herein, and imposed pursuant to 23 U.S.C. 140 shall constitute the EEO and specific affirmative action standards for the contractor's project activities under this contract. The Equal Opportunity Construction Contract Specifications set forth under 41 CFR 60-4.3 and the provisions of the American Disabilities Act of 1990 (42 U.S.C. 12101 et seq.) set forth under 28 CFR 35 and 29 CFR 1630 are incorporated by reference in this contract. In the execution of this contract, the contractor agrees to comply with the following minimum specific requirement activities of EEO:

- a. The contractor will work with the State highway agency (SHA) and the Federal Government in carrying out EEO obligations and in their review of his/her activities under the contract.
- b. The contractor will accept as his operating policy the following statement: "It is the policy of this Company to assure that applicants are employed, and that employees are treated during employment, without regard to their race, religion, sex, color, national origin, age or disability. Such action shall include: employment, upgrading, demotion, or transfer; recruitment or recruitment advertising; layoff or termination; rates of pay or other forms of compensation; and selection for training, including apprenticeship, preapprenticeship, and/or on-the-job-training."

2. EEO Officer: The contractor will designate and make known to the SHA contracting officers an EEO Officer who will have the responsibility for an must be capable of effectively administering and promoting an active contractor program of EEO and who must be assigned adequate authority and responsibility to do so.

3. Dissemination of Policy: All members of the contractor's staff who are authorized to hire, supervise, promote, and discharge employees, or who recommend such action, or who are substantially involved in such action, will be made fully cognizant of, and will implement, the contractor's EEO policy and contractual responsibilities to provide EEO in each grade and classification of employment. To ensure that the above agreement will be met, the following actions will be taken as a minimum:

- a. Periodic meetings of supervisory and personnel office employees will be conducted before the start of work and then not less often than once every six months, at which time the contractor's EEO policy and its implementation will be reviewed and explained. The meetings will be conducted by the EEO Officer.
- b. All new supervisory or personnel office employees will be given a thorough indoctrination by the EEO Officer, covering all major aspects of the contractor's EEO obligations within thirty days following their reporting for duty with the contractor.
- c. All personnel who are engaged in direct recruitment for the project will be instructed by the EEO Officer in the contractor's procedures for locating and hiring minority group employees.
- d. Notices and posters setting forth the contractor's EEO policy will be placed in areas readily accessible to employees, applicants for employment and potential employees.
- e. The contractor's EEO policy and the procedures to implement such policy will be brought to the attention of employees by means of meetings, employee handbooks, or other appropriate means.

4. Recruitment: When advertising for employees, the contractor will include in all advertisements for employees the notation: "An Equal Opportunity Employer." All such advertisements will be placed in publications having a large circulation among minority groups in the area from which the project work force would normally be derived.

- a. The contractor will, unless precluded by a valid bargaining agreement, conduct systematic and direct recruitment through public and private employees referral sources likely to yield qualified minority group applicants. To meet this requirement, the contractor will identify sources of potential minority group employees, and establish which such identified sources procedures whereby minority group applicants may be referred to the contractor for employment consideration.
- b. In the event the contractor has a valid bargaining agreement providing for exclusive hiring hall referrals, he is expected to observe the provisions of that agreement to the extent that the system permits the contractor's compliance with EEO contract provisions. (The DOL has held that where implementation of such agreements have the effect of discriminating against minorities or women, or obligates the contractor to do the same, such implementation violates Executive Order 11246, as amended.)
- c. The contractor will encourage his present employees to refer minority group applicants for employment. Information and procedures with regard to referring minority group applicants will be discussed with employees.

5. Personnel Actions: Wages, working conditions, and employee benefits shall be established and administered, and personnel actions of every type, including hiring, upgrading, promotion, transfer, demotion, layoff, and termination, shall be taken without regard to race, color, religion, sex, national origin, age or disability. The following procedures shall be followed:

- a. The contractor will conduct periodic inspections of project sites to insure that working conditions and employee facilities do not indicate discriminatory treatment of project site personnel.
- b. The contractor will periodically evaluate the spread of wages paid within each classification to determine any evidence of discriminatory wage practices.
- c. The contractor will periodically review selected personnel actions in depth to determine whether there is evidence of discrimination. Where evidence is found, the contractor will promptly take corrective action. If the review indicates that the discrimination may extend beyond the actions reviewed, such corrective action shall include all affected persons.
- d. The contractor will promptly investigate all complaints of alleged discrimination made to the contractor in connection with his obligations under this contract, will attempt to resolve such complaints, and will take appropriate corrective action within a reasonable time. If the investigation indicates that the discrimination may affect persons other than the complainant, such corrective action shall include such other persons. Upon completion of each investigation, the contractor will inform every complainant of all of his avenues of appeal.

6. Training and Promotion:

- a. The contractor will assist in locating, qualifying, and increasing the skills of minority group and women employees, and applicants for employment.
- b. Consistent with the contractor's work force requirements and as permissible under Federal and State regulations, the contractor shall make full use of training programs, i.e., apprenticeship, and on-the-job training programs for the geographical area of contract performance. Where feasible, 25 percent of apprentices or trainees in each occupation shall be in their first year of apprenticeship or training. In the event a special provision for training is provided under this contract, this subparagraph will be superseded as indicated in the special provision.
- c. The contractor will advise employees and applicants for employment of available training programs and entrance

requirements for each.

d. The contractor will periodically review the training and promotion potential of minority group and women employees and will encourage eligible employees to apply for such training and promotion.

7. Unions: If the contractor relies in whole or in part upon unions as a source of employees, the contractor will use his/her best efforts to obtain the cooperation of such unions to increase opportunities for minority groups and women within the unions, and to effect referrals by such unions of minority and female employees. Actions by the contractor either directly or through a contractor's association acting as agent will include the procedures set forth below:

- a. The contractor will use best efforts to develop, in cooperation with the unions, joint training programs aimed toward qualifying more minority group members and women for membership in the unions and increasing the skills of minority group employees and women so that they may qualify for higher paying employment.
- b. The contractor will use best efforts to incorporate an EEO clause into each union agreement to the end that such union will be contractually bound to refer applicants without regard to their race, color, religion, sex, national origin, age or disability.
- c. The contractor is to obtain information as to the referral practices and policies of the labor union except that to the extent such information is within the exclusive possession of the labor union and such labor union refuses to furnish such information to the contractor, the contractor shall so certify to the SHA and shall set forth what efforts have been made to obtain such information.
- d. In the event the union is unable to provide the contractor with a reasonable flow of minority and women referrals within the time limit set forth in the collective bargaining agreement, the contractor will, through independent recruitment efforts, fill the employment vacancies without regard to race, color, religion, sex, national origin, age or disability; making full efforts to obtain qualified and/or quailifiable minority group persons and women. (The DOL has held that it shall be no excuse that the union with which the contractor has a collective bargaining agreement providing for exclusive referral failed to refer minority employees.) In the event the union referral practice prevents the contractor from meeting the obligations pursuant to Executive Order 11246, as amended, and these special provisions, such contractor shall immediately notify the SHA.

8. Selection of Subcontractors, Procurement of Materials and Leasing of Equipment: The contractor shall not discriminate on the grounds of race, color, religion, sex, national origin, age or disability in the selection and retention of subcontractors, including procurement of materials and leases of equipment.

- a. The contractor shall notify all potential subcontractors and suppliers of his/her EEO obligations under this contract.
- b. Disadvantaged business enterprises (DBE), as defined in 49 CFR 23, shall have equal opportunity to compete for and perform subcontracts which the contractor enters into pursuant to this contract. The contractor will use his best efforts to solicit bids from and to utilize DBE subcontractors or subcontractors with meaningful minority group and female representation among their employees. Contractors shall obtain lists of DBE construction firms from SHA personnel.
- c. The contractor will use his best efforts to ensure subcontractor compliance with their EEO obligations.

9. Records and Reports: The contractor shall keep such records as necessary to document compliance with the EEO requirements. Such records shall be retained for a period of three years following completion of the contract work and shall be available at reasonable times and places for inspection by authorized representatives of the SHA and the FHWA.

a. The records kept by the contractor shall document the following:

(1) The number of minority and non-minority group members and women employed in each work classification on the project;

(2) The progress and efforts being made in cooperation with unions, when applicable, to increase employment opportunities for minorities and women;

(3) The progress and efforts being made in locating, hiring, training, qualifying, and upgrading minority and female employees; and

(4) The progress and efforts being made in securing the services of DBE subcontractors or subcontractors with meaningful minority and female representation among their employees.

b. The contractors will submit an annual report to the SHA each July for the duration of the project, indicating the number of minority, women, and non-minority group employees currently engaged in each work classification required by the contract work. This information is to be reported on Form FHWA-1391. If on-the-job training is being required by special provision, the contractor will be required to collect and report training data.

III. NONSEGREGATED FACILITIES

(Applicable to all Federal-aid construction contracts and to all related subcontracts of \$10,000 or more.)

a. By submission of this bid, the execution of this contract or subcontract, or the consummation of this material supply agreement or purchase order, as appropriate, the bidder, Federal-aid construction contractor, subcontractor, material supplier, or vendor, as appropriate, certifies that the firm does not maintain or provide for its employees any segregated facilities at any of its establishments, and that the firm does not permit its employees to perform their services at any location, under its control, where segregated facilities are maintained. The firm agrees that a breach of this certification is a violation of the EEO provisions of this contract. The firm further certifies that no employee will be denied access to adequate facilities on the basis of sex or disability.

b. As used in this certification, the term "segregated facilities" means any waiting rooms, work areas, restrooms and washrooms, restaurants and other eating areas, timeclocks, locker rooms, and other storage or dressing areas, parking lots, drinking fountains, recreation or entertainment areas, transportation, and housing facilities provided for employees which are segregated by explicit directive, or are, in fact, segregated on the basis of race, color, religion, national origin, age or disability, because of habit, local custom, or otherwise. The only exception will be for the disabled when the demands for accessibility override (e.g. disabled parking).

c. The contractor agrees that it has obtained or will obtain identical certification from proposed subcontractors or material suppliers prior to award of subcontracts or consummation of material supply agreements of \$10,000 or more and that it will retain such certifications in its files.

IV. PAYMENT OF PREDETERMINED MINIMUM WAGE

(Applicable to all Federal-aid construction contracts exceeding \$2,000 and to all related subcontracts, except for projects located on roadways classified as local roads or rural minor collectors, which are exempt.)

1. General:

a. All mechanics and laborers employed or working upon the site of the work will be paid unconditionally and not less often than once a week and without subsequent deduction or rebate on any account [except such payroll deductions as are permitted by regulations (29 CFR 3) issued by the Secretary of Labor under the Copeland Act (40 U.S.C. 276c)] the full amounts of wages and bona fide fringe benefits (or cash equivalents thereof) due at time of payment. The payment shall be computed at wage rates not less than those contained in the wage determination of the Secretary of Labor (hereinafter "the wage determination") which is attached hereto and made a part hereof, regardless of any contractual relationship which may be alleged to exist between the contractor or its subcontractors and such laborers and mechanics. The wage determination (including any additional classifications and wage rates conformed under paragraph 2 of this Section IV and the DOL poster (WH-1321) or Form FHWA-1495) shall be posted at all times by the contractor and its subcontractors at the site of the work in a prominent and accessible place where it can be easily seen by the workers. For the purpose of this Section, contributions made or costs reasonably anticipated for bona fide fringe benefits under Section 1(b)(2) of the Davis-Bacon Act (40 U.S.C. 276a) on behalf of laborers or mechanics are considered wages paid to such laborers or mechanics, subject to the provisions of Section IV, paragraph 3b, hereof. Also, for the purpose of this Section, regular contributions made or costs incurred for more than a weekly period (but not less often than quarterly) under plans, funds, or programs, which cover the particular weekly period, are deemed to be constructively made or incurred during such weekly period. Such laborers and mechanics shall be paid the appropriate wage rate and fringe benefits on the wage determination for the classification of work actually performed, without regard to skill, except as provided in paragraphs 4 and 5 of this Section IV.

b. Laborers or mechanics performing work in more than one classification may be compensated at the rate specified for each classification for the time actually worked therein, provided, that the employer's payroll records accurately set forth the time spent in each classification in which work is performed.

c. All rulings and interpretations of the Davis-Bacon Act and related acts contained in 29 CFR 1, 3, and 5 are herein incorporated by reference in this contract.

2. Classification:

a. The SHA contracting officer shall require that any class of laborers or mechanics employed under the contract, which is not listed in the wage determination, shall be classified in conformance with the wage determination.

b. The contracting officer shall approve an additional classification, wage rate and fringe benefits only when the following criteria have been met:

(1) the work to be performed by the additional classification requested is not performed by a classification in the wage determination;

(2) the additional classification is utilized in the area by the construction industry;

(3) the proposed wage rate, including any bona fide fringe benefits, bears a reasonable relationship to the wage rates contained in the wage determination; and

(4) with respect to helpers, when such a classification prevails in the area in which the work is performed.

c. If the contractor or subcontractors, as appropriate, the laborers and mechanics (if known) to be employed in the additional classification or their representatives, and the contracting officer agree on the classification and wage rate (including the amount designated for fringe benefits where appropriate), a report of the action taken shall be sent by the contracting officer to the DOL, Administrator of the Wage and Hour Division, Employment Standards Administration, Washington, D.C. 20210. The Wage and Hour Administrator, or an authorized representative, will approve, modify, or disapprove every additional classification action within 30 days of receipt and so advise the contracting officer or will notify the contracting officer within the 30-day period that additional time is necessary.

d. In the event the contractor or subcontractors, as appropriate, the laborers or mechanics to be employed in the additional classification or their representatives, and the contracting officer do not agree on the proposed classification and wage rate (including the amount designated for fringe benefits, where appropriate), the contracting officer shall refer the question, including the views of all interested parties and the recommendation of the contracting officer, to the Wage and Hour Administrator for determination. Said Administrator, or an authorized representative, will issue a determination within 30 days of receipt and so advise the contracting officer or will notify the contracting officer within the 30-day period that additional time is necessary.

e. The wage rate (including fringe benefits where appropriate) determined pursuant to paragraph 2c or 2d of this Section IV shall be paid to all workers performing work in the additional classification from the first day on which work is performed in the classification.

3. Payment of Fringe Benefits:

a. Whenever the minimum wage rate prescribed in the contract for a class of laborers or mechanics includes a fringe benefit which is not expressed as an hourly rate, the contractor or subcontractors, as appropriate, shall either pay the benefit as stated in the wage determination or shall pay another bona fide fringe benefit or an hourly case equivalent thereof.

b. If the contractor or subcontractor, as appropriate, does not make payments to a trustee or other third person, he/she may consider as a part of the wages of any laborer or mechanic the amount of any cost reasonably anticipated in providing bona fide fringe benefits under a plan or program, provided that the Secretary of Labor has found, upon the written request of the contractor, that the applicable standards of the Davis-Bacon Act have been met. The Secretary of Labor may require the contractor to set aside in a separate account assets for the meeting of obligations under the plan or program.

4. Apprentices and Trainees (Programs of the U.S. DOL) and Helpers:

a. Apprentices:

(1) Apprentices will be permitted to work at less than the predetermined rate for the work they performed when they are employed pursuant to and individually registered in a bona fide apprenticeship program registered with the DOL, Employment and Training Administration, Bureau of Apprenticeship and Training, or with a State apprenticeship agency recognized by the Bureau, or if a person is employed in his/her first 90 days of probationary employment as an apprentice in such an apprenticeship program, who is not individually registered in the program, but who has been certified by the Bureau of Apprenticeship and Training or a State apprenticeship agency (where appropriate) to be eligible for probationary employment as an apprentice.

(2) The allowable ratio of apprentices to journeyman-level employees on the job site in any craft classification shall not

be greater than the ratio permitted to the contractor as to the entire work force under the registered program. Any employee listed on a payroll at an apprentice wage rate, who is not registered or otherwise employed as stated above, shall be paid not less than the applicable wage rate listed in the wage determination for the classification of work actually performed. In addition, any apprentice performing work on the job site in excess of the ratio permitted under the registered program shall be paid not less than the applicable wage rate on the wage determination for the work actually performed. Where a contractor or subcontractor is performing construction on a project in a locality other than that in which its program is registered, the ratios and wage rates (expressed in percentages of the journeyman-level hourly rate) specified in the contractor's or subcontractor's registered program shall be observed.

(3) Every apprentice must be paid at not less than the rate specified in the registered program for the apprentice's level of progress, expressed as a percentage of the journeyman-level hourly rate specified in the applicable wage determination. Apprentices shall be paid fringe benefits in accordance with the provisions of the apprenticeship program. If the apprenticeship program does not specify fringe benefits, apprentices must be paid the full amount of fringe benefits listed on the wage determination for the applicable classification. If the Administrator for the Wage and Hour Division determines that a different practice prevails for the applicable apprentice classification, fringes shall be paid in accordance with that determination.

(4) In the event the Bureau of Apprenticeship and Training, or a State apprenticeship agency recognized by the Bureau, withdraws approval of an apprenticeship program, the contractor or subcontractor will no longer be permitted to utilize apprentices at less than the applicable predetermined rate for the comparable work performed by regular employees until an acceptable program is approved.

b. Trainees:

(1) Except as provided in 29 CFR 5.16, trainees will not be permitted to work at less than the predetermined rate for the work performed unless they are employed pursuant to and individually registered in a program which has received prior approval, evidenced by formal certification by the DOL, Employment and Training Administration.

(2) The ratio of trainees to journeyman-level employees on the job site shall not be greater than permitted under the plan approved by the Employment and Training Administration. Any employee listed on the payroll at a trainee rate who is not registered and participating in a training plan approved by the Employment and Training Administration shall be paid not less than the applicable wage rate on the wage determination for the classification of work actually performed. In addition, any trainee performing work on the job site in excess of the ratio permitted under the registered program shall be paid not less than the applicable wage rate on the wage determination for the work actually performed.

(3) Every trainee must be paid at not less than the rate specified in the approved program for his/her level of progress, expressed as a percentage of the journeyman-level hourly rate specified in the applicable wage determination. Trainees shall be paid fringe benefits in accordance with the provisions of the trainee program. If the trainee program does not mention fringe benefits, trainees shall be paid the full amount of fringe benefits listed on the wage determination unless the Administrator of the Wage and Hour Division determines that there is an apprenticeship program associated with the corresponding journeyman-level wage rate on the wage determination which provides for less than full fringe benefits for apprentices, in which cases such trainees shall receive the same fringe benefits as apprentices.

(4) In the event the Employment and Training Administration withdraws approval of a training program, the contractor or subcontractor will no longer be permitted to utilize trainees at less than the applicable predetermined rate for the work performed until an acceptable program is approved.

c. Helpers:

Helpers will be permitted to work on a project if the helper classification is specified and defined on the applicable wage determination or is approved pursuant to the conformance procedure set forth in Section IV. 2. Any worker listed on a payroll at a helper wage rate, who is not a helper under a approved definition, shall be paid not less than the applicable wage rate on the wage determination for the classification of work actually performed.

5. Apprentices and Trainees (Programs of the U.S. DOT):

Apprentices and trainees working under apprenticeship and skill training programs which have been certified by the Secretary of Transportation as promoting EEO in connection with Federal-aid highway construction programs are not subject to the requirements of paragraph 4 of this Section IV. The straight time hourly wage rates for apprentices and trainees under such programs will be established by the particular programs. The ratio of apprentices and trainees to journeymen shall not be greater than permitted by the terms of the particular program.

6. Withholding:

The SHA shall upon its own action or upon written request of an authorized representative of the DOL withhold, or cause to be withheld, from the contractor or subcontractor under this contract or any other Federal contract with the same prime contractor or any other Federally-assisted contract subject to Davis-Bacon prevailing wage requirements which is held by the same prime contractor, as much of the accrued payments or advances as may be considered necessary to pay laborers and mechanics, including apprentices, trainee's and helpers, employed by the contractor or any subcontractor the full amount of wages required by the contract. In the event of failure to pay any laborer or mechanic, including any apprentice, trainee, or helper, employed or working on the site of the work, all or part of the wages required by the contract, the SHA contracting officer may, after written notice to the contractor, take such action as may be necessary to cause the suspension of any further payment, advance, or guarantee of funds until such violations have ceased.

7. Overtime Requirements:

No contractor or subcontractor contracting for any part of the contract work which may require or involve the employment of laborers, mechanics, watchmen, or guards (including apprentices, trainees, and helpers described in paragraphs 4 and 5 above) shall require or permit any laborer, mechanic, watchman, or guard in any workweek in which he/she is employed on such work, to work in excess of 40 hours in such workweek unless such laborer, mechanic, watchman, or guard receives compensation at a rate not less than one-and-one-half times his/her basic rate of pay for all hours worked in excess of 40 hours in such workweek.

8. Violation:

Liability for Unpaid Wages; Liquidated Damages: In the event of any violation of the clause set forth in paragraph 7 above, the contractor and any subcontractor responsible thereof shall be liable to the affected employee for his/her unpaid wages. In addition, such contractor and subcontractor shall be liable to the United States (in the case of work done under contract for the District of Columbia or a territory, to such District or to such territory) for liquidated damages. Such liquidated damages shall be computed with respect to each individual laborer, mechanic, watchman, or guard employed in violation of the clause set forth in paragraph 7, in the sum of \$10

for each calendar day on which such employee was required or permitted to work in excess of the standard work week of 40 hours without payment of the overtime wages required by the clause set forth in paragraph 7.

9. Withholding for Unpaid Wages and Liquidated Damages:

The SHA shall; upon its own action or upon written request of any authorized representative of the DOL withhold, or cause to be withheld, from any monies payable on account of work performed by the contractor or subcontractor under any such contract or any other Federal contract with the same prime contractor, or any other Federally-assisted contract subject to the Contract Work Hours and Safety Standards Act, which is held by the same prime contractor, such sums as may be determined to be necessary to satisfy any liabilities of such contractor or subcontractor for unpaid wages and liquidated damages as provided in the clause set forth in paragraph 8 above.

V. STATEMENTS AND PAYROLLS

(Applicable to all Federal-aid construction contracts exceeding \$2,000 and to all related subcontracts, except for projects located on roadways classified as local roads or rural collectors, which are exempt.)

1. Compliance with Copeland Regulations (29 CFR 3):

The contractor shall comply with the Copeland Regulations of the Secretary of Labor which are herein incorporated by reference.

2. Payrolls and Payroll Records:

- a. Payrolls and basic records relating thereto shall be maintained by the contractor and each subcontractor during the course of the work and preserved for a period of 3 years from the date of completion of the contract for all laborers, mechanics, apprentices, trainees, watchmen, helpers, and guards working at the site of the work.
- b. The payroll records shall contain the name, social security number, and address of each such employee; his or her correct classification; hourly rates of wages paid (including rates of contributions or costs anticipated for bona fide fringe benefits or cash equivalent thereof the types described in Section 1(b)(2)(B) of the Davis Bacon Act); daily and weekly number of hours worked; deductions made; and actual wages paid. In addition, for Appalachian contracts, the payroll records shall contain a notation indicating whether the employee does, or does not, normally reside in the labor area as defined in Attachment A, paragraph 1. Whenever the Secretary of Labor, pursuant to Section IV, paragraph 3b, has found that the wages of any laborer or mechanic include the amount of any costs reasonably anticipated in providing benefits under a plan or program described in Section 1(b)(2)(B) of the Davis Bacon Act, the contractor and each subcontractor shall maintain records which show that the commitment to provide such benefits is enforceable, that the plan or program is financially responsible, that the plan or program has been communicated in writing to the laborers or mechanics affected, and show the cost anticipated or the actual cost incurred in providing benefits. Contractors or subcontractors employing apprentices or trainees under approved programs shall maintain written evidence of the registration of apprentices and trainees, and ratios and wage rates prescribed in the applicable programs.
- c. Each contractor and subcontractor shall furnish, each week in which any contract work is performed, to the SHA resident engineer a payroll of wages paid each of its employees

(including apprentices, trainees, and helpers, described in Section IV, paragraphs 4 and 5, and watchmen and guards engaged on work during the preceding weekly payroll period). The payroll submitted shall set out accurately and completely all of the information required to be maintained under paragraph 2b of this Section V. This information may be submitted in any form desired. Optional Form WH-347 is available for this purpose and may be purchased from the Superintendent of Documents (Federal stock number 029-005-0014-1), U.S. Government Printing Office, Washington, D.C. 20402. The prime contractor is responsible for submitting payroll copies of all subcontractors.

d. Each payroll submitted shall be accompanied by a "Statement of Compliance," signed by the Contractor or subcontractor or his/her agent who pays or supervises the payment of the persons employed under the contract and shall certify the following:

(1) that the payroll for the payroll period contains the information required to be maintained under paragraph 2b of this Section V and that such information is correct and complete;

(2) that such laborer or mechanic (including each helper, apprentice, and trainee) employed on the contract during the payroll period has been paid the full weekly wages earned, without rebate, either directly or indirectly, and that no deductions have been made either directly or indirectly from the full wages earned, other than permissible deductions as set forth in the Regulations, 29 CFR 3;

(3) that each laborer or mechanic has been paid not less than the applicable wage rate and fringe benefits or cash equivalent for the classification of work performed, as specified in the applicable wage determination incorporated into the contract.

e. The weekly submission of a properly executed certification set forth on the reverse side of Optional Form WH-347 shall satisfy the requirement for submission of the "Statement of Compliance" required by paragraph 2d of this Section V.

f. The falsification of any of the above certifications may subject the contractor to civil or criminal prosecution under 18 U.S.C. 1001 and 31 U.S.C. 231.

g. The contractor or subcontractor shall make the records required under paragraph 2b of this Section V available for inspection, copying, or transcription by authorized representatives of the SHA, the FHWA, or the DOL, and shall permit such representatives to interview employees during working hours on the job. If the contractor or subcontractor fails to submit the required records or to make them available, the SHA, the FHWA, the DOL, or all may, after written notice to the contractor, sponsor, applicant, or owner, take such actions as may be necessary to cause the suspension of any further payment, advance, or guarantee of funds. Furthermore, failure to submit the required records upon request or to make such records available may be grounds for debarment action pursuant to 29 CFR 5.12.

VI. RECORD OF MATERIALS, SUPPLIES, AND LABOR

1. On all federal-aid contracts on the national highway system, except those which provide solely for the installation of protective devices at railroad grade crossings, those which are constructed on a force account or direct labor basis, highway beautification contracts, and contracts for which the total final construction cost for roadway and bridge is less than \$1,000,000 (23 CFR 635) the contractor shall:

a. Become familiar with the list of specific materials and supplies contained in Form FHWA-47, "Statement of Materials and Labor Used by Contractor of Highway Construction Involving Federal Funds," prior to the commencement of work under this contract.

b. Maintain a record of the total cost of all materials and supplies purchased for and incorporated in the work, and also of the quantities of those specific materials and supplies listed

on Form FHWA-47, and in the units shown on Form FHWA-47.

c. Furnish, upon the completion of the contract, to the SHA resident engineer on Form FHWA-47 together with the data required in paragraph 1b relative to materials and supplies, a final labor summary of all contract work indicating the total hours worked and the total amount earned.

2. At the prime contractor's option, either a single report covering all contract work or separate reports for the contractor and for each subcontract shall be submitted.

VII. SUBLETTING OR ASSIGNING THE CONTRACT

1. The contractor shall perform with its own organization contract work amounting to not less than 30 percent (or a greater percentage if specified elsewhere in the contract) of the total original contract price, excluding any specialty items designated by the State. Specialty items may be performed by subcontract and the amount of any such specialty items performed may be deducted from the total original contract price before computing the amount of work required to be performed by the contractors' own organization (23 CFR 635).

a. "Its own organization" shall be construed to include only workers employed and paid directly by the prime contractor and equipment owned or rented by the prime contractor, with or without operators. Such term does not include employees or equipment of a subcontractor, assignee, or agent of the prime contractor.

b. "Specialty Items" shall be construed to be limited to work that requires highly specialized knowledge, abilities, or equipment not ordinarily available in the type of contracting organizations qualified and expected to bid on the contract as a whole and in general are to be limited to minor components of the overall contract.

2. The contract amount upon which the requirements set forth in paragraph 1 of Section VII is computed includes the cost of material and manufactured products which are to be purchased or produced by the contractor under the contract provisions.

3. The contractor shall furnish (a) a competent superintendent or supervisor who is employed by the firm, has full authority to direct performance of the work in accordance with the contract requirements, and is in charge of all construction operations (regardless of who performs the work) and (b) such other of its own organizational resources (supervision, management, and engineering services) as the SHA contracting officer determines is necessary to assure the performance of the contract.

4. No portion of the contract shall be sublet, assigned or otherwise disposed of except with the written consent of the SHA contracting officer, or authorized representative, and such consent when given shall not be construed to relieve the contractor of any responsibility for the fulfillment of the contract. Written consent will be given only after the SHA has assured that each subcontract is evidenced in writing and that it contains all pertinent provisions and requirements of the prime contract.

VIII. SAFETY: ACCIDENT PREVENTION

1. In the performance of this contract the contractor shall comply with all applicable Federal, State, and local laws governing safety, health, and sanitation (23 CFR 635). The contractor shall provide all safeguards, safety devices and protective equipment and take any other needed actions as it determines, or as the SHA contracting officer may determine, to be reasonably necessary to protect the life and health of employees on the job and the safety of the public and to protect property in connection with the performance of the work covered by the contract.

2. It is a condition of this contract, and shall be made a condition of each subcontract, which the contractor enters into pursuant to this contract, that the contractor and any subcontractor shall not permit any employee, in performance of the contract, to work in surroundings or under conditions which are unsanitary, hazardous or dangerous to his/her health or safety, as determined under construction safety and health standards (29 CFR 1926) promulgated by the Secretary of Labor, in accordance with Section 107 of the Contract Work Hours and Safety Standards Act (40 U.S. C. 333).

3. Pursuant to 29 CFR 1926.3, it is a condition of this contract that the Secretary of Labor or authorized representative thereof, shall have right of entry to any site of contract performance to inspect or investigate the matter of compliance with the construction safety and health standards and to carry out the duties of the Secretary under Section 107 of the Contract Work Hours and Safety Standards Act (40 U.S.C. 333).

IX. FALSE STATEMENTS CONCERNING HIGHWAY PROJECTS

In order to assure high quality and durable construction in conformity with approved plans and specifications and a high degree of reliability on statements and representations made by engineers, contractors, suppliers, and workers on Federal-aid highway projects, it is essential that all persons concerned with the project perform their functions as carefully, thoroughly, and honestly as possible. Willful falsification, distortion, or misrepresentation with respect to any facts related to the project is a violation of Federal law. To prevent any misunderstanding regarding the seriousness of these and similar acts, the following notice shall be posted on each Federal-aid highway project (23 CFR 635) in one or more places where it is readily available to all persons concerned with the project:

NOTICE TO ALL PERSONNEL ENGAGED ON FEDERAL-AID HIGHWAY PROJECTS

18 U.S.C. 1020 reads as follows:

"Whoever, being an officer, agent or employee of the United States, or of any State or Territory, or whoever, whether a person, association, firm, or corporation, knowingly makes any false statement, false representation, or false report as to the character, quality, quantity, or cost of the material used or to be used, or the quantity or quality of the work performed or to be performed, or the cost thereof in connection with the submission of plans, maps, specifications, contracts, or costs of construction on any highway or related project submitted for approval to the Secretary of Transportation; or

Whoever knowingly makes any false statement, false representation, false report or false claim with respect to the character, quality, quantity, or cost of any work performed or to be performed, or materials furnished or to be furnished, in connection with the construction of any highway or related project approved by the Secretary of Transportation; or

Whoever knowingly makes any false statement or false representation as to material fact in any statement, certificate, or report submitted pursuant to provisions of the Federal-aid Roads Act approved July 1, 1916, (39 Stat. 355), as amended and supplemented;

Shall be fined not more than \$10,000 or imprisoned not more than 5 years or both."

X. IMPLEMENTATION OF CLEAN AIR ACT AND FEDERAL WATER POLLUTION CONTROL ACT

(Applicable to all Federal-aid construction contracts and to all related subcontracts of \$100,000 or more).

By submission of this bid or the execution of this contract, or subcontract, as appropriate, the bidder, Federal-aid construction contractor, or subcontractor, as appropriate, will be deemed to have stipulated as follows:

1. That any facility that is or will be utilized in the performance of this contract, unless such contract is exempt under the Clean Air Act, as amended (42 U.S.C. 1857 et seq., as amended by Pub.L. 91-604), and under the Federal Water Pollution Control Act, as amended (33 U.S.C. 1251 et seq., as amended by Pub.L. 92-500), Executive Order 11738, and regulations in implementation thereof (40 CFR 15) is not listed, on the date of contract award, on the U.S. Environmental Protection Agency (EPA) List of Violating Facilities pursuant to 40 CFR 15.20.

2. That the firm agrees to comply and remain in compliance with all the requirements of Section 114 of the Clean Air Act and Section 308 of the Federal Water Pollution Control Act and all regulations and guidelines listed thereunder.

3. That the firm shall promptly notify the SHA of the receipt of any communication from the Director, Office of Federal Activities, EPA indicating that a facility that is or will be utilized for the contract is under consideration to be listed on the EPA List of Violating Facilities.

4. That the firm agrees to include or cause to be included the requirements of paragraph 1 through 4 of this Section X in every nonexempt subcontract, and further agrees to take such action as the government may direct as a means of enforcing such requirements.

XI. CERTIFICATION REGARDING DEBARMENT, SUSPENSION, INELIGIBILITY AND VOLUNTARY EXCLUSION

1. Instructions for Certification - Primary Covered Transactions:

(Applicable to all Federal-aid contracts - 49 CFR 29)

- a. By signing and submitting this proposal, the prospective primary participant is providing the certification set out below.
- b. The inability of a person to provide the certification set out below will not necessarily result in denial of participation in this covered transaction. The prospective participant shall submit an explanation of why it cannot provide the certification set out below. The certification or explanation will be considered in connection with the department or agency's determination whether to enter into this transaction. However, failure of the prospective primary participant to furnish a certification or an explanation shall disqualify such a person from participation in this transaction.
- c. The certification in this clause is a material representation of fact upon which reliance was placed when the department or agency determined to enter into this transaction. If it is later determined that the prospective primary participant knowingly rendered an erroneous certification, in addition to other remedies available to the Federal Government, the department or agency may terminate this transaction for cause of default.
- d. The prospective primary participant shall provide immediate written notice to the department or agency to whom this proposal is submitted if any time the prospective primary participant learns that its certification was erroneous when submitted or has become erroneous by reason of changed circumstances.

e. The terms "covered transaction," "debarred," "suspended," "ineligible," "lower tier covered transaction," "participant," "person," "primary covered transaction," "principal," "proposal," and "voluntarily excluded," as used in this clause, have the meanings set out in the Definitions and Coverage sections of rules implementing Executive Order 12549. You may contact the department or agency to which this proposal is submitted for assistance in obtaining a copy of those regulations.

f. The prospective primary participant agrees by submitting this proposal that, should the proposed covered transaction be entered into, it shall not knowingly enter into any lower tier covered transaction with a person who is debarred, suspended, declared ineligible, or voluntarily excluded from participation in this covered transaction, unless authorized by the department or agency entering into this transaction.

g. The prospective primary participant further agrees by submitting this proposal that it will include the clause titled "Certification Regarding Debarment, Suspension, Ineligibility and Voluntary Exclusion-Lower Tier Covered Transaction," provided by the department or agency entering into this covered transaction, without modification in all lower tier covered transactions and in all solicitations for lower tier covered transactions.

h. A participant in a covered transaction may rely upon a certification of a prospective participant in a lower tier covered transaction that is not debarred, suspended, ineligible, or voluntarily excluded from the covered transaction, unless it knows that the certification is erroneous. A participant may decide the method and frequency by which it determines the eligibility of its principals. Each participant may, but is not required to, check the nonprocurement portion of the "Lists of Parties Excluded from Federal Procurement or Nonprocurement Programs" (Nonprocurement List) which is compiled by the General Services Administration.

i. Nothing contained in the foregoing shall be construed to require establishment of a system of records in order to render in good faith the certification required by this clause. The knowledge and information of participant is not required to exceed that which is normally possessed by a prudent person in the ordinary course of business dealings.

j. Except for transactions authorized under paragraph f of these instructions, if a participant in a covered transaction knowingly enters into a lower tier covered transaction with a person who is suspended, debarred, ineligible, or voluntarily excluded from participation in this transaction, in addition to other remedies available to the Federal Government, the department or agency may terminate this transaction for cause or default.

Certification Regarding Debarment, Suspension, Ineligibility and Voluntary Exclusion-Primary Covered Transactions

1. The prospective primary participant certifies to the best of its knowledge and belief, that it and its principals:

- a. Are not presently debarred, suspended, proposed for debarment, declared ineligible, or voluntarily excluded from covered transactions by any Federal department or agency;
- b. Have not within a 3-year period preceding this proposal been convicted of or had a civil judgment rendered against them for commission of fraud or a criminal offense in connection with obtaining, attempting to obtain, or performing a public (Federal, State or local) transaction or contract under a public transaction; violation of Federal or State antitrust statutes or commission of embezzlement, theft, forgery, bribery, falsification or destruction of records, making false statements, or receiving stolen property;

c. Are not presently indicted for or otherwise criminally or civilly charged by a governmental entity (Federal, State or local) with commission of any of the offenses enumerated in paragraph 1b of this certification; and

d. Have not within a 3-year period preceding this application/proposal had one or more public transactions (Federal, State or local) terminated for cause or default.

2. Where the prospective primary participant is unable to certify to any of the statements in this certification, such prospective participant shall attach an explanation to this proposal.

2. Instructions for Certification - Lower Tier Covered Transactions:

(Applicable to all subcontracts, purchase orders and other lower tier transactions of \$25,000 or more - 49 CFR 29)

a. By signing and submitting this proposal, the prospective lower tier is providing the certification set out below.

b. The certification in this clause is a material representation of fact upon which reliance was placed when this transaction was entered into. If it is later determined that the prospective lower tier participant knowingly rendered an erroneous certification, in addition to other remedies available to the Federal Government, the department, or agency with which this transaction originated may pursue available remedies, including suspension and/or debarment.

c. The prospective lower tier participant shall provide immediate written notice to the person to which this proposal is submitted if at any time the prospective lower tier participant learns that its certification was erroneous by reason of changed circumstances.

d. The terms "covered transaction," "debarred," "suspended," "ineligible," "primary covered transaction," "participant," "person," "principal," "proposal," and "voluntarily excluded," as used in this clause, have the meanings set out in the Definitions and Coverage sections of rules implementing Executive Order 12549. You may contact the person to which this proposal is submitted for assistance in obtaining a copy of those regulations.

e. The prospective lower tier participant agrees by submitting this proposal that, should the proposed covered transaction be entered into, it shall not knowingly enter into any lower tier covered transaction with a person who is debarred, suspended, declared ineligible, or voluntarily excluded from participation in this covered transaction, unless authorized by the department or agency with which this transaction originated.

f. The prospective lower tier participant further agrees by submitting this proposal that it will include this clause titled "Certification Regarding Debarment, Suspension, Ineligibility and Voluntary Exclusion-Lower Tier Covered Transaction," without modification, in all lower tier covered transactions and in all solicitations for lower tier covered transactions.

g. A participant in a covered transaction may rely upon a certification of a prospective participant in a lower tier covered transaction that is not debarred, suspended, ineligible, or voluntarily excluded from the covered transaction, unless it knows that the certification is erroneous. A participant may decide the method and frequency by which it determines the eligibility of its principals. Each participant may, but is not required to, check the Nonprocurement List.

h. Nothing contained in the foregoing shall be construed to require establishment of a system of records in order to render in good faith the certification required by this clause. The knowledge and information of participant is not required to exceed that which is normally possessed by a prudent person in the ordinary course of business dealing.

i. Except for transactions authorized under paragraph e of these instructions, if a participant in a covered transaction knowingly enters into a lower tier covered transaction with a person who is suspended, debarred, ineligible, or voluntarily excluded from participation in this transaction, in addition to other remedies available to the Federal Government, the department or agency with which this transaction originated may pursue available remedies, including suspension and/or debarment.

3. The prospective participant also agrees by submitting his or her bid or proposal that he or she shall require that the language of this certification be included in all lower tier subcontracts, which exceed \$100,000 and that all such recipients shall certify and disclose accordingly.

Certification Regarding Debarment, Suspension, Ineligibility And Voluntary Exclusion-Lower Tier Covered Transactions:

1. The prospective lower tier participant certifies, by submission of this proposal, that neither it nor its principals is presently debarred, suspended, proposed for debarment, declared ineligible, or voluntarily excluded from participation in this transaction by any Federal department or agency.

2. Where the prospective lower tier participant is unable to certify to any of the statements in this certification, such prospective participant shall attach an explanation to this proposal.

XII. CERTIFICATION REGARDING USE OF CONTRACT FUNDS FOR LOBBYING

(Applicable to all Federal-aid construction contracts and to all related subcontracts which exceed \$100,000 - 49 CFR 20)

1. The prospective participant certifies, by signing and submitting this bid or proposal, to the best of his or her knowledge and belief, that:

a. No Federal appropriated funds have been paid or will be paid, by or on behalf of the undersigned, to any person for influencing or attempting to influence an officer or employee of any Federal agency, a Member of Congress, an officer or employee of Congress, or an employee of a Member of Congress in connection with the awarding of any Federal contract, the making of any Federal grant, the making of any Federal loan, the entering into of any cooperative agreement, and the extension, continuation, renewal, amendment, or modification of any Federal contract, grant, loan, or cooperative agreement.

b. If any funds other than Federal appropriated funds have been paid or will be paid to any person for influencing or attempting to influence an officer or employee of any Federal agency, a Member of Congress, an officer or employee of Congress, or an employee of a Member of Congress in connection with this Federal contract, grant, loan, or cooperative agreement, the undersigned shall complete and submit Standard Form-LLL, "Disclosure Form to Report Lobbying," in accordance with its instructions.

2. This certification is a material representation of fact upon which reliance was placed when this transaction was made or entered into. Submission of this certification is a prerequisite for making or entering into this transaction imposed by 31 U.S.C. 1352. Any person who fails to file the required certification shall be subject to a civil penalty of not less than \$10,000 and not more than \$100,000 for each such failure.

**MINIMUM WAGES FOR FEDERAL AND FEDERALLY
ASSISTED CONSTRUCTION CONTRACTS**

This project is funded, in part, with Federal-aid funds and, as such, is subject to the provisions of the Davis-Bacon Act of March 3, 1931, as amended (46 Sta. 1494, as amended, 40 U.S.C. 276a) and of other Federal statutes referred to in a 29 CFR Part 1, Appendix A, as well as such additional statutes as may from time to time be enacted containing provisions for the payment of wages determined to be prevailing by the Secretary of Labor in accordance with the Davis-Bacon Act and pursuant to the provisions of 29 CFR Part 1. The prevailing rates and fringe benefits shown in the General Wage Determination Decisions issued by the U.S. Department of Labor shall, in accordance with the provisions of the foregoing statutes, constitute the minimum wages payable on Federal and federally assisted construction projects to laborers and mechanics of the specified classes engaged on contract work of the character and in the localities described therein.

General Wage Determination Decisions, modifications and supersedes decisions thereto are to be used in accordance with the provisions of 29 CFR Parts 1 and 5. Accordingly, the applicable decision, together with any modifications issued, must be made a part of every contract for performance of the described work within the geographic area indicated as required by an applicable DBRA Federal prevailing wage law and 29 CFR Part 5. The wage rates and fringe benefits contained in the General Wage Determination Decision shall be the minimum paid by contractors and subcontractors to laborers and mechanics.

NOTICE

The most current **General Wage Determination Decisions** (wage rates) are available on the IDOT web site. They are located on the Letting and Bidding page at <http://www.dot.state.il.us/desenv/delett.html>.

In addition, ten (10) days prior to the letting, the applicable Federal wage rates will be e-mailed to subscribers. It is recommended that all contractors subscribe to the Federal Wage Rates List or the Contractor's Packet through IDOT's subscription service.

PLEASE NOTE: if you have already subscribed to the Contractor's Packet you will automatically receive the Federal Wage Rates.

The instructions for subscribing are at <http://www.dot.state.il.us/desenv/subsc.html>.

If you have any questions concerning the wage rates, please contact IDOT's Chief Contract Official at 217-782-7806.