

SECTION	COUNTY	TOTAL SHEETS	SHEET NO.
10-00091-00-BT	EFFINGHAM	17	11
CONTRACT NO. 95646			

BILL OF MATERIAL

Wood Decking Special, Abutment 1

Bar	No.	Size	Length	Shape
H5	3	#5	10'-8"	—
H6	5	#5	22'-8"	—
H7	10	#5	3'-8"	—
H8	10	#5	4'-0"	—
H9	3	#5	9'-8"	—
S4	11	#5	5'-0"	□
V11	24	#5	4'-4"	—
Concrete Structures			Cu. Yd.	4.4
Reinforcement Bars			Pound	430

BILL OF MATERIAL

Wood Decking Special, Abutment 2

Bar	No.	Size	Length	Shape
H5	3	#5	10'-8"	—
H10	5	#5	19'-8"	—
H7	10	#5	3'-8"	—
H8	10	#5	4'-0"	—
H9	3	#5	9'-8"	—
S4	11	#5	5'-0"	□
V11	22	#5	4'-4"	—
Concrete Structures			Cu. Yd.	4.3
Reinforcement Bars			Pound	405

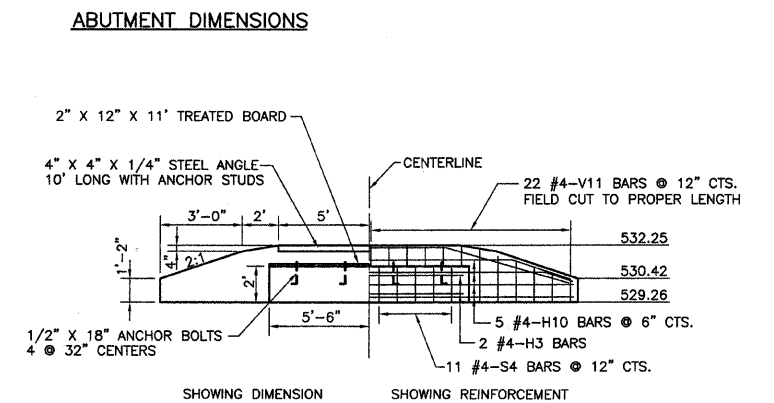
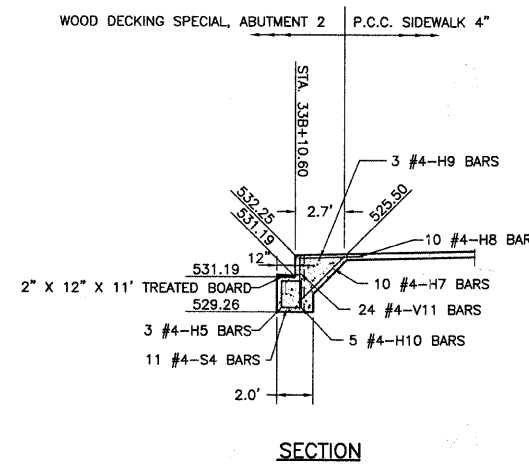
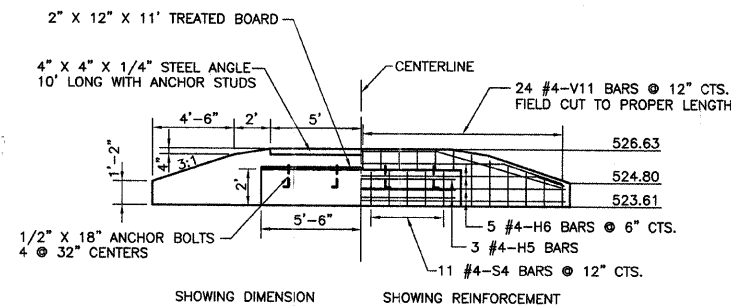
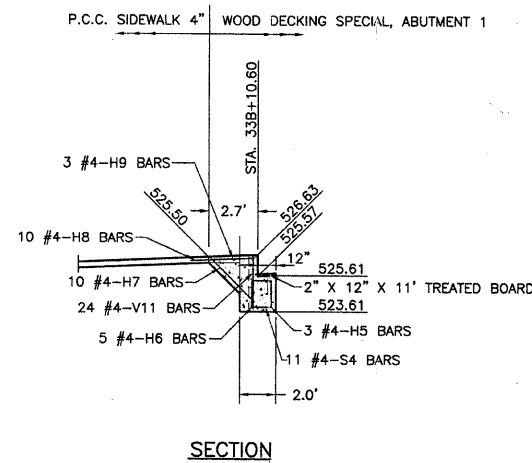
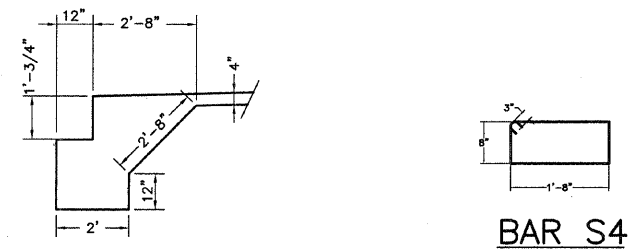
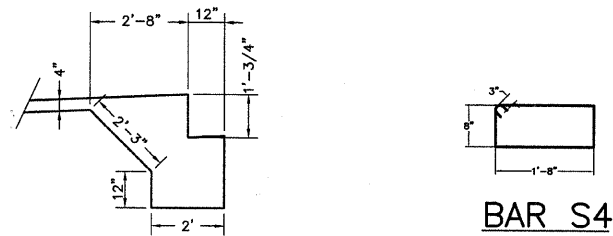
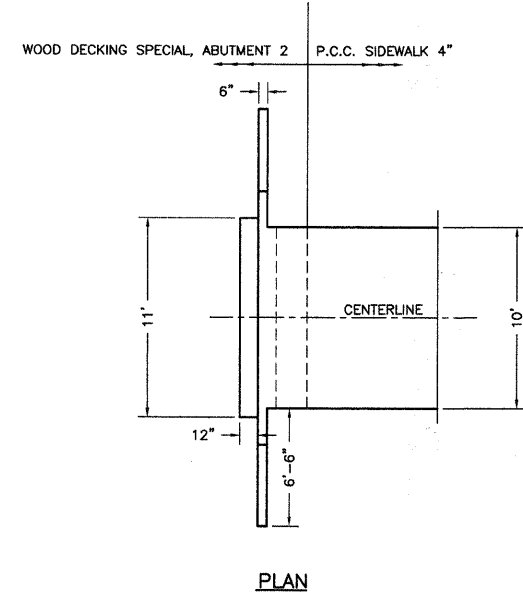
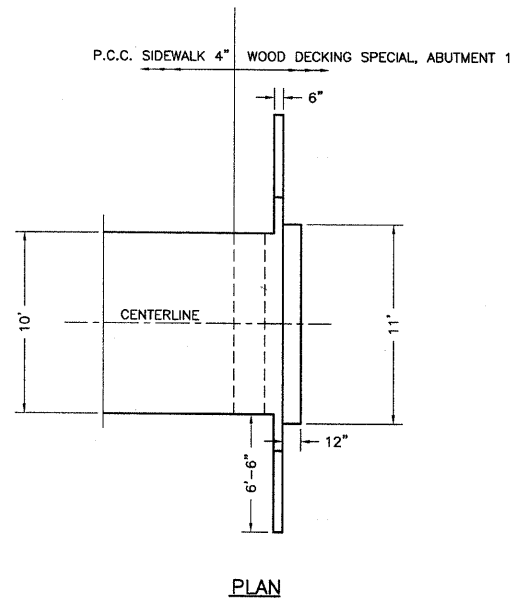

WOOD DECKING SPECIAL, ABUTMENT 1 DETAILS

LUMBER DIMENSIONS ARE NOMINAL

WOOD DECKING SPECIAL, ABUTMENT 1 DETAILS

LUMBER DIMENSIONS ARE NOMINAL