

**If you plan to submit a bid directly to the Department of Transportation**

**PREQUALIFICATION**

Any contractor who desires to become pre-qualified to bid on work advertised by IDOT must submit the properly completed pre-qualification forms to the Bureau of Construction no later than 4:30 p.m. prevailing time twenty-one days prior to the letting of interest. This pre-qualification requirement applies to first time contractors, contractors renewing expired ratings, contractors maintaining continuous pre-qualification or contractors requesting revised ratings. To be eligible to bid, existing pre-qualification ratings must be effective through the date of letting.

**REQUESTS FOR AUTHORIZATION TO BID**

Contractors wanting to bid on items included in a particular letting must submit the properly completed "Request for Authorization to Bid/or Not For Bid Status" (BDE 124) and the ORIGINAL "Affidavit of Availability" (BC 57) to the proper office no later than 4:30 p.m. prevailing time, three (3) days prior to the letting date. This does not apply to Small Business Set-Asides or to the Target Market Program projects.

**WHO CAN BID ?**

Bids will be accepted from only those companies that request and receive written **Authorization to Bid** from IDOT's Central Bureau of Construction. This does not apply to Small Business Set-Asides or to the Target Market Program projects.

**WHAT CONSTITUTES WRITTEN AUTHORIZATION TO BID?:** When a prospective prime bidder submits a "Request for Authorization to Bid/or Not For Bid Status" (BDE 124) he/she must indicate at that time which items are being requested For Bidding purposes. Only those items requested For Bidding will be analyzed. After the request has been analyzed, the bidder will be issued an **Authorization to Bid or Not for Bid Report**, approved by the Central Bureau of Construction that indicates which items have been approved For Bidding. If **Authorization to Bid** cannot be approved, the **Authorization to Bid or Not for Bid Report** will indicate the reason for denial.

**ABOUT AUTHORIZATION TO BID:** Firms that have not received an authorization form within a reasonable time of complete and correct original document submittal should contact the department as to status. This is critical in the week before the letting. These documents must be received three days before the letting date. Firms unsure as to authorization status should call the Prequalification Section of the Bureau of Construction at the number listed at the end of these instructions.

**ADDENDA AND REVISIONS:** It is the contractor's responsibility to determine which, if any, addenda or revisions pertain to any project they may be bidding. Failure to incorporate all relevant addenda or revisions may cause the bid to be declared unacceptable.

Each addendum will be placed with the contract number. Addenda and revisions will also be placed on the Addendum/Revision Checklist and each subscription service subscriber will be notified by e-mail of each addendum and revision issued.

The Internet is the Department's primary way of doing business. The subscription server e-mails are an added courtesy the Department provides. It is suggested that bidders check IDOT's website at <http://www.dot.il.gov/desenv/delett.html> before submitting final bid information.

***IDOT IS NOT RESPONSIBLE FOR ANY E-MAIL FAILURES.***

Addenda Questions may be directed to the Plans and Contracts Office at (217)782-7806 or [D&Econtracts@dot.il.gov](mailto:D&Econtracts@dot.il.gov)

Technical Questions about downloading these files may be directed to Tim Garman (217)524-1642 or [Timothy.Garman@illinois.gov](mailto:Timothy.Garman@illinois.gov).

**WHAT MUST BE INCLUDED WHEN BIDS ARE SUBMITTED?:** Bidders need not return the entire proposal when bids are submitted. That portion of the proposal that must be returned includes the following:

1. All documents from the Proposal Cover Sheet through the Proposal Bid Bond
2. Other special documentation and/or information that may be required by the contract special provisions

All proposal documents, including Proposal Guaranty Checks or Proposal Bid Bonds, should be stapled together to prevent loss when bids are processed by IDOT personnel.

**ABOUT SUBMITTING BIDS:** It is recommended that bidders deliver bids in person to insure they arrive at the proper location prior to the time specified for the receipt of bids. Any bid received at the place of letting after the time specified will not be accepted.

**WHO SHOULD BE CALLED IF ASSISTANCE IS NEEDED?**

<b>Questions Regarding</b>	<b>Call</b>
Prequalification and/or Authorization to Bid	217/782-3413
Preparation and submittal of bids	217/782-7806
Mailing of plans and proposals	217/782-7806

**ADDENDUMS AND REVISIONS TO THE PROPOSAL FORMS**

Planholders should verify that they have received and incorporated any addendum and/or revision prior to submitting their bid. Failure by the bidder to include an addendum or revision could result in a bid being rejected as irregular.

RETURN WITH BID

141

Proposal Submitted By
Name
Address
City

Letting March 11, 2011

BIDDERS NEED NOT RETURN THE ENTIRE PROPOSAL  
(See instructions inside front cover)

**NOTICE TO PROSPECTIVE BIDDERS**

This proposal can be used for bidding purposes by only those companies that request and receive written AUTHORIZATION TO BID from IDOT's Central Bureau of Construction. This does not apply to Small Business Set-Asides or to the Target Market Program projects. (SEE INSTRUCTIONS ON THE INSIDE OF COVER)

**Notice to Bidders,  
Specifications,  
Proposal, Contract  
and Contract Bond**



**Illinois Department  
of Transportation**

Springfield, Illinois 62764

**Contract No. 78222  
Various Counties  
Section D9 SCOUR REPAIR 2011-1  
Various Routes  
District 9 Construction Funds**

PLEASE MARK THE APPROPRIATE BOX BELOW:

- A Bid Bond is included.
- A Cashier's Check or a Certified Check is included.

Plans Included  
Herein

Prepared by	
Checked by	S

(Printed by authority of the State of Illinois)

---

---

## INSTRUCTIONS

**ABOUT IDOT PROPOSALS:** All proposals issued by IDOT are potential bidding proposals. Each proposal contains all Certifications and Affidavits, a Proposal Signature Sheet and a Proposal Bid Bond. In addition, this proposal contains new statutory requirements applicable to the use of subcontractors and, in particular, includes the State Required Ethical Standards Governing Subcontractors to be signed and incorporated into all subcontracts.

**WHO CAN BID?:** Bids will be accepted from only those companies that request and receive written **Authorization to Bid** from IDOT's Central Bureau of Construction. To request authorization, a potential bidder must complete and submit Part B of the Request for Authorization to Bid/or Not For Bid Status form (BDE 124) and submit an original Affidavit of Availability (BC 57). This does not apply to Small Business Set-Asides or to the Target Market Program projects.

**WHAT CONSTITUTES WRITTEN AUTHORIZATION TO BID?:** When a prospective prime bidder submits a **"Authorization to Bid or Not for Bid"** form, he/she must indicate at that time which items are being requested For Bidding purposes. Only those items requested For Bidding will be analyzed. After the request has been analyzed, the bidder will be issued a **Authorization to Bid or Not for Bid Report**, approved by the Central Bureau of Construction, that indicates which items have been approved For Bidding. If **Authorization to Bid** cannot be approved, the **Authorization to Bid or Not for Bid Report** will indicate the reason for denial. If a contractor has requested to bid but has not received a **Authorization to Bid or Not for Bid Report**, they should contact the Central Bureau of Construction in advance of the letting date.

**WHAT MUST BE INCLUDED WHEN BIDS ARE SUBMITTED?:** Bidders need not return the entire proposal when bids are submitted. That portion of the proposal that must be returned includes the following:

1. All documents from the Proposal Cover Sheet through the Proposal Bid Bond
2. Other special documentation and/or information that may be required by the contract special provisions

All proposal documents, including Proposal Guaranty Checks or Proposal Bid Bonds, should be stapled together to prevent loss when bids are processed by IDOT personnel.

**ABOUT SUBMITTING BIDS:** It is recommended that bidders deliver bids in person to insure they arrive at the proper location prior to the time specified for the receipt of bids. Any bid received at the place of letting after the time specified will not be accepted.

### WHO SHOULD BE CALLED IF ASSISTANCE IS NEEDED?

Questions Regarding	Call
Prequalification and/or Authorization to Bid	217/782-3413
Preparation and submittal of bids	217/782-7806

RETURN WITH BID



PROPOSAL

TO THE DEPARTMENT OF TRANSPORTATION

1. Proposal of \_\_\_\_\_

\_\_\_\_\_

Taxpayer Identification Number (Mandatory) \_\_\_\_\_ a

for the improvement identified and advertised for bids in the Invitation for Bids as:

**Contract No. 78222**  
**Various Counties**  
**Section D9 SCOUR REPAIR 2011-1**  
**Various Routes**  
**District 9 Construction Funds**

**Scour repair on nine structures at various locations as described in the plans.**

2. The undersigned bidder will furnish all labor, material and equipment to complete the above described project in a good and workmanlike manner as provided in the contract documents provided by the Department of Transportation. This proposal will become part of the contract and the terms and conditions contained in the contract documents shall govern performance and payments.

**RETURN WITH BID**

3. **ASSURANCE OF EXAMINATION AND INSPECTION/WAIVER.** The undersigned further declares that he/she has carefully examined the proposal, plans, specifications, addenda, form of contract and contract bond, and special provisions, and that he/she has inspected in detail the site of the proposed work, and that he/she has familiarized themselves with all of the local conditions affecting the contract and the detailed requirements of construction, and understands that in making this proposal he/she waives all right to plead any misunderstanding regarding the same.
4. **EXECUTION OF CONTRACT AND CONTRACT BOND.** The undersigned further agrees to execute a contract for this work and present the same to the department within fifteen (15) days after the contract has been mailed to him/her. The undersigned further agrees that he/she and his/her surety will execute and present within fifteen (15) days after the contract has been mailed to him/her contract bond satisfactory to and in the form prescribed by the Department of Transportation, in the penal sum of the full amount of the contract, guaranteeing the faithful performance of the work in accordance with the terms of the contract.
5. **PROPOSAL GUARANTY.** Accompanying this proposal is either a bid bond on the department form, executed by a corporate surety company satisfactory to the department, or a proposal guaranty check consisting of a bank cashier's check or a properly certified check for not less than 5 per cent of the amount bid or for the amount specified in the following schedule:

<u>Amount of Bid</u>		<u>Proposal Guaranty</u>	<u>Amount of Bid</u>		<u>Proposal Guaranty</u>	
Up to	\$5,000	\$150	\$2,000,000	to	\$3,000,000	\$100,000
\$5,000	to	\$10,000	\$3,000,000	to	\$5,000,000	\$150,000
\$10,000	to	\$50,000	\$5,000,000	to	\$7,500,000	\$250,000
\$50,000	to	\$100,000	\$7,500,000	to	\$10,000,000	\$400,000
\$100,000	to	\$150,000	\$10,000,000	to	\$15,000,000	\$500,000
\$150,000	to	\$250,000	\$15,000,000	to	\$20,000,000	\$600,000
\$250,000	to	\$500,000	\$20,000,000	to	\$25,000,000	\$700,000
\$500,000	to	\$1,000,000	\$25,000,000	to	\$30,000,000	\$800,000
\$1,000,000	to	\$1,500,000	\$30,000,000	to	\$35,000,000	\$900,000
\$1,500,000	to	\$2,000,000	over		\$35,000,000	\$1,000,000

Bank cashier's checks or properly certified checks accompanying proposals shall be made payable to the Treasurer, State of Illinois, when the state is awarding authority; the county treasurer, when a county is the awarding authority; or the city, village, or town treasurer, when a city, village, or town is the awarding authority.

If a combination bid is submitted, the proposal guaranties which accompany the individual proposals making up the combination will be considered as also covering the combination bid.

The amount of the proposal guaranty check is \_\_\_\_\_ \$( \_\_\_\_\_ ). If this proposal is accepted and the undersigned shall fail to execute a contract bond as required herein, it is hereby agreed that the amount of the proposal guaranty shall become the property of the State of Illinois, and shall be considered as payment of damages due to delay and other causes suffered by the State because of the failure to execute said contract and contract bond; otherwise, the bid bond shall become void or the proposal guaranty check shall be returned to the undersigned.

**Attach Cashier's Check or Certified Check Here**

In the event that one proposal guaranty check is intended to cover two or more proposals, the amount must be equal to the sum of the proposal guaranties which would be required for each individual proposal. If the guaranty check is placed in another proposal, state below where it may be found.

The proposal guaranty check will be found in the proposal for:

Item \_\_\_\_\_

Section No. \_\_\_\_\_

County \_\_\_\_\_

**Mark the proposal cover sheet as to the type of proposal guaranty submitted.**

**RETURN WITH BID**

6. **COMBINATION BIDS.** The undersigned further agrees that if awarded the contract for the sections contained in the following combination, he/she will perform the work in accordance with the requirements of each individual proposal comprising the combination bid specified in the schedule below, and that the combination bid shall be prorated against each section in proportion to the bid submitted for the same. If an error is found to exist in the gross sum bid for one or more of the individual sections included in a combination, the combination bid shall be corrected as provided in the specifications.

**When a combination bid is submitted, the schedule below must be completed in each proposal comprising the combination.**

**If alternate bids are submitted for one or more of the sections comprising the combination, a combination bid must be submitted for each alternate.**

**Schedule of Combination Bids**

Combination No.	Sections Included in Combination	Combination Bid	
		Dollars	Cents

7. **SCHEDULE OF PRICES.** The undersigned bidder submits herewith, in accordance with the rules and instructions, a schedule of prices for the items of work for which bids are sought. The unit prices bid are in U.S. dollars and cents, and all extensions and summations have been made. The bidder understands that the quantities appearing in the bid schedule are approximate and are provided for the purpose of obtaining a gross sum for the comparison of bids. If there is an error in the extension of the unit prices, the unit prices shall govern. Payment to the contractor awarded the contract will be made only for actual quantities of work performed and accepted or materials furnished according to the contract. The scheduled quantities of work to be done and materials to be furnished may be increased, decreased or omitted as provided elsewhere in the contract.

8. **AUTHORITY TO DO BUSINESS IN ILLINOIS.** Section 20-43 of the Illinois Procurement Code (30 ILCS 500/20-43) provides that a person (other than an individual acting as a sole proprietor) must be a legal entity authorized to do business in the State of Illinois prior to submitting the bid.

9. **The services of a subcontractor will or may be used.**

Check box Yes   
 Check box No

For known subcontractors with subcontracts with an annual value of more than \$25,000, the contract shall include their name, address, and the dollar allocation for each subcontractor.

---



---

10. **EXECUTION OF CONTRACT:** The Department of Transportation will, in accordance with the rules governing Department procurements, execute the contract and shall be the sole entity having the authority to accept performance and make payments under the contract. Execution of the contract by the Chief Procurement Officer or the State Purchasing Officer is for approval of the procurement process and execution of the contract by the Department. Neither the Chief Procurement Officer nor the State Purchasing Officer shall be responsible for administration of the contract or determinations respecting performance or payment there under except as otherwise permitted in the Illinois Procurement Code.







## RETURN WITH BID

### **STATE REQUIRED ETHICAL STANDARDS GOVERNING CONTRACT PROCUREMENT: ASSURANCES, CERTIFICATIONS AND DISCLOSURES**

#### **I. GENERAL**

**A.** Article 50 of the Illinois Procurement Code establishes the duty of all State chief procurement officers, State purchasing officers, and their designees to maximize the value of the expenditure of public moneys in procuring goods, services, and contracts for the State of Illinois and to act in a manner that maintains the integrity and public trust of State government. In discharging this duty, they are charged by law to use all available information, reasonable efforts, and reasonable actions to protect, safeguard, and maintain the procurement process of the State of Illinois.

**B.** In order to comply with the provisions of Article 50 and to carry out the duty established therein, all bidders are to adhere to ethical standards established for the procurement process, and to make such assurances, disclosures and certifications required by law. Except as otherwise required in subsection III, paragraphs J-M, by execution of the Proposal Signature Sheet, the bidder indicates that each of the mandated assurances have been read and understood, that each certification is made and understood, and that each disclosure requirement has been understood and completed.

**C.** In addition to all other remedies provided by law, failure to comply with any assurance, failure to make any disclosure or the making of a false certification shall be grounds for the chief procurement officer to void the contract, or subcontract, and may result in the suspension or debarment of the bidder or subcontractor.

#### **II. ASSURANCES**

The assurances hereinafter made by the bidder are each a material representation of fact upon which reliance is placed should the Department enter into the contract with the bidder.

##### **A. Conflicts of Interest**

1. The Illinois Procurement Code provides in pertinent part:

Section 50-13. Conflicts of Interest.

(a) Prohibition. It is unlawful for any person holding an elective office in this State, holding a seat in the General Assembly, or appointed to or employed in any of the offices or agencies of state government and who receives compensation for such employment in excess of 60% of the salary of the Governor of the State of Illinois, or who is an officer or employee of the Capital Development Board or the Illinois Toll Highway Authority, or who is the spouse or minor child of any such person to have or acquire any contract, or any direct pecuniary interest in any contract therein, whether for stationery, printing, paper, or any services, materials, or supplies, that will be wholly or partially satisfied by the payment of funds appropriated by the General Assembly of the State of Illinois or in any contract of the Capital Development Board or the Illinois Toll Highway authority.

(b) Interests. It is unlawful for any firm, partnership, association or corporation, in which any person listed in subsection (a) is entitled to receive (i) more than 7 1/2% of the total distributable income or (ii) an amount in excess of the salary of the Governor, to have or acquire any such contract or direct pecuniary interest therein.

(c) Combined interests. It is unlawful for any firm, partnership, association, or corporation, in which any person listed in subsection (a) together with his or her spouse or minor children is entitled to receive (i) more than 15%, in the aggregate, of the total distributable income or (ii) an amount in excess of 2 times the salary of the Governor, to have or acquire any such contract or direct pecuniary interest therein.

(d) Securities. Nothing in this Section invalidates the provisions of any bond or other security previously offered or to be offered for sale or sold by or for the State of Illinois.

(e) Prior interests. This Section does not affect the validity of any contract made between the State and an officer or employee of the State or member of the General Assembly, his or her spouse, minor child or any combination of those persons if that contract was in existence before his or her election or employment as an officer, member, or employee. The contract is voidable, however, if it cannot be completed within 365 days after the officer, member, or employee takes office or is employed.

The current salary of the Governor is \$177,412.00. Sixty percent of the salary is \$106,447.20.

## RETURN WITH BID

2. The bidder assures the Department that the award and execution of the contract would not cause a violation of Section 50-13, or that an effective exemption has been issued by the Board of Ethics to any individual subject to the Section 50-13 prohibitions pursuant to the provisions of Section 50-20 of the Code and Executive Order Number 3 (1998). Information concerning the exemption process is available from the Department upon request.

### **B. Negotiations**

1. The Illinois Procurement Code provides in pertinent part:

Section 50-15. Negotiations.

(a) It is unlawful for any person employed in or on a continual contractual relationship with any of the offices or agencies of State government to participate in contract negotiations on behalf of that office or agency with any firm, partnership, association, or corporation with whom that person has a contract for future employment or is negotiating concerning possible future employment.

2. The bidder assures the Department that the award and execution of the contract would not cause a violation of Section 50-15, and that the bidder has no knowledge of any facts relevant to the kinds of acts prohibited therein.

### **C. Inducements**

1. The Illinois Procurement Code provides:

Section 50-25. Inducement. Any person who offers or pays any money or other valuable thing to any person to induce him or her not to bid for a State contract or as recompense for not having bid on a State contract is guilty of a Class 4 felony. Any person who accepts any money or other valuable thing for not bidding for a State contract or who withholds a bid in consideration of the promise for the payment of money or other valuable thing is guilty of a Class 4 felony.

2. The bidder assures the Department that the award and execution of the contract would not cause a violation of Section 50-25, and that the bidder has no knowledge of any facts relevant to the kinds of acts prohibited therein.

### **D. Revolving Door Prohibition**

1. The Illinois Procurement Code provides:

Section 50-30. Revolving door prohibition. Chief procurement officers, State purchasing officers, procurement compliance monitors, their designees whose principal duties are directly related to State procurement, and executive officers confirmed by the Senate are expressly prohibited for a period of 2 years after terminating an affected position from engaging in any procurement activity relating to the State agency most recently employing them in an affected position for a period of at least 6 months. The prohibition includes, but is not limited to: lobbying the procurement process; specifying; bidding; proposing bid, proposal, or contract documents; on their own behalf or on behalf of any firm, partnership, association, or corporation. This Section applies only to persons who terminate an affected position on or after January 15, 1999.

2. The bidder assures the Department that the award and execution of the contract would not cause a violation of Section 50-30, and that the bidder has no knowledge of any facts relevant to the kinds of acts prohibited therein.

### **E. Reporting Anticompetitive Practices**

1. The Illinois Procurement Code provides:

Section 50-40. Reporting anticompetitive practices. When, for any reason, any vendor, bidder, contractor, chief procurement officer, State purchasing officer, designee, elected official, or State employee suspects collusion or other anticompetitive practice among any bidders, offerors, contractors, proposers, or employees of the State, a notice of the relevant facts shall be transmitted to the Attorney General and the chief procurement officer.

2. The bidder assures the Department that it has not failed to report any relevant facts concerning the practices addressed in Section 50-40 which may involve the contract for which the bid is submitted.

### **F. Confidentiality**

1. The Illinois Procurement Code provides:

Section 50-45. Confidentiality. Any chief procurement officer, State purchasing officer, designee, or executive officer who willfully uses or allows the use of specifications, competitive bid documents, proprietary competitive information, proposals, contracts, or selection information to compromise the fairness or integrity of the procurement, bidding, or contract process shall be subject to immediate dismissal, regardless of the Personnel code, any contract, or any collective bargaining agreement, and may in addition be subject to criminal prosecution.

2. The bidder assures the Department that it has no knowledge of any fact relevant to the practices addressed in Section 50-45 which may involve the contract for which the bid is submitted.

## RETURN WITH BID

### **G. Insider Information**

1. The Illinois Procurement Act provides:

Section 50-50. Insider information. It is unlawful for any current or former elected or appointed State official or State employee to knowingly use confidential information available only by virtue of that office or employment for actual or anticipated gain for themselves or another person.

2. The bidder assures the Department that it has no knowledge of any facts relevant to the practices addressed in Section 50-50 which may involve the contract for which the bid is submitted.

### **III. CERTIFICATIONS**

The certifications hereinafter made by the bidder are each a material representation of fact upon which reliance is placed should the Department enter into the contract with the bidder. Section 50-2 of the Illinois Procurement Code provides that every person that has entered into a multi-year contract and every subcontractor with a multi-year subcontract shall certify, by July 1 of each fiscal year covered by the contract after the initial fiscal year, to the responsible chief procurement officer whether it continues to satisfy the requirements of Article 50 pertaining to the eligibility for a contract award. If a contractor or subcontractor is not able to truthfully certify that it continues to meet all requirements, it shall provide with its certification a detailed explanation of the circumstances leading to the change in certification status. A contractor or subcontractor that makes a false statement material to any given certification required under Article 50 is, in addition to any other penalties or consequences prescribed by law, subject to liability under the Whistleblower Reward and Protection Act for submission of a false claim.

#### **A. Bribery**

1. The Illinois Procurement Code provides:

Section 50-5. Bribery.

(a) Prohibition. No person or business shall be awarded a contract or subcontract under this Code who:

(1) has been convicted under the laws of Illinois or any other state of bribery or attempting to bribe an officer or employee of the State of Illinois or any other state in that officer's or employee's official capacity; or

(2) has made an admission of guilt of that conduct that is a matter of record but has not been prosecuted for that conduct.

(b) Businesses. No business shall be barred from contracting with any unit of State or local government, or subcontracting under such a contract, as a result of a conviction under this Section of any employee or agent of the business if the employee or agent is no longer employed by the business and:

(1) the business has been finally adjudicated not guilty; or

(2) the business demonstrates to the governmental entity with which it seeks to contract, or which is signatory to the contract which the subcontract relates, and that entity finds that the commission of the offense was not authorized, requested, commanded, or performed by a director, officer, or high managerial agent on behalf of the business as provided in paragraph (2) of subsection (a) of Section 5-4 of the Criminal Code of 1961.

(c) Conduct on behalf of business. For purposes of this Section, when an official, agent, or employee of a business committed the bribery or attempted bribery on behalf of the business and in accordance with the direction or authorization of a responsible official of the business, the business shall be chargeable with the conduct.

(d) Certification. Every bid submitted to and contract executed by the State, and every subcontract subject to Section 20-120 of the Procurement Code shall contain a certification by the contractor or the subcontractor, respectively, that the contractor or subcontractor is not barred from being awarded a contract or subcontract under this Section and acknowledges that the chief procurement officer may declare the related contract void if any certifications required by this Section are false. A contractor who makes a false statement, material to the certification, commits a Class 3 felony.

2. The contractor or subcontractor certifies that it is not barred from being awarded a contract under Section 50.5.

#### **B. Felons**

1. The Illinois Procurement Code provides:

Section 50-10. Felons. Unless otherwise provided, no person or business convicted of a felony shall do business with the State of Illinois or any State agency, or enter into a subcontract, from the date of conviction until 5 years after the date of completion of the sentence for that felony, unless no person held responsible by a prosecutorial office for the facts upon which the conviction was based continues to have any involvement with the business.

2. Certification. Every bid submitted to and contract executed by the State and every subcontract subject to Section 20-120 of the Procurement Code shall contain a certification by the bidder or contractor or subcontractor, respectively, that the bidder, contractor, or subcontractor is not barred from being awarded a contract or subcontract under this Section and acknowledges that the chief procurement officer may declare the related contract void if any of the certifications required by this Section are false.

## RETURN WITH BID

### **C. Debt Delinquency**

1. The Illinois Procurement Code provides:

Section 50-11 and 50-12. Debt Delinquency.

The contractor or bidder or subcontractor, respectively, certifies that it, or any affiliate, is not barred from being awarded a contract or subcontract under the Procurement Code. Section 50-11 prohibits a person from entering into a contract with a State agency, or entering into a subcontract, if it knows or should know that it, or any affiliate, is delinquent in the payment of any debt to the State as defined by the Debt Collection Board. Section 50-12 prohibits a person from entering into a contract with a State agency, or entering into a subcontract, if it, or any affiliate, has failed to collect and remit Illinois Use Tax on all sales of tangible personal property into the State of Illinois in accordance with the provisions of the Illinois Use Tax Act. The bidder or contractor or subcontractor, respectively, further acknowledges that the chief procurement officer may declare the related contract void if this certification is false or if the bidder, contractor, or subcontractor, or any affiliate, is determined to be delinquent in the payment of any debt to the State during the term of the contract.

### **D. Prohibited Bidders, Contractors and Subcontractors**

1. The Illinois Procurement Code provides:

Section 50-10.5 and 50-60(c). Prohibited bidders, contractors and subcontractors.

The bidder or contractor or subcontractor, respectively, certifies in accordance with 30 ILCS 500/50-10.5 that no officer, director, partner or other managerial agent of the contracting business has been convicted of a felony under the Sarbanes-Oxley Act of 2002 or a Class 3 or Class 2 felony under the Illinois Securities Law of 1953 or if in violation of Subsection (c) for a period of five years from the date of conviction. Every bid submitted to and contract executed by the State and every subcontract subject to Section 20-120 of the Procurement Code shall contain a certification by the bidder, contractor, or subcontractor, respectively, that the bidder, contractor, or subcontractor is not barred from being awarded a contract or subcontract under this Section and acknowledges that the chief procurement officer shall declare the related contract void if any of the certifications completed pursuant to this Section are false.

### **E. Section 42 of the Environmental Protection Act**

The bidder or contractor or subcontractor, respectively, certifies in accordance with 30 ILCS 500/50-12 that the bidder, contractor, or subcontractor, is not barred from being awarded a contract or entering into a subcontract under this Section which prohibits the bidding on or entering into contracts with the State of Illinois or a State agency, or entering into any subcontract, that is subject to the Procurement Code by a person or business found by a court or the Pollution Control Board to have committed a willful or knowing violation of Section 42 of the Environmental Protection Act for a period of five years from the date of the order. The bidder or contractor or subcontractor, respectively, acknowledges that the chief procurement officer may declare the contract void if this certification is false.

### **F. Educational Loan**

1. Section 3 of the Educational Loan Default Act provides:

§ 3. No State agency shall contract with an individual for goods or services if that individual is in default, as defined in Section 2 of this Act, on an educational loan. Any contract used by any State agency shall include a statement certifying that the individual is not in default on an educational loan as provided in this Section.

2. The bidder, if an individual as opposed to a corporation, partnership or other form of business organization, certifies that the bidder is not in default on an educational loan as provided in Section 3 of the Act.

### **G. Bid-Rigging/Bid Rotating**

1. Section 33E-11 of the Criminal Code of 1961 provides:

§ 33E-11. (a) Every bid submitted to and public contract executed pursuant to such bid by the State or a unit of local government shall contain a certification by the prime contractor that the prime contractor is not barred from contracting with any unit of State or local government as a result of a violation of either Section 33E-3 or 33E-4 of this Article. The State and units of local government shall provide the appropriate forms for such certification.

- (b) A contractor who makes a false statement, material to the certification, commits a Class 3 felony.

A violation of Section 33E-3 would be represented by a conviction of the crime of bid-rigging which, in addition to Class 3 felony sentencing, provides that any person convicted of this offense or any similar offense of any state or the United States which contains the same elements as this offense shall be barred for 5 years from the date of conviction from contracting with any unit of State or local government. No corporation shall be barred from contracting with any unit of State or local government as a result of a conviction under this Section of any employee or agent of such corporation if the employee so convicted is no longer employed by the corporation and: (1) it has been finally adjudicated not guilty or (2) if it demonstrates to the governmental entity with which it seeks to contract and that entity finds that the commission of the offense was neither authorized, requested, commanded, nor performed by a director, officer or a high managerial agent in behalf of the corporation.

## RETURN WITH BID

A violation of Section 33E-4 would be represented by a conviction of the crime of bid-rotating which, in addition to Class 2 felony sentencing, provides that any person convicted of this offense or any similar offense of any state or the United States which contains the same elements as this offense shall be permanently barred from contracting with any unit of State or local government. No corporation shall be barred from contracting with any unit of State or local government as a result of a conviction under this Section of any employee or agent of such corporation if the employee so convicted is no longer employed by the corporation and: (1) it has been finally adjudicated not guilty or (2) if it demonstrates to the governmental entity with which it seeks to contract and that entity finds that the commission of the offense was neither authorized, requested, commanded, nor performed by a director, officer or a high managerial agent in behalf of the corporation.

2. The bidder certifies that it is not barred from contracting with the Department by reason of a violation of either Section 33E-3 or Section 33E-4.

### **H. International Anti-Boycott**

1. Section 5 of the International Anti-Boycott Certification Act provides:

§ 5. State contracts. Every contract entered into by the State of Illinois for the manufacture, furnishing, or purchasing of supplies, material, or equipment or for the furnishing of work, labor, or services, in an amount exceeding the threshold for small purchases according to the purchasing laws of this State or \$10,000.00, whichever is less, shall contain certification, as a material condition of the contract, by which the contractor agrees that neither the contractor nor any substantially-owned affiliated company is participating or shall participate in an international boycott in violation of the provisions of the U.S. Export Administration Act of 1979 or the regulations of the U.S. Department of Commerce promulgated under that Act.

2. The bidder makes the certification set forth in Section 5 of the Act.

### **I. Drug Free Workplace**

1. The Illinois "Drug Free Workplace Act" applies to this contract and it is necessary to comply with the provisions of the "Act" if the contractor is a corporation, partnership, or other entity (including a sole proprietorship) which has 25 or more employees.

2. The bidder certifies that if awarded a contract in excess of \$5,000 it will provide a drug free workplace by:

(a) Publishing a statement notifying employees that the unlawful manufacture, distribution, dispensation, possession or use of a controlled substance, including cannabis, is prohibited in the contractor's workplace; specifying the actions that will be taken against employees for violations of such prohibition; and notifying the employee that, as a condition of employment on such contract, the employee shall abide by the terms of the statement, and notify the employer of any criminal drug statute conviction for a violation occurring in the workplace no later than five (5) days after such conviction.

(b) Establishing a drug free awareness program to inform employees about the dangers of drug abuse in the workplace; the contractor's policy of maintaining a drug free workplace; any available drug counseling, rehabilitation, and employee assistance programs; and the penalties that may be imposed upon employees for drug violations.

(c) Providing a copy of the statement required by subparagraph (1) to each employee engaged in the performance of the contract and to post the statement in a prominent place in the workplace.

(d) Notifying the Department within ten (10) days after receiving notice from an employee or otherwise receiving actual notice of the conviction of an employee for a violation of any criminal drug statute occurring in the workplace.

(e) Imposing or requiring, within 30 days after receiving notice from an employee of a conviction or actual notice of such a conviction, an appropriate personnel action, up to and including termination, or the satisfactory participation in a drug abuse assistance or rehabilitation program approved by a federal, state or local health, law enforcement or other appropriate agency.

(f) Assisting employees in selecting a course of action in the event drug counseling, treatment, and rehabilitation is required and indicating that a trained referral team is in place.

(g) Making a good faith effort to continue to maintain a drug free workplace through implementation of the actions and efforts stated in this certification.

RETURN WITH BID

J. Disclosure of Business Operations in Iran

Section 50-36 of the Illinois Procurement Code, 30ILCS 500/50-36 provides that each bid, offer, or proposal submitted for a State contract shall include a disclosure of whether or not the Company acting as the bidder, offeror, or proposing entity, or any of its corporate parents or subsidiaries, within the 24 months before submission of the bid, offer, or proposal had business operations that involved contracts with or provision of supplies or services to the Government of Iran, companies in which the Government of Iran has any direct or indirect equity share, consortiums or projects commissioned by the Government of Iran, or companies involved in consortiums or projects commissioned by the Government of Iran and either of the following conditions apply:

- (1) More than 10% of the Company's revenues produced in or assets located in Iran involve oil-related activities or mineral-extraction activities; less than 75% of the Company's revenues produced in or assets located in Iran involve contracts with or provision of oil-related or mineral-extraction products or services to the Government of Iran or a project or consortium created exclusively by that government; and the Company has failed to take substantial action.
(2) The Company has, on or after August 5, 1996, made an investment of \$20 million or more, or any combination of investments of at least \$10 million each that in the aggregate equals or exceeds \$20 million in any 12-month period, which directly or significantly contributes to the enhancement of Iran's ability to develop petroleum resources of Iran.

The terms "Business operations", "Company", "Mineral-extraction activities", "Oil-related activities", "Petroleum resources", and "Substantial action" are all defined in the Code.

Failure to make the disclosure required by the Code shall cause the bid, offer or proposal to be considered not responsive. The disclosure will be considered when evaluating the bid, offer, or proposal or awarding the contract. The name of each Company disclosed as doing business or having done business in Iran will be provided to the State Comptroller.

Check the appropriate statement:

- /\_\_\_/ Company has no business operations in Iran to disclose.
/\_\_\_/ Company has business operations in Iran as disclosed the attached document.

K. Apprenticeship and Training Certification (Does not apply to federal aid projects)

In accordance with the provisions of Section 30-22 (6) of the Illinois Procurement Code, the bidder certifies that it is a participant, either as an individual or as part of a group program, in the approved apprenticeship and training programs applicable to each type of work or craft that the bidder will perform with its own forces. The bidder further certifies for work that will be performed by subcontract that each of its subcontractors submitted for approval either (a) is, at the time of such bid, participating in an approved, applicable apprenticeship and training program; or (b) will, prior to commencement of performance of work pursuant to this contract, begin participation in an approved apprenticeship and training program applicable to the work of the subcontract. The Department, at any time before or after award, may require the production of a copy of each applicable Certificate of Registration issued by the United States Department of Labor evidencing such participation by the contractor and any or all of its subcontractors. Applicable apprenticeship and training programs are those that have been approved and registered with the United States Department of Labor. The bidder shall list in the space below, the official name of the program sponsor holding the Certificate of Registration for all of the types of work or crafts in which the bidder is a participant and that will be performed with the bidder's forces. Types of work or craft work that will be subcontracted shall be included and listed as subcontract work. The list shall also indicate any type of work or craft job category that does not have an applicable apprenticeship or training program. The bidder is responsible for making a complete report and shall make certain that each type of work or craft job category that will be utilized on the project as reported on the Construction Employee Workforce Projection (Form BC-1256) and returned with the bid is accounted for and listed.

Three horizontal lines for listing program sponsors.

The requirements of this certification and disclosure are a material part of the contract, and the contractor shall require this certification provision to be included in all approved subcontracts. In order to fulfill this requirement, it shall not be necessary that an applicable program sponsor be currently taking or that it will take applications for apprenticeship, training or employment during the performance of the work of this contract.

**TO BE RETURNED WITH BID**

**L. Political Contributions and Registration with the State Board of Elections**

Sections 20-160 and 50-37 of the Illinois Procurement Code regulate political contributions from business entities and any affiliated entities or affiliated persons bidding on or contracting with the state. Generally under Section 50-37, any business entity, and any affiliated entity or affiliated person of the business entity, whose current year contracts with all state agencies exceed an awarded value of \$50,000, are prohibited from making any contributions to any political committees established to promote the candidacy of the officeholder responsible for the awarding of the contracts or any other declared candidate for that office for the duration of the term of office of the incumbent officeholder or a period 2 years after the termination of the contract, whichever is longer. Any business entity and affiliated entities or affiliated persons whose state contracts in the current year do not exceed an awarded value of \$50,000, but whose aggregate pending bids and proposals on state contracts exceed \$50,000, either alone or in combination with contracts not exceeding \$50,000, are prohibited from making any political contributions to any political committee established to promote the candidacy of the officeholder responsible for awarding the pending contract during the period beginning on the date the invitation for bids or request for proposals is issued and ending on the day after the date of award or selection if the entity was not awarded or selected. Section 20-160 requires certification of registration of affected business entities in accordance with procedures found in Section 9-35 of The Election Code.

By submission of a bid, the contractor business entity acknowledges and agrees that it has read and understands Sections 20-160 and 50-37 of the Illinois Procurement Code, and that it makes the following certification:

**The undersigned business entity certifies that it has registered as a business with the State Board of Elections and acknowledges a continuing duty to update the registration in accordance with the above referenced statutes. A copy of the certificate of registration shall be submitted with the bid. The bidder is cautioned that the Department will not award a contract without submission of the certificate of registration.**

These requirements and compliance with the above referenced statutory sections are a material part of the contract, and any breach thereof shall be cause to void the contract under Section 50-60 of the Illinois Procurement Code. This provision does not apply to Federal-aid contracts.

**M. Lobbyist Disclosure**

Section 50-38 of the Illinois Procurement Code requires that any bidder or offeror on a State contract that hires a person required to register under the Lobbyist Registration Act to assist in obtaining a contract shall:

- (i) Disclose all costs, fees, compensation, reimbursements, and other remunerations paid or to be paid to the lobbyist related to the contract,
- (ii) Not bill or otherwise cause the State of Illinois to pay for any of the lobbyist's costs, fees, compensation, reimbursements, or other remuneration, and
- (iii) Sign a verification certifying that none of the lobbyist's costs, fees, compensation, reimbursements, or other remuneration were billed to the State.

This information, along with all supporting documents, shall be filed with the agency awarding the contract and with the Secretary of State. The chief procurement officer shall post this information, together with the contract award notice, in the online Procurement Bulletin.

Pursuant to Subsection (c) of this Section, no person or entity shall retain a person or entity to attempt to influence the outcome of a procurement decision made under the Procurement Code for compensation contingent in whole or in part upon the decision or procurement. Any person who violates this subsection is guilty of a business offense and shall be fined not more than \$10,000.

Bidder acknowledges that it is required to disclose the hiring of any person required to register pursuant to the Illinois Lobbyist Registration Act (25 ILCS 170) in connection with this contract.

Bidder has not hired any person required to register pursuant to the Illinois Lobbyist Registration Act in connection with this contract.

Or

Bidder has hired the following persons required to register pursuant to the Illinois Lobbyist Registration Act in connection with the contract:

Name and address of person: \_\_\_\_\_  
All costs, fees, compensation, reimbursements and other remuneration paid to said person: \_\_\_\_\_  
\_\_\_\_\_  
\_\_\_\_\_



## RETURN WITH BID

### IV. DISCLOSURES

- A. The disclosures hereinafter made by the bidder are each a material representation of fact upon which reliance is placed should the Department enter into the contract with the bidder. The bidder further certifies that the Department has received the disclosure forms for each bid.

The chief procurement officer may void the bid, contract, or subcontract, respectively, if it is later determined that the bidder or subcontractor rendered a false or erroneous disclosure. A contractor or subcontractor may be suspended or debarred for violations of the Procurement Code. Furthermore, the chief procurement officer may void the contract and the surety providing the performance bond shall be responsible for completion of the contract.

### B. Financial Interests and Conflicts of Interest

1. Section 50-35 of the Illinois Procurement Code provides that all bids of more than \$25,000 shall be accompanied by disclosure of the financial interests of the bidder. This disclosed information for the successful bidder, will be maintained as public information subject to release by request pursuant to the Freedom of Information Act, filed with the Procurement Policy Board, and shall be incorporated as a material term of the contract. Furthermore, pursuant to Section 5-5, the Procurement Policy Board may review a proposal, bid, or contract and issue a recommendation to void a contract or reject a proposal or bid based on any violation of the Procurement Code or the existence of a conflict of interest as provided in subsections (b) and (d) of Section 50-35.

The financial interests to be disclosed shall include ownership or distributive income share that is in excess of 5%, or an amount greater than 60% of the annual salary of the Governor, of the bidding entity or its parent entity, whichever is less, unless the contractor or bidder is a publicly traded entity subject to Federal 10K reporting, in which case it may submit its 10K disclosure in place of the prescribed disclosure. If a bidder is a privately held entity that is exempt from Federal 10K reporting, but has more than 400 shareholders, it may submit the information that Federal 10K companies are required to report, and list the names of any person or entity holding any ownership share that is in excess of 5%. The disclosure shall include the names, addresses, and dollar or proportionate share of ownership of each person making the disclosure, their instrument of ownership or beneficial relationship, and notice of any potential conflict of interest resulting from the current ownership or beneficial interest of each person making the disclosure having any of the relationships identified in Section 50-35 and on the disclosure form.

**The current annual salary of the Governor is \$177,412.00**

In addition, all disclosures shall indicate any other current or pending contracts, proposals, leases, or other ongoing procurement relationships the bidding entity has with any other unit of state government and shall clearly identify the unit and the contract, proposal, lease, or other relationship.

2. Disclosure Forms. Disclosure Form A is attached for use concerning the individuals meeting the above ownership or distributive share requirements. Subject individuals should be covered each by one form. In addition, a second form (Disclosure Form B) provides for the disclosure of current or pending procurement relationships with other (non-IDOT) state agencies. **The forms must be included with each bid.**

### C. Disclosure Form Instructions

#### Form A Instructions for Financial Information & Potential Conflicts of Interest

If the bidder is a publicly traded entity subject to Federal 10K reporting, the 10K Report may be submitted to meet the requirements of Form A. If a bidder is a privately held entity that is exempt from Federal 10K reporting, but has more than 400 shareholders, it may submit the information that Federal 10K companies are required to report, and list the names of any person or entity holding any ownership share that is in excess of 5%. If a bidder is not subject to Federal 10K reporting, the bidder must determine if any individuals are required by law to complete a financial disclosure form. To do this, the bidder should answer each of the following questions. A "YES" answer indicates Form A must be completed. If the answer to each of the following questions is "NO", then the NOT APPLICABLE STATEMENT on Form A must be signed and dated by a person that is authorized to execute contracts for the bidding company. Note: These questions are for assistance only and are not required to be completed.

1. Does anyone in your organization have a direct or beneficial ownership share of greater than 5% of the bidding entity or parent entity? YES \_\_\_ NO \_\_\_
2. Does anyone in your organization have a direct or beneficial ownership share of less than 5%, but which has a value greater than 60% of the annual salary of the Governor? YES \_\_\_ NO \_\_\_
3. Does anyone in your organization receive more than 60% of the annual salary of the Governor of the bidding entity's or parent entity's distributive income? YES \_\_\_ NO \_\_\_

(Note: Distributive income is, for these purposes, any type of distribution of profits. An annual salary is not distributive income.)

4. Does anyone in your organization receive greater than 5% of the bidding entity's or parent entity's total distributive income, but which is less than 60% of the annual salary of the Governor? YES \_\_\_ NO \_\_\_

(Note: Only one set of forms needs to be completed per person per bid even if a specific individual would require a yes answer to more than one question.)

A "YES" answer to any of these questions requires the completion of Form A. The bidder must determine each individual in the bidding entity or the bidding entity's parent company that would cause the questions to be answered "Yes". Each form must be signed and dated by a person that is authorized to execute contracts for your organization. **Photocopied or stamped signatures are not acceptable.** The person signing can be, but does not have to be, the person for which the form is being completed. The bidder is responsible for the accuracy of any information provided.

If the answer to each of the above questions is "NO", then the NOT APPLICABLE STATEMENT of Form A must be signed and dated by a person that is authorized to execute contracts for your company.

## RETURN WITH BID

### **Form B: Instructions for Identifying Other Contracts & Procurement Related Information**

Disclosure Form B must be completed for each bid submitted by the bidding entity. *Note: Checking the NOT APPLICABLE STATEMENT on Form A does not allow the bidder to ignore Form B. Form B must be completed, checked, and dated or the bidder may be considered nonresponsive and the bid will not be accepted.*

The Bidder shall identify, by checking Yes or No on Form B, whether it has any pending contracts (including leases), bids, proposals, or other ongoing procurement relationship with any other (non-IDOT) State of Illinois agency. If "No" is checked, the bidder only needs to complete the check box on the bottom of Form B. If "Yes" is checked, the bidder must do one of the following:

Option I: If the bidder did not submit an Affidavit of Availability to obtain authorization to bid, the bidder must list all non-IDOT State of Illinois agency pending contracts, leases, bids, proposals, and other ongoing procurement relationships. These items may be listed on Form B or on an attached sheet(s). Do not include IDOT contracts. Contracts with cities, counties, villages, etc. are not considered State of Illinois agency contracts and are not to be included. Contracts with other State of Illinois agencies such as the Department of Natural Resources or the Capital Development Board must be included. Bidders who submit Affidavits of Availability are suggested to use Option II.

Option II: If the bidder is required and has submitted an Affidavit of Availability in order to obtain authorization to bid, the bidder may write or type "See Affidavit of Availability" which indicates that the Affidavit of Availability is incorporated by reference and includes all non-IDOT State of Illinois agency pending contracts, leases, bids, proposals, and other ongoing procurement relationships. For any contracts that are not covered by the Affidavit of Availability, the bidder must identify them on Form B or on an attached sheet(s). These might be such things as leases.

**ILLINOIS DEPARTMENT  
OF TRANSPORTATION**

**Form A  
Financial Information &  
Potential Conflicts of Interest  
Disclosure**

Contractor Name		
Legal Address		
City, State, Zip		
Telephone Number	Email Address	Fax Number (if available)

Disclosure of the information contained in this Form is required by the Section 50-35 of the Illinois Procurement Code (30 ILCS 500). Vendors desiring to enter into a contract with the State of Illinois must disclose the financial information and potential conflict of interest information as specified in this Disclosure Form. This information shall become part of the publicly available contract file. This Form A must be completed for bids in excess of \$25,000, and for all open-ended contracts. **A publicly traded company may submit a 10K disclosure (or equivalent if applicable) in satisfaction of the requirements set forth in Form A. See Disclosure Form Instructions.**

*The current annual salary of the Governor is \$177,412.00.*

**DISCLOSURE OF FINANCIAL INFORMATION**

**1. Disclosure of Financial Information.** The individual named below has an interest in the BIDDER (or its parent) in terms of ownership or distributive income share in excess of 5%, or an interest which has a value of more than 60% of the annual salary of the Governor. **(Make copies of this form as necessary and attach a separate Disclosure Form A for each individual meeting these requirements)**

<b>FOR INDIVIDUAL (type or print information)</b>	
<b>NAME:</b>	_____
<b>ADDRESS</b>	_____
<b>Type of ownership/distributable income share:</b>	
stock _____ sole proprietorship _____ Partnership _____ other: (explain on separate sheet):	
% or \$ value of ownership/distributable income share:	_____

**2. Disclosure of Potential Conflicts of Interest.** Check "Yes" or "No" to indicate which, if any, of the following potential conflict of interest relationships apply. If the answer to any question is "Yes", please attach additional pages and describe.

(a) State employment, currently or in the previous 3 years, including contractual employment of services. Yes \_\_\_ No \_\_\_

If your answer is yes, please answer each of the following questions.

1. Are you currently an officer or employee of either the Capitol Development Board or the Illinois State Toll Highway Authority? Yes \_\_\_ No \_\_\_

2. Are you currently appointed to or employed by any agency of the State of Illinois? If you are currently appointed to or employed by any agency of the State of Illinois, and your annual salary exceeds 60% of the annual salary of the Governor, provide the name the State agency for which you are employed and your annual salary. \_\_\_\_\_

**RETURN WITH BID**

3. If you are currently appointed to or employed by any agency of the State of Illinois, and your annual salary exceeds 60% of the annual salary of the Governor, are you entitled to receive (i) more than 7 1/2% of the total distributable income of your firm, partnership, association or corporation, or (ii) an amount in excess of 100% of the annual salary of the Governor?  
Yes \_\_\_ No \_\_\_

4. If you are currently appointed to or employed by any agency of the State of Illinois, and your annual salary exceeds 60% of the annual salary of the Governor, are you and your spouse or minor children entitled to receive (i) more than 15 % in the aggregate of the total distributable income of your firm, partnership, association or corporation, or (ii) an amount in excess of two times the salary of the Governor?  
Yes \_\_\_ No \_\_\_

---

(b) State employment of spouse, father, mother, son, or daughter, including contractual employment services in the previous 2 years.

Yes \_\_\_ No \_\_\_

If your answer is yes, please answer each of the following questions.

1. Is your spouse or any minor children currently an officer or employee of the Capitol Development Board or the Illinois State Toll Highway Authority?  
Yes \_\_\_ No \_\_\_

2. Is your spouse or any minor children currently appointed to or employed by any agency of the State of Illinois? If your spouse or minor children is/are currently appointed to or employed by any agency of the State of Illinois, and his/her annual salary exceeds 60% of the annual salary of the Governor, provide the name of your spouse and/or minor children, the name of the State agency for which he/she is employed and his/her annual salary. \_\_\_\_\_  
\_\_\_\_\_

3. If your spouse or any minor children is/are currently appointed to or employed by any agency of the State of Illinois, and his/her annual salary exceeds 60% of the annual salary of the Governor, as of 7/1/07 are you entitled to receive (i) more than 7 1/2% of the total distributable income of your firm, partnership, association or corporation, or (ii) an amount in excess of 100% of the annual salary of the Governor?  
Yes \_\_\_ No \_\_\_

4. If your spouse or any minor children are currently appointed to or employed by any agency of the State of Illinois, and his/her annual salary exceeds 60% of the annual salary of the Governor, are you and your spouse or minor children entitled to receive (i) more than 15 % in the aggregate of the total distributable income of your firm, partnership, association or corporation, or (ii) an amount in excess of 2 times the salary of the Governor?  
Yes \_\_\_ No \_\_\_

---

(c) Elective status; the holding of elective office of the State of Illinois, the government of the United States, any unit of local government authorized by the Constitution of the State of Illinois or the statutes of the State of Illinois currently or in the previous 3 years.  
Yes \_\_\_ No \_\_\_

---

(d) Relationship to anyone holding elective office currently or in the previous 2 years; spouse, father, mother, son, or daughter.  
Yes \_\_\_ No \_\_\_

---

(e) Appointive office; the holding of any appointive government office of the State of Illinois, the United States of America, or any unit of local government authorized by the Constitution of the State of Illinois or the statutes of the State of Illinois, which office entitles the holder to compensation in excess of the expenses incurred in the discharge of that office currently or in the previous 3 years.  
Yes \_\_\_ No \_\_\_

---

(f) Relationship to anyone holding appointive office currently or in the previous 2 years; spouse, father, mother, son, or daughter.  
Yes \_\_\_ No \_\_\_

---

(g) Employment, currently or in the previous 3 years, as or by any registered lobbyist of the State government.  
Yes \_\_\_ No \_\_\_

---

**RETURN WITH BID/OFFER**

(h) Relationship to anyone who is or was a registered lobbyist in the previous 2 years; spouse, father, mother, son, or daughter. Yes \_\_\_ No \_\_\_

(i) Compensated employment, currently or in the previous 3 years, by any registered election or reelection committee registered with the Secretary of State or any county clerk of the State of Illinois, or any political action committee registered with either the Secretary of State or the Federal Board of Elections. Yes \_\_\_ No \_\_\_

(j) Relationship to anyone; spouse, father, mother, son, or daughter; who was a compensated employee in the last 2 years by any registered election or re-election committee registered with the Secretary of State or any county clerk of the State of Illinois, or any political action committee registered with either the Secretary of State or the Federal Board of Elections. Yes \_\_\_ No \_\_\_

**2. Communication Disclosure.**

Disclose the name and address of each lobbyist and other agent of the bidder or offeror who is not identified in Section 2 of this form, who is has communicated, is communicating, or may communicate with any State officer or employee concerning the bid or offer. This disclosure is a continuing obligation and must be promptly supplemented for accuracy throughout the process and throughout the term of the contract. If no person is identified, enter "None" on the line below:

Name and address of person(s): \_\_\_\_\_  
\_\_\_\_\_  
\_\_\_\_\_  
\_\_\_\_\_

**RETURN WITH BID**

**4. Debarment Disclosure.** For each of the persons identified under Sections 2 and 3 of this form, disclose whether any of the following has occurred within the previous 10 years: debarment from contracting with any governmental entity; professional licensure discipline; bankruptcies; adverse civil judgments and administrative findings; and criminal felony convictions. This disclosure is a continuing obligation and must be promptly supplemented for accuracy throughout the procurement process and term of the contract. If no person is identified, enter "None" on the line below:

Name of person(s): \_\_\_\_\_

Nature of disclosure: \_\_\_\_\_

\_\_\_\_\_  
\_\_\_\_\_

**APPLICABLE STATEMENT**

**This Disclosure Form A is submitted on behalf of the INDIVIDUAL named on previous page. Under penalty of perjury, I certify the contents of this disclosure to be true and accurate to the best of my knowledge.**

Completed by:  \_\_\_\_\_ Date \_\_\_\_\_  
Signature of Individual or Authorized Representative

**NOT APPLICABLE STATEMENT**

**Under penalty of perjury, I have determined that no individuals associated with this organization meet the criteria that would require the completion of this Form A.**

**This Disclosure Form A is submitted on behalf of the CONTRACTOR listed on the previous page.**

\_\_\_\_\_ Date \_\_\_\_\_  
Signature of Authorized Representative

The bidder has a continuing obligation to supplement these disclosures under Sec. 50-35 of the Procurement Code.

RETURN WITH BID

**ILLINOIS DEPARTMENT  
OF TRANSPORTATION**

**Form B  
Other Contracts &  
Procurement Related Information  
Disclosure**

Contractor Name		
Legal Address		
City, State, Zip		
Telephone Number	Email Address	Fax Number (if available)

Disclosure of the information contained in this Form is required by the Section 50-35 of the Illinois Procurement Act (30 ILCS 500). This information shall become part of the publicly available contract file. This Form B must be completed for bids in excess of \$25,000, and for all open-ended contracts.

**DISCLOSURE OF OTHER CONTRACTS AND PROCUREMENT RELATED INFORMATION**

**1. Identifying Other Contracts & Procurement Related Information.** The BIDDER shall identify whether it has any pending contracts (including leases), bids, proposals, or other ongoing procurement relationship with any other State of Illinois agency: Yes \_\_\_ No \_\_\_

If **“No” is checked**, the bidder only needs to complete the signature box on the bottom of this page.

**2. If “Yes” is checked.** Identify each such relationship by showing State of Illinois agency name and other descriptive information such as bid or project number (attach additional pages as necessary). SEE DISCLOSURE FORM INSTRUCTIONS:

**THE FOLLOWING STATEMENT MUST BE CHECKED**

<input type="checkbox"/>	_____	_____
	Signature of Authorized Representative	Date

## **RETURN WITH BID**

### **SPECIAL NOTICE TO CONTRACTORS**

The following requirements of the Illinois Department of Human Rights' Rules and Regulations are applicable to bidders on all construction contracts advertised by the Illinois Department of Transportation:

#### **CONSTRUCTION EMPLOYEE UTILIZATION PROJECTION**

- (a) All bidders on construction contracts shall complete and submit, along with and as part of their bids, a Bidder's Employee Utilization Form (Form BC-1256) setting forth a projection and breakdown of the total workforce intended to be hired and/or allocated to such contract work by the bidder including a projection of minority and female employee utilization in all job classifications on the contract project.
- (b) The Department of Transportation shall review the Employee Utilization Form, and workforce projections contained therein, of the contract awardee to determine if such projections reflect an underutilization of minority persons and/or women in any job classification in accordance with the Equal Employment Opportunity Clause and Section 7.2 of the Illinois Department of Human Rights' Rules and Regulations for Public Contracts adopted as amended on September 17, 1980. If it is determined that the contract awardee's projections reflect an underutilization of minority persons and/or women in any job classification, it shall be advised in writing of the manner in which it is underutilizing and such awardee shall be considered to be in breach of the contract unless, prior to commencement of work on the contract project, it submits revised satisfactory projections or an acceptable written affirmative action plan to correct such underutilization including a specific timetable geared to the completion stages of the contract.
- (c) The Department of Transportation shall provide to the Department of Human Rights a copy of the contract awardee's Employee Utilization Form, a copy of any required written affirmative action plan, and any written correspondence related thereto. The Department of Human Rights may review and revise any action taken by the Department of Transportation with respect to these requirements.





**RETURN WITH BID**

**Contract No. 78222  
Various Counties  
Section D9 SCOUR REPAIR 2011-1  
Various Routes  
District 9 Construction Funds**

**PART II. WORKFORCE PROJECTION - continued**

- B. Included in "Total Employees" under Table A is the total number of **new hires** that would be employed in the event the undersigned bidder is awarded this contract.

The undersigned bidder projects that: (number) \_\_\_\_\_ new hires would be recruited from the area in which the contract project is located; and/or (number) \_\_\_\_\_ new hires would be recruited from the area in which the bidder's principal office or base of operation is located.

- C. Included in "Total Employees" under Table A is a projection of numbers of persons to be employed directly by the undersigned bidder as well as a projection of numbers of persons to be employed by subcontractors.

The undersigned bidder estimates that (number) \_\_\_\_\_ persons will be directly employed by the prime contractor and that (number) \_\_\_\_\_ persons will be employed by subcontractors.

**PART III. AFFIRMATIVE ACTION PLAN**

- A. The undersigned bidder understands and agrees that in the event the foregoing minority and female employee utilization projection included under **PART II** is determined to be an underutilization of minority persons or women in any job category, and in the event that the undersigned bidder is awarded this contract, he/she will, prior to commencement of work, develop and submit a written Affirmative Action Plan including a specific timetable (geared to the completion stages of the contract) whereby deficiencies in minority and/or female employee utilization are corrected. Such Affirmative Action Plan will be subject to approval by the contracting agency and the **Department of Human Rights**.
- B. The undersigned bidder understands and agrees that the minority and female employee utilization projection submitted herein, and the goals and timetable included under an Affirmative Action Plan if required, are deemed to be part of the contract specifications.

Company \_\_\_\_\_ Telephone Number \_\_\_\_\_  
\_\_\_\_\_  
Address \_\_\_\_\_

**NOTICE REGARDING SIGNATURE**

The Bidder's signature on the Proposal Signature Sheet will constitute the signing of this form. The following signature block needs to be completed if revisions are required.

Signature:  \_\_\_\_\_ Title: \_\_\_\_\_ Date: \_\_\_\_\_

- Instructions: All tables must include subcontractor personnel in addition to prime contractor personnel.
- Table A - Include both the number of employees that would be hired to perform the contract work and the total number currently employed (Table B) that will be allocated to contract work, and include all apprentices and on-the-job trainees. The "Total Employees" column should include all employees including all minorities, apprentices and on-the-job trainees to be employed on the contract work.
  - Table B - Include all employees currently employed that will be allocated to the contract work including any apprentices and on-the-job trainees currently employed.
  - Table C - Indicate the racial breakdown of the total apprentices and on-the-job trainees shown in Table A.

**RETURN WITH BID**  
**Contract No. 78222**  
**Various Counties**  
**Section D9 SCOUR REPAIR 2011-1**  
**Various Routes**  
**District 9 Construction Funds**

PROPOSAL SIGNATURE SHEET

The undersigned bidder hereby makes and submits this bid on the subject Proposal, thereby assuring the Department that all requirements of the Invitation for Bids and rules of the Department have been met, that there is no misunderstanding of the requirements of paragraph 3 of this Proposal, and that the contract will be executed in accordance with the rules of the Department if an award is made on this bid.

(IF AN INDIVIDUAL)

Firm Name \_\_\_\_\_

Signature of Owner \_\_\_\_\_

Business Address \_\_\_\_\_

\_\_\_\_\_

---

---

(IF A CO-PARTNERSHIP)

Firm Name \_\_\_\_\_

By \_\_\_\_\_

Business Address \_\_\_\_\_

\_\_\_\_\_

Name and Address of All Members of the Firm:

\_\_\_\_\_

\_\_\_\_\_

---

---

(IF A CORPORATION)

Corporate Name \_\_\_\_\_

By \_\_\_\_\_

Signature of Authorized Representative

\_\_\_\_\_

Typed or printed name and title of Authorized Representative

Attest \_\_\_\_\_

Signature

(IF A JOINT VENTURE, USE THIS SECTION FOR THE MANAGING PARTY AND THE SECOND PARTY SHOULD SIGN BELOW)

Business Address \_\_\_\_\_

\_\_\_\_\_

---

---

(IF A JOINT VENTURE)

Corporate Name \_\_\_\_\_

By \_\_\_\_\_

Signature of Authorized Representative

\_\_\_\_\_

Typed or printed name and title of Authorized Representative

Attest \_\_\_\_\_

Signature

Business Address \_\_\_\_\_

\_\_\_\_\_

---

---

If more than two parties are in the joint venture, please attach an additional signature sheet.



Return with Bid

Division of Highways
Proposal Bid Bond
(Effective November 1, 1992)

Item No.
Letting Date

KNOW ALL MEN BY THESE PRESENTS, That We

as PRINCIPAL, and

as SURETY, are held jointly, severally and firmly bound unto the STATE OF ILLINOIS in the penal sum of 5 percent of the total bid price, or for the amount specified in Article 102.09 of the "Standard Specifications for Road and Bridge Construction" in effect on the date of invitation for bids, whichever is the lesser sum, well and truly to be paid unto said STATE OF ILLINOIS, for the payment of which we bind ourselves, our heirs, executors, administrators, successors and assigns.

THE CONDITION OF THE FOREGOING OBLIGATION IS SUCH, that whereas, the PRINCIPAL has submitted a bid proposal to the STATE OF ILLINOIS, acting through the Department of Transportation, for the improvement designated by the Transportation Bulletin Item Number and Letting Date indicated above.

NOW, THEREFORE, if the Department shall accept the bid proposal of the PRINCIPAL; and if the PRINCIPAL shall, within the time and as specified in the bidding and contract documents, submit a DBE Utilization Plan that is accepted and approved by the Department; and if, after award by the Department, the PRINCIPAL shall enter into a contract in accordance with the terms of the bidding and contract documents including evidence of the required insurance coverages and providing such bond as specified with good and sufficient surety for the faithful performance of such contract and for the prompt payment of labor and material furnished in the prosecution thereof; or if, in the event of the failure of the PRINCIPAL to make the required DBE submission or to enter into such contract and to give the specified bond, the PRINCIPAL pays to the Department the difference not to exceed the penalty hereof between the amount specified in the bid proposal and such larger amount for which the Department may contract with another party to perform the work covered by said bid proposal, then this obligation shall be null and void, otherwise, it shall remain in full force and effect.

IN THE EVENT the Department determines the PRINCIPAL has failed to comply with any requirement as set forth in the preceding paragraph, then Surety shall pay the penal sum to the Department within fifteen (15) days of written demand therefor. If Surety does not make full payment within such period of time, the Department may bring an action to collect the amount owed. Surety is liable to the Department for all its expenses, including attorney's fees, incurred in any litigation in which it prevails either in whole or in part.

In TESTIMONY WHEREOF, the said PRINCIPAL and the said SURETY have caused this instrument to be signed by their respective officers this day of A.D.,

PRINCIPAL SURETY
(Company Name) (Company Name)
By (Signature & Title) By: (Signature of Attorney-in-Fact)

Notary Certification for Principal and Surety

STATE OF ILLINOIS,
County of
I, , a Notary Public in and for said County, do hereby certify that
and
(Insert names of individuals signing on behalf of PRINCIPAL & SURETY)

who are each personally known to me to be the same persons whose names are subscribed to the foregoing instrument on behalf of PRINCIPAL and SURETY, appeared before me this day in person and acknowledged respectively, that they signed and delivered said instrument as their free and voluntary act for the uses and purposes therein set forth.

Given under my hand and notarial seal this day of A.D.
My commission expires
Notary Public

In lieu of completing the above section of the Proposal Bid Form, the Principal may file an Electronic Bid Bond. By signing the proposal and marking the check box next to the Signature and Title line below, the Principal is ensuring the identified electronic bid bond has been executed and the Principal and Surety are firmly bound unto the State of Illinois under the conditions of the bid bond as shown above.

Electronic Bid Bond ID# Company / Bidder Name Signature and Title





# PROPOSAL ENVELOPE



# PROPOSALS

for construction work advertised for bids by the  
Illinois Department of Transportation

Item No.	Item No.	Item No.

Submitted By:

Name:
Address:
Phone No.

Bidders should use an IDOT proposal envelope or affix this form to the front of a 10" x 13" envelope for the submittal of bids. If proposals are mailed, they should be enclosed in a second or outer envelope addressed to:

Engineer of Design and Environment - Room 326  
Illinois Department of Transportation  
2300 South Dirksen Parkway  
Springfield, Illinois 62764

## **NOTICE**

**Individual bids, including Bid Bond and/or supplemental information if required, should be securely stapled.**

# CONTRACTOR OFFICE COPY OF CONTRACT SPECIFICATIONS

---

## NOTICE

None of the following material needs to be returned with the bid package unless the special provisions require documentation and/or other information to be submitted.

**Contract No. 78222**  
**Various Counties**  
**Section D9 SCOUR REPAIR 2011-1**  
**Various Routes**  
**District 9 Construction Funds**

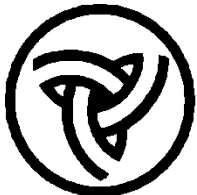

**Illinois Department of Transportation**



## **SUBCONTRACTOR DOCUMENTATION**

Public Acts 96-0795 and 96-0920, enacted substantial changes to the provisions of the Illinois Procurement Code (30 ILCS 500). Among the changes are provisions affecting subcontractors. The Contractor awarded this contract will be required as a material condition of the contract to implement and enforce the contract requirements applicable to subcontractors approved in accordance with article 108.01 of the Standard Specifications for Road and Bridge Construction.

If the Contractor seeks approval of subcontractors to perform a portion of the work, and approval is granted by the Department, the Contractor shall provide a copy of the subcontract to the Chief Procurement Officer within 20 calendar days after execution of the subcontract.

The subcontract shall contain the certifications required to be made by subcontractors pursuant to Article 50 of the Illinois Procurement Code. This Notice to Bidders includes a document incorporating all required subcontractor certifications and disclosures for use by the Contractor in compliance with this mandate. The document is entitled State Required Ethical Standards Governing Subcontractors.

## RETURN WITH SUBCONTRACT

### STATE ETHICAL STANDARDS GOVERNING SUBCONTRACTORS

Article 50 of the Illinois Procurement Code establishes the duty of all State chief procurement officers, State purchasing officers, and their designees to maximize the value of the expenditure of public moneys in procuring goods, services, and contracts for the State of Illinois and to act in a manner that maintains the integrity and public trust of State government. In discharging this duty, they are charged by law to use all available information, reasonable efforts, and reasonable actions to protect, safeguard, and maintain the procurement process of the State of Illinois.

The certifications hereinafter made by the subcontractor are each a material representation of fact upon which reliance is placed should the Department approve the subcontractor. The chief procurement officer may terminate or void the subcontract approval if it is later determined that the bidder or subcontractor rendered a false or erroneous certification.

Section 50-2 of the Illinois Procurement Code provides that every person that has entered into a multi-year contract and every subcontractor with a multi-year subcontract shall certify, by July 1 of each fiscal year covered by the contract after the initial fiscal year, to the responsible chief procurement officer whether it continues to satisfy the requirements of Article 50 pertaining to the eligibility for a contract award. If a contractor or subcontractor is not able to truthfully certify that it continues to meet all requirements, it shall provide with its certification a detailed explanation of the circumstances leading to the change in certification status. A contractor or subcontractor that makes a false statement material to any given certification required under Article 50 is, in addition to any other penalties or consequences prescribed by law, subject to liability under the Whistleblower Reward and Protection Act for submission of a false claim.

#### **A. Bribery**

1. The Illinois Procurement Code provides:

Section 50-5. Bribery.

(a) Prohibition. No person or business shall be awarded a contract or subcontract under this Code who:

(1) has been convicted under the laws of Illinois or any other state of bribery or attempting to bribe an officer or employee of the State of Illinois or any other state in that officer's or employee's official capacity; or

(2) has made an admission of guilt of that conduct that is a matter of record but has not been prosecuted for that conduct.

(b) Businesses. No business shall be barred from contracting with any unit of State or local government, or subcontracting under such a contract, as a result of a conviction under this Section of any employee or agent of the business if the employee or agent is no longer employed by the business and:

(1) the business has been finally adjudicated not guilty; or

(2) the business demonstrates to the governmental entity with which it seeks to contract, or which is signatory to the contract to which the subcontract relates, and that entity finds that the commission of the offense was not authorized, requested, commanded, or performed by a director, officer, or high managerial agent on behalf of the business as provided in paragraph (2) of subsection (a) of Section 5-4 of the Criminal Code of 1961.

(c) Conduct on behalf of business. For purposes of this Section, when an official, agent, or employee of a business committed the bribery or attempted bribery on behalf of the business and in accordance with the direction or authorization of a responsible official of the business, the business shall be chargeable with the conduct.

(d) Certification. Every bid submitted to and contract executed by the State, and every subcontract subject to Section 20-120 of the Procurement Code shall contain a certification by the contractor or the subcontractor, respectively, that the contractor or subcontractor is not barred from being awarded a contract or subcontract under this Section and acknowledges that the chief procurement officer may declare the related contract void if any certifications required by this Section are false. A contractor who makes a false statement, material to the certification, commits a Class 3 felony.

2. The contractor or subcontractor certifies that it is not barred from being awarded a contract under Section 50.5.

#### **B. Felons**

1. The Illinois Procurement Code provides:

Section 50-10. Felons. Unless otherwise provided, no person or business convicted of a felony shall do business with the State of Illinois or any State agency, or enter into a subcontract, from the date of conviction until 5 years after the date of completion of the sentence for that felony, unless no person held responsible by a prosecutorial office for the facts upon which the conviction was based continues to have any involvement with the business.

2. Certification. Every bid submitted to and contract executed by the State and every subcontract subject to Section 20-120 of the Procurement Code shall contain a certification by the bidder or contractor or subcontractor, respectively, that the bidder, contractor, or subcontractor is not barred from being awarded a contract or subcontract under this Section and acknowledges that the chief procurement officer may declare the related contract void if any of the certifications required by this Section are false.

**RETURN WITH SUBCONTRACT**

**C. Debt Delinquency**

1. The Illinois Procurement Code provides:

Section 50-11 and 50-12. Debt Delinquency.

The contractor or bidder or subcontractor, respectively, certifies that it, or any affiliate, is not barred from being awarded a contract or subcontract under the Procurement Code. Section 50-11 prohibits a person from entering into a contract with a State agency, or entering into a subcontract, if it knows or should know that it, or any affiliate, is delinquent in the payment of any debt to the State as defined by the Debt Collection Board. Section 50-12 prohibits a person from entering into a contract with a State agency, or entering into a subcontract, if it, or any affiliate, has failed to collect and remit Illinois Use Tax on all sales of tangible personal property into the State of Illinois in accordance with the provisions of the Illinois Use Tax Act. The bidder or contractor or subcontractor, respectively, further acknowledges that the chief procurement officer may declare the related contract void if this certification is false or if the bidder, contractor, or subcontractor, or any affiliate, is determined to be delinquent in the payment of any debt to the State during the term of the contract.

**D. Prohibited Bidders, Contractors and Subcontractors**

1. The Illinois Procurement Code provides:

Section 50-10.5 and 50-60(c). Prohibited bidders, contractors and subcontractors.

The bidder or contractor or subcontractor, respectively, certifies in accordance with 30 ILCS 500/50-10.5 that no officer, director, partner or other managerial agent of the contracting business has been convicted of a felony under the Sarbanes-Oxley Act of 2002 or a Class 3 or Class 2 felony under the Illinois Securities Law of 1953 or if in violation of Subsection (c) for a period of five years from the date of conviction.. Every bid submitted to and contract executed by the State and every subcontract subject to Section 20-120 of the Procurement Code shall contain a certification by the bidder, contractor, or subcontractor, respectively, that the bidder, contractor, or subcontractor is not barred from being awarded a contract or subcontract under this Section and acknowledges that the chief procurement officer shall declare the related contract void if any of the certifications completed pursuant to this Section are false.

**E. Section 42 of the Environmental Protection Act**

The bidder or contractor or subcontractor, respectively, certifies in accordance with 30 ILCS 500/50-12 that the bidder, contractor, or subcontractor, is not barred from being awarded a contract or entering into a subcontract under this Section which prohibits the bidding on or entering into contracts with the State of Illinois or a State agency, or entering into any subcontract, that is subject to the Procurement Code by a person or business found by a court or the Pollution Control Board to have committed a willful or knowing violation of Section 42 of the Environmental Protection Act for a period of five years from the date of the order. The bidder or contractor or subcontractor, respectively, acknowledges that the chief procurement officer may declare the contract void if this certification is false.

**The undersigned, on behalf of the subcontracting company, has read and understands the above certifications and makes the certifications as required by law.**

_____ Name of Subcontracting Company		
_____ Authorized Officer	_____ Date	

**RETURN WITH SUBCONTRACT**  
**SUBCONTRACTOR DISCLOSURES**

**I. DISCLOSURES**

- A.** The disclosures hereinafter made by the subcontractor are each a material representation of fact upon which reliance is placed. The subcontractor further certifies that the Department has received the disclosure forms for each subcontract.

The chief procurement officer may void the bid, contract, or subcontract, respectively, if it is later determined that the bidder or subcontractor rendered a false or erroneous disclosure. A contractor or subcontractor may be suspended or debarred for violations of the Procurement Code. Furthermore, the chief procurement officer may void the contract or subcontract.

**B. Financial Interests and Conflicts of Interest**

1. Section 50-35 of the Illinois Procurement Code provides that all subcontracts with a total value of \$25,000 or more from subcontractors identified in Section 20-120 of the Illinois Procurement Code, shall be accompanied by disclosure of the financial interests of the subcontractor. This disclosed information for the subcontractor, will be maintained as public information subject to release by request pursuant to the Freedom of Information Act, filed with the Procurement Policy Board, and shall be incorporated as a material term of the Prime Contractor's contract. Furthermore, pursuant to this Section, the Procurement Policy Board may recommend to allow or void a contract or subcontract based on a potential conflict of interest.

The financial interests to be disclosed shall include ownership or distributive income share that is in excess of 5%, or an amount greater than 60% of the annual salary of the Governor, of the subcontracting entity or its parent entity, whichever is less, unless the subcontractor is a publicly traded entity subject to Federal 10K reporting, in which case it may submit its 10K disclosure in place of the prescribed disclosure. If a subcontractor is a privately held entity that is exempt from Federal 10K reporting, but has more than 400 shareholders, it may submit the information that Federal 10K companies are required to report, and list the names of any person or entity holding any ownership share that is in excess of 5%. The disclosure shall include the names, addresses, and dollar or proportionate share of ownership of each person making the disclosure, their instrument of ownership or beneficial relationship, and notice of any potential conflict of interest resulting from the current ownership or beneficial interest of each person making the disclosure having any of the relationships identified in Section 50-35 and on the disclosure form.

**The current annual salary of the Governor is \$177,412.00.**

In addition, all disclosures shall indicate any other current or pending contracts, subcontracts, proposals, leases, or other ongoing procurement relationships the subcontracting entity has with any other unit of state government and shall clearly identify the unit and the contract, subcontract, proposal, lease, or other relationship.

2. **Disclosure Forms.** Disclosure Form A is attached for use concerning the individuals meeting the above ownership or distributive share requirements. Subject individuals should be covered each by one form. In addition, a second form (Disclosure Form B) provides for the disclosure of current or pending procurement relationships with other (non-IDOT) state agencies.

**C. Disclosure Form Instructions**

**Form A Instructions for Financial Information & Potential Conflicts of Interest**

If the subcontractor is a publicly traded entity subject to Federal 10K reporting, the 10K Report may be submitted to meet the requirements of Form A. If a subcontractor is a privately held entity that is exempt from Federal 10K reporting, but has more than 400 shareholders, it may submit the information that Federal 10K companies are required to report, and list the names of any person or entity holding any ownership share that is in excess of 5%. If a subcontractor is not subject to Federal 10K reporting, the subcontractor must determine if any individuals are required by law to complete a financial disclosure form. To do this, the subcontractor should answer each of the following questions. A "YES" answer indicates Form A must be completed. If the answer to each of the following questions is "NO", then the **NOT APPLICABLE STATEMENT** on the second page of Form A must be signed and dated by a person that is authorized to execute contracts for the subcontracting company. Note: These questions are for assistance only and are not required to be completed.

1. Does anyone in your organization have a direct or beneficial ownership share of greater than 5% of the bidding entity or parent entity? YES \_\_\_ NO \_\_\_
2. Does anyone in your organization have a direct or beneficial ownership share of less than 5%, but which has a value greater than 60% of the annual salary of the Governor? YES \_\_\_ NO \_\_\_
3. Does anyone in your organization receive more than 60% of the annual salary of the Governor of the subcontracting entity's or parent entity's distributive income? YES \_\_\_ NO \_\_\_

(Note: Distributive income is, for these purposes, any type of distribution of profits. An annual salary is not distributive income.)

4. Does anyone in your organization receive greater than 5% of the subcontracting entity's or parent entity's total distributive income, but which is less than 60% of the annual salary of the Governor? YES \_\_\_ NO \_\_\_

(Note: Only one set of forms needs to be completed per person per subcontract even if a specific individual would require a yes answer to more than one question.)

A "YES" answer to any of these questions requires the completion of Form A. The subcontractor must determine each individual in the subcontracting entity or the subcontracting entity's parent company that would cause the questions to be answered "Yes". Each form must be signed and dated by a person that is authorized to execute contracts for your organization. **Photocopied or stamped signatures are not acceptable.** The person signing can be, but does not have to be, the person for which the form is being completed. The subcontractor is responsible for the accuracy of any information provided.

If the answer to each of the above questions is "NO", then the **NOT APPLICABLE STATEMENT** on page 2 of Form A must be signed and dated by a person that is authorized to execute contracts for your company.

## RETURN WITH SUBCONTRACT

### **Form B: Instructions for Identifying Other Contracts & Procurement Related Information**

Disclosure Form B must be completed for each subcontract submitted by the subcontracting entity. *Note: Checking the NOT APPLICABLE STATEMENT on Form A does not allow the subcontractor to ignore Form B. Form B must be completed, checked, and dated or the subcontract will not be approved.*

The Subcontractor shall identify, by checking Yes or No on Form B, whether it has any pending contracts, subcontracts, leases, bids, proposals, or other ongoing procurement relationship with any other (non-IDOT) State of Illinois agency. If "No" is checked, the subcontractor only needs to complete the check box on the bottom of Form B. If "Yes" is checked, the subcontractor must list all non-IDOT State of Illinois agency pending contracts, subcontracts, leases, bids, proposals, and other ongoing procurement relationships. These items may be listed on Form B or on an attached sheet(s). Contracts with cities, counties, villages, etc. are not considered State of Illinois agency contracts and are not to be included. Contracts or subcontracts with other State of Illinois agencies such as the Department of Natural Resources or the Capital Development Board must be included.

ILLINOIS DEPARTMENT OF TRANSPORTATION

Form A Subcontractor: Financial Information & Potential Conflicts of Interest Disclosure

Subcontractor Name, Legal Address, City, State, Zip, Telephone Number, Email Address, Fax Number (if available)

Disclosure of the information contained in this Form is required by the Section 50-35 of the Illinois Procurement Code (30 ILCS 500). Subcontractors desiring to enter into a subcontract of a State of Illinois contract must disclose the financial information and potential conflict of interest information as specified in this Disclosure Form.

The current annual salary of the Governor is \$177,412.00.

DISCLOSURE OF FINANCIAL INFORMATION

1. Disclosure of Financial Information. The individual named below has an interest in the SUBCONTRACTOR (or its parent) in terms of ownership or distributive income share in excess of 5%, or an interest which has a value of more than 60% of the annual salary of the Governor.

FOR INDIVIDUAL (type or print information) NAME: ADDRESS Type of ownership/distributable income share: stock sole proprietorship Partnership other: (explain on separate sheet): % or \$ value of ownership/distributable income share:

2. Disclosure of Potential Conflicts of Interest. Check "Yes" or "No" to indicate which, if any, of the following potential conflict of interest relationships apply. If the answer to any question is "Yes", please attach additional pages and describe.

(a) State employment, currently or in the previous 3 years, including contractual employment of services. Yes \_\_\_ No \_\_\_

If your answer is yes, please answer each of the following questions.

- 1. Are you currently an officer or employee of either the Capitol Development Board or the Illinois State Toll Highway Authority? Yes \_\_\_ No \_\_\_
2. Are you currently appointed to or employed by any agency of the State of Illinois? If you are currently appointed to or employed by any agency of the State of Illinois, and your annual salary exceeds 60% of the annual salary of the Governor, provide the name the State agency for which you are employed and your annual salary.

**RETURN WITH SUBCONTRACT**

3. If you are currently appointed to or employed by any agency of the State of Illinois, and your annual salary exceeds 60% of the annual salary of the Governor, are you entitled to receive (i) more than 7 1/2% of the total distributable income of your firm, partnership, association or corporation, or (ii) an amount in excess of 100% of the annual salary of the Governor?  
Yes \_\_\_ No \_\_\_

4. If you are currently appointed to or employed by any agency of the State of Illinois, and your annual salary exceeds 60% of the annual salary of the Governor, are you and your spouse or minor children entitled to receive (i) more than 15 % in the aggregate of the total distributable income of your firm, partnership, association or corporation, or (ii) an amount in excess of two times the salary of the Governor?  
Yes \_\_\_ No \_\_\_

---

(b) State employment of spouse, father, mother, son, or daughter, including contractual employment services in the previous 2 years.

Yes \_\_\_ No \_\_\_

If your answer is yes, please answer each of the following questions.

1. Is your spouse or any minor children currently an officer or employee of the Capitol Development Board or the Illinois Toll Highway Authority?  
Yes \_\_\_ No \_\_\_

2. Is your spouse or any minor children currently appointed to or employed by any agency of the State of Illinois? If your spouse or minor children is/are currently appointed to or employed by any agency of the State of Illinois, and his/her annual salary exceeds 60% of the annual salary of the Governor, provide the name of your spouse and/or minor children, the name of the State agency for which he/she is employed and his/her annual salary. \_\_\_\_\_

---

3. If your spouse or any minor children is/are currently appointed to or employed by any agency of the State of Illinois, and his/her annual salary exceeds 60% of the annual salary of the Governor, as of 7/1/07 are you entitled to receive (i) more then 7 1/2% of the total distributable income of your firm, partnership, association or corporation, or (ii) an amount in excess of 100% of the annual salary of the Governor?  
Yes \_\_\_ No \_\_\_

4. If your spouse or any minor children are currently appointed to or employed by any agency of the State of Illinois, and his/her annual salary exceeds 60% of the annual salary of the Governor, are you and your spouse or minor children entitled to receive (i) more than 15 % in the aggregate of the total distributable income of your firm, partnership, association or corporation, or (ii) an amount in excess of two times the annual salary of the Governor?  
Yes \_\_\_ No \_\_\_

---

(c) Elective status; the holding of elective office of the State of Illinois, the government of the United States, any unit of local government authorized by the Constitution of the State of Illinois or the statutes of the State of Illinois currently or in the previous 3 years.  
Yes \_\_\_ No \_\_\_

---

(d) Relationship to anyone holding elective office currently or in the previous 2 years; spouse, father, mother, son, or daughter.  
Yes \_\_\_ No \_\_\_

---

(e) Appointive office; the holding of any appointive government office of the State of Illinois, the United States of America, or any unit of local government authorized by the Constitution of the State of Illinois or the statutes of the State of Illinois, which office entitles the holder to compensation in excess of the expenses incurred in the discharge of that office currently or in the previous 3 years.  
Yes \_\_\_ No \_\_\_

---

(f) Relationship to anyone holding appointive office currently or in the previous 2 years; spouse, father, mother, son, or daughter.  
Yes \_\_\_ No \_\_\_

---

(g) Employment, currently or in the previous 3 years, as or by any registered lobbyist of the State government.  
Yes \_\_\_ No \_\_\_

**RETURN WITH SUBCONTRACT**

(h) Relationship to anyone who is or was a registered lobbyist in the previous 2 years; spouse, father, mother, son, or daughter. Yes \_\_\_ No \_\_\_

(i) Compensated employment, currently or in the previous 3 years, by any registered election or reelection committee registered with the Secretary of State or any county clerk of the State of Illinois, or any political action committee registered with either the Secretary of State or the Federal Board of Elections. Yes \_\_\_ No \_\_\_

(j) Relationship to anyone; spouse, father, mother, son, or daughter; who was a compensated employee in the last 2 years by any registered election or re-election committee registered with the Secretary of State or any county clerk of the State of Illinois, or any political action committee registered with either the Secretary of State or the Federal Board of Elections. Yes \_\_\_ No \_\_\_

**3. Communication Disclosure.**

Disclose the name and address of each lobbyist and other agent of the bidder or offeror who is not identified in Section 2 of this form, who is has communicated, is communicating, or may communicate with any State officer or employee concerning the bid or offer. This disclosure is a continuing obligation and must be promptly supplemented for accuracy throughout the process and throughout the term of the contract. If no person is identified, enter "None" on the line below:

Name and address of person(s): \_\_\_\_\_  
\_\_\_\_\_  
\_\_\_\_\_  
\_\_\_\_\_



**RETURN WITH SUBCONTRACT**

**4. Debarment Disclosure.** For each of the persons identified under Sections 2 and 3 of this form, disclose whether any of the following has occurred within the previous 10 years: debarment from contracting with any governmental entity; professional licensure discipline; bankruptcies; adverse civil judgments and administrative findings; and criminal felony convictions. This disclosure is a continuing obligation and must be promptly supplemented for accuracy throughout the procurement process and term of the contract. If no person is identified, enter "None" on the line below:

Name of person(s): \_\_\_\_\_

Nature of disclosure: \_\_\_\_\_  
\_\_\_\_\_  
\_\_\_\_\_

**APPLICABLE STATEMENT**

**This Disclosure Form A is submitted on behalf of the INDIVIDUAL named on previous page. Under penalty of perjury, I certify the contents of this disclosure to be true and accurate to the best of my knowledge.**

Completed by:  \_\_\_\_\_ Date \_\_\_\_\_  
Signature of Individual or Authorized Officer

**NOT APPLICABLE STATEMENT**

**Under penalty of perjury, I have determined that no individuals associated with this organization meet the criteria that would require the completion of this Form A.**

**This Disclosure Form A is submitted on behalf of the SUBCONTRACTOR listed on the previous page.**

\_\_\_\_\_ Date \_\_\_\_\_  
Signature of Authorized Officer

RETURN WITH SUBCONTRACT

ILLINOIS DEPARTMENT  
OF TRANSPORTATION

Form B  
Subcontractor: Other Contracts &  
Procurement Related Information  
Disclosure

Subcontractor Name		
Legal Address		
City, State, Zip		
Telephone Number	Email Address	Fax Number (if available)

Disclosure of the information contained in this Form is required by the Section 50-35 of the Illinois Procurement Act (30 ILCS 500). This information shall become part of the publicly available contract file. This Form B must be completed for subcontracts with a total value of \$25,000 or more, from subcontractors identified in Section 20-120 of the Illinois Procurement Code, and for all open-ended contracts.

**DISCLOSURE OF OTHER CONTRACTS, SUBCONTRACTS, AND PROCUREMENT RELATED INFORMATION**

**1. Identifying Other Contracts & Procurement Related Information.** The SUBCONTRACTOR shall identify whether it has any pending contracts, subcontracts, including leases, bids, proposals, or other ongoing procurement relationship with any other State of Illinois agency: Yes \_\_\_ No \_\_\_

If "No" is checked, the subcontractor only needs to complete the signature box on the bottom of this page.

**2. If "Yes" is checked.** Identify each such relationship by showing State of Illinois agency name and other descriptive information such as bid or project number (attach additional pages as necessary). SEE DISCLOSURE FORM INSTRUCTIONS:

**THE FOLLOWING STATEMENT MUST BE CHECKED**

<input type="checkbox"/>	_____	_____
	Signature of Authorized Officer	Date



- 1. TIME AND PLACE OF OPENING BIDS.** Sealed proposals for the improvement described herein will be received by the Department of Transportation at the Harry R. Hanley Building, 2300 South Dirksen Parkway, in Springfield, Illinois until 10:00 o'clock a.m., March 11, 2011. All bids will be gathered, sorted, publicly opened and read in the auditorium at the Department of Transportation's Harry R. Hanley Building shortly after the 10:00 a.m. cut off time.
- 2. DESCRIPTION OF WORK.** The proposed improvement is identified and advertised for bids in the Invitation for Bids as:

**Contract No. 78222  
Various Counties  
Section D9 SCOUR REPAIR 2011-1  
Various Routes  
District 9 Construction Funds**

**Scour repair on nine structures at various locations as described in the plans.**

- 3. INSTRUCTIONS TO BIDDERS.** (a) This Notice, the invitation for bids, proposal and letter of award shall, together with all other documents in accordance with Article 101.09 of the Standard Specifications for Road and Bridge Construction, become part of the contract. Bidders are cautioned to read and examine carefully all documents, to make all required inspections, and to inquire or seek explanation of the same prior to submission of a bid.  
  
(b) State law, and, if the work is to be paid wholly or in part with Federal-aid funds, Federal law requires the bidder to make various certifications as a part of the proposal and contract. By execution and submission of the proposal, the bidder makes the certification contained therein. A false or fraudulent certification shall, in addition to all other remedies provided by law, be a breach of contract and may result in termination of the contract.
- 4. AWARD CRITERIA AND REJECTION OF BIDS.** This contract will be awarded to the lowest responsive and responsible bidder considering conformity with the terms and conditions established by the Department in the rules, Invitation for Bids and contract documents. The issuance of plans and proposal forms for bidding based upon a prequalification rating shall not be the sole determinant of responsibility. The Department reserves the right to determine responsibility at the time of award, to reject any or all proposals, to readvertise the proposed improvement, and to waive technicalities.

By Order of the  
Illinois Department of Transportation

Gary Hannig,  
Secretary

INDEX  
FOR  
SUPPLEMENTAL SPECIFICATIONS  
AND RECURRING SPECIAL PROVISIONS

Adopted January 1, 2011

This index contains a listing of SUPPLEMENTAL SPECIFICATIONS and frequently used RECURRING SPECIAL PROVISIONS.

ERRATA          Standard Specifications for Road and Bridge Construction (Adopted 1-1-07) (Revised 1-1-11)

SUPPLEMENTAL SPECIFICATIONS

<u>Std. Spec. Sec.</u>	<u>Page No.</u>
201 Clearing, Tree Removal and Protection .....	1
205 Embankment .....	2
251 Mulch .....	3
253 Planting Woody Plants .....	4
280 Temporary Erosion Control .....	6
406 Hot-Mix Asphalt Binder and Surface Course .....	7
420 Portland Cement Concrete Pavement .....	11
443 Reflective Crack Control Treatment .....	12
501 Removal of Existing Structures .....	15
502 Excavation for Structures .....	16
503 Concrete Structures .....	17
504 Precast Concrete Structures .....	18
505 Steel Structures .....	19
508 Reinforcement Bars .....	20
540 Box Culverts .....	21
581 Waterproofing Membrane System .....	22
606 Concrete Gutter, Curb, Median, and Paved Ditch .....	23
630 Steel Plate Beam Guardrail .....	24
633 Removing and Reerecting Guardrail and Terminals .....	25
637 Concrete Barrier .....	26
664 Chain Link Fence .....	27
669 Removal and Disposal of Regulated Substances .....	28
672 Sealing Abandoned Water Wells .....	29
701 Work Zone Traffic Control and Protection .....	30
720 Sign Panels and Appurtenances .....	32
721 Sign Panel Overlay .....	33
722 Demountable Sign Legend Characters and Arrows .....	34
726 Mile Post Marker Assembly .....	35
733 Overhead Sign Structures .....	36
780 Pavement Striping .....	37
782 Prismatic Reflectors .....	42
783 Pavement Marking and Marker Removal .....	43
801 Electrical Requirements .....	44
805 Electrical Service Installation – Traffic Signals .....	45
821 Roadway Luminaires .....	46
836 Pole Foundation .....	47
838 Breakaway Devices .....	48
843 Removal of Navigational Obstruction Warning Lighting System .....	49
862 Uninterruptable Power Supply .....	50
873 Electric Cable .....	52
878 Traffic Signal Concrete Foundation .....	54
1003 Fine Aggregates .....	55
1004 Coarse Aggregates .....	56
1005 Stone and Broken Concrete .....	57
1006 Metals .....	58
1008 Structural Steel Coatings .....	60
1010 Finely Divided Materials .....	65

Various Routes  
Section D9 Scour Repair 2011-1  
Various Counties  
Contract No. 78222

1020	Portland Cement Concrete .....	66
1022	Concrete Curing Materials .....	77
1024	Nonshrink Grout .....	78
1026	Concrete Sealer .....	79
1030	Hot-Mix Asphalt .....	80
1032	Bituminous Materials .....	87
1042	Precast Concrete Products .....	90
1062	Reflective Crack Control System .....	92
1069	Pole and Tower .....	94
1074	Control Equipment .....	97
1076	Wire and Cable .....	102
1077	Post and Foundation .....	103
1080	Fabric Materials .....	105
1081	Materials for Planting .....	106
1083	Elastomeric Bearings .....	108
1090	Sign Base .....	109
1091	Sign Face .....	111
1092	Sign Legend and Supplemental Panels .....	119
1093	Sign Supports .....	120
1094	Overhead Sign Structures .....	122
1095	Pavement Markings .....	128
1097	Reflectors .....	136
1101	General Equipment .....	137
1102	Hot-Mix Asphalt Equipment .....	138
1103	Portland Cement Concrete Equipment .....	140
1105	Pavement Marking Equipment .....	141
1106	Work Zone Traffic Control Devices .....	143

RECURRING SPECIAL PROVISIONS

The following RECURRING SPECIAL PROVISIONS indicated by an "X" are applicable to this contract and are included by reference:

<u>CHECK SHEET #</u>	<u>PAGE NO.</u>
1	145
2	148
3	149
4	159
5	164
6	169
7	170
8	171
9	172
10	175
11	178
12	180
13	184
14	186
15	187
16	189
17	190
18	192
19	193
20	194
21	198
22	200
23	202
24	204
25	205
26	206
27	207
28	208
29	209
30	210
31	218
32	230
33	231

## TABLE OF CONTENTS

LOCATION OF PROJECT .....	1
DESCRIPTION OF PROJECT .....	1
UTILITIES.....	1
TRAFFIC CONTROL PLAN .....	3
APPROVAL OF PROPOSED BORROW AREAS, USE AREAS, AND/OR WASTE AREAS (BDE) .....	4
CONSTRUCTION AIR QUALITY - DIESEL VEHICLE EMISSIONS CONTROL (BDE) .....	5
CONSTRUCTION AIR QUALITY - IDLING RESTRICTIONS (BDE).....	6
DISADVANTAGED BUSINESS ENTERPRISE PARTICIPATION (BDE) .....	7
EQUIPMENT RENTAL RATES (BDE).....	15
FLAGGER AT SIDE ROADS AND ENTRANCES (BDE) .....	16
LIQUIDATED DAMAGES (BDE).....	16
NATIONAL POLLUTANT DISCHARGE ELIMINATION SYSTEM / EROSION AND SEDIMENT CONTROL DEFICIENCY DEDUCTION (BDE) .....	17
PAYMENTS TO SUBCONTRACTORS (BDE) .....	18
POST MOUNTING OF SIGNS (BDE).....	19
SELECTION OF LABOR (BDE).....	19
SUBCONTRACTOR MOBILIZATION PAYMENTS (BDE) .....	19
WORKING DAYS (BDE) .....	20
404 PERMIT .....	21
NATIONWIDE PERMITS AND CONDITIONS .....	22
IEPA REGIONAL CONDITIONS.....	35

## STATE OF ILLINOIS

### SPECIAL PROVISIONS

The following Special Provisions supplement the "Standard Specifications for Road and Bridge Construction," adopted January 1, 2007, the latest edition of the "Manual on Uniform Traffic Control Devices for Streets and Highways," and the "Manual of Test Procedures for Materials" in effect on the date of invitation for bids, and the Supplemental Specifications and Recurring Special Provisions indicated on the Check Sheet included herein which apply to and govern the construction of Various Routes, Section D9 SCOUR REPAIR 2011-1 in Various Counties, Contract No. 78222 and in case of conflict with any part or parts of said Specifications, the said Special Provisions shall take precedence and shall govern.

#### LOCATION OF PROJECT

This project involves a total of nine structures in Franklin, Gallatin, Jackson, Johnson, Massac, Saline, and Williamson counties as shown in the plans.

#### DESCRIPTION OF PROJECT

The project consists of installing filter fabric, bedding material and stone riprap around substructure elements for the purpose of scour mitigation.

#### UTILITIES

Effective 1984

Revised 1/2/97

Add the following after the first paragraph of Article 105.07 of the Standard Specifications:

Underground utilities have been plotted from available surveys and records and, therefore, their locations must be considered approximate only. There also may be utilities for which the locations are unknown. Verification of locations of underground utilities, shown or not shown, will be the responsibility of the Contractor. The following utility companies have facilities which may require adjustment:

Name and Address of Utility	Type	Locations	Estimated Date Adjustment Completed
Akin Water District Delbert Winemiller P.O. Box 6 Akin, IL 62805	Water	Struct. No. 028-0029 Struct. No. 028-0047	None Anticipated None Anticipated
Frontier Communications Rick Shaw 208 W. Union Marion, IL 62959	Telephone	Struct. No. 028-0029 Struct. No. 028-0044 Struct. No. 028-0047 Struct. No. 039-0001 Struct. No. 044-0005 Struct. No. 064-0008 Struct. No. 083-0022 Struct. No. 100-3008	None Anticipated None Anticipated None Anticipated None Anticipated None Anticipated None Anticipated None Anticipated None Anticipated



Various Routes  
Section D9 Scour Repair 2011-1  
Various Counties  
Contract No. 78222

Southeastern Illinois Electric Coop Eric Jung P.O. Box 371 Eldorado, IL 62930	Electric	Struct. No. 028-0029 Struct. No. 028-0047 Struct. No. 083-0022	None Anticipated None Anticipated None Anticipated
Countrymark Cooperative LLP Mickey Smith 1200 Refinery Road Mt. Vernon, IN 47620	Electric	Struct. No. 028-0044	None Anticipated
Village of Hanaford Mary Mosley P.O. Box 190 Logan, IL 62856	Water	Struct. No. 028-0047	None Anticipated
Consumer Gas Company Dale Bratcher P.O. Box 639 Ridgeway, IL 62979	Natural Gas	Struct. No. 030-0015	None Anticipated
City of Equality Frank Sisk P.O. Box 190 Equality, IL 62934	Water	Struct. No. 030-0015	None Anticipated
Shawnee Telephone Company John Bourland P.O. Box 69 Equality, IL 62934	Telephone	Struct. No. 030-0015	None Anticipated
Saline Valley Conservancy District Larry Phelps P.O. Box 369 Eldorado, IL 62930	Water	Struct. No. 030-0015	None Anticipated
Time Warner Cable Brent Rafferty 100 Industrial Drive Owensboro, KY 42301	Cable TV	Struct. No. 030-0015	None Anticipated
Ameren CIPS Joe Reinhard P.O. Box 460 Marion, IL 62959	Electric	Struct. No. 039-0001 Struct. No. 044-0005 Struct. No. 100-3008	None Anticipated None Anticipated None Anticipated
City of Dowell Allen Cavitt P.O. Box 92 Dowell, IL 62927	Water	Struct. No. 039-0001	None Anticipated
Egyptian Electric Cooperative Kendall Bunselmeyer 10169 Old Highway 13 Murphysboro, IL 62966	Electric	Struct. No. 039-0001	None Anticipated
Mediacom Francis Addison 1603 E. DeYoung Marion, IL 62959	Cable TV	Struct. No. 039-0001  Struct. No. 100-3008	None Anticipated  Before or During Construction
360 Networks Steve Hendel 4024 Hounds Hill Drive Florissant, MO 63034	Fiber Optic Cable	Struct. No. 039-0001	None Anticipated

Centennial Pipeline LLC Brian McArthur P.O. Box 9 Creal Springs, IL 62922	Petroleum Products	Struct. No. 044-0005	None Anticipated
Galaxy Cablevision Jimmy Hayes 1718 Barlow Road P.O. Box 728 Wickliffe, KY 42087	Cable TV	Struct. No. 044-0005	None Anticipated
Trunkline Gas Company Dave Roybal 2101 Portland Road Grand Chain, IL 62941	Natural Gas	Struct. No. 044-0005	None Anticipated
City of Vienna Jon Simmons P.O. Box 1442 Vienna, IL 62995	Water	Struct. No. 044-0005	None Anticipated
Fort Massac Water District David Travis P.O. Box 491 Metropolis, IL 62960	Water	Struct. No. 064-0008	None Anticipated
Southern Illinois Power Cooperative Matt Crain 11543 Lake of Egypt Road Marion, IL 62959	Electric	Struct. No. 064-0008	None Anticipated
Mitchellville Water District Roman Kuppart 125 Triple S. Road Harrisburg, IL 62946	Water	Struct. No. 083-0022	None Anticipated
City of Herrin C/O Lipe Engineering Coy Cockrum 901 N. Duquoin Street Benton, IL 62812	Water	Struct. No. 100-3008	None Anticipated

Additional utility information may be obtained by calling the "Joint Utility Location Information for Excavators" phone number, 800-892-0123. This project is located in Northern, Benton, Cave, Equality, Elk, Vienna, Washington, Independence, and Herrin Townships.

**TRAFFIC CONTROL PLAN**

Effective 1985

Revised 2/17/99

Traffic control shall be in accordance with the applicable sections of the Standard Specifications for Road and Bridge Construction, the guidelines contained in the National Manual on Uniform Traffic Control Devices for Streets and Highways, the Supplemental Specifications, these Special Provisions, and any special details and highway standards contained herein and in the plans.

Special attention is called to Articles 107.09 and 107.14 of the Standard Specifications for Road and Bridge Construction and the following traffic control related (1) Highway Standards; (2) Supplemental Specifications and Recurring Special Provisions; (3) other Special Provisions; and (4) Plan Details which are included in this contract:

1. Standards: 701001, 701006, 701201, 701301, 701901
2. Supplemental Specifications and Recurring Special Provisions:  
701 Work Zone Traffic control and Protection  
1106 Work Zone Traffic Control Devices
3. Special Provisions: None
4. Plan Details: None

Traffic control standards shall be applied as directed by the Engineer. Suggested applications for each standard are as follow:

701001 This standard should be used for miscellaneous work which is performed at least 15' from the edge of the traffic lane.

701006 This standard should be used for miscellaneous work which is performed within 15', but not closer than 2' to the edge of the traffic lane.

701201 This standard should be applied during operations which require encroachment of any equipment, vehicles, or men within 2' of the edge of pavement.

701301 This standard will apply when short time work operations are being performed.

During the entire construction period, the road shall be kept open to traffic as follows:

- (a) In accordance with the applicable portions of the Standard Specifications at all times.
- (b) The highway shall be kept open to at least one lane of traffic at all times.
- (c) Access to all public roads and private entrances shall be maintained at all times.

If at any time the signs are in place but not applicable, they shall be turned from the view of motorists or covered as directed by the Engineer.

The cost of furnishing, erecting, maintaining, and removing the required signs shall be incidental to the contract.

**APPROVAL OF PROPOSED BORROW AREAS, USE AREAS, AND/OR WASTE AREAS (BDE)**

Effective: November 1, 2008

Revised: November 1, 2010

Replace the first paragraph of Article 107.22 of the Standard Specifications with the following:

“All proposed borrow areas, including commercial borrow areas; use areas, including, but not limited to temporary access roads, detours, runarounds, plant sites, and staging and storage areas; and/or waste areas are to be designated by the Contractor to the Engineer and approved prior to their use. Such areas outside the State of Illinois shall be evaluated, at no additional cost to the Department, according to the requirements of the state in which the area lies; and approval by the authority within that state having jurisdiction for such areas shall be forwarded to the Engineer. Such areas within Illinois shall be evaluated as described herein.

A location map delineating the proposed borrow area, use area, and/or waste area shall be submitted to the Engineer for approval along with an agreement from the property owner granting the Department permission to enter the property and conduct cultural and biological resource reconnaissance surveys of the site for archaeological resources, threatened or endangered species or their designated essential habitat, wetlands, prairies, and savannahs. The type of location map submitted shall be a topographic map, a plat map, or a 7.5 minute quadrangle map. Submittals shall include the intended use of the site and provide sufficient detail for the Engineer to determine the extent of impacts to the site. The Engineer will initiate cultural and biological resource reconnaissance surveys of the site, as necessary, at no cost to the Contractor. The Engineer will advise the Contractor of the expected time required to complete all surveys. If the proposed area is within 150 ft (45 m) of the highway right-of-way, a topographic map of the proposed site will be required as specified in Article 204.02.”

#### **CONSTRUCTION AIR QUALITY - DIESEL VEHICLE EMISSIONS CONTROL (BDE)**

Effective: April 1, 2009

Revised: July 1, 2009

Diesel Vehicle Emissions Control. The reduction of construction air emissions shall be accomplished by using cleaner burning diesel fuel. The term “equipment” refers to any and all diesel fuel powered devices rated at 50 hp and above, to be used on the project site in excess of seven calendar days over the course of the construction period on the project site (including any “rental” equipment).

All equipment on the jobsite, with engine ratings of 50 hp and above, shall be required to: use Ultra Low Sulfur Diesel fuel (ULSD) exclusively (15 ppm sulfur content or less).

Diesel powered equipment in non-compliance will not be allowed to be used on the project site, and is also subject to a notice of non-compliance as outlined below.

The Contractor shall submit copies of monthly summary reports and include certified copies of the ULSD diesel fuel delivery slips for diesel fuel delivered to the jobsite for the reporting time period, noting the quantity of diesel fuel used.

If any diesel powered equipment is found to be in non-compliance with any portion of this specification, the Engineer will issue the Contractor a notice of non-compliance and identify an appropriate period of time, as outlined below under environmental deficiency deduction, in which to bring the equipment into compliance or remove it from the project site.

Any costs associated with bringing any diesel powered equipment into compliance with these diesel vehicle emissions controls shall be considered as included in the contract unit prices bid for the various items of work involved and no additional compensation will be allowed.

The Contractor's compliance with this notice and any associated regulations shall also not be grounds for a claim.

Environmental Deficiency Deduction. When the Engineer is notified, or determines that an environmental control deficiency exists, he/she will notify the Contractor in writing, and direct the Contractor to correct the deficiency within a specified time period. The specified time-period, which begins upon Contractor notification, will be from 1/2 hour to 24 hours long, based on the urgency of the situation and the nature of the deficiency. The Engineer shall be the sole judge regarding the time period.

The deficiency will be based on lack of repair, maintenance and diesel vehicle emissions control.

If the Contractor fails to correct the deficiency within the specified time frame, a daily monetary deduction will be imposed for each calendar day or fraction thereof the deficiency continues to exist. The calendar day(s) will begin when the time period for correction is exceeded and end with the Engineer's written acceptance of the correction. The daily monetary deduction will be \$1,000.00 for each deficiency identified.

If a Contractor or subcontractor accumulates three environmental deficiency deductions in a contract period, the Contractor will be shutdown until the deficiency is corrected. Such a shutdown will not be grounds for any extension of contract time, waiver of penalties, or be grounds for any claim.

### **CONSTRUCTION AIR QUALITY - IDLING RESTRICTIONS (BDE)**

Effective: April 1, 2009

Idling Restrictions. The Contractor shall establish truck-staging areas for all diesel powered vehicles that are waiting to load or unload material at the jobsite. Staging areas shall be located where the diesel emissions from the equipment will have a minimum impact on adjacent sensitive receptors. The Department will review the selection of staging areas, whether within or outside the existing highway right-of-way, to avoid locations near sensitive areas or populations to the extent possible. Sensitive receptors include, but are not limited to, hospitals, schools, residences, motels, hotels, daycare facilities, elderly housing and convalescent facilities. Diesel powered engines shall also be located as far away as possible from fresh air intakes, air conditioners, and windows. The Engineer will approve staging areas before implementation.

Diesel powered vehicle operators may not cause or allow the motor vehicle, when it is not in motion, to idle for more than a total of 10 minutes within any 60 minute period, except under any of the following circumstances:

- 1) The motor vehicle has a gross vehicle weight rating of less than 8000 lb (3630 kg).
- 2) The motor vehicle idles while forced to remain motionless because of on-highway traffic, an official traffic control device or signal, or at the direction of a law enforcement official.
- 3) The motor vehicle idles when operating defrosters, heaters, air conditioners, or other equipment solely to prevent a safety or health emergency.

- 4) A police, fire, ambulance, public safety, other emergency or law enforcement motor vehicle, or any motor vehicle used in an emergency capacity, idles while in an emergency or training mode and not for the convenience of the vehicle operator.
- 5) The primary propulsion engine idles for maintenance, servicing, repairing, or diagnostic purposes if idling is necessary for such activity.
- 6) A motor vehicle idles as part of a government inspection to verify that all equipment is in good working order, provided idling is required as part of the inspection.
- 7) When idling of the motor vehicle is required to operate auxiliary equipment to accomplish the intended use of the vehicle (such as loading, unloading, mixing, or processing cargo; controlling cargo temperature; construction operations, lumbering operations; oil or gas well servicing; or farming operations), provided that this exemption does not apply when the vehicle is idling solely for cabin comfort or to operate non-essential equipment such as air conditioning, heating, microwave ovens, or televisions.
- 8) When the motor vehicle idles due to mechanical difficulties over which the operator has no control.
- 9) The outdoor temperature is less than 32 °F (0 °C) or greater than 80 °F (26 °C).

When the outdoor temperature is greater than or equal to 32 °F (0 °C) or less than or equal to 80 °F (26 °C), a person who operates a motor vehicle operating on diesel fuel shall not cause or allow the motor vehicle to idle for a period greater than 30 minutes in any 60 minute period while waiting to weigh, load, or unload cargo or freight, unless the vehicle is in a line of vehicles that regularly and periodically moves forward.

The above requirements do not prohibit the operation of an auxiliary power unit or generator set as an alternative to idling the main engine of a motor vehicle operating on diesel fuel.

Environmental Deficiency Deduction. When the Engineer is notified, or determines that an environmental control deficiency exists based on non-compliance with the idling restrictions, he/she will notify the Contractor, and direct the Contractor to correct the deficiency.

If the Contractor fails to correct the deficiency a monetary deduction will be imposed. The monetary deduction will be \$1,000.00 for each deficiency identified.

#### **DISADVANTAGED BUSINESS ENTERPRISE PARTICIPATION (BDE)**

Effective: September 1, 2000

Revised: January 1, 2011

FEDERAL OBLIGATION. The Department of Transportation, as a recipient of federal financial assistance, is required to take all necessary and reasonable steps to ensure nondiscrimination in the award and administration of contracts. Consequently, the federal regulatory provisions of 49 CFR part 26 apply to this contract concerning the utilization of disadvantaged business enterprises. For the purposes of this Special Provision, a disadvantaged business enterprise (DBE) means a business certified by the Department in accordance with the requirements of 49 CFR part 26 and listed in the Illinois Unified Certification Program (IL UCP) DBE Directory.

STATE OBLIGATION. This Special Provision will also be used by the Department to satisfy the requirements of the Business Enterprise for Minorities, Females, and Persons with Disabilities Act, 30 ILCS 575. When this Special Provision is used to satisfy state law requirements on 100 percent state-funded contracts, the federal government has no involvement in such contracts (not a federal-aid contract) and no responsibility to oversee the implementation of this Special Provision by the Department on those contracts.

DBE participation on 100 percent state-funded contracts will not be credited toward fulfilling the Department's annual overall DBE goal required by the US Department of Transportation to comply with the federal DBE program requirements.

CONTRACTOR ASSURANCE. The Contractor makes the following assurance and agrees to include the assurance in each subcontract that the Contractor signs with a subcontractor:

The Contractor, subrecipient, or subcontractor shall not discriminate on the basis of race, color, national origin, or sex in the performance of this contract. The Contractor shall carry out applicable requirements of 49 CFR part 26 in the award and administration of contracts funded in whole or in part with federal or state funds. Failure by the Contractor to carry out these requirements is a material breach of this contract, which may result in the termination of this contract or such other remedy as the recipient deems appropriate.

OVERALL GOAL SET FOR THE DEPARTMENT. As a requirement of compliance with 49 CFR part 26, the Department has set an overall goal for DBE participation in its federally assisted contracts. That goal applies to all federal-aid funds the Department will expend in its federally assisted contracts for the subject reporting fiscal year. The Department is required to make a good faith effort to achieve the overall goal. The dollar amount paid to all approved DBE companies performing work called for in this contract is eligible to be credited toward fulfillment of the Department's overall goal.

CONTRACT GOAL TO BE ACHIEVED BY THE CONTRACTOR. This contract includes a specific DBE utilization goal established by the Department. The goal has been included because the Department has determined that the work of this contract has subcontracting opportunities that may be suitable for performance by DBE companies. This determination is based on an assessment of the type of work, the location of the work, and the availability of DBE companies to do a part of the work. The assessment indicates that, in the absence of unlawful discrimination, and in an arena of fair and open competition, DBE companies can be expected to perform **7.00%** of the work. This percentage is set as the DBE participation goal for this contract. Consequently, in addition to the other award criteria established for this contract, the Department will only award this contract to a bidder who makes a good faith effort to meet this goal of DBE participation in the performance of the work. A bidder makes a good faith effort for award consideration if either of the following is done in accordance with the procedures set forth in this Special Provision:

- (a) The bidder documents that enough DBE participation has been obtained to meet the goal; or
- (b) The bidder documents that a good faith effort has been made to meet the goal, even though the effort did not succeed in obtaining enough DBE participation to meet the goal.

DBE LOCATOR REFERENCES. Bidders may consult the IL UCP DBE Directory as a reference source for DBE-certified companies. In addition, the Department maintains a letting and item specific DBE locator information system whereby DBE companies can register their interest in providing quotes on particular bid items advertised for letting. Information concerning DBE companies willing to quote work for particular contracts may be obtained by contacting the Department's Bureau of Small Business Enterprises at telephone number (217)785-4611, or by visiting the Department's web site at [www.dot.il.gov](http://www.dot.il.gov).

BIDDING PROCEDURES. Compliance with this Special Provision is a material bidding requirement. The failure of the bidder to comply will render the bid not responsive.

- (a) The bidder shall submit a Disadvantaged Business Utilization Plan on Department forms SBE 2025 and 2026 with the bid.
- (b) The Utilization Plan shall indicate that the bidder either has obtained sufficient DBE participation commitments to meet the contract goal or has not obtained enough DBE participation commitments in spite of a good faith effort to meet the goal. The Utilization Plan shall further provide the name, telephone number, and telefax number of a responsible official of the bidder designated for purposes of notification of plan approval or disapproval under the procedures of this Special Provision.
- (c) The Utilization Plan shall include a DBE Participation Commitment Statement, Department form SBE 2025, for each DBE proposed for the performance of work to achieve the contract goal. For bidding purposes, submission of the completed SBE 2025 forms, signed by the DBEs and faxed to the bidder will be acceptable as long as the original is available and provided upon request. All elements of information indicated on the said form shall be provided, including but not limited to the following:
  - (1) The names and addresses of DBE firms that will participate in the contract;
  - (2) A description, including pay item numbers, of the work each DBE will perform;
  - (3) The dollar amount of the participation of each DBE firm participating. The dollar amount of participation for identified work shall specifically state the quantity, unit price, and total subcontract price for the work to be completed by the DBE. If partial pay items are to be performed by the DBE, indicate the portion of each item, a unit price where appropriate and the subcontract price amount;
  - (4) DBE Participation Commitment Statements, form SBE 2025, signed by the bidder and each participating DBE firm documenting the commitment to use the DBE subcontractors whose participation is submitted to meet the contract goal;
  - (5) If the bidder is a joint venture comprised of DBE companies and non-DBE companies, the plan must also include a clear identification of the portion of the work to be performed by the DBE partner(s); and,
  - (6) If the contract goal is not met, evidence of good faith efforts.

GOOD FAITH EFFORT PROCEDURES. The contract will not be awarded until the Utilization Plan submitted by the apparent successful bidder is approved. All information submitted by the bidder must be complete, accurate and adequately document that enough DBE participation has been obtained or document the good faith efforts of the bidder, in the event enough DBE participation has not been obtained, before the Department will commit to the performance of the contract by the bidder. The Utilization Plan will be approved by the Department if the Utilization Plan documents sufficient commercially useful DBE work performance to meet the contract goal or the bidder submits sufficient documentation of a good faith effort to meet the contract goal pursuant to 49 CFR part 26, Appendix A.



The Utilization Plan will not be approved by the Department if the Utilization Plan does not document sufficient DBE participation to meet the contract goal unless the apparent successful bidder documented in the Utilization Plan that it made a good faith effort to meet the goal. This means that the bidder must show that all necessary and reasonable steps were taken to achieve the contract goal. Necessary and reasonable steps are those which, by their scope, intensity and appropriateness to the objective, could reasonably be expected to obtain sufficient DBE participation, even if they were not successful. The Department will consider the quality, quantity, and intensity of the kinds of efforts that the bidder has made. Mere *pro forma* efforts, in other words, efforts done as a matter of form, are not good faith efforts; rather, the bidder is expected to have taken genuine efforts that would be reasonably expected of a bidder actively and aggressively trying to obtain DBE participation sufficient to meet the contract goal.

- (a) The following is a list of types of action that the Department will consider as part of the evaluation of the bidder's good faith efforts to obtain participation. These listed factors are not intended to be a mandatory checklist and are not intended to be exhaustive. Other factors or efforts brought to the attention of the Department may be relevant in appropriate cases, and will be considered by the Department.
  - (1) Soliciting through all reasonable and available means (e.g. attendance at pre-bid meetings, advertising and/or written notices) the interest of all certified DBE companies that have the capability to perform the work of the contract. The bidder must solicit this interest within sufficient time to allow the DBE companies to respond to the solicitation. The bidder must determine with certainty if the DBE companies are interested by taking appropriate steps to follow up initial solicitations.
  - (2) Selecting portions of the work to be performed by DBE companies in order to increase the likelihood that the DBE goals will be achieved. This includes, where appropriate, breaking out contract work items into economically feasible units to facilitate DBE participation, even when the prime Contractor might otherwise prefer to perform these work items with its own forces.
  - (3) Providing interested DBE companies with adequate information about the plans, specifications, and requirements of the contract in a timely manner to assist them in responding to a solicitation.
  - (4) a. Negotiating in good faith with interested DBE companies. It is the bidder's responsibility to make a portion of the work available to DBE subcontractors and suppliers and to select those portions of the work or material needs consistent with the available DBE subcontractors and suppliers, so as to facilitate DBE participation. Evidence of such negotiation includes the names, addresses, and telephone numbers of DBE companies that were considered; a description of the information provided regarding the plans and specifications for the work selected for subcontracting; and evidence as to why additional agreements could not be reached for DBE companies to perform the work.
    - b. A bidder using good business judgment would consider a number of factors in negotiating with subcontractors, including DBE subcontractors, and would take a firm's price and capabilities as well as contract goals into consideration. However, the fact that there may be some additional costs involved in finding and using DBE companies is not in itself sufficient reason for a bidder's failure to meet the contract DBE goal, as long as such costs are reasonable.

Also, the ability or desire of a bidder to perform the work of a contract with its own organization does not relieve the bidder of the responsibility to make good faith efforts. Bidders are not, however, required to accept higher quotes from DBE companies if the price difference is excessive or unreasonable.

- (5) Not rejecting DBE companies as being unqualified without sound reasons based on a thorough investigation of their capabilities. The bidder's standing within its industry, membership in specific groups, organizations, or associations and political or social affiliations (for example union vs. non-union employee status) are not legitimate causes for the rejection or non-solicitation of bids in the bidder's efforts to meet the project goal.
  - (6) Making efforts to assist interested DBE companies in obtaining bonding, lines of credit, or insurance as required by the recipient or Contractor.
  - (7) Making efforts to assist interested DBE companies in obtaining necessary equipment, supplies, materials, or related assistance or services.
  - (8) Effectively using the services of available minority/women community organizations; minority/women contractors' groups; local, state, and federal minority/women business assistance offices; and other organizations as allowed on a case-by-case basis to provide assistance in the recruitment and placement of DBE companies.
- (b) If the Department determines that the apparent successful bidder has made a good faith effort to secure the work commitment of DBE companies to meet the contract goal, the Department will award the contract provided that it is otherwise eligible for award. If the Department determines that the bidder has failed to meet the requirements of this Special Provision or that a good faith effort has not been made, the Department will notify the responsible company official designated in the Utilization Plan that the bid is not responsive. The notification shall include a statement of reasons for the determination.
- (c) The bidder may request administrative reconsideration of a determination adverse to the bidder within the five working days after receipt of the notification date of the determination by delivering the request to the Department of Transportation, Bureau of Small Business Enterprises, Contract Compliance Section, 2300 South Dirksen Parkway, Room 319, Springfield, Illinois 62764 (Telefax: (217)785-1524). Deposit of the request in the United States mail on or before the fifth business day shall not be deemed delivery. The determination shall become final if a request is not made and delivered. A request may provide additional written documentation and/or argument concerning the issues raised in the determination statement of reasons, provided the documentation and arguments address efforts made prior to submitting the bid. The request will be forwarded to the Department's Reconsideration Officer. The Reconsideration Officer will extend an opportunity to the bidder to meet in person in order to consider all issues of documentation and whether the bidder made a good faith effort to meet the goal. After the review by the Reconsideration Officer, the bidder will be sent a written decision within ten working days after receipt of the request for reconsideration, explaining the basis for finding that the bidder did or did not meet the goal or make adequate good faith efforts to do so.

A final decision by the Reconsideration Officer that a good faith effort was made shall approve the Utilization Plan submitted by the bidder and shall clear the contract for award. A final decision that a good faith effort was not made shall render the bid not responsive.

CALCULATING DBE PARTICIPATION. The Utilization Plan values represent work anticipated to be performed and paid for upon satisfactory completion. The Department is only able to count toward the achievement of the overall goal and the contract goal the value of payments made for the work actually performed by DBE companies. In addition, a DBE must perform a commercially useful function on the contract to be counted. A commercially useful function is generally performed when the DBE is responsible for the work and is carrying out its responsibilities by actually performing, managing, and supervising the work involved. The Department and Contractor are governed by the provisions of 49 CFR part 26.55(c) on questions of commercially useful functions as it affects the work. Specific counting guidelines are provided in 49 CFR part 26.55, the provisions of which govern over the summary contained herein.

- (a) DBE as the Contractor: 100 percent goal credit for that portion of the work performed by the DBE's own forces, including the cost of materials and supplies. Work that a DBE subcontracts to a non-DBE does not count toward the DBE goals.
- (b) DBE as a joint venture Contractor: 100 percent goal credit for that portion of the total dollar value of the contract equal to the distinct, clearly defined portion of the work performed by the DBE's own forces.
- (c) DBE as a subcontractor: 100 percent goal credit for the work of the subcontract performed by the DBE's own forces, including the cost of materials and supplies, excluding the purchase of materials and supplies or the lease of equipment by the DBE subcontractor from the prime Contractor or its affiliates. Work that a DBE subcontractor in turn subcontracts to a non-DBE does not count toward the DBE goal.
- (d) DBE as a trucker: 100 percent goal credit for trucking participation provided the DBE is responsible for the management and supervision of the entire trucking operation for which it is responsible. At least one truck owned, operated, licensed, and insured by the DBE must be used on the contract. Credit will be given for the following:
  - (1) The DBE may lease trucks from another DBE firm, including an owner-operator who is certified as a DBE. The DBE who leases trucks from another DBE receives credit for the total value of the transportation services the lessee DBE provides on the contract.
  - (2) The DBE may also lease trucks from a non-DBE firm, including from an owner-operator. The DBE who leases trucks from a non-DBE is entitled to credit only for the fee or commission it receives as a result of the lease arrangement.
- (e) DBE as a material supplier:
  - (1) 60 percent goal credit for the cost of the materials or supplies purchased from a DBE regular dealer.

- (2) 100 percent goal credit for the cost of materials or supplies obtained from a DBE manufacturer.
- (3) 100 percent credit for the value of reasonable fees and commissions for the procurement of materials and supplies if not a regular dealer or manufacturer.

CONTRACT COMPLIANCE. Compliance with this Special Provision is an essential part of the contract. The Department is prohibited by federal regulations from crediting the participation of a DBE included in the Utilization Plan toward either the contract goal or the Department's overall goal until the amount to be applied toward the goals has been paid to the DBE. The following administrative procedures and remedies govern the compliance by the Contractor with the contractual obligations established by the Utilization Plan. After approval of the Utilization Plan and award of the contract, the Utilization Plan and individual DBE Participation Statements become part of the contract. If the Contractor did not succeed in obtaining enough DBE participation to achieve the advertised contract goal, and the Utilization Plan was approved and contract awarded based upon a determination of good faith, the total dollar value of DBE work calculated in the approved Utilization Plan as a percentage of the awarded contract value shall become the amended contract goal.

- (a) No amendment to the Utilization Plan may be made without prior written approval from the Department's Bureau of Small Business Enterprises. All requests for amendment to the Utilization Plan shall be submitted to the Department of Transportation, Bureau of Small Business Enterprises, Contract Compliance Section, 2300 South Dirksen Parkway, Room 319, Springfield, Illinois 62764. Telephone number (217) 785-4611. Telefax number (217) 785-1524.
- (b) The Contractor must notify and obtain written approval from the Department's Bureau of Small Business Enterprises prior to replacing a DBE or making any change in the participation of a DBE. Approval for replacement will be granted only if it is demonstrated that the DBE is unable or unwilling to perform. The Contractor must make every good faith effort to find another certified DBE subcontractor to substitute for the original DBE. The good faith efforts shall be directed at finding another DBE to perform at least the same amount of work under the contract as the original DBE, to the extent needed to meet the contract goal.
- (c) Any deviation from the DBE condition-of-award or contract specifications must be approved, in writing, by the Department. The Contractor shall notify affected DBEs in writing of any changes in the scope of work which result in a reduction in the dollar amount condition-of-award to the contract.
- (d) In addition to the above requirements for reductions in the condition of award, additional requirements apply to the two cases of Contractor-initiated work substitution proposals. Where the contract allows alternate work methods which serve to delete or create underruns in condition of award DBE work, and the Contractor selects that alternate method or, where the Contractor proposes a substitute work method or material that serves to diminish or delete work committed to a DBE and replace it with other work, then the Contractor must demonstrate one of the following:
  - (1) That the replacement work will be performed by the same DBE (as long as the DBE is certified in the respective item of work) in a modification of the condition of award;  
or

- (2) That the DBE is aware that its work will be deleted or will experience underruns and has agreed in writing to the change. If this occurs, the Contractor shall substitute other work of equivalent value to a certified DBE or provide documentation of good faith efforts to do so; or
  - (3) That the DBE is not capable of performing the replacement work or has declined to perform the work at a reasonably competitive price. If this occurs, the Contractor shall substitute other work of equivalent value to a certified DBE or provide documentation of good faith efforts to do so.
- (e) Where the revision includes work committed to a new DBE subcontractor, not previously involved in the project, then a Request for Approval of Subcontractor, Department form BC 260A, must be signed and submitted.
- (f) If the commitment of work is in the form of additional tasks assigned to an existing subcontract, then a new Request for Approval of Subcontractor shall not be required. However, the Contractor must document efforts to assure that the existing DBE subcontractor is capable of performing the additional work and has agreed in writing to the change.
- (g) All work indicated for performance by an approved DBE shall be performed, managed, and supervised by the DBE executing the Participation Statement. The Contractor shall not terminate for convenience a DBE listed in the Utilization Plan and then perform the work of the terminated DBE with its own forces, those of an affiliate or those of another subcontractor, whether DBE or not, without first obtaining the written consent of the Bureau of Small Business Enterprises to amend the Utilization Plan. The Contractor shall notify the Bureau of Small Business Enterprises of any termination for reasons other than convenience, and shall obtain approval for inclusion of the substitute DBE in the Utilization Plan. If good faith efforts following a termination of a DBE for cause are not successful, the Contractor shall contact the Bureau of Small Business Enterprises and provide a full accounting of the efforts undertaken to obtain substitute DBE participation. The Bureau of Small Business Enterprises will evaluate the good faith efforts in light of all circumstances surrounding the performance status of the contract, and determine whether the contract goal should be amended.
- (h) The Contractor shall maintain a record of payments for work performed to the DBE participants. The records shall be made available to the Department for inspection upon request. After the performance of the final item of work or delivery of material by a DBE and final payment therefore to the DBE by the Contractor, but not later than thirty calendar days after payment has been made by the Department to the Contractor for such work or material, the Contractor shall submit a DBE Payment Agreement on Department form SBE 2115 to the Regional Engineer. If full and final payment has not been made to the DBE, the DBE Payment Agreement shall indicate whether a disagreement as to the payment required exists between the Contractor and the DBE or if the Contractor believes that the work has not been satisfactorily completed. If the Contractor does not have the full amount of work indicated in the Utilization Plan performed by the DBE companies indicated in the Utilization Plan and after good faith efforts are reviewed, the Department may deduct from contract payments to the Contractor the amount of the goal not achieved as liquidated and ascertained damages. The Contractor may request an administrative reconsideration of any amount deducted as damages pursuant to subsection (j) of this part.

- (i) The Department reserves the right to withhold payment to the Contractor to enforce the provisions of this Special Provision. Final payment shall not be made on the contract until such time as the Contractor submits sufficient documentation demonstrating achievement of the goal in accordance with this Special Provision or after liquidated damages have been determined and collected.
- (j) Notwithstanding any other provision of the contract, including but not limited to Article 109.09 of the Standard Specifications, the Contractor may request administrative reconsideration of a decision to deduct the amount of the goal not achieved as liquidated damages. A request to reconsider shall be delivered to the Contract Compliance Section and shall be handled and considered in the same manner as set forth in paragraph (c) of "Good Faith Effort Procedures" of this Special Provision, except a final decision that a good faith effort was not made during contract performance to achieve the goal agreed to in the Utilization Plan shall be the final administrative decision of the Department.

### **EQUIPMENT RENTAL RATES (BDE)**

Effective: August 2, 2007

Revised: January 2, 2008

Replace the second and third paragraphs of Article 105.07(b)(4)a. of the Standard Specifications with the following:

"Equipment idled which cannot be used on other work, and which is authorized to standby on the project site by the Engineer, will be paid for according to Article 109.04(b)(4)."

Replace Article 109.04(b)(4) of the Standard Specifications with the following:

- "(4) Equipment. Equipment used for extra work shall be authorized by the Engineer. The equipment shall be specifically described, be of suitable size and capacity for the work to be performed, and be in good operating condition. For such equipment, the Contractor will be paid as follows.
  - a. Contractor Owned Equipment. Contractor owned equipment will be paid for by the hour using the applicable FHWA hourly rate from the "Equipment Watch Rental Rate Blue Book" (Blue Book) in effect when the force account work begins. The FHWA hourly rate is calculated as follows.

FHWA hourly rate = (monthly rate/176) x (model year adj.) x (Illinois adj.) + EOC  
Where: EOC = Estimated Operating Costs per hour (from the Blue Book)

The time allowed will be the actual time the equipment is operating on the extra work. For the time required to move the equipment to and from the site of the extra work and any authorized idle (standby) time, payment will be made at the following hourly rate: 0.5 x (FHWA hourly rate - EOC).

All time allowed shall fall within the working hours authorized for the extra work. The rates above include the cost of fuel, oil, lubrication, supplies, small tools, necessary attachments, repairs, overhaul and maintenance of any kind, depreciation, storage, overhead, profits, insurance, and all incidentals.

The rates do not include labor.

The Contractor shall submit to the Engineer sufficient information for each piece of equipment and its attachments to enable the Engineer to determine the proper equipment category. If a rate is not established in the Blue Book for a particular piece of equipment, the Engineer will establish a rate for that piece of equipment that is consistent with its cost and use in the industry.

- b. Rented Equipment. Whenever it is necessary for the Contractor to rent equipment to perform extra work, the rental and transportation costs of the equipment plus five percent for overhead will be paid. In no case shall the rental rates exceed those of established distributors or equipment rental agencies.

All prices shall be agreed to in writing before the equipment is used.”

**FLAGGER AT SIDE ROADS AND ENTRANCES (BDE)**

Effective: April 1, 2009

Revise the second paragraph of Article 701.13(a) of the Standard Specifications to read:

“The Engineer will determine when a side road or entrance shall be closed to traffic. A flagger will be required at each side road or entrance remaining open to traffic within the operation where two-way traffic is maintained on one lane of pavement. The flagger shall be positioned as shown on the plans or as directed by the Engineer.”

Revise the first and second paragraph of Article 701.20(i) of the Standard Specifications to read:

“Signs, barricades, or other traffic control devices required by the Engineer over and above those specified will be paid for according to Article 109.04. All flaggers required at side roads and entrances remaining open to traffic including those that are shown on the Highway Standards and/or additional barricades required by the Engineer to close side roads and entrances will be paid for according to Article 109.04.”

**LIQUIDATED DAMAGES (BDE)**

Effective: April 1, 2009

Revise the table in Article 108.09 of the Standard Specifications to read:

“Schedule of Deductions for Each Day of Overrun in Contract Time			
Original Contract Amount		Daily Charges	
From More Than	To and Including	Calendar Day	Work Day
\$ 0	\$ 100,000	\$ 375	\$ 500
100,000	500,000	625	875
500,000	1,000,000	1,025	1,425
1,000,000	3,000,000	1,125	1,550
3,000,000	5,000,000	1,425	1,950
5,000,000	10,000,000	1,700	2,350
10,000,000	And over	3,325	4,650”

**NATIONAL POLLUTANT DISCHARGE ELIMINATION SYSTEM / EROSION AND SEDIMENT CONTROL DEFICIENCY DEDUCTION (BDE)**

Effective: April 1, 2007

Revised: November 1, 2009

Revise Article 105.03(a) of the Standard Specifications to read:

“(a) National Pollutant Discharge Elimination System (NPDES) / Erosion and Sediment Control Deficiency Deduction When the Engineer is notified or determines an erosion and/or sediment control deficiency(s) exists, or the Contractor’s activities represents a violation of the Department’s NPDES permits, the Engineer will notify and direct the Contractor to correct the deficiency within a specified time. The specified time, which begins upon notification to the Contractor, will be from 1/2 hour to 1 week based on the urgency of the situation and the nature of the work effort required. The Engineer will be the sole judge.

A deficiency may be any lack of repair, maintenance, or implementation of erosion and/or sediment control devices included in the contract, or any failure to comply with the conditions of the Department’s NPDES permits. A deficiency may also be applied to situations where corrective action is not an option such as the failure to participate in a jobsite inspection of the project, failure to install required measures prior to initiating earth moving operations, disregard of concrete washout requirements, or other disregard of the NPDES permit.

If the Contractor fails to correct a deficiency within the specified time, a daily monetary deduction will be imposed for each calendar day or portion of a calendar day until the deficiency is corrected to the satisfaction of the Engineer. The calendar day(s) will begin with notification to the Contractor and end with the Engineer’s acceptance of the correction. The base value of the daily monetary deduction is \$1000.00 and will be applied to each location for which a deficiency exists. The value of the deficiency deduction assessed for each infraction will be determined by multiplying the base value by a Gravity Adjustment Factor provided in Table A. Except for failure to participate in a required jobsite inspection of the project prior to initiating earthmoving operations which will be based on the total acreage of planned disturbance at the following multipliers: <5 Acres: 1; 5-10 Acres: 2; >10-25 Acres: 3; >25 Acres: 5. For those deficiencies where corrective action was not an option, the monetary deduction will be immediate and will be valued at one calendar day multiplied by a Gravity Adjustment Factor.

Table A Deficiency Deduction Gravity Adjustment Factors				
Types of Violations	Soil Disturbed and Not Permanently Stabilized At Time of Violation			
	< 5 Acres	5 - 10 Acres	>10 - 25 Acres	> 25 Acres
Failure to Install or Properly Maintain BMP	0.1 - 0.5	0.2 - 1.0	0.5 - 2.5	1.0 - 5
Careless Destruction of BMP	0.2 - 1	0.5 - 2.5	1.0 - 5.	1.0 - 5
Intrusion into Protected Resource	1.0 - 5	1.0 - 5	2.0 - 10	2.0 - 10
Failure to properly manage Chemicals, Concrete Washouts or Residuals, Litter or other Wastes	0.2 - 1	0.2 - 1	0.5 - 2.5	1.0 - 5
Improper Vehicle and Equipment Maintenance, Fueling or Cleaning	0.1 - 0.5	0.2 - 1	0.2 - 1	0.5 - 2.5
Failure to Provide or Update Written or Graphic Plans Required by SWPPP	0.2 - 1	0.5 - 2.5	1.0 - 5	1.0 - 5
Failure to comply with Other Provisions of the NPDES Permit	0.1 - 0.5	0.2 - 1	0.2 - 1	0.5 - 2.5”



**PAYMENTS TO SUBCONTRACTORS (BDE)**

Effective: June 1, 2000

Revised: January 1, 2006

Federal regulations found at 49 CFR §26.29 mandate the Department to establish a contract clause to require Contractors to pay subcontractors for satisfactory performance of their subcontracts and to set the time for such payments.

State law also addresses the timing of payments to be made to subcontractors and material suppliers. Section 7 of the Prompt Payment Act, 30 ILCS 540/7, requires that when a Contractor receives any payment from the Department, the Contractor shall make corresponding, proportional payments to each subcontractor and material supplier performing work or supplying material within 15 calendar days after receipt of the Department payment. Section 7 of the Act further provides that interest in the amount of two percent per month, in addition to the payment due, shall be paid to any subcontractor or material supplier by the Contractor if the payment required by the Act is withheld or delayed without reasonable cause. The Act also provides that the time for payment required and the calculation of any interest due applies to transactions between subcontractors and lower-tier subcontractors and material suppliers throughout the contracting chain.

This Special Provision establishes the required federal contract clause, and adopts the 15 calendar day requirement of the State Prompt Payment Act for purposes of compliance with the federal regulation regarding payments to subcontractors. This contract is subject to the following payment obligations.

When progress payments are made to the Contractor according to Article 109.07 of the Standard Specifications, the Contractor shall make a corresponding payment to each subcontractor and material supplier in proportion to the work satisfactorily completed by each subcontractor and for the material supplied to perform any work of the contract. The proportionate amount of partial payment due to each subcontractor and material supplier throughout the contracting chain shall be determined by the quantities measured or otherwise determined as eligible for payment by the Department and included in the progress payment to the Contractor. Subcontractors and material suppliers shall be paid by the Contractor within 15 calendar days after the receipt of payment from the Department. The Contractor shall not hold retainage from the subcontractors. These obligations shall also apply to any payments made by subcontractors and material suppliers to their subcontractors and material suppliers; and to all payments made to lower tier subcontractors and material suppliers throughout the contracting chain. Any payment or portion of a payment subject to this provision may only be withheld from the subcontractor or material supplier to whom it is due for reasonable cause.

This Special Provision does not create any rights in favor of any subcontractor or material supplier against the State or authorize any cause of action against the State on account of any payment, nonpayment, delayed payment, or interest claimed by application of the State Prompt Payment Act. The Department will not approve any delay or postponement of the 15 day requirement except for reasonable cause shown after notice and hearing pursuant to Section 7(b) of the State Prompt Payment Act. State law creates other and additional remedies available to any subcontractor or material supplier, regardless of tier, who has not been paid for work properly performed or material furnished. These remedies are a lien against public funds set forth in Section 23(c) of the Mechanics Lien Act, 770 ILCS 60/23(c), and a recovery on the Contractor's payment bond according to the Public Construction Bond Act, 30 ILCS 550.

**POST MOUNTING OF SIGNS (BDE)**

Effective: January 1, 2011

Revise the second paragraph of Article 701.14 of the Standard Specifications to read:

“Post mounted signs shall be a breakaway design. The sign shall be within five degrees of vertical. Two posts shall be used for signs greater than 16 sq ft (1.5 sq m) in area or where the height between the sign and the ground exceeds 7 ft (2.1 m).”

**SELECTION OF LABOR (BDE)**

Effective: July 2, 2010

Revise Section I of Check Sheet #5 of the Recurring Special Provisions to read:

“I. SELECTION OF LABOR

The Contractor shall comply with all Illinois statutes pertaining to the selection of labor.

EMPLOYMENT OF ILLINOIS WORKERS DURING PERIODS OF EXCESSIVE  
UNEMPLOYMENT

Whenever there is a period of excessive unemployment in Illinois, which is defined herein as any month immediately following two consecutive calendar months during which the level of unemployment in the State of Illinois has exceeded five percent as measured by the United States Bureau of Labor Statistics in its monthly publication of employment and unemployment figures, the Contractor shall employ at least 90 percent Illinois laborers. "Illinois laborer" means any person who has resided in Illinois for at least 30 days and intends to become or remain an Illinois resident.

Other laborers may be used when Illinois laborers as defined herein are not available, or are incapable of performing the particular type of work involved, if so certified by the Contractor and approved by the Engineer. The Contractor may place no more than three of his/her regularly employed non-resident executive and technical experts, who do not qualify as Illinois laborers, to do work encompassed by this contract during period of excessive unemployment.

This provision applies to all labor, whether skilled, semi-skilled, or unskilled, whether manual or non-manual.”

**SUBCONTRACTOR MOBILIZATION PAYMENTS (BDE)**

Effective: April 2, 2005

To account for the preparatory work and operations necessary for the movement of subcontractor personnel, equipment, supplies, and incidentals to the project site and for all other work or operations that must be performed or costs incurred when beginning work approved for subcontracting in accordance with Article 108.01 of the Standard Specifications, the Contractor shall make a mobilization payment to each subcontractor.

This mobilization payment shall be made at least 14 days prior to the subcontractor starting work. The amount paid shall be equal to 3 percent of the amount of the subcontract reported on form BC 260A submitted for the approval of the subcontractor's work.

This provision shall be incorporated directly or by reference into each subcontract approved by the Department.

**WORKING DAYS (BDE)**

Effective: January 1, 2002

The Contractor shall complete the work within 70 working days.

**404 PERMIT**



**404 PERMIT**

Route Various Routes Marked IL 14, IL 34, IL 13, US 51, US 45, IL 145, FAS 903  
Section D9 Scour Repair 2011-1 Stream Name Various  
County Various Counties Location Franklin, Gallatin, Jackson, Johnson, Massac, Saline, and Williamson Counties

The Division of Highways, District Nine, has determined that the plans as prepared for letting are authorized under the provisions of 33 CFR 330 Nationwide Permit (NWP) No. 3, Maintenance, as published in the Federal Register March 12, 2007. Under the provisions of the authorization, the following attachments must be complied with:

1. Terms for Nationwide Permit No. 3.
2. Nationwide Permit General Conditions.
3. Illinois EPA Water Quality Certification Regional Conditions.

You are reminded that the permit determination is based upon plans as prepared for letting. Variation from these plans may result in the revocation of the permit.

## NATIONWIDE PERMITS AND CONDITIONS

The following information presents the requirements for nationwide Section 404/10 permits most often used on highway projects. The information in this guidance reflects the requirements associated with the nationwide permits that were published in the March 12, 2007 *Federal Register*.

**Permittees wishing to conduct activities under the nationwide permits must comply with the terms of the applicable permit and the conditions in Section C of this document.**

### B. Nationwide Permits

3. Maintenance. (a) The repair, rehabilitation, or replacement of any previously authorized, currently serviceable, structure, or fill, or of any currently serviceable structure or fill authorized by 33 CFR 330.3, provided that the structure or fill is not to be put to uses differing from those uses specified or contemplated for it in the original permit or the most recently authorized modification. Minor deviations in the structure's configuration or filled area, including those due to changes in materials, construction techniques, or current construction codes or safety standards that are necessary to make the repair, rehabilitation, or replacement are authorized. This NWP authorizes the repair, rehabilitation, or replacement of those structures or fills destroyed or damaged by storms, floods, fire or other discrete events, provided the repair, rehabilitation, or replacement is commenced, or is under contract to commence, within two years of the date of their destruction or damage. In cases of catastrophic events, such as hurricanes or tornadoes, this two-year limit may be waived by the district engineer, provided the permittee can demonstrate funding, contract, or other similar delays.

(b) This NWP also authorizes the removal of accumulated sediments and debris in the vicinity of and within existing structures (e.g., bridges, culverted road crossings, water intake structures, etc.) and the placement of new or additional riprap to protect the structure. The removal of sediment is limited to the minimum necessary to restore the waterway in the immediate vicinity of the structure to the approximate dimensions that existed when the structure was built, but cannot extend further than 200 feet in any direction from the structure. This 200 foot limit does not apply to maintenance dredging to remove accumulated sediments blocking or restricting outfall and intake structures or to maintenance dredging to remove accumulated sediments from canals associated with outfall and intake structures. All dredged or excavated materials must be deposited and retained in an upland area unless otherwise specifically approved by the district engineer under separate authorization. The placement of riprap must be the minimum necessary to protect the structure or to ensure the safety of the structure. Any bank stabilization measures not directly associated with the structure will require a separate authorization from the district engineer.

(c) This NWP also authorizes temporary structures, fills, and work necessary to conduct the maintenance activity. Appropriate measures must be taken to maintain normal downstream flows and minimize flooding to the maximum extent practicable, when temporary structures, work, and discharges, including cofferdams, are necessary for construction activities, access fills, or dewatering of construction sites. Temporary fills must consist of materials, and be placed in a manner, that will not be eroded by expected high flows. Temporary fills must be removed in their entirety and the affected areas returned to pre-construction elevations. The areas affected by temporary fills must be revegetated, as appropriate.

(d) This NWP does not authorize maintenance dredging for the primary purpose of navigation or beach restoration. This NWP does not authorize new stream channelization or stream relocation projects.

Notification: For activities authorized by paragraph (b) of this NWP, the permittee must submit a pre-construction notification to the district engineer prior to commencing the activity (see general condition 27). Where maintenance dredging is proposed, the pre-construction notification must include information regarding the original design capacities and configurations of the outfalls, intakes, small impoundments, and canals. (Sections 10 and 404)

Note: This NWP authorizes the repair, rehabilitation, or replacement of any previously authorized structure or fill that does not qualify for the Clean Water Act Section 404(f) exemption for maintenance.

13. Bank Stabilization. Bank stabilization activities necessary for erosion prevention, provided the activity meets all of the following criteria:

- (a) No material is placed in excess of the minimum needed for erosion protection;
- (b) The activity is no more than 500 feet in length along the bank, unless this criterion is waived in writing by the district engineer;
- (c) The activity will not exceed an average of one cubic yard per running foot placed along the bank below the plane of the ordinary high water mark or the high tide line, unless this criterion is waived in writing by the district engineer;
- (d) The activity does not involve discharges of dredged or fill material into special aquatic sites, unless this criterion is waived in writing by the district engineer;
- (e) No material is of the type, or is placed in any location, or in any manner, to impair surface water flow into or out of any water of the United States;
- (f) No material is placed in a manner that will be eroded by normal or expected high flows (properly anchored trees and treetops may be used in low energy areas); and,
- (g) The activity is not a stream channelization activity.

Notification: The permittee must submit a pre-construction notification to the district engineer prior to commencing the activity if the bank stabilization activity: (1) involves discharges into special aquatic sites; (2) is in excess of 500 feet in length; or (3) will involve the discharge of greater than an average of one cubic yard per running foot along the bank below the plane of the ordinary high water mark or the high tide line. (See general condition 27.) (Sections 10 and 404)

14. Linear Transportation Projects. Activities required for the construction, expansion, modification, or improvement of linear transportation projects (e.g., roads, highways, railways, trails, airport runways, and taxiways) in waters of the United States. For linear transportation projects in non-tidal waters, the discharge cannot cause the loss of greater than 1/2-acre of waters of the United States. For linear transportation projects in tidal waters, the discharge cannot cause the loss of greater than 1/3-acre of waters of the United States. Any stream channel modification, including bank stabilization, is limited to the minimum necessary to construct or protect the linear transportation project; such modifications must be in the immediate vicinity of the project.

This NWP also authorizes temporary structures, fills, and work necessary to construct the linear transportation project. Appropriate measures must be taken to maintain normal downstream flows and minimize flooding to the maximum extent practicable, when temporary structures, work, and discharges, including cofferdams, are necessary for construction activities, access fills, or dewatering of construction sites. Temporary fills must consist of materials, and be placed in a manner, that will not be eroded by expected high flows. Temporary fills must be removed in their entirety and the affected areas returned to pre-construction elevations. The areas affected by temporary fills must be revegetated, as appropriate.

This NWP cannot be used to authorize non-linear features commonly associated with transportation projects, such as vehicle maintenance or storage buildings, parking lots, train stations, or aircraft hangars.

Notification: The permittee must submit a pre-construction notification to the district engineer prior to commencing the activity if: (1) the loss of waters of the United States exceeds 1/10 acre; or (2) there is a discharge in a special aquatic site, including wetlands. (See general condition 27.) (Sections 10 and 404)

Note: Some discharges for the construction of farm roads or forest roads, or temporary roads for moving mining equipment, may qualify for an exemption under Section 404(f) of the Clean Water Act (see 33 CFR 323.4).

23. Approved Categorical Exclusions. Activities undertaken, assisted, authorized, regulated, funded, or financed, in whole or in part, by another Federal agency or department where:

(a) That agency or department has determined, pursuant to the Council on Environmental Quality's implementing regulations for the National Environmental Policy Act (40 CFR part 1500 et seq.), that the activity is categorically excluded from environmental documentation, because it is included within a category of actions which neither individually nor cumulatively have a significant effect on the human environment; and

(b) The Office of the Chief of Engineers (Attn: CECW-CO) has concurred with that agency's or department's determination that the activity is categorically excluded and approved the activity for authorization under NWP 23.

The Office of the Chief of Engineers may require additional conditions, including pre-construction notification, for authorization of an agency's categorical exclusions under this NWP.

Notification: Certain categorical exclusions approved for authorization under this NWP require the permittee to submit a pre-construction notification to the district engineer prior to commencing the activity (see general condition 27). The activities that require pre-construction notification are listed in the appropriate Regulatory Guidance Letters. (Sections 10 and 404)

Note: The agency or department may submit an application for an activity believed to be categorically excluded to the Office of the Chief of Engineers (Attn: CECW-CO). Prior to approval for authorization under this NWP of any agency's activity, the Office of the Chief of Engineers will solicit public comment. As of the date of issuance of this NWP, agencies with approved categorical exclusions are the: Bureau of Reclamation, Federal Highway

Administration, and U.S. Coast Guard. Activities approved for authorization under this NWP as of the date of this notice are found in Corps Regulatory Guidance Letter 05-07, which is available at: <http://www.usace.army.mil/inet/functions/cw/cecwo/reg/rxlsindx.htm> . Any future approved categorical exclusions will be announced in Regulatory Guidance Letters and posted on this same web site.

33. Temporary Construction, Access, and Dewatering. Temporary structures, work, and discharges, including cofferdams, necessary for construction activities or access fills or dewatering of construction sites, provided that the associated primary activity is authorized by the Corps of Engineers or the U.S. Coast Guard. This NWP also authorizes temporary structures, work, and discharges, including cofferdams, necessary for construction activities not otherwise subject to the Corps or U.S. Coast Guard permit requirements. Appropriate measures must be taken to maintain near normal downstream flows and to minimize flooding. Fill must consist of materials, and be placed in a manner, that will not be eroded by expected high flows. The use of dredged material may be allowed if the district engineer determines that it will not cause more than minimal adverse effects on aquatic resources. Following completion of construction, temporary fill must be entirely removed to upland areas, dredged material must be returned to its original location, and the affected areas must be restored to pre-construction elevations. The affected areas must also be revegetated, as appropriate. This permit does not authorize the use of cofferdams to dewater wetlands or other aquatic areas to change their use. Structures left in place after construction is completed require a section 10 permit if located in navigable waters of the United States. (See 33 CFR part 322.)

Notification: The permittee must submit a pre-construction notification to the district engineer prior to commencing the activity (see general condition 27). The pre-construction notification must include a restoration plan showing how all temporary fills and structures will be removed and the area restored to pre-project conditions. (Sections 10 and 404)

### **C. Nationwide Permit General Conditions**

Note: To qualify for NWP authorization, the prospective permittee must comply with the following general conditions, as appropriate, in addition to any regional or case-specific conditions imposed by the division engineer or district engineer. Prospective permittees should contact the appropriate Corps district office to determine if regional conditions have been imposed on an NWP. Prospective permittees should also contact the appropriate Corps district office to determine the status of Clean Water Act Section 401 water quality certification and/or Coastal Zone Management Act consistency for an NWP.

1. Navigation. (a) No activity may cause more than a minimal adverse effect on navigation.

(b) Any safety lights and signals prescribed by the U.S. Coast Guard, through regulations or otherwise, must be installed and maintained at the permittee's expense on authorized facilities in navigable waters of the United States.

(c) The permittee understands and agrees that, if future operations by the United States require the removal, relocation, or other alteration, of the structure or work herein authorized, or if, in the opinion of the Secretary of the Army or his authorized representative, said structure or work shall cause unreasonable obstruction to the free navigation of the navigable waters, the permittee will be required, upon due notice from the Corps of Engineers, to remove, relocate, or alter the structural work or obstructions caused thereby, without expense to the United States.



No claim shall be made against the United States on account of any such removal or alteration.

2. Aquatic Life Movements. No activity may substantially disrupt the necessary life cycle movements of those species of aquatic life indigenous to the waterbody, including those species that normally migrate through the area, unless the activity's primary purpose is to impound water. Culverts placed in streams must be installed to maintain low flow conditions.

3. Spawning Areas. Activities in spawning areas during spawning seasons must be avoided to the maximum extent practicable. Activities that result in the physical destruction (e.g., through excavation, fill, or downstream smothering by substantial turbidity) of an important spawning area are not authorized.

4. Migratory Bird Breeding Areas. Activities in waters of the United States that serve as breeding areas for migratory birds must be avoided to the maximum extent practicable.

5. Shellfish Beds. No activity may occur in areas of concentrated shellfish populations, unless the activity is directly related to a shellfish harvesting activity authorized by NWP 4 and 48.

6. Suitable Material. No activity may use unsuitable material (e.g., trash, debris, car bodies, asphalt, etc.). Material used for construction or discharged must be free from toxic pollutants in toxic amounts (see Section 307 of the Clean Water Act).

7. Water Supply Intakes. No activity may occur in the proximity of a public water supply intake, except where the activity is for the repair or improvement of public water supply intake structures or adjacent bank stabilization.

8. Adverse Effects From Impoundments. If the activity creates an impoundment of water, adverse effects to the aquatic system due to accelerating the passage of water, and/or restricting its flow must be minimized to the maximum extent practicable.

9. Management of Water Flows. To the maximum extent practicable, the pre-construction course, condition, capacity, and location of open waters must be maintained for each activity, including stream channelization and storm water management activities, except as provided below. The activity must be constructed to withstand expected high flows. The activity must not restrict or impede the passage of normal or high flows, unless the primary purpose of the activity is to impound water or manage high flows. The activity may alter the pre-construction course, condition, capacity, and location of open waters if it benefits the aquatic environment (e.g., stream restoration or relocation activities).

10. Fills Within 100-Year Floodplains. The activity must comply with applicable FEMA-approved state or local floodplain management requirements.

11. Equipment. Heavy equipment working in wetlands or mudflats must be placed on mats, or other measures must be taken to minimize soil disturbance.

12. Soil Erosion and Sediment Controls. Appropriate soil erosion and sediment controls must be used and maintained in effective operating condition during construction, and all

exposed soil and other fills, as well as any work below the ordinary high water mark or high tide line, must be permanently stabilized at the earliest practicable date. Permittees are encouraged to perform work within waters of the United States during periods of low-flow or no-flow.

13. Removal of Temporary Fills. Temporary fills must be removed in their entirety and the affected areas returned to pre-construction elevations. The affected areas must be revegetated, as appropriate.

14. Proper Maintenance. Any authorized structure or fill shall be properly maintained, including maintenance to ensure public safety.

15. Wild and Scenic Rivers. No activity may occur in a component of the National Wild and Scenic River System, or in a river officially designated by Congress as a “study river” for possible inclusion in the system while the river is in an official study status, unless the appropriate Federal agency with direct management responsibility for such river, has determined in writing that the proposed activity will not adversely affect the Wild and Scenic River designation or study status. Information on Wild and Scenic Rivers may be obtained from the appropriate Federal land management agency in the area (e.g., National Park Service, U.S. Forest Service, Bureau of Land Management, U.S. Fish and Wildlife Service).

16. Tribal Rights. No activity or its operation may impair reserved tribal rights, including, but not limited to, reserved water rights and treaty fishing and hunting rights.

17. Endangered Species. (a) No activity is authorized under any NWP which is likely to jeopardize the continued existence of a threatened or endangered species or a species proposed for such designation, as identified under the Federal Endangered Species Act (ESA), or which will destroy or adversely modify the critical habitat of such species. No activity is authorized under any NWP which “may affect” a listed species or critical habitat, unless Section 7 consultation addressing the effects of the proposed activity has been completed.

(b) Federal agencies should follow their own procedures for complying with the requirements of the ESA. Federal permittees must provide the district engineer with the appropriate documentation to demonstrate compliance with those requirements.

(c) Non-federal permittees shall notify the district engineer if any listed species or designated critical habitat might be affected or is in the vicinity of the project, or if the project is located in designated critical habitat, and shall not begin work on the activity until notified by the district engineer that the requirements of the ESA have been satisfied and that the activity is authorized. For activities that might affect Federally-listed endangered or threatened species or designated critical habitat, the pre-construction notification must include the name(s) of the endangered or threatened species that may be affected by the proposed work or that utilize the designated critical habitat that may be affected by the proposed work. The district engineer will determine whether the proposed activity “may affect” or will have “no effect” to listed species and designated critical habitat and will notify the non-Federal applicant of the Corps’ determination within 45 days of receipt of a complete pre-construction notification. In cases where the non-Federal applicant has identified listed species or critical habitat that might be affected or is in the vicinity of the project, and has so notified the Corps, the applicant shall not begin work until the Corps has provided notification the proposed activities will have “no effect” on listed species or critical habitat, or until Section 7 consultation has been completed.

(d) As a result of formal or informal consultation with the FWS or NMFS the district engineer may add species-specific regional endangered species conditions to the NWP.

(e) Authorization of an activity by a NWP does not authorize the “take” of a threatened or endangered species as defined under the ESA. In the absence of separate authorization (e.g., an ESA Section 10 Permit, a Biological Opinion with “incidental take” provisions, etc.) from the U.S. FWS or the NMFS, both lethal and non-lethal “takes” of protected species are in violation of the ESA. Information on the location of threatened and endangered species and their critical habitat can be obtained directly from the offices of the U.S. FWS and NMFS or their world wide Web pages at <http://www.fws.gov/> and <http://www.noaa.gov/fisheries.html> respectively.

18. Historic Properties. (a) In cases where the district engineer determines that the activity may affect properties listed, or eligible for listing, in the National Register of Historic Places, the activity is not authorized, until the requirements of Section 106 of the National Historic Preservation Act (NHPA) have been satisfied.

(b) Federal permittees should follow their own procedures for complying with the requirements of Section 106 of the National Historic Preservation Act. Federal permittees must provide the district engineer with the appropriate documentation to demonstrate compliance with those requirements.

(c) Non-federal permittees must submit a pre-construction notification to the district engineer if the authorized activity may have the potential to cause effects to any historic properties listed, determined to be eligible for listing on, or potentially eligible for listing on the National Register of Historic Places, including previously unidentified properties. For such activities, the pre-construction notification must state which historic properties may be affected by the proposed work or include a vicinity map indicating the location of the historic properties or the potential for the presence of historic properties. Assistance regarding information on the location of or potential for the presence of historic resources can be sought from the State Historic Preservation Officer or Tribal Historic Preservation Officer, as appropriate, and the National Register of Historic Places (see 33 CFR 330.4(g)). The district engineer shall make a reasonable and good faith effort to carry out appropriate identification efforts, which may include background research, consultation, oral history interviews, sample field investigation, and field survey. Based on the information submitted and these efforts, the district engineer shall determine whether the proposed activity has the potential to cause an effect on the historic properties. Where the non-Federal applicant has identified historic properties which the activity may have the potential to cause effects and so notified the Corps, the non-Federal applicant shall not begin the activity until notified by the district engineer either that the activity has no potential to cause effects or that consultation under Section 106 of the NHPA has been completed.

(d) The district engineer will notify the prospective permittee within 45 days of receipt of a complete pre-construction notification whether NHPA Section 106 consultation is required. Section 106 consultation is not required when the Corps determines that the activity does not have the potential to cause effects on historic properties (see 36 CFR 800.3(a)). If NHPA section 106 consultation is required and will occur, the district engineer will notify the non-Federal applicant that he or she cannot begin work until Section 106 consultation is completed.

(e) Prospective permittees should be aware that section 110k of the NHPA (16 U.S.C. 470h-2(k)) prevents the Corps from granting a permit or other assistance to an applicant who, with intent to avoid the requirements of Section 106 of the NHPA, has intentionally significantly adversely affected a historic property to which the permit would relate, or having legal power to prevent it, allowed such significant adverse effect to occur, unless the Corps, after consultation

with the Advisory Council on Historic Preservation (ACHP), determines that circumstances justify granting such assistance despite the adverse effect created or permitted by the applicant. If circumstances justify granting the assistance, the Corps is required to notify the ACHP and provide documentation specifying the circumstances, explaining the degree of damage to the integrity of any historic properties affected, and proposed mitigation. This documentation must include any views obtained from the applicant, SHPO/THPO, appropriate Indian tribes if the undertaking occurs on or affects historic properties on tribal lands or affects properties of interest to those tribes, and other parties known to have a legitimate interest in the impacts to the permitted activity on historic properties.

19. Designated Critical Resource Waters. Critical resource waters include, NOAA-designated marine sanctuaries, National Estuarine Research Reserves, state natural heritage sites, and outstanding national resource waters or other waters officially designated by a state as having particular environmental or ecological significance and identified by the district engineer after notice and opportunity for public comment. The district engineer may also designate additional critical resource waters after notice and opportunity for comment.

(a) Discharges of dredged or fill material into waters of the United States are not authorized by NWPs 7, 12, 14, 16, 17, 21, 29, 31, 35, 39, 40, 42, 43, 44, 49, and 50 for any activity within, or directly affecting, critical resource waters, including wetlands adjacent to such waters.

(b) For NWPs 3, 8, 10, 13, 15, 18, 19, 22, 23, 25, 27, 28, 30, 33, 34, 36, 37, and 38, notification is required in accordance with general condition 27, for any activity proposed in the designated critical resource waters including wetlands adjacent to those waters. The district engineer may authorize activities under these NWPs only after it is determined that the impacts to the critical resource waters will be no more than minimal.

20. Mitigation. The district engineer will consider the following factors when determining appropriate and practicable mitigation necessary to ensure that adverse effects on the aquatic environment are minimal:

(a) The activity must be designed and constructed to avoid and minimize adverse effects, both temporary and permanent, to waters of the United States to the maximum extent practicable at the project site (i.e., on site).

(b) Mitigation in all its forms (avoiding, minimizing, rectifying, reducing, or compensating) will be required to the extent necessary to ensure that the adverse effects to the aquatic environment are minimal.

(c) Compensatory mitigation at a minimum one-for-one ratio will be required for all wetland losses that exceed 1/10 acre and require pre-construction notification, unless the district engineer determines in writing that some other form of mitigation would be more environmentally appropriate and provides a project-specific waiver of this requirement. For wetland losses of 1/10 acre or less that require pre-construction notification, the district engineer may determine on a case-by-case basis that compensatory mitigation is required to ensure that the activity results in minimal adverse effects on the aquatic environment. Since the likelihood of success is greater and the impacts to potentially valuable uplands are reduced, wetland restoration should be the first compensatory mitigation option considered.

(d) For losses of streams or other open waters that require pre-construction notification, the district engineer may require compensatory mitigation, such as stream restoration, to ensure that the activity results in minimal adverse effects on the aquatic environment.

(e) Compensatory mitigation will not be used to increase the acreage losses allowed by the acreage limits of the NWPs. For example, if an NWP has an acreage limit of 1/2 acre, it cannot be used to authorize any project resulting in the loss of greater than 1/2 acre of waters of the United States, even if compensatory mitigation is provided that replaces or restores some of the lost waters. However, compensatory mitigation can and should be used, as necessary, to ensure that a project already meeting the established acreage limits also satisfies the minimal impact requirement associated with the NWPs.

(f) Compensatory mitigation plans for projects in or near streams or other open waters will normally include a requirement for the establishment, maintenance, and legal protection (e.g., conservation easements) of riparian areas next to open waters. In some cases, riparian areas may be the only compensatory mitigation required. Riparian areas should consist of native species. The width of the required riparian area will address documented water quality or aquatic habitat loss concerns. Normally, the riparian area will be 25 to 50 feet wide on each side of the stream, but the district engineer may require slightly wider riparian areas to address documented water quality or habitat loss concerns. Where both wetlands and open waters exist on the project site, the district engineer will determine the appropriate compensatory mitigation (e.g., riparian areas and/or wetlands compensation) based on what is best for the aquatic environment on a watershed basis. In cases where riparian areas are determined to be the most appropriate form of compensatory mitigation, the district engineer may waive or reduce the requirement to provide wetland compensatory mitigation for wetland losses.

(g) Permittees may propose the use of mitigation banks, in-lieu fee arrangements or separate activity-specific compensatory mitigation. In all cases, the mitigation provisions will specify the party responsible for accomplishing and/or complying with the mitigation plan.

(h) Where certain functions and services of waters of the United States are permanently adversely affected, such as the conversion of a forested or scrub-shrub wetland to a herbaceous wetland in a permanently maintained utility line right-of-way, mitigation may be required to reduce the adverse effects of the project to the minimal level.

21. Water Quality. Where States and authorized Tribes, or EPA where applicable, have not previously certified compliance of an NWP with CWA Section 401, individual 401 Water Quality Certification must be obtained or waived (see 33 CFR 330.4(c)). The district engineer or State or Tribe may require additional water quality management measures to ensure that the authorized activity does not result in more than minimal degradation of water quality.

22. Coastal Zone Management. In coastal states where an NWP has not previously received a state coastal zone management consistency concurrence, an individual state coastal zone management consistency concurrence must be obtained, or a presumption of concurrence must occur (see 33 CFR 330.4(d)). The district engineer or a State may require additional measures to ensure that the authorized activity is consistent with state coastal zone management requirements.

23. Regional and Case-By-Case Conditions. The activity must comply with any regional conditions that may have been added by the Division Engineer (see 33 CFR 330.4(e)) and with any case specific conditions added by the Corps or by the state, Indian Tribe, or U.S. EPA in its section 401 Water Quality Certification, or by the state in its Coastal Zone Management Act consistency determination.

24. Use of Multiple Nationwide Permits. The use of more than one NWP for a single and complete project is prohibited, except when the acreage loss of waters of the United States authorized by the NWP does not exceed the acreage limit of the NWP with the highest specified acreage limit. For example, if a road crossing over tidal waters is constructed under NWP 14, with associated bank stabilization authorized by NWP 13, the maximum acreage loss of waters of the United States for the total project cannot exceed 1/3-acre.

25. Transfer of Nationwide Permit Verifications. If the permittee sells the property associated with a nationwide permit verification, the permittee may transfer the nationwide permit verification to the new owner by submitting a letter to the appropriate Corps district office to validate the transfer. A copy of the nationwide permit verification must be attached to the letter, and the letter must contain the following statement and signature: "When the structures or work authorized by this nationwide permit are still in existence at the time the property is transferred, the terms and conditions of this nationwide permit, including any special conditions, will continue to be binding on the new owner(s) of the property. To validate the transfer of this nationwide permit and the associated liabilities associated with compliance with its terms and conditions, have the transferee sign and date below."

---

(Transferee)

---

(Date)

26. Compliance Certification. Each permittee who received an NWP verification from the Corps must submit a signed certification regarding the completed work and any required mitigation. The certification form must be forwarded by the Corps with the NWP verification letter and will include:

- (a) A statement that the authorized work was done in accordance with the NWP authorization, including any general or specific conditions;
- (b) A statement that any required mitigation was completed in accordance with the permit conditions; and
- (c) The signature of the permittee certifying the completion of the work and mitigation.

27. Pre-Construction Notification. (a) Timing. Where required by the terms of the NWP, the prospective permittee must notify the district engineer by submitting a pre-construction notification (PCN) as early as possible. The district engineer must determine if the PCN is complete within 30 calendar days of the date of receipt and, as a general rule, will request additional information necessary to make the PCN complete only once. However, if the prospective permittee does not provide all of the requested information, then the district engineer will notify the prospective permittee that the PCN is still incomplete and the PCN review process will not commence until all of the requested information has been received by the district engineer. The prospective permittee shall not begin the activity until either:

- (1) He or she is notified in writing by the district engineer that the activity may proceed under the NWP with any special conditions imposed by the district or division engineer; or
- (2) Forty-five calendar days have passed from the district engineer's receipt of the complete PCN and the prospective permittee has not received written notice from the district or division engineer. However, if the permittee was required to notify the Corps pursuant to general

condition 17 that listed species or critical habitat might be affected or in the vicinity of the project, or to notify the Corps pursuant to general condition 18 that the activity may have the potential to cause effects to historic properties, the permittee cannot begin the activity until receiving written notification from the Corps that is “no effect” on listed species or “no potential to cause effects” on historic properties, or that any consultation required under Section 7 of the Endangered Species Act (see 33 CFR 330.4(f)) and/or Section 106 of the National Historic Preservation Act (see 33 CFR 330.4(g)) is completed. Also, work cannot begin under NWP 21, 49, or 50 until the permittee has received written approval from the Corps. If the proposed activity requires a written waiver to exceed specified limits of an NWP, the permittee cannot begin the activity until the district engineer issues the waiver. If the district or division engineer notifies the permittee in writing that an individual permit is required within 45 calendar days of receipt of a complete PCN, the permittee cannot begin the activity until an individual permit has been obtained. Subsequently, the permittee’s right to proceed under the NWP may be modified, suspended, or revoked only in accordance with the procedure set forth in 33 CFR 330.5(d)(2).

(b) Contents of Pre-Construction Notification: The PCN must be in writing and include the following information:

- (1) Name, address and telephone numbers of the prospective permittee;
- (2) Location of the proposed project;
- (3) A description of the proposed project; the project’s purpose; direct and indirect adverse environmental effects the project would cause; any other NWP(s), regional general permit(s), or individual permit(s) used or intended to be used to authorize any part of the proposed project or any related activity. The description should be sufficiently detailed to allow the district engineer to determine that the adverse effects of the project will be minimal and to determine the need for compensatory mitigation. Sketches should be provided when necessary to show that the activity complies with the terms of the NWP. (Sketches usually clarify the project and when provided result in a quicker decision.);
- (4) The PCN must include a delineation of special aquatic sites and other waters of the United States on the project site. Wetland delineations must be prepared in accordance with the current method required by the Corps. The permittee may ask the Corps to delineate the special aquatic sites and other waters of the United States, but there may be a delay if the Corps does the delineation, especially if the project site is large or contains many waters of the United States. Furthermore, the 45 day period will not start until the delineation has been submitted to or completed by the Corps, where appropriate;
- (5) If the proposed activity will result in the loss of greater than 1/10 acre of wetlands and a PCN is required, the prospective permittee must submit a statement describing how the mitigation requirement will be satisfied. As an alternative, the prospective permittee may submit a conceptual or detailed mitigation plan.
- (6) If any listed species or designated critical habitat might be affected or is in the vicinity of the project, or if the project is located in designated critical habitat, for non-Federal applicants the PCN must include the name(s) of those endangered or threatened species that might be affected by the proposed work or utilize the designated critical habitat that may be affected by the proposed work. Federal applicants must provide documentation demonstrating compliance with the Endangered Species Act; and
- (7) For an activity that may affect a historic property listed on, determined to be eligible for listing on, or potentially eligible for listing on, the National Register of Historic Places, for non-Federal applicants the PCN must state which historic property may be affected by the proposed work or include a vicinity map indicating the location of the historic property. Federal applicants must provide documentation demonstrating compliance with Section 106 of the National Historic Preservation Act.

(c) Form of Pre-Construction Notification: The standard individual permit application form (Form ENG 4345) may be used, but the completed application form must clearly indicate that it is a PCN and must include all of the information required in paragraphs (b)(1) through (7) of this general condition. A letter containing the required information may also be used.

(d) Agency Coordination: (1) The district engineer will consider any comments from Federal and state agencies concerning the proposed activity's compliance with the terms and conditions of the NWP and the need for mitigation to reduce the project's adverse environmental effects to a minimal level.

(2) For all NWP 48 activities requiring pre-construction notification and for other NWP activities requiring pre-construction notification to the district engineer that result in the loss of greater than 1/2-acre of waters of the United States, the district engineer will immediately provide (e.g., via facsimile transmission, overnight mail, or other expeditious manner) a copy of the PCN to the appropriate Federal or state offices (U.S. FWS, state natural resource or water quality agency, EPA, State Historic Preservation Officer (SHPO) or Tribal Historic Preservation Office (THPO), and, if appropriate, the NMFS). With the exception of NWP 37, these agencies will then have 10 calendar days from the date the material is transmitted to telephone or fax the district engineer notice that they intend to provide substantive, site-specific comments. If so contacted by an agency, the district engineer will wait an additional 15 calendar days before making a decision on the pre-construction notification. The district engineer will fully consider agency comments received within the specified time frame, but will provide no response to the resource agency, except as provided below. The district engineer will indicate in the administrative record associated with each pre-construction notification that the resource agencies' concerns were considered. For NWP 37, the emergency watershed protection and rehabilitation activity may proceed immediately in cases where there is an unacceptable hazard to life or a significant loss of property or economic hardship will occur. The district engineer will consider any comments received to decide whether the NWP 37 authorization should be modified, suspended, or revoked in accordance with the procedures at 33 CFR 330.5.

(3) In cases of where the prospective permittee is not a Federal agency, the district engineer will provide a response to NMFS within 30 calendar days of receipt of any Essential Fish Habitat conservation recommendations, as required by Section 305(b)(4)(B) of the Magnuson-Stevens Fishery Conservation and Management Act.

(4) Applicants are encouraged to provide the Corps multiple copies of pre-construction notifications to expedite agency coordination.

(5) For NWP 48 activities that require reporting, the district engineer will provide a copy of each report within 10 calendar days of receipt to the appropriate regional office of the NMFS.

(e) District Engineer's Decision: In reviewing the PCN for the proposed activity, the district engineer will determine whether the activity authorized by the NWP will result in more than minimal individual or cumulative adverse environmental effects or may be contrary to the public interest. If the proposed activity requires a PCN and will result in a loss of greater than 1/10 acre of wetlands, the prospective permittee should submit a mitigation proposal with the PCN. Applicants may also propose compensatory mitigation for projects with smaller impacts. The district engineer will consider any proposed compensatory mitigation the applicant has included in the proposal in determining whether the net adverse environmental effects to the aquatic environment of the proposed work are minimal. The compensatory mitigation proposal may be either conceptual or detailed. If the district engineer determines that the activity complies with the terms and conditions of the NWP and that the adverse effects on the aquatic environment are minimal, after considering mitigation, the district engineer will notify the permittee and include any conditions the district engineer deems necessary. The district



engineer must approve any compensatory mitigation proposal before the permittee commences work. If the prospective permittee elects to submit a compensatory mitigation plan with the PCN, the district engineer will expeditiously review the proposed compensatory mitigation plan. The district engineer must review the plan within 45 calendar days of receiving a complete PCN and determine whether the proposed mitigation would ensure no more than minimal adverse effects on the aquatic environment. If the net adverse effects of the project on the aquatic environment (after consideration of the compensatory mitigation proposal) are determined by the district engineer to be minimal, the district engineer will provide a timely written response to the applicant. The response will state that the project can proceed under the terms and conditions of the NWP.

If the district engineer determines that the adverse effects of the proposed work are more than minimal, then the district engineer will notify the applicant either: (1) That the project does not qualify for authorization under the NWP and instruct the applicant on the procedures to seek authorization under an individual permit; (2) that the project is authorized under the NWP subject to the applicant's submission of a mitigation plan that would reduce the adverse effects on the aquatic environment to the minimal level; or (3) that the project is authorized under the NWP with specific modifications or conditions. Where the district engineer determines that mitigation is required to ensure no more than minimal adverse effects occur to the aquatic environment, the activity will be authorized within the 45-day PCN period. The authorization will include the necessary conceptual or specific mitigation or a requirement that the applicant submit a mitigation plan that would reduce the adverse effects on the aquatic environment to the minimal level. When mitigation is required, no work in waters of the United States may occur until the district engineer has approved a specific mitigation plan.

28. Single and Complete Project. The activity must be a single and complete project. The same NWP cannot be used more than once for the same single and complete project.

**IEPA REGIONAL CONDITIONS**



**ILLINOIS ENVIRONMENTAL PROTECTION AGENCY**

1021 NORTH GRAND AVENUE EAST, P.O. BOX 19276, SPRINGFIELD, ILLINOIS 62794-9276 - (217) 782-3397  
JAMES R. THOMPSON CENTER, 100 WEST RANDOLPH, SUITE 11-300, CHICAGO, IL 60601 - (312) 814-6026

ROD R. BLAGOJEVICH, GOVERNOR      DOUGLAS P. SCOTT, DIRECTOR

217/782-3362

MAY 10 2007

**RECEIVED**  
MAY 14 2007  
**CEMVR-OD-P**

Rock Island District  
Corps of Engineers  
Clock Tower Building  
Rock Island, IL 61201

Re: Final Notice of Issuance of Nationwide Permits, March 12, 2007  
Section 401 Certifications, Denials, and Regional Conditions

Gentlemen:

On March 12, 2007 the Corps of Engineers issued the final notice concerning the disposition of the expiring Nationwide Permits (NWP) under Section 10 of the 1899 Rivers and Harbors Act and Section 404 of the Clean Water Act.

Based on our review of the final rules, Section 401 certifications are hereby issued for the following NWP without conditions:

- NWP 4 - Fish and Wildlife Harvesting, Enhancement, and Attraction Device and Activities
- NWP 5 - Scientific Measuring Devices
- NWP 7 - Outfall Structures and Associated Intake Structures
- NWP 20 - Oil Spill Cleanup
- NWP 22 - Removal of Vessels
- NWP 36 - Boat Ramps
- NWP 45 - Emergency Repair Activities

In addition, the following NWP are hereby issued Section 401 certifications subject to the regional conditions as indicated below:

- NWP 3 - Maintenance. Refer to Regional Conditions contained in Attachment 1
- NWP 6 - Survey Activities. Refer to Regional Conditions contained in Attachment 2
- NWP 12 - Utility Line Activities. Refer to Regional Conditions contained in Attachment 3
- NWP 13 - Bank Stabilization. Refer to Regional Conditions contained in Attachment 4

ROCKFORD - 4302 North Main Street, Rockford, IL 61103 - (815) 987-7760 • DES PLAINES - 9511 W. Harrison St., Des Plaines, IL 60016 - (847) 294-4000  
ELGIN - 595 South State, Elgin, IL 60123 - (847) 608-3131 • PEORIA - 5415 N. University St., Peoria, IL 61614 - (309) 693-5463  
BUREAU OF LAND - PEORIA - 7620 N. University St., Peoria, IL 61614 - (309) 693-5462 • CHAMPAIGN - 2125 South First Street, Champaign, IL 61820 - (217) 278-5800  
SPRINGFIELD - 4500 S. Sixth Street Rd., Springfield, IL 62706 - (217) 786-6892 • COLLINSVILLE - 2009 Mall Street, Collinsville, IL 62234 - (618) 346-5120  
MARION - 2309 W. Main St., Suite 116, Marion, IL 62959 - (618) 993-7200

NWP 14 - Linear Transportation Projects. Refer to Regional Conditions contained in Attachment 5

NWP 27 - Aquatic Habitat Restoration, Establishment, and Enhancement Activities. All activities conducted under NWP 27 shall be in accordance with the provisions of 35 Ill. Adm. Code 405.108. Work in reclaimed surface coal mine areas are required to obtain prior authorization from the Illinois EPA for any activities that result in the use of acid-producing mine refuse.

NWP 33 - Temporary Construction, Access and Dewatering. Refer to Regional Conditions contained in Attachment 6

NWP 38 - Cleanup of Hazardous and Toxic Waste. Refer to Regional Conditions contained in Attachment 7

NWP 41 - Reshaping Existing Drainage Ditches. Refer to Regional Conditions contained in Attachment 8

NWP 46 - Discharges into Ditches. Refer to Regional Conditions contained in Attachment 9

NWP 47 - Pipeline Safety Program Designated Time Sensitive Inspections and Repairs. Refer to Regional Conditions contained in Attachment 10

Section 401 Certification is denied for the following NWP:

- NWP 15 - U.S. Coast Guard Approved Bridges
- NWP 16 - Return Water from Upland Contained Disposal Areas
- NWP 17 - Hydropower Projects
- NWP 18 - Minor Discharges
- NWP 19 - Minor Dredging
- NWP 21 - Surface Coal Mining Activities
- NWP 23 - Approved Categorical Exclusions
- NWP 25 - Structural Discharges
- NWP 29 - Residential Development
- NWP 30 - Moist Soil Management for Wildlife
- NWP 31 - Maintenance of Existing Flood Control Facilities
- NWP 32 - Completed Enforcement Actions
- NWP 34 - Cranberry Production Activities
- NWP 37 - Emergency Watershed Protection and Rehabilitation
- NWP 39 - Commercial, and Institutional Developments
- NWP 40 - Agricultural Activities
- NWP 42 - Recreational Facilities
- NWP 43 - Stormwater Management Facilities
- NWP 44 - Mining Activities

Page 3  
Nationwide Permits

NWP 48 - Commercial Shellfish Aquaculture Activities  
NWP 49 - Coal Remining Activities  
NWP 50 - Underground Coal Mining Activities

Should you have any questions or comments regarding the content of this letter, please contact me or my staff at the above telephone number and address.

Sincerely,

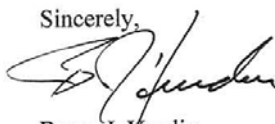

Bruce J. Yurdin  
Manager, Watershed Management Section  
Bureau of Water

cc: Records Unit  
CoE, Chicago District  
CoE, Louisville District  
CoE, Memphis District  
CoE, St. Louis District  
IDNR, OWR, DWRM, Schaumburg and Springfield  
USEPA, Region 5  
USFWS, Rock Island, Barrington and Marion

Attachment 1

**ILLINOIS EPA WATER QUALITY CERTIFICATION  
REGIONAL CONDITIONS FOR NATIONWIDE PERMIT 3**

1. The applicant shall not cause:
  - A. violation of applicable provisions of the Illinois Environmental Protection Act;
  - B. water pollution defined and prohibited by the Illinois Environmental Protection Act;
  - C. violation of applicable water quality standards of the Illinois Pollution Control Board, Title 35, Subtitle C: Water Pollution Rules and Regulation; or
  - D. interference with water use practices near public recreation areas or water supply intakes.
2. Any spoil material excavated, dredged or otherwise produced must not be returned to the waterway but must be deposited in a self-contained area in compliance with all state statutes, as determined by the Illinois EPA.
3. Any backfilling must be done with clean material and placed in a manner to prevent violation of applicable water quality standards.
4. The applicant for Nationwide Permit shall provide adequate planning and supervision during the project construction period for implementing construction methods, processes and cleanup procedures necessary to prevent water pollution and control erosion.
5. All areas affected by construction shall be mulched and seeded as soon after construction as possible. The applicant for Nationwide 3 shall undertake necessary measures and procedures to reduce erosion during construction. Interim measures to prevent erosion during construction shall be taken and may include the installation of staked straw bales, sedimentation basins and temporary mulching. All construction within the waterway shall be conducted during zero or low flow conditions. The applicant for Nationwide 3 shall be responsible for obtaining an NPDES Storm Water Permit prior to initiating construction if the construction activity associated with the project will result in the disturbance of 1 (one) or more acres, total land area. An NPDES Storm Water Permit may be obtained by submitting a properly completed Notice of Intent (NOI) form by certified mail to the Agency's Division of Water Pollution Control, Permit Section.
6. The applicant for Nationwide 3 shall implement erosion control measures consistent with the "Illinois Urban Manual" (IEPA/USDA, NRCS; 2002).
7. Temporary work pads, cofferdams, access roads and other temporary fills shall be constructed of clean coarse aggregate or non-erodible non-carthen fill material that will not cause siltation. Sandbags, pre-fabricated rigid materials, sheet piling, inflatable bladders and fabric lined basins may be used for temporary facilities.
8. The applicant for Nationwide 3 that uses temporary work pads, cofferdams, access roads and other temporary fills in order to perform work in creeks, streams, or rivers shall maintain flow in these waters by utilizing dam and pumping, fluming, culverts or other such techniques.

Attachment 2

**ILLINOIS EPA WATER QUALITY CERTIFICATION  
REGIONAL CONDITIONS FOR NATIONWIDE PERMIT 6**

1. The applicant shall not cause:
  - A. violation of applicable provisions of the Illinois Environmental Protection Act;
  - B. water pollution defined and prohibited by the Illinois Environmental Protection Act;
  - C. violation of applicable water quality standards of the Illinois Pollution Control Board, Title 35, Subtitle C: Water Pollution Rules and Regulation; or
  - D. interference with water use practices near public recreation areas or water supply intakes.
2. The applicant for Nationwide Permit shall provide adequate planning and supervision during the project construction period for implementing construction methods, processes and cleanup procedures necessary to prevent water pollution and control erosion.
3. Material resulting from trench excavation within surface waters of the State may be temporarily sidecast adjacent to the trench excavation provided that:
  - A. Sidecast material is not placed within a creek, stream, river or other flowing water body such that material dispersion could occur;
  - B. Side cast material is not placed within ponds or other water bodies other than wetlands; and
  - C. Sidecast material is not placed within a wetland for a period longer than twenty (20) calendar days. Such sidecast material shall either be removed from the site, or used as backfill (refer to Condition 4 and 5).
4. Backfill used within trenches passing through surface water of the State, except wetland areas, shall be clean course aggregate, gravel or other material which will not cause siltation. Excavated material may be used only if:
  - A. Particle size analysis is conducted and demonstrates the material to be at least 80% sand or larger size material, using a #230 U.S. sieve; or
  - B. Excavation and backfilling are done under dry conditions.
5. Backfill used within trenches passing through wetland areas shall consist of clean material which will not cause siltation. Excavated material shall be used to the extent practicable, with the upper six (6) to twelve (12) inches backfilled with the topsoil obtained during trench excavation.
6. Temporary work pads shall be constructed of clean coarse aggregate or non-erodible non-earthen fill material that will not cause siltation. Sandbags, pre-fabricated rigid materials, sheet piling, inflatable bladders and fabric lined basins may be used for temporary facilities.
7. The applicant for Nationwide 6 that uses temporary work pads in order to perform work in creeks, streams, or rivers shall maintain flow in the these waters by utilizing dam and pumping, fluming, culverts or other such techniques.

Attachment 3

**ILLINOIS EPA WATER QUALITY CERTIFICATION  
REGIONAL CONDITIONS FOR NATIONWIDE PERMIT 12**

The Illinois Environmental Protection Agency hereby issues Section 401 water quality certification applicable to Nationwide Permit 12. Department of the Army (DA) authorization pursuant to Section 404 of the Clean Water Act (33 U.S.C. 1344) under Nationwide 12 will be subject to the Illinois EPA conditions in addition to the conditions imposed by the Corps of Engineers, issued with the Nationwide Permits. The affected geographical area is the entire State of Illinois and all waters of the United States on the border and therein.

1. Case-specific water quality certification from the Illinois EPA will be required for activities in the following waters:
  - A. Chicago Sanitary and Ship Canal
  - B. Calumet-Sag Channel
  - C. Little Calumet River
  - D. Grand Calumet River
  - E. Calumet River
  - F. South Branch of the Chicago River (including the South Fork)
  - G. North Branch of the Chicago River (including the East and West Forks and the Skokie Lagoons)
  - H. Chicago River (Main Stem)
  - I. Lake Calumet
  - J. Des Plaines River
  - K. Fox River (including the Fox Chain of Lakes)
  - L. Saline River (in Hardin County)
  - M. Richland Creek (in St. Clair and Monroe Counties)
  - N. Lake Michigan
  - O. Rock River (in Winnebago County)
  - P. Illinois River upstream of mile 229.6 (Illinois Route 178 bridge)
  - Q. Illinois River between mile 140.0 and 182.0
  - R. Pettibone Creek (in Lake County)
  - S. DuPage River (including the East and West Branches)
  - T. Salt Creek (Des Plaines River Watershed)
  - U. Waukegan River (including the South Branch)
  - V. All Public and Food Processing Water Supplies with surface intake facilities. The Illinois EPA's Bureau of Water, Watershed Management Section at 217/782-3362 may be contacted for information on these water supplies.
  
2. Section 401 is hereby issued for all other waters, with the following conditions:
  - A. The applicant for Nationwide Permit 12 shall not cause:
    - i. violation of applicable provisions of the Illinois Environmental Protection Act;
    - ii. water pollution defined and prohibited by the Illinois Environmental Protection Act;
    - iii. violation of applicable water quality standards of the Illinois Pollution Control Board, Title 35, Subtitle C: Water Pollution Rules and Regulation; or

- iv. interference with water use practices near public recreation areas or water supply intakes.
- B. The applicant for Nationwide Permit shall provide adequate planning and supervision during the project construction period for implementing construction methods, processes and cleanup procedures necessary to prevent water pollution and control erosion.
- C. Material resulting from trench excavation within surface waters of the State may be temporarily sidecast adjacent to the trench excavation provided that:
  - i. Sidecast material is not placed within a creek, stream, river or other flowing water body such that material dispersion could occur;
  - ii. Side cast material is not placed within ponds or other water bodies other than wetlands; and
  - iii. Sidecast material is not placed within a wetland for a period longer than twenty (20) calendar days. Such sidecast material shall either be removed from the site (refer to Condition 2.F), or used as backfill (refer to Condition 2.D and 2.E).
- D. Backfill used within trenches passing through surface water of the State, except wetland areas, shall be clean course aggregate, gravel or other material which will not cause siltation, pipe damage during placement, or chemical corrosion in place. Excavated material may be used only if:
  - i. Particle size analysis is conducted and demonstrates the material to be at least 80% sand or larger size material, using a #230 U.S. sieve; or
  - ii. Excavation and backfilling are done under dry conditions.
- E. Backfill used within trenches passing through wetland areas shall consist of clean material which will not cause siltation, pipe damage during placement, or chemical corrosion in place. Excavated material shall be used to the extent practicable, with the upper six (6) to twelve (12) inches backfilled with the topsoil obtained during trench excavation.
- F. All material excavated which is not being used as backfill as stipulated in Condition 2.D and 2.E shall be stored or disposed in self-contained areas with no discharge to waters of the State. Material shall be disposed of appropriately under the regulations at 35 Il. Adm. Code Subtitle G.
- G. All areas affected by construction shall be mulched and seeded as soon after construction as possible. The applicant for Nationwide 12 shall undertake necessary measures and procedures to reduce erosion during construction. Interim measures to prevent erosion during construction shall be taken and may include the installation of staked straw bales, sedimentation basins and temporary mulching. All construction within the waterway shall be conducted during zero or low flow conditions. The applicant for Nationwide 12 shall be responsible for obtaining an NPDES Storm Water Permit required by the federal Clean Water Act prior to initiating construction if the construction activity associated with the project will result in the disturbance of 1 (one) or more acres, total land area. An NPDES Storm Water Permit may be obtained by submitting a properly completed Notice of Intent (NOI) form by certified mail to the Agency's Division of Water Pollution Control, Permit Section.
- H. The applicant for Nationwide 12 shall implement erosion control measures consistent with



the "Illinois Urban Manual" (IEPA/USDA, NRCS; 2002).

- I. The use of directional drilling to install utility pipelines below surface waters of the State is hereby certified provided that:
  - i. All pits and other construction necessary for the directional drilling process are located outside of surface waters of the State;
  - ii. All drilling fluids shall be adequately contained such that they cannot make their way to surface waters of the State. Such fluids shall be treated as stipulated in Condition 2.F; and
  - iii. Erosion and sediment control is provided in accordance with Conditions 2.B, 2.G, and 2.H.
- J. Temporary work pads, cofferdams, access roads and other temporary fills shall be constructed of clean coarse aggregate or non-erodible non-earthen fill material that will not cause siltation. Material excavated or dredged from the surface water or wetland shall not be used to construct the temporary facility. Sandbags, pre-fabricated rigid materials, sheet piling, inflatable bladders and fabric lined basins may be used for temporary facilities.
- K. The applicant for Nationwide 12 that uses temporary work pads, cofferdams, access roads or other temporary fills in order to perform work in creeks, streams, or rivers for construction activities shall maintain flow in the these waters during such construction activity by utilizing dam and pumping, fluming, culverts or other such techniques.
- L. Permanent access roads shall be constructed of clean coarse aggregate or non-erodible non-earthen fill material that will not cause siltation. Material excavated or dredged from the surface water or wetland shall not be used to construct the access road in waters of the state. The applicant for Nationwide 12 that constructs access roads shall maintain flow in creeks, streams and rivers by installing culverts, bridges or other such techniques.
- M. Case specific water quality certification from Illinois EPA will be required for projects that involve dredge and fill activities in bogs, fens or forested wetlands defined as follows:
  - i. A bog is a low nutrient peatland, usually in a glacial depression, that is acidic in the surface stratum and often dominated at least in part by the genus *Sphagnum*. *P*.
  - ii. A fen is a peatland, herbaceous (including calcareous floating mats) or wooded, with calcareous groundwater flow.
  - iii. A forested wetland is a wetland dominated by native woody vegetation with at least one of the following species or genera present: *Carya spp.*, *Cephalanthus occidentalis*, *Cornus alternifolia*, *Fraxinus nigra*, *Juglans cinerea*, *Nyssa sylvatica*, *Querus spp.*, *Thuja occidentalis*, *Betula nigra*, *Betula alleghaniensis*, *Betula papyrifera*, *Fagus grandifolia*.

Attachment 4

**ILLINOIS EPA WATER QUALITY CERTIFICATION  
REGIONAL CONDITIONS FOR NATIONWIDE PERMIT 13**

1. The bank stabilization activities shall not exceed 500 linear feet.
2. Asphalt, bituminous material and concrete with protruding material such as reinforcing bars or mesh shall not be:
  - A. used for backfill;
  - B. placed on shorelines/streambanks; or
  - C. placed in waters of the State.
3. Any spoil material excavated, dredged or otherwise produced must not be returned to the waterway but must be deposited in a self-contained area in compliance with all state statutes, as determined by the Illinois EPA.
4. Any backfilling must be done with clean material and placed in a manner to prevent violation of applicable water quality standards.
5. The applicant shall consider installing bioengineering practices in lieu of structural practices of bank stabilization to minimize impacts to the lake, pond, river or stream and enhance aquatic habitat. Bioengineering techniques may include, but are not limited to:
  - A. adequately sized riprap or A-Jack structures keyed into the toe of the slope with native plantings on the banks above;
  - B. vegetated geogrids;
  - C. coconut fiber (coir) logs;
  - D. live, woody vegetative cuttings, fascines or stumps;
  - E. brush layering; and
  - F. soil lifts.

Attachment 5

**ILLINOIS EPA WATER QUALITY CERTIFICATION  
REGIONAL CONDITIONS FOR NATIONWIDE PERMIT 14**

1. The affected area of the stream channel shall not exceed 100 linear feet, as measured along the stream corridor.
2. Any spoil material excavated, dredged or otherwise produced must not be returned to the waterway but must be deposited in a self-contained area in compliance with all state statues, as determined by the Illinois EPA
3. Any backfilling must be done with clean material and placed in a manner to prevent violation of applicable water quality standards.
4. The applicant shall not cause:
  - A. violation of applicable provisions of the Illinois Environmental Protection Act;
  - B. water pollution defined and prohibited by the Illinois Environmental Protection Act;
  - C. violation of applicable water quality standards of the Illinois Pollution Control Board, Title 35, Subtitle C: Water Pollution Rules and Regulation; or
  - D. interference with water use practices near public recreation areas or water supply intakes.
5. All areas affected by construction shall be mulched and seeded as soon after construction as possible. The applicant shall undertake necessary measures and procedures to reduce erosion during construction. Interim measures to prevent erosion during construction shall be taken and may include the installation of staked straw bales, sedimentation basins and temporary mulching. All construction within the waterway shall be conducted during zero or low flow conditions. The applicant shall be responsible for obtaining an NPDES Storm Water Permit prior to initiating construction if the construction activity associated with the project will result in the disturbance of 1 (one) or more acres, total land area. An NPDES Storm Water Permit may be obtained by submitting a properly completed Notice of Intent (NOI) form by certified mail to the Agency's Division of Water Pollution Control, Permit Section.
6. The applicant shall implement erosion control measures consistent with the "Illinois Urban Manual" (IEPA/USDA, NRCS; 2002).
7. Temporary work pads, cofferdams, access roads and other temporary fills shall be constructed of clean coarse aggregate or non-erodible non-earthen fill material that will not cause siltation. Sandbags, pre-fabricated rigid materials, sheet piling, inflatable bladders and fabric lined basins may be used for temporary facilities.
8. The applicant for Nationwide Permit 14 that uses temporary work pads, cofferdams, access roads and other temporary fills in order to perform work in creeks, streams, or rivers shall maintain flow in these waters by utilizing dam and pumping, fluming, culverts or other such techniques.
9. Case specific water quality certification from Illinois EPA will be required for projects that involve dredge and fill activities in bogs, fens or forested wetlands defined as follows:

- A. A bog is a low nutrient peatland, usually in a glacial depression, that is acidic in the surface stratum and often dominated at least in part by the genus *Sphagnum*. *P.*
- B. A fen is a peatland, herbaceous (including calcareous floating mats) or wooded, with calcareous groundwater flow.
- C. A forested wetland is a wetland dominated by native woody vegetation with at least one of the following species or genera present: *Carya spp.*, *Cephalanthus occidentalis*, *Cornus alternifolia*, *Fraxinus nigra*, *Juglans cinerea*, *Nyssa sylvatica*, *Querus spp.*, *Thuja occidentalis*, *Betula nigra*, *Betula alleghaniensis*, *Betula papyrifera*, *Fagus grandifolia*.

Attachment 6

**ILLINOIS EPA WATER QUALITY CERTIFICATION  
REGIONAL CONDITIONS FOR NATIONWIDE PERMIT 33**

1. Any spoil material excavated, dredged or otherwise produced must not be returned to the waterway but must be deposited in a self-contained area in compliance with all state statutes, as determined by the Illinois EPA.
2. Any backfilling must be done with clean material and placed in a manner to prevent violation of applicable water quality standards.
3. The applicant shall not cause:
  - A. violation of applicable provisions of the Illinois Environmental Protection Act;
  - B. water pollution defined and prohibited by the Illinois Environmental Protection Act;
  - C. violation of applicable water quality standards of the Illinois Pollution Control Board, Title 35, Subtitle C: Water Pollution Rules and Regulation; or
  - D. interference with water use practices near public recreation areas or water supply intakes.
4. All areas affected by construction shall be mulched and seeded as soon after construction as possible. The applicant shall undertake necessary measures and procedures to reduce erosion during construction. Interim measures to prevent erosion during construction shall be taken and may include the installation of staked straw bales, sedimentation basins and temporary mulching. All construction within the waterway shall be conducted during zero or low flow conditions. The applicant shall be responsible for obtaining an NPDES Storm Water Permit prior to initiating construction if the construction activity associated with the project will result in the disturbance of 1 (one) or more acres, total land area. An NPDES Storm Water Permit may be obtained by submitting a properly completed Notice of Intent (NOI) form by certified mail to the Agency's Division of Water Pollution Control, Permit Section.
5. The applicant shall implement erosion control measures consistent with the "Illinois Urban Manual" (IEPA/USDA, NRCS; 2002).
6. Temporary work pads, cofferdams, access roads and other temporary fills shall be constructed of clean coarse aggregate or non-erodible non-earthen fill material that will not cause siltation. Sandbags, pre-fabricated rigid materials, sheet piling, inflatable bladders and fabric lined basins may be used for temporary facilities.
7. The applicant for Nationwide Permit 33 that uses temporary work pads, cofferdams, access roads and other temporary fills in order to perform work in creeks, streams, or rivers shall maintain flow in these waters by utilizing dam and pumping, fluming, culverts or other such techniques.

Attachment 7

**ILLINOIS EPA WATER QUALITY CERTIFICATION  
REGIONAL CONDITIONS FOR NATIONWIDE PERMIT 38**

1. The applicant shall not cause:
  - A. violation of applicable provisions of the Illinois Environmental Protection Act;
  - B. water pollution defined and prohibited by the Illinois Environmental Protection Act;
  - C. violation of applicable water quality standards of the Illinois Pollution Control Board, Title 35, Subtitle C: Water Pollution Rules and Regulation; or
  - D. interference with water use practices near public recreation areas or water supply intakes.
  
2. In addition to any actions required of the NWP applicant with respect to the "Notification" General Condition 27, the applicant shall notify the Illinois EPA, Bureau of Water, of the specific activity. This notification shall include information concerning the orders and approvals that have been or will be obtained from the Illinois EPA Bureau of Land (BOL), for all cleanup activities under BOL jurisdiction or for which authorization or approval is sought from BOL for no further remedial action.
  
3. This certification for Nationwide Permit 38 is not valid for activities that do not require or will not receive authorization or approval from the BOL.

Attachment 8

**ILLINOIS EPA WATER QUALITY CERTIFICATION  
REGIONAL CONDITIONS FOR NATIONWIDE PERMIT 41**

1. The applicant shall not cause:
  - A. violation of applicable provisions of the Illinois Environmental Protection Act;
  - B. water pollution defined and prohibited by the Illinois Environmental Protection Act;
  - C. violation of applicable water quality standards of the Illinois Pollution Control Board, Title 35, Subtitle C: Water Pollution Rules and Regulation; or
  - D. interference with water use practices near public recreation areas or water supply intakes.
2. The applicant for Nationwide Permit shall provide adequate planning and supervision during the project construction period for implementing construction methods, processes and cleanup procedures necessary to prevent water pollution and control erosion.
3. Any spoil material excavated, dredged or otherwise produced must not be returned to the waterway but must be deposited in a self-contained area in compliance with all state statues, regulations and permit requirements with no discharge to waters of the State unless a permit has been issued by the Illinois EPA. Any backfilling must be done with clean material and placed in a manner to prevent violation of applicable water quality standards.
4. All areas affected by construction shall be mulched and seeded as soon after construction as possible. The applicant shall undertake necessary measures and procedures to reduce erosion during construction. Interim measures to prevent erosion during construction shall be taken and may include the installation of staked straw bales, sedimentation basins and temporary mulching. All construction within the waterway shall be conducted during zero or low flow conditions. The applicant shall be responsible for obtaining an NPDES Storm Water Permit prior to initiating construction if the construction activity associated with the project will result in the disturbance of 1 (one) or more acres, total land area. An NPDES Storm Water Permit may be obtained by submitting a properly completed Notice of Intent (NOI) form by certified mail to the Agency's Division of Water Pollution Control, Permit Section.
5. The applicant shall implement erosion control measures consistent with the "Illinois Urban Manual" (IEPA/USDA, NRCS; 2002).
6. The applicant is advised that the following permit(s) must be obtained from the Agency: permits to construct sanitary sewers, water mains and related facilities prior to construction.
7. The proposed work shall be constructed with adequate erosion control measures (i.e., silt fences, straw bales, etc.) to prevent transport of sediment and materials to the adjoining wetlands and/or streams.

Attachment 9

**ILLINOIS EPA WATER QUALITY CERTIFICATION  
REGIONAL CONDITIONS FOR NATIONWIDE PERMIT 46**

1. The applicant shall not cause:
  - A. violation of applicable provisions of the Illinois Environmental Protection Act;
  - B. water pollution defined and prohibited by the Illinois Environmental Protection Act;
  - C. violation of applicable water quality standards of the Illinois Pollution Control Board, Title 35, Subtitle C: Water Pollution Rules and Regulation; or
  - D. interference with water use practices near public recreation areas or water supply intakes.
2. The applicant for Nationwide Permit shall provide adequate planning and supervision during the project construction period for implementing construction methods, processes and cleanup procedures necessary to prevent water pollution and control erosion.
3. Any spoil material excavated, dredged or otherwise produced must not be returned to the waterway but must be deposited in a self-contained area in compliance with all state statues, regulations and permit requirements with no discharge to waters of the State unless a permit has been issued by the Illinois EPA. Any backfilling must be done with clean material and placed in a manner to prevent violation of applicable water quality standards.
4. All areas affected by construction shall be mulched and seeded as soon after construction as possible. The applicant shall undertake necessary measures and procedures to reduce erosion during construction. Interim measures to prevent erosion during construction shall be taken and may include the installation of staked straw bales, sedimentation basins and temporary mulching. All construction within the waterway shall be conducted during zero or low flow conditions. The applicant shall be responsible for obtaining an NPDES Storm Water Permit prior to initiating construction if the construction activity associated with the project will result in the disturbance of 1 (one) or more acres, total land area. An NPDES Storm Water Permit may be obtained by submitting a properly completed Notice of Intent (NOI) form by certified mail to the Agency's Division of Water Pollution Control, Permit Section.
5. The applicant shall implement erosion control measures consistent with the "Illinois Urban Manual" (IEPA/USDA, NRCS; 2002).
6. The applicant is advised that the following permit(s) must be obtained from the Agency: permits to construct sanitary sewers, water mains and related facilities prior to construction.
7. The proposed work shall be constructed with adequate erosion control measures (i.e., silt fences, straw bales, etc.) to prevent transport of sediment and materials to the adjoining wetlands and/or streams.
8. The applicant shall not sever the connection between upstream and downstream surface waters of the State by the discharge of dredged or fill material into ditches.



**Attachment 10**

**ILLINOIS EPA WATER QUALITY CERTIFICATION  
REGIONAL CONDITIONS FOR NATIONWIDE PERMIT 47**

The Illinois Environmental Protection Agency hereby issues Section 401 water quality certification applicable to Nationwide Permit 47. Department of the Army (DA) authorization pursuant to Section 404 of the Clean Water Act (33 U.S.C. 1344) under Nationwide 47 will be subject to the Illinois EPA conditions in addition to the conditions imposed by the Corps of Engineers, issued with the Nationwide Permits. The affected geographical area is the entire State of Illinois and all waters of the United States on the border and therein.

1. Case-specific water quality certification from the Illinois EPA will be required for the discharge of dredged materials in the following waters :
  - A. Chicago Sanitary and Ship Canal
  - B. Calumet-Sag Channel
  - C. Little Calumet River
  - D. Grand Calumet River
  - E. Calumet River
  - F. South Branch of the Chicago River (including the South Fork)
  - G. North Branch of the Chicago River (including the East and West Forks and the Skokie Lagoons)
  - H. Chicago River (Main Stem)
  - I. Lake Calumet
  - J. Des Plaines River
  - K. Fox River (including the Fox Chain of Lakes)
  - L. Saline River (in Hardin County)
  - M. Richland Creek (in St. Clair and Monroe Counties)
  - N. Lake Michigan
  - O. Rock River (in Winnebago County)
  - P. Illinois River upstream of mile 229.6 (Illinois Route 178 bridge)
  - Q. Illinois River between mile 140.0 and 182.0
  - R. Pettibone Creek (in Lake County)
  - S. DuPage River (including the East and West Branches)
  - T. Salt Creek (Des Plaines River Watershed)
  - U. Waukegan River (including the South Branch)
  - V. All Public and Food Processing Water Supplies with surface intake facilities. The Illinois EPA's Bureau of Water, Watershed Management Section can be contacted at 217-782-3362 for further information on these water supplies.

Page 17  
Nationwide Permits

2. Section 401 is hereby issued for all other waters and for projects in the waters identified in Condition 1 that do not involve discharge of dredged materials , with the following conditions:
  - A. The applicant shall not cause:
    - i. violation of applicable provisions of the Illinois Environmental Protection Act;
    - ii. water pollution defined and prohibited by the Illinois Environmental Protection Act;
    - iii. violation of applicable water quality standards of the Illinois Pollution Control Board, Title 35, Subtitle C: Water Pollution Rules and Regulation; or
    - iv. interference with water use practices near public recreation areas or water supply intakes.
  - B. The applicant for Nationwide Permit shall provide adequate planning and supervision during the project construction period for implementing construction methods, processes and cleanup procedures necessary to prevent water pollution and control erosion.
  - C. All areas affected by construction shall be mulched and seeded as soon after construction as possible. The applicant shall undertake necessary measures and procedures to reduce erosion during construction. Interim measures to prevent erosion during construction shall be taken and may include the installation of staked straw bales, sedimentation basins and temporary mulching. All construction within the waterway shall be conducted during zero or low flow conditions. The applicant shall be responsible for obtaining an NPDES Storm Water Permit required by the Clean Water Act prior to initiating construction if the construction activity associated with the project will result in the disturbance of 1 (one) or more acres, total land area. An NPDES Storm Water Permit may be obtained by submitting a properly completed Notice of Intent (NOI) form by certified mail to the Agency's Division of Water Pollution Control, Permit Section
  - D. The applicant shall implement erosion control measures consistent with the "Illinois Urban Manual" (IEPA/USDA, NRCS; 2002).
  - E. Backfill used within trenches passing through wetland areas shall consist of clean material which will not cause siltation, pipe damage during placement, or chemical corrosion in place. Excavated material shall be used to the extent practicable, with the upper six (6) to twelve (12) inches backfilled with the topsoil obtained during trench excavation.
  - F. All material excavated which is not being used as backfill as stipulated in Condition 2.F and 2.G shall be stored or disposed in self-contained areas with no discharge to waters of the State. Material shall be disposed of appropriately under the regulations at 35 Il. Adm. Code Subtitle G.
  - G. The use of directional drilling to install utility pipelines below surface waters of the State is hereby certified provided that:
    - i. All pits and other construction necessary for the directional drilling process are located outside of surface waters of the State;
    - ii. All drilling fluids shall be adequately contained such that they cannot make their way to surface waters of the State. Such fluids shall be treated as stipulated in Condition 2.H; and
    - iii. Erosion and sediment control is provided in accordance with Conditions 2.B, 2.C, and 2.D.

Page 18  
Nationwide Permits

- H. Temporary work pads, cofferdams, access roads and other temporary fills shall be constructed of clean coarse aggregate or non-erodible non-earthen fill material that will not cause siltation. Material dredged or excavated from the surface water or wetland shall not be used to construct the temporary facility. Sandbags, pre-fabricated rigid materials, sheet piling, inflatable bladders and fabric lined basins may be used for temporary facilities.
- I. The applicant for Nationwide 47 that uses temporary work pads, cofferdams, access roads or other temporary fills in order to perform work in creeks, streams, or rivers for construction activities shall maintain flow in the these waters during such construction activity by utilizing dam and pumping, fluming, culverts or other such techniques.

STATE OF ILLINOIS  
DEPARTMENT OF TRANSPORTATION  
DIVISION OF HIGHWAYS

VARIOUS ROUTES  
D9 SCOUR REPAIR 2011-1  
VARIOUS COUNTIES  
CONTRACT NO. 78222  
SHEET 1 of 25

D-99-078-10

**PROPOSED  
HIGHWAY PLANS**

VARIOUS ROUTES  
SECTION D9 SCOUR REPAIR 2011-1  
VARIOUS COUNTIES

C-99-081-10

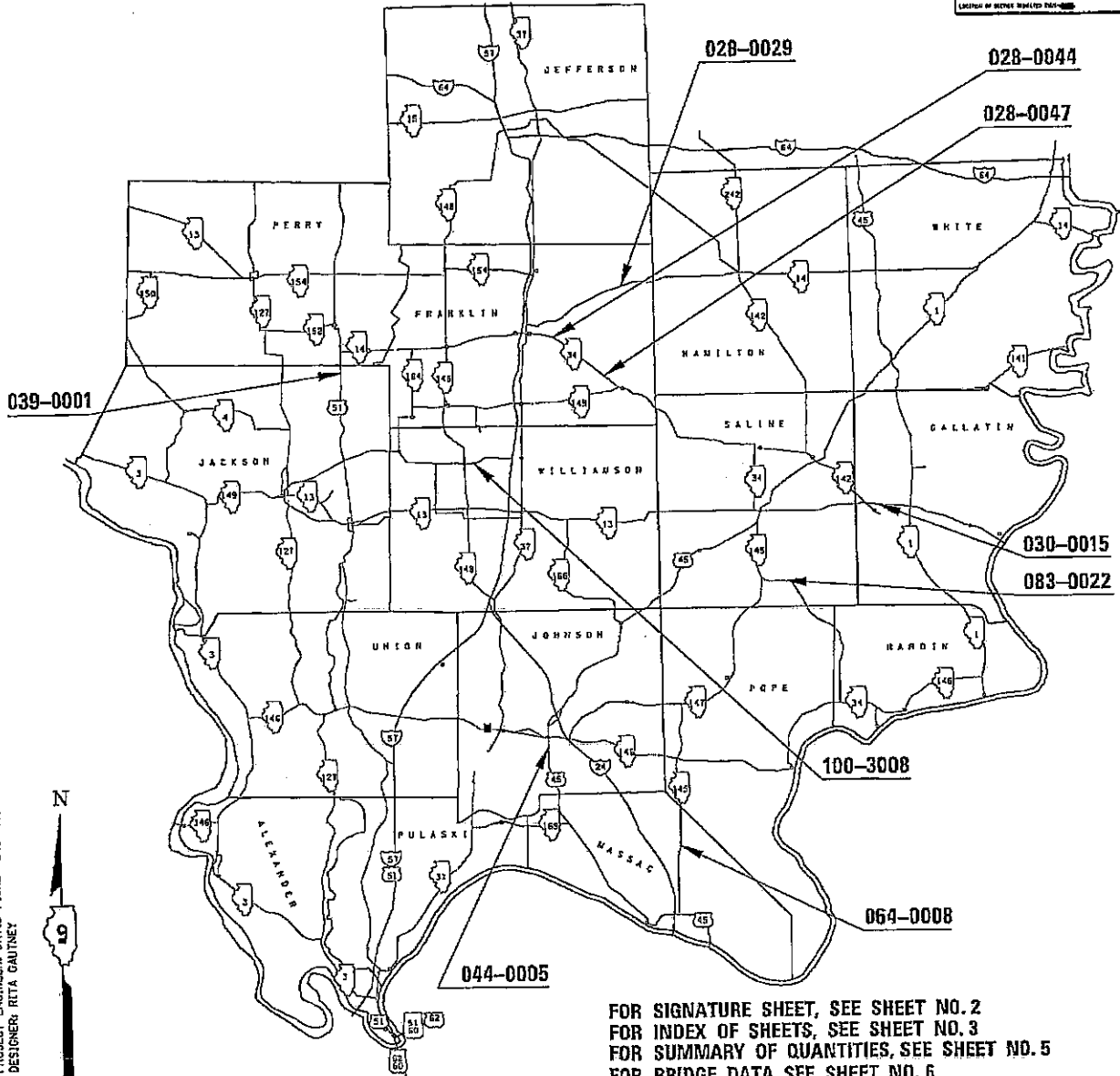
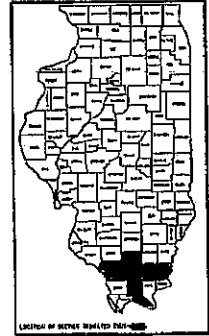

PROJECT ENGINEER: DAVID PICHE 549-2171 CENTREX 792-4554  
DESIGNER: RITA GAUTNEY

FOR SIGNATURE SHEET, SEE SHEET NO. 2  
FOR INDEX OF SHEETS, SEE SHEET NO. 3  
FOR SUMMARY OF QUANTITIES, SEE SHEET NO. 5  
FOR BRIDGE DATA, SEE SHEET NO. 6

**CONTRACT NO. 78222**

JULIE 1-800-892-0123

SIGNATURE SHEET

STATE OF ILLINOIS  
DEPARTMENT OF TRANSPORTATION  
DIVISION OF HIGHWAYS

SUBMITTED Jan 4 2011

Mary C. Lomic REGIONAL ENGINEER

PREPARED BY: Joe Zdaniewicz  
DISTRICT STUDIES & PLANS ENGINEER

EXAMINED BY: James Lewis Emery  
DISTRICT LAND ACQUISITION ENGINEER

EXAMINED BY: Chris Nelson  
DISTRICT PROGRAM DEVELOPMENT ENGINEER

EXAMINED BY: Kurt Wiley  
DISTRICT OPERATIONS ENGINEER

EXAMINED BY: [Signature]  
DISTRICT CONSTRUCTION ENGINEER

EXAMINED BY: Bruce Trebbles  
DISTRICT MATERIALS ENGINEER

EXAMINED BY: Danny H. Claster  
DISTRICT PROJECT IMPLEMENTATION ENGINEER

EXAMINED BY: Danny H. Claster  
ASSISTANT REGIONAL ENGINEER

## INDEX OF SHEETS

<u>SHEET NO.</u>	<u>DESCRIPTION</u>
1	COVER SHEET
2	SIGNATURES
3	INDEX OF SHEETS, STANDARDS
4	GENERAL NOTES
5	SUMMARY OF QUANTITIES
6	BRIDGE DATA
7, 8	028-0029 SCOUR REPAIR
9, 10	028-0044 SCOUR REPAIR
11, 12	028-0047 SCOUR REPAIR
13, 14	030-0015 SCOUR REPAIR
15, 16	039-0001 SCOUR REPAIR
17, 18	044-0005 SCOUR REPAIR
19, 20	064-0008 SCOUR REPAIR
21, 22	083-0022 SCOUR REPAIR
23, 24	100-3008 SCOUR REPAIR
25	RIPRAP SECTION VIEWS

## STANDARDS

701006-03	OFF-ROAD, 2L, 2W, 2' TO 15' FROM EDGE OF PAV'T
701201-04	LANE CLOSURE, 2L, 2W, DAY ONLY
701301-04	LANE CLOSURE, 2L, 2W, SHORT-TIME OPERATIONS
701901-01	TRAFFIC CONTROL DEVICES

## GENERAL NOTES

FACTORS USED FOR QUANTITY CALCULATIONS ARE AS FOLLOWS:  
STONE RIPRAP CLASS A5: 1.5 TONS/CU. YD.

THE ENGINEER SHALL DETERMINE THE EXACT LIMITS OF THE INSTALLATION.

COST OF REMOVAL OF EXISTING RIPRAP AND DEBRIS IS INCLUDED IN THE CONTRACT UNIT PRICE FOR STONE RIPRAP.

EACH RIPRAP INSTALLATION SHALL MEET THE EXISTING FLOWLINE BOTH UPSTREAM AND DOWNSTREAM.

NO REDUCTION IN WATERWAY OPENING SHALL OCCUR UNDER THAT ORIGINALLY PERMITTED.

IN ADDITION TO THE REQUIREMENTS OF ARTICLE 107.16, THE CONTRACTOR SHALL PROTECT THE SURFACE OF ALL BRIDGE DECKS AND BRIDGE APPROACH PAVEMENTS IN A MANNER SATISFACTORY TO THE ENGINEER BEFORE ANY EQUIPMENT IS ALLOWED TO CROSS THE STRUCTURE. PROTECTION SHALL BE PROVIDED FOR ALL EQUIPMENT AS DEFINED IN ARTICLE 107.16 REGARDLESS IF TRACK MOUNTED OR WHEELED.

PLAN DIMENSIONS AND DETAILS RELATIVE TO EXISTING PLANS ARE SUBJECT TO NOMINAL CONSTRUCTION VARIATIONS. THE CONTRACTOR SHALL FIELD VERIFY EXISTING DIMENSIONS AND DETAILS AFFECTING NEW CONSTRUCTION AND MAKE NECESSARY APPROVED ADJUSTMENTS PRIOR TO CONSTRUCTION OR ORDERING OF MATERIALS. SUCH VARIATIONS SHALL NOT BE CAUSE FOR ADDITIONAL COMPENSATION FOR A CHANGE IN THE SCOPE OF THE WORK; HOWEVER, THE CONTRACTOR WILL BE PAID FOR THE QUANTITY ACTUALLY FURNISHED AT THE UNIT PRICE BID FOR THE WORK.

ALL AREAS DISTURBED DURING CONSTRUCTION SHALL BE GRADED, FERTILIZED, SEEDED, AND MULCHED ACCORDING TO SECTION 250 AND 251 OF THE STANDARD SPECIFICATIONS, AS DIRECTED BY THE ENGINEER. THE PREFERRED SEED IS AGROSTIS ALBA, FIVE POUNDS PER ACRE. COST IS INCLUDED IN ASSOCIATED RIPRAP PAY ITEM.

ONLY THE CHANNEL EXCAVATION THAT EXCEEDS THE VOLUME OF PROPOSED RIPRAP AND BEDDING IS PAID FOR SEPARATELY.

THE CONTRACTOR SHALL BE RESPONSIBLE FOR CONTACTING ALL UTILITY COMPANIES OWNING UTILITIES AT EACH LOCATION ACCORDING TO ARTICLE 107.31.

SUMMARY OF QUANTITIES

VARIOUS

		CONSTRUCTION TYPE CODE: 0014																				
		100% STATE																				
		RURAL																				
		FRANKLIN			GALLATIN			JACKSON			JOHNSON			MASSAC			SALINE			WILLIAMSON		
CODE NO.	ITEM DESCRIPTION	UNIT	IL 14	IL 34	IL 13	US 51	US 45	IL 145	IL 34	IL 34	IL 34	IL 34	IL 34	IL 34	IL 34	IL 34	IL 34	IL 34	IL 34	IL 34	IL 34	IL 34
			028-0029	028-0044	028-0047	039-0001	044-0005	064-0008	083-0022	100-3008												
		TOTAL QUANTITY																				
20300100	CHANNEL EXCAVATION	CU YD	45	73	104	26	15	44														
28100109	STONE RIPRAP, CLASS A5	SQ YD	870	690	615	575	365	935														
28200200	FILTER FABRIC	SQ YD	950	770	675	635	410	1040														
67100100	MOBILIZATION	L SUM	.12	.11	.11	.11	.11	.11														
70100450	TRAFFIC CONTROL AND PROTECTION, STANDARD 701201	L SUM	.12	.11	.11	.11	.11	.22														

VARIOUS ROUTES  
D9 SCOUR REPAIR 2011-1  
VARIOUS COUNTIES  
CONTRACT NO. 78222  
SHEET 5 of 25



**BRIDGE DATA**

STRUCTURE	FACILITY CARRIED	INVENTORY RATING	OPERATING RATING	ADT YEAR	ADT	TRUCKS %	LOCATION	SECTION	TOWNSHIP	FEATURE CROSSED
028-0029	IL 14	16.4	28.6	2009	1600	9	3.9 MI. W. OF HAMILTON CO.	T5S R4E SEC 28	NORTHERN	SUGAR CAMP CREEK
028-0044	IL 34	21.9	36.5	2009	4300	7	2.4 MI. E. OF BENTON	T6S R3E SEC 22	BENTON	STREAM
028-0047	IL 34	32.4	54	2009	2600	10	2 MI. N.W. OF THOMPSONVILLE	T7S R4E SEC 5	CAVE	EWING CREEK
030-0015	IL 13	20.5	34.1	2009	6200	31	2.5 MI. W. OF ILL. RTE. 1	T9S R8E SEC 16	EQUALITY	NORTH FORK SALINE RIVER
039-0001	US 51	20.0	33	2009	7000	5	0.3 MI. S. OF PERRY CO.	T7S R1W SEC 5	ELK	SIX MILE CREEK
044-0005	US 45	27.0	43.5	2009	3400	6	0.3 MI. S. OF ILL. RTE. 146	T13S R3E SEC 5	VIENNA	MCCORKLE CREEK
064-0008	IL 145	30.7	51.3	2009	2200	10	4 MI. S. OF POPE CO.	T14S R5E SEC 33	WASHINGTON	MASSAC CREEK
083-0022	IL 34	23.9	39.9	2009	2550	25	0.2 MI. W. OF RUDEMENT	T10S R6E SEC 24	INDEPENDENCE	SPRING VALLEY CREEK
100-3008	FAS 903 (County Rd. 2)	14.7	24.3	2006	6700	8	0.75 MI. E. OF HERRIN	T8S R2E SEC. 20	HERRIN	TRIB. TO POND. CREEK

VARIOUS ROUTES  
D9 SCOUR REPAIR 2011-1  
VARIOUS COUNTIES  
CONTRACT NO. 78222  
SHEET 6 of 25

**UTILITIES LEGEND**

CABLE TV	—CTV—
FIBER OPTIC CABLE	—FO—
TELEPHONE	—T—
GAS	—G—
WATER	—W—
POWER POLE	□
TELEPHONE POLE	○

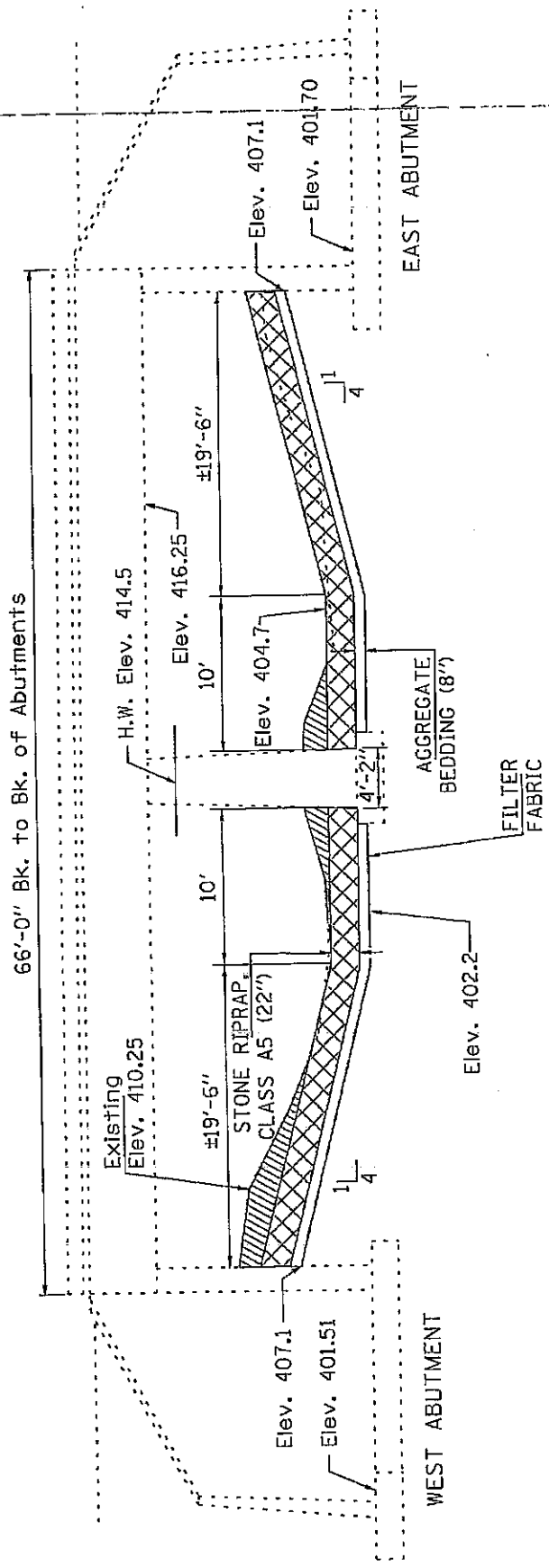

CHANNEL SECTION

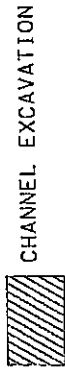

BILL OF MATERIAL

	870	SO. YD.
STONE RIPRAP, CLASS A5	870	SO. YD.
FILTER FABRIC	950	SO. YD.
CHANNEL EXCAVATION	45	CU YD

028-0029

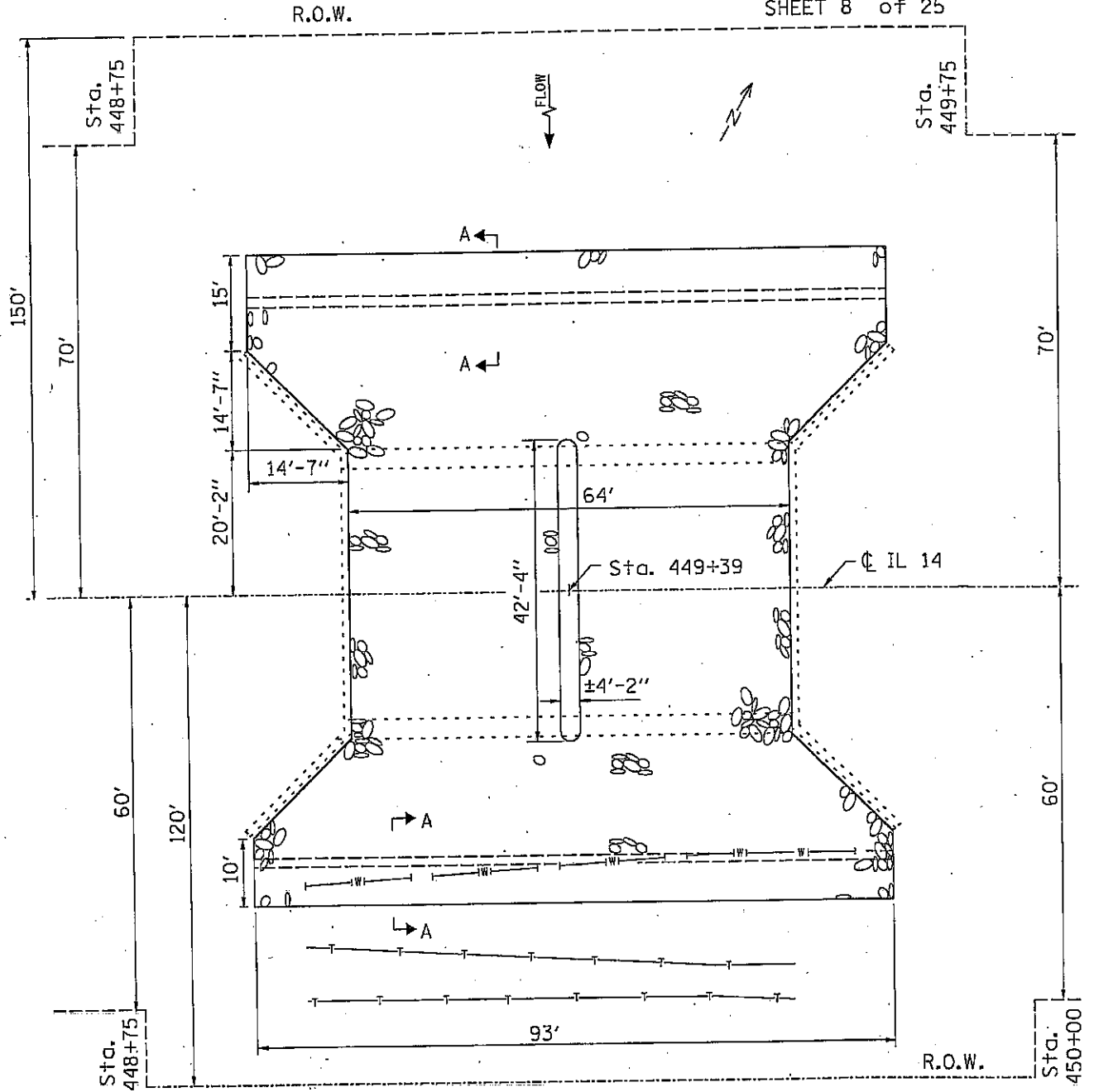

UTILITIES

STA.	UTILITY	OFFSET (FT.)
449+00	W	43 R
	T	52 R
	T	60 R
449+60	W	39 R
	T	56 R
	T	60 R
449+80	W	39 R
	T	56 R
	T	61 R

PLAN

See Section A-A on Sheet 25 of 25.

028-0029

89'-0" Bk. to Bk. Abuts.

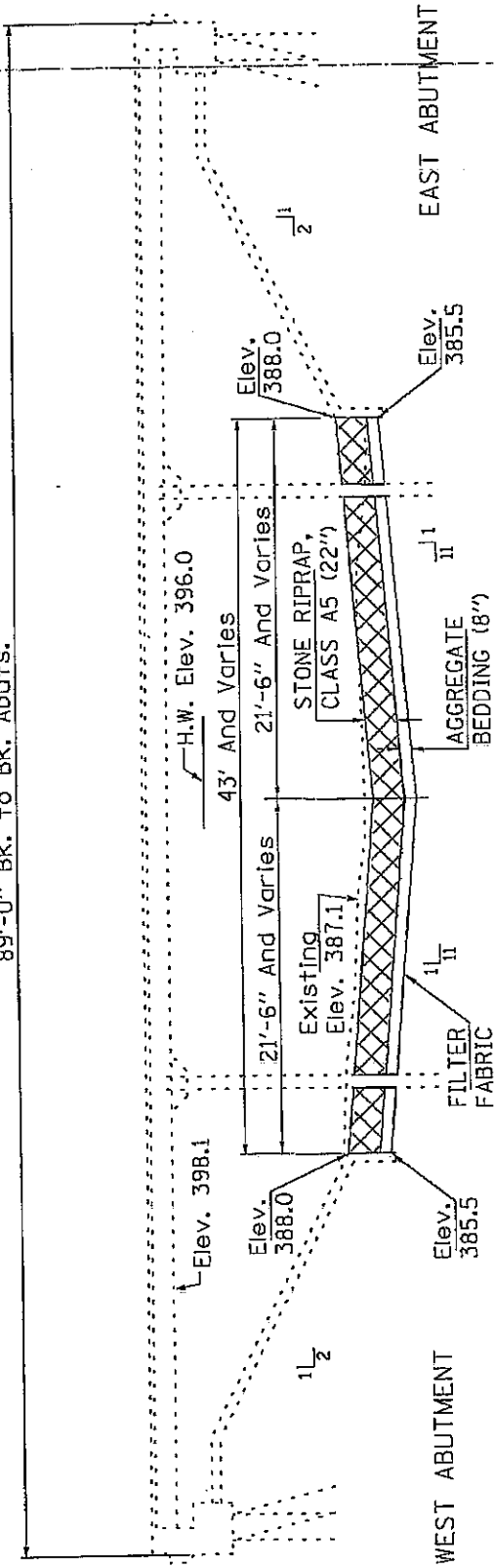

CHANNEL SECTION

BILL OF MATERIAL

	690	SO. YD.
STONE RIPRAP, CLASS A5	690	SO. YD.
FILTER FABRIC	770	SO. YD.

CHANNEL EXCAVATION



028-0044

VARIOUS ROUTES  
 D9 SCOUR REPAIR 2011-1  
 VARIOUS COUNTIES  
 CONTRACT NO. 78222  
 SHEET 10 of 25

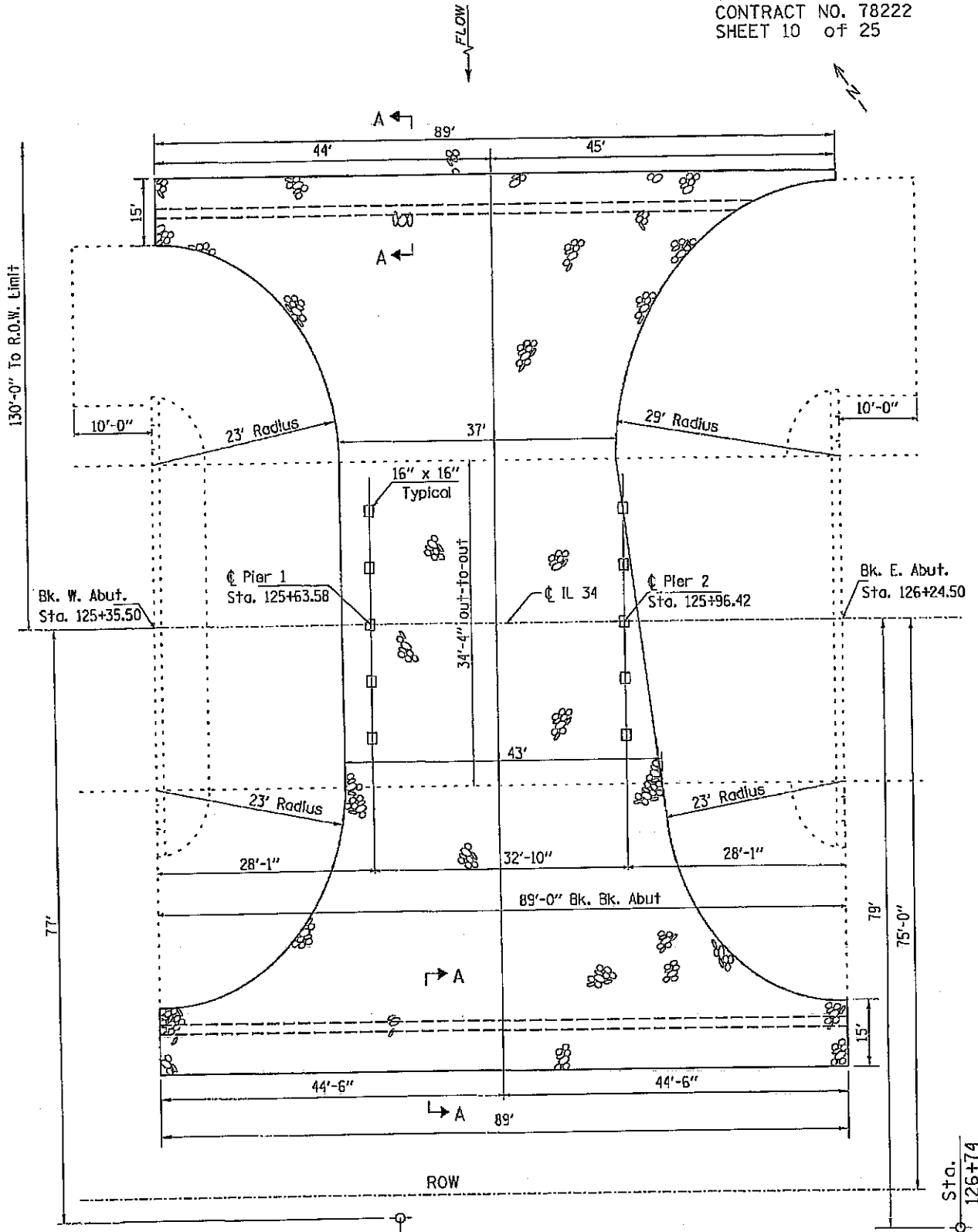

See Section A-A on  
 Sheet 25 of 25.

PLAN

028-0044

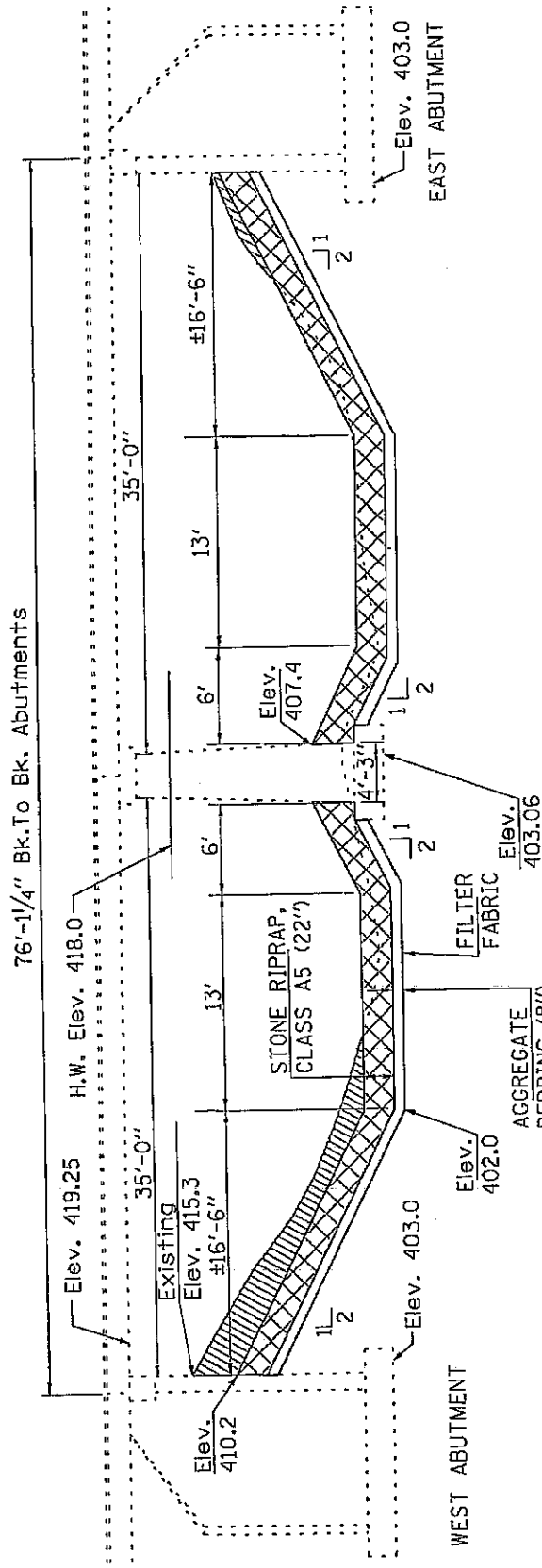

Dimensions along  $\phi$  of roadway.  
**CHANNEL SECTION**

**BILL OF MATERIAL**

	875	SQ. YD.
STONE RIPRAP, CLASS A5	875	SQ. YD.
FILTER FABRIC	970	SQ. YD.
CHANNEL EXCAVATION	73	CU YD



028-0047

VARIOUS ROUTES  
 D9 SCOUR REPAIR 2011-1  
 VARIOUS COUNTIES  
 CONTRACT NO. 78222  
 SHEET 12 of 25

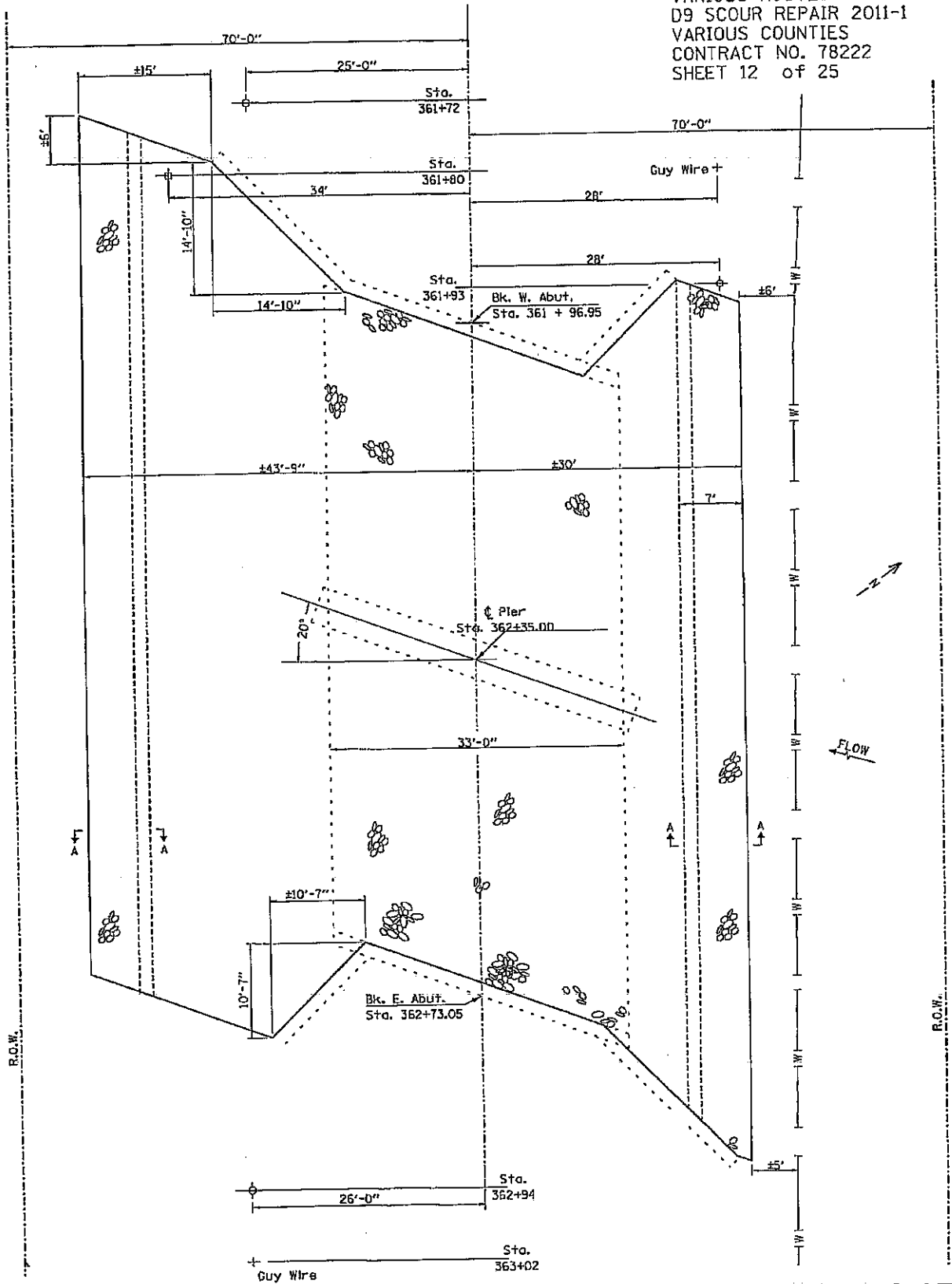

See Section A-A on Sheet 25 of 25.

PLAN

028-0047

VARIOUS ROUTES  
 D9 SCOUR REPAIR 2011-1  
 VARIOUS COUNTIES  
 CONTRACT NO. 78222  
 SHEET 13 of 25

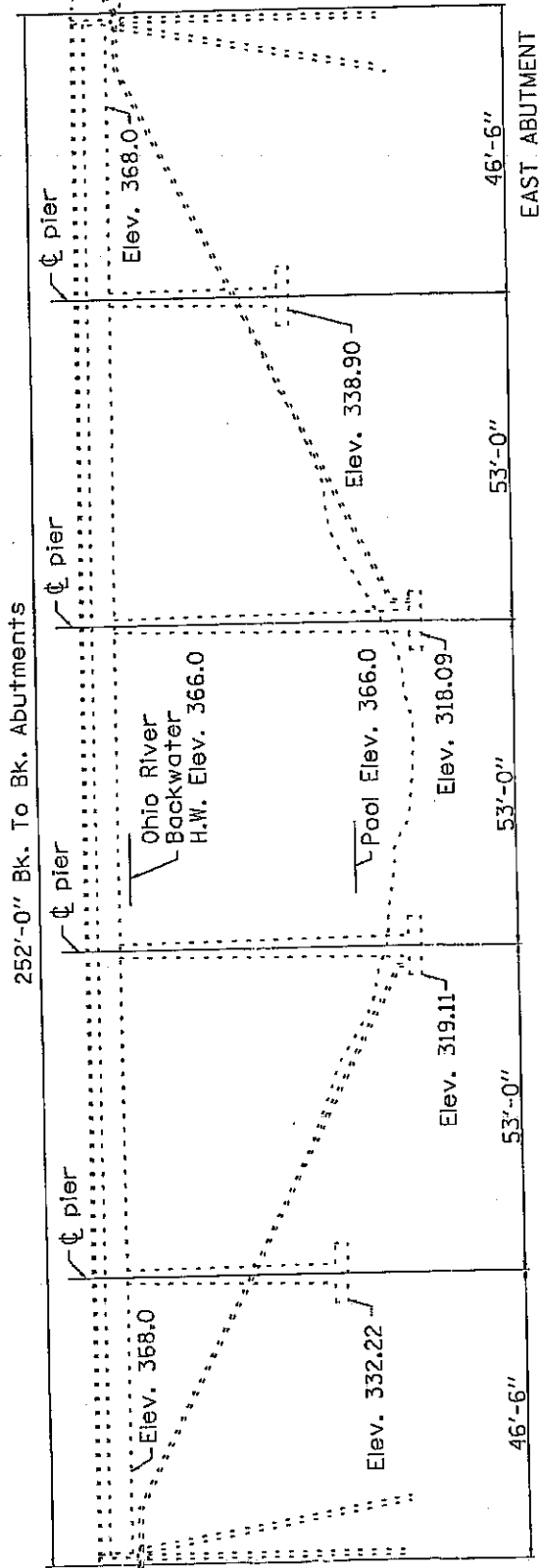

**GENERAL ELEVATION**

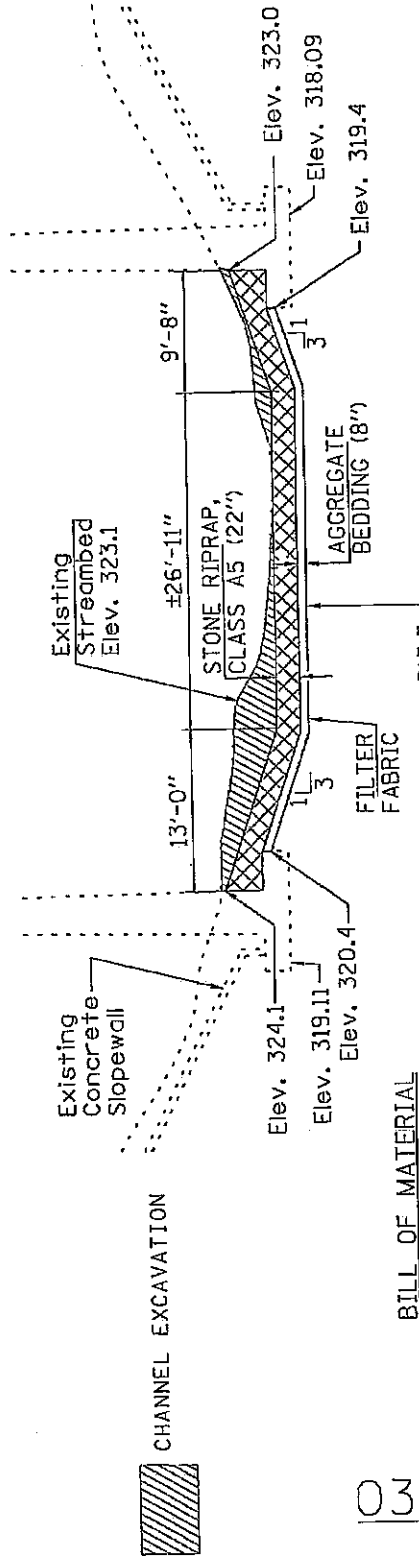

**BILL OF MATERIAL**

	SO. YD.	SO. YD.	SO. YD.
STONE RIPRAP, CLASS A5	615	675	104 CU YD
FILTER FABRIC			
CHANNEL EXCAVATION			

030 - 0015

DIMENSIONS PARALLEL TO  $\phi$  OF STRUCTURE

**CHANNEL SECTION**



VARIOUS ROUTES  
 D9 SCOUR REPAIR 2011-1  
 VARIOUS COUNTIES  
 CONTRACT NO. 78222  
 SHEET 14 of 25

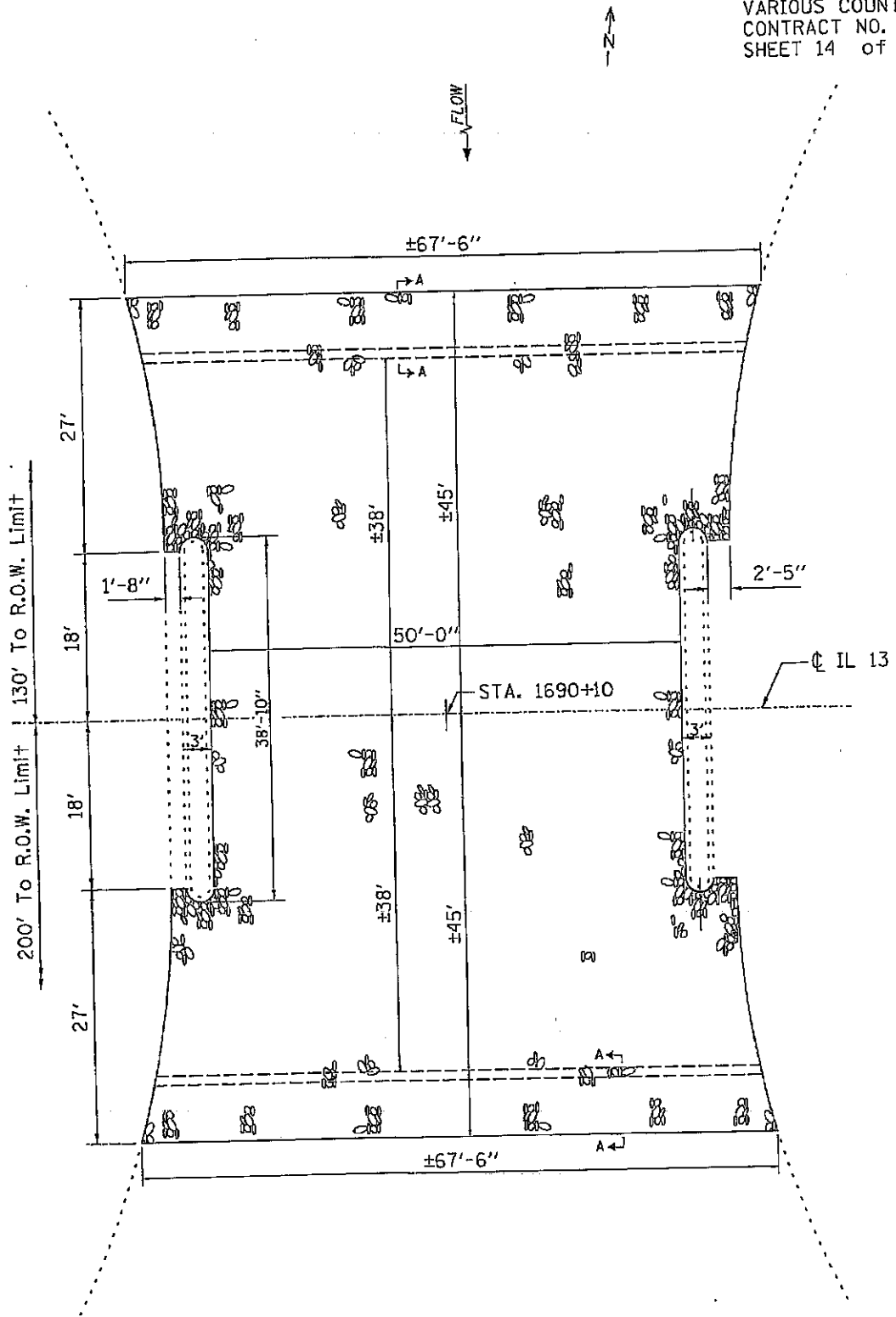

See Section A-A on Sheet 25 of 25.

CHANNEL PLAN VIEW

030-0015

VARIOUS ROUTES  
 D9 SCOUR REPAIR 2011-1  
 VARIOUS COUNTIES  
 CONTRACT NO. 78222  
 SHEET 15 of 25

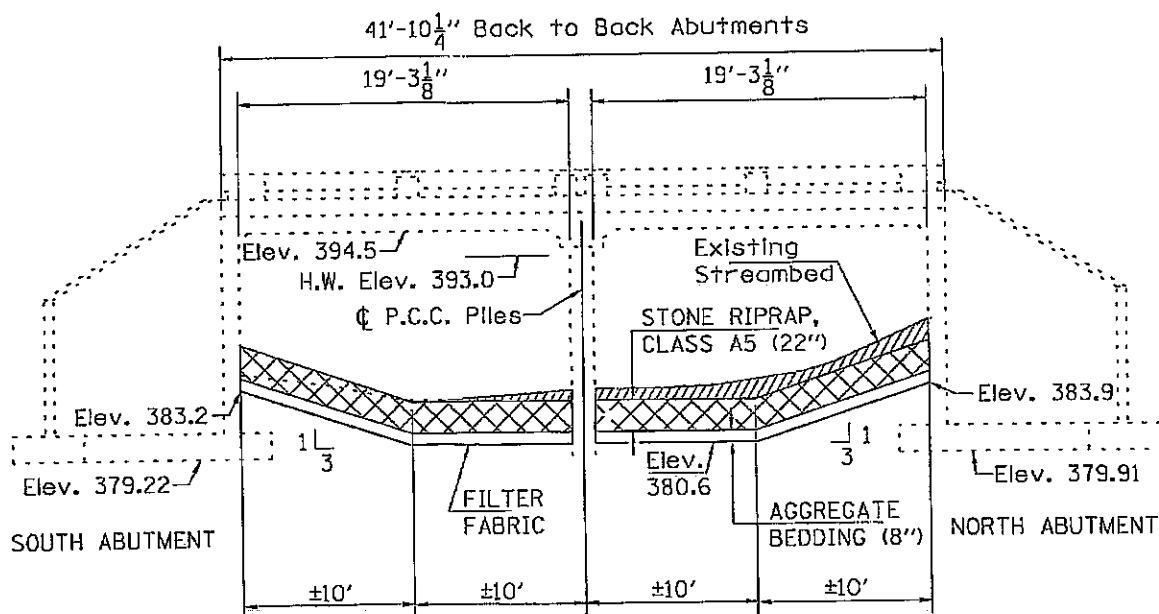

## CHANNEL SECTION

### BILL OF MATERIAL

STONE RIPRAP, CLASS A5	575 SQ. YD.
FILTER FABRIC	635 SQ. YD.
CHANNEL EXCAVATION	26 CU YD



CHANNEL EXCAVATION

039-0001

VARIOUS ROUTES  
 D9 SCOUR REPAIR 2011-1  
 VARIOUS COUNTIES  
 CONTRACT NO. 78222  
 SHEET 16 of 25

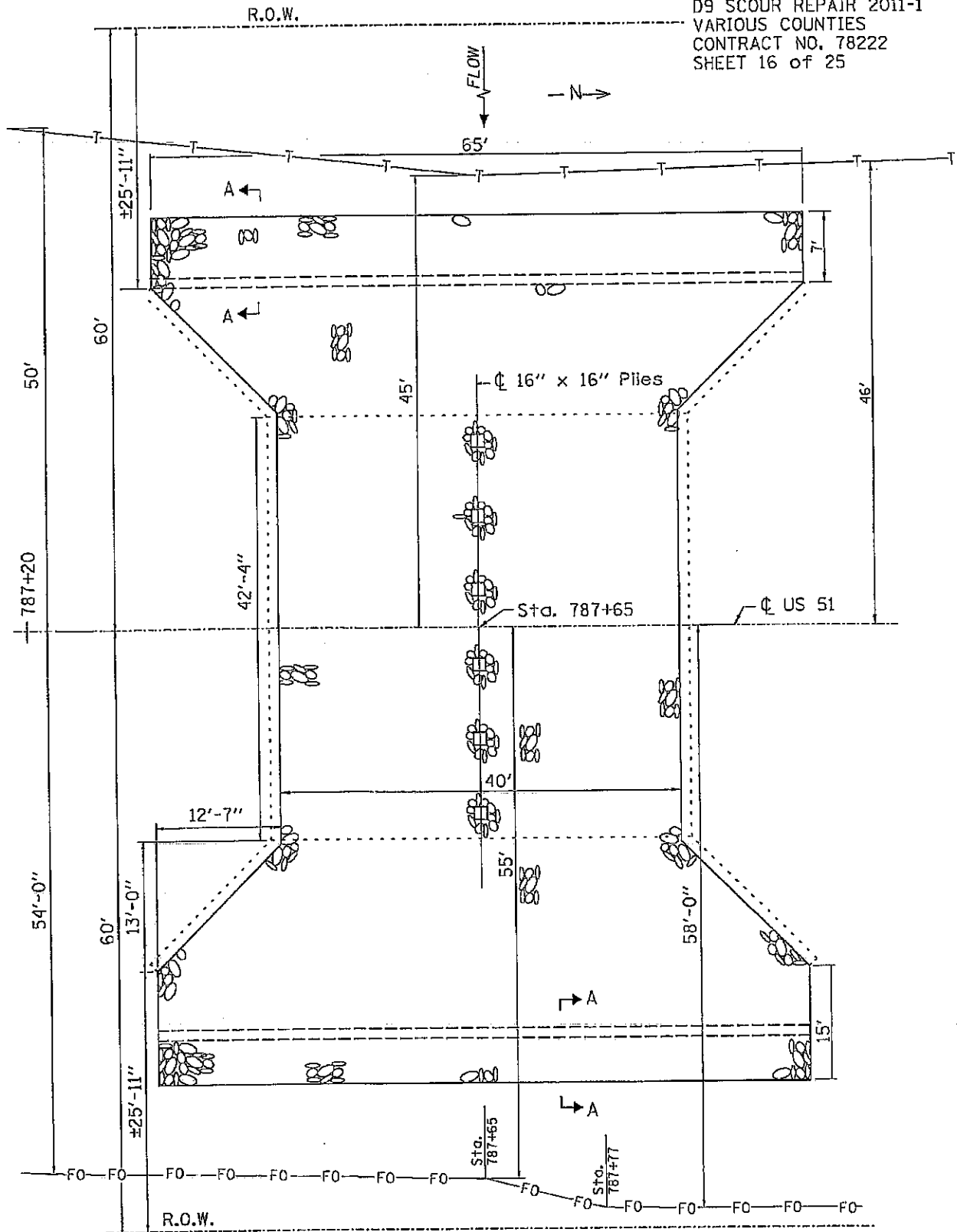

See Section A-A on Sheet 25 of 25.

PLAN

039-0001

VARIOUS ROUTES  
 D9 SCOUR REPAIR 2011-1  
 VARIOUS COUNTIES  
 CONTRACT NO. 78222  
 SHEET 17 of 25

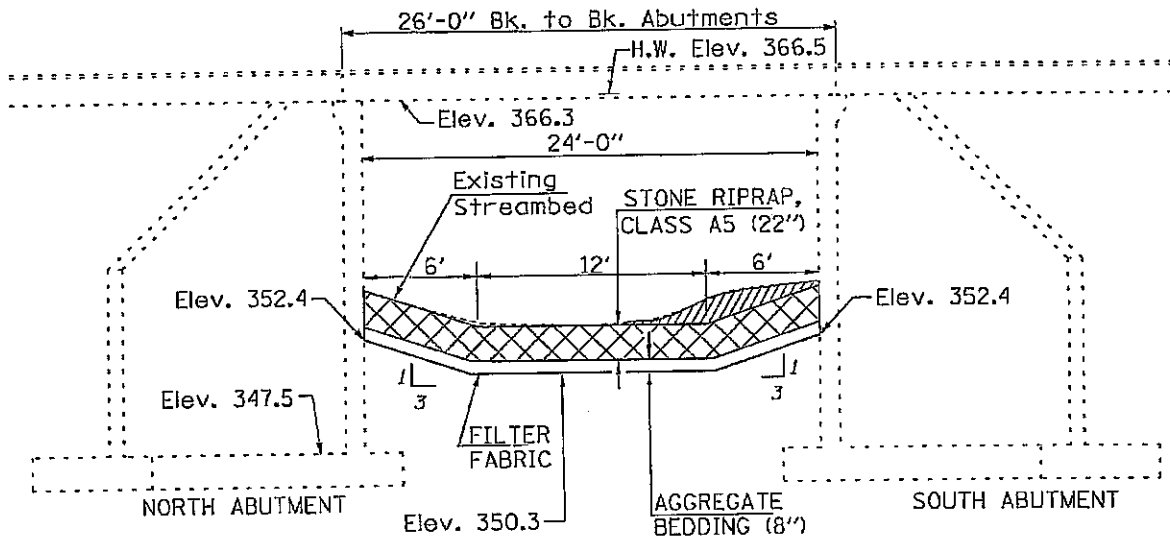

## CHANNEL SECTION

### BILL OF MATERIAL

STONE RIPRAP, CLASS A5	365	SQ. YD.
FILTER FABRIC	410	SQ. YD.
CHANNEL EXCAVATION	15	CU YD

044-0005

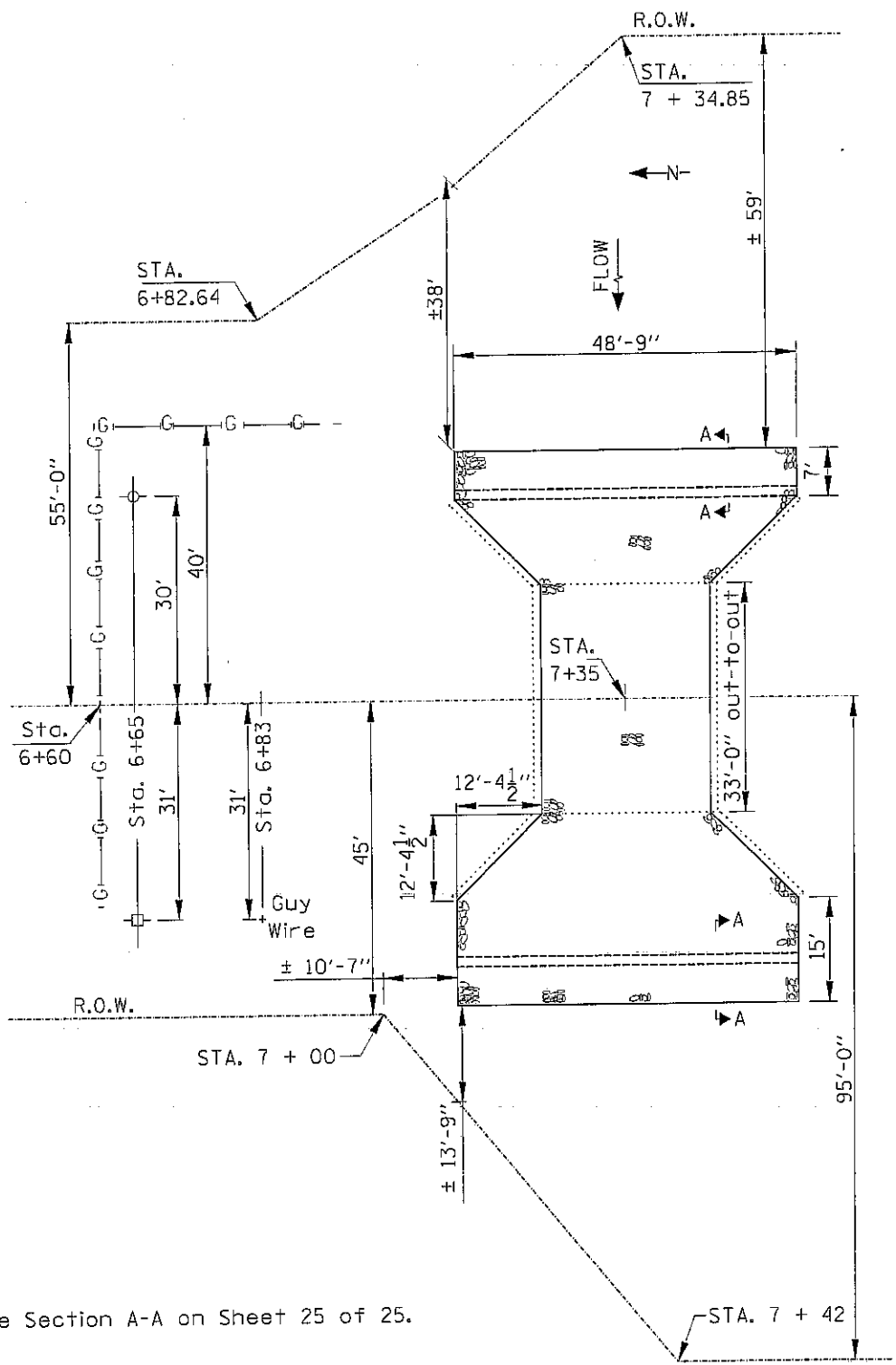

See Section A-A on Sheet 25 of 25.

PLAN

044-0005

VARIOUS ROUTES  
 D9 SCOUR REPAIR 2011-1  
 VARIOUS COUNTIES  
 CONTRACT NO. 78222  
 SHEET 19 of 25

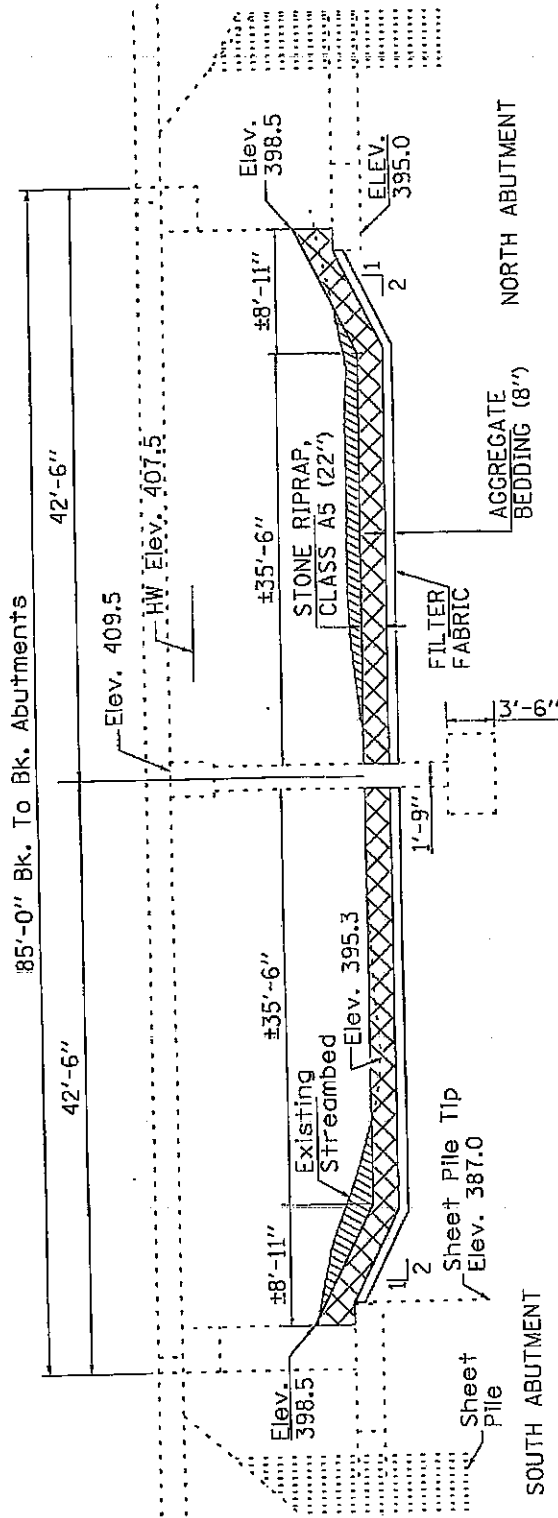

Dimensions Parallel to  $\phi$

CHANNEL SECTION

BILL OF MATERIAL

	935	SQ. YD.
STONE RIPRAP, CLASS A5	935	SQ. YD.
FILTER FABRIC	1040	SQ. YD.
CHANNEL EXCAVATION	44	CU YD

064-0008



VARIOUS ROUTES  
 D9 SCOUR REPAIR 2011-1  
 VARIOUS COUNTIES  
 CONTRACT NO. 78222  
 SHEET 21 of 25

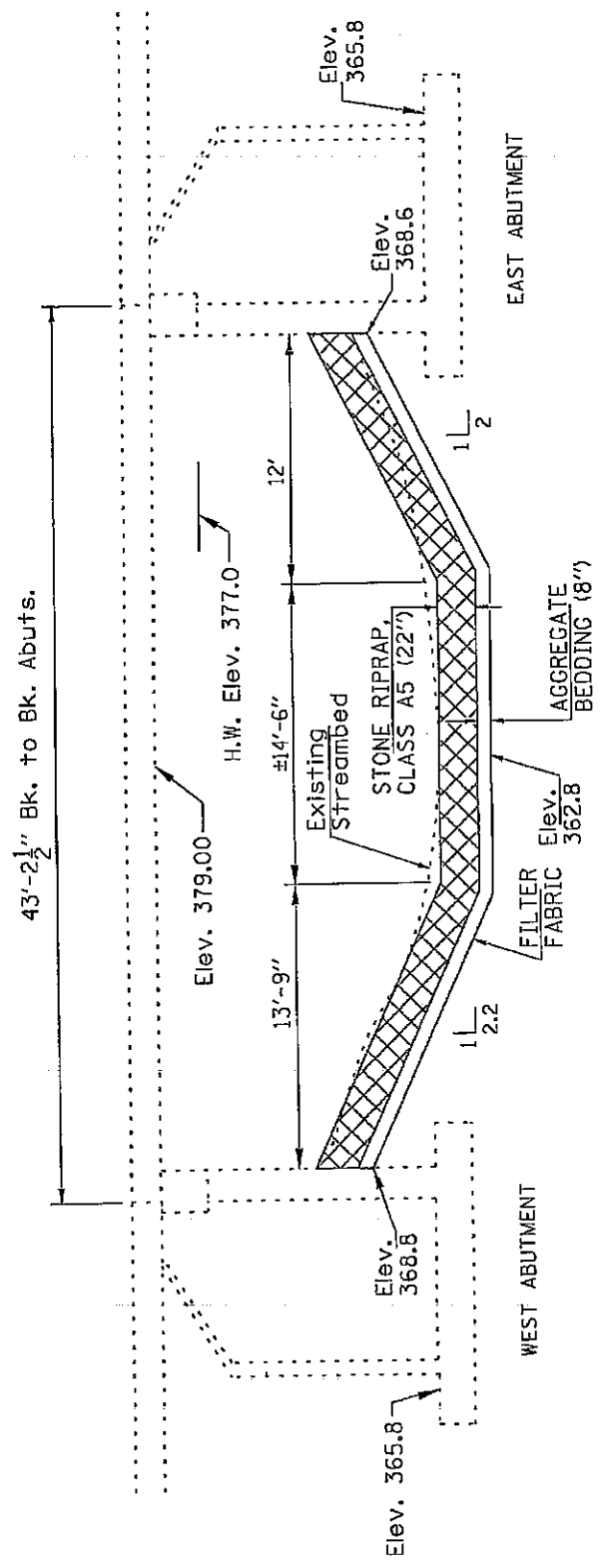

CHANNEL SECTION

BILL OF MATERIAL

STONE RIPRAP, CLASS A5	350	SQ. YD.
FILTER FABRIC	410	SQ. YD.
CHANNEL EXCAVATION	15	CU YD



083-0022



VARIOUS ROUTES  
 D9 SCOUR REPAIR 2011-1  
 VARIOUS COUNTIES  
 CONTRACT NO. 78222  
 SHEET 22 of 25

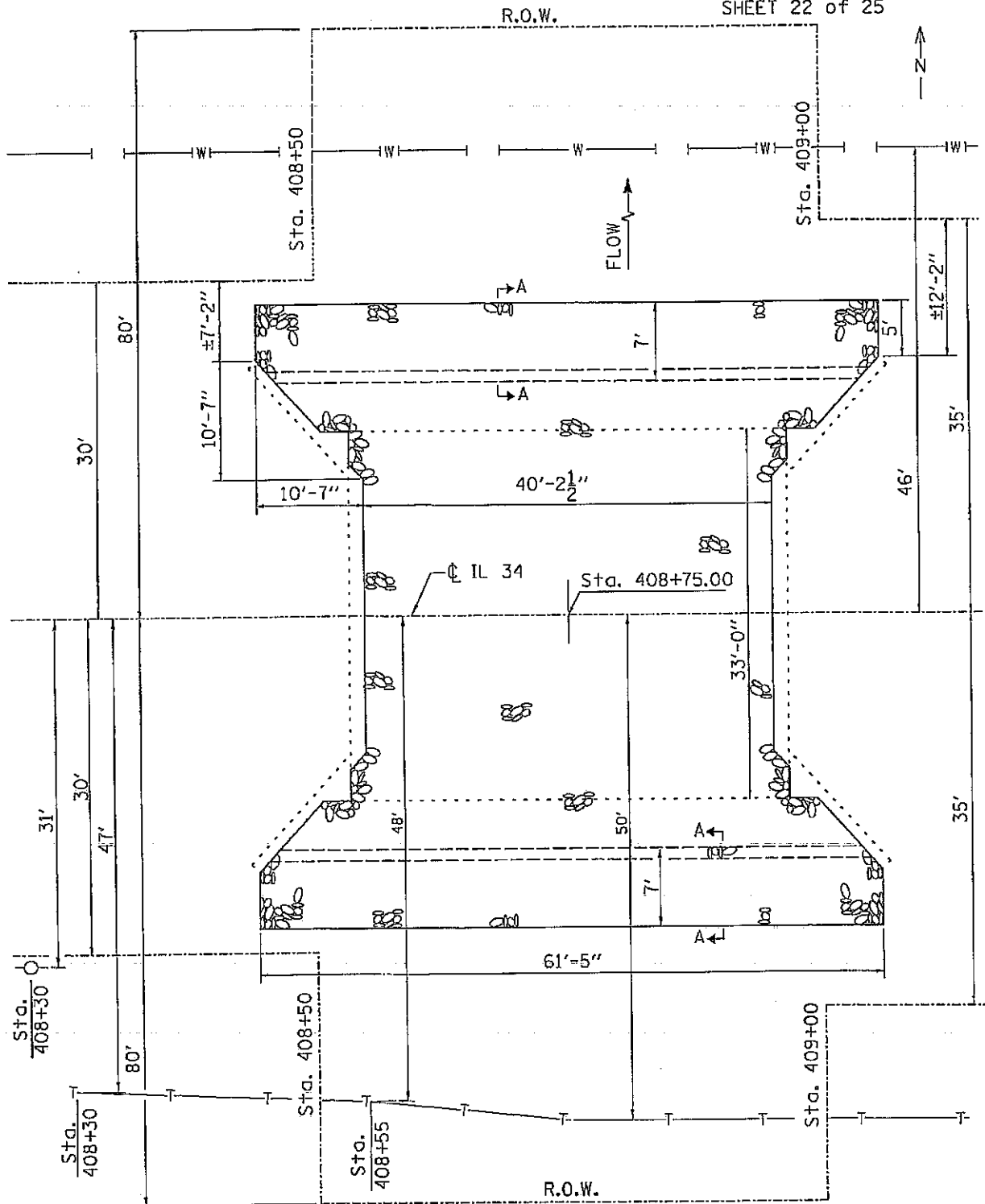

See Section A-A on Sheet 25 of 25.

PLAN

083-0022

VARIOUS ROUTES  
 D9 SCOUR REPAIR 2011-1  
 VARIOUS COUNTIES  
 CONTRACT NO. 78222  
 SHEET 23 of 25

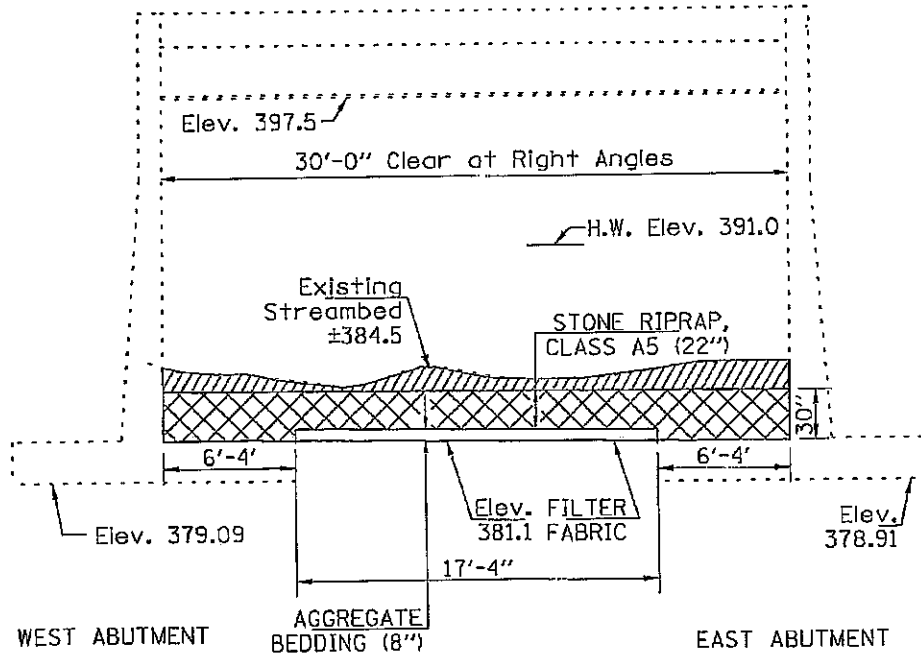

## CHANNEL SECTION

### BILL OF MATERIAL

STONE RIPRAP, CLASS A5	445	SQ. YD.
FILTER FABRIC	440	SQ. YD.
CHANNEL EXCAVATION	50	CU YD

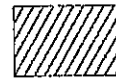

CHANNEL EXCAVATION

Note: At abutment, filter fabric extends onto the top of the footing for a distance of 1 ft.

100-3008

VARIOUS ROUTES  
D9 SCOUR REPAIR 2011-1  
VARIOUS COUNTIES  
CONTRACT NO. 78222  
SHEET 24 of 25

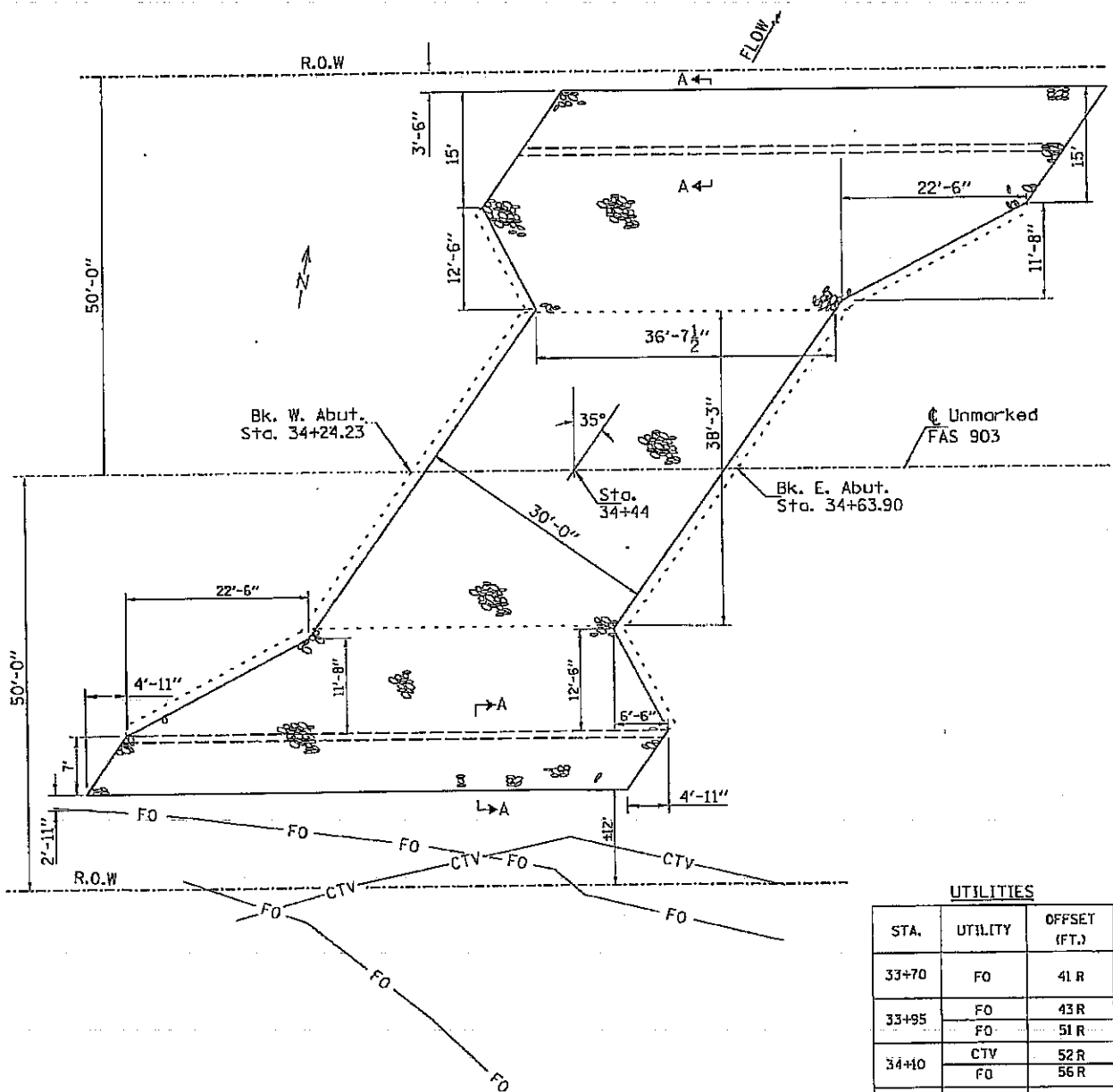

UTILITIES		
STA.	UTILITY	OFFSET (FT.)
33+70	FO	41 R
33+95	FO	43 R
	FO	51 R
34+10	CTV	52 R
	FO	56 R
34+25	FO	47 R
	FO	68 R
34+40	CTV	48 R
	FO	50 R
34+44	CTV	44 R
	FO	53 R
34+64	FO	58 R

See Section A-A on Sheet 25 of 25.

PLAN

100-3008

VARIOUS ROUTES  
D9 SCOUR REPAIR 2011-1  
VARIOUS COUNTIES  
CONTRACT NO. 78222  
SHEET 25 of 25

RIPRAP CLASS A	T	*B	C	D
RR4	16"	6"	2'-8"	4'-0"
RR5	22"	8"	3'-8"	5'-6"
RR6	26"	10"	4'-4"	6'-6"
RR7	30"	12"	5'-0"	7'-6"

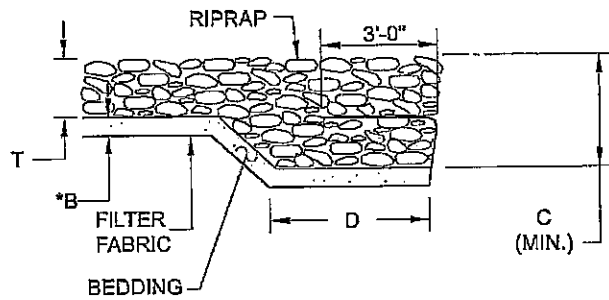

**SECTION A-A**

**STONE RIPRAP - TYPICAL DETAILS**

## **ILLINOIS DEPARTMENT OF LABOR**

### **PREVAILING WAGES FOR VARIOUS COUNTIES EFFECTIVE FEBRUARY 2011**

The Prevailing rates of wages are included in the Contract proposals which are subject to Check Sheet #5 of the Supplemental Specifications and Recurring Special Provisions. The rates have been ascertained and certified by the Illinois Department of Labor for the locality in which the work is to be performed and for each craft or type of work or mechanic needed to execute the work of the Contract. As required by Prevailing Wage Act (820 ILCS 130/0.01, et seq.) and Check Sheet #5 of the Contract, not less than the rates of wages ascertained by the Illinois Department of Labor and as revised during the performance of a Contract shall be paid to all laborers, workers and mechanics performing work under the Contract. Post the scale of wages in a prominent and easily accessible place at the site of work.

If the Illinois Department of Labor revises the prevailing rates of wages to be paid as listed in the specification of rates, the contractor shall post the revised rates of wages and shall pay not less than the revised rates of wages. Current wage rate information shall be obtained by visiting the Illinois Department of Labor web site at <http://www.state.il.us/agency/idol/> or by calling 312-793-2814. It is the responsibility of the contractor to review the rates applicable to the work of the contract at regular intervals in order to insure the timely payment of current rates. Provision of this information to the contractor by means of the Illinois Department of Labor web site satisfies the notification of revisions by the Department to the contractor pursuant to the Act, and the contractor agrees that no additional notice is required. The contractor shall notify each of its subcontractors of the revised rates of wages.

# Franklin County Prevailing Wage for February 2011

Trade Name	RG	TYP	C	Base	FRMAN	*M-F>8	OSA	OSH	H/W	Pensn	Vac	Trng
=====	==	===	=	=====	=====	=====	===	===	=====	=====	=====	=====
ASBESTOS ABT-GEN		ALL		23.650	24.100	1.5	1.5	2.0	5.450	8.500	0.000	0.900
ASBESTOS ABT-MEC		BLD		20.800	0.000	2.0	2.0	2.0	5.500	4.200	0.000	0.000
BOILERMAKER		BLD		31.500	34.000	1.5	1.5	2.0	6.820	11.43	1.500	0.350
BRICK MASON		BLD		27.220	28.720	1.5	1.5	2.0	7.950	6.690	0.000	0.430
CARPENTER		BLD		30.490	31.990	1.5	1.5	2.0	6.050	5.750	0.000	0.350
CARPENTER		HWY		30.440	31.940	1.5	1.5	2.0	6.050	5.750	0.000	0.350
CEMENT MASON		BLD		26.750	28.250	1.5	1.5	2.0	5.900	4.800	0.000	0.300
CEMENT MASON		HWY		26.350	27.350	1.5	1.5	2.0	5.900	4.350	0.000	0.300
CERAMIC TILE FNSHER		BLD		25.720	0.000	1.5	1.5	2.0	7.950	6.690	0.000	0.430
ELECTRICIAN		ALL		36.240	38.490	1.5	1.5	2.0	5.250	8.340	0.000	0.720
ELECTRONIC SYS TECH		BLD		29.530	31.280	1.5	1.5	2.0	5.250	3.840	0.000	0.250
FLOOR LAYER		BLD		28.930	29.680	1.5	1.5	2.0	6.050	5.750	0.000	0.350
GLAZIER		BLD		26.330	27.580	1.5	1.5	2.0	4.850	5.200	0.000	0.300
HT/FROST INSULATOR		BLD		28.920	29.920	1.5	1.5	2.0	4.800	8.160	0.000	0.280
IRON WORKER		ALL		26.250	27.500	1.5	1.5	2.0	5.780	9.100	0.000	0.345
LABORER		BLD		23.650	24.100	1.5	1.5	2.0	5.450	8.500	0.000	0.800
LABORER		HWY		23.650	24.100	1.5	1.5	2.0	5.450	8.450	0.000	0.800
LABORER		O&C		17.740	18.190	1.5	1.5	2.0	5.450	8.450	0.000	0.800
MACHINIST		BLD		43.160	45.160	1.5	1.5	2.0	7.640	8.700	0.000	0.000
MARBLE FINISHERS		BLD		25.720	0.000	1.5	1.5	2.0	7.950	6.690	0.000	0.430
MARBLE MASON		BLD		27.220	28.720	1.5	1.5	2.0	7.950	6.690	0.000	0.430
MILLWRIGHT		BLD		30.490	31.990	1.5	1.5	2.0	6.050	5.750	0.000	0.350
MILLWRIGHT		HWY		30.440	31.940	1.5	1.5	2.0	6.050	5.750	0.000	0.350
OE RIVER 1		RIV 1		30.950	31.950	1.5	1.5	2.0	6.000	7.800	0.000	1.300
OE RIVER 2		RIV 2		27.500	31.950	1.5	1.5	2.0	6.000	7.800	0.000	1.300
OPERATING ENGINEER		ALL 1		30.850	31.850	1.5	1.5	2.0	6.000	7.800	0.000	1.300
OPERATING ENGINEER		ALL 2		28.950	31.850	1.5	1.5	2.0	6.000	7.800	0.000	1.300
OPERATING ENGINEER		ALL 3		24.150	31.850	1.5	1.5	2.0	6.000	7.800	0.000	1.300
OPERATING ENGINEER		ALL 4		21.400	27.800	1.5	1.5	2.0	5.650	6.100	0.000	1.100
OPERATING ENGINEER		O&C 1		23.140	24.140	1.5	1.5	2.0	6.000	7.800	0.000	1.300
OPERATING ENGINEER		O&C 2		21.710	24.140	1.5	1.5	2.0	6.000	7.800	0.000	1.300
OPERATING ENGINEER		O&C 3		18.120	24.140	1.5	1.5	2.0	6.000	7.800	0.000	1.300
OPERATING ENGINEER		O&C 4		16.050	21.100	1.5	1.5	2.0	5.650	6.100	0.000	1.100
PAINTER		BLD		26.260	27.760	1.5	1.5	2.0	6.130	6.950	0.000	0.450
PAINTER		HWY		30.560	32.060	1.5	1.5	2.0	6.130	6.950	0.000	0.450
PAINTER OVER 30FT		BLD		27.260	28.760	1.5	1.5	2.0	6.130	6.950	0.000	0.450
PAINTER PWR EQMT		BLD		27.260	28.760	1.5	1.5	2.0	6.130	6.950	0.000	0.450
PAINTER PWR EQMT		HWY		31.560	33.060	1.5	1.5	2.0	6.130	6.950	0.000	0.450
PILEDRIIVER		BLD		30.490	31.990	1.5	1.5	2.0	6.050	5.750	0.000	0.350
PILEDRIIVER		HWY		30.440	31.940	1.5	1.5	2.0	6.050	5.750	0.000	0.350
PIPEFITTER		BLD		32.250	35.470	1.5	1.5	2.0	8.250	8.850	0.000	1.200
PLASTERER		BLD		26.750	28.250	1.5	1.5	2.0	5.900	4.800	0.000	0.300
PLUMBER		BLD		32.250	35.470	1.5	1.5	2.0	8.250	8.850	0.000	1.200
ROOFER		BLD		22.250	23.250	1.5	1.5	2.0	7.900	3.800	0.000	0.000
SHEETMETAL WORKER		ALL		31.390	32.890	1.5	1.5	2.0	6.430	6.490	1.890	0.360
SPRINKLER FITTER		BLD		36.140	38.890	1.5	1.5	2.0	8.200	6.550	0.000	0.250
STONE MASON		BLD		27.220	28.720	1.5	1.5	2.0	7.950	6.690	0.000	0.430
TERRAZZO FINISHER		BLD		25.720	0.000	1.5	1.5	2.0	7.950	6.690	0.000	0.430
TERRAZZO MASON		BLD		28.500	28.800	1.5	1.5	2.0	6.400	5.700	0.000	0.430
TRUCK DRIVER		ALL 1		28.430	0.000	1.5	1.5	2.0	9.050	5.500	0.000	0.250
TRUCK DRIVER		ALL 2		28.850	0.000	1.5	1.5	2.0	9.050	5.500	0.000	0.250
TRUCK DRIVER		ALL 3		29.050	0.000	1.5	1.5	2.0	9.050	5.500	0.000	0.250
TRUCK DRIVER		ALL 4		29.320	0.000	1.5	1.5	2.0	9.050	5.500	0.000	0.250
TRUCK DRIVER		ALL 5		30.100	0.000	1.5	1.5	2.0	9.050	5.500	0.000	0.250
TRUCK DRIVER		O&C 1		22.750	0.000	1.5	1.5	2.0	2.920	6.700	0.000	0.250
TRUCK DRIVER		O&C 2		19.150	0.000	1.5	1.5	2.0	2.920	6.700	0.000	0.250
TRUCK DRIVER		O&C 3		19.650	0.000	1.5	1.5	2.0	2.920	6.700	0.000	0.250
TUCKPOINTER		BLD		27.220	28.720	1.5	1.5	2.0	7.950	6.690	0.000	0.430

Legend :

M-F>8 (Overtime is required for any hour greater than 8 worked each day, Monday through Friday.)

OSA (Overtime is required for every hour worked on Saturday)

OSH (Overtime is required for every hour worked on Sunday and Holidays)

H/W (Health & Welfare Insurance)

Pensn (Pension)

Vac (Vacation)

Trng (Training)

## Explanations

### FRANKLIN COUNTY

The following list is considered as those days for which holiday rates of wages for work performed apply: New Years Day, Memorial Day, Fourth of July, Labor Day, Thanksgiving Day, Christmas Day and Veterans Day in some classifications/counties. Generally, any of these holidays which fall on a Sunday is celebrated on the following Monday. This then makes work performed on that Monday payable at the appropriate overtime rate for holiday pay. Common practice in a given local may alter certain days of celebration. If in doubt, please check with IDOL.

Oil and Chip Resealing (O&C) means the application of road oils and liquid asphalt to coat an existing road surface, followed by application of aggregate chips or gravel to coated surface, and subsequent rolling of material to seal the surface.

### EXPLANATION OF CLASSES

ASBESTOS - GENERAL - removal of asbestos material/mold and hazardous materials from any place in a building, including mechanical systems where those mechanical systems are to be removed. This includes the removal of asbestos materials/mold and hazardous materials from ductwork or pipes in a building when the building is to be demolished at the time or at some close future date.

ASBESTOS - MECHANICAL - removal of asbestos material from mechanical systems, such as pipes, ducts, and boilers, where the mechanical systems are to remain.

### CERAMIC TILE FINISHER, MARBLE FINISHER, TERRAZZO FINISHER

Assisting, helping or supporting the tile, marble and terrazzo mechanic by performing their historic and traditional work assignments required to complete the proper installation of the work covered by said crafts. The term "Ceramic" is used for naming the classification only, and is in no a limitation of the product handled. Ceramic takes into consideration most hard tiles.

### LABORER - OIL AND CHIP RESEALING ONLY

Hook and unhook chip box from aggregate truck; distribute material within chip box; perform flagging work related to oil and chip resealing; hand spray oil fluids; handle traffic control, including setting-up and maintaining barricades, drums, cones, delineators, signs and other such items, as well as laying-out and applying or removing temporary roadway markings used to control traffic in job site related to oil and chip resealing; and perform clean-up related to oil and chip resealing.

#### ELECTRONIC SYSTEMS TECHNICIAN

Installation, service and maintenance of low-voltage systems which utilizes the transmission and/or transference of voice, sound, vision, or digital for commercial, education, security and entertainment purposes for the following: TV monitoring and surveillance, background/foreground music, intercom and telephone interconnect, field programming, inventory control systems, microwave transmission, multi-media, multiplex, radio page, school, intercom and sound burglar alarms and low voltage master clock systems.

Excluded from this classification are energy management systems, life safety systems, supervisory controls and data acquisition systems not intrinsic with the above listed systems, fire alarm systems, nurse call systems and raceways exceeding fifteen feet in length.

#### TRUCK DRIVER - BUILDING, HEAVY AND HIGHWAY CONSTRUCTION

Class 1. Drivers on 2 axle trucks hauling less than 9 ton. Air compressor and welding machines and brooms, including those pulled by separate units, truck driver helpers, warehouse employees, mechanic helpers, greasers and tiremen, pickup trucks when hauling materials, tools, or workers to and from and on-the-job site, and fork lifts up to 6,000 lb. capacity.

Class 2. Two or three axle trucks hauling more than 9 ton but hauling less than 16 ton. A-frame winch trucks, hydrolift trucks, vector trucks or similar equipment when used for transportation purposes. Fork lifts over 6,000 lb. capacity, winch trucks, four axle combination units, and ticket writers.

Class 3. Two, three or four axle trucks hauling 16 ton or more. Drivers on water pulls, articulated dump trucks, mechanics and working forepersons, and dispatchers. Five axle or more combination units.

Class 4. Low Boy and Oil Distributors.

Class 5. Drivers who require special protective clothing while employed on hazardous waste work.

#### TRUCK DRIVER - O & C - (Oil and Chip Resealing)

It involves driving of contractor or subcontractor owned, leased, or hired pickup, dump, service, or oil distributor trucks. Includes transporting materials and equipment (including, but not limited to oils, aggregate supplies, parts, machinery and tools) to or from the job site; distributing oil or liquid asphalt and aggregate; stock piling material; and maintaining trucks at job site related to oil and chip resealing.

Class 1. Distributors, liquid asphalt hauling and hauling of asphalt rubber-tired rollers.

Class 2. Stockpiling.



Class 3. Tandem hauling to job site.

OPERATING ENGINEERS - BUILDING, HEAVY AND HIGHWAY CONSTRUCTION

Class 1. APSCO or Equal Spreading Machine, Backhoe, Backfiller, Boom or Winch Cat, Bituminous Mixplane Machine, Blacksmith, Bituminous Surfacing Machine, Bull-Dozer, Crane, Shovel, Dragline, Truck Crane, Pile Driver, Concrete Breaker, Concrete or Pumpcrete Pumps, Dinky or Standard Locomotives, Well or Caisson Drills, Elevating Grader, Fork Lifts, Flexplane, Gradeall, Hi-Lift Hoists, Guy-Derricks, Hysters, Mechanic Motor Patrol, Mixers-21 cu. ft. or over, Push Cats, Pulls and Scrapers, Two Well Point Pumps, Pulverizer or Tiller, PugMill, Rubber-Tired Farm Type Tractor with Bulldozer/Blade/Auger or hi-lift over 1/2 yd., Jersey Spreader, Tract-Air used with Drill or Hi-Lift, Trenching or Ditching Machines, Wood Chipper w/Tractor, Self-Propelled Roller w/Blade, Equipment Greaser, Self-Propelled Bump Grinder on Concrete pavement, Boat Operator, Skid-Loaders, Tuggers, Lazer Screed, and Self-Propelled Chip Spreader (when others run conveyors).

Class 2. Any type tractor pulling any type roller or disc, Two Air Compressors (220 cu. ft. capacity or over), Two AirTract Drills, Air-Track Drill w/Compressor, Automatic Bins or Scales w/Compressor or Generator, Pipeline Boring Machine, Bulk Cement Plant w/Separate Compressor, Power Operated Bull Float, Hydra-Lift w/Single Motor, Straw Mulcher Blower w/Spout, Self-Propelled Roller/Compactor, Back-End man on Bituminous Surfacing Machine, oiler on milling machine.

Class 3. Air Compressor w/Valve driving piling, Boom or Winch Type Truck, Two Conveyors, Self-Propelled Concrete Saw, Form Grader, Truck Crane Oiler, Self-Propelled Vibrator, Rubber Tired Farm Type Tractor w/Blade/Bulldozer/Auger/hi-lift - 1/2 yd. or less, Elevator Operator, Man Lift (scissor lift) when lifting materials.

Class 4. Air-Track Drill (one), Belt Drag Machine, Power Broom, Mechanical Plasterer Applicator, Trac-Air, Air Compressor (220 cu. ft. or over) One, Air Compressor (under 220 cu. ft) four, Automatic Bin, Bulk Cement Plant w/Built-in Compressor running off same motor or electric motor, Fireman or Switchman, Self-Propelled Form Tamper, Light Plants (4), Welding Machines (4), Pumps (4), or Combination of four (4) Pumps, Light Plants, Welding Machines, Air-Compressors (under 220 cu. ft.), Mudjacks or Wood Chipper, Mixers - less than 21 cu. ft. Mortar Mixer w/Skip or Pump, Pipeline Tract Jack. One Operating Engineer may operate and maintain any combination of the following pieces of equipment, not to exceed four (4) which shall be within a reasonable distance, such combination may include any equipment in this classification: (Compressors, Light Plants, Generators, Welding Machines, Pumps or Conveyors), One Well- Point Pump, Two Motor Driven Heaters, One Air Compressor (under 220 cu. ft.), One Engine-Driven Conveyor, One Motor Driven Heater, One Light Plant, One Pump, One Welding Machine, One Ulmac or Equal Spreader, Oilers, and one Generator 10 kw or greater.

OPERATING ENGINEER - O & C (Oil and Chip Resealing ONLY.)

Includes the operation of all motorized heavy equipment used in oil and chip rsealing, including but not limited to operating self-propelled chip spreaders, and all types of rollers (both hard and rubber tired); and other duties pertaining to the operation or maintenance of heavy equipment related to oil and chip resealing.

Class 1. See Class 1 above for types of equipment operated.

Class 2. See Class 2 above for types of equipment operated.

Class 3. See Class 3 above for types of equipment operated.

Class 4. See Class 4 above for types of equipment operated.

OPERATING ENGINEER RIVER WORK 1 - operate the following machines when working on River Work and Levee Work on the Mississippi and Ohio Rivers, Lakes and Tributaries: Crane, Shovel, Drageline, Scrapers, Dredge, Derrick, Pile-Driver, Push Boat, all power boat operators, Mechanic, Engineman on Dredge, Leverman on Dredge, All Bituminous Spreader machines, Backhoe, Backfiller, Boom, or Winch Cat, Bituminous Mixplane Machine, Blacksmith, Bituminous Surfacing Machine, Bulldozer, Truck Cranes, Hydraulic Truck Mounted Boom/Crane, Concrete Finishing Machine, or Spreader Machine, Concrete Breaker, Concrete or Pumpcrete Machines, Concrete Plant Operator, All Off Road Material Hauling Equipment, Dinky or Standard Locomotives, Well Drill, Elevating Grader, Fork-Lifts, Flexplane, Gradeall, Hi-Lift, Power Handblade Tugger type Hoist, Hoist Two Drum (or over one), Gyderrick, Hyster, Motor Patrol, Mixers - 21 Cu. Ft. or over, Push Cat, Pulls, & Scrapers, Pumps-Two Well Points, Equipment Greaser, P & H Pulverizer or Pulverizer equal to Pugmill, Pugmill, Rubber-Tired farm type tractor w/Bulldozer/Blade/Auger or Hi-Lift over ½ yard, Skimmer Scoops, Seaman Tiller, Jersey Spreader, Tract-Air used with Drill or Hi-Lift, Trenching or Ditching Machine, Wood Chipper w/Tractor, self-propelled roller w/Blade, Concrete Pumps and Small Equipment Operators.

OPERATING ENGINEER RIVER 2 - when working on River Work and Levee Work on the Mississippi and Ohio Rivers, Lakes and Tributaries shall be employed as the Oiler or Fireman on Crane, Dragline, Shovel, Dredge, Truck Crane, Pile Driver, Gradeall, Dinky or Standard Locomotive, Guy Derrick, Trenching Machine or Ditching Machine 80 H.P. and over, All Terrain (cherry-picker) with over 40 ton Lifting Capacity, Deck Oiler and Deckhands.

#### Other Classifications of Work:

For definitions of classifications not otherwise set out, the Department generally has on file such definitions which are available. If a task to be performed is not subject to one of the classifications of pay set out, the Department will upon being contacted state which neighboring county has such a classification and provide such rate, such rate being deemed to exist by reference in this document. If no neighboring county rate applies to the task, the Department shall undertake a special determination, such special determination being then deemed to have existed under this determination. If a project requires these, or any classification not listed, please contact IDOL at 217-782-1710 for wage rates or clarifications.

#### LANDSCAPING

Landscaping work falls under the existing classifications for laborer, operating engineer and truck driver. The work performed by landscape plantsman and landscape laborer is covered by the existing classification of laborer. The work performed by landscape operators (regardless of equipment used or its size) is covered by the classifications of operating engineer. The work performed by landscape truck drivers (regardless of size of truck driven) is covered by the classifications of truck driver.

# Gallatin County Prevailing Wage for February 2011

Trade Name	RG	TYP	C	Base	FRMAN	*M-F>8	OSA	OSH	H/W	Pensn	Vac	Trng
=====	==	===	=	=====	=====	=====	===	===	=====	=====	=====	=====
ASBESTOS ABT-GEN		ALL		23.650	24.100	1.5	1.5	2.0	5.450	8.500	0.000	0.900
ASBESTOS ABT-MEC		BLD		20.800	0.000	2.0	2.0	2.0	5.500	4.200	0.000	0.000
BOILERMAKER		BLD		31.500	34.000	1.5	1.5	2.0	6.820	11.43	1.500	0.350
BRICK MASON		BLD		27.220	28.720	1.5	1.5	2.0	7.950	6.690	0.000	0.430
CARPENTER		BLD		30.490	31.990	1.5	1.5	2.0	6.050	5.750	0.000	0.350
CARPENTER		HWY		30.440	31.940	1.5	1.5	2.0	6.050	5.750	0.000	0.350
CEMENT MASON		BLD		26.750	28.250	1.5	1.5	2.0	5.900	4.800	0.000	0.300
CEMENT MASON		HWY		26.350	27.350	1.5	1.5	2.0	5.900	4.350	0.000	0.300
CERAMIC TILE FNSHER		BLD		25.720	0.000	1.5	1.5	2.0	7.950	6.690	0.000	0.430
ELECTRICIAN		ALL		36.240	38.490	1.5	1.5	2.0	5.250	8.340	0.000	0.720
ELECTRONIC SYS TECH		BLD		29.530	31.280	1.5	1.5	2.0	5.250	3.840	0.000	0.250
FLOOR LAYER		BLD		28.930	29.680	1.5	1.5	2.0	6.050	5.750	0.000	0.350
GLAZIER		BLD		26.330	27.580	1.5	1.5	2.0	4.850	5.200	0.000	0.300
HT/FROST INSULATOR		BLD		28.920	29.920	1.5	1.5	2.0	4.800	8.160	0.000	0.280
IRON WORKER		ALL		26.250	27.500	1.5	1.5	2.0	5.780	9.100	0.000	0.345
LABORER		BLD		23.650	24.100	1.5	1.5	2.0	5.450	8.500	0.000	0.800
LABORER		HWY		23.650	24.100	1.5	1.5	2.0	5.450	8.450	0.000	0.800
LABORER		O&C		17.740	18.190	1.5	1.5	2.0	5.450	8.450	0.000	0.800
MACHINIST		BLD		43.160	45.160	1.5	1.5	2.0	7.640	8.700	0.000	0.000
MARBLE FINISHERS		BLD		25.720	0.000	1.5	1.5	2.0	7.950	6.690	0.000	0.430
MARBLE MASON		BLD		27.220	28.720	1.5	1.5	2.0	7.950	6.690	0.000	0.430
MILLWRIGHT		BLD		30.490	31.990	1.5	1.5	2.0	6.050	5.750	0.000	0.350
MILLWRIGHT		HWY		30.440	31.940	1.5	1.5	2.0	6.050	5.750	0.000	0.350
OE RIVER 1		RIV 1		30.950	31.950	1.5	1.5	2.0	6.000	7.800	0.000	1.300
OE RIVER 2		RIV 2		27.500	31.950	1.5	1.5	2.0	6.000	7.800	0.000	1.300
OPERATING ENGINEER		ALL 1		30.850	31.850	1.5	1.5	2.0	6.000	7.800	0.000	1.300
OPERATING ENGINEER		ALL 2		28.950	31.850	1.5	1.5	2.0	6.000	7.800	0.000	1.300
OPERATING ENGINEER		ALL 3		24.150	31.850	1.5	1.5	2.0	6.000	7.800	0.000	1.300
OPERATING ENGINEER		ALL 4		21.400	27.800	1.5	1.5	2.0	5.650	6.100	0.000	1.100
OPERATING ENGINEER		O&C 1		23.140	24.140	1.5	1.5	2.0	6.000	7.800	0.000	1.300
OPERATING ENGINEER		O&C 2		21.710	24.140	1.5	1.5	2.0	6.000	7.800	0.000	1.300
OPERATING ENGINEER		O&C 3		18.120	24.140	1.5	1.5	2.0	6.000	7.800	0.000	1.300
OPERATING ENGINEER		O&C 4		16.050	21.100	1.5	1.5	2.0	5.650	6.100	0.000	1.100
PAINTER		BLD		26.260	27.760	1.5	1.5	2.0	6.130	6.950	0.000	0.450
PAINTER		HWY		30.560	32.060	1.5	1.5	2.0	6.130	6.950	0.000	0.450
PAINTER OVER 30FT		BLD		27.260	28.760	1.5	1.5	2.0	6.130	6.950	0.000	0.450
PAINTER PWR EQMT		BLD		27.260	28.760	1.5	1.5	2.0	6.130	6.950	0.000	0.450
PAINTER PWR EQMT		HWY		31.560	33.060	1.5	1.5	2.0	6.130	6.950	0.000	0.450
PILEDRIVER		BLD		30.490	31.990	1.5	1.5	2.0	6.050	5.750	0.000	0.350
PILEDRIVER		HWY		30.440	31.940	1.5	1.5	2.0	6.050	5.750	0.000	0.350
PIPEFITTER		BLD		32.250	35.470	1.5	1.5	2.0	8.250	8.850	0.000	1.200
PLASTERER		BLD		26.750	28.250	1.5	1.5	2.0	5.900	4.800	0.000	0.300
PLUMBER		BLD		32.250	35.470	1.5	1.5	2.0	8.250	8.850	0.000	1.200
ROOFER		BLD		26.340	28.340	1.5	1.5	2.0	6.280	4.750	0.000	0.360
SHEETMETAL WORKER		ALL		31.390	32.890	1.5	1.5	2.0	6.430	6.490	1.890	0.360
SPRINKLER FITTER		BLD		36.140	38.890	1.5	1.5	2.0	8.200	6.550	0.000	0.250
STONE MASON		BLD		27.220	28.720	1.5	1.5	2.0	7.950	6.690	0.000	0.430
TERRAZZO FINISHER		BLD		25.720	0.000	1.5	1.5	2.0	7.950	6.690	0.000	0.430
TRUCK DRIVER		ALL 1		28.430	0.000	1.5	1.5	2.0	9.050	5.500	0.000	0.250
TRUCK DRIVER		ALL 2		28.850	0.000	1.5	1.5	2.0	9.050	5.500	0.000	0.250
TRUCK DRIVER		ALL 3		29.050	0.000	1.5	1.5	2.0	9.050	5.500	0.000	0.250
TRUCK DRIVER		ALL 4		29.320	0.000	1.5	1.5	2.0	9.050	5.500	0.000	0.250
TRUCK DRIVER		ALL 5		30.100	0.000	1.5	1.5	2.0	9.050	5.500	0.000	0.250
TRUCK DRIVER		O&C 1		22.750	0.000	1.5	1.5	2.0	2.920	6.700	0.000	0.250
TRUCK DRIVER		O&C 2		19.150	0.000	1.5	1.5	2.0	2.920	6.700	0.000	0.250
TRUCK DRIVER		O&C 3		19.650	0.000	1.5	1.5	2.0	2.920	6.700	0.000	0.250
TUCKPOINTER		BLD		27.220	28.720	1.5	1.5	2.0	7.950	6.690	0.000	0.430

## Legend:

M-F>8 (Overtime is required for any hour greater than 8 worked each day, Monday through Friday.)

OSA (Overtime is required for every hour worked on Saturday)

OSH (Overtime is required for every hour worked on Sunday and Holidays)

H/W (Health & Welfare Insurance)

Pensn (Pension)

Vac (Vacation)

Trng (Training)

## Explanations

### GALLATIN COUNTY

The following list is considered as those days for which holiday rates of wages for work performed apply: New Years Day, Memorial Day, Fourth of July, Labor Day, Thanksgiving Day, Christmas Day and Veterans Day in some classifications/counties. Generally, any of these holidays which fall on a Sunday is celebrated on the following Monday. This then makes work performed on that Monday payable at the appropriate overtime rate for holiday pay. Common practice in a given local may alter certain days of celebration. If in doubt, please check with IDOL.

Oil and chip resealing (O&C) means the application of road oils and liquid asphalt to coat an existing road surface, followed by application of aggregate chips or gravel to coated surface, and subsequent rolling of material to seal the surface.

### EXPLANATION OF CLASSES

ASBESTOS - GENERAL - removal of asbestos material/mold and hazardous materials from any place in a building, including mechanical systems where those mechanical systems are to be removed. This includes the removal of asbestos materials/mold and hazardous materials from ductwork or pipes in a building when the building is to be demolished at the time or at some close future date.

ASBESTOS - MECHANICAL - removal of asbestos material from mechanical systems, such as pipes, ducts, and boilers, where the mechanical systems are to remain.

### LABORER - OIL AND CHIP RESEALING ONLY

Hook and unhook chip box from aggregate truck; distribute material within chip box; perform flagging work related to oil and chip resealing; hand spray oil fluids; handle traffic control, including setting-up and maintaining barricades, drums, cones, delineators, signs and other such items, as well as laying-out and applying or removing temporary roadway markings used to control traffic in job site related to oil and chip resealing; and perform clean-up related to oil and chip resealing.

#### CERAMIC TILE FINISHER, MARBLE FINISHER, TERRAZZO FINISHER

Assisting, helping or supporting the tile, marble and terrazzo mechanic by performing their historic and traditional work assignments required to complete the proper installation of the work covered by said crafts. The term "Ceramic" is used for naming the classification only, and is in no a limitation of the product handled. Ceramic takes into consideration most hard tiles.

#### ELECTRONIC SYSTEMS TECHNICIAN

Installation, service and maintenance of low-voltage systems which utilizes the transmission and/or transference of voice, sound, vision, or digital for commercial, education, security and entertainment purposes for the following: TV monitoring and surveillance, background/foreground music, intercom and telephone interconnect, field programming, inventory control systems, microwave transmission, multi-media, multiplex, radio page, school, intercom and sound burglar alarms and low voltage master clock systems.

Excluded from this classification are energy management systems, life safety systems, supervisory controls and data acquisition systems not intrinsic with the above listed systems, fire alarm systems, nurse call systems and raceways exceeding fifteen feet in length.

#### TRUCK DRIVER - BUILDING, HEAVY AND HIGHWAY CONSTRUCTION

Class 1. Drivers on 2 axle trucks hauling less than 9 ton. Air compressor and welding machines and brooms, including those pulled by separate units, truck driver helpers, warehouse employees, mechanic helpers, greasers and tiremen, pickup trucks when hauling materials, tools, or workers to and from and on-the-job site, and fork lifts up to 6,000 lb. capacity.

Class 2. Two or three axle trucks hauling more than 9 ton but hauling less than 16 ton. A-frame winch trucks, hydrolift trucks, vector trucks or similar equipment when used for transportation purposes. Fork lifts over 6,000 lb. capacity, winch trucks, four axle combination units, and ticket writers.

Class 3. Two, three or four axle trucks hauling 16 ton or more. Drivers on water pulls, articulated dump trucks, mechanics and working forepersons, and dispatchers. Five axle or more combination units.

Class 4. Low Boy and Oil Distributors.

Class 5. Drivers who require special protective clothing while employed on hazardous waste work.

#### TRUCK DRIVER - O & C (Oil and Chip Resealing ONLY)

It involves driving of contractor or subcontractor owned, leased, or hired pickup, dump, service, or oil distributor trucks. Includes transporting materials and equipment (including, but not limited to oils, aggregate supplies, parts, machinery and tools) to or from the job site; distributing oil or liquid asphalt and aggregate; stock piling material; and maintaining trucks at job site related to oil and chip resealing.

Class 1. Distributors, liquid asphalt hauling and hauling of asphalt rubber-tired rollers.

Class 2. Stockpiling.

Class 3. Tandem hauling to job site.

OPERATING ENGINEERS - BUILDING, HEAVY AND HIGHWAY CONSTRUCTION

Class 1. APSCO or Equal Spreading Machine, Backhoe, Backfiller, Boom or Winch Cat, Bituminous Mixplane Machine, Blacksmith, Bituminous Surfacing Machine, Bull-Dozer, Crane, Shovel, Dragline, Truck Crane, Pile Driver, Concrete Breaker, Concrete or Pumpcrete Pumps, Dinky or Standard Locomotives, Well or Caisson Drills, Elevating Grader, Fork Lifts, Flexplane, Gradeall, Hi-Lift Hoists, Guy-Derricks, Hysters, Mechanic Motor Patrol, Mixers-21 cu. ft. or over, Push Cats, Pulls and Scrapers, Two Well Point Pumps, Pulverizer or Tiller, PugMill, Rubber-Tired Farm Type Tractor with Bulldozer/Blade/Auger or hi-lift over 1/2 yd., Jersey Spreader, Tract-Air used with Drill or Hi-Lift, Trenching or Ditching Machines, Wood Chipper w/Tractor, Self-Propelled Roller w/Blade, Equipment Greaser, Self-Propelled Bump Grinder on Concrete pavement, Boat Operator, Skid-Loaders, Tuggers, Lazer Screed, and Self-Propelled Chip Spreader (when others run conveyors).

Class 2. Any type tractor pulling any type roller or disc, Two Air Compressors (220 cu. ft. capacity or over), Two AirTract Drills, Air-Track Drill w/Compressor, Automatic Bins or Scales w/Compressor or Generator, Pipeline Boring Machine, Bulk Cement Plant w/Separate Compressor, Power Operated Bull Float, Hydra-Lift w/Single Motor, Straw Mulcher Blower w/Spout, Self-Propelled Roller/Compactor, Back-End man on Bituminous Surfacing Machine, oiler on milling machine.

Class 3. Air Compressor w/Valve driving piling, Boom or Winch Type Truck, Two Conveyors, Self-Propelled Concrete Saw, Form Grader, Truck Crane Oiler, Self-Propelled Vibrator, Rubber Tired Farm Type Tractor w/Blade/Bulldozer/Auger/hi-lift - 1/2 yd. or less, Elevator Operator, Man Lift (scissor lift) when lifting materials.

Class 4. Air-Track Drill (one), Belt Drag Machine, Power Broom, Mechanical Plasterer Applicator, Trac-Air, Air Compressor (220 cu. ft. or over) One, Air Compressor (under 220 cu. ft) four, Automatic Bin, Bulk Cement Plant w/Built-in Compressor running off same motor or electric motor, Fireman or Switchman, Self-Propelled Form Tamper, Light Plants (4), Welding Machines (4), Pumps (4), or Combination of four (4) Pumps, Light Plants, Welding Machines, Air-Compressors (under 220 cu. ft.), Mudjacks or Wood Chipper, Mixers - less than 21 cu. ft. Mortar Mixer w/Skip or Pump, Pipeline Tract Jack. One Operating Engineer may operate and maintain any combination of the following pieces of equipment, not to exceed four (4) which shall be within a reasonable distance, such combination may include any equipment in this classification: (Compressors, Light Plants, Generators, Welding Machines, Pumps or Conveyors), One Well- Point Pump, Two Motor Driven Heaters, One Air Compressor (under 220 cu. ft.), One Engine-Driven Conveyor, One Motor Driven Heater, One Light Plant, One Pump, One Welding Machine, One Ulmac or Equal Spreader, Oilers, and one Generator 10 kw or greater.

OPERATING ENGINEER - O & C (Oil and Chip Resealing ONLY). Includes the operation of all motorized heavy equipment used in oil and chip rsealing, including but not limited to operating self-propelled chip spreaders, and all types of rollers (both hard and rubber tired); and other duties pertaining to the operation or maintenance of heavy equipment relatd to oil and chip resealing.

Class 1. See Class 1 above for types of equipment operated.

Class 2. See Class 2 above for types of equipment operated.

Class 3. See Class 3 above for types of equipment operated.

Class 4. See Class 4 above for types of equipment operated.

OPERATING ENGINEER RIVER WORK 1 - operate the following machines when working on River Work and Levee Work on the Mississippi and Ohio Rivers, Lakes and Tributaries: Crane, Shovel, Drageline, Scrapers, Dredge, Derrick, Pile-Driver, Push Boat, all power boat operators, Mechanic, Engineman on Dredge, Leverman on Dredge, All Bituminous Spreader machines, Backhoe, Backfiller, Boom, or Winch Cat, Bituminous Mixplane Machine, Blacksmith, Bituminous Surfacing Machine, Bulldozer, Truck Cranes, Hydraulic Truck Mounted Boom/Crane, Concrete Finishing Machine, or Spreader Machine, Concrete Breaker, Concrete or Pumpcrete Machines, Concrete Plant Operator, All Off Road Material Hauling Equipment, Dinky or Standard Locomotives, Well Drill, Elevating Grader, Fork-Lifts, Flexplane, Gradeall, Hi-Lift, Power Handblade Tugger type Hoist, Hoist Two Drum (or over one), Gyderrick, Hyster, Motor Patrol, Mixers - 21 Cu. Ft. or over, Push Cat, Pulls, & Scrapers, Pumps-Two Well Points, Equipment Greaser, P & H Pulverizer or Pulverizer equal to Pugmill, Pugmill, Rubber-Tired farm type tractor w/Bulldozer/Blade/Auger or Hi-Lift over ½ yard, Skimmer Scoops, Seaman Tiller, Jersey Spreader, Tract-Air used with Drill or Hi-Lift, Trenching or Ditching Machine, Wood Chipper w/Tractor, self-propelled roller w/Blade, Concrete Pumps and Small Equipment Operators.

OPERATING ENGINEER RIVER 2 - when working on River Work and Levee Work on the Mississippi and Ohio Rivers, Lakes and Tributaries shall be employed as the Oiler or Fireman on Crane, Dragline, Shovel, Dredge, Truck Crane, Pile Driver, Gradeall, Dinky or Standard Locomotive, Guy Derrick, Trenching Machine or Ditching Machine 80 H.P. and over, All Terrain (cherry-picker) with over 40 ton Lifting Capacity, Deck Oiler and Deckhands.

Other Classifications of Work:

For definitions of classifications not otherwise set out, the Department generally has on file such definitions which are available. If a task to be performed is not subject to one of the classifications of pay set out, the Department will upon being contacted state which neighboring county has such a classification and provide such rate, such rate being deemed to exist by reference in this document. If no neighboring county rate applies to the task, the Department shall undertake a special determination, such special determination being then deemed to have existed under this determination. If a project requires these, or any classification not listed, please contact IDOL at 217-782-1710 for wage rates or clarifications.

#### LANDSCAPING

Landscaping work falls under the existing classifications for laborer, operating engineer and truck driver. The work performed by landscape plantsman and landscape laborer is covered by the existing classification of laborer. The work performed by landscape operators (regardless of equipment used or its size) is covered by the classifications of operating engineer. The work performed by landscape truck drivers (regardless of size of truck driven) is covered by the classifications of truck driver.

# Jackson County Prevailing Wage for February 2011

Trade Name	RG	TYP	C	Base	FRMAN	*M-F>8	OSA	OSH	H/W	Pensn	Vac	Trng
=====	==	===	=	=====	=====	=====	===	===	=====	=====	=====	=====
ASBESTOS ABT-GEN		ALL		23.650	24.100	1.5	1.5	2.0	5.450	8.500	0.000	0.900
ASBESTOS ABT-MEC		BLD		28.710	29.710	1.5	1.5	2.0	6.400	2.500	0.000	0.000
BOILERMAKER		BLD		31.500	34.000	1.5	1.5	2.0	6.820	11.43	1.500	0.350
BRICK MASON		BLD		27.220	28.720	1.5	1.5	2.0	7.950	6.690	0.000	0.430
CARPENTER		BLD		30.490	31.990	1.5	1.5	2.0	6.050	5.750	0.000	0.350
CARPENTER		HWY		30.440	31.940	1.5	1.5	2.0	6.050	5.750	0.000	0.350
CEMENT MASON		BLD		26.750	28.250	1.5	1.5	2.0	5.900	4.800	0.000	0.300
CEMENT MASON		HWY		26.350	27.350	1.5	1.5	2.0	5.900	4.350	0.000	0.300
CERAMIC TILE FNSHER		BLD		25.720	0.000	1.5	1.5	2.0	7.950	6.690	0.000	0.430
ELECTRICIAN		ALL		36.240	38.490	1.5	1.5	2.0	5.250	8.340	0.000	0.720
ELECTRONIC SYS TECH		BLD		29.530	31.280	1.5	1.5	2.0	5.250	3.840	0.000	0.250
FLOOR LAYER		BLD		28.930	29.680	1.5	1.5	2.0	6.050	5.750	0.000	0.350
GLAZIER		BLD		31.680	0.000	2.0	2.0	2.0	9.020	10.30	2.540	0.310
HT/FROST INSULATOR		BLD		36.260	37.260	1.5	1.5	2.0	7.150	10.46	0.000	0.500
IRON WORKER		ALL		26.740	28.740	1.5	1.5	2.0	5.760	9.590	0.000	0.500
LABORER		BLD		23.650	24.100	1.5	1.5	2.0	5.450	8.500	0.000	0.800
LABORER		HWY		23.650	24.100	1.5	1.5	2.0	5.450	8.450	0.000	0.800
LABORER		O&C		17.740	18.190	1.5	1.5	2.0	5.450	8.450	0.000	0.800
MACHINIST		BLD		43.160	45.160	1.5	1.5	2.0	7.640	8.700	0.000	0.000
MARBLE FINISHERS		BLD		25.720	0.000	1.5	1.5	2.0	7.950	6.690	0.000	0.430
MARBLE MASON		BLD		27.220	28.720	1.5	1.5	2.0	7.950	6.690	0.000	0.430
MILLWRIGHT		BLD		30.490	31.990	1.5	1.5	2.0	6.050	5.750	0.000	0.350
MILLWRIGHT		HWY		30.440	31.940	1.5	1.5	2.0	6.050	5.750	0.000	0.350
OE RIVER 1		RIV 1		30.950	31.950	1.5	1.5	2.0	6.000	7.800	0.000	1.300
OE RIVER 2		RIV 2		27.500	31.950	1.5	1.5	2.0	6.000	7.800	0.000	1.300
OPERATING ENGINEER		ALL 1		30.850	31.850	1.5	1.5	2.0	6.000	7.800	0.000	1.300
OPERATING ENGINEER		ALL 2		28.950	31.850	1.5	1.5	2.0	6.000	7.800	0.000	1.300
OPERATING ENGINEER		ALL 3		24.150	31.850	1.5	1.5	2.0	6.000	7.800	0.000	1.300
OPERATING ENGINEER		ALL 4		21.400	27.800	1.5	1.5	2.0	5.650	6.100	0.000	1.100
OPERATING ENGINEER		O&C 1		23.140	24.140	1.5	1.5	2.0	6.000	7.800	0.000	1.300
OPERATING ENGINEER		O&C 2		21.710	24.140	1.5	1.5	2.0	6.000	7.800	0.000	1.300
OPERATING ENGINEER		O&C 3		18.120	24.140	1.5	1.5	2.0	6.000	7.800	0.000	1.300
OPERATING ENGINEER		O&C 4		16.050	21.100	1.5	1.5	2.0	5.650	6.100	0.000	1.100
PAINTER		BLD		26.260	27.760	1.5	1.5	2.0	6.130	6.950	0.000	0.450
PAINTER		HWY		30.560	32.060	1.5	1.5	2.0	6.130	6.950	0.000	0.450
PAINTER OVER 30FT		BLD		27.260	28.760	1.5	1.5	2.0	6.130	6.950	0.000	0.450
PAINTER PWR EQMT		BLD		27.260	28.760	1.5	1.5	2.0	6.130	6.950	0.000	0.450
PAINTER PWR EQMT		HWY		31.560	33.060	1.5	1.5	2.0	6.130	6.950	0.000	0.450
PILEDRIVER		BLD		30.490	31.990	1.5	1.5	2.0	6.050	5.750	0.000	0.350
PILEDRIVER		HWY		30.440	31.940	1.5	1.5	2.0	6.050	5.750	0.000	0.350
PIPEFITTER		BLD		36.600	40.260	1.5	2.0	2.0	7.200	5.250	0.000	1.100
PLASTERER		BLD		26.750	28.250	1.5	1.5	2.0	5.900	4.800	0.000	0.300
PLUMBER		BLD		36.600	40.260	1.5	2.0	2.0	7.200	5.250	0.000	1.100
ROOFER		BLD		22.250	23.250	1.5	1.5	2.0	7.900	3.800	0.000	0.000
SHEETMETAL WORKER		ALL		31.390	32.890	1.5	1.5	2.0	6.430	6.490	1.890	0.360
SPRINKLER FITTER		BLD		36.140	38.890	1.5	1.5	2.0	8.200	6.550	0.000	0.250
STONE MASON		BLD		27.220	28.720	1.5	1.5	2.0	7.950	6.690	0.000	0.430
TERRAZZO FINISHER		BLD		25.720	0.000	1.5	1.5	2.0	7.950	6.690	0.000	0.430
TERRAZZO MASON		BLD		28.500	28.800	1.5	1.5	2.0	6.400	5.700	0.000	0.430
TRUCK DRIVER		ALL 1		28.430	0.000	1.5	1.5	2.0	9.050	5.500	0.000	0.250
TRUCK DRIVER		ALL 2		28.850	0.000	1.5	1.5	2.0	9.050	5.500	0.000	0.250
TRUCK DRIVER		ALL 3		29.050	0.000	1.5	1.5	2.0	9.050	5.500	0.000	0.250
TRUCK DRIVER		ALL 4		29.320	0.000	1.5	1.5	2.0	9.050	5.500	0.000	0.250
TRUCK DRIVER		ALL 5		30.100	0.000	1.5	1.5	2.0	9.050	5.500	0.000	0.250
TRUCK DRIVER		O&C 1		22.750	0.000	1.5	1.5	2.0	2.920	6.700	0.000	0.250
TRUCK DRIVER		O&C 2		19.150	0.000	1.5	1.5	2.0	2.920	6.700	0.000	0.250
TRUCK DRIVER		O&C 3		19.650	0.000	1.5	1.5	2.0	2.920	6.700	0.000	0.250
TUCKPOINTER		BLD		27.220	28.720	1.5	1.5	2.0	7.950	6.690	0.000	0.430



Legend:

M-F>8 (Overtime is required for any hour greater than 8 worked each day, Monday through Friday.)

OSA (Overtime is required for every hour worked on Saturday)

OSH (Overtime is required for every hour worked on Sunday and Holidays)

H/W (Health & Welfare Insurance)

Pensn (Pension)

Vac (Vacation)

Trng (Training)

## Explanations

### JACKSON COUNTY

The following list is considered as those days for which holiday rates of wages for work performed apply: New Years Day, Memorial Day, Fourth of July, Labor Day, Thanksgiving Day, Christmas Day and Veterans Day in some classifications/counties. Generally, any of these holidays which fall on a Sunday is celebrated on the following Monday. This then makes work performed on that Monday payable at the appropriate overtime rate for holiday pay. Common practice in a given local may alter certain days of celebration. If in doubt, please check with IDOL.

Oil and chip resealing (O&C) means the application of road oils and liquid asphalt to coat an existing road surface, followed by application of aggregate chips or gravel to coated surface, and subsequent rolling of material to seal the surface.

### EXPLANATION OF CLASSES

ASBESTOS - GENERAL - removal of asbestos material/mold and hazardous materials from any place in a building, including mechanical systems where those mechanical systems are to be removed. This includes the removal of asbestos materials/mold and hazardous materials from ductwork or pipes in a building when the building is to be demolished at the time or at some close future date.

ASBESTOS - MECHANICAL - removal of asbestos material from mechanical systems, such as pipes, ducts, and boilers, where the mechanical systems are to remain.

### LABORER - OIL AND CHIP RESEALING

Hook and unhook chip box from aggregate truck; distribute material within chip box; perform flagging work related to oil and chip resealing; hand spray oil fluids; handle traffic control, including setting-up and maintaining barricades, drums, cones, delineators, signs and other such items, as well as laying-out and applying or removing temporary roadway markings used to control traffic in job site related to oil and chip resealing; and perform clean-up related

to oil and chip resealing.

#### CERAMIC TILE FINISHER, MARBLE FINISHER, TERRAZZO FINISHER

Assisting, helping or supporting the tile, marble and terrazzo mechanic by performing their historic and traditional work assignments required to complete the proper installation of the work covered by said crafts. The term "Ceramic" is used for naming the classification only, and is in no a limitation of the product handled. Ceramic takes into consideration most hard tiles.

#### ELECTRONIC SYSTEMS TECHNICIAN

Installation, service and maintenance of low-voltage systems which utilizes the transmission and/or transference of voice, sound, vision, or digital for commercial, education, security and entertainment purposes for the following: TV monitoring and surveillance, background/foreground music, intercom and telephone interconnect, field programming, inventory control systems, microwave transmission, multi-media, multiplex, radio page, school, intercom and sound burglar alarms and low voltage master clock systems.

Excluded from this classification are energy management systems, life safety systems, supervisory controls and data acquisition systems not intrinsic with the above listed systems, fire alarm systems, nurse call systems and raceways exceeding fifteen feet in length.

#### TRUCK DRIVER - BUILDING, HEAVY AND HIGHWAY CONSTRUCTION

Class 1. Drivers on 2 axle trucks hauling less than 9 ton. Air compressor and welding machines and brooms, including those pulled by separate units, truck driver helpers, warehouse employees, mechanic helpers, greasers and tiremen, pickup trucks when hauling materials, tools, or workers to and from and on-the-job site, and fork lifts up to 6,000 lb. capacity.

Class 2. Two or three axle trucks hauling more than 9 ton but hauling less than 16 ton. A-frame winch trucks, hydrolift trucks, vector trucks or similar equipment when used for transportation purposes. Fork lifts over 6,000 lb. capacity, winch trucks, four axle combination units, and ticket writers.

Class 3. Two, three or four axle trucks hauling 16 ton or more. Drivers on water pulls, articulated dump trucks, mechanics and working forepersons, and dispatchers. Five axle or more combination units.

Class 4. Low Boy and Oil Distributors.

Class 5. Drivers who require special protective clothing while employed on hazardous waste work.

#### TRUCK DRIVER - O & C (Oil and Chip Resealing ONLY)

It involves driving of contractor or subcontractor owned, leased, or hired pickup, dump, service, or oil distributor trucks. Includes transporting materials and equipment (including, but not limited to oils, aggregate supplies, parts, machinery and tools) to or from the job site; distributing oil or liquid asphalt and aggregate; stock piling material; and maintaining trucks at job site related to oil and chip resealing.

Class 1. Distributors, liquid asphalt hauling and hauling of asphalt rubber-tired rollers.

Class 2. Stockpiling.

Class 3. Tandem hauling to job site.

OPERATING ENGINEERS - BUILDING, HEAVY AND HIGHWAY CONSTRUCTION

Class 1. APSCO or Equal Spreading Machine, Backhoe, Backfiller, Boom or Winch Cat, Bituminous Mixplane Machine, Blacksmith, Bituminous Surfacing Machine, Bull-Dozer, Crane, Shovel, Dragline, Truck Crane, Pile Driver, Concrete Breaker, Concrete or Pumpcrete Pumps, Dinky or Standard Locomotives, Well or Caisson Drills, Elevating Grader, Fork Lifts, Flexplane, Gradeall, Hi-Lift Hoists, Guy-Derricks, Hysters, Mechanic Motor Patrol, Mixers-21 cu. ft. or over, Push Cats, Pulls and Scrapers, Two Well Point Pumps, Pulverizer or Tiller, PugMill, Rubber-Tired Farm Type Tractor with Bulldozer/Blade/Auger or hi-lift over 1/2 yd., Jersey Spreader, Tract-Air used with Drill or Hi-Lift, Trenching or Ditching Machines, Wood Chipper w/Tractor, Self-Propelled Roller w/Blade, Equipment Greaser, Self-Propelled Bump Grinder on Concrete pavement, Boat Operator, Skid-Loaders, Tuggers, Lazer Screed, and Self-Propelled Chip Spreader (when others run conveyors).

Class 2. Any type tractor pulling any type roller or disc, Two Air Compressors (220 cu. ft. capacity or over), Two AirTract Drills, Air-Track Drill w/Compressor, Automatic Bins or Scales w/Compressor or Generator, Pipeline Boring Machine, Bulk Cement Plant w/Separate Compressor, Power Operated Bull Float, Hydra-Lift w/Single Motor, Straw Mulcher Blower w/Spout, Self-Propelled Roller/Compactor, Back-End man on Bituminous Surfacing Machine, oiler on milling machine.

Class 3. Air Compressor w/Valve driving piling, Boom or Winch Type Truck, Two Conveyors, Self-Propelled Concrete Saw, Form Grader, Truck Crane Oiler, Self-Propelled Vibrator, Rubber Tired Farm Type Tractor w/Blade/Bulldozer/Auger/hi-lift - 1/2 yd. or less, Elevator Operator, Man Lift (scissor lift) when lifting materials.

Class 4. Air-Track Drill (one), Belt Drag Machine, Power Broom, Mechanical Plasterer Applicator, Trac-Air, Air Compressor (220 cu. ft. or over) One, Air Compressor (under 220 cu. ft) four, Automatic Bin, Bulk Cement Plant w/Built-in Compressor running off same motor or electric motor, Fireman or Switchman, Self-Propelled Form Tamper, Light Plants (4), Welding Machines (4), Pumps (4), or Combination of four (4) Pumps, Light Plants, Welding Machines, Air-Compressors (under 220 cu. ft.), Mudjacks or Wood Chipper, Mixers - less than 21 cu. ft. Mortar Mixer w/Skip or Pump, Pipeline Tract Jack. One Operating Engineer may operate and maintain any combination of the following pieces of equipment, not to exceed four (4) which shall be within a reasonable distance, such combination may include any equipment in this classification: (Compressors, Light Plants, Generators, Welding Machines, Pumps or Conveyors), One Well- Point Pump, Two Motor Driven Heaters, One Air Compressor (under 220 cu. ft.), One Engine-Driven Conveyor, One Motor Driven Heater, One Light Plant, One Pump, One Welding Machine, One Ulmac or Equal Spreader, Oilers, and one Generator 10 kw or greater.

OPERATING ENGINEER - O & C (Oil and Chip Resealing ONLY). Includes the operation of all motorized heavy equipment used in oil and chip rsealing, including but not limited to operating self-propelled chip spreaders, and all types of rollers (both hard and rubber tired); and other duties pertaining to the operation or maintenance of heavy equipment relatd to oil and chip resealing.

Class 1. See Class 1 above for types of equipment operated.

Class 2. See Class 2 above for types of equipment operated.

Class 3. See Class 3 above for types of equipment operated.

Class 4. See Class 4 above for types of equipment operated.

OPERATING ENGINEER RIVER WORK 1 - operate the following machines when working on River Work and Levee Work on the Mississippi and Ohio Rivers, Lakes and Tributaries: Crane, Shovel, Drageline, Scrapers, Dredge, Derrick, Pile-Driver, Push Boat, all power boat operators, Mechanic, Engineman on Dredge, Leverman on Dredge, All Bituminous Spreader machines, Backhoe, Backfiller, Boom, or Winch Cat, Bituminous Mixplane Machine, Blacksmith, Bituminous Surfacing Machine, Bulldozer, Truck Cranes, Hydraulic Truck Mounted Boom/Crane, Concrete Finishing Machine, or Spreader Machine, Concrete Breaker, Concrete or Pumpcrete Machines, Concrete Plant Operator, All Off Road Material Hauling Equipment, Dinky or Standard Locomotives, Well Drill, Elevating Grader, Fork-Lifts, Flexplane, Gradeall, Hi-Lift, Power Handblade Tugger type Hoist, Hoist Two Drum (or over one), Gyderrick, Hyster, Motor Patrol, Mixers - 21 Cu. Ft. or over, Push Cat, Pulls, & Scrapers, Pumps-Two Well Points, Equipment Greaser, P & H Pulverizer or Pulverizer equal to Pugmill, Pugmill, Rubber-Tired farm type tractor w/Bulldozer/Blade/Auger or Hi-Lift over ½ yard, Skimmer Scoops, Seaman Tiller, Jersey Spreader, Tract-Air used with Drill or Hi-Lift, Trenching or Ditching Machine, Wood Chipper w/Tractor, self-propelled roller w/Blade, Concrete Pumps and Small Equipment Operators.

OPERATING ENGINEER RIVER 2 - when working on River Work and Levee Work on the Mississippi and Ohio Rivers, Lakes and Tributaries shall be employed as the Oiler or Fireman on Crane, Dragline, Shovel, Dredge, Truck Crane, Pile Driver, Gradeall, Dinky or Standard Locomotive, Guy Derrick, Trenching Machine or Ditching Machine 80 H.P. and over, All Terrain (cherry-picker) with over 40 ton Lifting Capacity, Deck Oiler and Deckhands.

#### Other Classifications of Work:

For definitions of classifications not otherwise set out, the Department generally has on file such definitions which are available. If a task to be performed is not subject to one of the classifications of pay set out, the Department will upon being contacted state which neighboring county has such a classification and provide such rate, such rate being deemed to exist by reference in this document. If no neighboring county rate applies to the task, the Department shall undertake a special determination, such special determination being then deemed to have existed under this determination. If a project requires these, or any classification not listed, please contact IDOL at 217-782-1710 for wage rates or clarifications.

#### LANDSCAPING

Landscaping work falls under the existing classifications for laborer, operating engineer and truck driver. The work performed by landscape plantsman and landscape laborer is covered by the existing classification of laborer. The work performed by landscape operators (regardless of equipment used or its size) is covered by the classifications of operating engineer. The work performed by landscape truck drivers (regardless of size of truck driven) is

covered by the classifications of truck driver.

# Johnson County Prevailing Wage for February 2011

Trade Name	RG	TYP	C	Base	FRMAN	*M-F>8	OSA	OSH	H/W	Pensn	Vac	Trng
=====	==	===	=	=====	=====	=====	===	===	=====	=====	=====	=====
ASBESTOS ABT-GEN		ALL		23.650	24.100	1.5	1.5	2.0	5.450	8.500	0.000	0.900
ASBESTOS ABT-MEC		BLD		20.800	0.000	2.0	2.0	2.0	5.500	4.200	0.000	0.000
BOILERMAKER		BLD		31.500	34.000	1.5	1.5	2.0	6.820	11.43	1.500	0.350
BRICK MASON		BLD		27.220	28.720	1.5	1.5	2.0	7.950	6.690	0.000	0.430
CARPENTER		BLD		30.490	31.990	1.5	1.5	2.0	6.050	5.750	0.000	0.350
CARPENTER		HWY		30.440	31.940	1.5	1.5	2.0	6.050	5.750	0.000	0.350
CEMENT MASON		BLD		26.750	28.250	1.5	1.5	2.0	5.900	4.800	0.000	0.300
CEMENT MASON		HWY		26.350	27.350	1.5	1.5	2.0	5.900	4.350	0.000	0.300
CERAMIC TILE FNSHER		BLD		25.720	0.000	1.5	1.5	2.0	7.950	6.690	0.000	0.430
ELECTRICIAN		ALL		36.240	38.490	1.5	1.5	2.0	5.250	8.340	0.000	0.720
ELECTRONIC SYS TECH		BLD		29.530	31.280	1.5	1.5	2.0	5.250	3.840	0.000	0.250
FLOOR LAYER		BLD		28.930	29.680	1.5	1.5	2.0	6.050	5.750	0.000	0.350
GLAZIER		BLD		26.330	27.580	1.5	1.5	2.0	4.850	5.200	0.000	0.300
HT/FROST INSULATOR		BLD		28.920	29.920	1.5	1.5	2.0	4.800	8.160	0.000	0.280
IRON WORKER		ALL		26.740	28.740	1.5	1.5	2.0	5.760	9.590	0.000	0.500
LABORER		BLD		23.650	24.100	1.5	1.5	2.0	5.450	8.500	0.000	0.800
LABORER		HWY		23.650	24.100	1.5	1.5	2.0	5.450	8.450	0.000	0.800
LABORER		O&C		17.740	18.190	1.5	1.5	2.0	5.450	8.450	0.000	0.800
MACHINIST		BLD		43.160	45.160	1.5	1.5	2.0	7.640	8.700	0.000	0.000
MARBLE FINISHERS		BLD		25.720	0.000	1.5	1.5	2.0	7.950	6.690	0.000	0.430
MARBLE MASON		BLD		27.220	28.720	1.5	1.5	2.0	7.950	6.690	0.000	0.430
MILLWRIGHT		BLD		30.490	31.990	1.5	1.5	2.0	6.050	5.750	0.000	0.350
MILLWRIGHT		HWY		30.440	31.940	1.5	1.5	2.0	6.050	5.750	0.000	0.350
OE RIVER 1		RIV 1		30.950	31.950	1.5	1.5	2.0	6.000	7.800	0.000	1.300
OE RIVER 2		RIV 2		27.500	31.950	1.5	1.5	2.0	6.000	7.800	0.000	1.300
OPERATING ENGINEER		ALL 1		30.850	31.850	1.5	1.5	2.0	6.000	7.800	0.000	1.300
OPERATING ENGINEER		ALL 2		28.950	31.850	1.5	1.5	2.0	6.000	7.800	0.000	1.300
OPERATING ENGINEER		ALL 3		24.150	31.850	1.5	1.5	2.0	6.000	7.800	0.000	1.300
OPERATING ENGINEER		ALL 4		21.400	27.800	1.5	1.5	2.0	5.650	6.100	0.000	1.100
OPERATING ENGINEER		O&C 1		23.140	24.140	1.5	1.5	2.0	6.000	7.800	0.000	1.300
OPERATING ENGINEER		O&C 2		21.710	24.140	1.5	1.5	2.0	6.000	7.800	0.000	1.300
OPERATING ENGINEER		O&C 3		18.120	24.140	1.5	1.5	2.0	6.000	7.800	0.000	1.300
OPERATING ENGINEER		O&C 4		16.050	21.100	1.5	1.5	2.0	5.650	6.100	0.000	1.100
PAINTER		BLD		26.260	27.760	1.5	1.5	2.0	6.130	6.950	0.000	0.450
PAINTER		HWY		30.560	32.060	1.5	1.5	2.0	6.130	6.950	0.000	0.450
PAINTER OVER 30FT		BLD		27.260	28.760	1.5	1.5	2.0	6.130	6.950	0.000	0.450
PAINTER PWR EQMT		BLD		27.260	28.760	1.5	1.5	2.0	6.130	6.950	0.000	0.450
PAINTER PWR EQMT		HWY		31.560	33.060	1.5	1.5	2.0	6.130	6.950	0.000	0.450
PILEDRIVER		BLD		30.490	31.990	1.5	1.5	2.0	6.050	5.750	0.000	0.350
PILEDRIVER		HWY		30.440	31.940	1.5	1.5	2.0	6.050	5.750	0.000	0.350
PIPEFITTER		BLD		36.600	40.260	1.5	2.0	2.0	7.200	5.250	0.000	1.100
PLASTERER		BLD		26.750	28.250	1.5	1.5	2.0	5.900	4.800	0.000	0.300
PLUMBER		BLD		36.600	40.260	1.5	2.0	2.0	7.200	5.250	0.000	1.100
ROOFER		BLD		22.250	23.250	1.5	1.5	2.0	7.900	3.800	0.000	0.000
SHEETMETAL WORKER		ALL		31.390	32.890	1.5	1.5	2.0	6.430	6.490	1.890	0.360
SPRINKLER FITTER		BLD		36.140	38.890	1.5	1.5	2.0	8.200	6.550	0.000	0.250
STONE MASON		BLD		27.220	28.720	1.5	1.5	2.0	7.950	6.690	0.000	0.430
TERRAZZO FINISHER		BLD		25.720	0.000	1.5	1.5	2.0	7.950	6.690	0.000	0.430
TERRAZZO MASON		BLD		28.500	28.800	1.5	1.5	2.0	6.400	5.700	0.000	0.430
TRUCK DRIVER		ALL 1		28.430	0.000	1.5	1.5	2.0	9.050	5.500	0.000	0.250
TRUCK DRIVER		ALL 2		28.850	0.000	1.5	1.5	2.0	9.050	5.500	0.000	0.250
TRUCK DRIVER		ALL 3		29.050	0.000	1.5	1.5	2.0	9.050	5.500	0.000	0.250
TRUCK DRIVER		ALL 4		29.320	0.000	1.5	1.5	2.0	9.050	5.500	0.000	0.250
TRUCK DRIVER		ALL 5		30.100	0.000	1.5	1.5	2.0	9.050	5.500	0.000	0.250
TRUCK DRIVER		O&C 1		22.750	0.000	1.5	1.5	2.0	2.920	6.700	0.000	0.250
TRUCK DRIVER		O&C 2		19.150	0.000	1.5	1.5	2.0	2.920	6.700	0.000	0.250
TRUCK DRIVER		O&C 3		19.650	0.000	1.5	1.5	2.0	2.920	6.700	0.000	0.250
TUCKPOINTER		BLD		27.220	28.720	1.5	1.5	2.0	7.950	6.690	0.000	0.430

Legend :

M-F>8 (Overtime is required for any hour greater than 8 worked each day, Monday through Friday.)

OSA (Overtime is required for every hour worked on Saturday)

OSH (Overtime is required for every hour worked on Sunday and Holidays)

H/W (Health & Welfare Insurance)

Pensn (Pension)

Vac (Vacation)

Trng (Training)

## Explanations

### JOHNSON COUNTY

The following list is considered as those days for which holiday rates of wages for work performed apply: New Years Day, Memorial Day, Fourth of July, Labor Day, Thanksgiving Day, Christmas Day and Veterans Day in some classifications/counties. Generally, any of these holidays which fall on a Sunday is celebrated on the following Monday. This then makes work performed on that Monday payable at the appropriate overtime rate for holiday pay. Common practice in a given local may alter certain days of celebration. If in doubt, please check with IDOL.

Oil and chip resealing (O&C) means the application of road oils and liquid asphalt to coat an existing road surface, followed by application of aggregate chips or gravel to coated surface, and subsequent rolling of material to seal the surface.

### EXPLANATION OF CLASSES

ASBESTOS - GENERAL - removal of asbestos material/mold and hazardous materials from any place in a building, including mechanical systems where those mechanical systems are to be removed. This includes the removal of asbestos materials/mold and hazardous materials from ductwork or pipes in a building when the building is to be demolished at the time or at some close future date.

ASBESTOS - MECHANICAL - removal of asbestos material from mechanical systems, such as pipes, ducts, and boilers, where the mechanical systems are to remain.

### LABORER - OIL AND CHIP RESEALING ONLY

Hook and unhook chip box from aggregate truck; distribute material within chip box; perform flagging work related to oil and chip resealing; hand spray oil fluids; handle traffic control, including setting-up and maintaining barricades, drums, cones, delineators, signs and other such items, as well as laying-out and applying or removing temporary roadway markings used to control traffic in job site related to oil and chip resealing; and perform clean-up related to oil and chip resealing.

## CERAMIC TILE FINISHER, MARBLE FINISHER, TERRAZZO FINISHER

Assisting, helping or supporting the tile, marble and terrazzo mechanic by performing their historic and traditional work assignments required to complete the proper installation of the work covered by said crafts. The term "Ceramic" is used for naming the classification only, and is in no a limitation of the product handled. Ceramic takes into consideration most hard tiles.

## ELECTRONIC SYSTEMS TECHNICIAN

Installation, service and maintenance of low-voltage systems which utilizes the transmission and/or transference of voice, sound, vision, or digital for commercial, education, security and entertainment purposes for the following: TV monitoring and surveillance, background/foreground music, intercom and telephone interconnect, field programming, inventory control systems, microwave transmission, multi-media, multiplex, radio page, school, intercom and sound burglar alarms and low voltage master clock systems.

Excluded from this classification are energy management systems, life safety systems, supervisory controls and data acquisition systems not intrinsic with the above listed systems, fire alarm systems, nurse call systems and raceways exceeding fifteen feet in length.

## TRUCK DRIVER - BUILDING, HEAVY AND HIGHWAY CONSTRUCTION

Class 1. Drivers on 2 axle trucks hauling less than 9 ton. Air compressor and welding machines and brooms, including those pulled by separate units, truck driver helpers, warehouse employees, mechanic helpers, greasers and tiremen, pickup trucks when hauling materials, tools, or workers to and from and on-the-job site, and fork lifts up to 6,000 lb. capacity.

Class 2. Two or three axle trucks hauling more than 9 ton but hauling less than 16 ton. A-frame winch trucks, hydrolift trucks, vector trucks or similar equipment when used for transportation purposes. Fork lifts over 6,000 lb. capacity, winch trucks, four axle combination units, and ticket writers.

Class 3. Two, three or four axle trucks hauling 16 ton or more. Drivers on water pulls, articulated dump trucks, mechanics and working forepersons, and dispatchers. Five axle or more combination units.

Class 4. Low Boy and Oil Distributors.

Class 5. Drivers who require special protective clothing while employed on hazardous waste work.

## TRUCK DRIVER - O & C (Oil and Chip Resealing ONLY)

It involves driving of contractor or subcontractor owned, leased, or hired pickup, dump, service, or oil distributor trucks. Includes transporting materials and equipment (including, but not limited to oils, aggregate supplies, parts, machinery and tools) to or from the job site; distributing oil or liquid asphalt and aggregate; stock piling material; and maintaining trucks at job site related to oil and chip resealing.

Class 1. Distributors, liquid asphalt hauling and hauling of asphalt rubber-tired rollers.

Class 2. Stockpiling.



Class 3. Tandem hauling to job site.

OPERATING ENGINEERS - BUILDING, HEAVY AND HIGHWAY CONSTRUCTION

Class 1. APSCO or Equal Spreading Machine, Backhoe, Backfiller, Boom or Winch Cat, Bituminous Mixplane Machine, Blacksmith, Bituminous Surfacing Machine, Bull-Dozer, Crane, Shovel, Dragline, Truck Crane, Pile Driver, Concrete Breaker, Concrete or Pumpcrete Pumps, Dinky or Standard Locomotives, Well or Caisson Drills, Elevating Grader, Fork Lifts, Flexplane, Gradeall, Hi-Lift Hoists, Guy-Derricks, Hysters, Mechanic Motor Patrol, Mixers-21 cu. ft. or over, Push Cats, Pulls and Scrapers, Two Well Point Pumps, Pulverizer or Tiller, PugMill, Rubber-Tired Farm Type Tractor with Bulldozer/Blade/Auger or hi-lift over 1/2 yd., Jersey Spreader, Tract-Air used with Drill or Hi-Lift, Trenching or Ditching Machines, Wood Chipper w/Tractor, Self-Propelled Roller w/Blade, Equipment Greaser, Self-Propelled Bump Grinder on Concrete pavement, Boat Operator, Skid-Loaders, Tuggers, Lazer Screed, and Self-Propelled Chip Spreader (when others run conveyors).

Class 2. Any type tractor pulling any type roller or disc, Two Air Compressors (220 cu. ft. capacity or over), Two AirTract Drills, Air-Track Drill w/Compressor, Automatic Bins or Scales w/Compressor or Generator, Pipeline Boring Machine, Bulk Cement Plant w/Separate Compressor, Power Operated Bull Float, Hydra-Lift w/Single Motor, Straw Mulcher Blower w/Spout, Self-Propelled Roller/Compactor, Back-End man on Bituminous Surfacing Machine, oiler on milling machine.

Class 3. Air Compressor w/Valve driving piling, Boom or Winch Type Truck, Two Conveyors, Self-Propelled Concrete Saw, Form Grader, Truck Crane Oiler, Self-Propelled Vibrator, Rubber Tired Farm Type Tractor w/Blade/Bulldozer/Auger/hi-lift - 1/2 yd. or less, Elevator Operator, Man Lift (scissor lift) when lifting materials.

Class 4. Air-Track Drill (one), Belt Drag Machine, Power Broom, Mechanical Plasterer Applicator, Trac-Air, Air Compressor (220 cu. ft. or over) One, Air Compressor (under 220 cu. ft) four, Automatic Bin, Bulk Cement Plant w/Built-in Compressor running off same motor or electric motor, Fireman or Switchman, Self-Propelled Form Tamper, Light Plants (4), Welding Machines (4), Pumps (4), or Combination of four (4) Pumps, Light Plants, Welding Machines, Air-Compressors (under 220 cu. ft.), Mudjacks or Wood Chipper, Mixers - less than 21 cu. ft. Mortar Mixer w/Skip or Pump, Pipeline Tract Jack. One Operating Engineer may operate and maintain any combination of the following pieces of equipment, not to exceed four (4) which shall be within a reasonable distance, such combination may include any equipment in this classification: (Compressors, Light Plants, Generators, Welding Machines, Pumps or Conveyors), One Well- Point Pump, Two Motor Driven Heaters, One Air Compressor (under 220 cu. ft.), One Engine-Driven Conveyor, One Motor Driven Heater, One Light Plant, One Pump, One Welding Machine, One Ulmac or Equal Spreader, Oilers, and one Generator 10 kw or greater.

OPERATING ENGINEER - O & C (Oil and Chip Resealing ONLY). Includes the operation of all motorized heavy equipment used in oil and chip rsealing, including but not limited to operating self-propelled chip spreaders, and all types of rollers (both hard and rubber tired); and other duties pertaining to the operation or maintenance of heavy equipment related to oil and chip resealing.

Class 1. See Class 1 above for types of equipment operated.

Class 2. See Class 2 above for types of equipment operated.

Class 3. See Class 3 above for types of equipment operated.

Class 4. See Class 4 above for types of equipment operated.

OPERATING ENGINEER RIVER WORK 1 - operate the following machines when working on River Work and Levee Work on the Mississippi and Ohio Rivers, Lakes and Tributaries: Crane, Shovel, Drageline, Scrapers, Dredge, Derrick, Pile-Driver, Push Boat, all power boat operators, Mechanic, Engineman on Dredge, Leverman on Dredge, All Bituminous Spreader machines, Backhoe, Backfiller, Boom, or Winch Cat, Bituminous Mixplane Machine, Blacksmith, Bituminous Surfacing Machine, Bulldozer, Truck Cranes, Hydraulic Truck Mounted Boom/Crane, Concrete Finishing Machine, or Spreader Machine, Concrete Breaker, Concrete or Pumpcrete Machines, Concrete Plant Operator, All Off Road Material Hauling Equipment, Dinky or Standard Locomotives, Well Drill, Elevating Grader, Fork-Lifts, Flexplane, Gradeall, Hi-Lift, Power Handblade Tugger type Hoist, Hoist Two Drum (or over one), Gyderrick, Hyster, Motor Patrol, Mixers - 21 Cu. Ft. or over, Push Cat, Pulls, & Scrapers, Pumps-Two Well Points, Equipment Greaser, P & H Pulverizer or Pulverizer equal to Pugmill, Pugmill, Rubber-Tired farm type tractor w/Bulldozer/Blade/Auger or Hi-Lift over ½ yard, Skimmer Scoops, Seaman Tiller, Jersey Spreader, Tract-Air used with Drill or Hi-Lift, Trenching or Ditching Machine, Wood Chipper w/Tractor, self-propelled roller w/Blade, Concrete Pumps and Small Equipment Operators.

OPERATING ENGINEER RIVER 2 - when working on River Work and Levee Work on the Mississippi and Ohio Rivers, Lakes and Tributaries shall be employed as the Oiler or Fireman on Crane, Dragline, Shovel, Dredge, Truck Crane, Pile Driver, Gradeall, Dinky or Standard Locomotive, Guy Derrick, Trenching Machine or Ditching Machine 80 H.P. and over, All Terrain (cherry-picker) with over 40 ton Lifting Capacity, Deck Oiler and Deckhands.

#### Other Classifications of Work:

For definitions of classifications not otherwise set out, the Department generally has on file such definitions which are available. If a task to be performed is not subject to one of the classifications of pay set out, the Department will upon being contacted state which neighboring county has such a classification and provide such rate, such rate being deemed to exist by reference in this document. If no neighboring county rate applies to the task, the Department shall undertake a special determination, such special determination being then deemed to have existed under this determination. If a project requires these, or any classification not listed, please contact IDOL at 217-782-1710 for wage rates or clarifications.

#### LANDSCAPING

Landscaping work falls under the existing classifications for laborer, operating engineer and truck driver. The work performed by landscape plantsman and landscape laborer is covered by the existing classification of laborer. The work performed by landscape operators (regardless of equipment used or its size) is covered by the classifications of operating engineer. The work performed by landscape truck drivers (regardless of size of truck driven) is covered by the classifications of truck driver.

# Massac County Prevailing Wage for February 2011

Trade Name	RG	TYP	C	Base	FRMAN	*M-F>8	OSA	OSH	H/W	Pensn	Vac	Trng
=====	==	===	=	=====	=====	=====	===	===	=====	=====	=====	=====
ASBESTOS ABT-GEN		ALL		23.650	24.100	1.5	1.5	2.0	5.450	8.500	0.000	0.900
ASBESTOS ABT-MEC		BLD		20.800	0.000	2.0	2.0	2.0	5.500	4.200	0.000	0.000
BOILERMAKER		BLD		31.500	34.000	1.5	1.5	2.0	6.820	11.43	1.500	0.350
BRICK MASON		BLD		27.220	28.720	1.5	1.5	2.0	7.950	6.690	0.000	0.430
CARPENTER		BLD		30.490	31.990	1.5	1.5	2.0	6.050	5.750	0.000	0.350
CARPENTER		HWY		30.440	31.940	1.5	1.5	2.0	6.050	5.750	0.000	0.350
CEMENT MASON		BLD		26.750	28.250	1.5	1.5	2.0	5.900	4.800	0.000	0.300
CEMENT MASON		HWY		26.350	27.350	1.5	1.5	2.0	5.900	4.350	0.000	0.300
CERAMIC TILE FNSHER		BLD		25.720	0.000	1.5	1.5	2.0	7.950	6.690	0.000	0.430
ELECTRICIAN		ALL		36.240	38.490	1.5	1.5	2.0	5.250	8.340	0.000	0.720
ELECTRONIC SYS TECH		BLD		29.530	31.280	1.5	1.5	2.0	5.250	3.840	0.000	0.250
FLOOR LAYER		BLD		28.930	29.680	1.5	1.5	2.0	6.050	5.750	0.000	0.350
GLAZIER		BLD		26.330	27.580	1.5	1.5	2.0	4.850	5.200	0.000	0.300
HT/FROST INSULATOR		BLD		28.920	29.920	1.5	1.5	2.0	4.800	8.160	0.000	0.280
IRON WORKER		ALL		26.740	28.740	1.5	1.5	2.0	5.760	9.590	0.000	0.500
LABORER		BLD		23.650	24.100	1.5	1.5	2.0	5.450	8.500	0.000	0.800
LABORER		HWY		23.650	24.100	1.5	1.5	2.0	5.450	8.450	0.000	0.800
LABORER		O&C		17.740	18.190	1.5	1.5	2.0	5.450	8.450	0.000	0.800
MACHINIST		BLD		43.160	45.160	1.5	1.5	2.0	7.640	8.700	0.000	0.000
MARBLE FINISHERS		BLD		25.720	0.000	1.5	1.5	2.0	7.950	6.690	0.000	0.430
MARBLE MASON		BLD		27.220	28.720	1.5	1.5	2.0	7.950	6.690	0.000	0.430
MILLWRIGHT		BLD		30.490	31.990	1.5	1.5	2.0	6.050	5.750	0.000	0.350
MILLWRIGHT		HWY		30.440	31.940	1.5	1.5	2.0	6.050	5.750	0.000	0.350
OE RIVER 1		RIV 1		30.950	31.950	1.5	1.5	2.0	6.000	7.800	0.000	1.300
OE RIVER 2		RIV 2		27.500	31.950	1.5	1.5	2.0	6.000	7.800	0.000	1.300
OPERATING ENGINEER		ALL 1		30.850	31.850	1.5	1.5	2.0	6.000	7.800	0.000	1.300
OPERATING ENGINEER		ALL 2		28.950	31.850	1.5	1.5	2.0	6.000	7.800	0.000	1.300
OPERATING ENGINEER		ALL 3		24.150	31.850	1.5	1.5	2.0	6.000	7.800	0.000	1.300
OPERATING ENGINEER		ALL 4		21.400	27.800	1.5	1.5	2.0	5.650	6.100	0.000	1.100
OPERATING ENGINEER		O&C 1		23.140	24.140	1.5	1.5	2.0	6.000	7.800	0.000	1.300
OPERATING ENGINEER		O&C 2		21.710	24.140	1.5	1.5	2.0	6.000	7.800	0.000	1.300
OPERATING ENGINEER		O&C 3		18.120	24.140	1.5	1.5	2.0	6.000	7.800	0.000	1.300
OPERATING ENGINEER		O&C 4		16.050	21.100	1.5	1.5	2.0	5.650	6.100	0.000	1.100
PAINTER		BLD		18.500	19.500	1.5	1.5	2.0	6.500	4.500	0.000	0.050
PAINTER		HWY		24.750	25.750	1.5	1.5	2.0	6.500	4.500	0.000	0.050
PAINTER OVER 30FT		BLD		21.000	22.000	1.5	1.5	2.0	6.500	4.500	0.000	0.050
PAINTER OVER 30FT		HWY		24.250	25.250	1.5	1.5	2.0	5.250	2.750	0.000	0.000
PAINTER PWR EQMT		BLD		18.500	19.500	1.5	1.5	2.0	6.500	4.500	0.000	0.050
PAINTER PWR EQMT		HWY		25.750	26.750	1.5	1.5	2.0	6.500	4.500	0.000	0.050
PILEDRIIVER		BLD		30.490	31.990	1.5	1.5	2.0	6.050	5.750	0.000	0.350
PILEDRIIVER		HWY		30.440	31.940	1.5	1.5	2.0	6.050	5.750	0.000	0.350
PIPEFITTER		BLD		36.600	40.260	1.5	2.0	2.0	7.200	5.250	0.000	1.100
PLASTERER		BLD		26.750	28.250	1.5	1.5	2.0	5.900	4.800	0.000	0.300
PLUMBER		BLD		36.600	40.260	1.5	2.0	2.0	7.200	5.250	0.000	1.100
ROOFER		BLD		26.340	28.340	1.5	1.5	2.0	6.280	4.750	0.000	0.360
SHEETMETAL WORKER		ALL		31.390	32.890	1.5	1.5	2.0	6.430	6.490	1.890	0.360
SPRINKLER FITTER		BLD		36.140	38.890	1.5	1.5	2.0	8.200	6.550	0.000	0.250
STONE MASON		BLD		27.220	28.720	1.5	1.5	2.0	7.950	6.690	0.000	0.430
TERRAZZO FINISHER		BLD		25.720	0.000	1.5	1.5	2.0	7.950	6.690	0.000	0.430
TRUCK DRIVER		ALL 1		28.430	0.000	1.5	1.5	2.0	9.050	5.500	0.000	0.250
TRUCK DRIVER		ALL 2		28.850	0.000	1.5	1.5	2.0	9.050	5.500	0.000	0.250
TRUCK DRIVER		ALL 3		29.050	0.000	1.5	1.5	2.0	9.050	5.500	0.000	0.250
TRUCK DRIVER		ALL 4		29.320	0.000	1.5	1.5	2.0	9.050	5.500	0.000	0.250
TRUCK DRIVER		ALL 5		30.100	0.000	1.5	1.5	2.0	9.050	5.500	0.000	0.250
TRUCK DRIVER		O&C 1		22.750	0.000	1.5	1.5	2.0	2.920	6.700	0.000	0.250
TRUCK DRIVER		O&C 2		19.150	0.000	1.5	1.5	2.0	2.920	6.700	0.000	0.250
TRUCK DRIVER		O&C 3		19.650	0.000	1.5	1.5	2.0	2.920	6.700	0.000	0.250
TUCKPOINTER		BLD		27.220	28.720	1.5	1.5	2.0	7.950	6.690	0.000	0.430

Legend :

M-F>8 (Overtime is required for any hour greater than 8 worked each day, Monday through Friday.)

OSA (Overtime is required for every hour worked on Saturday)

OSH (Overtime is required for every hour worked on Sunday and Holidays)

H/W (Health & Welfare Insurance)

Pensn (Pension)

Vac (Vacation)

Trng (Training)

## Explanations

### MASSAC COUNTY

The following list is considered as those days for which holiday rates of wages for work performed apply: New Years Day, Memorial Day, Fourth of July, Labor Day, Thanksgiving Day, Christmas Day and Veterans Day in some classifications/counties. Generally, any of these holidays which fall on a Sunday is celebrated on the following Monday. This then makes work performed on that Monday payable at the appropriate overtime rate for holiday pay. Common practice in a given local may alter certain days of celebration. If in doubt, please check with IDOL.

Oil and chip resealing (O&C) means the application of road oils and liquid asphalt to coat an existing road surface, followed by application of aggregate chips or gravel to coated surface, and subsequent rolling of material to seal the surface.

### EXPLANATION OF CLASSES

ASBESTOS - GENERAL - removal of asbestos material/mold and hazardous materials from any place in a building, including mechanical systems where those mechanical systems are to be removed. This includes the removal of asbestos materials/mold and hazardous materials from ductwork or pipes in a building when the building is to be demolished at the time or at some close future date.

ASBESTOS - MECHANICAL - removal of asbestos material from mechanical systems, such as pipes, ducts, and boilers, where the mechanical systems are to remain.

### LABORER - OIL AND CHIP RESEALING ONLY

Hook and unhook chip box from aggregate truck; distribute material within chip box; perform flagging work related to oil and chip resealing; hand spray oil fluids; handle traffic control, including setting-up and maintaining barricades, drums, cones, delineators, signs and other such items, as well as laying-out and applying or removing temporary roadway markings used to control traffic in job site related to oil and chip resealing; and perform clean-up related

to oil and chip resealing.

#### CERAMIC TILE FINISHER, MARBLE FINISHER, TERRAZZO FINISHER

Assisting, helping or supporting the tile, marble and terrazzo mechanic by performing their historic and traditional work assignments required to complete the proper installation of the work covered by said crafts. The term "Ceramic" is used for naming the classification only, and is in no a limitation of the product handled. Ceramic takes into consideration most hard tiles.

#### ELECTRONIC SYSTEMS TECHNICIAN

Installation, service and maintenance of low-voltage systems which utilizes the transmission and/or transference of voice, sound, vision, or digital for commercial, education, security and entertainment purposes for the following: TV monitoring and surveillance, background/foreground music, intercom and telephone interconnect, field programming, inventory control systems, microwave transmission, multi-media, multiplex, radio page, school, intercom and sound burglar alarms and low voltage master clock systems.

Excluded from this classification are energy management systems, life safety systems, supervisory controls and data acquisition systems not intrinsic with the above listed systems, fire alarm systems, nurse call systems and raceways exceeding fifteen feet in length.

#### TRUCK DRIVER - BUILDING, HEAVY AND HIGHWAY CONSTRUCTION

Class 1. Drivers on 2 axle trucks hauling less than 9 ton. Air compressor and welding machines and brooms, including those pulled by separate units, truck driver helpers, warehouse employees, mechanic helpers, greasers and tiremen, pickup trucks when hauling materials, tools, or workers to and from and on-the-job site, and fork lifts up to 6,000 lb. capacity.

Class 2. Two or three axle trucks hauling more than 9 ton but hauling less than 16 ton. A-frame winch trucks, hydrolift trucks, vector trucks or similar equipment when used for transportation purposes. Fork lifts over 6,000 lb. capacity, winch trucks, four axle combination units, and ticket writers.

Class 3. Two, three or four axle trucks hauling 16 ton or more. Drivers on water pulls, articulated dump trucks, mechanics and working forepersons, and dispatchers. Five axle or more combination units.

Class 4. Low Boy and Oil Distributors.

Class 5. Drivers who require special protective clothing while employed on hazardous waste work.

#### TRUCK DRIVER - O & C (Oil and Chip Resealing ONLY)

It involves driving of contractor or subcontractor owned, leased, or hired pickup, dump, service, or oil distributor trucks. Includes transporting materials and equipment (including, but not limited to oils, aggregate supplies, parts, machinery and tools) to or from the job site; distributing oil or liquid asphalt and aggregate; stock piling material; and maintaining trucks at job site related to oil and chip resealing.

Class 1. Distributors, liquid asphalt hauling and hauling of asphalt rubber-tired rollers.

Class 2. Stockpiling.

Class 3. Tandem hauling to job site.

OPERATING ENGINEERS - BUILDING, HEAVY AND HIGHWAY CONSTRUCTION

Class 1. APSCO or Equal Spreading Machine, Backhoe, Backfiller, Boom or Winch Cat, Bituminous Mixplane Machine, Blacksmith, Bituminous Surfacing Machine, Bull-Dozer, Crane, Shovel, Dragline, Truck Crane, Pile Driver, Concrete Breaker, Concrete or Pumpcrete Pumps, Dinky or Standard Locomotives, Well or Caisson Drills, Elevating Grader, Fork Lifts, Flexplane, Gradeall, Hi-Lift Hoists, Guy-Derricks, Hysters, Mechanic Motor Patrol, Mixers-21 cu. ft. or over, Push Cats, Pulls and Scrapers, Two Well Point Pumps, Pulverizer or Tiller, PugMill, Rubber-Tired Farm Type Tractor with Bulldozer/Blade/Auger or hi-lift over 1/2 yd., Jersey Spreader, Tract-Air used with Drill or Hi-Lift, Trenching or Ditching Machines, Wood Chipper w/Tractor, Self-Propelled Roller w/Blade, Equipment Greaser, Self-Propelled Bump Grinder on Concrete pavement, Boat Operator, Skid-Loaders, Tuggers, Lazer Screed, and Self-Propelled Chip Spreader (when others run conveyors).

Class 2. Any type tractor pulling any type roller or disc, Two Air Compressors (220 cu. ft. capacity or over), Two AirTract Drills, Air-Track Drill w/Compressor, Automatic Bins or Scales w/Compressor or Generator, Pipeline Boring Machine, Bulk Cement Plant w/Separate Compressor, Power Operated Bull Float, Hydra-Lift w/Single Motor, Straw Mulcher Blower w/Spout, Self-Propelled Roller/Compactor, Back-End man on Bituminous Surfacing Machine, oiler on milling machine.

Class 3. Air Compressor w/Valve driving piling, Boom or Winch Type Truck, Two Conveyors, Self-Propelled Concrete Saw, Form Grader, Truck Crane Oiler, Self-Propelled Vibrator, Rubber Tired Farm Type Tractor w/Blade/Bulldozer/Auger/hi-lift - 1/2 yd. or less, Elevator Operator, Man Lift (scissor lift) when lifting materials.

Class 4. Air-Track Drill (one), Belt Drag Machine, Power Broom, Mechanical Plasterer Applicator, Trac-Air, Air Compressor (220 cu. ft. or over) One, Air Compressor (under 220 cu. ft) four, Automatic Bin, Bulk Cement Plant w/Built-in Compressor running off same motor or electric motor, Fireman or Switchman, Self-Propelled Form Tamper, Light Plants (4), Welding Machines (4), Pumps (4), or Combination of four (4) Pumps, Light Plants, Welding Machines, Air-Compressors (under 220 cu. ft.), Mudjacks or Wood Chipper, Mixers - less than 21 cu. ft. Mortar Mixer w/Skip or Pump, Pipeline Tract Jack. One Operating Engineer may operate and maintain any combination of the following pieces of equipment, not to exceed four (4) which shall be within a reasonable distance, such combination may include any equipment in this classification: (Compressors, Light Plants, Generators, Welding Machines, Pumps or Conveyors), One Well- Point Pump, Two Motor Driven Heaters, One Air Compressor (under 220 cu. ft.), One Engine-Driven Conveyor, One Motor Driven Heater, One Light Plant, One Pump, One Welding Machine, One Ulmac or Equal Spreader, Oilers, and one Generator 10 kw or greater.

OPERATING ENGINEER - O & C (Oil and Chip Resealing ONLY). Includes the operation of all motorized heavy equipment used in oil and chip rsealing, including but not limited to operating self-propelled chip spreaders, and all types of rollers (both hard and rubber tired); and other duties pertaining to the operation or maintenance of heavy equipment related to oil and chip resealing.

Class 1. See Class 1 above for types of equipment operated.

Class 2. See Class 2 above for types of equipment operated.

Class 3. See Class 3 above for types of equipment operated.

Class 4. See Class 4 above for types of equipment operated.

OPERATING ENGINEER RIVER WORK 1 - operate the following machines when working on River Work and Levee Work on the Mississippi and Ohio Rivers, Lakes and Tributaries: Crane, Shovel, Drageline, Scrapers, Dredge, Derrick, Pile-Driver, Push Boat, all power boat operators, Mechanic, Engineman on Dredge, Leverman on Dredge, All Bituminous Spreader machines, Backhoe, Backfiller, Boom, or Winch Cat, Bituminous Mixplane Machine, Blacksmith, Bituminous Surfacing Machine, Bulldozer, Truck Cranes, Hydraulic Truck Mounted Boom/Crane, Concrete Finishing Machine, or Spreader Machine, Concrete Breaker, Concrete or Pumpcrete Machines, Concrete Plant Operator, All Off Road Material Hauling Equipment, Dinky or Standard Locomotives, Well Drill, Elevating Grader, Fork-Lifts, Flexplane, Gradeall, Hi-Lift, Power Handblade Tugger type Hoist, Hoist Two Drum (or over one), Gyderrick, Hyster, Motor Patrol, Mixers - 21 Cu. Ft. or over, Push Cat, Pulls, & Scrapers, Pumps-Two Well Points, Equipment Greaser, P & H Pulverizer or Pulverizer equal to Pugmill, Pugmill, Rubber-Tired farm type tractor w/Bulldozer/Blade/Auger or Hi-Lift over ½ yard, Skimmer Scoops, Seaman Tiller, Jersey Spreader, Tract-Air used with Drill or Hi-Lift, Trenching or Ditching Machine, Wood Chipper w/Tractor, self-propelled roller w/Blade, Concrete Pumps and Small Equipment Operators.

OPERATING ENGINEER RIVER 2 - when working on River Work and Levee Work on the Mississippi and Ohio Rivers, Lakes and Tributaries shall be employed as the Oiler or Fireman on Crane, Dragline, Shovel, Dredge, Truck Crane, Pile Driver, Gradeall, Dinky or Standard Locomotive, Guy Derrick, Trenching Machine or Ditching Machine 80 H.P. and over, All Terrain (cherry-picker) with over 40 ton Lifting Capacity, Deck Oiler and Deckhands.

Other Classifications of Work:

For definitions of classifications not otherwise set out, the Department generally has on file such definitions which are available. If a task to be performed is not subject to one of the classifications of pay set out, the Department will upon being contacted state which neighboring county has such a classification and provide such rate, such rate being deemed to exist by reference in this document. If no neighboring county rate applies to the task, the Department shall undertake a special determination, such special determination being then deemed to have existed under this determination. If a project requires these, or any classification not listed, please contact IDOL at 217-782-1710 for wage rates or clarifications.

#### LANDSCAPING

Landscaping work falls under the existing classifications for laborer, operating engineer and truck driver. The work performed by landscape plantsman and landscape laborer is covered by the existing classification of laborer. The work performed by landscape operators (regardless of equipment used or its size) is covered by the classifications of operating engineer. The work performed by landscape truck drivers (regardless of size of truck driven) is covered by the classifications of truck driver.

# Saline County Prevailing Wage for February 2011

Trade Name	RG	TYP	C	Base	FRMAN	*M-F>8	OSA	OSH	H/W	Pensn	Vac	Trng
=====	==	===	=	=====	=====	=====	===	===	=====	=====	=====	=====
ASBESTOS ABT-GEN		ALL		23.650	24.100	1.5	1.5	2.0	5.450	8.500	0.000	0.900
ASBESTOS ABT-MEC		BLD		20.800	0.000	2.0	2.0	2.0	5.500	4.200	0.000	0.000
BOILERMAKER		BLD		31.500	34.000	1.5	1.5	2.0	6.820	11.43	1.500	0.350
BRICK MASON		BLD		27.220	28.720	1.5	1.5	2.0	7.950	6.690	0.000	0.430
CARPENTER		BLD		30.490	31.990	1.5	1.5	2.0	6.050	5.750	0.000	0.350
CARPENTER		HWY		30.440	31.940	1.5	1.5	2.0	6.050	5.750	0.000	0.350
CEMENT MASON		BLD		26.750	28.250	1.5	1.5	2.0	5.900	4.800	0.000	0.300
CEMENT MASON		HWY		26.350	27.350	1.5	1.5	2.0	5.900	4.350	0.000	0.300
CERAMIC TILE FNSHER		BLD		25.720	0.000	1.5	1.5	2.0	7.950	6.690	0.000	0.430
ELECTRICIAN		ALL		36.240	38.490	1.5	1.5	2.0	5.250	8.340	0.000	0.720
ELECTRONIC SYS TECH		BLD		29.530	31.280	1.5	1.5	2.0	5.250	3.840	0.000	0.250
FLOOR LAYER		BLD		28.930	29.680	1.5	1.5	2.0	6.050	5.750	0.000	0.350
GLAZIER		BLD		26.330	27.580	1.5	1.5	2.0	4.850	5.200	0.000	0.300
HT/FROST INSULATOR		BLD		28.920	29.920	1.5	1.5	2.0	4.800	8.160	0.000	0.280
IRON WORKER		ALL		26.250	27.500	1.5	1.5	2.0	5.780	9.100	0.000	0.345
LABORER		BLD		23.650	24.100	1.5	1.5	2.0	5.450	8.500	0.000	0.800
LABORER		HWY		23.650	24.100	1.5	1.5	2.0	5.450	8.450	0.000	0.800
LABORER		O&C		17.740	18.190	1.5	1.5	2.0	5.450	8.450	0.000	0.800
MACHINIST		BLD		43.160	45.160	1.5	1.5	2.0	7.640	8.700	0.000	0.000
MARBLE FINISHERS		BLD		25.720	0.000	1.5	1.5	2.0	7.950	6.690	0.000	0.430
MARBLE MASON		BLD		27.220	28.720	1.5	1.5	2.0	7.950	6.690	0.000	0.430
MILLWRIGHT		BLD		30.490	31.990	1.5	1.5	2.0	6.050	5.750	0.000	0.350
MILLWRIGHT		HWY		30.440	31.940	1.5	1.5	2.0	6.050	5.750	0.000	0.350
OE RIVER 1		RIV 1		30.950	31.950	1.5	1.5	2.0	6.000	7.800	0.000	1.300
OE RIVER 2		RIV 2		27.500	31.950	1.5	1.5	2.0	6.000	7.800	0.000	1.300
OPERATING ENGINEER		ALL 1		30.850	31.850	1.5	1.5	2.0	6.000	7.800	0.000	1.300
OPERATING ENGINEER		ALL 2		28.950	31.850	1.5	1.5	2.0	6.000	7.800	0.000	1.300
OPERATING ENGINEER		ALL 3		24.150	31.850	1.5	1.5	2.0	6.000	7.800	0.000	1.300
OPERATING ENGINEER		ALL 4		21.400	27.800	1.5	1.5	2.0	5.650	6.100	0.000	1.100
OPERATING ENGINEER		O&C 1		23.140	24.140	1.5	1.5	2.0	6.000	7.800	0.000	1.300
OPERATING ENGINEER		O&C 2		21.710	24.140	1.5	1.5	2.0	6.000	7.800	0.000	1.300
OPERATING ENGINEER		O&C 3		18.120	24.140	1.5	1.5	2.0	6.000	7.800	0.000	1.300
OPERATING ENGINEER		O&C 4		16.050	21.100	1.5	1.5	2.0	5.650	6.100	0.000	1.100
PAINTER		BLD		26.260	27.760	1.5	1.5	2.0	6.130	6.950	0.000	0.450
PAINTER		HWY		30.560	32.060	1.5	1.5	2.0	6.130	6.950	0.000	0.450
PAINTER OVER 30FT		BLD		27.260	28.760	1.5	1.5	2.0	6.130	6.950	0.000	0.450
PAINTER PWR EQMT		BLD		27.260	28.760	1.5	1.5	2.0	6.130	6.950	0.000	0.450
PAINTER PWR EQMT		HWY		31.560	33.060	1.5	1.5	2.0	6.130	6.950	0.000	0.450
PILEDRIVER		BLD		30.490	31.990	1.5	1.5	2.0	6.050	5.750	0.000	0.350
PILEDRIVER		HWY		30.440	31.940	1.5	1.5	2.0	6.050	5.750	0.000	0.350
PIPEFITTER		BLD		32.250	35.470	1.5	1.5	2.0	8.250	8.850	0.000	1.200
PLASTERER		BLD		26.750	28.250	1.5	1.5	2.0	5.900	4.800	0.000	0.300
PLUMBER		BLD		32.250	35.470	1.5	1.5	2.0	8.250	8.850	0.000	1.200
ROOFER		BLD		22.250	23.250	1.5	1.5	2.0	7.900	3.800	0.000	0.000
SHEETMETAL WORKER		ALL		31.390	32.890	1.5	1.5	2.0	6.430	6.490	1.890	0.360
SPRINKLER FITTER		BLD		36.140	38.890	1.5	1.5	2.0	8.200	6.550	0.000	0.250
STONE MASON		BLD		27.220	28.720	1.5	1.5	2.0	7.950	6.690	0.000	0.430
TERRAZZO FINISHER		BLD		25.720	0.000	1.5	1.5	2.0	7.950	6.690	0.000	0.430
TERRAZZO MASON		BLD		28.500	28.800	1.5	1.5	2.0	6.400	5.700	0.000	0.430
TRUCK DRIVER		ALL 1		28.430	0.000	1.5	1.5	2.0	9.050	5.500	0.000	0.250
TRUCK DRIVER		ALL 2		28.850	0.000	1.5	1.5	2.0	9.050	5.500	0.000	0.250
TRUCK DRIVER		ALL 3		29.050	0.000	1.5	1.5	2.0	9.050	5.500	0.000	0.250
TRUCK DRIVER		ALL 4		29.320	0.000	1.5	1.5	2.0	9.050	5.500	0.000	0.250
TRUCK DRIVER		ALL 5		30.100	0.000	1.5	1.5	2.0	9.050	5.500	0.000	0.250
TRUCK DRIVER		O&C 1		22.750	0.000	1.5	1.5	2.0	2.920	6.700	0.000	0.250
TRUCK DRIVER		O&C 2		19.150	0.000	1.5	1.5	2.0	2.920	6.700	0.000	0.250
TRUCK DRIVER		O&C 3		19.650	0.000	1.5	1.5	2.0	2.920	6.700	0.000	0.250
TUCKPOINTER		BLD		27.220	28.720	1.5	1.5	2.0	7.950	6.690	0.000	0.430



Legend :

M-F>8 (Overtime is required for any hour greater than 8 worked each day, Monday through Friday.

OSA (Overtime is required for every hour worked on Saturday)

OSH (Overtime is required for every hour worked on Sunday and Holidays)

H/W (Health & Welfare Insurance)

Pensn (Pension)

Vac (Vacation)

Trng (Training)

## Explanations

### SALINE COUNTY

The following list is considered as those days for which holiday rates of wages for work performed apply: New Years Day, Memorial Day, Fourth of July, Labor Day, Thanksgiving Day, Christmas Day and Veterans Day in some classifications/counties. Generally, any of these holidays which fall on a Sunday is celebrated on the following Monday. This then makes work performed on that Monday payable at the appropriate overtime rate for holiday pay. Common practice in a given local may alter certain days of celebration. If in doubt, please check with IDOL.

Oil and chip resealing (O&C) means the application of road oils and liquid asphalt to coat an existing road surface, followed by application of aggregate chips or gravel to coated surface, and subsequent rolling of material to seal the surface.

### EXPLANATION OF CLASSES

ASBESTOS - GENERAL - removal of asbestos material/mold and hazardous materials from any place in a building, including mechanical systems where those mechanical systems are to be removed. This includes the removal of asbestos materials/mold and hazardous materials from ductwork or pipes in a building when the building is to be demolished at the time or at some close future date.

ASBESTOS - MECHANICAL - removal of asbestos material from mechanical systems, such as pipes, ducts, and boilers, where the mechanical systems are to remain.

### LABORER - OIL AND CHIP RESEALING ONLY

Hook and unhook chip box from aggregate truck; distribute material within chip box; perform flagging work related to oil and chip resealing; hand spray oil fluids; handle traffic control, including setting-up and maintaining barricades, drums, cones, delineators, signs and other such items, as well as laying-out and applying or removing temporary roadway markings used to control traffic in job site related to oil and chip resealing; and perform clean-up related

to oil and chip resealing.

#### CERAMIC TILE FINISHER, MARBLE FINISHER, TERRAZZO FINISHER

Assisting, helping or supporting the tile, marble and terrazzo mechanic by performing their historic and traditional work assignments required to complete the proper installation of the work covered by said crafts. The term "Ceramic" is used for naming the classification only, and is in no a limitation of the product handled. Ceramic takes into consideration most hard tiles.

#### ELECTRONIC SYSTEMS TECHNICIAN

Installation, service and maintenance of low-voltage systems which utilizes the transmission and/or transference of voice, sound, vision, or digital for commercial, education, security and entertainment purposes for the following: TV monitoring and surveillance, background/foreground music, intercom and telephone interconnect, field programming, inventory control systems, microwave transmission, multi-media, multiplex, radio page, school, intercom and sound burglar alarms and low voltage master clock systems.

Excluded from this classification are energy management systems, life safety systems, supervisory controls and data acquisition systems not intrinsic with the above listed systems, fire alarm systems, nurse call systems and raceways exceeding fifteen feet in length.

#### TRUCK DRIVER - BUILDING, HEAVY AND HIGHWAY CONSTRUCTION

Class 1. Drivers on 2 axle trucks hauling less than 9 ton. Air compressor and welding machines and brooms, including those pulled by separate units, truck driver helpers, warehouse employees, mechanic helpers, greasers and tiremen, pickup trucks when hauling materials, tools, or workers to and from and on-the-job site, and fork lifts up to 6,000 lb. capacity.

Class 2. Two or three axle trucks hauling more than 9 ton but hauling less than 16 ton. A-frame winch trucks, hydrolift trucks, vector trucks or similar equipment when used for transportation purposes. Fork lifts over 6,000 lb. capacity, winch trucks, four axle combination units, and ticket writers.

Class 3. Two, three or four axle trucks hauling 16 ton or more. Drivers on water pulls, articulated dump trucks, mechanics and working forepersons, and dispatchers. Five axle or more combination units.

Class 4. Low Boy and Oil Distributors.

Class 5. Drivers who require special protective clothing while employed on hazardous waste work.

#### TRUCK DRIVER - O & C (Oil and Chip Resealing ONLY)

It involves driving of contractor or subcontractor owned, leased, or hired pickup, dump, service, or oil distributor trucks. Includes transporting materials and equipment (including, but not limited to oils, aggregate supplies, parts, machinery and tools) to or from the job site; distributing oil or liquid asphalt and aggregate; stock piling material; and maintaining trucks at job site related to oil and chip resealing.

Class 1. Distributors, liquid asphalt hauling and hauling of asphalt rubber-tired rollers.

Class 2. Stockpiling.

Class 3. Tandem hauling to job site.

OPERATING ENGINEERS - BUILDING, HEAVY AND HIGHWAY CONSTRUCTION

Class 1. APSCO or Equal Spreading Machine, Backhoe, Backfiller, Boom or Winch Cat, Bituminous Mixplane Machine, Blacksmith, Bituminous Surfacing Machine, Bull-Dozer, Crane, Shovel, Dragline, Truck Crane, Pile Driver, Concrete Breaker, Concrete or Pumpcrete Pumps, Dinky or Standard Locomotives, Well or Caisson Drills, Elevating Grader, Fork Lifts, Flexplane, Gradeall, Hi-Lift Hoists, Guy-Derricks, Hysters, Mechanic Motor Patrol, Mixers-21 cu. ft. or over, Push Cats, Pulls and Scrapers, Two Well Point Pumps, Pulverizer or Tiller, PugMill, Rubber-Tired Farm Type Tractor with Bulldozer/Blade/Auger or hi-lift over 1/2 yd., Jersey Spreader, Tract-Air used with Drill or Hi-Lift, Trenching or Ditching Machines, Wood Chipper w/Tractor, Self-Propelled Roller w/Blade, Equipment Greaser, Self-Propelled Bump Grinder on Concrete pavement, Boat Operator, Skid-Loaders, Tuggers, Lazer Screed, and Self-Propelled Chip Spreader (when others run conveyors).

Class 2. Any type tractor pulling any type roller or disc, Two Air Compressors (220 cu. ft. capacity or over), Two AirTract Drills, Air-Track Drill w/Compressor, Automatic Bins or Scales w/Compressor or Generator, Pipeline Boring Machine, Bulk Cement Plant w/Separate Compressor, Power Operated Bull Float, Hydra-Lift w/Single Motor, Straw Mulcher Blower w/Spout, Self-Propelled Roller/Compactor, Back-End man on Bituminous Surfacing Machine, oiler on milling machine.

Class 3. Air Compressor w/Valve driving piling, Boom or Winch Type Truck, Two Conveyors, Self-Propelled Concrete Saw, Form Grader, Truck Crane Oiler, Self-Propelled Vibrator, Rubber Tired Farm Type Tractor w/Blade/Bulldozer/Auger/hi-lift - 1/2 yd. or less, Elevator Operator, Man Lift (scissor lift) when lifting materials.

Class 4. Air-Track Drill (one), Belt Drag Machine, Power Broom, Mechanical Plasterer Applicator, Trac-Air, Air Compressor (220 cu. ft. or over) One, Air Compressor (under 220 cu. ft) four, Automatic Bin, Bulk Cement Plant w/Built-in Compressor running off same motor or electric motor, Fireman or Switchman, Self-Propelled Form Tamper, Light Plants (4), Welding Machines (4), Pumps (4), or Combination of four (4) Pumps, Light Plants, Welding Machines, Air-Compressors (under 220 cu. ft.), Mudjacks or Wood Chipper, Mixers - less than 21 cu. ft. Mortar Mixer w/Skip or Pump, Pipeline Tract Jack. One Operating Engineer may operate and maintain any combination of the following pieces of equipment, not to exceed four (4) which shall be within a reasonable distance, such combination may include any equipment in this classification: (Compressors, Light Plants, Generators, Welding Machines, Pumps or Conveyors), One Well- Point Pump, Two Motor Driven Heaters, One Air Compressor (under 220 cu. ft.), One Engine-Driven Conveyor, One Motor Driven Heater, One Light Plant, One Pump, One Welding Machine, One Ulmac or Equal Spreader, Oilers, and one Generator 10 kw or greater.

OPERATING ENGINEER - O & C (Oil and Chip Resealing ONLY). Includes the operation of all motorized heavy equipment used in oil and chip rsealing, including but not limited to operating self-propelled chip spreaders, and all types of rollers (both hard and rubber tired); and other duties pertaining to the operation or maintenance of heavy equipment relatd to oil and chip resealing.

Class 1. See Class 1 above for types of equipment operated.

Class 2. See Class 2 above for types of equipment operated.

Class 3. See Class 3 above for types of equipment operated.

Class 4. See Class 4 above for types of equipment operated.

OPERATING ENGINEER RIVER WORK 1 - operate the following machines when working on River Work and Levee Work on the Mississippi and Ohio Rivers, Lakes and Tributaries: Crane, Shovel, Drageline, Scrapers, Dredge, Derrick, Pile-Driver, Push Boat, all power boat operators, Mechanic, Engineman on Dredge, Leverman on Dredge, All Bituminous Spreader machines, Backhoe, Backfiller, Boom, or Winch Cat, Bituminous Mixplane Machine, Blacksmith, Bituminous Surfacing Machine, Bulldozer, Truck Cranes, Hydraulic Truck Mounted Boom/Crane, Concrete Finishing Machine, or Spreader Machine, Concrete Breaker, Concrete or Pumpcrete Machines, Concrete Plant Operator, All Off Road Material Hauling Equipment, Dinky or Standard Locomotives, Well Drill, Elevating Grader, Fork-Lifts, Flexplane, Gradeall, Hi-Lift, Power Handblade Tugger type Hoist, Hoist Two Drum (or over one), Gyderrick, Hyster, Motor Patrol, Mixers - 21 Cu. Ft. or over, Push Cat, Pulls, & Scrapers, Pumps-Two Well Points, Equipment Greaser, P & H Pulverizer or Pulverizer equal to Pugmill, Pugmill, Rubber-Tired farm type tractor w/Bulldozer/Blade/Auger or Hi-Lift over ½ yard, Skimmer Scoops, Seaman Tiller, Jersey Spreader, Tract-Air used with Drill or Hi-Lift, Trenching or Ditching Machine, Wood Chipper w/Tractor, self-propelled roller w/Blade, Concrete Pumps and Small Equipment Operators.

OPERATING ENGINEER RIVER 2 - when working on River Work and Levee Work on the Mississippi and Ohio Rivers, Lakes and Tributaries shall be employed as the Oiler or Fireman on Crane, Dragline, Shovel, Dredge, Truck Crane, Pile Driver, Gradeall, Dinky or Standard Locomotive, Guy Derrick, Trenching Machine or Ditching Machine 80 H.P. and over, All Terrain (cherry-picker) with over 40 ton Lifting Capacity, Deck Oiler and Deckhands.

Other Classifications of Work:

For definitions of classifications not otherwise set out, the Department generally has on file such definitions which are available. If a task to be performed is not subject to one of the classifications of pay set out, the Department will upon being contacted state which neighboring county has such a classification and provide such rate, such rate being deemed to exist by reference in this document. If no neighboring county rate applies to the task, the Department shall undertake a special determination, such special determination being then deemed to have existed under this determination. If a project requires these, or any classification not listed, please contact IDOL at 217-782-1710 for wage rates or clarifications.

#### LANDSCAPING

Landscaping work falls under the existing classifications for laborer, operating engineer and truck driver. The work performed by landscape plantsman and landscape laborer is covered by the existing classification of laborer. The work performed by landscape operators (regardless of equipment used or its size) is covered by the classifications of operating engineer. The work performed by landscape truck drivers (regardless of size of truck driven) is covered by the classifications of truck driver.

# Williamson County Prevailing Wage for February 2011

Trade Name	RG	TYP	C	Base	FRMAN	*M-F>8	OSA	OSH	H/W	Pensn	Vac	Trng
=====	==	===	=	=====	=====	=====	===	===	=====	=====	=====	=====
ASBESTOS ABT-GEN		ALL		23.650	24.100	1.5	1.5	2.0	5.450	8.500	0.000	0.900
ASBESTOS ABT-MEC		BLD		20.800	0.000	2.0	2.0	2.0	5.500	4.200	0.000	0.000
BOILERMAKER		BLD		31.500	34.000	1.5	1.5	2.0	6.820	11.43	1.500	0.350
BRICK MASON		BLD		27.220	28.720	1.5	1.5	2.0	7.950	6.690	0.000	0.430
CARPENTER		BLD		30.490	31.990	1.5	1.5	2.0	6.050	5.750	0.000	0.350
CARPENTER		HWY		30.440	31.940	1.5	1.5	2.0	6.050	5.750	0.000	0.350
CEMENT MASON		BLD		26.750	28.250	1.5	1.5	2.0	5.900	4.800	0.000	0.300
CEMENT MASON		HWY		26.350	27.350	1.5	1.5	2.0	5.900	4.350	0.000	0.300
CERAMIC TILE FNSHER		BLD		25.720	0.000	1.5	1.5	2.0	7.950	6.690	0.000	0.430
ELECTRICIAN		ALL		36.240	38.490	1.5	1.5	2.0	5.250	8.340	0.000	0.720
ELECTRONIC SYS TECH		BLD		29.530	31.280	1.5	1.5	2.0	5.250	3.840	0.000	0.250
FLOOR LAYER		BLD		28.930	29.680	1.5	1.5	2.0	6.050	5.750	0.000	0.350
GLAZIER		BLD		26.330	27.580	1.5	1.5	2.0	4.850	5.200	0.000	0.300
HT/FROST INSULATOR		BLD		28.920	29.920	1.5	1.5	2.0	4.800	8.160	0.000	0.280
IRON WORKER		ALL		26.740	28.740	1.5	1.5	2.0	5.760	9.590	0.000	0.500
LABORER		BLD		23.650	24.100	1.5	1.5	2.0	5.450	8.500	0.000	0.800
LABORER		HWY		23.650	24.100	1.5	1.5	2.0	5.450	8.450	0.000	0.800
LABORER		O&C		17.740	18.190	1.5	1.5	2.0	5.450	8.450	0.000	0.800
MACHINIST		BLD		43.160	45.160	1.5	1.5	2.0	7.640	8.700	0.000	0.000
MARBLE FINISHERS		BLD		25.720	0.000	1.5	1.5	2.0	7.950	6.690	0.000	0.430
MARBLE MASON		BLD		27.220	28.720	1.5	1.5	2.0	7.950	6.690	0.000	0.430
MILLWRIGHT		BLD		30.490	31.990	1.5	1.5	2.0	6.050	5.750	0.000	0.350
MILLWRIGHT		HWY		30.440	31.940	1.5	1.5	2.0	6.050	5.750	0.000	0.350
OE RIVER 1		RIV 1		30.950	31.950	1.5	1.5	2.0	6.000	7.800	0.000	1.300
OE RIVER 2		RIV 2		27.500	31.950	1.5	1.5	2.0	6.000	7.800	0.000	1.300
OPERATING ENGINEER		ALL 1		30.850	31.850	1.5	1.5	2.0	6.000	7.800	0.000	1.300
OPERATING ENGINEER		ALL 2		28.950	31.850	1.5	1.5	2.0	6.000	7.800	0.000	1.300
OPERATING ENGINEER		ALL 3		24.150	31.850	1.5	1.5	2.0	6.000	7.800	0.000	1.300
OPERATING ENGINEER		ALL 4		21.400	27.800	1.5	1.5	2.0	5.650	6.100	0.000	1.100
OPERATING ENGINEER		O&C 1		23.140	24.140	1.5	1.5	2.0	6.000	7.800	0.000	1.300
OPERATING ENGINEER		O&C 2		21.710	24.140	1.5	1.5	2.0	6.000	7.800	0.000	1.300
OPERATING ENGINEER		O&C 3		18.120	24.140	1.5	1.5	2.0	6.000	7.800	0.000	1.300
OPERATING ENGINEER		O&C 4		16.050	21.100	1.5	1.5	2.0	5.650	6.100	0.000	1.100
PAINTER		BLD		26.260	27.760	1.5	1.5	2.0	6.130	6.950	0.000	0.450
PAINTER		HWY		30.560	32.060	1.5	1.5	2.0	6.130	6.950	0.000	0.450
PAINTER OVER 30FT		BLD		27.260	28.760	1.5	1.5	2.0	6.130	6.950	0.000	0.450
PAINTER PWR EQMT		BLD		27.260	28.760	1.5	1.5	2.0	6.130	6.950	0.000	0.450
PAINTER PWR EQMT		HWY		31.560	33.060	1.5	1.5	2.0	6.130	6.950	0.000	0.450
PILEDRIVER		BLD		30.490	31.990	1.5	1.5	2.0	6.050	5.750	0.000	0.350
PILEDRIVER		HWY		30.440	31.940	1.5	1.5	2.0	6.050	5.750	0.000	0.350
PIPEFITTER		BLD		32.250	35.470	1.5	1.5	2.0	8.250	8.850	0.000	1.200
PLASTERER		BLD		26.750	28.250	1.5	1.5	2.0	5.900	4.800	0.000	0.300
PLUMBER		BLD		32.250	35.470	1.5	1.5	2.0	8.250	8.850	0.000	1.200
ROOFER		BLD		22.250	23.250	1.5	1.5	2.0	7.900	3.800	0.000	0.000
SHEETMETAL WORKER		ALL		31.390	32.890	1.5	1.5	2.0	6.430	6.490	1.890	0.360
SPRINKLER FITTER		BLD		36.140	38.890	1.5	1.5	2.0	8.200	6.550	0.000	0.250
STONE MASON		BLD		27.220	28.720	1.5	1.5	2.0	7.950	6.690	0.000	0.430
TERRAZZO FINISHER		BLD		25.720	0.000	1.5	1.5	2.0	7.950	6.690	0.000	0.430
TERRAZZO MASON		BLD		28.500	28.800	1.5	1.5	2.0	6.400	5.700	0.000	0.430
TRUCK DRIVER		ALL 1		28.430	0.000	1.5	1.5	2.0	9.050	5.500	0.000	0.250
TRUCK DRIVER		ALL 2		28.850	0.000	1.5	1.5	2.0	9.050	5.500	0.000	0.250
TRUCK DRIVER		ALL 3		29.050	0.000	1.5	1.5	2.0	9.050	5.500	0.000	0.250
TRUCK DRIVER		ALL 4		29.320	0.000	1.5	1.5	2.0	9.050	5.500	0.000	0.250
TRUCK DRIVER		ALL 5		30.100	0.000	1.5	1.5	2.0	9.050	5.500	0.000	0.250
TRUCK DRIVER		O&C 1		22.750	0.000	1.5	1.5	2.0	2.920	6.700	0.000	0.250
TRUCK DRIVER		O&C 2		19.150	0.000	1.5	1.5	2.0	2.920	6.700	0.000	0.250
TRUCK DRIVER		O&C 3		19.650	0.000	1.5	1.5	2.0	2.920	6.700	0.000	0.250
TUCKPOINTER		BLD		27.220	28.720	1.5	1.5	2.0	7.950	6.690	0.000	0.430

Legend :

M-F>8 (Overtime is required for any hour greater than 8 worked each day, Monday through Friday.)

OSA (Overtime is required for every hour worked on Saturday)

OSH (Overtime is required for every hour worked on Sunday and Holidays)

H/W (Health & Welfare Insurance)

Pensn (Pension)

Vac (Vacation)

Trng (Training)

## Explanations

### WILLIAMSON COUNTY

The following list is considered as those days for which holiday rates of wages for work performed apply: New Years Day, Memorial Day, Fourth of July, Labor Day, Thanksgiving Day, Christmas Day and Veterans Day in some classifications/counties. Generally, any of these holidays which fall on a Sunday is celebrated on the following Monday. This then makes work performed on that Monday payable at the appropriate overtime rate for holiday pay. Common practice in a given local may alter certain days of celebration. If in doubt, please check with IDOL.

Oil and chip resealing (O&C) means the application of road oils and liquid asphalt to coat an existing road surface, followed by application of aggregate chips or gravel to coated surface, and subsequent rolling of material to seal the surface.

### EXPLANATION OF CLASSES

ASBESTOS - GENERAL - removal of asbestos material/mold and hazardous materials from any place in a building, including mechanical systems where those mechanical systems are to be removed. This includes the removal of asbestos materials/mold and hazardous materials from ductwork or pipes in a building when the building is to be demolished at the time or at some close future date.

ASBESTOS - MECHANICAL - removal of asbestos material from mechanical systems, such as pipes, ducts, and boilers, where the mechanical systems are to remain.

### LABORER - OIL AND CHIP RESEALING ONLY

Hook and unhook chip box from aggregate truck; distribute material within chip box; perform flagging work related to oil and chip resealing; hand spray oil fluids; handle traffic control, including setting-up and maintaining barricades, drums, cones, delineators, signs and other such items, as well as laying-out and applying or removing temporary roadway markings used to control traffic in job

site related to oil and chip resealing; and perform clean-up related to oil and chip resealing.

#### CERAMIC TILE FINISHER, MARBLE FINISHER, TERRAZZO FINISHER

Assisting, helping or supporting the tile, marble and terrazzo mechanic by performing their historic and traditional work assignments required to complete the proper installation of the work covered by said crafts. The term "Ceramic" is used for naming the classification only, and is in no a limitation of the product handled. Ceramic takes into consideration most hard tiles.

#### ELECTRONIC SYSTEMS TECHNICIAN

Installation, service and maintenance of low-voltage systems which utilizes the transmission and/or transference of voice, sound, vision, or digital for commercial, education, security and entertainment purposes for the following: TV monitoring and surveillance, background/foreground music, intercom and telephone interconnect, field programming, inventory control systems, microwave transmission, multi-media, multiplex, radio page, school, intercom and sound burglar alarms and low voltage master clock systems.

Excluded from this classification are energy management systems, life safety systems, supervisory controls and data acquisition systems not intrinsic with the above listed systems, fire alarm systems, nurse call systems and raceways exceeding fifteen feet in length.

#### TRUCK DRIVER - BUILDING, HEAVY AND HIGHWAY CONSTRUCTION

Class 1. Drivers on 2 axle trucks hauling less than 9 ton. Air compressor and welding machines and brooms, including those pulled by separate units, truck driver helpers, warehouse employees, mechanic helpers, greasers and tiremen, pickup trucks when hauling materials, tools, or workers to and from and on-the-job site, and fork lifts up to 6,000 lb. capacity.

Class 2. Two or three axle trucks hauling more than 9 ton but hauling less than 16 ton. A-frame winch trucks, hydrolift trucks, vector trucks or similar equipment when used for transportation purposes. Fork lifts over 6,000 lb. capacity, winch trucks, four axle combination units, and ticket writers.

Class 3. Two, three or four axle trucks hauling 16 ton or more. Drivers on water pulls, articulated dump trucks, mechanics and working forepersons, and dispatchers. Five axle or more combination units.

Class 4. Low Boy and Oil Distributors.

Class 5. Drivers who require special protective clothing while employed on hazardous waste work.

#### TRUCK DRIVER - O & C (Oil and Chip Resealing ONLY)

It involves driving of contractor or subcontractor owned, leased, or hired pickup, dump, service, or oil distributor trucks. Includes transporting materials and equipment (including, but not limited to oils, aggregate supplies, parts, machinery and tools) to or from the job site; distributing oil or liquid asphalt and aggregate; stock piling material; and maintaining trucks at job site related to oil and chip resealing.

Class 1. Distributors, liquid asphalt hauling and hauling of asphalt rubber-tired rollers.

Class 2. Stockpiling.

Class 3. Tandem hauling to job site.

#### OPERATING ENGINEERS - BUILDING, HEAVY AND HIGHWAY CONSTRUCTION

Class 1. APSCO or Equal Spreading Machine, Backhoe, Backfiller, Boom or Winch Cat, Bituminous Mixplane Machine, Blacksmith, Bituminous Surfacing Machine, Bull-Dozer, Crane, Shovel, Dragline, Truck Crane, Pile Driver, Concrete Breaker, Concrete or Pumpcrete Pumps, Dinky or Standard Locomotives, Well or Caisson Drills, Elevating Grader, Fork Lifts, Flexplane, Gradeall, Hi-Lift Hoists, Guy-Derricks, Hysters, Mechanic Motor Patrol, Mixers-21 cu. ft. or over, Push Cats, Pulls and Scrapers, Two Well Point Pumps, Pulverizer or Tiller, PugMill, Rubber-Tired Farm Type Tractor with Bulldozer/Blade/Auger or hi-lift over 1/2 yd., Jersey Spreader, Tract-Air used with Drill or Hi-Lift, Trenching or Ditching Machines, Wood Chipper w/Tractor, Self-Propelled Roller w/Blade, Equipment Greaser, Self-Propelled Bump Grinder on Concrete pavement, Boat Operator, Skid-Loaders, Tuggers, Lazer Screed, and Self-Propelled Chip Spreader (when others run conveyors).

Class 2. Any type tractor pulling any type roller or disc, Two Air Compressors (220 cu. ft. capacity or over), Two AirTract Drills, Air-Track Drill w/Compressor, Automatic Bins or Scales w/Compressor or Generator, Pipeline Boring Machine, Bulk Cement Plant w/Separate Compressor, Power Operated Bull Float, Hydra-Lift w/Single Motor, Straw Mulcher Blower w/Spout, Self-Propelled Roller/Compactor, Back-End man on Bituminous Surfacing Machine, oiler on milling machine.

Class 3. Air Compressor w/Valve driving piling, Boom or Winch Type Truck, Two Conveyors, Self-Propelled Concrete Saw, Form Grader, Truck Crane Oiler, Self-Propelled Vibrator, Rubber Tired Farm Type Tractor w/Blade/Bulldozer/Auger/hi-lift - 1/2 yd. or less, Elevator Operator, Man Lift (scissor lift) when lifting materials.

Class 4. Air-Track Drill (one), Belt Drag Machine, Power Broom, Mechanical Plasterer Applicator, Trac-Air, Air Compressor (220 cu. ft. or over) One, Air Compressor (under 220 cu. ft) four, Automatic Bin, Bulk Cement Plant w/Built-in Compressor running off same motor or electric motor, Fireman or Switchman, Self-Propelled Form Tamper, Light Plants (4), Welding Machines (4), Pumps (4), or Combination of four (4) Pumps, Light Plants, Welding Machines, Air-Compressors (under 220 cu. ft.), Mudjacks or Wood Chipper, Mixers - less than 21 cu. ft. Mortar Mixer w/Skip or Pump, Pipeline Tract Jack. One Operating Engineer may operate and maintain any combination of the following pieces of equipment, not to exceed four (4) which shall be within a reasonable distance, such combination may include any equipment in this classification: (Compressors, Light Plants, Generators, Welding Machines, Pumps or Conveyors), One Well- Point Pump, Two Motor Driven Heaters, One Air Compressor (under 220 cu. ft.), One Engine-Driven Conveyor, One Motor Driven Heater, One Light Plant, One Pump, One Welding Machine, One Ulmac or Equal Spreader, Oilers, and one Generator 10 kw or greater.

OPERATING ENGINEER - O & C (Oil and Chip Resealing ONLY). Includes the operation of all motorized heavy equipment used in oil and chip rsealing, including but not limited to operating self-propelled chip spreaders, and all types of rollers (both hard and rubber tired); and other duties pertaining to the operation or maintenance of heavy equipment related to oil and chip resealing.

Class 1. See Class 1 above for types of equipment operated.



Class 2. See Class 2 above for types of equipment operated.  
Class 3. See Class 3 above for types of equipment operated.  
Class 4. See Class 4 above for types of equipment operated.

OPERATING ENGINEER RIVER WORK 1 - operate the following machines when working on River Work and Levee Work on the Mississippi and Ohio Rivers, Lakes and Tributaries: Crane, Shovel, Drageline, Scrapers, Dredge, Derrick, Pile-Driver, Push Boat, all power boat operators, Mechanic, Engineman on Dredge, Leverman on Dredge, All Bituminous Spreader machines, Backhoe, Backfiller, Boom, or Winch Cat, Bituminous Mixplane Machine, Blacksmith, Bituminous Surfacing Machine, Bulldozer, Truck Cranes, Hydraulic Truck Mounted Boom/Crane, Concrete Finishing Machine, or Spreader Machine, Concrete Breaker, Concrete or Pumpcrete Machines, Concrete Plant Operator, All Off Road Material Hauling Equipment, Dinky or Standard Locomotives, Well Drill, Elevating Grader, Fork-Lifts, Flexplane, Gradeall, Hi-Lift, Power Handblade Tugger type Hoist, Hoist Two Drum (or over one), Gyderrick, Hyster, Motor Patrol, Mixers - 21 Cu. Ft. or over, Push Cat, Pulls, & Scrapers, Pumps-Two Well Points, Equipment Greaser, P & H Pulverizer or Pulverizer equal to Pugmill, Pugmill, Rubber-Tired farm type tractor w/Bulldozer/Blade/Auger or Hi-Lift over ½ yard, Skimmer Scoops, Seaman Tiller, Jersey Spreader, Tract-Air used with Drill or Hi-Lift, Trenching or Ditching Machine, Wood Chipper w/Tractor, self-propelled roller w/Blade, Concrete Pumps and Small Equipment Operators.

OPERATING ENGINEER RIVER 2 - when working on River Work and Levee Work on the Mississippi and Ohio Rivers, Lakes and Tributaries shall be employed as the Oiler or Fireman on Crane, Dragline, Shovel, Dredge, Truck Crane, Pile Driver, Gradeall, Dinky or Standard Locomotive, Guy Derrick, Trenching Machine or Ditching Machine 80 H.P. and over, All Terrain (cherry-picker) with over 40 ton Lifting Capacity, Deck Oiler and Deckhands.

#### Other Classifications of Work:

For definitions of classifications not otherwise set out, the Department generally has on file such definitions which are available. If a task to be performed is not subject to one of the classifications of pay set out, the Department will upon being contacted state which neighboring county has such a classification and provide such rate, such rate being deemed to exist by reference in this document. If no neighboring county rate applies to the task, the Department shall undertake a special determination, such special determination being then deemed to have existed under this determination. If a project requires these, or any classification not listed, please contact IDOL at 217-782-1710 for wage rates or clarifications.

#### LANDSCAPING

Landscaping work falls under the existing classifications for laborer, operating engineer and truck driver. The work performed by landscape plantsman and landscape laborer is covered by the existing classification of laborer. The work performed by landscape operators (regardless of equipment used or its size) is covered by the classifications of operating engineer. The work performed by landscape truck drivers (regardless of size of truck driven) is covered by the classifications of truck driver.