

STATE OF ILLINOIS
DEPARTMENT OF TRANSPORTATION

ROUTE NO.	SECTION	COUNTY	TOTAL SHEETS	SHEET NO.
F.A.P. 595	I-3-K	Rock Island	476	272
FED. ROAD DIST. NO. 7		ILLINOIS	FED. AID PROJECT-	

SHEET NO. 21
22 SHEETS

NOTES

Bar splicer assemblies shall be of an approved type and shall develop in tension at least 125 percent of the yield strength of the lapped reinforcement bars.
Splicer rods shall be of minimum 60 ksi yield strength, threaded or coiled full length.
All reinforcement bars shall be lapped and tied to the splicer rods or dowel bars.
Bar splicer assemblies shall be epoxy coated according to the requirements for reinforcement bars.
Other systems of similar design may be submitted to the Engineer for approval. Approval shall be based on certified test results from an approved testing laboratory that the proposed bar splicer assembly satisfies the following requirements:

- ① Minimum Capacity = $1.25 \times f_y \times A_t$
(Tension in kips)
- ② Minimum *Pull-out Strength = $1.25 \times f_{s_{allow}} \times A_t$
(Tension in kips)

Where f_y = Yield strength of lapped reinforcement bars in ksi.
 $f_{s_{allow}}$ = Allowable tensile stress in lapped reinforcement bars in ksi (Service Load)
 A_t = Tensile stress area of lapped reinforcement bars.
* = 28 day concrete

Bar Size to be Spliced	Splicer Rod or Dowel Bar Length	Strength Requirements	
		Min. Capacity kips - tension	Min. Pull-Out Strength kips - tension
#4	1'-8"	14.7	5.9
#5	2'-0"	23.0	9.2
#6	2'-7"	33.1	13.3
#7	3'-5"	45.1	18.0
#8	4'-6"	58.9	23.6
#9	5'-9"	75.0	30.0
#10	7'-3"	95.0	38.0
#11	9'-0"	117.4	46.8

Bar splicer assemblies shall be according to Section 508 of the Standard Specifications, except as noted. The furnishing and installation of bar splicer assemblies will be measured and paid for at the contract unit price each for "BAR SPLICERS."

The diameter of this part is equal or larger than the diameter of bar spliced.

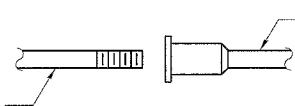

ROLLED THREAD DOWEL BAR



** ONE PIECE

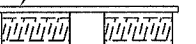
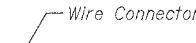

WELDED SECTIONS

BAR SPLICER ASSEMBLY ALTERNATIVES

** Heavy Hex Nuts conforming to ASTM A 563, Grade C, D or DH may be used.

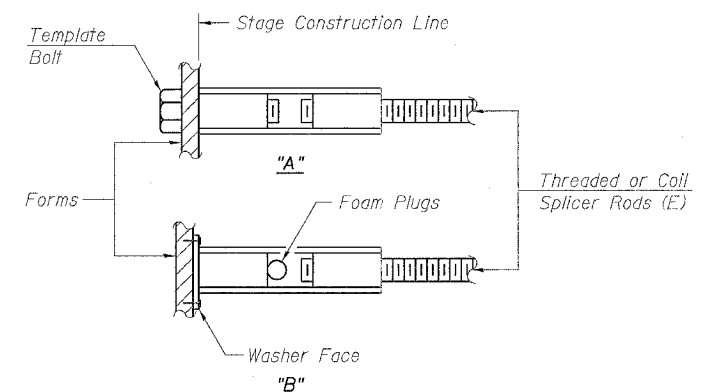

INSTALLATION AND SETTING METHODS

"A" : Set bar splicer assembly by means of a template bolt.
"B" : Set bar splicer assembly by nailing to wood forms or cementing to steel forms.
(E) : Indicates epoxy coating.

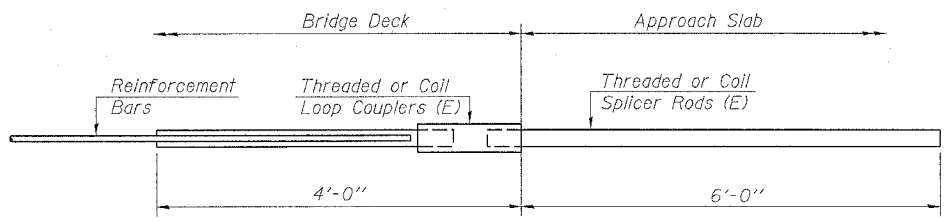

FOR INTEGRAL OR SEMI-INTEGRAL ABUTMENTS

Bar Splicer for #5 bar	
Min. Capacity =	23.0 kips - tension
Min. Pull-out Strength =	9.2 kips - tension
No. Required =	140

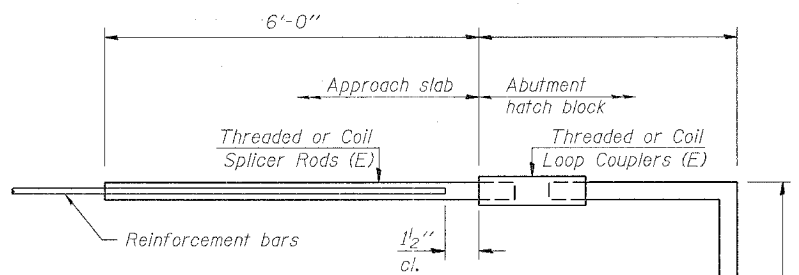

FOR PILE BENT ABUTMENTS

Bar Splicer for #5 bar	
Min. Capacity =	23.0 kips - tension
Min. Pull-out Strength =	9.2 kips - tension
No. Required =	0

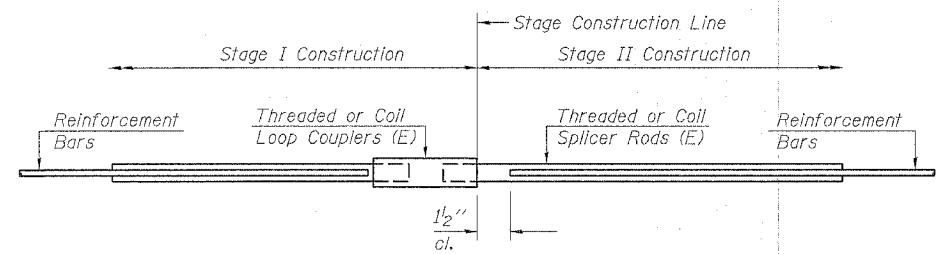

STANDARD

Bar Size	No. Assemblies Required	Location
N/A	0	N/A

BAR SPLICER ASSEMBLY DETAILS

52nd AVE. OVER MILAN BELTWAY
FAU ROUTE 5822 SECTION I-3
ROCK ISLAND COUNTY
STATION 1159+12.92
STRUCTURE NO. 081-0156

DESIGNED	JBF
CHECKED	JBF
DRAWN	RAP
CHECKED	JBF

BSD-1 9-01-03