

104

Letting March 10, 2023

Notice to Bidders, Specifications and Proposal



**Contract No. 87772
DEKALB County
Section 21-00008-00-RS (Cortland)
Route FAU 5363 (Somonauk Road)
Project CR2A-892 ()
District 3 Construction Funds**

Plans Included
Herein

Prepared by	
Checked by	F

(Printed by authority of the State of Illinois)



- 1. TIME AND PLACE OF OPENING BIDS.** Electronic bids are to be submitted to the electronic bidding system (iCX-Integrated Contractors Exchange). All bids must be submitted to the iCX system prior to 12:00 p.m. March 10, 2023 at which time the bids will be publicly opened from the iCX SecureVault.
- 2. DESCRIPTION OF WORK.** The proposed improvement is identified and advertised for bids in the Invitation for Bids as:

**Contract No. 87772
DEKALB County
Section 21-00008-00-RS (Cortland)
Project CR2A-892 ()
Route FAU 5363 (Somonauk Road)
District 3 Construction Funds**

HMA resurfacing on Somonauk Road from North Avenue to IL 38 in Cortland.

- 3. INSTRUCTIONS TO BIDDERS.** (a) This Notice, the invitation for bids, proposal and letter of award shall, together with all other documents in accordance with Article 101.09 of the Standard Specifications for Road and Bridge Construction, become part of the contract. Bidders are cautioned to read and examine carefully all documents, to make all required inspections, and to inquire or seek explanation of the same prior to submission of a bid.

(b) State law, and, if the work is to be paid wholly or in part with Federal-aid funds, Federal law requires the bidder to make various certifications as a part of the proposal and contract. By execution and submission of the proposal, the bidder makes the certification contained therein. A false or fraudulent certification shall, in addition to all other remedies provided by law, be a breach of contract and may result in termination of the contract.
- 4. AWARD CRITERIA AND REJECTION OF BIDS.** This contract will be awarded to the lowest responsive and responsible bidder considering conformity with the terms and conditions established by the Department in the rules, Invitation for Bids and contract documents. The issuance of plans and proposal forms for bidding based upon a prequalification rating shall not be the sole determinant of responsibility. The Department reserves the right to determine responsibility at the time of award, to reject any or all proposals, to re-advertise the proposed improvement, and to waive technicalities.

By Order of the
Illinois Department of Transportation

Omer Osman,
Secretary

INDEX
FOR
SUPPLEMENTAL SPECIFICATIONS
AND RECURRING SPECIAL PROVISIONS

Adopted January 1, 2023

This index contains a listing of SUPPLEMENTAL SPECIFICATIONS, frequently used RECURRING SPECIAL PROVISIONS, and LOCAL ROADS AND STREETS RECURRING SPECIAL PROVISIONS.

ERRATA Standard Specifications for Road and Bridge Construction (Adopted 1-1-22) (Revised 1-1-23)

SUPPLEMENTAL SPECIFICATIONS

<u>Std. Spec. Sec.</u>	<u>Page No.</u>
202 Earth and Rock Excavation	1
204 Borrow and Furnished Excavation	2
207 Porous Granular Embankment	3
211 Topsoil and Compost	4
407 Hot-Mix Asphalt Pavement (Full-Depth)	5
420 Portland Cement Concrete Pavement	6
502 Excavation for Structures	7
509 Metal Railings	8
540 Box Culverts	9
542 Pipe Culverts	29
586 Granular Backfill for Structures	34
644 High Tension Cable Median Barrier	35
782 Reflectors	36
801 Electrical Requirements	38
821 Roadway Luminaires	40
1003 Fine Aggregates	41
1004 Coarse Aggregates	42
1020 Portland Cement Concrete	43
1030 Hot-Mix Asphalt	44
1067 Luminaire	45
1097 Reflectors	52

RECURRING SPECIAL PROVISIONS

The following RECURRING SPECIAL PROVISIONS indicated by an "X" are applicable to this contract and are included by reference:

<u>CHECK SHEET #</u>		<u>PAGE NO.</u>
1	<input checked="" type="checkbox"/> Additional State Requirements for Federal-Aid Construction Contracts	53
2	<input checked="" type="checkbox"/> Subletting of Contracts (Federal-Aid Contracts)	56
3	<input checked="" type="checkbox"/> EEO	57
4	<input type="checkbox"/> Specific EEO Responsibilities Non Federal-Aid Contracts	67
5	<input type="checkbox"/> Required Provisions - State Contracts	72
6	<input type="checkbox"/> Asbestos Bearing Pad Removal	78
7	<input type="checkbox"/> Asbestos Waterproofing Membrane and Asbestos HMA Surface Removal	79
8	<input type="checkbox"/> Temporary Stream Crossings and In-Stream Work Pads	80
9	<input type="checkbox"/> Construction Layout Stakes	81
10	<input type="checkbox"/> Use of Geotextile Fabric for Railroad Crossing	84
11	<input type="checkbox"/> Subsealing of Concrete Pavements	86
12	<input type="checkbox"/> Hot-Mix Asphalt Surface Correction	90
13	<input type="checkbox"/> Pavement and Shoulder Resurfacing	92
14	<input type="checkbox"/> Patching with Hot-Mix Asphalt Overlay Removal	93
15	<input type="checkbox"/> Polymer Concrete	95
16	<input type="checkbox"/> Reserved	97
17	<input type="checkbox"/> Bicycle Racks	98
18	<input type="checkbox"/> Temporary Portable Bridge Traffic Signals	100
19	<input type="checkbox"/> Nighttime Inspection of Roadway Lighting	102
20	<input type="checkbox"/> English Substitution of Metric Bolts	103
21	<input type="checkbox"/> Calcium Chloride Accelerator for Portland Cement Concrete	104
22	<input type="checkbox"/> Quality Control of Concrete Mixtures at the Plant	105
23	<input type="checkbox"/> Quality Control/Quality Assurance of Concrete Mixtures	113
24	<input type="checkbox"/> Reserved	129
25	<input type="checkbox"/> Reserved	130
26	<input type="checkbox"/> Temporary Raised Pavement Markers	131
27	<input type="checkbox"/> Restoring Bridge Approach Pavements Using High-Density Foam	132
28	<input type="checkbox"/> Portland Cement Concrete Inlay or Overlay	135
29	<input type="checkbox"/> Portland Cement Concrete Partial Depth Hot-Mix Asphalt Patching	139
30	<input type="checkbox"/> Longitudinal Joint and Crack Patching	142
31	<input type="checkbox"/> Concrete Mix Design – Department Provided	144
32	<input type="checkbox"/> Station Numbers in Pavements or Overlays	145

LOCAL ROADS AND STREETS RECURRING SPECIAL PROVISIONS

Table of Contents

<u>CHECK SHEET #</u>		<u>PAGE NO.</u>
LRS1	<input type="checkbox"/> Reserved	147
LRS2	<input type="checkbox"/> Furnished Excavation	148
LRS3	<input checked="" type="checkbox"/> Work Zone Traffic Control Surveillance	149
LRS4	<input checked="" type="checkbox"/> Flaggers in Work Zones	150
LRS5	<input type="checkbox"/> Contract Claims	151
LRS6	<input type="checkbox"/> Bidding Requirements and Conditions for Contract Proposals	152
LRS7	<input type="checkbox"/> Bidding Requirements and Conditions for Material Proposals	158
LRS8	<input type="checkbox"/> Reserved	164
LRS9	<input type="checkbox"/> Bituminous Surface Treatments	165
LRS10	<input type="checkbox"/> Reserved	169
LRS11	<input type="checkbox"/> Employment Practices	170
LRS12	<input type="checkbox"/> Wages of Employees on Public Works	172
LRS13	<input type="checkbox"/> Selection of Labor	174
LRS14	<input type="checkbox"/> Paving Brick and Concrete Paver Pavements and Sidewalks	175
LRS15	<input type="checkbox"/> Partial Payments	178
LRS16	<input type="checkbox"/> Protests on Local Lettings	179
LRS17	<input type="checkbox"/> Substance Abuse Prevention Program	180
LRS18	<input type="checkbox"/> Multigrade Cold Mix Asphalt	181
LRS19	<input type="checkbox"/> Reflective Crack Control Treatment	182



TABLE OF CONTENTS OF SPECIAL PROVISIONS

Title	Page Number
LOCATION OF PROJECT.....	1
DESCRIPTION OF WORK.....	1
HOT-MIX ASPHALT SURFACE COURSE, IL 9.5, MIX "D", N70	1
HOT-MIX ASPHALT SURFACE REMOVAL	1
WATER VALVES TO BE ADJUSTED.....	1
DELINEATOR SYSTEM	2
DELINEATOR REMOVAL	2
TRAFFIC CONTROL AND PROTECTION, (SPECIAL).....	2
PROSECUTION OF WORK.....	3
WORKING DAYS	3
LR 107-4.....	4
LR 1030-2.....	5

BDE SPECIAL PROVISIONS

The following special provisions indicated by an "X" are applicable to this contract. An * indicates a new or revised special provision for the letting.

<u>File Name</u>	<u>Pg.</u>	<u>Special Provision Title</u>	<u>Effective</u>	<u>Revised</u>
80099		<input type="checkbox"/> Accessible Pedestrian Signals (APS)	April 1, 2003	Jan. 1, 2022
80274		<input type="checkbox"/> Aggregate Subgrade Improvement	April 1, 2012	April 1, 2022
80192		<input type="checkbox"/> Automated Flagger Assistance Device	Jan. 1, 2008	
80173	7	<input checked="" type="checkbox"/> Bituminous Materials Cost Adjustments	Nov. 2, 2006	Aug. 1, 2017
80426		<input type="checkbox"/> Bituminous Surface Treatment with Fog Seal	Jan. 1, 2020	Jan. 1, 2022
80436		<input type="checkbox"/> Blended Finely Divided Minerals	April 1, 2021	
80241		<input type="checkbox"/> Bridge Demolition Debris	July 1, 2009	
50531		<input type="checkbox"/> Building Removal	Sept. 1, 1990	Aug. 1, 2022
50261		<input type="checkbox"/> Building Removal with Asbestos Abatement	Sept. 1, 1990	Aug. 1, 2022
80384	9	<input checked="" type="checkbox"/> Compensable Delay Costs	June 2, 2017	April 1, 2019
80198		<input type="checkbox"/> Completion Date (via calendar days)	April 1, 2008	
80199		<input type="checkbox"/> Completion Date (via calendar days) Plus Working Days	April 1, 2008	
80261		<input type="checkbox"/> Construction Air Quality – Diesel Retrofit	June 1, 2010	Nov. 1, 2014
80434		<input type="checkbox"/> Corrugated Plastic Pipe (Culvert and Storm Sewer)	Jan. 1, 2021	
80029	13	<input checked="" type="checkbox"/> Disadvantaged Business Enterprise Participation	Sept. 1, 2000	Mar. 2, 2019
80229		<input type="checkbox"/> Fuel Cost Adjustment	April 1, 2009	Aug. 1, 2017
* 80447		<input type="checkbox"/> Grading and Shaping Ditches	Jan 1, 2023	
80433		<input type="checkbox"/> Green Preformed Thermoplastic Pavement Markings	Jan. 1, 2021	Jan. 1, 2022
80443		<input type="checkbox"/> High Tension Cable Median Barrier Removal	April 1, 2022	
80446	23	<input checked="" type="checkbox"/> Hot-Mix Asphalt – Longitudinal Joint Sealant	Nov. 1, 2022	
80438		<input type="checkbox"/> Illinois Works Apprenticeship Initiative – State Funded Contracts	June 2, 2021	Sept. 2, 2021
80045		<input type="checkbox"/> Material Transfer Device	June 15, 1999	Jan. 1, 2022
* 80441	24	<input checked="" type="checkbox"/> Performance Graded Asphalt Binder	Jan 1, 2023	
34261	29	<input checked="" type="checkbox"/> Railroad Protective Liability Insurance	Dec. 1, 1986	Jan. 1, 2022
80445		<input type="checkbox"/> Seeding	Nov. 1, 2022	
* 80448	30	<input checked="" type="checkbox"/> Source of Supply and Quality Requirements	Jan. 2, 2023	
80340		<input type="checkbox"/> Speed Display Trailer	April 2, 2014	Jan. 1, 2022
80127		<input type="checkbox"/> Steel Cost Adjustment	April 2, 2014	Jan. 1, 2022
80397	31	<input checked="" type="checkbox"/> Subcontractor and DBE Payment Reporting	April 2, 2018	
80391	32	<input checked="" type="checkbox"/> Subcontractor Mobilization Payments	Nov. 2, 2017	April 1, 2019
80437	33	<input checked="" type="checkbox"/> Submission of Payroll Records	April 1, 2021	Nov. 1, 2022
* 80435		<input type="checkbox"/> Surface Testing of Pavements – IRI	Jan. 1, 2021	Jan. 1, 2023
80410		<input type="checkbox"/> Traffic Spotters	Jan. 1, 2019	
20338		<input type="checkbox"/> Training Special Provisions	Oct. 15, 1975	Sept. 2, 2021
80429		<input type="checkbox"/> Ultra-Thin Bonded Wearing Course	April 1, 2020	Jan. 1, 2022
80439	35	<input checked="" type="checkbox"/> Vehicle and Equipment Warning Lights	Nov. 1, 2021	Nov. 1, 2022
80440		<input type="checkbox"/> Waterproofing Membrane System	Nov. 1, 2021	
80302	36	<input checked="" type="checkbox"/> Weekly DBE Trucking Reports	June 2, 2012	Nov. 1, 2021
80427		<input type="checkbox"/> Work Zone Traffic Control Devices	Mar. 2, 2020	
80071	37	<input checked="" type="checkbox"/> Working Days	Jan. 1, 2002	



Local Public Agency	County	Section Number
Town of Cortland	DeKalb	21-00008-00-RS

The following Special Provision supplement the "Standard Specifications for Road and Bridge Construction", adopted

January 1, 2022, the latest edition of the "Manual on Uniform Traffic Control Devices for Streets and Highways", and the "Manual of Test Procedures of Materials" in effect on the date of invitation of bids, and the Supplemental Specification and Recurring Special Provisions indicated on the Check Sheet included here in which apply to and govern the construction of the above named section, and in case of conflict with any parts, or parts of said Specifications, the said Special Provisions shall take precedence and shall govern.

LOCATION OF PROJECT

This project is located on Somonauk Road from Illinois Route 38 to North Avenue, near the center of the Town of Cortland, IL in DeKalb County.

DESCRIPTION OF WORK

The work of this section shall consist of Hot-Mix Asphalt Surface Removal, 3" and placing one 1 1/2" lift of Hot-Mix Asphalt Binder Course, IL-9.5, N70 and one 1 1/2" lift of Hot Mix Asphalt Surface Course, IL-9.5, Mix "D", N70 and other incidental work on Somonauk Road between Illinois Route 38 and North Avenue in Cortland, IL.

HOT-MIX ASPHALT SURFACE COURSE, IL-9.5, MIX "D", N70

This work shall consist of placing a 1 1/2" lift of Hot Mix Asphalt Surface Course on the proposed binder course of Somonauk Road.

Local Quality Assurance / Quality Management QC/QA for HMA will be performed per LR1030-2.

The Tack Coat shall be placed on any section of roadway no more than five days in advance of the placement of HMA.

Quantities are estimate prepared for the establishment of pay item prices and are the responsibility of the contractor to confirm prior to bidding. Quantities may be increased, decreased, or omitted to satisfactorily complete the project.

HOT-MIX ASPHALT SURFACE REMOVAL

This work shall be done in accordance with Section 406.08 of the Standard Specifications. The work shall consist of milling the existing pavement at various locations throughout the project.

Method of Measurement - Only that portion of the pavement that has been milled to a minimum depth of 1/4" will be measured for payment. This work, including all milling, hauling and disposal of the millings shall be paid for at the contract unit price per square yard for Hot-Mix Asphalt Surface Removal.

WATER VALVES TO BE ADJUSTED

This work shall consist of adjusting water valves. This work shall be done according to the applicable portions of Section 603 of the Standard Specifications and the following.

During to the milling operation, the Contractor shall exercise caution around water valve boxes.

Prior to placing the surface course, the Contractor shall adjust the water valve boxes to the finished pavement elevation.

This work will be paid at the contract unit price each for WATER VALVES TO BE ADJUSTED.

DELINEATOR SYSTEM

The Contractor shall provide and permanently install a channelizing system adjacent to the Union Pacific Railroad on both the north and south sides. The system shall include yellow interlocking continuous curb with reflective marker panels (minimum 42" height) mounted on reboundable connections. Any delineator system provided must meet the approval of the Federal Railroad Administration as a quiet zone traffic channelization and median barrier supplemental safety measure.

The delineator system must be installed in accordance with manufacturer instructions for permanent installation. The placement of the delineator system shall be in the same location as the existing Qwick Kurb system.

The delineator system shall consist of 60 feet of curb on the south side and 63 feet of curb on the north side for a total of 123 feet. Each terminal end of curbing shall have a formed, tapered end curb piece.

This work shall be paid for at the contract unit price per EACH for DELINEATOR SYSTEM.

DELINEATOR REMOVAL

This work shall include the removal of 123 feet of anchored raised curb channelizing system and appurtenances.

The Contractor shall remove and dispose of all curb, panels, and hardware.

This work shall be paid for at the contract unit price per EACH for DELINEATOR REMOVAL.

TRAFFIC CONTROL AND PROTECTION, (SPECIAL)

Traffic Control shall be in accordance with the applicable sections of the Standard Specifications for Road and Bridge Construction, the applicable guidelines contained in the Manual on Uniform Traffic Control Devices for Streets and Highways, these Special Provisions, and any special details and Highway Standards contained herein and in the plans.

Standards 701301, 701311, 701501, 701502, 701701, 701901, 780001.

The entire section shall remain open to a minimum of one lane traffic during construction. Work shall be performed between sunrise and sunset only. After hours of operation each day, the contractor shall open both lanes to overnight traffic.

All signs shall conform to the following:

- Bump, Low Shoulder, and Road Construction Ahead signs shall be 48" x 48" black on fluorescent orange.
- Supplemental black on fluorescent orange 21" x 15", left/right arrow shall be installed below the W20-I103 sign.
- Signs in place longer than 4 days shall be post mounted.
- Completed BSPE 725, Traffic Control Authorization, form will be required to be submitted prior to work operations.

The presence of temporary traffic control drawings or standards in the project plans, whether a pay item or not, does not relieve the contractor of his obligation to the public, in accordance with Article 107.14 of the Standard Specifications for Road and Bridge Construction. The contractor shall provide, to the satisfaction of the Engineer, all protection deemed necessary beyond that shown in the plans or Special Provisions.

Local Public Agency	County	Section Number
Town of Cortland	DeKalb	21-00008-00-RS

“BUMP” signs shall be installed as directed by the Engineer.
 “ROAD CONSTRUCTION AHEAD’ signs shall be installed on Somonauk Road south of Illinois Route 38 and on Somonauk Road north of Cortland Center Road with a supplemental black on fluorescent orange indicating arrow.

Flagger shall comply with all requirements contained in the Department’s “Flagger Handbook” with the following exception: The ANSI Class 2 vest will not be supplied by the Department.

The cost of any and all traffic control required by these special provisions and the standards included in this proposal shall be paid for per Lump Sum for TRAFFIC CONTROL & PROTECTION, (SPECIAL).

PROSECUTION OF WORK

The Contractor shall notify the Engineer a minimum of two (2) working days (i.e. notice given on Thursday A.M. for work to begin the following Monday) prior to commencement of any work which would be considered as a pay item in the contract. No payment will be made to the Contractor for any pay item work performed without the aforementioned notice being given unless otherwise approved by the Engineer. Work shall be performed between sunrise and sunset only.

WORKING DAYS

All contract work including punch list items shall be completed on or before the allowable 25 working days. Failure to complete the work by the completion date will result in liquidated damages being assessed in accordance with Article 108.09 of the Standard Specifications.

State of Illinois
Department of Transportation
Bureau of Local Roads and Streets

SPECIAL PROVISION
FOR
INSURANCE

Effective: February 1, 2007
Revised: August 1, 2007

All references to Sections or Articles in this specification shall be construed to mean specific Section or Article of the Standard Specifications for Road and Bridge Construction, adopted by the Department of Transportation.

The Contractor shall name the following entities as additional insured under the Contractor's general liability insurance policy in accordance with Article 107.27:

Town of Cortland

DeKalb County

The entities listed above and their officers, employees, and agents shall be indemnified and held harmless in accordance with Article 107.26.

State of Illinois
 DEPARTMENT OF TRANSPORTATION
 Bureau of Local Roads & Streets
 SPECIAL PROVISION
 FOR
 LOCAL QUALITY ASSURANCE/ QUALITY MANAGEMENT QC/QA
 Effective: January 1, 2022

Replace the first five paragraphs of Article 1030.06 of the Standard Specifications with the following:

“1030.06 Quality Management Program. The Quality Management Program (QMP) will be Quality Control / Quality Assurance (QC/QA) according to the following.”

Delete Article 1030.06(d)(1) of the Standard Specifications.

Revise Article 1030.09(g)(3) of the Standard Specifications to read:

“(3) If core testing is the density verification method, the Contractor shall provide personnel and equipment to collect density verification cores for the Engineer. Core locations will be determined by the Engineer following the document “Hot-Mix Asphalt QC/QA Procedure for Determining Random Density Locations” at density verification intervals defined in Article 1030.09(b). After the Engineer identifies a density verification location and prior to opening to traffic, the Contractor shall cut a 4 in. (100 mm) diameter core. With the approval of the Engineer, the cores may be cut at a later time.”

Revise Article 1030.09(h)(2) of the Standard Specifications to read:

“(2) After final rolling and prior to paving subsequent lifts, the Engineer will identify the random density verification test locations. Cores or nuclear density gauge testing will be used for density verification. The method used for density verification will be as selected below.

Density Verification Method	
<input checked="" type="checkbox"/>	Cores
<input type="checkbox"/>	Nuclear Density Gauge (Correlated when paving ≥ 3,000 tons per mixture)

Density verification test locations will be determined according to the document “Hot-Mix Asphalt QC/QA Procedure for Determining Random Density Locations”. The density testing interval for paving wider than or equal to 3 ft (1 m) will be 0.5 miles (800 m) for lift thicknesses of 3 in. (75 mm) or less and 0.2 miles (320 m) for lift thicknesses greater than 3 in. (75 mm). The density testing interval for paving less than 3 ft (1 m) wide will be 1 mile (1,600 m). If a day’s paving will be less than the prescribed density testing interval, the length of the day’s paving will be the interval for that day. The density testing interval for mixtures used for patching will be 50 patches with a minimum of one test per mixture per project.

If core testing is the density verification method, the Engineer will witness the Contractor coring, and secure and take possession of all density samples at the

density verification locations. The Engineer will test the cores collected by the Contractor for density according to Illinois Modified AASHTO T 166 or AASHTO T 275.

If nuclear density gauge testing is the density verification method, the Engineer will conduct nuclear density gauge tests. The Engineer will follow the density testing procedure detailed in the document "Illinois Modified ASTM D 2950, Standard Test Method for Density of Bituminous Concrete In-Place by Nuclear Method".

A density verification test will be the result of a single core or the average of the nuclear density tests at one location. The results of each density test must be within acceptable limits. The Engineer will promptly notify the Contractor of observed deficiencies."

Revise the seventh paragraph and all subsequent paragraphs in Section D. of the document "Hot-Mix Asphalt QC/QA Initial Daily Plant and Random Samples" to read:

"Mixtures shall be sampled from the truck at the plant by the Contractor following the same procedure used to collect QC mixture samples (Section A). This process will be witnessed by the Engineer who will take custody of the verification sample. Each sample bag with a verification mixture sample will be secured by the Engineer using a locking ID tag. Sample boxes containing the verification mixture sample will be sealed/taped by the Engineer using a security ID label."

BITUMINOUS MATERIALS COST ADJUSTMENTS (BDE)

Effective: November 2, 2006

Revised: August 1, 2017

Description. Bituminous material cost adjustments will be made to provide additional compensation to the Contractor, or credit to the Department, for fluctuations in the cost of bituminous materials when optioned by the Contractor. The bidder shall indicate with their bid whether or not this special provision will be part of the contract.

The adjustments shall apply to permanent and temporary hot-mix asphalt (HMA) mixtures, bituminous surface treatments (cover and seal coats), and preventative maintenance type surface treatments that are part of the original proposed construction, or added as extra work and paid for by agreed unit prices. The adjustments shall not apply to bituminous prime coats, tack coats, crack filling/sealing, joint filling/sealing, or extra work paid for at a lump sum price or by force account.

Method of Adjustment. Bituminous materials cost adjustments will be computed as follows.

$$CA = (BPI_P - BPI_L) \times (\%AC_V / 100) \times Q$$

Where: CA = Cost Adjustment, \$.

BPI_P = Bituminous Price Index, as published by the Department for the month the work is performed, \$/ton (\$/metric ton).

BPI_L = Bituminous Price Index, as published by the Department for the month prior to the letting for work paid for at the contract price; or for the month the agreed unit price letter is submitted by the Contractor for extra work paid for by agreed unit price, \$/ton (\$/metric ton).

%AC_V = Percent of virgin Asphalt Cement in the Quantity being adjusted. For HMA mixtures, the % AC_V will be determined from the adjusted job mix formula. For bituminous materials applied, a performance graded or cutback asphalt will be considered to be 100% AC_V and undiluted emulsified asphalt will be considered to be 65% AC_V.

Q = Authorized construction Quantity, tons (metric tons) (see below).

For HMA mixtures measured in square yards: $Q, \text{ tons} = A \times D \times (G_{mb} \times 46.8) / 2000$. For HMA mixtures measured in square meters: $Q, \text{ metric tons} = A \times D \times (G_{mb} \times 1) / 1000$. When computing adjustments for full-depth HMA pavement, separate calculations will be made for the binder and surface courses to account for their different G_{mb} and % AC_V.

For bituminous materials measured in gallons: $Q, \text{ tons} = V \times 8.33 \text{ lb/gal} \times SG / 2000$

For bituminous materials measured in liters: $Q, \text{ metric tons} = V \times 1.0 \text{ kg/L} \times SG / 1000$

Where: A = Area of the HMA mixture, sq yd (sq m).

D = Depth of the HMA mixture, in. (mm).

G_{mb} = Average bulk specific gravity of the mixture, from the approved mix design.

V = Volume of the bituminous material, gal (L).
SG = Specific Gravity of bituminous material as shown on the bill of lading.

Basis of Payment. Bituminous materials cost adjustments may be positive or negative but will only be made when there is a difference between the BPI_L and BPI_P in excess of five percent, as calculated by:

$$\text{Percent Difference} = \{(BPI_L - BPI_P) \div BPI_L\} \times 100$$

Bituminous materials cost adjustments will be calculated for each calendar month in which applicable bituminous material is placed; and will be paid or deducted when all other contract requirements for the work placed during the month are satisfied. The adjustments shall not apply during contract time subject to liquidated damages for completion of the entire contract.

80173

COMPENSABLE DELAY COSTS (BDE)

Effective: June 2, 2017

Revised: April 1, 2019

Revise Article 107.40(b) of the Standard Specifications to read:

“(b) Compensation. Compensation will not be allowed for delays, inconveniences, or damages sustained by the Contractor from conflicts with facilities not meeting the above definition; or if a conflict with a utility in an unanticipated location does not cause a shutdown of the work or a documentable reduction in the rate of progress exceeding the limits set herein. The provisions of Article 104.03 notwithstanding, compensation for delays caused by a utility in an unanticipated location will be paid according to the provisions of this Article governing minor and major delays or reduced rate of production which are defined as follows.

- (1) Minor Delay. A minor delay occurs when the work in conflict with the utility in an unanticipated location is completely stopped for more than two hours, but not to exceed two weeks.
- (2) Major Delay. A major delay occurs when the work in conflict with the utility in an unanticipated location is completely stopped for more than two weeks.
- (3) Reduced Rate of Production Delay. A reduced rate of production delay occurs when the rate of production on the work in conflict with the utility in an unanticipated location decreases by more than 25 percent and lasts longer than seven calendar days.”

Revise Article 107.40(c) of the Standard Specifications to read:

“(c) Payment. Payment for Minor, Major, and Reduced Rate of Production Delays will be made as follows.

- (1) Minor Delay. Labor idled which cannot be used on other work will be paid for according to Article 109.04(b)(1) and (2) for the time between start of the delay and the minimum remaining hours in the work shift required by the prevailing practice in the area.

Equipment idled which cannot be used on other work, and which is authorized to standby on the project site by the Engineer, will be paid for according to Article 109.04(b)(4).

- (2) Major Delay. Labor will be the same as for a minor delay.

Equipment will be the same as for a minor delay, except Contractor-owned equipment will be limited to two weeks plus the cost of move-out to either the

Contractor's yard or another job and the cost to re-mobilize, whichever is less. Rental equipment may be paid for longer than two weeks provided the Contractor presents adequate support to the Department (including lease agreement) to show retaining equipment on the job is the most economical course to follow and in the public interest.

- (3) Reduced Rate of Production Delay. The Contractor will be compensated for the reduced productivity for labor and equipment time in excess of the 25 percent threshold for that portion of the delay in excess of seven calendar days. Determination of compensation will be in accordance with Article 104.02, except labor and material additives will not be permitted.

Payment for escalated material costs, escalated labor costs, extended project overhead, and extended traffic control will be determined according to Article 109.13.”

Revise Article 108.04(b) of the Standard Specifications to read:

“(b) No working day will be charged under the following conditions.

- (1) When adverse weather prevents work on the controlling item.
- (2) When job conditions due to recent weather prevent work on the controlling item.
- (3) When conduct or lack of conduct by the Department or its consultants, representatives, officers, agents, or employees; delay by the Department in making the site available; or delay in furnishing any items required to be furnished to the Contractor by the Department prevents work on the controlling item.
- (4) When delays caused by utility or railroad adjustments prevent work on the controlling item.
- (5) When strikes, lock-outs, extraordinary delays in transportation, or inability to procure critical materials prevent work on the controlling item, as long as these delays are not due to any fault of the Contractor.
- (6) When any condition over which the Contractor has no control prevents work on the controlling item.”

Revise Article 109.09(f) of the Standard Specifications to read:

“(f) Basis of Payment. After resolution of a claim in favor of the Contractor, any adjustment in time required for the work will be made according to Section 108. Any adjustment in the costs to be paid will be made for direct labor, direct materials, direct equipment, direct jobsite overhead, direct offsite overhead, and other direct costs allowed by the resolution. Adjustments in costs will not be made for interest charges, loss of anticipated profit, undocumented loss of efficiency, home office overhead and unabsorbed overhead

other than as allowed by Article 109.13, lost opportunity, preparation of claim expenses and other consequential indirect costs regardless of method of calculation.

The above Basis of Payment is an essential element of the contract and the claim cost recovery of the Contractor shall be so limited.”

Add the following to Section 109 of the Standard Specifications.

“109.13 Payment for Contract Delay. Compensation for escalated material costs, escalated labor costs, extended project overhead, and extended traffic control will be allowed when such costs result from a delay meeting the criteria in the following table.

Contract Type	Cause of Delay	Length of Delay
Working Days	Article 108.04(b)(3) or Article 108.04(b)(4)	No working days have been charged for two consecutive weeks.
Completion Date	Article 108.08(b)(1) or Article 108.08(b)(7)	The Contractor has been granted a minimum two week extension of contract time, according to Article 108.08.

Payment for each of the various costs will be according to the following.

- (a) Escalated Material and/or Labor Costs. When the delay causes work, which would have otherwise been completed, to be done after material and/or labor costs have increased, such increases will be paid. Payment for escalated material costs will be limited to the increased costs substantiated by documentation furnished by the Contractor. Payment for escalated labor costs will be limited to those items in Article 109.04(b)(1) and (2), except the 35 percent and 10 percent additives will not be permitted.
- (b) Extended Project Overhead. For the duration of the delay, payment for extended project overhead will be paid as follows.
 - (1) Direct Jobsite and Offsite Overhead. Payment for documented direct jobsite overhead and documented direct offsite overhead, including onsite supervisory and administrative personnel, will be allowed according to the following table.

Original Contract Amount	Supervisory and Administrative Personnel
Up to \$5,000,000	One Project Superintendent
Over \$ 5,000,000 - up to \$25,000,000	One Project Manager, One Project Superintendent or Engineer, and One Clerk
Over \$25,000,000 - up to \$50,000,000	One Project Manager, One Project Superintendent, One Engineer, and

	One Clerk
Over \$50,000,000	One Project Manager, Two Project Superintendents, One Engineer, and One Clerk

(2) Home Office and Unabsorbed Overhead. Payment for home office and unabsorbed overhead will be calculated as 8 percent of the total delay cost.

(c) Extended Traffic Control. Traffic control required for an extended period of time due to the delay will be paid for according to Article 109.04.

When an extended traffic control adjustment is paid under this provision, an adjusted unit price as provided for in Article 701.20(a) for increase or decrease in the value of work by more than ten percent will not be paid.

Upon payment for a contract delay under this provision, the Contractor shall assign subrogation rights to the Department for the Department's efforts of recovery from any other party for monies paid by the Department as a result of any claim under this provision. The Contractor shall fully cooperate with the Department in its efforts to recover from another party any money paid to the Contractor for delay damages under this provision."

80384

DISADVANTAGED BUSINESS ENTERPRISE PARTICIPATION (BDE)

Effective: September 1, 2000

Revised: March 2, 2019

FEDERAL OBLIGATION. The Department of Transportation, as a recipient of federal financial assistance, is required to take all necessary and reasonable steps to ensure nondiscrimination in the award and administration of contracts. Consequently, the federal regulatory provisions of 49 CFR Part 26 apply to this contract concerning the utilization of disadvantaged business enterprises. For the purposes of this Special Provision, a disadvantaged business enterprise (DBE) means a business certified by the Department in accordance with the requirements of 49 CFR Part 26 and listed in the Illinois Unified Certification Program (IL UCP) DBE Directory.

STATE OBLIGATION. This Special Provision will also be used by the Department to satisfy the requirements of the Business Enterprise for Minorities, Females, and Persons with Disabilities Act, 30 ILCS 575. When this Special Provision is used to satisfy state law requirements on 100 percent state-funded contracts, the federal government has no involvement in such contracts (not a federal-aid contract) and no responsibility to oversee the implementation of this Special Provision by the Department on those contracts. DBE participation on 100 percent state-funded contracts will not be credited toward fulfilling the Department's annual overall DBE goal required by the US Department of Transportation to comply with the federal DBE program requirements.

CONTRACTOR ASSURANCE. The Contractor makes the following assurance and agrees to include the assurance in each subcontract the Contractor signs with a subcontractor.

The Contractor, subrecipient, or subcontractor shall not discriminate on the basis of race, color, national origin, or sex in the performance of this contract. The Contractor shall carry out applicable requirements of 49 CFR Part 26 in the award and administration of contracts funded in whole or in part with federal or state funds. Failure by the Contractor to carry out these requirements is a material breach of this contract, which may result in the termination of this contract or such other remedy as the recipient deems appropriate, which may include, but is not limited to:

- (a) Withholding progress payments;
- (b) Assessing sanctions;
- (c) Liquidated damages; and/or
- (d) Disqualifying the Contractor from future bidding as non-responsible.

OVERALL GOAL SET FOR THE DEPARTMENT. As a requirement of compliance with 49 CFR Part 26, the Department has set an overall goal for DBE participation in its federally assisted contracts. That goal applies to all federal-aid funds the Department will expend in its federally assisted contracts for the subject reporting fiscal year. The Department is required to make a

good faith effort to achieve the overall goal. The dollar amount paid to all approved DBE companies performing work called for in this contract is eligible to be credited toward fulfillment of the Department's overall goal.

CONTRACT GOAL TO BE ACHIEVED BY THE CONTRACTOR. This contract includes a specific DBE utilization goal established by the Department. The goal has been included because the Department has determined the work of this contract has subcontracting opportunities that may be suitable for performance by DBE companies. The determination is based on an assessment of the type of work, the location of the work, and the availability of DBE companies to do a part of the work. The assessment indicates, in the absence of unlawful discrimination and in an arena of fair and open competition, DBE companies can be expected to perform 9 % of the work. This percentage is set as the DBE participation goal for this contract. Consequently, in addition to the other award criteria established for this contract, the Department will only award this contract to a bidder who makes a good faith effort to meet this goal of DBE participation in the performance of the work. A bidder makes a good faith effort for award consideration if either of the following is done in accordance with the procedures set for in this Special Provision:

- (a) The bidder documents enough DBE participation has been obtained to meet the goal or,
- (b) The bidder documents a good faith effort has been made to meet the goal, even though the effort did not succeed in obtaining enough DBE participation to meet the goal.

DBE LOCATOR REFERENCES. Bidders shall consult the IL UCP DBE Directory as a reference source for DBE-certified companies. In addition, the Department maintains a letting and item specific DBE locator information system whereby DBE companies can register their interest in providing quotes on particular bid items advertised for letting. Information concerning DBE companies willing to quote work for particular contracts may be obtained by contacting the Department's Bureau of Small Business Enterprises at telephone number (217) 785-4611, or by visiting the Department's website at:

<http://www.idot.illinois.gov/doing-business/certifications/disadvantaged-business-enterprise-certification/il-ucp-directory/index>.

BIDDING PROCEDURES. Compliance with this Special Provision is a material bidding requirement and failure of the bidder to comply will render the bid not responsive.

The bidder shall submit a DBE Utilization Plan (form SBE 2026), and a DBE Participation Statement (form SBE 2025) for each DBE company proposed for the performance of work to achieve the contract goal, with the bid. If the Utilization Plan indicates the contract goal will not be met, documentation of good faith efforts shall also be submitted. The documentation of good faith efforts must include copies of each DBE and non-DBE subcontractor quote submitted to the bidder when a non-DBE subcontractor is selected over a DBE for work on the contract. The required forms and documentation must be submitted as a single .pdf file using the "Integrated Contractor Exchange (iCX)" application within the Department's "EBids System".

The Department will not accept a Utilization Plan if it does not meet the bidding procedures set forth herein and the bid will be declared not responsive. In the event the bid is declared not responsive, the Department may elect to cause the forfeiture of the penal sum of the bidder's proposal guaranty and may deny authorization to bid the project if re-advertised for bids.

GOOD FAITH EFFORT PROCEDURES. The contract will not be awarded until the Utilization Plan is approved. All information submitted by the bidder must be complete, accurate and adequately document enough DBE participation has been obtained or document the good faith efforts of the bidder, in the event enough DBE participation has not been obtained, before the Department will commit to the performance of the contract by the bidder. The Utilization Plan will be approved by the Department if the Utilization Plan documents sufficient commercially useful DBE work to meet the contract goal or the bidder submits sufficient documentation of a good faith effort to meet the contract goal pursuant to 49 CFR Part 26, Appendix A. This means the bidder must show that all necessary and reasonable steps were taken to achieve the contract goal. Necessary and reasonable steps are those which, by their scope, intensity and appropriateness to the objective, could reasonably be expected to obtain sufficient DBE participation, even if they were not successful. The Department will consider the quality, quantity, and intensity of the kinds of efforts the bidder has made. Mere *pro forma* efforts, in other words efforts done as a matter of form, are not good faith efforts; rather, the bidder is expected to have taken genuine efforts that would be reasonably expected of a bidder actively and aggressively trying to obtain DBE participation sufficient to meet the contract goal.

- (a) The following is a list of types of action that the Department will consider as part of the evaluation of the bidder's good faith efforts to obtain participation. These listed factors are not intended to be a mandatory checklist and are not intended to be exhaustive. Other factors or efforts brought to the attention of the Department may be relevant in appropriate cases and will be considered by the Department.
 - (1) Soliciting through all reasonable and available means (e.g. attendance at pre-bid meetings, advertising and/or written notices) the interest of all certified DBE companies that have the capability to perform the work of the contract. The bidder must solicit this interest within sufficient time to allow the DBE companies to respond to the solicitation. The bidder must determine with certainty if the DBE companies are interested by taking appropriate steps to follow up initial solicitations.
 - (2) Selecting portions of the work to be performed by DBE companies in order to increase the likelihood that the DBE goals will be achieved. This includes, where appropriate, breaking out contract work items into economically feasible units to facilitate DBE participation, even when the Contractor might otherwise prefer to perform these work items with its own forces.
 - (3) Providing interested DBE companies with adequate information about the plans, specifications, and requirements of the contract in a timely manner to assist them in responding to a solicitation.

- (4) a. Negotiating in good faith with interested DBE companies. It is the bidder's responsibility to make a portion of the work available to DBE subcontractors and suppliers and to select those portions of the work or material needs consistent with the available DBE subcontractors and suppliers, so as to facilitate DBE participation. Evidence of such negotiation includes the names, addresses, and telephone numbers of DBE companies that were considered; a description of the information provided regarding the plans and specifications for the work selected for subcontracting; and evidence as to why additional agreements could not be reached for DBE companies to perform the work.
 - b. A bidder using good business judgment would consider a number of factors in negotiating with subcontractors, including DBE subcontractors, and would take a firm's price and capabilities as well as contract goals into consideration. However, the fact that there may be some additional costs involved in finding and using DBE companies is not in itself sufficient reason for a bidder's failure to meet the contract DBE goal, as long as such costs are reasonable. Also the ability or desire of a bidder to perform the work of a contract with its own organization does not relieve the bidder of the responsibility to make good faith efforts. Bidders are not, however, required to accept higher quotes from DBE companies if the price difference is excessive or unreasonable. In accordance with the above Bidding Procedures, the documentation of good faith efforts must include copies of each DBE and non-DBE subcontractor quote submitted to the bidder when a non-DBE subcontractor was selected over a DBE for work on the contract.
- (5) Not rejecting DBE companies as being unqualified without sound reasons based on a thorough investigation of their capabilities. The bidder's standing within its industry, membership in specific groups, organizations, or associations and political or social affiliations (for example union vs. non-union employee status) are not legitimate causes for the rejection or non-solicitation of bids in the bidder's efforts to meet the project goal.
 - (6) Making efforts to assist interested DBE companies in obtaining bonding, lines of credit, or insurance as required by the recipient or Contractor.
 - (7) Making efforts to assist interested DBE companies in obtaining necessary equipment, supplies, materials, or related assistance or services.
 - (8) Effectively using the services of available minority/women community organizations; minority/women contractors' groups; local, state, and federal minority/women business assistance offices; and other organizations as allowed on a case-by-case basis to provide assistance in the recruitment and placement of DBE companies.
- (b) If the Department determines the bidder has made a good faith effort to secure the work commitment of DBE companies to meet the contract goal, the Department will award the contract provided it is otherwise eligible for award. If the Department determines the

bidder has failed to meet the requirements of this Special Provision or that a good faith effort has not been made, the Department will notify the responsible company official designated in the Utilization Plan that the bid is not responsive. The notification will also include a statement of reasons for the adverse determination. If the Utilization Plan is not approved because it is deficient as a technical matter, unless waived by the Department, the bidder will be notified and will be allowed no more than a five calendar day period to cure the deficiency.

- (c) The bidder may request administrative reconsideration of an adverse determination by emailing the Department at "DOT.DBE.UP@illinois.gov" within the five calendar days after the receipt of the notification of the determination. The determination shall become final if a request is not made on or before the fifth calendar day. A request may provide additional written documentation or argument concerning the issues raised in the determination statement of reasons, provided the documentation and arguments address efforts made prior to submitting the bid. The request will be reviewed by the Department's Reconsideration Officer. The Reconsideration Officer will extend an opportunity to the bidder to meet in person to consider all issues of documentation and whether the bidder made a good faith effort to meet the goal. After the review by the Reconsideration Officer, the bidder will be sent a written decision within ten working days after receipt of the request for reconsideration, explaining the basis for finding that the bidder did or did not meet the goal or make adequate good faith efforts to do so. A final decision by the Reconsideration Officer that a good faith effort was made shall approve the Utilization Plan submitted by the bidder and shall clear the contract for award. A final decision that a good faith effort was not made shall render the bid not responsive.

CALCULATING DBE PARTICIPATION. The Utilization Plan values represent work anticipated to be performed and paid for upon satisfactory completion. The Department is only able to count toward the achievement of the overall goal and the contract goal the value of payments made for the work actually performed by DBE companies. In addition, a DBE must perform a commercially useful function on the contract to be counted. A commercially useful function is generally performed when the DBE is responsible for the work and is carrying out its responsibilities by actually performing, managing, and supervising the work involved. The Department and Contractor are governed by the provisions of 49 CFR Part 26.55(c) on questions of commercially useful functions as it affects the work. Specific counting guidelines are provided in 49 CFR Part 26.55, the provisions of which govern over the summary contained herein.

- (a) DBE as the Contractor: 100 percent goal credit for that portion of the work performed by the DBE's own forces, including the cost of materials and supplies. Work that a DBE subcontracts to a non-DBE does not count toward the DBE goals.
- (b) DBE as a joint venture Contractor: 100 percent goal credit for that portion of the total dollar value of the contract equal to the distinct, clearly defined portion of the work performed by the DBE's own forces.

- (c) DBE as a subcontractor: 100 percent goal credit for the work of the subcontract performed by the DBE's own forces, including the cost of materials and supplies, excluding the purchase of materials and supplies or the lease of equipment by the DBE subcontractor from the Contractor or its affiliates. Work that a DBE subcontractor in turn subcontracts to a non-DBE does not count toward the DBE goal.
- (d) DBE as a trucker: 100 percent goal credit for trucking participation provided the DBE is responsible for the management and supervision of the entire trucking operation for which it is responsible. At least one truck owned, operated, licensed, and insured by the DBE must be used on the contract. Credit will be given for the following:
 - (1) The DBE may lease trucks from another DBE firm, including an owner-operator who is certified as a DBE. The DBE who leases trucks from another DBE receives credit for the total value of the transportation services the lessee DBE provides on the contract.
 - (2) The DBE may also lease trucks from a non-DBE firm, including from an owner-operator. The DBE who leases trucks from a non-DBE is entitled to credit only for the fee or commission it receives as a result of the lease arrangement.
- (e) DBE as a material supplier:
 - (1) 60 percent goal credit for the cost of the materials or supplies purchased from a DBE regular dealer.
 - (2) 100 percent goal credit for the cost of materials or supplies obtained from a DBE manufacturer.
 - (3) 100 percent credit for the value of reasonable fees and commissions for the procurement of materials and supplies if not a DBE regular dealer or DBE manufacturer.

CONTRACT COMPLIANCE. Compliance with this Special Provision is an essential part of the contract. The Department is prohibited by federal regulations from crediting the participation of a DBE included in the Utilization Plan toward either the contract goal or the Department's overall goal until the amount to be applied toward the goals has been paid to the DBE. The following administrative procedures and remedies govern the compliance by the Contractor with the contractual obligations established by the Utilization Plan. After approval of the Utilization Plan and award of the contract, the Utilization Plan and individual DBE Participation Statements become part of the contract. If the Contractor did not succeed in obtaining enough DBE participation to achieve the advertised contract goal, and the Utilization Plan was approved and contract awarded based upon a determination of good faith, the total dollar value of DBE work calculated in the approved Utilization Plan as a percentage of the awarded contract value shall become the amended contract goal. All work indicated for performance by an approved DBE shall be performed, managed, and supervised by the DBE executing the DBE Participation Commitment Statement.

- (a) NO AMENDMENT. No amendment to the Utilization Plan may be made without prior written approval from the Department's Bureau of Small Business Enterprises. All requests for amendment to the Utilization Plan shall be emailed to the Department at DOT.DBE.UP@illinois.gov.
- (b) CHANGES TO WORK. Any deviation from the DBE condition-of-award or contract plans, specifications, or special provisions must be approved, in writing, by the Department as provided elsewhere in the Contract. The Contractor shall notify affected DBEs in writing of any changes in the scope of work which result in a reduction in the dollar amount condition-of-award to the contract. Where the revision includes work committed to a new DBE subcontractor, not previously involved in the project, then a Request for Approval of Subcontractor, Department form BC 260A or AER 260A, must be signed and submitted. If the commitment of work is in the form of additional tasks assigned to an existing subcontract, a new Request for Approval of Subcontractor will not be required. However, the Contractor must document efforts to assure the existing DBE subcontractor is capable of performing the additional work and has agreed in writing to the change.
- (c) SUBCONTRACT. The Contractor must provide copies of DBE subcontracts to the Department upon request. Subcontractors shall ensure that all lower tier subcontracts or agreements with DBEs to supply labor or materials be performed in accordance with this Special Provision.
- (d) ALTERNATIVE WORK METHODS. In addition to the above requirements for reductions in the condition of award, additional requirements apply to the two cases of Contractor-initiated work substitution proposals. Where the contract allows alternate work methods which serve to delete or create underruns in condition of award DBE work, and the Contractor selects that alternate method or, where the Contractor proposes a substitute work method or material that serves to diminish or delete work committed to a DBE and replace it with other work, then the Contractor must demonstrate one of the following:
- (1) The replacement work will be performed by the same DBE (as long as the DBE is certified in the respective item of work) in a modification of the condition of award; or
 - (2) The DBE is aware its work will be deleted or will experience underruns and has agreed in writing to the change. If this occurs, the Contractor shall substitute other work of equivalent value to a certified DBE or provide documentation of good faith efforts to do so; or
 - (3) The DBE is not capable of performing the replacement work or has declined to perform the work at a reasonable competitive price. If this occurs, the Contractor shall substitute other work of equivalent value to a certified DBE or provide documentation of good faith efforts to do so.

- (e) TERMINATION AND REPLACEMENT PROCEDURES. The Contractor shall not terminate or replace a DBE listed on the approved Utilization Plan, or perform with other forces work designated for a listed DBE except as provided in this Special Provision. The Contractor shall utilize the specific DBEs listed to perform the work and supply the materials for which each is listed unless the Contractor obtains the Department's written consent as provided in subsection (a) of this part. Unless Department consent is provided for termination of a DBE subcontractor, the Contractor shall not be entitled to any payment for work or material unless it is performed or supplied by the DBE in the Utilization Plan.

As stated above, the Contractor shall not terminate or replace a DBE subcontractor listed in the approved Utilization Plan without prior written consent. This includes, but is not limited to, instances in which the Contractor seeks to perform work originally designated for a DBE subcontractor with its own forces or those of an affiliate, a non-DBE firm, or with another DBE firm. Written consent will be granted only if the Bureau of Small Business Enterprises agrees, for reasons stated in its concurrence document, that the Contractor has good cause to terminate or replace the DBE firm. Before transmitting to the Bureau of Small Business Enterprises any request to terminate and/or substitute a DBE subcontractor, the Contractor shall give notice in writing to the DBE subcontractor, with a copy to the Bureau, of its intent to request to terminate and/or substitute, and the reason for the request. The Contractor shall give the DBE five days to respond to the Contractor's notice. The DBE so notified shall advise the Bureau and the Contractor of the reasons, if any, why it objects to the proposed termination of its subcontract and why the Bureau should not approve the Contractor's action. If required in a particular case as a matter of public necessity, the Bureau may provide a response period shorter than five days.

For purposes of this paragraph, good cause includes the following circumstances:

- (1) The listed DBE subcontractor fails or refuses to execute a written contract;
- (2) The listed DBE subcontractor fails or refuses to perform the work of its subcontract in a way consistent with normal industry standards. Provided, however, that good cause does not exist if the failure or refusal of the DBE subcontractor to perform its work on the subcontract results from the bad faith or discriminatory action of the Contractor;
- (3) The listed DBE subcontractor fails or refuses to meet the Contractor's reasonable, nondiscriminatory bond requirements;
- (4) The listed DBE subcontractor becomes bankrupt, insolvent, or exhibits credit unworthiness;
- (5) The listed DBE subcontractor is ineligible to work on public works projects because of suspension and debarment proceedings pursuant 2 CFR Parts 180, 215 and 1200 or applicable state law.

- (6) The Contractor has determined the listed DBE subcontractor is not a responsible contractor;
- (7) The listed DBE subcontractor voluntarily withdraws from the projects and provides written notice to the Contractor of its withdrawal;
- (8) The listed DBE is ineligible to receive DBE credit for the type of work required;
- (9) A DBE owner dies or becomes disabled with the result that the listed DBE subcontractor is unable to complete its work on the contract;
- (10) Other documented good cause that compels the termination of the DBE subcontractor. Provided, that good cause does not exist if the Contractor seeks to terminate a DBE it relied upon to obtain the contract so that the Contractor can self-perform the work for which the DBE contractor was engaged or so that the Contractor can substitute another DBE or non-DBE contractor after contract award.

When a DBE is terminated or fails to complete its work on the Contract for any reason, the Contractor shall make a good faith effort to find another DBE to substitute for the original DBE to perform at least the same amount of work under the contract as the terminated DBE to the extent needed to meet the established Contract goal. The good faith efforts shall be documented by the Contractor. If the Department requests documentation under this provision, the Contractor shall submit the documentation within seven days, which may be extended for an additional seven days if necessary at the request of the Contractor. The Department will provide a written determination to the Contractor stating whether or not good faith efforts have been demonstrated.

- (f) FINAL PAYMENT. After the performance of the final item of work or delivery of material by a DBE and final payment therefore to the DBE by the Contractor, but not later than 30 calendar days after payment has been made by the Department to the Contractor for such work or material, the Contractor shall submit a DBE Payment Agreement on Department form SBE 2115 to the Resident Engineer. If full and final payment has not been made to the DBE, the DBE Payment Agreement shall indicate whether a disagreement as to the payment required exists between the Contractor and the DBE or if the Contractor believes the work has not been satisfactorily completed. If the Contractor does not have the full amount of work indicated in the Utilization Plan performed by the DBE companies indicated in the Utilization Plan and after good faith efforts are reviewed, the Department may deduct from contract payments to the Contractor the amount of the goal not achieved as liquidated and ascertained damages. The Contractor may request an administrative reconsideration of any amount deducted as damages pursuant to subsection (h) of this part.
- (g) ENFORCEMENT. The Department reserves the right to withhold payment to the Contractor to enforce the provisions of this Special Provision. Final payment shall not be

made on the contract until such time as the Contractor submits sufficient documentation demonstrating achievement of the goal in accordance with this Special Provision or after liquidated damages have been determined and collected.

- (h) RECONSIDERATION. Notwithstanding any other provision of the contract, including but not limited to Article 109.09 of the Standard Specifications, the Contractor may request administrative reconsideration of a decision to deduct the amount of the goal not achieved as liquidated damages. A request to reconsider shall be delivered to the Contract Compliance Section and shall be handled and considered in the same manner as set forth in paragraph (c) of “Good Faith Effort Procedures” of this Special Provision, except a final decision that a good faith effort was not made during contract performance to achieve the goal agreed to in the Utilization Plan shall be the final administrative decision of the Department. The result of the reconsideration process is not administratively appealable to the U.S. Department of Transportation.

80029

HOT-MIX ASPHALT – LONGITUDINAL JOINT SEALANT (BDE)

Effective: November 1, 2022

Add the following after the second sentence in the eighth paragraph of Article 406.06(h)(2) of the Standard Specifications:

“If rain is forecasted and traffic is to be on the LJS or if pickup/tracking of the LJS material is likely, the LJS shall be covered immediately following its application with FA 20 fine aggregate mechanically spread uniformly at a rate of 1.5 ± 0.5 lb/sq yd (0.75 ± 0.25 kg/sq m). Fine aggregate landing outside of the LJS shall be removed prior to application of tack coat.”

Add the following after the first sentence in the ninth paragraph of Article 406.06(h)(2) of the Standard Specifications:

“LJS half-width shall be applied at a width of 9 ± 1 in. (225 ± 25 mm) in the immediate lane to be placed with the outside edge flush with the joint of the next HMA lift. The vertical face of any longitudinal joint remaining in place shall also be coated.”

Add the following after the eleventh paragraph of Article 406.06(h)(2):

“LJS Half-Width Application Rate, lb/ft (kg/m) ^{1/}			
Lift Thickness, in. (mm)	Coarse Graded Mixture (IL-19.0, IL-19.0L, IL-9.5, IL-9.5L, IL-4.75)	Fine Graded Mixture (IL-9.5FG)	SMA Mixture (SMA-9.5, SMA-12.5)
3/4 (19)	0.44 (0.66)		
1 (25)	0.58 (0.86)		
1 1/4 (32)	0.66 (0.98)	0.44 (0.66)	
1 1/2 (38)	0.74 (1.10)	0.48 (0.71)	0.63 (0.94)
1 3/4 (44)	0.82 (1.22)	0.52 (0.77)	0.69 (1.03)
2 (50)	0.90 (1.34)	0.56 (0.83)	0.76 (1.13)
≥ 2 1/4 (60)	0.98 (1.46)		

1/ The application rate includes a surface demand for liquid. The thickness of the LJS may taper from the center of the application to a lesser thickness on the edge of the application, provided the correct width and application rate are maintained.”

Add the following to the end of the second paragraph of Article 406.14 of the Standard Specifications:

“Longitudinal joint sealant (LJS) half-width will be paid for at the contract unit price per foot (meter) for LONGITUDINAL JOINT SEALANT, HALF-WIDTH.”

PERFORMANCE GRADED ASPHALT BINDER (BDE)

Effective: January 1, 2023

Revise Article 1032.05 of the Standard Specifications to read:

“1032.05 Performance Graded Asphalt Binder. These materials will be accepted according to the Bureau of Materials Policy Memorandum, “Performance Graded Asphalt Binder Qualification Procedure.” The Department will maintain a qualified producer list. These materials shall be free from water and shall not foam when heated to any temperature below the actual flash point. Air blown asphalt, recycle engine oil bottoms (ReOB), and polyphosphoric acid (PPA) modification shall not be used.

When requested, producers shall provide the Engineer with viscosity/temperature relationships for the performance graded asphalt binders delivered and incorporated in the work.

- (a) Performance Graded (PG) Asphalt Binder. The asphalt binder shall meet the requirements of AASHTO M 320, Table 1 “Standard Specification for Performance Graded Asphalt Binder” for the grade shown on the plans and the following.

Test	Parameter
Small Strain Parameter (AASHTO PP 113) BBR, ΔT_c , 40 hrs PAV (40 hrs continuous or 2 PAV at 20 hrs)	-5 °C min.

- (b) Modified Performance Graded (PG) Asphalt Binder. The asphalt binder shall meet the requirements of AASHTO M 320, Table 1 “Standard Specification for Performance Graded Asphalt Binder” for the grade shown on the plans.

Asphalt binder modification shall be performed at the source, as defined in the Bureau of Materials Policy Memorandum, “Performance Graded Asphalt Binder Qualification Procedure.”

Modified asphalt binder shall be safe to handle at asphalt binder production and storage temperatures or HMA construction temperatures. Safety Data Sheets (SDS) shall be provided for all asphalt modifiers.

- (1) Polymer Modification (SB/SBS or SBR). Elastomers shall be added to the base asphalt binder to achieve the specified performance grade and shall be either a styrene-butadiene diblock, triblock copolymer without oil extension, or a styrene-butadiene rubber. The polymer modified asphalt binder shall be smooth, homogeneous, and be according to the requirements shown in Table 1 or 2 for the grade shown on the plans.

Table 1 - Requirements for Styrene-Butadiene Copolymer (SB/SBS) Modified Asphalt Binders		
Test	Asphalt Grade SB/SBS PG 64-28 SB/SBS PG 70-22	Asphalt Grade SB/SBS PG 64-34 SB/SBS PG 70-28 SB/SBS PG 76-22 SB/SBS PG 76-28
Separation of Polymer ITP, "Separation of Polymer from Asphalt Binder" Difference in °F (°C) of the softening point between top and bottom portions	4 (2) max.	4 (2) max.
TESTS ON RESIDUE FROM ROLLING THIN FILM OVEN TEST (AASHTO T 240)		
Elastic Recovery ASTM D 6084, Procedure A, 77 °F (25 °C), 100 mm elongation, %	60 min.	70 min.

Table 2 - Requirements for Styrene-Butadiene Rubber (SBR) Modified Asphalt Binders		
Test	Asphalt Grade SBR PG 64-28 SBR PG 70-22	Asphalt Grade SB/SBS PG 64-34 SB/SBS PG 70-28 SBR PG 76-22 SBR PG 76-28
Separation of Polymer ITP, "Separation of Polymer from Asphalt Binder" Difference in °F (°C) of the softening point between top and bottom portions	4 (2) max.	4 (2) max.
Toughness ASTM D 5801, 77 °F (25 °C), 20 in./min. (500 mm/min.), in.-lbs (N-m)	110 (12.5) min.	110 (12.5) min.
Tenacity ASTM D 5801, 77 °F (25 °C), 20 in./min. (500 mm/min.), in.-lbs (N-m)	75 (8.5) min.	75 (8.5) min.
TESTS ON RESIDUE FROM ROLLING THIN FILM OVEN TEST (AASHTO T 240)		
Elastic Recovery ASTM D 6084, Procedure A, 77 °F (25 °C), 100 mm elongation, %	40 min.	50 min.

- (2) Ground Tire Rubber (GTR) Modification. GTR modification is the addition of recycled ground tire rubber to liquid asphalt binder to achieve the specified performance grade. GTR shall be produced from processing automobile and/or truck tires by the ambient

grinding method or micronizing through a cryogenic process. GTR shall not exceed 1/16 in. (2 mm) in any dimension and shall not contain free metal particles, moisture that would cause foaming of the asphalt, or other foreign materials. A mineral powder (such as talc) meeting the requirements of AASHTO M 17 may be added, up to a maximum of four percent by weight of GTR to reduce sticking and caking of the GTR particles. When tested in accordance with Illinois Modified AASHTO T 27 “Standard Method of Test for Sieve Analysis of Fine and Coarse Aggregates” or AASHTO PP 74 “Standard Practice for Determination of Size and Shape of Glass Beads Used in Traffic Markings by Means of Computerized Optical Method”, a 50 g sample of the GTR shall conform to the following gradation requirements.

Sieve Size	Percent Passing
No. 16 (1.18 mm)	100
No. 30 (600 µm)	95 ± 5
No. 50 (300 µm)	> 20

GTR modified asphalt binder shall be tested for rotational viscosity according to AASHTO T 316 using spindle S27. GTR modified asphalt binder shall be tested for original dynamic shear and RTFO dynamic shear according to AASHTO T 315 using a gap of 2 mm.

The GTR modified asphalt binder shall meet the requirements of Table 3.

Table 3 - Requirements for Ground Tire Rubber (GTR) Modified Asphalt Binders		
Test	Asphalt Grade GTR PG 64-28 GTR PG 70-22	Asphalt Grade GTR PG 76-22 GTR PG 76-28 GTR PG 70-28
TESTS ON RESIDUE FROM ROLLING THIN FILM OVEN TEST (AASHTO T 240)		
Elastic Recovery ASTM D 6084, Procedure A, 77 °F (25 °C), 100 mm elongation, %	60 min.	70 min.

- (3) Softener Modification (SM). Softener modification is the addition of organic compounds, such as engineered flux, bio-oil blends, modified vegetable oils, glycol amines, and fatty acid derivatives, to the base asphalt binder to achieve the specified performance grade. Softeners shall be dissolved, dispersed, or reacted in the asphalt binder to enhance its performance and shall remain compatible with the asphalt binder with no separation. Softeners shall not be added to modified PG asphalt binder as defined in Articles 1032.05(b)(1) or 1032.05(b)(2).

An Attenuated Total Reflectance-Fourier Transform Infrared spectrum (ATR-FTIR) shall be collected for both the softening compound as well as the softener modified

asphalt binder at the dose intended for qualification. The ATR-FTIR spectra shall be collected on unaged softener modified binder, 20-hour Pressurized Aging Vessel (PAV) aged softener modified binder, and 40-hour PAV aged softener modified binder. The ATR-FTIR shall be collected in accordance with Illinois Test Procedure 601. The electronic files spectral files (in one of the following extensions or equivalent: *.SPA, *.SPG, *.IRD, *.IFG, *.CSV, *.SP, *.IRS, *.GAML, *. [0-9], *.IGM, *.ABS, *.DRT, *.SBM, *.RAS) shall be submitted to the Central Bureau of Materials.

Softener modified asphalt binders shall meet the requirements in Table 4.

Test	Asphalt Grade	
	SM PG 46-28	SM PG 46-34
	SM PG 52-28	SM PG 52-34
	SM PG 58-22	SM PG 58-28
	SM PG 64-22	
Small Strain Parameter (AASHTO PP 113) BBR, ΔT_c , 40 hrs PAV (40 hrs continuous or 2 PAV at 20 hrs)	-5°C min.	
Large Strain Parameter (Illinois Modified AASHTO T 391) DSR/LAS Fatigue Property, $\Delta G^* _{peak}$, 40 hrs PAV (40 hrs continuous or 2 PAV at 20 hrs)	≥ 54 %	

The following grades may be specified as tack coats.

Asphalt Grade	Use
PG 58-22, PG 58-28, PG 64-22	Tack Coat

Revise Article 1031.06(c)(1) and 1031.06(c)(2) of the Standard Specifications to read:

“(1) RAP/RAS. When RAP is used alone or RAP is used in conjunction with RAS, the percentage of virgin ABR shall not exceed the amounts listed in the following table.

Ndesign	Binder	Surface	Polymer Modified Binder or Surface ^{3/}
30	30	30	10
50	25	15	10
70	15	10	10
90	10	10	10

1/ For Low ESAL HMA shoulder and stabilized subbase, the RAP/RAS ABR shall not exceed 50 percent of the mixture.

- 2/ When RAP/RAS ABR exceeds 20 percent, the high and low virgin asphalt binder grades shall each be reduced by one grade (i.e. 25 percent ABR would require a virgin asphalt binder grade of PG 64-22 to be reduced to a PG 58-28).
- 3/ The maximum ABR percentages for ground tire rubber (GTR) modified mixes shall be equivalent to the percentages specified for SBS/SBR polymer modified mixes.
- (2) FRAP/RAS. When FRAP is used alone or FRAP is used in conjunction with RAS, the percentage of virgin asphalt binder replacement shall not exceed the amounts listed in the following table.

HMA Mixtures - FRAP/RAS Maximum ABR % ^{1/2/}			
Ndesign	Binder	Surface	Polymer Modified Binder or Surface ^{3/}
30	55	45	15
50	45	40	15
70	45	35	15
90	45	35	15
SMA	--	--	25
IL-4.75	--	--	35

- 1/ For Low ESAL HMA shoulder and stabilized subbase, the FRAP/RAS ABR shall not exceed 50 percent of the mixture.
- 2/ When FRAP/RAS ABR exceeds 20 percent for all mixes, the high and low virgin asphalt binder grades shall each be reduced by one grade (i.e. 25 percent ABR would require a virgin asphalt binder grade of PG 64-22 to be reduced to a PG 58-28).
- 3/ The maximum ABR percentages for GTR modified mixes shall be equivalent to the percentages specified for SBS/SBR polymer modified mixes.”

Add the following to the end of Note 2 of Article 1030.03 of the Standard Specifications.

“A dedicated storage tank for the ground tire rubber (GTR) modified asphalt binder shall be provided. This tank shall be capable of providing continuous mechanical mixing throughout and/or recirculation of the asphalt binder to provide a uniform mixture. The tank shall be heated and capable of maintaining the temperature of the asphalt binder at 300 °F to 350 °F (149 °C to 177 °C). The asphalt binder metering systems of dryer drum plants shall be calibrated with the actual GTR modified asphalt binder material with an accuracy of ±0.40 percent.”

RAILROAD PROTECTIVE LIABILITY INSURANCE (BDE)

Effective: December 1, 1986
 Revised: January 1, 2022

Description. Railroad Protective Liability and Property Damage Liability Insurance shall be carried according to Article 107.11 of the Standard Specifications. A separate policy is required for each railroad unless otherwise noted.

NAMED INSURED & ADDRESS	NUMBER & SPEED OF PASSENGER TRAINS	NUMBER & SPEED OF FREIGHT TRAINS
Union Pacific Railroad Central Region 101 N. Wacker Dr., Ste #1910 Chicago, IL 60606-1786	0	35/day 70 mph max
Class 1 RR (Y or N): Y DOT/AAR No.: DOT #175027T RR Division: Great Lakes	RR Mile Post: 55.3	RR Sub-Division: Geneva
For Freight/Passenger Information Contact: Leo Craig - Rail Pros For Insurance Information Contact:	Leo Craig - Leo.Craig@RailPros.com	Phone: 817-901-9560 Phone: 817-901-9560

Class 1 RR (Y or N):
 DOT/AAR No.:
 RR Division:

RR Mile Post:
 RR Sub-Division:

For Freight/Passenger Information Contact: Phone:
 For Insurance Information Contact: Phone:

Basis of Payment. Providing Railroad Protective Liability and Property Damage Liability Insurance will be paid for at the contract unit price per Lump Sum for RAILROAD PROTECTIVE LIABILITY INSURANCE.

3426I

SOURCE OF SUPPLY AND QUALITY REQUIREMENTS (BDE)

Effective: January 2, 2023

Add the following to Article 106.01 of the Standard Specifications:

“The final manufacturing process for construction materials and the immediately preceding manufacturing stage for construction materials shall occur within the United States. Construction materials shall include an article, material, or supply that is or consists primarily of the following.

- (a) Non-ferrous metals;
- (b) Plastic and polymer-based products (including polyvinylchloride, composite building materials, and polymers used in fiber optic cables);
- (c) Glass (including optic glass);
- (d) Lumber;
- (e) Drywall.

Items consisting of two or more of the listed construction materials that have been combined through a manufacturing process, and items including at least one of the listed materials combined with a material that is not listed through a manufacturing process shall be exempt.”

80448

SUBCONTRACTOR AND DBE PAYMENT REPORTING (BDE)

Effective: April 2, 2018

Add the following to Section 109 of the Standard Specifications.

“109.14 Subcontractor and Disadvantaged Business Enterprise Payment Reporting.
The Contractor shall report all payments made to the following parties:

- (a) first tier subcontractors;
- (b) lower tier subcontractors affecting disadvantaged business enterprise (DBE) goal credit;
- (c) material suppliers or trucking firms that are part of the Contractor’s submitted DBE utilization plan.

The report shall be made through the Department’s on-line subcontractor payment reporting system within 21 days of making the payment.”

80397

SUBCONTRACTOR MOBILIZATION PAYMENTS (BDE)

Effective: November 2, 2017

Revised: April 1, 2019

Replace the second paragraph of Article 109.12 of the Standard Specifications with the following:

“This mobilization payment shall be made at least seven days prior to the subcontractor starting work. The amount paid shall be at the following percentage of the amount of the subcontract reported on form BC 260A submitted for the approval of the subcontractor’s work.

Value of Subcontract Reported on Form BC 260A	Mobilization Percentage
Less than \$10,000	25%
\$10,000 to less than \$20,000	20%
\$20,000 to less than \$40,000	18%
\$40,000 to less than \$60,000	16%
\$60,000 to less than \$80,000	14%
\$80,000 to less than \$100,000	12%
\$100,000 to less than \$250,000	10%
\$250,000 to less than \$500,000	9%
\$500,000 to \$750,000	8%
Over \$750,000	7%”

80391

SUBMISSION OF PAYROLL RECORDS (BDE)

Effective: April 1, 2021

Revised: November 1, 2022

FEDERAL AID CONTRACTS. Revise the following section of Check Sheet #1 of the Recurring Special Provisions to read:

“STATEMENTS AND PAYROLLS

The payroll records shall include the worker’s name, the worker’s address, the worker’s telephone number when available, the worker’s social security number, the worker’s classification or classifications, the worker’s gross and net wages paid in each pay period, the worker’s number of hours worked each day, and the worker’s starting and ending times of work each day. However, any Contractor or subcontractor who remits contributions to a fringe benefit fund that is not jointly maintained and jointly governed by one or more employers and one or more labor organization must additionally submit the worker’s hourly wage rate, the worker’s hourly overtime wage rate, the worker’s hourly fringe benefit rates, the name and address of each fringe benefit fund, the plan sponsor of each fringe benefit, if applicable, and the plan administrator of each fringe benefit, if applicable.

The Contractor and each subcontractor shall certify and submit payroll records to the Department each week from the start to the completion of their respective work, except that full social security numbers shall not be included on weekly submittals. Instead, the payrolls shall include an identification number for each employee (e.g., the last four digits of the employee’s social security number). In addition, starting and ending times of work each day may be omitted from the payroll records submitted. The submittals shall be made using LCPTracker Pro software. The software is web-based and can be accessed at <https://lcptracker.com/>. When there has been no activity during a work week, a payroll record shall still be submitted with the appropriate option (“No Work”, “Suspended”, or “Complete”) selected.”

STATE CONTRACTS. Revise Item 3 of Section IV of Check Sheet #5 of the Recurring Special Provisions to read:

- “3. Submission of Payroll Records. The Contractor and each subcontractor shall, no later than the 15th day of each calendar month, file a certified payroll for the immediately preceding month to the Illinois Department of Labor (IDOL) through the Illinois Prevailing Wage Portal in compliance with the State Prevailing Wage Act (820 ILCS 130). The portal can be found on the IDOL website at <https://www2.illinois.gov/idol/Laws-Rules/CONMED/Pages/Prevailing-Wage-Portal.aspx>. Payrolls shall be submitted in the format prescribed by the IDOL.

In addition to filing certified payroll(s) with the IDOL, the Contractor and each subcontractor shall certify and submit payroll records to the Department each week from the start to the completion of their respective work, except that full social security numbers shall not be included on weekly submittals. Instead, the payrolls shall include an

identification number for each employee (e.g., the last four digits of the employee's social security number). In addition, starting and ending times of work each day may be omitted from the payroll records submitted. The submittals shall be made using LCPtracker Pro software. The software is web-based and can be accessed at <https://lcptracker.com/>. When there has been no activity during a work week, a payroll record shall still be submitted with the appropriate option ("No Work", "Suspended", or "Complete") selected."

80437

VEHICLE AND EQUIPMENT WARNING LIGHTS (BDE)

Effective: November 1, 2021

Revised: November 1, 2022

Add the following paragraph after the first paragraph of Article 701.08 of the Standard Specifications:

“The Contractor shall equip all vehicles and equipment with high-intensity oscillating, rotating, or flashing, amber or amber-and-white, warning lights which are visible from all directions. In accordance with 625 ILCS 5/12-215, the lights may only be in operation while the vehicle or equipment is engaged in construction operations.”

80439

WEEKLY DBE TRUCKING REPORTS (BDE)

Effective: June 2, 2012

Revised: November 1, 2021

The Contractor shall submit a weekly report of Disadvantaged Business Enterprise (DBE) trucks hired by the Contractor or subcontractors (i.e. not owned by the Contractor or subcontractors) that are used for DBE goal credit.

The report shall be submitted to the Engineer on Department form "SBE 723" within ten business days following the reporting period. The reporting period shall be Sunday through Saturday for each week reportable trucking activities occur.

Any costs associated with providing weekly DBE trucking reports shall be considered as included in the contract unit prices bid for the various items of work involved and no additional compensation will be allowed.

80302

WORKING DAYS (BDE)

Effective: January 1, 2002

The Contractor shall complete the work within 25 working days.

80071

STATE OF ILLINOIS
DEPARTMENT OF TRANSPORTATION

ROUTE NO.	SECTION	TOTAL SHEETS	SHEET NO.
FAU 5363	21-00008-00-RS	22	1
Contract 87772	TOWN OF CORTLAND	FED. AID PROJ. CR2A(892)	

SURFACE TRANSPORTATION PROGRAM FUNDS
TOWN OF CORTLAND
SECTION 21-00008-00-RS
F.A.U. ROUTE 5363
Somonauk Road
IL Route 38 (FAP 567) to North Avenue
DeKalb County
Project No. CR2A(892)
Job No. C-93-007-22
Contract No. 87772

INDEX OF SHEETS

- 1 Cover Sheet
- 2 Location Map
- 3 Summary of Quantities
- 4 HMA Mixture Table
- 5-10 Schedule of Quantities
- 11-22 Typical Sections

HIGHWAY STANDARDS

701301-04	701502-09
701311-03	701701-10
701501-06	701901-08
	780001-05

FAU 5363 (Somonauk Road)
GROSS LENGTH = 3,104 ft (0.59 mi)
NET LENGTH = 3,066 ft (0.58 mi)



LOCATION OF SECTION INDICATED THIS:



ROAD, FUNCTIONAL CLASS, CURRENT ADT (YEAR), DESIGN ADT (YEAR), SPEED
SOMONAUK ROAD, MINOR ARTERIAL, 4850 (2017), 5911 (2027), 30 MPH

PRINTED BY THE AUTHORITY
OF THE STATE OF ILLINOIS

STATE OF ILLINOIS DEPARTMENT OF TRANSPORTATION	
APPROVED	12/27 20 22
LOCAL PUBLIC AGENCY	
PASSED	JANUARY 5, 20 23
DISTRICT 3 ENGINEER OF LOCAL ROADS & STREETS	
RELEASING FOR BID BASED ON LIMITED REVIEW	JANUARY 5, 20 23
REGION 2 ENGINEER	

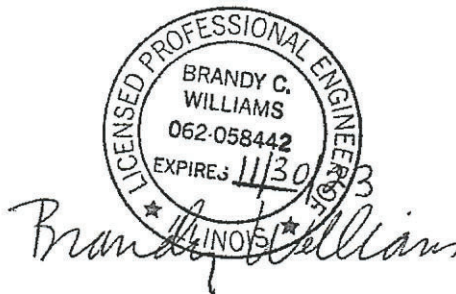

D-2 4-B 4-C 5-A 5-B 5-C 6-A

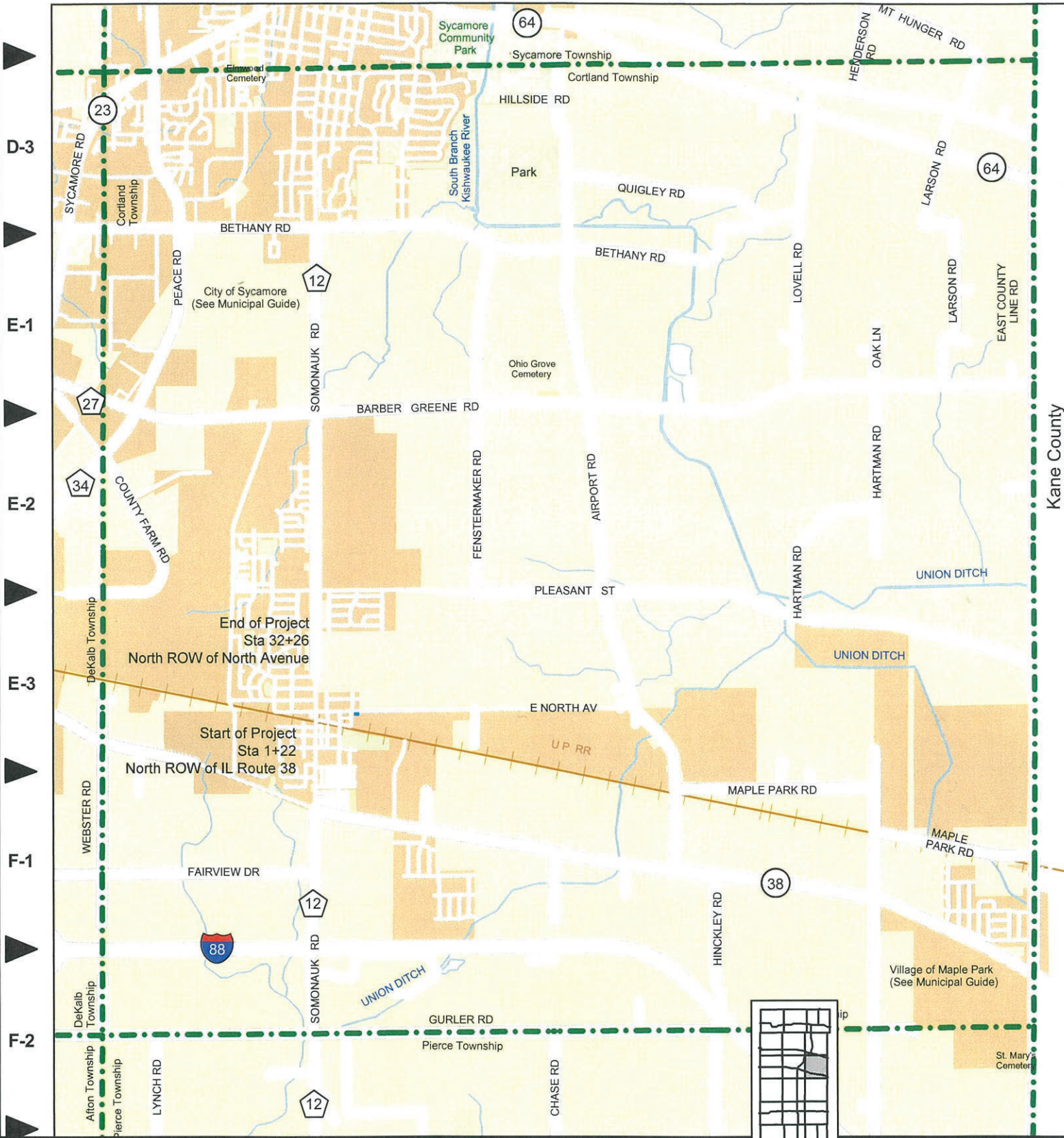

Kane County



DeKalb County Government
 Information Management Office
 110 E Sycamore Street
 Sycamore, IL 60178
 815-895-1643
 view at www.dekalbcounty.org

Cortland Township

Pop. 10,968

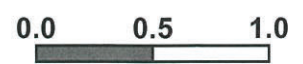

ROUTE NO.	SECTION	TOTAL SHEETS	SHEET NO.
FAU 5363	21-00008-00-RS	22	2
CONTRACT 87772	TOWN OF CORTLAND	FED. AID PROJ. CR2A(892)	

ROUTE NO.	SECTION	TOTAL SHEETS	SHEET NO.
FAU 5363	21-00008-00-RS	22	3
CONTRACT 8772	TOWN OF CORTLAND	FED. AID PROJ. CR2A(892)	

**CONSTRUCTION TYPE CODE 0005
SUMMARY OF QUANTITIES**

Code Number	Item	Unit of Measure	Quantity
40600290	Bituminous Material (Tack Coat)	Pound	14,452
40600370	Longitudinal Joint Sealant	Foot	7,221
40600990	Temporary Ramp	SQ YD	504
40602985	Hot-Mix Asphalt Binder Course, IL-9.5, N70	Ton	1,351
*40604062	Hot-Mix Asphalt Surface Course, IL-9.5, Mix "D", N70	Ton	1,351
*44000161	Hot-Mix Asphalt Surface Removal, 3"	SQ YD	16,057
44201674	Class D Patches, Type III, 2 Inch	SQ YD	115
44201676	Class D Patches, Type IV, 2 Inch	SQ YD	114
*56109210	Water Valves to be Adjusted	Each	9
60255500	Manholes to be Adjusted	Each	10
67100100	Mobilization	L Sum	1
70300100	Short Term Pavement Marking	Foot	2,780
70300150	Short Term Pavement Marking Removal	SQ FT	919
△ 78000100	Thermo Pavement Marking - L & S	SQ FT	347
△ 78000200	Thermo Pavement Marking - Line 4"	Foot	4,397
△ 78000400	Thermo Pavement Marking - Line 6"	Foot	2,012
△ 78000500	Thermo Pavement Marking - Line 8"	Foot	80
△ 78000600	Thermo Pavement Marking - Line 12"	Foot	120
△ 78000650	Thermo Pavement Marking - Line 24"	Foot	409
△ 78011000	Grooving for Recessed Pavement Marking, L & S	SQ FT	365
△ 78011025	Grooving for Recessed Pavement Marking 5"	Foot	4,397
△ 78011035	Grooving for Recessed Pavement Marking 7"	Foot	2,012
△ 78011045	Grooving for Recessed Pavement Marking 9"	Foot	80
△ 78011065	Grooving for Recessed Pavement Marking 13"	Foot	120
△ 78011125	Grooving for Recessed Pavement Marking 25"	Foot	409
△ *X2600020	Delineator System	Each	1
*X6350120	Delineator Removal	Each	1
*X7010216	Traffic Control & Protection (Special)	L Sum	1
Z0048665	Railroad Protective Liability Insurance	L Sum	1

△ SPECIALTY ITEMS

* Has Special Provision

Quantities are estimates prepared for the establishment of pay item prices and are the responsibility of the contractor to confirm prior to bidding. Quantities may be increased, decreased, or omitted to satisfactorily complete the project.

ROUTE NO.	SECTION	TOTAL SHEETS	SHEET NO.
FAU 5363	21-00008-00-RS	22	4
CONTRACT 8772	TOWN OF CORTLAND	FED. AID PROJ. CR2A(892)	

HMA MIXTURE REQUIREMENT TABLE

LOCATION	ENTIRE PROJECT	ENTIRE PROJECT	ENTIRE PROJECT
MIXTURE USE	HMA BINDER	HMA SURFACE	HMA CLASS D PATCH (2")
PG	PG 64-22	PG 64-22	PG 64-22
DESIGN AIR VOIDS	4.0% @ N70	4.0% @ N70	4.0% @ N70
MIXTURE COMPOSITION	IL-9.5	IL-9.5	IL-9.5
FRICTION AGGREGATE		MIXTURE D	
MIXTURE WEIGHT	112.0 LB/SY/IN	112.0 LB/SY/IN	112.0 LB/SY/IN
QUALITY MANAGEMENT PROGRAM	QCQA	QCQA	QCQA
SUBLOT SIZE	N/A	N/A	N/A
DENSITY VERIF. METHOD	CORES	CORES	CORES
MATERIAL TRANSFER DEVICE (REQUIRED?)	NO	NO	NO

APPLICATION RATES:

Bituminous Materials (Tack Coat)

Type of Surface to be Primed	Residual Asphalt Rate lb/sq ft (kg/sq m)
Milled HMA, Aged Non-Milled HMA, Milled Concrete, Non-Milled Concrete & Tined Concrete	0.05 (0.244)
Fog Coat between HMA Lifts, IL-4.75 & Brick	0.025 (0.122)

SHORT TERM PAVEMENT MARKING

4 ft. in length and a minimum of 4 in. wide at a maximum spacing of 40 ft between stripes

UNION PACIFIC RAILROAD REPRESENTATIVE

Leo Craig
817-901-9560
Leo.Craig@RailPros.com

ROUTE NO.	SECTION	TOTAL SHEETS	SHEET NO.
FAU 5363	21-00008-00-RS	22	5
Contract 87772	TOWN OF CORTLAND	FED. AID PROJ. CR2A(892)	

CONSTRUCTION TYPE CODE 0005

SCHEDULE OF QUANTITIES

(BREAKDOWN OF QUANTITIES PER SECTION OF ROAD)

Town of Cortland
FAU 5363
Section 21-00008-00-RS

Location	From	To
Somonauk Road	IL Route 38 joint	West Benson Avenue

Hot Mix Material	Asphalt Thickness	Length	Width	Area
HMA BC and SC, IL-9.5, N70	3 in	909 ft	40 - 50 ft	4,777 sq yd

Code Number	Item	UOM	Quantity
40600290	Bituminous Material (Tack Coat)	Lb	4300
40600370	Longitudinal Joint Sealant	Ft	2817
40600990	Temporary Ramp	SY	110
40602985	Hot-Mix Asphalt Binder Course, IL-9.5, N70	Ton	402
40604062	Hot-Mix Asphalt Surface Course, IL-9.5, Mix "D", N70	Ton	402
44000161	Hot-Mix Asphalt Surface Removal, 3"	SY	4777
44201674	Class D Patches, Type III, 2 Inch	SY	32
44201676	Class D Patches, Type IV, 2 Inch	SY	76
56109210	Water Valves to be Adjusted	Each	0
60255500	Manholes to be Adjusted	Each	0
70300100	Short Term Pavement Marking	Ft	2424
70300150	Short Term Pavement Marking Removal	SF	800
78000100	Thermo Pavement Marking - L & S	SF	219
78000200	Thermo Pavement Marking - Line 4"	Foot	2424
78000400	Thermo Pavement Marking - Line 6"	Foot	290
78000500	Thermo Pavement Marking - Line 8"	Foot	0
78000600	Thermo Pavement Marking - Line 12"	Foot	0
78000650	Thermo Pavement Marking - Line 24"	Foot	41
78011000	Grooving for Recessed Pavement Marking, L & S	SF	230
78011025	Grooving for Recessed Pavement Marking 5"	Foot	2424
78011035	Grooving for Recessed Pavement Marking 7"	Foot	290
78011045	Grooving for Recessed Pavement Marking 9"	Foot	0
78011065	Grooving for Recessed Pavement Marking 13"	Foot	0
78011125	Grooving for Recessed Pavement Marking 25"	Foot	41

Quantities are estimates prepared for the establishment of pay item prices and are the responsibility of the contractor to confirm prior to bidding. Quantities may be increased, decreased, or omitted to satisfactorily complete the project.

ROUTE NO.	SECTION	TOTAL SHEETS	SHEET NO.
FAU 5363	21-00008-00-RS	22	6
Contract 87772	TOWN OF CORTLAND	FED. AID PROJ. CR2A(892)	

CONSTRUCTION TYPE CODE 0005

SCHEDULE OF QUANTITIES

(BREAKDOWN OF QUANTITIES PER SECTION OF ROAD)

Town of Cortland
FAU 5363
Section 21-00008-00-RS

<u>Location</u>	<u>From</u>	<u>To</u>
Somonauk Road	West Benson Aveue	East South Avenue

<u>Hot Mix Material</u>	<u>Asphalt Thickness</u>	<u>Length</u>	<u>Width</u>	<u>Area</u>
HMA BC and SC, IL-9.5, N70	3 in	303 ft	27 - 40 ft	1,510 sq yd

Code Number	Item	UOM	Quantity
40600290	Bituminous Material (Tack Coat)	Lb	1359
40600370	Longitudinal Joint Sealant	Ft	535
40600990	Temporary Ramp	SY	37
40602985	Hot-Mix Asphalt Binder Course, IL-9.5, N70	Ton	127
40604062	Hot-Mix Asphalt Surface Course, IL-9.5, Mix "D", N70	Ton	127
44000161	Hot-Mix Asphalt Surface Removal, 3"	SY	1510
44201674	Class D Patches, Type III, 2 Inch	SY	38
44201676	Class D Patches, Type IV, 2 Inch	SY	38
56109210	Water Valves to be Adjusted	Each	0
60255500	Manholes to be Adjusted	Each	1
70300100	Short Term Pavement Marking	Ft	55
70300150	Short Term Pavement Marking Removal	SF	19
78000100	Thermo Pavement Marking - L & S	SF	0
78000200	Thermo Pavement Marking - Line 4"	Foot	1320
78000400	Thermo Pavement Marking - Line 6"	Foot	106
78000500	Thermo Pavement Marking - Line 8"	Foot	0
78000600	Thermo Pavement Marking - Line 12"	Foot	0
78000650	Thermo Pavement Marking - Line 24"	Foot	83
78011000	Grooving for Recessed Pavement Marking, L & S	SF	0
78011025	Grooving for Recessed Pavement Marking 5"	Foot	1320
78011035	Grooving for Recessed Pavement Marking 7"	Foot	106
78011045	Grooving for Recessed Pavement Marking 9"	Foot	0
78011065	Grooving for Recessed Pavement Marking 13"	Foot	0
78011125	Grooving for Recessed Pavement Marking 25"	Foot	83

Quantities are estimates prepared for the establishment of pay item prices and are the responsibility of the contractor to confirm prior to bidding. Quantities may be increased, decreased, or omitted to satisfactorily complete the project.

ROUTE NO.	SECTION	TOTAL SHEETS	SHEET NO.
FAU 5363	21-00008-00-RS	22	7
Contract 87772	TOWN OF CORTLAND	FED. AID PROJ. CR2A(892)	

CONSTRUCTION TYPE CODE 0005

SCHEDULE OF QUANTITIES

(BREAKDOWN OF QUANTITIES PER SECTION OF ROAD)

Town of Cortland
FAU 5363
Section 21-00008-00-RS

<u>Location</u>	<u>From</u>	<u>To</u>
Somonauk Road	East South Avenue	Chestnut Avenue

<u>Hot Mix Material</u>	<u>Asphalt Thickness</u>	<u>Length</u>	<u>Width</u>	<u>Area</u>
HMA BC and SC, IL-9.5, N70	3 in	1,049 ft	42 ft	5,663 sq yd

Code Number	Item	UOM	Quantity
40600290	Bituminous Material (Tack Coat)	Lb	5097
40600370	Longitudinal Joint Sealant	Ft	2599
40600990	Temporary Ramp	SY	101
40602985	Hot-Mix Asphalt Binder Course, IL-9.5, N70	Ton	476
40604062	Hot-Mix Asphalt Surface Course, IL-9.5, Mix "D", N70	Ton	476
44000161	Hot-Mix Asphalt Surface Removal, 3"	SY	5663
44201674	Class D Patches, Type III, 2 Inch	SY	15
44201676	Class D Patches, Type IV, 2 Inch	SY	0
56109210	Water Valves to be Adjusted	Each	4
60255500	Manholes to be Adjusted	Each	4
70300100	Short Term Pavement Marking	Ft	175
70300150	Short Term Pavement Marking Removal	SF	58
78000100	Thermo Pavement Marking - L & S	SF	0
78000200	Thermo Pavement Marking - Line 4"	Foot	303
78000400	Thermo Pavement Marking - Line 6"	Foot	686
78000500	Thermo Pavement Marking - Line 8"	Foot	0
78000600	Thermo Pavement Marking - Line 12"	Foot	0
78000650	Thermo Pavement Marking - Line 24"	Foot	93
78011000	Grooving for Recessed Pavement Marking, L & S	SF	0
78011025	Grooving for Recessed Pavement Marking 5"	Foot	303
78011035	Grooving for Recessed Pavement Marking 7"	Foot	686
78011045	Grooving for Recessed Pavement Marking 9"	Foot	0
78011065	Grooving for Recessed Pavement Marking 13"	Foot	0
78011125	Grooving for Recessed Pavement Marking 25"	Foot	93

Quantities are estimates prepared for the establishment of pay item prices and are the responsibility of the contractor to confirm prior to bidding. Quantities may be increased, decreased, or omitted to satisfactorily complete the project.

ROUTE NO.	SECTION	TOTAL SHEETS	SHEET NO.
FAU 5363	21-00008-00-RS	22	8
Contract 87772	TOWN OF CORTLAND	FED. AID PROJ. CR2A(892)	

CONSTRUCTION TYPE CODE 0005

SCHEDULE OF QUANTITIES

(BREAKDOWN OF QUANTITIES PER SECTION OF ROAD)

Town of Cortland
FAU 5363
Section 21-00008-00-RS

Location	From	To
Somonauk Road	Chestnut Avenue	Elm Avenue

Hot Mix Material	Asphalt Thickness	Length	Width	Area
HMA BC and SC, IL-9.5, N70	3 in	273 ft	35 ft	1,367 sq yd

Code Number	Item	UOM	Quantity
40600290	Bituminous Material (Tack Coat)	Lb	1230
40600370	Longitudinal Joint Sealant	Ft	477
40600990	Temporary Ramp	SY	53
40602985	Hot-Mix Asphalt Binder Course, IL-9.5, N70	Ton	115
40604062	Hot-Mix Asphalt Surface Course, IL-9.5, Mix "D", N70	Ton	115
44000161	Hot-Mix Asphalt Surface Removal, 3"	SY	1367
44201674	Class D Patches, Type III, 2 Inch	SY	0
44201676	Class D Patches, Type IV, 2 Inch	SY	0
56109210	Water Valves to be Adjusted	Each	1
60255500	Manholes to be Adjusted	Each	1
70300100	Short Term Pavement Marking	Ft	46
70300150	Short Term Pavement Marking Removal	SF	15
78000100	Thermo Pavement Marking - L & S	SF	4
78000200	Thermo Pavement Marking - Line 4"	Foot	62
78000400	Thermo Pavement Marking - Line 6"	Foot	344
78000500	Thermo Pavement Marking - Line 8"	Foot	0
78000600	Thermo Pavement Marking - Line 12"	Foot	0
78000650	Thermo Pavement Marking - Line 24"	Foot	47
78011000	Grooving for Recessed Pavement Marking, L & S	SF	5
78011025	Grooving for Recessed Pavement Marking 5"	Foot	62
78011035	Grooving for Recessed Pavement Marking 7"	Foot	344
78011045	Grooving for Recessed Pavement Marking 9"	Foot	0
78011065	Grooving for Recessed Pavement Marking 13"	Foot	0
78011125	Grooving for Recessed Pavement Marking 25"	Foot	47

Quantities are estimates prepared for the establishment of pay item prices and are the responsibility of the contractor to confirm prior to bidding. Quantities may be increased, decreased, or omitted to satisfactorily complete the project.

ROUTE NO.	SECTION	TOTAL SHEETS	SHEET NO.
FAU 5363	21-00008-00-RS	22	9
Contract 87772	TOWN OF CORTLAND	FED. AID PROJ. CR2A(892)	

CONSTRUCTION TYPE CODE 0005

SCHEDULE OF QUANTITIES

(BREAKDOWN OF QUANTITIES PER SECTION OF ROAD)

Town of Cortland
FAU 5363
Section 21-00008-00-RS

Location	From	To
Somonauk Road	Elm Avenue	South RR Omission

Hot Mix Material	Asphalt Thickness	Length	Width	Area
HMA BC and SC, IL-9.5, N70	3 in	168 ft	27 ft	612 sq yd

Code Number	Item	UOM	Quantity
40600290	Bituminous Material (Tack Coat)	Lb	551
40600370	Longitudinal Joint Sealant	Ft	168
40600990	Temporary Ramp	SY	50
40602985	Hot-Mix Asphalt Binder Course, IL-9.5, N70	Ton	52
40604062	Hot-Mix Asphalt Surface Course, IL-9.5, Mix "D", N70	Ton	52
44000161	Hot-Mix Asphalt Surface Removal, 3"	SY	612
44201674	Class D Patches, Type III, 2 Inch	SY	0
44201676	Class D Patches, Type IV, 2 Inch	SY	0
56109210	Water Valves to be Adjusted	Each	0
60255500	Manholes to be Adjusted	Each	0
70300100	Short Term Pavement Marking	Ft	28
70300150	Short Term Pavement Marking Removal	SF	10
78000100	Thermo Pavement Marking - L & S	SF	62
78000200	Thermo Pavement Marking - Line 4"	Foot	213
78000400	Thermo Pavement Marking - Line 6"	Foot	50
78000500	Thermo Pavement Marking - Line 8"	Foot	0
78000600	Thermo Pavement Marking - Line 12"	Foot	0
78000650	Thermo Pavement Marking - Line 24"	Foot	45
78011000	Grooving for Recessed Pavement Marking, L & S	SF	65
78011025	Grooving for Recessed Pavement Marking 5"	Foot	213
78011035	Grooving for Recessed Pavement Marking 7"	Foot	50
78011045	Grooving for Recessed Pavement Marking 9"	Foot	0
78011065	Grooving for Recessed Pavement Marking 13"	Foot	0
78011125	Grooving for Recessed Pavement Marking 25"	Foot	45

Quantities are estimates prepared for the establishment of pay item prices and are the responsibility of the contractor to confirm prior to bidding. Quantities may be increased, decreased, or omitted to satisfactorily complete the project.

ROUTE NO.	SECTION	TOTAL SHEETS	SHEET NO.
FAU 5363	21-00008-00-RS	22	10
Contract 87772	TOWN OF CORTLAND	FED. AID PROJ. CR2A(892)	

CONSTRUCTION TYPE CODE 0005

SCHEDULE OF QUANTITIES

(BREAKDOWN OF QUANTITIES PER SECTION OF ROAD)

Town of Cortland
FAU 5363
Section 21-00008-00-RS

Location	From	To
Somonauk Road	North RR Omission	North Avenue

Hot Mix Material	Asphalt Thickness	Length	Width	Area
HMA BC and SC, IL-9.5, N70	3 in	307 ft	35 ft	2,128 sq yd

Code Number	Item	UOM	Quantity
40600290	Bituminous Material (Tack Coat)	Lb	1915
40600370	Longitudinal Joint Sealant	Ft	625
40600990	Temporary Ramp	SY	153
40602985	Hot-Mix Asphalt Binder Course, IL-9.5, N70	Ton	179
40604062	Hot-Mix Asphalt Surface Course, IL-9.5, Mix "D", N70	Ton	179
44000161	Hot-Mix Asphalt Surface Removal, 3"	SY	2128
44201674	Class D Patches, Type III, 2 Inch	SY	30
44201676	Class D Patches, Type IV, 2 Inch	SY	0
56109210	Water Valves to be Adjusted	Each	4
60255500	Manholes to be Adjusted	Each	4
70300100	Short Term Pavement Marking	Ft	52
70300150	Short Term Pavement Marking Removal	SF	17
78000100	Thermo Pavement Marking - L & S	SF	62
78000200	Thermo Pavement Marking - Line 4"	Foot	75
78000400	Thermo Pavement Marking - Line 6"	Foot	536
78000500	Thermo Pavement Marking - Line 8"	Foot	80
78000600	Thermo Pavement Marking - Line 12"	Foot	120
78000650	Thermo Pavement Marking - Line 24"	Foot	100
78011000	Grooving for Recessed Pavement Marking, L & S	SF	65
78011025	Grooving for Recessed Pavement Marking 5"	Foot	75
78011035	Grooving for Recessed Pavement Marking 7"	Foot	536
78011045	Grooving for Recessed Pavement Marking 9"	Foot	80
78011065	Grooving for Recessed Pavement Marking 13"	Foot	120
78011125	Grooving for Recessed Pavement Marking 25"	Foot	100

Quantities are estimates prepared for the establishment of pay item prices and are the responsibility of the contractor to confirm prior to bidding. Quantities may be increased, decreased, or omitted to satisfactorily complete the project.

EXISTING TYPICAL SECTION

SOMONAUK ROAD

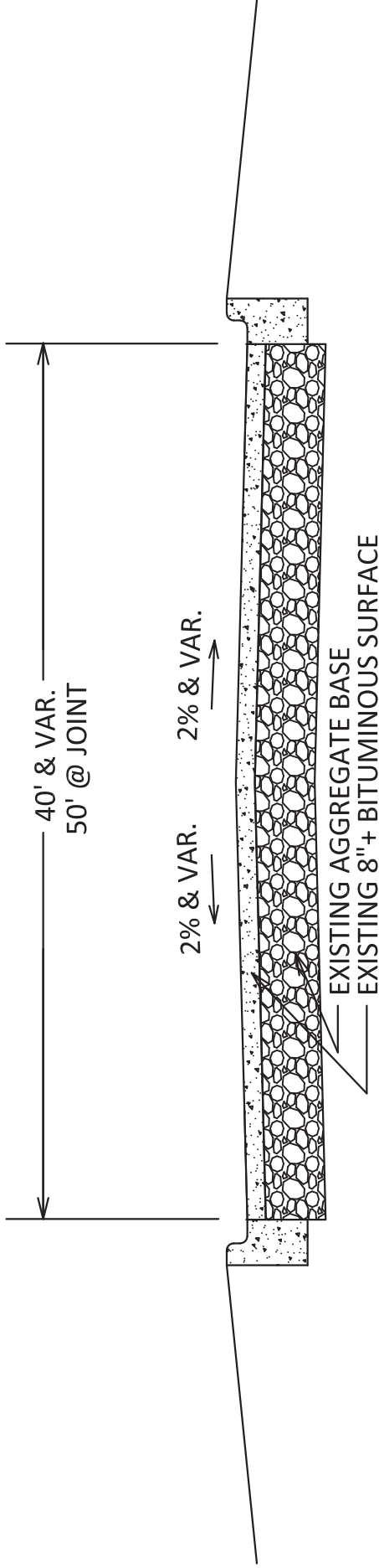

SECTION 21-00008-00-RS

STATION 1+22 TO STATION 10+31
(ROUTE 38 JOINT TO WEST BENSON AVENUE)

ROUTE NO.	SECTION	TOTAL SHEETS	SHEET NO.
FAU 5363	21-00008-00-RS	22	11
Contract 87772	TOWN OF CORTLAND	FED. AID PROJ. CR2A(892)	

EXISTING TYPICAL SECTION

SOMONAUK ROAD

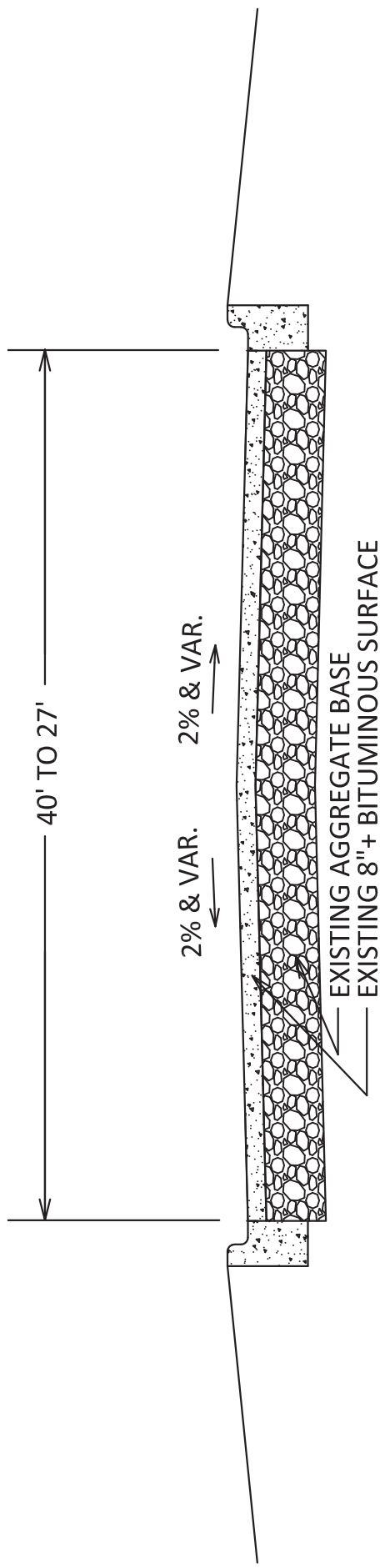

SECTION 21-00008-00-RS

STATION 10+31 TO STATION 13+61
(WEST BENSON AVENUE TO EAST SOUTH AVENUE)

ROUTE NO.	SECTION	TOTAL SHEETS	SHEET NO.
FAU 5363	21-00008-00-RS	22	12
Contract 87772	TOWN OF CORTLAND	FED. AID PROJ. CR2A(892)	

EXISTING TYPICAL SECTION

SOMONAUK ROAD

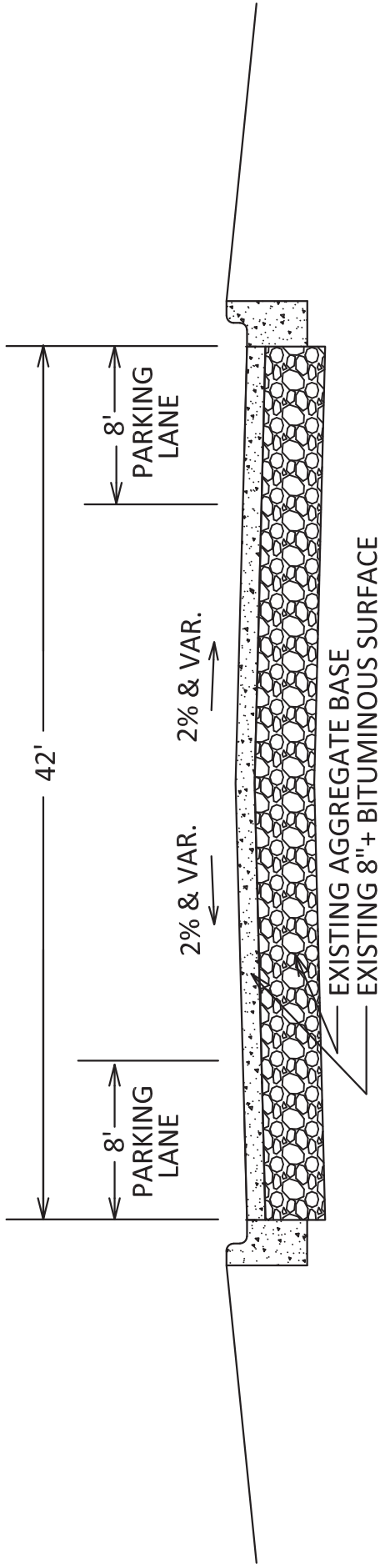

SECTION 21-00008-00-RS

STATION 13+61 TO STATION 24+10
(EAST SOUTH AVENUE TO CHESTNUT AVENUE)

ROUTE NO.	SECTION	TOTAL SHEETS	SHEET NO.
FAU 5363	21-00008-00-RS	22	13
Contract 87772	TOWN OF CORTLAND	FED. AID PROJ. CR2A(892)	

EXISTING TYPICAL SECTION

SOMONAUK ROAD

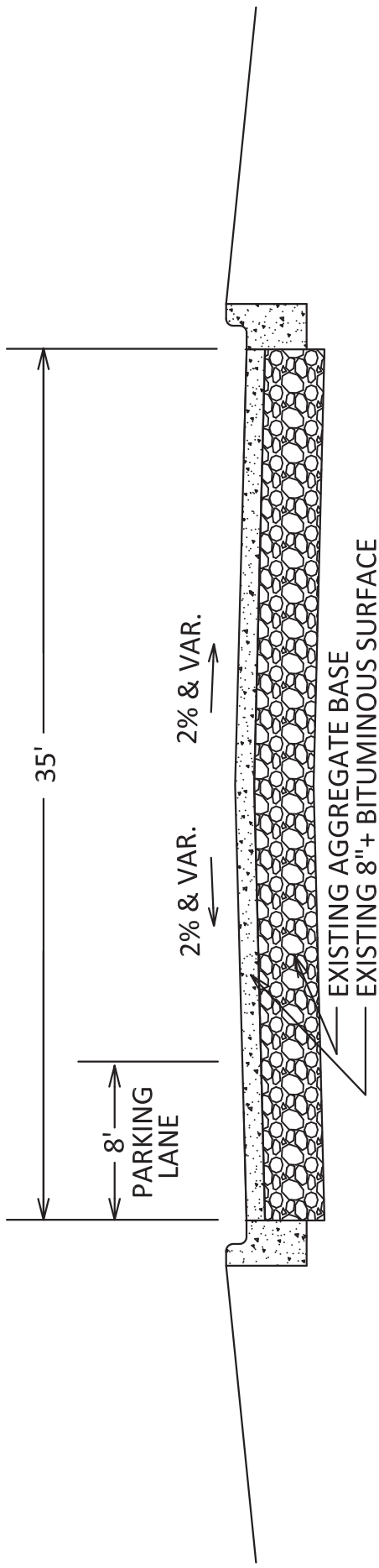

SECTION 21-00008-00-RS

STATION 24+10 TO STATION 26+83
(CHESTNUT AVENUE TO WEST ELM AVENUE)

ROUTE NO.	SECTION	TOTAL SHEETS	SHEET NO.
FAU 5363	21-00008-00-RS	22.	14
Contract 87772	TOWN OF CORTLAND	FED. AID PROJ. CR2A(892)	

EXISTING TYPICAL SECTION

SOMONAUK ROAD

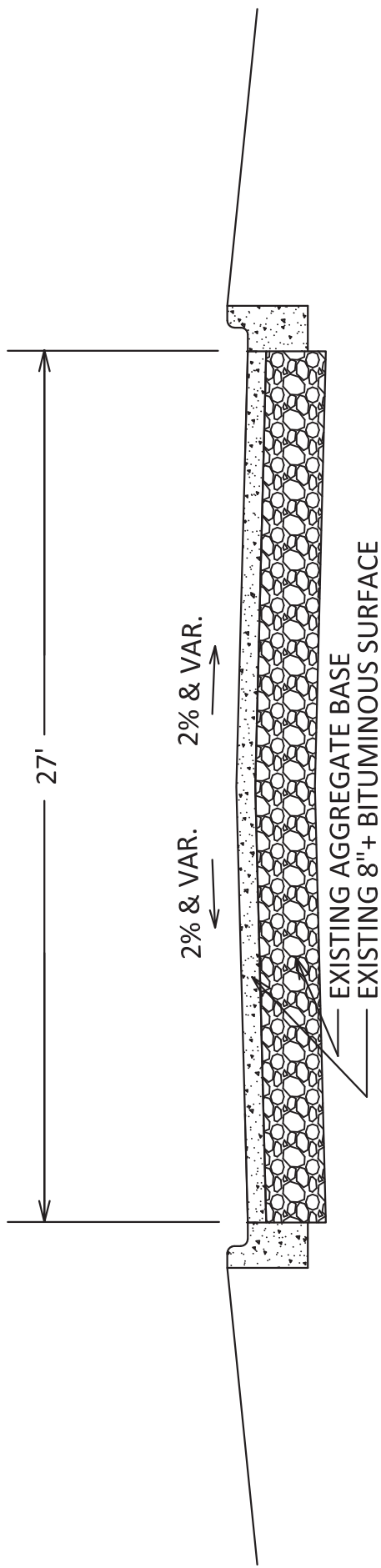

SECTION 21-00008-00-RS

STATION 26+83 TO STATION 28+51
(WEST ELM AVENUE TO SOUTH RAILROAD OMISSION)

ROUTE NO.	SECTION	TOTAL SHEETS	SHEET NO.
FAU 5363	21-00008-00-RS	22	15
Contract 87772	TOWN OF CORTLAND	FED. AID PROJ. CR2A(892)	

EXISTING TYPICAL SECTION

SOMONAUK ROAD

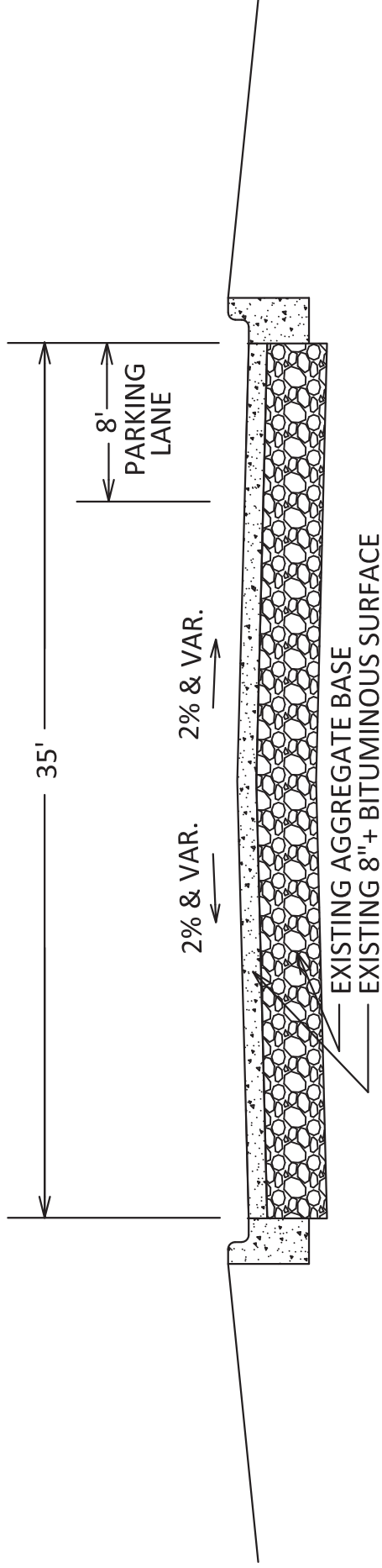

SECTION 21-00008-00-RS

STATION 28+89 TO STATION 31+96
(NORTH RAILROAD OMISSION TO NORTH AVENUE)

ROUTE NO.	SECTION	TOTAL SHEETS	SHEET NO.
FAU 5363	21-00008-00-RS	22	16
Contract 87772	TOWN OF CORTLAND	FED. AID PROJ. CR2A(892)	

PROPOSED TYPICAL SECTION

SOMONAUK ROAD

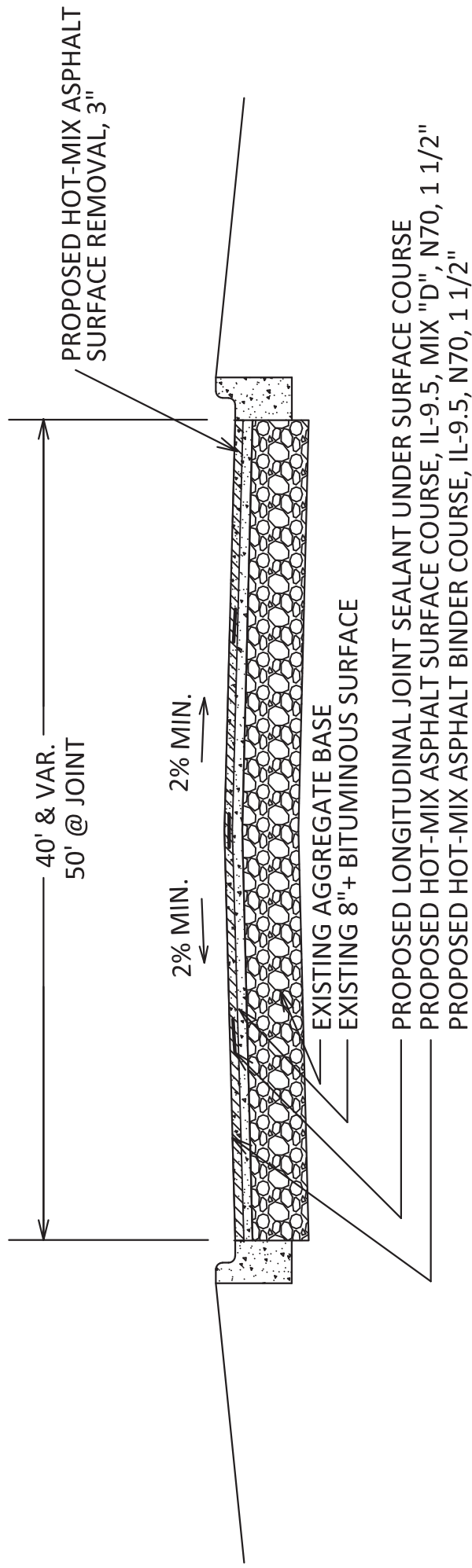

SECTION 21-00008-00-RS

STATION 1+22 TO STATION 10+31
(ROUTE 38 JOINT TO WEST BENSON AVENUE)

ROUTE NO.	SECTION	TOTAL SHEETS	SHEET NO.
FAU 5363	21-00008-00-RS	22	17
Contract 87772	TOWN OF CORTLAND	FED. AID PROJ. CR2A(892)	

PROPOSED TYPICAL SECTION

SOMONAUK ROAD

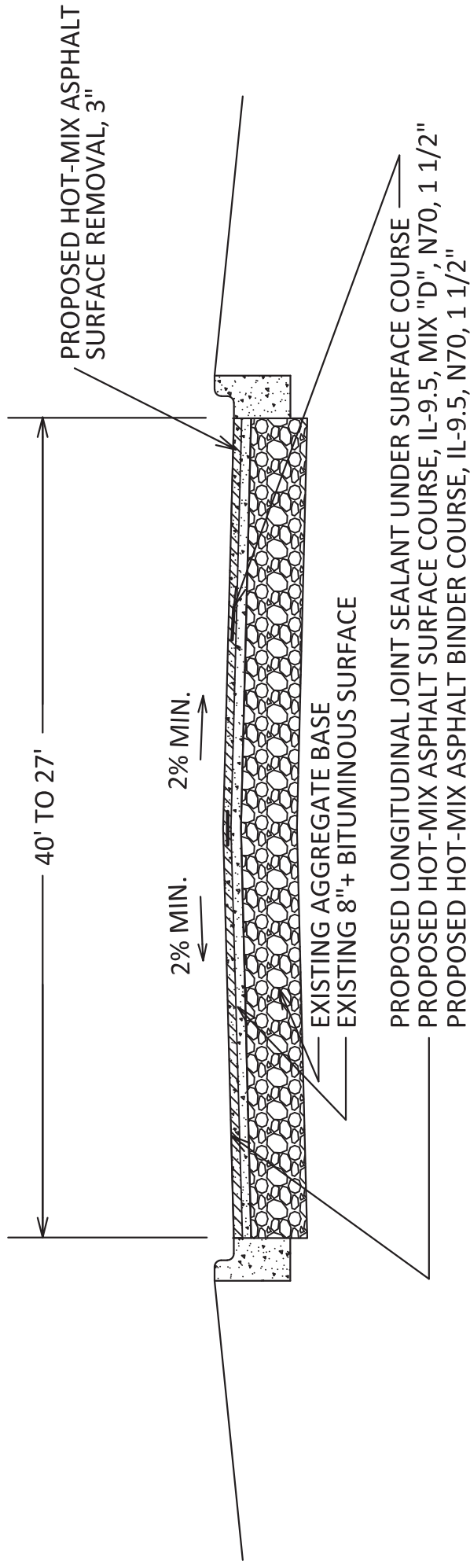

SECTION 21-00008-00-RS

STATION 10+31 TO STATION 13+61
(WEST BENSON AVENUE TO EAST SOUTH AVENUE)

ROUTE NO.	SECTION	TOTAL SHEETS	SHEET NO.
FAU 5363	21-00008-00-RS	22	18
Contract 87772	TOWN OF CORTLAND	FED. AID PROJ. CR2A(892)	

PROPOSED TYPICAL SECTION

SOMONAUK ROAD

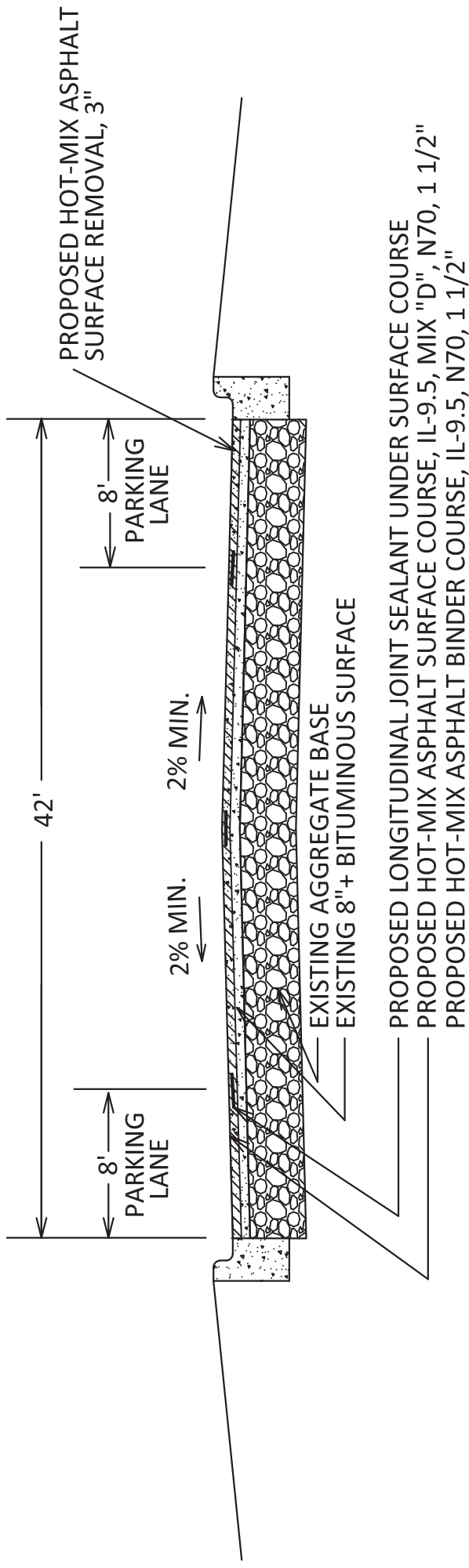

SECTION 21-00008-00-RS

STATION 13+61 TO STATION 24+10
(EAST SOUTH AVENUE TO CHESTNUT AVENUE)

ROUTE NO.	SECTION	TOTAL SHEETS	SHEET NO.
FAU 5363	21-00008-00-RS	22	19
Contract 87772	TOWN OF CORTLAND	FED. AID PROJ. CR2A(892)	

PROPOSED TYPICAL SECTION

SOMONAUK ROAD

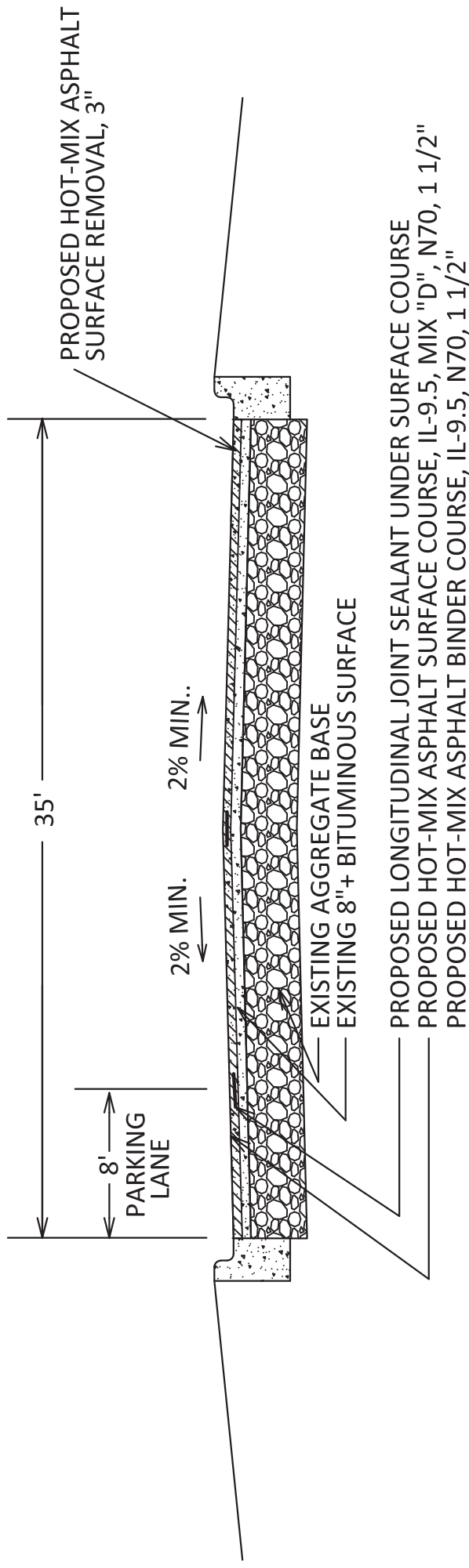

SECTION 21-00008-00-RS

STATION 24+10 TO STATION 26+83
(CHESTNUT AVENUE TO WEST ELM AVENUE)

ROUTE NO.	SECTION	TOTAL SHEETS	SHEET NO.
FAU 5363	21-00008-00-RS	22	20
Contract 87772	TOWN OF CORTLAND	FED. AID PROJ. CR2A(892)	

PROPOSED TYPICAL SECTION

SOMONAUK ROAD

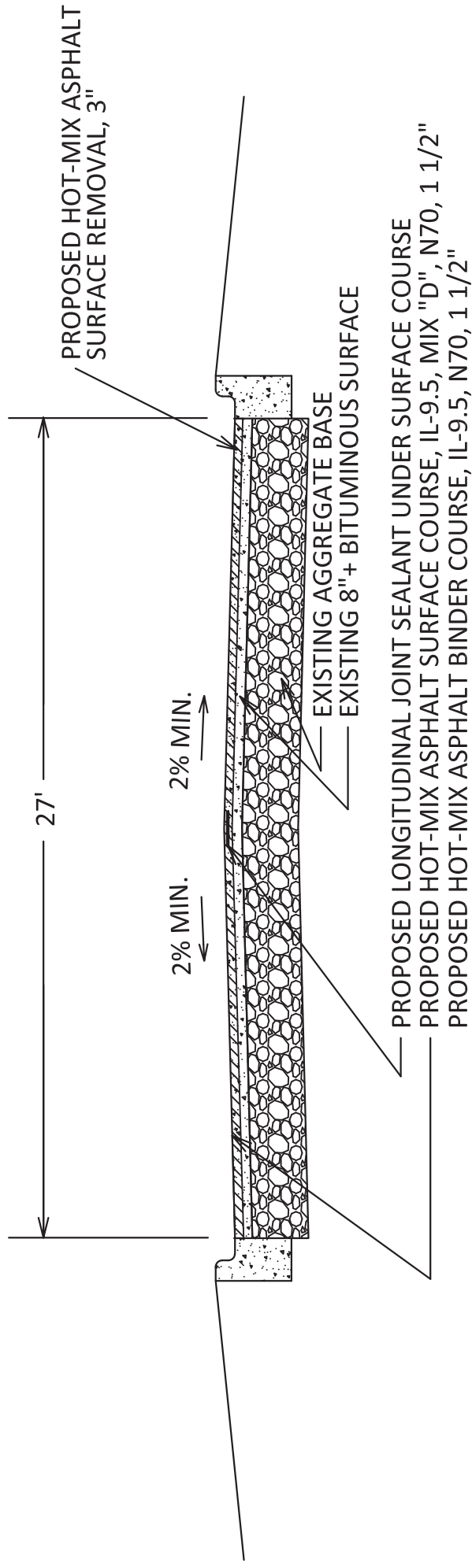

SECTION 21-00008-00-RS

STATION 26+83 TO STATION 28+51
(WEST ELM AVENUE TO SOUTH RAILROAD OMISSION)

ROUTE NO.	SECTION	TOTAL SHEETS	SHEET NO.
FAU 5363	21-00008-00-RS	22	21
Contract 87772	TOWN OF CORTLAND	FED. AID PROJ. CR2A(892)	

PROPOSED TYPICAL SECTION

SOMONAUK ROAD

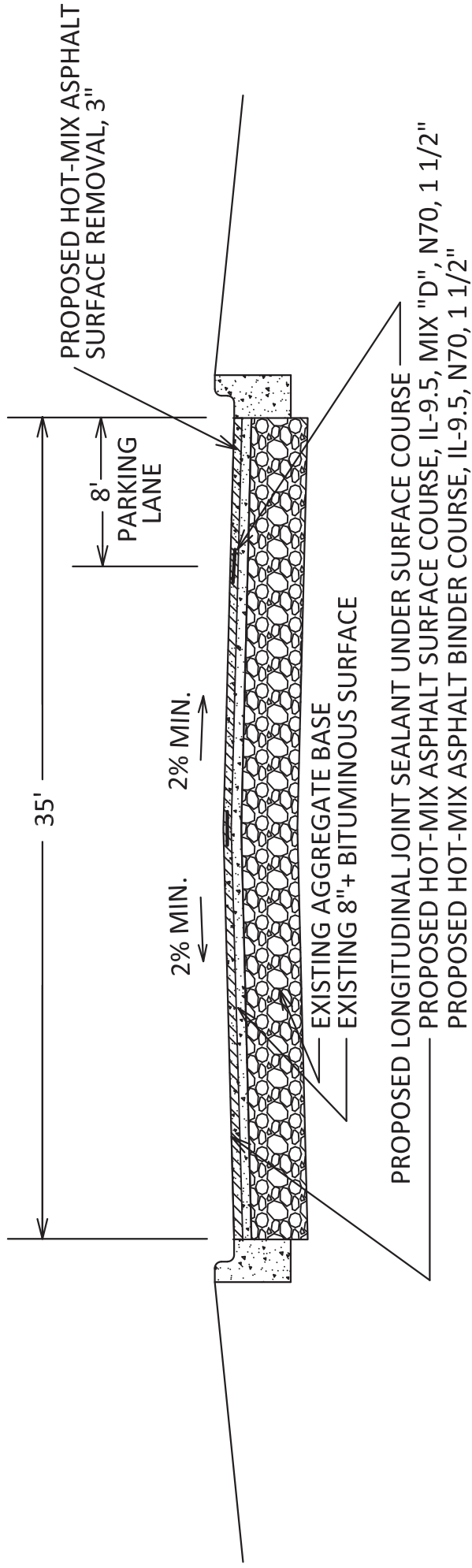

SECTION 21-00008-00-RS

STATION 28+89 TO STATION 31+96
(NORTH RAILROAD OMISSION TO NORTH AVENUE)

ROUTE NO.	SECTION	TOTAL SHEETS	SHEET NO.
FAU 5363	21-00008-00-RS	22	22
Contract 87772	TOWN OF CORTLAND	FED. AID PROJ. CR2A(892)	

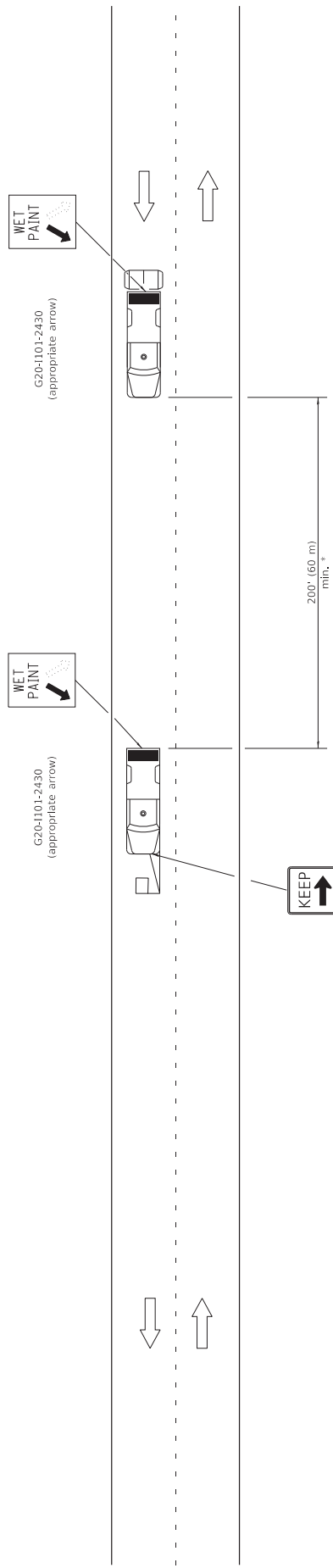

* Distance varies depending on terrain and susceptibility of pavement marking or crack sealant to wheel tracking.

TYPICAL APPLICATIONS

- Landscape work
- Utility work
- Pavement marking
- Weed spraying
- Roadmeter measurements
- Debris cleanup
- Crack pouring

SYMBOLS

- Arrow board (Hazard Mode only)
- Truck with headlights, emergency flashers and flashing amber light, (visible from all directions)
- 18x18 (450x450) min., orange flag (use when guide wheel is used)
- Truck mounted attenuator

GENERAL NOTES

This Standard is used where any vehicle, equipment, workers or their activities will require a continuous moving operation where the average speed is greater than 3 mph (5 km/h).

For shoulder operations not encroaching on the pavement, use DETAIL A, Standard 701426. All dimensions are in inches (millimeters) unless otherwise shown.

DATE	REVISIONS
1-1-09	Switched units to English (metric). Omitted Pass With Care sign.
1-1-00	Elim. speed restrictions in Standard title.

LANE CLOSURE 2L, 2W MOVING OPERATIONS- DAY ONLY

STANDARD 701311-03

Illinois Department of Transportation
 PASSED January 1, 2009
 ENGINEER OF OPERATIONS
 APPROVED January 1, 2009
 ENGINEER OF DESIGN AND ENVIRONMENT

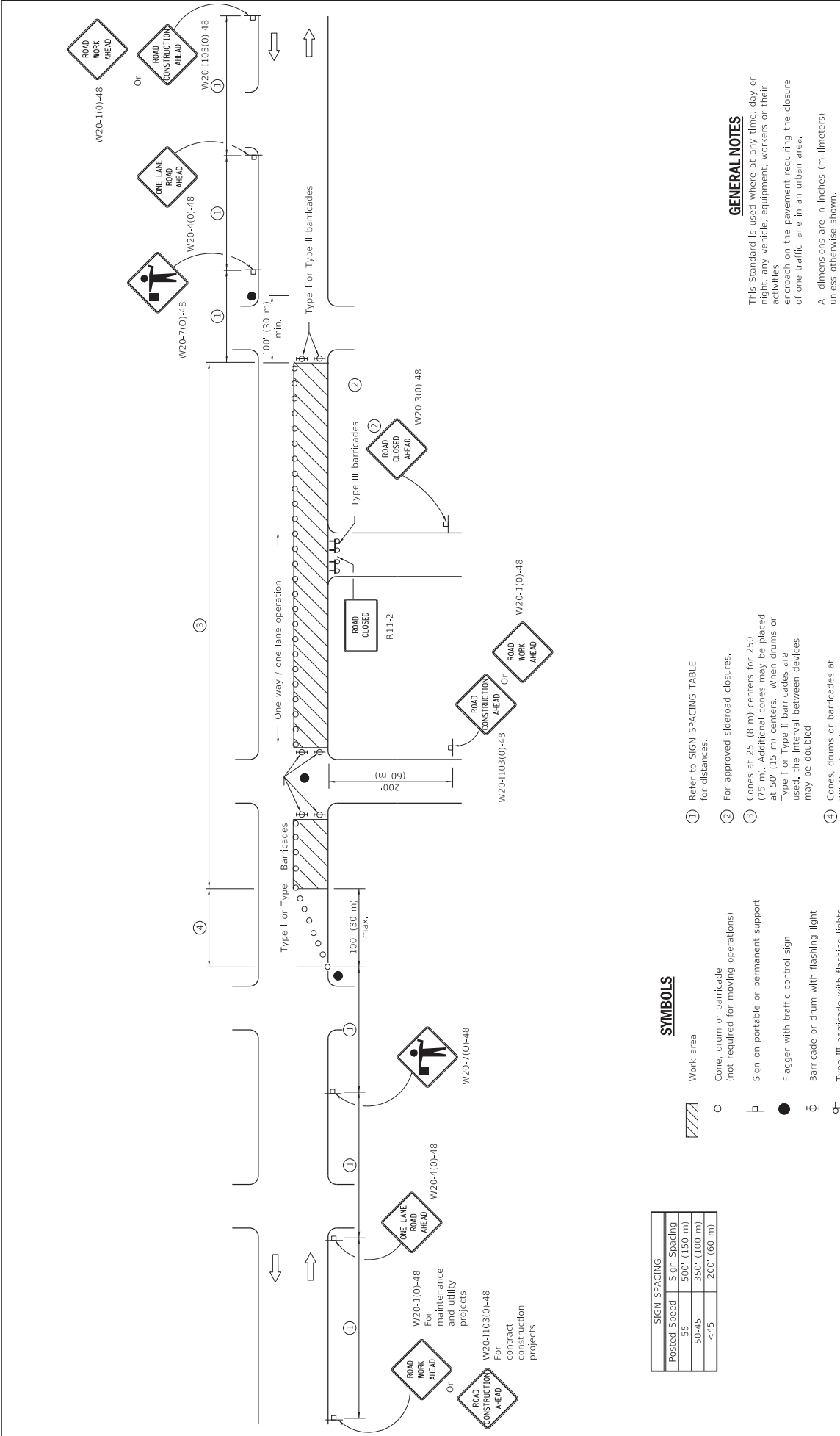

SIGN SPACING	
Posted Speed	Sign Spacing
55	500' (150 m)
50-45	350' (100 m)
<45	200' (60 m)

SYMBOLS

- Work area
- Cone, drum or barricade (not required for moving operations)
- Sign on portable or permanent support
- Flagger with traffic control sign
- Barricade or drum with flashing light
- Type III barricade with flashing lights

- ① Refer to SIGN SPACING TABLE for distances.
- ② For approved sideroad closures.
- ③ Cones at 25' (8 m) centers for 250' (75 m). Additional cones may be placed at 50' (15 m) centers. When drums or Type I or Type II barricades are used, the interval between devices may be doubled.
- ④ Cones, drums or barricades at 20' (6 m) centers.

GENERAL NOTES

This Standard is used where at any time, day or night, any vehicle, equipment, workers or their activities encroach on the pavement requiring the closure of one traffic lane in an urban area.

All dimensions are in inches (millimeters) unless otherwise shown.

DATE	REVISIONS
1-1-11	Revised flagger sign.
1-1-09	Switched units to English (metric).
	Corrected sign No. 5.

**URBAN LANE CLOSURE,
2L, 2W, UNDIVIDED**

STANDARD 701501-06

Illinois Department of Transportation

PASSED January 1, 2011

APPROVED January 1, 2011

ENGINEER OF SAFETY ENGINEERING

ENGINEER OF DESIGN AND ENVIRONMENT

ISSUED 1-1-07

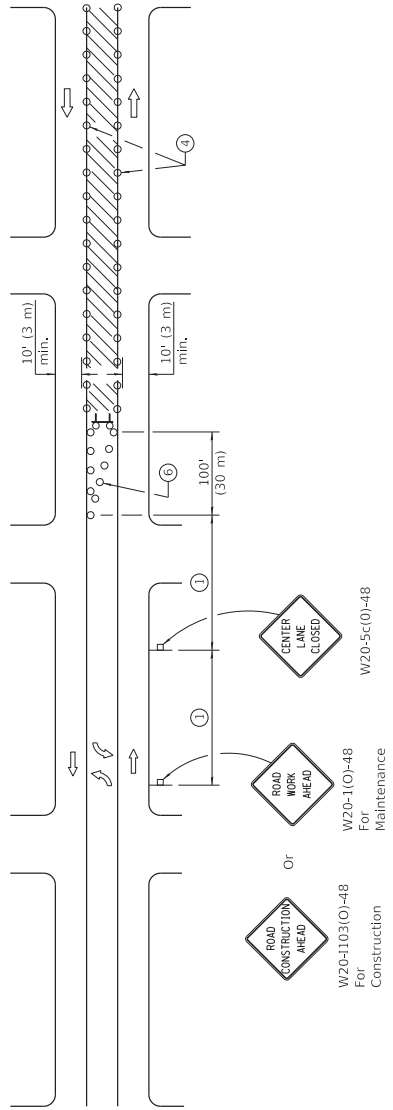

CASE I

(Signs required for both directions)

SIGN SPACING	
Posted Speed	Sign Spacing
55	500' (150 m)
50-45	350' (100 m)
<45	200' (60 m)

- ① Refer to SIGN SPACING TABLE for distances.
- ② Required for speeds > 40 mph (70 km/h).
- ③ Required if work exceeds 500' (164 m) or 1 block.
- ④ Cones at 25' (8 m) centers for 250' (75 m) on approach. Additional cones may be placed at 50' (15 m) centers. When drums or type I or II barricades are used, the interval between devices may be doubled.
- ⑤ For approved sideroad closures.
- ⑥ Cones, drums or barricades at 20' (6 m) centers in taper.
- ⑦ Use flagger sign only when flagger is present.

SYMBOLS

- Work area
- Barricade or drum with flashing light
- Flagger with traffic control sign
- Cone, drum or barricade
- Sign on portable or permanent support
- Type III barricade with flashing lights

GENERAL NOTES

This Standard is used to close one lane of an urban, two lane, two way roadway with a bidirectional turn lane.

Case I applies when no workers are present. When workers are present, two lanes shall be closed and traffic control shall be according to Standard 701501.

Calculate L as follows:

SPEED LIMIT

English (Metric)

$L = \frac{WS^2}{60}$ $L = \frac{WS^2}{150}$

$L = (W)(S)$ $L = 0.65(W)(S)$

40 mph (70 km/h) or less: $L = \frac{WS^2}{60}$ $L = (W)(S)$ $L = 0.65(W)(S)$

45 mph (80 km/h) or greater: $L = \frac{WS^2}{150}$

W = Width of offset in feet (meters).

S = Normal posted speed mph (km/h).

All dimensions are in inches (millimeters) unless otherwise shown.

DATE	REVISIONS
1-1-19	Revised to allow cones at night.
1-1-18	Corrected sign number for TWO WAY TRAFFIC sign for CASE II.

URBAN LANE CLOSURE, 2L, 2W, WITH BIDIRECTIONAL LEFT TURN LANE

(Sheet 1 of 2)

STANDARD 701502-09

Illinois Department of Transportation

APPROVED January 1, 2019

Cynthia D. ...
ENGINEER OF SAFETY PROC. AND ENGINEERING

APPROVED January 1, 2019

... ..
ENGINEER OF DESIGN AND ENVIRONMENT

ISSUED 1-1-01

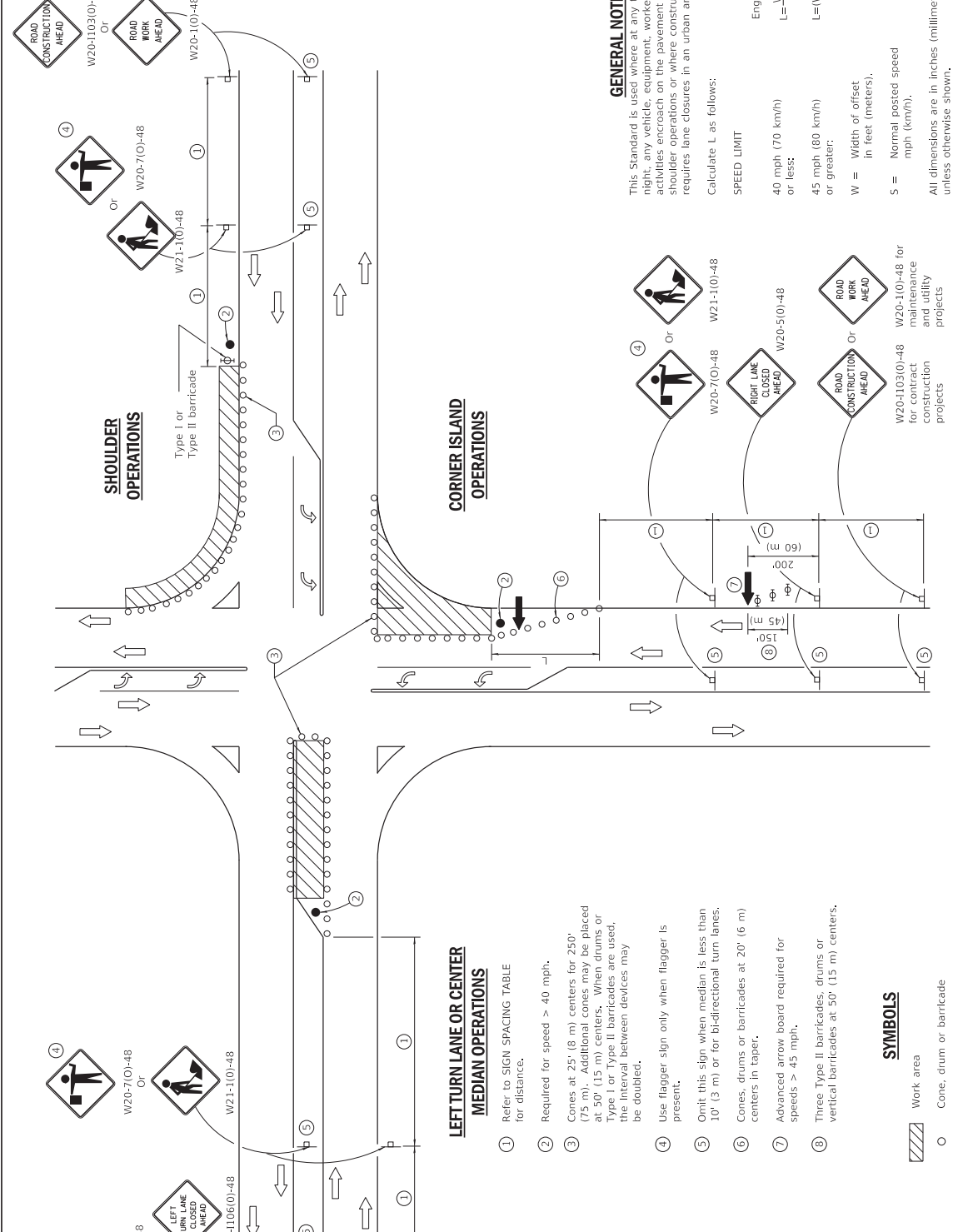

LEFT TURN LANE OR CENTER MEDIAN OPERATIONS

- 1 Refer to SIGN SPACING TABLE for distance.
- 2 Required for speed > 40 mph.
- 3 Cones at 25' (8 m) centers for 250' (75 m). Additional cones may be placed at 50' (15 m) centers. When drums or Type I or Type II barricades are used, the interval between devices may be doubled.
- 4 Use flagger sign only when flagger is present.
- 5 Omit this sign when median is less than 10' (3 m) or for bi-directional turn lanes.
- 6 Cones, drums or barricades at 20' (6 m) centers in taper.
- 7 Advanced arrow board required for speeds > 45 mph.
- 8 Three Type II barricades, drums or vertical barricades at 50' (15 m) centers.

SIGN SPACING	
Posted Speed	Sign Spacing
55	500' (150 m)
50-45	350' (100 m)
<45	200' (60 m)

SYMBOLS

- Work area
- Cone, drum or barricade
- Sign on portable or permanent support
- Arrow board
- Barricade or drum with flashing light
- Flagger with traffic control sign

GENERAL NOTES

This Standard is used where at any time, day or night, any vehicle, equipment, workers or their activities encroach on the pavement during shoulder operations or where construction requires lane closures in an urban area.

Calculate L as follows:

SPEED LIMIT		FORMULAS (Metric)	
English	$L = \frac{WS^2}{60}$	English	$L = \frac{WS^2}{150}$
Metric	$L = \frac{WS^2}{60}$	Metric	$L = 0.65(W)(S)$

W = Width of offset in feet (meters).
 S = Normal posted speed in mph (km/h).
 All dimensions are in inches (millimeters) unless otherwise shown.

DATE	REVISIONS
4-1-16	Corrected sign number for LEFT TURN LANE CLOSED AHEAD.
1-1-14	Added devices at arrow board upstream from taper.
	Rev. workers sign number.

URBAN LANE CLOSURE, MULTILANE INTERSECTION

STANDARD 701701-10

Illinois Department of Transportation
 PASSED April 1, 2016
 ENGINEER OF SAFETY ENGINEERING
 APPROVED April 1, 2016
 ENGINEER OF DESIGN AND ENVIRONMENT

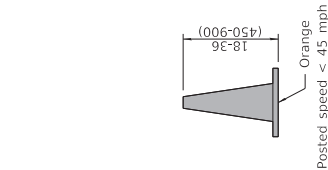

Orange
Posted speed < 45 mph

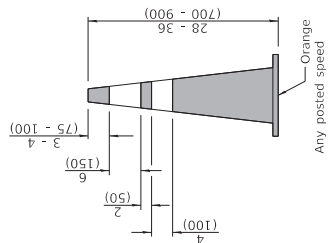

Orange
Any posted speed

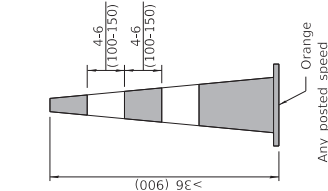

Orange
Any posted speed

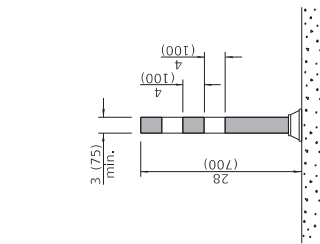

TUBULAR MARKER

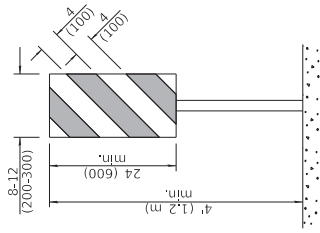

**VERTICAL PANEL
POST MOUNTED**

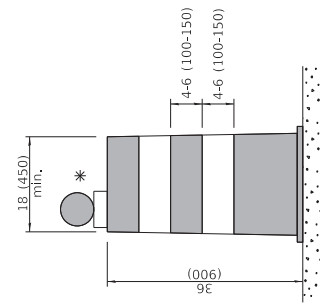

DRUM

CONES

DAYTIME USE

DAY OR NIGHTTIME USE

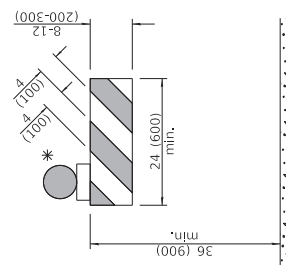

TYPE I BARRICADE

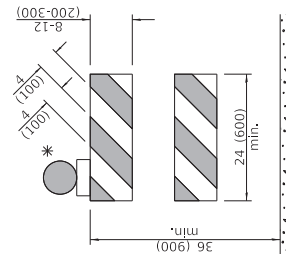

TYPE II BARRICADE

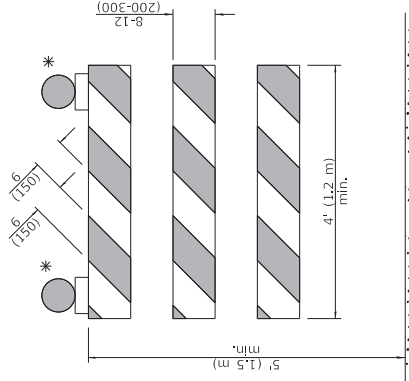

TYPE III BARRICADE

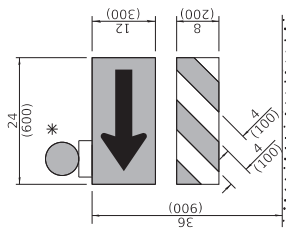

**DIRECTION INDICATOR
BARRICADE**

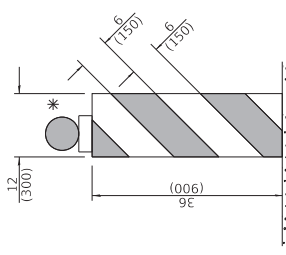

VERTICAL BARRICADE

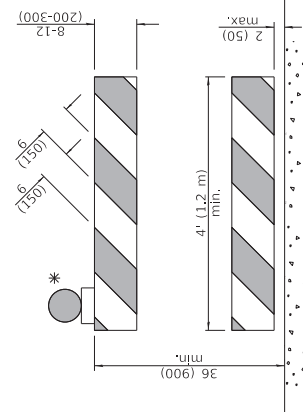

**DETECTABLE PEDESTRIAN
CHANNELIZING BARRICADE**

* Warning lights (if required)

GENERAL NOTES

All heights shown shall be measured above the pavement surface.
All dimensions are in inches (millimeters) unless otherwise shown.

DATE	REVISIONS
1-1-19	Revised cone usage and added cones >36" (900 m) height.
1-1-18	Revised END WORK ZONE SPEED LIMIT sign from orange to white background.

TRAFFIC CONTROL DEVICES

(Sheet 1 of 3)

STANDARD 701901-08

Illinois Department of Transportation
 APPROVED January 1, 2019
 [Signature] ENGINEER OF SAFETY PROC. AND ENGINEERING
 APPROVED January 1, 2019
 [Signature] ENGINEER OF DESIGN AND ENVIRONMENT

ISSUED 1-1-13

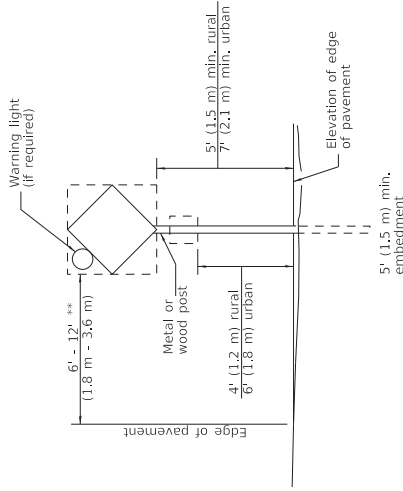

POST MOUNTED SIGNS

** When curb or paved shoulder are present this dimension shall be 24 (600) to the face of curb or 6' (1.8 m) to the outside edge of the paved shoulder.

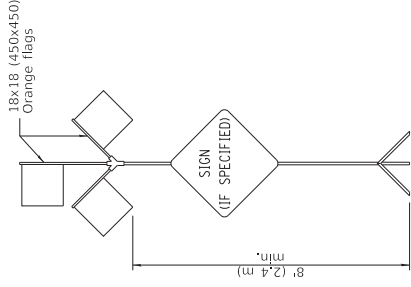

HIGH LEVEL WARNING DEVICE

SIGNS ON TEMPORARY SUPPORTS

*** When work operations exceed four days, this dimension shall be 5' (1.5 m) to the top of the sign behind other devices; the height shall be sufficient to be seen completely above the devices.

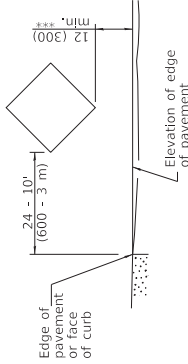

ROAD CONSTRUCTION NEXT X MILES
G20-1104(0)-6036

END CONSTRUCTION
G20-1105(0)-6024

This signing is required for all projects 2 miles (3200 m) or more in length.
ROAD CONSTRUCTION NEXT X MILES sign shall be placed 500' (150 m) in advance of project limits.
END CONSTRUCTION sign shall be erected at the end of the job unless another job is within 2 miles (3200 m).
Dual sign displays shall be utilized on multi-lane highways.

WORK LIMIT SIGNING

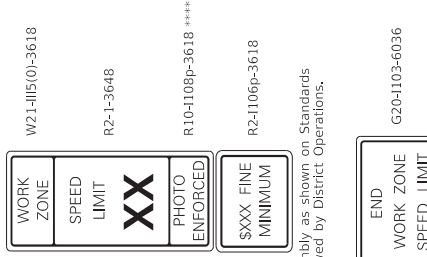

Sign assembly as shown on Standards or as allowed by District Operations.

This sign shall be used when the above sign assembly is used.

HIGHWAY CONSTRUCTION SPEED ZONE SIGNS

**** R10-1108p shall only be used along roadways under the jurisdiction of the State.

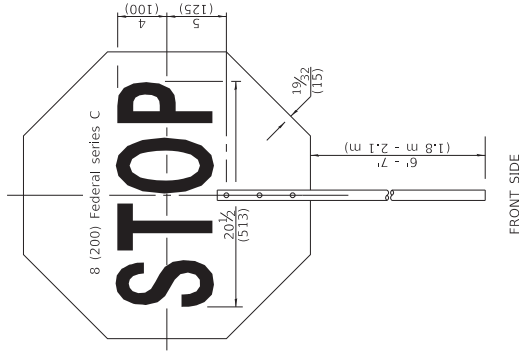

FRONT SIDE

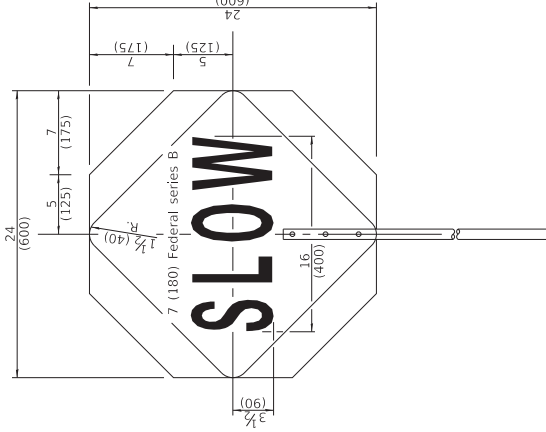

REVERSE SIDE

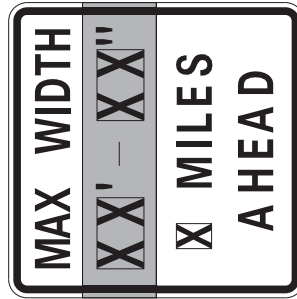

W12-1103-4848

WIDTH RESTRICTION SIGN

XX-XX" width and X miles are variable.

Illinois Department of Transportation
 APPROVED January 1, 2019
 Cynthia C. [Signature]
 ENGINEER OF SAFETY PROC. AND ENGINEERING
 APPROVED January 1, 2019
 [Signature]
 ENGINEER OF DESIGN AND ENVIRONMENT

ISSUED 1-1-13

FLAGGER TRAFFIC CONTROL SIGN

TRAFFIC CONTROL DEVICES
 (Sheet 2 of 3)
STANDARD 701901-08

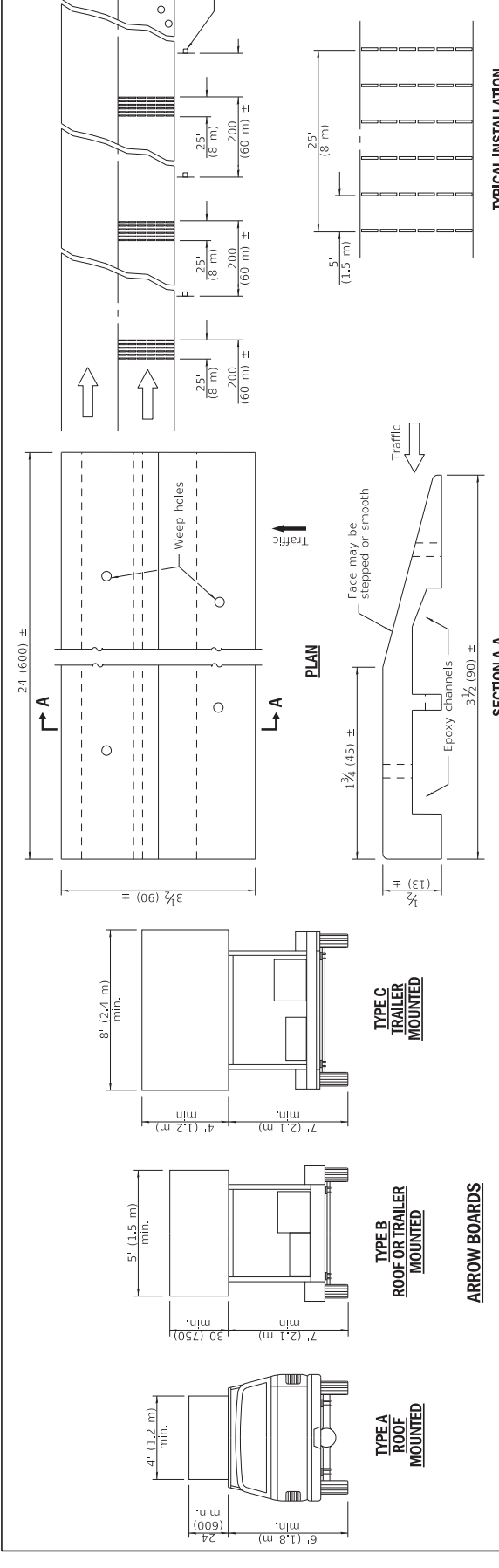

ARROW BOARDS

SECTION A-A

TYPICAL INSTALLATION

TEMPORARY RUMBLE STRIPS

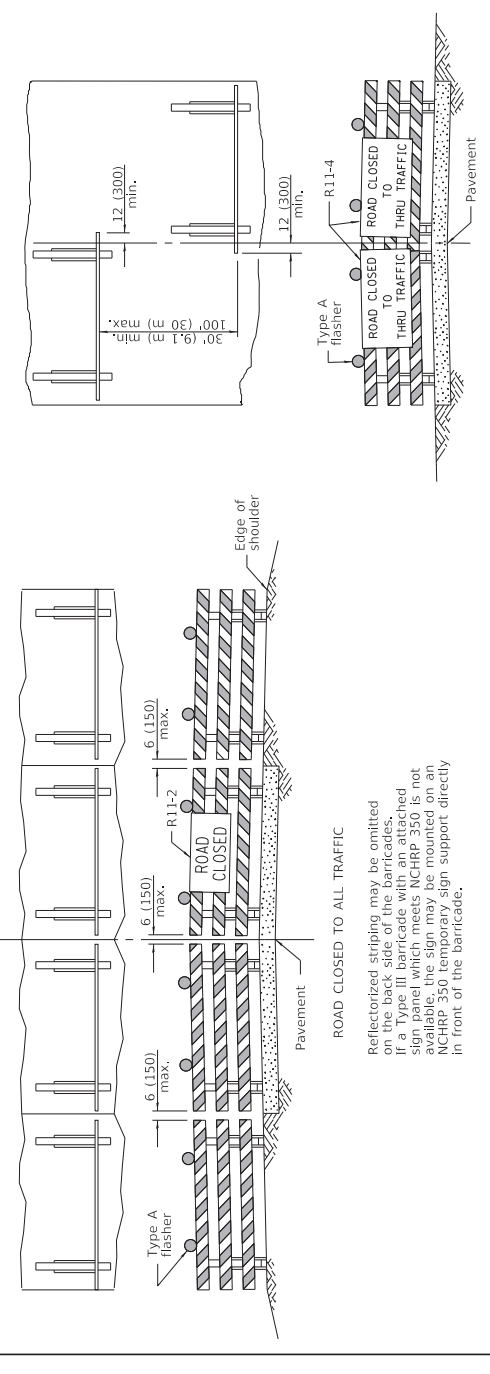

ROAD CLOSED TO ALL TRAFFIC

ReflectORIZED striping may be omitted on the back side of the barricades. If a Type III barricade with reflectORIZED striping is used, the sign may be mounted on an MCHRP 350 temporary sign support directly in front of the barricade.

ROAD CLOSED TO THRU TRAFFIC

ReflectORIZED striping shall appear on both sides of the barricades. If a Type III barricade with reflectORIZED striping is used, the sign may be mounted on an MCHRP 350 temporary sign support directly in front of the barricade.

ROAD CLOSED TO THRU TRAFFIC

ReflectORIZED striping shall appear on both sides of the barricades. If a Type III barricade with reflectORIZED striping is used, the sign may be mounted on an MCHRP 350 temporary sign support directly in front of the barricade.

TYPICAL APPLICATIONS OF TYPE III BARRICADES CLOSING A ROAD

TRAFFIC CONTROL DEVICES
STANDARD 701901-08
(Sheet 3 of 3)

Illinois Department of Transportation
APPROVED January 1, 2019
Cynthia A. C...
ENGINEER OF SAFETY PROC. AND ENGINEERING
APPROVED January 1, 2019
S...
ENGINEER OF DESIGN AND ENVIRONMENT

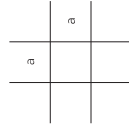
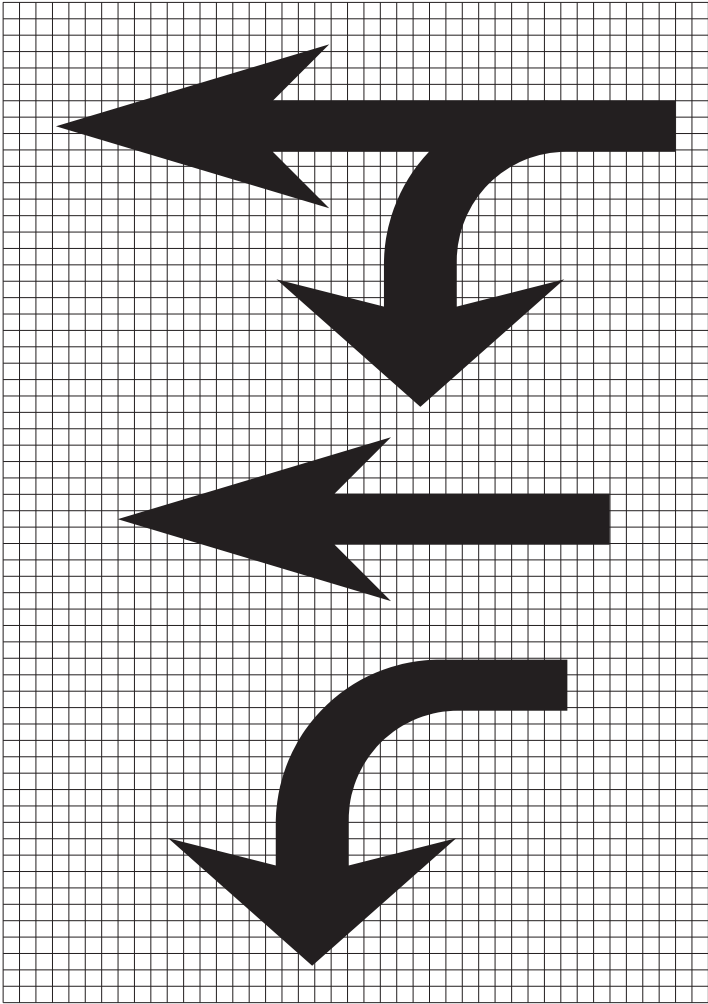
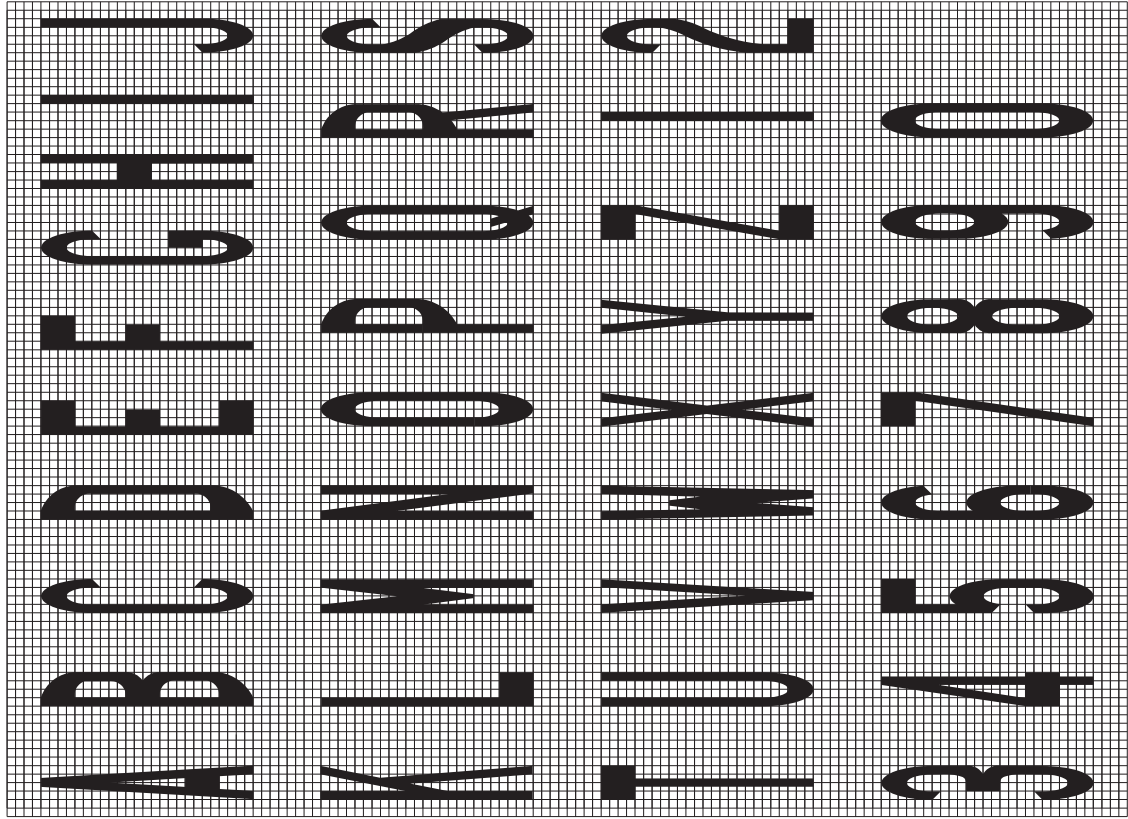

Legend Height	Arrow Size	a
6' (1.8 m)	Small	2.9 (74)
8' (2.4 m)	Large	3.8 (96)

The space between adjacent letters or numerals should be approximately 3/4 (75) for 6' (1.8 m) legend and 4/100 (100) for 8' (2.4 m) legend.

LETTER AND ARROW GRID SCALE

Illinois Department of Transportation
 PASSED January 1, 2015
 ENGINEER OF OPERATIONS
 APPROVED January 1, 2015
 ENGINEER OF DESIGN AND ENVIRONMENT

TYPICAL PAVEMENT MARKINGS
 (Sheet 2 of 3)
 STANDARD 780001-05

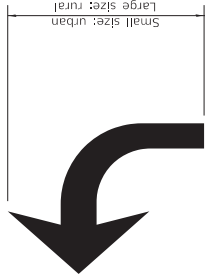

20' (6 m): urban
50' (15 m): rural
(Between arrow
and word or
between words)

Small size: urban
Large size: rural

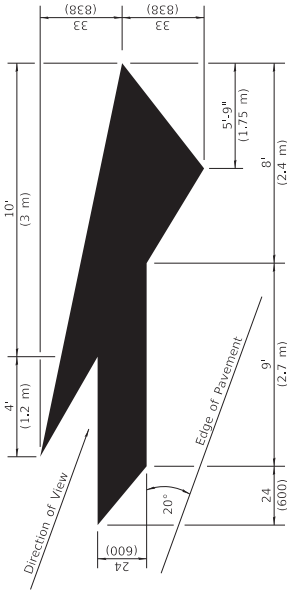

LANE-REDUCTION ARROW

Right lane-reduction arrow shown.
Use mirror image for left lane.

ONLY

6' (1.8 m): urban
8' (2.4 m): rural

WORD AND ARROW LAYOUT

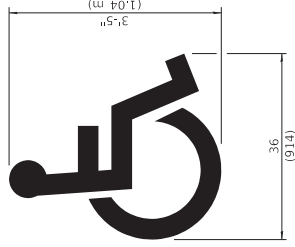

**INTERNATIONAL
SYMBOL OF
ACCESSIBILITY**

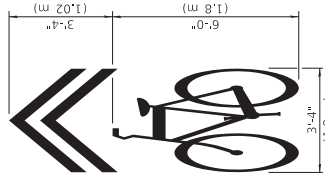

**SHARED LANE
SYMBOL**

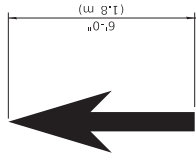

6'-0" (1.8 m)

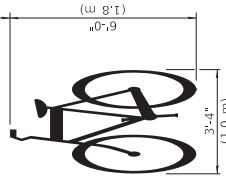

BIKE SYMBOL
(Arrow is optional)

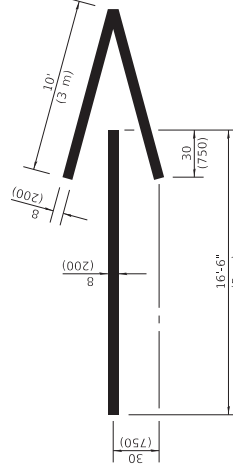

WRONG WAY ARROW

Illinois Department of Transportation

PASSED January 1, 2015
 ENGINEER OF OPERATIONS
 APPROVED January 1, 2015
 ENGINEER OF DESIGN AND ENVIRONMENT

**TYPICAL PAVEMENT
MARKINGS**

(Sheet 3 of 3)

STANDARD 780001-05

REQUIRED CONTRACT PROVISIONS FEDERAL-AID CONSTRUCTION CONTRACTS

- I. General
- II. Nondiscrimination
- III. Non-segregated Facilities
- IV. Davis-Bacon and Related Act Provisions
- V. Contract Work Hours and Safety Standards Act Provisions
- VI. Subletting or Assigning the Contract
- VII. Safety: Accident Prevention
- VIII. False Statements Concerning Highway Projects
- IX. Implementation of Clean Air Act and Federal Water Pollution Control Act
- X. Certification Regarding Debarment, Suspension, Ineligibility and Voluntary Exclusion
- XI. Certification Regarding Use of Contract Funds for Lobbying
- XII. Use of United States-Flag Vessels:

ATTACHMENTS

A. Employment and Materials Preference for Appalachian Development Highway System or Appalachian Local Access Road Contracts (included in Appalachian contracts only)

I. GENERAL

1. Form FHWA-1273 must be physically incorporated in each construction contract funded under title 23, United States Code, as required in 23 CFR 633.102(b) (excluding emergency contracts solely intended for debris removal). The contractor (or subcontractor) must insert this form in each subcontract and further require its inclusion in all lower tier subcontracts (excluding purchase orders, rental agreements and other agreements for supplies or services). 23 CFR 633.102(e).

The applicable requirements of Form FHWA-1273 are incorporated by reference for work done under any purchase order, rental agreement or agreement for other services. The prime contractor shall be responsible for compliance by any subcontractor, lower-tier subcontractor or service provider. 23 CFR 633.102(e).

Form FHWA-1273 must be included in all Federal-aid design-build contracts, in all subcontracts and in lower tier subcontracts (excluding subcontracts for design services, purchase orders, rental agreements and other agreements for supplies or services) in accordance with 23 CFR 633.102. The design-builder shall be responsible for compliance by any subcontractor, lower-tier subcontractor or service provider.

Contracting agencies may reference Form FHWA-1273 in solicitation-for-bids or request-for-proposals documents, however, the Form FHWA-1273 must be physically incorporated (not referenced) in all contracts, subcontracts and lower-tier subcontracts (excluding purchase orders, rental agreements and other agreements for supplies or services related to a construction contract). 23 CFR 633.102(b).

2. Subject to the applicability criteria noted in the following sections, these contract provisions shall apply to all work

performed on the contract by the contractor's own organization and with the assistance of workers under the contractor's immediate superintendence and to all work performed on the contract by piecework, station work, or by subcontract. 23 CFR 633.102(d).

3. A breach of any of the stipulations contained in these Required Contract Provisions may be sufficient grounds for withholding of progress payments, withholding of final payment, termination of the contract, suspension / debarment or any other action determined to be appropriate by the contracting agency and FHWA.

4. Selection of Labor: During the performance of this contract, the contractor shall not use convict labor for any purpose within the limits of a construction project on a Federal-aid highway unless it is labor performed by convicts who are on parole, supervised release, or probation. 23 U.S.C. 114(b). The term Federal-aid highway does not include roadways functionally classified as local roads or rural minor collectors. 23 U.S.C. 101(a).

II. NONDISCRIMINATION (23 CFR 230.107(a); 23 CFR Part 230, Subpart A, Appendix A; EO 11246)

The provisions of this section related to 23 CFR Part 230, Subpart A, Appendix A are applicable to all Federal-aid construction contracts and to all related construction subcontracts of \$10,000 or more. The provisions of 23 CFR Part 230 are not applicable to material supply, engineering, or architectural service contracts.

In addition, the contractor and all subcontractors must comply with the following policies: Executive Order 11246, 41 CFR Part 60, 29 CFR Parts 1625-1627, 23 U.S.C. 140, Section 504 of the Rehabilitation Act of 1973, as amended (29 U.S.C. 794), Title VI of the Civil Rights Act of 1964, as amended (42 U.S.C. 2000d et seq.), and related regulations including 49 CFR Parts 21, 26, and 27; and 23 CFR Parts 200, 230, and 633.

The contractor and all subcontractors must comply with: the requirements of the Equal Opportunity Clause in 41 CFR 60-1.4(b) and, for all construction contracts exceeding \$10,000, the Standard Federal Equal Employment Opportunity Construction Contract Specifications in 41 CFR 60-4.3.

Note: The U.S. Department of Labor has exclusive authority to determine compliance with Executive Order 11246 and the policies of the Secretary of Labor including 41 CFR Part 60, and 29 CFR Parts 1625-1627. The contracting agency and the FHWA have the authority and the responsibility to ensure compliance with 23 U.S.C. 140, Section 504 of the Rehabilitation Act of 1973, as amended (29 U.S.C. 794), and Title VI of the Civil Rights Act of 1964, as amended (42 U.S.C. 2000d et seq.), and related regulations including 49 CFR Parts 21, 26, and 27; and 23 CFR Parts 200, 230, and 633.

The following provision is adopted from 23 CFR Part 230, Subpart A, Appendix A, with appropriate revisions to conform to the U.S. Department of Labor (US DOL) and FHWA requirements.

1. Equal Employment Opportunity: Equal Employment Opportunity (EEO) requirements not to discriminate and to take affirmative action to assure equal opportunity as set forth under laws, executive orders, rules, regulations (see 28 CFR Part 35, 29 CFR Part 1630, 29 CFR Parts 1625-1627, 41 CFR Part 60 and 49 CFR Part 27) and orders of the Secretary of Labor as modified by the provisions prescribed herein, and imposed pursuant to 23 U.S.C. 140, shall constitute the EEO and specific affirmative action standards for the contractor's project activities under this contract. The provisions of the Americans with Disabilities Act of 1990 (42 U.S.C. 12101 et seq.) set forth under 28 CFR Part 35 and 29 CFR Part 1630 are incorporated by reference in this contract. In the execution of this contract, the contractor agrees to comply with the following minimum specific requirement activities of EEO:

a. The contractor will work with the contracting agency and the Federal Government to ensure that it has made every good faith effort to provide equal opportunity with respect to all of its terms and conditions of employment and in their review of activities under the contract. 23 CFR 230.409 (g)(4) & (5).

b. The contractor will accept as its operating policy the following statement:

"It is the policy of this Company to assure that applicants are employed, and that employees are treated during employment, without regard to their race, religion, sex, sexual orientation, gender identity, color, national origin, age or disability. Such action shall include: employment, upgrading, demotion, or transfer; recruitment or recruitment advertising; layoff or termination; rates of pay or other forms of compensation; and selection for training, including apprenticeship, pre-apprenticeship, and/or on-the-job training."

2. EEO Officer: The contractor will designate and make known to the contracting officers an EEO Officer who will have the responsibility for and must be capable of effectively administering and promoting an active EEO program and who must be assigned adequate authority and responsibility to do so.

3. Dissemination of Policy: All members of the contractor's staff who are authorized to hire, supervise, promote, and discharge employees, or who recommend such action or are substantially involved in such action, will be made fully cognizant of and will implement the contractor's EEO policy and contractual responsibilities to provide EEO in each grade and classification of employment. To ensure that the above agreement will be met, the following actions will be taken as a minimum:

a. Periodic meetings of supervisory and personnel office employees will be conducted before the start of work and then not less often than once every six months, at which time the contractor's EEO policy and its implementation will be reviewed and explained. The meetings will be conducted by the EEO Officer or other knowledgeable company official.

b. All new supervisory or personnel office employees will be given a thorough indoctrination by the EEO Officer, covering all major aspects of the contractor's EEO obligations within thirty days following their reporting for duty with the contractor.

c. All personnel who are engaged in direct recruitment for the project will be instructed by the EEO Officer in the contractor's procedures for locating and hiring minorities and women.

d. Notices and posters setting forth the contractor's EEO policy will be placed in areas readily accessible to employees, applicants for employment and potential employees.

e. The contractor's EEO policy and the procedures to implement such policy will be brought to the attention of employees by means of meetings, employee handbooks, or other appropriate means.

4. Recruitment: When advertising for employees, the contractor will include in all advertisements for employees the notation: "An Equal Opportunity Employer." All such advertisements will be placed in publications having a large circulation among minorities and women in the area from which the project work force would normally be derived.

a. The contractor will, unless precluded by a valid bargaining agreement, conduct systematic and direct recruitment through public and private employee referral sources likely to yield qualified minorities and women. To meet this requirement, the contractor will identify sources of potential minority group employees and establish with such identified sources procedures whereby minority and women applicants may be referred to the contractor for employment consideration.

b. In the event the contractor has a valid bargaining agreement providing for exclusive hiring hall referrals, the contractor is expected to observe the provisions of that agreement to the extent that the system meets the contractor's compliance with EEO contract provisions. Where implementation of such an agreement has the effect of discriminating against minorities or women, or obligates the contractor to do the same, such implementation violates Federal nondiscrimination provisions.

c. The contractor will encourage its present employees to refer minorities and women as applicants for employment. Information and procedures with regard to referring such applicants will be discussed with employees.

5. Personnel Actions: Wages, working conditions, and employee benefits shall be established and administered, and personnel actions of every type, including hiring, upgrading, promotion, transfer, demotion, layoff, and termination, shall be taken without regard to race, color, religion, sex, sexual orientation, gender identity, national origin, age or disability. The following procedures shall be followed:

a. The contractor will conduct periodic inspections of project sites to ensure that working conditions and employee facilities do not indicate discriminatory treatment of project site personnel.

b. The contractor will periodically evaluate the spread of wages paid within each classification to determine any evidence of discriminatory wage practices.

c. The contractor will periodically review selected personnel actions in depth to determine whether there is evidence of discrimination. Where evidence is found, the contractor will promptly take corrective action. If the review indicates that the discrimination may extend beyond the actions reviewed, such corrective action shall include all affected persons.

d. The contractor will promptly investigate all complaints of alleged discrimination made to the contractor in connection with its obligations under this contract, will attempt to resolve such complaints, and will take appropriate corrective action

within a reasonable time. If the investigation indicates that the discrimination may affect persons other than the complainant, such corrective action shall include such other persons. Upon completion of each investigation, the contractor will inform every complainant of all of their avenues of appeal.

6. Training and Promotion:

a. The contractor will assist in locating, qualifying, and increasing the skills of minorities and women who are applicants for employment or current employees. Such efforts should be aimed at developing full journey level status employees in the type of trade or job classification involved.

b. Consistent with the contractor's work force requirements and as permissible under Federal and State regulations, the contractor shall make full use of training programs (i.e., apprenticeship and on-the-job training programs for the geographical area of contract performance). In the event a special provision for training is provided under this contract, this subparagraph will be superseded as indicated in the special provision. The contracting agency may reserve training positions for persons who receive welfare assistance in accordance with 23 U.S.C. 140(a).

c. The contractor will advise employees and applicants for employment of available training programs and entrance requirements for each.

d. The contractor will periodically review the training and promotion potential of employees who are minorities and women and will encourage eligible employees to apply for such training and promotion.

7. Unions: If the contractor relies in whole or in part upon unions as a source of employees, the contractor will use good faith efforts to obtain the cooperation of such unions to increase opportunities for minorities and women. 23 CFR 230.409. Actions by the contractor, either directly or through a contractor's association acting as agent, will include the procedures set forth below:

a. The contractor will use good faith efforts to develop, in cooperation with the unions, joint training programs aimed toward qualifying more minorities and women for membership in the unions and increasing the skills of minorities and women so that they may qualify for higher paying employment.

b. The contractor will use good faith efforts to incorporate an EEO clause into each union agreement to the end that such union will be contractually bound to refer applicants without regard to their race, color, religion, sex, sexual orientation, gender identity, national origin, age, or disability.

c. The contractor is to obtain information as to the referral practices and policies of the labor union except that to the extent such information is within the exclusive possession of the labor union and such labor union refuses to furnish such information to the contractor, the contractor shall so certify to the contracting agency and shall set forth what efforts have been made to obtain such information.

d. In the event the union is unable to provide the contractor with a reasonable flow of referrals within the time limit set forth in the collective bargaining agreement, the contractor will, through independent recruitment efforts, fill the employment vacancies without regard to race, color, religion, sex, sexual orientation, gender identity, national origin, age, or disability; making full efforts to obtain qualified and/or qualifiable minorities and women. The failure of a union to provide

sufficient referrals (even though it is obligated to provide exclusive referrals under the terms of a collective bargaining agreement) does not relieve the contractor from the requirements of this paragraph. In the event the union referral practice prevents the contractor from meeting the obligations pursuant to Executive Order 11246, as amended, and these special provisions, such contractor shall immediately notify the contracting agency.

8. Reasonable Accommodation for Applicants /

Employees with Disabilities: The contractor must be familiar with the requirements for and comply with the Americans with Disabilities Act and all rules and regulations established thereunder. Employers must provide reasonable accommodation in all employment activities unless to do so would cause an undue hardship.

9. Selection of Subcontractors, Procurement of Materials and Leasing of Equipment:

The contractor shall not discriminate on the grounds of race, color, religion, sex, sexual orientation, gender identity, national origin, age, or disability in the selection and retention of subcontractors, including procurement of materials and leases of equipment. The contractor shall take all necessary and reasonable steps to ensure nondiscrimination in the administration of this contract.

a. The contractor shall notify all potential subcontractors, suppliers, and lessors of their EEO obligations under this contract.

b. The contractor will use good faith efforts to ensure subcontractor compliance with their EEO obligations.

10. Assurances Required:

a. The requirements of 49 CFR Part 26 and the State DOT's FHWA-approved Disadvantaged Business Enterprise (DBE) program are incorporated by reference.

b. The contractor, subrecipient or subcontractor shall not discriminate on the basis of race, color, national origin, or sex in the performance of this contract. The contractor shall carry out applicable requirements of 49 CFR part 26 in the award and administration of DOT-assisted contracts. Failure by the contractor to carry out these requirements is a material breach of this contract, which may result in the termination of this contract or such other remedy as the recipient deems appropriate, which may include, but is not limited to:

- (1) Withholding monthly progress payments;
- (2) Assessing sanctions;
- (3) Liquidating damages; and/or
- (4) Disqualifying the contractor from future bidding as non-responsible.

c. The Title VI and nondiscrimination provisions of U.S. DOT Order 1050.2A at Appendixes A and E are incorporated by reference. 49 CFR Part 21.

11. Records and Reports: The contractor shall keep such records as necessary to document compliance with the EEO requirements. Such records shall be retained for a period of three years following the date of the final payment to the contractor for all contract work and shall be available at reasonable times and places for inspection by authorized representatives of the contracting agency and the FHWA.

a. The records kept by the contractor shall document the following:

(1) The number and work hours of minority and non-minority group members and women employed in each work classification on the project;

(2) The progress and efforts being made in cooperation with unions, when applicable, to increase employment opportunities for minorities and women; and

(3) The progress and efforts being made in locating, hiring, training, qualifying, and upgrading minorities and women.

b. The contractors and subcontractors will submit an annual report to the contracting agency each July for the duration of the project indicating the number of minority, women, and non-minority group employees currently engaged in each work classification required by the contract work. This information is to be reported on [Form FHWA-1391](#). The staffing data should represent the project work force on board in all or any part of the last payroll period preceding the end of July. If on-the-job training is being required by special provision, the contractor will be required to collect and report training data. The employment data should reflect the work force on board during all or any part of the last payroll period preceding the end of July.

III. NONSEGREGATED FACILITIES

This provision is applicable to all Federal-aid construction contracts and to all related construction subcontracts of more than \$10,000. 41 CFR 60-1.5.

As prescribed by 41 CFR 60-1.8, the contractor must ensure that facilities provided for employees are provided in such a manner that segregation on the basis of race, color, religion, sex, sexual orientation, gender identity, or national origin cannot result. The contractor may neither require such segregated use by written or oral policies nor tolerate such use by employee custom. The contractor's obligation extends further to ensure that its employees are not assigned to perform their services at any location under the contractor's control where the facilities are segregated. The term "facilities" includes waiting rooms, work areas, restaurants and other eating areas, time clocks, restrooms, washrooms, locker rooms and other storage or dressing areas, parking lots, drinking fountains, recreation or entertainment areas, transportation, and housing provided for employees. The contractor shall provide separate or single-user restrooms and necessary dressing or sleeping areas to assure privacy between sexes.

IV. DAVIS-BACON AND RELATED ACT PROVISIONS

This section is applicable to all Federal-aid construction projects exceeding \$2,000 and to all related subcontracts and lower-tier subcontracts (regardless of subcontract size), in accordance with 29 CFR 5.5. The requirements apply to all projects located within the right-of-way of a roadway that is functionally classified as Federal-aid highway. 23 U.S.C. 113. This excludes roadways functionally classified as local roads or rural minor collectors, which are exempt. 23 U.S.C. 101. Where applicable law requires that projects be treated as a project on a Federal-aid highway, the provisions of this subpart will apply regardless of the location of the project. Examples include: Surface Transportation Block Grant Program projects funded under 23 U.S.C. 133 [excluding recreational trails projects], the Nationally Significant Freight and Highway

Projects funded under 23 U.S.C. 117, and National Highway Freight Program projects funded under 23 U.S.C. 167.

The following provisions are from the U.S. Department of Labor regulations in 29 CFR 5.5 "Contract provisions and related matters" with minor revisions to conform to the FHWA- 1273 format and FHWA program requirements.

1. Minimum wages (29 CFR 5.5)

a. All laborers and mechanics employed or working upon the site of the work, will be paid unconditionally and not less often than once a week, and without subsequent deduction or rebate on any account (except such payroll deductions as are permitted by regulations issued by the Secretary of Labor under the Copeland Act (29 CFR part 3)), the full amount of wages and bona fide fringe benefits (or cash equivalents thereof) due at time of payment computed at rates not less than those contained in the wage determination of the Secretary of Labor which is attached hereto and made a part hereof, regardless of any contractual relationship which may be alleged to exist between the contractor and such laborers and mechanics.

Contributions made or costs reasonably anticipated for bona fide fringe benefits under section 1(b)(2) of the Davis-Bacon Act on behalf of laborers or mechanics are considered wages paid to such laborers or mechanics, subject to the provisions of paragraph 1.d. of this section; also, regular contributions made or costs incurred for more than a weekly period (but not less often than quarterly) under plans, funds, or programs which cover the particular weekly period, are deemed to be constructively made or incurred during such weekly period. Such laborers and mechanics shall be paid the appropriate wage rate and fringe benefits on the wage determination for the classification of work actually performed, without regard to skill, except as provided in 29 CFR 5.5(a)(4). Laborers or mechanics performing work in more than one classification may be compensated at the rate specified for each classification for the time actually worked therein: Provided, That the employer's payroll records accurately set forth the time spent in each classification in which work is performed. The wage determination (including any additional classification and wage rates conformed under paragraph 1.b. of this section) and the Davis-Bacon poster (WH-1321) shall be posted at all times by the contractor and its subcontractors at the site of the work in a prominent and accessible place where it can be easily seen by the workers.

b. (1) The contracting officer shall require that any class of laborers or mechanics, including helpers, which is not listed in the wage determination and which is to be employed under the contract shall be classified in conformance with the wage determination. The contracting officer shall approve an additional classification and wage rate and fringe benefits therefore only when the following criteria have been met:

(i) The work to be performed by the classification requested is not performed by a classification in the wage determination; and

(ii) The classification is utilized in the area by the construction industry; and

(iii) The proposed wage rate, including any bona fide fringe benefits, bears a reasonable relationship to the wage rates contained in the wage determination.

(2) If the contractor and the laborers and mechanics to be employed in the classification (if known), or their representatives, and the contracting officer agree on the classification and wage rate (including the amount designated for fringe benefits where appropriate), a report of the action taken shall be sent by the contracting officer to the Administrator of the Wage and Hour Division, U.S. Department of Labor, Washington, DC 20210. The Administrator, or an authorized representative, will approve, modify, or disapprove every additional classification action within 30 days of receipt and so advise the contracting officer or will notify the contracting officer within the 30-day period that additional time is necessary.

(3) In the event the contractor, the laborers or mechanics to be employed in the classification or their representatives, and the contracting officer do not agree on the proposed classification and wage rate (including the amount designated for fringe benefits, where appropriate), the contracting officer shall refer the questions, including the views of all interested parties and the recommendation of the contracting officer, to the Administrator for determination. The Administrator, or an authorized representative, will issue a determination within 30 days of receipt and so advise the contracting officer or will notify the contracting officer within the 30-day period that additional time is necessary.

(4) The wage rate (including fringe benefits where appropriate) determined pursuant to paragraphs 1.b.(2) or 1.b.(3) of this section, shall be paid to all workers performing work in the classification under this contract from the first day on which work is performed in the classification.

c. Whenever the minimum wage rate prescribed in the contract for a class of laborers or mechanics includes a fringe benefit which is not expressed as an hourly rate, the contractor shall either pay the benefit as stated in the wage determination or shall pay another bona fide fringe benefit or an hourly cash equivalent thereof.

d. If the contractor does not make payments to a trustee or other third person, the contractor may consider as part of the wages of any laborer or mechanic the amount of any costs reasonably anticipated in providing bona fide fringe benefits under a plan or program, Provided, That the Secretary of Labor has found, upon the written request of the contractor, that the applicable standards of the Davis-Bacon Act have been met. The Secretary of Labor may require the contractor to set aside in a separate account assets for the meeting of obligations under the plan or program.

2. Withholding (29 CFR 5.5)

The contracting agency shall upon its own action or upon written request of an authorized representative of the Department of Labor, withhold or cause to be withheld from the contractor under this contract, or any other Federal contract with the same prime contractor, or any other federally- assisted contract subject to Davis-Bacon prevailing wage requirements, which is held by the same prime contractor, so much of the accrued payments or advances as may be considered necessary to pay laborers and mechanics,

including apprentices, trainees, and helpers, employed by the contractor or any subcontractor the full amount of wages required by the contract. In the event of failure to pay any laborer or mechanic, including any apprentice, trainee, or helper, employed or working on the site of the work, all or part of the wages required by the contract, the contracting agency may, after written notice to the contractor, take such action as may be necessary to cause the suspension of any further payment, advance, or guarantee of funds until such violations have ceased.

3. Payrolls and basic records (29 CFR 5.5)

a. Payrolls and basic records relating thereto shall be maintained by the contractor during the course of the work and preserved for a period of three years thereafter for all laborers and mechanics working at the site of the work. Such records shall contain the name, address, and social security number of each such worker, his or her correct classification, hourly rates of wages paid (including rates of contributions or costs anticipated for bona fide fringe benefits or cash equivalents thereof of the types described in section 1(b)(2)(B) of the Davis-Bacon Act), daily and weekly number of hours worked, deductions made and actual wages paid. Whenever the Secretary of Labor has found under 29 CFR 5.5(a)(1)(iv) that the wages of any laborer or mechanic include the amount of any costs reasonably anticipated in providing benefits under a plan or program described in section 1(b)(2)(B) of the Davis-Bacon Act, the contractor shall maintain records which show that the commitment to provide such benefits is enforceable, that the plan or program is financially responsible, and that the plan or program has been communicated in writing to the laborers or mechanics affected, and records which show the costs anticipated or the actual cost incurred in providing such benefits. Contractors employing apprentices or trainees under approved programs shall maintain written evidence of the registration of apprenticeship programs and certification of trainee programs, the registration of the apprentices and trainees, and the ratios and wage rates prescribed in the applicable programs.

b. (1) The contractor shall submit weekly for each week in which any contract work is performed a copy of all payrolls to the contracting agency. The payrolls submitted shall set out accurately and completely all of the information required to be maintained under 29 CFR 5.5(a)(3)(i), except that full social security numbers and home addresses shall not be included on weekly transmittals. Instead the payrolls shall only need to include an individually identifying number for each employee (e.g., the last four digits of the employee's social security number). The required weekly payroll information may be submitted in any form desired. Optional Form WH-347 is available for this purpose from the Wage and Hour Division Web site. The prime contractor is responsible for the submission of copies of payrolls by all subcontractors. Contractors and subcontractors shall maintain the full social security number and current address of each covered worker, and shall provide them upon request to the contracting agency for transmission to the State DOT, the FHWA or the Wage and Hour Division of the Department of Labor for purposes of an investigation or audit of compliance with prevailing wage requirements. It is not a violation of this section for a prime contractor to require a subcontractor to provide addresses and social security numbers to the prime contractor for its own records, without weekly submission to the contracting agency.

(2) Each payroll submitted shall be accompanied by a "Statement of Compliance," signed by the contractor or

subcontractor or his or her agent who pays or supervises the payment of the persons employed under the contract and shall certify the following:

(i) That the payroll for the payroll period contains the information required to be provided under 29 CFR 5.5(a)(3)(ii), the appropriate information is being maintained under 29 CFR 5.5(a)(3)(i), and that such information is correct and complete;

(ii) That each laborer or mechanic (including each helper, apprentice, and trainee) employed on the contract during the payroll period has been paid the full weekly wages earned, without rebate, either directly or indirectly, and that no deductions have been made either directly or indirectly from the full wages earned, other than permissible deductions as set forth in 29 CFR part 3;

(iii) That each laborer or mechanic has been paid not less than the applicable wage rates and fringe benefits or cash equivalents for the classification of work performed, as specified in the applicable wage determination incorporated into the contract.

(3) The weekly submission of a properly executed certification set forth on the reverse side of Optional Form WH-347 shall satisfy the requirement for submission of the "Statement of Compliance" required by paragraph 3.b.(2) of this section.

(4) The falsification of any of the above certifications may subject the contractor or subcontractor to civil or criminal prosecution under 18 U.S.C. 1001 and 31 U.S.C. 231.

c. The contractor or subcontractor shall make the records required under paragraph 3.a. of this section available for inspection, copying, or transcription by authorized representatives of the contracting agency, the State DOT, the FHWA, or the Department of Labor, and shall permit such representatives to interview employees during working hours on the job. If the contractor or subcontractor fails to submit the required records or to make them available, the FHWA may, after written notice to the contractor, the contracting agency or the State DOT, take such action as may be necessary to cause the suspension of any further payment, advance, or guarantee of funds. Furthermore, failure to submit the required records upon request or to make such records available may be grounds for debarment action pursuant to 29 CFR 5.12.

4. Apprentices and trainees (29 CFR 5.5)

a. Apprentices (programs of the USDOL).

Apprentices will be permitted to work at less than the predetermined rate for the work they performed when they are employed pursuant to and individually registered in a bona fide apprenticeship program registered with the U.S. Department of Labor, Employment and Training Administration, Office of Apprenticeship Training, Employer and Labor Services, or with a State Apprenticeship Agency recognized by the Office, or if a person is employed in his or her first 90 days of probationary employment as an apprentice in such an apprenticeship program, who is not individually registered in the program, but who has been certified by the Office of Apprenticeship Training, Employer and Labor Services or a State

Apprenticeship Agency (where appropriate) to be eligible for probationary employment as an apprentice.

The allowable ratio of apprentices to journeymen on the job site in any craft classification shall not be greater than the ratio permitted to the contractor as to the entire work force under the registered program. Any worker listed on a payroll at an apprentice wage rate, who is not registered or otherwise employed as stated above, shall be paid not less than the applicable wage rate on the wage determination for the classification of work actually performed. In addition, any apprentice performing work on the job site in excess of the ratio permitted under the registered program shall be paid not less than the applicable wage rate on the wage determination for the work actually performed. Where a contractor is performing construction on a project in a locality other than that in which its program is registered, the ratios and wage rates (expressed in percentages of the journeyman's hourly rate) specified in the contractor's or subcontractor's registered program shall be observed.

Every apprentice must be paid at not less than the rate specified in the registered program for the apprentice's level of progress, expressed as a percentage of the journeymen hourly rate specified in the applicable wage determination. Apprentices shall be paid fringe benefits in accordance with the provisions of the apprenticeship program. If the apprenticeship program does not specify fringe benefits, apprentices must be paid the full amount of fringe benefits listed on the wage determination for the applicable classification. If the Administrator determines that a different practice prevails for the applicable apprentice classification, fringes shall be paid in accordance with that determination.

In the event the Office of Apprenticeship Training, Employer and Labor Services, or a State Apprenticeship Agency recognized by the Office, withdraws approval of an apprenticeship program, the contractor will no longer be permitted to utilize apprentices at less than the applicable predetermined rate for the work performed until an acceptable program is approved.

b. Trainees (programs of the USDOL).

Except as provided in 29 CFR 5.16, trainees will not be permitted to work at less than the predetermined rate for the work performed unless they are employed pursuant to and individually registered in a program which has received prior approval, evidenced by formal certification by the U.S. Department of Labor, Employment and Training Administration.

The ratio of trainees to journeymen on the job site shall not be greater than permitted under the plan approved by the Employment and Training Administration.

Every trainee must be paid at not less than the rate specified in the approved program for the trainee's level of progress, expressed as a percentage of the journeyman hourly rate specified in the applicable wage determination. Trainees shall be paid fringe benefits in accordance with the provisions of the trainee program. If the trainee program does not mention fringe benefits, trainees shall be paid the full amount of fringe benefits listed on the wage determination unless the Administrator of the Wage and Hour Division determines that there is an apprenticeship program associated with the

corresponding journeyman wage rate on the wage determination which provides for less than full fringe benefits for apprentices. Any employee listed on the payroll at a trainee rate who is not registered and participating in a training plan approved by the Employment and Training Administration shall be paid not less than the applicable wage rate on the wage determination for the classification of work actually performed. In addition, any trainee performing work on the job site in excess of the ratio permitted under the registered program shall be paid not less than the applicable wage rate on the wage determination for the work actually performed.

In the event the Employment and Training Administration withdraws approval of a training program, the contractor will no longer be permitted to utilize trainees at less than the applicable predetermined rate for the work performed until an acceptable program is approved.

c. Equal employment opportunity. The utilization of apprentices, trainees and journeymen under this part shall be in conformity with the equal employment opportunity requirements of Executive Order 11246, as amended, and 29 CFR part 30.

d. Apprentices and Trainees (programs of the U.S. DOT).

Apprentices and trainees working under apprenticeship and skill training programs which have been certified by the Secretary of Transportation as promoting EEO in connection with Federal-aid highway construction programs are not subject to the requirements of paragraph 4 of this Section IV. 29 CFR 230.111(e)(2). The straight time hourly wage rates for apprentices and trainees under such programs will be established by the particular programs. The ratio of apprentices and trainees to journeymen shall not be greater than permitted by the terms of the particular program.

5. Compliance with Copeland Act requirements. The contractor shall comply with the requirements of 29 CFR part 3, which are incorporated by reference in this contract as provided in 29 CFR 5.5.

6. Subcontracts. The contractor or subcontractor shall insert Form FHWA-1273 in any subcontracts and also require the subcontractors to include Form FHWA-1273 in any lower tier subcontracts. The prime contractor shall be responsible for the compliance by any subcontractor or lower tier subcontractor with all the contract clauses in 29 CFR 5.5.

7. Contract termination: debarment. A breach of the contract clauses in 29 CFR 5.5 may be grounds for termination of the contract, and for debarment as a contractor and a subcontractor as provided in 29 CFR 5.12.

8. Compliance with Davis-Bacon and Related Act requirements. All rulings and interpretations of the Davis-Bacon and Related Acts contained in 29 CFR parts 1, 3, and 5 are herein incorporated by reference in this contract as provided in 29 CFR 5.5.

9. Disputes concerning labor standards. As provided in 29 CFR 5.5, disputes arising out of the labor standards provisions of this contract shall not be subject to the general disputes clause of this contract. Such disputes shall be resolved in accordance with the procedures of the Department of Labor

set forth in 29 CFR parts 5, 6, and 7. Disputes within the meaning of this clause include disputes between the contractor (or any of its subcontractors) and the contracting agency, the U.S. Department of Labor, or the employees or their representatives.

10. Certification of eligibility (29 CFR 5.5)

a. By entering into this contract, the contractor certifies that neither it (nor he or she) nor any person or firm who has an interest in the contractor's firm is a person or firm ineligible to be awarded Government contracts by virtue of section 3(a) of the Davis-Bacon Act or 29 CFR 5.12(a)(1).

b. No part of this contract shall be subcontracted to any person or firm ineligible for award of a Government contract by virtue of section 3(a) of the Davis-Bacon Act or 29 CFR 5.12(a)(1).

c. The penalty for making false statements is prescribed in the U.S. Criminal Code, 18 U.S.C. 1001.

V. CONTRACT WORK HOURS AND SAFETY STANDARDS ACT

Pursuant to 29 CFR 5.5(b), the following clauses apply to any Federal-aid construction contract in an amount in excess of \$100,000 and subject to the overtime provisions of the Contract Work Hours and Safety Standards Act. These clauses shall be inserted in addition to the clauses required by 29 CFR 5.5(a) or 29 CFR 4.6. As used in this paragraph, the terms laborers and mechanics include watchmen and guards.

1. Overtime requirements. No contractor or subcontractor contracting for any part of the contract work which may require or involve the employment of laborers or mechanics shall require or permit any such laborer or mechanic in any workweek in which he or she is employed on such work to work in excess of forty hours in such workweek unless such laborer or mechanic receives compensation at a rate not less than one and one-half times the basic rate of pay for all hours worked in excess of forty hours in such workweek. 29 CFR 5.5.

2. Violation; liability for unpaid wages; liquidated damages. In the event of any violation of the clause set forth in paragraph 1 of this section, the contractor and any subcontractor responsible therefor shall be liable for the unpaid wages. In addition, such contractor and subcontractor shall be liable to the United States (in the case of work done under contract for the District of Columbia or a territory, to such District or to such territory), for liquidated damages. Such liquidated damages shall be computed with respect to each individual laborer or mechanic, including watchmen and guards, employed in violation of the clause set forth in paragraph 1 of this section, in the sum currently provided in 29 CFR 5.5(b)(2)* for each calendar day on which such individual was required or permitted to work in excess of the standard workweek of forty hours without payment of the overtime wages required by the clause set forth in paragraph 1 of this section. 29 CFR 5.5.

* \$27 as of January 23, 2019 (See 84 FR 213-01, 218) as may be adjusted annually by the Department of Labor; pursuant to the Federal Civil Penalties Inflation Adjustment Act of 1990).

3. Withholding for unpaid wages and liquidated damages.

The FHWA or the contracting agency shall upon its own action or upon written request of an authorized representative of the Department of Labor withhold or cause to be withheld, from any moneys payable on account of work performed by the contractor or subcontractor under any such contract or any other Federal contract with the same prime contractor, or any other federally-assisted contract subject to the Contract Work Hours and Safety Standards Act, which is held by the same prime contractor, such sums as may be determined to be necessary to satisfy any liabilities of such contractor or subcontractor for unpaid wages and liquidated damages as provided in the clause set forth in paragraph 2 of this section. 29 CFR 5.5.

4. Subcontracts. The contractor or subcontractor shall insert in any subcontracts the clauses set forth in paragraphs 1 through 4 of this section and also a clause requiring the subcontractors to include these clauses in any lower tier subcontracts. The prime contractor shall be responsible for compliance by any subcontractor or lower tier subcontractor with the clauses set forth in paragraphs 1 through 4 of this section. 29 CFR 5.5.

VI. SUBLETTING OR ASSIGNING THE CONTRACT

This provision is applicable to all Federal-aid construction contracts on the National Highway System pursuant to 23 CFR 635.116.

1. The contractor shall perform with its own organization contract work amounting to not less than 30 percent (or a greater percentage if specified elsewhere in the contract) of the total original contract price, excluding any specialty items designated by the contracting agency. Specialty items may be performed by subcontract and the amount of any such specialty items performed may be deducted from the total original contract price before computing the amount of work required to be performed by the contractor's own organization (23 CFR 635.116).

a. The term "perform work with its own organization" in paragraph 1 of Section VI refers to workers employed or leased by the prime contractor, and equipment owned or rented by the prime contractor, with or without operators. Such term does not include employees or equipment of a subcontractor or lower tier subcontractor, agents of the prime contractor, or any other assignees. The term may include payments for the costs of hiring leased employees from an employee leasing firm meeting all relevant Federal and State regulatory requirements. Leased employees may only be included in this term if the prime contractor meets all of the following conditions: (based on longstanding interpretation)

- (1) the prime contractor maintains control over the supervision of the day-to-day activities of the leased employees;
- (2) the prime contractor remains responsible for the quality of the work of the leased employees;
- (3) the prime contractor retains all power to accept or exclude individual employees from work on the project; and
- (4) the prime contractor remains ultimately responsible for the payment of predetermined minimum wages, the submission of payrolls, statements of compliance and all other Federal regulatory requirements.

b. "Specialty Items" shall be construed to be limited to work that requires highly specialized knowledge, abilities, or

equipment not ordinarily available in the type of contracting organizations qualified and expected to bid or propose on the contract as a whole and in general are to be limited to minor components of the overall contract. 23 CFR 635.102.

2. Pursuant to 23 CFR 635.116(a), the contract amount upon which the requirements set forth in paragraph (1) of Section VI is computed includes the cost of material and manufactured products which are to be purchased or produced by the contractor under the contract provisions.

3. Pursuant to 23 CFR 635.116(c), the contractor shall furnish (a) a competent superintendent or supervisor who is employed by the firm, has full authority to direct performance of the work in accordance with the contract requirements, and is in charge of all construction operations (regardless of who performs the work) and (b) such other of its own organizational resources (supervision, management, and engineering services) as the contracting officer determines is necessary to assure the performance of the contract.

4. No portion of the contract shall be sublet, assigned or otherwise disposed of except with the written consent of the contracting officer, or authorized representative, and such consent when given shall not be construed to relieve the contractor of any responsibility for the fulfillment of the contract. Written consent will be given only after the contracting agency has assured that each subcontract is evidenced in writing and that it contains all pertinent provisions and requirements of the prime contract. (based on long-standing interpretation of 23 CFR 635.116).

5. The 30-percent self-performance requirement of paragraph (1) is not applicable to design-build contracts; however, contracting agencies may establish their own self-performance requirements. 23 CFR 635.116(d).

VII. SAFETY: ACCIDENT PREVENTION

This provision is applicable to all Federal-aid construction contracts and to all related subcontracts.

1. In the performance of this contract the contractor shall comply with all applicable Federal, State, and local laws governing safety, health, and sanitation (23 CFR Part 635). The contractor shall provide all safeguards, safety devices and protective equipment and take any other needed actions as it determines, or as the contracting officer may determine, to be reasonably necessary to protect the life and health of employees on the job and the safety of the public and to protect property in connection with the performance of the work covered by the contract. 23 CFR 635.108.

2. It is a condition of this contract, and shall be made a condition of each subcontract, which the contractor enters into pursuant to this contract, that the contractor and any subcontractor shall not permit any employee, in performance of the contract, to work in surroundings or under conditions which are unsanitary, hazardous or dangerous to his/her health or safety, as determined under construction safety and health standards (29 CFR Part 1926) promulgated by the Secretary of Labor, in accordance with Section 107 of the Contract Work Hours and Safety Standards Act (40 U.S.C. 3704). 29 CFR 1926.10.

3. Pursuant to 29 CFR 1926.3, it is a condition of this contract that the Secretary of Labor or authorized representative thereof, shall have right of entry to any site of contract performance to inspect or investigate the matter of compliance

with the construction safety and health standards and to carry out the duties of the Secretary under Section 107 of the Contract Work Hours and Safety Standards Act (40 U.S.C. 3704).

VIII. FALSE STATEMENTS CONCERNING HIGHWAY PROJECTS

This provision is applicable to all Federal-aid construction contracts and to all related subcontracts.

In order to assure high quality and durable construction in conformity with approved plans and specifications and a high degree of reliability on statements and representations made by engineers, contractors, suppliers, and workers on Federal-aid highway projects, it is essential that all persons concerned with the project perform their functions as carefully, thoroughly, and honestly as possible. Willful falsification, distortion, or misrepresentation with respect to any facts related to the project is a violation of Federal law. To prevent any misunderstanding regarding the seriousness of these and similar acts, Form FHWA-1022 shall be posted on each Federal-aid highway project (23 CFR Part 635) in one or more places where it is readily available to all persons concerned with the project:

18 U.S.C. 1020 reads as follows:

"Whoever, being an officer, agent, or employee of the United States, or of any State or Territory, or whoever, whether a person, association, firm, or corporation, knowingly makes any false statement, false representation, or false report as to the character, quality, quantity, or cost of the material used or to be used, or the quantity or quality of the work performed or to be performed, or the cost thereof in connection with the submission of plans, maps, specifications, contracts, or costs of construction on any highway or related project submitted for approval to the Secretary of Transportation; or

Whoever knowingly makes any false statement, false representation, false report or false claim with respect to the character, quality, quantity, or cost of any work performed or to be performed, or materials furnished or to be furnished, in connection with the construction of any highway or related project approved by the Secretary of Transportation; or

Whoever knowingly makes any false statement or false representation as to material fact in any statement, certificate, or report submitted pursuant to provisions of the Federal-aid Roads Act approved July 11, 1916, (39 Stat. 355), as amended and supplemented;

Shall be fined under this title or imprisoned not more than 5 years or both."

IX. IMPLEMENTATION OF CLEAN AIR ACT AND FEDERAL WATER POLLUTION CONTROL ACT (42 U.S.C. 7606; 2 CFR 200.88; EO 11738)

This provision is applicable to all Federal-aid construction contracts in excess of \$150,000 and to all related subcontracts. 48 CFR 2.101; 2 CFR 200.326.

By submission of this bid/proposal or the execution of this contract or subcontract, as appropriate, the bidder, proposer, Federal-aid construction contractor, subcontractor, supplier, or vendor agrees to comply with all applicable standards, orders

or regulations issued pursuant to the Clean Air Act (42 U.S.C. 7401-7671q) and the Federal Water Pollution Control Act, as amended (33 U.S.C. 1251-1387). Violations must be reported to the Federal Highway Administration and the Regional Office of the Environmental Protection Agency. 2 CFR Part 200, Appendix II.

The contractor agrees to include or cause to be included the requirements of this Section in every subcontract, and further agrees to take such action as the contracting agency may direct as a means of enforcing such requirements. 2 CFR 200.326.

X. CERTIFICATION REGARDING DEBARMENT, SUSPENSION, INELIGIBILITY AND VOLUNTARY EXCLUSION

This provision is applicable to all Federal-aid construction contracts, design-build contracts, subcontracts, lower-tier subcontracts, purchase orders, lease agreements, consultant contracts or any other covered transaction requiring FHWA approval or that is estimated to cost \$25,000 or more – as defined in 2 CFR Parts 180 and 1200. 2 CFR 180.220 and 1200.220.

1. Instructions for Certification – First Tier Participants:

a. By signing and submitting this proposal, the prospective first tier participant is providing the certification set out below.

b. The inability of a person to provide the certification set out below will not necessarily result in denial of participation in this covered transaction. The prospective first tier participant shall submit an explanation of why it cannot provide the certification set out below. The certification or explanation will be considered in connection with the department or agency's determination whether to enter into this transaction. However, failure of the prospective first tier participant to furnish a certification or an explanation shall disqualify such a person from participation in this transaction. 2 CFR 180.320.

c. The certification in this clause is a material representation of fact upon which reliance was placed when the contracting agency determined to enter into this transaction. If it is later determined that the prospective participant knowingly rendered an erroneous certification, in addition to other remedies available to the Federal Government, the contracting agency may terminate this transaction for cause of default. 2 CFR 180.325.

d. The prospective first tier participant shall provide immediate written notice to the contracting agency to whom this proposal is submitted if any time the prospective first tier participant learns that its certification was erroneous when submitted or has become erroneous by reason of changed circumstances. 2 CFR 180.345 and 180.350.

e. The terms "covered transaction," "debarred," "suspended," "ineligible," "participant," "person," "principal," and "voluntarily excluded," as used in this clause, are defined in 2 CFR Parts 180, Subpart I, 180.900-180.1020, and 1200. "First Tier Covered Transactions" refers to any covered transaction between a recipient or subrecipient of Federal funds and a participant (such as the prime or general contract). "Lower Tier Covered Transactions" refers to any covered transaction under a First Tier Covered Transaction (such as subcontracts). "First Tier Participant" refers to the participant

who has entered into a covered transaction with a recipient or subrecipient of Federal funds (such as the prime or general contractor). "Lower Tier Participant" refers any participant who has entered into a covered transaction with a First Tier Participant or other Lower Tier Participants (such as subcontractors and suppliers).

f. The prospective first tier participant agrees by submitting this proposal that, should the proposed covered transaction be entered into, it shall not knowingly enter into any lower tier covered transaction with a person who is debarred, suspended, declared ineligible, or voluntarily excluded from participation in this covered transaction, unless authorized by the department or agency entering into this transaction. 2 CFR 180.330.

g. The prospective first tier participant further agrees by submitting this proposal that it will include the clause titled "Certification Regarding Debarment, Suspension, Ineligibility and Voluntary Exclusion-Lower Tier Covered Transactions," provided by the department or contracting agency, entering into this covered transaction, without modification, in all lower tier covered transactions and in all solicitations for lower tier covered transactions exceeding the \$25,000 threshold. 2 CFR 180.220 and 180.300.

h. A participant in a covered transaction may rely upon a certification of a prospective participant in a lower tier covered transaction that is not debarred, suspended, ineligible, or voluntarily excluded from the covered transaction, unless it knows that the certification is erroneous. 2 CFR 180.300; 180.320, and 180.325. A participant is responsible for ensuring that its principals are not suspended, debarred, or otherwise ineligible to participate in covered transactions. 2 CFR 180.335. To verify the eligibility of its principals, as well as the eligibility of any lower tier prospective participants, each participant may, but is not required to, check the System for Award Management website (<https://www.sam.gov/>). 2 CFR 180.300, 180.320, and 180.325.

i. Nothing contained in the foregoing shall be construed to require the establishment of a system of records in order to render in good faith the certification required by this clause. The knowledge and information of the prospective participant is not required to exceed that which is normally possessed by a prudent person in the ordinary course of business dealings.

j. Except for transactions authorized under paragraph (f) of these instructions, if a participant in a covered transaction knowingly enters into a lower tier covered transaction with a person who is suspended, debarred, ineligible, or voluntarily excluded from participation in this transaction, in addition to other remedies available to the Federal Government, the department or agency may terminate this transaction for cause or default. 2 CFR 180.325.

* * * * *

2. Certification Regarding Debarment, Suspension, Ineligibility and Voluntary Exclusion – First Tier Participants:

a. The prospective first tier participant certifies to the best of its knowledge and belief, that it and its principals:

(1) Are not presently debarred, suspended, proposed for debarment, declared ineligible, or voluntarily excluded from participating in covered transactions by any Federal department or agency, 2 CFR 180.335;.

(2) Have not within a three-year period preceding this proposal been convicted of or had a civil judgment rendered against them for commission of fraud or a criminal offense in connection with obtaining, attempting to obtain, or performing a public (Federal, State, or local) transaction or contract under a public transaction; violation of Federal or State antitrust statutes or commission of embezzlement, theft, forgery, bribery, falsification or destruction of records, making false statements, or receiving stolen property, 2 CFR 180.800;

(3) Are not presently indicted for or otherwise criminally or civilly charged by a governmental entity (Federal, State or local) with commission of any of the offenses enumerated in paragraph (a)(2) of this certification, 2 CFR 180.700 and 180.800; and

(4) Have not within a three-year period preceding this application/proposal had one or more public transactions (Federal, State or local) terminated for cause or default. 2 CFR 180.335(d).

(5) Are not a corporation that has been convicted of a felony violation under any Federal law within the two-year period preceding this proposal (USDOT Order 4200.6 implementing appropriations act requirements); and

(6) Are not a corporation with any unpaid Federal tax liability that has been assessed, for which all judicial and administrative remedies have been exhausted, or have lapsed, and that is not being paid in a timely manner pursuant to an agreement with the authority responsible for collecting the tax liability (USDOT Order 4200.6 implementing appropriations act requirements).

b. Where the prospective participant is unable to certify to any of the statements in this certification, such prospective participant should attach an explanation to this proposal. 2 CFR 180.335 and 180.340.

3. Instructions for Certification - Lower Tier Participants:

(Applicable to all subcontracts, purchase orders, and other lower tier transactions requiring prior FHWA approval or estimated to cost \$25,000 or more - 2 CFR Parts 180 and 1200). 2 CFR 180.220 and 1200.220.

a. By signing and submitting this proposal, the prospective lower tier participant is providing the certification set out below.

b. The certification in this clause is a material representation of fact upon which reliance was placed when this transaction was entered into. If it is later determined that the prospective lower tier participant knowingly rendered an erroneous certification, in addition to other remedies available to the Federal Government, the department, or agency with which this transaction originated may pursue available remedies, including suspension and/or debarment.

c. The prospective lower tier participant shall provide immediate written notice to the person to which this proposal is submitted if at any time the prospective lower tier participant learns that its certification was erroneous by reason of changed circumstances. 2 CFR 180.365.

d. The terms "covered transaction," "debarred," "suspended," "ineligible," "participant," "person," "principal," and "voluntarily excluded," as used in this clause, are defined in 2 CFR Parts 180, Subpart I, 180.900 – 180.1020, and 1200. You may contact the person to which this proposal is

submitted for assistance in obtaining a copy of those regulations. "First Tier Covered Transactions" refers to any covered transaction between a recipient or subrecipient of Federal funds and a participant (such as the prime or general contractor). "Lower Tier Covered Transactions" refers to any covered transaction under a First Tier Covered Transaction (such as subcontracts). "First Tier Participant" refers to the participant who has entered into a covered transaction with a recipient or subrecipient of Federal funds (such as the prime or general contractor). "Lower Tier Participant" refers any participant who has entered into a covered transaction with a First Tier Participant or other Lower Tier Participants (such as subcontractors and suppliers).

e. The prospective lower tier participant agrees by submitting this proposal that, should the proposed covered transaction be entered into, it shall not knowingly enter into any lower tier covered transaction with a person who is debarred, suspended, declared ineligible, or voluntarily excluded from participation in this covered transaction, unless authorized by the department or agency with which this transaction originated. 2 CFR 1200.220 and 1200.332.

f. The prospective lower tier participant further agrees by submitting this proposal that it will include this clause titled "Certification Regarding Debarment, Suspension, Ineligibility and Voluntary Exclusion-Lower Tier Covered Transaction," without modification, in all lower tier covered transactions and in all solicitations for lower tier covered transactions exceeding the \$25,000 threshold. 2 CFR 180.220 and 1200.220.

g. A participant in a covered transaction may rely upon a certification of a prospective participant in a lower tier covered transaction that is not debarred, suspended, ineligible, or voluntarily excluded from the covered transaction, unless it knows that the certification is erroneous. A participant is responsible for ensuring that its principals are not suspended, debarred, or otherwise ineligible to participate in covered transactions. To verify the eligibility of its principals, as well as the eligibility of any lower tier prospective participants, each participant may, but is not required to, check the System for Award Management website (<https://www.sam.gov/>), which is compiled by the General Services Administration. 2 CFR 180.300, 180.320, 180.330, and 180.335.

h. Nothing contained in the foregoing shall be construed to require establishment of a system of records in order to render in good faith the certification required by this clause. The knowledge and information of participant is not required to exceed that which is normally possessed by a prudent person in the ordinary course of business dealings.

i. Except for transactions authorized under paragraph e of these instructions, if a participant in a covered transaction knowingly enters into a lower tier covered transaction with a person who is suspended, debarred, ineligible, or voluntarily excluded from participation in this transaction, in addition to other remedies available to the Federal Government, the department or agency with which this transaction originated may pursue available remedies, including suspension and/or debarment. 2 CFR 180.325.

* * * * *

Certification Regarding Debarment, Suspension, Ineligibility and Voluntary Exclusion--Lower Tier Participants:

1. The prospective lower tier participant certifies, by submission of this proposal, that neither it nor its principals:

(a) is presently debarred, suspended, proposed for debarment, declared ineligible, or voluntarily excluded from participating in covered transactions by any Federal department or agency, 2 CFR 180.355;

(b) is a corporation that has been convicted of a felony violation under any Federal law within the two-year period preceding this proposal (USDOT Order 4200.6 implementing appropriations act requirements); and

(c) is a corporation with any unpaid Federal tax liability that has been assessed, for which all judicial and administrative remedies have been exhausted, or have lapsed, and that is not being paid in a timely manner pursuant to an agreement with the authority responsible for collecting the tax liability. (USDOT Order 4200.6 implementing appropriations act requirements)

2. Where the prospective lower tier participant is unable to certify to any of the statements in this certification, such prospective participant should attach an explanation to this proposal.

* * * * *

XI. CERTIFICATION REGARDING USE OF CONTRACT FUNDS FOR LOBBYING

This provision is applicable to all Federal-aid construction contracts and to all related subcontracts which exceed \$100,000. 49 CFR Part 20, App. A.

1. The prospective participant certifies, by signing and submitting this bid or proposal, to the best of his or her knowledge and belief, that:

a. No Federal appropriated funds have been paid or will be paid, by or on behalf of the undersigned, to any person for influencing or attempting to influence an officer or employee of any Federal agency, a Member of Congress, an officer or employee of Congress, or an employee of a Member of Congress in connection with the awarding of any Federal contract, the making of any Federal grant, the making of any Federal loan, the entering into of any cooperative agreement, and the extension, continuation, renewal, amendment, or modification of any Federal contract, grant, loan, or cooperative agreement.

b. If any funds other than Federal appropriated funds have been paid or will be paid to any person for influencing or attempting to influence an officer or employee of any Federal agency, a Member of Congress, an officer or employee of Congress, or an employee of a Member of Congress in connection with this Federal contract, grant, loan, or cooperative agreement, the undersigned shall complete and submit Standard Form-LLL, "Disclosure Form to Report Lobbying," in accordance with its instructions.

2. This certification is a material representation of fact upon which reliance was placed when this transaction was made or entered into. Submission of this certification is a prerequisite for making or entering into this transaction imposed by 31 U.S.C. 1352. Any person who fails to file the required certification shall be subject to a civil penalty of not less than \$10,000 and not more than \$100,000 for each such failure.

3. The prospective participant also agrees by submitting its bid or proposal that the participant shall require that the language of this certification be included in all lower tier

subcontracts, which exceed \$100,000 and that all such recipients shall certify and disclose accordingly.

XII. USE OF UNITED STATES-FLAG VESSELS:

This provision is applicable to all Federal-aid construction contracts, design-build contracts, subcontracts, lower-tier subcontracts, purchase orders, lease agreements, or any other covered transaction. 46 CFR Part 381.

This requirement applies to material or equipment that is acquired for a specific Federal-aid highway project. 46 CFR 381.7. It is not applicable to goods or materials that come into inventories independent of an FHWA funded-contract.

When oceanic shipments (or shipments across the Great Lakes) are necessary for materials or equipment acquired for a specific Federal-aid construction project, the bidder, proposer, contractor, subcontractor, or vendor agrees:

1. To utilize privately owned United States-flag commercial vessels to ship at least 50 percent of the gross tonnage (computed separately for dry bulk carriers, dry cargo liners, and tankers) involved, whenever shipping any equipment, material, or commodities pursuant to this contract, to the extent such vessels are available at fair and reasonable rates for United States-flag commercial vessels. 46 CFR 381.7.
2. To furnish within 20 days following the date of loading for shipments originating within the United States or within 30 working days following the date of loading for shipments originating outside the United States, a legible copy of a rated, 'on-board' commercial ocean bill-of-lading in English for each shipment of cargo described in paragraph (b)(1) of this section to both the Contracting Officer (through the prime contractor in the case of subcontractor bills-of-lading) and to the Office of Cargo and Commercial Sealift (MAR-620), Maritime Administration, Washington, DC 20590. (MARAD requires copies of the ocean carrier's (master) bills of lading, certified onboard, dated, with rates and charges. These bills of lading may contain business sensitive information and therefore may be submitted directly to MARAD by the Ocean Transportation Intermediary on behalf of the contractor). 46 CFR 381.7.

Contract Provision - Cargo Preference Requirements

In accordance with Title 46 CFR § 381.7 (b), the contractor agrees—

“(1) To utilize privately owned United States-flag commercial vessels to ship at least 50 percent of the gross tonnage (computed separately for dry bulk carriers, dry cargo liners, and tankers) involved, whenever shipping any equipment, material, or commodities pursuant to this contract, to the extent such vessels are available at fair and reasonable rates for United States-flag commercial vessels.

(2) To furnish within 20 days following the date of loading for shipments originating within the United States or within 30 working days following the date of loading for shipments originating outside the United States, a legible copy of a rated, ‘on-board’ commercial ocean bill-of-lading in English for each shipment of cargo described in paragraph (b) (1) of this section to both the Contracting Officer (through the prime contractor in the case of subcontractor bills-of-lading) and to the Division of National Cargo, Office of Market Development, Maritime Administration, Washington, DC 20590.

(3) To insert the substance of the provisions of this clause in all subcontracts issued pursuant to this contract.”

Provisions (1) and (2) apply to materials or equipment that are acquired solely for the project. The two provisions do not apply to goods or materials that come into inventories independent of the project, such as shipments of Portland cement, asphalt cement, or aggregates, when industry suppliers and contractors use these materials to replenish existing inventories.

**MINIMUM WAGES FOR FEDERAL AND FEDERALLY
ASSISTED CONSTRUCTION CONTRACTS**

This project is funded, in part, with Federal-aid funds and, as such, is subject to the provisions of the Davis-Bacon Act of March 3, 1931, as amended (46 Sta. 1494, as amended, 40 U.S.C. 276a) and of other Federal statutes referred to in a 29 CFR Part 1, Appendix A, as well as such additional statutes as may from time to time be enacted containing provisions for the payment of wages determined to be prevailing by the Secretary of Labor in accordance with the Davis-Bacon Act and pursuant to the provisions of 29 CFR Part 1. The prevailing rates and fringe benefits shown in the General Wage Determination Decisions issued by the U.S. Department of Labor shall, in accordance with the provisions of the foregoing statutes, constitute the minimum wages payable on Federal and federally assisted construction projects to laborers and mechanics of the specified classes engaged on contract work of the character and in the localities described therein.

General Wage Determination Decisions, modifications and supersedes decisions thereto are to be used in accordance with the provisions of 29 CFR Parts 1 and 5. Accordingly, the applicable decision, together with any modifications issued, must be made a part of every contract for performance of the described work within the geographic area indicated as required by an applicable DBRA Federal prevailing wage law and 29 CFR Part 5. The wage rates and fringe benefits contained in the General Wage Determination Decision shall be the minimum paid by contractors and subcontractors to laborers and mechanics.