

RETURN WITH BID

LETTING DATE March 10, 2006

ITEM NUMBER 11A

Proposal Submitted By

Name

Address

City/State

Zip Code

Telephone Number

FEIN Number

FAX Number

BIDDERS NEED NOT RETURN THE ENTIRE PROPOSAL
(See instructions inside front cover)

NOTICE TO PROSPECTIVE BIDDERS

This proposal can be used for bidding purposes
by only those companies that request and receive written
AUTHORIZATION TO BID from IDOT's Central Bureau of
Construction.
(SEE INSTRUCTIONS ON THE INSIDE OF COVER)

PROPOSAL COVER SHEET



AIRPORT Quad-City International

MUNICIPAL DESIGNATION Moline

COUNTY DESIGNATION Rock Island

ILLINOIS PROJECT NO. MLI-3496

FEDERAL PROJECT NO. 3-17-0068-XX

PLEASE MARK THE APPROPRIATE BOX BELOW:

A Bid Bond is included.

A Cashier's Check or a Certified Check is included.

INSTRUCTIONS

ABOUT IDOT PROPOSALS: All proposals issued by IDOT are potential bidding proposals. Each proposal contains all Certifications and Affidavits, a Proposal Signature Sheet and a Proposal Bid Bond required for Prime Contractors to submit a bid after written **Authorization to Bid** has been issued by IDOT’s Central Bureau of Construction.

HOW MANY PROPOSALS SHOULD PROSPECTIVE BIDDERS REQUEST?: Prospective bidders should, prior to submitting their initial request for plans and proposals, determine their needs and request the total number of plans and proposals needed for each item requested. There will be a nonrefundable charge of \$15 for each set of plans and specifications issued.

WHO CAN BID?: Bids will be accepted from only those companies that request and receive written **Authorization to Bid** from IDOT’s Central Bureau of Construction.

WHAT CONSTITUTES WRITTEN AUTHORIZATION TO BID?: When a prospective prime bidder submits a “Request for Proposal Forms and Plans” he/she must indicate at that time which items are being requested For Bidding purposes. Only those items requested For Bidding will be analyzed. After the request has been analyzed, the bidder will be issued a **Proposal Denial and/or Authorization Form**, approved by the Central Bureau of Construction, that indicates which items have been approved For Bidding. If **Authorization to Bid** cannot be approved, the **Proposal Denial and/or Authorization Form** will indicate the reason for denial. If a contractor has requested to bid but has not received a **Proposal Denial and/or Authorization Form**, they should contact the Central Bureau of Construction in advance of the letting date.

WHAT MUST BE INCLUDED WHEN BIDS ARE SUBMITTED?: Bidders need not return the entire proposal when bids are submitted. That portion of the proposal that must be returned includes the following:

1. All documents from the Proposal Cover Sheet through the Proposal Bid Bond
2. Other special documentation and/or information that may be required by the contract special provisions

All proposal documents, including Proposal Guaranty Checks or Proposal Bid Bonds, should be stapled together to prevent loss when bids are processed by IDOT personnel.

ABOUT SUBMITTING BIDS: It is recommended that bidders deliver bids in person to insure they arrive at the proper location prior to the time specified for the receipt of bids. Any bid received at the place of letting after the time specified will not be accepted.

WHO SHOULD BE CALLED IF ASSISTANCE IS NEEDED?

Questions Regarding	Call
Prequalification and/or Authorization to Bid	217/782-3413
Preparation and submittal of bids	217/782-7806
Mailing of plans and proposals	217/782-7806

RETURN WITH BID



PROPOSAL

1. Proposal of _____

Taxpayer Identification Number (Mandatory) _____

for the improvement officially known as:

(a) Quad-City International Airport

(b) The proposed improvement shown in detail on the plans issued by the Department schedule and detail sheets included herein, includes, in general, the following described work:

Excavation and Construction of 6' Surcharge Embankment for Future Extensions to Runway 5 (500' X 150'), Taxiway D (745' X 50') and Taxiway K (770' X 50') along with Associated Utility Adjustments and Turfing.

TO THE DEPARTMENT OF TRANSPORTATION

2. The plans for the proposed work are those issued by the Department of Transportation to cover the work described above.

The specifications are those prepared by the Department of Transportation, Division of Aeronautics and designated as "Standard Specifications for Construction of Airports," adopted January, 1985, the "Supplemental Specifications and Recurring Special Provisions," adopted July 1, 2004 and the "Special Provisions" thereto, adopted and in effect on the date of invitation for bids.

3. **COMPLETION TIME/LIQUIDATED DAMAGES.** It being understood and agreed that the completion within the time limit is an essential part of the contract, the bidder agrees to complete the work within 91 calendar days, unless additional time is granted by the Engineer in accordance with the provisions of the specifications. In case of failure to complete the work on or before the time named herein, or within such extra time as may have been allowed by extensions, the bidder agrees that the Department of Transportation shall withhold from such sum as may be due him/her under the terms of this contract, the costs, as set forth below, which costs shall be considered and treated not as a penalty but as damages due to the State from the bidder by reason of the failure of the bidder to complete the work within the time specified in the contract. The following Schedule of Deductions supersedes the table given in Section 60-09 of the Division's Standard Specifications for Construction of Airports.

Schedule of Deductions for Each Day of Overrun in Contract Time

<u>Original Contract Amount</u>		<u>Daily Charge</u>
<u>From More Than</u>	<u>To and Including</u>	<u>Calendar Day</u>
\$ 0	\$ 25,000	\$ 300
25,000	100,000	375
100,000	500,000	550
500,000	1,000,000	725
1,000,000	2,000,000	900
2,000,000	3,000,000	1,100
3,000,000	5,000,000	1,300
5,000,000	7,500,000	1,450
7,500,000	10,000,000	1,650

A daily charge shall be made for every day shown on the calendar beyond the specified contract time in calendar days.

RETURN WITH BID

4. **ASSURANCE OF EXAMINATION AND INSPECTION/WAIVER.** The undersigned further declares that he/she has carefully examined the proposal, plans, specifications, supplemental and applicable recurring special provisions, form of contract and contract bonds, and special provisions, and that he/she has inspected in detail the site of the proposed work, and that he/she has familiarized themselves with all of the local conditions affecting the contract and the detailed requirements of construction, and understands that in making this proposal he/she waives all right to plead any misunderstanding regarding the same.

5. **EXECUTION OF CONTRACT AND CONTRACT BONDS.** The undersigned further agrees to execute a contract for this work and present the same to the department within fifteen (15) days after the contract has been mailed to him/her. The undersigned further agrees that he/she and his/her surety will execute and present within fifteen (15) days after the contract has been mailed to him/her contract bonds satisfactory to and in the form prescribed by the Department of Transportation, in the penal sum of the full amount of the contract, guaranteeing the faithful performance of the work in accordance with the terms of the contract and guaranteeing payment in full all bills and accounts for materials and labor used in the construction of the work.

6. **PROPOSAL GUARANTY.** Accompanying this proposal is either a bid bond on the department form, executed by a corporate surety company satisfactory to the department, or a proposal guaranty check consisting of a bank cashier's check or a properly certified check for not less than 5 per cent of the amount bid or for the amount specified in the following schedule:

<u>Amount of Bid</u>		<u>Proposal Guaranty</u>	<u>Amount of Bid</u>		<u>Proposal Guaranty</u>
Up to	\$5,000.....	\$150	\$2,000,000	to	\$3,000,000..... \$100,000
\$5,000	to	\$10,000.....\$300	\$3,000,000	to	\$5,000,000..... \$150,000
\$10,000	to	\$50,000.....\$1,000	\$5,000,000	to	\$7,500,000..... \$250,000
\$50,000	to	\$100,000.....\$3,000	\$7,500,000	to	\$10,000,000..... \$400,000
\$100,000	to	\$150,000.....\$5,000	\$10,000,000	to	\$15,000,000..... \$500,000
\$150,000	to	\$250,000.....\$7,500	\$15,000,000	to	\$20,000,000..... \$600,000
\$250,000	to	\$500,000.....\$12,500	\$20,000,000	to	\$25,000,000.....\$700,000
\$500,000	to	\$1,000,000.....\$25,000	\$25,000,000	to	\$30,000,000..... \$800,000
\$1,000,000	to	\$1,500,000.....\$50,000	\$30,000,000	to	\$35,000,000..... \$900,000
\$1,500,000	to	\$2,000,000.....\$75,000	over		\$35,000,000..... \$1,000,000

Bank cashier's checks or properly certified checks accompanying proposals shall be made payable to the Treasurer, State of Illinois, when the state is awarding authority; the county treasurer, when a county is the awarding authority; or the city, village, or town treasurer, when a city, village, or town is the awarding authority.

If a combination bid is submitted, the proposal guaranties which accompany the individual proposals making up the combination will be considered as also covering the combination bid.

The amount of the proposal guaranty check is _____ \$(). If this proposal is accepted and the undersigned shall fail to execute contract bonds as required herein, it is hereby agreed that the amount of the proposal guaranty shall become the property of the State of Illinois, and shall be considered as payment of damages due to delay and other causes suffered by the State because of the failure to execute said contract and contract bonds; otherwise, the bid bond shall become void or the proposal guaranty check shall be returned to the undersigned.

RETURN WITH BID

(e) The plans and Special Provisions for each separate contract shall be construed separately for all requirements, except as described in paragraphs (a) through (d) listed above.

When a combination bid is submitted, the schedule below must be completed in each proposal comprising the combination.

If alternate bids are submitted for one or more of the sections comprising the combination, a combination bid must be submitted for each alternate.

Schedule of Combination Bids

Combination No.	Sections Included in Combination	Combination Bid	
		Dollars	Cents

8. **SCHEDULE OF PRICES.** The undersigned submits herewith his/her schedule of prices covering the work to be performed under this contract; he/she understands that he/she must show in the schedule the unit prices (with no more than two decimal places, i.e. \$25.35, not \$25.348) for which he/she proposes to perform each item of work, that the extensions must be made by him/her, and that if not so done his/her proposal may be rejected as irregular.

The undersigned further agrees that the unit prices submitted herewith are for the purpose of obtaining a gross sum, and for use in computing the value of additions and deductions; that if there is a discrepancy between the gross sum bid and that resulting from the summation of the quantities multiplied by their respective unit prices, the latter shall govern.

COUNTY NAME	CODE	DIST	AIRPORT NAME	FED PROJECT	ILL PROJECT
ROCK ISLAND	161	02	QUAD-CITY INTERNATIONAL	3-17-0068-XX	ML-I -3496

ITEM NUMBER	PAY ITEM DESCRIPTION	UNIT OF MEASURE	QUANTITY	UNIT PRICE		TOTAL PRICE	
				DOLLARS	CENTS	DOLLARS	CTS
AR108158	1/C #8 5 KV UG CABLE IN UD	L.F.	670.000	X			
AR108258	2/C #8 5 KV UG CABLE IN UD	L.F.	80.000	X			
AR125415	MITL-BASE MOUNTED	EACH	5.000	X			
AR125931	REPLACE LIGHT LENSE	EACH	4.000	X			
AR125944	ADJUST TAXI GUIDANCE SIGN	EACH	1.000	X			
AR125962	RELOCATE BASE MOUNTED LIGHT	EACH	6.000	X			
AR125964	RELOCATE TAXI GUIDANCE SIGN	EACH	1.000	X			
AR150512	ENGINEERS FIELD OFFICE (MONTHLY)	C.M.	8.000	X			
AR150530	TRAFFIC MAINTENANCE	L.S.	1.000	X			
AR151450	CLEARING AND GRUBBING	ACRE	2.100	X			
AR152410	UNCLASSIFIED EXCAVATION	C.Y.	48,330.000	X			
AR152440	BORROW EXCAVATION	C.Y.	14,165.000	X			
AR156500	TEMPORARY EROSION CONTROL	L.S.	1.000	X			
AR209511	CRUSHED AGGREGATE BASE, (CA-1)	TON	100.000	X			
AR620510	PAVEMENT MARKING	S.F.	4,350.000	X			

ITEM NUMBER	PAY ITEM DESCRIPTION	UNIT OF MEASURE	QUANTITY	UNIT PRICE		TOTAL PRICE	
				DOLLARS	CENTS	DOLLARS	CTS
AR620900	PAVEMENT MARKING REMOVAL	S.F.	12,100.000 X	=			
AR801604	SETTLEMENT PLATES	EACH	8.000 X	=			
AR801605	REPLACE TAXI GUIDANCE SIGN PANEL	EACH	7.000 X	=			
AR801614	SUPPLY TAXI GUIDANCE SIGN PANEL	EACH	20.000 X	=			
AR901510	SEEDING	ACRE	21.000 X	=			
AR908513	MULCHING-METHOD 3	ACRE	21.000 X	=			

TOTAL \$

- NOTE:
1. EACH PAY ITEM SHOULD HAVE A UNIT PRICE AND A TOTAL PRICE.
 2. THE UNIT PRICE SHALL GOVERN IF NO TOTAL PRICE IS SHOWN OR IF THERE IS A DISCREPANCY BETWEEN THE PRODUCT OF THE UNIT PRICE MULTIPLIED BY THE QUANTITY.
 3. IF A UNIT PRICE IS OMITTED, THE TOTAL PRICE WILL BE DIVIDED BY THE QUANTITY IN ORDER TO ESTABLISH A UNIT PRICE.
 4. A BID MAY BE DECLARED UNACCEPTABLE IF NEITHER A UNIT PRICE NOR A TOTAL PRICE IS SHOWN.

RETURN WITH BID

THE PRECEDING SCHEDULE OF PRICES MUST BE

COMPLETED AND RETURNED.

RETURN WITH BID

**STATE REQUIRED ETHICAL
STANDARDS GOVERNING CONTRACT
PROCUREMENT: ASSURANCES, CERTIFICATIONS
AND DISCLOSURES**

I. GENERAL

A. Article 50 of the Illinois Procurement Code establishes the duty of all State chief procurement officers, State purchasing officers, and their designees to maximize the value of the expenditure of public moneys in procuring goods, services, and contracts for the State of Illinois and to act in a manner that maintains the integrity and public trust of State government. In discharging this duty, they are charged by law to use all available information, reasonable efforts, and reasonable actions to protect, safeguard, and maintain the procurement process of the State of Illinois.

B. In order to comply with the provisions of Article 50 and to carry out the duty established therein, all bidders are to adhere to ethical standards established for the procurement process, and to make such assurances, disclosures and certifications required by law. By execution of the Proposal Signature Sheet, the bidder indicates that each of the mandated assurances has been read and understood, that each certification is made and understood, and that each disclosure requirement has been understood and completed.

C. In addition to all other remedies provided by law, failure to comply with any assurance, failure to make any disclosure or the making of a false certification shall be grounds for termination of the contract and the suspension or debarment of the bidder.

II. ASSURANCES

A. The assurances hereinafter made by the bidder are each a material representation of fact upon which reliance is placed should the Department enter into the contract with the bidder. The Department may terminate the contract if it is later determined that the bidder rendered a false or erroneous assurance, and the surety providing the performance bond shall be responsible for the completion of the contract.

B. Felons

1. The Illinois Procurement Code provides:

Section 50-10. Felons. Unless otherwise provided, no person or business convicted of a felony shall do business with the State of Illinois or any state agency from the date of conviction until 5 years after the date of completion of the sentence for that felony, unless no person held responsible by a prosecutorial office for the facts upon which the conviction was based continues to have any involvement with the business.

2. The bidder assures the Department that the award and execution of the contract would not cause a violation of Section 50-10.

RETURN WITH BID

C. Conflicts of Interest

1. The Illinois Procurement Code provides in pertinent part:

Section 50-13. Conflicts of Interest.

(a) Prohibition. It is unlawful for any person holding an elective office in this State, holding a seat in the General Assembly, or appointed to or employed in any of the offices or agencies of state government and who receives compensation for such employment in excess of 60% of the salary of the Governor of the State of Illinois, or who is an officer or employee of the Capital Development Board or the Illinois Toll Highway Authority, or who is the spouse or minor child of any such person to have or acquire any contract, or any direct pecuniary interest in any contract therein, whether for stationery, printing, paper, or any services, materials, or supplies, that will be wholly or partially satisfied by the payment of funds appropriated by the General Assembly of the State of Illinois or in any contract of the Capital Development Board or the Illinois Toll Highway authority.

(b) Interests. It is unlawful for any firm, partnership, association or corporation, in which any person listed in subsection (a) is entitled to receive (i) more than 7 1/2% of the total distributable income or (ii) an amount in excess of the salary of the Governor, to have or acquire any such contract or direct pecuniary interest therein.

(c) Combined interests. It is unlawful for any firm, partnership, association, or corporation, in which any person listed in subsection (a) together with his or her spouse or minor children is entitled to receive (i) more than 15%, in the aggregate, of the total distributable income or (ii) an amount in excess of 2 times the salary of the Governor, to have or acquire any such contract or direct pecuniary interest therein.

(d) Securities. Nothing in this Section invalidates the provisions of any bond or other security previously offered or to be offered for sale or sold by or for the State of Illinois.

(e) Prior interests. This Section does not affect the validity of any contract made between the State and an officer or employee of the State or member of the General Assembly, his or her spouse, minor child or any combination of those persons if that contract was in existence before his or her election or employment as an officer, member, or employee. The contract is voidable, however, if it cannot be completed within 365 days after the officer, member, or employee takes office or is employed.

The current salary of the Governor is \$145,877.00. Sixty percent of the salary is \$87,526.20.

2. The bidder assures the Department that the award and execution of the contract would not cause a violation of Section 50-13, or that an effective exemption has been issued by the Board of Ethics to any individual subject to the Section 50-13 prohibitions pursuant to the provisions of Section 50-20 of the Code and Executive Order Number 3 (1998). Information concerning the exemption process is available from the Department upon request.

D. Negotiations

1. The Illinois Procurement Code provides in pertinent part:

Section 50-15. Negotiations.

(a) It is unlawful for any person employed in or on a continual contractual relationship with any of the offices or agencies of State government to participate in contract negotiations on behalf of that office or agency with any firm, partnership, association, or corporation with whom that person has a contract for future employment or is negotiating concerning possible future employment.

2. The bidder assures the Department that the award and execution of the contract would not cause a violation of Section 50-15, and that the bidder has no knowledge of any facts relevant to the kinds of acts prohibited therein.

RETURN WITH BID

E. Inducements

1. The Illinois Procurement Code provides:

Section 50-25. Inducement. Any person who offers or pays any money or other valuable thing to any person to induce him or her not to bid for a State contract or as recompense for not having bid on a State contract is guilty of a Class 4 felony. Any person who accepts any money or other valuable thing for not bidding for a State contract or who withholds a bid in consideration of the promise for the payment of money or other valuable thing is guilty of a Class 4 felony.

2. The bidder assures the Department that the award and execution of the contract would not cause a violation of Section 50-25, and that the bidder has no knowledge of any facts relevant to the kinds of acts prohibited therein.

F. Revolving Door Prohibition

1. The Illinois Procurement Code provides:

Section 50-30. Revolving door prohibition. Chief procurement officers, associate procurement officers, State purchasing officers, their designees whose principal duties are directly related to State procurement, and executive officers confirmed by the Senate are expressly prohibited for a period of 2 years after terminating an affected position from engaging in any procurement activity relating to the State agency most recently employing them in an affected position for a period of at least 6 months. The prohibition includes, but is not limited to: lobbying the procurement process; specifying; bidding; proposing bid, proposal, or contract documents; on their own behalf or on behalf of any firm, partnership, association, or corporation. This Section applies only to persons who terminate an affected position on or after January 15, 1999.

2. The bidder assures the Department that the award and execution of the contract would not cause a violation of Section 50-30, and that the bidder has no knowledge of any facts relevant to the kinds of acts prohibited therein.

G. Reporting Anticompetitive Practices

1. The Illinois Procurement Code provides:

Section 50-40. Reporting anticompetitive practices. When, for any reason, any vendor, bidder, contractor, chief procurement officer, State purchasing officer, designee, elected official, or State employee suspects collusion or other anticompetitive practice among any bidders, offers, contractors, proposers, or employees of the State, a notice of the relevant facts shall be transmitted to the Attorney General and the chief procurement officer.

2. The bidder assures the Department that it has not failed to report any relevant facts concerning the practices addressed in Section 50-40 which may involve the contract for which the bid is submitted.

H. Confidentiality

1. The Illinois Procurement Code provides:

Section 50-45. Confidentiality. Any chief procurement officer, State purchasing officer, designee, or executive officer who willfully uses or allows the use of specifications, competitive bid documents, proprietary competitive information, proposals, contracts, or selection information to compromise the fairness or integrity of the procurement, bidding, or contract process shall be subject to immediate dismissal, regardless of the Personnel code, any contract, or any collective bargaining agreement, and may in addition be subject to criminal prosecution.

2. The bidder assures the Department that it has no knowledge of any fact relevant to the practices addressed in Section 50-45 which may involve the contract for which the bid is submitted.

RETURN WITH BID

I. Insider Information

1. The Illinois Procurement Act provides:

Section 50-50. Insider information. It is unlawful for any current or former elected or appointed State official or State employee to knowingly use confidential information available only by virtue of that office or employment for actual or anticipated gain for themselves or another person.

2. The bidder assures the Department that it has no knowledge of any facts relevant to the practices addressed in Section 50-50 which may involve the contract for which the bid is submitted.

III. CERTIFICATIONS

A. The certifications hereinafter made by the bidder are each a material representation of fact upon which reliance is placed should the Department enter into the contract with the bidder. The Department may terminate the contract if it is later determined that the bidder rendered a false or erroneous certification, and the surety providing the performance bond shall be responsible for completion of the contract.

B. Bribery

1. The Illinois Procurement Code provides:

Section 50-5. Bribery.

(a) Prohibition. No person or business shall be awarded a contract or subcontract under this Code who:

(1) has been convicted under the laws of Illinois or any other state of bribery or attempting to bribe an officer or employee of the State of Illinois or any other state in that officer's or employee's official capacity; or

(2) has made an admission of guilt of that conduct that is a matter of record but has not been prosecuted for that conduct.

(b) Businesses. No business shall be barred from contracting with any unit of State or local government as a result of a conviction under this Section of any employee or agent of the business if the employee or agent is no longer employed by the business and:

(1) the business has been finally adjudicated not guilty; or

(2) the business demonstrates to the governmental entity with which it seeks to contract, and that entity finds that the commission of the offense was not authorized, requested, commanded, or performed by a director, officer, or high managerial agent on behalf of the business as provided in paragraph (2) of subsection (a) of Section 5-4 of the Criminal Code of 1961.

(c) Conduct on behalf of business. For purposes of this Section, when an official, agent, or employee of a business committed the bribery or attempted bribery on behalf of the business and in accordance with the direction or authorization of a responsible official of the business, the business shall be chargeable with the conduct.

(d) Certification. Every bid submitted to and contract executed by the State shall contain a certification by the contractor that the contractor is not barred from being awarded a contract or subcontract under this Section. A contractor who makes a false statement, material to the certification, commits a Class 3 felony.

2. The bidder certifies that it is not barred from being awarded a contract under Section 50.5.

RETURN WITH BID

C. Educational Loan

1. Section 3 of the Educational Loan Default Act provides:

§ 3. No State agency shall contract with an individual for goods or services if that individual is in default, as defined in Section 2 of this Act, on an educational loan. Any contract used by any State agency shall include a statement certifying that the individual is not in default on an educational loan as provided in this Section.

2. The bidder, if an individual as opposed to a corporation, partnership or other form of business organization, certifies that the bidder is not in default on an educational loan as provided in Section 3 of the Act.

D. Bid-Rigging/Bid Rotating

1. Section 33E-11 of the Criminal Code of 1961 provides:

§ 33E-11. (a) Every bid submitted to and public contract executed pursuant to such bid by the State or a unit of local government shall contain a certification by the prime contractor that the prime contractor is not barred from contracting with any unit of State or local government as a result of a violation of either Section 33E-3 or 33E-4 of this Article. The State and units of local government shall provide the appropriate forms for such certification.

(b) A contractor who makes a false statement, material to the certification, commits a Class 3 felony.

A violation of Section 33E-3 would be represented by a conviction of the crime of bid-rigging which, in addition to Class 3 felony sentencing, provides that any person convicted of this offense or any similar offense of any state or the United States which contains the same elements as this offense shall be barred for 5 years from the date of conviction from contracting with any unit of State or local government. No corporation shall be barred from contracting with any unit of State or local government as a result of a conviction under this Section of any employee or agent of such corporation if the employee so convicted is no longer employed by the corporation and: (1) it has been finally adjudicated not guilty or (2) if it demonstrates to the governmental entity with which it seeks to contract and that entity finds that the commission of the offense was neither authorized, requested, commanded, nor performed by a director, officer or a high managerial agent in behalf of the corporation.

A violation of Section 33E-4 would be represented by a conviction of the crime of bid-rotating which, in addition to Class 2 felony sentencing, provides that any person convicted of this offense or any similar offense of any state or the United States which contains the same elements as this offense shall be permanently barred from contracting with any unit of State or local government. No corporation shall be barred from contracting with any unit of State or local government as a result of a conviction under this Section of any employee or agent of such corporation if the employee so convicted is no longer employed by the corporation and: (1) it has been finally adjudicated not guilty or (2) if it demonstrates to the governmental entity with which it seeks to contract and that entity finds that the commission of the offense was neither authorized, requested, commanded, nor performed by a director, officer or a high managerial agent in behalf of the corporation.

2. The bidder certifies that it is not barred from contracting with the Department by reason of a violation of either Section 33E-3 or Section 33E-4.

E. International Anti-Boycott

1. Section 5 of the International Anti-Boycott Certification Act provides:

§ 5. State contracts. Every contract entered into by the State of Illinois for the manufacture, furnishing, or purchasing of supplies, material, or equipment or for the furnishing of work, labor, or services, in an amount exceeding the threshold for small purchases according to the purchasing laws of this State or \$10,000.00, whichever is less, shall contain certification, as a material condition of the contract, by which the contractor agrees that neither the contractor nor any substantially-owned affiliated company is participating or shall participate in an international boycott in violation of the provisions of the U.S. Export Administration Act of 1979 or the regulations of the U.S. Department of Commerce promulgated under that Act.

2. The bidder makes the certification set forth in Section 5 of the Act.

RETURN WITH BID

F. Drug Free Workplace

1. The Illinois “Drug Free Workplace Act” applies to this contract and it is necessary to comply with the provisions of the “Act” if the contractor is a corporation, partnership, or other entity (including a sole proprietorship) which has 25 or more employees.

2. The bidder certifies that if awarded a contract in excess of \$5,000 it will provide a drug free workplace by:

(a) Publishing a statement notifying employees that the unlawful manufacture, distribution, dispensation, possession or use of a controlled substance, including cannabis, is prohibited in the contractor’s workplace; specifying the actions that will be taken against employees for violations of such prohibition; and notifying the employee that, as a condition of employment on such contract, the employee shall abide by the terms of the statement, and notify the employer of any criminal drug statute conviction for a violation occurring in the workplace no later than five (5) days after such conviction.

(b) Establishing a drug free awareness program to inform employees about the dangers of drug abuse in the workplace; the contractor’s policy of maintaining a drug free workplace; any available drug counseling, rehabilitation, and employee assistance programs; and the penalties that may be imposed upon employees for drug violations.

(c) Providing a copy of the statement required by subparagraph (1) to each employee engaged in the performance of the contract and to post the statement in a prominent place in the workplace.

(d) Notifying the Department within ten (10) days after receiving notice from an employee or otherwise receiving actual notice of the conviction of an employee for a violation of any criminal drug statute occurring in the workplace.

(e) Imposing or requiring, within 30 days after receiving notice from an employee of a conviction or actual notice of such a conviction, an appropriate personnel action, up to and including termination, or the satisfactory participation in a drug abuse assistance or rehabilitation program approved by a federal, state or local health, law enforcement or other appropriate agency.

(f) Assisting employees in selecting a course of action in the event drug counseling, treatment, and rehabilitation is required and indicating that a trained referral team is in place.

(g) Making a good faith effort to continue to maintain a drug free workplace through implementation of the actions and efforts stated in this certification.

G. Debt Delinquency

1. The Illinois Procurement Code provides:

Section 50-11 and 50-12. Debt Delinquency.

The contractor or bidder certifies that it, or any affiliate, is not barred from being awarded a contract under 30 ILCS 500. Section 50-11 prohibits a person from entering into a contract with a State agency if it knows or should know that it, or any affiliate, is delinquent in the payment of any debt to the State as defined by the Debt Collection Board. Section 50-12 prohibits a person from entering into a contract with a State agency if it, or any affiliate, has failed to collect and remit Illinois Use Tax on all sales of tangible personal property into the State of Illinois in accordance with the provisions of the Illinois Use Tax Act. The contractor further acknowledges that the contracting State agency may declare the contract void if this certification is false or if the contractor, or any affiliate, is determined to be delinquent in the payment of any debt to the State during the term of the contract.

RETURN WITH BID

H. Sarbanes-Oxley Act of 2002

1. The Illinois Procurement Code provides:

Section 50-60(c).

The contractor certifies in accordance with 30 ILCS 500/50-10.5 that no officer, director, partner or other managerial agent of the contracting business has been convicted of a felony under the Sarbanes-Oxley Act of 2002 or a Class 3 or Class 2 felony under the Illinois Securities Law of 1953 for a period of five years prior to the date of the bid or contract. The contractor acknowledges that the contracting agency shall declare the contract void if this certification is false.

I. Section 42 of the Environmental Protection Act

The contractor certifies in accordance with 30 ILCS 500/50-12 that the bidder or contractor is not barred from being awarded a contract under this Section which prohibits the bidding on or entering into contracts with the State of Illinois or a State agency by a person or business found by a court or the Pollution Control Board to have committed a willful or knowing violation of Section 42 of the Environmental Protection Act for a period of five years from the date of the order. The contractor acknowledges that the contracting agency may declare the contract void if this certification is false.

RETURN WITH BID

IV. DISCLOSURES

A. The disclosures hereinafter made by the bidder are each a material representation of fact upon which reliance is placed should the Department enter into the contract with the bidder. The Department may terminate the contract if it is later determined that the bidder rendered a false or erroneous disclosure, and the surety providing the performance bond shall be responsible for completion of the contract.

B. Financial Interests and Conflicts of Interest

1. Section 50-35 of the Illinois Procurement Code provides that all bids of more than \$10,000 shall be accompanied by disclosure of the financial interests of the bidder. This disclosed information for the successful bidder, will be maintained as public information subject to release by request pursuant to the Freedom of Information Act.

The financial interests to be disclosed shall include ownership or distributive income share that is in excess of 5%, or an amount greater than 60% of the annual salary of the Governor, of the bidding entity or its parent entity, whichever is less, unless the contractor or bidder is a publicly traded entity subject to Federal 10K reporting, in which case it may submit its 10K disclosure in place of the prescribed disclosure. The disclosure shall include the names, addresses, and dollar or proportionate share of ownership of each person making the disclosure, their instrument of ownership or beneficial relationship, and notice of any potential conflict of interest resulting from the current ownership or beneficial interest of each person making the disclosure having any of the relationships identified in Section 50-35 and on the disclosure form.

In addition, all disclosures shall indicate any other current or pending contracts, proposals, leases, or other ongoing procurement relationships the bidding entity has with any other unit of state government and shall clearly identify the unit and the contract, proposal, lease, or other relationship.

2. Disclosure Forms. Disclosure Form A is attached for use concerning the individuals meeting the above ownership or distributive share requirements. Subject individuals should be covered each by one form. In addition, a second form (Disclosure Form B) provides for the disclosure of current or pending procurement relationships with other (non-IDOT) state agencies. **The forms must be included with each bid or incorporated by reference.**

C. Disclosure Form Instructions

Form A: For bidders that have previously submitted the information requested in Form A

The Department has retained the Form A disclosures submitted by all bidders responding to these requirements for the April 24, 1998 or any subsequent letting conducted by the Department. The bidder has the option of submitting the information again or the bidder may sign the following certification statement indicating that the information previously submitted by the bidder is, as of the date of signature, current and accurate. The Certification must be signed and dated by a person who is authorized to execute contracts for the bidding company. Before signing this certification, the bidder should carefully review its prior submissions to ensure the Certification is correct. If the Bidder signs the Certification, the Bidder should proceed to Form B instructions.

CERTIFICATION STATEMENT

I have determined that the Form A disclosure information previously submitted is current and accurate, and all forms are hereby incorporated by reference in this bid. Any necessary additional forms or amendments to previously submitted forms are attached to this bid.

(Bidding Company)

Name of Authorized Representative (type or print)

Title of Authorized Representative (type or print)

Signature of Authorized Representative

Date

Form A: For bidders who have NOT previously submitted the information requested in Form A

If the bidder is a publicly traded entity subject to Federal 10K reporting, the 10K Report may be submitted to meet the requirements of Form A. If a bidder is not subject to Federal 10K reporting, the bidder must determine if any individuals are required by law to complete a financial disclosure form. To do this, the bidder should answer each of the following questions. A "YES" answer indicates Form A must be completed. If the answer to each of the following questions is "NO", then the **NOT APPLICABLE STATEMENT** on the second page of Form A must be signed and dated by a person that is authorized to execute contracts for the bidding company. Note These questions are for assistance only and are not required to be completed.

1. Does anyone in your organization have a direct or beneficial ownership share of greater than 5% of the bidding entity or parent entity? YES _____ NO _____
2. Does anyone in your organization have a direct or beneficial ownership share of less than 5%, but which has a value greater than \$87,526.20? YES _____ NO _____
3. Does anyone in your organization receive more than \$87,526.20 of the bidding entity's or parent entity's distributive income? (Note: Distributive income is, for these purposes, any type of distribution of profits. An annual salary is not distributive income.) YES _____ NO _____
4. Does anyone in your organization receive greater than 5% of the bidding entity's or parent entity's total distributive income, but which is less than \$87,526.20? YES _____ NO _____

(Note: Only one set of forms needs to be completed per person per bid even if a specific individual would require a yes answer to more than one question.)

A "YES" answer to any of these questions requires the completion of Form A. The bidder must determine each individual in the bidding entity or the bidding entity's parent company that would cause the questions to be answered "Yes". Each form must be signed and dated by a person that is authorized to execute contracts for your organization. **Photocopied or stamped signatures are not acceptable.** The person signing can be, but does not have to be, the person for which the form is being completed. The bidder is responsible for the accuracy of any information provided.

If the answer to each of the above questions is "NO", then the **NOT APPLICABLE STATEMENT** on page 2 of Form A must be signed and dated by a person that is authorized to execute contracts for your company.

Form B: Identifying Other Contracts & Procurement Related Information Disclosure Form B must be completed for each bid submitted by the bidding entity. It must be signed by an individual who is authorized to execute contracts for the bidding entity. *Note: Signing the **NOT APPLICABLE STATEMENT** on Form A does not allow the bidder to ignore Form B. Form B must be completed, signed and dated or the bidder may be considered nonresponsive and the bid will not be accepted.*

The Bidder shall identify, by checking Yes or No on Form B, whether it has any pending contracts (including leases), bids, proposals, or other ongoing procurement relationship with any other (non-IDOT) State of Illinois agency. If "No" is checked, the bidder only needs to complete the signature box on the bottom of Form B. If "Yes" is checked, the bidder must do one of the following:

Option I: If the bidder did not submit an Affidavit of Availability to obtain authorization to bid, the bidder must list all non-IDOT State of Illinois agency pending contracts, leases, bids, proposals, and other ongoing procurement relationships. These items may be listed on Form B or on an attached sheet(s). Do not include IDOT contracts. Contracts with cities, counties, villages, etc. are not considered State of Illinois agency contracts and are not to be included. Contracts with other State of Illinois agencies such as the Department of Natural Resources or the Capital Development Board must be included. Bidders who submit Affidavits of Availability are suggested to use Option II.

Option II: If the bidder is required and has submitted an Affidavit of Availability in order to obtain authorization to bid, the bidder may write or type "See Affidavit of Availability" which indicates that the Affidavit of Availability is incorporated by reference and includes all non-IDOT State of Illinois agency pending contracts, leases, bids, proposals, and other ongoing procurement relationships. For any contracts that are not covered by the Affidavit of Availability, the bidder must identify them on Form B or on an attached sheet(s). These might be such things as leases.

D. Bidders Submitting More Than One Bid

Bidders submitting multiple bids may submit one set of forms consisting of all required Form A disclosures and one Form B for use with all bids. Please indicate in the space provided below the bid item that contains the original disclosure forms and the bid items which incorporate the forms by reference.

- The bid submitted for letting item _____ contains the Form A disclosures or Certification Statement and the Form B disclosures. The following letting items incorporate the said forms by reference:

**ILLINOIS DEPARTMENT
OF TRANSPORTATION**

**Form A
Financial Information &
Potential Conflicts of Interest
Disclosure**

Contractor Name		
Legal Address		
City, State, Zip		
Telephone Number		Fax Number (if available)

Disclosure of the information contained in this Form is required by the Section 50-35 of the Illinois Procurement Code (30 ILCS 500). Vendors desiring to enter into a contract with the State of Illinois must disclose the financial information and potential conflict of interest information as specified in this Disclosure Form. This information shall become part of the publicly available contract file. This Form A must be completed for bids in excess of \$10,000, and for all open-ended contracts. **A publicly traded company may submit a 10K disclosure in satisfaction of the requirements set forth in Form A. See Disclosure Form Instructions.**

DISCLOSURE OF FINANCIAL INFORMATION

1. Disclosure of Financial Information. The individual named below has an interest in the BIDDER (or its parent) in terms of ownership or distributive income share in excess of 5%, or an interest which has a value of more than \$87,526.20 (60% of the Governor’s salary as of 10/1/2000). **(Make copies of this form as necessary and attach a separate Disclosure Form A for each individual meeting these requirements)**

FOR INDIVIDUAL (type or print information)	
NAME:	_____
ADDRESS	_____
Type of ownership/distributable income share:	
stock _____	sole proprietorship _____
partnership _____	other: (explain on separate sheet): _____
% or \$ value of ownership/distributable income share: _____	

2. Disclosure of Potential Conflicts of Interest. Check “Yes” or “No” to indicate which, if any, of the following potential conflict of interest relationships apply. If the answer to any question is “Yes”, please attach additional pages and describe.

(a) State employment, currently or in the previous 3 years, including contractual employment of services.
 Yes _____ No _____

(b) State employment of spouse, father, mother, son, or daughter, including contractual employment for services in the previous 2 years.
 Yes _____ No _____

(c) Elective status; the holding of elective office of the State of Illinois, the government of the United States, any unit of local government authorized by the Constitution of the State of Illinois or the statutes of the State of Illinois currently or in the previous 3 years.
 Yes _____ No _____

(d) Relationship to anyone holding elective office currently or in the previous 2 years; spouse, father, mother, son, or daughter
 Yes _____ No _____

RETURN WITH BID/OFFER

(e) Appointive office; the holding of any appointive government office of the State of Illinois, the United States of America, or any unit of local government authorized by the Constitution of the State of Illinois or the statutes of the State of Illinois, which office entitles the holder to compensation in excess of the expenses incurred in the discharge of that office currently or in the previous 3 years.

Yes _____ No _____

(f) Relationship to anyone holding appointive office currently or in the previous 2 years; spouse, father, mother, son, or daughter.

Yes _____ No _____

(g) Employment, currently or in the previous 3 years, as or by any registered lobbyist of the State government.

Yes _____ No _____

(h) Relationship to anyone who is or was a registered lobbyist in the previous 2 years; spouse, father, mother, son, or daughter.

Yes _____ No _____

(i) Compensated employment, currently or in the previous 3 years, by any registered election or reelection committee registered with the Secretary of State or any county clerk of the State of Illinois, or any political action committee registered with either the Secretary of State or the Federal Board of Elections.

Yes _____ No _____

(j) Relationship to anyone; spouse, father, mother, son, or daughter; who was a compensated employee in the last 2 years by any registered election or re-election committee registered with the Secretary of State or any county clerk of the State of Illinois, or any political action committee registered with either the Secretary of State or the Federal Board of Elections.

Yes _____ No _____

APPLICABLE STATEMENT

This Disclosure Form A is submitted on behalf of the INDIVIDUAL named on previous page.

Completed by:

Name of Authorized Representative (type or print)

Completed by:

Title of Authorized Representative (type or print)

Completed by:

Signature of Individual or Authorized Representative

Date

NOT APPLICABLE STATEMENT

I have determined that no individuals associated with this organization meet the criteria that would require the completion of this Form A.

This Disclosure Form A is submitted on behalf of the CONTRACTOR listed on the previous page.

Name of Authorized Representative (type or print)

Title of Authorized Representative (type or print)

Signature of Authorized Representative

Date

**ILLINOIS DEPARTMENT
OF TRANSPORTATION**

**Form B
Other Contracts &
Procurement Related Information
Disclosure**

Contractor Name		
Legal Address		
City, State, Zip		
Telephone Number		Fax Number (if available)

Disclosure of the information contained in this Form is required by the Section 50-35 of the Illinois Procurement Act (30 ILCS 500). This information shall become part of the publicly available contract file. This Form B must be completed for bids in excess of \$10,000, and for all open-ended contracts.

DISCLOSURE OF OTHER CONTRACTS AND PROCUREMENT RELATED INFORMATION

1. Identifying Other Contracts & Procurement Related Information. The BIDDER shall identify whether it has any pending contracts (including leases), bids, proposals, or other ongoing procurement relationship with any other State of Illinois agency: Yes _____ No _____

If **“No”** is checked, the bidder only needs to complete the signature box on the bottom of this page.

2. If “Yes” is checked. Identify each such relationship by showing State of Illinois agency name and other descriptive information such as bid or project number (attach additional pages as necessary). SEE DISCLOSURE FORM INSTRUCTIONS:

THE FOLLOWING STATEMENT MUST BE SIGNED

Name of Authorized Representative (type or print)	

Title of Authorized Representative (type or print)	
_____	_____
Signature of Authorized Representative	Date

RETURN WITH BID

SPECIAL NOTICE TO CONTRACTORS

The following requirements of the Illinois Department of Human Rights' Rules and Regulations are applicable to bidders on all construction contracts advertised by the Illinois Department of Transportation:

CONSTRUCTION EMPLOYEE UTILIZATION PROJECTION

- (a) All bidders on construction contracts shall complete and submit, along with and as part of their bids, a Bidder's Employee Utilization Form (Form BC-1256) setting forth a projection and breakdown of the total workforce intended to be hired and/or allocated to such contract work by the bidder including a projection of minority and female employee utilization in all job classifications on the contract project.
- (b) The Department of Transportation shall review the Employee Utilization Form, and workforce projections contained therein, of the contract awardee to determine if such projections reflect an underutilization of minority persons and/or women in any job classification in accordance with the Equal Employment Opportunity Clause and Section 7.2 of the Illinois Department of Human Rights' Rules and Regulations for Public Contracts adopted as amended on September 17, 1980. If it is determined that the contract awardee's projections reflect an underutilization of minority persons and/or women in any job classification, it shall be advised in writing of the manner in which it is underutilizing and such awardee shall be considered to be in breach of the contract unless, prior to commencement of work on the contract project, it submits revised satisfactory projections or an acceptable written affirmative action plan to correct such underutilization including a specific timetable geared to the completion stages of the contract.
- (c) The Department of Transportation shall provide to the Department of Human Rights a copy of the contract awardee's Employee Utilization Form, a copy of any required written affirmative action plan, and any written correspondence related thereto. The Department of Human Rights may review and revise any action taken by the Department of Transportation with respect to these requirements.



PART I. IDENTIFICATION

Human Rights

Bid Number: _____ Duration of Project: _____

Name of Bidder: _____

PART II. WORKFORCE PROJECTION

A. The undersigned bidder has analyzed minority group and female populations, unemployment rates and availability of workers for the location in which this contract work is to be performed, and for the locations from which the bidder recruits employees, and hereby submits the following workforce projection including a projection for minority and female employee utilization in all job categories in the workforce to be allocated to this contract:

TABLE A

TOTAL Workforce Projection for Contract												
JOB CATEGORIES	TOTAL EMPLOYEES		MINORITY EMPLOYEES						TRAINEES			
			BLACK		HISPANIC		*OTHER MINOR.		APPRENTICES		ON THE JOB TRAINEES	
	M	F	M	F	M	F	M	F	M	F	M	F
OFFICIALS (MANAGERS)												
SUPERVISORS												
FOREMEN												
CLERICAL												
EQUIPMENT OPERATORS												
MECHANICS												
TRUCK DRIVERS												
IRONWORKERS												
CARPENTERS												
CEMENT MASONS												
ELECTRICIANS												
PIPEFITTERS, PLUMBERS												
PAINTERS												
LABORERS, SEMI-SKILLED												
LABORERS, UNSKILLED												
TOTAL												

TABLE B

CURRENT EMPLOYEES TO BE ASSIGNED TO CONTRACT			
TOTAL EMPLOYEES		MINORITY EMPLOYEES	
M	F	M	F

TABLE C

TOTAL Training Projection for Contract								
EMPLOYEES IN TRAINING	TOTAL EMPLOYEES		BLACK		HISPANIC		*OTHER MINOR.	
	M	F	M	F	M	F	M	F
APPRENTICES								
ON THE JOB TRAINEES								

*Other minorities are defined as Asians (A) or Native Americans (N).

Please specify race of each employee shown in Other Minorities column.

Note: See instructions on page 2

FOR DEPARTMENT USE ONLY

RETURN WITH BID

PART II. WORKFORCE PROJECTION - continued

- B. Included in "Total Employees" under Table A is the total number of **new hires** that would be employed in the event the undersigned bidder is awarded this contract.

The undersigned bidder projects that: (number) _____ new hires would be recruited from the area in which the contract project is located; and/or (number) _____ new hires would be recruited from the area in which the bidder's principal office or base of operation is located.

- C. Included in "Total Employees" under Table A is a projection of numbers of persons to be employed directly by the undersigned bidder as well as a projection of numbers of persons to be employed by subcontractors.

The undersigned bidder estimates that (number) _____ persons will be directly employed by the prime contractor and that (number) _____ persons will be employed by subcontractors.

PART III. AFFIRMATIVE ACTION PLAN

- A. The undersigned bidder understands and agrees that in the event the foregoing minority and female employee utilization projection included under **PART II** is determined to be an underutilization of minority persons or women in any job category, and in the event that the undersigned bidder is awarded this contract, he/she will, prior to commencement of work, develop and submit a written Affirmative Action Plan including a specific timetable (geared to the completion stages of the contract) whereby deficiencies in minority and/or female employee utilization are corrected. Such Affirmative Action Plan will be subject to approval by the contracting agency and the **Department of Human Rights**.
- B. The undersigned bidder understands and agrees that the minority and female employee utilization projection submitted herein, and the goals and timetable included under an Affirmative Action Plan if required, are deemed to be part of the contract specifications.

Company _____ Telephone Number _____

 Address _____

NOTICE REGARDING SIGNATURE

The Bidder's signature on the Proposal Signature Sheet will constitute the signing of this form. The following signature block needs to be completed only if revisions are required.

Signature: _____ Title: _____ Date: _____

- Instructions: All tables must include subcontractor personnel in addition to prime contractor personnel.
- Table A - Include both the number of employees that would be hired to perform the contract work and the total number currently employed (Table B) that will be allocated to contract work, and include all apprentices and on-the-job trainees. The "Total Employees" column should include all employees including all minorities, apprentices and on-the-job trainees to be employed on the contract work.
 - Table B - Include all employees currently employed that will be allocated to the contract work including any apprentices and on-the-job trainees currently employed.
 - Table C - Indicate the racial breakdown of the total apprentices and on-the-job trainees shown in Table A.

RETURN WITH BID

CERTIFICATIONS REQUIRED BY STATE AND/OR FEDERAL LAW. The bidder is required by State and/or Federal law to make the below certifications and assurances as a part of the proposal and contract upon award. It is understood by the bidder that the certifications and assurances made herein are a part of the contract.

By signing the Proposal Signature Sheet, the bidder certifies that he/she has read and completed each of the following certifications and assurances, that required responses are true and correct and that the certified signature of the Proposal Signature Sheet constitutes an endorsement and execution of each certification and assurance as though each was individually signed:

A. By the execution of this proposal, the signing bidder certifies that the bidding entity has not, either directly or indirectly, entered into any agreement, participated in any collusion, or otherwise taken any action, in restraint of free competitive bidding in connection with the submitted bid. This statement made by the undersigned bidder is true and correct under penalty of perjury under the laws of the United States.

B. **CERTIFICATION, EQUAL EMPLOYMENT OPPORTUNITY:**

1. Have you participated in any previous contracts or subcontracts subject to the equal opportunity clause.
YES _____ NO _____

2. If answer to #1 is yes, have you filed with the Joint Reporting Committee, the Director of OFCC, any Federal agency, or the former President's Committee on Equal Employment Opportunity, all reports due under the applicable filing requirements of those organizations? YES _____ NO _____

C. **BUY AMERICAN - STEEL AND MANUFACTURED PRODUCTS FOR CONSTRUCTION CONTRACTS (JAN 1991)**

(a) The Aviation Safety and Capacity Expansion Act of 1990 provides that preference be given to steel and manufactured products produced in the United States when funds are expended pursuant to a grant issued under the Airport Improvement Program. The following terms apply:

1. Steel and manufactured products. As used in this clause, steel and manufactured products include (1) steel produced in the United States or (2) a manufactured product produced in the United States, if the cost of its components mined, produced or manufactured in the United States exceeds 60 percent of the cost of all its components and final assembly has taken place in the United States. Components of foreign origin of the same class or kind as the products referred to in subparagraphs (b)(1) or (2) shall be treated as domestic.

2. Components. As used in this clause, components means those articles, materials, and supplies incorporated directly into steel and manufactured products.

3. Cost of Components. This means the costs for production of the components, exclusive of final assembly labor costs.

(b) The successful bidder will be required to assure that only domestic steel and manufactured products will be used by the Contractor, subcontractors, materialmen, and suppliers in the performance of this contract, except those-

- (1) that the U.S. Department of Transportation has determined, under the Aviation Safety and Capacity Expansion Act of 1990, are not produced in the United States in sufficient and reasonably available quantities of a satisfactory quality;

- (2) that the U.S. Department of Transportation has determined, under the Aviation Safety and Capacity Expansion Act of 1990, that domestic preference would be inconsistent with the public interest; or

- (3) that inclusion of domestic material will increase the cost of the overall project contract by more than 25 percent.

(End of Clause)

RETURN WITH BID

D. BUY AMERICAN CERTIFICATE (JAN 1991)

By submitting a bid/proposal under this solicitation, except for those items listed by the offeror below or on a separate and clearly identified attachment to this bid/proposal, the offeror certifies that steel and each manufactured product, is produced in the United States (as defined in the clause Buy American - Steel and Manufactured Products or Buy American - Steel and Manufactured Products For Construction Contracts) and that components of unknown origin are considered to have been produced or manufactured outside the United States.

Offerors may obtain from (IDOT, Division of Aeronautics) lists of articles, materials, and supplies excepted from this provision.

PRODUCT

COUNTRY OF ORIGIN

E. NPDES CERTIFICATION

In accordance with the provisions of the Illinois Environmental Protection Act, the Illinois Pollution Control Board Rules and Regulations (35 Ill. Adm. Code, Subtitle C, Chapter I), and the Clean Water Act, and the regulations thereunder, this certification is required for all construction contracts that will result in the disturbance of five or more acres total land area.

The undersigned bidder certifies under penalty of law that he/she understands the terms and conditions of the general National Pollutant Discharge Elimination System (NPDES) permit (ILR100000) that authorizes the storm water discharges associated with industrial activity from the construction site identified as part of this certification.

The Airport Owner or its Agent will:

- 1) prepare, sign and submit the Notice of Intent (NOI)
- 2) conduct site inspections and complete and file the inspection reports
- 3) submit Incidence of Non-Compliance (ION) forms
- 4) submit Notice of Termination (NOT) form

Prior to the issuance of the Notice-to-Proceed, for each erosion control measure identified in the Storm Water Pollution Prevention Plan, the contractor or subcontractor responsible for the control measure(s) must sign the above certification (forms to be provided by the Department).

F. NON-APPROPRIATION CLAUSE

By submitting a bid/proposal under this solicitation the offeror certifies that he/she understands that obligations of the State will cease immediately without penalty or further payment being required in any fiscal year the Illinois General Assembly fails to appropriate or otherwise make available sufficient funds for this contract.

G. Contractor is not delinquent in the payment of any debt to the State (or if delinquent has entered into a deferred payment plan to pay the debt), and Contractor acknowledges the contracting state agency may declare the contract void if this certification is false (30 ILCS 500/50-11, effective July 1, 2002).

RETURN WITH BID

NOTICE TO BIDDERS

1. **TIME AND PLACE OF OPENING BIDS.** Sealed proposals for the improvement described herein will be received by the Department of Transportation at the Harry R. Hanley Building, 2300 South Dirksen Parkway in Springfield, Illinois until 10:00 o'clock a.m., March 10, 2006. All bids will be gathered, sorted, publicly opened and read in the auditorium at the Department of Transportation's Harry R. Hanley Building shortly after the 10:00 a.m. cut off time.
2. **DESCRIPTION OF WORK.** The proposed improvement, shown in detail on the plans issued by the Department includes, in general, the following described work:

Excavation and Construction of 6' Surcharge Embankment for Future Extensions to Runway 5 (500' X 150'), Taxiway D (745' X 50') and Taxiway K (770' X 50') along with Associated Utility Adjustments and Turfing.
3. **INSTRUCTIONS TO BIDDERS.** (a) This Notice, the invitation for bids, proposal and award shall, together with all other documents in accordance with Article 10-15 of the Illinois Standard Specifications for Construction of Airports, become part of the contract. Bidders are cautioned to read and examine carefully all documents, to make all required inspections, and to inquire or seek explanation of the same prior to submission of a bid.

(b) State law, and, if the work is to be paid wholly or in part with Federal-aid funds, Federal law requires the bidder to make various certifications as a part of the proposal and contract. By execution and submission of the proposal, the bidder makes the certification contained therein. A false or fraudulent certification shall, in addition to all other remedies provided by law, be a breach of contract and may result in termination of the contract.
4. **AWARD CRITERIA AND REJECTION OF BIDS.** This contract will be awarded to the lowest responsive and responsible bidder considering conformity with the terms and conditions established by the Department in the proposal and contract documents. The issuance of plans and proposal forms for bidding based upon a prequalification rating shall not be the sole determinant of responsibility. The Department reserves the right to determine responsibility at the time of award, to reject any or all proposals, to readvertise the proposed improvement, and to waive technicalities.
5. **PRE-BID CONFERENCE.** There will be a pre-bid conference held at N/A at the Quad-City International Airport administration building. For engineering information, contact Denny Martin of Missman, Stanley and Associates at (309) 788-7644 .
6. **DISADVANTAGED BUSINESS POLICY.** The DBE goal for this contract is 10.0%.
7. **SPECIFICATIONS AND DRAWINGS.** The work shall be done in accordance with the Illinois Standard Specifications for Construction of Airports, the Illinois Division of Aeronautics Supplemental Specifications and Recurring Special Provisions, the Special Provisions dated January 25, 2006 and the Construction Plans dated January 25, 2006 as approved by the Department of Transportation, Division of Aeronautics.

RETURN WITH BID

- 8. INSPECTION OF RECORDS.** The Contractor shall maintain an acceptable cost accounting system. The Sponsor, the FAA, and the Comptroller General of the United States shall have access to any books, documents, paper, and records of the Contractor which are directly pertinent to the specific contract for the purposes of making an audit, examination, excerpts, and transcriptions. The Contractor shall maintain all required records for three years after the Sponsor makes final payment and all other pending matters are closed.
- 9. RIGHTS TO INVENTIONS.** All rights to inventions and materials generated under this contract are subject to Illinois law and to regulations issued by the FAA and the Sponsor of the Federal grant under which this contract is executed. Information regarding these rights is available from the FAA and the Sponsor.
- 10. TERMINATION OF CONTRACT.**
1. The Sponsor may, by written notice, terminate this contract in whole or in part at any time, either for the Sponsor's convenience or because of failure to fulfill the contract obligations. Upon receipt of such notice services shall be immediately discontinued (unless the notice directs otherwise) and all materials as may have been accumulated in performing this contract, whether completed or in progress, delivered to the Sponsor.
 2. If the termination is for the convenience of the Sponsor, an equitable adjustment in the contract price shall be made, but no amount shall be allowed for anticipated profit on unperformed services.
 3. If the termination is due to failure to fulfill the Contractor's obligations, the Sponsor may take over the work and prosecute the same to completion by contract or otherwise. In such case, the Contractor shall be liable to the Sponsor for any additional cost occasioned to the Sponsor thereby.
 4. If, after notice of termination for failure to fulfill contract obligations, it is determined that the Contractor had not so failed, the termination shall be deemed to have been effected for the convenience of the Sponsor. In such event, adjustment in the contract price shall be made as provided in paragraph 2 of this clause.
 5. The rights and remedies of the sponsor provided in this clause are in addition to any other rights and remedies provided by law or under this contract.

RETURN WITH BID

11. BIDDING REQUIREMENTS AND BASIS OF AWARD. When alternates are included in the proposal, the following shall apply:

a. Additive Alternates

- (1) Bidders must submit a bid for the Base Bid and for all Additive Alternates.
- (2) Award of this contract will be made to the lowest responsible qualified bidder computed as follows:

The lowest aggregate amount of (i) the Base Bid plus (ii) any Additive Alternate(s) which the Department elects to award.

The Department may elect not to award any Additive Alternates. In that case, award will be to the lowest responsible qualified bidder of the Base Bid.

b. Optional Alternates

- (1) Bidders must submit a bid for the Base Bid and for either Alternate A or Alternate B or for both Alternate A and Alternate B.
- (2) Award of this contract will be made to the lowest responsible qualified bidder computed as follows:

The lower of the aggregate of either (i) the Base Bid plus Alternate A or (ii) the Base Bid plus Alternate B.

12. CONTRACT TIME. The Contractor shall complete all work within the specified contract time. Any calendar day extension beyond the specified contract time must be fully justified, requested by the Contractor in writing, and approved by the Engineer, or be subject to liquidated damages.

The contract time for this contract is 91 calendar days and is based on anticipated notice-to-proceed date of May 1, 2006.

13. INDEPENDENT WEIGHT CHECKS. The Department reserves the right to conduct random unannounced independent weight checks on any delivery for bituminous, aggregate or other pay item for which the method of measurement for payment is based on weight. The weight checks will be accomplished by selecting, at random, a loaded truck and obtaining a loaded and empty weight on an independent scale. In addition, the department may perform random weight checks by obtaining loaded and empty truck weights on portable scales operated by department personnel.

14. GOOD FAITH COMPLIANCE. The Illinois Department of Transportation has made a good faith effort to include all statements, requirements, and other language required by federal and state law and by various offices within federal and state governments whether that language is required by law or not. If anything of this nature has been left out or if additional language etc. is later required, the bidder/contractor shall cooperate fully with the Department to modify the contract or bid documents to correct the deficiency. If the change results in increased operational costs, the Department shall reimburse the contractor for such costs as it may find to be reasonable.

RETURN WITH BID

PROPOSAL SIGNATURE SHEET

The undersigned bidder hereby makes and submits this bid on the subject Proposal, thereby assuring the Department that all requirements of the Invitation for Bids and rules of the Department have been met, that there is no misunderstanding of the requirements of paragraph 4 of this Proposal, and that the contract will be executed in accordance with the rules of the Department if an award is made on this bid.

Firm Name _____

(IF AN INDIVIDUAL)

Signature of Owner _____

Business Address _____

Firm Name _____

By _____

(IF A CO-PARTNERSHIP)

Business Address _____

Name and Address of All Members of the Firm:

Corporate Name _____

Corporate Seal

By _____

President

(IF A CORPORATION)

Attest _____

Corporate Secretary

Business Address _____

Name of Corporate Officers:

President Corporate Secretary Treasurer

NOTARY CERTIFICATION

STATE OF ILLINOIS,

ALL SIGNATURES MUST BE NOTARIZED

COUNTY OF _____

I, _____, a Notary Public in and for said county, do hereby certify that _____

_____ AND _____

(Insert names of individual(s) signing on behalf of bidder)

who are each personally known to me to be the same persons whose names are subscribed to the foregoing instrument on behalf of the bidder, appeared before me this day in person and acknowledged that they signed, sealed, and delivered said instrument as their free and voluntary act for the uses and purposes therein set forth.

Given under my hand and notarial seal this _____ day of _____, A.D. _____

My commission expires _____ (Seal)

Notary Public



Return with Bid

Division of Aeronautics
Proposal Bid Bond
(Effective January 1, 2002)

Item No. 11A
Letting Date: March 10, 2006

Airport: Quad-City International Airport
Ill. Proj. No. MLI-3496
Fed. Proj. No. 3-17-0068-XX

KNOW ALL MEN BY THESE PRESENTS. that we, _____, as PRINCIPAL, and _____, as SURETY are held and firmly bound unto the, hereinafter called the SPONSOR, in the penal sum of 5 percent of the total bid price or of the amount specified in Section 6, PROPOSAL GUARANTEE of the Proposal Document, whichever is the lesser sum, well and truly to be paid unto the said SPONSOR, for the payment of which we bind ourselves, our heirs, executors, administrators, successors, and assigns.

THE CONDITION OF THIS OBLIGATION IS SUCH, that whereas the PRINCIPAL has submitted a Bid Proposal to the SPONSOR through its AGENT, the State of Illinois, Department of Transportation, Division of Aeronautics, for the improvement designated by the Transportation Bulletin Item Number and Letting Date indicated above;

NOW, THEREFORE, if the SPONSOR through its AGENT shall accept the Bid Proposal of the PRINCIPAL; and if PRINCIPAL shall within the time and as specified in the Bidding and Contract Documents, submit the DBE Utilization Plan that is acceptable and approved by the AGENT, and if after the award, the PRINCIPAL shall enter into a contract in accordance with the terms of the Bidding and Contract Documents including evidence of insurance coverage's and providing such bond as specified with good and sufficient surety for the faithful performance of such contract and for prompt payment of labor and material furnished in the prosecution thereof; or if, in the event of the failure of the PRINCIPAL to make the required DBE submission or to enter into such contract and to give the specified bond, the PRINCIPAL pays to the SPONSOR the difference not to exceed the penalty hereof between the amount in the Bid Proposal and such larger amount for which the SPONSOR may contract with another party to perform the work covered by said Proposal Document, then, this obligation to be void; otherwise to remain in full force and effect.

IN THE EVENT the SPONSOR acting through its AGENT determines the PRINCIPAL has failed to comply with any requirement as set forth in the preceding paragraph, then the SURETY shall pay the penal sum to the SPONSOR within fifteen (15) days of written demand therefor. If the SURETY does not make full payment within such period of time, the AGENT may bring an action to collect the amount owed. The SURETY is liable to the SPONSOR and to the AGENT for all its expenses, including attorney's fees, incurred in any litigation in which SPONSOR or AGENT prevail either in whole or in part.

IN WITNESS WHEREOF, the said PRINCIPAL and the said SURETY have caused this instrument to be signed by

their respective officers this _____ day of _____ A.D., 20 ____.

PRINCIPAL

SURETY

(Company Name)

(Company Name)

By: _____ (Signature & Title)

By: _____ (Signature of Attorney-in-Fact)

Notary Certification for Principal and Surety

State of Illinois)
) ss:
County of _____)

I, _____, a Notary Public in and for said County, do hereby certify that _____ and _____ (Insert names of individuals signing on behalf of PRINCIPAL & SURETY)

who are each personally known to me to be the same persons whose names are subscribed to the foregoing instrument on behalf of PRINCIPAL and SURETY, appeared before me this day in person and acknowledged respectively, that they signed and delivered said instrument as their free and voluntary act for uses and purposes therein set forth.

Given under my hand and notary seal this _____ day of _____ A.D., 20 ____

My commission expires _____ (Notary Public)

In lieu of completing the above section of the Proposal Bid Form, the PRINCIPAL may file an Electronic Bid Bond. By signing below, the PRINCIPAL is ensuring the identified electronic bid bond has been executed and the PRINCIPAL and SURETY are firmly bound to the SPONSOR through its AGENT under the conditions of the Bid Bond as shown above.

Electronic Bid Bond ID# _____ Company/Bidder Name _____ Signature and Title _____ Form D.E. (Rev. 12-2001)



PROPOSALS

for construction work advertised for bids by the
Illinois Department of Transportation

Item No.	Item No.	Item No.

Submitted By:

Name:
Address:
Phone No.

Bidders should affix this form to the front of a 10" x 13" envelope and use that envelope for the submittal of bids. If proposals are mailed, they should be enclosed in a second or outer envelope addressed to:

Engineer of Design and Environment - Room 323
Illinois Department of Transportation
2300 South Dirksen Parkway
Springfield, Illinois 62764

CONTRACTOR OFFICE COPY OF CONTRACT SPECIFICATIONS

NOTICE

None of the following material needs to be returned with the bid package unless the special provisions require documentation and/or other information to be submitted.



Illinois Department of Transportation

CONTRACT REQUIREMENTS

(1) Airport Improvement Program projects. The work in this contract is included in the federal Airport Improvement Program and is being undertaken and accomplished by the Illinois Department of Transportation, Division of Aeronautics and the Municipality, hereinafter called the Co-Sponsors, in accordance with the terms and conditions of a Grant Agreement between the Co-Sponsors and the United States, under the Airport and Airway Improvement Act of 1982 (Public Law 97-248; Title V, Section 501 et seq., September 3, 1982; 96 Stat. 671; codified at 49 U.S.C Section 2201 et seq.) and Part 152 of the Federal Aviation Regulations (14 CFR Part 152), pursuant to which the United States has agreed to pay a certain percentage of the costs of the Project that are determined to be allowable Project costs under the Act. The United States is not a party to this contract and no reference in this contract to FAA or representative thereof, or to any rights granted to the FAA or any representative thereof, or the United States, by the contract, makes the United States a party to this contract.

(2) Consent of Assignment. The Contractor shall obtain the prior written consent of the Co-Sponsors to any proposed assignment of any interest in or part of this contract.

(3) Convict Labor. No convict labor may be employed under this contract.

(4) Veterans Preference. In the employment of labor, except in executive, administrative, and supervisory positions, preference shall be given to veterans of the Vietnam era and disabled veterans as defined in Section 515(c) of the Airport and Airway Improvement Act of 1982. However, this preference shall apply only where the individuals are available and qualified to perform the work to which the employment relates.

(5) Withholding: Sponsor from Contractor. Whether or not payments or advances to the Co-Sponsors are withheld or suspended by the FAA, the Co-Sponsors may withhold or cause to be withheld from the Contractor so much of the accrued payments or advances as may be considered necessary to pay laborers and mechanics employed by the Contractor or any subcontractor on the work the full amount of wages required by this contract.

(6) Nonpayment of Wages. If the Contractor or subcontractor fails to pay any laborer or mechanic employed or working on the site of the work any of the wages required by this contract the Co-Sponsors may, after written notice to the Contractor, take such action as may be necessary to cause the suspension of any further payment or advance of funds until the violations cease.

(7) FAA Inspection and Review. The Contractor shall allow any authorized representative of the FAA to inspect and review any work or materials used in the performance of this contract.

(8) Subcontracts. The Contractor shall insert in each of his subcontracts the provisions contained in Paragraphs (1), (3), (4), (5), (6), and (7) above and also a clause requiring the subcontractors to include these provisions in any lower tier subcontracts which they may enter into, together with a clause requiring this insertion in any further subcontracts that may in turn be made.

(9) Contract Termination. A breach of Paragraph (6), (7), and (8) above may be grounds for termination of the contract.

PROVISIONS REQUIRED BY THE REGULATIONS OF THE SECRETARY OF LABOR 29 CFR 5.5

(a) Contract Provisions and Related Matters.

(1) Minimum Wages.

Revised 1/92

(i) All laborers and mechanics employed or working upon the site of the work will be paid unconditionally and not less often than once a week, and without subsequent deduction or rebate on any account (except such payroll deductions as are permitted by regulations issued by the Secretary of Labor under the Copeland Act (29 CFR Part 3)), the full amount of wages and bona fide fringe benefits (or cash equivalents thereof) due at time of payment computed at rates not less than those contained in the wage determination of the Secretary of Labor which is attached hereto and made a part hereof, regardless of any contractual relationship which may be alleged to exist between the Contractor and such laborers and mechanics. Contributions made or costs reasonably anticipated for bona fide fringe benefits under section 1(b)(2) of the Davis-Bacon Act on behalf of laborers or mechanics are considered wages paid to such laborers or mechanics, subject to the provision of paragraph (a)(1)(iv) of this section; also, regular contributions made or costs incurred for more than a weekly period (but not less often than quarterly) under plans, funds, or programs which cover the particular weekly period, are deemed to be constructively made or incurred during such weekly period. Such laborers and mechanics shall be paid the appropriate wage rate and fringe benefits on the wage determination for the classification of work actually performed, without regard to skill, except as provided in paragraph 5.5(a)(4). Laborers or mechanics performing work in more than one classification may be compensated at the rate specified for each classification for the time actually worked therein: provided, that the employer's payroll records accurately set forth the time spent in each classification in which work is performed. The wage determination (including any additional classification and wage rates conformed under paragraph (a)(1)(ii) of this section) and the Davis-Bacon poster (WH-1321) shall be posted at all times by the Contractor and its subcontractors at the site of the work in a prominent and accessible place where it can be easily seen by the workers.

(ii)(A) The contracting officer shall require that any class of laborers or mechanics which is not listed in the wage determination and which is to be employed under the contract shall be classified in conformance with the wage determination. The contracting officer shall approve an additional classification and wage rate and fringe benefits therefor only when the following criteria have been met:

- (1) The work to be performed by the classification requested is not performed by a classification in the wage determination; and
- (2) The classification is utilized in the area by the construction industry; and
- (3) The proposed wage rate, including any bona fide fringe benefits, bears a reasonable relationship to the wage rates contained in the wage determination.

(ii)(B) If the Contractor and the laborers and mechanics to be employed in the classification (if known), or their representatives, and the contracting officer agree on the classification and wage rate (including the amount designated for fringe benefits where appropriate), a report of the action taken shall be sent by the contracting officer to the Administrator of the Wage and Hour Division, Employment Standards Administration, U.S. Department of Labor, Washington, D.C. 20210. The Administrator, or an authorized representative, will approve, modify, or disapprove every additional classification action within 30 days of receipt and so advise the contracting officer or will notify the contracting officer within the 30-day period that additional time is necessary. (Approved by the Office of Management and Budget under OMB control number 1215-0140).

(ii)(C) In the event the Contractor, the laborers or mechanics to be employed in the classification or their representatives, and the contracting officer do not agree on the proposed classification and wage rate (including the amount designated for fringe benefits, where appropriate), the contracting officer shall refer the questions, including the views of all interested parties and the recommendation of the contracting officer, to the Administrator for determination. The Administrator, or an authorized representative, will issue a determination within 30 days of receipt and so advise the contracting officer or will notify the contracting officer within the 30-day period that additional time is necessary. (Approved by the Office of Management and Budget under OMB control number 1215-0140).

(ii)(D) The wage rate (including fringe benefits where appropriate) determined pursuant to subparagraphs (1)(B) or (C) of this paragraph, shall be paid to all workers performing work in the classification under this contract from the first day on which work is performed in the classification.

(iii) Whenever the minimum wage rate prescribed in the contract for a class of laborers or mechanics includes a fringe benefit which is not expressed as an hourly rate, the Contractor shall either pay the benefit as stated in the wage determination or shall pay another bona fide fringe benefit or an hourly cash equivalent thereof.

(iv) If the Contractor does not make payments to a trustee or other third person, the Contractor may consider as part of the wages of any laborer or mechanic the amount of any costs reasonably anticipated in providing bona fide fringe benefits under a plan or program, provided, that the Secretary of Labor has found, upon the written request of the Contractor, that the applicable standards of the Davis-Bacon Act have been met. The Secretary of Labor may require the Contractor to set aside in a separate account assets for the meeting of obligations under the plan or program. (Approved by the Office of Management and Budget under OMB control number 1215-0140).

(2) Withholding. The Federal Aviation Administration shall upon its own action or written request of an authorized representative of the Department of Labor withhold or cause to be withheld from the Contractor under this contract or any other Federal contract with the same prime Contractor, or any other Federally-assisted contract subject to Davis-Bacon prevailing wage requirements, which is held by the same prime Contractor, so much of the accrued payments or advances as may be considered necessary to pay laborers and mechanics, including apprentices, trainees, and helpers, employed by the Contractor or any subcontractor the full amount of wages required by the contract. In the event of failure to pay any laborer or mechanic, including any apprentice, trainee, or helper, employed or working on the site of the work, all or part of the wages required by the contract, the (Agency) may, after written notice to the Contractor, sponsor, applicant, or owner, take such action as may be necessary to cause the suspension of any further payment, advance, or guarantee of funds until such violations have ceased.

(3) Payrolls and basic records.

(i) Payrolls and basic records relating thereto shall be maintained by the Contractor during the course of the work and preserved for a period of three years thereafter for all laborers and mechanics working at the site of the work. Such records shall contain the name, address, and social security number of each such work, his or her correct classification, hourly rates of wages paid (including rates of contributions or costs anticipated for bona fide fringe benefits or cash equivalents thereof of the types described in section 1(b)(2)(B) of the Davis-Bacon Act), daily and weekly number of hours worked, deductions made and actual wages paid. Whenever the Secretary of Labor has found under 29 CFR 5.5(a)(1)(iv) that the wages of any laborer or mechanic include the amount of any costs reasonably anticipated in providing benefits under a plan or program described in section 1(b)(2)(B) of the Davis-Bacon Act, the Contractor shall maintain records which show that the commitment to provide such benefits is enforceable, that the plan or program is financially responsible, and that the plan or program has been communicated in writing to the laborers or mechanics affected, and records which show the costs anticipated or the actual cost incurred in providing such benefits. Contractors employing apprentices or trainees under approved programs shall maintain written evidence of the registration of apprenticeship programs and certification of trainee programs, the registration of the apprentices and trainees, and the ratios and wage rates prescribed in the applicable programs. (Approved by the Office Management and Budget under OMB control numbers 1215-0140 and 1215-0017).

(ii)(A) The Contractor shall submit weekly for each week in which any contract work is performed a copy of all payrolls to the Federal Aviation Administration if the agency is a party to the contract, but if the agency is not such a party, the Contractor will submit the payrolls to the applicant, sponsor, or owner, as the case may be, for transmission to the Federal Aviation Administration. The payrolls submitted shall set out accurately and completely all of the information required to be maintained under paragraph 5.5(a)(3)(i) of Regulations, 29 CFR Part 5. This information may be submitted in any form desired.

Optional Form WH-347 is available for this purpose and may be purchased from the Superintendent of Documents (Federal Stock Number 029-005-00014-1), U.S. Government Printing Office, Washington, D.C. 20402. The prime Contractor is responsible for the submission of copies of payrolls by all subcontractors. (Approved by the Office of Management and Budget under OMB control number 1215-0149).

(ii)(B) Each payroll submitted shall be accompanied by a "Statement of Compliance," signed by the Contractor, or subcontractor or his or her agent who pays or supervises the payment of the persons employed under the contract and shall certify the following:

(1) That the payroll for the payroll period contains the information required to be maintained under paragraph 5.5(a)(3)(i) of Regulations, 29 CFR Part 5 and that such information is correct and complete;

(2) That each laborer or mechanic (including each helper, apprentice, and trainee) employed on the contract during the payroll period has been paid the full weekly wages earned, without rebate, either directly or indirectly, and that no deductions have been made either directly or indirectly from the full wages earned, other than permissible deductions as set forth in Regulations, 29 CFR Part 3;

(3) That each laborer or mechanic has been paid not less than the applicable wage rates and fringe benefits or cash equivalents for the classification of work performed as specified in the applicable wage determination incorporated into the contract.

(ii)(C) The weekly submission of a properly executed certification set forth on the reverse side of Optional Form WH-347 shall satisfy the requirement for submission of the "Statement of Compliance" required by paragraph (a)(3)(ii)(B) of this section.

(ii)(D) The falsification of any of the above certifications may subject the Contractor or subcontractor to civil or criminal prosecution under Section 1001 of Title 18 and Section 231 of Title 31 of the United States Code.

(iii) The Contractor or subcontractor shall make the records required under paragraph (a)(3)(i) of this section available for inspection, copying, or transcription by authorized representatives of the (write the name of the agency) or the Department of Labor, and shall permit such representatives to interview employees during working hours on the job. If the Contractor or subcontractor fails to submit the required records or to make them available, the Federal agency may, after written notice to the Contractor, sponsor, applicant, or owner, take such action as may be necessary to cause the suspension of any further payment, advance, or guarantee of funds. Furthermore, failure to submit the required records upon request or to make such records available may be grounds for debarment action pursuant to 29 CFR 5.12.

(4) Apprentices and Trainees

(i) Apprentices. Apprentices will be permitted to work at less than the predetermined rate for the work they performed when they are employed pursuant to and individually registered in a bona fide apprenticeship program registered with the U.S. Department of Labor, Employment and Training Administration, Bureau of Apprenticeship and Training, or with a State Apprenticeship Agency recognized by the Bureau, or if a person is employed in his or her first 90 days of probationary employment as a apprentice in such an apprenticeship program, who is not individually registered in the program, but who has been certified by the Bureau of Apprenticeship and Training or a State Apprenticeship Agency (where appropriate) to be eligible for probationary employment as an apprentice. The allowable ratio of apprentices to journeymen on the job site in any craft classification shall not be greater than the ratio permitted to the Contractor as to the entire work force under the registered program. Any worker listed on a payroll at an apprentice wage rate, who is not registered or otherwise employed as stated above, shall be paid not less than the applicable wage rate on the wage determination for the classification of work actually performed. In addition, any apprentice performing work on the job site in excess of the ratio permitted under the registered program shall be paid not less than the applicable wage rate on the wage determination for the work actually performed. Where a Contractor is performing construction on a project in a locality other than that in which its program is registered, the ratios and wage rates (expressed in percentages of the journeyman's hourly rate) specified in the Contractor's or subcontractor's registered program shall be observed. Every apprentice must be paid at not less than the rate specified in the registered program for the apprentice's level of progress, expressed as a percentage of the journeymen hourly rate specified in the applicable wage determination. Apprentices shall be paid fringe benefits in accordance with the provisions of the apprenticeship program. If the apprenticeship program does not specify fringe benefits, apprentices must be paid the full amount of fringe benefits listed on the wage determination for the applicable classification. If the Administrator determines that a different practice prevails for the applicable apprentice classification, fringes shall be paid in accordance with that determination. In the event the Bureau of Apprenticeship and Training, or a State Apprenticeship Agency recognized by the Bureau, withdraws approval of an apprenticeship program, the Contractor will no longer be permitted to utilize apprentices at less than the applicable predetermined rate for the work performed until an acceptable program is approved.

(ii) Trainees. Except as provided in 29 CFR 5.16, trainees will not be permitted to work at less than the predetermined rate for the work performed unless they are employed pursuant to and individually registered in a program which has received prior approval, evidenced by formal certification by the U.S. Department of Labor, Employment and Training Administration. The ratio of trainees to journeymen on the job site shall not be greater than permitted under the plan approved by the Employment and Training Administration. Every trainee must be paid at not less than the rate specified in the approved program for the trainee's level of progress, expressed as a percentage of the journeyman hourly rate specified in the applicable wage determination. Trainees shall be paid fringe benefits in accordance with the provisions of the trainee program. If the trainee program does not mention fringe benefits, trainees shall be paid the full amount of fringe benefits listed on the wage determination unless the Administrator of the Wage and Hour Division determines that there is an apprenticeship program associated with the corresponding journeyman wage rate on the wage determination which provides for less than full fringe benefits for apprentices. Any employee listed on the payroll at a trainee rate who is not registered and participating in a training plan approved by the Employment and Training Administration shall be paid not less than the applicable wage rate on the wage determination for the classification of work actually performed. In addition, any trainee performing work on the job site in excess of the ration permitted under the registered program shall be paid not less than the applicable wage rate on the wage determination for the work actually performed. In the event the Employment and Training Administration withdraws approval of a training program, the contract will no longer be permitted to utilize trainees at less than the applicable predetermined rate for the work performed until an acceptable program is approved.

(iii) Equal employment opportunity. The utilization of apprentices, trainees and journeymen under this part shall be in conformity with the equal employment opportunity requirements of Executive Order 11246, as amended, and 29 CFR Part 30.

(5) Compliance with Copeland Act requirements. The Contractor shall comply with the requirements of 29 CFR Part 3, which are incorporated by reference in this contract.

(6) Subcontracts. The Contractor or subcontractor shall insert in any subcontracts the clauses contained in paragraph (a)(1) through (10) of this contract and such other clauses as the Federal Aviation Administration may by appropriate instructions require, and also a clause requiring the subcontractors to include these clauses in any lower tier subcontracts. The prime Contractor shall be responsible for the compliance by an subcontractor or lower tier subcontractor with all the contract clauses in 29 CFR 5.5.

(7) Contract determination: debarment. A breach of these contract clauses paragraphs (a)(1) through (10) and the 2nd clause (b)(1) through (5) below may be grounds for termination of the contract and for debarment as a Contractor and a subcontractor as provided in 29 CFR 5.12.

(8) Compliance with Davis-Bacon and Related Act requirements. All rulings and interpretations of the Davis-Bacon and Related Acts contained in 29 CFR Parts 1, 3, and 5 are herein incorporated by referenced in this contract.

(9) Disputes concerning labor standards. Disputes arising out of the labor standards provisions of this contract shall not be subject to the general disputes clause of this contract. Such disputes shall be resolved in accordance with the procedures of the Department of Labor set forth in 29 CFR Parts 5, 6, and 7. Disputes within the meaning of this clause include disputes between the Contractor (or any of its subcontractors) and the contracting agency, the U.S. Department of Labor, or the employees or their representatives.

(10) Certification of Eligibility.

(i) By entering into this contract, the Contractor certifies that neither it (nor he or she) nor any person or firm who has an interest in the Contractor's firm is a person or firm ineligible to be awarded Government contracts by virtue of section 3(a) of the Davis-Bacon Act or 29 CFR 5.12(a)(1).

(ii) No part of this contract shall be subcontracted to any person or firm ineligible for award of a Government contract by virtue of section 3(a) of the Davis-Bacon Act or 29 CFR 5.12(a)(1).

(iii) The penalty for making false statements is prescribed in the U.S. Criminal Code, 18 U.S.C. 1001.

(b) Contract Work Hours and Safety Standards Act. The Agency Head shall cause or require the contracting officer to insert the following clauses set forth in paragraphs (b)(1), (2), (3), (4) and (5) of this section in full in AIP construction contracts in excess of \$2,000. These clauses shall be inserted in addition to the clauses required by paragraph 5.5(a) or paragraph 4.6 of Part 4 of this title. As used in this paragraph, the terms "laborers" and "mechanics" include watchmen and guards.

(1) Overtime requirements: No Contractor or subcontractor contracting for any part of the contract work which may require or involve the employment of laborers, mechanics, watchmen or guards (including apprentices and trainees described in paragraphs 5 and 6 above) shall require or permit any laborer, mechanic, watchman or guard in any workweek in which he/she is employed on such work, to work in excess of 40 hours in such workweek unless such laborer, mechanic, watchman or guard receives compensation at a rate not less than one and one-half times his/her basic rate of pay for all hours worked in excess of 40 hours in such workweek.

(2) Violations: Liability for Unpaid Wages; Liquidated Damages: In the event of any violation of the clause set forth in subparagraph (1) of this paragraph, the Contractor and any subcontractor responsible therefore shall be liable to any affected employee for his/her unpaid wages. In addition, such Contractor and subcontractor shall be liable to the United States (in case of work done under contract for the District of Columbia or a territory, to such District or to such territory), for liquidated damages. Such liquidated damages shall be computed with respect to each individual laborer, mechanic, watchman or guard employed in violation of the clause set forth in subparagraph (1) of this paragraph, in the sum of \$10.00 for each calendar day on which such employee was required or permitted to work in excess of the standard workweek of 40 hours without payment of the overtime wages required by the clause set forth in subparagraph (1) of this paragraph.

(3) Withholding for unpaid wages and liquidated damages. The (write in the name of the Federal agency or the loan or grant recipient) shall upon its own action or upon written request of an authorized representative of the Department of Labor withhold or cause to be withheld, from any moneys payable on account of work performed by the Contractor or subcontractor under any such contract or any other Federal contract with the same prime Contractor, or any other Federally-assisted contract subject to the Contract Work Hours and Safety Standards Act, which is held by the same prime Contractor, such sums as may be determined to be necessary to satisfy any liabilities of such Contractor or subcontractor for unpaid wages and liquidated damages as provided in the clause set forth in subparagraph (2) of this paragraph.

(4) Subcontracts. The Contractor or subcontractor shall insert in any subcontracts the clauses set forth in subparagraph (1) through (4) of this paragraph and also a clause requiring the subcontractors to include these clauses in any lower tier subcontracts. The prime Contractor shall be responsible for compliance by any subcontractor or lower tier subcontractor with the clauses set forth in subparagraphs (1) through (4) of this paragraph.

(5) Working Conditions. No Contractor or subcontractor may require any laborer or mechanic employed in the performance of any contract to work in surroundings or under working conditions that are unsanitary, hazardous, or dangerous to his health or safety as determined under construction safety and health standards (29 CFR 1926) issued by Department of Labor.

(c) In addition to the clauses contained in paragraph (b), in any contract subject only to the Contract Work Hours and Safety Standards Act and not to any of the other statutes cited in paragraph 5.1, the Agency Head shall cause or require the contracting officer to insert a clause requiring that the Contractor or subcontractor shall maintain payrolls and basic payroll records during the course of the work and shall preserve them for a period of three years from the completion of the contract for all laborers and mechanics, including guards and watchmen, working on the contract. Such records shall contain the name and address of each such employee, social security number, correct classifications, hourly rates of wages paid, daily and weekly number of hours worked, deductions made, and actual wages paid. Further, the Agency Head shall cause or require the contracting officer to insert in any such contract a clause providing that the records to be maintained under this paragraph shall be made available by the Contractor or subcontractor for inspection, copying, or transcription by authorized representatives of the (write the name of agency) and the Department of Labor, and the Contractor or subcontractor will permit such representatives to interview employees during working hours on the job. (Approved by the Office of Management and Budget under OMB control numbers 1215-0140 and 1215-0017).

FEDERAL REGULATIONS VOL. 40, #74,
WEDNESDAY, APRIL 16, 1975, PAGE 17124,
ADMINISTRATION OF THE CLEAR AIR ACT
& WATER POLLUTION CONTROL ACT
(with respect to Federal Grants)

In connection with the administration of the Clean Air Act and the Water Pollution Control Act with respect to Federal Grants, specific requirements have been imposed of any contract which is not exempt under the provisions of 40 CFR 15.5.

(1) Any facility listed on the EPA List of Violating Facilities pursuant to Paragraph 15.20 of 40 CFR as of the date of the contract award will not be utilized in the performance of any non-exempt contract or subcontract.

(2) The Contractor shall comply with all the requirements of Section 114 of the Clean Air Act, as amended, 42 USC 1857 et seq. and Section 308 of the Federal Water Pollution Control Act, as amended, 33 USC 1251 et seq. relating to inspection, monitoring, entry, reports and information, as well as all other requirements specified in Section 114 and Section 308 of the Air Act and Water Act, respectively, and all regulations and guidelines issued thereunder after the award of the contract.

(3) Prompt notification shall be required prior to contract award to the awarding official by the Contractor who will receive the award of the receipt of any communication from the Director, Office of Federal Activities, U.S. Environmental Protection Agency, indicating that a facility to be utilized for the contract is under consideration to be listed on the EPA List of Violating Facilities.

(4) The Contractor shall include or cause to be included the criteria and requirements in paragraphs 1 through 4 in any non-exempt subcontract and will take such action as the Government may direct as a means of enforcing such provisions.

Attachment No. 1

During the performance of the contract, the Contractor agrees as follows:

- (1) The Contractor will not discriminate against any employee or applicant for employment because of race, color, religion, sex or national origin. The Contractor will take affirmative action to ensure that applicants are employed, and that employees are treated during employment without regard to their race, color, religion, sex or national origin. Such action shall include, but not be limited to the following: Employment, upgrading, demotion or transfer, recruitment or recruitment advertising, layoff or termination, rates of pay or other forms of compensation, and selection for training including apprenticeship. The Contractor agrees to post in conspicuous places, available to employees and applicants for employment, notices to be provided setting forth the provisions of this nondiscrimination clause.
- (2) The Contractor will, in all solicitations or advertisements for employees placed by or on the behalf of the Contractor, state that all qualified applicants will receive consideration for employment without regard to race, color, religion, sex or national origin.
- (3) The Contractor will send to each labor union or representative of workers with which he has a collective bargaining agreement or other contract or understanding, a notice to be provided advising the said labor union or worker's representatives of the Contractor's commitments under this section, and shall post copies of the notice in conspicuous places available to employees and applicants for employment.
- (4) The Contractor will comply with all provisions of Executive Order 11246 of September 24, 1965, and of the rules, regulations, and relevant orders of the Secretary of Labor.
- (5) The Contractor will furnish all information and reports required by Executive Order 11246 of September 24, 1965, and by rules, regulations and orders of the Secretary of Labor, or pursuant thereto, and will permit access to his books, records, and accounts by the administering agency and the Secretary of Labor for purposes of investigation to ascertain compliance with such rules, regulations, and orders.
- (6) In the event of the Contractor's noncompliance with the nondiscrimination clauses of this contract or with any of the said rules, regulations, or orders, this contract may be canceled, terminated, or suspended in whole or in part and the Contractor may be declared ineligible for further government contracts or federally assisted construction contracts in accordance with procedures authorized in Executive Order 11246 of 24 September 1965, and such other sanctions may be imposed and remedies invoked as provided in Executive Order 11246 of 24 September 1965, or by rule, regulation or order of the Secretary of Labor, or as otherwise provided by law.
- (7) The Contractor will include the portion of the sentence immediately preceding paragraph (1) and the provisions of paragraphs (1) through (7) in every subcontract or purchase order unless exempted by rules, regulations, or orders of the Secretary of Labor issued pursuant to Section 204 of Executive Order 11246 of 24 September 1965, so that such provisions will be binding upon each subcontractor or vendor. The Contractor will take such action with respect to any subcontract or purchase order as the administering agency may direct as means of enforcing such provisions, including sanctions for noncompliance; provided, however, that in the event a Contractor becomes involved in, or is threatened with, litigation with a subcontractor or vendor as a result of such direction by the administering agency, the Contractor may request the United States to enter into such litigation to protect the interests of the United States.

ATTACHMENT NO. 2

EACH PRIME CONTRACTOR SHALL INSERT IN EACH SUBCONTRACT THE CERTIFICATION IN APPENDIX B, AND FURTHER, SHALL REQUIRE ITS INCLUSION IN ANY LOWER TIER SUBCONTRACT, PURCHASE ORDER, OR TRANSACTION THAT MAY IN TURN BE MADE.

- Appendix B of 49 CFR Part 29 -

This certification applies to subcontractors, material suppliers, vendors and other lower tier participants.

Appendix B--Certification Regarding Debarment, Suspension, Ineligibility and Voluntary Exclusion--Lower Tier Covered Transactions

Instructions for Certification

1. By signing and submitting this proposal, the prospective lower tier participant is providing the certification set out below.

2. The certification in this clause is a material representation of fact upon which reliance was placed when this transaction was entered into. If it is later determined that the prospective lower tier participant knowingly rendered an erroneous certification, in addition to other remedies available to the Federal Government, the department or agency with which this transaction originated may pursue available remedies, including suspension and/or debarment.

3. The prospective lower tier participant shall provide immediate written notice to the person to which this proposal is submitted if at any time the prospective lower tier participant learns that its certification was erroneous when submitted or has become erroneous by reason of changed circumstances.

4. The terms "covered transaction," "debarred," "suspended," "ineligible," "lower tier covered transaction," "participant," "person," "primary covered transaction," "principal," "proposal," and "voluntarily excluded," as used in this clause sections of rules implementing Executive Order 12549. You may contact the person to which this proposal is submitted for assistance in obtaining a copy of those regulations.

5. The prospective lower tier participant agrees by submitting this proposal that, should the proposed covered transaction be entered into, it shall not knowingly enter into any lower tier covered transaction with a person who is debarred, suspended, declared ineligible, or voluntarily excluded from participation in this covered transaction, unless authorized by the department or agency with which this transaction originated.

6. The prospective lower tier participant further agrees by submitting this proposal that it will include this clause titled "Certification Regarding Debarment, Suspension, Ineligibility and Voluntary Exclusion--Lower Tier Covered Transaction," without modification, in all lower tier covered transactions and in all solicitations for lower tier covered transactions.

7. A participant in a covered transaction may rely upon a certification of a prospective participant in a lower tier covered transaction that it is not debarred, suspended, ineligible, or voluntarily excluded from the covered transaction, unless it knows that the certification is erroneous. A participant may decide the method and frequency by which it determines the eligibility of its principals. Each participant may, but is not required to, check the Nonprocurement List.

8. Nothing contained in the foregoing shall be construed to require establishment of a system of records in order to render in good faith the certification required by this clause. The knowledge and information of a participant is not required to exceed that which is normally possessed by a prudent person in the ordinary course of business dealings.

9. Except for transactions authorized under paragraph 5 of these instructions, if a participant in a covered transaction knowingly enters into a lower tier covered transaction with a person who is suspended, debarred, ineligible, or voluntarily excluded from participation in this transaction, in addition to other remedies available to the Federal Government, the department or agency with which this transaction originated may pursue available remedies, including suspension and/or debarment.

Certification Regarding Debarment, Suspension, Ineligibility and Voluntary Exclusion--Lower Tier Covered Transactions

(1) The prospective lower tier participant certifies, by submission of this proposal, that neither it nor its principals is presently debarred, suspended, proposed for debarment, declared ineligible, or voluntarily excluded from participation in this transaction by any Federal department or agency.

(2) Where the prospective lower tier participant is unable to certify to any of the statements in this certification, such prospective participant shall attach an explanation to this proposal.

STATE REQUIRED CONTRACT PROVISIONS
ALL FEDERAL-AID CONSTRUCTION CONTRACTS

Effective February 1, 1969
Revised January 2, 1973

The following provisions are State of Illinois requirements and are in addition to the Federal requirements.

"EQUAL EMPLOYMENT OPPORTUNITY"

In the event of the Contractor's noncompliance with any provisions of this Equal Employment Opportunity Clause, the Illinois Fair Employment Practices Act or the Fair Employment Practices Commission's Rules and Regulations for Public Contracts, the Contractor may be declared nonresponsible and therefore ineligible for future contracts or subcontracts with the State of Illinois or any of its political subdivisions or municipal corporations, and the contract may be canceled or avoided in whole or in part, and such other sanctions or penalties may be imposed or remedies invoked as provided by statute or regulation.

During the performance of this contract, the Contractor agrees as follows:

- (1) That it will not discriminate against any employee or applicant for employment because of race, color, religion, sex, national origin or ancestry; and further that it will examine all job classifications to determine if minority persons or women are underutilized and will take appropriate affirmative action to rectify any such underutilization.
- (2) That, if it hires additional employees in order to perform this contract or any portion hereof, it will determine the availability (in accordance with the Commission's Rules and Regulations for Public Contracts) of minorities and women in the area(s) from which it may reasonably recruit and it will hire for each job classification for which employees are hired in such a way that minorities and women are not underutilized.
- (3) That, in all solicitations or advertisements for employees placed by it or on its behalf, it will state that all applicants will be afforded equal opportunity without discrimination because of race, color, religion, sex, national origin or ancestry.
- (4) That it will send to each labor organization or representative of workers with which it has or is bound by a collective bargaining or other agreement or understanding, a notice advising such labor organization or representative of the Contractor's obligations under the Illinois Fair Employment Practices Act and the Commission's Rules and Regulations for Public Contracts. If any such labor organization or representative fails or refuses to cooperate with the Contractor in its efforts to comply with such Act and Rules and Regulations, the Contractor will promptly so notify the Illinois Fair Employment Practices Commission and the contracting agency and will recruit employees from other sources when necessary to fulfill its obligations thereunder.
- (5) That it will submit reports as required by the Illinois Fair Employment Practices Commission's Rules and Regulations for Public Contracts, furnish all relevant information as may from time to time be requested by the Commission or the contracting agency, and in all respects comply with the Illinois Fair Employment Practices Act and the Commission's Rules and Regulations for Public Contracts.
- (6) That it will permit access to all relevant books, records, accounts and work sites by personnel of the contracting agency and the Illinois Fair Employment Practices Commission for purposes of investigation to ascertain compliance with the Illinois Fair Employment Practices Act and the Commission's Rules and Regulations for Public Contracts.
- (7) That it will include verbatim or by reference the provisions of paragraphs 1 through 7 of this clause in every performance subcontract as defined in Section 2.10(b) of the Commission's Rules and Regulations for Public Contracts so that such provisions will be binding upon every subcontractor; and that it will also so include the provisions or paragraphs 1, 5, 6 and 7 in every supply subcontract as defined in Section 2.10(a) of the Commission's Rules and Regulations for Public Contracts so that such provisions will be binding upon every such subcontractor. In the same manner as with other provisions of this contract, the Contractor will be liable for compliance with applicable provisions of this clause by all its subcontractors; and further it will promptly notify the contracting agency and the Illinois Fair Employment Practices Commission in the event any subcontractor fails or refuses to comply therewith. In addition, no Contractor will utilize any subcontractor declared by the Commission to be nonresponsible and therefore ineligible for contracts or subcontracts with the State of Illinois or any of its political subdivisions or municipal corporations.

CONSTRUCTION CONTRACT PROCUREMENT POLICIES

TABLE OF CONTENTS

SECTION 1

Proposal Requirements and Conditions

SUB-SECTION

1-01 ADVERTISEMENT (Notice to Bidders).....	42
1-02 PREQUALIFICATION OF BIDDERS.....	42
1-03 CONTENTS OF PROPOSAL FORMS	43
1-04 ISSUANCE OF PROPOSAL FORMS.....	43
1-05 INTERPRETATION OF QUANTITIES IN BID SCHEDULE.....	43
1-06 EXAMINATION OF PLANS, SPECIFICATIONS, AND SITE.....	43
1-07 PREPARATION OF THE PROPOSAL	44
1-08 REJECTION OF PROPOSALS	44
1-09 PROPOSAL GUARANTY	44
1-10 DELIVERY OF PROPOSALS	45
1-11 WITHDRAWAL OF PROPOSALS.....	45
1-12 PUBLIC OPENING OF PROPOSALS.....	45
1-13 DISQUALIFICATION OF BIDDERS.....	45
1-14 WORKER'S COMPENSATION INSURANCE.....	45

SECTION 2

Award and Execution of Contract

SUB-SECTION

2-01 CONSIDERATION OF PROPOSALS	45
2-02 AWARD OF CONTRACT	46
2-03 CANCELLATION OF AWARD	46
2-04 RETURN OF PROPOSAL GUARANTY	46
2-05 REQUIREMENT OF PERFORMANCE AND PAYMENT BONDS.....	46
2-06 EXECUTION OF CONTRACT.....	46
2-07 APPROVAL OF CONTRACT	46
2-08 FAILURE TO EXECUTE CONTRACT	46

SECTION 1

PROPOSAL REQUIREMENTS AND CONDITIONS

1-01 ADVERTISEMENT (Notice to Bidders). The State of Illinois shall publish the advertisement at such places and at such times as are required by local law or ordinances. The published advertisement shall state the time and place for submitting sealed proposals; a description of the proposed work; instructions to bidders as to obtaining proposal forms, plans, and specifications; proposal guaranty required; and the Owner's right to reject any and all bids.

For Federally assisted contracts the advertisement shall conform to the requirements of local laws and ordinances pertaining to letting of contracts and, in addition, shall conform to the requirements of the appropriate parts of the Federal Aviation Regulations applicable to the particular contract being advertised.

1-02 PREQUALIFICATION OF BIDDERS.

- (a) When the awarding authority is the State of Illinois, each prospective bidder, prior to being considered for issuance of any proposal forms will be required to file, on forms furnished by the Department, an experience questionnaire and a confidential financial statement in accordance with the Department's Instructions for Prequalification of Contractors. The Statement shall include a complete report of the prospective bidder's financial resources and liabilities, equipment, past record and personnel, and must be submitted at least thirty (30) days prior to the scheduled opening of bids in which the Contractor is interested.

After the Department has analyzed the submitted "Contractor's Statement of Experience and Financial Condition" and related information and has determined appropriate ratings, the Department will issue to the Contractor a "Certificate of Eligibility". The Certificate will permit the Contractor to obtain proposal forms and plans for any Department of Transportation letting on work which is within the limits of the Contractor's potential as indicated on his "Certificate of Eligibility", subject to any limitations due to present work under contract or pending award as determined from the Contractor's submitted "Affidavit of Availability". Bidders intending to consistently submit proposals shall submit a "Contractor's Statement of Experience and Financial Condition" at least once a year. However, prequalification may be changed during that period upon the submission of additional favorable reports or upon reports of unsatisfactory performance.

Before a proposal is issued, the prospective bidder will be required to furnish an "Affidavit of Availability" indicating the location and amount of all uncompleted work under contract, or pending award, either as principal or subcontractor, as well as a listing of all subcontractors and value of work sublet to others. The prospective bidder may be requested to file a statement showing the amount and condition of equipment which will be available.

Before an award is made, the bidder may be required to furnish an outline of his plans for conducting the work.

- (b) When the awarding authority for contract construction work is the County Board of a county; the Council, the City Council, or the President and Board of Trustees of a city, village or town, each prospective bidder, in evidence of his competence, shall furnish the awarding authority as a prerequisite to the release of proposal forms by the awarding authority, a certified or photostatic copy of a "Certificate of Eligibility" issued by the Department of Transportation, in accordance with Section 1-02(a).

The two low bidders must file within 24 hours after the letting a sworn affidavit, in triplicate, showing all uncompleted contracts awarded to them and all low bids pending award for Federal, State, County, Municipal and private work, using the blank form made available for this affidavit. One copy shall be filed with the awarding authority and two copies with the District Highway Office.

1-03 CONTENTS OF PROPOSAL FORMS. Upon request, the Department will furnish the prequalified bidders a proposal form. This form will state the location and description of the contemplated construction and will show the estimate of the various quantities and kinds of work to be performed or materials to be furnished, and will have a schedule of items for which unit bid prices are invited. The proposal form will state the time in which work must be completed, the amount of the proposal guaranty, labor requirements, and date, time and place of the opening of proposals. The form will also include any special provisions or requirements which vary from or are not contained in these specifications.

All papers bound with or attached to the proposal form are considered a part thereof and must not be detached or altered when the proposal is submitted. Any addenda officially issued by the Department, will be considered a part of the proposal whether attached or not.

For Federally assisted contracts, the proposal shall conform to the requirements of local laws and ordinances pertaining to letting of contracts and, in addition, shall conform to the requirements of the appropriate parts of the Federal Aviation Regulations pertaining to the particular contract being let.

1-04 ISSUANCE OF PROPOSAL FORMS. The Department shall refuse to issue a proposal form for any of the following reasons:

- (a) Lack of competency and adequate machinery, plant and other equipment, as revealed by the financial statement and experience questionnaires required under Section 1-02(a).
- (b) Uncompleted work which, in the judgment of the Department, might hinder or prevent the prompt completion of additional work if awarded.
- (c) False information provided on a bidder's "Affidavit of Availability".
- (d) Failure to pay, or satisfactorily settle, all bills due for labor and material on former contracts in force at the time of issuance of proposal forms.
- (e) Failure to comply with any prequalification regulations of the Department.
- (f) Default under previous contracts.
- (g) Unsatisfactory performance record as shown by past work for the Department, judged from the standpoint of workmanship and progress.
- (h) When the Contractor is suspended from eligibility to bid at a public letting where the contract is awarded by, or require approval of, the Department.
- (i) When any agent, servant, or employee of the prospective bidder currently serves as a member, employee, or agent of a governmental body that is financially involved in the proposed work.
- (j) When any agent, servant, or employee of the prospective bidder has participated in the preparation of plans or specifications for the proposed work.

1-05 INTERPRETATION OF QUANTITIES IN BID SCHEDULE. An estimate of quantities of work to be done and materials to be furnished under these specifications is given in the proposal. It is the result of careful calculations and is believed to be correct. It is given only as a basis for comparison of proposals and the award of the contract. The Owner does not expressly or by implication agree that the actual quantities involved will correspond exactly therewith; nor shall the bidder plead misunderstanding or deception because of such estimates of quantities, or of the character, location, or other conditions pertaining to the work. Payment to the Contractor will be made only for the actual quantities of work performed or materials furnished in accordance with the plans and specifications. It is understood that the quantities may be increased or decreased as provided in the subsection titled ALTERATION OF WORK AND QUANTITIES of Section 20 of the Illinois Standard Specifications for Construction of Airports without in any way invalidating the unit bid prices.

1-06 EXAMINATION OF PLANS, SPECIFICATIONS, AND SITE. The bidder is expected to carefully examine the site of the proposed work, the proposal, plans, specifications, and contract forms. He shall satisfy himself as to the character, quality, and quantities of work to be performed, materials to be furnished, and as to the requirements of the proposed contract. The submission of a proposal shall be prima facie evidence that the bidder has made such examination and is satisfied as to the conditions to be encountered in performing the work and as to the requirements of the proposed contract, plans, and specifications.

Boring logs, underground utilities and other records of subsurface investigations and tests are available for inspection of bidders. It is understood and agreed that such subsurface information, whether included in the plans, specifications, or otherwise made available to the bidder, was obtained and is intended for the Owner's design and estimating purposes only. Such information has been made available for the convenience of all bidders. It is further understood and agreed that each bidder is solely responsible for all assumptions, deductions, or conclusions which he may make or obtain from his examination of the boring logs and other records of subsurface investigations and tests that are furnished by the Owner.

1-07 PREPARATION OF THE PROPOSAL. The bidder shall submit his proposal on the form furnished by the Department. The proposal shall be executed property, and bids shall be made for all items indicated in the proposal form, except that when alternate bids are asked, a bid on more than one alternate for each item is not required, unless otherwise provided. The bidder shall indicate, in figures, a unit price for each of the separate items called for in the proposal; he shall show the products of the respective quantities and unit prices in the column provided for that purpose, and the gross sum shown in the place indicated in the proposal shall be the summation of said products. All writing shall be with ink or typewriter, except the signature of the bidder which shall be written with ink.

If the proposal is made by an individual, his name and business address shall be shown. If made by a firm or partnership, the name and business address of each member of the firm or partnership shall be shown. If made by a corporation, the proposal shall show the names, titles, and business address of the president, secretary, and treasurer, and the seal of the corporation shall be affixed and attested by the secretary.

The proposal shall be issued to a prequalified bidder in the same name and style as the financial statement used for prequalification and shall be submitted in like manner.

1-08 REJECTION OF PROPOSALS. The Department reserves the right to reject proposals for any of the conditions in Article 1-04 or for any of the following reasons:

- (a) More than one proposal for the same work from an individual, firm, partnership, or corporation under the same or different names.
- (b) Evidence of collusion among bidders.
- (c) Unbalanced proposals in which the prices for some items are obviously out of proportion to the prices for other items.
- (d) If the proposal does not contain a unit price for each pay item listed except in the case of authorized alternate pay items or lump sum pay items.
- (e) If the proposal is other than that furnished by the Department; or if the form is altered or any part thereof is detached.
- (f) If there are omissions, erasures, alterations, unauthorized additions, conditional or alternate bids, or irregularities of any kind which may tend to make the proposal incomplete, indefinite, or ambiguous as to its meaning.
- (g) If the bidder adds any provisions reserving the right to accept or reject an award, or to enter into a contract pursuant to an award.
- (h) If the proposal is not accompanied by the proper proposal guaranty.
- (i) If the proposal is prepared with other than ink or typewriter.
- (j) If the proposal is submitted in any other name other than that to whom it was issued by the Department.

1-09 PROPOSAL GUARANTY. Each Proposal shall be accompanied by either a bid bond on the Department of Transportation, Division of Aeronautics form contained in the proposal, executed by a corporate surety company satisfactory to the Department or by a bank cashier's check or a properly certified check for not less than 5 percent of the amount bid.

Bank cashier's checks, or properly certified checks accompanying proposals shall be made payable to the Treasurer, State of Illinois.

1-10 DELIVERY OF PROPOSALS. Each proposal should be submitted in a special envelope furnished by the Department. The blank spaces on the envelope shall be filled in correctly to clearly indicate its contents. When an envelope other than the special one furnished by the Department is used, it shall be of the same general size and shape and be similarly marked to clearly indicate its contents. When sent by mail, the sealed proposal shall be addressed to the Department at the address and in care of the official in whose office the bids are to be received. All proposals shall be filed prior to the time and place specified in the Notice to Bidders. Proposals received after the time for opening of bids will be returned to the bidder unopened.

1-11 WITHDRAWAL OF PROPOSALS. Permission will be given a bidder to withdraw a proposal if he makes his request in writing or by telegram before the time for opening proposals. If a proposal is withdrawn, the bidder will not be permitted to resubmit this proposal at the same letting. With the approval of the Engineer, a bidder may withdraw a proposal and substitute a new proposal prior to the time of opening bids.

1-12 PUBLIC OPENING OF PROPOSALS. Proposals will be opened and read publicly at the time and place specified in the Notice to Bidders. Bidders, their authorized agents, and other interested parties are invited to be present.

1-13 DISQUALIFICATION OF BIDDERS. A bidder shall be considered disqualified for any of the following reasons:

- (a) Submitting more than one proposal from the same partnership, firm, or corporation under the same or different name.
- (b) Evidence of collusion among bidders. Bidders participating in such collusion shall be disqualified as bidders for any future work of the Owner.
- (c) If the bidder is considered to be in "default" for any reason specified in the Subsection 1-04 titled ISSUANCE OF PROPOSAL FORMS of this section.

1-14 WORKER'S COMPENSATION INSURANCE. Prior to the approval of his contract by the Division, the Contractor shall furnish to the Division certificates of insurance covering Worker's Compensation, or satisfactory evidence that this liability is otherwise taken care of in accordance with Section 4.(a) of the "Worker's Compensation Act of the State of Illinois" as amended.

SECTION 2

AWARD AND EXECUTION OF CONTRACT

2-01 CONSIDERATION OF PROPOSALS. After the proposals are publicly opened and read, they will be compared on the basis of the summation of the products obtained by multiplying the estimated quantities shown in the proposal by the unit bid prices. In the event of a discrepancy between unit bid prices and extensions, the unit bid price shall govern.

Until the award of a contract is made, the Owner reserves the right to reject a bidder's proposal for any of the following reasons:

- (a) If the proposal is irregular as specified in the subsection titled REJECTION OF PROPOSALS of Section 1.
- (b) If the bidder is disqualified for any of the reasons specified in the subsection titled DISQUALIFICATION OF BIDDERS of Section 1.

In addition, until the award of a contract is made, the Owner reserves the right to reject any or all proposals; waive technicalities, if such waiver is in the best interest of the Owner and is in conformance with applicable State and Local laws or regulations pertaining to the letting of construction contracts; advertise for new proposals; or proceed with the work otherwise.

2-02 AWARD OF CONTRACT. The award of contract will be made within 60 calendar days after the opening of proposals to the lowest responsible and qualified bidder whose proposal complies with all the requirements prescribed. The successful bidder will be notified by letter, that his bid has been accepted, and that he has been awarded the contract.

If a contract is not awarded within 60 days after the opening of proposals, a bidder may file a written request with the Division for the withdrawal of his bid and the Division will permit such withdrawal.

For Federally assisted contracts, unless otherwise specified in this subsection, no award shall be made until the FAA has concurred in the Owner's recommendation to make such award and has approved the Owner's proposal contract to the extent that such concurrence and approval are required by Federal Regulations.

2-03 CANCELLATION OF AWARD. The Division reserves the right to cancel the award without liability to the bidder at any time before a contract has been fully executed by all parties and is approved by the Owner in accordance with the subsection titled APPROVAL OF CONTRACT of this section. The Division at the time of cancellation will return the proposal guaranty.

2-04 RETURN OF PROPOSAL GUARANTY. The proposal guaranties of all except the two lowest bidders will be returned promptly after the proposals have been checked, tabulated, and the relation of the proposals established. Proposal guaranties of the two lowest bidders will be returned as soon as the Construction Contract, Performance Bonds, and Payment Bonds of the successful bidder have been properly executed and approved.

If any other form of proposal guaranty is used, other than a bid bond, a bid bond may be substituted at the Contractor's option.

2-05 REQUIREMENT OF PERFORMANCE AND PAYMENT BONDS. The successful bidder for a contract, at the time of the execution of the contract, shall deposit with the Division separate performance and payment bonds each for the full amount of the contract. The form of the bonds shall be that furnished by the Division, and the sureties shall be acceptable to the Division.

2-06 EXECUTION OF CONTRACT. The successful bidder shall sign (execute) the Contract and shall return the signed Contract to the Owner (Sponsor) for signature (execution) and subsequently return all copies to the Division. The fully executed surety bonds specified in the subsection title REQUIREMENTS OF PERFORMANCE AND PAYMENT BONDS of this section will be forwarded to the Division within 15 days of the date mailed or otherwise delivered to the successful bidder. If the Contract and Bonds are mailed, special handling is recommended.

If the bidder to whom award is to be made is a corporation organized under the laws of a State other than Illinois, the bidder shall furnish the Division a copy of the corporation's certificate of authority to do business in the State of Illinois with the return of the executed contract and bond. Failure to furnish such evidence of a certificate of authority within the time required will be considered as just cause for the annulment of the award and the forfeiture of the proposal guaranty to the State, not as a penalty, but in payment of liquidated damages sustained as a result of such failure.

2-07 APPROVAL OF CONTRACT. Upon receipt of the contract and bonds that have been executed by the successful bidder, the Owner shall complete the execution of the contract in accordance with local laws or ordinances, and return the contract to the Division for approval and execution by the Division. Delivery of the fully executed contract to the Contractor shall constitute the Department's approval to be bound by the successful bidder's proposal and the terms of the contract.

2-08 FAILURE TO EXECUTE CONTRACT. If the contract is not executed by the Division within 15 days following receipt from the bidder of the properly executed contracts and bonds, the bidder shall have the right to withdraw his bid without penalty.

Failure of the successful bidder to execute the contract and file acceptable bonds within 15 days after the contract has been mailed to him shall be just cause for the cancellation of the award and the forfeiture of the proposal guaranty which shall become the property of the State, not as a penalty, but as liquidation of damages sustained.

ILLINOIS DEPARTMENT OF TRANSPORTATION

DIVISION OF AERONAUTICS

The requirements of the following provisions written for Federally-assisted construction contracts, including all goals and timetables and affirmative action steps, shall also apply to all State-funded construction contracts awarded by the Illinois Department of Transportation.

NOTICE OF REQUIREMENT FOR AFFIRMATIVE ACTION TO ENSURE EQUAL EMPLOYMENT OPPORTUNITY (EXECUTIVE ORDER 11246)

1. The Offeror's or Bidder's attention is called to the "Equal Opportunity Clause" and the "Standard Federal Equal Employment Opportunity Construction Contract Specifications" set forth herein.

2. The goals and timetables for minority and female participation, expressed in percentage terms for the Contractor's aggregate workforce in each trade on all construction work in the covered area, are as follows:

APPENDIX A

The following goal for female utilization in each construction craft and trade shall apply to all Contractors holding Federal and federally assisted construction contracts and subcontracts in excess of \$10,000. The goal is applicable to the Contractor's total on-site construction workforce, regardless of whether or not part of that workforce is performing work on a Federal, federally assisted or nonfederally related construction contract or subcontract.

AREA COVERED (STATEWIDE)

Goals for Women apply nationwide.

GOAL

	Goal (percent)
Female Utilization.....	... 6.9

APPENDIX B

Until further notice, the following goals for minority utilization in each construction craft and trade shall apply to all Contractors holding Federal and federally-assisted construction contracts and subcontracts in excess of \$10,000. to be performed in the respective geographical areas. The goals are applicable to the Contractor's total on-site construction workforce, regardless of whether or not part of that workforce is performing work on a Federal, federally-assisted or nonfederally related construction contract or subcontract.

<u>Economic Area</u>	<u>Goal (percent)</u>
056 Paducah, KY:	
Non-SMSA Counties -	5.2
IL - Hardin, Massac, Pope	
KY - Ballard, Caldwell, Calloway, Carlisle, Crittenden,	
Fulton, Graves, Hickman, Livingston, Lyon, McCracken, Marshall	

Revised 08-31-83

<u>Economic Area</u>	<u>Goal (percent)</u>
080 Evansville, IN:	
Non-SMSA Counties -	3.5
IL - Edwards, Gallatin, Hamilton, Lawrence, Saline, Wabash, White	
IN - Dubois, Knox, Perry, Pike, Spencer	
KY - Hancock, Hopkins, McLean, Mublenberg, Ohio, Union, Webster	
081 Terre Haute, IN:	
Non-SMSA Counties -	2.5
IL - Clark, Crawford	
IN - Parke	
083 Chicago, IL:	
SMSA Counties:	19.6
1600 Chicago, IL -	
IL - Cook, DuPage, Kane, Lake, McHenry, Will	
3740 Kankakee, IL -	9.1
IL - Kankakee	
Non-SMSA Counties	18.4
IL - Bureau, DeKalb, Grundy, Iroquois, Kendall, LaSalle, Livingston, Putnam	
IN - Jasper, Laporte, Newton, Pulaski, Starke	
084 Champaign - Urbana, IL:	
SMSA Counties:	
1400 Champaign - Urbana - Rantoul, IL -	7.8
IL - Champaign	
Non-SMSA Counties -	4.8
IL - Coles, Cumberland, Douglas, Edgar, Ford, Piatt, Vermilion	
085 Springfield - Decatur, IL:	
SMSA Counties:	
2040 Decatur, IL -	7.6
IL - Macon	
7880 Springfield, IL -	4.5
IL - Mendard, Sangamon	
Non-SMSA Counties	4.0
IL - Cass, Christian, Dewitt, Logan, Morgan, Moultrie, Scott, Shelby	
086 Quincy, IL:	
Non-SMSA Counties	3.1
IL - Adams, Brown, Pike	
MO - Lewis, Marion, Pike, Ralls	
087 Peoria, IL:	
SMSA Counties:	
1040 Bloomington - Normal, IL -	2.5
IL - McLean	

Revised 08-31-83

APPENDIX B (CONTINUED)

<u>Economic Area</u>	<u>Goal (percent)</u>
6120 Peoria, IL - IL - Peoria, Tazewell, Woodford	4.4
Non-SMSA Counties - IL - Fulton, Knox, McDonough, Marshall, Mason, Schuyler, Stark, Warren	3.3
088 Rockford, IL: SMSA Counties: 6880 Rockford, IL - IL - Boone, Winnebago	6.3
Non-SMSA Counties - IL - Lee, Ogle, Stephenson	4.6
098 Dubuque, IA: Non-SMSA Counties - IL - JoDaviess IA - Atlamakee, Clayton, Delaware, Jackson, Winnesheik WI - Crawford, Grant, Lafayette	0.5
099 Davenport, Rock Island, Moline, IA - IL: SMSA Counties: 1960 Davenport, Rock Island, Moline, IA - IL - IL - Henry, Rock Island IA - Scott	4.6
Non-SMSA Counties - IL - Carroll, Hancock, Henderson, Mercer, Whiteside IA - Clinton, DesMoines, Henry, Lee, Louisa, Muscatine MO - Clark	3.4
107 St. Louis, MO: SMSA Counties: 7040 St. Louis, MO - IL - IL - Clinton, Madison, Monroe, St. Clair MO - Franklin, Jefferson, St. Charles, St. Louis, St. Louis City	14.7
Non-SMSA Counties - IL - Alexander, Bond, Calhoun, Clay, Effingham, Fayette, Franklin, Greene, Jackson, Jasper, Jefferson, Jersey, Johnson, Macoupin, Marion, Montgomery, Perry, Pulaski, Randolph, Richland, Union, Washington, Wayne, Williamson MO - Bollinger, Butler, Cape Girardeau, Carter, Crawford, Dent, Gasconade, Iron, Lincoln, Madison, Maries, Mississippi, Montgomery, Perry, Phelps, Reynolds, Ripley, St. Francois, St. Genevieve, Scott, Stoddard, Warren, Washington, Wayne	11.4

Revised 08-31-83

These goals are applicable to all the Contractor's construction work (whether or not it is Federal or federally assisted) performed in the covered area. If the Contractor performs construction work in a geographical area located outside of the covered area, it shall apply the goals established for such geographical area where the work is actually performed. With regard to this second area, the Contractor also is subject to the goals for both its federally involved and nonfederally involved construction.

The Contractor's compliance with Executive Order and the regulations in 41 CFR Part 60-4 shall be based on its implementation of the Equal Opportunity Clause, specific affirmative action obligations required by the provisions and specifications set forth in its federally assisted contracts, and its efforts to meet the goals established for the geographical area where the contract resulting from this solicitation is to be performed. The hours of minority and female employment and training must be substantially uniform throughout the length of the contract, and in each trade, and the Contractor shall make a good faith effort to employ minorities and women evenly on each of its projects. The transfer of minority or female employees or trainees from Contractor to Contractor or from project to project for the sole purpose of meeting the Contractor's goals shall be a violation of the contract, the Executive Order and the regulations in 41 CFR Part 60-4. Compliance with the goals will be measured against the total work hours performed.

3. The Illinois Division of Aeronautics will provide written notification to the Director of the Office of Federal Contract Compliance Programs within 10 working days of award of any construction contract and/or subcontract in excess of \$10,000 at any tier for construction work under the contract resulting from this solicitation. This notification will list the name, address and telephone number of the subcontractor; employer identification number; estimated dollar amount of the subcontract; estimated starting and completion dates of the subcontract; and the geographical area in which the contract is to be performed.

4. As used in this Notice, and in the contract resulting from this solicitation, the "covered area" is the entire State of Illinois for the goal set forth in APPENDIX A and the county or counties in which the work is located for the goals set forth in APPENDIX B.

STANDARD FEDERAL EQUAL EMPLOYMENT
OPPORTUNITY CONSTRUCTION CONTRACT
SPECIFICATIONS (EXECUTIVE ORDER 11246)

1. As used in these specifications:
 - a) "Covered area" means the geographical area described in the solicitation from which this contract resulted;
 - b) "Director" means Director, Office of Federal Contract Compliance Programs, United States Department of Labor, or any person to whom the Director delegates authority;
 - c) "Employer identification number" means the Federal Social Security number used on the Employer's Quarterly Federal Tax Return, U.S. Treasury Department Form 941;
 - d) "Minority" includes:
 - (i) Black (all persons having origins in any of the Black African racial groups not of Hispanic origin);
 - (ii) Hispanic (all persons of Mexican, Puerto Rican, Cuban, Central or South American or other Spanish Culture or origin, regardless of race);
 - (iii) Asian and Pacific Islander (all persons having origins in any of the original peoples of the Far East, Southeast Asia, the Indian Subcontinent, or the Pacific Islands); and
 - (iv) American Indian or Alaskan Native (all persons having origins in any of the original peoples of North America and maintaining identifiable tribal affiliations through membership and participation or community identification).
2. Whenever the Contractor, or any Subcontractor at any tier, subcontracts a portion of the work involving any construction trade, it shall physically include in each subcontract in excess of \$10,000. the provisions of these specifications and the Notice which contains the applicable goals for minority and female participation and which is set forth in the solicitations from which this contract resulted.

Revised 08-31-83

3. If the Contractor is participating (pursuant to 41 CFR 60-4.5) in a Hometown Plan approved by the U.S. Department of Labor in the covered area either individually or through an association, its affirmative action obligations on all work in the plan area (including goals and timetables) shall be in accordance with that Plan for those trades which have unions participating in the Plan. Contractors must be able to demonstrate their participation in and compliance with the provisions of any such Hometown Plan. Each Contractor or Subcontractor participating in an approved Plan is individually required to comply with its obligations under the EEO clause, and to make a good faith effort to achieve each goal under the Plan in each trade in which it has employees. The overall good faith performance by other Contractors or Subcontractors toward a goal in an approved Plan does not excuse any covered Contractor's or Subcontractor's failure to take good faith efforts to achieve the Plan goals and timetables.
4. The Contractor shall implement the specific affirmative action standards provided in paragraphs 7a through p of these specifications. The goals set forth in the solicitation from which this contract resulted are expressed as percentages of the total hours of employment and training of minority and female utilization the Contractor should reasonably be able to achieve in each construction trade in which it has employees in the covered area. Covered Construction Contractors performing construction work in geographical areas where they do not have a Federal or federally assisted construction contract shall apply the minority and female goals established for the geographical area where the work is being performed. Goals are published periodically in the Federal Register in notice form, and such notices may be obtained from any Office of Federal Contract Compliance Programs office or from Federal procurement contracting officers. The Contractor is expected to make substantially uniform progress toward its goals in each craft during the period specified.
5. Neither the provisions of any collective bargaining agreement, nor the failure by a union with whom the Contractor has a collective bargaining agreement, to refer either minorities or women shall excuse the Contractor's obligations under these specifications, Executive Order 11246, or the regulations promulgated pursuant thereto.
6. In order for the nonworking training hours of apprentices and trainees to be counted in meeting the goals, such apprentices and trainees must be employed by the Contractor during the training period, and the Contractor must have made a commitment to employ the apprentices and trainees at the completion of their training, subject to the availability of employment opportunities. Trainees must be trained pursuant to training programs approved by the U.S. Department of Labor.
7. The Contractor shall take specific affirmative actions to ensure equal employment opportunity. The evaluation of the Contractor's compliance with these specifications shall be based upon its effort to achieve maximum results from its actions. The Contractor shall document these efforts fully, and shall implement affirmative action steps at least as extensive as the following:
 - a) Ensure and maintain a working environment free of harassment, intimidation, and coercion at all sites, and in all facilities at which the Contractor's employees are assigned to work. The Contractor, where possible, will assign two or more women to each construction project. The Contractor shall specifically ensure that all foremen, superintendents, and other on-site supervisory personnel are aware of and carry out the Contractor's obligation to maintain such a working environment, with specific attention to minority or female individuals working as such sites or in such facilities.
 - b) Establish and maintain a current list of minority and female recruitment sources, provide written notification to minority and female recruitment sources and to community organizations when the Contractor or its unions have employment opportunities available, and maintain a record of the organizations' responses.
 - c) Maintain a current file of the names, addresses and telephone numbers of each minority and female off-the-street applicant and minority or female referral from a union, a recruitment source or community organization and of what action was taken with respect to each such individual. If such individual was sent to the union hiring hall for referral and was not referred back to the Contractor by the union or, if referred, not employed by the Contractor, this shall be documented in the file with the reason therefor, along with whatever additional actions the Contractors may have taken.

Revised 08-31-83

- d) Provide immediate written notification to the Director when the union or unions with which the Contractor has a collective bargaining agreement has not referred to the Contractor a minority person or woman sent by the Contractor, or when the Contractor has other information that the union referral process has impeded the Contractor's efforts to meet its obligations.
- e) Develop on-the-job training opportunities and/or participate in training programs for the area which expressly include minorities and women, including upgrading programs and apprenticeship and trainee programs relevant to the Contractor's employment needs, especially those programs funded or approved by the Department of Labor. The Contractor shall provide notice of these programs to the sources compiled under 7b above.
- f) Disseminate the Contractor's EEO policy by providing notice of the policy to unions and training programs and requesting their cooperation in assisting the Contractor in meeting its EEO obligations; by including it in any policy manual and collective bargaining agreements; by publicizing it in the company newspaper, annual report, etc.; by specific review of the policy with all management personnel and with all minority and female employees at least once a year; and by posting the company EEO policy on bulletin boards accessible to all employees at each location where construction work is performed.
- g) Review, at least annually, the company's EEO policy and affirmative action obligations under these specifications with all employees having any responsibility for hiring, assignment, layoff, termination or other employment decisions including specific review of these items with onsite supervisory personnel such as Superintendents, General Foreman, etc., prior to the initiation of construction work at any job site. A written record shall be made and maintained identifying the time and place of these meetings, persons attending, subject matter discussed, and disposition of the subject matter.
- h) Disseminate the Contractor's EEO policy externally by including it in any advertising in the news media, specifically including minority and female news media, and providing written notification to and discussing the Contractor's EEO policy with other Contractors and Subcontractors with whom the Contractor does or anticipates doing business.
- i) Direct its recruitment efforts, both oral and written, to minority, female and community organizations, to schools with minority and female students and to minority and female recruitment and training organizations serving the Contractor's recruitment area and employment needs. Not later than one month prior to the date for the acceptance of applications for apprenticeship or other training by any recruitment source, the Contractor shall send written notification to organizations such as the above, describing the openings, screening procedures, and tests to be used in the selection process.
- j) Encourage present minority and female employees to recruit other minority persons and women and, where reasonable, provide after school, summer and vacation employment to minority and female youth both on the site and in other areas of a Contractor's workforce.
- k) Validate all tests and other selection requirements where there is an obligation to do so under 41 CFR Part 60-3.
- l) Conduct, at least annually, an inventory and evaluation at least of all minority and female personnel for promotional opportunities and encourage these employees to seek or to prepare for, through appropriate training, etc., such opportunities.
- m) Ensure that seniority practices, job classifications, work assignments and other personnel practices, do not have a discriminatory effect by continually monitoring all personnel and employment related activities to ensure that the EEO policy and the Contractor's obligations under these specifications are being carried out.
- n) Ensure that all facilities and company activities are nonsegregated except that separate or single-user toilet and necessary changing facilities shall be provided to assure privacy between the sexes.
- o) Document and maintain a record of all solicitations of offers for subcontracts from minority and female construction Contractors and suppliers, including circulation of solicitations to minority and female Contractor associations and other business associations.

Revised 08-31-83

- p) Conduct a review, at least annually, of all supervisors' adherence to and performance under the Contractor's EEO policies and affirmative action obligations.
8. Contractors are encouraged to participate in voluntary associations which assist in fulfilling one or more of their affirmative action obligations (7a through p). The efforts of a Contractor association, joint Contractor-union, Contractor-community, or other similar group of which the Contractor is a member and participant, may be asserted as fulfilling any one or more of its obligations under 7a through p of these Specifications provided that the Contractor actively participates in the group, makes every effort to assure that the group has a positive impact on the employment of minorities and women in the industry, ensures that the concrete benefits of the program are reflected in the Contractor's minority and female workforce participation makes a good faith effort to meet its individual goals and timetables, and can provide access to documentation which demonstrates the effectiveness of actions taken on behalf of the Contractor. The obligation to comply, however, is the Contractor's and failure of such a group to fulfill an obligation shall not be a defense for the Contractor's noncompliance.
9. A single goal for minorities and a separate single goal for women have been established. The Contractor, however, is required to provide equal employment opportunity and to take affirmative action for all minority groups, both male and female, and all women, both minority and non-minority. Consequently, the Contractor may be in violation of the Executive Order if a particular group is employed in a substantially disparate manner (for example, even though the Contractor has achieved its goals for women generally, the Contractor may be in violation of the Executive Order if a specified minority group of women is underutilized).
10. The Contractor shall not use the goals and timetables or affirmative action standards to discriminate against any person because of race, color, religion, sex, or national origin.
11. The Contractor shall not enter into any Subcontract with any person or firm debarred from Government contracts pursuant to Executive Order 11246.
12. The Contractor shall carry out such sanctions and penalties for violation of these specifications and of the Equal Opportunity Clause, including suspension, termination and cancellation of existing subcontracts as may be imposed or ordered pursuant to Executive Order 11246, as amended, and its implementing regulations, by the Office of Federal Contract Compliance Programs. Any Contractor who fails to carry out such sanctions and penalties shall be in violation of these specifications and Executive Order 11246, as amended.
13. The Contractor, in fulfilling its obligations under these specifications, shall implement specific affirmative action steps, at least as extensive as those standards prescribed in paragraph 7 of these specifications, so as to achieve maximum results from its efforts to ensure equal opportunity. If the Contractor fails to comply with the requirements of the Executive Order, the implementing regulations, or these specifications, the Director shall proceed in accordance with 41 CFR 60-4.8.
14. The Contractor shall designate a responsible official to monitor all employment related activity to ensure that the company EEO policy is being carried out, to submit reports relating to the provisions hereof as may be required by the Government and to keep records. Records shall at least include for each employee the name, address, telephone numbers, construction trade, union affiliation if any, employee identification number when assigned, social security number, race, sex, status (e.g., mechanic, apprentice, trainee, helper, or laborer), dates of changes in status, hours worked per week in the indicated trade, rate of pay, and locations at which the work was performed. Records shall be maintained in an easily understandable and retrievable form; however, to the degree that existing records satisfy his requirement, Contractors shall not be required to maintain separate records.
15. Nothing herein provided shall be construed as a limitation upon the application of other laws which establish different standards of compliance or upon the application of requirements for the hiring of local or other area residents (e.g., those under the Public Works Employment Act of 1977 and the Community Development Block Grant Program).

Revised 08-31-83

ANNUAL EEO-1 REPORT TO JOINT REPORTING COMMITTEE AS REQUIRED AT

41 CFR 60-1.7(a)

Any Contractor having a Federal contract of \$50,000 or more and 50 or more employees is required to file annual compliance reports on Standard Form 100 (EEO-1) with the Joint Reporting Committee in accordance with the instructions provided with the form. The Contractor will provide a copy of such a report to the contracting agency within 30 days after the award of a contract.

The Contractor shall require its subcontractors to file an SF 100 within 30 days after award of the subcontract if (1) it is not exempt from the provisions of these regulations in accordance with 60-1.5, (2) has 50 or more employees, (3) first tier subcontractor, and (4) has a subcontract amounting to \$50,000 or more.

Subcontractors below the first tier which perform construction work at the site of construction shall be required to file such a report if (1) it is not exempt from the provisions of these regulations in accordance with 60-1.5, (2) has 50 or more employees and has a subcontract amounting to \$50,000 or more.

The SF 100 is available at the following address:

Joint Reports Committee
EEOC - Survey Division
1801 "L" Street N.W.
Washington, D.C. 20750

Phone (202) 663-4968

DISADVANTAGED BUSINESS POLICY

I. NOTICE

This proposal contains the special provision entitled "Required Disadvantaged Business Participation." Inclusion of this Special Provision in this contract satisfies the obligations of the Department of Transportation under federal law as implemented by 49 CFR 23 and under the Illinois "Minority and Female Business Enterprise Act."

II. POLICY

It is public policy that the businesses defined in 49 CFR Part 23 shall have the maximum opportunity to participate in the performance of contracts financed in whole or in part with State or Federal funds. Consequently, the requirements of 49 CFR Part 23 apply to this contract.

III. OBLIGATION

The Contractor agrees to ensure that the businesses defined in 49 CFR Part 23 have the maximum opportunity to participate in the performance of this contract. In this regard, the Contractor shall take all necessary and reasonable steps, in accordance with 49 CFR Part 23, to ensure that the said businesses have the maximum opportunity to compete for and perform portions of this contract. The Contractor shall not discriminate on the basis of race, color, national origin, or sex in the selection and retention of subcontractors, including procurement of materials and leases of equipment.

The Contractor shall include the above Policy and Obligation statements of this Special Provision in every subcontract, including procurement of materials and leases of equipment.

IV. DBE/WBE CONTRACTOR FINANCE PROGRAM

On contracts where a loan has been obtained through the DBE/WBE Contractor Finance Program, the Contractor shall cooperate with the Department by making all payments due to the DBE/WBE Contractor by means of a two-payee check payable to the Lender (Bank) and the Borrower (DBE/WBE Contractor).

V. BREACH OF CONTRACT

Failure to carry out the requirements set forth above and in the Special Provision shall constitute a breach of contract and may result in termination of the contract or liquidated damages as provided in the special provision.

(Rev. 9/21/92)

State of Illinois
Department of Transportation

SPECIAL PROVISION
FOR
DISADVANTAGED BUSINESS ENTERPRISE PARTICIPATION

- I. FEDERAL OBLIGATION: The Department of Transportation, as a recipient of federal financial assistance, is required to take all necessary and reasonable steps to ensure nondiscrimination in the award and administration of contracts. Consequently, the federal regulatory provisions of 49 CFR part 26 apply to this contract concerning the utilization of disadvantaged business enterprises. This Special Provision will also be used by the Department to satisfy the requirements of the Business Enterprise for Minorities, Females, and Persons with Disabilities Act, 30 ILCS 575. For the purposes of this Special Provision, a disadvantaged business enterprise (DBE) means a business certified by the Department in accordance with the requirements of 49 CFR part 26 and listed in the DBE Directory or most recent addendum.
- II. CONTRACTOR ASSURANCE: The Contractor makes the following assurance and agrees to include the assurance in each subcontract that the Contractor signs with a subcontractor:
- The contractor, subrecipient or subcontractor shall not discriminate on the basis of race, color, national origin, or sex in the performance of this contract. The contractor shall carry out applicable requirements of 49 CFR part 26 in the award and administration of federally-assisted contracts. Failure by the contractor to carry out these requirements is a material breach of this contract, which may result in the termination of this contract or such other remedy as the recipient deems appropriate.
- III. OVERALL GOAL SET FOR THE DEPARTMENT: As a requirement of compliance with 49 CFR part 26, the Department has set an overall goal for DBE participation in its federally assisted contracts. That goal is 22.77% of all federal-aid funds the Department will expend in its federally assisted contracts for the subject reporting fiscal year. The Department is required to make a good faith effort to achieve this goal. The dollar amount paid to all approved DBE firms performing work called for in this contract is eligible to be credited toward fulfillment of the Department's overall goal.
- IV. CONTRACT GOAL TO BE ACHIEVED BY THE CONTRACTOR: This contract includes a specific DBE utilization goal established by the Department. The goal has been included because the Department has determined that the work of this contract has subcontracting opportunities that may be suitable for performance by DBE companies. This determination is based on an assessment of the type of work, the location of the work, and the availability of DBE companies to do a part of the work. The assessment indicates that, in the absence of unlawful discrimination, and in an arena of fair and open competition, DBE companies can be expected to perform **10.0%** of the work. This percentage is set as the DBE participation goal for this contract. Consequently, in addition to the other award criteria established for this contract, the Department will award this contract to a bidder who makes a good faith effort to meet this goal of DBE participation in the performance of the work. A bidder makes a good faith effort for award consideration if either of the following is done in accordance with the procedures set forth in this Special Provision:
- A. The bidder documents that firmly committed DBE participation has been obtained to meet the goal; or
- B. The bidder documents that a good faith effort has been made to meet the goal, even though the effort did not succeed in obtaining enough DBE participation to meet the goal.

- V. DBE LOCATOR REFERENCES: Bidders may consult the DBE Directory as a reference source for DBE companies certified by the Department. In addition, the Department maintains a letting and item specific DBE locator information system whereby DBE companies can register their interest in providing quotes on particular bid items advertised for letting. Information concerning DBE companies willing to quote work for particular contracts may be obtained by contacting the Department's Bureau of Small Business Enterprises at telephone number (217)785-4611, or by visiting the Department's web site at www.dot.state.il.us.
- VI. BIDDING PROCEDURES: Compliance with the bidding procedures of this Special Provision is required prior to the award of the contract and the failure of the as-read low bidder to comply will render the bid nonresponsive.
- A. In order to assure the timely award of the contract, the as-read low bidder must submit a Disadvantaged Business Utilization Plan on Department form SBE 2026 within seven (7) working days after the date of letting. To meet the seven (7) day requirement, the bidder may send the Plan by certified mail or delivery service within the seven (7) working day period. If a question arises concerning the mailing date of a Plan, the mailing date will be established by the U.S. Postal Service postmark on the original certified mail receipt from the U.S. Postal Service or the receipt issued by a delivery service. It is the responsibility of the as-read low bidder to ensure that the postmark or receipt date is affixed within the seven (7) working days if the bidder intends to rely upon mailing or delivery to satisfy the submission day requirement. The Plan is to be submitted to the Department of Transportation, Bureau of Small Business Enterprises, Contract Compliance Section, 2300 South Dirksen Parkway, Room 319, Springfield, Illinois 62764 (Telefax: (217) 785-1524). It is the responsibility of the bidder to obtain confirmation of telefax delivery. The Department will not accept a Utilization Plan if it does not meet the seven (7) day submittal requirement, and the bid will be declared nonresponsive. In the event the bid is declared nonresponsive due to a failure to submit a Plan or failure to comply with the bidding procedures set forth herein, the Department may elect to cause the forfeiture of the penal sum of the bidder's proposal guaranty, and may deny authorization to bid the project if re-advertised for bids. The Department reserves the right to invite any other bidder to submit a Utilization Plan at any time for award consideration or to extend the time for award.
- B. The Utilization Plan shall indicate that the bidder either has obtained sufficient DBE participation commitments to meet the contract goal or has not obtained enough DBE participation commitments in spite of a good faith effort to meet the goal. The Utilization Plan shall further provide the name, telephone number and telefax number of a responsible official of the bidder designated for purposes of notification of plan approval or disapproval under the procedures of this Special Provision.
- C. The Utilization Plan shall include a DBE Participation Commitment Statement, Department form SBE 2025, for each DBE proposed for the performance of work to achieve the contract goal. The signatures on these forms must be original signatures. All elements of information indicated on the said form shall be provided, including but not limited to the following:
1. The name and address of each DBE to be used;
 2. A description, including pay item numbers, of the commercially useful work to be done by each DBE;
 3. The price to be paid to each DBE for the identified work specifically stating the quantity, unit price and total subcontract price for the work to be completed by the DBE. If partial pay items are to be performed by the DBE, indicate the portion of each item, a unit price where appropriate and the subcontract price amount;
 4. A commitment statement signed by the bidder and each DBE evidencing availability and intent to perform commercially useful work on the project; and
 5. If the bidder is a joint venture comprised of DBE firms and non-DBE firms, the plan must also include a clear identification of the portion of the work to be performed by the DBE partner(s).

D. The contract will not be awarded until the Utilization Plan submitted by the bidder is approved. The Utilization Plan will be approved by the Department if the Plan commits sufficient commercially useful DBE work performance to meet the contract goal. The Utilization Plan will not be approved by the Department if the Plan does not commit sufficient DBE performance to meet the contract goal unless the bidder documents that it made a good faith effort to meet the goal. The good faith procedures of Section VIII of this special provision apply. If the Utilization Plan is not approved because it is deficient in a technical matter, unless waived by the Department, the bidder will be notified and will be allowed no less than a five (5) working day period in order to cure the deficiency.

VII. CALCULATING DBE PARTICIPATION: The Utilization Plan values represent work anticipated to be performed and paid for upon satisfactory completion. The Department is only able to count toward the achievement of the overall goal and the contract goal the value of payments made for the work actually performed by DBE companies. In addition, a DBE must perform a commercially useful function on the contract to be counted. A commercially useful function is generally performed when the DBE is responsible for the work and is carrying out its responsibilities by actually performing, managing, and supervising the work involved. The Department and Contractor are governed by the provisions of 49 CFR part 26.55(c) on questions of commercially useful functions as it affects the work. Specific counting guidelines are provided in 49 CFR part 26.55, the provisions of which govern over the summary contained herein.

A. DBE as the Contractor: 100% goal credit for that portion of the work performed by the DBE's own forces, including the cost of materials and supplies. Work that a DBE subcontracts to a non-DBE firm does not count toward the DBE goals.

B. DBE as a joint venture Contractor: 100% goal credit for that portion of the total dollar value of the contract equal to the distinct, clearly defined portion of the work performed by the DBE's own forces.

C. DBE as a subcontractor: 100% goal credit for the work of the subcontract performed by the DBE's own forces, including the cost of materials and supplies. Work that a DBE subcontractor in turn subcontracts to a non-DBE firm does not count toward the DBE goal.

D. DBE as a trucker: 100% goal credit for trucking participation provided the DBE is responsible for the management and supervision of the entire trucking operation for which it is responsible. At least one truck owned, operated, licensed and insured by the DBE must be used on the contract. Credit will be given for the full value of all such DBE trucks operated using DBE employed drivers. Goal credit will be limited to the value of the reasonable fee or commission received by the DBE if trucks are leased from a non-DBE company.

E. DBE as a material supplier:

1. 60% goal credit for the cost of the materials or supplies purchased from a DBE regular dealer.
2. 100% goal credit for the cost of materials or supplies obtained from a DBE manufacturer.
3. 100% credit for the value of reasonable fees and commissions for the procurement of materials and supplies if not a regular dealer or manufacturer.

VIII. GOOD FAITH EFFORT PROCEDURES: If the bidder cannot obtain sufficient DBE commitments to meet the contract goal, the bidder must document in the Utilization Plan the good faith efforts made in the attempt to meet the goal. This means that the bidder must show that all necessary and reasonable steps were taken to achieve the contract goal. Necessary and reasonable steps are those which could reasonably be expected to obtain sufficient DBE participation. The Department will consider the quality, quantity and intensity of the kinds of efforts that the bidder has made. Mere *pro forma* efforts are not good faith efforts; rather, the bidder is expected to have taken those efforts that would be reasonably expected of a bidder actively and aggressively trying to obtain DBE participation sufficient to meet the contract goal.

- A. The following is a list of types of action that the Department will consider as part of the evaluation of the bidder's good faith efforts to obtain participation. These listed factors are not intended to be a mandatory checklist and are not intended to be exhaustive. Other factors or efforts brought to the attention of the Department may be relevant in appropriate cases, and will be considered by the Department.
1. Soliciting through all reasonable and available means (e.g. attendance at pre-bid meetings, advertising and/or written notices) the interest of all certified DBE companies that have the capability to perform the work of the contract. The bidder must solicit this interest within sufficient time to allow the DBE companies to respond to the solicitation. The bidder must determine with certainty if the DBE companies are interested by taking appropriate steps to follow up initial solicitations.
 2. Selecting portions of the work to be performed by DBE companies in order to increase the likelihood that the DBE goals will be achieved. This includes, where appropriate, breaking out contract work items into economically feasible units to facilitate DBE participation, even when the prime contractor might otherwise prefer to perform these work items with its own forces.
 3. Providing interested DBE companies with adequate information about the plans, specifications, and requirements of the contract in a timely manner to assist them in responding to a solicitation.
 4. (a) Negotiating in good faith with interested DBE companies. It is the bidder's responsibility to make a portion of the work available to DBE subcontractors and suppliers and to select those portions of the work or material needs consistent with the available DBE subcontractors and suppliers, so as to facilitate DBE participation. Evidence of such negotiation includes the names, addresses, and telephone numbers of DBE companies that were considered; a description of the information provided regarding the plans and specifications for the work selected for subcontracting; and evidence as to why additional agreements could not be reached for DBE companies to perform the work.

(b) A bidder using good business judgment would consider a number of factors in negotiating with subcontractors, including DBE subcontractors, and would take a firm's price and capabilities as well as contract goals into consideration. However, the fact that there may be some additional costs involved in finding and using DBE companies is not in itself sufficient reason for a bidder's failure to meet the contract DBE goal, as long as such costs are reasonable. Also, the ability or desire of a prime contractor to perform the work of a contract with its own organization does not relieve the bidder of the responsibility to make good faith efforts. Prime contractors are not, however, required to accept higher quotes from DBE companies if the price difference is excessive or unreasonable.
 5. Not rejecting DBE companies as being unqualified without sound reasons based on a thorough investigation of their capabilities. The contractor's standing within its industry, membership in specific groups, organizations, or associations and political or social affiliations (for example union vs. non-union employee status) are not legitimate causes for the rejection or non-solicitation of bids in the contractor's efforts to meet the project goal.
 6. Making efforts to assist interested DBE companies in obtaining bonding, lines of credit, or insurance as required by the recipient or contractor.
 7. Making efforts to assist interested DBE companies in obtaining necessary equipment, supplies, materials, or related assistance or services.
 8. Effectively using the services of available minority/women community organizations; minority/women contractors' groups; local, state, and Federal minority/women business assistance offices; and other organizations as allowed on a case-by-case basis to provide assistance in the recruitment and placement of DBE companies.
- B. If the Department determines that the Contractor has made a good faith effort to secure the work commitment of DBE companies to meet the contract goal, the Department will award the contract provided that it is otherwise eligible for award. If the Department determines that a good faith effort has not been made, the Department will notify the bidder of that preliminary determination by contacting the responsible company official designated in the Utilization Plan. The preliminary determination shall include a statement of reasons why good faith efforts have not been found, and may include additional good faith efforts that the bidder could take. The notification will

designate a five (5) working day period during which the bidder shall take additional efforts. The bidder is not limited by a statement of additional efforts, but may take other action beyond any stated additional efforts in order to obtain additional DBE commitments. The bidder shall submit an amended Utilization Plan if additional DBE commitments to meet the contract goal are secured. If additional DBE commitments sufficient to meet the contract goal are not secured, the bidder shall report the final good faith efforts made in the time allotted. All additional efforts taken by the bidder will be considered as part of the bidder's good faith efforts. If the bidder is not able to meet the goal after taking additional efforts, the Department will make a pre-final determination of the good faith efforts of the bidder and will notify the designated responsible company official of the reasons for an adverse determination.

- C. The bidder may request administrative reconsideration of a pre-final determination adverse to the bidder within the five (5) working days after the notification date of the determination by delivering the request to the Department of Transportation, Division of Aeronautics, 1 Langhorne Bond Drive, Capital Airport, Springfield, IL 62707-8415 (Telefax: 217-785-4533). Deposit of the request in the United States mail on or before the fifth business day shall not be deemed delivery. The pre-final determination shall become final if a request is not made and delivered. A request may provide additional written documentation and/or argument concerning the issue of whether an adequate good faith effort was made to meet the contract goal. In addition, the request shall be considered a consent by the bidder to extend the time for award. The request will be forwarded to the Department's Reconsideration Officer. The Reconsideration Officer will extend an opportunity to the bidder to meet in person in order to consider all issues of whether the bidder made a good faith effort to meet the goal. After the review by the Reconsideration Officer, the bidder will be sent a written decision within ten (10) working days after receipt of the request for reconsideration, explaining the basis for finding that the bidder did or did not meet the goal or make adequate good faith efforts to do so. A final decision by the Reconsideration Officer that a good faith effort was made shall approve the Utilization Plan submitted by the bidder and shall clear the contract for award. A final decision that a good faith effort was not made shall render the bid nonresponsive.

IX. CONTRACT COMPLIANCE: Compliance with this Special Provision is an essential part of the contract. The Department is prohibited by federal regulations from crediting the participation of a DBE included in the Utilization Plan toward either the contract goal or the Department's overall goal until the amount to be applied toward the goals has been paid to the DBE. The following administrative procedures and remedies govern the compliance by the Contractor with the contractual obligations established by the Utilization Plan. After approval of the Plan and award of the contract, the Utilization Plan and individual DBE Participation Statements become part of the contract. If the contractor did not succeed in obtaining enough DBE participation to achieve the advertised contract goal, and the Utilization Plan was approved and contract awarded based upon a determination of good faith, the total dollar value of DBE work calculated in the approved Utilization Plan as a percentage of the awarded contract value shall become the amended contract goal.

- A. No amendment to the Utilization Plan may be made without prior written approval from the Division of Aeronautics. All requests for amendment to the Utilization Plan shall be submitted to the Department of Transportation, Division of Aeronautics, 1 Langhorne Bond Drive, Capital Airport, Springfield, IL 62707-8415. Telephone number (217) 785-8514. Telefax number (217) 785-4533.
- B. All work indicated for performance by an approved DBE shall be performed, managed and supervised by the DBE executing the Participation Statement. The Contractor shall not terminate for convenience a DBE listed in the Utilization Plan and then perform the work of the terminated DBE with its own forces, those of an affiliate or those of another subcontractor, whether DBE or not, without first obtaining the written consent of the Bureau of Small Business Enterprises to amend the Utilization Plan. If a DBE listed in the Utilization Plan is terminated for reasons other than convenience, or fails to complete its work on the contract for any reason, the Contractor shall make good faith efforts to find another DBE to substitute for the terminated DBE. The good faith efforts shall be directed at finding another DBE to perform at least the same amount of work under the contract as the DBE that was terminated, but only to the extent needed to meet the contract goal or the amended contract goal. The Contractor shall notify the Division of Aeronautics of any termination for reasons other than convenience, and shall obtain approval for inclusion of the substitute DBE in the Utilization Plan. If good faith efforts following a termination of a DBE for cause are not successful, the Contractor shall contact the Division and provide a full accounting of the efforts undertaken to obtain substitute DBE participation. The Division will evaluate the good faith efforts in light of all circumstances surrounding the performance status of the contract, and determine whether the contract goal should be amended.

- C. The Contractor shall maintain a record of payments for work performed to the DBE participants. The records shall be made available to the Department for inspection upon request. After the performance of the final item of work or delivery of material by a DBE and final payment therefor to the DBE by the Contractor, but not later than thirty (30) calendar days after payment has been made by the Department to the Contractor for such work or material without regard to any retainage withheld by the Department, the Contractor shall submit a DBE Payment Report on Department form SBE 2115 to the Division's Chief Engineer. If full and final payment has not been made to the DBE, the Report shall indicate whether a disagreement as to the payment required exists between the Contractor and the DBE or if the Contractor believes that the work has not been satisfactorily completed. If the Contractor does not have the full amount of work indicated in the Utilization Plan performed by the DBE companies indicated in the Plan, the Department will deduct from contract payments to the Contractor the amount of the goal not achieved as liquidated and ascertained damages.

- D. The Department reserves the right to withhold payment to the Contractor to enforce the provisions of this Special Provision. Final payment shall not be made on the contract until such time as the Contractor submits sufficient documentation demonstrating achievement of the goal in accordance with this Special Provision or after liquidated damages have been determined and collected.

Certification of Nonsegregated Facilities - as Required by 41 CFR 60-1.8

(Applicable to (1) contracts, (2) subcontracts, and (3) agreements with applicants who are themselves performing federally assisted construction contracts, exceeding \$10,000.00 which are not exempt from the provisions of the Equal Opportunity clause).

By the submission of this bid, the bidder, offeror, applicant, or subcontractor certifies that he does not maintain or provide for his employees any segregated facilities at any of his establishments and that that he does not permit his employees to perform their services at any location, under his control, where segregated facilities are maintained. He certifies further that he will not maintain or provide for his employees any segregated facilities at any of his establishments and that he will not permit his employees to perform their services at any location, under his control, where segregated facilities are maintained. The bidder, offeror, applicant, or subcontractor agrees that a breach of his certification is a violation of the Equal opportunity clause in this contract. As used in this certification, the term "segregated facilities" means any waiting rooms, work areas, rest rooms and wash rooms, restaurants and other eating areas, time clocks, locker rooms and other storage or dressing areas, parking lots, drinking fountains, recreation or entertainment areas, transportation, and housing facilities provided for employees which are segregated by explicit directive or are in fact segregated on the basis of race, color, religion, or national origin, because of habit, local custom, or otherwise. He further agrees that (except where he has obtained identical certifications from proposed subcontractors for specific time periods) he will obtain identical certifications from proposed subcontractors prior to the award of subcontracts exceeding \$10,000.00 which are not exempt from the provisions of the Equal Opportunity clause; that he will retain such certifications in his files and that he will forward the following notice to such proposed subcontractors (except where the proposed subcontractors have submitted identical certifications for specific time periods):

NOTICE TO PROSPECTIVE SUBCONTRACTORS OF REQUIREMENT FOR
CERTIFICATIONS OF NONSEGREGATED FACILITIES

A certification of Nonsegregated Facilities must be submitted prior to the award of a subcontract exceeding \$10,000.00 which is not exempt from the provisions of the Equal Opportunity clause. The certification may be submitted either for each subcontract or for all subcontracts during a period (i.e., quarterly, semiannually or annually).

NOTE: The penalty for making false statements in offers is prescribed in 18 U.S.C 1001.

CERTIFICATION REGARDING DEBARMENT, SUSPENSION, AND OTHER RESPONSIBILITY MATTERS
Instructions for Certification

1. By signing and submitting this proposal, the prospective primary participant is providing the certification set out below.
2. The inability of a person to provide the certification required below will not necessarily result in denial of participation in this covered transaction. The prospective participant shall submit an explanation of why it cannot provide the certification set out below. The certification or explanation will be considered in connection with the department or agency's determination whether to enter into this transaction. However, failure of the prospective primary participant to furnish a certification or an explanation shall disqualify such person from participation in this transaction.
3. The certification in this clause is a material representation of fact upon which reliance was placed when the department or agency determined to enter into this transaction. If it is later determined that the prospective primary participant knowingly rendered an erroneous certification in addition to other remedies available to the Federal Government, the department or agency may terminate this transaction for cause of default.
4. The prospective primary participant shall provide immediate written notice to the department or agency to whom this proposal is submitted if at any time the prospective primary participant learns that its certification was erroneous when submitted or has become erroneous by reason of changed circumstances.
5. The terms "covered transaction" "debarred" "suspended" "ineligible" "lower tier covered transaction" "participant" "person" "primary covered transaction" "principal" "proposal" and "voluntarily excluded" as used in this clause have the meaning set out in the Definitions and Coverage sections of the rules implementing Executive Order 12540. You may contact the department or agency to which this proposal is being submitted for assistance in obtaining a copy of those regulations.
6. The prospective primary participant agrees by submitting this proposal that should the proposed covered transaction be entered into, it shall not knowingly enter into any lower tier covered transaction with a person who is debarred, suspended, declared ineligible, or voluntarily excluded from participation in this covered transaction unless authorized by the department or agency entering into this transaction.
7. The prospective primary participant further agrees by submitting this proposal that it will include the clause titled "Certification Regarding Debarment, Suspension, Ineligibility and Voluntary Exclusion - Lower Tier Transaction", provided by the department or agency entering into this covered transaction without modification in all lower covered transactions and in all solicitations for lower covered transactions.
8. A participant in a covered transaction may rely upon a certification of a prospective participant in a lower tier covered transaction that it is not debarred, suspended, ineligible, or voluntarily excluded from the covered transaction unless it knows that the certification is erroneous. A participant may decide the method and frequency by which it determines the eligibility of its principals. Each participant may, but is not required to check the Nonprocurement List (Tel. #).
9. Nothing contained in the foregoing shall be construed to require establishment of a system of records in order to render in good faith the certification required by this clause. The knowledge and information of a participant is not required to exceed that which is normally possessed by a prudent person in the ordinary course of business dealings.
10. Except for transactions authorized under paragraph 8 of these instructions, if a participant in a covered transaction knowingly enters into a lower tier covered transaction with a person who is suspended, debarred, ineligible, or voluntarily excluded from participation in this transaction, in addition to other remedies available to the Federal Government, the department or agency may terminate this transaction for cause or default.

Certification Regarding Debarment, Suspension, and
Other Responsibility Matters - Primary Covered Transactions

1. The prospective primary participant certifies to the best of its knowledge and belief that it and its principals:
 - a. Are not presently debarred, suspended, proposed for debarment, declared ineligible, or voluntarily excluded from covered transactions by an Federal department or agency;
 - b. Have not within a three-year period preceding this proposal been convicted of or had a civil judgment rendered against them for commission of fraud or a criminal offense in connection with obtaining, attempting to obtain or performing a public (Federal, State or Local) transaction or contract under a public transaction: violation of Federal or State antitrust statutes or commission of embezzlement, theft, forgery, bribery, falsification or destruction or destruction of records, making false statements, or receiving stolen property;
 - c. Are not presently indicted for or otherwise criminally or civilly charged by a governmental entity (Federal, State or local) with commission of any of the offenses enumerated in paragraph (1)(b) of this certification; and
 - d. Have not within a three-period preceding this application/proposal had one or more public transactions (Federal, State or local) terminated for cause or default.
2. Where the prospective primary participant is unable to certify to any of the statements in this certification, such prospective participant shall attach an explanation to this proposal.

CERTIFICATION REGARDING LOBBYING (Applicable to contracts in excess of \$100,000):

Certification for Contracts, Grants, Loans and Cooperative Agreements.

The undersigned bidder certifies, to the best of his or her knowledge and belief, that:

- (1) No Federal appropriated funds have paid or will be paid, by or behalf of the undersigned, to any person for influencing or attempting to influence an officer or employee of any agency, a Member of Congress, an Officer or employee of Congress, or an employee of a Member of Congress in connection with the awarding of any Federal contract, the making of any Federal grant, the making of any Federal loan, the entering into of any cooperative agreement, and the extension, continuation, renewal, amendment, or modification of any Federal contract, grant, loan, or cooperative agreement.
- (2) If any funds other than Federal appropriated funds have been paid or will be paid to any person for influencing or attempting to influence an officer or employee of any agency, a Member of Congress, an officer or employee of Congress, or an employee of a Member of Congress in connection with this Federal contract, grant, loan, or cooperative agreement, the undersigned shall complete and submit Standard Form-LLL, "Disclosure Form to Report Lobbying", in accordance with its instructions.
- (3) The undersigned shall require that the language of this certification be included in the award documents for all subawards at all tiers (including subcontracts, subgrants, and contracts under grants, loans, and cooperative agreements) and that all subrecipients shall certify and disclose accordingly.

This certification is a material representation of fact upon which reliance was placed when this transaction was made or entered into. Submission of this certification is a prerequisite for making or entering into this transaction imposed by Section 1352, title 31, U.S. Code. Any person who fails to file the required certification shall be subject to a civil penalty of not less than \$10,000 and not more than \$100,000 for each such failure.

WORKERS' COMPENSATION INSURANCE

Prior to the execution of his construction contract by the Illinois Department of Transportation, Division of Aeronautics, hereinafter referred to as "Division", the Contractor shall furnish to the Division certificates of insurance covering Workers' Compensation, or satisfactory evidence that this liability is otherwise taken care of in accordance with Section 4.(a) of the "Workers' Compensation Act of the State of Illinois" as amended.

Such insurance, or other means of protection as herein provided, shall be kept in force until all work to be performed under the terms of the contract has been completed and accepted in accordance with the specifications, and it is hereby understood and agreed that the maintenance of such insurance or other protection, until acceptance of the work by the Division is a part of the contract. Failure to maintain such insurance, cancellation by the Industrial Commission of its approval of such other means of protection as might have been elected, or any other act which results in lack of protection under the said "Workers' Compensation Act" may be considered as a breach of the contract.

SPECIAL PROVISION FOR DOMESTIC SOURCE FOR STEEL

Control of Materials: All steel products, as defined by the Illinois Steel Products Procurement Act, incorporated into this project shall be manufactured or produced in the United States and, in addition, shall be domestically fabricated. The Contractor shall obtain from the steel producer and/or fabricator, in addition to the mill analysis, a certification that all steel products meet these domestic source requirements.

CLAUSE TO BE INCLUDED IN ALL SOLICITATIONS,
CONTRACTS, AND SUBCONTRACTS RESULTING FROM PROJECTS FUNDED UNDER THE AIP

The Contractor or subcontractor, by submission of an offer and/or execution of a contract, certifies that it:

- a. is not owned or controlled by one or more citizens or nationals of a foreign country included in the list of countries that discriminate against U.S. firms published by the Office of the United States Trade Representative (USTR);
- b. has not knowingly entered into any contract or subcontract for this project with a Contractor that is a citizen or national of a foreign country on said list, or is owned or controlled directly or indirectly by one or more citizens or nationals of a foreign country on said list.
- c. has not procured any product nor subcontracted for the supply of any product for use on the project that is produced in a foreign country on said list.

Unless the restrictions of this clause are waived by the Secretary of Transportation in accordance with 49 CFR 30.17, no contract shall be awarded to a Contractor or subcontractor who is unable to certify to the above. If the Contractor knowingly procures or subcontracts for the supply of any product or service of a foreign country on the said list for use on the project, the Federal Aviation Administration may direct, through the sponsor, cancellation of the contract at no cost to the Government.

Further, the Contractor agrees that, if awarded a contract resulting from this solicitation, it will incorporate this provision for certification without modification in each contract and in all lower tier subcontracts. The Contractor may rely upon the certification of a prospective subcontractor unless it has knowledge that the certification is erroneous.

The Contractor shall provide immediate written notice to the sponsor if the Contractor learns that its certification or that of a subcontractor was erroneous when submitted or has become erroneous by reason of changed circumstances. The subcontractor agrees to provide immediate written notice to the Contractor, if at any time it learns that its certification was erroneous by reason of changed circumstances.

This certification is a material representation of fact upon which reliance was placed when making the award. If it is later determined that the Contractor or subcontractor knowingly rendered an erroneous certification, the Federal Aviation Administration may direct, through this sponsor, cancellation of the contract or subcontract for default at no cost to the Government.

Nothing contained in the foregoing shall be construed to require establishment of a system of records in order to render, in good faith, the certification required by this provision. The knowledge and information of a Contractor is not required to exceed that which is normally possessed by a prudent person in the ordinary course of business dealings.

This certification concerns a matter within the jurisdiction of an agency of the United States of America and the making of false, fictitious, or fraudulent certification may render the maker subject to prosecution under Title 18, United States Code, Section 1001.

SECTION III
SPECIAL PROVISIONS
FOR

EXCAVATION AND CONSTRUCTION OF 6'
SURCHARGE EMBANKMENT FOR FUTURE
EXTENSIONS TO RUNWAY 5 (500'X150'), TAXIWAY D
(745'X50') AND TAXIWAY K (770'X50') ALONG WITH
ASSOCIATED UTILITY ADJUSTMENTS AND TURFING.

AT

QUAD CITY INTERNATIONAL AIRPORT
MOLINE, ILLINOIS

ILLINOIS PROJECT: MLI-3496
A.I.P. PROJECT: 3-17-0068-XX

PREPARED BY:



CONSULTING ENGINEERS
P.O. BOX 6040
ROCK ISLAND, ILLINOIS 61204-6040

JANUARY 25, 2006

RECURRING SPECIAL PROVISIONS

The following RECURRING SPECIAL PROVISIONS indicated by an "X" are Applicable to this contract and are included by reference:

Check Sheet	<u>No.</u>	<u>Item No.</u>	<u>Page No.</u>
	1	AR101580 Refurbish 36" Beacon	155
	2	AR106000 Apron Lighting	160
	3	AR119000 Airport Obstruction Lighting (Not Included)	166
	4	AR127000 Airport Navaid Installation (Not Included)	167
X	5	AR150510 Engineer's Field Office	168
	6	AR150560 Temporary Threshold	170
	7	AR152540 Soil Stabilization Fabric	173
X	8	AR156000 Erosion Control	175
	9	AR156513 Separation Fabric	180
	10	AR156540 Riprap	182
	11	AR201001 Bituminous Base Course - Method I	185
	12	AR201002 Bituminous Base Course - Method II	193
	13	AR201003 Bituminous Base Course - Method I, Superpave	209
	14	AR201004 Bituminous Base Course - Method II, Superpave	217
	15	AR201661 Clean & Seal Bituminous Cracks	230
	16	AR201663 Sand Mix Crack Repair	233
	17	AR201671 Crack Control Fabric	235
	18	AR302000 Asphalt Treated Permeable Subbase	237
	19	AR401001 Bituminous Surface Course - Method I	245
	20	AR401002 Bituminous Surface Course - Method II	253
	21	AR401003 Bituminous Surface Course - Method I, Superpave	269
	22	AR401004 Bituminous Surface Course - Method II, Superpave	277
	23	AR401640 Bituminous Pavement Grooving	290
	24	AR401650 Bituminous Pavement Milling	293
	25	AR401655 Butt Joint Construction	295
	26	AR401900 Remove Bituminous Pavement	297
	27	AR501001 Portland Cement Concrete - Pavement Method I	299
	28	AR501002 Portland Cement Concrete - Pavement Method II	316
	29	AR501003 Portland Cement Concrete - Pavement Method III	338
	30	AR501115 Crack and Seat Pavement	362
	31	AR501540 PCC Pavement Grooving	365
	32	AR501550 PCC Pavement Milling	368
	33	AR501900 Remove PCC Pavement	370
	34	AR510500 Tie-down/Ground Rod	372
	35	AR605000 Silicone Joint Sealing Filler	373

Section III Special Provisions
Quad City International Airport
Moline, Illinois

ILL. PRJT. No. MLI-3496
A.I.P. PRJT. No. 3-17-0068-XX
11A
QUO95

STATE OF ILLINOIS
DEPARTMENT OF TRANSPORTATION
DIVISION OF AERONAUTICS
POLICY MEMORANDUM

The following IDOT-DOA Policy Memorandum are applicable to this contract and are included in this contract by reference. The latest version of these documents may be viewed and downloaded off the Division of Aeronautics internet web site at <http://www.dot.state.il.us/aero/iindex.html>.

IDOT-DOA Policy Memorandum Numbers 96-1 & 97-1

INDEX TO SPECIAL PROVISIONS

<u>ITEM</u>	<u>DESCRIPTION</u>	<u>PAGE NO.</u>
	GENERAL	1
DIVISION I	GENERAL PROVISIONS	2-14
20	MAINTENANCE OF TRAFFIC	2-13
150	ENGINEER'S FIELD OFFICE	14
DIVISION II	PAVING CONSTRUCTION DETAILS	15-26
151	CLEARING AND GRUBBING	15
152	EXCAVATION AND EMBANKMENT	16-21
156	EROSION CONTROL	22
209	CRUSHED AGGREGATE BASE COURSE	23-24
620	PAVEMENT MARKING	25-26
DIVISION V	TURFING	27-30
901	SEEDING	27-28
908	MULCHING	29-30
DIVISION VI	LIGHTING INSTALLATION	31-43
108	INSTALLATION OF UNDERGROUND CABLE FOR AIRPORTS	31-36
125	INSTALLATION OF AIRPORT LIGHTING SYSTEMS	37-43
DIVISION VIII	MISCELLANEOUS	44-45
801604	SETTLEMENT PLATES	44-45
	DETAIL DRAWINGS	46-51
	TEMPORARY EROSION CONTROL SYSTEMS (IDOT 280001-02)	46-48
	TRAFFIC CONTROL DEVICES (IDOT 702001-05)	49-51
APPENDIX	AC 150/5370-4, PROTECTION OF EXISTING CABLES, CONTROLS, NAVAIDS, AND WEATHER BUREAU FACILITIES	52

GENERAL

The following Section III Special Provisions supplement the “Standard Specifications for Construction of Airports”, adopted January 1985 by IDOT-DOA, the “Standard Specifications for Road and Bridge Construction”, adopted January 1, 2002 by IDOT, the “Supplemental Specifications and Recurring Special Provisions”, adopted July 1, 2004, and IDOT-DOA’s Policy Memorandum Numbers 96-1 and 97-2, all of which shall govern the construction of Illinois Project No. MLI-3496, A.I.P. Project No. 3-17-0068-XX. In case of conflict with any part or parts of said specifications, the said Section III Special Provisions shall take precedence and shall govern.

DESCRIPTION OF WORK:

The proposed improvement at the Quad City International Airport in Moline, Illinois shall include, but not be limited to, the following major work items:

1. Excavation of existing soils and the construction of a six foot (6’) soil surcharge embankment in the location of the future southwesterly pavement extensions to existing Runway 5, Taxiway D, and Taxiway K. This is being accomplished to accelerate the consolidation of the existing high moisture content soils located below the existing ground surface.
2. Installation of the proposed Runway 5 temporary relocated threshold.
3. Relocate and/or adjust existing utilities (edge lights, manholes, guidance signs, etc.) as required.
4. Re-grade an existing ditch bank area located west on the existing Runway 5 threshold.
5. Re-grade two in-field areas located south and north of existing Taxiway H, just east of Taxiway E.
6. The installation of settlement plates below the proposed surcharge embankment.
7. Miscellaneous grading, turfing and erosion control items as required.
8. Traffic maintenance for the duration of the proposed project.

DIVISION I - GENERAL PROVISIONS

20-02 ALTERATION OF WORK AND QUANTITIES

ADD the following paragraphs to this Section:

The MAA reserves and shall have the right to delete all or part of the 209511-Crushed Aggregate Base, CA1 and 620510 pavement marking pay items and/or contract quantities from the contract work. The Contractor shall not be entitled to any extra compensation, beyond the contract unit prices, due to change in contract quantities. The Contractor agrees to accept payment for the remaining work based upon the original contract unit rate prices without negotiating new contract unit rate prices if only partial quantities are completed.

20-05 MAINTENANCE OF TRAFFIC

ADD the following paragraphs to this Section:

- 20-05.1.1 This item shall include all work necessary to control and maintain aircraft, vehicle, equipment, and personnel traffic on the airfield during the duration of this project. The Contractor shall operate his construction activities in a manner that complies with the requirements of FAA Advisory Circular No. 150/5370-2, "Operational Safety On Airport During Construction," latest edition at the time of bidding; and Subsection 20-05 and Subsection 50-09 of the Standard Specifications for Construction of Airports.
- 20-05.1.2 The proposed haul route between the Taxiway H earthwork area and the proposed construction staging/Runway 5 construction area shall follow the contractor temporary haul road to 69th Avenue to Airport Road to Milan Beltway to Indian Bluff Road to 47th Street to service road to contractor temporary haul road. Construction traffic shall not cross the airfield.
- 20-05.1.3 It is the desire of the owner to complete this project in a timely and safe manner with the least possible disruption to airport operations. The following construction limitations, as well as the safety plan included in the Construction Plans, shall be followed to achieve the above goals:
1. Runway 5-23, Taxiway D, Taxiway E, Taxiway H, and Taxiway K shall remain open to aircraft traffic as much as possible during the construction of this project. When required for construction operations, these pavements may be closed to aircraft traffic under local short term FAA tower controlled closures. All other pavements shall be open to aircraft traffic at all times unless "NOTAM"ed otherwise.

2. For work located north of existing Runway 9-27, the Contractor shall enter and exit the airfield at the existing locked security gate located at the east end of 69th Avenue. The gate shall be locked or guarded at all times. While on the airfield, the Contractor shall stay within the limits of the Taxiway H earthwork area haul route and/or within the Taxiway H earthwork area limits of construction as shown on the safety plan.
3. For work located south of existing Runway 9-27, the Contractor shall enter and exit the airfield at the existing locked security gate located north of the intersection of 47th Street and 73rd Avenue (just north of the Airport Industrial Park). While on the airfield, the Contractor shall stay on the existing service road (between the construction entrance gate and the job site) or within the Runway 5/ditch area limits of construction as shown on the safety plan.
4. The Contractor shall install the proposed barricades and lath lines as indicated on the safety plan, or as directed by the Engineer, prior to the commencement of any work. The barricades shall be removed and reinstalled by the Contractor as required by the MAA for airfield operations.
5. The Contractor shall supply traffic control guards and tractor brushes at the locations where the haul route intersects Taxiway E and Taxiway H during hauling operations in the Taxiway H earthwork area. All construction traffic shall stop at the intersections and yield to all airfield traffic at all times.
6. Runway 5-23, Taxiway D, Taxiway E, Taxiway H, Taxiway K, and Taxiway L shall remain open as much as possible during the construction of this project and aircraft traffic shall have priority over construction at all times. The Contractor's employees, equipment, and materials shall not enter or be left in the safety areas, unless permission to do so has been granted to the Contractor by the MAA and contact has been made with the FAA control tower. When a runway and/or taxiway is closed by the MAA, the Contractor may proceed with his work which requires manpower, equipment, and materials in the runway and/or taxiway safety areas. The MAA reserves and shall have the right to stop work as required by wind conditions, weather conditions, or aircraft operations which requires the use of a runway. The Contractor shall remove all employees, equipment and materials, including stockpiles from the runway and/or taxiway safety areas and regrade the areas within one-half (1/2) hour of notification by the Resident Engineer.

7. The Contractor shall schedule his construction activities so that the following conditions exist at the end of all work periods in the Runway and Taxiway safety areas.
 - A. No exposed faces in excess of one and one-half (1-1/2) inches in height will be permitted in the safety areas, either longitudinal or transverse to the edge of runway.
 - B. All excavations and removal areas have been backfilled.
 - C. All shoulder areas have been backfilled and smoothly graded.
 - D. No mound of dirt or irregularities greater than 3" exists in the safety area.
 - E. All active airfield pavements and the runways have been broom cleaned.
 8. Prior to the relocation of the existing Runway 5 threshold, the Contractor shall not have any men, equipment, or materials (including stockpiled materials) above the existing 20:1 approach surface for Runway 5 as shown on the Construction Plans unless the runway is closed to air traffic or permission to work above the approach surface has been granted to the Contractor by the MAA and contact has been made with the FAA control tower. The elevation of this surface shall be determined by the Resident Engineer.
- 20-05.1.4 The Contractor shall not be entitled to any extra compensation due to delays or inconveniences caused by above said necessary methods, procedures and measures required to protect air traffic.
- 20-05.1.5 This item shall also include the furnishing, installing, moving, maintaining and removal of all equipment, material, miscellaneous items, and incidentals necessary to control traffic to the satisfaction of the Metropolitan Airport Authority and the Resident Engineer.

EQUIPMENT AND MATERIALS

20-05.2.1 This item shall include, but not be limited to, the following work and supplies:

- (a) Barricades, cones, warning signs, hazard markings: Provide, placement and maintenance.
- (b) Material for providing temporary runway closure markings.
- (c) Traffic control devices for construction and airport vehicular traffic.
- (d) Temporary traffic connections necessary for ingress to and egress from the airfield.
- (e) Temporary security measures at the point(s) of ingress/egress to the airfield (guard, fencing, gates, chain, locks, etc.)
- (f) Cleaning and maintaining airfield pavements used during construction.
- (g) Constructing, cleaning and maintaining haul roads and/or service roads.
- (h) Radio equipment for communication with the FAA control tower.
- (i) Identification and marking devices for construction personnel and equipment.
- (j) All measures necessary to comply with the safety plan included in the Construction Plans.
- (k) All measures necessary to comply with the special provisions to Section 20-05 "Maintenance of Traffic" included in this Special Provision.
- (l) Restoration of staging areas, storage areas, haul roads, construction access roads, service drives, borrow areas, and any other areas damaged during construction.
- (m) Demobilization and mobilization of manpower and equipment to open and/or close runways as required by the Metropolitan Airport Authority.
- (n) Installation and removal of any temporary electrical power and/or telephone facilities required by the Contractor and/or contract during construction to the satisfaction of the MAA and Resident Engineer.

- (o) Installation and maintenance of safety area lath lines as shown on the Safety Plan in the Construction Plans. Lath lines shall consist of 2"x2" wood posts spaced at 15' intervals and driven into the ground with rope or heavy twine tied between the posts. Six inch wide yellow plastic warning ribbon shall be wrapped around the rope or heavy twine between the posts.
- (p) All other items as necessary to maintain control of the project as outlined in the Construction Plans and specification or as directed by the Resident Engineers.

CONSTRUCTION METHODS

- 20-05.3.1 The traffic maintenance equipment and materials shall be provided, placed, and maintained during the construction as indicated in the plans or as directed by the Resident Engineer.
- 20-05.3.2 The traffic maintenance equipment and materials shall be removed, and reinstalled by the Contractor during the construction of the project as directed by the Resident Engineer and/or as dictated by the current construction activity location.
- 20-05.3.3 After the construction has been completed and accepted by the Resident Engineer the traffic maintenance equipment and materials shall be removed by the Contractor. The removal of traffic maintenance equipment and materials shall not commence until approval by the Resident Engineer has been received. The Contractor shall clean up all debris resulting from maintaining traffic.
- 20-05.3.4 Work included in this item shall conform to applicable FAA Regulations and shall be approved in advance by the Resident Engineer and the MAA.

METHOD OF MEASUREMENT

- 20-05.4.1. The quantity of traffic maintenance to be paid for under this item shall be measured per lump sum for furnishing all materials, equipment, and labor required for this construction including, but not limited to maintenance of traffic, compliance with safety plan, compliance with Section 20-05 "Maintenance of Traffic" items, restoration, and all other necessary items to complete the construction operations for this project.

BASIS FOR PAYMENT

20-05.5.1 Payment will be made at the contract unit price per lump sum for Traffic Maintenance. This price shall be full compensation for furnishing all materials and for all preparation, assembly, installation, removal, reinstallation as required of these materials and for all labor, equipment, tools and incidentals necessary to complete this item.

Payment will be made under:

ITEM AR150530 TRAFFIC MAINTENANCE – per lump sum.

20-06 REMOVAL OF EXISTING STRUCTURES

REVISE the first paragraphs to read as follows:

All existing structures encountered within the established lines, grades, grading sections, or as indicated in the Construction Plans shall be removed by the Contractor, unless such existing structures are otherwise specified to be relocated, adjusted up or down, salvaged, abandoned in place, reused in the work or to remain in place. The cost of removing and disposing of such existing structures shall not be measured or counted for separately as a contract pay item. The cost for removing and disposing of such existing structures shall be included in the contract unit prices.

30.06 CONSTRUCTION LAYOUT
CONSTRUCTION LAYOUT STAKES

DELETE Entire Section.

ADD: The Resident Engineer shall furnish all construction layout for this project.

30-12 LOAD RESTRICTIONS

ADD the following to this Section:

The Contractor shall coordinate construction access with the County Superintendent of Highways and/or the Township Road Commissioner. The Contractor shall be responsible for damage to any public road caused by his construction operations. The Contractor shall repair any damage caused by his construction traffic to the satisfaction of the Owner. The Contractor shall provide and install any warning signs (trucks entering highway, etc.) as required by the County Superintendent of Highways.

30-18 PLANS AND WORK DRAWINGS

REVISE references to “approval” in first paragraph to “review”.

The following information shall be clearly marked on each shop, working, and layout drawing, catalog cut, pamphlet specifications sheet, etc. submitted.

PROJECT LOCATION: Quad City International Airport

PROJECT NUMBERS: Illinois Project MLI-3496
AIP Project 3-17-0068-XX

CONTRACT ITEM: (E.G. 751-5.20)

SUBMITTED BY: (Contractor/Subcontractor Name)

DATE: (current date)

50-10 BARRICADES, WARNING SIGNS, AND HAZARD MARKINGS

ADD the following paragraphs to this Section:

It will be the responsibility of the Contractor to properly mark the closed runway; and, when the runway is reopened, to remove the marking. A detail drawing of the closed runway marking is included on the proposed safety plan. The Contractor will be responsible for placing and removing the crosses as the runway is closed and opened.

Any cost of labor and equipment which is necessary to insure safety at the airport during the duration of the project will be included in the Traffic Maintenance contract unit price. No additional reimbursement beyond the contract unit price shall occur.

50-12 PROTECTION AND RESTORATION OF PROPERTY

ADD the following paragraphs to this Section:

The Contractor shall take special precautions during construction so as not to damage the existing roads, parking lots, runways, aprons, taxiways, building and other existing improvements.

Any such existing improvements damaged by the Contractor during construction shall be repaired or replaced by him at his own expense.

The Contractor shall take special care when working in the vicinity of existing airport lighting systems so as not to damage them. Should the Contractor damage any of the lighting systems and/or underground cables, he shall immediately repair or replace them, and make any necessary repairs to place them in working order. The cost of equipment and making the repairs will be the responsibility of the Contractor. If during the course of construction it is necessary to interrupt any lighting circuits, temporary cables shall be installed as needed to make the circuit operational.

The Contractor shall maintain the premises in reasonably clean condition and shall not allow any sizable accumulation of rubbish on the premises.

He shall leave the premises in broom-clean condition upon completion of the project.

50-13 RESPONSIBILITY FOR DAMAGE CLAIMS

REVISE the second line of the first paragraph to read as follows:

"...indemnify and save harmless the Division, the Owner, the Consultant Engineers, Subconsulting Engineer, and the F.A.A....."

ADD the following three paragraphs between the first and second paragraphs of this Section:

To the fullest extent permitted by law, CONTRACTOR shall indemnify and hold harmless the OWNER, PARTICIPATING AGENCIES (the Division and the FAA), SUBCONSULTANTS, CONSULTANT ENGINEERS, and their respective agents and employees (indemnities) from and against any and all claims, damages, losses, economic losses and expenses, including but not limited to attorney's fees, arising out of or resulting from performance of the Work (including specifically claims arising under the Illinois Structural Work Act), provided that such claim, loss or expense is attributable to bodily injury, sickness, disease or death, or to injury or destruction of tangible property (other than the Work itself), including loss of use resulting therefrom, but only to the extent caused in whole or in part by negligent acts or omission of the Contractor, a Subcontractor, anyone directly or indirectly employed by them or anyone for whose acts they may be liable, excluding any proportionate amount of any claim, damage, loss or expense which is caused by a party indemnified hereunder. Such obligation shall not be construed to negate, abridge or reduce other rights or obligations of indemnity which would otherwise exist as to a party or person described in this Paragraph.

In claims against any person or entity indemnified under this Paragraph by an employee of the Contractor, a Subcontractor, anyone directly employed by them or anyone for whose acts they be liable, the indemnification obligation under this Paragraph shall not be limited by a limitation on the amount or type of damages, compensation or benefits payable by or for the Contractor or a Subcontractor under workers' or workmen's compensation acts, disability benefit acts or other employee benefit acts.

This indemnification shall also include, but not be limited to, any penalties, fines or other actions imposed by the U. S. Department of Labor or the State of Illinois under the Occupational Safety and Health Act (O.S.H.A.) as a result of the Contractor's acts or omissions on this project.

REVISE the last paragraph of this Section to read as follows:

"The Contractor, prior to execution of the contract, shall file with the Division and the Consultant Engineer, copies of completed certificates of insurance, satisfactory to the Division and the Consultant Engineer, to afford protection against all claims for damages to public or private property, and injuries to persons, arising out of and during the progress of the work to its completion, as defined by Section 60-12. The policy of insurance shall include the Owner, the participating agencies (the Division and the FAA), Subconsultant Engineers, and Consultant Engineers, as additional insured or provide separate coverages with individual protective policies for all of the above named parties. The minimum amounts of insurance shall be as follows, except no restrictions or occurrence limits will be permitted:

General Public Liability Insurance: \$1,000,000/Person
\$2,000,000/Occurrence

Property Damage Insurance: \$1,000,000/Occurrence

In addition to the above policies, Contractor shall provide an "Umbrella" policy covering his entire operation in the amount of \$3,000,000.

All such insurance must include an endorsement whereby the insurer agrees to notify the Division and the Consultant Engineer at least 30 days prior to nonrenewal, reduction or cancellation. Contractor shall furnish to the Division and the Consultant Engineer a copy of the endorsement in addition to any other insurance certificate required. The Contractor shall cease operations on the project if the insurance is canceled or reduced below the required amount of coverage. All costs for insurance as specified herein will not be paid for separately, but shall be considered as incidental to the contract."

50-17 CONTRACTOR'S RESPONSIBILITY FOR UTILITY SERVICE AND FACILITIES OF OTHERS

ADD the following to this Section:

<u>Utility Service or Facility</u>	<u>Person to Contact</u>	<u>Telephone Number</u>
Airport Facilities	Metropolitan Airport Authority	757-1743
Airport Lighting	Metropolitan Airport Authority	757-1752
FAA Control and Communications Cable	Airways Facility Unit	799-7303
Water Mains	Metropolitan Airport Authority	764-9621
Electric Cables Mid-American Energy Company	JULIE (Joint Utility Locating Information for Excavators)	1-800-892-0123
Telephone Cables Illinois Bell Telephone Company	JULIE	1-800-892-0123
Gas Mains Mid-American Energy Company	JULIE	1-800-892-0123

50-25 CONTRACTOR'S WARRANTY

ADD the following paragraphs to this Section:

Airport lighting equipment and materials covered by F.A.A. Specifications to be supplied to this project, shall have the prior manufacturer's approval by the F.A.A. and listed in the most current Advisory Circular for Approved Airport Lighting Equipment.

All other equipment and materials covered by other referenced specifications shall be subject to acceptance through manufacturer's certification of compliance with the applicable specifications.

60-07 TEMPORARY SUSPENSION OF THE WORK

DELETE the first two paragraphs and INSERT the following:

The Contracting Agent (IDOT-DOA and/or the MAA) reserves the right to temporarily suspend the work wholly, or in part, for such periods as they may deem necessary, due to unsuitable weather, airport operation considerations, or other such conditions as are considered unfavorable for the prosecution of the work or for such time as is necessary due to the failure on the part of the Contractor to carry out orders given or perform any or all provisions of the contract.

All measures necessary to comply with the temporary suspension of the work, as required by the Contracting Agent (IDOT-DOA and/or the MAA), shall be included in the traffic maintenance contract unit price. The Contractor shall not be entitled to any additional compensation (beyond this pay item) due to delays or inconveniences caused by the temporary suspension of the work.

ADD the following special Sections:

HAUL ROUTE

The Contractor will use only the designated haul route as shown on Sheets 3 and 4 of the Construction Plans. The Contractor's men and equipment shall not traverse outside the designated work areas to other locations on the airport or off of airport property. The designated haul route will be the only vehicular access to the construction site.

It will be the Contractor's responsibility to clear and build the haul routes and construction staging area as required to complete the contract work. The Contractor shall restore the haul routes and construction staging area upon completion of the project. All costs for clearing, maintaining, and restoring the haul routes and construction staging area shall be included in contract unit prices.

Failure to use the prescribed haul route or adhere to the safety requirements will result in the suspension of work.

EQUIPMENT PARKING

The Contractor shall park equipment in the areas designated for construction staging. This area is shown on Sheet 3 of the Construction Plans.

SCHEDULING OF OPERATIONS

The Contractor shall coordinate all work on this project with the Resident Engineer and the Metropolitan Airport Authority to insure that the construction will cause the least amount of inconvenience possible to normal airport activity.

The Contractor will be required to submit a work schedule to the State of Illinois, Division of Aeronautics, and to the Resident Engineer showing proposed sequence of work.

In the event that other construction projects are in progress at the airport at the same time as this project, the Contractor will be required to cooperate with all other Contractors and the Metropolitan Airport Authority in the coordination of the work. The paving Contractor shall cooperate and coordinate his paving activities with the other Contractors' activities in order to provide an orderly and properly sequenced progression of construction. Any disagreement between Contractors will be settled by the Contracting Agent (IDOT-DOA). No extra compensation will be due to the paving Contractor for delays caused by sequencing of construction events. Cooperation and coordination shall occur between the Contractor's during the construction of these projects.

The Metropolitan Airport Authority will at all times have jurisdiction over the safety of air traffic during construction. Whenever the safety of air traffic during construction is concerned, his decision as to methods, procedures, and measures used shall be final, and any and all Contractors performing work must be governed by such decisions.

The Contractor shall not be entitled to any extra compensation due to delays or inconvenience caused by said necessary methods, procedures, and measures to protect air traffic, delays caused by sequencing of construction events, and/or delays caused by coordination with others.

SITE INSPECTION

<p>The Contractor shall be responsible for an on-site inspection prior to submitting a bid on this project. Upon receipt of a bid, it shall be assumed that the Contractor is fully familiar with the construction site.</p>
--

MODIFICATIONS TO RECURRING
SPECIAL PROVISION FOR ITEM AR150510

ENGINEER'S FIELD OFFICE

EFFECTIVE: JULY 1, 2004

ADD the following Section:

METHOD OF MEASUREMENT

- 3.1 The quantity of Engineer's Field Office to be paid for shall be the number of calendar months that the Resident Engineer occupies the office in accordance with this special provision.

BASIS OF PAYMENT

DELETE Section 3.1 and insert the following:

- 4.1 This item will be paid for at the contract price per calendar month for a field office, which price shall include all utility costs (including long distance telephone service for the Resident Engineer and his representatives) and shall reflect the salvage value of the building or mobile unit, equipment, and furniture which becomes the property of the Contractor after release by the Resident Engineer.

Payment will be made under:

ITEM AR150512 -- ENGINEERS FIELD OFFICE (MONTHLY) -- per calendar month.

DIVISION II – PAVING CONSTRUCTION DETAILS

EARTHWORK

MODIFICATIONS TO RECURRING
SPECIAL PROVISIONS FOR ITEM AR 151

CLEARING AND GRUBBING

EFFECTIVE: JULY 1, 2004

DESCRIPTION

151-1.1 DELETE the second paragraph and ADD the following:

The clearing and grubbing for this project shall occur in the areas designated on the Construction Plans. The cost of disposal of all spoil materials shall be included in the contract unit price. It shall be the Contractor's responsibility to comply with all local ordinances.

CONSTRUCTION METHODS

151-2.1 GENERAL:

ADD the following:

The approximate areas and estimated quantities for clearing and grubbing shown on the plans have been determined by aerial mapping and are subject to change at the time of construction. The actual area of clearing and grubbing will be marked for removal by the Resident Engineer at the time of construction.

Prior to the start of construction, the MAA will drop the larger trees in the clearing and grubbing area as shown on the Construction Plans. The Contractor will be responsible to remove and dispose of the downed timber, stumps, logs, brush, undergrowth, and all other natural obstructions remaining in the area.

BASIS OF PAYMENT

151-4.1 DELETE the first paragraph and insert the following:

Payment shall be made at the contract unit price per acre for CLEARING AND GRUBBING. This price shall be full compensation for furnishing all materials and for all labor, equipment, tools, permits, and incidentals (including disposal of all spoil materials) necessary to complete the item.

Payment will be made under:

ITEM AR151450 -- CLEARING AND GRUBBING -- per acre.

MODIFICATIONS TO SUPPLEMENTAL SPECIFICATION
FOR ITEM 152-EXCAVATION AND EMBANKMENT

DESCRIPTION

152.1.1 ADD the following to this Section:

This item shall include, but not be limited to, all work necessary to remove existing soils from the proposed cut areas, stockpile soils as required, haul soils from the proposed cut areas or stockpile areas to the proposed embankment areas, installation of soils/topsoils, and backfill, compaction of soils where required, final grading, disposal of waste soils and other miscellaneous grading and backfilling as shown on the Construction Plans or as required by the Resident Engineer.

The Contractor shall remove existing topsoil materials, complete earthwork and then reinstall topsoil materials as required to guarantee the final 4” of soil materials will support vegetation growth. If Contractor installs soil that will not support vegetation growth, the Contractor shall remove the top 4” of the soil materials and haul in topsoil materials at his own expense without additional compensation beyond the contract unit prices.

The Contractor will be paid for hauling the soil materials one time only. The cost of moving, stockpiling, removing, reinstalling, etc. of the soil materials as required to complete the contract work shall be included in the single UNCLASSIFIED EXCAVATION/BORROW EXCAVATION cubic yard prices as defined in this Special Provision.

152-1.2 CLASSIFICATION

ADD the following to this Section:

All materials excavated, regardless of the source and type, including vegetation strippings, concrete materials and solid rock materials shall be defined as “UNCLASSIFIED EXCAVATION” or “BORROW EXCAVATION”. Unclassified excavation/borrow excavation shall include the removal and off site disposal of existing concrete slabs, broken concrete, concrete footings, concrete drainage structures, and solid rock materials from the proposed excavation areas.

Unclassified excavation shall include all materials found in the Runway 5/Taxiway D/Taxiway K pavement extension area and the ditch area. These areas are located south of Runway 9-27.

Borrow excavation shall include all materials found in the Taxiway H earthwork area. This area is located north of Runway 9-27. Materials removed from this area must be hauled around the outside of the airfield.

CONSTRUCTION METHODS

152-2.1 GENERAL

ADD the following to this Section:

The payment under ITEM AR152410-UNCLASSIFIED EXCAVATION and ITEM AR152440-BORROW EXCAVATION shall be based upon measuring the volume of cubic feet of soils removed as shown in the Construction Plans. The following information is approximate and included for informational purposes only to help educate the Contractor on the scope of the work to be included in the contract unit prices. A twenty-five (25) percent shrinkage factor is included in the calculations for necessary compacted embankment materials. A five (5) percent shrinkage factor is included in the calculations for necessary uncompacted embankment materials. Separate measurement for payments and/or payments shall not be made for the individual functions or steps required to complete the earthwork activities. The Contractor shall include all costs in the single UNCLASSIFIED EXCAVATION/BORROW EXCAVATION cubic yard prices. The below figures are approximate and no adjustments to the contract unit prices shall be made for minor variations.

QCIA, RUNWAY 5 EXTENSION - EARTHWORK
EARTHWORK SUMMARY

ITEM NUMBER	ITEM / LOCATION	RAW CUT (C.Y.)	RAW FILL (C.Y.)	FILL @ * SHRINKAGE (C.Y.)	PAYMENT MADE UNDER (C.Y.)		REMARK
					AR152410 (UNCLASSIFIED)	AR152440 (BORROW)	
1	Runway 5, Sta. 10+00 to Sta. 15+50: A. Compacted B. Uncompacted	2,828	4,572 19,080	5,715 20,034	2,828		25% Shrinkage Applied 5% Shrinkage Applied
2	Taxiway D, Sta. 108+50 to Sta. 119+00: A. Compacted B. Uncompacted	4,256	2,819 15,219	3,524 15,980	4,256		25% Shrinkage Applied 5% Shrinkage Applied
3	Taxiway K, Sta. 208+50 to Sta. 215+50: A. Compacted B. Uncompacted	5,109	2,059 11,965	2,574 12,563	5,109		25% Shrinkage Applied 5% Shrinkage Applied
4	Taxiway H, Sta. 429+98 to Sta. 437+50: A. Compacted B. Uncompacted	13,752	0 0	0 0		13,752	Cut Waste = 13,752 C.Y. to Areas 1, 2 & 3 (Haul Around Airfield)
5	Ditch Area, Sta. 195+00 to Sta. 205+60: A. Compacted B. Uncompacted	34,730	0 0	0 0	34,730		Cut Waste = 34,730 C.Y. to Areas 1, 2 & 3
	TOTALS	60,675	55,714	60,390	46,923	13,752	Project Shrinkage Provided: *A. Compacted = 25% B. Uncompacted = 5%

NOTE: Above earthwork summary table does not include volumes or earthwork for items not measured and/or paid for. No measurements or payments shall be made for stripping, stockpiling, topsoils, and/or minor erosion control ditches.

152-2.2 EXCAVATION

ADD the following to this Section:

Compaction control testing shall be accomplished for aircraft weights of 60,000 pounds or more.

152-2.4 DITCH EXCAVATION

ADD the following to this Section:

The Contractor shall transport materials along the haul roads only. The locations of all haul roads shall be approved by the Resident Engineer prior to beginning any work on this item. The Contractor shall also be responsible for placing, maintaining, and removing any necessary drainage structures to allow crossing the various drainage ditches located on airport property. The Contractor shall take special precautions when hauling excavated materials so as not to create deep ruts. All existing graded, turfed, sodded and/or formed areas which are disturbed or rutted by the Contractor, during his hauling operations, shall be regraded, returfed and refinished at his own expense and to the satisfaction of the Resident Engineer. No additional payment for haul will be allowed the Contractor.

152-2.6 STRIPPING

DELETE this Section and Insert the following:

All vegetation such as brush, heavy sods, heavy growth of grass, decayed vegetable matter, rubbish, and any other unsuitable material within 10' of the future paved areas shall be stripped or otherwise removed before embankment operations are started. Strippings from under the future paved areas may be stockpiled and used for topsoil and/or may be placed in the shoulder embankment area outside the limits of future pavement (as directed by the Resident Engineer), scarified, and broken by means of a disc harrow, plow or other approved equipment to the satisfaction of the Resident Engineer.

All vegetation such a brush, heavy sods, heavy growth of grass, decayed vegetable matter, rubbish, and any other unsuitable material 10' or more outside the future paved areas shall be stripped or otherwise removed before earthwork operations are started. Strippings from outside the future paved areas shall be stockpiled and used for topsoil upon the completion of the earthwork activities. These materials shall be scarified, and broken by means of a disc harrow, plow or other approved equipment to the satisfaction of the Resident Engineer.

No direct payment and/or measurements shall be made for the work performed under this section. The costs for all strippings, stockpiling, topsoil placement, and minor erosion control measures shall be included in the contract unit price for unclassified excavation.

152-2.9 PREPARATION AND PROTECTION OF THE TOP OF THE SUBGRADE

ADD the following to this Section:

At all times during construction, the ground surface shall be properly graded to promote rapid clearing of rainwater. The Contractor shall install temporary drainage ditches as requested by the Resident Engineer. Any water that accumulates on the ground surface shall be immediately removed by the Contractor. Excessively wet or disturbed soils at the base of any excavation or fill areas shall be removed prior to the placement of any additional fill. Any ground surface which will be exposed to weather and not immediately worked shall be bladed off with a motor grader and compacted with a smooth roller to seal the ground surface and prevent infiltration of moisture as approved by the Resident Engineer. When requested by the Resident Engineer and/or when it is predicted that inclement weather may develop, the Contractor shall cease embankment construction and seal the embankment ground surface.

152-2.12 TOPSOIL

ADD the following to this Section:

Topsoil shall be salvaged from strippings or other grading operations. Strippings shall be stockpiled during excavation operations so that soils can be removed. The strippings shall be reinstalled after excavation operations are complete. Grade stakes for topsoil placement shall not be set. No direct payment or measurements will be made for topsoil.

No direct payment or measurements shall be made for the work performed under this section. The costs for all stripping, stockpiling, topsoil placement, and minor erosion control ditches shall be included in the contract unit prices for UNCLASSIFIED/BORROW EXCAVATION.

METHOD OF MEASUREMENT

152-3.1 DELETE:

The phrase “and stripped” from the last sentence of the first paragraph.

Add to this Section:

Excavation or handling of soils shall be paid for only once. Stockpiling of soils for later reuse and redistribution shall be done at the Contractor’s expense. Redistribution or spreading of stockpiled soils shall be done at the Contractor’s expense.

No direct measurements shall be made for stripping, stockpiling, topsoil placement, minor fill-in of abandoned structures and ditches, minor erosion control ditches, and the removal and disposal of existing concrete slabs, footings, drainage structures, and storm sewers. These items shall be considered incidental to the contract unit prices for UNCLASSIFIED/BORROW EXCAVATION.

152-3.2 DELETE the entire article.

152-3.3 ADD to this Section:

Only material excavated from the Taxiway H earthwork area shall be measured for borrow excavation.

BASIS OF PAYMENT

152-4.2 DELETE the entire article

152-4.3 DELETE the entire article.

Payment will be made under:

Item AR152410 -- UNCLASSIFIED EXCAVATION -- per cubic yard.

Item AR152440 -- BORROW EXCAVATION -- per cubic yard.

MODIFICATIONS TO RECURRING
SPECIAL PROVISION FOR ITEM AR156000

EROSION CONTROL

EFFECTIVE: JULY 1, 2004

METHOD OF MEASUREMENT

DELETE Sections 4.1 and 4.2 and INSERT the following:

- 4.1 The quantity of Temporary Erosion Control to be paid for under this item shall be measured per lump sum for furnishing all materials, equipment, overhead, and labor required for this construction and administration including, but not limited to, compliance with the storm water pollution prevention plan, IEPA construction site activities NPDES Permit No. ILR100000, IEPA regulations, and all other necessary items to complete this item.

BASIS OF PAYMENT

DELETE Section 5.1 and INSERT the following:

- 5.1 Payment will be made at the contract unit price per lump sum for Temporary Erosion Control. This price shall be full compensation for furnishing all materials and for all preparation, assembly, installation, removal, reinstallation as required of these materials and for all labor, equipment, tools and incidentals necessary to complete this item.

Payment will be made under:

ITEM AR156500 -- TEMPORARY EROSION CONTROL -- per lump sum.

MODIFICATIONS TO SUPPLEMENTAL SPECIFICATION
FOR ITEM 209 – CRUSHED AGGREGATE BASE COURSE

DESCRIPTION

209-1-1 ADD:

Item 209511 Crushed Aggregate Base, CA 1 gradation materials will be used to repair soft subgrade areas found under the proposed pavements. The MAA reserves and shall have the right to delete part or all of the 209511 pay item from the proposed contract work. The Contractor shall not be entitled to any extra compensation for the deletion of this pay item or quantities.

MATERIALS

209-2.3 ADD:

IDOT coarse aggregate gradation number CA-1 shall be used in the locations as directed by the Resident Engineer for the crushed aggregate base, CA-1 materials.

209-3.6 FINISHING AND COMPACTING

DELETE the fifth sentence in the first paragraph and insert the following sentence in its place:

Rolling shall continue until the base material has been compacted to not less than 95% density, as determined by the compaction control tests specified in Division VII.

Compaction control testing shall be accomplished for aircraft weights of 60,000 pounds or more.

METHOD OF MEASUREMENT

ADD the following Sections:

209-4.2 The quantity of Crushed Aggregate Base, CA 1 to be paid for shall be the number of tons of material placed, bonded and accepted by the Resident Engineer in the completed repair area. Aggregate in excess of 12” beyond the repair area will not be measured for payment but shall be considered incidental to this pay item.

BASIS OF PAYMENT

209-5.1 ADD the following to this Section:

Payment will not be made for aggregate in excess of 105 percent of the amount specified by the Resident Engineer nor for aggregate placed outside the design width.

The tonnage of each type of aggregate base measured as provided above shall be paid for at the contract unit price per ton for each type of aggregate base course, which price and payment shall constitute full compensation for removal and disposal of existing materials as required to install proposed materials, preparing subgrade; furnishing, hauling and placing the materials; for spreading, sprinkling (if required), compacting and rolling, for refilling test holes (when necessary); and for furnishing all labor, equipment, tools, water and incidentals necessary to complete the work. This item shall not include aggregate materials required for paving operations (form setting and/or slip form machinery).

Payment will be made under:

ITEM AR209511 -- CRUSHED AGGREGATE BASE, (CA-1) -- per ton.

MODIFICATIONS TO SUPPLEMENTAL SPECIFICATION
FOR ITEM 620 – PAVEMENT MARKING

DESCRIPTION

620-1.1 ADD the following to this Section:

The MAA reserves and shall have the right to delete the pavement marking pay item from the proposed contract work. The sponsor may opt to complete this work with their own work force. Prior to ordering any materials or starting any work, the Contractor shall confirm the status of this work with the MAA. The Contractor shall not be entitled to any extra compensation for the deletion of these pay items.

This item shall include the removal of existing pavement marking as shown on the Construction Plans.

The pavement markings shown on the Construction Plans shall be applied as approved by the Resident Engineer.

MATERIALS

620-2.2 PAINT

ADD:

The paint for this project shall be Waterborne.

DELETE the entire paragraphs:

2. EPOXY

CONSTRUCTION METHODS

620-3.3 LAYOUT OF MARKINGS

ADD:

The Contractor or painting subcontractor shall be responsible for the layout of the proposed paint markings. Paint shall not be applied until the condition of the surface have been reviewed by the Resident Engineer. If, in the opinion of the Resident Engineer, the markings applied do not conform with these special provisions or the Construction Plans the Contractor shall remove and correct the markings at his own expense.

620-3.5 APPLICATION

CHANGE the first sentence of the second paragraph to read:

The paint shall be mixed in accordance with the manufacture's instructions and applied to the pavement with a marking machine in two separate applications, each at the rate(s) shown in Table 1.

Table 1. Application Rates for Paint and Glass Beads

Paint Type	Paint Square feet per gallon, ft ² /gal	Glass Beads, Type I, Gradation A Pounds per gallon of paint, lb/gal
Permanent Waterborne Markings	115 ft ² /gal maximum	10 lb/gal minimum
Temporary Waterborne Markings	90 ft ² /gal maximum	7 lb/gal minimum

DELETE the last sentence of the fourth paragraph.

ADD the following paragraph:

A period of 24 hours shall elapse prior to the first application of paint if TT-P-1952 is used.

METHOD OF MEASUREMENT

620-4.1 ADD the following to this Section:

Measurements for payment shall be made for the pavement marking surface area only once. The contract unit price shall include costs for all applications of paint on the pavement marking surface area.

BASIS OF PAYMENT

620-5.1 ADD the following to this Section:

Payment will be made under:

ITEM AR620510 -- PAVEMENT MARKING -- per square foot.

ITEM AR620900 -- PAVEMENT MARKING REMOVAL -- per square foot.

DIVISION V - TURFING

MODIFICATIONS TO SUPPLEMENTAL SPECIFICATION
FOR ITEM 901-SEEDING

DESCRIPTION

901-1.1 ADD to this Section as follows:

This item shall include, but not be limited to, all work necessary to seed all areas disturbed by the construction of this project. Areas disturbed which are outside the limits of construction/seeding shall be seeded according to this Special Provision by the Contractor, but shall not be measured for payment or paid for.

MATERIALS

901-2.1 SEED

ADD to this Section as follows:

The seeds shall be planted at a depth between 1/4 inch and 1/2 inch below the final ground surface. All sowing of seed shall not begin prior to March 15 and shall be completed by May 15, or shall not begin prior to August 15 and shall be completed by October 15.

The seeding operation for any area shall be completed within forty-eight (48) hours following the application of fertilizer to that area.

CONSTRUCTION METHODS

901-3.4 MAINTENANCE OF SEEDED AREAS:

ADD the following to this Section:

It will be the responsibility of the Contractor to establish a good stand of grass of uniform color and density to the satisfaction of the Resident Engineer. In areas where the seeds sown fail to grow, in the opinion of the Resident Engineer, the Contractor shall reseed the areas as required and as many times as required until the Resident Engineer is satisfied with the results. No measurements for payment or payments will be made for areas requiring reseeding.

METHOD OF MEASUREMENT

901-4.1 ADD to this Section as follows:

The areas to be seeded will consist of the areas designated on the plans. Areas disturbed due to Contractor carelessness or for the convenience of the Contractor, such as haul roads, parking areas, storage areas, soil waste areas, etc., shall be seeded but will not be measured for payment. Areas requiring more than one application of seeding shall be measured for payment only once.

MODIFICATIONS TO SUPPLEMENTAL SPECIFICATION
FOR ITEM 908-MULCHING

DESCRIPTION

908-1.1 ADD to this Section as follows:

This item shall include, but not be limited to, all work necessary to hydraulic mulch all areas disturbed by the construction of this project. Areas disturbed which are outside the limits of construction/seeding shall be hydraulic mulched according to this Special Provision by the Contractor, but shall not be measured for payment or paid for.

CONSTRUCTION METHODS

908-3.3 CARE AND REPAIR

ADD to this Section as follows:

It will be the responsibility of the Contractor to establish a good stand of grass of uniform color and density to the satisfaction of the Resident Engineer. In areas where the seeds sown fail to grow, in the opinion of the Resident Engineer, the Contractor shall re-mulch the areas as required and as many times as required until the Resident Engineer is satisfied with the results. No measurements for payment or payments will be made for areas requiring remulching. Hydraulic mulch will be required in all areas where additional applications area necessary.

METHOD OF MEASUREMENT

908-4.1 ADD to this Section as follows:

The areas to be hydraulic mulched will consist of the areas designated on the plans. Areas disturbed due to Contractor carelessness or for the convenience of the Contractor, such as haul roads, parking areas, storage areas, stockpile areas, etc., shall be hydraulic mulched, but will not be measured for payment. Areas requiring more than one application of mulch shall be measured for payment only once.

BASIS OF PAYMENT

908-5.1 DELETE the entire Article and insert the following:

Payment will be made at the contract unit price per acre for MULCHING-METHOD 3. This price shall be full compensation for furnishing all materials and for placing and anchoring the materials, and for all labor, equipment, tools, and incidentals necessary to complete the item.

Payment will be made under:

ITEM AR908513 -- MULCHING-METHOD 3 -- per Acre.

DIVISION VI - LIGHTING INSTALLATION

ITEM 108 - INSTALLATION OF UNDERGROUND CABLE FOR AIRPORTS

DESCRIPTION

108-1.1 ADD the following to this Section:

This item of work shall consist of the installation of cable at the locations shown on the plans and in accordance with these specifications.

If the Contractor wishes to lay cable on a line other than that shown on the plans, he shall obtain approval of the Resident Engineer before doing so. Any additional cable or wire needed because of such change will be at the Contractor's expense.

At locations where the existing cable to be replaced might obstruct or interfere with the efficient operation of the electrical system and in locations indicated on the Construction Plans, the existing cable shall be removed and disposed of by the Contractor. The Contractor shall install pull cords and plugs in the existing conduits where existing cables are removed and no new cable is proposed. The costs of removing and disposing of any existing cable, new pull cords, and new plugs shall be considered as incidental to the contract unit price and no additional compensation will be allowed.

When required, the Contractor shall pull out and reinstall existing cables in the existing facilities as indicated on the Construction Plans. The costs of pulling and reinstalling the existing cables and proposed cables shall be included in the 108 Underground Cable contract unit price.

In areas where there is a congestion of buried cables or where the proposed cable crosses an existing cable, the Contractor shall be required to hand dig the proposed cable into place or hand dig to remove an existing cable. In all other areas, the Contractor has the option to either trench or plow the proposed cable in unit duct into place.

Prior to excavating any area, the Contractor shall be required to megger all existing light circuit cables at the regulators in the transformer. All readings shall be submitted to the Resident Engineer.

Upon completion of the project, similar megger readings shall be made on both new and existing light circuit cables to insure that existing cable has not been damaged due to construction. All readings shall be submitted to the Resident Engineer.

The Contractor shall be required to provide a 24-hour answering service with a one hour response to enact repairs to existing lighting cable damaged due to construction as authorized by the Owner. All costs borne to repair such damaged cable shall be the responsibility of the Contractor.

In order to avoid existing underground cable, the Contractor shall connect a thumper to all existing circuits after which the cables shall be staked in all areas requiring trenching or excavation. Contractor shall also note that low voltage, FAA, cables also run underground throughout these areas.

EQUIPMENT AND MATERIALS

108-2.2 CABLE

REVISE this Section to read as follows:

Underground cable shall conform to the requirements of F.A.A. Advisory Circular 150/5345-7D, "Specifications for L-824 Underground Electrical Cable for Airport Lighting Circuits." Cable used for the taxiway lighting circuits shall be (Tamaqua Cable Products Corporation or approved equal) No. 8, 5000 Volt, EPR, MV 90, L-824 Type B, one or two conductors, stranded, cable with PVC jacket meeting ICEA S-68-516, in unit duct. The proposed cable and unit duct shall be factory assembled and delivered to the site on reels. The unit duct shall be manufactured from yellow polyethylene complying with NEMA standard for high density, smooth wall, coilable polyethylene electrical plastic duct Pub. No. TC7-1978. The unit duct surface shall have three integral black stripes with a separation angle of 120 degrees. Airfield series circuit cables shall be unit assembly with one inch (1") diameter unit duct. Homerun cables and cables to guidance signs shall be two of the above cables in one unit duct, 1-1/2" assembly. Field terminate homeruns in manholes or splice cans with a minimum of three each 2" diameter conduit openings.

It is the desire of the Owner to have interchangeable lighting cable throughout the airport, therefore the Metropolitan Airport Authority reserves the right to select and/or approve electrical cable and materials to be supplied for this project.

15 KV rated cable shall be shielded power cable Type MV-90 compact copper conductor Class B strand. Insulation type shall be ethylene propylene rubber (EPR) with polyvinyl chloride (PVC) outer jacket.

Cable shall meet or exceed requirements of ICEA S-68-516 and AEIC CS6 standard for EPR insulated wire and cable.

Cable gauge and number of conductors shall be as detailed on the plans.

CONSTRUCTION METHODS

108-3.1 GENERAL

ADD the following to this Section:

The cable quantities as shown on the Construction Plans are based on straight line measurement and do not consider any vertical distances or the required cable slack as stated under Item 108-3.4 in Illinois Standard Specifications for Construction of Airports, January 1985.

All cable shall be installed direct buried or plowed as indicated on the drawings, using new and existing cable ducts under runways, roads, home runs to transformer vaults, etc.

Each day, prior to leaving the job site, the Contractor, in the presence of the Owner's representative, shall activate all airport lighting circuits to insure operation.

At base mounted lights and splice cans the unit duct shall be attached to the base can rigid steel conduits with fittings as indicated on the Construction Plans.

108-3.2 INSTALLATION IN DUCT OR CONDUIT

ADD the following to this Section:

The unit duct will be run continuous through all ducts.

108-3.4 INSTALLATION IN TRENCHES

CHANGE the first sentence to read as follows:

Except for installation of cable (or cables) in unit duct, the Contractor will not use a cable plow for installing the cable.

ADD the following to this Section:

At locations, such as in an existing duct or wireway, in the existing electrical vault area, existing electrical manhole, utility tunnel, duct bank or near a proposed light location, where the existing cable to be replaced might obstruct or interfere with the efficient operation of the electrical system, it shall be removed and disposed of by the Contractor. The cost of removing and disposing of this existing cable shall be considered as incidental to the contract unit price per linear foot for underground cable installed in trench or duct, and no additional compensation will be allowed.

Any and all trenches will be backfilled to a smooth grade to the satisfaction of the Resident Engineer. The disturbed areas will be either sodded or seeded, limed and fertilized. Lime will be applied at the rate of two (2) tons per acre. Any combination of the following nutrient materials is acceptable providing the minimum requirements are met: complete fertilizer, sulphate of ammonia, ammonium nitrate, ammonium phosphate or muriate of potash.

FERTILIZER APPLICATION RATES

<u>Minimum Pounds of Available Nutrient</u>	<u>Plant Food Per Acre</u>
N	90
P ₂ O ₅	350
K ₂ O	<u>240</u>
Total	680

The sodding, seeding and fertilizing of trench areas as described will be incidental to Item 108 and no additional compensation will be allowed. Seed used shall be Alta Fescue, applied at the rate of 100 lbs. of pure live seed per acre.

ADD the following to this Section:

The unit duct shall be installed so that it is possible to withdraw a cable and pull in a new one. Sweeping long radius bends shall be used. Any run with a kink or short radius bend will be rejected. The cable in unit duct will be installed continuous between lights without any splices in cable or unit duct. Splices in homeruns shall be made inside an approved splice box as directed by the Resident Engineer.

Where two or more cables are laid parallel in the trench, they shall be placed laterally a minimum distance of three (3) inches apart, and the trench will be widened sufficiently to accomplish this.

Color code all phase wiring by use of colored wire insulation and/or colored tape. Where tape is used, the wire insulation shall be black. Black and red shall be used for single-phase, three wire systems and black, red and blue shall be used for three-phase systems. Neutral conductors, size No. 6 AWG or smaller, shall be identified by a continuous white or natural gray outer finish along its entire length. Neutral conductors larger than No. 6 AWG shall be identified either by a continuous white or natural gray outer finish along its entire length or by the use of white tape at its terminations and inside accessible wireways.

<u>Circuit</u>	<u>MIMIC Panel Colors</u>
T-D Circuit	Orange
Taxiway K-1 Circuit	Red
R5-23 Circuit	White

All branch circuit conductors connected to a particular phase shall be identified with the same color. The color coding shall be extended to the point of utilization.

Direction of primary cables shall be identified by color coding as follows: When facing light with back to pavement, cable to the left is coded red and cable to right is coded blue. This applies to stake mounted lights and base mounted lights where the base has only one entrance.

In control wiring the same color shall be used throughout the system for the same function, such as 10%, 30%, 100% brightness control, etc.

All power and control circuit conductors shall be copper, aluminum shall not be accepted. This includes wire, cable, busses, terminals, switch/panel components, etc.

Low voltage (600 V.) and high voltage (5000 V.) conductors shall be installed in separate wireways.

108-3.9 ADD to this Section the following:

Bare copper counterpoise wire will not be required on the proposed edge light circuits.

METHOD OF MEASUREMENT

108-4.1 REVISE the first paragraph in this Section to read as follows:

The footage of cable or counterpoise wire installed or relocated in trench, duct, or conduit to be paid for shall be the number of linear foot of cable installed or relocated in trench, duct, or conduit measured in place by direct measurement, completed, ready for operation and accepted as satisfactory with no allowance being made for overrun due to required slack, turns, splices, etc. The Contractor shall take this into consideration in preparing his bid for the items concerned. Existing cables moved, replaced, and/or relocated as part of removing and replacing concrete duct banks shall not be measured for payment and/or paid for under this item.

Cable trenching shall not be measured for payment or paid for separately. The costs of cable trenching shall be included in the "Underground Cable in Unit Duct" contract unit prices.

BASIS OF PAYMENT

Payment will be made under:

ITEM AR108158 -- 1/C #8 5KV UG CABLE IN UD -- per lineal foot.
ITEM AR108258 -- 2/C #8 5KV UG CABLE IN UD -- per lineal foot.

ITEM 125 - INSTALLATION OF AIRPORT LIGHTING SYSTEMS

DESCRIPTION

125-1.2 ADD to this Section the following:

This item shall consist of base mounted MITL units, replacing light lense, adjusting taxi guidance signs, relocating base mounted lights, relocating taxi guidance signs, replacing taxi guidance sign panels and supplying taxi guidance sign panels as indicated on and at the locations shown on the Construction Plans in accordance with these special provisions. Also included in this item will be the testing of the installed, relocated, refurbished items and all other incidentals necessary to place and/or replace the lighting back into operation complete to the satisfaction of the Resident Engineer.

The existing equipment and materials scheduled to be removed, refurbished, and/or relocated shall be removed by the Contractor with care so that all materials considered suitable for future use by the Resident Engineer may be salvaged. Equipment and materials having salvage value shall be removed without damage and those having no salvage value shall be removed and disposed of by the Contractor in a suitable location off of airport property. The Contractor shall clean the salvageable materials and equipment to the satisfaction of the Resident Engineer. Any components damaged by the Contractor during removal, refurbished, and/or relocation shall be replaced or repaired by him at no additional cost with a similar unit (approved by the Resident Engineer) that is compatible with the remainder of the system. All salvageable equipment and materials removed and not reused shall remain the property of and be delivered to the Metropolitan Airport Authority. The Contractor shall deliver the salvaged items to a location designated by the Airport Maintenance Manager. All excavating required to remove existing equipment and materials shall be backfilled with compacted sand.

The Contractor shall field inspect the existing runway/taxiway lighting system and guidance signs prior to purchasing the proposed equipment and cables, to ensure the new equipment and cables are compatible to the existing system. Any noncompatible components furnished by the Contractor shall be replaced by him at no additional costs with a similar unit (approved by the Resident Engineer) that is compatible with the remainder of the system.

All new equipment supplied by the Contractor shall appear on the current approved Equipment List found in AC 150/5345-53A and -2 (Airport Lighting Equipment Certification Program and/or Airport Electronic Bulletin Board Number 14).

EQUIPMENT AND MATERIALS

125-2.1 GENERAL

ADD the following to this Section:

- (d) The existing L-862 high intensity runway edge / threshold lights on Runway 9-27 and Runway 13-31 are supplied with quartz light fixtures and lamps. The existing L-861 medium intensity runway / taxiway lights on Runway 5-23 and all of the taxiways are supplied with incandescent light fixtures and lamps. All new lights shall have an overall height of 20 inches.

Existing light fixtures:

A. Runway Edge Lights:

R9-27 and R13-31 = L-862/120 watt, quartz.
R5-23 = L-861/30W, incandescent.

B. Runway Threshold Lights:

R9-27 and R13-31 = L-862/200 watt, quartz.
R5-23 = L-861E/45W, incandescent.

C. Taxiway edge lights = L-861T/30 watt, 6.6 AMP, incandescent.

Existing isolation transformers:

A. Runway Edge Lights:

R9-27 and R13-31 = L-830-4, 100 watt.
R5-23 = L-830-1, 30W/45W.

B. Runway Threshold Lights:

R9-27 and R13-31 = L-836-6, 200 watt.
R5-23 = L-830-1, 30W/45W.

C. Taxiway edge lights = L-830-1, 30/45 watt, 6.6/6.6 AMP.

- (e) It is the desire of the Owner to have interchangeable lighting equipment throughout the airport, therefore the Metropolitan Airport Authority reserves the right to select and/or approve electrical equipment and materials to be supplied for this project.

ADD the following paragraphs to this Section:

125-2.14 ANTI-SEIZE COMPOUND

Prior to reinstalling the existing light fixtures, the Contractor will apply an oxide inhibiting, anti-seizing compound to all screws, nuts, breakable coupling and all places where metal comes into contact with metal. The anti-seize compound will be as manufactured by I.T.T. brand "Contax" or an approved equal.

125-2.15 STAINLESS STEEL BOLTS

All base plate and stake mounting bolts shall be stainless steel. The Contractor shall supply and install new stainless steel bolts, washers, and nuts as required.

125-2.16 SIGNS

Signs shall be double faced; Type L-858Y, L-858R, L-858L, or L-858B as indicated on the Construction Plans; and in accordance with the requirements of the latest revision of FAA Advisory Circular 15/5345-44, Specifications for Taxiway and Runway Signs.

Each sign shall be supplied with sign panels as indicated in the Construction Plans. The Contractor may reuse existing sign panels as indicated on the Construction Plans, if the panels are in acceptable condition, as determined by the Resident Engineer.

Signs shall be compatible in all respects with each other and with signs currently in place at the airport. Signs shall be Lumacurve or approved equal. Each sign installation shall include a sign splice can with it. The cost of the sign splice can shall be included in the sign contract unit price.

CONSTRUCTION METHODS

125-3.1 GENERAL

ADD the following to this Section:

Upon completion of the signage work, all frames, legend panels, and associated parts shall be sealed watertight with a durable silicone caulking compound approved by the Resident Engineer.

ADD the following to this Section:

125-3.4 IDENTIFICATION NUMBERS

Per instructions from the MAA, identification numbers will not be required on this project.

125-3.5 ITEM AR125415 MITL - BASE MOUNTED

This item shall include all work necessary to furnish and install a new base mounted L-861T MITL unit at the proposed locations as indicated on and detailed in the Construction Plans.

125-3.6 ITEM AR125931 REPLACE LIGHT LENSE

This item shall include all work necessary to furnish and install new light lense (or globes) on existing light fixtures at the proposed locations as indicated on and detailed in the Construction Plans.

125-3.7 ITEM AR125944 ADJUST TAXI GUIDANCE SIGN

This item shall include all work items that are necessary to vertically adjust the existing guidance signs as detailed in the construction plans. The work to be included in this item includes, but is not limited to, disconnecting existing unit duct, cables, transformers, and signs; excavating; removing transformer can and sign base; removing and disposal of concrete pads not being reused; installation and compaction of leveling sand; reset transformer can and sign base; elevating and reconnecting existing unit duct/cable and/or installing new unit duct/cable; reinstallation and reconnection of equipment; backfilling with compacted sand; testing, supplying and replacing damaged equipment; resealing adjusted signs; and all other incidentals necessary to vertically adjust the existing equipment and return the system back into operation, complete to the satisfaction of the Engineer and the MAA. Separate payment for these shall not be made.

The cost to complete these items shall be included in the contract unit prices. The Contractor shall replace any item damaged during the vertical adjustment of the guidance sign with a similar unit (approved by the Resident Engineer). The Contractor shall ascertain that the equipment and cables furnished by him are compatible in all respects with the existing equipment and cables. Any noncompatible components shall be replaced by the Contractor at no additional costs with a similar compatible unit.

Separate payments shall not be made for the different sizes of signs. Vertical adjustment of existing 1,2,3, and/or 4 module signs shall be paid for at the same single contract unit price.

The Contractor may reuse the existing equipment as much as possible. Contractor shall furnish and install items which cannot be reused. Vertical adjustment sign shall be resealed watertight with a durable silicone caulking compound approved by the Engineer.

125-3.8 ITEM AR25962 RELOCATE BASE MOUNTED LIGHT

This item shall include all work items that are necessary to remove and reinstall existing base mounted edge lights as detailed in the Construction Plans. The work to be included in this item includes, but is not limited to, disconnecting light fixtures, excavating base can, disconnecting unit duct, removing base can, transporting base can, relocating short sections of existing edge light cable in unit duct, backfilling excavation with compacted sand, excavating new can location, installation and compaction of sand leveling cushion, reconnecting unit duct, concrete backfill, backfilling with compacted sand, reinstalling equipment, testing, supplying and replacing damaged equipment, and all other incidentals necessary to relocate the existing equipment and return the system back into operation, completed to the satisfaction of the Resident Engineer. Separate payments for these items shall not be made.

The cost to complete these items shall be included in the contract unit prices. The Contractor shall replace any item damaged during the relocation of the edge lights with a similar unit (approved by the Resident Engineer). The Contractor shall ascertain that the equipment and cables furnished by him are compatible in all respects with the existing equipment and cables. Any noncompatible components shall be replaced by the Contractor at no additional costs with a similar compatible unit.

125-3.9 ITEM AR125964 RELOCATE TAXI GUIDANCE SIGN

This item shall include all work items that are necessary to remove and reinstall existing guidance signs as detailed in the Construction Plans. The work to be included in this item includes, but is not limited to, disconnecting existing cables, transformers, and signs; removing existing signs, covers, and mounting plates; excavating transformer can and light base, disconnecting unit duct, removing transformer can and sign base, removing and disposal of concrete pads not being reused, backfilling excavation with compacted sand, seed area, transporting transformer can and sign base, excavating new location, install leveling sand, reset transformer can and sign base, connect new unit duct, concrete backfill, backfilling with compacted sand, reinstall equipment, pour new concrete pads, testing, supplying and replacing damaged equipment, resealing relocated signs, and all other incidentals necessary to relocate the existing equipment and return the system back into operation, completed to the satisfaction of the Resident Engineer and the MAA. Separate payment for these items shall not be made.

The cost to complete these items shall be included in the contract unit prices. The Contractor shall replace any item damaged during the relocation of the guidance sign with a similar unit (approved by the Resident Engineer). The Contractor shall ascertain that the equipment and cables furnished by him are compatible in all respects with the existing equipment and cables. Any noncompatible components shall be replaced by the Contractor at no additional costs with a similar compatible unit.

Separate payments shall not be made for the different sizes of signs. Relocation of existing 1,2,3, and/or 4 module signs shall be paid for at the same single contract unit price.

The Contractor may reuse the existing equipment as much as possible. Contractor shall furnish and install items which can not be reused. Relocated sign shall be resealed watertight with a durable silicone caulking compound approved by the Engineer.

125-3.10 ITEM AR801605 REPLACE TAXI GUIDANCE SIGN PANEL

This item shall include all work items that are necessary to remove existing and supply/install new taxiway guidance sign panels as directed by the Engineer. The work to be included in this item includes, but is not limited to, supplying new lumacurve sign panels, removing existing sign panels, disposal of removed sign panels, installing new lumacurve sign panels, resealing sign, and all other incidentals necessary to replace the existing sign panels and return the system back into operation, completed to the satisfaction of the Engineer and the MAA. The proposed sign panel legends and sign locations shall be identified in the field at the time of construction.

125-3.11 ITEM AR801614 SUPPLY TAXI GUIDANCE SIGN PANEL

This item shall include all work items that are necessary to supply and deliver new taxiway guidance sign panels to be installed by the MAA in existing signs as directed by the Resident Engineer. The work to be included in this item includes, but is not limited to, supplying and delivering new lumacurve sign panels to the MAA maintenance building at the airport. The proposed sign panel legends shall be identified in the field at the time of construction.

METHOD OF MEASUREMENT

ADD the following to this Section:

- 125-4.2 The quantity of new light units, existing light units, and guidance signs to be installed, removed, adjusted and/or relocated, and existing taxi guidance sign panels to be replaced to be paid for under this item shall be the number, counted in place as indicated in this special provision, of each type and style installed, removed, adjusted, relocated and/or replaced as complete and accepted by the Resident Engineer.

BASIS OF PAYMENT

- 125-5.1 REVISE the first sentence of this Section to read as follows:

Payment will be made at the contract unit price per each complete light, guidance sign, and/or guidance sign panel installed in place, removed, adjusted, relocated, and/or replaced by the Contractor and accepted by the Resident Engineer.

Payment will be made under:

- ITEM AR125415 -- MITL - BASE MOUNTED -- per each.
- ITEM AR125944 -- ADJUST TAXI GUIDANCE SIGN -- per each.
- ITEM AR125962 -- RELOCATE BASE MOUNTED LIGHT -- per each.
- ITEM AR125964 -- RELOCATE TAXI GUIDANCE SIGN -- per each.
- ITEM AR801605 -- REPLACE TAXI GUIDANCE SIGN PANEL -- per each.
- ITEM AR801614 -- SUPPLY TAXI GUIDANCE SIGN PANEL -- per each.

ADD the following Division:

DIVISION VIII – MISCELLANEOUS

ITEM AR801604 SETTLEMENT PLATES

DESCRIPTION

- 1.1 This item shall consist of furnishing and installing settlement plates at the locations directed by the Resident Engineer.

MATERIALS

- 2.1 The settlement plate itself shall consist of a 3' x 3' square steel plate fabricated of 3/8" thick steel plate. A 12" long section of 1-5/16" diameter round solid bar stock steel shall be welded securely to the plate so that it is perpendicular in two planes 90 degrees apart. Threaded couplings of standard pipe thread as well as an adequate number of 3' long 1" diameter extra strong Schedule 80 steel pipe properly threaded sections to extend at least 1' above the proposed top of embankment shall be included.

CONSTRUCTION METHODS

- 3.1 At least three sections of vertical pipe shall initially be installed on each settlement plate to allow verification by the Resident Engineer that the overall installation is plumb. The plates must be adequately secured by a method approved by the Resident Engineer and verification of plumbness shall continue to be checked during embankment construction. If at any time the pipe extensions are more than two (2) degrees out of plumb on any axis, the Contractor shall remove and reinstall the plates, including recompacting where necessary, at his own expense. The surcharge embankment shall be compacted to a point that is within six (6") inches of the vertical pipes. The compaction requirements over the settlement plates shall be equal to the compaction standards of the remainder of the embankment and accomplished by whatever means the Contractor chooses so long as damage to the vertical pipes is avoided. The Resident Engineer shall be the final authority as to what method of compaction and construction is allowed. The Contractor shall paint numbers on the pipe at a point above the final embankment. The number shall be designated by the Resident Engineer.

METHOD OF MEASUREMENT

- 4.1 The quantity of settlement plates to be paid for under this item shall be the number of plates installed as completed assemblies, in place, and accepted by the Engineer.

BASIS OF PAYMENT

- 5.1 This item shall be paid for at the contract unit price each for furnishing and installing settlement plates. This price shall be full compensation for all labor, materials, and equipment necessary to complete this item.

Payment will be made under:

ITEM AR801604 -- SETTLEMENT PLATES -- per each.

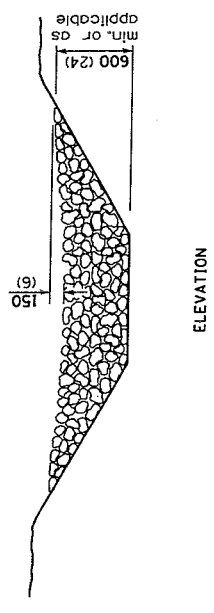
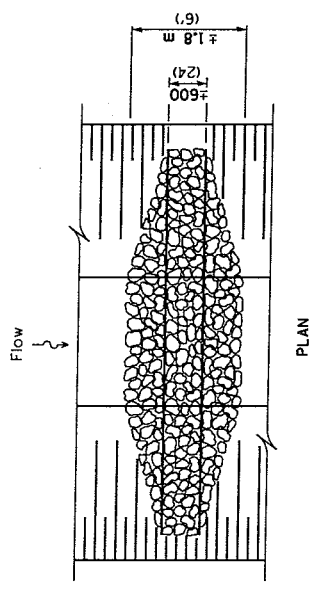

AGGREGATE DITCH CHECK

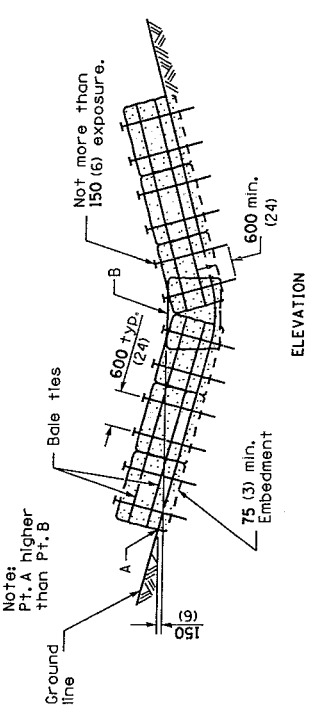
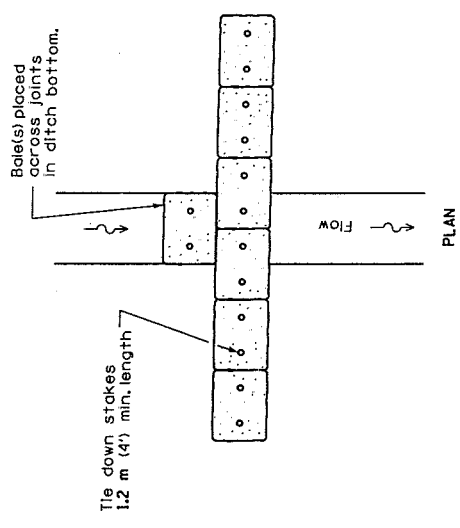

ROLLED EXCELSIOR OR STRAW BALES FOR DITCH CHECK

GENERAL NOTES

The dimensions and installation methods for ditch checks shall be the same for perimeter erosion barriers and inlet and outlet protection unless otherwise specified.

All dimensions are in millimeters (inches) unless otherwise shown.

Illinois Department of Transportation
 PASSED January 1, 2002
 ENGINEER OF SAFETY AND PROCEDURES
 APPROVED: [Signature] January 1, 2002
 ENGINEER OF CONSTRUCTION ENVIRONMENT

DATE	REVISIONS
1-1-02	Rev. ditch ok details & added perimeter erosion barrier detail.
1-1-99	Clar. ditch check dimen. Rev. filter fence sym. & inlet & pipe prot. detail.

TEMPORARY EROSION CONTROL SYSTEMS
 STANDARD 280001-02
 (Sheet 1 of 3)

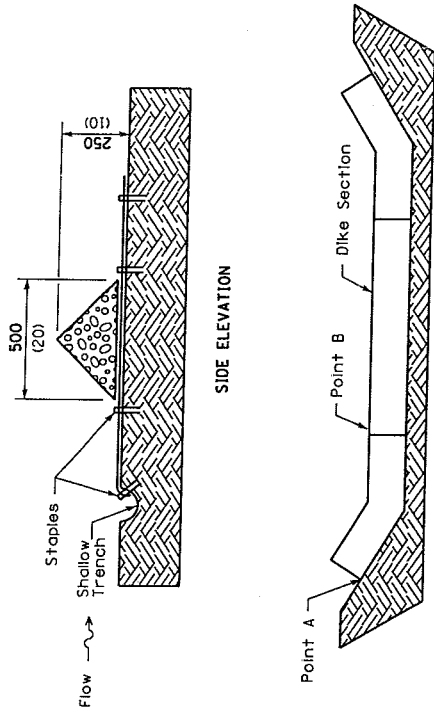
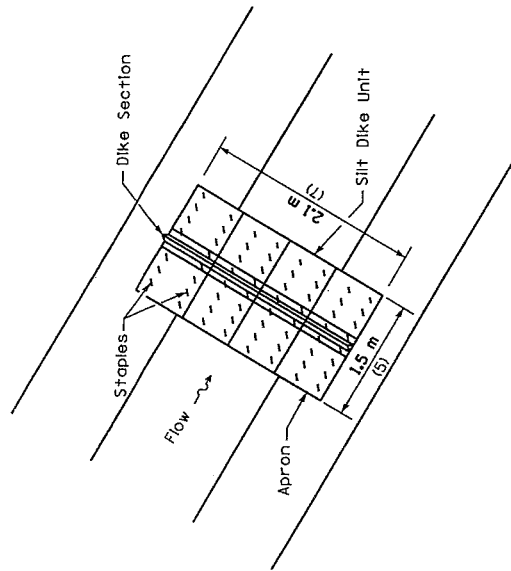

Point A must be higher than Point B to ensure that water flows over the dike and not around the ends.

FRONT ELEVATION

PLAN

URETHANE FOAM/GEOTEXTILE DITCH CHECK

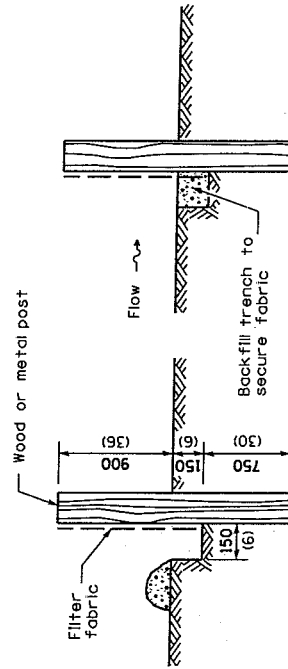

SILT FILTER FENCE AS A PERIMETER EROSION BARRIER

Illinois Department of Transportation
 PASSED
 JORDAN'S L. 2002
 ENGINEER OF QUALITY AND PROCEDURES
 APPROVED
 JORDAN'S L. 2002
 ENGINEER OF DESIGN AND ENVIRONMENT

TEMPORARY EROSION CONTROL SYSTEMS
 (Sheet 2 of 3)
 STANDARD 280001-02

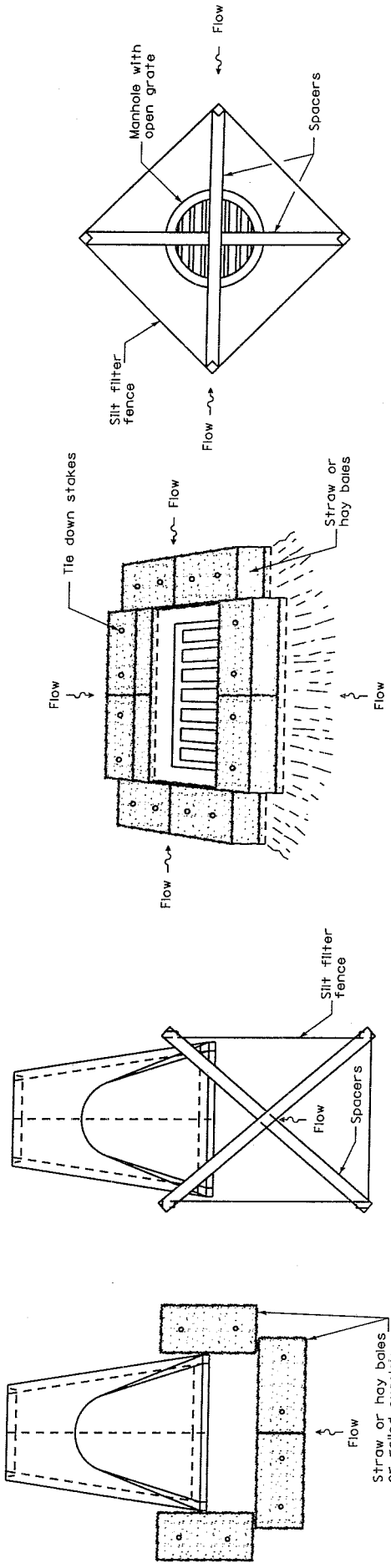

INLET AND PIPE PROTECTION

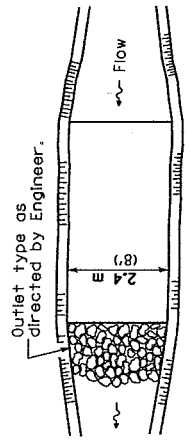

The performance of the basin will improve if put into a series.

ELEVATION

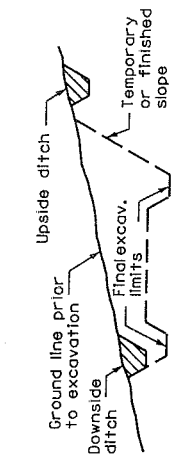

TYPICAL CUT CROSS SECTION

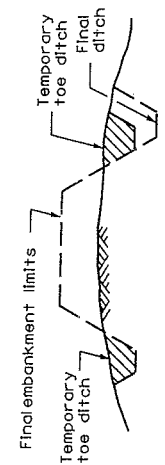

TYPICAL FILL CROSS SECTION

PLAN

SEDIMENT BASIN

TEMPORARY DITCHES FOR CUT & FILL SECTIONS

Illinois Department of Transportation
 PASSED JANUARY 1, 2002
 ENGINEER OF POLICY AND PROCEDURES
 APPROVED: [Signature] JANUARY 1, 2002
 ENGINEER OF DESIGN AND ENVIRONMENT

TEMPORARY EROSION CONTROL SYSTEMS
 (Sheet 3 of 3)
 STANDARD 280001-02

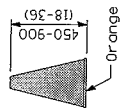

CONE

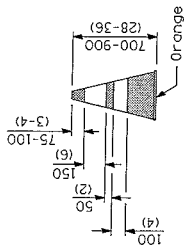

REFLECTORIZED CONE

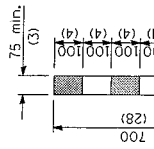

FLEXIBLE DELINEATOR

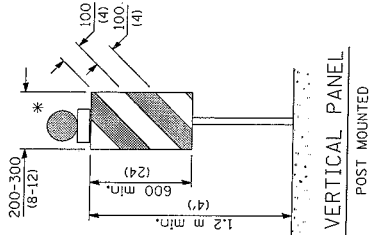

VERTICAL PANEL
POST MOUNTED

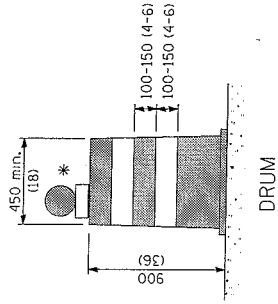

DRUM

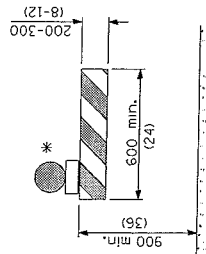

TYPE I BARRICADE

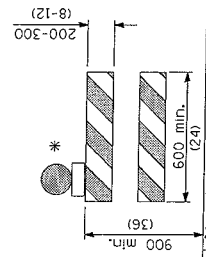

TYPE II BARRICADE

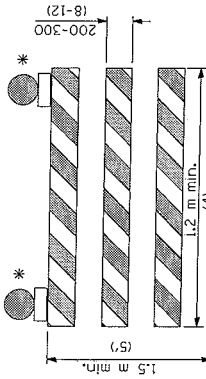

TYPE III BARRICADE

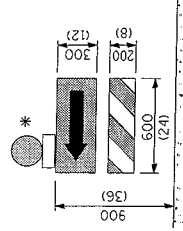

DIRECTION INDICATOR
BARRICADE

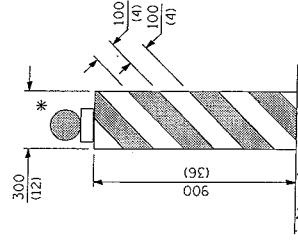

VERTICAL BARRICADE

* Warning lights (if required)

GENERAL NOTES

All heights shown shall be measured above the pavement surface.
All dimensions are in millimeters (inches) unless otherwise shown.

Illinois Department of Transportation		ISSUED 1-1-05	
APPROVED	SENSEY, L. 2005	APPROVED	SENSEY, L. 2005
ENGINEER OF OPERATIONS	<i>[Signature]</i>	APPROVED	<i>[Signature]</i>
ENGINEER OF DESIGN AND ENVIRONMENT	<i>[Signature]</i>		

DATE	REVISIONS
1-1-05	Added note to work limit signing and re-oded type I barricade.
4-1-04	Removed Type I barricade and constr. speed limit sign.

TRAFFIC CONTROL DEVICES

(Sheet 1 of 3)

STANDARD 702001-05

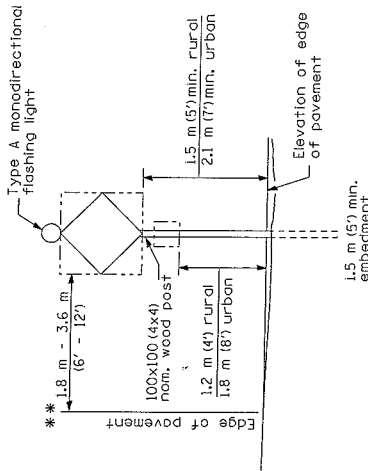

POST MOUNTED SIGNS

** When curb or raised shoulder are present this dimension shall be 600 (24) to the face of curb or 1.8 m (6') to the outside edge of the paved shoulder.

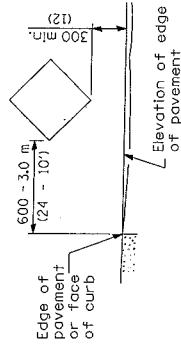

SIGNS ON TEMPORARY SUPPORTS

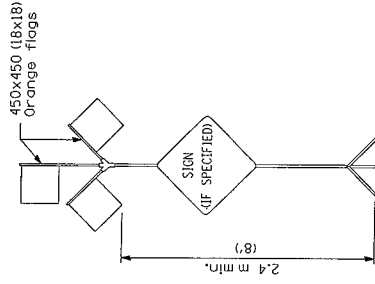

HIGH LEVEL WARNING DEVICE

ROAD CONSTRUCTION NEXT X MILES
G20-100-6036

END CONSTRUCTION
G20-2a(0)-6024

This signing is required for all projects 3200 m (2 miles) or more in length.

ROAD CONSTRUCTION NEXT X MILES sign shall be placed 150 m (500') in advance of project limits.

END CONSTRUCTION sign shall be erected at the end of the job unless another job is within 3200 m (2 miles).

Dual sign displays shall be utilized on multi-lane highways.

WORK LIMIT SIGNING

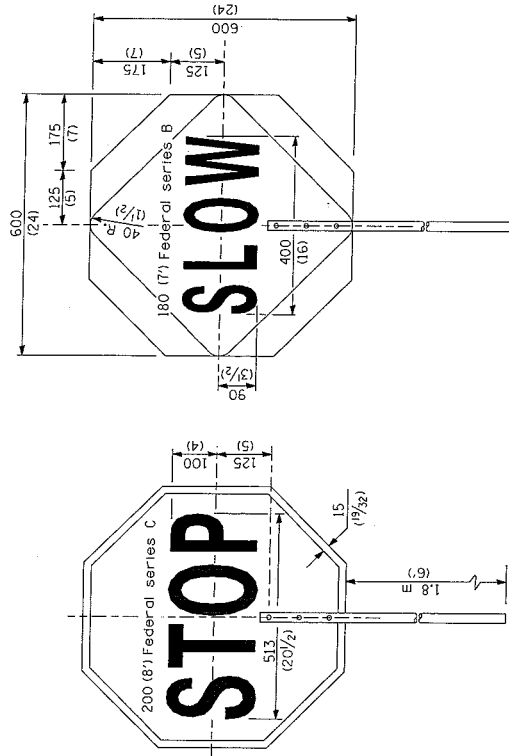

FLAGGER TRAFFIC CONTROL SIGN

All dimensions are in millimeters (inches) unless otherwise shown.

TRAFFIC CONTROL DEVICES
(Sheet 2 of 3)

STANDARD 702001-05

Illinois Department of Transportation
APPROVED: [Signature] JANUARY 1, 2005
ENGINEER OF OPERATIONS
APPROVED: [Signature] JANUARY 1, 2005
ENGINEER OF DESIGN AND ENVIRONMENT

ISSUED 1-1-97

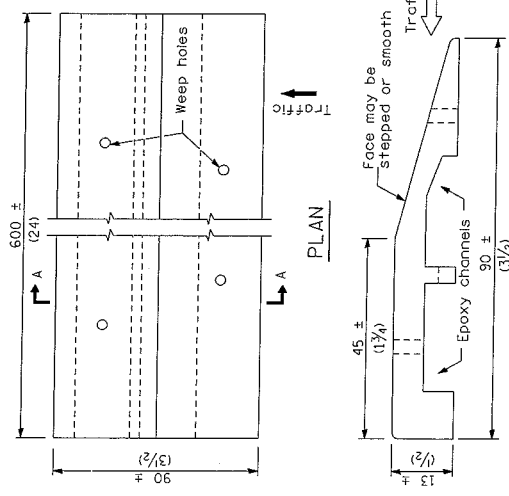

SECTION A-A

TYPICAL INSTALLATION

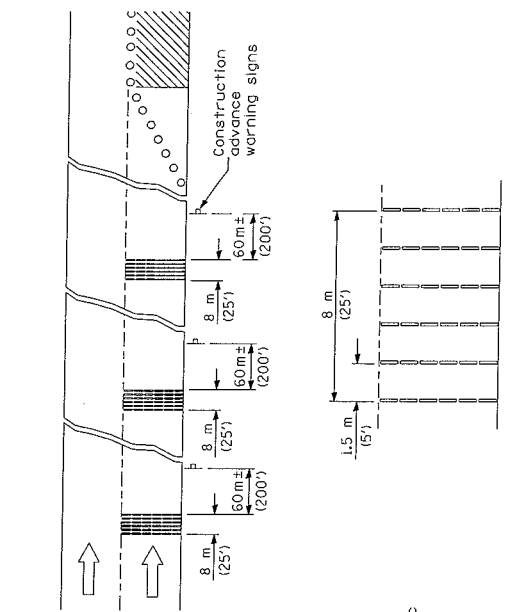

TEMPORARY RUMBLE STRIPS

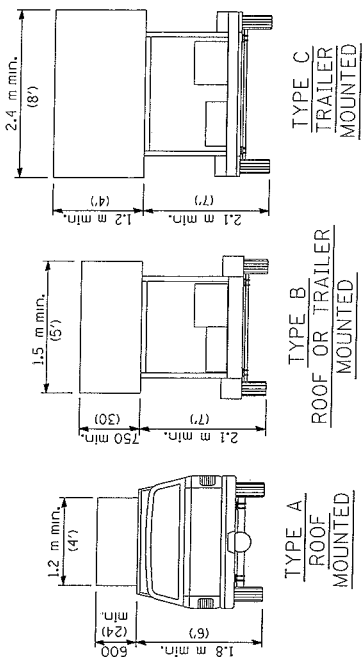

ARROW BOARDS

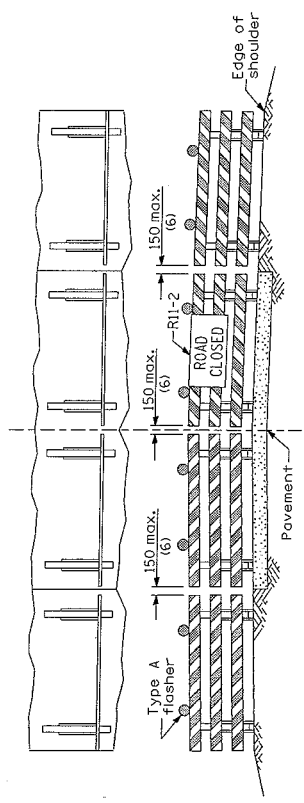

ROAD CLOSED TO ALL TRAFFIC

ReflectORIZED striping may be omitted on the back side of the barricades. If a Type III barricade with an attached sign panel which meets NCHRP 350 is not available, the sign may be mounted on an NCHRP 350 temporary sign support directly in front of the barricade.

Illinois Department of Transportation
 APPROVED JANUARY 1, 2005
 ENGINEER OF OPERATIONS
 APPROVED JANUARY 1, 2005
 ENGINEER OF DESIGN AND SURVEILLANCE

TYPICAL APPLICATIONS OF TYPE III BARRICADES CLOSING A ROAD

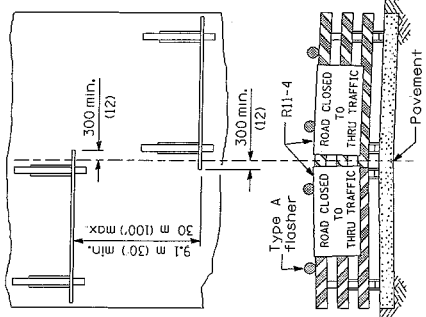

ROAD CLOSED TO THRU TRAFFIC

ReflectORIZED striping shall appear on both sides of the barricades. If a Type III barricade with an attached sign panel which meets NCHRP 350 is not available, the signs may be mounted on NCHRP 350 temporary sign supports directly in front of the barricade.

All dimensions are in millimeters (inches) unless otherwise shown.

TRAFFIC CONTROL DEVICES

(Sheet 3 of 3)

STANDARD 702001-05

SPECIAL PROVISION FOR PROTECTION OF CABLES,
CONTROLS, NAVAIDS AND WEATHER BUREAU FACILITIES

The Contractor is hereby informed that there are installed on the airport FAA NAVAIDS; including, without limitation, ASR, UHF and VHF Receivers and Transmitters; U.S. Weather Bureau facilities; electric cables and control relating to such NAVAIDS and facilities, and other electric power cables serving other facilities. Such NAVAIDS, Weather Bureau and other facilities and electric cables must be fully protected during the entire construction time. Work under this contract can be accomplished in the vicinity of these facilities and cables only at approved periods of time. Approval is subject to withdrawal at any time because of changes in the weather, emergency conditions on the existing airfield areas, anticipation of emergency conditions, and for any other reason determined by the Engineers acting under the orders and instructions of the airport management and/or the designated FAA representative. Any instructions to this Contractor to clear any given area, at any time, by the Engineers, the airport management, or the FAA control tower (by radio or other means) shall be immediately executed. Construction work will be commenced in the cleared area only when additional instructions are issued by the proper authorities.

The Contractor shall be responsible for contacting the appropriate agencies for locations. Power and control cables leading to and from any FAA NAVAIDS, Weather Bureau, and other facilities will then be marked in the field by those agencies for the information of the Contractor, before any work in their general vicinity is started. Thereafter, through the entire time of this construction they shall be protected from any possible damage, including crossing with unauthorized equipment, etc.

These special provisions intend to make perfectly clear the need for protection of FAA NAVAIDS, Weather Bureau, and other facilities and cables by this Contractor at all times.

The Contractor shall immediately repair, with identical material by skilled workmen, any underground cables serving FAA NAVAIDS, Weather Bureau and other airport facilities, which are damaged by his workmen, equipment, or work. Prior approval of the FAA must be obtained for the materials, workmen, time of day or night, method of repairs, and for any temporary or permanent repairs the Contractor proposes to make to any FAA NAVAIDS and facilities damaged by the Contractor. Prior approval of the Engineer or of the representative designated by the airport management must be obtained for the materials, workmen, time of day or night, and for the method of repairs for any temporary or permanent repairs the Contractor proposes to make to any other airport facilities and cables damaged by this Contractor. COSTS INCIDENTAL TO 108. CONTRACT UNIT PRICES.

**MINIMUM WAGES FOR FEDERAL AND FEDERALLY
ASSISTED CONSTRUCTION CONTRACTS**

This project is funded, in part, with Federal-aid funds and, as such, is subject to the provisions of the Davis-Bacon Act of March 3, 1931, as amended (46 Sta. 1494, as amended, 40 U.S.C. 276a) and of other Federal statutes referred to in a 29 CFR Part 1, Appendix A, as well as such additional statutes as may from time to time be enacted containing provisions for the payment of wages determined to be prevailing by the Secretary of Labor in accordance with the Davis-Bacon Act and pursuant to the provisions of 29 CFR Part 1. The prevailing rates and fringe benefits shown in the General Wage Determination Decisions issued by the U.S. Department of Labor shall, in accordance with the provisions of the foregoing statutes, constitute the minimum wages payable on Federal and federally assisted construction projects to laborers and mechanics of the specified classes engaged on contract work of the character and in the localities described therein.

General Wage Determination Decisions, modifications and supersedes decisions thereto are to be used in accordance with the provisions of 29 CFR Parts 1 and 5. Accordingly, the applicable decision, together with any modifications issued, must be made a part of every contract for performance of the described work within the geographic area indicated as required by an applicable DBRA Federal prevailing wage law and 29 CFR Part 5. The wage rates and fringe benefits contained in the General Wage Determination Decision shall be the minimum paid by contractors and subcontractors to laborers and mechanics.

NOTICE

The most current **General Wage Determination Decisions** (wage rates) are available on the IDOT web site. They are located on the Letting and Bidding page at <http://www.dot.state.il.us/desenv/delett.html>.

In addition, ten (10) days prior to the letting, the applicable Federal wage rates will be e-mailed to subscribers. It is recommended that all contractors subscribe to the Federal Wage Rates List or the Contractor's Packet through IDOT's subscription service.

PLEASE NOTE: if you have already subscribed to the Contractor's Packet you will automatically receive the Federal Wage Rates.

The instructions for subscribing are at <http://www.dot.state.il.us/desenv/subsc.html>.

If you have any questions concerning the wage rates, please contact IDOT's Chief Contract Official at 217-782-7806.