

**If you plan to submit a bid directly to the Department of Transportation**

**PREQUALIFICATION**

Any contractor who desires to become pre-qualified to bid on work advertised by IDOT must submit the properly completed pre-qualification forms to the Bureau of Construction no later than 4:30 p.m. prevailing time twenty-one days prior to the letting of interest. This pre-qualification requirement applies to first time contractors, contractors renewing expired ratings, contractors maintaining continuous pre-qualification or contractors requesting revised ratings. To be eligible to bid, existing pre-qualification ratings must be effective through the date of letting.

**REQUESTS FOR AUTHORIZATION TO BID**

Contractors downloading and/or ordering CD-ROM's and are wanting to bid on items included in a particular letting must submit the properly completed "Request for Authorization to Bid/or Not For Bid Status" (BDE 124INT) and the ORIGINAL, signed and notarized, "Affidavit of Availability" (BC 57) to the proper office no later than 4:30 p.m. prevailing time, three (3) days prior to the letting date.

**WHO CAN BID ?**

Bids will be accepted from only those companies that request and receive written **Authorization to Bid** from IDOT's Central Bureau of Construction.

**WHAT CONSTITUTES WRITTEN AUTHORIZATION TO BID?** When a prospective prime bidder submits a "Request for Authorization to Bid/or Not For Bid Status"(BDE 124INT) he/she must indicate at that time which items are being requested For Bidding purposes. Only those items requested For Bidding will be analyzed. After the request has been analyzed, the bidder will be issued a **Proposal Denial and/or Authorization Form**, approved by the Central Bureau of Construction, that indicates which items have been approved For Bidding. If **Authorization to Bid** cannot be approved, the **Proposal Denial and/or Authorization Form** will indicate the reason for denial.

**ABOUT AUTHORIZATION TO BID:** Firms that have not received an authorization form within a reasonable time of complete and correct original document submittal should contact the department as to status. This is critical in the week before the letting. These documents must be received three days before the letting date. Firms unsure as to authorization status should call the Prequalification Section of the Bureau of Construction at the number listed at the end of these instructions.

**ADDENDA AND REVISIONS:** It is the contractor's responsibility to determine which, if any, addenda or revisions pertain to any project they may be bidding. Failure to incorporate all relevant addenda or revisions may cause the bid to be declared unacceptable.

Each addendum will be placed with the contract number. Addenda and revisions will also be placed on the Addendum/Revision Checklist and each subscription service subscriber will be notified by e-mail of each addendum and revision issued.

The Internet is the Department's primary way of doing business. The subscription server e-mails are an added courtesy the Department provides. It is suggested that bidder check IDOT's website <http://www.dot.il.gov/desenv/delett.html> before submitting final bid information.

**IDOT is not responsible for any e-mail related failures.**

Addenda Questions may be directed to the Contracts Office at (217)782-7806 or [D&Econtracts@dot.il.gov](mailto:D&Econtracts@dot.il.gov)

Technical Questions about downloading these files may be directed to Tim Garman (217)524-1642 or [garmantr@dot.il.gov](mailto:garmantr@dot.il.gov).

**WHAT MUST BE INCLUDED WHEN BIDS ARE SUBMITTED?:** Bidders need not return the entire proposal when bids are submitted. That portion of the proposal that must be returned includes the following:

1. All documents from the Proposal Cover Sheet through the Proposal Bid Bond
2. Other special documentation and/or information that may be required by the contract special provisions

All proposal documents, including Proposal Guaranty Checks or Proposal Bid Bonds, should be stapled together to prevent loss when bids are processed by IDOT personnel.

**ABOUT SUBMITTING BIDS:** It is recommended that bidders deliver bids in person to insure they arrive at the proper location prior to the time specified for the receipt of bids. Any bid received at the place of letting after the time specified will not be accepted.

**WHO SHOULD BE CALLED IF ASSISTANCE IS NEEDED?**

<b>Questions Regarding</b>	<b>Call</b>
Prequalification and/or Authorization to Bid	(217)782-3413
Preparation and submittal of bids	(217)782-7806
Mailing of plans and proposals	(217)782-7806
Electronic plans and proposals	(217)524-1642

**ADDENDUMS AND REVISIONS TO THE PROPOSAL FORMS**

Planholders should verify that they have received and incorporated the addendum and/or revision prior to submitting their bid. Failure by the bidder to include an addendum could result in a bid being rejected as irregular.

# 47

RETURN WITH BID

Proposal Submitted By
Name
Address
City

## Letting March 9, 2007

**BIDDERS NEED NOT RETURN THE ENTIRE PROPOSAL**  
(See instructions inside front cover)

### NOTICE TO PROSPECTIVE BIDDERS

This proposal can be used for bidding purposes by only those companies that request and receive written AUTHORIZATION TO BID from IDOT's Central Bureau of Construction.

(SEE INSTRUCTIONS ON THE INSIDE OF COVER)

# Notice To Bidders, Specifications, Proposal, Contract and Contract Bond



**Illinois Department  
of Transportation**

Springfield, Illinois 62764

**Contract No. 91372  
CHAMPAIGN County  
Section 04-00358-01-RS  
Route FAS 516 (CH 9)  
Project ACRS-516(112)  
District 5 Construction Funds**

PLEASE MARK THE APPROPRIATE BOX BELOW:

- A Bid Bond is included.
- A Cashier's Check or a Certified Check is included

Plans Included  
Herein

Prepared by

F

Checked by

(Printed by authority of the State of Illinois)

---

---

## INSTRUCTIONS

**ABOUT IDOT PROPOSALS:** All proposals issued by IDOT are potential bidding proposals. Each proposal contains all Certifications and Affidavits, a Proposal Signature Sheet and a Proposal Bid Bond required for Prime Contractors to submit a bid after written **Authorization to Bid** has been issued by IDOT's Central Bureau of Construction.

**WHO CAN BID?:** Bids will be accepted from only those companies that request and receive written **Authorization to Bid** from IDOT's Central Bureau of Construction. To request authorization, a potential bidder must complete and submit Part B of the Request for Authorization to Bid/or Not For Bid Status form (BDE 124 INT) and submit an original Affidavit of Availability (BC 57).

**WHAT CONSTITUTES WRITTEN AUTHORIZATION TO BID?:** When a prospective prime bidder submits a "Request for Proposal Forms and Plans" he/she must indicate at that time which items are being requested For Bidding purposes. Only those items requested For Bidding will be analyzed. After the request has been analyzed, the bidder will be issued a **Proposal Denial and/or Authorization Form**, approved by the Central Bureau of Construction, that indicates which items have been approved For Bidding. If **Authorization to Bid** cannot be approved, the **Proposal Denial and/or Authorization Form** will indicate the reason for denial. If a contractor has requested to bid but has not received a **Proposal Denial and/or Authorization Form**, they should contact the Central Bureau of Construction in advance of the letting date.

**WHAT MUST BE INCLUDED WHEN BIDS ARE SUBMITTED?:** Bidders need not return the entire proposal when bids are submitted. That portion of the proposal that must be returned includes the following:

1. All documents from the Proposal Cover Sheet through the Proposal Bid Bond
2. Other special documentation and/or information that may be required by the contract special provisions

All proposal documents, including Proposal Guaranty Checks or Proposal Bid Bonds, should be stapled together to prevent loss when bids are processed by IDOT personnel.

**ABOUT SUBMITTING BIDS:** It is recommended that bidders deliver bids in person to insure they arrive at the proper location prior to the time specified for the receipt of bids. Any bid received at the place of letting after the time specified will not be accepted.

### WHO SHOULD BE CALLED IF ASSISTANCE IS NEEDED?

Questions Regarding	Call
Prequalification and/or Authorization to Bid	217/782-3413
Preparation and submittal of bids	217/782-7806
Mailing of CD-ROMS	217/782-7806

**RETURN WITH BID**



**PROPOSAL**

TO THE DEPARTMENT OF TRANSPORTATION

1. Proposal of \_\_\_\_\_  
\_\_\_\_\_

Taxpayer Identification Number (Mandatory) \_\_\_\_\_

for the improvement identified and advertised for bids in the Invitation for Bids as:

**Contract No. 91372  
CHAMPAIGN County  
Section 04-00358-01-RS  
Project ACRS-516(112)  
Route FAS 516 (CH 9)  
District 5 Construction Funds**

**Construction consists of 5.48 miles resurfacing FAS Route 516, CH 9 from FAS Route 339, CH 23 to U.S. Route 45 at the Village of Ludlow.**

2. The undersigned bidder will furnish all labor, material and equipment to complete the above described project in a good and workmanlike manner as provided in the contract documents provided by the Department of Transportation. This proposal will become part of the contract and the terms and conditions contained in the contract documents shall govern performance and payments.

**RETURN WITH BID**

3. **ASSURANCE OF EXAMINATION AND INSPECTION/WAIVER.** The undersigned further declares that he/she has carefully examined the proposal, plans, specifications, form of contract and contract bond, and special provisions, and that he/she has inspected in detail the site of the proposed work, and that he/she has familiarized themselves with all of the local conditions affecting the contract and the detailed requirements of construction, and understands that in making this proposal he/she waives all right to plead any misunderstanding regarding the same.
  
4. **EXECUTION OF CONTRACT AND CONTRACT BOND.** The undersigned further agrees to execute a contract for this work and present the same to the department within fifteen (15) days after the contract has been mailed to him/her. The undersigned further agrees that he/she and his/her surety will execute and present within fifteen (15) days after the contract has been mailed to him/her contract bond satisfactory to and in the form prescribed by the Department of Transportation, in the penal sum of the full amount of the contract, guaranteeing the faithful performance of the work in accordance with the terms of the contract.
  
5. **PROPOSAL GUARANTY.** Accompanying this proposal is either a bid bond on the department form, executed by a corporate surety company satisfactory to the department, or a proposal guaranty check consisting of a bank cashier's check or a properly certified check for not less than 5 per cent of the amount bid or for the amount specified in the following schedule:

<u>Amount of Bid</u>		<u>Proposal Guaranty</u>	<u>Amount of Bid</u>		<u>Proposal Guaranty</u>	
Up to	\$5,000 .....	\$150	\$2,000,000	to	\$3,000,000 .....	\$100,000
\$5,000	to \$10,000 .....	\$300	\$3,000,000	to	\$5,000,000 .....	\$150,000
\$10,000	to \$50,000 .....	\$1,000	\$5,000,000	to	\$7,500,000 .....	\$250,000
\$50,000	to \$100,000 .....	\$3,000	\$7,500,000	to	\$10,000,000 .....	\$400,000
\$100,000	to \$150,000 .....	\$5,000	\$10,000,000	to	\$15,000,000 .....	\$500,000
\$150,000	to \$250,000 .....	\$7,500	\$15,000,000	to	\$20,000,000 .....	\$600,000
\$250,000	to \$500,000 .....	\$12,500	\$20,000,000	to	\$25,000,000 .....	\$700,000
\$500,000	to \$1,000,000 .....	\$25,000	\$25,000,000	to	\$30,000,000 .....	\$800,000
\$1,000,000	to \$1,500,000 .....	\$50,000	\$30,000,000	to	\$35,000,000 .....	\$900,000
\$1,500,000	to \$2,000,000 .....	\$75,000	over		\$35,000,000 .....	\$1,000,000

Bank cashier's checks or properly certified checks accompanying proposals shall be made payable to the Treasurer, State of Illinois, when the state is awarding authority; the county treasurer, when a county is the awarding authority; or the city, village, or town treasurer, when a city, village, or town is the awarding authority.

If a combination bid is submitted, the proposal guaranties which accompany the individual proposals making up the combination will be considered as also covering the combination bid.

The amount of the proposal guaranty check is \_\_\_\_\_ \$( \_\_\_\_\_ ). If this proposal is accepted and the undersigned shall fail to execute a contract bond as required herein, it is hereby agreed that the amount of the proposal guaranty shall become the property of the State of Illinois, and shall be considered as payment of damages due to delay and other causes suffered by the State because of the failure to execute said contract and contract bond; otherwise, the bid bond shall become void or the proposal guaranty check shall be returned to the undersigned.

**Attach Cashier's Check or Certified Check Here**

In the event that one proposal guaranty check is intended to cover two or more proposals, the amount must be equal to the sum of the proposal guaranties which would be required for each individual proposal. If the guaranty check is placed in another proposal, state below where it may be found.

The proposal guaranty check will be found in the proposal for:

Item \_\_\_\_\_

Section No. \_\_\_\_\_

County \_\_\_\_\_

**Mark the proposal cover sheet as to the type of proposal guaranty submitted.**

BD 354 (Rev. 11/2001)

**RETURN WITH BID**

6. **COMBINATION BIDS.** The undersigned further agrees that if awarded the contract for the sections contained in the following combination, he/she will perform the work in accordance with the requirements of each individual proposal comprising the combination bid specified in the schedule below, and that the combination bid shall be prorated against each section in proportion to the bid submitted for the same. If an error is found to exist in the gross sum bid for one or more of the individual sections included in a combination, the combination bid shall be corrected as provided in the specifications.

**When a combination bid is submitted, the schedule below must be completed in each proposal comprising the combination.**

**If alternate bids are submitted for one or more of the sections comprising the combination, a combination bid must be submitted for each alternate.**

**Schedule of Combination Bids**

Combination No.	Sections Included in Combination	Combination Bid	
		Dollars	Cents

7. **SCHEDULE OF PRICES.** The undersigned bidder submits herewith, in accordance with the rules and instructions, a schedule of prices for the items of work for which bids are sought. The unit prices bid are in U.S. dollars and cents, and all extensions and summations have been made. The bidder understands that the quantities appearing in the bid schedule are approximate and are provided for the purpose of obtaining a gross sum for the comparison of bids. If there is an error in the extension of the unit prices, the unit prices shall govern. Payment to the contractor awarded the contract will be made only for actual quantities of work performed and accepted or materials furnished according to the contract. The scheduled quantities of work to be done and materials to be furnished may be increased, decreased or omitted as provided elsewhere in the contract.
8. **CERTIFICATE OF AUTHORITY.** The undersigned bidder, if a business organized under the laws of another State, assures the Department that it will furnish a copy of its certificate of authority to do business in the State of Illinois with the return of the executed contract and bond. Failure to furnish the certificate within the time provided for execution of an awarded contract may be cause for cancellation of the award and forfeiture of the proposal guaranty to the State.

STATE JOB # - C-95-306-07  
 PPS NBR - 5-10061-0000

ILLINOIS DEPARTMENT OF TRANSPORTATION  
 SCHEDULE OF PRICES  
 CONTRACT NUMBER - 91372

ECMS002 DTGECM03 ECMR003 PAGE 1  
 RUN DATE - 01/10/07  
 RUN TIME - 183318

COUNTY NAME	CODE	DIST	SECTION NUMBER	PROJECT NUMBER	ROUTE		
CHAMPAIGN	019	05	04-00358-01-RS	ACRS-0516/112/000	FAS 516		
ITEM NUMBER	PAY ITEM DESCRIPTION	UNIT OF MEASURE	QUANTITY	UNIT PRICE DOLLARS	CENTS	TOTAL PRICE DOLLARS	CTS
X0300471	RUBBLIZING PCC PAVT	SQ YD	37,467.000	=			
Z0048665	RR PROT LIABILITY INS	L SUM	1.000	=			
40300100	BIT MATLS PR CT	GALLON	14,913.000	=			
40600982	HMA SURF REM BUTT JT	SQ YD	969.200	=			
40600990	TEMPORARY RAMP	SQ YD	154.700	=			
40603080	HMA BC IL-19.0 N50	TON	8,976.000	=			
40603310	HMA SC "C" N50	TON	11,231.000	=			
40800050	INCIDENTAL HMA SURF	TON	324.000	=			
44000157	HMA SURF REM 2	SQ YD	4,383.000	=			
44000198	HMA SURF REM VAR DP	SQ YD	45,597.400	=			
48101800	AGGREGATE SHLDS SPL	SQ YD	25,605.000	=			
67100100	MOBILIZATION	L SUM	1.000	=			
70101700	TRAF CONT & PROT	L SUM	1.000	=			
70300100	SHORT-TERM PAVT MKING	FOOT	1,959.000	=			

TOTAL \$

NOTE:  
 \*\*\* PLEASE TURN PAGE FOR IMPORTANT NOTES \*\*\*



FAS 516  
04-00358-01-RS  
CHAMPAGNE

ILLINOIS DEPARTMENT OF TRANSPORTATION  
SCHEDULE OF PRICES  
CONTRACT NUMBER - 91372

ECMS002 DTGECM03 ECMR003 PAGE 2  
RUN DATE - 01/10/07  
RUN TIME - 183318

NOTE:

1. EACH PAY ITEM SHOULD HAVE A UNIT PRICE AND A TOTAL PRICE.
2. THE UNIT PRICE SHALL GOVERN IF NO TOTAL PRICE IS SHOWN OR IF THERE IS A DISCREPANCY BETWEEN THE PRODUCT OF THE UNIT PRICE MULTIPLIED BY THE QUANTITY.
3. IF A UNIT PRICE IS OMITTED, THE TOTAL PRICE WILL BE DIVIDED BY THE QUANTITY IN ORDER TO ESTABLISH A UNIT PRICE.
4. A BID MAY BE DECLARED UNACCEPTABLE IF NEITHER A UNIT PRICE NOR A TOTAL PRICE IS SHOWN.

## RETURN WITH BID

### STATE REQUIRED ETHICAL STANDARDS GOVERNING CONTRACT PROCUREMENT: ASSURANCES, CERTIFICATIONS AND DISCLOSURES

#### I. GENERAL

A. Article 50 of the Illinois Procurement Code establishes the duty of all State chief procurement officers, State purchasing officers, and their designees to maximize the value of the expenditure of public moneys in procuring goods, services, and contracts for the State of Illinois and to act in a manner that maintains the integrity and public trust of State government. In discharging this duty, they are charged by law to use all available information, reasonable efforts, and reasonable actions to protect, safeguard, and maintain the procurement process of the State of Illinois.

B. In order to comply with the provisions of Article 50 and to carry out the duty established therein, all bidders are to adhere to ethical standards established for the procurement process, and to make such assurances, disclosures and certifications required by law. By execution of the Proposal Signature Sheet, the bidder indicates that each of the mandated assurances has been read and understood, that each certification is made and understood, and that each disclosure requirement has been understood and completed.

C. In addition to all other remedies provided by law, failure to comply with any assurance, failure to make any disclosure or the making of a false certification shall be grounds for termination of the contract and the suspension or debarment of the bidder.

#### II. ASSURANCES

A. The assurances hereinafter made by the bidder are each a material representation of fact upon which reliance is placed should the Department enter into the contract with the bidder. The Department may terminate the contract if it is later determined that the bidder rendered a false or erroneous assurance, and the surety providing the performance bond shall be responsible for the completion of the contract.

##### B. Felons

1. The Illinois Procurement Code provides:

Section 50-10. Felons. Unless otherwise provided, no person or business convicted of a felony shall do business with the State of Illinois or any state agency from the date of conviction until 5 years after the date of completion of the sentence for that felony, unless no person held responsible by a prosecutorial office for the facts upon which the conviction was based continues to have any involvement with the business.

2. The bidder assures the Department that the award and execution of the contract would not cause a violation of Section 50-10.

##### C. Conflicts of Interest

1. The Illinois Procurement Code provides in pertinent part:

Section 50-13. Conflicts of Interest.

(a) Prohibition. It is unlawful for any person holding an elective office in this State, holding a seat in the General Assembly, or appointed to or employed in any of the offices or agencies of state government and who receives compensation for such employment in excess of 60% of the salary of the Governor of the State of Illinois, or who is an officer or employee of the Capital Development Board or the Illinois Toll Highway Authority, or who is the spouse or minor child of any such person to have or acquire any contract, or any direct pecuniary interest in any contract therein, whether for stationery, printing, paper, or any services, materials, or supplies, that will be wholly or partially satisfied by the payment of funds appropriated by the General Assembly of the State of Illinois or in any contract of the Capital Development Board or the Illinois Toll Highway authority.

(b) Interests. It is unlawful for any firm, partnership, association or corporation, in which any person listed in subsection (a) is entitled to receive (i) more than 7 1/2% of the total distributable income or (ii) an amount in excess of the salary of the Governor, to have or acquire any such contract or direct pecuniary interest therein.

(c) Combined interests. It is unlawful for any firm, partnership, association, or corporation, in which any person listed in subsection (a) together with his or her spouse or minor children is entitled to receive (i) more than 15%, in the aggregate, of the total distributable income or (ii) an amount in excess of 2 times the salary of the Governor, to have or acquire any such contract or direct pecuniary interest therein.

(d) Securities. Nothing in this Section invalidates the provisions of any bond or other security previously offered or to be offered for sale or sold by or for the State of Illinois.

(e) Prior interests. This Section does not affect the validity of any contract made between the State and an officer or employee of the State or member of the General Assembly, his or her spouse, minor child or any combination of those persons if that contract was in existence before his or her election or employment as an officer, member, or employee. The contract is voidable, however, if it cannot be completed within 365 days after the officer, member, or employee takes office or is employed.

The current salary of the Governor is \$150,700.00. Sixty percent of the salary is \$90,420.00.

## RETURN WITH BID

2. The bidder assures the Department that the award and execution of the contract would not cause a violation of Section 50-13, or that an effective exemption has been issued by the Board of Ethics to any individual subject to the Section 50-13 prohibitions pursuant to the provisions of Section 50-20 of the Code and Executive Order Number 3 (1998). Information concerning the exemption process is available from the Department upon request.

### **D. Negotiations**

1. The Illinois Procurement Code provides in pertinent part:

Section 50-15. Negotiations.

(a) It is unlawful for any person employed in or on a continual contractual relationship with any of the offices or agencies of State government to participate in contract negotiations on behalf of that office or agency with any firm, partnership, association, or corporation with whom that person has a contract for future employment or is negotiating concerning possible future employment.

2. The bidder assures the Department that the award and execution of the contract would not cause a violation of Section 50-15, and that the bidder has no knowledge of any facts relevant to the kinds of acts prohibited therein.

### **E. Inducements**

1. The Illinois Procurement Code provides:

Section 50-25. Inducement. Any person who offers or pays any money or other valuable thing to any person to induce him or her not to bid for a State contract or as recompense for not having bid on a State contract is guilty of a Class 4 felony. Any person who accepts any money or other valuable thing for not bidding for a State contract or who withholds a bid in consideration of the promise for the payment of money or other valuable thing is guilty of a Class 4 felony.

2. The bidder assures the Department that the award and execution of the contract would not cause a violation of Section 50-25, and that the bidder has no knowledge of any facts relevant to the kinds of acts prohibited therein.

### **F. Revolving Door Prohibition**

1. The Illinois Procurement Code provides:

Section 50-30. Revolving door prohibition. Chief procurement officers, associate procurement officers, State purchasing officers, their designees whose principal duties are directly related to State procurement, and executive officers confirmed by the Senate are expressly prohibited for a period of 2 years after terminating an affected position from engaging in any procurement activity relating to the State agency most recently employing them in an affected position for a period of at least 6 months. The prohibition includes, but is not limited to: lobbying the procurement process; specifying; bidding; proposing bid, proposal, or contract documents; on their own behalf or on behalf of any firm, partnership, association, or corporation. This Section applies only to persons who terminate an affected position on or after January 15, 1999.

2. The bidder assures the Department that the award and execution of the contract would not cause a violation of Section 50-30, and that the bidder has no knowledge of any facts relevant to the kinds of acts prohibited therein.

### **G. Reporting Anticompetitive Practices**

1. The Illinois Procurement Code provides:

Section 50-40. Reporting anticompetitive practices. When, for any reason, any vendor, bidder, contractor, chief procurement officer, State purchasing officer, designee, elected official, or State employee suspects collusion or other anticompetitive practice among any bidders, offerors, contractors, proposers, or employees of the State, a notice of the relevant facts shall be transmitted to the Attorney General and the chief procurement officer.

2. The bidder assures the Department that it has not failed to report any relevant facts concerning the practices addressed in Section 50-40 which may involve the contract for which the bid is submitted.

### **H. Confidentiality**

1. The Illinois Procurement Code provides:

Section 50-45. Confidentiality. Any chief procurement officer, State purchasing officer, designee, or executive officer who willfully uses or allows the use of specifications, competitive bid documents, proprietary competitive information, proposals, contracts, or selection information to compromise the fairness or integrity of the procurement, bidding, or contract process shall be subject to immediate dismissal, regardless of the Personnel code, any contract, or any collective bargaining agreement, and may in addition be subject to criminal prosecution.

2. The bidder assures the Department that it has no knowledge of any fact relevant to the practices addressed in Section 50-45 which may involve the contract for which the bid is submitted.

## RETURN WITH BID

### **I. Insider Information**

1. The Illinois Procurement Act provides:

Section 50-50. Insider information. It is unlawful for any current or former elected or appointed State official or State employee to knowingly use confidential information available only by virtue of that office or employment for actual or anticipated gain for themselves or another person.

2. The bidder assures the Department that it has no knowledge of any facts relevant to the practices addressed in Section 50-50 which may involve the contract for which the bid is submitted.

### **III. CERTIFICATIONS**

**A.** The certifications hereinafter made by the bidder are each a material representation of fact upon which reliance is placed should the Department enter into the contract with the bidder. The Department may terminate the contract if it is later determined that the bidder rendered a false or erroneous certification, and the surety providing the performance bond shall be responsible for completion of the contract.

#### **B. Bribery**

1. The Illinois Procurement Code provides:

Section 50-5. Bribery.

(a) Prohibition. No person or business shall be awarded a contract or subcontract under this Code who:

(1) has been convicted under the laws of Illinois or any other state of bribery or attempting to bribe an officer or employee of the State of Illinois or any other state in that officer's or employee's official capacity; or

(2) has made an admission of guilt of that conduct that is a matter of record but has not been prosecuted for that conduct.

(b) Businesses. No business shall be barred from contracting with any unit of State or local government as a result of a conviction under this Section of any employee or agent of the business if the employee or agent is no longer employed by the business and:

(1) the business has been finally adjudicated not guilty; or

(2) the business demonstrates to the governmental entity with which it seeks to contract, and that entity finds that the commission of the offense was not authorized, requested, commanded, or performed by a director, officer, or high managerial agent on behalf of the business as provided in paragraph (2) of subsection (a) of Section 5-4 of the Criminal Code of 1961.

(c) Conduct on behalf of business. For purposes of this Section, when an official, agent, or employee of a business committed the bribery or attempted bribery on behalf of the business and in accordance with the direction or authorization of a responsible official of the business, the business shall be chargeable with the conduct.

(d) Certification. Every bid submitted to and contract executed by the State shall contain a certification by the contractor that the contractor is not barred from being awarded a contract or subcontract under this Section. A contractor who makes a false statement, material to the certification, commits a Class 3 felony.

2. The bidder certifies that it is not barred from being awarded a contract under Section 50.5.

#### **C. Educational Loan**

1. Section 3 of the Educational Loan Default Act provides:

§ 3. No State agency shall contract with an individual for goods or services if that individual is in default, as defined in Section 2 of this Act, on an educational loan. Any contract used by any State agency shall include a statement certifying that the individual is not in default on an educational loan as provided in this Section.

2. The bidder, if an individual as opposed to a corporation, partnership or other form of business organization, certifies that the bidder is not in default on an educational loan as provided in Section 3 of the Act.

#### **D. Bid-Rigging/Bid Rotating**

1. Section 33E-11 of the Criminal Code of 1961 provides:

§ 33E-11. (a) Every bid submitted to and public contract executed pursuant to such bid by the State or a unit of local government shall contain a certification by the prime contractor that the prime contractor is not barred from contracting with any unit of State or local government as a result of a violation of either Section 33E-3 or 33E-4 of this Article. The State and units of local government shall provide the appropriate forms for such certification.

## RETURN WITH BID

(b) A contractor who makes a false statement, material to the certification, commits a Class 3 felony.

A violation of Section 33E-3 would be represented by a conviction of the crime of bid-rigging which, in addition to Class 3 felony sentencing, provides that any person convicted of this offense or any similar offense of any state or the United States which contains the same elements as this offense shall be barred for 5 years from the date of conviction from contracting with any unit of State or local government. No corporation shall be barred from contracting with any unit of State or local government as a result of a conviction under this Section of any employee or agent of such corporation if the employee so convicted is no longer employed by the corporation and: (1) it has been finally adjudicated not guilty or (2) if it demonstrates to the governmental entity with which it seeks to contract and that entity finds that the commission of the offense was neither authorized, requested, commanded, nor performed by a director, officer or a high managerial agent in behalf of the corporation.

A violation of Section 33E-4 would be represented by a conviction of the crime of bid-rotating which, in addition to Class 2 felony sentencing, provides that any person convicted of this offense or any similar offense of any state or the United States which contains the same elements as this offense shall be permanently barred from contracting with any unit of State or local government. No corporation shall be barred from contracting with any unit of State or local government as a result of a conviction under this Section of any employee or agent of such corporation if the employee so convicted is no longer employed by the corporation and: (1) it has been finally adjudicated not guilty or (2) if it demonstrates to the governmental entity with which it seeks to contract and that entity finds that the commission of the offense was neither authorized, requested, commanded, nor performed by a director, officer or a high managerial agent in behalf of the corporation.

2. The bidder certifies that it is not barred from contracting with the Department by reason of a violation of either Section 33E-3 or Section 33E-4.

### **E. International Anti-Boycott**

1. Section 5 of the International Anti-Boycott Certification Act provides:

§ 5. State contracts. Every contract entered into by the State of Illinois for the manufacture, furnishing, or purchasing of supplies, material, or equipment or for the furnishing of work, labor, or services, in an amount exceeding the threshold for small purchases according to the purchasing laws of this State or \$10,000.00, whichever is less, shall contain certification, as a material condition of the contract, by which the contractor agrees that neither the contractor nor any substantially-owned affiliated company is participating or shall participate in an international boycott in violation of the provisions of the U.S. Export Administration Act of 1979 or the regulations of the U.S. Department of Commerce promulgated under that Act.

2. The bidder makes the certification set forth in Section 5 of the Act.

### **F. Drug Free Workplace**

1. The Illinois "Drug Free Workplace Act" applies to this contract and it is necessary to comply with the provisions of the "Act" if the contractor is a corporation, partnership, or other entity (including a sole proprietorship) which has 25 or more employees.

2. The bidder certifies that if awarded a contract in excess of \$5,000 it will provide a drug free workplace by:

(a) Publishing a statement notifying employees that the unlawful manufacture, distribution, dispensation, possession or use of a controlled substance, including cannabis, is prohibited in the contractor's workplace; specifying the actions that will be taken against employees for violations of such prohibition; and notifying the employee that, as a condition of employment on such contract, the employee shall abide by the terms of the statement, and notify the employer of any criminal drug statute conviction for a violation occurring in the workplace no later than five (5) days after such conviction.

(b) Establishing a drug free awareness program to inform employees about the dangers of drug abuse in the workplace; the contractor's policy of maintaining a drug free workplace; any available drug counseling, rehabilitation, and employee assistance programs; and the penalties that may be imposed upon employees for drug violations.

(c) Providing a copy of the statement required by subparagraph (1) to each employee engaged in the performance of the contract and to post the statement in a prominent place in the workplace.

(d) Notifying the Department within ten (10) days after receiving notice from an employee or otherwise receiving actual notice of the conviction of an employee for a violation of any criminal drug statute occurring in the workplace.

(e) Imposing or requiring, within 30 days after receiving notice from an employee of a conviction or actual notice of such a conviction, an appropriate personnel action, up to and including termination, or the satisfactory participation in a drug abuse assistance or rehabilitation program approved by a federal, state or local health, law enforcement or other appropriate agency.

(f) Assisting employees in selecting a course of action in the event drug counseling, treatment, and rehabilitation is required and indicating that a trained referral team is in place.

(g) Making a good faith effort to continue to maintain a drug free workplace through implementation of the actions and efforts stated in this certification.

**G. Debt Delinquency**

1. The Illinois Procurement Code provides:

Section 50-11 and 50-12. Debt Delinquency.

The contractor or bidder certifies that it, or any affiliate, is not barred from being awarded a contract under 30 ILCS 500. Section 50-11 prohibits a person from entering into a contract with a State agency if it knows or should know that it, or any affiliate, is delinquent in the payment of any debt to the State as defined by the Debt Collection Board. Section 50-12 prohibits a person from entering into a contract with a State agency if it, or any affiliate, has failed to collect and remit Illinois Use Tax on all sales of tangible personal property into the State of Illinois in accordance with the provisions of the Illinois Use Tax Act. The contractor further acknowledges that the contracting State agency may declare the contract void if this certification is false or if the contractor, or any affiliate, is determined to be delinquent in the payment of any debt to the State during the term of the contract.

**H. Sarbanes-Oxley Act of 2002**

1. The Illinois Procurement Code provides:

Section 50-60(c).

The contractor certifies in accordance with 30 ILCS 500/50-10.5 that no officer, director, partner or other managerial agent of the contracting business has been convicted of a felony under the Sarbanes-Oxley Act of 2002 or a Class 3 or Class 2 felony under the Illinois Securities Law of 1953 for a period of five years prior to the date of the bid or contract. The contractor acknowledges that the contracting agency shall declare the contract void if this certification is false.

**I. ADDENDA**

The contractor or bidder certifies that all relevant addenda have been incorporated in to this contract. Failure to do so may cause the bid to be declared unacceptable.

**J. Section 42 of the Environmental Protection Act**

The contractor certifies in accordance with 30 ILCS 500/50-12 that the bidder or contractor is not barred from being awarded a contract under this Section which prohibits the bidding on or entering into contracts with the State of Illinois or a State agency by a person or business found by a court or the Pollution Control Board to have committed a willful or knowing violation of Section 42 of the Environmental Protection Act for a period of five years from the date of the order. The contractor acknowledges that the contracting agency may declare the contract void if this certification is false.

**K. Apprenticeship and Training Certification (Does not apply to federal aid projects)**

In accordance with the provisions of Section 30-22 (6) of the Illinois Procurement Code, the bidder certifies that it is a participant, either as an individual or as part of a group program, in the approved apprenticeship and training programs applicable to each type of work or craft that the bidder will perform with its own forces. The bidder further certifies for work that will be performed by subcontract that each of its subcontractors submitted for approval either (a) is, at the time of such bid, participating in an approved, applicable apprenticeship and training program; or (b) will, prior to commencement of performance of work pursuant to this contract, begin participation in an approved apprenticeship and training program applicable to the work of the subcontract. The Department, at any time before or after award, may require the production of a copy of each applicable Certificate of Registration issued by the United States Department of Labor evidencing such participation by the contractor and any or all of its subcontractors. Applicable apprenticeship and training programs are those that have been approved and registered with the United States Department of Labor. The bidder shall list in the space below, the official name of the program sponsor holding the Certificate of Registration for all of the types of work or crafts in which the bidder is a participant and that will be performed with the bidder's forces. Types of work or craft work that will be subcontracted shall be included and listed as subcontract work. The list shall also indicate any type of work or craft job category that does not have an applicable apprenticeship or training program. **The bidder is responsible for making a complete report and shall make certain that each type of work or craft job category that will be utilized on the project as reported on the Construction Employee Workforce Projection (Form BC-1256) and returned with the bid is accounted for and listed.**

**NA - FEDERAL**

---

---

---

The requirements of this certification and disclosure are a material part of the contract, and the contractor shall require this certification provision to be included in all approved subcontracts. In order to fulfill this requirement, it shall not be necessary that an applicable program sponsor be currently taking or that it will take applications for apprenticeship, training or employment during the performance of the work of this contract.

## TO BE RETURNED WITH BID

### IV. DISCLOSURES

**A.** The disclosures hereinafter made by the bidder are each a material representation of fact upon which reliance is placed should the Department enter into the contract with the bidder. The Department may terminate the contract if it is later determined that the bidder rendered a false or erroneous disclosure, and the surety providing the performance bond shall be responsible for completion of the contract.

### **B. Financial Interests and Conflicts of Interest**

1. Section 50-35 of the Illinois Procurement Code provides that all bids of more than \$10,000 shall be accompanied by disclosure of the financial interests of the bidder. This disclosed information for the successful bidder, will be maintained as public information subject to release by request pursuant to the Freedom of Information Act.

The financial interests to be disclosed shall include ownership or distributive income share that is in excess of 5%, or an amount greater than 60% of the annual salary of the Governor, of the bidding entity or its parent entity, whichever is less, unless the contractor or bidder is a publicly traded entity subject to Federal 10K reporting, in which case it may submit its 10K disclosure in place of the prescribed disclosure. If a bidder is a privately held entity that is exempt from Federal 10K reporting, but has more than 400 shareholders, it may submit the information that Federal 10K companies are required to report, and list the names of any person or entity holding any ownership share that is in excess of 5%. The disclosure shall include the names, addresses, and dollar or proportionate share of ownership of each person making the disclosure, their instrument of ownership or beneficial relationship, and notice of any potential conflict of interest resulting from the current ownership or beneficial interest of each person making the disclosure having any of the relationships identified in Section 50-35 and on the disclosure form.

In addition, all disclosures shall indicate any other current or pending contracts, proposals, leases, or other ongoing procurement relationships the bidding entity has with any other unit of state government and shall clearly identify the unit and the contract, proposal, lease, or other relationship.

2. Disclosure Forms. Disclosure Form A is attached for use concerning the individuals meeting the above ownership or distributive share requirements. Subject individuals should be covered each by one form. In addition, a second form (Disclosure Form B) provides for the disclosure of current or pending procurement relationships with other (non-IDOT) state agencies. **The forms must be included with each bid or incorporated by reference.**

### **C. Disclosure Form Instructions**

#### **Form A: For bidders that have previously submitted the information requested in Form A**

The Department has retained the Form A disclosures submitted by all bidders responding to these requirements for the April 24, 1998 or any subsequent letting conducted by the Department. The bidder has the option of submitting the information again or the bidder may sign the following certification statement indicating that the information previously submitted by the bidder is, as of the date of signature, current and accurate. The Certification must be signed and dated by a person who is authorized to execute contracts for the bidding company. Before signing this certification, the bidder should carefully review its prior submissions to ensure the Certification is correct. If the Bidder signs the Certification, the Bidder should proceed to Form B instructions.

### CERTIFICATION STATEMENT

**I have determined that the Form A disclosure information previously submitted is current and accurate, and all forms are hereby incorporated by reference in this bid. Any necessary additional forms or amendments to previously submitted forms are attached to this bid.**

\_\_\_\_\_  
(Bidding Company)

\_\_\_\_\_  
Name of Authorized Representative (type or print)

\_\_\_\_\_  
Title of Authorized Representative (type or print)

\_\_\_\_\_  
Signature of Authorized Representative

\_\_\_\_\_  
Date

**Form A: For bidders who have NOT previously submitted the information requested in Form A**

If the bidder is a publicly traded entity subject to Federal 10K reporting, the 10K Report may be submitted to meet the requirements of Form A. If a bidder is a privately held entity that is exempt from Federal 10K reporting, but has more than 400 shareholders, it may submit the information that Federal 10K companies are required to report, and list the names of any person or entity holding any ownership share that is in excess of 5%. If a bidder is not subject to Federal 10K reporting, the bidder must determine if any individuals are required by law to complete a financial disclosure form. To do this, the bidder should answer each of the following questions. A "YES" answer indicates Form A must be completed. If the answer to each of the following questions is "NO", then the NOT APPLICABLE STATEMENT on the second page of Form A must be signed and dated by a person that is authorized to execute contracts for the bidding company. Note: These questions are for assistance only and are not required to be completed.

1. Does anyone in your organization have a direct or beneficial ownership share of greater than 5% of the bidding entity or parent entity? YES \_\_\_ NO \_\_\_
2. Does anyone in your organization have a direct or beneficial ownership share of less than 5%, but which has a value greater than \$90,420.00? YES \_\_\_ NO \_\_\_
3. Does anyone in your organization receive more than \$90,420.00 of the bidding entity's or parent entity's distributive income? (Note: Distributive income is, for these purposes, any type of distribution of profits. An annual salary is not distributive income.) YES \_\_\_ NO \_\_\_
4. Does anyone in your organization receive greater than 5% of the bidding entity's or parent entity's total distributive income, but which is less than \$90,420.00? YES \_\_\_ NO \_\_\_  
(Note: Only one set of forms needs to be completed per person per bid even if a specific individual would require a yes answer to more than one question.)

A "YES" answer to any of these questions requires the completion of Form A. The bidder must determine each individual in the bidding entity or the bidding entity's parent company that would cause the questions to be answered "Yes". Each form must be signed and dated by a person that is authorized to execute contracts for your organization. **Photocopied or stamped signatures are not acceptable.** The person signing can be, but does not have to be, the person for which the form is being completed. The bidder is responsible for the accuracy of any information provided.

If the answer to each of the above questions is "NO", then the NOT APPLICABLE STATEMENT on page 2 of Form A must be signed and dated by a person that is authorized to execute contracts for your company.

**Form B: Identifying Other Contracts & Procurement Related Information** Disclosure Form B must be completed for each bid submitted by the bidding entity. It must be signed by an individual who is authorized to execute contracts for the bidding entity. *Note: Signing the NOT APPLICABLE STATEMENT on Form A does not allow the bidder to ignore Form B. Form B must be completed, signed and dated or the bidder may be considered nonresponsive and the bid will not be accepted.*

The Bidder shall identify, by checking Yes or No on Form B, whether it has any pending contracts (including leases), bids, proposals, or other ongoing procurement relationship with any other (non-IDOT) State of Illinois agency. If "No" is checked, the bidder only needs to complete the signature box on the bottom of Form B. If "Yes" is checked, the bidder must do one of the following:

Option I: If the bidder did not submit an Affidavit of Availability to obtain authorization to bid, the bidder must list all non-IDOT State of Illinois agency pending contracts, leases, bids, proposals, and other ongoing procurement relationships. These items may be listed on Form B or on an attached sheet(s). Do not include IDOT contracts. Contracts with cities, counties, villages, etc. are not considered State of Illinois agency contracts and are not to be included. Contracts with other State of Illinois agencies such as the Department of Natural Resources or the Capital Development Board must be included. Bidders who submit Affidavits of Availability are suggested to use Option II.

Option II: If the bidder is required and has submitted an Affidavit of Availability in order to obtain authorization to bid, the bidder may write or type "See Affidavit of Availability" which indicates that the Affidavit of Availability is incorporated by reference and includes all non-IDOT State of Illinois agency pending contracts, leases, bids, proposals, and other ongoing procurement relationships. For any contracts that are not covered by the Affidavit of Availability, the bidder must identify them on Form B or on an attached sheet(s). These might be such things as leases.

**D. Bidders Submitting More Than One Bid**

Bidders submitting multiple bids may submit one set of forms consisting of all required Form A disclosures and one Form B for use with all bids. Please indicate in the space provided below the bid item that contains the original disclosure forms and the bid items which incorporate the forms by reference.

- The bid submitted for letting item \_\_\_\_\_ contains the Form A disclosures or Certification Statement and the Form B disclosures. The following letting items incorporate the said forms by reference:

---



---



RETURN WITH BID/OFFER

ILLINOIS DEPARTMENT OF TRANSPORTATION

Form A Financial Information & Potential Conflicts of Interest Disclosure

Contractor Name
Legal Address
City, State, Zip
Telephone Number Email Address Fax Number (if available)

Disclosure of the information contained in this Form is required by the Section 50-35 of the Illinois Procurement Code (30 ILCS 500). Vendors desiring to enter into a contract with the State of Illinois must disclose the financial information and potential conflict of interest information as specified in this Disclosure Form. This information shall become part of the publicly available contract file. This Form A must be completed for bids in excess of \$10,000, and for all open-ended contracts. A publicly traded company may submit a 10K disclosure (or equivalent if applicable) in satisfaction of the requirements set forth in Form A. See Disclosure Form Instructions.

DISCLOSURE OF FINANCIAL INFORMATION

1. Disclosure of Financial Information. The individual named below has an interest in the BIDDER (or its parent) in terms of ownership or distributive income share in excess of 5%, or an interest which has a value of more than \$90,420.00 (60% of the Governor's salary as of 7/1/01). (Make copies of this form as necessary and attach a separate Disclosure Form A for each individual meeting these requirements)

FOR INDIVIDUAL (type or print information)

NAME:

ADDRESS

Type of ownership/distributable income share:

stock sole proprietorship Partnership other: (explain on separate sheet):
% or \$ value of ownership/distributable income share:

2. Disclosure of Potential Conflicts of Interest. Check "Yes" or "No" to indicate which, if any, of the following potential conflict of interest relationships apply. If the answer to any question is "Yes", please attach additional pages and describe.

(a) State employment, currently or in the previous 3 years, including contractual employment of services.

Yes \_\_\_ No \_\_\_

If your answer is yes, please answer each of the following questions.

- 1. Are you currently an officer or employee of either the Capitol Development Board or the Illinois Toll Highway Authority? Yes \_\_\_ No \_\_\_
2. Are you currently appointed to or employed by any agency of the State of Illinois? If you are currently appointed to or employed by any agency of the State of Illinois, and your annual salary exceeds \$90,420.00, (60% of the Governor's salary as of 7/1/01) provide the name the State agency for which you are employed and your annual salary.

**RETURN WITH BID/OFFER**

- 3. If you are currently appointed to or employed by any agency of the State of Illinois, and your annual salary exceeds \$90,420.00, (60% of the Governor's salary as of 7/1/01) are you entitled to receive (i) more than 7 1/2% of the total distributable income of your firm, partnership, association or corporation, or (ii) an amount in excess of the salary of the Governor? Yes \_\_\_ No \_\_\_
  
- 4. If you are currently appointed to or employed by any agency of the State of Illinois, and your annual salary exceeds \$90,420.00, (60% of the Governor's salary as of 7/1/01) are you and your spouse or minor children entitled to receive (i) more than 15% in aggregate of the total distributable income of your firm, partnership, association or corporation, or (ii) an amount in excess of 2 times the salary of the Governor? Yes \_\_\_ No \_\_\_

---

(b) State employment of spouse, father, mother, son, or daughter, including contractual employment for services in the previous 2 years.

Yes \_\_\_ No \_\_\_

If your answer is yes, please answer each of the following questions.

- 1. Is your spouse or any minor children currently an officer or employee of the Capitol Development Board or the Illinois Toll Highway Authority? Yes \_\_\_ No \_\_\_
  
- 2. Is your spouse or any minor children currently appointed to or employed by any agency of the State of Illinois? If your spouse or minor children is/are currently appointed to or employed by any agency of the State of Illinois, and his/her annual salary exceeds \$90,420.00, (60% of the Governor's salary as of 7/1/01) provide the name of the spouse and/or minor children, the name of the State agency for which he/she is employed and his/her annual salary. \_\_\_\_\_

---

3. If your spouse or any minor children is/are currently appointed to or employed by any agency of the State of Illinois, and his/her annual salary exceeds \$90,420.00, (60% of the salary of the Governor as of 7/1/01) are you entitled to receive (i) more than 7 1/2% of the total distributable income of your firm, partnership, association or corporation, or (ii) an amount in excess of the salary of the Governor? Yes \_\_\_ No \_\_\_

4. If your spouse or any minor children are currently appointed to or employed by any agency of the State of Illinois, and his/her annual salary exceeds \$90,420.00, (60% of the Governor's salary as of 7/1/01) are you and your spouse or any minor children entitled to receive (i) more than 15% in the aggregate of the total distributable income from your firm, partnership, association or corporation, or (ii) an amount in excess of 2 times the salary of the Governor?

Yes \_\_\_ No \_\_\_

---

(c) Elective status; the holding of elective office of the State of Illinois, the government of the United States, any unit of local government authorized by the Constitution of the State of Illinois or the statutes of the State of Illinois currently or in the previous 3 years.

Yes \_\_\_ No \_\_\_

---

(d) Relationship to anyone holding elective office currently or in the previous 2 years; spouse, father, mother, son, or daughter.

Yes \_\_\_ No \_\_\_

---

(e) Appointive office; the holding of any appointive government office of the State of Illinois, the United State of America, or any unit of local government authorized by the Constitution of the State of Illinois or the statutes of the State of Illinois, which office entitles the holder to compensation in excess of the expenses incurred in the discharge of that office currently or in the previous 3 years.

Yes \_\_\_ No \_\_\_

---

(f) Relationship to anyone holding appointive office currently or in the previous 2 years; spouse, father, mother, son, or daughter.

Yes \_\_\_ No \_\_\_

---

(g) Employment, currently or in the previous 3 years, as or by any registered lobbyist of the State government.

Yes \_\_\_ No \_\_\_

**RETURN WITH BID/OFFER**

(h) Relationship to anyone who is or was a registered lobbyist in the previous 2 years; spouse, father, mother, son, or daughter. Yes \_\_\_ No \_\_\_

(i) Compensated employment, currently or in the previous 3 years, by any registered election or reelection committee registered with the Secretary of State or any county clerk of the State of Illinois, or any political action committee registered with either the Secretary of State or the Federal Board of Elections. Yes \_\_\_ No \_\_\_

(j) Relationship to anyone; spouse, father, mother, son, or daughter; who was a compensated employee in the last 2 years by any registered election or re-election committee registered with the Secretary of State or any county clerk of the State of Illinois, or any political action committee registered with either the Secretary of State or the Federal Board of Elections. Yes \_\_\_ No \_\_\_

**APPLICABLE STATEMENT**

**This Disclosure Form A is submitted on behalf of the INDIVIDUAL named on previous page.**

Completed by: \_\_\_\_\_  
Name of Authorized Representative (type or print)

Completed by: \_\_\_\_\_  
Title of Authorized Representative (type or print)

Completed by: \_\_\_\_\_  
Signature of Individual or Authorized Representative \_\_\_\_\_ Date \_\_\_\_\_

**NOT APPLICABLE STATEMENT**

**I have determined that no individuals associated with this organization meet the criteria that would require the completion of this Form A.**

**This Disclosure Form A is submitted on behalf of the CONTRACTOR listed on the previous page.**

\_\_\_\_\_  
Name of Authorized Representative (type or print)

\_\_\_\_\_  
Title of Authorized Representative (type or print)

\_\_\_\_\_  
Signature of Authorized Representative \_\_\_\_\_ Date \_\_\_\_\_

RETURN WITH BID/OFFER

**ILLINOIS DEPARTMENT  
OF TRANSPORTATION**

**Form B  
Other Contracts &  
Procurement Related Information  
Disclosure**

Contractor Name		
Legal Address		
City, State, Zip		
Telephone Number	Email Address	Fax Number (if available)

Disclosure of the information contained in this Form is required by the Section 50-35 of the Illinois Procurement Act (30 ILCS 500). This information shall become part of the publicly available contract file. This Form B must be completed for bids in excess of \$10,000, and for all open-ended contracts.

**DISCLOSURE OF OTHER CONTRACTS AND PROCUREMENT RELATED INFORMATION**

**1. Identifying Other Contracts & Procurement Related Information.** The BIDDER shall identify whether it has any pending contracts (including leases), bids, proposals, or other ongoing procurement relationship with any other State of Illinois agency: Yes \_\_\_ No \_\_\_

If "No" is checked, the bidder only needs to complete the signature box on the bottom of this page.

**2. If "Yes" is checked.** Identify each such relationship by showing State of Illinois agency name and other descriptive information such as bid or project number (attach additional pages as necessary). SEE DISCLOSURE FORM INSTRUCTIONS:

**THE FOLLOWING STATEMENT MUST BE SIGNED**

_____	
Name of Authorized Representative (type or print)	
_____	
Title of Authorized Representative (type or print)	
_____	_____
Signature of Authorized Representative	Date

## **RETURN WITH BID**

### **SPECIAL NOTICE TO CONTRACTORS**

The following requirements of the Illinois Department of Human Rights' Rules and Regulations are applicable to bidders on all construction contracts advertised by the Illinois Department of Transportation:

#### **CONSTRUCTION EMPLOYEE UTILIZATION PROJECTION**

- (a) All bidders on construction contracts shall complete and submit, along with and as part of their bids, a Bidder's Employee Utilization Form (Form BC-1256) setting forth a projection and breakdown of the total workforce intended to be hired and/or allocated to such contract work by the bidder including a projection of minority and female employee utilization in all job classifications on the contract project.
- (b) The Department of Transportation shall review the Employee Utilization Form, and workforce projections contained therein, of the contract awardee to determine if such projections reflect an underutilization of minority persons and/or women in any job classification in accordance with the Equal Employment Opportunity Clause and Section 7.2 of the Illinois Department of Human Rights' Rules and Regulations for Public Contracts adopted as amended on September 17, 1980. If it is determined that the contract awardee's projections reflect an underutilization of minority persons and/or women in any job classification, it shall be advised in writing of the manner in which it is underutilizing and such awardee shall be considered to be in breach of the contract unless, prior to commencement of work on the contract project, it submits revised satisfactory projections or an acceptable written affirmative action plan to correct such underutilization including a specific timetable geared to the completion stages of the contract.
- (c) The Department of Transportation shall provide to the Department of Human Rights a copy of the contract awardee's Employee Utilization Form, a copy of any required written affirmative action plan, and any written correspondence related thereto. The Department of Human Rights may review and revise any action taken by the Department of Transportation with respect to these requirements.



**RETURN WITH BID**

**Contract No. 91372  
CHAMPAIGN County  
Section 04-00358-01-RS  
Project ACRS-516(112)  
Route FAS 516 (CH 9)  
District 5 Construction Funds**

**PART II. WORKFORCE PROJECTION - continued**

- B. Included in "Total Employees" under Table A is the total number of **new hires** that would be employed in the event the undersigned bidder is awarded this contract.

The undersigned bidder projects that: (number) \_\_\_\_\_ new hires would be recruited from the area in which the contract project is located; and/or (number) \_\_\_\_\_ new hires would be recruited from the area in which the bidder's principal office or base of operation is located.

- C. Included in "Total Employees" under Table A is a projection of numbers of persons to be employed directly by the undersigned bidder as well as a projection of numbers of persons to be employed by subcontractors.

The undersigned bidder estimates that (number) \_\_\_\_\_ persons will be directly employed by the prime contractor and that (number) \_\_\_\_\_ persons will be employed by subcontractors.

**PART III. AFFIRMATIVE ACTION PLAN**

- A. The undersigned bidder understands and agrees that in the event the foregoing minority and female employee utilization projection included under **PART II** is determined to be an underutilization of minority persons or women in any job category, and in the event that the undersigned bidder is awarded this contract, he/she will, prior to commencement of work, develop and submit a written Affirmative Action Plan including a specific timetable (geared to the completion stages of the contract) whereby deficiencies in minority and/or female employee utilization are corrected. Such Affirmative Action Plan will be subject to approval by the contracting agency and the **Department of Human Rights**.
- B. The undersigned bidder understands and agrees that the minority and female employee utilization projection submitted herein, and the goals and timetable included under an Affirmative Action Plan if required, are deemed to be part of the contract specifications.

Company \_\_\_\_\_ Telephone Number \_\_\_\_\_

Address \_\_\_\_\_

**NOTICE REGARDING SIGNATURE**

The Bidder's signature on the Proposal Signature Sheet will constitute the signing of this form. The following signature block needs to be completed only if revisions are required.

Signature: \_\_\_\_\_ Title: \_\_\_\_\_ Date: \_\_\_\_\_

Instructions: All tables must include subcontractor personnel in addition to prime contractor personnel.

Table A - Include both the number of employees that would be hired to perform the contract work and the total number currently employed (Table B) that will be allocated to contract work, and include all apprentices and on-the-job trainees. The "Total Employees" column should include all employees including all minorities, apprentices and on-the-job trainees to be employed on the contract work.

Table B - Include all employees currently employed that will be allocated to the contract work including any apprentices and on-the-job trainees currently employed.

Table C - Indicate the racial breakdown of the total apprentices and on-the-job trainees shown in Table A.

**RETURN WITH BID**

**ADDITIONAL FEDERAL REQUIREMENTS**

In addition to the Required Contract Provisions for Federal-Aid Construction Contracts (FHWA 1273), all bidders make the following certifications.

- A. By the execution of this proposal, the signing bidder certifies that the bidding entity has not, either directly or indirectly, entered into any agreement, participated in any collusion, or otherwise taken any action, in restraint of free competitive bidding in connection with the submitted bid. This statement made by the undersigned bidder is true and correct under penalty of perjury under the laws of the United States.
- B. CERTIFICATION, EQUAL EMPLOYMENT OPPORTUNITY:
1. Have you participated in any previous contracts or subcontracts subject to the equal opportunity clause. YES \_\_\_\_\_ NO \_\_\_\_\_
  2. If answer to #1 is yes, have you filed with the Joint Reporting Committee, the Director of OFCC, any Federal agency, or the former President's Committee on Equal Employment Opportunity, all reports due under the applicable filing requirements of those organizations? YES \_\_\_\_\_ NO \_\_\_\_\_



**RETURN WITH BID**

**Contract No. 91372  
CHAMPAIGN County  
Section 04-00358-01-RS  
Project ACRS-516(112)  
Route FAS 516 (CH 9)  
District 5 Construction Funds**

PROPOSAL SIGNATURE SHEET

The undersigned bidder hereby makes and submits this bid on the subject Proposal, thereby assuring the Department that all requirements of the Invitation for Bids and rules of the Department have been met, that there is no misunderstanding of the requirements of paragraph 3 of this Proposal, and that the contract will be executed in accordance with the rules of the Department if an award is made on this bid.

(IF AN INDIVIDUAL) Firm Name \_\_\_\_\_  
Signature of Owner \_\_\_\_\_  
Business Address \_\_\_\_\_  
\_\_\_\_\_

---

(IF A CO-PARTNERSHIP) Firm Name \_\_\_\_\_  
By \_\_\_\_\_  
Business Address \_\_\_\_\_  
Name and Address of All Members of the Firm: \_\_\_\_\_  
\_\_\_\_\_

---

(IF A CORPORATION) Corporate Name \_\_\_\_\_  
By \_\_\_\_\_  
Signature of Authorized Representative \_\_\_\_\_  
Typed or printed name and title of Authorized Representative \_\_\_\_\_

(IF A JOINT VENTURE, USE THIS SECTION FOR THE MANAGING PARTY AND THE SECOND PARTY SHOULD SIGN BELOW) Attest \_\_\_\_\_  
Signature \_\_\_\_\_  
Business Address \_\_\_\_\_

---

(IF A JOINT VENTURE) Corporate Name \_\_\_\_\_  
By \_\_\_\_\_  
Signature of Authorized Representative \_\_\_\_\_  
Typed or printed name and title of Authorized Representative \_\_\_\_\_

Attest \_\_\_\_\_  
Signature \_\_\_\_\_  
Business Address \_\_\_\_\_

If more than two parties are in the joint venture, please attach an additional signature sheet.

RETURN WITH BID



Division of Highways
Proposal Bid Bond
(Effective November 1, 1992)

Item No.
Letting Date

KNOW ALL MEN BY THESE PRESENTS, That We

as PRINCIPAL, and

as SURETY, are held jointly, severally and firmly bound unto the STATE OF ILLINOIS in the penal sum of 5 percent of the total bid price, or for the amount specified in Article 102.09 of the "Standard Specifications for Road and Bridge Construction" in effect on the date of invitation for bids, whichever is the lesser sum, well and truly to be paid unto said STATE OF ILLINOIS, for the payment of which we bind ourselves, our heirs, executors, administrators, successors and assigns.

THE CONDITION OF THE FOREGOING OBLIGATION IS SUCH, That Whereas, the PRINCIPAL has submitted a bid proposal to the STATE OF ILLINOIS, acting through the Department of Transportation, for the improvement designated by the Transportation Bulletin Item Number and Letting Date indicated above.

NOW, THEREFORE, if the Department shall accept the bid proposal of the PRINCIPAL; and if the PRINCIPAL shall, within the time and as specified in the bidding and contract documents, submit a DBE Utilization Plan that is accepted and approved by the Department; and if, after award by the Department, the PRINCIPAL shall enter into a contract in accordance with the terms of the bidding and contract documents including evidence of the required insurance coverages and providing such bond as specified with good and sufficient surety for the faithful performance of such contract and for the prompt payment of labor and material furnished in the prosecution thereof; or if, in the event of the failure of the PRINCIPAL to make the required DBE submission or to enter into such contract and to give the specified bond, the PRINCIPAL pays to the Department the difference not to exceed the penalty hereof between the amount specified in the bid proposal and such larger amount for which the Department may contract with another party to perform the work covered by said bid proposal, then this obligation shall be null and void, otherwise, it shall remain in full force and effect.

IN THE EVENT the Department determines the PRINCIPAL has failed to comply with any requirement as set forth in the preceding paragraph, then Surety shall pay the penal sum to the Department within fifteen (15) days of written demand therefor. If Surety does not make full payment within such period of time, the Department may bring an action to collect the amount owed. Surety is liable to the Department for all its expenses, including attorney's fees, incurred in any litigation in which it prevails either in whole or in part.

In TESTIMONY WHEREOF, the said PRINCIPAL and the said SURETY have caused this instrument to be signed by their respective officers this day of A.D.,

PRINCIPAL SURETY
(Company Name)
By: (Signature & Title) By: (Signature of Attorney-in-Fact)

Notary Certification for Principal and Surety

STATE OF ILLINOIS,
COUNTY OF

I, a Notary Public in and for said County, do hereby certify that and

(Insert names of individuals signing on behalf of PRINCIPAL & SURETY)

who are each personally known to me to be the same persons whose names are subscribed to the foregoing instrument on behalf of PRINCIPAL and SURETY, appeared before me this day in person and acknowledged respectively, that they signed and delivered said instrument as their free and voluntary act for the uses and purposes therein set forth.

Given under my hand and notarial seal this day of, A.D.

My commission expires Notary Public

In lieu of completing the above section of the Proposal Bid Form, the Principal may file an Electronic Bid Bond. By signing below the Principal is ensuring the identified electronic bid bond has been executed and the Principal and Surety are firmly bound unto the State of Illinois under the conditions of the bid bond as shown above.

Electronic Bid Bond ID# Company/Bidder Name Signature and Title

# PROPOSAL ENVELOPE



## PROPOSALS

for construction work advertised for bids by the  
Illinois Department of Transportation

Item No.	Item No.	Item No.

Submitted By:

Name:
Address:
Phone No.

Bidders should use an IDOT proposal envelope or affix this form to the front of a 10" x 13" envelope for the submittal of bids. If proposals are mailed, they should be enclosed in a second or outer envelope addressed to:

Engineer of Design and Environment - Room 326  
Illinois Department of Transportation  
2300 South Dirksen Parkway  
Springfield, Illinois 62764

### **NOTICE**

**Individual bids, including Bid Bond and/or supplemental information if required, should be securely stapled.**

# CONTRACTOR OFFICE COPY OF CONTRACT SPECIFICATIONS

## NOTICE

None of the following material needs to be returned with the bid package unless the special provisions require documentation and/or other information to be submitted.

**Contract No. 91372  
CHAMPAIGN County  
Section 04-00358-01-RS  
Project ACRS-516(112)  
Route FAS 516 (CH 9)  
District 5 Construction Funds**



**Illinois Department of Transportation**



## NOTICE TO BIDDERS

- 1. TIME AND PLACE OF OPENING BIDS.** Sealed proposals for the improvement described herein will be received by the Department of Transportation at the Harry R. Hanley Building, 2300 South Dirksen Parkway, in Springfield, Illinois until 10:00 o'clock a.m., March 9, 2007. All bids will be gathered, sorted, publicly opened and read in the auditorium at the Department of Transportation's Harry R. Hanley Building shortly after the 10:00 a.m. cut off time.
- 2. DESCRIPTION OF WORK.** The proposed improvement is identified and advertised for bids in the Invitation for Bids as:

**Contract No. 91372  
CHAMPAIGN County  
Section 04-00358-01-RS  
Project ACRS-516(112)  
Route FAS 516 (CH 9)  
District 5 Construction Funds**

**Construction consists of 5.48 miles resurfacing FAS Route 516, CH 9 from FAS Route 339, CH 23 to U.S. Route 45 at the Village of Ludlow.**

- 3. INSTRUCTIONS TO BIDDERS.** (a) This Notice, the invitation for bids, proposal and letter of award shall, together with all other documents in accordance with Article 101.09 of the Standard Specifications for Road and Bridge Construction, become part of the contract. Bidders are cautioned to read and examine carefully all documents, to make all required inspections, and to inquire or seek explanation of the same prior to submission of a bid.  
  
(b) State law, and, if the work is to be paid wholly or in part with Federal-aid funds, Federal law requires the bidder to make various certifications as a part of the proposal and contract. By execution and submission of the proposal, the bidder makes the certification contained therein. A false or fraudulent certification shall, in addition to all other remedies provided by law, be a breach of contract and may result in termination of the contract.
- 4. AWARD CRITERIA AND REJECTION OF BIDS.** This contract will be awarded to the lowest responsive and responsible bidder considering conformity with the terms and conditions established by the Department in the rules, Invitation for Bids and contract documents. The issuance of plans and proposal forms for bidding based upon a prequalification rating shall not be the sole determinant of responsibility. The Department reserves the right to determine responsibility at the time of award, to reject any or all proposals, to readvertise the proposed improvement, and to waive technicalities.

By Order of the  
Illinois Department of Transportation

Timothy W. Martin, Secretary

BD 351 (Rev. 01/2003)

INDEX  
FOR  
SUPPLEMENTAL SPECIFICATIONS  
AND RECURRING SPECIAL PROVISIONS

Adopted January 1, 2007

This index contains a listing of SUPPLEMENTAL SPECIFICATIONS and frequently used RECURRING SPECIAL PROVISIONS.

SUPPLEMENTAL SPECIFICATIONS

Std. Spec. Sec.

Page No.

No Supplemental Specifications this year.

RECURRING SPECIAL PROVISIONS

The following RECURRING SPECIAL PROVISIONS indicated by an "X" are applicable to this contract and are included by reference:

<u>CHECK SHEET #</u>	<u>PAGE NO.</u>
1, X Additional State Requirements For Federal-Aid Construction Contracts (Eff. 2-1-69) (Rev. 1-1-07).....	1
2 X Subletting of Contracts (Federal-Aid Contracts) (Eff. 1-1-88) (Rev. 5-1-93) .....	3
3 X EEO (Eff. 7-21-78) (Rev. 11-18-80) .....	4
4 Specific Equal Employment Opportunity Responsibilities	
Non Federal-Aid Contracts (Eff. 3-20-69) (Rev. 1-1-94) .....	14
5 Required Provisions - State Contracts (Eff. 4-1-65) (Rev. 1-1-07) .....	19
6 Reserved.....	24
7 National Pollutant Discharge Elimination System Permit (Eff. 7-1-94) (Rev. 1-1-03) .....	25
8 Haul Road Stream Crossings, Other Temporary Stream Crossings, and In-Stream Work Pads (Eff. 1-2-92) (Rev. 1-1-98).....	26
9 Construction Layout Stakes Except for Bridges (Eff. 1-1-99) (Rev. 1-1-07).....	27
10 Construction Layout Stakes (Eff. 5-1-93) (Rev. 1-1-07) .....	30
11 Use of Geotextile Fabric for Railroad Crossing (Eff. 1-1-95) (Rev. 1-1-07).....	33
12 Subsealing of Concrete Pavements (Eff. 11-1-84) (Rev. 1-1-07).....	35
13 X Hot-Mix Asphalt Surface Removal (Cold Milling) (Eff. 11-1-87) (Rev. 1-1-07) .....	39
14 Pavement and Shoulder Resurfacing (Eff. 2-1-00) (Rev. 1-1-07) .....	41
15 PCC Partial Depth Hot-Mix Asphalt Patching (Eff. 1-1-98) (Rev. 1-1-07) .....	42
16 Patching with Hot-Mix Asphalt Overlay Removal (Eff. 10-1-95) (Rev. 1-1-07).....	44
17 Polymer Concrete (Eff. 8-1-95) (Rev. 3-1-05) .....	45
18 PVC Pipeliner (Eff. 4-1-04) (Rev. 1-1-07) .....	47
19 Pipe Underdrains (Eff. 9-9-87) (Rev. 1-1-07) .....	48
20 Guardrail and Barrier Wall Delineation (Eff. 12-15-93) (Rev. 1-1-97).....	49
21 Bicycle Racks (Eff. 4-1-94) (Rev. 1-1-07) .....	53
22 Temporary Modular Glare Screen System (Eff. 1-1-00) (Rev. 1-1-07).....	55
23 Temporary Portable Bridge Traffic Signals (Eff. 8-1-03) (Rev. 1-1-07) .....	57
24 Work Zone Public Information Signs (Eff. 9-1-02) (Rev. 1-1-07).....	59
25 Night Time Inspection of Roadway Lighting (Eff. 5-1-96).....	60
26 English Substitution of Metric Bolts (Eff. 7-1-96).....	61
27 English Substitution of Metric Reinforcement Bars (Eff. 4-1-96) (Rev. 1-1-03) .....	62
28 Calcium Chloride Accelerator for Portland Cement Concrete (Eff. 1-1-01) .....	63
29 Quality Control of Concrete Mixtures at the Plant-Single A (Eff. 8-1-00) (Rev. 1-1-04).....	64
30 Quality Control of Concrete Mixtures at the Plant-Double A (Eff. 8-1-00) (Rev. 1-1-04) .....	70
31 Quality Control/Quality Assurance of Concrete Mixtures (Eff. 4-1-92) (Rev. 1-1-07) .....	78
LRS 1 <b>Reserved</b> .....	91
LRS 2 <input type="checkbox"/> Furnished Excavation (Eff. 1-1-99) (Rev. 1-1-07) .....	92
LRS 3       X Work Zone Traffic Control (Eff. 1-1-99) (Rev. 1-1-07).....	93
LRS 4       X Flaggers in Work Zones (Eff. 1-1-99) (Rev. 1-1-07).....	94
LRS 5 <input type="checkbox"/> Contract Claims (Eff. 1-1-02) (Rev. 1-1-07).....	95
LRS 6 <input type="checkbox"/> Bidding Requirements and Conditions for Contract Proposals (Eff. 1-1-02).....	96
LRS 7 <input type="checkbox"/> Bidding Requirements and Conditions for Material Proposals (Eff. 1-1-02) (Rev. 1-1-03).....	102
LRS 8 <input type="checkbox"/> Failure to Complete the Work on Time (Eff. 1-1-99) .....	108
LRS 9 <input type="checkbox"/> Bituminous Surface Treatments (Eff. 1-1-99) .....	109
LRS 10 <input type="checkbox"/> Reflective Sheeting Type C (Eff. 1-1-99) (Rev. 1-1-02) .....	110
LRS 11 <input type="checkbox"/> Employment Practices (Eff. 1-1-99) .....	111
LRS 12 <input type="checkbox"/> Wages of Employees on Public Works (Eff. 1-1-99) (Rev. 1-1-06).....	113
LRS 13 <input type="checkbox"/> Selection of Labor (Eff. 1-1-99) .....	114
LRS 14 <input type="checkbox"/> Paving Brick and Concrete Paver Pavements and Sidewalks (Eff. 1-1-04) (Rev. 1-1-07).....	115
LRS 15 <input type="checkbox"/> Partial Payments (Eff. 1-1-07) .....	118

## SPECIAL PROVISIONS INDEX

<u>Special Provisions</u>	<u>Page #</u>
DESCRIPTION OF WORK	1
TRAFFIC CONTROL	1
TRAFFIC CONTROL PLAN	1
MOBILIZATION	2
RAILROAD FLAGGER	2
HMA SURFACE REMOVAL, VARIABLE DEPTH	2
HMA SURFACE REMOVAL, 2"	3
AGGREGATE SHOULDERS, SPECIAL	3
TEMPORARY RAMPS	3
SHORT TERM PAVEMENT MARKING	3
INCIDENTAL HMA SURFACING	4
HMA BINDER CSE, IL 19.0, N50	4
HMA SURF. CSE, SUPER, MIX C, N50	4
ANTI-STRIP ADDITIVES	4
HMA MIXTURES REQUIREMENTS	4
RUBBLIZATING PCC PAVEMENT	5 - 7
STATUS OF UTILITIES	8



**INDEX LOCAL ROADS AND STREETS SPECIAL PROVISIONS**

<u>LR#</u>	<u>Title (Effective Date) (Revision Date)</u>	<u>Page #</u>
LR SD 12	"Slab Movement Detection Device" (Eff. 11-1-84) (Rev. 1-1-07).....	
LR SD 13	"Required Cold Milled Surface Texture" (Eff. 11-1-87) (Rev. 1-1-07).....	
LR SD 631	"Traffic Barrier Terminal Type 5A" (Eff. 1-1-07). Developed to keep the Traffic Barrier Terminal Type 5A as an option for local agencies. ....	
LR 102	"Protests on Local Lettings" (Eff. 1-1-07). Developed to allow local agencies to adopt the department's interested party protest procedures outlined in Title 44 of the IL Administrative Code. ....	
LR 105	"Cooperation with Utilities" (Eff 1/1/99) (Rev 1/1/07). Formerly issued as LRS 1 and was reissued as an LR Contract Special Provision based on industry concerns discussed at the Joint Coop. ....	
LR 107-1	"Nationwide Permit No. 14" (Eff. 2-1-04) (Rev. 3-1-05). Developed to outline the necessary requirements to comply with No. 14 permits. ....	
LR 107-2	"Railroad Protective Liability Insurance for Local Lettings" (Eff. 3-1-05) (Rev 1-1-06). Developed to require insurance policies to be submitted to the letting agency rather than the department. ....	
LR 107-3	"Disadvantaged Business Enterprise Participation" (Eff. 1-1-07). Developed to require DBE utilization plans to be submitted to the local agency. ....	
LR 108	"Combination Bids (Eff. 1-1-94) (Rev. 3-1-05). Developed to allow the revision of working days and calendar days. Revised to incorporate applicable portions of deleted Sections 102 & 103. ....	
LR 109	"Contract Claims" (Eff. 1-1-02) (Rev. 5-1-02). Developed to assist local agencies in handling contract claims. ...	
LR 212	"Shaping Roadway" (Eff. 8-1-69) (Rev. 1-1-02). ....	
LR 355-1	"Asphalt Stabilized Base Course, Road Mix or Traveling Plant Mix" (Eff. 10-1-73) (Rev. 1-1-07) .....	
LR 355-2	"Asphalt Stabilized Base Course, Plant Mix" (Eff. 2-20-63) (Rev. 1-1-07) .....	
LR 400	"Bituminous Treated Earth Surface (Eff. 1-1-07). Developed since Section 401 was eliminated from the 2007 Standard Specifications. ....	
LR 402	"Salt Stabilized Surface Course" (Eff. 2-20-63) (Rev. 1-1-07) .....	
LR 403-2	Bituminous Hot Mix Sand Seal Coat" (Eff. 8-1-69) (Rev. 1-1-07) .....	
LR 420	"PCC Pavement (Special)" (Eff. 5-12-64) (Rev. 1-1-07). Developed to allow local agencies to construct quality PCC pavements for low volume roads. ....	
LR 442	"Bituminous Patching Mixtures for Maintenance Use" (Eff 1-1-04). Developed to reference approved bituminous patching mixtures. ....	
LR 451	"Crack Filling Bituminous Pavement with Fiber-Asphalt" (Eff. 10-1-91) (Rev. 1-1-07) .....	
LR 503-1	"Furnishing Class SI Concrete" (Eff. 10-1-73) (Rev. 1-1-02) .....	
LR 503-2	"Furnishing Class SI Concrete (Short Load)" (Eff. 1-1-89) (Rev. 1-1-02). Developed to allow a load charge to be added when short loads are expected during the contract. ....	
LR 542	"Pipe Culverts, Type _____ (Furnished)" (Eff. 9-1-64) (Rev. 1-1-07) .....	
LR 663	"Calcium Chloride Applied" (Eff. 6-1-58) (Rev. 1-1-07) .....	
LR 702	"Construction and Maintenance Signs" (Eff 1-1-04) (Rev 1-1-07). Developed to require florescent orange sheeting and a minimum sign size of 48" X 48" on construction and maintenance signs. ....	
LR 1004	"Coarse Aggregate for Bituminous Surface Treatment" (Eff. 1-1-02) (Rev 1-1-07). Developed to provide a coarser mix when aggregate producers have adjusted the CA-16 gradation according to the Aggregate Gradation Control System (AGCS) to a finer mix for Hot-Mix Asphalt. ....	
LR 1013	"Rock Salt (Sodium Chloride)" (Eff. 8-1-69) (Rev. 1-1-02) .....	
LR 1032-1	"Penetrating Emulsions" (Eff. 1-1-07). Developed to combine Penetrating Emulsified Asphalt and Penetrating Emulsified Prime into a single special provision. ....	
LR 1032-2	"Multigrade Cold Mix Asphalt" (Eff. 1-1-07). Developed to provide the material specification for Multigrade cold mix asphalt. ....	
LR 1102	"Road Mix or Traveling Plan Mix Equipment" (Eff. 1-1-07). Developed to replace road mix and traveling plant mix bituminous equipment that was eliminated from the Standard Specifications. ....	

**BDE SPECIAL PROVISIONS**  
For the January 19 and March 9, 2007 Lettings

The following special provisions indicated by an "x" are applicable to this contract. An \* indicates a new or revised special provision for the letting.

<u>File Name</u>	<u>Pg#</u>	<u>Special Provision Title</u>	<u>Effective</u>	<u>Revised</u>
* 80099		Accessible Pedestrian Signals (APS)	April 1, 2003	Jan. 1, 2007
80108		Asbestos Bearing Pad Removal	Nov. 1, 2003	
* 72541		Asbestos Waterproofing Membrane and Asbestos Hot-Mix Asphalt Surface Removal (NOTE: This special provision was previously named "Asbestos Waterproofing Membrane and Asbestos Bituminous Concrete Surface Removal".)	June 1, 1989	Jan. 2, 2007
* 50261		Building Removal-Case I (Non-Friable and Friable Asbestos)	Sept. 1, 1990	Jan. 1, 2007
* 50481		Building Removal-Case II (Non-Friable Asbestos)	Sept. 1, 1990	Jan. 1, 2007
* 50491		Building Removal-Case III (Friable Asbestos)	Sept. 1, 1990	Jan. 1, 2007
* 50531		Building Removal-Case IV (No Asbestos)	Sept. 1, 1990	Jan. 1, 2007
* 80166		Cement	Jan. 1, 2007	
* 80029	11	X Disadvantaged Business Enterprise Participation	Sept. 1, 2000	Jan. 1, 2007
* 80167		Electrical Service Installation – Traffic Signals	Jan. 1, 2007	
* 80168	19	X Errata for the 2007 Standard Specifications	Jan. 1, 2007	
* 80169		High Tension Cable Median Barrier	Jan. 1, 2007	
* 80142	21	X Hot-Mix Asphalt Equipment, Spreading and Finishing Machine (NOTE: This special provision was previously named "Bituminous Equipment, Spreading and Finishing Machine".)	Jan. 1, 2005	Jan. 1, 2007
* 80136		Hot-Mix Asphalt Mixture IL-4.75 (NOTE: This special provision was previously named "Superpave Bituminous Concrete Mixture IL-4.75".)	Nov. 1, 2004	Jan. 1, 2007
* 80109		Impact Attenuators	Nov. 1, 2003	Jan. 1, 2007
* 80110		Impact Attenuators, Temporary	Nov. 1, 2003	Jan. 1, 2007
* 80045		Material Transfer Device	June 15, 1999	Jan. 1, 2007
* 80165		Moisture Cured Urethane Paint System	Nov. 1, 2006	Jan. 1, 2007
80082		Multilane Pavement Patching	Nov. 1, 2002	
* 80129		Notched Wedge Longitudinal Joint	July 1, 2004	Jan. 1, 2007
* 80069		Organic Zinc-Rich Paint System	Nov. 1, 2001	Jan. 1, 2007
80022	22	X Payments to Subcontractors	June 1, 2000	Jan. 1, 2006
80148		Planting Woody Plants	Jan. 1, 2006	
* 80134		Plastic Blockouts for Guardrail	Nov. 1, 2004	Jan. 1, 2007
* 80119		Polyurea Pavement Marking	April 1, 2004	Jan. 1, 2007
* 80170		Portland Cement Concrete Plants	Jan. 1, 2007	
* 80171		Precast Handling Holes	Jan. 1, 2007	
80015		Public Convenience and Safety	Jan. 1, 2000	
34261		Railroad Protective Liability Insurance	Dec. 1, 1986	Jan. 1, 2006
80157	24	X Railroad Protective Liability Insurance (5 and 10)	Jan. 1, 2006	
* 80172	26	X Reclaimed Asphalt Pavement (RAP)	Jan. 1, 2007	Jan. 2, 2007
* 80160		Reflective Crack Control Treatment	April 1, 2006	Jan. 1, 2007
* 80151		Reinforcement Bars	Nov. 1, 2005	Jan. 1, 2007
* 80164		Removal and Disposal of Regulated Substances	Aug. 1, 2006	Jan. 1, 2007
* 80131		Seeding (NOTE: This special provision was previously named "Seeding and Sodding".)	July 1, 2004	Jan. 1, 2007
* 80152		Self-Consolidating Concrete for Cast-In-Place Construction	Nov. 1, 2005	Jan. 1, 2007
* 80132		Self-Consolidating Concrete for Precast Products	July 1, 2004	Jan. 1, 2007

File Name	Pg#		Special Provision Title	Effective	Revised
* 80127			Steel Cost Adjustment	April 2, 2004	Jan. 1, 2007
* 80153			Steel Plate Beam Guardrail	Nov. 1, 2005	Jan. 1, 2007
80143	31	X	Subcontractor Mobilization Payments	April 2, 2005	
* 80075			Surface Testing of Pavements	April 1, 2002	Jan. 1, 2007
* 80087			Temporary Erosion Control	Nov. 1, 2002	Jan. 1, 2007
* 80161			Traffic Signal Grounding	April 1, 2006	Jan. 1, 2007
20338			Training Special Provisions	Oct. 15, 1975	
* 80154			Turf Reinforcement Mat	Nov. 1, 2005	Jan. 1, 2007
* 80162			Uninterruptable Power Supply (UPS)	April 1, 2006	Jan. 1, 2007
* 80149			Variable Spaced Tining	Aug. 1, 2005	Jan. 1, 2007
* 80163			Water Blaster with Vacuum Recovery	April 1, 2006	Jan. 1, 2007
80071	32	X	Working Days	Jan. 1, 2002	

33 X Plans and Standards

The following special provisions have been **deleted** from use:

80139 Portland Cement This special provision is now covered in a BMPR Policy Memorandum "Portland or Blended Cement Acceptance Procedure for Qualified and Non-Qualified Plants".

80120 Precast, Prestressed Concrete Members This special provision is now in BMPR's "Manual for Fabrication of Precast Prestressed Concrete Products".

80145 Suspension of Slipformed Parapets This special provision is no longer required.

The following special provisions are either in the 2007 Standard Specifications or the 2007 Recurring Special Provisions:

File Name	Special Provision Title	New Location	Effective	Revised
80156	Aggregate Shipping Tickets	Articles 1003.01(f), 1004.01(f) & 1005.01(d)	Jan. 1, 2006	
80128	Authority of Railroad Engineer	Article 105.02	July 1, 2004	
80065	Bituminous Base Course/Widening Superpave	Sections 355, 356, 1030 & 1102	April 1, 2002	Aug. 1, 2005
80050	Bituminous Concrete Surface Course	Article 406.13(b)	April 1, 2001	April 1, 2003
80066	Bridge Deck Construction	Sections 503, 1004, 1020 & 1103	April 1, 2002	April 1, 2004
80118	Butt Joints	Article 406.08	April 1, 2004	April 1, 2005
80031	Calcium Chloride Accelerator for Portland Cement Concrete Patching	Recurring # 28	Jan. 1, 2001	
80077	Chair Supports	Article 421.04(a)	Nov. 1, 2002	Nov. 2, 2002
80051	Coarse Aggregate for Trench Backfill, Backfill and Bedding	Sections 208, 542, 550, 1003 & 1004	April 1, 2001	Nov. 1, 2003
80094	Concrete Admixtures	Article 1020.05(b) & Section 1021	Jan. 1, 2003	July 1, 2004
80112	Concrete Barrier	Section 637	Jan. 1, 2004	April 2, 2004
80102	Corrugated Metal Pipe Culverts	Articles 542.04(d), 1006.01(a)(4) & 1006.03(d)	Aug. 1, 2003	July 1, 2004
80114	Curing and Protection of Concrete Construction	Sections 503, 1020 & 1022	Jan. 1, 2004	Nov. 1, 2005
80146	Detectable Warnings	Section 424	Aug. 1, 2005	
80144	Elastomeric Bearings	Section 1083	April 1, 2005	
31578	Epoxy Coating on Reinforcement	Sections 420, 483 & 606	April 1, 1997	Jan. 1, 2003
80041	Epoxy Pavement Marking	Article 1095.04	Jan. 1, 2001	Aug. 1, 2003

<u>File Name</u>	<u>Special Provision Title</u>	<u>New Location</u>	<u>Effective</u>	<u>Revised</u>
80055	Erosion and Sediment Control Deficiency Deduction	Article 105.03(a)	Aug. 1, 2001	Nov. 1, 2001
80103	Expansion Joints	Article 420.05(d)	Aug. 1, 2003	
80101	Flagger Vests	Article 701.13	April 1, 2003	Jan. 1, 2006
80079	Freeze-Thaw Rating	Article 1004.02(f)	Nov. 1, 2002	
80072	Furnished Excavation	Section 204	Aug. 1, 2002	Nov. 1, 2004
80054	Hand Vibrator	Article 1103.17(a)	Nov. 1, 2003	
80147	Illuminated Sign	Sections 801, 891 & 1084	Aug. 1, 2005	
80104	Inlet Filters	Section 280 & Article 1081.15(h)	Aug. 1, 2003	
80080	Insertion Lining of Pipe Culverts	Section 543 & Article 1040.04	Nov. 1, 2002	Aug. 1, 2003
80150	Light Emitting Diode (LED) Pedestrian Signal Head	Sections 801, 881, & 1078	Nov. 1, 2005	April 1, 2006
80067	Light Emitting Diode (LED) Signal Head	Sections 801, 880 & 1078	April 1, 2002	Nov. 1, 2005
80081	Lime Gradation Requirements	Article 1012.03	Nov. 1, 2002	
80133	Lime Stabilized Soil Mixture	Section 310	Nov. 1, 2004	April 1, 2006
80158	Manholes	Article 1042.10	April 1, 2006	
80137	Minimum Lane Width with Lane Closure	Article 701.06	Jan. 1, 2005	
80138	Mulching Seeded Areas	Section 251 & Article 1081.06(a)(4)	Jan. 1, 2005	
80116	Partial Payments	Article 109.07	Sept. 1, 2003	
80013	Pavement and Shoulder Resurfacing	Recurring # 14	Feb. 1, 2000	July 1, 2004
53600	Pavement Thickness Determination for Payment	Articles 407.03, 407.10, 420.03, 420.15 & 421.04	April 1, 1999	Jan. 1, 2004
80155	Payrolls and Payroll Records	Recurring #1 & #5	Aug. 10, 2005	
80130	Personal Protective Equipment	Article 701.12	July 1, 2004	
80073	Polymer Modified Emulsified Asphalt	Article 1032.06	Nov. 1, 2002	
80124	Portable Changeable Message Signs	Articles 701.15(j), 701.20(h) & 1106.02(j)	Nov. 1, 1993	April 2, 2004
80083	Portland Cement Concrete	Articles 1103.01 & 1103.02	Nov. 1, 2002	
80036	Portland Cement Concrete Patching	Sections 442, 701, 1013 & 1020	Jan. 1, 2001	Jan. 1, 2004
419	Precast Concrete Products	Sections 540, 1020 & 1042	July 1, 1999	Nov. 1, 2004
80084	Preformed Recycled Rubber Joint Filler	Articles 503.02, 637.02 & 1051.10	Nov. 1, 2002	
80121	PVC Pipeliner	Recurring # 18	April 1, 2004	April 1, 2005
80159	Railroad Flaggers	Article 107.12	April 1, 2006	
80122	Railroad, Full-Actuated Controller and Cabinet	Articles 857.04, 1073.01(c)(2) & 1074.03(a)(5)e.	April 1, 2004	
80105	Raised Reflective Pavement Markers (Bridge)	Articles 781.03(a), 781.05 & 1096.01(b)	Aug. 1, 2003	
80011	RAP for Use in Bituminous Concrete Mixtures	Sections 1030 & 1031	Jan. 1, 2000	April 1, 2002
80032	Remove and Re-Erect Steel Plate Beam Guardrail and Traffic Barrier Terminals	Section 633	Jan. 1, 2001	Jan. 1, 2005
80085	Sealing Abandoned Water Wells	Section 672	Nov. 1, 2002	
80096	Shoulder Rumble Strips	Section 642	Jan. 1, 2003	
80140	Shoulder Stabilization at Guardrail	Article 630.06	Jan. 1, 2005	
80135	Soil Modification	Section 302	Nov. 1, 2004	April 1, 2006
80070	Stabilized Subbase and Bituminous Shoulders Superpave	Sections 312, 482, 1030 & 1102	April 1, 2002	Aug. 1, 2005
80086	Subgrade Preparation	Section 301	Nov. 1, 2002	
80010	Superpave Bituminous Concrete Mixtures	Sections 406, 407 & 1030	Jan. 1, 2000	April 1, 2004
80039	Superpave Bituminous Concrete Mixtures (Low ESAL)	Sections 406, 407 & 1030	Jan. 1, 2001	April 1, 2004

<u>File Name</u>	<u>Special Provision Title</u>	<u>New Location</u>	<u>Effective</u>	<u>Revised</u>
80092	Temporary Concrete Barrier	Section 704	Oct. 1, 2002	Nov. 1, 2003
80008	Temporary Module Glare Screen System	Recurring # 22	Jan. 1, 2000	
80106	Temporary Portable Bridge Traffic Signals	Recurring # 23	Aug. 1, 2003	
80098	Traffic Barrier Terminals	Section 631	Jan. 1, 2003	
5729I	Traffic Control Deficiency Deduction	Article 105.03(b)	April 1, 1992	Jan. 1, 2005
80107	Transient Voltage Surge Suppression	Article 1074.03(a)(4)	Aug. 1, 2003	
80123	Truck Bed Release Agent	Article 1030.08	April 1, 2004	
80048	Weight Control Deficiency Deduction	Article 109.01	April 1, 2001	Aug. 1, 2002
80090	Work Zone Public Information Signs	Recurring # 24	Sept. 1, 2002	Jan. 1, 2005
80125	Work Zone Speed Limit Signs	Article 701.14(b)	April 2, 2004	Jan. 1, 2006
80126	Work Zone Traffic Control	Articles 701.19 & 701.20	April 2, 2004	Nov. 1, 2005
80097	Work Zone Traffic Control Devices	Section 701 & Article 1106.02	Jan. 1, 2003	Nov. 1, 2004

The following special provisions require additional information from the designer. The additional information needs to be included in a separate document attached to this check sheet. The Project Development and Implementation section will then include the information in the applicable special provision. The Special Provisions are:

- Building Removal-Case I
- Building Removal-Case II
- Building Removal-Case III
- Building Removal-Case IV
- DBE Participation
- Material Transfer Device
- Railroad Protective Liability Insurance
- Training Special Provisions
- Working Days



The following Special Provisions supplement the "Standard Specifications for Road and Bridge Construction", Adopted January 1, 2007, the latest edition of the "Manual on Uniform Traffic Control Devices for Streets and Highways", and the "Manual of Test Procedures of Materials" in effect on the date of invitation of bids, and the Supplemental Specifications and Recurring Special Provisions indicated on the Check Sheet included here in which and govern the construction of FAS Route 516, Section 04-00358-01-RS, and in case of conflict with any part or parts, of said Specifications, the said Special Provisions shall take precedence and shall govern.

**DESCRIPTION OF WORK**

This project consists of two sections, located on County Highway 9, between County Highway 23 and U.S. Rte 45.

Section 1, between C.H. 23 and I-57 bridge (from station 0+77 to station 375+16), 7.1 miles long includes:

- 1) Variable depth milling of the existing HMA pavement over the 9"-7"-9" PCC slab and stockpiling the millings for later use
- 2) Rubblizing the existing PCC slab.
- 3) HMA binder course inlay over the rubblized lane
- 4) Full width 2 inch HMA surface course overlay, 22 ft wide
- 5) Construction of 3 ft wide aggregate shoulders

Section 2, in Ludlow from station 391+29 to station 425+08, 0.6 mile long

- 1) 2 inch inlay milling of the existing HMA pavement, in the "V" gutter section of town
- 2) 2 inch HMA surface paving, one lane pass at a time, 22 ft wide, sta 391+29 to sta 425+08
- 3) Construction of 3 ft wide aggregate shoulders

**TRAFFIC CONTROL:**

Traffic control shall be in accordance with the applicable sections of the Standard Specifications for Road and Bridge, the applicable guidelines contained in the Illinois Manual on Uniform Traffic Control Devices for streets and Highways, these Special Provisions and any special details and Highway Standards contained herein.

**TRAFFIC CONTROL PLAN**

It is the intent of the County that Section 1 of County Highway 9 shall remain closed to through traffic during the following operations:

- 1) milling
- 2) rubllization
- 3) HMA binder course overlay
- 4) HMA surface course overlay

The Contractor shall erect staggered barricades, as per BLR 22, to provide access for local traffic only. It shall be understood that the Contractor shall not close the road(s) at any location until he is ready to begin work, and that he diligently continue the work, once it has begun, until the normal flow of traffic may be restored.

The Contractor shall close one mile sections of road at a time for the purpose of full width bituminous surface paving in Section 1.

Residents shall be allowed access in accordance with Articles 107.09 of the Standards Specifications. At no time shall a private entrance be closed for an extended period of time as determined by the Engineer.

The traffic control protection shall be required for the work being performed in accordance with the following standards:

**701006** Use this standard for any operation or activity that will encroach in the area within 2 to 15 feet from the E.O.P. while the road remains open to traffic

**701011** Construction of incidental HMA surfacing and shoulder work.

**701201** Construction of butt joints in areas where the speed limit is equal to or greater than 45 mph.

**701306** Placement of aggregate shoulders, milling operations and HMA resurfacing in areas where the speed limit is equal to or greater than 45 mph. Special attention is called to article 701.04 pertaining to shoulder drop-off in excess of 3 inches.

**702001** Traffic Control Devices

Contractor shall erect and maintain staggered barricades, according to Standard 702001-05 detail.

**BLR 22** This standard shall be used during pavement removal, rubblization, and HMA binder paving in Section 1. This standard can also be used for side road closures during the mainline work operations.

**BASIS OF PAYMENT:**

Work involved in complying with the "TRAFFIC CONTROL PLAN" will be paid for at contract unit price per lump sum for TRAFFIC CONTROL AND PROTECTION and no additional compensation will be allowed.

**MOBILIZATION**

This work will be paid for at the contract unit price of lump sum for MOBILIZATION according to schedule described in Article 671 of the Standard Specifications.

**RAILROAD FLAGGER**

The contractor shall pay the costs of providing flaggers as specified in Article 107.12 of the Standard Specifications with the exception of flaggers required for transporting material or equipment across the track. The contractor will be reimbursed for eligible flagging cost in accordance with Article 109.05 of the Standard Specifications.

**HMA SURFACE REMOVAL, VARIABLE DEPTH**

This work refers to Section 1, between County Highway 23 and I-57 (sta. 0+11 to sta. 375+16). It consists of milling of the existing bituminous surface covering 9"-7"-9" PCC slab. The PCC slab to be exposed is located in the westbound lane between station 0+11 and 107+75, and in the eastbound lane between station 108+10 and 375+16. No construction traffic shall be allowed on the rubblized pavement except as indicated for HMA Binder Course Paving.

This operation will yield approximately 6300 tons of millings, which will be stockpiled in Ludlow, at Ludlow Township maintenance shed for later use on the project.

The Contractor shall be responsible for the transportation, and screening of the millings, as well as shaping of the stockpile. Millings shall meet the requirements of Article 1031.03 and 1031.06 b) of the Standard Specifications.

This work will be paid for at the contract unit price per square yard for HMA SURFACE REMOVAL, VARIABLE DEPTH which shall include the cost of the equipment, labor and transportation of the millings, as described herein, and no additional compensation shall be allowed.

### **HMA SURFACE REMOVAL, 2"**

This work refers to Section 2 (sta. 391+29 to 425+08) in Ludlow. It consists of 2" inlay milling of the existing pavement, 22' wide, in the "V" gutter section of town. This operation will yield approximately 600 tons of millings which will be stockpiled in Ludlow, as above.

The Contractor shall be responsible for the transportation of the millings to the stockpile, screening, as well as for the shaping of the stockpile. Millings shall meet the requirements of Article 1031.03 and 1031.06 b) of the Standard Specifications.

This work will be paid for at the contract unit price per square yard for HMA SURFACE REMOVAL, 2", which shall include the cost of the equipment, labor and transportation of the millings, as described herein, and no additional compensation will be allowed.

### **AGGREGATE SHOULDERS, SPECIAL**

The material for the shoulders shall come from the stockpile of millings from Section 1 and 2 (see above). The material shall meet the requirements of article 481 and 1031 of the Standard Specifications. Construction of the shoulders shall meet the requirements for Aggregate Shoulders, Type B, as described in Article 481.06 and 481.07 of the Standard Specifications. See typical cross sections for details showing typical depths in Section 1 and Section 2.

This work will be paid for at the contract unit price per square yard for AGGREGATE SHOULDERS, which will include loading, hauling, placing, shaping and compacting aggregate and no additional compensation shall be allowed.

### **TEMPORARY RAMPS**

The Contractor shall provide temporary ramps at the limits of the pavement removal in Section 1, and access points to private properties along the project, or as directed by the Engineer. This work shall meet the requirements of Article 406.08 a) of the Standard Specifications.

The cost of this work will be paid for at the contract unit price per square yard for TEMPORARY RAMPS and no additional compensation will be allowed.

### **SHORT TERM PAVEMENT MARKING**

Immediately upon completion of the rolling of the binder course and the surface course, short term pavement marking shall be applied to the new pavement on the centerline. Application shall be in accordance with the requirements of Section 703 of the Standard Specifications except that only a one foot length of tape shall be placed every 40 feet and short term markings need not be removed prior to placement of permanent markings. The short term markings must be carefully placed on the centerline so as not to detract from the appearance of the permanent markings.

This work will be paid for at the contract unit price per foot of SHORT TERM PAVEMENT MARKING which price shall be payment in full for furnishing all materials, installing and maintaining short term pavement markings as specified.



**INCIDENTAL HMA SURFACING**

This pay item consists of HMA surfacing of field entrances, private entrances, mailbox turnouts, and side roads, and shall meet the requirements of Article 408 of the Standard Specifications for Road and Bridge Construction. The material used for this work shall be of the same type as the HMA surface mixture used for the mainline paving.

Section 1 includes 14 private entrances, 59 field entrances, 14 mailbox turnouts, and 12 side roads. The estimated quantity of bituminous surface to complete this work is 324 tons.

This work will be paid for at the unit price per ton for INCIDENTAL BITUMINOUS, and no additional compensation will be allowed.

**HMA BINDER COURSE PAVING**

It is the intent of the County to minimize construction traffic on the rubblized pavement lane in order to preserve the integrity of the existing subgrade.

Therefore, no trucks will be allowed on the rubblized pavement, except immediately in front of the paver while unloading the material during paving. All other trucks, empty or loaded, shall use the adjacent lane for travel.

**HMA SURFACE COURSE PAVING**

Bituminous surface paving on this project consists of the following procedures:

- 1) full width paving (22') 2 inch lift in Section 1, between C.H. 23 and I-57
- 2) two 11' wide lanes in Ludlow; 2 inch inlay adjacent to "V" gutter
- 3) two 11' wide lanes in Ludlow, 2 inch overlay, ending at U.S. Rte 45

**ANTI-STRIP ADDITIVES**

The cost of anti-strip additive shall be included in the bid price for HMA mix, as applicable, and no additional compensation will be allowed.

**HMA MIXTURE REQUIREMENTS**

The following are the requirements for the bituminous concrete binder and surface mixes, to be used for paving

**GN 406H Mixture Requirements**

Location	CH 9, Section 1	CH 9, Section 1 & 2
Mixture Use	Binder	Surface
Thickness	3" and Variable	2"
AC/PG *	PG 64-22	PG 64-22
RAP % (Max)	25	15
Design Air Voids	4.0% @ Ndes=50	4.0% @ Ndes=50
Mix Comp(Gradation)	IL 19.0	IL 9.5
Friction Aggregate	N.A.	Mix C

\* NOTE: Use PG 58-22 if 25% or more RAP is used in the mix.

## RUBBLIZING PORTLAND CEMENT CONCRETE PAVEMENT

**Description:** This work shall consist of rubblizing the existing Portland cement concrete (PCC) pavement.

**Materials:** Aggregate replacement material, for areas of approximately 10 sq. feet or less, shall be a Class D Quality (or better) crushed stone, crushed slag, crushed concrete, or crushed gravel meeting a CA 6 or CA 10 gradation: according to Section 1004 of the Standard Specification. Bituminous concrete mixture used for repairs shall be the same as noted in the mixture requirements for mainline binder.

**Equipment:** Equipment shall be according to the following Articles of Section 1100:

- a. Vibratory Steel Wheel Roller.. (Note 1)..... 1101.01
- b. Pneumatic Tired Rollers.....(Note 2)..... 1101.01
- c. Multi-head Breaker (MHB). The equipment shall consist of a self-contained, self-propelled MHB. Hammer heads shall be mounted laterally in pairs with half the hammers in a forward row, and the remainder diagonally offset in a rear row so there is continuous pavement breaking from side to side. Hammer drop height shall have the ability to be independently controlled. (Note 3)
- d. Z-pattern Steel Grid Roller. The equipment shall consist of a self-contained, self-propelled vibratory steel wheel roller with a Z-pattern grid cladding bolted transversely to the surface of the drum. The vibratory roller shall have a minimum gross weight of 10 tons.

Note 1. The vibratory roller shall have a minimum gross weight of 10 tons.

Note 2. The pneumatic tired rollers shall develop a compression of not less than 300 lb. /in., nor more than 500 lb. /in., of width of the tire tread in surface contact.

Note 3. When the MHB is used, a Z-pattern steel grid roller shall be used for additional particle break down as described herein.

## CONSTRUCTION REQUIREMENTS

**General.** Rubblizing shall commence after removal of any existing HMA overlay in the area to be rubblized. Any HMA overlay left on the pavement (after the milling process) shall be removed prior to rubblizing to the satisfaction of the Engineer.

Partial-depth HMA patches may be left in place and impacted by rubblizing equipment. If breaking is not satisfactory under partial-depth HMA patches, alternate methods shall be used to break the pavement with approval of the Engineer. Full-depth HMA patches will be reviewed by the Engineer prior to rubblizing. Unsound patches will be removed and replaced with a Class C or D patch. If the patch is concrete it shall be rubblized. Lane width, full-depth HMA patches that exceed 10 ft. in length shall not be impacted by breaking equipment. The Engineer will direct the removal of an unstable material, and method of replacement.

If the unsound patch is greater than 10 sq. ft., HMA binder mixture shall be used. When the unsound patch is less than or equal to 10 sq. ft., the replacement material may be aggregate.

PCC pavement or other PCC appurtenances to remain in place shall be severed from the pavement to be rubblized with full-depth saw cut. Rubblized pavement less than or equal to 10 sq. ft. dislodged by construction traffic shall be repaired with aggregate replacement material and compacted prior to the paving operation. Rubblized pavement greater than 10 sq. ft. dislodged by construction traffic shall be repaired with HMA binder mixture.

The Contractor shall prevent damage to underground utilities and drainage structures during rubblizing. Approved alternate breaking methods shall be used over underground utilities and drainage structures as specified on the plans or directed by the Engineer.

Reinforcement shall be left in place, except that reinforcement projecting from the surface after breaking or compaction shall be cut off below the surface and removed. Any loose joint fillers, expansion material, or other similar items shall also be removed.

Pavement Breaking. The concrete pavement shall be rubblized into PCC segments with a vast majority (approximately 75% as determined by visual inspection) of PCC segments having the largest dimension not exceeding 12 inches at the surface and the maximum allowable PCC segment size shall not exceed 16 inches.

Breaking shall be accomplished only by the method(s) specified on the plans and defined as follows:

Method I- This method uses the MHB and Z-pattern steel grid roller to break the pavement, as specified herein.

Prior to the acceptance of the proposed breaking procedure, the Contractor shall complete a strip for evaluation by the Engineer. To ensure the pavement is being broken to the specified dimensions; the Contractor shall excavate a broken area of 10 sq. ft., in two separate locations during the first day of breaking, as directed by the Engineer. Modification to the breaking procedure must be made if the size requirements are not met. These excavations may be repaired with replacement material. If breaking procedures or conditions change, additional excavations to inspect the broken pavement dimensions shall be made, as directed by the Engineer. Any large concrete pieces that result from inadequate breaking shall be treated as follows:

<u>Size and Location of Pieces</u>	<u>Action *</u>
Greater than 16 in. at surface of broken pavement	Reduce size to under 16 in., or remove and replace.

\* This requirement may be waived at the discretion of the engineer.

Unsuitable or unstable material encountered during the breaking process shall be removed and disposed of, according to Article 202.03 of the Standard Specifications. Areas approximately 10 sq. ft. or less may be repaired by use of aggregate replacement material. Larger unstable areas require removal and replacement, as directed by the Engineer. Following subgrade repairs, bituminous concrete binder mixture shall be placed to the depth of the original PCC pavement, compacted to the satisfaction of the Engineer.

Compaction. Prior to placing the bituminous overlay, the complete width of the broken pavement shall be compacted by vibratory steel wheel and pneumatic tired rollers in the following sequence:

After breaking:

1. Minimum of four passes with Z-pattern steel grid roller (only with the MHB).
2. Four passes with a vibratory roller.
3. Two passes with a pneumatic-tired roller.

The contractor shall not trim the broken or rubblized pavement, or otherwise attempt to grade the broken or rubblized pavement to improve the grade lines.

Immediately prior to overlay:

Two passes with a vibratory roller.

Any unstable material encountered while compacting or under construction traffic shall be treated as defined in the section entitled Pavement Breaking. If a large area of unstable material is identified during the rubblizing process, work shall be halted and the Engineer notified. Any depressions greater than 2 in. in depth shall be filled with replacement material and compacted. When specified by the Engineer, replacement material shall be used to reestablish the pavement crown. Water may be used to aid in compaction of the replacement material, when approved by the Engineer.

Opening Roadway to Traffic. Public traffic will not be allowed on the rubblized pavement before the required binder layers are in place, except at access points. Construction traffic shall be limited to delivery of materials directly ahead of the paver.

Paving Limitations. A tracked paver shall be used to place the first lift of HMA binder over the prepared rubblized pavement. At a given location, the overlay shall be placed within 48 hours of the pavement breaking operation. If rain occurs between rubblizing and paving, the rubblized pavement shall be dry and stable to the satisfaction of the Engineer before the paving operation begins.

Method of Measurement. Rubblizing will be measured for payment in square yards of existing pavement in place.

Basis of Payment. This work will be paid for at the contract unit price per square yards for RUBBLIZING PORTLAND CEMENT CONCRETE PAVEMENT, utilizing Method I as shown in the plans and as specified herein.

Any required removal of unsuitable or unstable material, subgrade repair, and HMA placement will be paid for according to Article 109.04 of the Standard Specifications.

Action taken to address any large concrete pieces resulting from inadequate breaking will not be paid for separately.

Contract# 91372  
Champaign County  
Section #04-00358-01-RS  
Project RS-516(112)  
FAS 516

## STATUS OF UTILITIES

Utility adjustment or relocation should not be required by this project. The Illinois Underground Utility Facilities Damage Prevention Act requires persons excavating to contact the one call system (J.U.L.I.E. 800-892-0123) before digging.

The following is the list of utilities present in the area of the project with contact information.

<u>Name of Utility Co./ Contact Person</u>		<u>Status</u>
<u>SBC</u> Joan Gray	847-898-4702	No work required
<u>Ameren/CIPS</u> 1112 Anthony Dr. P.O. Box 17070, MC P35 Urbana, IL 61803-7070 John Indelicato, Mike Tipton	217-2340559	No work required
<u>CONXXUS, LLC</u> 330 W. Ottawa P.O. Box 328 Paxton, IL 60957 Kevin Osterbur	217-379-2026	No work required
<u>Eastern Illini Electric Coop</u> 330 W. Ottawa P.O. Box 96 Paxton, IL 60957 Alan Schweighart	217-379-2131x173	No work required
<u>Verizon, North</u> 212 E. Grove St. Rantoul, IL 61866 Greg Curtis, Jackie Roelfs	217-892-34267	No work required
<u>Marathon Ashland Pipe, Line LLC</u> 5825 E. Cumberland Rd. P.O. Box F Martinsville, IL 62442-0573 Jerry Self	217-382-4911x2215	No work required

Contract# 91372  
Champaign County  
Section #04-00358-01-RS  
Project RS-516(112)  
FAS 516

## STATUS OF UTILITIES

<u>Name of Utility Co./ Contact Person</u>		<u>Status</u>
<u>McLeod USA</u> 102 Shafer St Forsyth, IL 62535 Mark Mills; Bob Miles, OSP Supervisor	217-8767194x240	No work required
<u>Nicor Gas</u> 1305 Martin Luther King Dr. Bloomington, IL 61701 Jack Fike	630-388-2362	No work required
<u>Mediacom</u> 1102 North 4 <sup>th</sup> St. P.O. Box 334 Chillicothe, IL 61523 Amy Robinson, Dave Conkle	309-274-4500	No work required
<u>Ludlow Township Highway Commissioner</u> Kenneth During	217-396-8803	
<u>Village of Ludlow</u>	217-396-8862	

G.N.-107.12

THE NAME ADDRESS AND TELEPHONE NUMBER OF THE LOCAL RAILROAD  
CONTACT IS:

Mr. Hardy Taylor  
1907 Marion Avenue  
Mattoon, IL 61938  
(217) 238-2443

SPECIAL ATTENTION IS CALLED TO ARTICLE 107.12 REGARDING FLAGGERS.  
THE NAME, ADDRESS AND TELEPHONE NUMBER OF THE RAILROAD CONTACT  
PERSON FOR FLAGGERS IS:

Mr. Tom Tucker  
2800 Livernois Rd.  
Troy, MI 48083  
(248) 740-6227

## **DISADVANTAGED BUSINESS ENTERPRISE PARTICIPATION (BDE)**

Effective: September 1, 2000

Revised: January 1, 2007

**FEDERAL OBLIGATION.** The Department of Transportation, as a recipient of federal financial assistance, is required to take all necessary and reasonable steps to ensure nondiscrimination in the award and administration of contracts. Consequently, the federal regulatory provisions of 49 CFR part 26 apply to this contract concerning the utilization of disadvantaged business enterprises. For the purposes of this Special Provision, a disadvantaged business enterprise (DBE) means a business certified by the Department in accordance with the requirements of 49 CFR part 26 and listed in the DBE Directory or most recent addendum.

**STATE OBLIGATION.** This Special Provision will also be used by the Department to satisfy the requirements of the Business Enterprise for Minorities, Females, and Persons with Disabilities Act, 30 ILCS 575. When this Special Provision is used to satisfy state law requirements on 100 percent state-funded contracts, the federal government has no involvement in such contracts (not a federal-aid contract) and no responsibility to oversee the implementation of this Special Provision by the Department on those contracts. DBE participation on 100 percent state-funded contracts will not be credited toward fulfilling the Department's annual overall DBE goal required by the US Department of Transportation to comply with the federal DBE program requirements.

**CONTRACTOR ASSURANCE.** The Contractor makes the following assurance and agrees to include the assurance in each subcontract that the Contractor signs with a subcontractor:

The Contractor, subrecipient, or subcontractor shall not discriminate on the basis of race, color, national origin, or sex in the performance of this contract. The Contractor shall carry out applicable requirements of 49 CFR part 26 in the award and administration of contracts funded in whole or in part with federal or state funds. Failure by the Contractor to carry out these requirements is a material breach of this contract, which may result in the termination of this contract or such other remedy as the recipient deems appropriate.

**OVERALL GOAL SET FOR THE DEPARTMENT.** As a requirement of compliance with 49 CFR part 26, the Department has set an overall goal for DBE participation in its federally assisted contracts. That goal applies to all federal-aid funds the Department will expend in its federally assisted contracts for the subject reporting fiscal year. The Department is required to make a good faith effort to achieve the overall goal. The dollar amount paid to all approved DBE firms performing work called for in this contract is eligible to be credited toward fulfillment of the Department's overall goal.

**CONTRACT GOAL TO BE ACHIEVED BY THE CONTRACTOR.** This contract includes a specific DBE utilization goal established by the Department. The goal has been included because the Department has determined that the work of this contract has subcontracting opportunities that may be suitable for performance by DBE companies. This determination is based on an assessment of the type of work, the location of the work, and the availability of



DBE companies to do a part of the work. The assessment indicates that, in the absence of unlawful discrimination, and in an arena of fair and open competition, DBE companies can be expected to perform 3 % of the work. This percentage is set as the DBE participation goal for this contract. Consequently, in addition to the other award criteria established for this contract, the Department will award this contract to a bidder who makes a good faith effort to meet this goal of DBE participation in the performance of the work. A bidder makes a good faith effort for award consideration if either of the following is done in accordance with the procedures set forth in this Special Provision:

- (a) The bidder documents that firmly committed DBE participation has been obtained to meet the goal; or
- (b) The bidder documents that a good faith effort has been made to meet the goal, even though the effort did not succeed in obtaining enough DBE participation to meet the goal.

**DBE LOCATOR REFERENCES.** Bidders may consult the DBE Directory as a reference source for DBE companies certified by the Department. In addition, the Department maintains a letting and item specific DBE locator information system whereby DBE companies can register their interest in providing quotes on particular bid items advertised for letting. Information concerning DBE companies willing to quote work for particular contracts may be obtained by contacting the Department's Bureau of Small Business Enterprises at telephone number (217)785-4611, or by visiting the Department's web site at [www.dot.il.gov](http://www.dot.il.gov).

**BIDDING PROCEDURES.** Compliance with the bidding procedures of this Special Provision is required prior to the award of the contract and the failure of the as-read low bidder to comply will render the bid not responsive.

- (a) In order to assure the timely award of the contract, the as-read low bidder shall submit a Disadvantaged Business Utilization Plan on Department form SBE 2026 within seven working days after the date of letting. To meet the seven day requirement, the bidder may send the Plan by certified mail or delivery service within the seven working day period. If a question arises concerning the mailing date of a Plan, the mailing date will be established by the U.S. Postal Service postmark on the original certified mail receipt from the U.S. Postal Service or the receipt issued by a delivery service. It is the responsibility of the bidder to ensure that the postmark or receipt date is affixed within the seven working days if the bidder intends to rely upon mailing or delivery to satisfy the submission day requirement. The Plan is to be submitted to the Department of Transportation, Bureau of Small Business Enterprises, Contract Compliance Section, 2300 South Dirksen Parkway, Room 319, Springfield, Illinois 62764 (Telefax: (217)785-1524). It is the responsibility of the bidder to obtain confirmation of telefax delivery. The Department will not accept a Utilization Plan if it does not meet the seven day submittal requirement and the bid will be declared not responsive. In the event the bid is declared not responsive due to a failure to submit a Plan or failure to comply with the bidding procedures set forth herein, the Department may elect to cause the forfeiture of the penal sum of the bidder's proposal guaranty, and may deny authorization to bid the

project if re-advertised for bids. The Department reserves the right to invite any other bidder to submit a Utilization Plan at any time for award consideration or to extend the time for award.

- (b) The Utilization Plan shall indicate that the bidder either has obtained sufficient DBE participation commitments to meet the contract goal or has not obtained enough DBE participation commitments in spite of a good faith effort to meet the goal. The Utilization Plan shall further provide the name, telephone number, and telefax number of a responsible official of the bidder designated for purposes of notification of plan approval or disapproval under the procedures of this Special Provision.
- (c) The Utilization Plan shall include a DBE Participation Commitment Statement, Department form SBE 2025, for each DBE proposed for the performance of work to achieve the contract goal. The signatures on these forms must be original signatures. All elements of information indicated on the said form shall be provided, including but not limited to the following:
  - (1) The name and address of each DBE to be used;
  - (2) A description, including pay item numbers, of the commercially useful work to be done by each DBE;
  - (3) The price to be paid to each DBE for the identified work specifically stating the quantity, unit price, and total subcontract price for the work to be completed by the DBE. If partial pay items are to be performed by the DBE, indicate the portion of each item, a unit price where appropriate and the subcontract price amount;
  - (4) A commitment statement signed by the bidder and each DBE evidencing availability and intent to perform commercially useful work on the project; and
  - (5) If the bidder is a joint venture comprised of DBE firms and non-DBE firms, the plan must also include a clear identification of the portion of the work to be performed by the DBE partner(s).
- (d) The contract will not be awarded until the Utilization Plan submitted by the bidder is approved. The Utilization Plan will be approved by the Department if the Plan commits sufficient commercially useful DBE work performance to meet the contract goal. The Utilization Plan will not be approved by the Department if the Plan does not commit sufficient DBE performance to meet the contract goal unless the bidder documents that it made a good faith effort to meet the goal. The good faith procedures of Section VIII of this special provision apply. If the Utilization Plan is not approved because it is deficient in a technical matter, unless waived by the Department, the bidder will be notified and will be allowed no less than a five working day period in order to cure the deficiency.

CALCULATING DBE PARTICIPATION. The Utilization Plan values represent work anticipated to be performed and paid for upon satisfactory completion. The Department is only able to

count toward the achievement of the overall goal and the contract goal the value of payments made for the work actually performed by DBE companies. In addition, a DBE must perform a commercially useful function on the contract to be counted. A commercially useful function is generally performed when the DBE is responsible for the work and is carrying out its responsibilities by actually performing, managing, and supervising the work involved. The Department and Contractor are governed by the provisions of 49 CFR part 26.55(c) on questions of commercially useful functions as it affects the work. Specific counting guidelines are provided in 49 CFR part 26.55, the provisions of which govern over the summary contained herein.

- (a) DBE as the Contractor: 100 percent goal credit for that portion of the work performed by the DBE's own forces, including the cost of materials and supplies. Work that a DBE subcontracts to a non-DBE firm does not count toward the DBE goals.
- (b) DBE as a joint venture Contractor: 100 percent goal credit for that portion of the total dollar value of the contract equal to the distinct, clearly defined portion of the work performed by the DBE's own forces.
- (c) DBE as a subcontractor: 100 percent goal credit for the work of the subcontract performed by the DBE's own forces, including the cost of materials and supplies, excluding the purchase of materials and supplies or the lease of equipment by the DBE subcontractor from the prime Contractor or its affiliates. Work that a DBE subcontractor in turn subcontracts to a non-DBE firm does not count toward the DBE goal.
- (d) DBE as a trucker: 100 percent goal credit for trucking participation provided the DBE is responsible for the management and supervision of the entire trucking operation for which it is responsible. At least one truck owned, operated, licensed, and insured by the DBE must be used on the contract. Credit will be given for the full value of all such DBE trucks operated using DBE employed drivers. Goal credit will be limited to the value of the reasonable fee or commission received by the DBE if trucks are leased from a non-DBE company.
- (e) DBE as a material supplier:
  - (1) 60 percent goal credit for the cost of the materials or supplies purchased from a DBE regular dealer.
  - (2) 100 percent goal credit for the cost of materials or supplies obtained from a DBE manufacturer.
  - (3) 100 percent credit for the value of reasonable fees and commissions for the procurement of materials and supplies if not a regular dealer or manufacturer.

GOOD FAITH EFFORT PROCEDURES. If the bidder cannot obtain sufficient DBE commitments to meet the contract goal, the bidder must document in the Utilization Plan the good faith efforts made in the attempt to meet the goal. This means that the bidder must show

that all necessary and reasonable steps were taken to achieve the contract goal. Necessary and reasonable steps are those which could reasonably be expected to obtain sufficient DBE participation. The Department will consider the quality, quantity, and intensity of the kinds of efforts that the bidder has made. Mere *pro forma* efforts are not good faith efforts; rather, the bidder is expected to have taken those efforts that would be reasonably expected of a bidder actively and aggressively trying to obtain DBE participation sufficient to meet the contract goal.

- (a) The following is a list of types of action that the Department will consider as part of the evaluation of the bidder's good faith efforts to obtain participation. These listed factors are not intended to be a mandatory checklist and are not intended to be exhaustive. Other factors or efforts brought to the attention of the Department may be relevant in appropriate cases, and will be considered by the Department.
  - (1) Soliciting through all reasonable and available means (e.g. attendance at pre-bid meetings, advertising and/or written notices) the interest of all certified DBE companies that have the capability to perform the work of the contract. The bidder must solicit this interest within sufficient time to allow the DBE companies to respond to the solicitation. The bidder must determine with certainty if the DBE companies are interested by taking appropriate steps to follow up initial solicitations.
  - (2) Selecting portions of the work to be performed by DBE companies in order to increase the likelihood that the DBE goals will be achieved. This includes, where appropriate, breaking out contract work items into economically feasible units to facilitate DBE participation, even when the prime Contractor might otherwise prefer to perform these work items with its own forces.
  - (3) Providing interested DBE companies with adequate information about the plans, specifications, and requirements of the contract in a timely manner to assist them in responding to a solicitation.
  - (4) a. Negotiating in good faith with interested DBE companies. It is the bidder's responsibility to make a portion of the work available to DBE subcontractors and suppliers and to select those portions of the work or material needs consistent with the available DBE subcontractors and suppliers, so as to facilitate DBE participation. Evidence of such negotiation includes the names, addresses, and telephone numbers of DBE companies that were considered; a description of the information provided regarding the plans and specifications for the work selected for subcontracting; and evidence as to why additional agreements could not be reached for DBE companies to perform the work.
    - b. A bidder using good business judgment would consider a number of factors in negotiating with subcontractors, including DBE subcontractors, and would take a firm's price and capabilities as well as contract goals into consideration. However, the fact that there may be some additional costs involved in finding and using DBE companies is not in itself sufficient reason for a bidder's failure to meet the contract DBE goal, as long as such costs are reasonable. Also, the

ability or desire of a bidder to perform the work of a contract with its own organization does not relieve the bidder of the responsibility to make good faith efforts. Bidders are not, however, required to accept higher quotes from DBE companies if the price difference is excessive or unreasonable.

- (5) Not rejecting DBE companies as being unqualified without sound reasons based on a thorough investigation of their capabilities. The bidder's standing within its industry, membership in specific groups, organizations, or associations and political or social affiliations (for example union vs. non-union employee status) are not legitimate causes for the rejection or non-solicitation of bids in the bidder's efforts to meet the project goal.
  - (6) Making efforts to assist interested DBE companies in obtaining bonding, lines of credit, or insurance as required by the recipient or Contractor.
  - (7) Making efforts to assist interested DBE companies in obtaining necessary equipment, supplies, materials, or related assistance or services.
  - (8) Effectively using the services of available minority/women community organizations; minority/women contractors' groups; local, state, and federal minority/women business assistance offices; and other organizations as allowed on a case-by-case basis to provide assistance in the recruitment and placement of DBE companies.
- (b) If the Department determines that the bidder has made a good faith effort to secure the work commitment of DBE companies to meet the contract goal, the Department will award the contract provided that it is otherwise eligible for award. If the Department determines that a good faith effort has not been made, the Department will notify the bidder of that preliminary determination by contacting the responsible company official designated in the Utilization Plan. The preliminary determination shall include a statement of reasons why good faith efforts have not been found, and may include additional good faith efforts that the bidder could take. The notification will designate a five working day period during which the bidder shall take additional efforts. The bidder is not limited by a statement of additional efforts, but may take other action beyond any stated additional efforts in order to obtain additional DBE commitments. The bidder shall submit an amended Utilization Plan if additional DBE commitments to meet the contract goal are secured. If additional DBE commitments sufficient to meet the contract goal are not secured, the bidder shall report the final good faith efforts made in the time allotted. All additional efforts taken by the bidder will be considered as part of the bidder's good faith efforts. If the bidder is not able to meet the goal after taking additional efforts, the Department will make a pre-final determination of the good faith efforts of the bidder and will notify the designated responsible company official of the reasons for an adverse determination.
- (c) The bidder may request administrative reconsideration of a pre-final determination adverse to the bidder within the five working days after the notification date of the determination by delivering the request to the Department of Transportation, Bureau of

Small Business Enterprises, Contract Compliance Section, 2300 South Dirksen Parkway, Room 319, Springfield, Illinois 62764 (Telefax: (217)785-1524). Deposit of the request in the United States mail on or before the fifth business day shall not be deemed delivery. The pre-final determination shall become final if a request is not made and delivered. A request may provide additional written documentation and/or argument concerning the issue of whether an adequate good faith effort was made to meet the contract goal. In addition, the request shall be considered a consent by the bidder to extend the time for award. The request will be forwarded to the Department's Reconsideration Officer. The Reconsideration Officer will extend an opportunity to the bidder to meet in person in order to consider all issues of whether the bidder made a good faith effort to meet the goal. After the review by the Reconsideration Officer, the bidder will be sent a written decision within ten working days after receipt of the request for reconsideration, explaining the basis for finding that the bidder did or did not meet the goal or make adequate good faith efforts to do so. A final decision by the Reconsideration Officer that a good faith effort was made shall approve the Utilization Plan submitted by the bidder and shall clear the contract for award. A final decision that a good faith effort was not made shall render the bid not responsive.

**CONTRACT COMPLIANCE.** Compliance with this Special Provision is an essential part of the contract. The Department is prohibited by federal regulations from crediting the participation of a DBE included in the Utilization Plan toward either the contract goal or the Department's overall goal until the amount to be applied toward the goals has been paid to the DBE. The following administrative procedures and remedies govern the compliance by the Contractor with the contractual obligations established by the Utilization Plan. After approval of the Plan and award of the contract, the Utilization Plan and individual DBE Participation Statements become part of the contract. If the Contractor did not succeed in obtaining enough DBE participation to achieve the advertised contract goal, and the Utilization Plan was approved and contract awarded based upon a determination of good faith, the total dollar value of DBE work calculated in the approved Utilization Plan as a percentage of the awarded contract value shall become the amended contract goal.

- (a) No amendment to the Utilization Plan may be made without prior written approval from the Department's Bureau of Small Business Enterprises. All requests for amendment to the Utilization Plan shall be submitted to the Department of Transportation, Bureau of Small Business Enterprises, Contract Compliance Section, 2300 South Dirksen Parkway, Room 319, Springfield, Illinois 62764. Telephone number (217) 785-4611. Telefax number (217) 785-1524.
- (b) All work indicated for performance by an approved DBE shall be performed, managed, and supervised by the DBE executing the Participation Statement. The Contractor shall not terminate for convenience a DBE listed in the Utilization Plan and then perform the work of the terminated DBE with its own forces, those of an affiliate or those of another subcontractor, whether DBE or not, without first obtaining the written consent of the Bureau of Small Business Enterprises to amend the Utilization Plan. If a DBE listed in the Utilization Plan is terminated for reasons other than convenience, or fails to complete its work on the contract for any reason, the Contractor shall make good faith efforts to

find another DBE to substitute for the terminated DBE. The good faith efforts shall be directed at finding another DBE to perform at least the same amount of work under the contract as the DBE that was terminated, but only to the extent needed to meet the contract goal or the amended contract goal. The Contractor shall notify the Bureau of Small Business Enterprises of any termination for reasons other than convenience, and shall obtain approval for inclusion of the substitute DBE in the Utilization Plan. If good faith efforts following a termination of a DBE for cause are not successful, the Contractor shall contact the Bureau and provide a full accounting of the efforts undertaken to obtain substitute DBE participation. The Bureau will evaluate the good faith efforts in light of all circumstances surrounding the performance status of the contract, and determine whether the contract goal should be amended.

- (c) The Contractor shall maintain a record of payments for work performed to the DBE participants. The records shall be made available to the Department for inspection upon request. After the performance of the final item of work or delivery of material by a DBE and final payment therefor to the DBE by the Contractor, but not later than thirty calendar days after payment has been made by the Department to the Contractor for such work or material, the Contractor shall submit a DBE Payment Report on Department form SBE 2115 to the Regional Engineer. If full and final payment has not been made to the DBE, the Report shall indicate whether a disagreement as to the payment required exists between the Contractor and the DBE or if the Contractor believes that the work has not been satisfactorily completed. If the Contractor does not have the full amount of work indicated in the Utilization Plan performed by the DBE companies indicated in the Plan, the Department will deduct from contract payments to the Contractor the amount of the goal not achieved as liquidated and ascertained damages.
- (d) The Department reserves the right to withhold payment to the Contractor to enforce the provisions of this Special Provision. Final payment shall not be made on the contract until such time as the Contractor submits sufficient documentation demonstrating achievement of the goal in accordance with this Special Provision or after liquidated damages have been determined and collected.
- (e) Notwithstanding any other provision of the contract, including but not limited to Article 109.09 of the Standard Specifications, the Contractor may request administrative reconsideration of a decision to deduct the amount of the goal not achieved as liquidated damages. A request to reconsider shall be delivered to the Contract Compliance Section and shall be handled and considered in the same manner as set forth in paragraph (c) of "Good Faith Effort Procedures" of this Special Provision, except a final decision that a good faith effort was not made during contract performance to achieve the goal agreed to in the Utilization Plan shall be the final administrative decision of the Department.

80029

## **ERRATA FOR THE 2007 STANDARD SPECIFICATIONS (BDE)**

Effective: January 1, 2007

- Page 60 Article 109.07(a). In the second line of the first paragraph change "amount" to "quantity".
- Page 207 Article 406.14. In the second line of the second paragraph change "MIXTURE FOR CRACKS, JOINTS, AND FLANGEWAYS, of the mixture composition specified;" to "MIXTURE FOR CRACKS, JOINTS, AND FLANGEWAYS;".
- Page 398 Article 540.07(b). Add the following two paragraphs after the third paragraph:
- "Excavation in rock will be measured for payment according to Article 502.12.
- Removal and disposal of unstable and/or unsuitable material below plan bedding grade will be measured for payment according to Article 202.07."
- Page 398 Article 540.08. Add the following two paragraphs after the fifth paragraph:
- "Excavation in rock will be paid for according to Article 502.13.
- Removal and disposal of unstable and/or unsuitable material below plan bedding grade will be paid for according to Article 202.08."
- Page 465 Article 551.06. In the second line of the first paragraph change "or" to "and/or".
- Page 585 Article 701.19(a). Add "701400" to the second line of the first paragraph.
- Page 586 Article 701.19(c). Delete "701400" from the second line of the first paragraph.
- Page 586 Article 701.19. Add the following subparagraph to this Article:
- "(f) Removal of existing pavement markings and raised reflective pavement markers will be measured for payment according to Article 783.05."
- Page 587 Article 701.20(b). Delete "TRAFFIC CONTROL AND PROTECTION 701400;" from the first paragraph.
- Page 588 Article 701.20. Add the following subparagraph to this Article.
- "(j) Removal of existing pavement markings and raised reflective pavement markers will be paid for according to Article 783.06."
- Page 762 Article 1020.04. In Table 1 Classes of Portland Cement Concrete and Mix Design Criteria, add to the minimum cement factor for Class PC Concrete "5.65 (TY III)", and add to the maximum cement factor for Class PC Concrete "7.05 (TY III)".



- Page 765 Article 1020.04. In Table 1 Classes of Portland Cement Concrete and Mix Design Criteria (metric), add to the minimum cement factor for Class PC Concrete "335 (TY III)", and add to the maximum cement factor for Class PC Concrete "418 (TY III)".
- Page 809 Article 1030.05. Revise the subparagraph "(a) Quality Assurance by the Engineer." to read "(e) Quality Assurance by the Engineer."
- Page 946 Article 1080.03(a)(1). In the third line of the first paragraph revise "(300  $\mu\text{m}$ )" to "(600  $\mu\text{m}$ )".
- Page 963 Article 1083.02(b). In the second line of the first paragraph revise "ASTM D 4894" to "ASTM D 4895".
- Page 1076 In the Index of Pay Items delete the pay item "BITUMINOUS SURFACE REMOVAL – BUTT JOINT".
- Page 1081 In the Index of Pay Items add "Section 406, HOT-MIX ASPHALT SURFACE REMOVAL – BUTT JOINT, Page 207".

80168

## **HOT-MIX ASPHALT EQUIPMENT, SPREADING AND FINISHING MACHINE (BDE)**

Effective: January 1, 2005

Revised: January 1, 2007

Revise the fourth paragraph of Article 1102.03 of the Standard Specifications to read:

“The paver shall be equipped with a receiving hopper having sufficient capacity for a uniform spreading operation. The hopper shall be equipped with a distribution system to uniformly place a non-segregated mixture in front of the screed. The distribution system shall have chain curtains, deflector plates, and /or other devices designed and built by the paver manufacturer to prevent segregation during distribution of the mixture from the hopper to the paver screed. The Contractor shall submit a written certification that the devices recommended by the paver manufacturer to prevent segregation have been installed and are operational. Prior to paving, the Contractor, in the presence of the Engineer, shall visually inspect paver parts specifically identified by the manufacturer for excessive wear and the need for replacement. The Contractor shall supply a completed check list to the Engineer noting the condition of the parts. Worn parts shall be replaced. The Engineer may require an additional inspection prior to placement of the surface course or at other times throughout the work.”

80142

## PAYMENTS TO SUBCONTRACTORS (BDE)

Effective: June 1, 2000

Revised: January 1, 2006

Federal regulations found at 49 CFR §26.29 mandate the Department to establish a contract clause to require Contractors to pay subcontractors for satisfactory performance of their subcontracts and to set the time for such payments.

State law also addresses the timing of payments to be made to subcontractors and material suppliers. Section 7 of the Prompt Payment Act, 30 ILCS 540/7, requires that when a Contractor receives any payment from the Department, the Contractor shall make corresponding, proportional payments to each subcontractor and material supplier performing work or supplying material within 15 calendar days after receipt of the Department payment. Section 7 of the Act further provides that interest in the amount of two percent per month, in addition to the payment due, shall be paid to any subcontractor or material supplier by the Contractor if the payment required by the Act is withheld or delayed without reasonable cause. The Act also provides that the time for payment required and the calculation of any interest due applies to transactions between subcontractors and lower-tier subcontractors and material suppliers throughout the contracting chain.

This Special Provision establishes the required federal contract clause, and adopts the 15 calendar day requirement of the State Prompt Payment Act for purposes of compliance with the federal regulation regarding payments to subcontractors. This contract is subject to the following payment obligations.

When progress payments are made to the Contractor according to Article 109.07 of the Standard Specifications, the Contractor shall make a corresponding payment to each subcontractor and material supplier in proportion to the work satisfactorily completed by each subcontractor and for the material supplied to perform any work of the contract. The proportionate amount of partial payment due to each subcontractor and material supplier throughout the contracting chain shall be determined by the quantities measured or otherwise determined as eligible for payment by the Department and included in the progress payment to the Contractor. Subcontractors and material suppliers shall be paid by the Contractor within 15 calendar days after the receipt of payment from the Department. The Contractor shall not hold retainage from the subcontractors. These obligations shall also apply to any payments made by subcontractors and material suppliers to their subcontractors and material suppliers; and to all payments made to lower tier subcontractors and material suppliers throughout the contracting chain. Any payment or portion of a payment subject to this provision may only be withheld from the subcontractor or material supplier to whom it is due for reasonable cause.

This Special Provision does not create any rights in favor of any subcontractor or material supplier against the State or authorize any cause of action against the State on account of any payment, nonpayment, delayed payment, or interest claimed by application of the State Prompt Payment Act. The Department will not approve any delay or postponement of the 15 day requirement except for reasonable cause shown after notice and hearing pursuant to Section

| 7(b) of the State Prompt Payment Act. State law creates other and additional remedies available to any subcontractor or material supplier, regardless of tier, who has not been paid for work properly performed or material furnished. These remedies are a lien against public funds set forth in Section 23(c) of the Mechanics Lien Act, 770 ILCS 60/23(c), and a recovery on the Contractor's payment bond according to the Public Construction Bond Act, 30 ILCS 550.

80022



The Contractor will be advised when the Department has received approval of the insurance from the railroad(s). Before any work begins on railroad right-of-way, the Contractor shall submit to the Engineer evidence that the required insurance has been approved by the railroad(s). The Contractor shall also provide the Engineer with the expiration date of each required policy.

Basis of Payment. Providing Railroad Protective Liability and Property Damage Liability Insurance will be paid for at the contract unit price per Lump Sum for RAILROAD PROTECTIVE LIABILITY INSURANCE.

80157

## RECLAIMED ASPHALT PAVEMENT (RAP) (BDE)

Effective: January 1, 2007

Revised: January 2, 2007

In Article 1030.02(g), delete the last sentence of the first paragraph in (Note 2).

Revise Section 1031 of the Standard Specifications to read:

### "SECTION 1031. RECLAIMED ASPHALT PAVEMENT

**1031.01 Description.** Reclaimed asphalt pavement (RAP) is reclaimed asphalt pavement resulting from cold milling or crushing of an existing dense graded hot-mix asphalt (HMA) pavement. The Contractor shall supply written documentation that the RAP originated from routes or airfields under federal, state, or local agency jurisdiction.

**1031.02 Stockpiles.** The Contractor shall construct individual, sealed RAP stockpiles meeting one of the following definitions. No additional RAP shall be added to the pile after the pile has been sealed. Stockpiles shall be sufficiently separated to prevent intermingling at the base. Stockpiles shall be identified by signs indicating the type as listed below (i.e. "Homogeneous Surface").

Prior to milling, the Contractor shall request the District to provide verification of the quality of the RAP to clarify appropriate stockpile.

- (a) Homogeneous. Homogeneous RAP stockpiles shall consist of RAP from Class I, Superpave (High ESAL), HMA (High ESAL), or equivalent mixtures and represent: 1) the same aggregate quality, but shall be at least C quality; 2) the same type of crushed aggregate (either crushed natural aggregate, ACBF slag, or steel slag); 3) similar gradation; and 4) similar asphalt binder content. If approved by the Engineer, combined single pass surface/binder millings may be considered "homogenous" with a quality rating dictated by the lowest coarse aggregate quality present in the mixture.
- (b) Conglomerate 5/8. Conglomerate 5/8 RAP stockpiles shall consist of RAP from Class I, Superpave (High ESAL), HMA (High ESAL), or equivalent mixtures. The coarse aggregate in this RAP shall be crushed aggregate and may represent more than one aggregate type and/or quality but shall be at least C quality. This RAP may have an inconsistent gradation and/or asphalt binder content prior to processing. All conglomerate 5/8 RAP shall be processed prior to testing by crushing to where all RAP shall pass the 5/8 in. (16 mm) or smaller screen. Conglomerate 5/8 RAP stockpiles shall not contain steel slag or other expansive material as determined by the Department.
- (c) Conglomerate 3/8. Conglomerate 3/8 RAP stockpiles shall consist of RAP from Class I, Superpave (High ESAL), HMA (High ESAL), or equivalent mixtures. The coarse aggregate in this RAP shall be crushed aggregate and may represent more than one aggregate type and/or quality but shall be at least B quality. This RAP may have an

inconsistent gradation and/or asphalt binder content prior to processing. All conglomerate 3/8 RAP shall be processed prior to testing by crushing to where all RAP shall pass the 3/8 in. (9.5 mm) or smaller screen. Conglomerate 3/8 RAP stockpiles shall not contain steel slag or other expansive material as determined by the Department.

(d) Conglomerate "D" Quality (DQ). Conglomerate DQ RAP stockpiles shall consist of RAP from Class I, Superpave (High or Low ESAL), HMA (High or Low ESAL), or equivalent mixtures. The coarse aggregate in this RAP may be crushed or round but shall be at least D quality. This RAP may have an inconsistent gradation and/or asphalt binder content. Conglomerate DQ RAP stockpiles shall not contain steel slag or other expansive material as determined by the Department.

(e) Non-Quality. RAP stockpiles that do not meet the requirements of the stockpile categories listed above shall be classified as "Non-Quality".

RAP containing contaminants, such as earth, brick, sand, concrete, sheet asphalt, bituminous surface treatment (i.e. chip seal), pavement fabric, joint sealants, etc., will be unacceptable unless the contaminants are removed to the satisfaction of the Engineer. Sheet asphalt shall be stockpiled separately.

**1031.03 Testing.** When used in HMA, the RAP shall be sampled and tested either during or after stockpiling.

For testing during stockpiling, washed extraction samples shall be run at the minimum frequency of one sample per 500 tons (450 metric tons) for the first 2000 tons (1800 metric tons) and one sample per 2000 tons (1800 metric tons) thereafter. A minimum of five tests shall be required for stockpiles less than 4000 tons (3600 metric tons).

For testing after stockpiling, the Contractor shall submit a plan for approval to the District proposing a satisfactory method of sampling and testing the RAP pile either in-situ or by restockpiling. The sampling plan shall meet the minimum frequency required above and detail the procedure used to obtain representative samples throughout the pile for testing.

Before extraction, each field sample shall be split to obtain two samples of test sample size. One of the two test samples from the final split shall be labeled and stored for Department use. The Contractor shall extract the other test sample according to Department procedure. The Engineer reserves the right to test any sample (split or Department-taken) to verify Contractor test results.

(a) Testing Conglomerate 3/8. In addition to the requirements above, conglomerate 3/8 RAP shall be tested for maximum theoretical specific gravity ( $G_{mm}$ ) at a frequency of one sample per 500 tons (450 metric tons) for the first 2000 tons (1800 metric tons) and one sample per 2000 tons (1800 metric tons) thereafter. A minimum of five tests shall be required for stockpiles less than 4000 tons (3600 metric tons).



- (b) Evaluation of Test Results. All of the extraction results shall be compiled and averaged for asphalt binder content and gradation and, when applicable  $G_{mm}$ . Individual extraction test results, when compared to the averages, will be accepted if within the tolerances listed below.

Parameter	Homogeneous / Conglomerate	Conglomerate "D" Quality
1 in. (25 mm)		± 5 %
1/2 in. (12.5 mm)	± 8 %	± 15 %
No. 4 (4.75 mm)	± 6 %	± 13 %
No. 8 (2.36 mm)	± 5 %	
No. 16 (1.18 mm)		± 15 %
No. 30 (600 μm)	± 5 %	
No. 200 (75 μm)	± 2.0 %	± 4.0 %
Asphalt Binder	± 0.4 % <sup>1/</sup>	± 0.5 %
$G_{mm}$	± 0.02 % <sup>2/</sup>	

1/ The tolerance for conglomerate 3/8 shall be ± 0.3 %.

2/ Applies only to conglomerate 3/8. When variation of the  $G_{mm}$  exceeds the ± 0.02 % tolerance, a new conglomerate 3/8 stockpile shall be created which will also require an additional mix design.

If more than 20 percent of the individual sieves are out of the gradation tolerances, or if more than 20 percent of the asphalt binder content test results fall outside the appropriate tolerances, the RAP shall not be used in HMA unless the RAP representing the failing tests is removed from the stockpile. All test data and acceptance ranges shall be sent to the District for evaluation.

With the approval of the Engineer, the ignition oven may be substituted for extractions according to the Illinois Test Procedure, "Calibration of the Ignition Oven for the Purpose of Characterizing Reclaimed Asphalt Pavement (RAP)".

**1031.04 Quality Designation of Aggregate in RAP.** The quality of the RAP shall be set by the lowest quality of coarse aggregate in the RAP stockpile and are designated as follows.

- (a) RAP from Class I, Superpave (High ESAL), or HMA (High ESAL) surface mixtures are designated as containing Class B quality coarse aggregate.
- (b) RAP from Superpave (Low ESAL)/HMA (Low ESAL) IL-19.0L binder and IL-9.5L surface mixtures are designated as Class D quality coarse aggregate.
- (c) RAP from Class I, Superpave (High ESAL), or HMA (High ESAL) binder mixtures, bituminous base course mixtures, and bituminous base course widening mixtures are designated as containing Class C quality coarse aggregate.

- (d) RAP from bituminous stabilized subbase and BAM shoulders are designated as containing Class D quality coarse aggregate.

**1031.05 Use of RAP in HMA.** The use of RAP in HMA shall be as follows.

- (a) Coarse Aggregate Size. The coarse aggregate in all RAP shall be equal to or less than the nominal maximum size requirement for the HMA mixture to be produced.
- (b) Steel Slag Stockpiles. RAP stockpiles containing steel slag or other expansive material, as determined by the Department, shall be homogeneous and will be approved for use in HMA (High ESAL and Low ESAL) surface mixtures only.
- (c) Use in HMA Surface Mixtures (High and Low ESAL). RAP stockpiles for use in HMA surface mixtures (High and Low ESAL) shall be either homogeneous or conglomerate 3/8, in which the coarse aggregate is Class B quality or better.
- (d) Use in HMA Binder Mixtures (High and Low ESAL), HMA Base Course, and HMA Base Course Widening. RAP stockpiles for use in HMA binder mixtures (High and Low ESAL), HMA base course, and HMA base course widening shall be homogeneous, conglomerate 5/8, or conglomerate 3/8, in which the coarse aggregate is Class C quality or better.
- (e) Use in Shoulders and Subbase. RAP stockpiles for use in HMA shoulders and stabilized subbase (HMA) shall be homogeneous, conglomerate 5/8, conglomerate 3/8, or conglomerate DQ.
- (f) The use of RAP shall be a contractor's option when constructing HMA in all contracts. When the contractor chooses the RAP option, the percentage of RAP shall not exceed the amounts indicated in the table for a given N Design.

Max RAP Percentage

SUPERPAVE MIXTURES <sup>1/, 3/</sup>	MAXIMUM % RAP			
	Ndesign	Binder/Leveling Binder	Surface	Polymer Modified
30	30	30	10	10
50	25	15	10	10
70	15 / 25 <sup>2/</sup>	10 / 15 <sup>2/</sup>	10	10
90	10	10	10	10
105	10	10	10	10

Note 1: For HMA Shoulder and Stabilized Sub-Base (HMA) N-30, the amount of RAP shall not exceed 50% of the mixture.

Note 2: Value of Max % RAP if 3/8 RAP is utilized.

Note 3: When RAP exceeds 20%, the high & low virgin asphalt binder grades shall each be reduced by one grade (i.e. 25% RAP would require a virgin asphalt binder grade of PG64-22 to be reduced to a PG58-28).

**1031.06 HMA Mix Designs.** At the Contractor's option, HMA mixtures may be constructed utilizing RAP material meeting the above detailed requirements.

RAP designs shall be submitted for volumetric verification. If additional RAP stockpiles are tested and found that no more than 20 percent of the results, as defined under "Testing" herein, are outside of the control tolerances set for the original RAP stockpile and HMA mix design, and meets all of the requirements herein, the additional RAP stockpiles may be used in the original mix design at the percent previously verified.

**1031.07 HMA Production.** The coarse aggregate in all RAP used shall be equal to or less than the nominal maximum size requirement for the HMA mixture being produced.

To remove or reduce agglomerated material, a scalping screen, crushing unit, or comparable sizing device approved by the Engineer shall be used in the RAP feed system to remove or reduce oversized material. If material passing the sizing device adversely affects the mix production or quality of the mix, the sizing device shall be set at a size specified by the Engineer.

If the RAP control tolerances or QC/QA test results require corrective action, the Contractor shall cease production of the mixture containing RAP and either switch to the virgin aggregate design or submit a new RAP design. When producing mixtures containing conglomerate 3/8 RAP, a positive dust control system shall be utilized.

HMA plants utilizing RAP shall be capable of automatically recording and printing the mixture proportions and asphalt binder content. The asphalt binder content as a percentage of the total mix shall be printed as well as the individual percentages of virgin asphalt binder and residual asphalt binder from the RAP.

**1031.08 RAP in Aggregate Surface Course and Aggregate Shoulders.** The use of RAP in aggregate surface course and aggregate shoulders shall be as follows.

- (a) Stockpiles and Testing. RAP stockpiles may be any of those listed in Article 1031.02, except "Other". The testing requirements of Article 1031.03 shall not apply.
- (b) Gradation. One hundred percent of the RAP material shall pass the 1 1/2 in. (37.5 mm) sieve. The RAP material shall be reasonably well graded from coarse to fine. RAP material that is gap-graded or single sized will not be accepted."

80172

## **SUBCONTRACTOR MOBILIZATION PAYMENTS (BDE)**

Effective: April 2, 2005

To account for the preparatory work and operations necessary for the movement of subcontractor personnel, equipment, supplies, and incidentals to the project site and for all other work or operations that must be performed or costs incurred when beginning work approved for subcontracting in accordance with Article 108.01 of the Standard Specifications, the Contractor shall make a mobilization payment to each subcontractor.

This mobilization payment shall be made at least 14 days prior to the subcontractor starting work. The amount paid shall be equal to 3 percent of the amount of the subcontract reported on form BC 260A submitted for the approval of the subcontractor's work.

This provision shall be incorporated directly or by reference into each subcontract approved by the Department.

80143

**WORKING DAYS (BDE)**

Effective: January 1, 2002

The Contractor shall complete the work within **35** working days.

80071

**CHAMPAIGN COUNTY  
SECTION NO. 04-00358-01-RS  
FAS ROUTE 516 (C.H. 9)  
PROJECT NO. ACRS-516 (112)  
JOB NO. C-95-306-07  
CONTRACT NO. 91372**

FUNC. CLASS: MAJOR COLLECTOR, 2007 ADT = 350

**STANDARDS**

00001-04 - STD SYM, ABBREV & PATTERNS  
701006-02 - OFF RD OPER, 2L, 2W, MIN. 15' AWAY, >45 MPH  
701011-01 - OFF RD MOV. OPER, 2L, 2W, DAY ONLY, >45 MPH  
701201-02 - LN CLOS, 2L, 2W, DAY ONLY, ON RD >45MPH  
701301-02 - LANE CLOSE, 2L, 2W, SHORT TIME OPER  
701306-01 - LANE CLOSE, 2L, 2W, >45MPH  
702001-06 - TRAFFIC CONTROL DEVICES  
BLR 22-4 - MAILBOX TURNOUTS

J.U.L.I.E. 1-800-892-0123

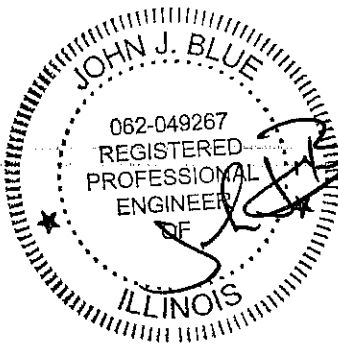

Approved	<u>12-7-06</u>
	Date
	<u>J. Blue</u> <i>Champaign County Engineer</i>
	Local Agency, Position
Approved	<u>12/7/06</u>
	Date
	<u>D. H. S.</u>
	Dist # Engineer of Local Roads & Streets
Releasing for Bid Based on Limited Review	<u>12/10/06</u>
	Date
	<u>J. Blue</u>
	Deputy Director of Hwys, Region # Engineer

Contract No. 91372

# LOCATION MAP

## 04-00358-01-RS, County Highway 9

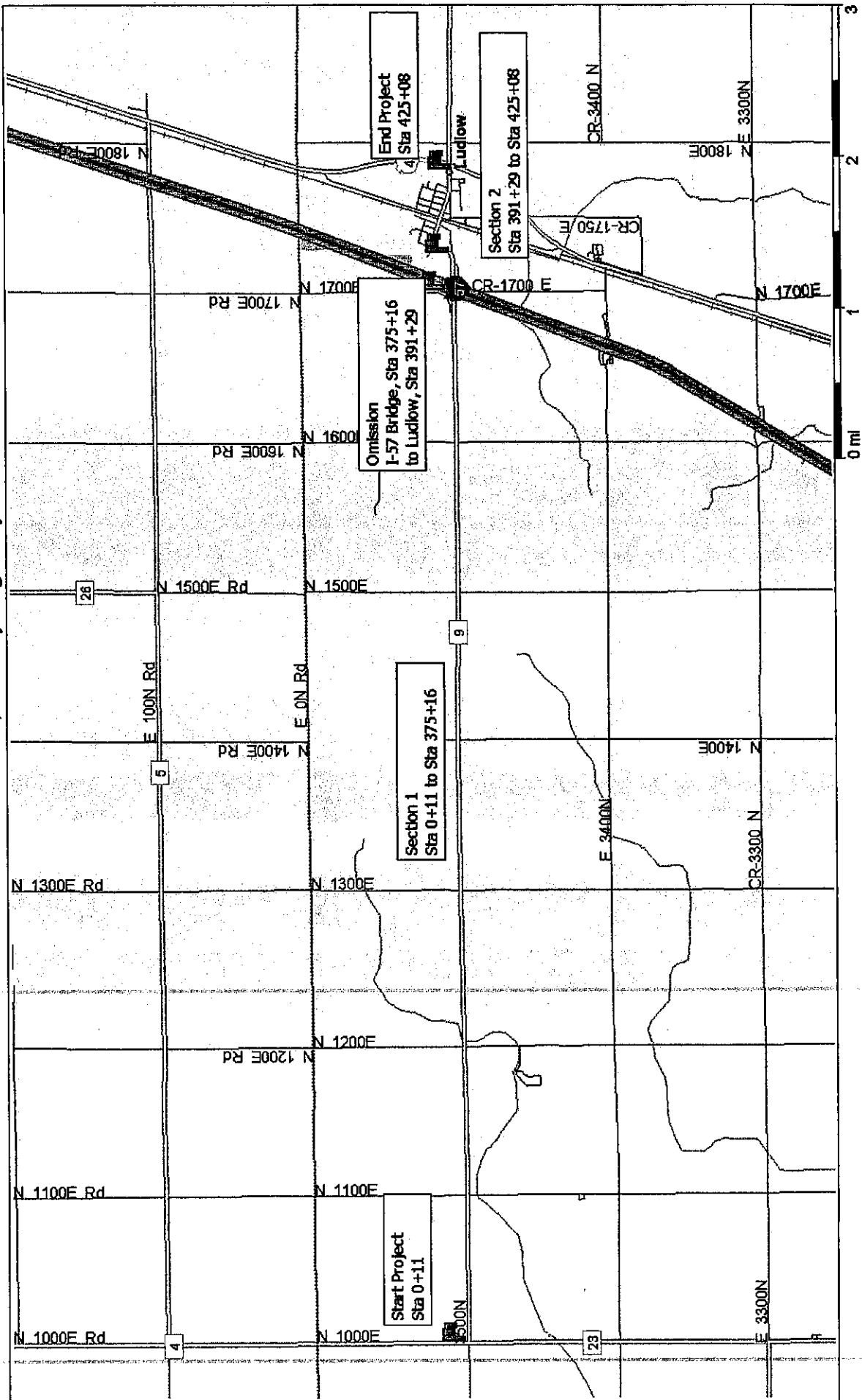

Copyright © 1988-2004 Microsoft Corp. and/or its suppliers. All rights reserved. <http://www.microsoft.com/streets/>  
 © Copyright 2003 by Geographic Data Technology, Inc. All rights reserved. This data includes information taken with permission from Canadian authorities © Her Majesty the Queen in Right of Canada.

**SUMMARY OF QUANTITIES**

Item No.	Item	Unit	Quantity
40300100	Bit. Materials, Prime Coat	Gallon	14,913.00
40600932	HMA Surf. Removal. Butt Joints	Sy. Yd.	969.20
40600990	Temporary Ramps	Sy. Yd.	154.70
40603080	HMA BC IL 19.0 N50	Ton	8,976.00
40603310	HMA Surface Cse, Mix C, N50	Ton	11,231.00
44000157	HMA Surface Removal, 2"	Sy. Yd.	4,383.00
44000198	HMA Removal, Variable Depth	Sq. Yd.	45,597.40
40800050	Incidental HMA Surfacing	Ton	324.00
48101800	Aggregate Shoulder, Spl	Sy. Yd.	25,605.00
67100100	Mobilization	L. Sum	1.00
70101700	Traffic Control & Protection	L. Sum	1.00
70300100	Short Term Pvt Marking Tape	Ft.	1,959.00
X0300471	Rubblizing PCC Pavement	Sy. Yd.	37,467.00
Z0048665	RR Prot. Liability Insurance	L. Sum	1.00



TOT. SHEET NO.	COUNTY	SECTION
1	CHAMPAIGN	14-000001-002
COUNTY HIGHWAY 9 (PAR. RTE 616), SECTION 1		

**SECTION 1, STA 0+11 TO 108+10**

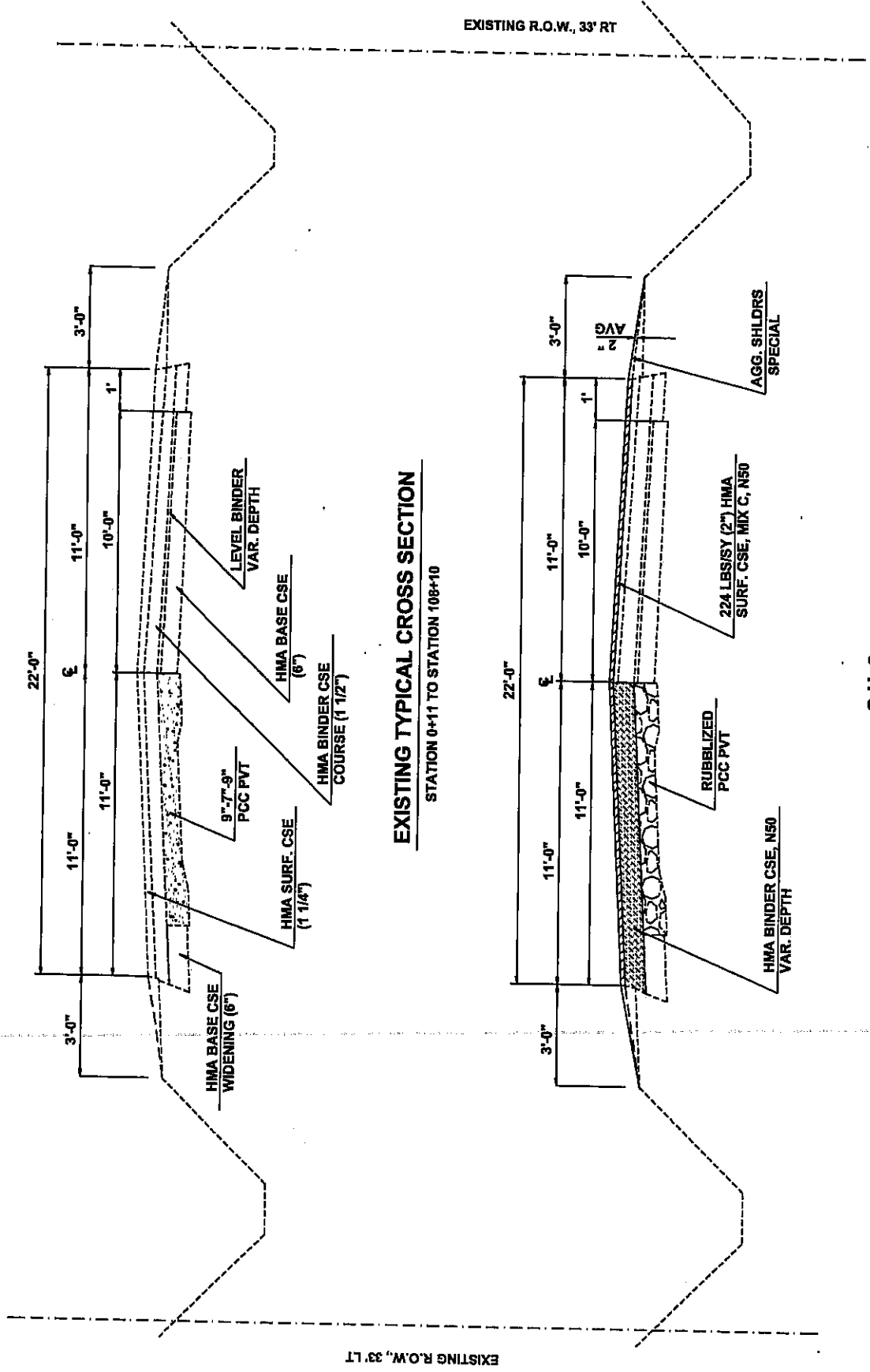

**EXISTING TYPICAL CROSS SECTION**

STATION 0+11 TO STATION 108+10

**PROPOSED TYPICAL CROSS SECTION**

STATION 0+11 TO STATION 108+10

C.H. 9

SECTION	COUNTY	DATE	BY
84-00382-1-RE	CHAMPAIGN		
COUNTY HIGHWAY 8 (FAS RTE 216), SECTION 1			

**SECTION 1, STA 108+10 TO 375+16**

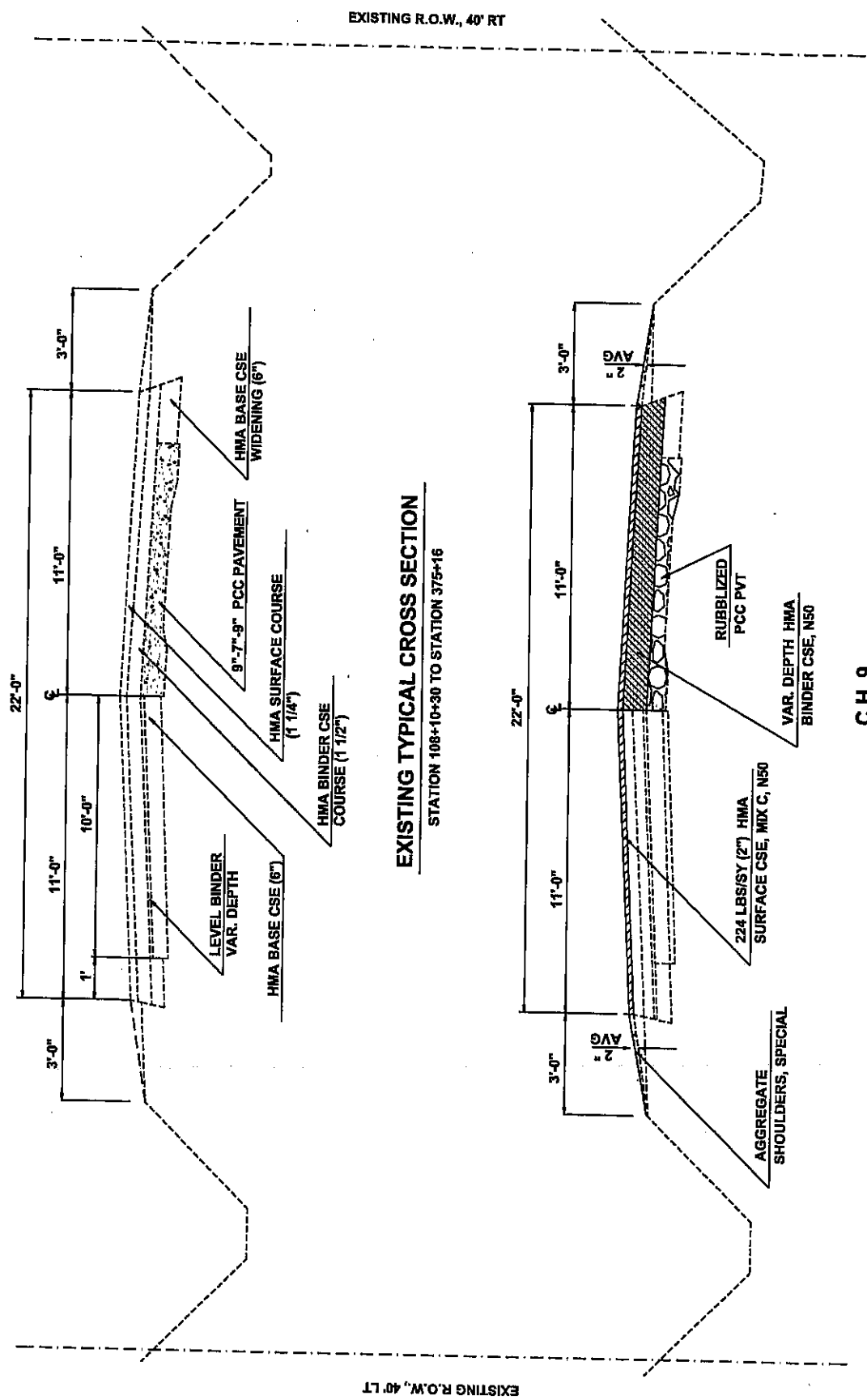

**EXISTING TYPICAL CROSS SECTION**  
STATION 108+10+30 TO STATION 375+16

**PROPOSED TYPICAL CROSS SECTION**  
STATION 108+10 TO STATION 375+16

C.H. 9

TOT. SHEET NO.	SECTION	COUNTY	SHEET NO.
	4-00552-105	CHAMPLAIN	
COUNTY HIGHWAY 8 (PAV RTE 815), SECTION 2			

**SECTION 2, STA 391+29 TO 415+70**  
**LUDLOW**

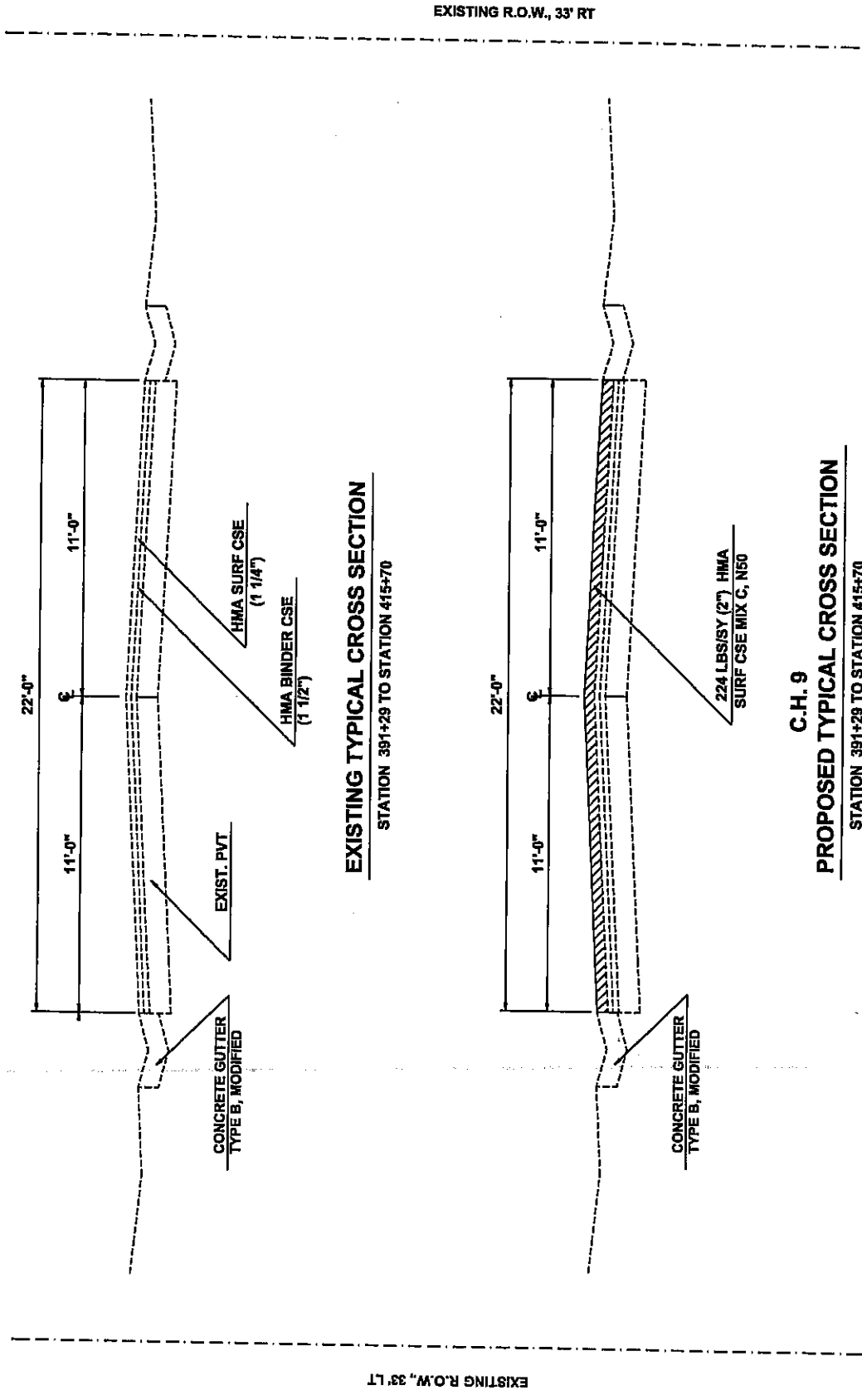

TOT. SHEET NO.	
COUNTY	CHUMPAKONG
SECTION	SECTION 2
PROJECT NO.	425+08
COUNTY HIGHWAY 8 (P.A.S. RTE. 816), SECTION 2	

**SECTION 2, STA 415+70 TO 425+08**  
**LUDLOW**

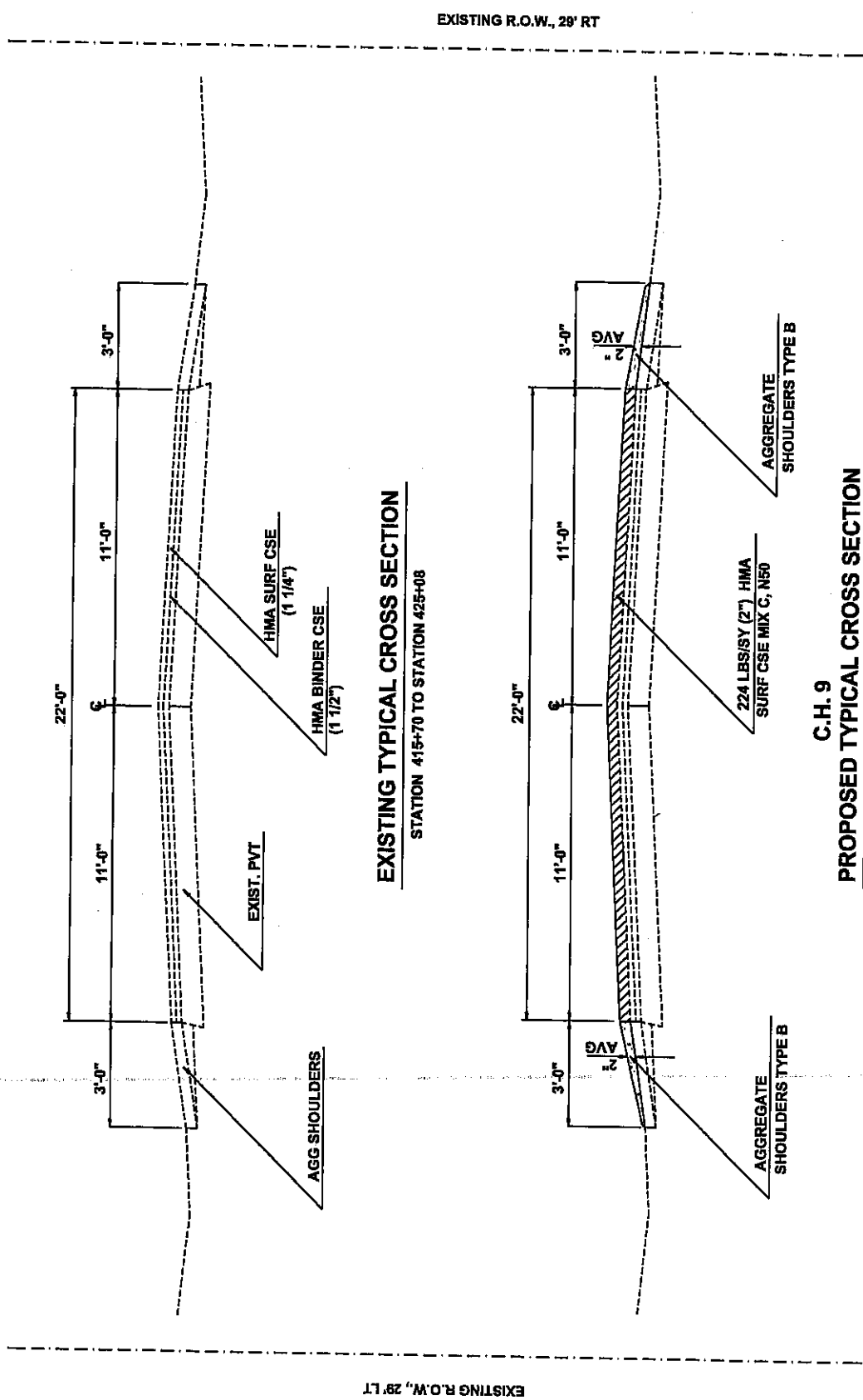

**EXISTING TYPICAL CROSS SECTION**  
STATION 415+70 TO STATION 425+08

**PROPOSED TYPICAL CROSS SECTION**  
STATION 415+70 TO STATION 425+08

C.H. 9

F.A.S. RTE.	SECTION	COUNTY	TOT SHTS	SHT NO
516	D4-00358-01-RB	CHAMPAIGN		
COUNTY HIGHWAY 9				

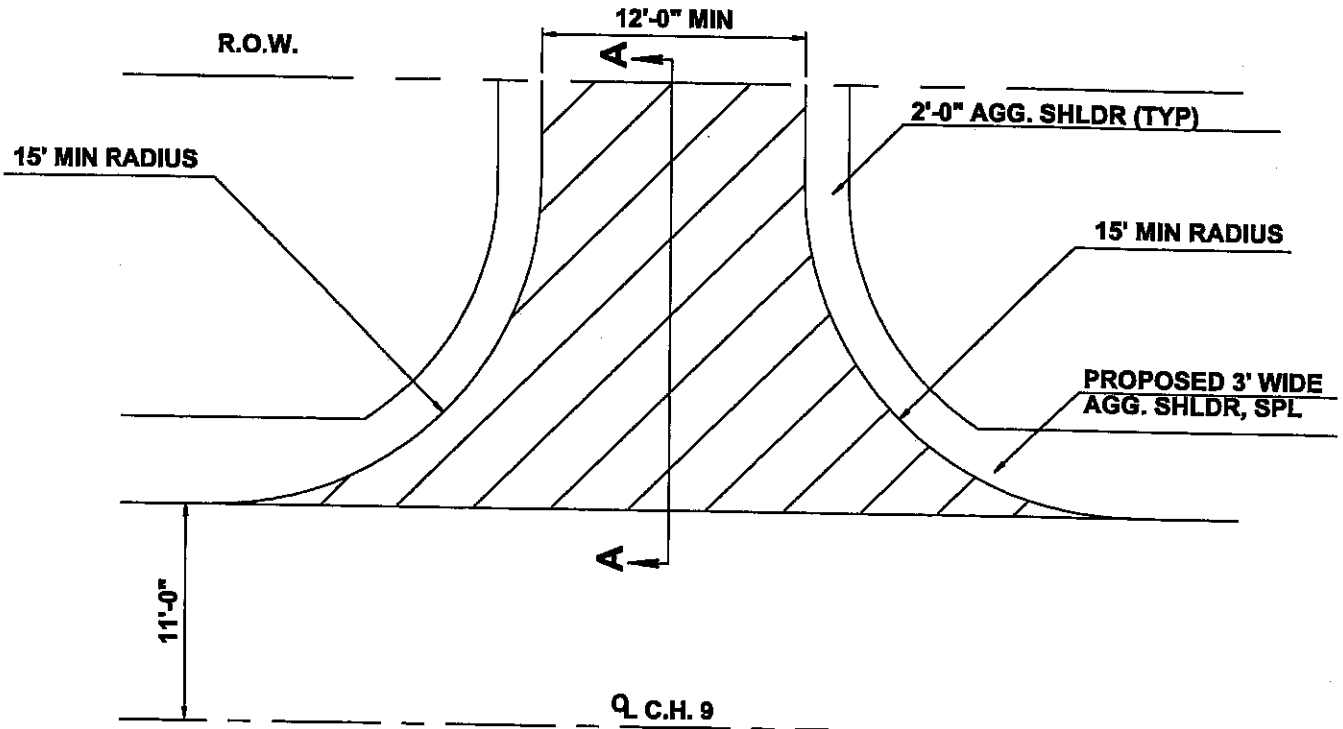

**PRIVATE & COMMERCIAL ENTRANCE DETAIL**  
 TOTAL = 14 P.E. EACH

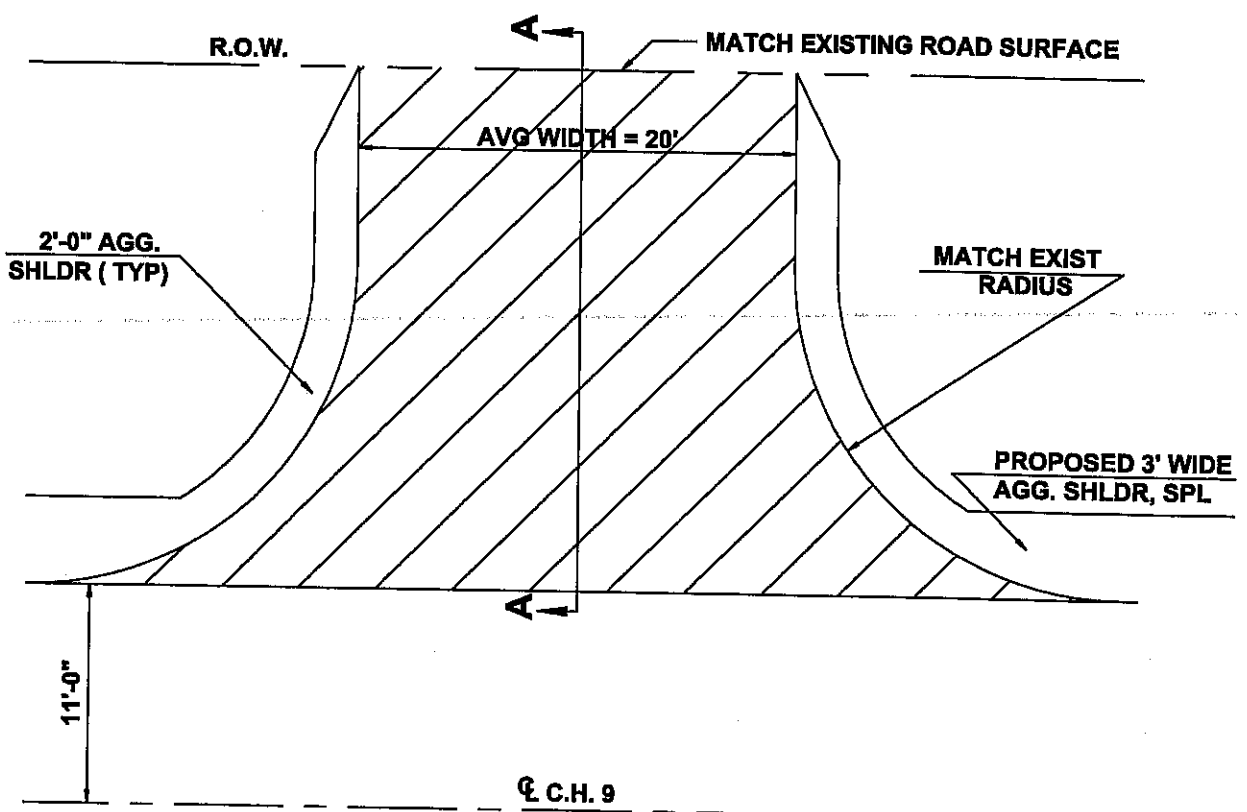

**SIDE ROAD RESURFACING DETAIL**  
 TOTAL = 12 EACH

F.A.S. RTE.	SECTION	COUNTY	TOT SHTS	SHT NO
518	04-00358-01-R5	CHAMPAIGN		
COUNTY HIGHWAY 9				

AVG THICKNESS = 2"

PROPOSED 3' WIDE  
AGG. SHOULDER, SPL

15'-0" RADIUS  
(TYP)

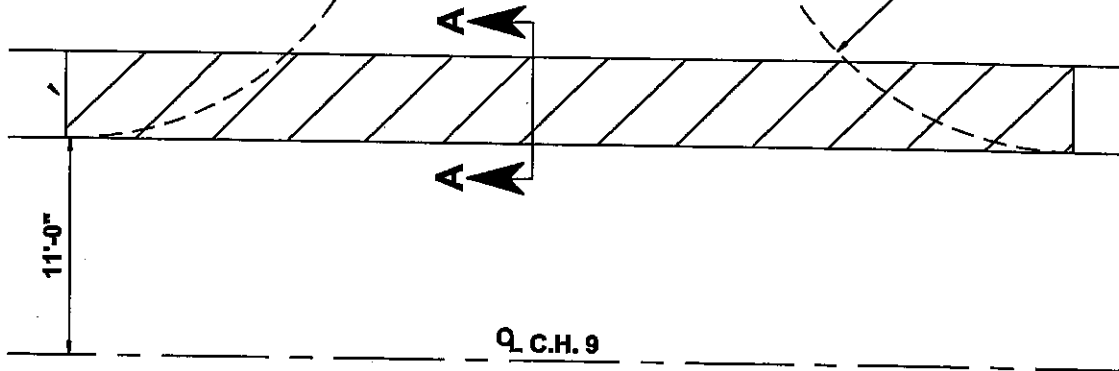

**FIELD ENTRANCE DETAIL**  
TOTAL = 59 EACH

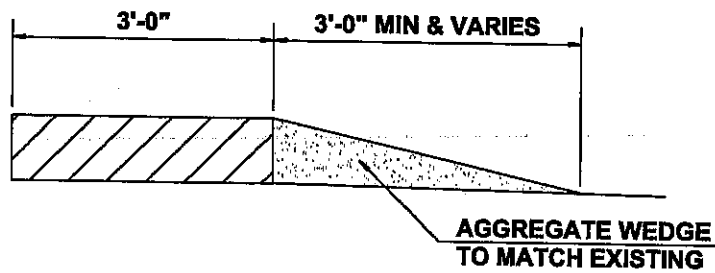

**SECTION A-A**

F.A.S. RTE.	SECTION	COUNTY	TOT SHTS	SHT NO
518	04-00358-01-R8	CHAMPAIGN		
COUNTY HIGHWAY 9				

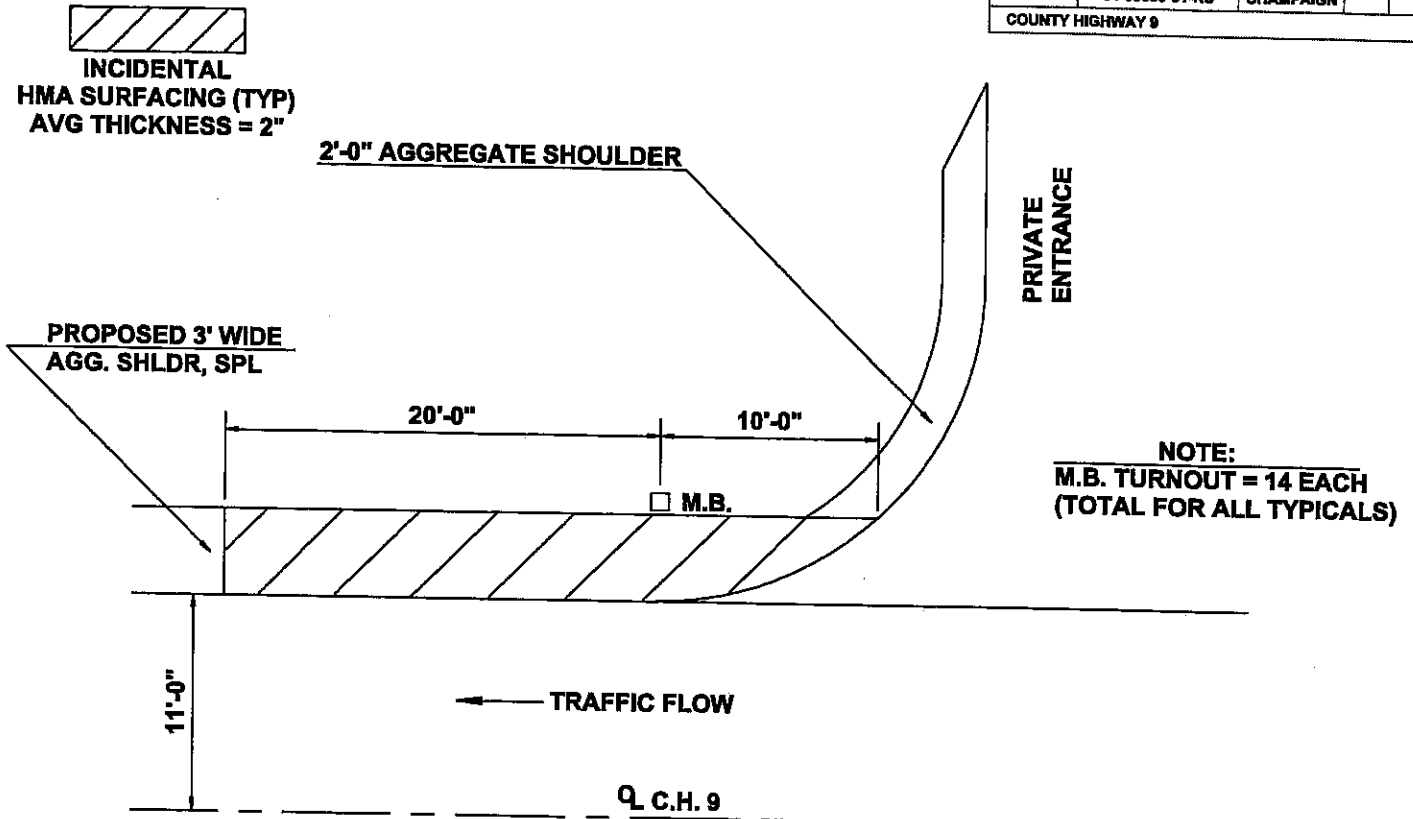

## MAILBOX TURNOUT BEYOND PRIVATE ENTRANCE

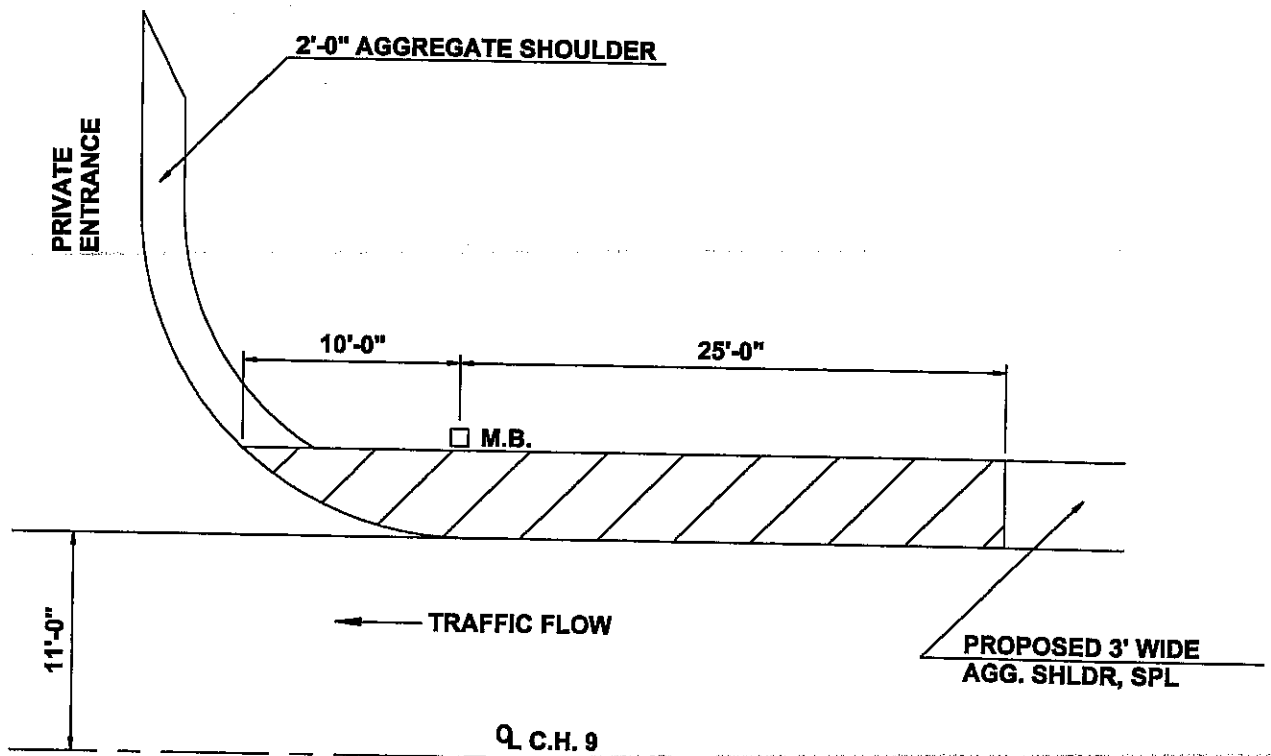

## MAILBOX TURNOUT AHEAD OF PRIVATE ENTRANCE

F.A.S. RTE.	SECTION	COUNTY	TOT SHTS	SHT NO
516	04-00356-01-R6	CHAMPAIGN		
COUNTY HIGHWAY 9				

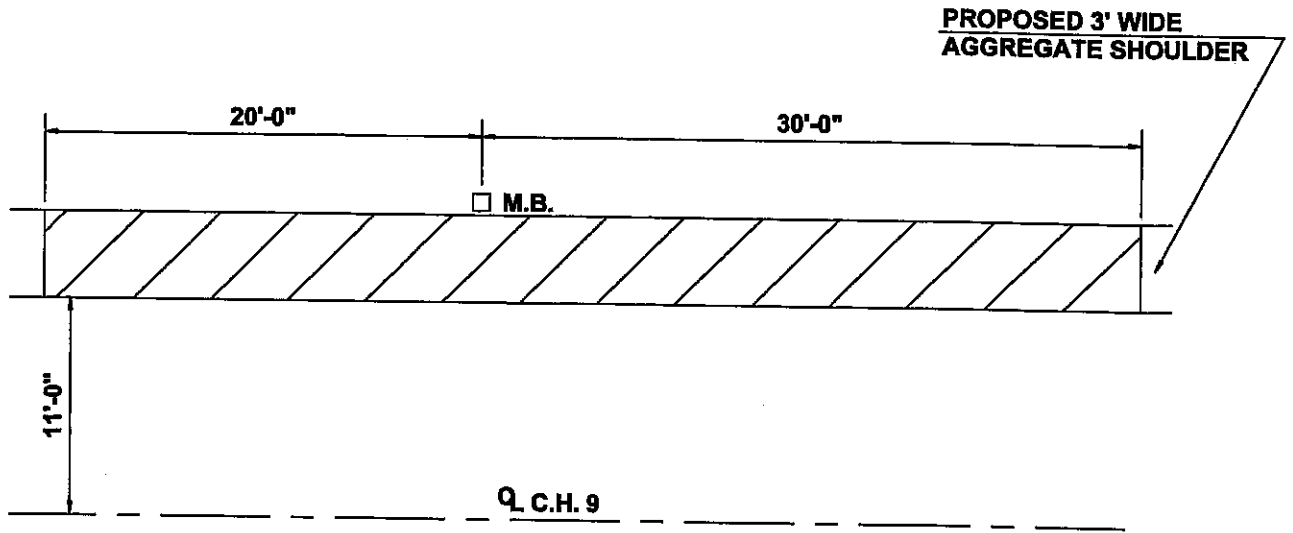

**MAILBOX TURNOUT (ISOLATED)**

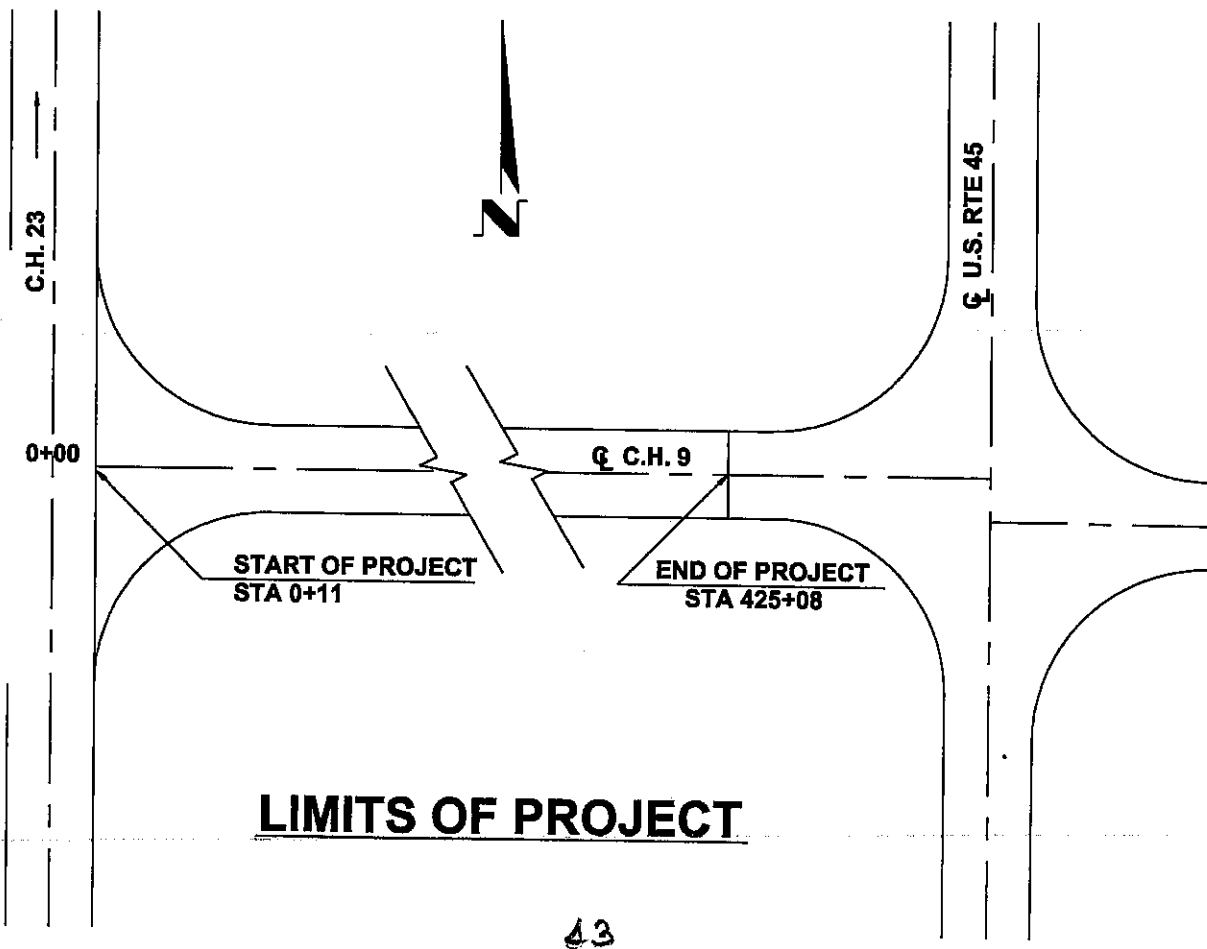



F.A.S. RTE.	SECTION	COUNTY	TOT SHTS	SHT NO
518	04-00358-01-R8	CHAMPAIGN		
COUNTY HIGHWAY 9				

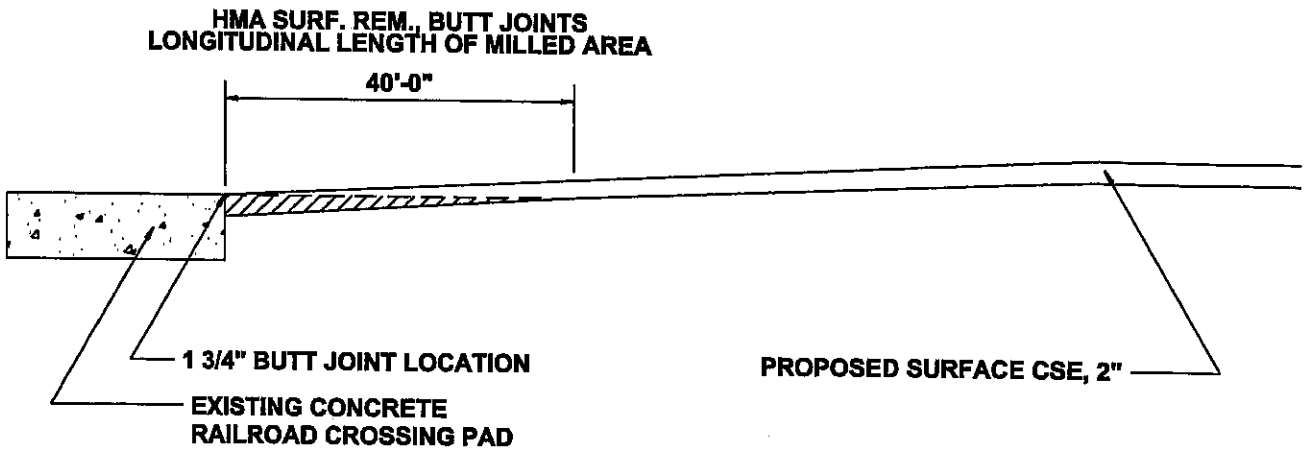

**RAILROAD CROSSING BUTT JOINT DETAIL**  
SECTION ALONG  $\text{\textcircled{C}}$  OF ROAD

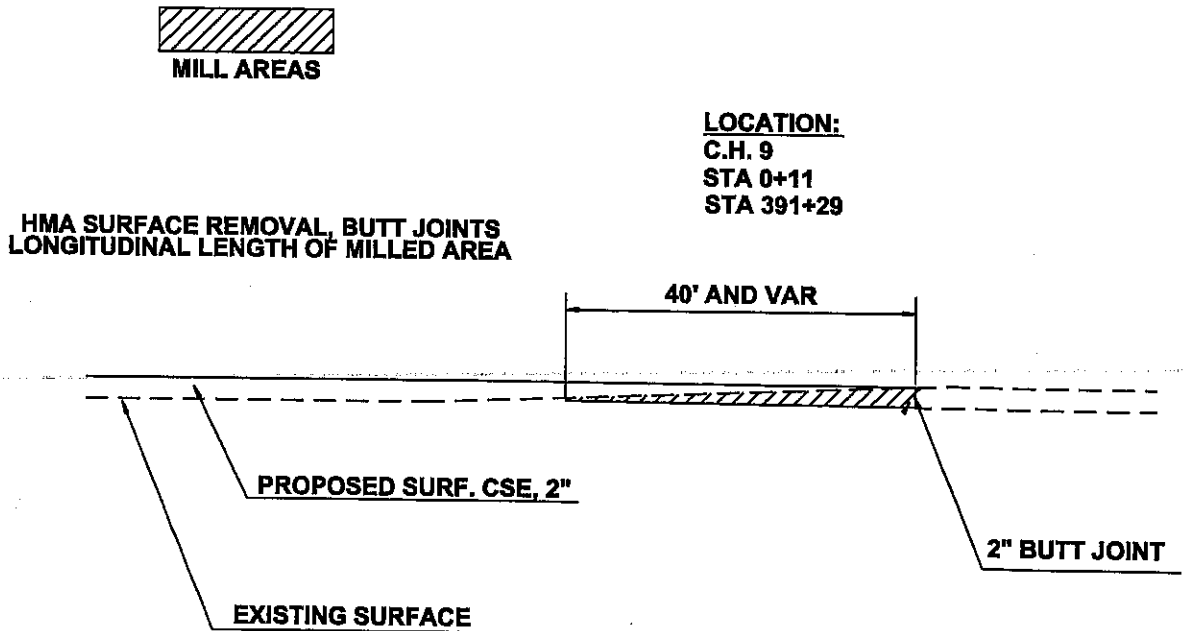

**MAINLINE BUTT JOINT DETAIL**  
SECTION ALONG  $\text{\textcircled{C}}$  OF ROAD

F.A.S. RTE.	SECTION	COUNTY	TOT SHTS	SHT NO
516	04-00358-01-R8	CHAMPAIGN		
COUNTY HIGHWAY 9				



**MILL AREAS**

**LOCATION:**  
**C.H. 9**  
**STA 107+75**

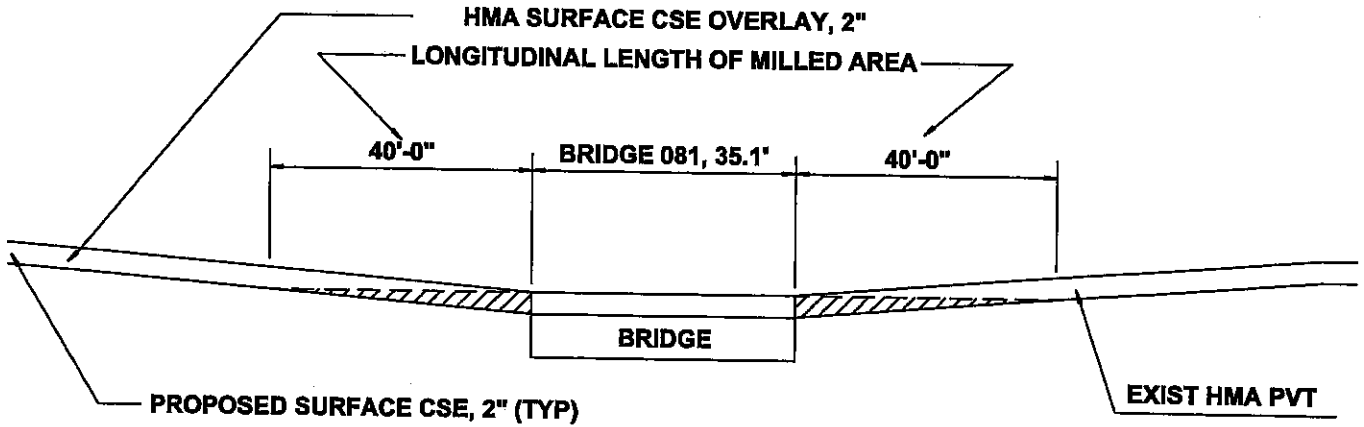

**BUTT JOINT DETAIL AT STRUCTURE NO. 081**  
 SECTION ALONG  $\text{\textcircled{C}}$  OF ROAD

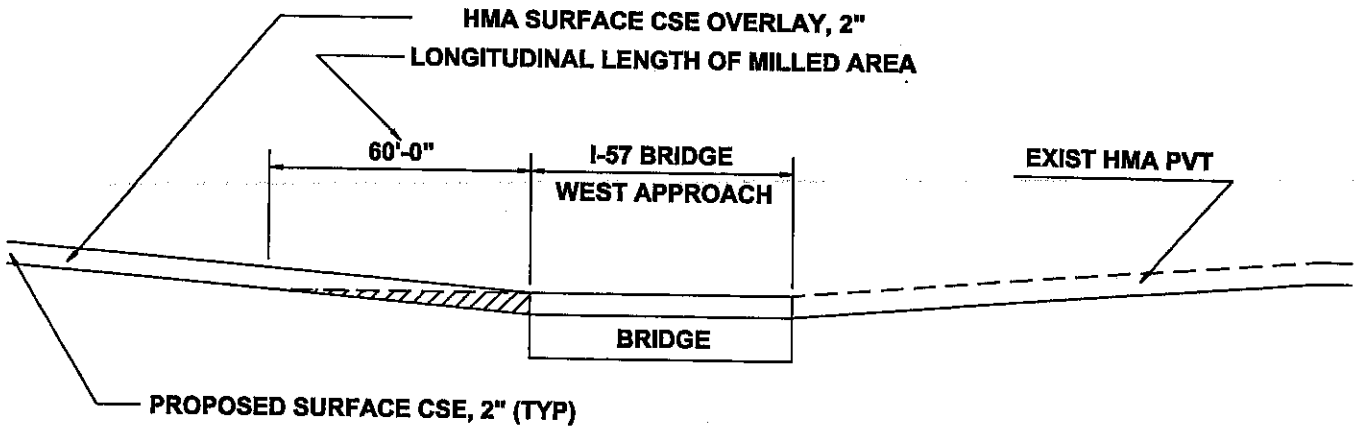

**DETAIL FOR MILLED AREA AT I-57 BRIDGE**  
 SECTION ALONG  $\text{\textcircled{C}}$  OF ROAD



**ADJUSTMENT ITEMS**

Structure To Be Adjusted

Structure To Be Cleaned

Structure To Be Filled

Structure To Be Removed

Structure To Be Reconstructed

Frame and Grate To Be Adjusted

Frame and Lid To Be Adjusted

Domestic Service Box To Be Adjusted

Valve Vault To Be Adjusted

Special Adjustment

Item To Be Abandoned

Item To Be Moved

Item To Be Relocated

Pavement Removal and Replacement

EX

PR

ADJ

C

F

R

REC

A

A

A

SP

AB

M

REL



**ALIGNMENT ITEMS**

Baseline

Centerline

Centerline Break Circle

Baseline Symbol

Centerline Symbol

PI Indicator

Point Indicator

Horiz Curve Data

EX

PR

O

B

C

A

O

CURVE

P.I. STA=  
 $\Delta$ =  
 R=  
 T=  
 L=  
 E=  
 $\theta$ =  
 T.R.=  
 S.E. RUN=  
 P.C. STA=  
 P.T. STA=

**BOUNDARIES ITEMS**

Dashed Property Line

Solid Property/Lot Line

Section/Grant Line

County/Township Line

State Line

Iron Pipe Found

Iron Pipe Set

Survey Marker

Property Line Symbol

Same Ownership Symbol

Northwest Quarter Corner

Section Corner

Southeast Quarter Corner

EX

PR

---

---

---

---

●

○

⊙

R

↙

⌒

⊕

⊕

**CONTOUR ITEMS**

Approx. Index Line

Approx. Intermediate Line

Index Contour

Intermediate Contour

Slope Limit Line

**DRAINAGE ITEMS**

Culvert Line

Ditch Profile Line

Grading & Shaping Ditches

Drainage Boundary Line

Paved Ditch

Aggregate Ditch

Flowline

Ditch, Check

Headwall

Inlet

Manhole

Summit

Roadway Ditch Flow

Swale

Catch Basin

Culvert End Section

Water Surface Indicator

Riprap

EX

PR

---

---

---

EX

---

---

---

---

---

---

---

---

---

---

---

---

---

---

---

---

---

---

**STANDARD SYMBOLS, ABBREVIATIONS AND PATTERNS**  
 (Sheet 2 of 8)

**STANDARD 000001-04**

Illinois Department of Transportation  
 ISSUED 1-1-87  
 PROJECT: [blank]  
 DRAWING: [blank]  
 SHEET: [blank] OF [blank]  
 APPROVED: [blank]  
 DESIGNED: [blank]

**EROSION & SEDIMENT CONTROL ITEMS**

Cleaning & Grading Limits	PR
Dike	EX
Erosion Control Fence	PR
Perimeter Erosion Barrier	EX
Temporary Fence	PR
Ditch Check Temporary	EX
Ditch Check Permanent	PR
Inlet & Pipe Protection	EX
Sediment Basin	PR
Erosion Control Blanket	EX
Fabric Formed Concrete Revetment Mat	PR
Turf Reinforcement Mat	EX
Mulch Temporary	PR
Mulch Method 1	EX
Mulch Method 2 Stabilized	PR
Mulch Method 3 Hydraulic	EX

**EXISTING IMPROVEMENT ITEMS**

Noise Attn./Levee	EX
Fence	PR
Base of Levee	EX
Mailbox	PR
Pay Telephones	EX
Advertising Sign	PR
Contour Mounding Line	EX
Shrubs	PR
Mowline	EX
Perennial Plants	PR
Seeding Class 2	EX
Seeding Class 2A	PR
Seeding Class 3	EX
Seeding Class 4	PR
Seeding Class 4 & 5 Combined	EX
Seeding Class 5	PR
Seeding Class 7	EX

**EXISTING LANDSCAPING ITEMS (cont.)**

Seedlings Type 1	EX
Seedlings Type 2	PR
Sodding	EX
Mowstake w/Sign	PR
Tree Trunk Protection	EX
Evergreen Tree	PR
Shade Tree	EX

**LIGHTING**

Cable In Duct w/o Ground	EX
Conduit w/Ground	PR
Electrical Aerial Cable	EX
Electrical Buried Cable	PR
Controller	EX
Underpass Luminaire	PR
Power Pole	EX
Pull Point	PR

Illinois Department of Transportation  
 ISSUED 1-1-97  
 PROJECT NO. 000001-04

**STANDARD SYMBOLS, ABBREVIATIONS AND PATTERNS**  
 (Sheet 3 of 8)  
**STANDARD 000001-04**

**LIGHTING  
(cont.)**

Handhole		<b>EX</b>		<b>PR</b>
Heavy Duty Handhole		<b>EX</b>		<b>PR</b>
Junction Box		<b>EX</b>		<b>PR</b>
Light Unit Comb.		<b>EX</b>		<b>PR</b>
Electrical Ground		<b>EX</b>		<b>PR</b>
Traffic Flow Arrow		<b>EX</b>		<b>PR</b>
High Mast Pole		<b>EX</b>		<b>PR</b>
Light Unit-1		<b>EX</b>		<b>PR</b>

**PAVEMENT (MISC.)**

Keyed Long. Joint		<b>EX</b>		<b>PR</b>
Keyed Long. Joint w/Tie Bars		<b>EX</b>		<b>PR</b>
Sawed Long. Joint w/Tie Bars		<b>EX</b>		<b>PR</b>
Bituminous Shoulder		<b>EX</b>		<b>PR</b>
Bituminous Taper		<b>EX</b>		<b>PR</b>
Stabilized Dirtway		<b>EX</b>		<b>PR</b>
Widening		<b>EX</b>		<b>PR</b>

**PAVEMENT MARKINGS**

RR Crossing		<b>EX</b>		<b>PR</b>
Raised Marker Amber 1 Way		<b>EX</b>		<b>PR</b>
Raised Marker Amber 2 Way		<b>EX</b>		<b>PR</b>
Raised Marker Crystal 1 Way		<b>EX</b>		<b>PR</b>
Two Way Turn Left		<b>EX</b>		<b>PR</b>
Shoulder Diag. Pattern		<b>EX</b>		<b>PR</b>
Skip-Dash White		<b>EX</b>		<b>PR</b>
Skip-Dash Yellow		<b>EX</b>		<b>PR</b>
Stop Line		<b>EX</b>		<b>PR</b>
Solid Line		<b>EX</b>		<b>PR</b>
Double Centerline		<b>EX</b>		<b>PR</b>
Dotted Lines		<b>EX</b>		<b>PR</b>
CL 2Ln 2Way RRPM 12.2 m (40') o.c.		<b>EX</b>		<b>PR</b>
CL 2Ln 2Way RRPM 24.4 m (80') o.c.		<b>EX</b>		<b>PR</b>
CL Multilane Div. RRPM 12.2 m (40') o.c.		<b>EX</b>		<b>PR</b>
CL Multilane Div. RRPM 24.4 m (80') o.c.		<b>EX</b>		<b>PR</b>
CL Multilane Div. Dbl. RRPM 24.4 m (80') o.c.		<b>EX</b>		<b>PR</b>
CL Multilane Undiv.		<b>EX</b>		<b>PR</b>
Two Way Turn Left Line		<b>EX</b>		<b>PR</b>

**STANDARD SYMBOLS,  
ABBREVIATIONS  
AND PATTERNS**  
(Sheet 4 of 8)

**STANDARD 000001-04**

Illinois Department of Transportation  
 PASSED: [Signature] DATE: [Date]  
 DESIGNED BY: [Signature] DATE: [Date]  
 APPROVED: [Signature] DATE: [Date]  
 PROJECT: [Project Name]

ISSUED: 1-1-97

**PAVEMENT MARKINGS  
( cont. )**

PR

EX

Urban Combination Left Only



Urban Combination Right Only



Urban Left Turn Arrow



Urban Right Turn Arrow



Urban Left Turn Only



Urban Right Turn Only



Urban Thru Only



Rural Combination Left Only



Rural Combination Right Only



Rural Left Turn Arrow



Rural Right Turn Arrow



Rural Left Turn Only



Rural Right Turn Only



Rural Thru Only



**RAILROAD ITEMS**

EX

PR

Abandoned Railroad



Railroad



Railroad Point



Control Box



Crossing Gate



Flashing Signal



Railroad Cont. Mast Arm



Crossbuck



**REMOVAL ITEMS**

EX

PR

Removal Tic



Bituminous Removal



Hatch Pattern



**RIGHT OF WAY  
ITEMS**

EX

PR

Future ROW Corner Monument



ROW Marker



ROW Line



Easement

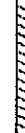

Temporary Easement



Missouri Department of Transportation  
 JANUARY 1, 2002  
 DIVISION OF HIGHWAY AND TRANSPORTATION  
 APPROVED: [Signature] JANUARY 1, 2002  
 DIVISION OF HIGHWAY AND TRANSPORTATION

**STANDARD SYMBOLS,  
ABBREVIATIONS  
AND PATTERNS**  
(Sheet 5 of 8)  
**STANDARD 000007-04**

ROADWAY PLAN ITEMS	EX	PR	SIGNING ITEMS (cont.)	EX	PR
Edge of Pavement			Detour Ahead W20-2		
Bit Shoulders, Medians and C&G Line			Left Lane Closed Ahead		
Aggregate Shoulder			Road Closed Ahead W20-R-(0)		
Shoulders, Driveways,			Road Closed Ahead W20-3-(0)		
Guardrail			Road Construction Ahead W20-1-(0)		
Guardrail Post			Single Lane Ahead		
Traffic Sign			Transition Left W4-2L		
Corrugated Median			Transition Right W4-2R		
<b>ROADWAY PROFILES</b>					
Profile Line					
P.I. Indicator					
Point Indicator					
Earthworks Balance Point					
Begin Point					
Vert. Curve Data	VPI = ELEV = L = E =	VPI = ELEV = L = E =			
<b>SIGNING ITEMS</b>					
Barricade Type 1 or 2					
Barricade Type II					

STANDARD SYMBOLS,  
ABBREVIATIONS  
AND PATTERNS  
(Sheet 6 of 8)  
**STANDARD 000001-04**

Missouri Department of Transportation  
 ISSUED 1-1-91  
 APPROVED: [Signature]  
 DEPARTMENT OF TRANSPORTATION  
 DIVISION OF DESIGN AND CONSTRUCTION  
 PROJECT NO. 70-1-1-1

51



SIGNING ITEMS (cont.)	EX	PR	TRAFFIC SHEET ITEMS	EX	PR	TRAFFIC SIGNAL ITEMS (cont.)	EX	PR
Left Turn Lane R3-1100L						Conduit Splice		
Keep Left R4-7AL						Controller		
Keep Left R4-7BL						Gutbox Junction		
Keep Right R4-7AR						Wood Pole		
Keep Right R4-7BR						Temp. Signal Head		
Stop Here On Red R10-6-4L						Handhole		
Stop Here On Red R10-6-4R						Heavy Duty Handhole		
No Left Turn R3-2						Junction Box		
No Right Turn R3-1						Ped. Pushbutton Detector		
Road Closed R11-2						Ped. Signal Head		
Road Closed Thru Traffic R11-2						Power Pole Service		
						Priority Veh. Detector		
						Signal Head		
						Signal Head w/Backplate		
						Signal Post		

**STANDARD SYMBOLS,  
ABBREVIATIONS  
AND PATTERNS**  
(Sheet 7 of 8)

**STANDARD 000001-04**

Illinois Department of Transportation































DESIGNED BY: [Signature] DATE: 11/11/2008

CHECKED BY: [Signature] DATE: 11/11/2008

APPROVED BY: [Signature] DATE: 11/11/2008

PROJECT: [Signature] DATE: 11/11/2008

1-1-1

	<u>EX</u>	<u>PR</u>	<u>EX</u>	<u>PR</u>
<u>UNDERGROUND UTILITY ITEMS (cont.)</u> Sanitary Sewer Storm Sewer Telephone Cable Water Pipe	   			
<u>UTILITIES ITEMS</u> Controller Double Handhole Fire Hydrant Handhole Heavy Duty Handhole Junction Box Light Pole Manhole Power Pole Splice Box Above Ground Telephone Splice Box Above Ground Telephone Pole Traffic Signal Water Meter Valve Box	             			
<u>VEGETATION ITEMS</u> Deciduous Tree Bush Evergreen Tree Stump Vegetation Line Woods & Bush Line	     			
<u>WATER FEATURE ITEMS</u> Stream or Drainage Ditch Waters Edge Water Surface Indicator Water Point Disappearing Ditch Marsh			     	

STANDARD SYMBOLS,  
 ABBREVIATIONS  
 AND PATTERNS  
(Sheet 8 of 8)  
 STANDARD 000001-04

Issued by: Department of Transportation  
 ISSUED 1-1-91  
 APPROVED: [Signature]  
 SUPERVISOR OF DESIGN AND CONSTRUCTION

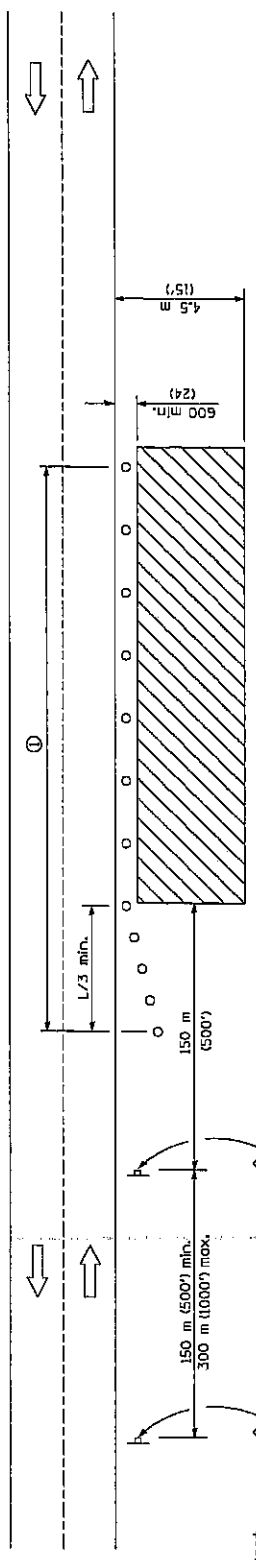

For contract construction projects

W20-1103-48

For maintenance and utility projects

W21-4101-48

W21-1a101-48 OR

W21-1110101-48

**GENERAL NOTES**

This Standard is used where any vehicles, equipment, workers or their activities will encroach in the area 4.5 m (15') to 600 (24') from the edge of pavement.

Calculate L as follows:

**FORMULAS**

**SPEED LIMIT**  
 70 km/h (40 mph) or less: Metric L = WS/2 150 (English) L = WS/2 60  
 80 km/h (45 mph) or greater: Metric L = 0.65WS 150 (English) L = 0.65WS 60  
 W = Width of offset in meters (feet).  
 S = Normal posted speed km/h (mph).

① When the work operation exceeds one hour, cones, drums or barricades shall be placed at 8 m (25') centers for L/3 distance, and at 15 m (50') centers through the remainder of the work area.

**TYPICAL APPLICATIONS**

- Utility operations
- Culvert extensions
- Side slope changes
- Guardrail installation and maintenance
- Delinquent installation
- Landscape operations
- Shoulder repair
- Sign installation and maintenance

**SYMBOLS**

- Work area
- Sign
- Cone, drum or barricade

All dimensions are in millimeters (inches) unless otherwise shown.

DATE	REVISIONS
1-1-05	Revised title, notes, and sign spacing.
1-1-98	Rev. 1st GEN. NOTE.
	Rev. (24') to (24') in 3rd GEN. NOTE.

**OFF-RD OPERATIONS, 2L, 2W, 4.5 m (15') TO 600 mm (24") FROM PAVEMENT EDGE**

**STANDARD 701006-02**

Illinois Department of Transportation  
 APPROVED: [Signature] JANUARY 1, 2005  
 ENGINEER OF TRANSPORTATION  
 APPROVED: [Signature] JANUARY 1, 2005  
 ENGINEER OF HIGHWAY AND TRANSPORTATION

ISSUED 1-1-97

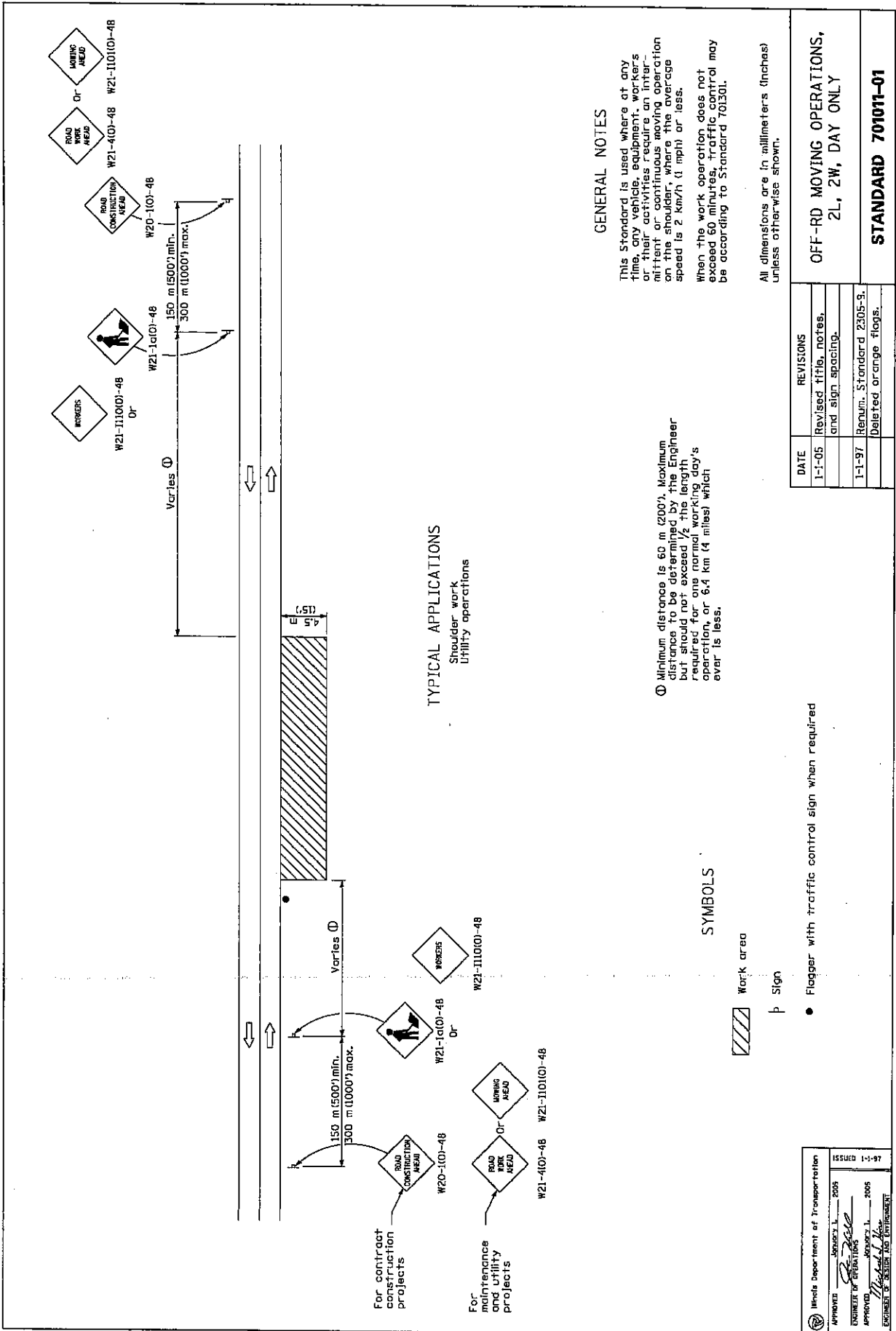

DATE	REVISIONS
1-1-05	Revised title, notes, and sign spacing.
1-1-97	Revised Standard 2305-9. Deleted orange flags.

**OFF-RD MOVING OPERATIONS,  
2L, 2W, DAY ONLY**

**STANDARD 701011-01**

Issue Department of Transportation

APPROVED: \_\_\_\_\_ 2005  
 ENGINEER OF OPERATIONS

APPROVED: \_\_\_\_\_ 2005  
 ENGINEER OF DESIGN AND ENVIRONMENT

ISSUED 1-1-97

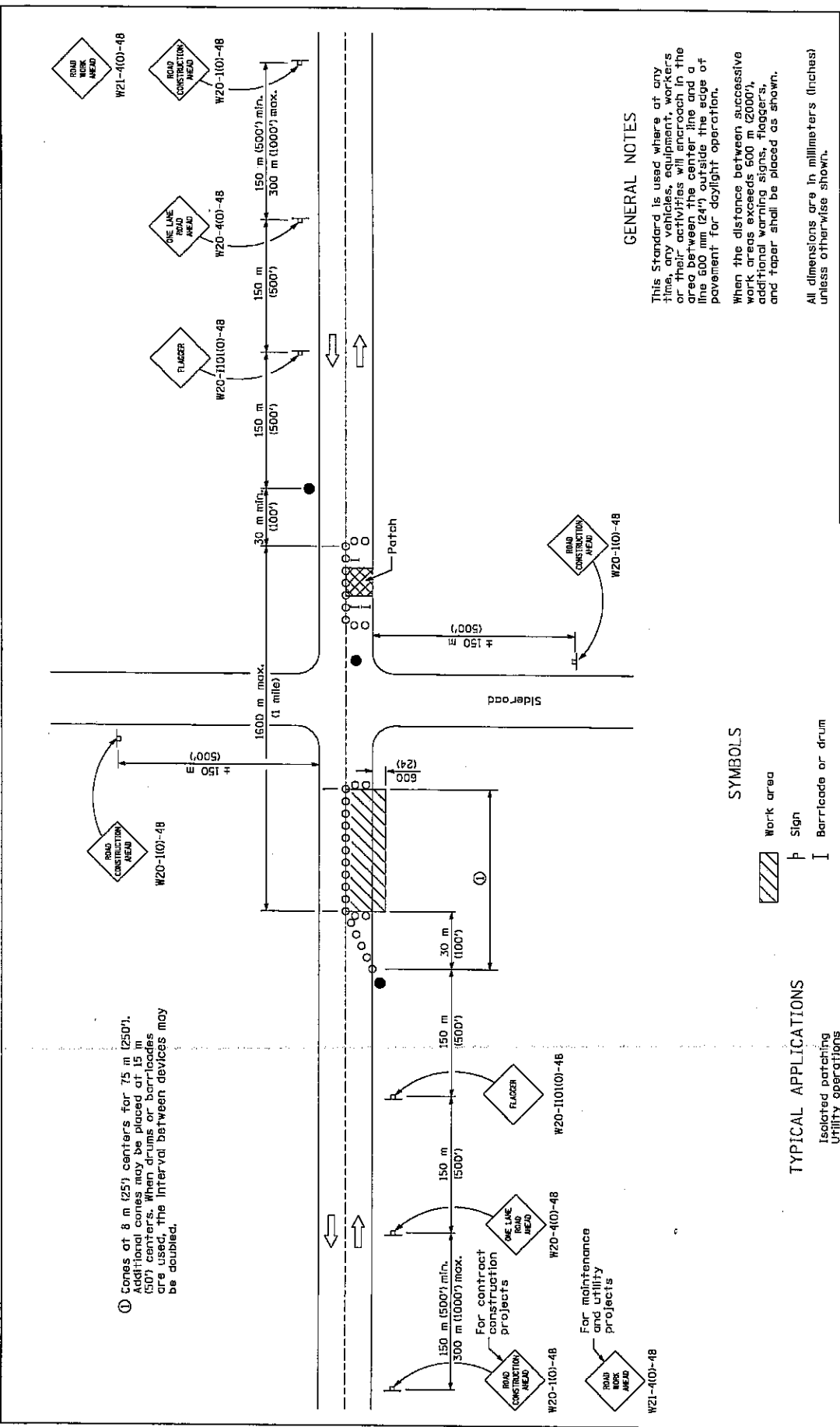

① Cones at 8 m (25') centers for 75 m (250'). Additional cones may be used at 15 (50') centers. When drums or barricades are used, the interval between devices may be doubled.

For contract construction projects

For maintenance and utility projects

**GENERAL NOTES**

This Standard is used where at any time, any vehicles, equipment, workers or their activities will encroach in the work area. The center line and a line 600 meters (24') outside the edge of pavement for daylight operation.

When the distance between successive work areas exceeds 600 m (2000'), additional warning signs, flaggers, and taper shall be placed as shown.

All dimensions are in millimeters (inches) unless otherwise shown.

**SYMBOLS**

- ▨ Work area
- ⊥ Sign
- I Barricade or drum
- Cone, drum or barricade
- Flagger with traffic control sign

**TYPICAL APPLICATIONS**

- Isolated patching
- Utility operations
- Storm sewer
- Culverts
- Cable placement

DATE	REVISIONS
1-1-05	Revised title and notes. Moved flagger.
1-1-00	Rev. TYPICAL APPLICATION & detail of patch area.

**LANE CLOSURE, 2L, 2W, DAY ONLY,  
FOR SPEEDS > 45 MPH**

**STANDARD 701201-02**

Illinois Department of Transportation

APPROVED: [Signature] JANUARY 1, 2005

ENGINEER OF TRANSPORTATION

APPROVED: [Signature] JANUARY 1, 2005

ENGINEER OF DESIGN AND ENVIRONMENT

ISSUED 1-1-97



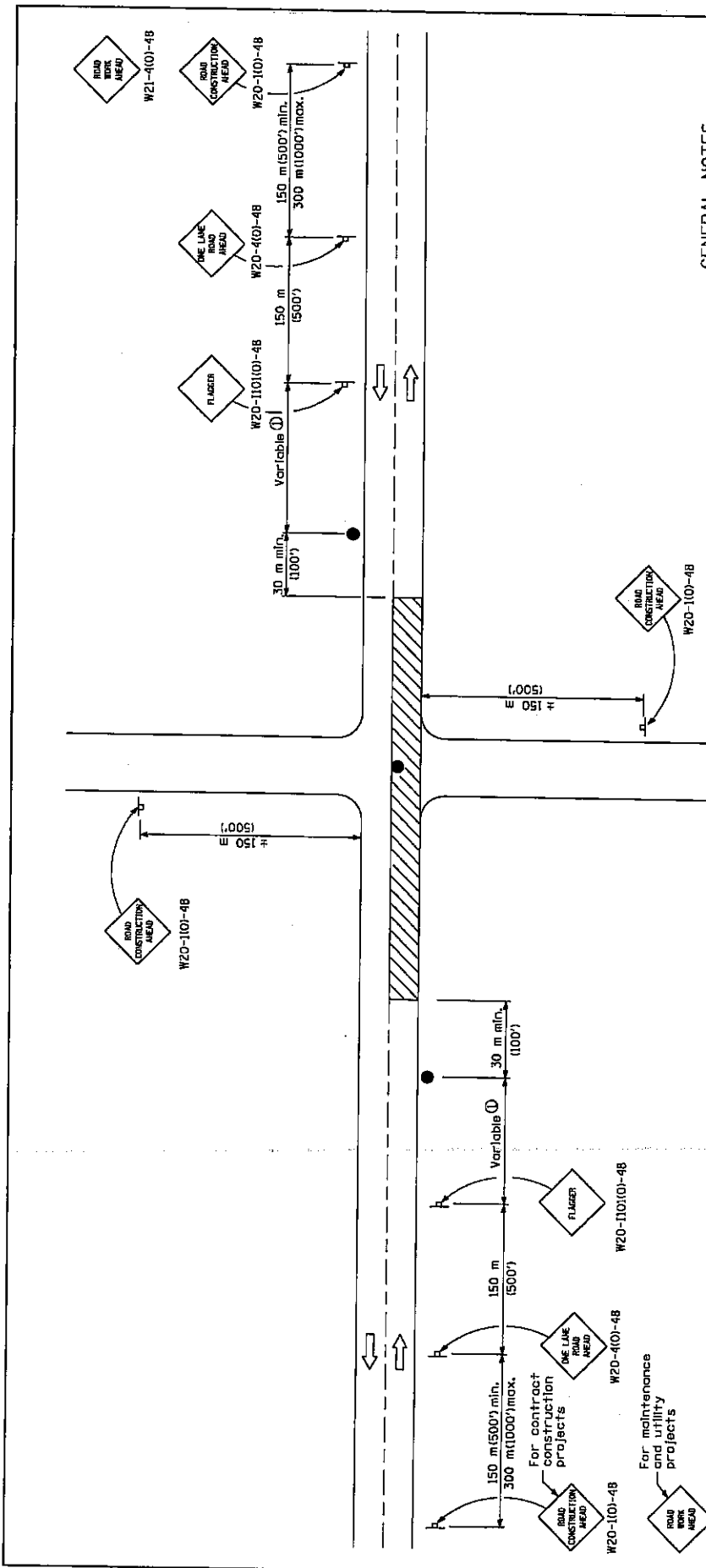

**GENERAL NOTES**

This Standard is used where at any time, any vehicle, equipment, workers or their activities require an intermittent or continuous moving operation on the pavement where the average speed of movement is greater than 2 km/h (1 mph) and less than 6 km/h (4 mph).

When the operation does not exceed 60 minutes, traffic control may be according to Standard 701301.

All dimensions are in millimeters (inches) unless otherwise shown.

① Minimum distance is 60 m (200'). Maximum distance to be determined by the Engineer but should not exceed 1/2 the length required for one normal working day's operation or 3200 m (12 miles), which ever is less.

**TYPICAL APPLICATIONS**

- Bituminous resurfacing
- Utility operations
- Shoulder operations

**SYMBOLS**

- Work area
- Sign on portable or permanent support
- Flagger with traffic control sign

DATE	REVISIONS
1-1-05	Deleted FLAGGER SYMBOL sign and revised sign spacing.
1-1-97	Renum. Standard 2306-10. Deleted orange flags and FRESH OIL sign.

**LANE CLOSURE, 2L, 2W, SLOW MOVING OPERATIONS DAY ONLY, FOR SPEEDS > 45 MPH**

**STANDARD 701306-01**

Illinois Department of Transportation

APPROVED: [Signature] JANUARY 1, 2005

DESIGNED BY: [Signature] JANUARY 1, 2005

ISSUED: 1-1-05

REVISIONS: [Signature] JANUARY 1, 2005

ENGINEER: [Signature] JANUARY 1, 2005

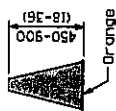

**CONE**

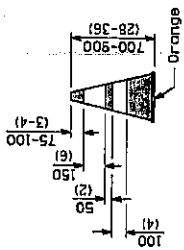

**REFLECTORIZED CONE**

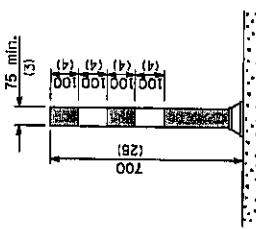

**FLEXIBLE DELINEATOR**

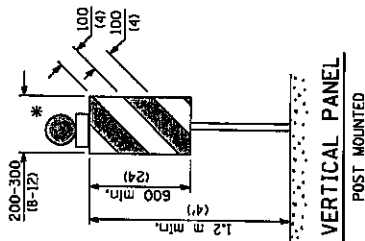

**VERTICAL PANEL  
POST MOUNTED**

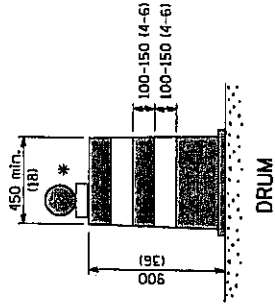

**DRUM**

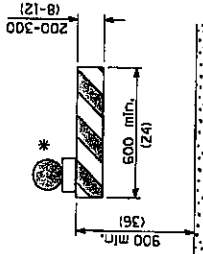

**TYPE I BARRICADE**

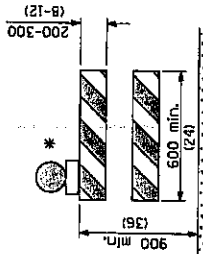

**TYPE II BARRICADE**

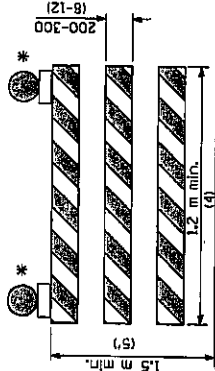

**TYPE III BARRICADE**

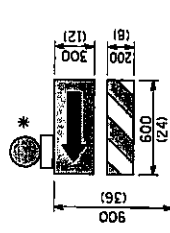

**DIRECTION INDICATOR  
BARRICADE**

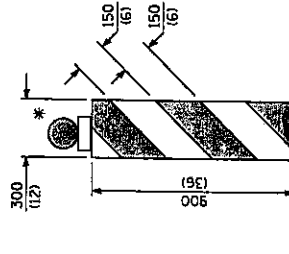

**VERTICAL BARRICADE**

\* Warning lights (if required)

**GENERAL NOTES**

All heights shown shall be measured above the pavement surface.  
All dimensions are in millimeters (inches) unless otherwise shown.

Illinois Department of Transportation		16-1-1	ISSUED
APPROVED	April 1, 2006		
ENGINEER OF DESIGNATION	<i>[Signature]</i>		
APPROVED	April 1, 2006		
ENGINEER OF DESIGNATION	<i>[Signature]</i>		

DATE	REVISIONS
4-1-06	Revised vert. barricade, post mounted signs, and signs on temp. supports.
1-1-05	Added note to work limit signing and re-added Type I barricade.

**TRAFFIC CONTROL DEVICES**

(Sheet 1 of 3)

**STANDARD 702001-06**



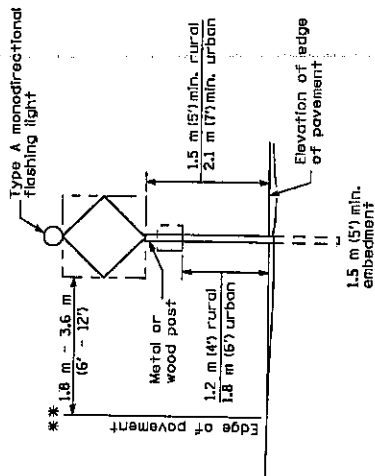

**POST MOUNTED SIGNS**

\*\* When curb or paved shoulder are present this dimension shall be 500 (24) to the face of curb or 18 m (6') to the outside edge of the paved shoulder.

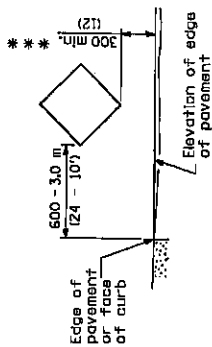

**SIGNS ON TEMPORARY SUPPORTS**

\*\*\* When work operations exceed four days, this dimension shall be 1.5 m (5') min.

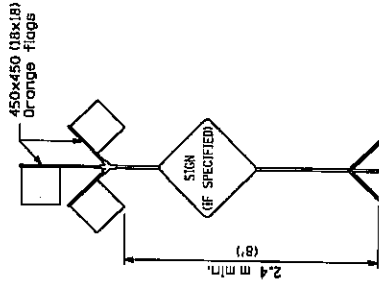

**HIGH LEVEL WARNING DEVICE**

ROAD CONSTRUCTION NEXT X MILES  
620-110)-6036

END CONSTRUCTION  
620-20(01)-6024

This signing is required for all projects 3200 m (2 miles) or more in length. ROAD CONSTRUCTION NEXT X MILES sign shall be placed 150 m (500') in advance of project limits.

END CONSTRUCTION sign shall be erected at the end of the job, unless another job is within 3200 m (2 miles).

Dual sign displays shall be utilized on multi-lane highways.

**WORK LIMIT SIGNING**

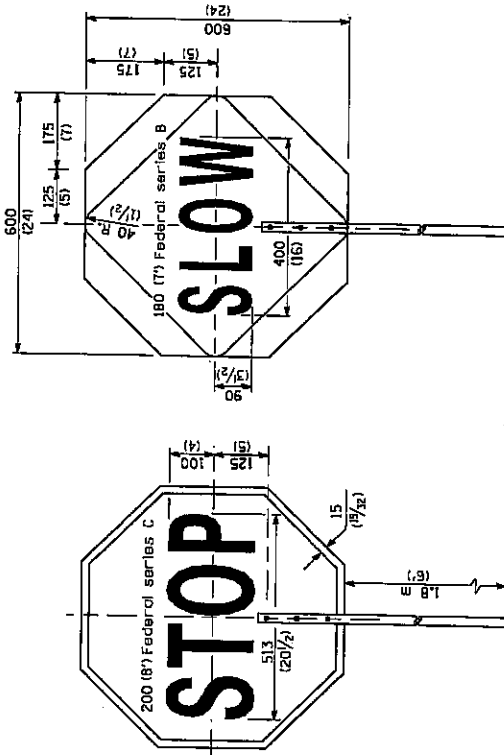

**FLAGGER TRAFFIC CONTROL SIGN**

REVERSE SIDE

FRONT SIDE

All dimensions are in millimeters (inches) unless otherwise shown.

Illinois Department of Transportation

APPROVED: [Signature] 2006

ENGINEER OF OPERATIONS

APPROVED: [Signature] 2006

ENGINEER OF DESIGN AND ENVIRONMENT

ISSUED 1-1-97

**TRAFFIC CONTROL DEVICES**

(Sheet 2 of 3)

**STANDARD 702001-06**

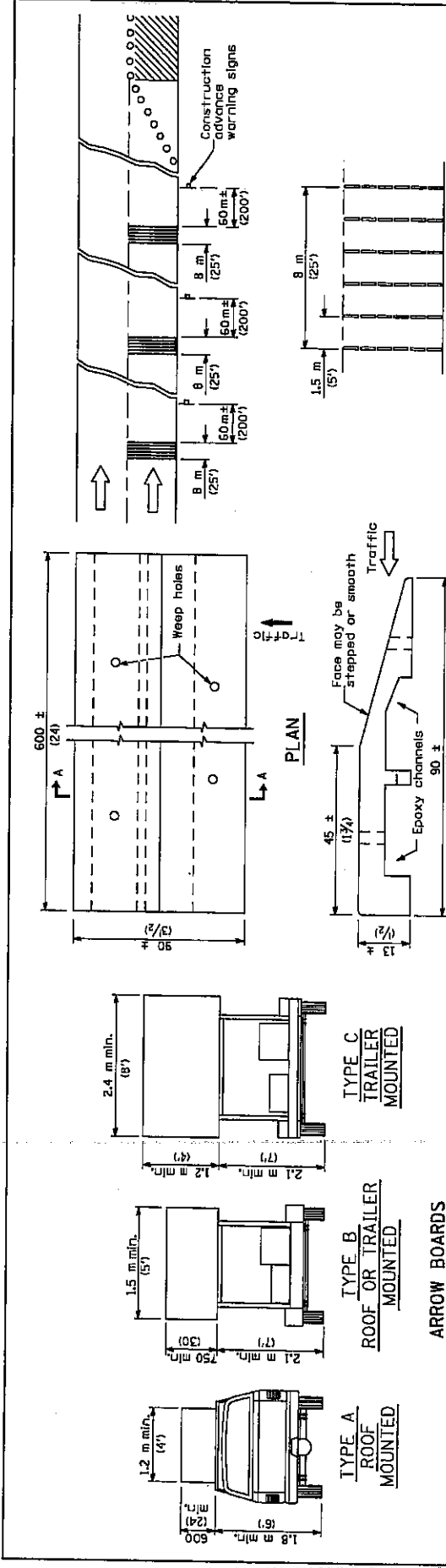

**ARROW BOARDS**

TYPE A  
ROOF MOUNTED

TYPE B  
ROOF OR TRAILER MOUNTED

TYPE C  
TRAILER MOUNTED

SECTION A-A

PLAN

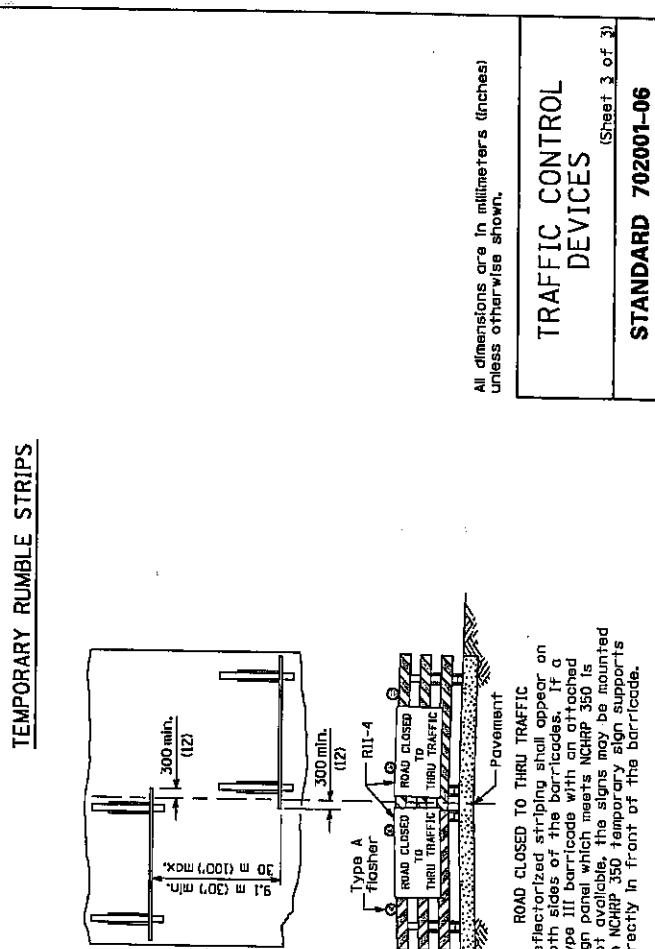

**TEMPORARY RUMBLE STRIPS**

TYPICAL INSTALLATION

TYPICAL APPLICATIONS OF TYPE III BARRICADES CLOSING A ROAD

ROAD CLOSED TO ALL TRAFFIC

ROAD CLOSED TO THRU TRAFFIC

All dimensions are in millimeters (inches) unless otherwise shown.

**TRAFFIC CONTROL DEVICES**

STANDARD 702001-06

(Sheet 3 of 3)

ReflectORIZED striping shall appear on both sides of the barricades. If a Type III barricade with an attached sign panel which meets NCHRP 350 is not available, the signs may be mounted on NCHRP 350 temporary sign supports directly in front of the barricade.

ReflectORIZED striping may be omitted on the back side of the barricades. If a Type III barricade with an attached sign panel which meets NCHRP 350 is not available, the sign may be mounted on an NCHRP 350 temporary sign support directly in front of the barricade.

Illinois Department of Transportation	
APPROVED	DATE: 11/11/2006
ENGINEER OF OPERATIONS	APPROVED
REVISOR OF DESIGN AND ESTIMATION	DATE: 11/11/2006

**CONDITION I**  
**APPROACH TRAFFIC STOPPED**

**CONDITION II**  
**APPROACH TRAFFIC DOES NOT STOP**

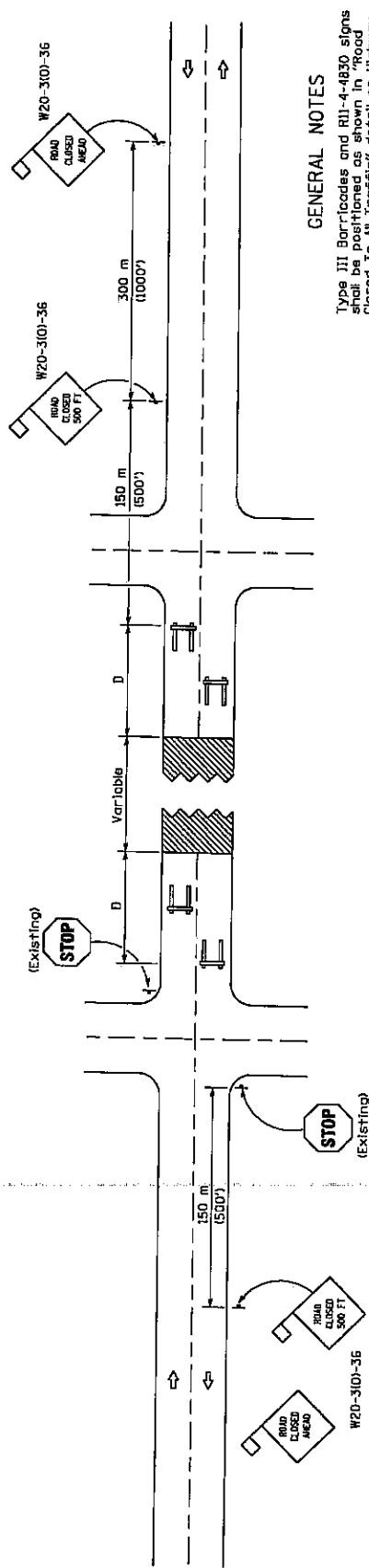

**GENERAL NOTES**

Type III Barricades and R11-4-4830 signs shall be positioned as shown in "Road Closed To All Traffic" detail on Highway Standard 70200. If the distance "D" exceeds 600 m (2000') an additional set of barricades and R11-4-4830 shall be placed at each end of the work area.

Two Type A Low Intensity Flashing Lights shall be used on each approach in advance of the work area. One light shall be placed above each barricade. If only one light is required, the other light shall be installed above the first advance warning sign.

All signs shall be post mounted if the closure time exceeds four days.

All warning signs shall have minimum dimensions of 300 mm (36") by 900 mm (36") and have a black legend on an orange reflectorized background.

All work zone signs are required to meet, as a minimum, Type B reflectivity requirements of Table 1091-2, in Article 1091.02 of the Standard Specifications.

Longitudinal dimensions may be adjusted to fit field conditions.

When fluorescent signs are used, orange flags are not required.

All dimensions are in millimeters (inches) unless otherwise shown.

**SYMBOLS**

- Work area
- Type III Barricade
- Sign with 450 (18) by 450 (18) minimum orange flag attached

Irrish Department of Transportation		ISSUED 1-1-97
APPROVED	SIGNED	2003
<i>David G. O'Connell</i>		
CHIEF ENGINEER LOCAL ROADS & STREETS		
APPROVED	SIGNED	2003
<i>Michael J. ...</i>		
DEPUTY CHIEF ENGINEER LOCAL ROADS & STREETS		

DATE	REVISIONS
1-1-03	Revised specification reference in 5th General Note.
1-1-98	Removed lights. Rev. 5th General Note.
	Added 7th General Note.

**TYPICAL APPLICATION OF TRAFFIC CONTROL DEVICES FOR CONSTRUCTION ON RURAL LOCAL HIGHWAYS**  
(TWO-LANE TWO-WAY RURAL TRAFFIC) (ROAD CLOSED TO THRU TRAFFIC)

**STANDARD B.L.R. 22-4**

**REQUIRED CONTRACT PROVISIONS  
FEDERAL-AID CONSTRUCTION CONTRACTS**

	Page
I. General .....	1
II. Nondiscrimination .....	1
III. Nonsegregated Facilities .....	3
IV. Payment of Predetermined Minimum Wage.....	3
V. Statements and Payrolls .....	6
VI. Record of Materials, Supplies, and Labor.....	7
VIII. Safety: Accident Prevention .....	7
IX. False Statements Concerning Highway Projects.....	7
X. Implementation of Clean Air Act and Federal Water Pollution Control Act .....	8
XI. Certification Regarding Debarment, Suspension, Ineligibility, and Voluntary Exclusion .....	8
XII. Certification Regarding Use of Contract Funds for Lobbying .....	9

**ATTACHMENTS**

- A. Employment Preference for Appalachian Contracts  
(included in Appalachian contracts only)

**I. GENERAL**

1. These contract provisions shall apply to all work performed on the contract by the contractor's own organization and with the assistance of workers under the contractor's immediate superintendence and to all work performed on the contract by piecework, station work, or by subcontract.

2. Except as otherwise provided for in each section, the contractor shall insert in each subcontract all of the stipulations contained in these Required Contract Provisions, and further require their inclusion in any lower tier subcontract or purchase order that may in turn be made. The Required Contract Provisions shall not be incorporated by reference in any case. The prime contractor shall be responsible for compliance by any subcontractor or lower tier subcontractor with these Required Contract Provisions.

3. A breach of any of the stipulations contained in these Required Contract Provisions shall be sufficient grounds for termination of the contract.

4. A breach of the following clauses of the Required Contract Provisions may also be grounds for debarment as provided in 29 CFR 5.12:

- Section I, paragraph 2;
- Section IV, paragraphs 1, 2, 3, 4 and 7;
- Section V, paragraphs 1 and 2a through 2g.

5. Disputes arising out of the labor standards provisions of Section IV (except paragraph 5) and Section V of these Required Contract Provisions shall not be subject to the general disputes clause of this contract. Such disputes shall be resolved in accordance with the procedures of the U.S. Department of Labor (DOL) as set forth in 29 CFR 5, 6 and 7. Disputes within the meaning of this clause include disputes between the contractor (or any of its subcontractors) and the contracting agency, the DOL, or the contractor's employees or their representatives.

6. Selection of Labor: During the performance of this contract, the contractor shall not:

- a. Discriminate against labor from any other State, possession, or territory of the United States (except for employment preference for Appalachian contracts, when applicable, as specified in Attachment A), or
- b. Employ convict labor for any purpose within the limits of the project unless it is labor performed by convicts who are on parole, supervised release, or probation.

**II. NONDISCRIMINATION**

1. Equal Employment Opportunity: Equal employment opportunity (EEO) requirements not to discriminate and to take affirmative action to assure equal opportunity as set forth under laws, executive orders, rules, regulations (28 CFR 35, 29 CFR 1630 and 41 CFR 60 (and orders of the Secretary of Labor as modified by the provisions prescribed herein, and imposed pursuant to 23 U.S.C. 140 shall constitute the EEO and specific affirmative action standards for the contractor's project activities under this contract. The Equal Opportunity Construction Contract Specifications set forth under 41 CFR 60-4.3 and the provisions of the American Disabilities Act of 1990 (42 U.S.C. 12101 et seq.) set forth under 28 CFR 35 and 29 CFR 1630 are incorporated by reference in this contract. In the execution of this contract, the contractor agrees to comply with the following minimum specific requirement activities of EEO:

a. The contractor will work with the State highway agency (SHA) and the Federal Government in carrying out EEO obligations and in their review of his/her activities under the contract.

b. The contractor will accept as his operating policy the following statement:

"It is the policy of this Company to assure that applicants are employed, and that employees are treated during employment, without regard to their race, religion, sex, color, national origin, age or disability. Such action shall include: employment, upgrading, demotion, or transfer; recruitment or recruitment advertising; layoff or termination; rates of pay or other forms of compensation; and selection for training, including apprenticeship, preapprenticeship, and/or on-the-job-training."

2. EEO Officer: The contractor will designate and make known to the SHA contracting officers an EEO Officer who will have the responsibility for an must be capable of effectively administering and promoting an active contractor program of EEO and who must be assigned adequate authority and responsibility to do so.

3. Dissemination of Policy: All members of the contractor's staff who are authorized to hire, supervise, promote, and discharge employees, or who recommend such action, or who are substantially involved in such action, will be made fully cognizant of, and will implement, the contractor's EEO policy and contractual responsibilities to provide EEO in each grade and classification of employment. To ensure that the above

agreement will be met, the following actions will be taken as a minimum:

a. Periodic meetings of supervisory and personnel office employees will be conducted before the start of work and then not less often than once every six months, at which time the contractor's EEO policy and its implementation will be reviewed and explained. The meetings will be conducted by the EEO Officer.

b. All new supervisory or personnel office employees will be given a thorough indoctrination by the EEO Officer, covering all major aspects of the contractor's EEO obligations within thirty days following their reporting for duty with the contractor.

c. All personnel who are engaged in direct recruitment for the project will be instructed by the EEO Officer in the contractor's procedures for locating and hiring minority group employees.

d. Notices and posters setting forth the contractor's EEO policy will be placed in areas readily accessible to employees, applicants for employment and potential employees.

e. The contractor's EEO policy and the procedures to implement such policy will be brought to the attention of employees by means of meetings, employee handbooks, or other appropriate means.

4. Recruitment: When advertising for employees, the contractor will include in all advertisements for employees the notation: "An Equal Opportunity Employer." All such advertisements will be placed in publications having a large circulation among minority groups in the area from which the project work force would normally be derived.

a. The contractor will, unless precluded by a valid bargaining agreement, conduct systematic and direct recruitment through public and private employees referral sources likely to yield qualified minority group applicants. To meet this requirement, the contractor will identify sources of potential minority group employees, and establish which such identified sources procedures whereby minority group applicants may be referred to the contractor for employment consideration.

b. In the event the contractor has a valid bargaining agreement providing for exclusive hiring hall referrals, he is expected to observe the provisions of that agreement to the extent that the system permits the contractor's compliance with EEO contract provisions. (The DOL has held that where implementation of such agreements have the effect of discriminating against minorities or women, or obligates the contractor to do the same, such implementation violates Executive Order 11246, as amended.)

c. The contractor will encourage his present employees to refer minority group applicants for employment. Information and procedures with regard to referring minority group applicants will be discussed with employees.

5. Personnel Actions: Wages, working conditions, and employee benefits shall be established and administered, and personnel actions of every type, including hiring, upgrading, promotion, transfer, demotion, layoff, and termination, shall be taken without regard to race, color, religion, sex, national origin, age or disability. The following procedures shall be followed:

a. The contractor will conduct periodic inspections of project sites to insure that working conditions and employee facilities do not indicate discriminatory treatment of project site personnel.

b. The contractor will periodically evaluate the spread of wages paid within each classification to determine any

evidence of discriminatory wage practices.

c. The contractor will periodically review selected personnel actions in depth to determine whether there is evidence of discrimination. Where evidence is found, the contractor will promptly take corrective action. If the review indicates that the discrimination may extend beyond the actions reviewed, such corrective action shall include all affected persons.

d. The contractor will promptly investigate all complaints of alleged discrimination made to the contractor in connection with his obligations under this contract, will attempt to resolve such complaints, and will take appropriate corrective action within a reasonable time. If the investigation indicates that the discrimination may affect persons other than the complainant, such corrective action shall include such other persons. Upon completion of each investigation, the contractor will inform every complainant of all of his avenues of appeal.

6. Training and Promotion:

a. The contractor will assist in locating, qualifying, and increasing the skills of minority group and women employees, and applicants for employment.

b. Consistent with the contractor's work force requirements and as permissible under Federal and State regulations, the contractor shall make full use of training programs, i.e., apprenticeship, and on-the-job training programs for the geographical area of contract performance. Where feasible, 25 percent of apprentices or trainees in each occupation shall be in their first year of apprenticeship or training. In the event a special provision for training is provided under this contract, this subparagraph will be superseded as indicated in the special provision.

c. The contractor will advise employees and applicants for employment of available training programs and entrance requirements for each.

d. The contractor will periodically review the training and promotion potential of minority group and women employees and will encourage eligible employees to apply for such training and promotion.

7. Unions: If the contractor relies in whole or in part upon unions as a source of employees, the contractor will use his/her best efforts to obtain the cooperation of such unions to increase opportunities for minority groups and women within the unions, and to effect referrals by such unions of minority and female employees. Actions by the contractor either directly or through a contractor's association acting as agent will include the procedures set forth below:

a. The contractor will use best efforts to develop, in cooperation with the unions, joint training programs aimed toward qualifying more minority group members and women for membership in the unions and increasing the skills of minority group employees and women so that they may qualify for higher paying employment.

b. The contractor will use best efforts to incorporate an EEO clause into each union agreement to the end that such union will be contractually bound to refer applicants without regard to their race, color, religion, sex, national origin, age or disability.

c. The contractor is to obtain information as to the referral practices and policies of the labor union except that to the extent such information is within the exclusive possession of the labor union and such labor union refuses to furnish such information to the contractor, the contractor shall so certify to

the SHA and shall set forth what efforts have been made to obtain such information.

d. In the event the union is unable to provide the contractor with a reasonable flow of minority and women referrals within the time limit set forth in the collective bargaining agreement, the contractor will, through independent recruitment efforts, fill the employment vacancies without regard to race, color, religion, sex, national origin, age or disability; making full efforts to obtain qualified and/or quailifiable minority group persons and women. (The DOL has held that it shall be no excuse that the union with which the contractor has a collective bargaining agreement providing for exclusive referral failed to refer minority employees.) In the event the union referral practice prevents the contractor from meeting the obligations pursuant to Executive Order 11246, as amended, and these special provisions, such contractor shall immediately notify the SHA.

8. Selection of Subcontractors, Procurement of Materials and Leasing of Equipment: The contractor shall not discriminate on the grounds of race, color, religion, sex, national origin, age or disability in the selection and retention of subcontractors, including procurement of materials and leases of equipment.

a. The contractor shall notify all potential subcontractors and suppliers of his/her EEO obligations under this contract.

b. Disadvantaged business enterprises (DBE), as defined in 49 CFR 23, shall have equal opportunity to compete for and perform subcontracts which the contractor enters into pursuant to this contract. The contractor will use his best efforts to solicit bids from and to utilize DBE subcontractors or subcontractors with meaningful minority group and female representation among their employees. Contractors shall obtain lists of DBE construction firms from SHA personnel.

c. The contractor will use his best efforts to ensure subcontractor compliance with their EEO obligations.

9. Records and Reports: The contractor shall keep such records as necessary to document compliance with the EEO requirements. Such records shall be retained for a period of three years following completion of the contract work and shall be available at reasonable times and places for inspection by authorized representatives of the SHA and the FHWA.

a. The records kept by the contractor shall document the following:

(1) The number of minority and non-minority group members and women employed in each work classification on the project;

(2) The progress and efforts being made in cooperation with unions, when applicable, to increase employment opportunities for minorities and women;

(3) The progress and efforts being made in locating, hiring, training, qualifying, and upgrading minority and female employees; and

(4) The progress and efforts being made in securing the services of DBE subcontractors or subcontractors with meaningful minority and female representation among their employees.

b. The contractors will submit an annual report to the SHA each July for the duration of the project, indicating the number of minority, women, and non-minority group employees currently engaged in each work classification required by the contract work. This information is to be reported on Form FHWA-1391. If on-the-job training is being required by special provision, the contractor will be required to collect and report training data.

### III. NONSEGREGATED FACILITIES

(Applicable to all Federal-aid construction contracts and to all related subcontracts of \$10,000 or more.)

a. By submission of this bid, the execution of this contract or subcontract, or the consummation of this material supply agreement or purchase order, as appropriate, the bidder, Federal-aid construction contractor, subcontractor, material supplier, or vendor, as appropriate, certifies that the firm does not maintain or provide for its employees any segregated facilities at any of its establishments, and that the firm does not permit its employees to perform their services at any location, under its control, where segregated facilities are maintained. The firm agrees that a breach of this certification is a violation of the EEO provisions of this contract. The firm further certifies that no employee will be denied access to adequate facilities on the basis of sex or disability.

b. As used in this certification, the term "segregated facilities" means any waiting rooms, work areas, restrooms and washrooms, restaurants and other eating areas, timeclocks, locker rooms, and other storage or dressing areas, parking lots, drinking fountains, recreation or entertainment areas, transportation, and housing facilities provided for employees which are segregated by explicit directive, or are, in fact, segregated on the basis of race, color, religion, national origin, age or disability, because of habit, local custom, or otherwise. The only exception will be for the disabled when the demands for accessibility override (e.g. disabled parking).

c. The contractor agrees that it has obtained or will obtain identical certification from proposed subcontractors or material suppliers prior to award of subcontracts or consummation of material supply agreements of \$10,000 or more and that it will retain such certifications in its files.

### IV. PAYMENT OF PREDETERMINED MINIMUM WAGE

(Applicable to all Federal-aid construction contracts exceeding \$2,000 and to all related subcontracts, except for projects located on roadways classified as local roads or rural minor collectors, which are exempt.)

#### 1. General:

a. All mechanics and laborers employed or working upon the site of the work will be paid unconditionally and not less often than once a week and without subsequent deduction or rebate on any account [except such payroll deductions as are permitted by regulations (29 CFR 3) issued by the Secretary of Labor under the Copeland Act (40 U.S.C. 276c)] the full amounts of wages and bona fide fringe benefits (or cash equivalents thereof) due at time of payment. The payment shall be computed at wage rates not less than those contained in the wage determination of the Secretary of Labor (hereinafter "the wage determination") which is attached hereto and made a part hereof, regardless of any contractual relationship which may be alleged to exist between the

contractor or its subcontractors and such laborers and mechanics. The wage determination (including any additional classifications and wage rates conformed under paragraph 2 of this Section IV and the DOL poster (WH-1321) or Form FHWA-1495) shall be posted at all times by the contractor and its subcontractors at the site of the work in a prominent and accessible place where it can be easily seen by the workers. For the purpose of this Section, contributions made or costs reasonably anticipated for bona fide fringe benefits under Section 1(b)(2) of the Davis-Bacon Act (40 U.S.C. 276a) on behalf of laborers or mechanics are considered wages paid to such laborers or mechanics, subject to the provisions of Section IV, paragraph 3b, hereof. Also, for the purpose of this Section, regular contributions made or costs incurred for more than a weekly period (but not less often than quarterly) under plans, funds, or programs, which cover the particular weekly period, are deemed to be constructively made or incurred during such weekly period. Such laborers and mechanics shall be paid the appropriate wage rate and fringe benefits on the wage determination for the classification of work actually performed, without regard to skill, except as provided in paragraphs 4 and 5 of this Section IV.

b. Laborers or mechanics performing work in more than one classification may be compensated at the rate specified for each classification for the time actually worked therein, provided, that the employer's payroll records accurately set forth the time spent in each classification in which work is performed.

c. All rulings and interpretations of the Davis-Bacon Act and related acts contained in 29 CFR 1, 3, and 5 are herein incorporated by reference in this contract.

## 2. Classification:

a. The SHA contracting officer shall require that any class of laborers or mechanics employed under the contract, which is not listed in the wage determination, shall be classified in conformance with the wage determination.

b. The contracting officer shall approve an additional classification, wage rate and fringe benefits only when the following criteria have been met:

(1) the work to be performed by the additional classification requested is not performed by a classification in the wage determination;

(2) the additional classification is utilized in the area by the construction industry;

(3) the proposed wage rate, including any bona fide fringe benefits, bears a reasonable relationship to the wage rates contained in the wage determination; and

(4) with respect to helpers, when such a classification prevails in the area in which the work is performed.

c. If the contractor or subcontractors, as appropriate, the laborers and mechanics (if known) to be employed in the additional classification or their representatives, and the contracting officer agree on the classification and wage rate (including the amount designated for fringe benefits where appropriate), a report of the action taken shall be sent by the contracting officer to the DOL, Administrator of the Wage and Hour Division, Employment Standards Administration, Washington, D.C. 20210. The Wage and Hour Administrator, or an authorized representative, will approve, modify, or

disapprove every additional classification action within 30 days of receipt and so advise the contracting officer or will notify the contracting officer within the 30-day period that additional time is necessary.

d. In the event the contractor or subcontractors, as appropriate, the laborers or mechanics to be employed in the additional classification or their representatives, and the contracting officer do not agree on the proposed classification and wage rate (including the amount designated for fringe benefits, where appropriate), the contracting officer shall refer the question, including the views of all interested parties and the recommendation of the contracting officer, to the Wage and Hour Administrator for determination. Said Administrator, or an authorized representative, will issue a determination within 30 days of receipt and so advise the contracting officer or will notify the contracting officer within the 30-day period that additional time is necessary.

e. The wage rate (including fringe benefits where appropriate) determined pursuant to paragraph 2c or 2d of this Section IV shall be paid to all workers performing work in the additional classification from the first day on which work is performed in the classification.

## 3. Payment of Fringe Benefits:

a. Whenever the minimum wage rate prescribed in the contract for a class of laborers or mechanics includes a fringe benefit which is not expressed as an hourly rate, the contractor or subcontractors, as appropriate, shall either pay the benefit as stated in the wage determination or shall pay another bona fide fringe benefit or an hourly case equivalent thereof.

b. If the contractor or subcontractor, as appropriate, does not make payments to a trustee or other third person, he/she may consider as a part of the wages of any laborer or mechanic the amount of any cost reasonably anticipated in providing bona fide fringe benefits under a plan or program, provided that the Secretary of Labor has found, upon the written request of the contractor, that the applicable standards of the Davis-Bacon Act have been met. The Secretary of Labor may require the contractor to set aside in a separate account assets for the meeting of obligations under the plan or program.

## 4. Apprentices and Trainees (Programs of the U.S. DOL) and Helpers:

### a. Apprentices:

(1) Apprentices will be permitted to work at less than the predetermined rate for the work they performed when they are employed pursuant to and individually registered in a bona fide apprenticeship program registered with the DOL, Employment and Training Administration, Bureau of Apprenticeship and Training, or with a State apprenticeship agency recognized by the Bureau, or if a person is employed in his/her first 90 days of probationary employment as an apprentice in such an apprenticeship program, who is not individually registered in the program, but who has been certified by the Bureau of Apprenticeship and Training or a State apprenticeship agency (where appropriate) to be eligible for probationary employment as an apprentice.

(2) The allowable ratio of apprentices to journeyman-level employees on the job site in any craft classification shall not

listed on the wage determination unless the Administrator of the

be greater than the ratio permitted to the contractor as to the entire work force under the registered program. Any employee listed on a payroll at an apprentice wage rate, who is not registered or otherwise employed as stated above, shall be paid not less than the applicable wage rate listed in the wage determination for the classification of work actually performed. In addition, any apprentice performing work on the job site in excess of the ratio permitted under the registered program shall be paid not less than the applicable wage rate on the wage determination for the work actually performed. Where a contractor or subcontractor is performing construction on a project in a locality other than that in which its program is registered, the ratios and wage rates (expressed in percentages of the journeyman-level hourly rate) specified in the contractor's or subcontractor's registered program shall be observed.

(3) Every apprentice must be paid at not less than the rate specified in the registered program for the apprentice's level of progress, expressed as a percentage of the journeyman-level hourly rate specified in the applicable wage determination. Apprentices shall be paid fringe benefits in accordance with the provisions of the apprenticeship program. If the apprenticeship program does not specify fringe benefits, apprentices must be paid the full amount of fringe benefits listed on the wage determination for the applicable classification. If the Administrator for the Wage and Hour Division determines that a different practice prevails for the applicable apprentice classification, fringes shall be paid in accordance with that determination.

(4) In the event the Bureau of Apprenticeship and Training, or a State apprenticeship agency recognized by the Bureau, withdraws approval of an apprenticeship program, the contractor or subcontractor will no longer be permitted to utilize apprentices at less than the applicable predetermined rate for the comparable work performed by regular employees until an acceptable program is approved.

b. Trainees:

(1) Except as provided in 29 CFR 5.16, trainees will not be permitted to work at less than the predetermined rate for the work performed unless they are employed pursuant to and individually registered in a program which has received prior approval, evidenced by formal certification by the DOL, Employment and Training Administration.

(2) The ratio of trainees to journeyman-level employees on the job site shall not be greater than permitted under the plan approved by the Employment and Training Administration. Any employee listed on the payroll at a trainee rate who is not registered and participating in a training plan approved by the Employment and Training Administration shall be paid not less than the applicable wage rate on the wage determination for the classification of work actually performed. In addition, any trainee performing work on the job site in excess of the ratio permitted under the registered program shall be paid not less than the applicable wage rate on the wage determination for the work actually performed.

(3) Every trainee must be paid at not less than the rate specified in the approved program for his/her level of progress, expressed as a percentage of the journeyman-level hourly rate specified in the applicable wage determination. Trainees shall be paid fringe benefits in accordance with the provisions of the trainee program. If the trainee program does not mention fringe benefits, trainees shall be paid the full amount of fringe benefits

Wage and Hour Division determines that there is an apprenticeship program associated with the corresponding journeyman-level wage rate on the wage determination which provides for less than full fringe benefits for apprentices, in which cases such trainees shall receive the same fringe benefits as apprentices.

(4) In the event the Employment and Training Administration withdraws approval of a training program, the contractor or subcontractor will no longer be permitted to utilize trainees at less than the applicable predetermined rate for the work performed until an acceptable program is approved.

c. Helpers:

Helpers will be permitted to work on a project if the helper classification is specified and defined on the applicable wage determination or is approved pursuant to the conformance procedure set forth in Section IV. 2. Any worker listed on a payroll at a helper wage rate, who is not a helper under a approved definition, shall be paid not less than the applicable wage rate on the wage determination for the classification of work actually performed.

5. Apprentices and Trainees (Programs of the U.S. DOT):

Apprentices and trainees working under apprenticeship and skill training programs which have been certified by the Secretary of Transportation as promoting EEO in connection with Federal-aid highway construction programs are not subject to the requirements of paragraph 4 of this Section IV. The straight time hourly wage rates for apprentices and trainees under such programs will be established by the particular programs. The ratio of apprentices and trainees to journeymen shall not be greater than permitted by the terms of the particular program.

6. Withholding:

The SHA shall upon its own action or upon written request of an authorized representative of the DOL withhold, or cause to be withheld, from the contractor or subcontractor under this contract or any other Federal contract with the same prime contractor or any other Federally-assisted contract subject to Davis-Bacon prevailing wage requirements which is held by the same prime contractor, as much of the accrued payments or advances as may be considered necessary to pay laborers and mechanics, including apprentices, trainee's and helpers, employed by the contractor or any subcontractor the full amount of wages required by the contract. In the event of failure to pay any laborer or mechanic, including any apprentice, trainee, or helper, employed or working on the site of the work, all or part of the wages required by the contract, the SHA contracting officer may, after written notice to the contractor, take such action as may be necessary to cause the suspension of any further payment, advance, or guarantee of funds until such violations have ceased.

7. Overtime Requirements:

No contractor or subcontractor contracting for any part of the contract work which may require or involve the employment of laborers, mechanics, watchmen, or guards (including apprentices, trainees, and helpers described in paragraphs 4 and 5 above) shall require or permit any laborer, mechanic, watchman, or guard in any workweek in which he/she is employed on such work, to work in excess of 40 hours in such workweek unless such laborer, mechanic, watchman, or guard receives compensation at a rate not less than one-and-one-half times his/her basic rate of pay for all hours worked in excess of 40 hours in such workweek.



## 8. Violation:

Liability for Unpaid Wages; Liquidated Damages: In the event of any violation of the clause set forth in paragraph 7 above, the contractor and any subcontractor responsible thereof shall be liable to the affected employee for his/her unpaid wages. In addition, such contractor and subcontractor shall be liable to the United States (in the case of work done under contract for the District of Columbia or a territory, to such District or to such territory) for liquidated damages. Such liquidated damages shall be computed with respect to each individual laborer, mechanic, watchman, or guard employed in violation of the clause set forth in paragraph 7, in the sum of \$10 for each calendar day on which such employee was required or permitted to work in excess of the standard work week of 40 hours without payment of the overtime wages required by the clause set forth in paragraph 7.

## 9. Withholding for Unpaid Wages and Liquidated Damages:

The SHA shall; upon its own action or upon written request of any authorized representative of the DOL withhold, or cause to be withheld, from any monies payable on account of work performed by the contractor or subcontractor under any such contract or any other Federal contract with the same prime contractor, or any other Federally-assisted contract subject to the Contract Work Hours and Safety Standards Act, which is held by the same prime contractor, such sums as may be determined to be necessary to satisfy any liabilities of such contractor or subcontractor for unpaid wages and liquidated damages as provided in the clause set forth in paragraph 8 above.

## V. STATEMENTS AND PAYROLLS

(Applicable to all Federal-aid construction contracts exceeding \$2,000 and to all related subcontracts, except for projects located on roadways classified as local roads or rural collectors, which are exempt.)

### 1. Compliance with Copeland Regulations (29 CFR 3):

The contractor shall comply with the Copeland Regulations of the Secretary of Labor which are herein incorporated by reference.

### 2. Payrolls and Payroll Records:

a. Payrolls and basic records relating thereto shall be maintained by the contractor and each subcontractor during the course of the work and preserved for a period of 3 years from the date of completion of the contract for all laborers, mechanics, apprentices, trainees, watchmen, helpers, and guards working at the site of the work.

b. The payroll records shall contain the name, social security number, and address of each such employee; his or her correct classification; hourly rates of wages paid (including rates of contributions or costs anticipated for bona fide fringe benefits or cash equivalent thereof the types described in Section 1(b)(2)(B) of the Davis Bacon Act); daily and weekly number of hours worked; deductions made; and actual wages paid. In addition, for Appalachian contracts, the payroll records shall contain a notation indicating whether the employee does, or does not, normally reside in the labor area as defined in Attachment A, paragraph 1. Whenever the Secretary of Labor, pursuant to Section IV, paragraph 3b, has found that the wages of any laborer or mechanic include the amount of any costs reasonably anticipated in providing benefits under a plan

or program described in Section 1(b)(2)(B) of the Davis Bacon Act, the contractor and each subcontractor shall maintain records which show that the commitment to provide such benefits is enforceable, that the plan or program is financially responsible, that the plan or program has been communicated in writing to the laborers or mechanics affected, and show the cost anticipated or the actual cost incurred in providing benefits. Contractors or subcontractors employing apprentices or trainees under approved programs shall maintain written evidence of the registration of apprentices and trainees, and ratios and wage rates prescribed in the applicable programs.

c. Each contractor and subcontractor shall furnish, each week in which any contract work is performed, to the SHA resident engineer a payroll of wages paid each of its employees (including apprentices trainees, and helpers, described in Section IV, paragraphs 4 and 5, and watchmen and guards engaged on work during the preceding weekly payroll period).

The payroll submitted shall set out accurately and completely all of the information required to be maintained under paragraph 2b of this Section V.

This information may be submitted in any form desired. Optional Form WH-347 is available for this purpose and may be purchased from the Superintendent of Documents (Federal stock number 029-005-0014-1), U.S. Government Printing Office, Washington, D.C. 20402. The prime contractor is responsible for the submission of copies of payrolls by all subcontractors.

d. Each payroll submitted shall be accompanied by a "Statement of Compliance," signed by the Contractor or subcontractor or his/her agent who pays or supervises the payment of the persons employed under the contract and shall certify the following:

(1) that the payroll for the payroll period contains the information required to be maintained under paragraph 2b of this Section V and that such information is correct and complete;

(2) that such laborer or mechanic (including each helper, apprentice, and trainee) employed on the contract during the payroll period has been paid the full weekly wages earned, without rebate, either directly or indirectly, and that no deductions have been made either directly or indirectly from the full wages earned, other than permissible deductions as set forth in the Regulations, 29 CFR 3;

(3) that each laborer or mechanic has been paid not less than the applicable wage rate and fringe benefits or cash equivalent for the classification of work performed, as specified in the applicable wage determination incorporated into the contract.

e. The weekly submission of a properly executed certification set forth on the reverse side of Optional Form WH-347 shall satisfy the requirement for submission of the "Statement of Compliance" required by paragraph 2d of this Section V.

f. The falsification of any of the above certifications may subject the contractor to civil or criminal prosecution under 18 U/S. C. 1001 and 31 U.S.C. 231.

g. The contractor or subcontractor shall make the records required under paragraph 2b of this Section V available for

inspection, copying, or transcription by authorized representatives of the SHA, the FHWA, or the DOL, and shall permit such representatives to interview employees during working hours on the job. If the contractor or subcontractor fails to submit the required records or to make them available, the SHA, the FHWA, the DOL, or all may, after written notice to the contractor, sponsor, applicant, or owner, take such actions as may be necessary to cause the suspension of any further payment, advance, or guarantee of funds. Furthermore, failure to submit the required records upon request or to make such records available may be grounds for debarment action pursuant to 29 CFR 5.12.

## **VI. RECORD OF MATERIALS, SUPPLIES, AND LABOR**

1. On all federal-aid contracts on the national highway system, except those which provide solely for the installation of protective devices at railroad grade crossings, those which are constructed on a force account or direct labor basis, highway beautification contracts, and contracts for which the total final construction cost for roadway and bridge is less than \$1,000,000 (23 CFR 635) the contractor shall:

a. Become familiar with the list of specific materials and supplies contained in Form FHWA-47, "Statement of Materials and Labor Used by Contractor of Highway Construction Involving Federal Funds," prior to the commencement of work under this contract.

b. Maintain a record of the total cost of all materials and supplies purchased for and incorporated in the work, and also of the quantities of those specific materials and supplies listed on Form FHWA-47, and in the units shown on Form FHWA-47.

c. Furnish, upon the completion of the contract, to the SHA resident engineer on Form FHWA-47 together with the data required in paragraph 1b relative to materials and supplies, a final labor summary of all contract work indicating the total hours worked and the total amount earned.

2. At the prime contractor's option, either a single report covering all contract work or separate reports for the contractor and for each subcontract shall be submitted.

## **VII. SUBLETTING OR ASSIGNING THE CONTRACT**

1. The contractor shall perform with its own organization contract work amounting to not less than 30 percent (or a greater percentage if specified elsewhere in the contract) of the total original contract price, excluding any specialty items designated by the State. Specialty items may be performed by subcontract and the amount of any such specialty items performed may be deducted from the total original contract price before computing the amount of work required to be performed by the contractor's own organization (23 CFR 635).

a. "Its own organization" shall be construed to include only workers employed and paid directly by the prime contractor and equipment owned or rented by the prime contractor, with or without operators. Such term does not include employees or equipment of a subcontractor, assignee, or agent of the prime contractor.

b. "Specialty Items" shall be construed to be limited to work that requires highly specialized knowledge, abilities, or equipment not ordinarily available in the type of contracting organizations qualified and expected to bid on the contract as a

whole and in general are to be limited to minor components of the overall contract.

2. The contract amount upon which the requirements set forth in paragraph 1 of Section VII is computed includes the cost of material and manufactured products which are to be purchased or produced by the contractor under the contract provisions.

3. The contractor shall furnish (a) a competent superintendent or supervisor who is employed by the firm, has full authority to direct performance of the work in accordance with the contract requirements, and is in charge of all construction operations (regardless of who performs the work) and (b) such other of its own organizational resources (supervision, management, and engineering services) as the SHA contracting officer determines is necessary to assure the performance of the contract.

4. No portion of the contract shall be sublet, assigned or otherwise disposed of except with the written consent of the SHA contracting officer, or authorized representative, and such consent when given shall not be construed to relieve the contractor of any responsibility for the fulfillment of the contract.

Written consent will be given only after the SHA has assured that each subcontract is evidenced in writing and that it contains all pertinent provisions and requirements of the prime contract.

## **VIII. SAFETY: ACCIDENT PREVENTION**

1. In the performance of this contract the contractor shall comply with all applicable Federal, State, and local laws governing safety, health, and sanitation (23 CFR 635). The contractor shall provide all safeguards, safety devices and protective equipment and take any other needed actions as it determines, or as the SHA contracting officer may determine, to be reasonably necessary to protect the life and health of employees on the job and the safety of the public and to protect property in connection with the performance of the work covered by the contract.

2. It is a condition of this contract, and shall be made a condition of each subcontract, which the contractor enters into pursuant to this contract, that the contractor and any subcontractor shall not permit any employee, in performance of the contract, to work in surroundings or under conditions which are unsanitary, hazardous or dangerous to his/her health or safety, as determined under construction safety and health standards (29 CFR 1926) promulgated by the Secretary of Labor, in accordance with Section 107 of the Contract Work Hours and Safety Standards Act (40 U.S.C. 333).

3. Pursuant to 29 CFR 1926.3, it is a condition of this contract that the Secretary of Labor or authorized representative thereof, shall have right of entry to any site of contract performance to inspect or investigate the matter of compliance with the construction safety and health standards and to carry out the duties of the Secretary under Section 107 of the Contract Work Hours and Safety Standards Act (40 U.S.C. 333).

## **IX. FALSE STATEMENTS CONCERNING HIGHWAY PROJECTS**

In order to assure high quality and durable construction in conformity with approved plans and specifications and a high degree of reliability on statements and representations made by engineers, contractors, suppliers, and workers on Federal-aid highway projects, it is essential that all persons concerned with the project perform their functions as carefully, thoroughly, and honestly as possible. Willful falsification,

distortion, or misrepresentation with respect to any facts related to the project is a violation of Federal law. To prevent any misunderstanding regarding the seriousness of these and similar acts, the following notice shall be posted on each Federal-aid highway project (23 CFR 635) in one or more places where it is readily available to all persons concerned with the project:

**NOTICE TO ALL PERSONNEL ENGAGED ON FEDERAL-AID HIGHWAY PROJECTS**

18 U.S.C. 1020 reads as follows:

*“Whoever, being an officer, agent or employee of the United States, or of any State or Territory, or whoever, whether a person, association, firm, or corporation, knowingly makes any false statement, false representation, or false report as to the character, quality, quantity, or cost of the material used or to be used, or the quantity or quality of the work performed or to be performed, or the cost thereof in connection with the submission of plans, maps, specifications, contracts, or costs of construction on any highway or related project submitted for approval to the Secretary of Transportation; or*

*Whoever knowingly makes any false statement, false representation, false report or false claim with respect to the character, quality, quantity, or cost of any work performed or to be performed, or materials furnished or to be furnished, in connection with the construction of any highway or related project approved by the Secretary of Transportation; or*

*Whoever knowingly makes any false statement or false representation as to material fact in any statement, certificate, or report submitted pursuant to provisions of the Federal-aid Roads Act approved July 1, 1916, (39 Stat. 355), as amended and supplemented;*

*Shall be fined not more than \$10,000 or imprisoned not more than 5 years or both.”*

**X. IMPLEMENTATION OF CLEAN AIR ACT AND FEDERAL WATER POLLUTION CONTROL ACT**

(Applicable to all Federal-aid construction contracts and to all related subcontracts of \$100,000 or more).

By submission of this bid or the execution of this contract, or subcontract, as appropriate, the bidder, Federal-aid construction contractor, or subcontractor, as appropriate, will be deemed to have stipulated as follows:

1. That any facility that is or will be utilized in the performance of this contract, unless such contract is exempt under the Clean Air Act, as amended (42 U.S.C. 1857 et seq., as amended by Pub.L. 91-604), and under the Federal Water Pollution Control Act, as amended (33 U.S.C. 1251 et seq., as amended by Pub.L. 92-500), Executive Order 11738, and regulations in implementation thereof (40 CFR 15) is not listed, on the date of contract award, on the U.S. Environmental Protection Agency (EPA) List of Violating Facilities pursuant to 40 CFR 15.20.

2. That the firm agrees to comply and remain in compliance with all the requirements of Section 114 of the Clean Air Act and Section 308 of the Federal Water Pollution Control Act and all regulations and guidelines listed thereunder.

3. That the firm shall promptly notify the SHA of the receipt of

any communication from the Director, Office of Federal Activities, EPA indicating that a facility that is or will be utilized for the contract is under consideration to be listed on the EPA List of Violating Facilities.

4. That the firm agrees to include or cause to be included the requirements of paragraph 1 through 4 of this Section X in every nonexempt subcontract, and further agrees to take such action as the government may direct as a means of enforcing such requirements.

**XI. CERTIFICATION REGARDING DEBARMENT, SUSPENSION, INELIGIBILITY AND VOLUNTARY EXCLUSION**

1. Instructions for Certification - Primary Covered Transactions:

(Applicable to all Federal-aid contracts - 49 CFR 29)

a. By signing and submitting this proposal, the prospective primary participant is providing the certification set out below.

b. The inability of a person to provide the certification set out below will not necessarily result in denial of participation in this covered transaction. The prospective participant shall submit an explanation of why it cannot provide the certification set out below. The certification or explanation will be considered in connection with the department or agency's determination whether to enter into this transaction. However, failure of the prospective primary participant to furnish a certification or an explanation shall disqualify such a person from participation in this transaction.

c. The certification in this clause is a material representation of fact upon which reliance was placed when the department or agency determined to enter into this transaction. If it is later determined that the prospective primary participant knowingly rendered an erroneous certification, in addition to other remedies available to the Federal Government, the department or agency may terminate this transaction for cause of default.

d. The prospective primary participant shall provide immediate written notice to the department or agency to whom this proposal is submitted if any time the prospective primary participant learns that its certification was erroneous when submitted or has become erroneous by reason of changed circumstances.

e. The terms “covered transaction,” “debarred,” “suspended,” “ineligible,” “lower tier covered transaction,” “participant,” “person,” “primary covered transaction,” “principal,” “proposal,” and “voluntarily excluded,” as used in this clause, have the meanings set out in the Definitions and Coverage sections of rules implementing Executive Order 12549. You may contact the department or agency to which this proposal is submitted for assistance in obtaining a copy of those regulations.

f. The prospective primary participant agrees by submitting this proposal that, should the proposed covered transaction be entered into, it shall not knowingly enter into any lower tier covered transaction with a person who is debarred, suspended, declared ineligible, or voluntarily excluded from participation in this covered transaction, unless authorized by the department or agency entering into this transaction.

g. The prospective primary participant further agrees by submitting this proposal that it will include the clause titled

\*\*\*\*\*

"Certification Regarding Debarment, Suspension, Ineligibility and Voluntary Exclusion-Lower Tier Covered Transaction," provided by the department or agency entering into this covered transaction, without modification in all lower tier covered transactions and in all solicitations for lower tier covered transactions.

h. A participant in a covered transaction may rely upon a certification of a prospective participant in a lower tier covered transaction that is not debarred, suspended, ineligible, or voluntarily excluded from the covered transaction, unless it knows that the certification is erroneous. A participant may decide the method and frequency by which it determines the eligibility of its principals. Each participant may, but is not required to, check the nonprocurement portion of the "Lists of Parties Excluded from Federal Procurement or Nonprocurement Programs" (Nonprocurement List) which is compiled by the General Services Administration.

i. Nothing contained in the foregoing shall be construed to require establishment of a system of records in order to render in good faith the certification required by this clause. The knowledge and information of participant is not required to exceed that which is normally possessed by a prudent person in the ordinary course of business dealings.

j. Except for transactions authorized under paragraph f of these instructions, if a participant in a covered transaction knowingly enters into a lower tier covered transaction with a person who is suspended, debarred, ineligible, or voluntarily excluded from participation in this transaction, in addition to other remedies available to the Federal Government, the department or agency may terminate this transaction for cause or default.

\*\*\*\*\*

### **Certification Regarding Debarment, Suspension, Ineligibility and Voluntary Exclusion-Primary Covered Transactions**

1. The prospective primary participant certifies to the best of its knowledge and belief, that it and its principals:

- a. Are not presently debarred, suspended, proposed for debarment, declared ineligible, or voluntarily excluded from covered transactions by any Federal department or agency;
- b. Have not within a 3-year period preceding this proposal been convicted of or had a civil judgment rendered against them for commission of fraud or a criminal offense in connection with obtaining, attempting to obtain, or performing a public (Federal, State or local) transaction or contract under a public transaction; violation of Federal or State antitrust statutes or commission of embezzlement, theft, forgery, bribery, falsification or destruction of records, making false statements, or receiving stolen property;
- c. Are not presently indicted for or otherwise criminally or civilly charged by a governmental entity (Federal, State or local) with commission of any of the offenses enumerated in paragraph 1b of this certification; and
- d. Have not within a 3-year period preceding this application/proposal had one or more public transactions (Federal, State or local) terminated for cause or default.

2. Where the prospective primary participant is unable to certify to any of the statements in this certification, such prospective participant shall attach an explanation to this proposal.

### **2. Instructions for Certification - Lower Tier Covered Transactions:**

(Applicable to all subcontracts, purchase orders and other lower tier transactions of \$25,000 or more - 49 CFR 29)

- a. By signing and submitting this proposal, the prospective lower tier is providing the certification set out below.
- b. The certification in this clause is a material representation of fact upon which reliance was placed when this transaction was entered into. If it is later determined that the prospective lower tier participant knowingly rendered an erroneous certification, in addition to other remedies available to the Federal Government, the department, or agency with which this transaction originated may pursue available remedies, including suspension and/or debarment.
- c. The prospective lower tier participant shall provide immediate written notice to the person to which this proposal is submitted if at any time the prospective lower tier participant learns that its certification was erroneous by reason of changed circumstances.
- d. The terms "covered transaction," "debarred," "suspended," "ineligible," "primary covered transaction," "participant," "person," "principal," "proposal," and "voluntarily excluded," as used in this clause, have the meanings set out in the Definitions and Coverage sections of rules implementing Executive Order 12549. You may contact the person to which this proposal is submitted for assistance in obtaining a copy of those regulations.
- e. The prospective lower tier participant agrees by submitting this proposal that, should the proposed covered transaction be entered into, it shall not knowingly enter into any lower tier covered transaction with a person who is debarred, suspended, declared ineligible, or voluntarily excluded from participation in this covered transaction, unless authorized by the department or agency with which this transaction originated.
- f. The prospective lower tier participant further agrees by submitting this proposal that it will include this clause titled "Certification Regarding Debarment, Suspension, Ineligibility and Voluntary Exclusion-Lower Tier Covered Transaction," without modification, in all lower tier covered transactions and in all solicitations for lower tier covered transactions.
- g. A participant in a covered transaction may rely upon a certification of a prospective participant in a lower tier covered transaction that is not debarred, suspended, ineligible, or voluntarily excluded from the covered transaction, unless it knows that the certification is erroneous. A participant may decide the method and frequency by which it determines the eligibility of its principals. Each participant may, but is not required to, check the Nonprocurement List.
- h. Nothing contained in the foregoing shall be construed to require establishment of a system of records in order to render in good faith the certification required by this clause. The knowledge and information of participant is not required to exceed that which is normally possessed by a prudent person in the ordinary course of business dealing.
- i. Except for transactions authorized under paragraph e of these instructions, if a participant in a covered transaction knowingly enters into a lower tier covered transaction with a person who is suspended, debarred, ineligible, or voluntarily

excluded from participation in this transaction, in addition to other remedies available to the Federal Government, the department or agency with which this transaction originated may pursue available remedies, including suspension and/or debarment.

\*\*\*\*\*

**Certification Regarding Debarment, Suspension, Ineligibility And Voluntary Exclusion-Lower Tier Covered Transactions:**

1. The prospective lower tier participant certifies, by submission of this proposal, that neither it nor its principals is presently debarred, suspended, proposed for debarment, declared ineligible, or voluntarily excluded from participation in this transaction by any Federal department or agency.

2. Where the prospective lower tier participant is unable to certify to any of the statements in this certification, such prospective participant shall attach an explanation to this proposal.

\*\*\*\*\*

**XII. CERTIFICATION REGARDING USE OF CONTRACT FUNDS FOR LOBBYING**

(Applicable to all Federal-aid construction contracts and to all related subcontracts which exceed \$100,000 - 49 CFR 20)

1. The prospective participant certifies, by signing and submitting this bid or proposal, to the best of his or her knowledge and belief, that:

a. No Federal appropriated funds have been paid or will be paid, by or on behalf of the undersigned, to any person for influencing or attempting to influence an officer or employee of any Federal agency, a Member of Congress, an officer or employee of Congress, or an employee of a Member of Congress in connection with the awarding of any Federal contract, the making of any Federal grant, the making of any Federal loan, the entering into of any cooperative agreement, and the extension, continuation, renewal, amendment, or modification of any Federal contract, grant, loan, or cooperative agreement.

b. If any funds other than Federal appropriated funds have been paid or will be paid to any person for influencing or attempting to influence an officer or employee of any Federal agency, a Member of Congress, an officer or employee of Congress, or an employee of a Member of Congress in connection with this Federal contract, grant, loan, or cooperative agreement, the undersigned shall complete and submit Standard Form-LLL, "Disclosure Form to Report Lobbying," in accordance with its instructions.

2. This certification is a material representation of fact upon which reliance was placed when this transaction was made or entered into. Submission of this certification is a prerequisite for making or entering into this transaction imposed by 31 U.S.C. 1352. Any person who fails to file the required certification shall be subject to a civil penalty of not less than \$10,000 and not more than \$100,000 for each such failure.

3. The prospective participant also agrees by submitting his or her bid or proposal that he or she shall require that the language of this certification be included in all lower tier subcontracts, which exceed \$100,000 and that all such recipients shall certify and disclose accordingly.

## **MINIMUM WAGES FOR FEDERAL AND FEDERALLY ASSISTED CONSTRUCTION CONTRACTS**

This project is funded, in part, with Federal-aid funds and, as such, is subject to the provisions of the Davis-Bacon Act of March 3, 1931, as amended (46 Sta. 1494, as amended, 40 U.S.C. 276a) and of other Federal statutes referred to in a 29 CFR Part 1, Appendix A, as well as such additional statutes as may from time to time be enacted containing provisions for the payment of wages determined to be prevailing by the Secretary of Labor in accordance with the Davis-Bacon Act and pursuant to the provisions of 29 CFR Part 1. The prevailing rates and fringe benefits shown in the General Wage Determination Decisions issued by the U.S. Department of Labor shall, in accordance with the provisions of the foregoing statutes, constitute the minimum wages payable on Federal and federally assisted construction projects to laborers and mechanics of the specified classes engaged on contract work of the character and in the localities described therein.

General Wage Determination Decisions, modifications and supersedes decisions thereto are to be used in accordance with the provisions of 29 CFR Parts 1 and 5. Accordingly, the applicable decision, together with any modifications issued, must be made a part of every contract for performance of the described work within the geographic area indicated as required by an applicable DBRA Federal prevailing wage law and 29 CFR Part 5. The wage rates and fringe benefits contained in the General Wage Determination Decision

### **NOTICE**

The most current **General Wage Determination Decisions** (wage rates) are available on the IDOT web site. They are located on the Letting and Bidding page at <http://www.dot.il.gov/desenv/delett.html>.

In addition, ten (10) days prior to the letting, the applicable Federal wage rates will be e-mailed to subscribers. It is recommended that all contractors subscribe to the Federal Wage Rates List or the Contractor's Packet through IDOT's subscription service.

PLEASE NOTE: if you have already subscribed to the Contractor's Packet you will automatically receive the Federal Wage Rates.

The instructions for subscribing are at <http://www.dot.il.gov/desenv/subsc.html>.

If you have any questions concerning the wage rates, please contact IDOT's Chief Contract Official at 217-782-7806.