

## **If you plan to submit a bid directly to the Department of Transportation**

### **PREQUALIFICATION**

Any contractor who desires to become pre-qualified to bid on work advertised by IDOT must submit the properly completed pre-qualification forms to the Bureau of Construction no later than 4:30 p.m. prevailing time twenty-one days prior to the letting of interest. This pre-qualification requirement applies to first time contractors, contractors renewing expired ratings, contractors maintaining continuous pre-qualification or contractors requesting revised ratings. To be eligible to bid, existing pre-qualification ratings must be effective through the date of letting.

### **REQUESTS FOR AUTHORIZATION TO BID**

Contractors wanting to bid on items included in a particular letting must submit the properly completed "Request for Authorization to Bid/or Not For Bid Status" (BDE 124INT) and the ORIGINAL "Affidavit of Availability" (BC 57) to the proper office no later than 4:30 p.m. prevailing time, three (3) days prior to the letting date.

### **WHO CAN BID ?**

Bids will be accepted from only those companies that request and receive written **Authorization to Bid** from IDOT's Central Bureau of Construction.

**WHAT CONSTITUTES WRITTEN AUTHORIZATION TO BID?:** When a prospective prime bidder submits a "Request for Authorization to Bid/or Not For Bid Status" (BDE 124INT) he/she must indicate at that time which items are being requested For Bidding purposes. Only those items requested For Bidding will be analyzed. After the request has been analyzed, the bidder will be issued an **Authorization to Bid or Not for Bid Report**, approved by the Central Bureau of Construction that indicates which items have been approved For Bidding. If **Authorization to Bid** cannot be approved, the **Authorization to Bid or Not for Bid Report** will indicate the reason for denial.

**ABOUT AUTHORIZATION TO BID:** Firms that have not received an authorization form within a reasonable time of complete and correct original document submittal should contact the department as to status. This is critical in the week before the letting. These documents must be received three days before the letting date. Firms unsure as to authorization status should call the Prequalification Section of the Bureau of Construction at the number listed at the end of these instructions.

**ADDENDA AND REVISIONS:** It is the contractor's responsibility to determine which, if any, addenda or revisions pertain to any project they may be bidding. Failure to incorporate all relevant addenda or revisions may cause the bid to be declared unacceptable.

Each addendum will be placed with the contract number. Addenda and revisions will also be placed on the Addendum/Revision Checklist and each subscription service subscriber will be notified by e-mail of each addendum and revision issued.

The Internet is the Department's primary way of doing business. The subscription server e-mails are an added courtesy the Department provides. It is suggested that bidders check IDOT's website at <http://www.dot.il.gov/desenv/delett.html> before submitting final bid information.

### ***IDOT IS NOT RESPONSIBLE FOR ANY E-MAIL FAILURES.***

Addenda Questions may be directed to the Contracts Office at (217)782-7806 or [D&Econtracts@dot.il.gov](mailto:D&Econtracts@dot.il.gov)

Technical Questions about downloading these files may be directed to Tim Garman (217)524-1642 or [Timothy.Garman@illinois.gov](mailto:Timothy.Garman@illinois.gov).

**WHAT MUST BE INCLUDED WHEN BIDS ARE SUBMITTED?:** Bidders need not return the entire proposal when bids are submitted. That portion of the proposal that must be returned includes the following:

1. All documents from the Proposal Cover Sheet through the Proposal Bid Bond
2. Other special documentation and/or information that may be required by the contract special provisions

All proposal documents, including Proposal Guaranty Checks or Proposal Bid Bonds, should be stapled together to prevent loss when bids are processed by IDOT personnel.

**ABOUT SUBMITTING BIDS:** It is recommended that bidders deliver bids in person to insure they arrive at the proper location prior to the time specified for the receipt of bids. Any bid received at the place of letting after the time specified will not be accepted.

**WHO SHOULD BE CALLED IF ASSISTANCE IS NEEDED?**

<b>Questions Regarding</b>	<b>Call</b>
Prequalification and/or Authorization to Bid	217/782-3413
Preparation and submittal of bids	217/782-7806
Mailing of plans and proposals	217/782-7806

**ADDENDUMS AND REVISIONS TO THE PROPOSAL FORMS**

Planholders should verify that they have received and incorporated any addendum and/or revision prior to submitting their bid. Failure by the bidder to include an addendum or revision could result in a bid being rejected as irregular.

# 257

RETURN WITH BID

Proposal Submitted By
Name
Address
City

## Letting March 5, 2010

**BIDDERS NEED NOT RETURN THE ENTIRE PROPOSAL**  
(See instructions inside front cover)

### NOTICE TO PROSPECTIVE BIDDERS

This proposal can be used for bidding purposes by only those companies that request and receive written AUTHORIZATION TO BID from IDOT's Central Bureau of Construction.  
(SEE INSTRUCTIONS ON THE INSIDE OF COVER)

# Notice To Bidders, Specifications, Proposal, Contract and Contract Bond



**Illinois Department  
of Transportation**

Springfield, Illinois 62764

**Contract No. 68916  
WARREN-HENDERSON Counties  
Section 105RS-2  
District 4 Construction Funds  
Route FAS 1412**

PLEASE MARK THE APPROPRIATE BOX BELOW:

- A Bid Bond is included.
- A Cashier's Check or a Certified Check is included.

Plans Included  
Herein

Prepared by

Checked by

S

(Printed by authority of the State of Illinois)

---

---

## INSTRUCTIONS

**ABOUT IDOT PROPOSALS:** All proposals issued by IDOT are potential bidding proposals. Each proposal contains all Certifications and Affidavits, a Proposal Signature Sheet and a Proposal Bid Bond required for Prime Contractors to submit a bid after written **Authorization to Bid** has been issued by IDOT's Central Bureau of Construction.

**WHO CAN BID?:** Bids will be accepted from only those companies that request and receive written **Authorization to Bid** from IDOT's Central Bureau of Construction. To request authorization, a potential bidder must complete and submit Part B of the Request for Authorization to Bid/or Not For Bid Status form (BDE 124 INT) and submit an original Affidavit of Availability (BC 57).

**WHAT CONSTITUTES WRITTEN AUTHORIZATION TO BID?:** When a prospective prime bidder submits a **"Authorization to Bid or Not for Bid"** form, he/she must indicate at that time which items are being requested For Bidding purposes. Only those items requested For Bidding will be analyzed. After the request has been analyzed, the bidder will be issued a **Authorization to Bid or Not for Bid Report**, approved by the Central Bureau of Construction, that indicates which items have been approved For Bidding. If **Authorization to Bid** cannot be approved, the **Authorization to Bid or Not for Bid Report** will indicate the reason for denial. If a contractor has requested to bid but has not received a **Authorization to Bid or Not for Bid Report**, they should contact the Central Bureau of Construction in advance of the letting date.

**WHAT MUST BE INCLUDED WHEN BIDS ARE SUBMITTED?:** Bidders need not return the entire proposal when bids are submitted. That portion of the proposal that must be returned includes the following:

1. All documents from the Proposal Cover Sheet through the Proposal Bid Bond
2. Other special documentation and/or information that may be required by the contract special provisions

All proposal documents, including Proposal Guaranty Checks or Proposal Bid Bonds, should be stapled together to prevent loss when bids are processed by IDOT personnel.

**ABOUT SUBMITTING BIDS:** It is recommended that bidders deliver bids in person to insure they arrive at the proper location prior to the time specified for the receipt of bids. Any bid received at the place of letting after the time specified will not be accepted.

### WHO SHOULD BE CALLED IF ASSISTANCE IS NEEDED?

Questions Regarding	Call
Prequalification and/or Authorization to Bid	217/782-3413
Preparation and submittal of bids	217/782-7806

RETURN WITH BID



PROPOSAL

TO THE DEPARTMENT OF TRANSPORTATION

1. Proposal of \_\_\_\_\_

\_\_\_\_\_

Taxpayer Identification Number (Mandatory) \_\_\_\_\_ a

for the improvement identified and advertised for bids in the Invitation for Bids as:

**Contract No. 68916  
WARREN-HENDERSON Counties  
Section 105RS-2  
Route FAS 1412  
District 4 Construction Funds**

**6.49 miles of surface maintenance located on IL Route 94 from IL Route 135 to south of Township Road 29, south of Bald Bluff.**

2. The undersigned bidder will furnish all labor, material and equipment to complete the above described project in a good and workmanlike manner as provided in the contract documents provided by the Department of Transportation. This proposal will become part of the contract and the terms and conditions contained in the contract documents shall govern performance and payments.

**RETURN WITH BID**

3. **ASSURANCE OF EXAMINATION AND INSPECTION/WAIVER.** The undersigned further declares that he/she has carefully examined the proposal, plans, specifications, form of contract and contract bond, and special provisions, and that he/she has inspected in detail the site of the proposed work, and that he/she has familiarized themselves with all of the local conditions affecting the contract and the detailed requirements of construction, and understands that in making this proposal he/she waives all right to plead any misunderstanding regarding the same.
4. **EXECUTION OF CONTRACT AND CONTRACT BOND.** The undersigned further agrees to execute a contract for this work and present the same to the department within fifteen (15) days after the contract has been mailed to him/her. The undersigned further agrees that he/she and his/her surety will execute and present within fifteen (15) days after the contract has been mailed to him/her contract bond satisfactory to and in the form prescribed by the Department of Transportation, in the penal sum of the full amount of the contract, guaranteeing the faithful performance of the work in accordance with the terms of the contract.
5. **PROPOSAL GUARANTY.** Accompanying this proposal is either a bid bond on the department form, executed by a corporate surety company satisfactory to the department, or a proposal guaranty check consisting of a bank cashier's check or a properly certified check for not less than 5 per cent of the amount bid or for the amount specified in the following schedule:

<u>Amount of Bid</u>		<u>Proposal Guaranty</u>	<u>Amount of Bid</u>		<u>Proposal Guaranty</u>	
Up to	\$5,000 .....	\$150	\$2,000,000	to	\$3,000,000 .....	\$100,000
\$5,000	to \$10,000 .....	\$300	\$3,000,000	to	\$5,000,000 .....	\$150,000
\$10,000	to \$50,000 .....	\$1,000	\$5,000,000	to	\$7,500,000 .....	\$250,000
\$50,000	to \$100,000 .....	\$3,000	\$7,500,000	to	\$10,000,000 .....	\$400,000
\$100,000	to \$150,000 .....	\$5,000	\$10,000,000	to	\$15,000,000 .....	\$500,000
\$150,000	to \$250,000 .....	\$7,500	\$15,000,000	to	\$20,000,000 .....	\$600,000
\$250,000	to \$500,000 .....	\$12,500	\$20,000,000	to	\$25,000,000 .....	\$700,000
\$500,000	to \$1,000,000 .....	\$25,000	\$25,000,000	to	\$30,000,000 .....	\$800,000
\$1,000,000	to \$1,500,000 .....	\$50,000	\$30,000,000	to	\$35,000,000 .....	\$900,000
\$1,500,000	to \$2,000,000 .....	\$75,000	over		\$35,000,000 .....	\$1,000,000

Bank cashier's checks or properly certified checks accompanying proposals shall be made payable to the Treasurer, State of Illinois, when the state is awarding authority; the county treasurer, when a county is the awarding authority; or the city, village, or town treasurer, when a city, village, or town is the awarding authority.

If a combination bid is submitted, the proposal guaranties which accompany the individual proposals making up the combination will be considered as also covering the combination bid.

The amount of the proposal guaranty check is \_\_\_\_\_ \$( \_\_\_\_\_ ). If this proposal is accepted and the undersigned shall fail to execute a contract bond as required herein, it is hereby agreed that the amount of the proposal guaranty shall become the property of the State of Illinois, and shall be considered as payment of damages due to delay and other causes suffered by the State because of the failure to execute said contract and contract bond; otherwise, the bid bond shall become void or the proposal guaranty check shall be returned to the undersigned.

**Attach Cashier's Check or Certified Check Here**

In the event that one proposal guaranty check is intended to cover two or more proposals, the amount must be equal to the sum of the proposal guaranties which would be required for each individual proposal. If the guaranty check is placed in another proposal, state below where it may be found.

The proposal guaranty check will be found in the proposal for:

Item \_\_\_\_\_

Section No. \_\_\_\_\_

County \_\_\_\_\_

**Mark the proposal cover sheet as to the type of proposal guaranty submitted.**

**RETURN WITH BID**

6. **COMBINATION BIDS.** The undersigned further agrees that if awarded the contract for the sections contained in the following combination, he/she will perform the work in accordance with the requirements of each individual proposal comprising the combination bid specified in the schedule below, and that the combination bid shall be prorated against each section in proportion to the bid submitted for the same. If an error is found to exist in the gross sum bid for one or more of the individual sections included in a combination, the combination bid shall be corrected as provided in the specifications.

**When a combination bid is submitted, the schedule below must be completed in each proposal comprising the combination.**

**If alternate bids are submitted for one or more of the sections comprising the combination, a combination bid must be submitted for each alternate.**

**Schedule of Combination Bids**

Combination No.	Sections Included in Combination	Combination Bid	
		Dollars	Cents

7. **SCHEDULE OF PRICES.** The undersigned bidder submits herewith, in accordance with the rules and instructions, a schedule of prices for the items of work for which bids are sought. The unit prices bid are in U.S. dollars and cents, and all extensions and summations have been made. The bidder understands that the quantities appearing in the bid schedule are approximate and are provided for the purpose of obtaining a gross sum for the comparison of bids. If there is an error in the extension of the unit prices, the unit prices shall govern. Payment to the contractor awarded the contract will be made only for actual quantities of work performed and accepted or materials furnished according to the contract. The scheduled quantities of work to be done and materials to be furnished may be increased, decreased or omitted as provided elsewhere in the contract.

8. **CERTIFICATE OF AUTHORITY.** The undersigned bidder, if a business organized under the laws of another State, assures the Department that it will furnish a copy of its certificate of authority to do business in the State of Illinois with the return of the executed contract and bond. Failure to furnish the certificate within the time provided for execution of an awarded contract may be cause for cancellation of the award and forfeiture of the proposal guaranty to the State.

ILLINOIS DEPARTMENT OF TRANSPORTATION  
 SCHEDULE OF PRICES  
 CONTRACT  
 NUMBER - 68916

State Job # - C-94-132-09  
 PPS NBR - 4-00158-0500  
 County Name - HENDERSON- WARREN-  
 Code - 71 - 187 -  
 District - 4 - 4 -  
 Section Number - 105RS-2

Project Number

Route  
 FAS 1412

Item Number	Pay Item Description	Unit of Measure	Quantity	x	Unit Price	=	Total Price
X0322729	MATL TRANSFER DEVICE	TON	7,685.000				
40600215	P BIT MATLS PR CT	TON	37.000				
40600300	AGG PR CT	TON	183.000				
40600895	CONSTRUC TEST STRIP	EACH	1.000				
40600982	HMA SURF REM BUTT JT	SQ YD	1,052.000				
40600990	TEMPORARY RAMP	SQ YD	165.000				
40603335	HMA SC "D" N50	TON	7,685.000				
44000152	HMA SURF REM 3/4	SQ YD	76,297.000				
44000155	HMA SURF REM 1 1/2	SQ YD	7,589.000				
44000198	HMA SURF REM VAR DP	SQ YD	5,945.000				
44003100	MEDIAN REMOVAL	SQ FT	200.000				
44201803	CL D PATCH T2 13	SQ YD	913.000				
44201807	CL D PATCH T3 13	SQ YD	64.000				
44201809	CL D PATCH T4 13	SQ YD	140.000				
48101200	AGGREGATE SHLDS B	TON	730.000				







## RETURN WITH BID

### STATE REQUIRED ETHICAL STANDARDS GOVERNING CONTRACT PROCUREMENT: ASSURANCES, CERTIFICATIONS AND DISCLOSURES

#### I. GENERAL

A. Article 50 of the Illinois Procurement Code establishes the duty of all State chief procurement officers, State purchasing officers, and their designees to maximize the value of the expenditure of public moneys in procuring goods, services, and contracts for the State of Illinois and to act in a manner that maintains the integrity and public trust of State government. In discharging this duty, they are charged by law to use all available information, reasonable efforts, and reasonable actions to protect, safeguard, and maintain the procurement process of the State of Illinois.

B. In order to comply with the provisions of Article 50 and to carry out the duty established therein, all bidders are to adhere to ethical standards established for the procurement process, and to make such assurances, disclosures and certifications required by law. By execution of the Proposal Signature Sheet, the bidder indicates that each of the mandated assurances has been read and understood, that each certification is made and understood, and that each disclosure requirement has been understood and completed.

C. In addition to all other remedies provided by law, failure to comply with any assurance, failure to make any disclosure or the making of a false certification shall be grounds for termination of the contract and the suspension or debarment of the bidder.

#### II. ASSURANCES

A. The assurances hereinafter made by the bidder are each a material representation of fact upon which reliance is placed should the Department enter into the contract with the bidder. The Department may terminate the contract if it is later determined that the bidder rendered a false or erroneous assurance, and the surety providing the performance bond shall be responsible for the completion of the contract.

##### B. Felons

1. The Illinois Procurement Code provides:

Section 50-10. Felons. Unless otherwise provided, no person or business convicted of a felony shall do business with the State of Illinois or any state agency from the date of conviction until 5 years after the date of completion of the sentence for that felony, unless no person held responsible by a prosecutorial office for the facts upon which the conviction was based continues to have any involvement with the business.

2. The bidder assures the Department that the award and execution of the contract would not cause a violation of Section 50-10.

##### C. Conflicts of Interest

1. The Illinois Procurement Code provides in pertinent part:

Section 50-13. Conflicts of Interest.

(a) Prohibition. It is unlawful for any person holding an elective office in this State, holding a seat in the General Assembly, or appointed to or employed in any of the offices or agencies of state government and who receives compensation for such employment in excess of 60% of the salary of the Governor of the State of Illinois, or who is an officer or employee of the Capital Development Board or the Illinois Toll Highway Authority, or who is the spouse or minor child of any such person to have or acquire any contract, or any direct pecuniary interest in any contract therein, whether for stationery, printing, paper, or any services, materials, or supplies, that will be wholly or partially satisfied by the payment of funds appropriated by the General Assembly of the State of Illinois or in any contract of the Capital Development Board or the Illinois Toll Highway authority.

(b) Interests. It is unlawful for any firm, partnership, association or corporation, in which any person listed in subsection (a) is entitled to receive (i) more than 7 1/2% of the total distributable income or (ii) an amount in excess of the salary of the Governor, to have or acquire any such contract or direct pecuniary interest therein.

(c) Combined interests. It is unlawful for any firm, partnership, association, or corporation, in which any person listed in subsection (a) together with his or her spouse or minor children is entitled to receive (i) more than 15%, in the aggregate, of the total distributable income or (ii) an amount in excess of 2 times the salary of the Governor, to have or acquire any such contract or direct pecuniary interest therein.

(d) Securities. Nothing in this Section invalidates the provisions of any bond or other security previously offered or to be offered for sale or sold by or for the State of Illinois.

(e) Prior interests. This Section does not affect the validity of any contract made between the State and an officer or employee of the State or member of the General Assembly, his or her spouse, minor child or any combination of those persons if that contract was in existence before his or her election or employment as an officer, member, or employee. The contract is voidable, however, if it cannot be completed within 365 days after the officer, member, or employee takes office or is employed.

The current salary of the Governor is \$177,412.00. Sixty percent of the salary is \$106,447.20.

## RETURN WITH BID

2. The bidder assures the Department that the award and execution of the contract would not cause a violation of Section 50-13, or that an effective exemption has been issued by the Board of Ethics to any individual subject to the Section 50-13 prohibitions pursuant to the provisions of Section 50-20 of the Code and Executive Order Number 3 (1998). Information concerning the exemption process is available from the Department upon request.

### **D. Negotiations**

1. The Illinois Procurement Code provides in pertinent part:

Section 50-15. Negotiations.

(a) It is unlawful for any person employed in or on a continual contractual relationship with any of the offices or agencies of State government to participate in contract negotiations on behalf of that office or agency with any firm, partnership, association, or corporation with whom that person has a contract for future employment or is negotiating concerning possible future employment.

2. The bidder assures the Department that the award and execution of the contract would not cause a violation of Section 50-15, and that the bidder has no knowledge of any facts relevant to the kinds of acts prohibited therein.

### **E. Inducements**

1. The Illinois Procurement Code provides:

Section 50-25. Inducement. Any person who offers or pays any money or other valuable thing to any person to induce him or her not to bid for a State contract or as recompense for not having bid on a State contract is guilty of a Class 4 felony. Any person who accepts any money or other valuable thing for not bidding for a State contract or who withholds a bid in consideration of the promise for the payment of money or other valuable thing is guilty of a Class 4 felony.

2. The bidder assures the Department that the award and execution of the contract would not cause a violation of Section 50-25, and that the bidder has no knowledge of any facts relevant to the kinds of acts prohibited therein.

### **F. Revolving Door Prohibition**

1. The Illinois Procurement Code provides:

Section 50-30. Revolving door prohibition. Chief procurement officers, associate procurement officers, State purchasing officers, their designees whose principal duties are directly related to State procurement, and executive officers confirmed by the Senate are expressly prohibited for a period of 2 years after terminating an affected position from engaging in any procurement activity relating to the State agency most recently employing them in an affected position for a period of at least 6 months. The prohibition includes, but is not limited to: lobbying the procurement process; specifying; bidding; proposing bid, proposal, or contract documents; on their own behalf or on behalf of any firm, partnership, association, or corporation. This Section applies only to persons who terminate an affected position on or after January 15, 1999.

2. The bidder assures the Department that the award and execution of the contract would not cause a violation of Section 50-30, and that the bidder has no knowledge of any facts relevant to the kinds of acts prohibited therein.

### **G. Reporting Anticompetitive Practices**

1. The Illinois Procurement Code provides:

Section 50-40. Reporting anticompetitive practices. When, for any reason, any vendor, bidder, contractor, chief procurement officer, State purchasing officer, designee, elected official, or State employee suspects collusion or other anticompetitive practice among any bidders, offerors, contractors, proposers, or employees of the State, a notice of the relevant facts shall be transmitted to the Attorney General and the chief procurement officer.

2. The bidder assures the Department that it has not failed to report any relevant facts concerning the practices addressed in Section 50-40 which may involve the contract for which the bid is submitted.

### **H. Confidentiality**

1. The Illinois Procurement Code provides:

Section 50-45. Confidentiality. Any chief procurement officer, State purchasing officer, designee, or executive officer who willfully uses or allows the use of specifications, competitive bid documents, proprietary competitive information, proposals, contracts, or selection information to compromise the fairness or integrity of the procurement, bidding, or contract process shall be subject to immediate dismissal, regardless of the Personnel code, any contract, or any collective bargaining agreement, and may in addition be subject to criminal prosecution.

2. The bidder assures the Department that it has no knowledge of any fact relevant to the practices addressed in Section 50-45 which may involve the contract for which the bid is submitted.

## RETURN WITH BID

### **I. Insider Information**

1. The Illinois Procurement Act provides:

Section 50-50. Insider information. It is unlawful for any current or former elected or appointed State official or State employee to knowingly use confidential information available only by virtue of that office or employment for actual or anticipated gain for themselves or another person.

2. The bidder assures the Department that it has no knowledge of any facts relevant to the practices addressed in Section 50-50 which may involve the contract for which the bid is submitted.

### **III. CERTIFICATIONS**

**A.** The certifications hereinafter made by the bidder are each a material representation of fact upon which reliance is placed should the Department enter into the contract with the bidder. The Department may terminate the contract if it is later determined that the bidder rendered a false or erroneous certification, and the surety providing the performance bond shall be responsible for completion of the contract.

### **B. Bribery**

1. The Illinois Procurement Code provides:

Section 50-5. Bribery.

(a) Prohibition. No person or business shall be awarded a contract or subcontract under this Code who:

(1) has been convicted under the laws of Illinois or any other state of bribery or attempting to bribe an officer or employee of the State of Illinois or any other state in that officer's or employee's official capacity; or

(2) has made an admission of guilt of that conduct that is a matter of record but has not been prosecuted for that conduct.

(b) Businesses. No business shall be barred from contracting with any unit of State or local government as a result of a conviction under this Section of any employee or agent of the business if the employee or agent is no longer employed by the business and:

(1) the business has been finally adjudicated not guilty; or

(2) the business demonstrates to the governmental entity with which it seeks to contract, and that entity finds that the commission of the offense was not authorized, requested, commanded, or performed by a director, officer, or high managerial agent on behalf of the business as provided in paragraph (2) of subsection (a) of Section 5-4 of the Criminal Code of 1961.

(c) Conduct on behalf of business. For purposes of this Section, when an official, agent, or employee of a business committed the bribery or attempted bribery on behalf of the business and in accordance with the direction or authorization of a responsible official of the business, the business shall be chargeable with the conduct.

(d) Certification. Every bid submitted to and contract executed by the State shall contain a certification by the contractor that the contractor is not barred from being awarded a contract or subcontract under this Section. A contractor who makes a false statement, material to the certification, commits a Class 3 felony.

2. The bidder certifies that it is not barred from being awarded a contract under Section 50.5.

### **C. Educational Loan**

1. Section 3 of the Educational Loan Default Act provides:

§ 3. No State agency shall contract with an individual for goods or services if that individual is in default, as defined in Section 2 of this Act, on an educational loan. Any contract used by any State agency shall include a statement certifying that the individual is not in default on an educational loan as provided in this Section.

2. The bidder, if an individual as opposed to a corporation, partnership or other form of business organization, certifies that the bidder is not in default on an educational loan as provided in Section 3 of the Act.

### **D. Bid-Rigging/Bid Rotating**

1. Section 33E-11 of the Criminal Code of 1961 provides:

§ 33E-11. (a) Every bid submitted to and public contract executed pursuant to such bid by the State or a unit of local government shall contain a certification by the prime contractor that the prime contractor is not barred from contracting with any unit of State or local government as a result of a violation of either Section 33E-3 or 33E-4 of this Article. The State and units of local government shall provide the appropriate forms for such certification.

## RETURN WITH BID

(b) A contractor who makes a false statement, material to the certification, commits a Class 3 felony.

A violation of Section 33E-3 would be represented by a conviction of the crime of bid-rigging which, in addition to Class 3 felony sentencing, provides that any person convicted of this offense or any similar offense of any state or the United States which contains the same elements as this offense shall be barred for 5 years from the date of conviction from contracting with any unit of State or local government. No corporation shall be barred from contracting with any unit of State or local government as a result of a conviction under this Section of any employee or agent of such corporation if the employee so convicted is no longer employed by the corporation and: (1) it has been finally adjudicated not guilty or (2) if it demonstrates to the governmental entity with which it seeks to contract and that entity finds that the commission of the offense was neither authorized, requested, commanded, nor performed by a director, officer or a high managerial agent in behalf of the corporation.

A violation of Section 33E-4 would be represented by a conviction of the crime of bid-rotating which, in addition to Class 2 felony sentencing, provides that any person convicted of this offense or any similar offense of any state or the United States which contains the same elements as this offense shall be permanently barred from contracting with any unit of State or local government. No corporation shall be barred from contracting with any unit of State or local government as a result of a conviction under this Section of any employee or agent of such corporation if the employee so convicted is no longer employed by the corporation and: (1) it has been finally adjudicated not guilty or (2) if it demonstrates to the governmental entity with which it seeks to contract and that entity finds that the commission of the offense was neither authorized, requested, commanded, nor performed by a director, officer or a high managerial agent in behalf of the corporation.

2. The bidder certifies that it is not barred from contracting with the Department by reason of a violation of either Section 33E-3 or Section 33E-4.

### **E. International Anti-Boycott**

1. Section 5 of the International Anti-Boycott Certification Act provides:

§ 5. State contracts. Every contract entered into by the State of Illinois for the manufacture, furnishing, or purchasing of supplies, material, or equipment or for the furnishing of work, labor, or services, in an amount exceeding the threshold for small purchases according to the purchasing laws of this State or \$10,000.00, whichever is less, shall contain certification, as a material condition of the contract, by which the contractor agrees that neither the contractor nor any substantially-owned affiliated company is participating or shall participate in an international boycott in violation of the provisions of the U.S. Export Administration Act of 1979 or the regulations of the U.S. Department of Commerce promulgated under that Act.

2. The bidder makes the certification set forth in Section 5 of the Act.

### **F. Drug Free Workplace**

1. The Illinois "Drug Free Workplace Act" applies to this contract and it is necessary to comply with the provisions of the "Act" if the contractor is a corporation, partnership, or other entity (including a sole proprietorship) which has 25 or more employees.

2. The bidder certifies that if awarded a contract in excess of \$5,000 it will provide a drug free workplace by:

(a) Publishing a statement notifying employees that the unlawful manufacture, distribution, dispensation, possession or use of a controlled substance, including cannabis, is prohibited in the contractor's workplace; specifying the actions that will be taken against employees for violations of such prohibition; and notifying the employee that, as a condition of employment on such contract, the employee shall abide by the terms of the statement, and notify the employer of any criminal drug statute conviction for a violation occurring in the workplace no later than five (5) days after such conviction.

(b) Establishing a drug free awareness program to inform employees about the dangers of drug abuse in the workplace; the contractor's policy of maintaining a drug free workplace; any available drug counseling, rehabilitation, and employee assistance programs; and the penalties that may be imposed upon employees for drug violations.

(c) Providing a copy of the statement required by subparagraph (1) to each employee engaged in the performance of the contract and to post the statement in a prominent place in the workplace.

(d) Notifying the Department within ten (10) days after receiving notice from an employee or otherwise receiving actual notice of the conviction of an employee for a violation of any criminal drug statute occurring in the workplace.

(e) Imposing or requiring, within 30 days after receiving notice from an employee of a conviction or actual notice of such a conviction, an appropriate personnel action, up to and including termination, or the satisfactory participation in a drug abuse assistance or rehabilitation program approved by a federal, state or local health, law enforcement or other appropriate agency.

(f) Assisting employees in selecting a course of action in the event drug counseling, treatment, and rehabilitation is required and indicating that a trained referral team is in place.

(g) Making a good faith effort to continue to maintain a drug free workplace through implementation of the actions and efforts stated in this certification.

## RETURN WITH BID

### **G. Debt Delinquency**

1. The Illinois Procurement Code provides:

Section 50-11 and 50-12. Debt Delinquency.

The contractor or bidder certifies that it, or any affiliate, is not barred from being awarded a contract under 30 ILCS 500. Section 50-11 prohibits a person from entering into a contract with a State agency if it knows or should know that it, or any affiliate, is delinquent in the payment of any debt to the State as defined by the Debt Collection Board. Section 50-12 prohibits a person from entering into a contract with a State agency if it, or any affiliate, has failed to collect and remit Illinois Use Tax on all sales of tangible personal property into the State of Illinois in accordance with the provisions of the Illinois Use Tax Act. The contractor further acknowledges that the contracting State agency may declare the contract void if this certification is false or if the contractor, or any affiliate, is determined to be delinquent in the payment of any debt to the State during the term of the contract.

### **H. Sarbanes-Oxley Act of 2002**

1. The Illinois Procurement Code provides:

Section 50-60(c).

The contractor certifies in accordance with 30 ILCS 500/50-10.5 that no officer, director, partner or other managerial agent of the contracting business has been convicted of a felony under the Sarbanes-Oxley Act of 2002 or a Class 3 or Class 2 felony under the Illinois Securities Law of 1953 for a period of five years prior to the date of the bid or contract. The contractor acknowledges that the contracting agency shall declare the contract void if this certification is false.

### **I. Addenda**

The contractor or bidder certifies that all relevant addenda have been incorporated in to this contract. Failure to do so may cause the bid to be declared unacceptable.

### **J. Section 42 of the Environmental Protection Act**

The contractor certifies in accordance with 30 ILCS 500/50-12 that the bidder or contractor is not barred from being awarded a contract under this Section which prohibits the bidding on or entering into contracts with the State of Illinois or a State agency by a person or business found by a court or the Pollution Control Board to have committed a willful or knowing violation of Section 42 of the Environmental Protection Act for a period of five years from the date of the order. The contractor acknowledges that the contracting agency may declare the contract void if this certification is false.

### **K. Apprenticeship and Training Certification (Does not apply to federal aid projects)**

In accordance with the provisions of Section 30-22 (6) of the Illinois Procurement Code, the bidder certifies that it is a participant, either as an individual or as part of a group program, in the approved apprenticeship and training programs applicable to each type of work or craft that the bidder will perform with its own forces. The bidder further certifies for work that will be performed by subcontract that each of its subcontractors submitted for approval either (a) is, at the time of such bid, participating in an approved, applicable apprenticeship and training program; or (b) will, prior to commencement of performance of work pursuant to this contract, begin participation in an approved apprenticeship and training program applicable to the work of the subcontract. The Department, at any time before or after award, may require the production of a copy of each applicable Certificate of Registration issued by the United States Department of Labor evidencing such participation by the contractor and any or all of its subcontractors. Applicable apprenticeship and training programs are those that have been approved and registered with the United States Department of Labor. The bidder shall list in the space below, the official name of the program sponsor holding the Certificate of Registration for all of the types of work or crafts in which the bidder is a participant and that will be performed with the bidder's forces. Types of work or craft work that will be subcontracted shall be included and listed as subcontract work. The list shall also indicate any type of work or craft job category that does not have an applicable apprenticeship or training program. **The bidder is responsible for making a complete report and shall make certain that each type of work or craft job category that will be utilized on the project as reported on the Construction Employee Workforce Projection (Form BC-1256) and returned with the bid is accounted for and listed.**

---

---

---

The requirements of this certification and disclosure are a material part of the contract, and the contractor shall require this certification provision to be included in all approved subcontracts. In order to fulfill this requirement, it shall not be necessary that an applicable program sponsor be currently taking or that it will take applications for apprenticeship, training or employment during the performance of the work of this contract.

### **L. Executive Order Number 1 (2007) Regarding Lobbying on Government Procurements**

The bidder hereby warrants and certifies that they have complied and will comply with the requirements set forth in this Order. The requirements of this warrant and certification are a material part of the contract, and the contractor shall require this warrant and certification provision to be included in all approved subcontracts.

## RETURN WITH BID

### **M. Disclosure of Business Operations in Iran**

Section 50-36 of the Illinois Procurement Code, 30ILCS 500/50-36 provides that each bid, offer, or proposal submitted for a State contract shall include a disclosure of whether or not the Company acting as the bidder, offeror, or proposing entity, or any of its corporate parents or subsidiaries, within the 24 months before submission of the bid, offer, or proposal had business operations that involved contracts with or provision of supplies or services to the Government of Iran, companies in which the Government of Iran has any direct or indirect equity share, consortiums or projects commissioned by the Government of Iran, or companies involved in consortiums or projects commissioned by the Government of Iran and either of the following conditions apply:

- (1) More than 10% of the Company's revenues produced in or assets located in Iran involve oil-related activities or mineral-extraction activities; less than 75% of the Company's revenues produced in or assets located in Iran involve contracts with or provision of oil-related or mineral-extraction products or services to the Government of Iran or a project or consortium created exclusively by that government; and the Company has failed to take substantial action.
- (2) The Company has, on or after August 5, 1996, made an investment of \$20 million or more, or any combination of investments of at least \$10 million each that in the aggregate equals or exceeds \$20 million in any 12-month period, which directly or significantly contributes to the enhancement of Iran's ability to develop petroleum resources of Iran.

The terms "Business operations", "Company", "Mineral-extraction activities", "Oil-related activities", "Petroleum resources", and "Substantial action" are all defined in the Code.

Failure to make the disclosure required by the Code shall cause the bid, offer or proposal to be considered not responsive. The disclosure will be considered when evaluating the bid, offer, or proposal or awarding the contract. The name of each Company disclosed as doing business or having done business in Iran will be provided to the State Comptroller.

Check the appropriate statement:

Company has no business operations in Iran to disclose.

Company has business operations in Iran as disclosed the attached document.

### **N. Political Contributions and Registration with the State Board of Elections**

Sections 20-160 and 50-37 of the Illinois Procurement Code regulate political contributions from business entities and any affiliated entities or affiliated persons bidding on or contracting with the state. Generally under Section 50-37, any business entity, and any affiliated entity or affiliated person of the business entity, whose current year contracts with all state agencies exceed an awarded value of \$50,000, are prohibited from making any contributions to any political committees established to promote the candidacy of the officeholder responsible for the awarding of the contracts or any other declared candidate for that office for the duration of the term of office of the incumbent officeholder or a period 2 years after the termination of the contract, whichever is longer. Any business entity and affiliated entities or affiliated persons whose state contracts in the current year do not exceed an awarded value of \$50,000, but whose aggregate pending bids and proposals on state contracts exceed \$50,000, either alone or in combination with contracts not exceeding \$50,000, are prohibited from making any political contributions to any political committee established to promote the candidacy of the officeholder responsible for awarding the pending contract during the period beginning on the date the invitation for bids or request for proposals is issued and ending on the day after the date of award or selection if the entity was not awarded or selected. Section 20-160 requires certification of registration of affected business entities in accordance with procedures found in Section 9-35 of The Election Code.

By submission of a bid, the contractor business entity acknowledges and agrees that it has read and understands Sections 20-160 and 50-37 of the Illinois Procurement Code, and that it makes the following certification:

**The undersigned business entity certifies that it has registered as a business with the State Board of Elections and acknowledges a continuing duty to update the registration in accordance with the above referenced statutes. A copy of the certificate of registration shall be submitted with the bid. The bidder is cautioned that the Department will not award a contract without submission of the certificate of registration.**

These requirements and compliance with the above referenced statutory sections are a material part of the contract, and any breach thereof shall be cause to void the contract under Section 50-60 of the Illinois Procurement Code. This provision does not apply to Federal-aid contracts.



**TO BE RETURNED WITH BID**

**IV. DISCLOSURES**

**A.** The disclosures hereinafter made by the bidder are each a material representation of fact upon which reliance is placed should the Department enter into the contract with the bidder. The Department may terminate the contract if it is later determined that the bidder rendered a false or erroneous disclosure, and the surety providing the performance bond shall be responsible for completion of the contract.

**B. Financial Interests and Conflicts of Interest**

1. Section 50-35 of the Illinois Procurement Code provides that all bids of more than \$10,000 shall be accompanied by disclosure of the financial interests of the bidder. This disclosed information for the successful bidder, will be maintained as public information subject to release by request pursuant to the Freedom of Information Act.

The financial interests to be disclosed shall include ownership or distributive income share that is in excess of 5%, or an amount greater than 60% of the annual salary of the Governor, of the bidding entity or its parent entity, whichever is less, unless the contractor or bidder is a publicly traded entity subject to Federal 10K reporting, in which case it may submit its 10K disclosure in place of the prescribed disclosure. If a bidder is a privately held entity that is exempt from Federal 10K reporting, but has more than 400 shareholders, it may submit the information that Federal 10K companies are required to report, and list the names of any person or entity holding any ownership share that is in excess of 5%. The disclosure shall include the names, addresses, and dollar or proportionate share of ownership of each person making the disclosure, their instrument of ownership or beneficial relationship, and notice of any potential conflict of interest resulting from the current ownership or beneficial interest of each person making the disclosure having any of the relationships identified in Section 50-35 and on the disclosure form.

In addition, all disclosures shall indicate any other current or pending contracts, proposals, leases, or other ongoing procurement relationships the bidding entity has with any other unit of state government and shall clearly identify the unit and the contract, proposal, lease, or other relationship.

2. Disclosure Forms. Disclosure Form A is attached for use concerning the individuals meeting the above ownership or distributive share requirements. Subject individuals should be covered each by one form. In addition, a second form (Disclosure Form B) provides for the disclosure of current or pending procurement relationships with other (non-IDOT) state agencies. **The forms must be included with each bid or incorporated by reference.**

**C. Disclosure Form Instructions**

**Form A: For bidders that have previously submitted the information requested in Form A**

The Department has retained the Form A disclosures submitted by all bidders responding to these requirements for the April 24, 1998 or any subsequent letting conducted by the Department. The bidder has the option of submitting the information again or the bidder may check the following certification statement indicating that the information previously submitted by the bidder is, as of the date of submission, current and accurate. Before checking this certification, the bidder should carefully review its prior submissions to ensure the Certification is correct. If the Bidder checks the Certification, the Bidder should proceed to Form B instructions.

**CERTIFICATION STATEMENT**

**I have determined that the Form A disclosure information previously submitted is current and accurate, and all forms are hereby incorporated by reference in this bid. Any necessary additional forms or amendments to previously submitted forms are attached to this bid.**

\_\_\_\_\_  
(Bidding Company)



\_\_\_\_\_  
Signature of Authorized Representative

\_\_\_\_\_  
Date

**Form A: For bidders who have NOT previously submitted the information requested in Form A**

If the bidder is a publicly traded entity subject to Federal 10K reporting, the 10K Report may be submitted to meet the requirements of Form A. If a bidder is a privately held entity that is exempt from Federal 10K reporting, but has more than 400 shareholders, it may submit the information that Federal 10K companies are required to report, and list the names of any person or entity holding any ownership share that is in excess of 5%. If a bidder is not subject to Federal 10K reporting, the bidder must determine if any individuals are required by law to complete a financial disclosure form. To do this, the bidder should answer each of the following questions. A "YES" answer indicates Form A must be completed. If the answer to each of the following questions is "NO", then the NOT APPLICABLE STATEMENT on the second page of Form A must be signed and dated by a person that is authorized to execute contracts for the bidding company. Note: These questions are for assistance only and are not required to be completed.

1. Does anyone in your organization have a direct or beneficial ownership share of greater than 5% of the bidding entity or parent entity? YES \_\_\_ NO \_\_\_
2. Does anyone in your organization have a direct or beneficial ownership share of less than 5%, but which has a value greater than \$106,447.20? YES \_\_\_ NO \_\_\_
3. Does anyone in your organization receive more than \$106,447.20 of the bidding entity's or parent entity's distributive income? (Note: Distributive income is, for these purposes, any type of distribution of profits. An annual salary is not distributive income.) YES \_\_\_ NO \_\_\_
4. Does anyone in your organization receive greater than 5% of the bidding entity's or parent entity's total distributive income, but which is less than \$106,447.20? YES \_\_\_ NO \_\_\_

(Note: Only one set of forms needs to be completed per person per bid even if a specific individual would require a yes answer to more than one question.)

A "YES" answer to any of these questions requires the completion of Form A. The bidder must determine each individual in the bidding entity or the bidding entity's parent company that would cause the questions to be answered "Yes". Each form must be signed and dated by a person that is authorized to execute contracts for your organization. **Photocopied or stamped signatures are not acceptable.** The person signing can be, but does not have to be, the person for which the form is being completed. The bidder is responsible for the accuracy of any information provided.

If the answer to each of the above questions is "NO", then the NOT APPLICABLE STATEMENT on page 2 of Form A must be signed and dated by a person that is authorized to execute contracts for your company.

**Form B: Identifying Other Contracts & Procurement Related Information** Disclosure Form B must be completed for each bid submitted by the bidding entity. Note: *Checking the NOT APPLICABLE STATEMENT on Form A does not allow the bidder to ignore Form B. Form B must be completed, checked, and dated or the bidder may be considered nonresponsive and the bid will not be accepted.*

The Bidder shall identify, by checking Yes or No on Form B, whether it has any pending contracts (including leases), bids, proposals, or other ongoing procurement relationship with any other (non-IDOT) State of Illinois agency. If "No" is checked, the bidder only needs to complete the check box on the bottom of Form B. If "Yes" is checked, the bidder must do one of the following:

Option I: If the bidder did not submit an Affidavit of Availability to obtain authorization to bid, the bidder must list all non-IDOT State of Illinois agency pending contracts, leases, bids, proposals, and other ongoing procurement relationships. These items may be listed on Form B or on an attached sheet(s). Do not include IDOT contracts. Contracts with cities, counties, villages, etc. are not considered State of Illinois agency contracts and are not to be included. Contracts with other State of Illinois agencies such as the Department of Natural Resources or the Capital Development Board must be included. Bidders who submit Affidavits of Availability are suggested to use Option II.

Option II: If the bidder is required and has submitted an Affidavit of Availability in order to obtain authorization to bid, the bidder may write or type "See Affidavit of Availability" which indicates that the Affidavit of Availability is incorporated by reference and includes all non-IDOT State of Illinois agency pending contracts, leases, bids, proposals, and other ongoing procurement relationships. For any contracts that are not covered by the Affidavit of Availability, the bidder must identify them on Form B or on an attached sheet(s). These might be such things as leases.

**D. Bidders Submitting More Than One Bid**

Bidders submitting multiple bids may submit one set of forms consisting of all required Form A disclosures and one Form B for use with all bids. Please indicate in the space provided below the bid item that contains the original disclosure forms and the bid items which incorporate the forms by reference.

- The bid submitted for letting item \_\_\_\_\_ contains the Form A disclosures or Certification Statement and the Form B disclosures. The following letting items incorporate the said forms by reference:

---



---

**ILLINOIS DEPARTMENT  
OF TRANSPORTATION**

**Form A  
Financial Information &  
Potential Conflicts of Interest  
Disclosure**

Contractor Name		
Legal Address		
City, State, Zip		
Telephone Number	Email Address	Fax Number (if available)

Disclosure of the information contained in this Form is required by the Section 50-35 of the Illinois Procurement Code (30 ILCS 500). Vendors desiring to enter into a contract with the State of Illinois must disclose the financial information and potential conflict of interest information as specified in this Disclosure Form. This information shall become part of the publicly available contract file. This Form A must be completed for bids in excess of \$10,000, and for all open-ended contracts. **A publicly traded company may submit a 10K disclosure (or equivalent if applicable) in satisfaction of the requirements set forth in Form A. See Disclosure Form Instructions.**

**DISCLOSURE OF FINANCIAL INFORMATION**

**1. Disclosure of Financial Information.** The individual named below has an interest in the BIDDER (or its parent) in terms of ownership or distributive income share in excess of 5%, or an interest which has a value of more than \$106,447.20 (60% of the Governor's salary as of 7/1/07). **(Make copies of this form as necessary and attach a separate Disclosure Form A for each individual meeting these requirements)**

**FOR INDIVIDUAL (type or print information)**

**NAME:** \_\_\_\_\_

**ADDRESS** \_\_\_\_\_

**Type of ownership/distributable income share:**

stock \_\_\_\_\_ sole proprietorship \_\_\_\_\_ Partnership \_\_\_\_\_ other: (explain on separate sheet):  
% or \$ value of ownership/distributable income share: \_\_\_\_\_

**2. Disclosure of Potential Conflicts of Interest.** Check "Yes" or "No" to indicate which, if any, of the following potential conflict of interest relationships apply. If the answer to any question is "Yes", please attach additional pages and describe.

(a) State employment, currently or in the previous 3 years, including contractual employment of services. Yes \_\_\_ No \_\_\_

If your answer is yes, please answer each of the following questions.

1. Are you currently an officer or employee of either the Capitol Development Board or the Illinois Toll Highway Authority? Yes \_\_\_ No \_\_\_
2. Are you currently appointed to or employed by any agency of the State of Illinois? If you are currently appointed to or employed by any agency of the State of Illinois, and your annual salary exceeds \$106,447.20, (60% of the Governor's salary as of 7/1/07) provide the name the State agency for which you are employed and your annual salary. \_\_\_\_\_  
\_\_\_\_\_

**RETURN WITH BID/OFFER**

- 3. If you are currently appointed to or employed by any agency of the State of Illinois, and your annual salary exceeds \$106,447.20, (60% of the Governor's salary as of 7/1/07) are you entitled to receive (i) more than 7 1/2% of the total distributable income of your firm, partnership, association or corporation, or (ii) an amount in excess of the salary of the Governor? Yes \_\_\_ No \_\_\_
  
- 4. If you are currently appointed to or employed by any agency of the State of Illinois, and your annual salary exceeds \$106,447.20, (60% of the Governor's salary as of 7/1/07) are you and your spouse or minor children entitled to receive (i) more than 15 % in the aggregate of the total distributable income of your firm, partnership, association or corporation, or (ii) an amount in excess of 2 times the salary of the Governor? Yes \_\_\_ No \_\_\_

---

(b) State employment of spouse, father, mother, son, or daughter, including contractual employment services in the previous 2 years.

Yes \_\_\_ No \_\_\_

If your answer is yes, please answer each of the following questions.

- 1. Is your spouse or any minor children currently an officer or employee of the Capitol Development Board or the Illinois Toll Highway Authority? Yes \_\_\_ No \_\_\_
  
- 2. Is your spouse or any minor children currently appointed to or employed by any agency of the State of Illinois? If your spouse or minor children is/are currently appointed to or employed by any agency of the State of Illinois, and his/her annual salary exceeds \$106,447.20, (60 % of the Governor's salary as of 7/1/07) provide the name of your spouse and/or minor children, the name of the State agency for which he/she is employed and his/her annual salary. \_\_\_\_\_  
\_\_\_\_\_
  
- 3. If your spouse or any minor children is/are currently appointed to or employed by any agency of the State of Illinois, and his/her annual salary exceeds \$106,447.20, (60% of the salary of the Governor as of 7/1/07) are you entitled to receive (i) more then 71/2% of the total distributable income of your firm, partnership, association or corporation, or (ii) an amount in excess of the salary of the Governor? Yes \_\_\_ No \_\_\_
  
- 4. If your spouse or any minor children are currently appointed to or employed by any agency of the State of Illinois, and his/her annual salary exceeds \$106,447.20, (60% of the Governor's salary as of 7/1/07) are you and your spouse or minor children entitled to receive (i) more than 15 % in the aggregate of the total distributable income of your firm, partnership, association or corporation, or (ii) an amount in excess of 2 times the salary of the Governor? Yes \_\_\_ No \_\_\_

---

(c) Elective status; the holding of elective office of the State of Illinois, the government of the United States, any unit of local government authorized by the Constitution of the State of Illinois or the statutes of the State of Illinois currently or in the previous 3 years. Yes \_\_\_ No \_\_\_

---

(d) Relationship to anyone holding elective office currently or in the previous 2 years; spouse, father, mother, son, or daughter. Yes \_\_\_ No \_\_\_

---

(e) Appointive office; the holding of any appointive government office of the State of Illinois, the United States of America, or any unit of local government authorized by the Constitution of the State of Illinois or the statutes of the State of Illinois, which office entitles the holder to compensation in excess of the expenses incurred in the discharge of that office currently or in the previous 3 years. Yes \_\_\_ No \_\_\_

---

(f) Relationship to anyone holding appointive office currently or in the previous 2 years; spouse, father, mother, son, or daughter. Yes \_\_\_ No \_\_\_

---

(g) Employment, currently or in the previous 3 years, as or by any registered lobbyist of the State government. Yes \_\_\_ No \_\_\_

---

**RETURN WITH BID/OFFER**

(h) Relationship to anyone who is or was a registered lobbyist in the previous 2 years; spouse, father, mother, son, or daughter. Yes \_\_\_ No \_\_\_

(i) Compensated employment, currently or in the previous 3 years, by any registered election or reelection committee registered with the Secretary of State or any county clerk of the State of Illinois, or any political action committee registered with either the Secretary of State or the Federal Board of Elections. Yes \_\_\_ No \_\_\_

(j) Relationship to anyone; spouse, father, mother, son, or daughter; who was a compensated employee in the last 2 years by any registered election or re-election committee registered with the Secretary of State or any county clerk of the State of Illinois, or any political action committee registered with either the Secretary of State or the Federal Board of Elections. Yes \_\_\_ No \_\_\_

**APPLICABLE STATEMENT**

**This Disclosure Form A is submitted on behalf of the INDIVIDUAL named on previous page.**

Completed by:  \_\_\_\_\_ Date \_\_\_\_\_  
Signature of Individual or Authorized Representative

**NOT APPLICABLE STATEMENT**

**I have determined that no individuals associated with this organization meet the criteria that would require the completion of this Form A.**

**This Disclosure Form A is submitted on behalf of the CONTRACTOR listed on the previous page.**

\_\_\_\_\_ Date \_\_\_\_\_  
Signature of Authorized Representative

RETURN WITH BID/OFFER

ILLINOIS DEPARTMENT OF TRANSPORTATION

Form B Other Contracts & Procurement Related Information Disclosure

Contractor Name		
Legal Address		
City, State, Zip		
Telephone Number	Email Address	Fax Number (if available)

Disclosure of the information contained in this Form is required by the Section 50-35 of the Illinois Procurement Act (30 ILCS 500). This information shall become part of the publicly available contract file. This Form B must be completed for bids in excess of \$10,000, and for all open-ended contracts.

DISCLOSURE OF OTHER CONTRACTS AND PROCUREMENT RELATED INFORMATION

1. Identifying Other Contracts & Procurement Related Information. The BIDDER shall identify whether it has any pending contracts (including leases), bids, proposals, or other ongoing procurement relationship with any other State of Illinois agency: Yes \_\_\_ No \_\_\_

If "No" is checked, the bidder only needs to complete the signature box on the bottom of this page.

2. If "Yes" is checked. Identify each such relationship by showing State of Illinois agency name and other descriptive information such as bid or project number (attach additional pages as necessary). SEE DISCLOSURE FORM INSTRUCTIONS:

THE FOLLOWING STATEMENT MUST BE CHECKED

<input type="checkbox"/>	<hr style="border: none; border-top: 1px solid black;"/> Signature of Authorized Representative	<hr style="border: none; border-top: 1px solid black;"/> Date
--------------------------	---	---

## **RETURN WITH BID**

### **SPECIAL NOTICE TO CONTRACTORS**

The following requirements of the Illinois Department of Human Rights' Rules and Regulations are applicable to bidders on all construction contracts advertised by the Illinois Department of Transportation:

#### **CONSTRUCTION EMPLOYEE UTILIZATION PROJECTION**

- (a) All bidders on construction contracts shall complete and submit, along with and as part of their bids, a Bidder's Employee Utilization Form (Form BC-1256) setting forth a projection and breakdown of the total workforce intended to be hired and/or allocated to such contract work by the bidder including a projection of minority and female employee utilization in all job classifications on the contract project.
- (b) The Department of Transportation shall review the Employee Utilization Form, and workforce projections contained therein, of the contract awardee to determine if such projections reflect an underutilization of minority persons and/or women in any job classification in accordance with the Equal Employment Opportunity Clause and Section 7.2 of the Illinois Department of Human Rights' Rules and Regulations for Public Contracts adopted as amended on September 17, 1980. If it is determined that the contract awardee's projections reflect an underutilization of minority persons and/or women in any job classification, it shall be advised in writing of the manner in which it is underutilizing and such awardee shall be considered to be in breach of the contract unless, prior to commencement of work on the contract project, it submits revised satisfactory projections or an acceptable written affirmative action plan to correct such underutilization including a specific timetable geared to the completion stages of the contract.
- (c) The Department of Transportation shall provide to the Department of Human Rights a copy of the contract awardee's Employee Utilization Form, a copy of any required written affirmative action plan, and any written correspondence related thereto. The Department of Human Rights may review and revise any action taken by the Department of Transportation with respect to these requirements.





**RETURN WITH BID**

**Contract No. 68916  
WARREN-HENDERSON Counties  
Section 105RS-2  
Route FAS 1412  
District 4 Construction Funds**

**PART II. WORKFORCE PROJECTION - continued**

- B. Included in "Total Employees" under Table A is the total number of **new hires** that would be employed in the event the undersigned bidder is awarded this contract.

The undersigned bidder projects that: (number) \_\_\_\_\_ new hires would be recruited from the area in which the contract project is located; and/or (number) \_\_\_\_\_ new hires would be recruited from the area in which the bidder's principal office or base of operation is located.

- C. Included in "Total Employees" under Table A is a projection of numbers of persons to be employed directly by the undersigned bidder as well as a projection of numbers of persons to be employed by subcontractors.

The undersigned bidder estimates that (number) \_\_\_\_\_ persons will be directly employed by the prime contractor and that (number) \_\_\_\_\_ persons will be employed by subcontractors.

**PART III. AFFIRMATIVE ACTION PLAN**

- A. The undersigned bidder understands and agrees that in the event the foregoing minority and female employee utilization projection included under **PART II** is determined to be an underutilization of minority persons or women in any job category, and in the event that the undersigned bidder is awarded this contract, he/she will, prior to commencement of work, develop and submit a written Affirmative Action Plan including a specific timetable (geared to the completion stages of the contract) whereby deficiencies in minority and/or female employee utilization are corrected. Such Affirmative Action Plan will be subject to approval by the contracting agency and the **Department of Human Rights**.
- B. The undersigned bidder understands and agrees that the minority and female employee utilization projection submitted herein, and the goals and timetable included under an Affirmative Action Plan if required, are deemed to be part of the contract specifications.

Company \_\_\_\_\_  
\_\_\_\_\_

Telephone Number \_\_\_\_\_

Address \_\_\_\_\_  
\_\_\_\_\_

**NOTICE REGARDING SIGNATURE**

The Bidder's signature on the Proposal Signature Sheet will constitute the signing of this form. The following signature block needs to be completed if revisions are required.

Signature:  \_\_\_\_\_ Title: \_\_\_\_\_ Date: \_\_\_\_\_

Instructions: All tables must include subcontractor personnel in addition to prime contractor personnel.

Table A - Include both the number of employees that would be hired to perform the contract work and the total number currently employed (Table B) that will be allocated to contract work, and include all apprentices and on-the-job trainees. The "Total Employees" column should include all employees including all minorities, apprentices and on-the-job trainees to be employed on the contract work.

Table B - Include all employees currently employed that will be allocated to the contract work including any apprentices and on-the-job trainees currently employed.

Table C - Indicate the racial breakdown of the total apprentices and on-the-job trainees shown in Table A.

**RETURN WITH BID**

**Contract No. 68916  
WARREN-HENDERSON Counties  
Section 105RS-2  
Route FAS 1412  
District 4 Construction Funds**

PROPOSAL SIGNATURE SHEET

The undersigned bidder hereby makes and submits this bid on the subject Proposal, thereby assuring the Department that all requirements of the Invitation for Bids and rules of the Department have been met, that there is no misunderstanding of the requirements of paragraph 3 of this Proposal, and that the contract will be executed in accordance with the rules of the Department if an award is made on this bid.

(IF AN INDIVIDUAL) Firm Name \_\_\_\_\_  
Signature of Owner \_\_\_\_\_  
Business Address \_\_\_\_\_  
\_\_\_\_\_

(IF A CO-PARTNERSHIP) Firm Name \_\_\_\_\_  
By \_\_\_\_\_  
Business Address \_\_\_\_\_  
Name and Address of All Members of the Firm:  
\_\_\_\_\_  
\_\_\_\_\_

(IF A CORPORATION)  
(IF A JOINT VENTURE, USE THIS SECTION FOR THE MANAGING PARTY AND THE SECOND PARTY SHOULD SIGN BELOW)  
Corporate Name \_\_\_\_\_  
By \_\_\_\_\_  
Signature of Authorized Representative \_\_\_\_\_  
Typed or printed name and title of Authorized Representative \_\_\_\_\_  
Attest \_\_\_\_\_  
Signature \_\_\_\_\_  
Business Address \_\_\_\_\_  
\_\_\_\_\_

(IF A JOINT VENTURE)  
Corporate Name \_\_\_\_\_  
By \_\_\_\_\_  
Signature of Authorized Representative \_\_\_\_\_  
Typed or printed name and title of Authorized Representative \_\_\_\_\_  
Attest \_\_\_\_\_  
Signature \_\_\_\_\_  
Business Address \_\_\_\_\_  
\_\_\_\_\_

If more than two parties are in the joint venture, please attach an additional signature sheet.



Return with Bid

Division of Highways
Proposal Bid Bond
(Effective November 1, 1992)

Item No. \_\_\_\_\_

Letting Date \_\_\_\_\_

KNOW ALL MEN BY THESE PRESENTS, That We \_\_\_\_\_

as PRINCIPAL, and \_\_\_\_\_

\_\_\_\_\_ as SURETY, are held jointly, severally and firmly bound unto the STATE OF ILLINOIS in the penal sum of 5 percent of the total bid price, or for the amount specified in Article 102.09 of the "Standard Specifications for Road and Bridge Construction" in effect on the date of invitation for bids, whichever is the lesser sum, well and truly to be paid unto said STATE OF ILLINOIS, for the payment of which we bind ourselves, our heirs, executors, administrators, successors and assigns.

THE CONDITION OF THE FOREGOING OBLIGATION IS SUCH, that whereas, the PRINCIPAL has submitted a bid proposal to the STATE OF ILLINOIS, acting through the Department of Transportation, for the improvement designated by the Transportation Bulletin Item Number and Letting Date indicated above.

NOW, THEREFORE, if the Department shall accept the bid proposal of the PRINCIPAL; and if the PRINCIPAL shall, within the time and as specified in the bidding and contract documents, submit a DBE Utilization Plan that is accepted and approved by the Department; and if, after award by the Department, the PRINCIPAL shall enter into a contract in accordance with the terms of the bidding and contract documents including evidence of the required insurance coverages and providing such bond as specified with good and sufficient surety for the faithful performance of such contract and for the prompt payment of labor and material furnished in the prosecution thereof; or if, in the event of the failure of the PRINCIPAL to make the required DBE submission or to enter into such contract and to give the specified bond, the PRINCIPAL pays to the Department the difference not to exceed the penalty hereof between the amount specified in the bid proposal and such larger amount for which the Department may contract with another party to perform the work covered by said bid proposal, then this obligation shall be null and void, otherwise, it shall remain in full force and effect.

IN THE EVENT the Department determines the PRINCIPAL has failed to comply with any requirement as set forth in the preceding paragraph, then Surety shall pay the penal sum to the Department within fifteen (15) days of written demand therefor. If Surety does not make full payment within such period of time, the Department may bring an action to collect the amount owed. Surety is liable to the Department for all its expenses, including attorney's fees, incurred in any litigation in which it prevails either in whole or in part.

In TESTIMONY WHEREOF, the said PRINCIPAL and the said SURETY have caused this instrument to be signed by

their respective officers this \_\_\_\_\_ day of \_\_\_\_\_ A.D., \_\_\_\_\_ .

PRINCIPAL

SURETY

\_\_\_\_\_  
(Company Name)

\_\_\_\_\_  
(Company Name)

By \_\_\_\_\_  
(Signature & Title)

By: \_\_\_\_\_  
(Signature of Attorney-in-Fact)

Notary Certification for Principal and Surety

STATE OF ILLINOIS,  
County of \_\_\_\_\_

I, \_\_\_\_\_, a Notary Public in and for said County, do hereby certify that

\_\_\_\_\_ and \_\_\_\_\_  
(Insert names of individuals signing on behalf of PRINCIPAL & SURETY)

who are each personally known to me to be the same persons whose names are subscribed to the foregoing instrument on behalf of PRINCIPAL and SURETY, appeared before me this day in person and acknowledged respectively, that they signed and delivered said instrument as their free and voluntary act for the uses and purposes therein set forth.

Given under my hand and notarial seal this \_\_\_\_\_ day of \_\_\_\_\_ A.D. \_\_\_\_\_

My commission expires \_\_\_\_\_

Notary Public

In lieu of completing the above section of the Proposal Bid Form, the Principal may file an Electronic Bid Bond. By signing the proposal and marking the check box next to the Signature and Title line below, the Principal is ensuring the identified electronic bid bond has been executed and the Principal and Surety are firmly bound unto the State of Illinois under the conditions of the bid bond as shown above.

Electronic Bid Bond ID# \_\_\_\_\_

Company / Bidder Name \_\_\_\_\_



Signature and Title \_\_\_\_\_

# PROPOSAL ENVELOPE



# PROPOSALS

for construction work advertised for bids by the  
Illinois Department of Transportation

Item No.	Item No.	Item No.

Submitted By:

Name:
Address:
Phone No.

Bidders should use an IDOT proposal envelope or affix this form to the front of a 10" x 13" envelope for the submittal of bids. If proposals are mailed, they should be enclosed in a second or outer envelope addressed to:

Engineer of Design and Environment - Room 326  
Illinois Department of Transportation  
2300 South Dirksen Parkway  
Springfield, Illinois 62764

## **NOTICE**

**Individual bids, including Bid Bond and/or supplemental information if required, should be securely stapled.**

# CONTRACTOR OFFICE COPY OF CONTRACT SPECIFICATIONS

---

## NOTICE

None of the following material needs to be returned with the bid package unless the special provisions require documentation and/or other information to be submitted.

**Contract No. 68916  
WARREN-HENDERSON Counties  
Section 105RS-2  
Route FAS 1412  
District 4 Construction Funds**



**Illinois Department of Transportation**



## NOTICE TO BIDDERS

1. **TIME AND PLACE OF OPENING BIDS.** Sealed proposals for the improvement described herein will be received by the Department of Transportation at the Harry R. Hanley Building, 2300 South Dirksen Parkway, in Springfield, Illinois until 10:00 o'clock a.m., March 5, 2010. All bids will be gathered, sorted, publicly opened and read in the auditorium at the Department of Transportation's Harry R. Hanley Building shortly after the 10:00 a.m. cut off time.

2. **DESCRIPTION OF WORK.** The proposed improvement is identified and advertised for bids in the Invitation for Bids as:

**Contract No. 68916  
WARREN-HENDERSON Counties  
Section 105RS-2  
Route FAS 1412  
District 4 Construction Funds**

**6.49 miles of surface maintenance located on IL Route 94 from IL Route 135 to south of Township Road 29, south of Bald Bluff.**

3. **INSTRUCTIONS TO BIDDERS.** (a) This Notice, the invitation for bids, proposal and letter of award shall, together with all other documents in accordance with Article 101.09 of the Standard Specifications for Road and Bridge Construction, become part of the contract. Bidders are cautioned to read and examine carefully all documents, to make all required inspections, and to inquire or seek explanation of the same prior to submission of a bid.

(b) State law, and, if the work is to be paid wholly or in part with Federal-aid funds, Federal law requires the bidder to make various certifications as a part of the proposal and contract. By execution and submission of the proposal, the bidder makes the certification contained therein. A false or fraudulent certification shall, in addition to all other remedies provided by law, be a breach of contract and may result in termination of the contract.

4. **AWARD CRITERIA AND REJECTION OF BIDS.** This contract will be awarded to the lowest responsive and responsible bidder considering conformity with the terms and conditions established by the Department in the rules, Invitation for Bids and contract documents. The issuance of plans and proposal forms for bidding based upon a prequalification rating shall not be the sole determinant of responsibility. The Department reserves the right to determine responsibility at the time of award, to reject any or all proposals, to readvertise the proposed improvement, and to waive technicalities.

By Order of the  
Illinois Department of Transportation

Gary Hannig,  
Secretary

INDEX  
 FOR  
 SUPPLEMENTAL SPECIFICATIONS  
 AND RECURRING SPECIAL PROVISIONS

Adopted January 1, 2010

This index contains a listing of SUPPLEMENTAL SPECIFICATIONS and frequently used RECURRING SPECIAL PROVISIONS.

ERRATA Standard Specifications for Road and Bridge Construction (Adopted 1-1-07) (Revised 1-1-10)

SUPPLEMENTAL SPECIFICATIONS

<u>Std. Spec. Sec.</u>	<u>Page No.</u>
201 Clearing, Tree Removal and Protection .....	1
205 Embankment .....	2
251 Mulch .....	3
253 Planting Woody Plants .....	4
280 Temporary Erosion Control .....	6
406 Hot-Mix Asphalt Binder and Surface Course .....	7
443 Reflective Crack Control Treatment .....	12
502 Excavation for Structures .....	15
503 Concrete Structures .....	16
504 Precast Concrete Structures .....	17
505 Steel Structures .....	18
540 Box Culverts .....	19
581 Waterproofing Membrane System .....	20
630 Steel Plate Beam Guardrail .....	21
633 Removing and Reerecting Guardrail and Terminals .....	22
637 Concrete Barrier .....	23
669 Removal and Disposal of Regulated Substances .....	24
672 Sealing Abandoned Water Wells .....	25
701 Work Zone Traffic Control and Protection .....	26
720 Sign Panels and Appurtenances .....	27
721 Sign Panel Overlay .....	28
722 Demountable Sign Legend Characters and Arrows .....	29
726 Mile Post Marker Assembly .....	30
733 Overhead Sign Structures .....	31
783 Pavement Marking and Marker Removal .....	32
801 Electrical Requirements .....	33
805 Electrical Service Installation – Traffic Signals .....	34
836 Pole Foundation .....	35
838 Breakaway Devices .....	36
862 Uninterruptable Power Supply .....	37
873 Electric Cable .....	39
878 Traffic Signal Concrete Foundation .....	41
1003 Fine Aggregates .....	42
1004 Coarse Aggregates .....	43
1005 Stone and Broken Concrete .....	44
1006 Metals .....	45
1008 Structural Steel Coatings .....	47
1010 Finely Divided Materials .....	48
1020 Portland Cement Concrete .....	49
1022 Concrete Curing Materials .....	58
1024 Nonshrink Grout .....	59
1030 Hot-Mix Asphalt .....	60
1032 Bituminous Materials .....	65

FAS Route 1412 (IL 94)  
Section 105RS-2  
Warren and Henderson  
Contract No. 68916

1042	Precast Concrete Products .....	68
1062	Reflective Crack Control System .....	70
1069	Pole and Tower .....	72
1074	Control Equipment .....	75
1076	Wire and Cable .....	80
1080	Fabric Materials .....	81
1081	Materials for Planting .....	82
1083	Elastomeric Bearings .....	84
1090	Sign Base .....	85
1091	Sign Face .....	87
1092	Sign Legend and Supplemental Panels .....	95
1093	Sign Supports .....	96
1094	Overhead Sign Structures .....	98
1095	Pavement Markings .....	104
1101	General Equipment .....	106
1102	Hot-Mix Asphalt Equipment .....	107
1103	Portland Cement Concrete Equipment .....	109
1106	Work Zone Traffic Control Devices .....	110



RECURRING SPECIAL PROVISIONS

The following RECURRING SPECIAL PROVISIONS indicated by an "X" are applicable to this contract and are included by reference:

<u>CHECK SHEET #</u>	<u>PAGE NO.</u>
1	111
Additional State Requirements For Federal-Aid Construction Contracts (Eff. 2-1-69) (Rev. 1-1-10) .....	
2	114
Subletting of Contracts (Federal-Aid Contracts) (Eff. 1-1-88) (Rev. 5-1-93) .....	
3	115
X	115
EEO (Eff. 7-21-78) (Rev. 11-18-80) .....	
4	125
X	130
Specific Equal Employment Opportunity Responsibilities Non Federal-Aid Contracts (Eff. 3-20-69) (Rev. 1-1-94) .....	
5	135
X	136
Required Provisions - State Contracts (Eff. 4-1-65) (Rev. 1-1-10) .....	
6	137
Reserved .....	
7	138
Reserved .....	
8	137
Haul Road Stream Crossings, Other Temporary Stream Crossings, and In-Stream Work Pads (Eff. 1-2-92) (Rev. 1-1-98) .....	
9	138
Construction Layout Stakes Except for Bridges (Eff. 1-1-99) (Rev. 1-1-07) .....	
10	141
Construction Layout Stakes (Eff. 5-1-93) (Rev. 1-1-07) .....	
11	144
Use of Geotextile Fabric for Railroad Crossing (Eff. 1-1-95) (Rev. 1-1-07) .....	
12	146
Subsealing of Concrete Pavements (Eff. 11-1-84) (Rev. 1-1-07) .....	
13	150
Hot-Mix Asphalt Surface Correction (Eff. 11-1-87) (Rev. 1-1-09) .....	
14	152
Pavement and Shoulder Resurfacing (Eff. 2-1-00) (Rev. 1-1-09) .....	
15	153
PCC Partial Depth Hot-Mix Asphalt Patching (Eff. 1-1-98) (Rev. 1-1-07) .....	
16	155
Patching with Hot-Mix Asphalt Overlay Removal (Eff. 10-1-95) (Rev. 1-1-07) .....	
17	156
Polymer Concrete (Eff. 8-1-95) (Rev. 1-1-08) .....	
18	158
PVC Pipeliner (Eff. 4-1-04) (Rev. 1-1-07) .....	
19	159
Pipe Underdrains (Eff. 9-9-87) (Rev. 1-1-07) .....	
20	160
Guardrail and Barrier Wall Delineation (Eff. 12-15-93) (Rev. 1-1-97) .....	
21	164
Bicycle Racks (Eff. 4-1-94) (Rev. 1-1-07) .....	
22	166
Temporary Modular Glare Screen System (Eff. 1-1-00) (Rev. 1-1-07) .....	
23	168
Temporary Portable Bridge Traffic Signals (Eff. 8-1-03) (Rev. 1-1-07) .....	
24	170
Work Zone Public Information Signs (Eff. 9-1-02) (Rev. 1-1-07) .....	
25	171
Night Time Inspection of Roadway Lighting (Eff. 5-1-96) .....	
26	172
English Substitution of Metric Bolts (Eff. 7-1-96) .....	
27	173
English Substitution of Metric Reinforcement Bars (Eff. 4-1-96) (Rev. 1-1-03) .....	
28	174
Calcium Chloride Accelerator for Portland Cement Concrete (Eff. 1-1-01) .....	
29	175
Reserved .....	
30	176
Quality Control of Concrete Mixtures at the Plant (Eff. 8-1-00) (Rev. 1-1-09) .....	
31	184
Quality Control/Quality Assurance of Concrete Mixtures (Eff. 4-1-92) (Rev. 1-1-09) .....	
32	196
Asbestos Bearing Pad Removal (Eff. 11-1-03) .....	
33	197
Asbestos Hot-Mix Asphalt Surface Removal (Eff. 6-1-89) (Rev. 1-1-09) .....	

**TABLE OF CONTENTS**

LOCATION OF PROJECT ..... 1  
DESCRIPTION OF PROJECT ..... 1  
AGGREGATE QUALITY ..... 1  
PLACEMENT OF HOT-MIX ASPHALT SURFACE COURSES ..... 2  
HOT-MIX ASPHALT SURFACE COURSE SURFACE TESTS ..... 2  
HOT-MIX ASPHALT SURFACE REMOVAL, ¾", 1½", VARIABLE DEPTH ..... 2  
PAVEMENT DRAINAGE AFTER COLD MILLING ..... 5  
TRAFFIC CONTROL PLAN ..... 5  
MATERIAL TRANSFER DEVICE (BDE) ..... 5  
HOT-MIX ASPHALT SHOULDER RESURFACING REQUIRED TO BE CONSTRUCTED  
SIMULTANEOUSLY WITH MAINLINE PAVING ..... 7  
POLYMER MODIFIED EMULSIFIED PRIME COAT CONSTRUCTION REQUIREMENTS ..... 7  
AUTOMATED FLAGGER ASSISTANCE DEVICES (BDE) ..... 8  
CEMENT (BDE) ..... 9  
CONCRETE ADMIXTURES (BDE) ..... 11  
CONSTRUCTION AIR QUALITY - DIESEL VEHICLE EMISSIONS CONTROL (BDE) ..... 14  
CONSTRUCTION AIR QUALITY - IDLING RESTRICTIONS (BDE) ..... 15  
DISADVANTAGED BUSINESS ENTERPRISE PARTICIPATION (BDE) ..... 17  
ENGINEER'S FIELD OFFICE TYPE A (BDE) ..... 25  
EQUIPMENT RENTAL RATES (BDE) ..... 27  
FLAGGER AT SIDE ROADS AND ENTRANCES (BDE) ..... 28  
HOT-MIX ASPHALT – ANTI-STRIPPING ADDITIVE (BDE) ..... 28  
HOT-MIX ASPHALT - DENSITY TESTING OF LONGITUDINAL JOINTS (BDE) ..... 29  
HOT-MIX ASPHALT – DROP-OFFS (BDE) ..... 30  
HOT-MIX ASPHALT – PLANT TEST FREQUENCY (BDE) ..... 30  
HOT-MIX ASPHALT – QC/QA ACCEPTANCE CRITERIA (BDE) ..... 31  
HOT-MIX ASPHALT – TRANSPORTATION (BDE) ..... 31  
LIQUIDATED DAMAGES (BDE) ..... 32  
MONTHLY EMPLOYMENT REPORT (BDE) ..... 32  
NATIONAL POLLUTANT DISCHARGE ELIMINATION SYSTEM / EROSION AND SEDIMENT  
CONTROL DEFICIENCY DEDUCTION (BDE) ..... 35  
PAVEMENT MARKING REMOVAL (BDE) ..... 36  
PAVEMENT PATCHING (BDE) ..... 36  
PAYMENTS TO SUBCONTRACTORS (BDE) ..... 36  
PERSONAL PROTECTIVE EQUIPMENT (BDE) ..... 38  
RAISED REFLECTIVE PAVEMENT MARKERS (BDE) ..... 38

RECLAIMED ASPHALT PAVEMENT (RAP) (BDE) ..... 38  
REFLECTIVE SHEETING ON CHANNELIZING DEVICES (BDE) ..... 45  
SUBCONTRACTOR MOBILIZATION PAYMENTS (BDE) ..... 46  
TRUCK MOUNTED/TRAILER MOUNTED ATTENUATORS (BDE) ..... 46  
WORKING DAYS (BDE) ..... 47  
BITUMINOUS MATERIALS COST ADJUSTMENTS (BDE) (RETURN FORM WITH BID) ..... 47  
FUEL COST ADJUSTMENT (BDE) (RETURN FORM WITH BID) ..... 49

## STATE OF ILLINOIS

---

### SPECIAL PROVISIONS

The following Special Provisions supplement the "Standard Specifications for Road and Bridge Construction," adopted January 1, 2007, the latest edition of the "Manual on Uniform Traffic Control Devices for Streets and Highways," and the "Manual of Test Procedures for Materials" in effect on the date of invitation for bids, and the Supplemental Specifications and Recurring Special Provisions indicated on the Check Sheet included herein which apply to and govern the construction of FAS Route 1412 (IL 94), Section 105RS-2, Warren and Henderson Counties, Contract No. 68916 and in case of conflict with any part or parts of said Specifications, the said Special Provisions shall take precedence and shall govern.

#### LOCATION OF PROJECT

This project is located on Illinois Route 94 from Illinois Route 135 in Warren County to south of Township Road 29 in Henderson County, south of Bald Bluff.

#### DESCRIPTION OF PROJECT

This project consists of surface maintenance on Illinois Route 94 from Illinois Route 135 in Warren County to south of Township Road 29 in Henderson County, south of Bald Bluff.

#### AGGREGATE QUALITY

Effective July 1, 1990

Revised September 23, 1996

Coarse aggregate for Granular Embankment Special, Sub-base Granular Material, Aggregate Shoulders, Aggregate Surface and Base Courses, and Erosion Control Aggregate shall conform to Article 1004.04 of the Standard Specifications for Road and Bridge Construction except that all of the following revisions to Article 1004.04(b) shall apply:

1. Revise the maximum allowable percentage of weighted average loss when the material is subjected to 5 cycles of sodium sulfate soundness test from 25%, as shown under the Class D of the Quality Chart in Article 1004.01(b) of the Standard Specifications, to 40%; and
2. Revise the maximum allowable percentage of wear as determined by the Los Angeles Abrasion Method from 45%, as shown under Class D of the Quality Chart in Article 1004.01(b) of the Standard Specifications, to 65%; and
3. The sum of the percentages of weighted average loss when the material is subjected to 5 cycles of the sodium sulfate soundness test and the percentage of wear as determined by the Los Angeles Abrasion Method shall not exceed 95%.

## **PLACEMENT OF HOT-MIX ASPHALT SURFACE COURSES**

Effective: March 22, 2001      Revised: January 1, 2007

Placement of hot-mix asphalt surface courses shall not be allowed after October 15<sup>th</sup> of any calendar year. The contractor is responsible for scheduling construction activities to complete placement of surface courses prior to October 15<sup>th</sup>. If surface courses are not in place by October 15<sup>th</sup>, the contractor is responsible for implementing any measures needed to make the roadway suitable for winter traffic and snow plowing activities. Any additional costs associated with this provision shall be considered included in the cost of the unit prices bid for hot-mix asphalt surface course items.

## **HOT-MIX ASPHALT SURFACE COURSE SURFACE TESTS**

Effective: November 1, 2003

Revised January 1, 2007

The Contractor shall provide a person to operate the straight edge in accordance with Article 406.11 of the Standard Specifications and communicate with IDOT personnel to minimize the surface course bumps. If surface course bumps cannot be removed at this time, IDOT personnel will record the locations and provide deductions as stated in Article 406.11.

## **HOT-MIX ASPHALT SURFACE REMOVAL, ¾", 1½", VARIABLE DEPTH**

Effective March 1, 1993

Revised July 31, 2009

Description: This work shall consist of removing a portion of the existing hot-mix asphalt concrete surface course in accordance with the applicable portions of Section 440 and 1101 of the Standard Specifications, this special provision, details in the plans and as directed by the Engineer. The cold milled salvaged aggregate resulting from this operation shall become the property of the Contractor.

Equipment: The machine used for milling and planing shall be a self-propelled grinding machine having a minimum 12' (3.6 m) wide drum at least 28" (710 mm) in diameter. When a milling width in excess of 12' is required and the Contractor's milling machine is less than the required width shown in the plans, the remaining area shall be milled with a machine capable of meeting the requirements of this special provision. Milling attachments used with skid steer tractors will not be allowed for longitudinal areas to mill additional widths.

When the teeth become worn so that they do not produce a uniform surface texture, they shall all be changed at the same time (as a unit). Occasionally, individual teeth may be changed if they lock up or break, but this method shall not be used to avoid changing the set of teeth as a unit. Occasional gouges, due to deteriorated pavement condition, or separation of lifts will not be cause to replace all teeth. The Engineer will be the sole judge of the cause of the pavement gouging and the corrective work required. Corrective work due to negligence or poor workmanship shall be at the Contractor's expense.

The moldboard is critical in obtaining the desired surface texture. It shall be straight, true, and free of excessive nicks or wear, and it shall be replaced as necessary to uniformly produce the required surface texture. Gouging of the pavement by more than 1/4 inch (6 mm) shall be sufficient cause to require replacement of all teeth.

### Construction Requirements

General: Weather conditions, when milling work is performed, must be such that short term or temporary pavement markings can be placed the day the surface is milled in accordance with Section 703 "Work Zone Pavement Markings".

An automatic grade control device shall be used when milling mainline pavement and shall be capable of controlling the elevation of the drum relative to either a preset grade control stringline or a grade reference device traveling on the adjacent pavement surface. The automatic grade control device may be utilized only on one side of the machine with a automatic slope control device controlling the opposite side. The traveling grade reference device shall not be less than 30 feet (9 m) in length. When milling cross roads, turn lanes, intersections, crossovers, or other miscellaneous areas, the Engineer may permit the matching shoe. The Contractor, at his option, may also substitute an approved 6' wide (1.8 m) machine for areas other than mainline pavement.

The Contractor shall mill  $\frac{3}{4}$ " inch and  $1\frac{1}{2}$ " inches at the centerline and project the proposed cross slope to the edge of pavement. In the event the milling at the outer edge of the lane would exceed 1.5 inches (40 mm); then the Contractor shall reduce the cut at the centerline to provide the maximum cut of 1.5 inches (40 mm) at the edge of pavement. If deemed necessary, the Contractor may reduce the cross slope from normal 1.5% to 1%.

Surface tests will be performed in accordance with Article 407.09(a) of the Standard Specifications. The longitudinal profile will be taken 3 ft. (0.9 m) from and parallel to each edge of pavement and 3 ft. (0.9 m) from and parallel to the centerline on each side. If a shadow area is found at the 3 ft. (0.9 m) points the pavement smoothness tester will be moved sufficient distance either side to measure the Contractor's milling efforts. Any surface variations exceeding the tolerance of Table 1 of Article 407.09 shall be corrected by reprofiling at no additional expense to the Department. In addition, the Contractor shall be responsible for refilling with approved hot-mix asphalt mixtures any area that lowered the pavement profile as a result of faulty milling operations if directed by the Engineer. The Contractor shall be responsible for providing the pavement smoothness tester described elsewhere to retest the pavement profile obtained.

If the milling depth is intended to expose the original concrete pavement, then additional hand or machine work may be necessary to remove any remaining veneer of bituminous pavement which may be left in place behind the milling machine. Such work will be at the direction of the Engineer and at no extra cost to the Department.

The Contractor shall provide a 10 foot (3 m) straightedge equipped with a carpenter's level or a 7 foot (2.1 m) electronic straightedge to check the cross slope of the roadway at regular intervals as directed by the Engineer.

Surface Texture: Each tooth on the cutting drum shall produce a series of discontinuous longitudinal striations. There shall be 16 to 20 striations (tooth marks) for each tooth for each 6 feet (1.8 m) in the longitudinal direction, and each striation shall be 1.7 inches  $\pm$  0.2 inch (43  $\pm$  5 mm) in length after the area is planed by the moldboard. Thus, the planed length between each pair of striations shall be 2.3 inches  $\pm$  0.2 inch (58  $\pm$  5 mm). There shall be 80 to 96 rows of discontinuous longitudinal striations for each 5 feet (1.5 m) in the transverse dimension. The areas between the striations in both the longitudinal and transverse directions shall be flat topped and coplaner. The moldboard shall be used to cut this plane; and any time the operation fails to produce this flat plane interspersed with a uniform pattern of discontinuous longitudinal striations, the operation shall be stopped and the cause determined and corrected before recommencing. Other similar patterns of uniform discontinuous longitudinal striations interspersed on a flat plane may be approved by the Engineer. The drawing titled "Hot-Mix Asphalt Surface Removal" showing the desired surface texture is included in the plans.

The start-up milling speed shall be limited to a maximum of 50 foot (15 m) per minute. The Contractor shall limit his operations to this speed to demonstrate his ability to obtain the striations and ride ability as described above. If the Contractor is able to demonstrate that he can consistently obtain the desired striations and ride ability at a greater speed he will be permitted to run at the increased speed.

Cleanup: After cold milling a traffic lane and before opening the lane to traffic, the pavement shall be swept by a mechanical broom to prevent compaction of the cuttings onto the pavement. All loose material shall be removed from the roadway. Before the prime coat is placed, the pavement shall be cleaned of all foreign material to the satisfaction of the Engineer.

This cleanup work shall be considered included in the contract unit price per square meter (square yard) for HOT-MIX ASPHALT SURFACE REMOVAL of the depth specified, and no additional compensation will be allowed.

Method of Measurement:

- (a) Contract Quantities. The requirements for the use of Contract Quantities shall be Article 202.07(a) of the Standard Specifications.
- (b) Measured Quantities. Cold milling and planing will be measured and the area computed in square yards (square meters) of surface.

Areas not milled (shadowed areas) due to rutting in the existing pavement surface will be included in the area measured for payment.

Basis of Payment: The cold milling and planing will be paid for at the contract unit price per square yard (square meter) for HOT-MIX ASPHALT SURFACE REMOVAL of the depth specified. Payment as specified will include variations in depth of cuts due to rutting, superelevations, and pavement crown and no additional compensation will be allowed.

**PAVEMENT DRAINAGE AFTER COLD MILLING**

Effective March 15, 1996

Revised January 1, 2007

This work shall consist of cold milling a 1.5" (40 mm) deep and 2' (0.6 m) wide drainage channel through the existing shoulder at locations as directed by the Engineer and replacing the mix after the surface has been placed.

To prevent pooling of water in the milled surface, a drainage channel shall be cut in the shoulder at low spots in superelevated curves and other locations where pooling of water may occur as specified by the Engineer.

After the surface has been placed on the adjacent through lane, the drainage channel shall be primed and then filled with a hot-mix asphalt shoulder mix approved by the Engineer and compacted to the satisfaction of the Engineer.

This work shall be paid for under the provisions of Article 109.04.

**TRAFFIC CONTROL PLAN**

Effective December 16, 2009

Traffic control shall be in accordance with the applicable sections of the "Standard Specifications for Road and Bridge Construction," the applicable guidelines contained in the "Illinois Manual on Uniform Traffic Control Devices for Streets and Highways," these Special Provisions, and any special details and Highway Standards contained herein and in the plans.

Special attention is called to Section 701 and Articles 107.09 and 107.14 of the "Standard Specifications for Road and Bridge Construction" and the following Highway Standards relating to traffic control:

701301      701306      701311      701336      701901

**MATERIAL TRANSFER DEVICE (BDE)**

Effective Date: June 15, 1999

Revised Date: January 1, 2009

Description. This work shall consist of placing hot-mix asphalt surface course mixtures according to Section 406 of the Standard Specifications, except that these materials shall be placed using a material transfer device.

Materials and Equipment. The material transfer device shall have a minimum surge capacity of 15 tons (13.5 metric tons), shall be self-propelled and capable of moving independent of the paver, and shall be equipped with the following:



- (a) Front-Dump Hopper and Conveyor. The conveyor shall provide a positive restraint along the sides of the conveyor to prevent material spillage. Material Transfer devices having paver style hoppers shall have a horizontal bar restraint placed across the foldable wings which prevents the wings from being folded.
- (b) Paver Hopper Insert. The paver hopper insert shall have a minimum capacity of 14 tons (12.7 metric tons).
- (c) Mixer/Agitator Mechanism. This re-mixing mechanism shall consist of a segmented, anti-segregation, re-mixing auger or two full-length longitudinal paddle mixers designed for the purpose of re-mixing the hot-mix asphalt (HMA). The longitudinal paddle mixers shall be located in the paver hopper insert.

### CONSTRUCTION REQUIREMENTS

General. The material transfer device shall be used for the placement of all hot-mix asphalt surface course mixtures placed with a paver. The material transfer device speed shall be adjusted to the speed of the paver to maintain a continuous, non-stop paving operation.

Use of a material transfer device with a roadway contact pressure exceeding 20 psi (138 kPa) will be limited to partially completed segments of full-depth HMA pavement where the thickness of binder in place is 10 in. (250 mm) or greater.

Structures. The material transfer device may be allowed to travel over structures under the following conditions:

- (a) Approval will be given by the Engineer.
- (b) The vehicle shall be emptied of HMA material prior to crossing the structure and shall travel at crawl speed across the structure.
- (c) The tires of the vehicle shall travel on or in close proximity and parallel to the beam and/or girder lines of the structure.

Method of Measurement. This work will be measured for payment in tons (metric tons) for hot-mix surface course materials placed with a material transfer device.

Basis of Payment. This work will be paid for at the contract unit price per ton (metric ton) for MATERIAL TRANSFER DEVICE.

The various HMA mixtures placed with the material transfer device will be paid for as specified in their respective specifications. The Contractor may choose to use the material transfer device for other applications on this project; however, no additional compensation will be allowed.

## **HOT-MIX ASPHALT SHOULDER RESURFACING REQUIRED TO BE CONSTRUCTED SIMULTANEOUSLY WITH MAINLINE PAVING**

The top lift of hot-mix asphalt shoulders four feet or less in width shall be resurfaced simultaneously with the mainline pavement resurfacing.

Any surface course placed on shoulders four feet or narrower will be paid for as the hot-mix asphalt surface course pay item specified in the plans. When the shoulders are specified to be placed simultaneously with the mainline surface course and a Material Transfer Device is required for the mainline surface course, the shoulder will be placed with the Material Transfer Device and both the mainline and shoulder tonnage will be paid for at the contract unit price for Material Transfer Device.

A roller meeting the requirements of Article 1101.01 of the Standard Specifications shall be required. This roller will be in addition to any rollers required for compaction of the mainline roadway resurfacing. This additional roller will not be paid for separately, but shall be included in the contract unit price bid for the hot-mix asphalt surface course material being placed.

The various hot-mix asphalt mixtures placed with the material transfer device will be paid for as specified in their respective specifications.

## **POLYMER MODIFIED EMULSIFIED PRIME COAT CONSTRUCTION REQUIREMENTS**

When applying polymer modified emulsified prime coat, delete the third paragraph of Article 406.05(b)(1) and replace with the following:

When a polymer modified emulsified asphalt prime is used, the prime coat shall be placed at least one day in advance of the placement of HMA, but no more than five days in advance of the placement of HMA. If the prime coat shows evidence of water or loss of adhesion prior to placement of HMA, the Engineer may request re-application of the prime coat at a rate to be determined by the Engineer; payment for re-application will be at the Engineer's discretion.

When prime coat is applied on two-lane roadways, the pavement shall be primed one lane at a time. The lane shall remain closed for a minimum of one hour and shall remain closed until the prime does not pickup under traffic. On multi-lane pavements, traffic will not be allowed on the primed surface until it is fully cured, such that it does not pickup under traffic.

Prime coat must be fully cured prior to placement of HMA to prevent pickup by haul trucks or paving equipment. If pickup occurs, paving shall cease in order to provide additional cure time, or an approved release agent may be applied to the tires of the haul trucks or paving equipment as needed to prevent pickup of the prime coat.

On milled surface, the residual rate of asphalt prime will be 0.04 gal/sy. On smooth surfaces, the residual rate of asphalt prime will be 0.025 gal/sy.

## **AUTOMATED FLAGGER ASSISTANCE DEVICES (BDE)**

Effective: January 1, 2008

Description. This work shall consist of furnishing and operating automated flagger assistance devices (AFADs) as part of the work zone traffic control and protection for two-lane highways where two-way traffic is maintained over one lane of pavement. Use of these devices shall be at the option of the Contractor.

Equipment. AFADs shall be according to the FHWA memorandum, "MUTCD - Revised Interim Approval for the use of Automated Flagger Assistance Devices in Temporary Traffic Control Zones (IA-4R)", dated January 28, 2005. The devices shall be mounted on a trailer or a moveable cart and shall meet the requirements of NCHRP 350, Category 4.

The AFAD shall be the Stop/Slow type. This device uses remotely controlled "STOP" and "SLOW" signs to alternately control right-of-way.

Signs for the AFAD shall be according to Article 701.03 of the Standard Specifications and the MUTCD. The signs shall be 24 x 24 in. (600 x 600 mm) having an octagon shaped "STOP" sign on one side and a diamond shaped "SLOW" sign on the opposite side. The letters on the signs shall be 8 in. (200 mm) high. If the "STOP" sign has louvers, the full sign face shall be visible at a distance of 50 ft (15 m) and greater.

The signs shall be supplemented with one of the following types of lights.

- (a) Flashing Lights. When flashing lights are used, white or red flashing lights shall be mounted within the "STOP" sign face and white or yellow flashing lights within the "SLOW" sign face.
- (b) Stop and Warning Beacons. When beacons are used, a stop beacon shall be mounted 24 in. (600 mm) or less above the "STOP" sign face and a warning beacon mounted 24 in. (600 mm) or less above, below, or to the side of the "SLOW" sign face. As an option, a Type B warning light may be used in lieu of the warning beacon.

A "WAIT ON STOP" sign shall be placed on the right hand side of the roadway at a point where drivers are expected to stop. The sign shall be 24 x 30 in. (600 x 750 mm) with a black legend and border on a white background. The letters shall be at least 6 in. (150 mm) high.

This device may include a gate arm or mast arm that descends to a horizontal position when the "STOP" sign is displayed and rises to a vertical position when the "SLOW" sign is displayed. When included, the end of the arm shall reach at least to the center of the lane being controlled. The arm shall have alternating red and white retroreflective stripes, on both sides, sloping downward at 45 degrees toward the side on which traffic will pass. The stripes shall be 6 in. (150 mm) in width and at least 2 in. (50 mm) in height.

Flagging Requirements. Flaggers and flagging requirements shall be according to Article 701.13 of the Standard Specifications and the following.

AFADs shall be placed at each end of the traffic control, where a flagger is shown on the plans. The flaggers shall be able to view the face of the AFAD and approaching traffic during operation.

To stop traffic, the "STOP" sign shall be displayed, the corresponding lights/beacon shall flash, and when included, the gate arm shall descend to a horizontal position. To permit traffic to move, the "SLOW" sign shall be displayed, the corresponding lights/beacon shall flash, and when included, the gate arm shall rise to a vertical position.

If used at night, the AFAD location shall be illuminated according to Section 701 of the Standard Specifications.

When not in use, AFADs will be considered nonoperating equipment and shall be stored according to Article 701.11 of the Standard Specifications.

Basis of Payment. This work will not be paid for separately but shall be considered as included in the cost of the various traffic control items included in the contract.

## **CEMENT (BDE)**

Effective: January 1, 2007

Revised: April 1, 2009

Revise Section 1001 of the Standard Specifications to read:

### **"SECTION 1001. CEMENT**

**1001.01 Cement Types.** Cement shall be according to the following.

- (a) Portland Cement. Acceptance of portland cement shall be according to the current Bureau of Materials and Physical Research's Policy Memorandum, "Portland or Blended Cement Acceptance Procedure for Qualified and Non-Qualified Plants".

Portland cement shall be according to ASTM C 150, and shall meet the standard physical and chemical requirements. Type I or Type II may be used for cast-in-place, precast, and precast prestressed concrete. Type III may be used according to Article 1020.04, or when approved by the Engineer. All other cements referenced in ASTM C 150 may be used when approved by the Engineer.

The total of all organic processing additions shall be a maximum of 1.0 percent by weight (mass) of the cement. The total of all inorganic processing additions shall be a maximum of 4.0 percent by weight (mass) of the cement. However, a cement kiln dust inorganic processing addition shall be limited to a maximum of 1.0 percent. Organic processing additions shall be limited to grinding aids that improve the flowability of cement, reduce pack set, and improve grinding efficiency. Inorganic processing additions shall be limited to granulated blast-furnace slag according to the chemical requirements of AASHTO M 302, Class C fly ash according to the chemical requirements of AASHTO M 295, and cement kiln dust.

- (b) Portland-Pozzolan Cement. Acceptance of portland-pozzolan cement shall be according to the current Bureau of Materials and Physical Research's Policy Memorandum, "Portland or Blended Cement Acceptance Procedure for Qualified and Non-Qualified Plants".

Portland-pozzolan cement shall be according to ASTM C 595 and shall meet the standard physical and chemical requirements. Type IP may be used for cast-in-place, precast, and precast prestressed concrete, except when Class PP concrete is used. The pozzolan constituent for Type IP shall be a maximum of 21 percent of the weight (mass) of the portland-pozzolan cement.

For cast-in-place construction, portland-pozzolan cement shall not be used in concrete mixtures when the air temperature is below 40 °F (4 °C) without permission of the Engineer. If permission is given, the mix design strength requirement may require the Contractor to increase the cement or eliminate the cement factor reduction for a water-reducing or high range water-reducing admixture which is permitted according to Article 1020.05(b).

The total of all organic processing additions shall be a maximum of 1.0 percent by weight (mass) of the cement. Organic processing additions shall be limited to grinding aids as defined in (a) above. Inorganic processing additions shall be limited to cement kiln dust at a maximum of 1.0 percent.

- (c) Portland Blast-Furnace Slag Cement. Acceptance of portland blast-furnace slag cement shall be according to the current Bureau of Materials and Physical Research's Policy Memorandum, "Portland or Blended Cement Acceptance Procedure for Qualified and Non-Qualified Plants".

Portland blast-furnace slag cement shall be according to ASTM C 595 and shall meet the standard physical and chemical requirements. Type IS portland blast-furnace slag cement may be used for cast-in-place, precast, and precast prestressed concrete, except when Class PP concrete is used. The blast-furnace slag constituent for Type IS shall be a maximum of 25 percent of the weight (mass) of the portland blast-furnace slag cement.

For cast-in-place construction, portland blast-furnace slag cement shall not be used in concrete mixtures when the air temperature is below 40 °F (4 °C) without permission of the Engineer. If permission is given, the mix design strength requirement may require the Contractor to increase the cement or eliminate the cement factor reduction for a water-reducing or high range water-reducing admixture which is permitted according to Article 1020.05(b).

The total of all organic processing additions shall be a maximum of 1.0 percent by weight (mass) of the cement. Organic processing additions shall be limited to grinding aids as defined in (a) above. Inorganic processing additions shall be limited to cement kiln dust at a maximum of 1.0 percent.

- (d) Rapid Hardening Cement. Rapid hardening cement shall be used according to Article 1020.04 or when approved by the Engineer. The cement shall be on the Department's current "Approved List of Packaged, Dry, Rapid Hardening Cementitious Materials for Concrete Repairs", and shall be according to the following.

- (1) The cement shall have a maximum final set of 25 minutes, according to Illinois Modified ASTM C 191.

- (2) The cement shall have a minimum compressive strength of 2000 psi (13,800 kPa) at 3.0 hours, 3200 psi (22,100 kPa) at 6.0 hours, and 4000 psi (27,600 kPa) at 24.0 hours, according to Illinois Modified ASTM C 109.
  - (3) The cement shall have a maximum drying shrinkage of 0.050 percent at seven days, according to Illinois Modified ASTM C 596.
  - (4) The cement shall have a maximum expansion of 0.020 percent at 14 days, according to Illinois Modified ASTM C 1038.
  - (5) The cement shall have a minimum 80 percent relative dynamic modulus of elasticity; and shall not have a weight (mass) gain in excess of 0.15 percent or a weight (mass) loss in excess of 1.0 percent, after 100 cycles, according to AASHTO T 161, Procedure B.
- (e) Calcium Aluminate Cement. Calcium aluminate cement shall be used only where specified by the Engineer. The cement shall meet the standard physical requirements for Type I cement according to ASTM C 150, except the time of setting shall not apply. The chemical requirements shall be determined according to ASTM C 114 and shall be as follows: minimum 38 percent aluminum oxide ( $Al_2O_3$ ), maximum 42 percent calcium oxide (CaO), maximum 1 percent magnesium oxide (MgO), maximum 0.4 percent sulfur trioxide ( $SO_3$ ), maximum 1 percent loss on ignition, and maximum 3.5 percent insoluble residue.

**1001.02 Uniformity of Color.** Cement contained in single loads or in shipments of several loads to the same project shall not have visible differences in color.

**1001.03 Mixing Brands and Types.** Different brands or different types of cement from the same manufacturing plant, or the same brand or type from different plants shall not be mixed or used alternately in the same item of construction unless approved by the Engineer.

**1001.04 Storage.** Cement shall be stored and protected against damage, such as dampness which may cause partial set or hardened lumps. Different brands or different types of cement from the same manufacturing plant, or the same brand or type from different plants shall be kept separate.”

## **CONCRETE ADMIXTURES (BDE)**

Effective: January 1, 2003

Revised: April 1, 2009

Replace the first paragraph of Article 1020.05(b) of the Standard Specifications to read:

- “(b) Admixtures. The use of admixtures to increase the workability or to accelerate the hardening of the concrete will be permitted when approved by the Engineer. Admixture dosages shall result in the mixture meeting the specified plastic and hardened properties. The Department will maintain an Approved List of Corrosion Inhibitors. Corrosion inhibitor dosage rates shall be according to Article 1020.05(b)(12). The Department will also maintain an Approved List of Concrete Admixtures, and an admixture technical representative shall be consulted when determining an admixture dosage from this list.

The dosage shall be within the range indicated on the approved list unless the influence by other admixtures, jobsite conditions (such as a very short haul time), or other circumstances warrant a dosage outside the range. The Engineer shall be notified when a dosage is proposed outside the range. To determine an admixture dosage, air temperature, concrete temperature, cement source and quantity, finely divided mineral sources(s) and quantity, influence of other admixtures, haul time, placement conditions, and other factors as appropriate shall be considered. The Engineer may request the Contractor to have a batch of concrete mixed in the lab or field to verify the admixture dosage is correct. An admixture dosage or combination of admixture dosages shall not delay the initial set of concrete by more than one hour. When a retarding admixture is required or appropriate for a bridge deck or bridge deck overlayer pour, the initial set time shall be delayed until the deflections due to the concrete dead load are no longer a concern for inducing cracks in the completed work. However, a retarding admixture shall not be used to further extend the pour time and justify the alteration of a bridge deck pour sequence.

When determining water in admixtures for water/cement ratio, the Contractor shall calculate 70 percent of the admixture dosage as water, except a value of 50 percent shall be used for a latex admixture used in bridge deck latex concrete overlays.”

Revise Section 1021 of the Standard Specifications to read:

#### **“SECTION 1021. CONCRETE ADMIXTURES**

**1021.01 General.** Admixtures shall be furnished in liquid form ready for use. The admixtures shall be delivered in the manufacturer's original containers, bulk tank trucks or such containers or tanks as are acceptable to the Engineer. Delivery shall be accompanied by a ticket which clearly identifies the manufacturer and trade name of the material. Containers shall be readily identifiable as to manufacturer and trade name of the material they contain.

Corrosion inhibitors will be maintained on the Department's Approved List of Corrosion Inhibitors. All other concrete admixture products will be maintained on the Department's Approved List of Concrete Admixtures. For the admixture submittal, a report prepared by an independent laboratory accredited by the AASHTO Materials Reference Laboratory (AMRL) for Portland Cement Concrete shall be provided. The report shall show the results of physical tests conducted no more than five years prior to the time of submittal, according to applicable specifications. However, for corrosion inhibitors the ASTM G 109 test information specified in ASTM C 1582 is not required to be from an independent lab. All other information in ASTM C 1582 shall be from an independent lab.

Tests shall be conducted using materials and methods specified on a "test" concrete and a "reference" concrete, together with a certification that no changes have been made in the formulation of the material since the performance of the tests. Per the manufacturer's option, the cement content for all required tests shall either be according to applicable specifications or 5.65 cwt/cu yd (335 kg/cu m). Compressive strength test results for six months and one year will not be required.

Prior to the approval of an admixture, the Engineer reserves the right to request a sample for testing. The test and reference concrete mixtures tested by the Engineer will contain a cement content of 5.65 cwt/cu yd (335 kg/cu m). For freeze-thaw testing, the Department will perform the test according to AASHTO T 161, Procedure B. The flexural strength test will be performed according to AASHTO T 177. If the Engineer decides to test the admixture, the manufacturer shall submit AASHTO T 197 water content and set time test results on the standard cement used by the Department. The test and reference concrete mixture shall contain a cement content of 5.65 cwt/cu yd (335 kg/cu m). The manufacturer may select their lab or an independent lab to perform this testing. The laboratory is not required to be accredited by AASHTO.

The manufacturer shall include in the submittal the following admixture information: the manufacturing range for specific gravity, the midpoint and manufacturing range for residue by oven drying, and the manufacturing range for pH. The submittal shall also include an infrared spectrophotometer trace no more than five years old.

For air-entraining admixtures according to Article 1021.02, the specific gravity allowable manufacturing range shall be established by the manufacturer and the test method shall be according to ASTM C 494. For residue by oven drying and pH, the allowable manufacturing range and test methods shall be according to ASTM C 260.

For admixtures according to Articles 1021.03, 1021.04, 1021.05, 1021.06, and 1021.07, the pH allowable manufacturing range shall be established by the manufacturer and the test method shall be according to ASTM E 70. For specific gravity and residue by oven drying, the allowable manufacturing range and test methods shall be according to ASTM C 494.

When test results are more than seven years old, the manufacturer shall re-submit the infrared spectrophotometer trace and the report prepared by an independent laboratory accredited by AASHTO.

All admixtures, except chloride-based accelerators, shall contain a maximum of 0.3 percent chloride by weight (mass).

Random field samples may be taken by the Department to verify an admixture meets specification. A split sample will be provided to the manufacturer if requested. Admixtures that do not meet specification requirements or an allowable manufacturing range established by the manufacturer shall be replaced with new material.

**1021.02 Air-Entraining Admixtures.** Air-entraining admixtures shall be according to AASHTO M 154.

**1021.03 Retarding and Water-Reducing Admixtures.** The admixture shall be according to the following.

- (a) The retarding admixture shall be according to AASHTO M 194, Type B (retarding) or Type D (water-reducing and retarding).
- (b) The water-reducing admixture shall be according to AASHTO M 194, Type A.



- (c) The high range water-reducing admixture shall be according to AASHTO M 194, Type F (high range water-reducing) or Type G (high range water-reducing and retarding).

**1021.04 Accelerating Admixtures.** The admixture shall be according to AASHTO M 194, Type C (accelerating) or Type E (water reducing and accelerating).

**1021.05 Self-Consolidating Admixtures.** The self-consolidating admixture system shall consist of either a high range water-reducing admixture only or a high range water-reducing admixture combined with a separate viscosity modifying admixture. The one or two component admixture system shall be capable of producing a concrete mixture that can flow around reinforcement and consolidate under its own weight without additional effort and without segregation.

The high range water-reducing admixture shall be according to AASHTO M 194, Type F.

The viscosity modifying admixture shall be according to ASTM C 494, Type S (specific performance).

**1021.06 Rheology-Controlling Admixture.** The rheology-controlling admixture shall be capable of producing a concrete mixture with a lower yield stress that will consolidate easier for slipform applications used by the Contractor. The rheology-controlling admixture shall be according to ASTM C 494, Type S (specific performance).

**1021.07 Corrosion Inhibitor.** The corrosion inhibitor shall be according to one of the following.

- (a) Calcium Nitrite. The corrosion inhibitor shall contain a minimum 30 percent calcium nitrite by weight (mass) of solution, and shall comply with the requirements of AASHTO M 194, Type C (accelerating).

- (b) Other Materials. The corrosion inhibitor shall be according to ASTM C 1582.”

## **CONSTRUCTION AIR QUALITY - DIESEL VEHICLE EMISSIONS CONTROL (BDE)**

Effective: April 1, 2009

Revised: July 1, 2009

Diesel Vehicle Emissions Control. The reduction of construction air emissions shall be accomplished by using cleaner burning diesel fuel. The term “equipment” refers to any and all diesel fuel powered devices rated at 50 hp and above, to be used on the project site in excess of seven calendar days over the course of the construction period on the project site (including any “rental” equipment).

All equipment on the jobsite, with engine ratings of 50 hp and above, shall be required to: use Ultra Low Sulfur Diesel fuel (ULSD) exclusively (15 ppm sulfur content or less).

Diesel powered equipment in non-compliance will not be allowed to be used on the project site, and is also subject to a notice of non-compliance as outlined below.

The Contractor shall submit copies of monthly summary reports and include certified copies of the ULSD diesel fuel delivery slips for diesel fuel delivered to the jobsite for the reporting time period, noting the quantity of diesel fuel used.

If any diesel powered equipment is found to be in non-compliance with any portion of this specification, the Engineer will issue the Contractor a notice of non-compliance and identify an appropriate period of time, as outlined below under environmental deficiency deduction, in which to bring the equipment into compliance or remove it from the project site.

Any costs associated with bringing any diesel powered equipment into compliance with these diesel vehicle emissions controls shall be considered as included in the contract unit prices bid for the various items of work involved and no additional compensation will be allowed. The Contractor's compliance with this notice and any associated regulations shall also not be grounds for a claim.

Environmental Deficiency Deduction. When the Engineer is notified, or determines that an environmental control deficiency exists, he/she will notify the Contractor in writing, and direct the Contractor to correct the deficiency within a specified time period. The specified time-period, which begins upon Contractor notification, will be from 1/2 hour to 24 hours long, based on the urgency of the situation and the nature of the deficiency. The Engineer shall be the sole judge regarding the time period.

The deficiency will be based on lack of repair, maintenance and diesel vehicle emissions control.

If the Contractor fails to correct the deficiency within the specified time frame, a daily monetary deduction will be imposed for each calendar day or fraction thereof the deficiency continues to exist. The calendar day(s) will begin when the time period for correction is exceeded and end with the Engineer's written acceptance of the correction. The daily monetary deduction will be \$1,000.00 for each deficiency identified.

If a Contractor or subcontractor accumulates three environmental deficiency deductions in a contract period, the Contractor will be shutdown until the deficiency is corrected. Such a shutdown will not be grounds for any extension of contract time, waiver of penalties, or be grounds for any claim.

### **CONSTRUCTION AIR QUALITY - IDLING RESTRICTIONS (BDE)**

Effective: April 1, 2009

Idling Restrictions. The Contractor shall establish truck-staging areas for all diesel powered vehicles that are waiting to load or unload material at the jobsite. Staging areas shall be located where the diesel emissions from the equipment will have a minimum impact on adjacent sensitive receptors. The Department will review the selection of staging areas, whether within or outside the existing highway right-of-way, to avoid locations near sensitive areas or populations to the extent possible. Sensitive receptors include, but are not limited to, hospitals, schools, residences, motels, hotels, daycare facilities, elderly housing and convalescent facilities. Diesel powered engines shall also be located as far away as possible from fresh air intakes, air conditioners, and windows. The Engineer will approve staging areas before implementation.

Diesel powered vehicle operators may not cause or allow the motor vehicle, when it is not in motion, to idle for more than a total of 10 minutes within any 60 minute period, except under any of the following circumstances:

- 1) The motor vehicle has a gross vehicle weight rating of less than 8000 lb (3630 kg).
- 2) The motor vehicle idles while forced to remain motionless because of on-highway traffic, an official traffic control device or signal, or at the direction of a law enforcement official.
- 3) The motor vehicle idles when operating defrosters, heaters, air conditioners, or other equipment solely to prevent a safety or health emergency.
- 4) A police, fire, ambulance, public safety, other emergency or law enforcement motor vehicle, or any motor vehicle used in an emergency capacity, idles while in an emergency or training mode and not for the convenience of the vehicle operator.
- 5) The primary propulsion engine idles for maintenance, servicing, repairing, or diagnostic purposes if idling is necessary for such activity.
- 6) A motor vehicle idles as part of a government inspection to verify that all equipment is in good working order, provided idling is required as part of the inspection.
- 7) When idling of the motor vehicle is required to operate auxiliary equipment to accomplish the intended use of the vehicle (such as loading, unloading, mixing, or processing cargo; controlling cargo temperature; construction operations, lumbering operations; oil or gas well servicing; or farming operations), provided that this exemption does not apply when the vehicle is idling solely for cabin comfort or to operate non-essential equipment such as air conditioning, heating, microwave ovens, or televisions.
- 8) When the motor vehicle idles due to mechanical difficulties over which the operator has no control.
- 9) The outdoor temperature is less than 32 °F (0 °C) or greater than 80 °F (26 °C).

When the outdoor temperature is greater than or equal to 32 °F (0 °C) or less than or equal to 80 °F (26 °C), a person who operates a motor vehicle operating on diesel fuel shall not cause or allow the motor vehicle to idle for a period greater than 30 minutes in any 60 minute period while waiting to weigh, load, or unload cargo or freight, unless the vehicle is in a line of vehicles that regularly and periodically moves forward.

The above requirements do not prohibit the operation of an auxiliary power unit or generator set as an alternative to idling the main engine of a motor vehicle operating on diesel fuel.

Environmental Deficiency Deduction. When the Engineer is notified, or determines that an environmental control deficiency exists based on non-compliance with the idling restrictions, he/she will notify the Contractor, and direct the Contractor to correct the deficiency.

If the Contractor fails to correct the deficiency a monetary deduction will be imposed. The monetary deduction will be \$1,000.00 for each deficiency identified.

**DISADVANTAGED BUSINESS ENTERPRISE PARTICIPATION (DBE)**

Effective: September 1, 2000

Revised: January 1, 2010

FEDERAL OBLIGATION. The Department of Transportation, as a recipient of federal financial assistance, is required to take all necessary and reasonable steps to ensure nondiscrimination in the award and administration of contracts. Consequently, the federal regulatory provisions of 49 CFR part 26 apply to this contract concerning the utilization of disadvantaged business enterprises. For the purposes of this Special Provision, a disadvantaged business enterprise (DBE) means a business certified by the Department in accordance with the requirements of 49 CFR part 26 and listed in the Illinois Unified Certification Program (IL UCP) DBE Directory.

STATE OBLIGATION. This Special Provision will also be used by the Department to satisfy the requirements of the Business Enterprise for Minorities, Females, and Persons with Disabilities Act, 30 ILCS 575. When this Special Provision is used to satisfy state law requirements on 100 percent state-funded contracts, the federal government has no involvement in such contracts (not a federal-aid contract) and no responsibility to oversee the implementation of this Special Provision by the Department on those contracts. DBE participation on 100 percent state-funded contracts will not be credited toward fulfilling the Department's annual overall DBE goal required by the US Department of Transportation to comply with the federal DBE program requirements.

CONTRACTOR ASSURANCE. The Contractor makes the following assurance and agrees to include the assurance in each subcontract that the Contractor signs with a subcontractor:

The Contractor, subrecipient, or subcontractor shall not discriminate on the basis of race, color, national origin, or sex in the performance of this contract. The Contractor shall carry out applicable requirements of 49 CFR part 26 in the award and administration of contracts funded in whole or in part with federal or state funds. Failure by the Contractor to carry out these requirements is a material breach of this contract, which may result in the termination of this contract or such other remedy as the recipient deems appropriate.

OVERALL GOAL SET FOR THE DEPARTMENT. As a requirement of compliance with 49 CFR part 26, the Department has set an overall goal for DBE participation in its federally assisted contracts. That goal applies to all federal-aid funds the Department will expend in its federally assisted contracts for the subject reporting fiscal year. The Department is required to make a good faith effort to achieve the overall goal. The dollar amount paid to all approved DBE companies performing work called for in this contract is eligible to be credited toward fulfillment of the Department's overall goal.

CONTRACT GOAL TO BE ACHIEVED BY THE CONTRACTOR. This contract includes a specific DBE utilization goal established by the Department. The goal has been included because the Department has determined that the work of this contract has subcontracting opportunities that may be suitable for performance by DBE companies. This determination is based on an assessment of the type of work, the location of the work, and the availability of DBE companies to do a part of the work. The assessment indicates that, in the absence of unlawful discrimination, and in an arena of fair and open competition, DBE companies can be expected to perform 4.0 % of the work. This percentage is set as the DBE participation goal for this contract.

Consequently, in addition to the other award criteria established for this contract, the Department will only award this contract to a bidder who makes a good faith effort to meet this goal of DBE participation in the performance of the work. A bidder makes a good faith effort for award consideration if either of the following is done in accordance with the procedures set forth in this Special Provision:

- (a) The bidder documents that enough DBE participation has been obtained to meet the goal; or
- (b) The bidder documents that a good faith effort has been made to meet the goal, even though the effort did not succeed in obtaining enough DBE participation to meet the goal.

DBE LOCATOR REFERENCES. Bidders may consult the IL UCP DBE Directory as a reference source for DBE-certified companies. In addition, the Department maintains a letting and item specific DBE locator information system whereby DBE companies can register their interest in providing quotes on particular bid items advertised for letting. Information concerning DBE companies willing to quote work for particular contracts may be obtained by contacting the Department's Bureau of Small Business Enterprises at telephone number (217)785-4611, or by visiting the Department's web site at [www.dot.il.gov](http://www.dot.il.gov).

BIDDING PROCEDURES. Compliance with this Special Provision is a material bidding requirement. The failure of the bidder to comply will render the bid not responsive.

- (a) The bidder shall submit a Disadvantaged Business Utilization Plan on Department forms SBE 2025 and 2026 with the bid.
- (b) The Utilization Plan shall indicate that the bidder either has obtained sufficient DBE participation commitments to meet the contract goal or has not obtained enough DBE participation commitments in spite of a good faith effort to meet the goal. The Utilization Plan shall further provide the name, telephone number, and telefax number of a responsible official of the bidder designated for purposes of notification of plan approval or disapproval under the procedures of this Special Provision.
- (c) The Utilization Plan shall include a DBE Participation Commitment Statement, Department form SBE 2025, for each DBE proposed for the performance of work to achieve the contract goal. For bidding purposes, submission of the completed SBE 2025 forms, signed by the DBEs and faxed to the bidder will be acceptable as long as the original is available and provided upon request. All elements of information indicated on the said form shall be provided, including but not limited to the following:
  - (1) The names and addresses of DBE firms that will participate in the contract;
  - (2) A description, including pay item numbers, of the work each DBE will perform;
  - (3) The dollar amount of the participation of each DBE firm participating. The dollar amount of participation for identified work shall specifically state the quantity, unit price, and total subcontract price for the work to be completed by the DBE. If partial pay items are to be performed by the DBE, indicate the portion of each item, a unit price where appropriate and the subcontract price amount;

- (4) DBE Participation Commitment Statements, form SBE 2025, signed by the bidder and each participating DBE firm documenting the commitment to use the DBE subcontractors whose participation is submitted to meet the contract goal;
- (5) If the bidder is a joint venture comprised of DBE companies and non-DBE companies, the plan must also include a clear identification of the portion of the work to be performed by the DBE partner(s); and,
- (6) If the contract goal is not met, evidence of good faith efforts.

GOOD FAITH EFFORT PROCEDURES. The contract will not be awarded until the Utilization Plan submitted by the apparent successful bidder is approved. All information submitted by the bidder must be complete, accurate and adequately document the good faith efforts of the bidder before the Department will commit to the performance of the contract by the bidder. The Utilization Plan will be approved by the Department if the Utilization Plan commits sufficient commercially useful DBE work performance to meet the contract goal or the bidder submits sufficient documentation of a good faith effort to meet the contract goal pursuant to 49 CFR part 26, Appendix A. The Utilization Plan will not be approved by the Department if the Utilization Plan does not commit sufficient DBE participation to meet the contract goal unless the apparent successful bidder documented in the Utilization Plan that it made a good faith effort to meet the goal. This means that the bidder must show that all necessary and reasonable steps were taken to achieve the contract goal. Necessary and reasonable steps are those which, by their scope, intensity and appropriateness to the objective, could reasonably be expected to obtain sufficient DBE participation, even if they were not successful. The Department will consider the quality, quantity, and intensity of the kinds of efforts that the bidder has made. Mere *pro forma* efforts, in other words, efforts done as a matter of form, are not good faith efforts; rather, the bidder is expected to have taken genuine efforts that would be reasonably expected of a bidder actively and aggressively trying to obtain DBE participation sufficient to meet the contract goal.

- (a) The following is a list of types of action that the Department will consider as part of the evaluation of the bidder's good faith efforts to obtain participation. These listed factors are not intended to be a mandatory checklist and are not intended to be exhaustive. Other factors or efforts brought to the attention of the Department may be relevant in appropriate cases, and will be considered by the Department.
  - (1) Soliciting through all reasonable and available means (e.g. attendance at pre-bid meetings, advertising and/or written notices) the interest of all certified DBE companies that have the capability to perform the work of the contract. The bidder must solicit this interest within sufficient time to allow the DBE companies to respond to the solicitation. The bidder must determine with certainty if the DBE companies are interested by taking appropriate steps to follow up initial solicitations.
  - (2) Selecting portions of the work to be performed by DBE companies in order to increase the likelihood that the DBE goals will be achieved. This includes, where appropriate, breaking out contract work items into economically feasible units to facilitate DBE participation, even when the prime Contractor might otherwise prefer to perform these work items with its own forces.

- (3) Providing interested DBE companies with adequate information about the plans, specifications, and requirements of the contract in a timely manner to assist them in responding to a solicitation.
- (4) a. Negotiating in good faith with interested DBE companies. It is the bidder's responsibility to make a portion of the work available to DBE subcontractors and suppliers and to select those portions of the work or material needs consistent with the available DBE subcontractors and suppliers, so as to facilitate DBE participation. Evidence of such negotiation includes the names, addresses, and telephone numbers of DBE companies that were considered; a description of the information provided regarding the plans and specifications for the work selected for subcontracting; and evidence as to why additional agreements could not be reached for DBE companies to perform the work.
  - b. A bidder using good business judgment would consider a number of factors in negotiating with subcontractors, including DBE subcontractors, and would take a firm's price and capabilities as well as contract goals into consideration. However, the fact that there may be some additional costs involved in finding and using DBE companies is not in itself sufficient reason for a bidder's failure to meet the contract DBE goal, as long as such costs are reasonable. Also, the ability or desire of a bidder to perform the work of a contract with its own organization does not relieve the bidder of the responsibility to make good faith efforts. Bidders are not, however, required to accept higher quotes from DBE companies if the price difference is excessive or unreasonable.
- (5) Not rejecting DBE companies as being unqualified without sound reasons based on a thorough investigation of their capabilities. The bidder's standing within its industry, membership in specific groups, organizations, or associations and political or social affiliations (for example union vs. non-union employee status) are not legitimate causes for the rejection or non-solicitation of bids in the bidder's efforts to meet the project goal.
- (6) Making efforts to assist interested DBE companies in obtaining bonding, lines of credit, or insurance as required by the recipient or Contractor.
- (7) Making efforts to assist interested DBE companies in obtaining necessary equipment, supplies, materials, or related assistance or services.
- (8) Effectively using the services of available minority/women community organizations; minority/women contractors' groups; local, state, and federal minority/women business assistance offices; and other organizations as allowed on a case-by-case basis to provide assistance in the recruitment and placement of DBE companies.

- (b) If the Department determines that the apparent successful bidder has made a good faith effort to secure the work commitment of DBE companies to meet the contract goal, the Department will award the contract provided that it is otherwise eligible for award. If the Department determines that the bidder has failed to meet the requirements of this Special Provision and that a good faith effort has not been made, the Department will notify the responsible company official designated in the Utilization Plan that the bid is not responsive. The notification shall include a statement of reasons why good faith efforts have not been found.
- (c) The bidder may request administrative reconsideration of a determination adverse to the bidder within the five working days after receipt of the notification date of the determination by delivering the request to the Department of Transportation, Bureau of Small Business Enterprises, Contract Compliance Section, 2300 South Dirksen Parkway, Room 319, Springfield, Illinois 62764 (Telefax: (217)785-1524). Deposit of the request in the United States mail on or before the fifth business day shall not be deemed delivery. The determination shall become final if a request is not made and delivered. A request may provide additional written documentation and/or argument concerning the issue of whether an adequate good faith effort was made to meet the contract goal. The request will be forwarded to the Department's Reconsideration Officer. The Reconsideration Officer will extend an opportunity to the bidder to meet in person in order to consider all issues of whether the bidder made a good faith effort to meet the goal. After the review by the Reconsideration Officer, the bidder will be sent a written decision within ten working days after receipt of the request for reconsideration, explaining the basis for finding that the bidder did or did not meet the goal or make adequate good faith efforts to do so. A final decision by the Reconsideration Officer that a good faith effort was made shall approve the Utilization Plan submitted by the bidder and shall clear the contract for award. A final decision that a good faith effort was not made shall render the bid not responsive.

CALCULATING DBE PARTICIPATION. The Utilization Plan values represent work anticipated to be performed and paid for upon satisfactory completion. The Department is only able to count toward the achievement of the overall goal and the contract goal the value of payments made for the work actually performed by DBE companies. In addition, a DBE must perform a commercially useful function on the contract to be counted. A commercially useful function is generally performed when the DBE is responsible for the work and is carrying out its responsibilities by actually performing, managing, and supervising the work involved. The Department and Contractor are governed by the provisions of 49 CFR part 26.55(c) on questions of commercially useful functions as it affects the work. Specific counting guidelines are provided in 49 CFR part 26.55, the provisions of which govern over the summary contained herein.

- (a) DBE as the Contractor: 100 percent goal credit for that portion of the work performed by the DBE's own forces, including the cost of materials and supplies. Work that a DBE subcontracts to a non-DBE does not count toward the DBE goals.
- (b) DBE as a joint venture Contractor: 100 percent goal credit for that portion of the total dollar value of the contract equal to the distinct, clearly defined portion of the work performed by the DBE's own forces.



- (c) DBE as a subcontractor: 100 percent goal credit for the work of the subcontract performed by the DBE's own forces, including the cost of materials and supplies, excluding the purchase of materials and supplies or the lease of equipment by the DBE subcontractor from the prime Contractor or its affiliates. Work that a DBE subcontractor in turn subcontracts to a non-DBE does not count toward the DBE goal.
- (d) DBE as a trucker: 100 percent goal credit for trucking participation provided the DBE is responsible for the management and supervision of the entire trucking operation for which it is responsible. At least one truck owned, operated, licensed, and insured by the DBE must be used on the contract. Credit will be given for the following:
  - (1) The DBE may lease trucks from another DBE firm, including an owner-operator who is certified as a DBE. The DBE who leases trucks from another DBE receives credit for the total value of the transportation services the lessee DBE provides on the contract.
  - (2) The DBE may also lease trucks from a non-DBE firm, including from an owner-operator. The DBE who leases trucks from a non-DBE is entitled to credit only for the fee or commission it receives as a result of the lease arrangement.
- (e) DBE as a material supplier:
  - (1) 60 percent goal credit for the cost of the materials or supplies purchased from a DBE regular dealer.
  - (2) 100 percent goal credit for the cost of materials or supplies obtained from a DBE manufacturer.
  - (3) 100 percent credit for the value of reasonable fees and commissions for the procurement of materials and supplies if not a regular dealer or manufacturer.

CONTRACT COMPLIANCE. Compliance with this Special Provision is an essential part of the contract. The Department is prohibited by federal regulations from crediting the participation of a DBE included in the Utilization Plan toward either the contract goal or the Department's overall goal until the amount to be applied toward the goals has been paid to the DBE. The following administrative procedures and remedies govern the compliance by the Contractor with the contractual obligations established by the Utilization Plan. After approval of the Utilization Plan and award of the contract, the Utilization Plan and individual DBE Participation Statements become part of the contract. If the Contractor did not succeed in obtaining enough DBE participation to achieve the advertised contract goal, and the Utilization Plan was approved and contract awarded based upon a determination of good faith, the total dollar value of DBE work calculated in the approved Utilization Plan as a percentage of the awarded contract value shall become the amended contract goal.

- (a) No amendment to the Utilization Plan may be made without prior written approval from the Department's Bureau of Small Business Enterprises. All requests for amendment to the Utilization Plan shall be submitted to the Department of Transportation, Bureau of Small Business Enterprises, Contract Compliance Section, 2300 South Dirksen Parkway, Room 319, Springfield, Illinois 62764. Telephone number (217) 785-4611. Telefax number (217) 785-1524.
- (b) The Contractor must notify and obtain written approval from the Department's Bureau of Small Business Enterprises prior to replacing a DBE or making any change in the participation of a DBE. Approval for replacement will be granted only if it is demonstrated that the DBE is unable or unwilling to perform. The Contractor must make every good faith effort to find another certified DBE subcontractor to substitute for the original DBE. The good faith efforts shall be directed at finding another DBE to perform at least the same amount of work under the contract as the original DBE, to the extent needed to meet the contract goal.
- (c) Any deviation from the DBE condition-of-award or contract specifications must be approved, in writing, by the Department. The Contractor shall notify affected DBEs in writing of any changes in the scope of work which result in a reduction in the dollar amount condition-of-award to the contract.
- (d) In addition to the above requirements for reductions in the condition of award, additional requirements apply to the two cases of Contractor-initiated work substitution proposals. Where the contract allows alternate work methods which serve to delete or create underruns in condition of award DBE work, and the Contractor selects that alternate method or, where the Contractor proposes a substitute work method or material that serves to diminish or delete work committed to a DBE and replace it with other work, then the Contractor must demonstrate one of the following:
  - (1) That the replacement work will be performed by the same DBE (as long as the DBE is certified in the respective item of work) in a modification of the condition of award; or
  - (2) That the DBE is aware that its work will be deleted or will experience underruns and has agreed in writing to the change. If this occurs, the Contractor shall substitute other work of equivalent value to a certified DBE or provide documentation of good faith efforts to do so; or
  - (3) That the DBE is not capable of performing the replacement work or has declined to perform the work at a reasonably competitive price. If this occurs, the Contractor shall substitute other work of equivalent value to a certified DBE or provide documentation of good faith efforts to do so.
- (e) Where the revision includes work committed to a new DBE subcontractor, not previously involved in the project, then a Request for Approval of Subcontractor, Department form BC 260A, must be signed and submitted.

- (f) If the commitment of work is in the form of additional tasks assigned to an existing subcontract, than a new Request for Approval of Subcontractor shall not be required. However, the Contractor must document efforts to assure that the existing DBE subcontractor is capable of performing the additional work and has agreed in writing to the change.
- (g) All work indicated for performance by an approved DBE shall be performed, managed, and supervised by the DBE executing the Participation Statement. The Contractor shall not terminate for convenience a DBE listed in the Utilization Plan and then perform the work of the terminated DBE with its own forces, those of an affiliate or those of another subcontractor, whether DBE or not, without first obtaining the written consent of the Bureau of Small Business Enterprises to amend the Utilization Plan. The Contractor shall notify the Bureau of Small Business Enterprises of any termination for reasons other than convenience, and shall obtain approval for inclusion of the substitute DBE in the Utilization Plan. If good faith efforts following a termination of a DBE for cause are not successful, the Contractor shall contact the Bureau of Small Business Enterprises and provide a full accounting of the efforts undertaken to obtain substitute DBE participation. The Bureau of Small Business Enterprises will evaluate the good faith efforts in light of all circumstances surrounding the performance status of the contract, and determine whether the contract goal should be amended.
- (h) The Contractor shall maintain a record of payments for work performed to the DBE participants. The records shall be made available to the Department for inspection upon request. After the performance of the final item of work or delivery of material by a DBE and final payment therefore to the DBE by the Contractor, but not later than thirty calendar days after payment has been made by the Department to the Contractor for such work or material, the Contractor shall submit a DBE Payment Agreement on Department form SBE 2115 to the Regional Engineer. If full and final payment has not been made to the DBE, the DBE Payment Agreement shall indicate whether a disagreement as to the payment required exists between the Contractor and the DBE or if the Contractor believes that the work has not been satisfactorily completed. If the Contractor does not have the full amount of work indicated in the Utilization Plan performed by the DBE companies indicated in the Utilization Plan and after good faith efforts are reviewed, the Department may deduct from contract payments to the Contractor the amount of the goal not achieved as liquidated and ascertained damages. The Contractor may request an administrative reconsideration of any amount deducted as damages pursuant to subsection (j) of this part.
- (i) The Department reserves the right to withhold payment to the Contractor to enforce the provisions of this Special Provision. Final payment shall not be made on the contract until such time as the Contractor submits sufficient documentation demonstrating achievement of the goal in accordance with this Special Provision or after liquidated damages have been determined and collected.

- (j) Notwithstanding any other provision of the contract, including but not limited to Article 109.09 of the Standard Specifications, the Contractor may request administrative reconsideration of a decision to deduct the amount of the goal not achieved as liquidated damages. A request to reconsider shall be delivered to the Contract Compliance Section and shall be handled and considered in the same manner as set forth in paragraph (c) of "Good Faith Effort Procedures" of this Special Provision, except a final decision that a good faith effort was not made during contract performance to achieve the goal agreed to in the Utilization Plan shall be the final administrative decision of the Department.

**ENGINEER'S FIELD OFFICE TYPE A (BDE)**

Effective: April 1, 2007

Revised: August 1, 2008

Revise Article 670.02 of the Standard Specifications to read:

**"670.02 Engineer's Field Office Type A.** Type A field offices shall have a minimum ceiling height of 7 ft (2 m) and a minimum floor space 450 sq ft (42 sq m). The office shall be provided with sufficient heat, natural and artificial light, and air conditioning.

The office shall have an electronic security system that will respond to any breach of exterior doors and windows. Doors and windows shall be equipped with locks. Doors shall also be equipped with dead bolt locks or other secondary locking device.

Windows shall be equipped with exterior screens to allow adequate ventilation. All windows shall be equipped with interior shades, curtains, or blinds. Adequate all-weather parking space shall be available to accommodate a minimum of ten vehicles.

Suitable on-site sanitary facilities meeting Federal, State, and local health department requirements shall be provided, maintained clean and in good working condition, and shall be stocked with lavatory and sanitary supplies at all times.

Sanitary facilities shall include hot and cold potable running water, lavatory and toilet as an integral part of the office where available. Solid waste disposal consisting of two waste baskets and an outside trash container of sufficient size to accommodate a weekly provided pick-up service.

In addition, the following furniture and equipment shall be furnished.

- (a) Four desks with minimum working surface 42 x 30 in. (1.1 m x 750 mm) each and five non-folding chairs with upholstered seats and backs.
- (b) One desk with minimum working surface 48 x 72 in. (1.2 x 1.8 m) with height adjustment of 23 to 30 in. (585 to 750 mm).
- (c) One four-post drafting table with minimum top size of 37 1/2 x 48 in. (950 mm x 1.2 m). The top shall be basswood or equivalent and capable of being tilted through an angle of 50 degrees. An adjustable height drafting stool with upholstered seat and back shall also be provided.

- (d) Two free standing four drawer legal size file cabinet with lock and an underwriters' laboratories insulated file device 350 degrees one hour rating.
- (e) One 6 ft (1.8 m) folding table with six folding chairs.
- (f) One equipment cabinet of minimum inside dimension of 44 in. (1100 mm) high x 24 in. (600 mm) wide x 30 in. (750 mm) deep with lock. The walls shall be of steel with a 3/32 in. (2 mm) minimum thickness with concealed hinges and enclosed lock constructed in such a manner as to prevent entry by force. The cabinet assembly shall be permanently attached to a structural element of the field office in a manner to prevent theft of the entire cabinet.
- (g) One refrigerator with a minimum size of 16 cu ft (0.45 cu m) with a freezer unit.
- (h) One electric desk type tape printing calculator.
- (i) A minimum of two communication paths. The configuration shall include:
  - (1) Internet Connection. An internet service connection using telephone DSL, cable broadband, or CDMA wireless technology. Additionally, an 802.11g/N wireless router shall be provided, which will allow connection by the Engineer and up to four Department staff.
  - (2) Telephone Lines. Three separate telephone lines.
- (j) One plain paper copy machine capable of reproducing prints up to 11 x 17 in. (280 x 432 mm) with an automatic feed tray capable of storing 30 sheets of paper. Letter size and 11 x 17 in. (280 x 432 mm) paper shall be provided.
- (k) One plain paper fax machine with paper.
- (l) Two telephones, with touch tone, where available, and a digital telephone answering machine, for exclusive use by the Engineer.
- (m) One electric water cooler dispenser.
- (n) One first-aid cabinet fully equipped.
- (o) One microwave oven, 1 cu ft (0.03 cu m) minimum capacity.
- (p) One fire-proof safe, 0.5 cu ft (0.01 cu m) minimum capacity.
- (q) One electric paper shredder.
- (r) One post mounted rain gauge, located on the project site for each 5 miles (8 km) of project length."

Revise the first sentence of the first paragraph of Article 670.07 of the Standard Specifications to read:

“The building or buildings fully equipped as specified will be paid for on a monthly basis until the building or buildings are released by the Engineer.”

Revise the last sentence of the first paragraph of Article 670.07 of the Standard Specifications to read:

“This price shall include all utility costs and shall reflect the salvage value of the building or buildings, equipment, and furniture which become the property of the Contractor after release by the Engineer, except that the Department will pay that portion of the monthly long distance telephone bills that, when combined, exceed \$150.”

### **EQUIPMENT RENTAL RATES (BDE)**

Effective: August 2, 2007

Revised: January 2, 2008

Replace the second and third paragraphs of Article 105.07(b)(4)a. of the Standard Specifications with the following:

“Equipment idled which cannot be used on other work, and which is authorized to standby on the project site by the Engineer, will be paid for according to Article 109.04(b)(4).”

Replace Article 109.04(b)(4) of the Standard Specifications with the following:

“(4) Equipment. Equipment used for extra work shall be authorized by the Engineer. The equipment shall be specifically described, be of suitable size and capacity for the work to be performed, and be in good operating condition. For such equipment, the Contractor will be paid as follows.

- a. Contractor Owned Equipment. Contractor owned equipment will be paid for by the hour using the applicable FHWA hourly rate from the “Equipment Watch Rental Rate Blue Book” (Blue Book) in effect when the force account work begins. The FHWA hourly rate is calculated as follows.

$$\text{FHWA hourly rate} = (\text{monthly rate}/176) \times (\text{model year adj.}) \times (\text{Illinois adj.}) + \text{EOC}$$

Where: EOC = Estimated Operating Costs per hour (from the Blue Book)

The time allowed will be the actual time the equipment is operating on the extra work. For the time required to move the equipment to and from the site of the extra work and any authorized idle (standby) time, payment will be made at the following hourly rate:  $0.5 \times (\text{FHWA hourly rate} - \text{EOC})$ .

All time allowed shall fall within the working hours authorized for the extra work.

The rates above include the cost of fuel, oil, lubrication, supplies, small tools, necessary attachments, repairs, overhaul and maintenance of any kind, depreciation, storage, overhead, profits, insurance, and all incidentals. The rates do not include labor.

The Contractor shall submit to the Engineer sufficient information for each piece of equipment and its attachments to enable the Engineer to determine the proper equipment category. If a rate is not established in the Blue Book for a particular piece of equipment, the Engineer will establish a rate for that piece of equipment that is consistent with its cost and use in the industry.

- b. Rented Equipment. Whenever it is necessary for the Contractor to rent equipment to perform extra work, the rental and transportation costs of the equipment plus five percent for overhead will be paid. In no case shall the rental rates exceed those of established distributors or equipment rental agencies.

All prices shall be agreed to in writing before the equipment is used.”

### **FLAGGER AT SIDE ROADS AND ENTRANCES (BDE)**

Effective: April 1, 2009

Revise the second paragraph of Article 701.13(a) of the Standard Specifications to read:

“The Engineer will determine when a side road or entrance shall be closed to traffic. A flagger will be required at each side road or entrance remaining open to traffic within the operation where two-way traffic is maintained on one lane of pavement. The flagger shall be positioned as shown on the plans or as directed by the Engineer.”

Revise the first and second paragraph of Article 701.20(i) of the Standard Specifications to read:

“Signs, barricades, or other traffic control devices required by the Engineer over and above those specified will be paid for according to Article 109.04. All flaggers required at side roads and entrances remaining open to traffic including those that are shown on the Highway Standards and/or additional barricades required by the Engineer to close side roads and entrances will be paid for according to Article 109.04.”

### **HOT-MIX ASPHALT – ANTI-STRIPPING ADDITIVE (BDE)**

Effective: November 1, 2009

Revise the first and second paragraphs of Article 1030.04(c) of the Standard Specifications to read:

- “(c) Determination of Need for Anti-Stripping Additive. The mixture designer shall determine if an additive is needed in the mix to prevent stripping. The determination will be made on the basis of tests performed according to Illinois Modified AASHTO T 283. To be considered acceptable by the Department as a mixture not susceptible to stripping, the conditioned to unconditioned split tensile strength ratio (TSR) shall be equal to or greater than 0.85 for 6 in. (150 mm) specimens. Mixtures, either with or without an additive, with TSRs less than 0.85 for 6 in. (150 mm) specimens will be considered unacceptable. Also, the conditioned tensile strength for mixtures containing an anti-strip additive shall not be lower than the original conditioned tensile strength determined for the same mixture without the anti-strip additive.

If it is determined that an additive is required, the additive may be hydrated lime, slaked quicklime, or a liquid additive, at the Contractor's option.”

**HOT-MIX ASPHALT - DENSITY TESTING OF LONGITUDINAL JOINTS (BDE)**

Effective: January 1, 2010

Description. This work shall consist of testing the density of longitudinal joints as part of the quality control/quality assurance (QC/QA) of hot-mix asphalt (HMA). Work shall be according to Section 1030 of the Standard Specifications except as follows.

Quality Control/Quality Assurance (QC/QA). Delete the second and third sentence of the third paragraph of Article 1030.05(d)(3) of the Standard Specifications.

Add the following paragraphs to the end of Article 1030.05(d)(3) of the Standard Specifications:

“Longitudinal joint density testing shall be performed at each random density test location. Longitudinal joint testing shall be located at a distance equal to the lift thickness or a minimum of 2 in. (50 mm), from each pavement edge. (i.e. for a 4 in. (100 mm) lift the near edge of the density gauge or core barrel shall be within 4 in. (100 mm) from the edge of pavement.) Longitudinal joint density testing shall be performed using either a correlated nuclear gauge or cores.

- a. Confined Edge. Each confined edge density shall be represented by a one-minute nuclear density reading or a core density and shall be included in the average of density readings or core densities taken across the mat which represents the Individual Test.
- b. Unconfined Edge. Each unconfined edge joint density shall be represented by an average of three one-minute density readings or a single core density at the given density test location and shall meet the density requirements specified herein. The three one-minute readings shall be spaced ten feet apart longitudinally along the unconfined pavement edge and centered at the random density test location.”

Revise the Density Control Limits table in Article 1030.05(d)(4) of the Standard Specifications to read:

“Mixture Composition	Parameter	Individual Test (includes confined edges)	Unconfined Edge Joint Density Minimum
IL-9.5, IL-12.5	Ndesign ≥ 90	92.0 – 96.0%	90.0%
IL-9.5,IL-9.5L, IL-12.5	Ndesign < 90	92.5 – 97.4%	90.0%
IL-19.0, IL-25.0	Ndesign ≥ 90	93.0 – 96.0%	90.0%
IL-19.0, IL-19.0L, IL-25.0	Ndesign < 90	93.0 – 97.4%	90.0%
SMA	Ndesign = 50 & 80	93.5 – 97.4%	91.0%
All Other	Ndesign = 30	93.0 - 97.4%	90.0%”



**HOT-MIX ASPHALT – DROP-OFFS (BDE)**

Effective: January 1, 2010

Revise the third paragraph of Article 701.07 of the Standard Specifications to read:

“At locations where construction operations result in a differential in elevation exceeding 3 in. (75 mm) between the edge of pavement or edge of shoulder within 3 ft (900 mm) of the edge of the pavement and the earth or aggregate shoulders, Type I or II barricades or vertical panels shall be placed at 100 ft (30 m) centers on roadways where the posted speed limit is 45 mph or greater and at 50 ft (15 m) centers on roadways where the posted speed limit is less than 45 mph.”

**HOT-MIX ASPHALT – PLANT TEST FREQUENCY (BDE)**

Effective: April 1, 2008

Revised: January 1, 2010

Revise the table in Article 1030.05(d)(2)a. of the Standard Specifications to read:

"Parameter	Frequency of Tests		Test Method See Manual of Test Procedures for Materials
	High ESAL Mixture Low ESAL Mixture	Frequency of Tests All Other Mixtures	
Aggregate Gradation  % passing sieves: 1/2 in. (12.5 mm), No. 4 (4.75 mm), No. 8 (2.36 mm), No. 30 (600 μm) No. 200 (75 μm)  Note 1.	1 washed ignition oven test on the mix per half day of production  Note 4.	1 washed ignition oven test on the mix per day of production  Note 4.	Illinois Procedure
Asphalt Binder Content by Ignition Oven  Note 2.	1 per half day of production	1 per day	Illinois-Modified AASHTO T 308
VMA  Note 3.	Day's production ≥ 1200 tons:  1 per half day of production  Day's production < 1200 tons:  1 per half day of production for first 2 days and 1 per day thereafter (first sample of the day)	N/A	Illinois Modified AASHTO R 35

Air Voids  Bulk Specific Gravity of Gyrotory Sample	Day's production $\geq$ 1200 tons:  1 per half day of production	1 per day	Illinois-Modified AASHTO T 312
	Day's production < 1200 tons:  1 per half day of production for first 2 days and 1 per day thereafter (first sample of the day)		
Maximum Specific Gravity of Mixture	Day's production $\geq$ 1200 tons:  1 per half day of production	1 per day	Illinois-Modified AASHTO T 209
	Day's production < 1200 tons:  1 per half day of production for first 2 days and 1 per day thereafter (first sample of the day)		

Note 1. The No. 8 (2.36 mm) and No. 30 (600  $\mu$ m) sieves are not required for All Other Mixtures.

Note 2. The Engineer may waive the ignition oven requirement for asphalt binder content if the aggregates to be used are known to have ignition asphalt binder content calibration factors which exceed 1.5 percent. If the ignition oven requirement is waived, other Department approved methods shall be used to determine the asphalt binder content.

Note 3. The  $G_{sb}$  used in the voids in the mineral aggregate (VMA) calculation shall be the same average  $G_{sb}$  value listed in the mix design.

Note 4. The Engineer reserves the right to require additional hot bin gradations for batch plants if control problems are evident.”

**HOT-MIX ASPHALT – QC/QA ACCEPTANCE CRITERIA (BDE)**

Effective: January 1, 2010

Revise Article 1030.05(f)(3) of the Standard Specifications to read:

“(3) Department assurance tests for voids, field VMA, and density.”

**HOT-MIX ASPHALT – TRANSPORTATION (BDE)**

Effective: April 1, 2008

Revise Article 1030.08 of the Standard Specifications to read:

“**1030.08 Transportation.** Vehicles used in transporting HMA shall have clean and tight beds. The beds shall be sprayed with asphalt release agents from the Department’s approved list. In lieu of a release agent, the Contractor may use a light spray of water with a light scatter of manufactured sand (FA 20 or FA 21) evenly distributed over the bed of the vehicle. After spraying, the bed of the vehicle shall be in a completely raised position and it shall remain in this position until all excess asphalt release agent or water has been drained.

When the air temperature is below 60 °F (15 °C), the bed, including the end, endgate, sides and bottom shall be insulated with fiberboard, plywood or other approved insulating material and shall have a thickness of not less than 3/4 in (20 mm). When the insulation is placed inside the bed, the insulation shall be covered with sheet steel approved by the Engineer. Each vehicle shall be equipped with a cover of canvas or other suitable material meeting the approval of the Engineer which shall be used if any one of the following conditions is present.

- (a) Ambient air temperature is below 60 °F (15 °C).
- (b) The weather is inclement.
- (c) The temperature of the HMA immediately behind the paver screed is below 250 °F (120 °C).

The cover shall extend down over the sides and ends of the bed for a distance of approximately 12 in. (300 mm) and shall be fastened securely. The covering shall be rolled back before the load is dumped into the finishing machine.”

**LIQUIDATED DAMAGES (BDE)**

Effective: April 1, 2009

Revise the table in Article 108.09 of the Standard Specifications to read:

“Schedule of Deductions for Each Day of Overrun in Contract Time			
Original Contract Amount		Daily Charges	
From More Than	To and Including	Calendar Day	Work Day
\$ 0	\$ 100,000	\$ 375	\$ 500
100,000	500,000	625	875
500,000	1,000,000	1,025	1,425
1,000,000	3,000,000	1,125	1,550
3,000,000	5,000,000	1,425	1,950
5,000,000	10,000,000	1,700	2,350
10,000,000	And over	3,325	4,650”

**MONTHLY EMPLOYMENT REPORT (BDE)**

Effective: April 1, 2009

In addition to any other reporting required by the contract, the Contractor shall provide to the Engineer an employment summary for all employees working on the contract from the contract execution date to the last full pay period each month for the duration of the contract. The report may include but is not limited to:

- a) A listing of the total number of employees.
- b) The employee job classification.
- c) The total hours worked and payroll for each employee.

The report shall be completed by the Contractor and each subcontractor. Employee hours worked from home office or other off-site office hours worked related directly to this contract shall be included. Engineering consulting firms performing construction layout and material testing for the Contractor shall also be included.

Hours worked for material suppliers, services provided by purchase orders, Department employees or consulting firms performing inspection or testing for the Department shall not be included in the report.

The report shall contain all hours worked under the contract from the start of the month to the last full pay period each month and shall be submitted no later than 10 business days after the end of each month.

The report shall be submitted electronically in a format determined by the Engineer. See attachment for potential reporting format.

Any costs associated with complying with this provision shall be considered as included in the contract unit prices bid for the various items of work involved and no additional compensation will be allowed.

**Attachment**

<b>MONTHLY PRIME AND SUBCONTRACTOR EMPLOYMENT REPORT AMERICAN RECOVERY AND REINVESTMENT ACT</b>				
1. First day of reporting period (mm/dd/yyyy)	2. Last day of reporting period (mm/dd/yyyy)	3. Notice to Proceed Date (mm/dd/yyyy)		
4. NAME AND ADDRESS OF FIRM		5. FEDERAL-AID PROJECT NUMBER		
		6. State Project Number or ID		
7. CONTRACTING AGENCY		8. STATE (or Federal Lands Region)		
<b>Employment Data</b>				
Direct, On-Project Jobs		TOTAL EMPLOYEES	TOTAL HOURS	TOTAL PAYROLL
<b>CONSTRUCTION</b>		NEW HIRES		
		EXISTING EMPLOYEES		
<b>NON-CONSTRUCTION</b>		NEW HIRES		
		EXISTING EMPLOYEES		
<b>TOTAL</b>				
10. PREPARED BY (Signature and Title)			DATE	
11. REVIEWED BY (Signature and Title of State Highway Official)			DATE	

This form is issued in association with the American Recovery and Reinvestment Act of 2009

**NATIONAL POLLUTANT DISCHARGE ELIMINATION SYSTEM / EROSION AND SEDIMENT CONTROL DEFICIENCY DEDUCTION (BDE)**

Effective: April 1, 2007

Revised: November 1, 2009

Revise Article 105.03(a) of the Standard Specifications to read:

- “(a) National Pollutant Discharge Elimination System (NPDES) / Erosion and Sediment Control Deficiency Deduction When the Engineer is notified or determines an erosion and/or sediment control deficiency(s) exists, or the Contractor’s activities represents a violation of the Department’s NPDES permits, the Engineer will notify and direct the Contractor to correct the deficiency within a specified time. The specified time, which begins upon notification to the Contractor, will be from 1/2 hour to 1 week based on the urgency of the situation and the nature of the work effort required. The Engineer will be the sole judge.

A deficiency may be any lack of repair, maintenance, or implementation of erosion and/or sediment control devices included in the contract, or any failure to comply with the conditions of the Department’s NPDES permits. A deficiency may also be applied to situations where corrective action is not an option such as the failure to participate in a jobsite inspection of the project, failure to install required measures prior to initiating earth moving operations, disregard of concrete washout requirements, or other disregard of the NPDES permit.

If the Contractor fails to correct a deficiency within the specified time, a daily monetary deduction will be imposed for each calendar day or portion of a calendar day until the deficiency is corrected to the satisfaction of the Engineer. The calendar day(s) will begin with notification to the Contractor and end with the Engineer’s acceptance of the correction. The base value of the daily monetary deduction is \$1000.00 and will be applied to each location for which a deficiency exists. The value of the deficiency deduction assessed for each infraction will be determined by multiplying the base value by a Gravity Adjustment Factor provided in Table A. Except for failure to participate in a required jobsite inspection of the project prior to initiating earthmoving operations which will be based on the total acreage of planned disturbance at the following multipliers: <5 Acres: 1; 5-10 Acres: 2; >10-25 Acres: 3; >25 Acres: 5. For those deficiencies where corrective action was not an option, the monetary deduction will be immediate and will be valued at one calendar day multiplied by a Gravity Adjustment Factor.

Table A Deficiency Deduction Gravity Adjustment Factors				
Types of Violations	Soil Disturbed and Not Permanently Stabilized At Time of Violation			
	< 5 Acres	5 - 10 Acres	>10 - 25 Acres	> 25 Acres
Failure to Install or Properly Maintain BMP	0.1 - 0.5	0.2 - 1.0	0.5 - 2.5	1.0 - 5
Careless Destruction of BMP	0.2 - 1	0.5 - 2.5	1.0 - 5	1.0 - 5
Intrusion into Protected Resource	1.0 - 5	1.0 - 5	2.0 - 10	2.0 - 10
Failure to properly manage Chemicals, Concrete Washouts or Residuals, Litter or other Wastes	0.2 - 1	0.2 - 1	0.5 - 2.5	1.0 - 5
Improper Vehicle and Equipment Maintenance, Fueling or Cleaning	0.1 - 0.5	0.2 - 1	0.2 - 1	0.5 - 2.5
Failure to Provide or Update Written or Graphic Plans Required by SWPPP	0.2 - 1	0.5 - 2.5	1.0 - 5	1.0 - 5
Failure to comply with Other Provisions of the NPDES Permit	0.1 - 0.5	0.2 - 1	0.2 - 1	0.5 - 2.5"

**PAVEMENT MARKING REMOVAL (BDE)**

Effective: April 1, 2009

Add the following to the end of the first paragraph of Article 783.03(a) of the Standard Specifications:

“The use of grinders will not be allowed on new surface courses.”

**PAVEMENT PATCHING (BDE)**

Effective: January 1, 2010

Revise the first sentence of the second paragraph of Article 701.17(e)(1) of the Standard Specifications to read:

“In addition to the traffic control and protection shown elsewhere in the contract for pavement, two devices shall be placed immediately in front of each open patch, open hole, and broken pavement where temporary concrete barriers are not used to separate traffic from the work area.”

**PAYMENTS TO SUBCONTRACTORS (BDE)**

Effective: June 1, 2000

Revised: January 1, 2006

Federal regulations found at 49 CFR §26.29 mandate the Department to establish a contract clause to require Contractors to pay subcontractors for satisfactory performance of their subcontracts and to set the time for such payments.

State law also addresses the timing of payments to be made to subcontractors and material suppliers. Section 7 of the Prompt Payment Act, 30 ILCS 540/7, requires that when a Contractor receives any payment from the Department, the Contractor shall make corresponding, proportional payments to each subcontractor and material supplier performing work or supplying material within 15 calendar days after receipt of the Department payment. Section 7 of the Act further provides that interest in the amount of two percent per month, in addition to the payment due, shall be paid to any subcontractor or material supplier by the Contractor if the payment required by the Act is withheld or delayed without reasonable cause. The Act also provides that the time for payment required and the calculation of any interest due applies to transactions between subcontractors and lower-tier subcontractors and material suppliers throughout the contracting chain.

This Special Provision establishes the required federal contract clause, and adopts the 15 calendar day requirement of the State Prompt Payment Act for purposes of compliance with the federal regulation regarding payments to subcontractors. This contract is subject to the following payment obligations.

When progress payments are made to the Contractor according to Article 109.07 of the Standard Specifications, the Contractor shall make a corresponding payment to each subcontractor and material supplier in proportion to the work satisfactorily completed by each subcontractor and for the material supplied to perform any work of the contract. The proportionate amount of partial payment due to each subcontractor and material supplier throughout the contracting chain shall be determined by the quantities measured or otherwise determined as eligible for payment by the Department and included in the progress payment to the Contractor. Subcontractors and material suppliers shall be paid by the Contractor within 15 calendar days after the receipt of payment from the Department. The Contractor shall not hold retainage from the subcontractors. These obligations shall also apply to any payments made by subcontractors and material suppliers to their subcontractors and material suppliers; and to all payments made to lower tier subcontractors and material suppliers throughout the contracting chain. Any payment or portion of a payment subject to this provision may only be withheld from the subcontractor or material supplier to whom it is due for reasonable cause.

This Special Provision does not create any rights in favor of any subcontractor or material supplier against the State or authorize any cause of action against the State on account of any payment, nonpayment, delayed payment, or interest claimed by application of the State Prompt Payment Act. The Department will not approve any delay or postponement of the 15 day requirement except for reasonable cause shown after notice and hearing pursuant to Section 7(b) of the State Prompt Payment Act. State law creates other and additional remedies available to any subcontractor or material supplier, regardless of tier, who has not been paid for work properly performed or material furnished. These remedies are a lien against public funds set forth in Section 23(c) of the Mechanics Lien Act, 770 ILCS 60/23(c), and a recovery on the Contractor's payment bond according to the Public Construction Bond Act, 30 ILCS 550.



**PERSONAL PROTECTIVE EQUIPMENT (BDE)**

Effective: November 1, 2008

Revise the first sentence of Article 701.12 of the Standard Specifications to read:

“All personnel on foot, excluding flaggers, within the highway right-of-way shall wear a fluorescent orange, fluorescent yellow/green, or a combination of fluorescent orange and fluorescent yellow/green vest meeting the requirements of ANSI/ISEA 107-2004 for Conspicuity Class 2 garments.”

**RAISED REFLECTIVE PAVEMENT MARKERS (BDE)**

Effective: November 1, 2009

Revise the first sentence of the second paragraph of Article 781.03 of the Standard Specifications to read:

“The pavement shall be cut to match the bottom contour of the marker using a concrete saw fitted with 18 and 20 in. (450 and 500 mm) diameter blades.”

**RECLAIMED ASPHALT PAVEMENT (RAP) (BDE)**

Effective: January 1, 2007

Revised: January 1, 2010

In Article 1030.02(g), delete the last sentence of the first paragraph in (Note 2).

Revise Section 1031 of the Standard Specifications to read:

**“SECTION 1031. RECLAIMED ASPHALT PAVEMENT**

**1031.01 Description.** Reclaimed asphalt pavement (RAP) is reclaimed asphalt pavement resulting from cold milling or crushing of an existing dense graded hot-mix asphalt (HMA) pavement. The Contractor shall supply written documentation that the RAP originated from routes or airfields under federal, state, or local agency jurisdiction.

**1031.02 Stockpiles.** The Contractor shall construct individual, sealed RAP stockpiles meeting one of the following definitions. No additional RAP shall be added to the pile after the pile has been sealed. Stockpiles shall be sufficiently separated to prevent intermingling at the base. Stockpiles shall be identified by signs indicating the type as listed below (i.e. “Homogeneous Surface”).

Prior to milling, the Contractor shall request the District to provide verification of the quality of the RAP to clarify appropriate stockpile.

- (a) Fractionated RAP (FRAP). FRAP shall consist of RAP from Class I, Superpave (High ESAL), HMA (High ESAL), or equivalent mixtures. The coarse aggregate in FRAP shall be crushed aggregate and may represent more than one aggregate type and/or quality but shall be at least C quality. All FRAP shall be fractionated prior to testing by screening into a minimum of two size fractions with the separation occurring on or between the #4 (4.75 mm) and 1/2 in. (12.5 mm) sieves. Agglomerations shall be minimized such that 100 percent of the RAP in the coarse fraction shall pass one sieve size larger than the maximum sieve size specified for the mix the RAP will be used in.
- (b) Homogeneous. Homogeneous RAP stockpiles shall consist of RAP from Class I, Superpave (High ESAL), HMA (High ESAL), or equivalent mixtures and represent: 1) the same aggregate quality, but shall be at least C quality; 2) the same type of crushed aggregate (either crushed natural aggregate, ACBF slag, or steel slag); 3) similar gradation; and 4) similar asphalt binder content. If approved by the Engineer, combined single pass surface/binder millings may be considered "homogenous" with a quality rating dictated by the lowest coarse aggregate quality present in the mixture.
- (c) Conglomerate. Conglomerate RAP stockpiles shall consist of RAP from Class I, Superpave (High ESAL), HMA (High ESAL), or equivalent mixtures. The coarse aggregate in this RAP shall be crushed aggregate and may represent more than one aggregate type and/or quality but shall be at least C quality. This RAP may have an inconsistent gradation and/or asphalt binder content prior to processing. All conglomerate RAP shall be processed prior to testing by crushing to where all RAP shall pass the 5/8 in. (16 mm) or smaller screen. Conglomerate RAP stockpiles shall not contain steel slag or other expansive material as determined by the Department.
- (d) Conglomerate "D" Quality (DQ). Conglomerate DQ RAP stockpiles shall consist of RAP from Class I, Superpave (High or Low ESAL), HMA (High or Low ESAL), or equivalent mixtures. The coarse aggregate in this RAP may be crushed or round but shall be at least D quality. This RAP may have an inconsistent gradation and/or asphalt binder content. Conglomerate DQ RAP stockpiles shall not contain steel slag or other expansive material as determined by the Department.
- (e) Non-Quality. RAP stockpiles that do not meet the requirements of the stockpile categories listed above shall be classified as "Non-Quality".

RAP/FRAP containing contaminants, such as earth, brick, sand, concrete, sheet asphalt, bituminous surface treatment (i.e. chip seal), pavement fabric, joint sealants, etc., will be unacceptable unless the contaminants are removed to the satisfaction of the Engineer. Sheet asphalt shall be stockpiled separately.

**1031.03 Testing.** When used in HMA, the RAP/FRAP shall be sampled and tested either during or after stockpiling.

For testing during stockpiling, washed extraction samples shall be run at the minimum frequency of one sample per 500 tons (450 metric tons) for the first 2000 tons (1800 metric tons) and one sample per 2000 tons (1800 metric tons) thereafter. A minimum of five tests shall be required for stockpiles less than 4000 tons (3600 metric tons).

For testing after stockpiling, the Contractor shall submit a plan for approval to the District proposing a satisfactory method of sampling and testing the RAP/FRAP pile either in-situ or by restocking. The sampling plan shall meet the minimum frequency required above and detail the procedure used to obtain representative samples throughout the pile for testing.

Before extraction, each field sample shall be split to obtain two samples of test sample size. One of the two test samples from the final split shall be labeled and stored for Department use. The Contractor shall extract the other test sample according to Department procedure. The Engineer reserves the right to test any sample (split or Department-taken) to verify Contractor test results.

Evaluation of Test Results. All of the extraction results shall be compiled and averaged for asphalt binder content and gradation and, when applicable  $G_{mm}$ . Individual extraction test results, when compared to the averages, will be accepted if within the tolerances listed below.

Parameter	FRAP/Homogeneous /Conglomerate	Conglomerate "D" Quality
1 in. (25 mm)		± 5 %
1/2 in. (12.5 mm)	± 8 %	± 15 %
No. 4 (4.75 mm)	± 6 %	± 13 %
No. 8 (2.36 mm)	± 5 %	
No. 16 (1.18 mm)		± 15 %
No. 30 (600 μm)	± 5 %	
No. 200 (75 μm)	± 2.0 %	± 4.0 %
Asphalt Binder	± 0.4 % <sup>1/</sup>	± 0.5 %
$G_{mm}$	± 0.03	

1/ The tolerance for FRAP shall be ± 0.3 %.

If more than 20 percent of the individual sieves are out of the gradation tolerances, or if more than 20 percent of the asphalt binder content test results fall outside the appropriate tolerances, the RAP/FRAP shall not be used in HMA unless the RAP/FRAP representing the failing tests is removed from the stockpile. All test data and acceptance ranges shall be sent to the District for evaluation.

With the approval of the Engineer, the ignition oven may be substituted for extractions according to the Illinois Test Procedure, "Calibration of the Ignition Oven for the Purpose of Characterizing Reclaimed Asphalt Pavement (RAP)".

**1031.04 Quality Designation of Aggregate in RAP/FRAP.**

(a) The aggregate quality of the RAP for homogenous, conglomerate, and conglomerate "D" quality stockpiles shall be set by the lowest quality of coarse aggregate in the RAP stockpile and are designated as follows.

(1) RAP from Class I, Superpave (High ESAL)/HMA (High ESAL), or HMA (Low ESAL) IL-9.5L surface mixtures are designated as containing Class B quality coarse aggregate.

- (2) RAP from Superpave (Low ESAL)/HMA (Low ESAL) IL-19.0L binder mixture is designated as Class D quality coarse aggregate.
- (3) RAP from Class I, Superpave (High ESAL), or HMA (High ESAL) binder mixtures, bituminous base course mixtures, and bituminous base course widening mixtures are designated as containing Class C quality coarse aggregate.
- (4) RAP from bituminous stabilized subbase and BAM shoulders are designated as containing Class D quality coarse aggregate.

(b) The aggregate quality of FRAP shall be determined as follows.

Fractionated stockpiles containing plus #4 (4.75 mm) sieve coarse aggregate shall have a maximum tonnage of 5000 tons (4500 metric tons). The Contractor shall obtain a representative sample witnessed by the Engineer. The sample shall be a minimum of 50 lb (25 kg). The sample shall be extracted according to Illinois Modified AASHTO T 164 by a consultant prequalified by the Department for the specified testing. The consultant shall submit the test results along with the recovered aggregate to the District Office. The cost for this testing shall be paid by the Contractor. The District will forward the sample to the BMPR Aggregate Lab for MicroDeval Testing, according to Illinois Modified AASHTO T 327. A maximum loss of 15.0 percent will be applied for all HMA applications.”

**1031.05 Use of RAP/FRAP in HMA.** The use of RAP/FRAP shall be a Contractor’s option when constructing HMA in all contracts. The use of RAP/FRAP in HMA shall be as follows.

- (a) Coarse Aggregate Size. The coarse aggregate in all RAP shall be equal to or less than the nominal maximum size requirement for the HMA mixture to be produced.
- (b) Steel Slag Stockpiles. RAP stockpiles containing steel slag or other expansive material, as determined by the Department, shall be homogeneous and will be approved for use in HMA (High ESAL and Low ESAL) surface mixtures only.
- (c) Use in HMA Surface Mixtures (High and Low ESAL). RAP/FRAP stockpiles for use in HMA surface mixtures (High and Low ESAL) shall be FRAP or homogeneous in which the coarse aggregate is Class B quality or better.
- (d) Use in HMA Binder Mixtures (High and Low ESAL), HMA Base Course, and HMA Base Course Widening. RAP/FRAP stockpiles for use in HMA binder mixtures (High and Low ESAL), HMA base course, and HMA base course widening shall be FRAP, homogeneous, or conglomerate, in which the coarse aggregate is Class C quality or better.
- (e) Use in Shoulders and Subbase. RAP/FRAP stockpiles for use in HMA shoulders and stabilized subbase (HMA) shall be FRAP, homogeneous, conglomerate, or conglomerate DQ.
- (f) When the Contractor chooses the RAP option, the percentage of RAP shall not exceed the amounts indicated in the table below for a given N Design.

Max RAP Percentage

HMA Mixtures <sup>1/, 3/</sup>	Maximum % RAP		
	Ndesign	Binder/Leveling Binder	Surface
30	30	30	10
50	25	15	10
70	15 / 25 <sup>2/</sup>	10 / 15 <sup>2/</sup>	10
90	10	10	10
105	10	10	10

- 1/ For HMA shoulder and stabilized subbase (HMA) N-30, the amount of RAP shall not exceed 50% of the mixture.
- 2/ Value of Max % RAP if homogeneous RAP stockpile of IL-9.5 RAP is utilized.
- 3/ When RAP exceeds 20 percent, the high and low virgin asphalt binder grades shall each be reduced by one grade (i.e. 25 percent RAP would require a virgin asphalt binder grade of PG64-22 to be reduced to a PG58-28). If warm mix asphalt (WMA) technology is utilized, and production temperatures do not exceed 275°F (135 °C) the grades shall be reduced as follows:

Overlays:

When WMA contains between 20 and 30 percent RAP the high temperature shall be reduced by one grade (i.e. 25 percent RAP would require a virgin asphalt binder grade of PG64-22 to be reduced to a PG58-22). When WMA contains 30 percent or more RAP the high and low temperature grades shall each be reduced by one grade (i.e. 35 percent RAP would require a virgin asphalt binder grade of PG64-22 to be reduced to a PG58-28).

Full Depth:

When WMA contains between 20 and 30 percent RAP, the low temperature shall be reduced by one grade (i.e. 25 percent RAP would require a virgin asphalt binder grade of PG64-22 to be reduced to a PG64-28). When the WMA contains 30 percent or more RAP the high and low temperature grades shall each be reduced by one grade (i.e. 35 percent RAP would require a virgin asphalt binder grade of PG64-22 to be reduced to a PG58-28).

- (g) When the Contractor chooses the FRAP option, the percentage of FRAP shall not exceed the amounts indicated in the table below for a given N Design.

Max FRAP Percentage

HMA Mixtures <sup>1/, 2/</sup>	Maximum % FRAP		
	Ndesign	Binder/Leveling Binder	Surface
30	35	35	10
50	30	25	10
70	25	20	10
90	20	15	10
105	10	10	10

- 1/ For HMA shoulder and stabilized subbase (HMA) N30, the amount of FRAP shall not exceed 50 percent of the mixture.
- 2/ When FRAP exceeds 20 percent, the high and low virgin asphalt binder grades shall each be reduced by one grade (i.e. 25 percent FRAP would require a virgin asphalt binder grade of PG64-22 to be reduced to a PG58-28). If warm mix asphalt (WMA) technology is utilized, and production temperatures do not exceed 275°F (135 °C) the grades shall be reduced as follows:

Overlays:

When WMA contains between 20 and 30 percent FRAP the high temperature shall be reduced by one grade (i.e. 25 percent FRAP would require a virgin asphalt binder grade of PG64-22 to be reduced to a PG58-22). When WMA contains 30 percent or more FRAP the high and low temperature grades shall each be reduced by one grade (i.e. 35 percent FRAP would require a virgin asphalt binder grade of PG64-22 to be reduced to a PG58-28).

Full Depth:

When WMA contains between 20 and 30 percent FRAP, the low temperature shall be reduced by one grade (i.e. 25 percent FRAP would require a virgin asphalt binder grade of PG64-22 to be reduced to a PG64-28). When the WMA contains 30 percent or more FRAP the high and low temperature grades shall each be reduced by one grade (i.e. 35 percent FRAP would require a virgin asphalt binder grade of PG64-22 to be reduced to a PG58-28).

**1031.06 HMA Mix Designs.** At the Contractor’s option, HMA mixtures may be constructed utilizing RAP/FRAP material meeting the above detailed requirements.

RAP/FRAP designs shall be submitted for volumetric verification. If additional RAP/FRAP stockpiles are tested and found that no more than 20 percent of the results, as defined under “Testing” herein, are outside of the control tolerances set for the original RAP/FRAP stockpile and HMA mix design, and meets all of the requirements herein, the additional RAP/FRAP stockpiles may be used in the original mix design at the percent previously verified.

**1031.07 HMA Production.** The coarse aggregate in all RAP used shall be equal to or less than the nominal maximum size requirement for the HMA mixture being produced.

To remove or reduce agglomerated material, a scalping screen, gator, crushing unit, or comparable sizing device approved by the Engineer shall be used in the RAP feed system to remove or reduce oversized material. If material passing the sizing device adversely affects the mix production or quality of the mix, the sizing device shall be set at a size specified by the Engineer.

If the RAP/FRAP control tolerances or QC/QA test results require corrective action, the Contractor shall cease production of the mixture containing RAP/FRAP and either switch to the virgin aggregate design or submit a new RAP/FRAP design.

HMA plants utilizing RAP/FRAP shall be capable of automatically recording and printing the following information.

(a) Dryer Drum Plants.

- (1) Date, month, year, and time to the nearest minute for each print.
- (2) HMA mix number assigned by the Department.
- (3) Accumulated weight of dry aggregate (combined or individual) in tons (metric tons) to the nearest 0.1 ton (0.1 metric ton).
- (4) Accumulated dry weight of RAP/FRAP in tons (metric tons) to the nearest 0.1 ton (0.1 metric ton).
- (5) Accumulated mineral filler in revolutions, tons (metric tons), etc. to the nearest 0.1 unit.
- (6) Accumulated asphalt binder in gallons (liters), tons (metric tons), etc. to the nearest 0.1 unit.
- (7) Residual asphalt binder in the RAP/FRAP material as a percent of the total mix to the nearest 0.1 percent.
- (8) Aggregate and RAP/FRAP moisture compensators in percent as set on the control panel. (Required when accumulated or individual aggregate and RAP/FRAP are printed in wet condition.)

(b) Batch Plants.

- (1) Date, month, year, and time to the nearest minute for each print.
- (2) HMA mix number assigned by the Department.
- (3) Individual virgin aggregate hot bin batch weights to the nearest pound (kilogram).
- (4) Mineral filler weight to the nearest pound (kilogram).
- (5) RAP/FRAP weight to the nearest pound (kilogram).

- (6) Virgin asphalt binder weight to the nearest pound (kilogram).
- (7) Residual asphalt binder in the RAP/FRAP material as a percent of the total mix to the nearest 0.1 percent.

The printouts shall be maintained in a file at the plant for a minimum of one year or as directed by the Engineer and shall be made available upon request. The printing system will be inspected by the Engineer prior to production and verified at the beginning of each construction season thereafter.

**1031.08 RAP in Aggregate Surface Course and Aggregate Shoulders.** The use of RAP in aggregate surface course and aggregate shoulders shall be as follows.

- (a) Stockpiles and Testing. RAP stockpiles may be any of those listed in Article 1031.02, except “Non-Quality” and “FRAP”. The testing requirements of Article 1031.03 shall not apply.
- (b) Gradation. One hundred percent of the RAP material shall pass the 1 1/2 in. (37.5 mm) sieve. The RAP material shall be reasonably well graded from coarse to fine. RAP material that is gap-graded or single sized will not be accepted.”

**REFLECTIVE SHEETING ON CHANNELIZING DEVICES (BDE)**

Effective: April 1, 2007

Revised: November 1, 2008

Revise the seventh paragraph of Article 1106.02 of the Standard Specifications to read:

“At the time of manufacturing, the retroreflective prismatic sheeting used on channelizing devices shall meet or exceed the initial minimum coefficient of retroreflection as specified in the following table. Measurements shall be conducted according to ASTM E 810, without averaging. Shheeting used on cones, drums and flexible delineators shall be reboundable as tested according to ASTM D 4956. Prestriped sheeting for rigid substrates on barricades shall be white and orange. The sheeting shall be uniform in color and devoid of streaks throughout the length of each roll. The color shall conform to the latest appropriate standard color tolerance chart issued by the U.S. Department of Transportation, Federal Highway Administration, and to the daytime and nighttime color requirements of ASTM D 4956.

Initial Minimum Coefficient of Retroreflection candelas/foot candle/sq ft (candelas/lux/sq m) of material				
Observation Angle (deg.)	Entrance Angle (deg.)	White	Orange	Fluorescent Orange
0.2	-4	365	160	150
0.2	+30	175	80	70
0.5	-4	245	100	95
0.5	+30	100	50	40”

Revise the first sentence of the first paragraph of Article 1106.02(c) of the Standard Specifications to read:



“Barricades and vertical panels shall have alternating white and orange stripes sloping downward at 45 degrees toward the side on which traffic will pass.”

Revise the third sentence of the first paragraph of Article 1106.02(d) of the Standard Specifications to read:

“The bottom panels shall be 8 x 24 in. (200 x 600 mm) with alternating white and orange stripes sloping downward at 45 degrees toward the side on which traffic will pass.”

**SUBCONTRACTOR MOBILIZATION PAYMENTS (BDE)**

Effective: April 2, 2005

To account for the preparatory work and operations necessary for the movement of subcontractor personnel, equipment, supplies, and incidentals to the project site and for all other work or operations that must be performed or costs incurred when beginning work approved for subcontracting in accordance with Article 108.01 of the Standard Specifications, the Contractor shall make a mobilization payment to each subcontractor.

This mobilization payment shall be made at least 14 days prior to the subcontractor starting work. The amount paid shall be equal to 3 percent of the amount of the subcontract reported on form BC 260A submitted for the approval of the subcontractor’s work.

This provision shall be incorporated directly or by reference into each subcontract approved by the Department.

**TRUCK MOUNTED/TRAILER MOUNTED ATTENUATORS (BDE)**

Effective: January 1, 2010

Revise Article 701.03(k) of the Standard Specifications to read:

“(k) Truck Mounted/Trailer Mounted Attenuators ..... 1106.02”

Revise Article 701.15(h) of the Standard Specifications to read:

“(h) Truck Mounted/Trailer Mounted Attenuators (TMA). TMA units shall have a roll ahead distance in the event of an impact. The TMA shall be between 100 and 200 ft (30 and 60 m) behind the vehicle ahead or the workers. This distance may be extended by the Engineer.

TMA host vehicles shall have the parking brake engaged when stationary.

The driver and passengers of the TMA host vehicle should exit the vehicle if the TMA is to remain stationary for 15 minutes or more in duration.”

Revise Article 1106.02(g) of the Standard Specifications to read:

“(g) Truck Mounted/Trailer Mounted Attenuators. The attenuator shall be a NCHRP 350 approved unit for Test Level 3. Test Level 2 may be used as directed by the Engineer for normal posted speeds less than or equal to 45 mph.”

**WORKING DAYS (BDE)**

Effective: January 1, 2002

The Contractor shall complete the work within 20 working days.

**BITUMINOUS MATERIALS COST ADJUSTMENTS (BDE) (RETURN FORM WITH BID)**

Effective: November 2, 2006

Revised: April 1, 2009

Description. Bituminous material cost adjustments will be made to provide additional compensation to the Contractor, or credit to the Department, for fluctuations in the cost of bituminous materials when optioned by the Contractor. The adjustments shall apply to permanent and temporary hot-mix asphalt (HMA) mixtures, bituminous surface treatments (cover and seal coats), and pavement preservation type surface treatments. The adjustments shall not apply to bituminous prime coats, tack coats, crack filling/sealing, or joint filling/sealing.

The bidder shall indicate on the attached form whether or not this special provision will be part of the contract and submit the completed form with his/her bid. Failure to submit the form, or failure to fill out the form completely, shall make this contract exempt of bituminous materials cost adjustments.

Method of Adjustment. Bituminous materials cost adjustments will be computed as follows.

$$CA = (BPI_P - BPI_L) \times (\%AC_V / 100) \times Q$$

Where: CA = Cost Adjustment, \$.

BPI<sub>P</sub> = Bituminous Price Index, as published by the Department for the month the work is performed, \$/ton (\$/metric ton).

BPI<sub>L</sub> = Bituminous Price Index, as published by the Department for the month prior to the letting, \$/ton (\$/metric ton).

%AC<sub>V</sub> = Percent of virgin Asphalt Cement in the Quantity being adjusted. For HMA mixtures, the % AC<sub>V</sub> will be determined from the adjusted job mix formula. For bituminous materials applied, a performance graded or cutback asphalt will be considered to be 100% AC<sub>V</sub> and undiluted emulsified asphalt will be considered to be 65% AC<sub>V</sub>.

Q = Authorized construction Quantity, tons (metric tons) (see below).

For HMA mixtures measured in square yards:  $Q, \text{ tons} = A \times D \times (G_{mb} \times 46.8) / 2000$ . For HMA mixtures measured in square meters:  $Q, \text{ metric tons} = A \times D \times (G_{mb} \times 24.99) / 1000$ . When computing adjustments for full-depth HMA pavement, separate calculations will be made for the binder and surface courses to account for their different  $G_{mb}$  and % AC<sub>V</sub>.

For bituminous materials measured in gallons:  $Q, \text{ tons} = V \times 8.33 \text{ lb/gal} \times \text{SG} / 2000$   
For bituminous materials measured in liters:  $Q, \text{ metric tons} = V \times 1.0 \text{ kg/L} \times \text{SG} / 1000$

Where: A = Area of the HMA mixture, sq yd (sq m).  
D = Depth of the HMA mixture, in. (mm).  
 $G_{mb}$  = Average bulk specific gravity of the mixture, from the approved mix design.  
V = Volume of the bituminous material, gal (L).  
SG = Specific Gravity of bituminous material as shown on the bill of lading.

Basis of Payment. Bituminous materials cost adjustments may be positive or negative but will only be made when there is a difference between the  $BPI_L$  and  $BPI_P$  in excess of five percent, as calculated by:

$$\text{Percent Difference} = \{(BPI_L - BPI_P) \div BPI_L\} \times 100$$

Bituminous materials cost adjustments will be calculated for each calendar month in which applicable bituminous material is placed; and will be paid or deducted when all other contract requirements for the work placed during the month are satisfied. The adjustments shall not apply during contract time subject to liquidated damages for completion of the entire contract.

## RETURN WITH BID

### ILLINOIS DEPARTMENT OF TRANSPORTATION

### OPTION FOR BITUMINOUS MATERIALS COST ADJUSTMENTS

The bidder shall submit this completed form with his/her bid. Failure to submit the form, or failure to fill out the form completely, shall make this contract exempt of bituminous materials cost adjustments. After award, this form, when submitted, shall become part of the contract.

Contract No.: \_\_\_\_\_

Company Name: \_\_\_\_\_

#### Contractor's Option:

Is your company opting to include this special provision as part of the contract?

Yes  No

Signature: \_\_\_\_\_ Date: \_\_\_\_\_

80173

#### **FUEL COST ADJUSTMENT (BDE) (RETURN FORM WITH BID)**

Effective: April 1, 2009

Revised: July 1, 2009

Description. Fuel cost adjustments will be made to provide additional compensation to the Contractor, or a credit to the Department, for fluctuations in fuel prices when optioned by the Contractor. The bidder shall indicate on the attached form whether or not this special provision will be part of the contract and submit the completed form with his/her bid. Failure to submit the form or failure to indicate contract number, company name and sign and date the form shall make this contract exempt of fuel cost adjustments for all categories of work. Failure to indicate "Yes" for any category of work will make that category of work exempt from fuel cost adjustment.

General. The fuel cost adjustment shall apply to contract pay items as grouped by category. The adjustment shall only apply to those categories of work checked "Yes", and only when the cumulative plan quantities for a category exceed the required threshold. Adjustments to work items in a category, either up or down, and work added by adjusted unit price will be subject to fuel cost adjustment only when the category representing the added work was subject to the fuel cost adjustment. Added work paid for by time and materials will not be subject to fuel cost adjustment. Category descriptions and thresholds for application and the fuel usage factors which are applicable to each are as follows:

- (a) Categories of Work.

- (1) Category A: Earthwork. Contract pay items performed under Sections 202, 204, and 206 including any modified standard or nonstandard items where the character of the work to be performed is considered earthwork. The cumulative total of all applicable item plan quantities shall exceed 25,000 cu yd (20,000 cu m). Included in the fuel usage factor is a weighted average 0.10 gal/cu yd (0.50 liters/cu m) factor for trucking.
- (2) Category B: Subbases and Aggregate Base Courses. Contract pay items constructed under Sections 311, 312 and 351 including any modified standard or nonstandard items where the character of the work to be performed is considered construction of a subbase or aggregate, stabilized or modified base course. The cumulative total of all applicable item plan quantities shall exceed 5000 tons (4500 metric tons). Included in the fuel usage factor is a 0.60 gal/ton (2.50 liters/metric ton) factor for trucking.
- (3) Category C: Hot-Mix Asphalt (HMA) Bases, Pavements and Shoulders. Contract pay items constructed under Sections 355, 406, 407 and 482 including any modified standard or nonstandard items where the character of the work to be performed is considered HMA bases, pavements and shoulders. The cumulative total of all applicable item plan quantities shall exceed 5000 tons (4500 metric tons). Included in the fuel usage factor is 0.60 gal/ton (2.50 liters/metric ton) factor for trucking.
- (4) Category D: Portland Cement Concrete (PCC) Bases, Pavements and Shoulders. Contract pay items constructed under Sections 353, 420, 421 and 483 including any modified standard or nonstandard items where the character of the work to be performed is considered PCC base, pavement or shoulder. The cumulative total of all applicable item plan quantities shall exceed 7500 sq yd (6000 sq m). Included in the fuel usage factor is 1.20 gal/cu yd (5.94 liters/cu m) factor for trucking.
- (5) Category E: Structures. Structure items having a cumulative bid price that exceeds \$250,000 for pay items constructed under Sections 502, 503, 504, 505, 512, 516 and 540 including any modified standard or nonstandard items where the character of the work to be performed is considered structure work when similar to that performed under these sections and not included in categories A through D.

(b) Fuel Usage Factors.

English Units		
Category	Factor	Units
A - Earthwork	0.34	gal / cu yd
B – Subbase and Aggregate Base courses	0.62	gal / ton
C – HMA Bases, Pavements and Shoulders	1.05	gal / ton
D – PCC Bases, Pavements and Shoulders	2.53	gal / cu yd
E – Structures	8.00	gal / \$1000

Metric Units		
Category	Factor	Units
A - Earthwork	1.68	liters / cu m
B – Subbase and Aggregate Base courses	2.58	liters / metric ton
C – HMA Bases, Pavements and Shoulders	4.37	liters / metric ton

D – PCC Bases, Pavements and Shoulders	12.52	liters / cu m
E – Structures	30.28	liters / \$1000

(c) Quantity Conversion Factors.

Category	Conversion	Factor
B	sq yd to ton	0.057 ton / sq yd / in depth
	sq m to metric ton	0.00243 metric ton / sq m / mm depth
C	sq yd to ton	0.056 ton / sq yd / in depth
	sq m to metric ton	0.00239 m ton / sq m / mm depth
D	sq yd to cu yd	0.028 cu yd / sq yd / in depth
	sq m to cu m	0.001 cu m / sq m / mm depth

Method of Adjustment. Fuel cost adjustments will be computed as follows.

$$CA = (FPI_P - FPI_L) \times FUF \times Q$$

- Where: CA = Cost Adjustment, \$  
 FPI<sub>P</sub> = Fuel Price Index, as published by the Department for the month the work is performed, \$/gal (\$/liter)  
 FPI<sub>L</sub> = Fuel Price Index, as published by the Department for the month prior to the letting, \$/gal (\$/liter)  
 FUF = Fuel Usage Factor in the pay item(s) being adjusted  
 Q = Authorized construction Quantity, tons (metric tons) or cu yd (cu m)

The entire FUF indicated in paragraph (b) will be used regardless of use of trucking to perform the work.

Progress Payments. Fuel cost adjustments will be calculated for each calendar month in which applicable work is performed; and will be paid or deducted when all other contract requirements for the items of work are satisfied. The adjustments shall not apply during contract time subject to liquidated damages for completion of the entire contract.

Final Quantities. Upon completion of the work and determination of final pay quantities, an adjustment will be prepared to reconcile any differences between estimated quantities previously paid and the final quantities. The value for the balancing adjustment will be based on a weighted average of FPI<sub>P</sub> and Q only for those months requiring the cost adjustment. The cost adjustment will be applicable to the final measured quantities of all applicable pay items.

Basis of Payment. Fuel cost adjustments may be positive or negative but will only be made when there is a difference between the FPI<sub>L</sub> and FPI<sub>P</sub> in excess of five percent, as calculated by:

$$\text{Percent Difference} = \{(FPI_L - FPI_P) \div FPI_L\} \times 100$$

Return With Bid

**ILLINOIS DEPARTMENT  
OF TRANSPORTATION**

**OPTION FOR  
FUEL COST ADJUSTMENT**

The bidder shall submit this completed form with his/her bid. Failure to submit the form or properly complete contract number, company name, and sign and date the form shall make this contract exempt of fuel cost adjustments in all categories. Failure to indicate "Yes" for any category of work at the time of bid will make that category of work exempt from fuel cost adjustment. After award, this form, when submitted shall become part of the contract.

**Contract No.:** \_\_\_\_\_

**Company Name:** \_\_\_\_\_

**Contractor's Option:**

Is your company opting to include this special provision as part of the contract plans for the following categories of work?

- |  |     |                          |
|--|-----|--------------------------|
| Category A Earthwork.                          | Yes | <input type="checkbox"/> |
| Category B Subbases and Aggregate Base Courses | Yes | <input type="checkbox"/> |
| Category C HMA Bases, Pavements and Shoulders  | Yes | <input type="checkbox"/> |
| Category D PCC Bases, Pavements and Shoulders  | Yes | <input type="checkbox"/> |
| Category E Structures                          | Yes | <input type="checkbox"/> |

**Signature:** \_\_\_\_\_ **Date:** \_\_\_\_\_



**STATE OF ILLINOIS**  
**DEPARTMENT OF TRANSPORTATION**  
**DIVISION OF HIGHWAYS**  
**FAS ROUTE 1412 (IL 94)**  
**SECTION 105RS-2**  
**HENDERSON & WARREN COUNTY**  
**C-94-132-09**

INDEX OF SHEETS

1. COVER SHEET
2. COMMITMENT & PROJECT NOTES
- 3 - 7. GENERAL NOTES
- 8 - 10. SUMMARY OF QUANTITIES
- 11 - 14. TYPICAL SECTIONS
- 15 - 24. SCHEDULE OF QUANTITIES
25. LINE DIAGRAM
- 26 - 28. CONCRETE MEDIAN DETAIL
29. ENTRANCE, MAILBOX TURNOUT & SIDE ROAD DETAIL
- 30 - 33. CADD STANDARDS

STANDARDS

- 420001-0701306-02
- 442201-03701311-03
- 606001-0701336-05
- 606301-0701901-01
- 701301-0780001-02
- 781001-03

BRIDGE OMISSION:  
STA. 178+30 TO STA. 182+65  
NS 036-0040 (IL 94 OVER  
N. HENDERSON CREEK)

IMPROVEMENT BEGINS  
STA. 0+12

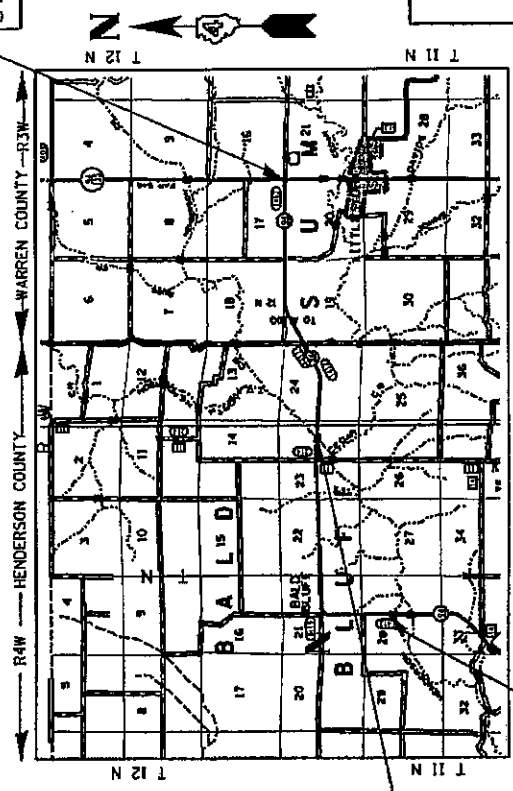

DESCRIPTION OF WORK

SURFACE MAINTENANCE ON IL 94 FROM IL 135 IN WARREN COUNTY TO SOUTH OF TR 29 IN HENDERSON COUNTY, SOUTH OF BALD BLUFF.

J. JULIE  
JOINT UTILITY LOCATION INFORMATION FOR EXCAVATION  
1-800-892-0123

STATE OF ILLINOIS  
DEPARTMENT OF TRANSPORTATION  
DIVISION OF HIGHWAYS

SUBMITTED Dec 10 09 20\_\_\_\_

DEPUTY DIRECTOR OF HIGHWAYS, REGION ENGINEER

ENGINEER OF DESIGN AND ENVIRONMENT \_\_\_\_\_ 20\_\_\_\_

DIRECTOR OF HIGHWAYS, CHIEF ENGINEER \_\_\_\_\_

STATION EQUATIONS

- (1) STA. 95+33.42 BK = STA. 95+25.74 AH
- (2) STA. 304+26.32 BK = STA. 304+28.41 AH

IMPROVEMENT ENDS  
STA. 342+79

ADT = 550  
MU = 9.1%

GROSS LENGTH = 34,272.79 FT = 6.49 MILES  
BRIDGE OMISSION = 435 FT = .08 MILES  
NET LENGTH = 33,837.79 FT = 6.41 MILES

CONTRACT NO. 68916  
CATALOG NO. 034287-000

PRINTED BY THE AUTHORITY OF THE STATE OF ILLINOIS



ROUTE		SECTION	COUNTY	SHEET	
F.A.S.	1412	105RS-2	HENDERSON & WARREN	TOTAL	NO.
MKD.	IL 94			33	2

CONTRACT 68916

**COMMITMENTS**

Commitments are not to be altered without the written consent of all parties to which the commitments was made.

No commitments have been made for this project.

**PROJECT SPECIFIC NOTES**

For no passing marking the resident engineer shall verify the location of all no passing zones prior to surface removal.

Existing gutter near the west end of the job shall be cleaned as directed by the Engineer and be paid for according to Article 109.04 of the Standard Specifications.

**COMMITMENTS &  
PROJECT SPECIFIC NOTES**

ROUTE		SECTION	COUNTY	SHEET	
F.A.S.	1412	105RS-2	HENDERSON & WARREN	TOTAL	NO.
MKD.	IL 94			33	3

CONTRACT 68916

### ENVIRONMENTAL REVIEWS

Prior to the use of any proposed borrow areas, use areas (temporary access roads, detours, run-arounds, etc.) and/or waste areas, the Contractor shall file the required environmental resource request surveys according to Section 107.22 of the Standard Specifications. These surveys are required in order for the Department to conduct cultural and biological resource surveys for the proposed site.

Prior to any waste materials being removed from the construction site the required environmental resource surveys will need to be obtained and filed by the Contractor. Excess waste products removed from the construction site shall be disposed of as required in Section 202.03 of the Standard Specifications.

Any protruding metal bars shall be removed prior to the disposal of broken concrete at approved disposal sites.

The required environmental resource documentation shall include the following:

- \* BDE Form 2289 (Environmental Survey Request)
- \* A location map showing the size limits and location of the use area
- \* Signed property owner agreement form-D4 P10100
- \* Borrow Area Entry Agreement form-D4 P10101
- \* Color photographs depicting the use area

Please note that a minimum of two weeks shall be allowed for the District to obtain the required environmental clearances.

GENERAL NOTES

ROUTE		SECTION	COUNTY	SHEET	
F.A.S.	1412			TOTAL	NO.
MKD.	IL 94	105RS-2	HENDERSON & WARREN	33	4

CONTRACT 68916

**MEDIAN AND ISLAND NOSES**

When constructing median and island noses the following criteria should be used:

- Barrier curb shall be used to construct noses when the median or island surrounds a mast arm or other non-breakaway foundation.
- Ramped noses shall be used on medians or islands with breakaway posts.

**PROPERTY OWNER ACCESS REQUIREMENTS**

Access must be maintained to all existing properties during construction per Article 107.09 unless arrangements are made in writing by the Contractor with the property owners with a copy to the Engineer for short-term closures.

**WINTER SHUTDOWN RESTRICTIONS ON COLD MILLED PROJECTS**

Prior to winter shutdown the following steps shall be taken:

- \* All cold milled surfaces shall be overtailed.
- \* All lanes shall be reopened to traffic.
- \* Manholes, where applicable, shall be adjusted to the elevation of the binder course/leveling binder to ease in plowing snow, and re-adjusted to finished grade in the Spring. The initial manhole adjustment will be paid for at the contract unit price and any re-adjustment, as directed by the Engineer, will be paid for in accordance with Article 109.04.
- \* Temporary or permanent pavement marking shall be placed as applicable.

GENERAL NOTES

ROUTE		SECTION	COUNTY	SHEET	
F.A.S.	1412			TOTAL	NO.
MKD.	IL 94			33	5

CONTRACT 68916

Mixture Use(s):	Surface Course	CI D Patches
AC/PG:	PG 64-22	PG 64-22
RAP% (Max): **	15%	25%
Design Air Voids:	4.0% @ N=50	4.0% @ N=50
Mixture Composition: (Gradation Mixture)	IL 9.5 or IL12.5	IL 19.0
Friction Aggregate:	Mixture D	N.A.

\*\* If RAP option is selected, the asphalt cement grade may need to be adjusted, this will be determined by the Materials Engineer.

GENERAL NOTES

ROUTE		SECTION	COUNTY	SHEET	
F.A.S.	1412			TOTAL	NO.
MKD.	IL 94			33	6

CONTRACT 68916

**PAVEMENT STATIONING NUMBERS & PLACEMENT**

The Contractor shall provide labor and materials required to imprint pavement station numbers in the finished surface of the pavement and/or overlay. The numbers shall be approximately 3/4 inch (20mm) wide, 5 inches (125 mm ) high and 5/8 inch (15 mm ) deep.

The pavement station numbers shall be installed as specified herein:

Interval - 200 feet (English stationing) or 100 meters (metric stationing)

Bottom of Numbers - 6 inches (150 mm ) from the inside edge of the pavement marking

Location:

- \* 2,3, & 5 Lane Pavements - right edge of pavement in direction of increasing stations
- \* Multi-Lane Divided Roadways - outside edge of pavement in both directions
- \* Ramps - along baseline edge of pavement

Position - stations shall be placed so they can be read from the adjacent shoulder

Format - English (Metric) pavement stations shall use this format "XXX (XX+X00)" where X represents the pavement station

This work will not be paid for separately, but will be considered included in the cost of the associated pavement and/or overlay pay items.

**ENGINEERS FIELD OFFICE**

Add the following sentence to the end of paragraph 670.02 (j) and 670.04 (e):

All of the telephone lines provided shall have unpublished numbers.

GENERAL NOTES

ROUTE		SECTION	COUNTY	SHEET	
F.A.S.	1412	105RS-2	HENDERSON & WARREN	TOTAL	NO.
MKD.	IL 94			33	7

CONTRACT 68916

**BUTT JOINT CUTTING TIME RESTRICTION**

Butt joints shall not be milled more than three (3) days prior to placement of the bituminous surface course.

**PAVING SURFACE COURSE**

Continuous paving operations on the main roadway shall be maintained at all times during the construction of the hot-mix asphalt surface. No interruptions for side roads, entrances, turn lanes, etc. will be allowed.

**AGGREGATE SHOULDERS, TYPE B**

Aggregate (Description), Type B shall be required for all granular construction of side roads, entrances, and mailbox turnouts, whether or not portions of the surfaces thus constructed are to be covered with a bituminous surface, except where noted differently on the plans.

GENERAL NOTES

# Summary of Quantities

Code Order

ROUTE		SECTION		COUNTY		SHEET	
FAS	1412	105RS-2		WARREN	TOTAL NO.		
IL	94			HENDERSON	33	8	
				CONTRACT NO. 68916			

CONSTRUCTION TYPE CODE	WARREN	HENDERSON		
	1000	1000		
	100% STATE	100% STATE		
CODE No.	ITEM	UNIT	Tot.QTY	

40600215	POLYMERIZED BITUMINOUS MATERIALS (PRIME COAT)	TON	37	12	25
----------	---	-----	----	----	----

40600300	AGGREGATE (PRIME COAT)	TON	183	59	124
----------	------------------------	-----	-----	----	-----

40600895	CONSTRUCTING TEST STRIP	EACH	1	0.3	0.7
----------	-------------------------	------	---	-----	-----

40600982	HOT - MIX ASPHALT SURFACE REMOVAL - BUTT JOINT	SQ YD	1052	785	267
----------	--	-------	------	-----	-----

40600990	TEMPORARY RAMP	SQ YD	165	125	40
----------	----------------	-------	-----	-----	----

40603335	HOT - MIX ASPHALT SURFACE COURSE, MIX "D", N50	TON	7685	2482	5203
----------	--	-----	------	------	------

44000152	HOT - MIX ASPHALT SURFACE REMOVAL, 3/4"	SQ YD	76297	27958	48339
----------	---	-------	-------	-------	-------

44000155	HOT - MIX ASPHALT SURFACE REMOVAL, 1 1/2"	SQ YD	7589		7589
----------	---	-------	------	--	------

44000198	HOT - MIX ASPHALT SURFACE REMOVAL, VARIABLE DEPTH	SQ YD	5945	547	5398
----------	---	-------	------	-----	------

44003100	MEDIAN REMOVAL	SQ FT	200	200	
----------	----------------	-------	-----	-----	--

# Summary of Quantities

Code Order

ROUTE		SECTION		COUNTY		SHEET	
		105RS-2		WARREN	TOTAL		NO.
FAS	1412			HENDERSON		33	9
IL	94					CONTRACT NO.	

CONSTRUCTION TYPE CODE	WARREN	HENDERSON
	1000	1000
	100% STATE	100% STATE

CODE No.	ITEM	UNIT	Tot.QTY		
44201803	CLASS D PATCHES, TYPE II, 13 INCH	SQ YD	913	487	426
44201807	CLASS D PATCHES, TYPE III, 13 INCH	SQ YD	64		64
44201809	CLASS D PATCHES, TYPE IV, 13 INCH	SQ YD	140		140
48101200	AGGREGATE SHOULDERS, TYPE B	TON	730	306	424
60623711	CONCRETE MEDIAN	SQ FT	200	200	
67000400	ENGINEER'S FIELD OFFICE, TYPE A	CAL MO	3		3
67100100	MOBILIZATION	L SUM	1	0.3	0.7
70100460	TRAFFIC CONTROL AND PROTECTION, STANDARD 701306	L SUM	1	0.3	0.7
70100600	TRAFFIC CONTROL AND PROTECTION, STANDARD 701336	L SUM	1	0.3	0.7
70300100	SHORT-TERM PAVEMENT MARKING	FOOT	6768	2272	4496



# Summary of Quantities

Code Order

ROUTE		SECTION		COUNTY		SHEET	
		105RS-2		WARREN		TOTAL NO.	
FAS	1412			HENDERSON		33	
IL	94					10	
				CONTRACT NO. 68916			

CONSTRUCTION TYPE CODE	
WARREN	HENDERSON
1000	1000
100% STATE	100% STATE

CODE No.	ITEM	UNIT	Tot.QTY	CONSTRUCTION TYPE CODE	
70301000	WORK ZONE PAVEMENT MARKING REMOVAL	SQ FT	1126	378	748
78005110	EPOXY PAVEMENT MARKING - LINE 4"	FOOT	103990	32380	71610
78005140	EPOXY PAVEMENT MARKING - LINE 8"	FOOT	187	187	
78005150	EPOXY PAVEMENT MARKING - LINE 12"	FOOT	115	115	
78005180	EPOXY PAVEMENT MARKING - LINE 24"	FOOT	29	29	
78100100	RAISED REFLECTIVE PAVEMENT MARKER	EACH	438	144	294
78300200	RAISED REFLECTIVE PAVEMENT MARKER REMOVAL	EACH	438	144	294
X0322729	MATERIAL TRANSFER DEVICE	TON	7685	2482	5203

ROUTE		SECTION	COUNTY	SHEET	
F.A.S.	1412	105RS-2	HENDERSON & WARREN	TOTAL	NO.
MKD.	IL 94			33	11

CONTRACT 68916

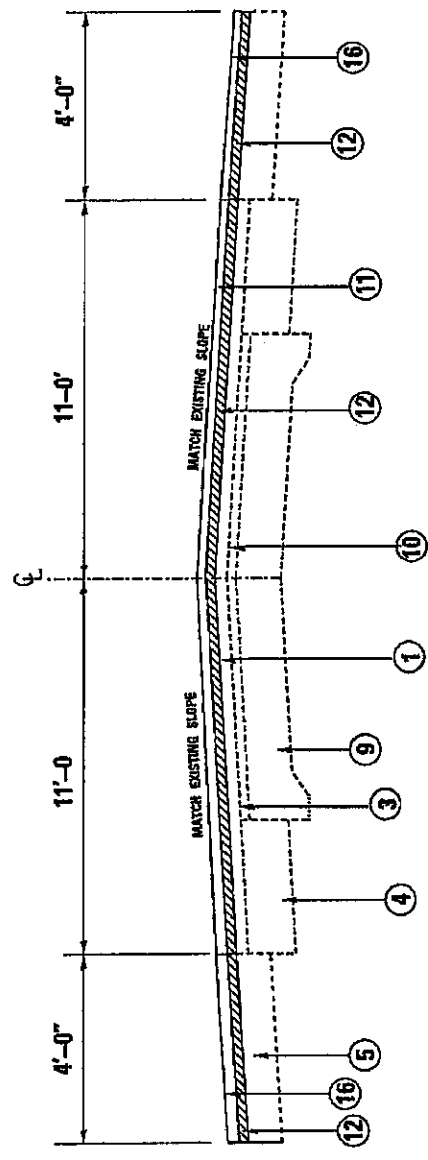

IL 94 STA 268 + 95 TO STA 281 + 30 LT  
 IL 94 STA 296 + 74 TO STA 305 + 00 LT  
 IL 94 STA 340 + 20 TO STA. 342 + 79

- ① EXIST. HMA SURF OVERLAY
- ② EXIST. AREA REFL. CRACK CONTROL
- ③ EXIST. HMA BASE COURSE WIDE 9"
- ④ EXIST. HMA SHOULDER 6"
- ⑤ EXIST. AGGREGATE SHOULDER, TY B
- ⑥ EXIST. UNDERDRAIN
- ⑦ EXIST. CONCRETE GUTTER, TY B (MOD)
- ⑧ EXIST. PCC PAVEMENT, 9" - 6" - 9"
- ⑨ EXIST. HMA OVERLAY, 3"
- ⑩ PROP. HMA SURF. COURSE, MIX "D", N50 (1 1/2")
- ⑪ PROPOSED HMA SURF. REMOVAL, 3/4"
- ⑫ PROPOSED HMA SURF. REMOVAL, 1 1/2"
- ⑬ PROPOSED AGG SHOULDER, TY B
- ⑭ PROPOSED HMA SURF REM, VARIABLE DEPTH
- ⑮ PROPOSED HMA SHOULDERS, 1 1/2"

TYPICAL SECTIONS

ROUTE		SECTION	COUNTY	SHEET	
F.A.S.	1412	105RS-2	HENDERSON & WARREN	TOTAL	NO.
MKD.	IL 94			33	12

CONTRACT 68916

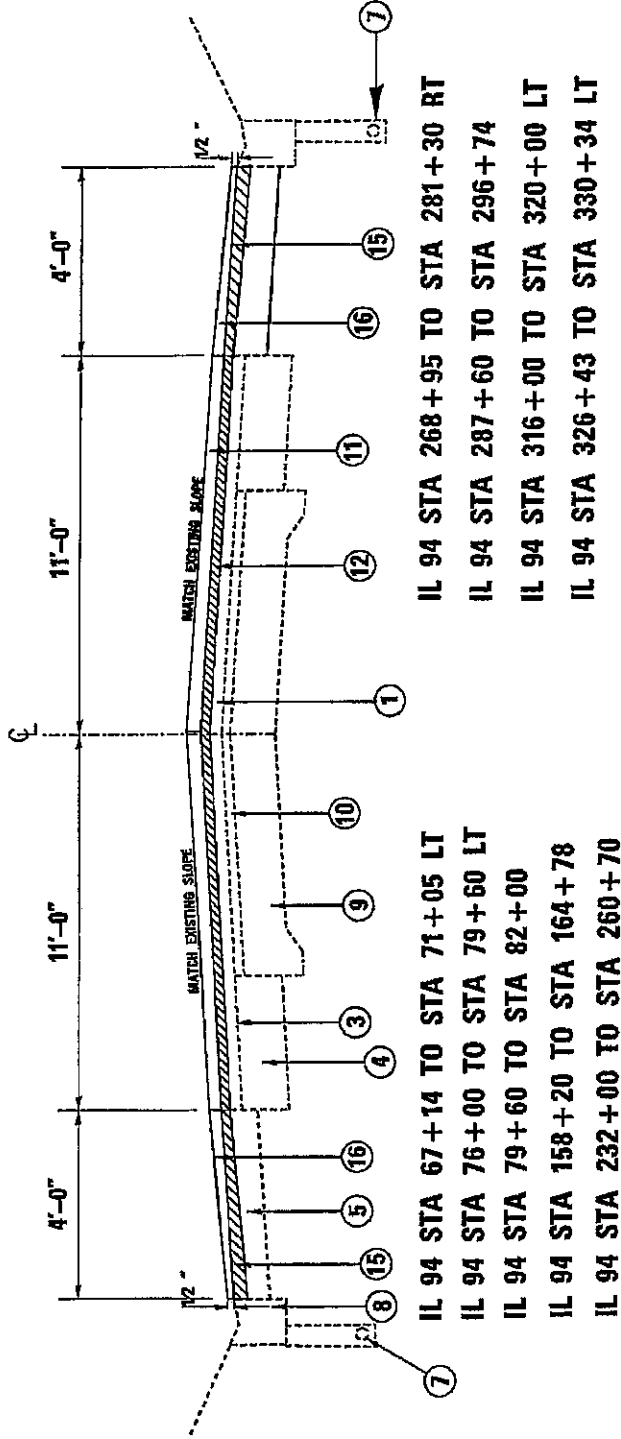

- IL 94 STA 67+14 TO STA 71+05 LT
- IL 94 STA 76+00 TO STA 79+60 LT
- IL 94 STA 79+60 TO STA 82+00
- IL 94 STA 158+20 TO STA 164+78
- IL 94 STA 232+00 TO STA 260+70
- IL 94 STA 268+95 TO STA 281+30 RT
- IL 94 STA 287+60 TO STA 296+74
- IL 94 STA 316+00 TO STA 320+00 LT
- IL 94 STA 326+43 TO STA 330+34 LT

- ① EXIST. HMA SURF OVERLAY
- ③ EXIST. AREA REFL. CRACK CONTROL
- ④ EXIST. HMA BASE COURSE WIDE 9"
- ⑤ EXIST. HMA SHOULDER 6"
- ⑥ EXIST. AGGREGATE SHOULDER, TY B
- ⑦ EXIST. UNDERDRAIN
- ⑧ EXIST. CONCRETE GUTTER, TY B (MOD)
- ⑨ EXIST. PCC PAVEMENT, 9" - 6" - 9"
- ⑩ EXIST. HMA OVERLAY, 3"
- ⑪ PROP. HMA SURF. COURSE, MIX "D", N50 (1 1/2")
- ⑫ PROPOSED HMA SURF. REMOVAL, 3/4"
- ⑬ PROPOSED HMA SURF. REMOVAL, 1 1/2"
- ⑭ PROPOSED AGG SHOULDER, TY B
- ⑮ PROPOSED HMA SURF REM, VARIABLE DEPTH
- ⑯ PROPOSED HMA SHOULDERS, 1 1/2"

TYPICAL SECTIONS

ROUTE		SECTION	COUNTY	SHEET	
F.A.S.	1412	105RS-2	HENDERSON & WARREN	TOTAL	NO.
MKD.	IL 94			33	13

CONTRACT 68916

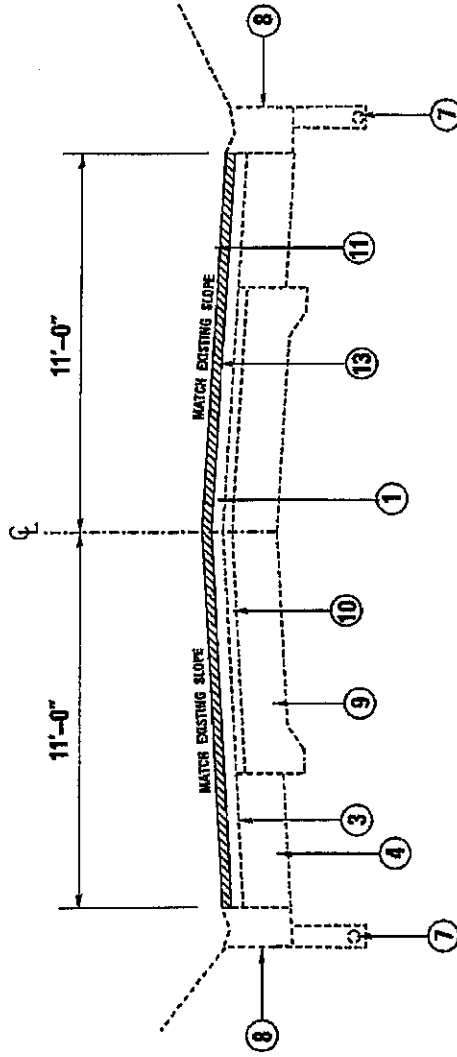

IL 94 STA 330+34 TO STA 333+30 LT  
 IL 94 STA 333+30 TO STA 340+20

- ① EXIST. HMA SURF OVERLAY
- ② EXIST. AREA REFL. CRACK CONTROL
- ③ EXIST. HMA BASE COURSE WIDE 9"
- ④ EXIST. HMA SHOULDER 6"
- ⑤ EXIST. AGGREGATE SHOULDER, TY B
- ⑥ EXIST. UNDERDRAIN
- ⑦ EXIST. CONCRETE GUTTER, TY B (MOD)
- ⑧ EXIST. PCC PAVEMENT, 9" - 6" - 9"
- ⑨ EXIST. HMA SURF OVERLAY, 3"
- ⑩ PROP. HMA SURF. COURSE, MIX "D", N50 (1 1/2")
- ⑪ PROPOSED HMA SURF. REMOVAL, 3/4"
- ⑫ PROPOSED HMA SURF. REMOVAL, 1 1/2"
- ⑬ PROPOSED AGG SHOULDER, TY B
- ⑭ PROPOSED HMA SURF REM, VARIABLE DEPTH
- ⑮ PROPOSED HMA SHOULDERS, 1 1/2"

TYPICAL SECTIONS

ROUTE		SECTION	COUNTY	SHEET	
F.A.S.	1412	105RS-2	HENDERSON & WARREN	TOTAL	NO.
MKD.	IL 94			33	14

CONTRACT 68916

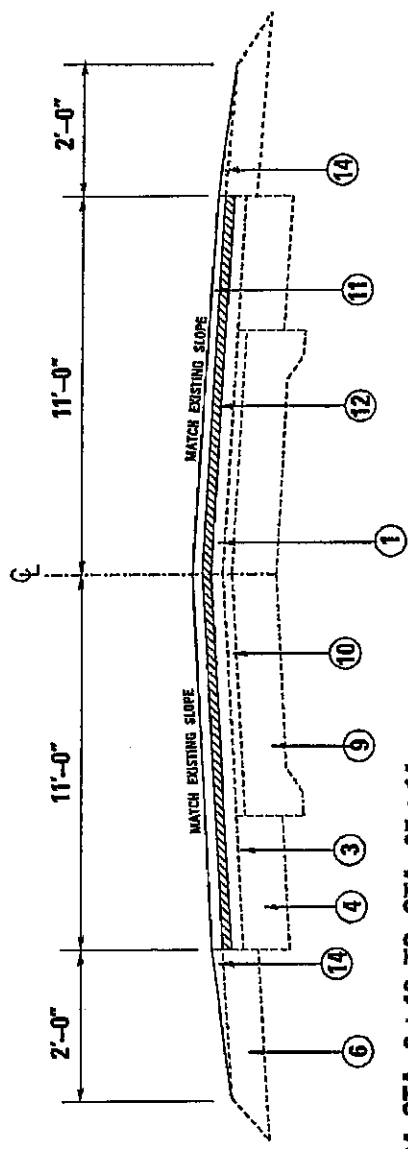

IL 94 STA 0+12 TO STA 67+14  
 IL 94 STA 67+14 TO STA 71+05 RT  
 IL 94 STA 71+05 TO STA 76+00  
 IL 94 STA 76+00 TO STA 79+60 RT  
 IL 94 STA 82+00 TO STA 158+20  
 IL 94 STA 164+78 TO STA 178+30  
 IL 94 STA 182+65 TO STA 232+00

IL 94 STA 260+70 TO STA 268+95  
 IL 94 STA 281+30 TO STA 287+60  
 IL 94 STA 296+74 TO STA 305+00 RT  
 IL 94 STA 305+00 TO STA 316+00  
 IL 94 STA 316+00 TO STA 320+00 RT  
 IL 94 STA 320+00 TO STA 326+43  
 IL 94 STA 326+43 TO STA 330+34 RT  
 IL 94 STA 330+34 TO STA 333+30 RT

- ① EXIST. HMA SURF OVERLAY
- ③ EXIST. AREA REFL. CRACK CONTROL
- ④ EXIST. HMA BASE COURSE WIDE 9"
- ⑤ EXIST. HMA SHOULDER 6"
- ⑥ EXIST. AGGREGATE SHOULDER, TY B
- ⑦ EXIST. UNDERDRAIN
- ⑧ EXIST. CONCRETE GUTTER, TY B (MOD)
- ⑨ EXIST. PCC PAVEMENT, 9" - 6" - 9"
- ⑩ EXIST. HMA OVERLAY, 3"
- ⑪ PROP. HMA SURF. COURSE, MIX "D", N50 (1 1/2")
- ⑫ PROPOSED HMA SURF. REMOVAL, 3/4"
- ⑬ PROPOSED HMA SURF. REMOVAL, 1 1/2"
- ⑭ PROPOSED AGG SHOULDER, TY B
- ⑮ PROPOSED HMA SURF REM, VARIABLE DEPTH
- ⑯ PROPOSED HMA SHOULDERS, 1 1/2"

TYPICAL SECTIONS

ROUTE		SECTION	COUNTY	SHEET	
F.A.S.	1412	105RS-2	HENDERSON & WARREN	TOTAL	NO.
MKD.	IL 94			33	15

CONTRACT 68916

<b>MOBILIZATION</b>	
IL 94	
WARREN COUNTY	L SUM
SUB-TOTAL	0.3
HENDERSON COUNTY	L SUM
SUB-TOTAL	0.7
<b>GRAND TOTAL</b>	<b>1.0</b>

<b>TRAFFIC CONTROL &amp; PROTECTION</b>	
STANDARD 701336	
IL 94	
WARREN COUNTY	L SUM
SUB-TOTAL	0.3
HENDERSON COUNTY	L SUM
SUB-TOTAL	0.7
<b>GRAND TOTAL</b>	<b>1.0</b>

<b>TRAFFIC CONTROL &amp; PROTECTION</b>	
STANDARD 701306	
IL 94	
WARREN COUNTY	L SUM
SUB-TOTAL	0.3
HENDERSON COUNTY	L SUM
SUB-TOTAL	0.7
<b>GRAND TOTAL</b>	<b>1.0</b>

SCHEDULE OF QUANTITIES

ROUTE		SECTION	COUNTY	SHEET	
F.A.S.	1412	105RS-2	HENDERSON & WARREN	TOTAL	NO.
MKD.	IL 94			33	16

CONTRACT 68916

<b>ENGINEERS FIELD OFFICE, TY A</b>	
IL 94	
HENDERSON COUNTY	CAL MO
Sub-Total	3.0
<b>GRAND TOTAL</b>	<b>3.0</b>

<b>CONSTRUCTING TEST STRIP</b>	
IL 94	
Warren County	EACH
Sub-Total	0.3
IL 94	
HENDERSON COUNTY	EACH
Sub-Total	0.7
<b>GRAND TOTAL</b>	<b>1.0</b>

SCHEDULE OF  
QUANTITIES

ROUTE		SECTION	COUNTY	SHEET	
F.A.S.	1412	105RS-2	HENDERSON & WARREN	TOTAL	NO.
MKD.	IL 94			33	17

CONTRACT 68916

### PATCHING SCHEDULE

#### IL 94 - WARREN COUNTY

PATCH UNITS	CLD TY II - 13 "		CLD TY III - 13 "		CLD TY IV - 13 "	
	NO.	SQ. YD	NO.	SQ. YD	NO.	SQ. YD
1	18	144				
2	40	320				
<b>SUBTOTAL</b>	<b>58</b>	<b>464</b>				
<b>5% FOR WINTER BREAK-UP</b>		<b>23</b>				
<b>TOTAL</b>		<b>487</b>				

#### IL 94 - HENDERSON COUNTY

PATCH UNITS	CLD TY II - 13 "		CLD TY III - 13 "		CLD TY IV - 13 "	
	NO.	SQ. YD	NO.	SQ. YD	NO.	SQ. YD
3	16	128	1	16		
4	34	277	3	45	1	133
<b>SUBTOTAL</b>	<b>50</b>	<b>405</b>	<b>4</b>	<b>61</b>	<b>1</b>	
<b>5% FOR WINTER BREAK-UP</b>		<b>21</b>		<b>3</b>		<b>7</b>
<b>TOTAL</b>		<b>426</b>		<b>64</b>		<b>140</b>
<b>GRAND TOTAL</b>		<b>913</b>		<b>64</b>		<b>140</b>

SCHEDULE OF  
QUANTITIES



ROUTE		SECTION		COUNTY		SHEET	
F.A.S. 1412		105RS-2		HENDERSON & WARREN		TOTAL	NO.
MKD. IL 94						33	18

CONTRACT 58916

TABULATION OF RESURFACING QUANTITIES

LOCATION	PAVEMENT/ SHOULDER WIDTH FT	LENGTH FT	AREA SQ YD	HMA SURFACE REMOVAL (BUILT JOINT) SQ YD	TEMP RAMP SQ YD	HMA SURFACE REMOVAL 0.75" SQ YD	HMA SURFACE REMOVAL, 1.5" SQ YD	HMA SURFACE REMOVAL, VAR. DEPTH SQ YD	POLY. BIT. MATERIALS PRIME COAT TON	AGGREGATE MATERIALS PRIME COAT TON	HMA SURF. CSE. MIX D, NSQ TON	MATERIAL TRANSFER DEVICE TON
WARREN COUNTY												
IL 94 MAINLINE-NB/SB LANES												
STA. 00+12 TO 00+42	VARIABLE	30.0	785.0	785.00	125.0				0.31	1.8	65.9	65.9
STA. 00+42 TO 01+52	VARIABLE	110.0	532.0			532.0			0.21	1.1	44.7	44.7
STA. 01+52 TO 05+33.42 BK	22.00	9381.4	22932.4			22932.4			9.17	45.9	1926.3	1926.3
STA. 05+25.74 AH TO 113+64	22.00	1838.3	4493.5			4493.5			1.80	9.0	377.6	377.6
IL 94 MAINLINE-NB/SB SHOULDERS												
STA. 67+14 TO 71+05	4.00	391.0	173.8				173.8		0.07	0.3	14.6	14.6
STA. 76+00 TO 79+60	4.00	360.0	160.0				160.0		0.06	0.3	13.4	13.4
STA. 79+60 TO 82+00	8.00	240.0	213.3				213.3		0.09	0.4	17.9	17.9
3 SIDE ROADS AT 30 SQ YD EACH			90.0						0.04	0.2	7.6	7.6
6 MAILBOX T.O. AT 16.67 SQ YD EA.			83.3						0.03	0.2	7.0	7.0
SUB-TOTAL WARREN COUNTY			29546.7	785.00	125.0	27957.9	0.0	547.1	11.82	69.1	2481.9	2481.9
HENDERSON COUNTY												
IL 94 MAINLINE-NB/SB LANES												
STA. 113+64 TO 171+06	22.00	6742.0	14036.0			14036.0			5.61	28.1	1179.0	1179.0
STA. 171+06 TO 178+00	24.00	694.0	1650.7			1650.7			0.74	3.7	155.5	155.5
STA. 178+00 TO 178+30	24.00	30.0	80.0	80.00	13.3				0.05	0.2	6.7	6.7
BRIDGE OMISSION												
STA. 182+65 TO 182+95	24.00	30.0	80.0	80.00	13.3				0.03	0.2	6.7	6.7
STA. 182+95 TO 192+32	24.00	937.0	2498.7			2498.7			1.00	5.0	209.9	209.9
STA. 192+32 TO 304+26.32 BK	22.00	11194.3	27363.9			27363.9			10.95	54.7	2296.8	2296.8
STA. 304+26.41 AH TO 330+34	22.00	2605.6	6369.2			6369.2			2.55	12.7	535.0	535.0
STA. 330+34 TO 342+46	24.00	1215.0	3240.0			3240.0			1.30	6.5	272.2	272.2
STA. 342+46 TO 342+79	24.00	30.0	80.0	80.00	13.3				0.03	0.2	6.7	6.7
IL 94 MAINLINE-NB/SB SHOULDERS												
STA. 158+20 TO 164+78	8.00	658.0	584.9				584.9		0.23	1.2	49.1	49.1
STA. 232+00 TO 260+70	8.00	2870.0	2691.1				2691.1		1.02	5.1	214.3	214.3
STA. 269+95 TO 281+30	8.00	1236.0	1097.8				1097.8		0.44	2.2	92.2	92.2
STA. 287+60 TO 296+74	8.00	914.0	812.4				812.4		0.32	1.6	58.2	58.2
STA. 296+74 TO 304+26.32 BK	4.00	762.3	334.4				334.4		0.13	0.7	28.1	28.1
STA. 304+26.41 AH TO 305+00	4.00	71.6	31.8				31.8		0.01	0.1	2.7	2.7
STA. 316+00 TO 320+00	4.00	400.0	177.8				177.8		0.07	0.4	14.9	14.9
STA. 326+43 TO 339+34	4.00	391.0	175.8				175.8		0.07	0.3	14.6	14.6
STA. 340+20 TO 342+49	8.00	229.0	203.6				203.6		0.08	0.4	17.1	17.1
STA. 342+49 TO 342+79	8.00	30.0	26.7	28.87					2.2	0.1	2.2	2.2
7 SIDE ROADS AT 30 SQ YD EACH			210.0						0.08	0.4	17.6	17.6
4 MAILBOX T.O. AT 16.67 SQ YD EACH			86.7						0.03	0.1	5.6	5.6
4 DRIVEWAYS AT 16.67 SQ YD EACH			66.7						0.03	0.1	5.6	5.6
SUB-TOTAL HENDERSON COUNTY			61936.0	266.67	40.0	45338.9	7589.3	5397.8	24.77	123.87	5202.9	5202.9
GRAND-TOTAL				1052	165	76297	7689	6945	36.6	183	7686	7686

RESURFACING SCHEDULE

ROUTE		SECTION	COUNTY	SHEET	
F.A.S. 1412		105RS-2	HENDERSON & WARREN	TOTAL	NO.
MKD. IL 94				33	19

CONTRACT 68916

TABULATION OF RESURFACING QUANTITIES						
LOCATION	TOTAL SHOULDER WIDTH (LT+RT)		LENGTH	AGGREGATE SHOULDERS, TYPE B	TON	
	FT	FT			FT	TON
<u>WARREN COUNTY</u>						
STA. 00+12 TO 67+14	6		6702			190.8
STA. 67+14 TO 71+05	3		391			5.6
STA. 71+05 TO 76+00	6		495			14.1
STA. 76+00 TO 79+60	3		360			5.1
STA. 82+00 TO 95+33.42 BK	6		1333			38.0
STA. 95+25.74 AH TO 113+64	6		1838			52.3
SUB-TOTAL WARREN COUNTY						
						305.9
<u>HENDERSON COUNTY</u>						
STA. 113+64 TO 158+20	6		4456			126.9
STA. 164+78 TO 178+30	6		1352			38.5
STA. 182+65 TO 232+00	6		4935			140.5
STA. 260+70 TO 268+95	6		825			23.5
STA. 281+30 TO 287+60	6		630			17.9
STA. 296+74 TO 305+00	3		826			11.8
STA. 305+00 TO 316+00	6		1100			31.3
STA. 316+00 TO 320+00	3		400			5.7
STA. 320+00 TO 326+43	6		643			18.3
STA. 326+43 TO 333+30	3		687			9.8
SUB-TOTAL HENDERSON COUNTY						
						424.2
GRAND-TOTAL						
						730

RESURFACING  
SCHEDULE

ROUTE		SECTION	COUNTY	SHEET	
F.A.S.	1412	105RS-2	HENDERSON & WARREN	TOTAL	NO.
MKD.	IL 94			33	20

CONTRACT 68916

<b>SHORT-TERM PAVEMENT MARKING</b>	
IL 94	
Warren County	
2 applications (Milled & Surface)	
Station to Station	FOOT
0+12 To 95+33.42 sta eqn	952.0
95+25.74 To 113+63.67	184.0
Sub-Total	1136.0
2 x 1136.0	
TOTAL	2272.0
IL 94	
HENDERSON COUNTY	
2 applications (Milled & Surface)	
Station to Station	FOOT
113+63.67 To 178+30	646.6
182+65 To 304+26.32 sta eqn	1216.0
304+28.41 To 342+79	385.0
Sub-Total	2247.6
2 x 2248	
TOTAL	4496.0
<b>GRAND TOTAL</b>	<b>6768.0</b>

<b>WORK ZONE PAVEMENT MARKING REMOVAL</b>	
IL 94	
Warren County	
Station to Station	SQ FT
0+12 To 95+33.42 sta eqn	317.0
95+25.74 To 113+63.67	61.0
Sub-Total	378.0
IL 94	
HENDERSON COUNTY	
Station to Station	SQ FT
113+63.67 To 178+30	215.0
182+65 To 304+26.32 sta eqn	405.0
304+28.41 To 342+79	128.0
Sub-Total	748.0
<b>GRAND TOTAL</b>	<b>1126.0</b>

SCHEDULE OF  
QUANTITIES

ROUTE		SECTION	COUNTY	SHEET	
F.A.S.	1412			HENDERSON & WARREN	TOTAL
MKD.	IL 94	105RS-2		33	21

CONTRACT 68916

<b>EPOXY PAVEMENT MARKING-LINE 4"</b>	
IL 94	
Warren County	FOOT
(White) 0+12 To County Line	22799.0
(Yellow) 0+12 To County Line	9581.0
Sub-Total	32380.0
IL 94	
HENDERSON COUNTY	
(White) County Line To 342+79	45797.0
(Yellow) County Line To 342+79	25813.0
Sub-Total	71610.0
<b>GRAND TOTAL</b>	<b>103990.0</b>

<b>EPOXY PAVEMENT MARKING-LINE 8"</b>	
IL 94	
Warren County	FOOT
Island & Pedestrian crossing	187.0
Sub-Total	187.0
<b>GRAND TOTAL</b>	<b>187.0</b>

SCHEDULE OF QUANTITIES

ROUTE		SECTION	COUNTY	SHEET	
F.A.S.	1412	105RS-2	HENDERSON & WARREN	TOTAL	NO.
MKD.	IL 94			33	22

CONTRACT 68916

<b>EPOXY PAVEMENT MARKING-LINE 12"</b>	
IL 94	
Warren County	FOOT
Island	115.0
Sub-Total	115.0
<b>GRAND TOTAL</b>	<b>115.0</b>

<b>EPOXY PAVEMENT MARKING-LINE 24"</b>	
IL 94	
Warren County	FOOT
Stop bars at IL 94/135 intersection	29.0
Sub-Total	29.0
<b>GRAND TOTAL</b>	<b>29.0</b>

SCHEDULE OF  
QUANTITIES

ROUTE		SECTION	COUNTY	SHEET	
F.A.S.	1412	105RS-2	HENDERSON & WARREN	TOTAL	NO.
MKD.	IL 94			33	23

CONTRACT 68916

<b>RAISED REFLECTIVE PAVEMENT MARKERS REMOVAL</b>	
IL 94	
Warren County	
Station to Station	EACH
0+12 To 95+33.42 sta eqn	120.0
95+25.74 To 113+63.67	24.0
Sub-Total	144.0
IL 94	
HENDERSON COUNTY	
Station to Station	EACH
113+63.67 To 178+30	82.0
182+65 To 304+26.32 sta eqn	163.0
304+28.41 To 342+79	49.0
Sub-Total	294.0
<b>GRAND TOTAL</b>	<b>438.0</b>

<b>RAISED REFLECTIVE PAVEMENT MARKERS</b>	
IL 94	
Warren County	
Station to Station	EACH
0+12 To 95+33.42 sta eqn	120.0
95+25.74 To 113+63.67	24.0
Sub-Total	144.0
IL 94	
HENDERSON COUNTY	
Station to Station	EACH
113+63.67 To 178+30	82.0
182+65 To 304+26.32 sta eqn	163.0
304+28.41 To 342+79	49.0
Sub-Total	294.0
<b>GRAND TOTAL</b>	<b>438.0</b>

SCHEDULE OF  
QUANTITIES

ROUTE		SECTION	COUNTY	SHEET	
F.A.S.	1412	105RS-2	HENDERSON & WARREN	TOTAL	NO.
MKD.	IL 94			33	24

CONTRACT 68916

<b>MEDIAN REMOVAL</b>	
IL 94 & IL 135	
Warren County	SQ FT
IL 94/135 intersection	200.0
Sub-Total	200.0
<b>GRAND TOTAL</b>	<b>200.0</b>

<b>CONCRETE MEDIAN</b>	
IL 94 & IL 135	
Warren County	SQ FT
IL 94/135 intersection	200.0
Sub-Total	200.0
<b>GRAND TOTAL</b>	<b>200.0</b>

SCHEDULE OF  
QUANTITIES

ROUTE		SECTION	COUNTY	SHEET	
F.A.S.	1412	105RS-2	HENDERSON & WARREN	TOTAL	NO.
MKD.	IL 94			33	25

CONTRACT 68916

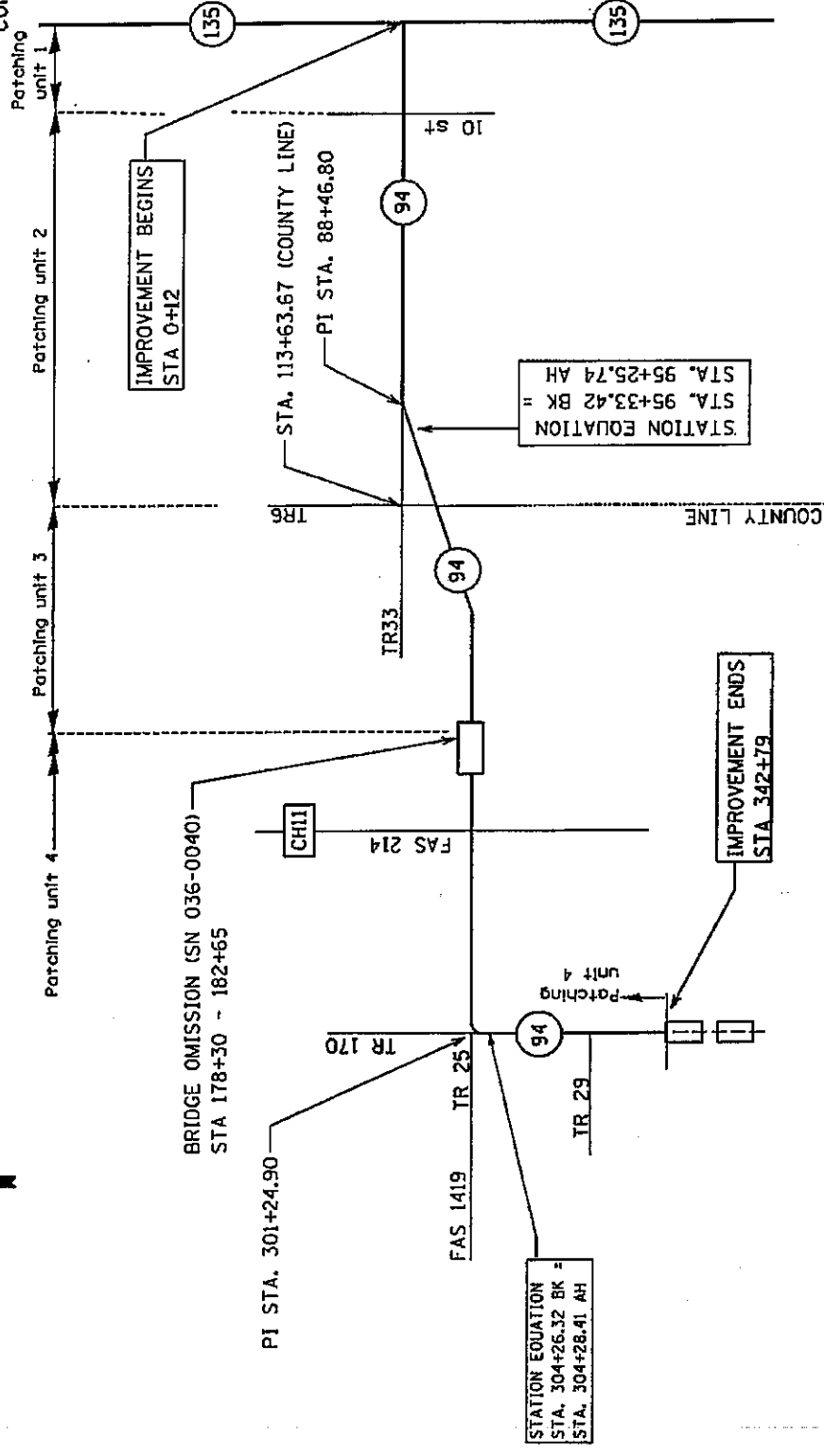

HENDERSON COUNTY      WARREN COUNTY

LINE DIAGRAM



ROUTE		SECTION	COUNTY	SHEET	
F.A.S.	1412	105RS-2	HENDERSON & WARREN	TOTAL	NO.
MKD.	IL 94			33	26

CONTRACT 68916

SEE FOLLOWING SHEET FOR SECTION A-A DETAIL.

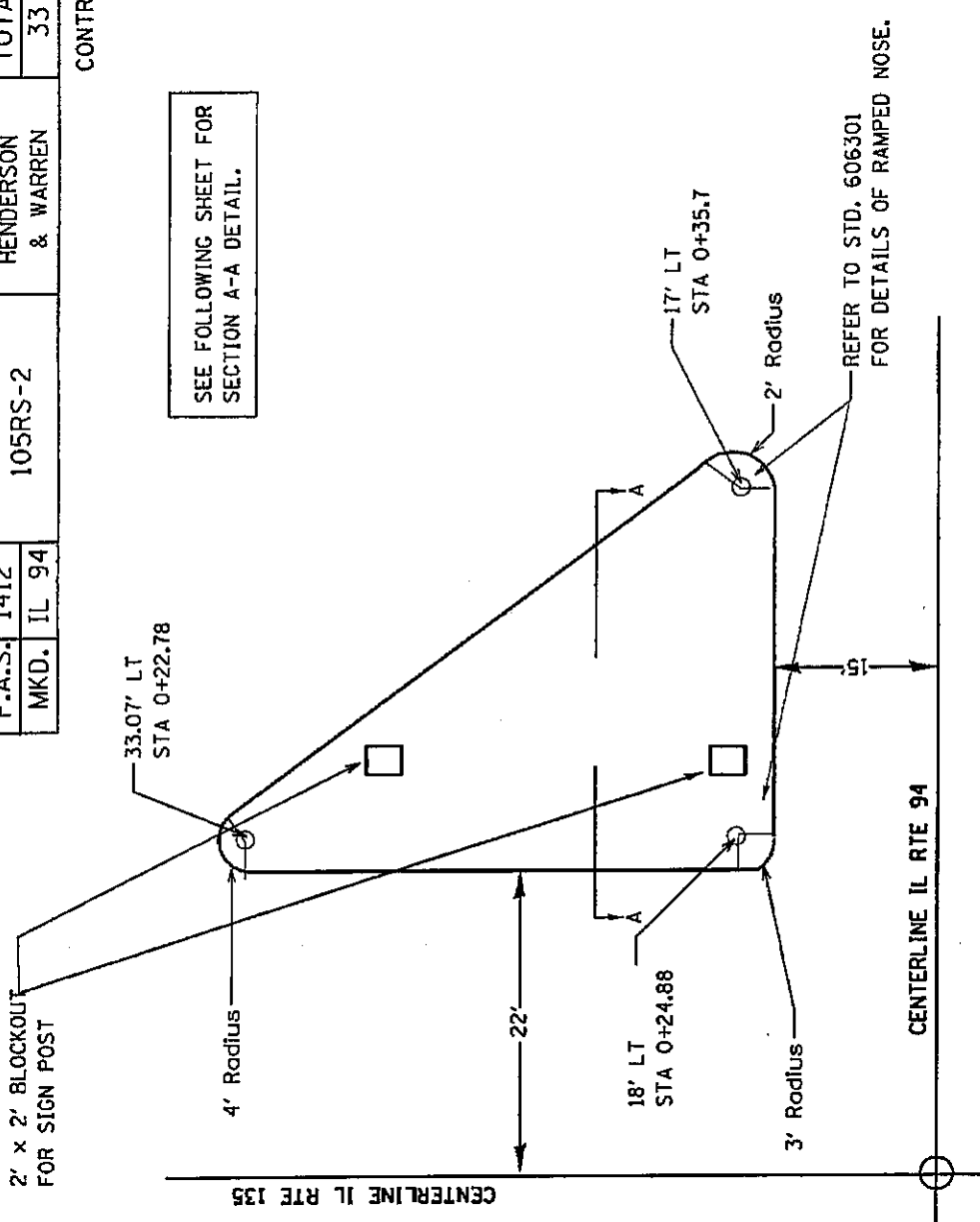

**CONCRETE MEDIAN**  
STA. 0+30, LT

**MEDIAN DETAIL**  
(SHEET 1 OF 2)

ROUTE		SECTION	COUNTY	SHEET	
F.A.S.	1412	105RS-2	HENDERSON & WARREN	TOTAL	NO.
MKD.	IL 94			33	27

CONTRACT 68916

**NOTES:**

1. REMOVAL OF THE EXISTING PAVEMENT BELOW THE EXISTING MEDIAN SHALL BE INCLUDED IN THE COST OF MEDIAN REMOVAL.
2. THE MEDIAN SHALL BE CONSTRUCTED AS DETAILED IN STANDARD 606301 FOR TYPE SM-4.06 MEDIAN, EXCEPT THAT DIMENSION "A" SHALL BE EQUAL TO 0.0 FT.

REMOVAL OF EXISTING MEDIAN  
AND UNDERLYING PAVEMENT.  
REPLACEMENT WITH  
CONCRETE MEDIAN.

PROPOSED HMA SURFACE COURSE

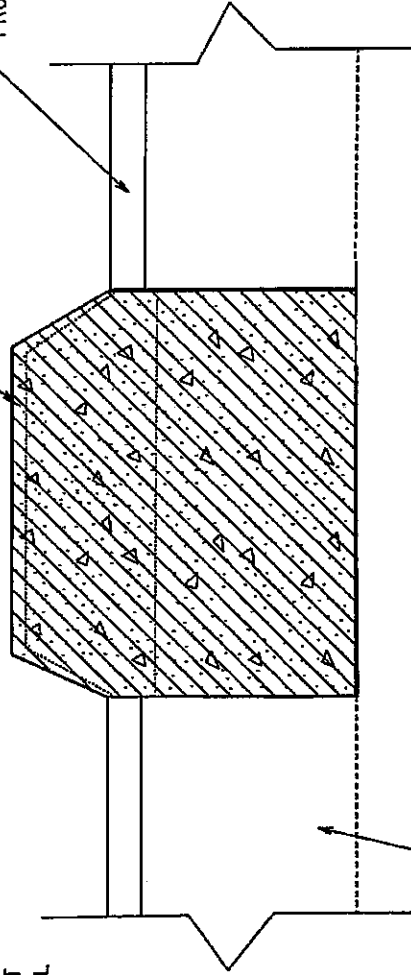

CONCRETE MEDIAN SECTION A-A

EXISTING PAVEMENT

MEDIAN DETAIL  
(SHEET 2 OF 2)

ROUTE		SECTION	COUNTY	SHEET	
F.A.S.	1412			105RS-2	HENDERSON & WARREN
MKD.	IL 94			33	28

CONTRACT 68916

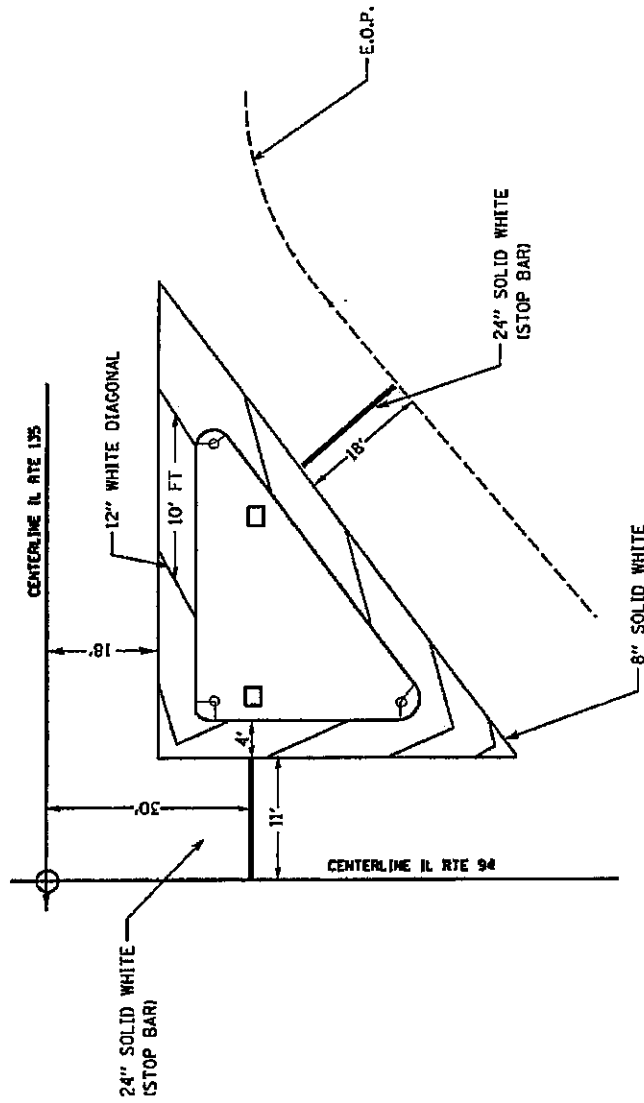

CONCRETE MEDIAN  
PAVEMENT MARKING  
DETAIL

ROUTE		SECTION	COUNTY	SHEET	
F.A.S. 1412	MKD. IL 94	105RS-2	HENDERSON & WARREN	TOTAL	NO.
				33	29

CONTRACT 68916

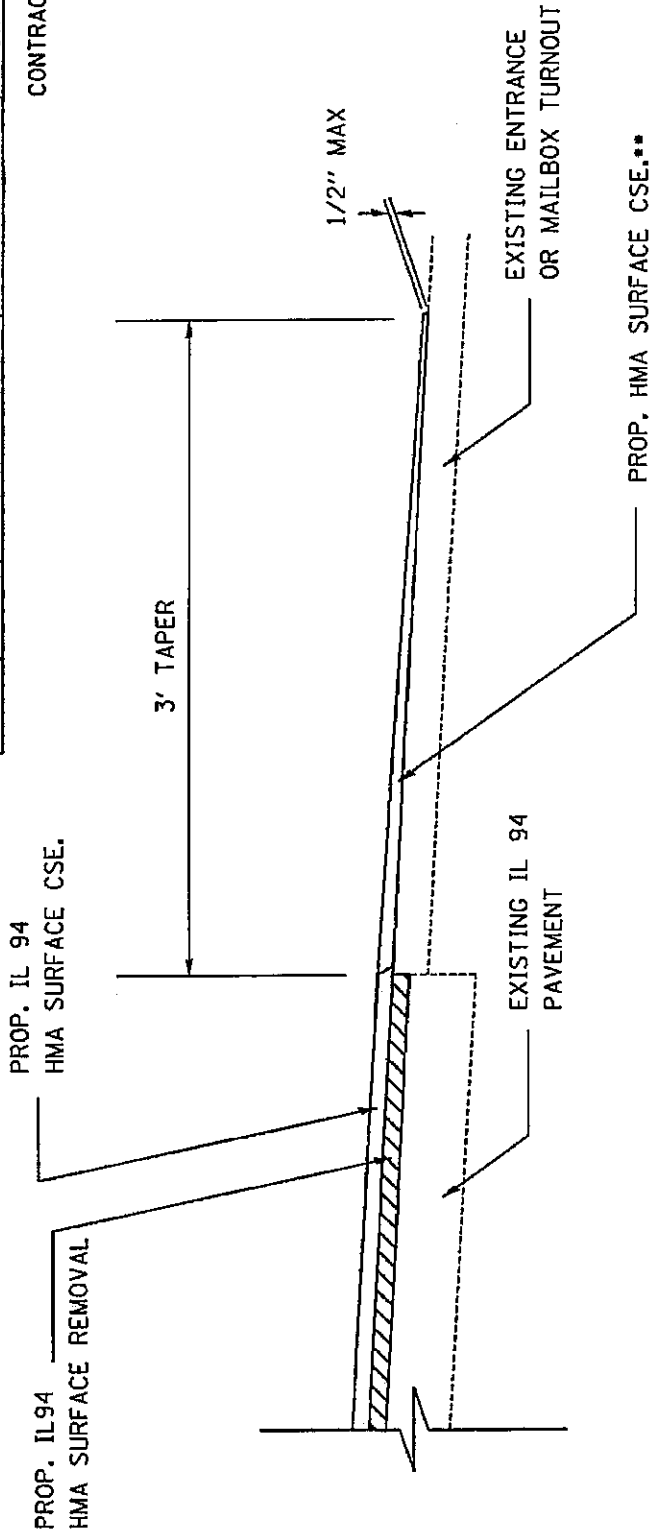

\*\*IF EXISTING ENTRANCE OR MAILBOX TURNOUT IS AGGREGATE WITHIN THE LIMITS OF THE PROPOSED TAPER, THE TAPER SHALL BE CONSTRUCTED WITH AGGREGATE AND PAID FOR AS AGGREGATE SHOULDERS, TYPE B.

ENTRANCES, MAILBOX  
TURNOUT &  
SIDE ROAD DETAIL

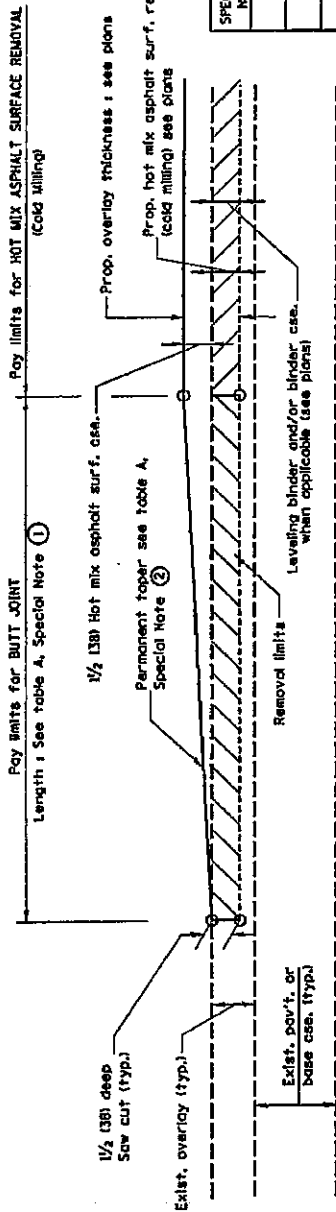

CASE 1 : WITH HOT MIX ASPHALT SURFACE REMOVAL (COLD MILLING)

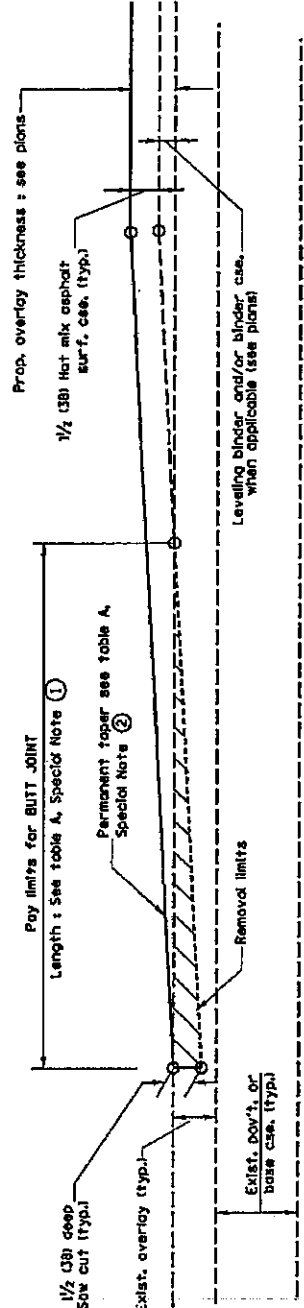

CASE 2 : NO HOT MIX ASPHALT SURFACE REMOVAL (COLD MILLING)

TABLE A  
(LENGTHS AND TAPER RATES)

SPECIAL NOTE NUMBER	ELEMENT	MAINLINE INTERSTATES & 4-LANE EXPRESSWAYS	ALL OTHERS
1	LENGTH OF BUTT JOINT	60'(18.0 m)	30'(9.0 m)
2	PERMANENT TAPER RATE	1:480	1:240
3	TEMPORARY RAMP TAPER RATE	1:80	1:40
4	TEMPORARY RAMP LENGTH	10'(3.0 m)	5'(1.5 m)
5	LENGTH OF BUTT JOINT	10'(3.0 m)	10'(3.0 m)

GENERAL NOTES

- The work shall be done in accordance with Article 406.08 and the Special Provision for Butt Joints.
- The pavement surface to be removed may be either bituminous or P.C. concrete. The work shall be performed in accordance with Article 410.04 and the Special Provisions for Butt Joints.
- The saw cut joints shall be primed just prior to the placing of bituminous material. The work will be in accordance with the applicable portions of Article 406.05.

DESIGNER NOTES:  
 1. Includes Special Provision for Butt Joints & for Hot Mix Asphalt Removal (Cold Milling).  
 2. The butt joint pay item includes the saw cut & temporary ramp. Payment for the butt joint applies whether or not the project features hot mix asphalt removal (cold milling).  
 3. All dimensions are in inches unless otherwise stated.

STATE OF ILLINOIS DEPARTMENT OF TRANSPORTATION		BUTT JOINTS	
NOT TO SCALE		SCALE: 1" = 10'	
PROJECT NO. 111-1-100-100-100		CONTRACT NO. 111-1-100-100-100	
SECTION 111-1-100-100-100		SHEET NO. 111-1-100-100-100	
DATE: 11/1/11		DRAWN BY: J. SMITH	
CHECKED BY: M. JONES		APPROVED BY: D. BROWN	

Pay limits for BUTT JOINT  
Length: see table A, Special Note ①

Pay limits for HOT MIX ASPHALT SURFACE REMOVAL  
(Cold Milling)

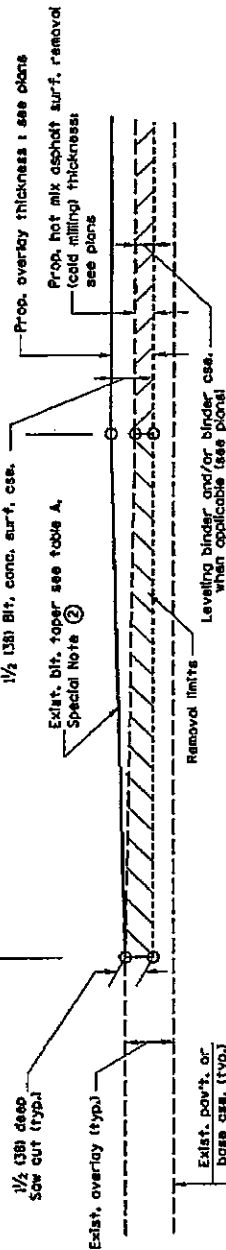

**CASE 3 : WITH HOT MIX ASPHALT SURFACE REMOVAL (COLD MILLING)  
TIE-IN TO EXISTING BITUMINOUS TAPER**

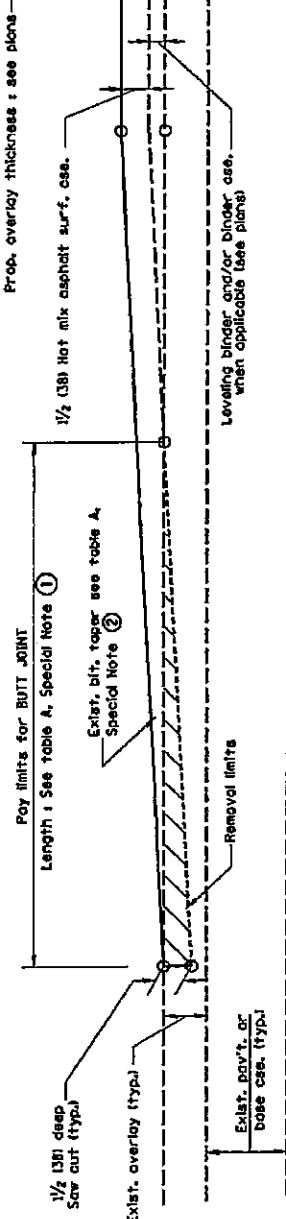

**CASE 4 : NO HOT MIX ASPHALT SURFACE REMOVAL (COLD MILLING)  
TIE-IN TO EXISTING BITUMINOUS TAPER**

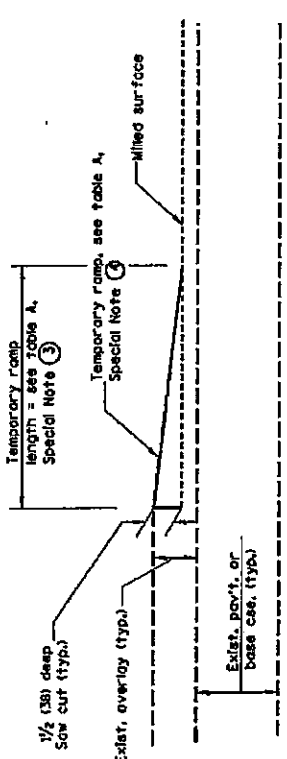

**DETAIL TEMPORARY RAMP**

All dimensions are in inches unless otherwise noted.

DATE	SCALE	PROJECT
REV.	NO.	NO.
BY	DATE	BY
CHECKED	DATE	CHECKED
DESIGNED	DATE	DESIGNED
DRAWN	DATE	DRAWN
IN CHARGE	DATE	IN CHARGE

NOT TO SCALE

STATE OF ILLINOIS  
DEPARTMENT OF TRANSPORTATION

PROJECT NO.	CONTRACT NO.
SECTION NO.	SHEET NO.
BUTT JOINTS	

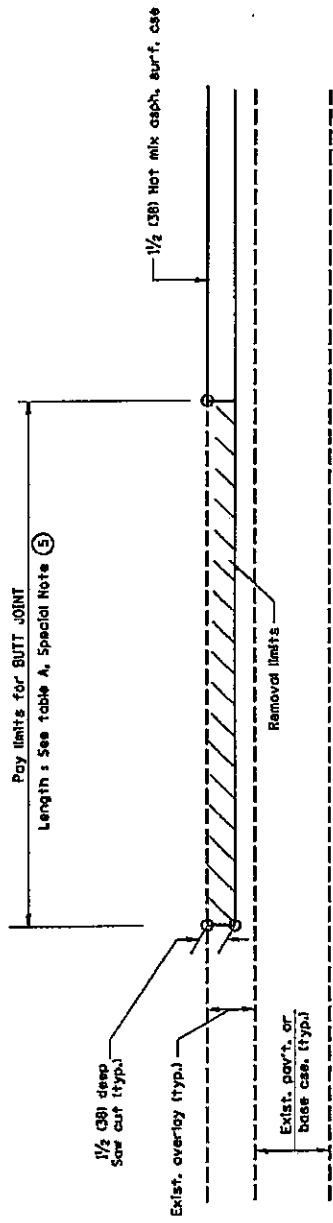

**CASE 5 : WITH HOT MIX ASPHALT SURFACE REMOVAL (COLD MILLING)  
TIE-IN TO EXISTING BITUMINOUS TAPER**

All dimensions are in inches (millimeters) unless otherwise noted.

STATE OF ILLINOIS DEPARTMENT OF TRANSPORTATION	BUTT JOINTS	SCALE	1/2" = 1'-0"
PROJECT NO. 111-1111-1111		DATE 11/11/11	
CONTRACT NO. 111-1111-1111		SHEET NO. 111-1111-1111	
DRAWN BY: 111-1111-1111		CHECKED BY: 111-1111-1111	
APPROVED BY: 111-1111-1111		DATE: 11/11/11	

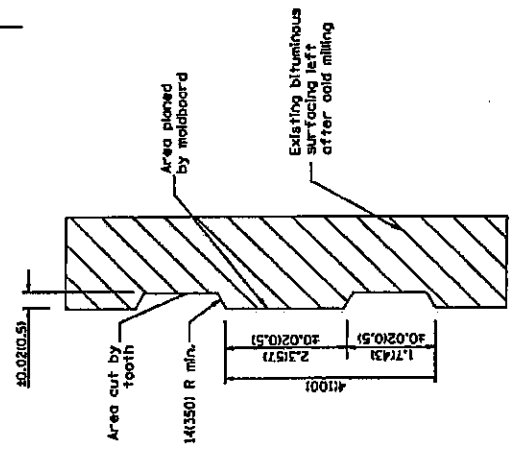
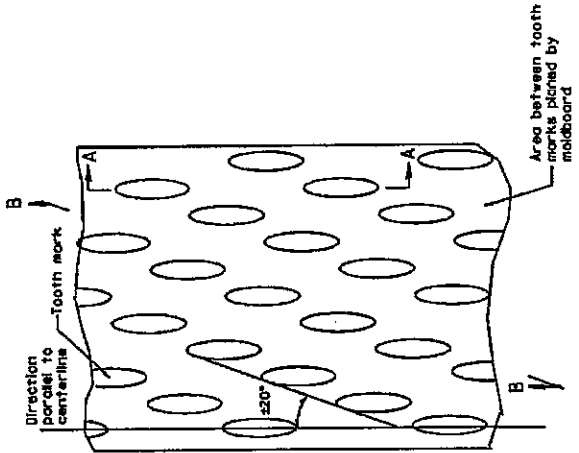

SECTION A-A

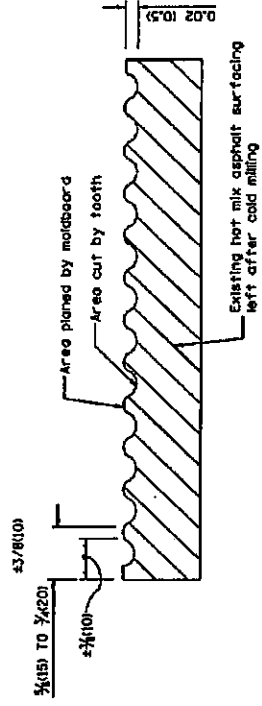

SECTION B-B PROJECTED  
PERPENDICULAR TO CENTERLINE

- General notes:**
1. Coldmilling shall consist of two processes: Cutting with carbide teeth mounted on a rotating drum, and planing with a moldboard mounted immediately behind the cutting drum.
  2. Other similar patterns will be acceptable if they consist of a smooth, flat, plained surface interspersed with a pattern of discontinuous longitudinal striations.

DESIGNER NOTES:  
1. INCLUDE DISTRICT SPECIAL PROVISION, IF APPLICABLE.

All dimensions are in inches unless otherwise indicated.  
Unless otherwise noted.

DATE	BY	CHECKED	SCALE	PROJECT	SHEET NO.	TOTAL SHEETS

STATE OF ILLINOIS  
DEPARTMENT OF TRANSPORTATION  
HOT MIX ASPHALT SURFACE REMOVAL (COLD MILLING)  
NOT TO SCALE

STATE OF ILLINOIS  
DEPARTMENT OF TRANSPORTATION  
HOT MIX ASPHALT SURFACE REMOVAL (COLD MILLING)  
NOT TO SCALE



## **ILLINOIS DEPARTMENT OF LABOR**

### **PREVAILING WAGES FOR HENDERSON & WARREN COUNTIES EFFECTIVE FEBRUARY 2010**

The Prevailing rates of wages are included in the Contract proposals which are subject to Check Sheet #5 of the Supplemental Specifications and Recurring Special Provisions. The rates have been ascertained and certified by the Illinois Department of Labor for the locality in which the work is to be performed and for each craft or type of work or mechanic needed to execute the work of the Contract. As required by Prevailing Wage Act (820 ILCS 130/0.01, et seq.) and Check Sheet #5 of the Contract, not less than the rates of wages ascertained by the Illinois Department of Labor and as revised during the performance of a Contract shall be paid to all laborers, workers and mechanics performing work under the Contract. Post the scale of wages in a prominent and easily accessible place at the site of work.

If the Illinois Department of Labor revises the prevailing rates of wages to be paid as listed in the specification of rates, the contractor shall post the revised rates of wages and shall pay not less than the revised rates of wages. Current wage rate information shall be obtained by visiting the Illinois Department of Labor web site at <http://www.state.il.us/agency/idol/> or by calling 312-793-2814. It is the responsibility of the contractor to review the rates applicable to the work of the contract at regular intervals in order to insure the timely payment of current rates. Provision of this information to the contractor by means of the Illinois Department of Labor web site satisfies the notification of revisions by the Department to the contractor pursuant to the Act, and the contractor agrees that no additional notice is required. The contractor shall notify each of its subcontractors of the revised rates of wages.

# Henderson County Prevailing Wage for February 2010

Trade Name	RG	TYP	C	Base	FRMAN	*M-F>8	OSA	OSH	H/W	Pensn	Vac	Trng
=====	==	===	=	=====	=====	=====	===	===	=====	=====	=====	=====
ASBESTOS ABT-GEN		BLD		25.740	26.740	1.5	1.5	2.0	7.290	8.000	0.000	0.800
ASBESTOS ABT-GEN		HWY		24.390	24.890	1.5	1.5	2.0	7.290	7.600	0.000	0.900
ASBESTOS ABT-MEC		BLD		19.750	20.750	1.5	1.5	2.0	5.750	2.500	0.000	0.000
BOILERMAKER		BLD		34.170	37.170	2.0	2.0	2.0	6.820	8.550	0.000	0.350
BRICK MASON		BLD		29.620	31.120	1.5	1.5	2.0	6.550	8.080	0.000	0.460
CARPENTER		BLD		26.380	27.700	1.5	1.5	2.0	6.710	6.300	0.000	0.600
CARPENTER		HWY		26.940	28.690	1.5	1.5	2.0	6.880	8.520	0.000	0.450
CEMENT MASON		BLD		24.320	25.820	1.5	1.5	2.0	5.500	11.03	0.000	0.450
CEMENT MASON		HWY		25.000	26.000	1.5	1.5	2.0	5.500	8.500	0.000	0.500
CERAMIC TILE FNSHER		BLD		27.310	0.000	1.5	1.5	2.0	6.550	8.080	0.000	0.460
ELECTRIC PWR EQMT OP		ALL		32.770	0.000	1.5	1.5	2.0	4.750	9.170	0.000	0.000
ELECTRIC PWR GRNDMAN		ALL		22.480	0.000	1.5	1.5	2.0	4.750	6.290	0.000	0.000
ELECTRIC PWR LINEMAN		ALL		36.410	38.750	1.5	1.5	2.0	4.750	10.19	0.000	0.000
ELECTRIC PWR TRK DRV		ALL		23.590	0.000	1.5	1.5	2.0	4.750	6.610	0.000	0.000
ELECTRICIAN		BLD		28.950	31.450	1.5	1.5	2.0	5.150	8.180	0.000	0.250
ELECTRONIC SYS TECH		BLD		26.330	28.080	1.5	1.5	2.0	5.250	7.790	0.000	0.250
ELEVATOR CONSTRUCTOR		BLD		37.850	42.580	2.0	2.0	2.0	10.03	9.460	2.270	0.000
GLAZIER		BLD		21.580	22.870	1.5	1.5	2.0	6.050	5.400	0.000	0.350
HT/FROST INSULATOR		BLD		27.860	29.060	1.5	1.5	2.0	5.000	11.00	0.000	0.800
IRON WORKER		ALL		23.700	24.950	1.5	1.5	2.0	5.760	8.290	0.000	0.260
LABORER		BLD		24.740	25.740	1.5	1.5	2.0	7.290	8.000	0.000	0.800
LABORER		HWY		23.390	23.890	1.5	1.5	2.0	7.290	7.600	0.000	0.800
LABORER, SKILLED		BLD		24.740	25.740	1.5	1.5	2.0	7.290	8.000	0.000	0.800
LABORER, SKILLED		HWY		23.690	24.190	1.5	1.5	2.0	7.290	7.600	0.000	0.800
LATHER		BLD		26.380	27.700	1.5	1.5	2.0	6.710	6.300	0.000	0.600
MACHINIST		BLD		42.770	44.770	1.5	1.5	2.0	7.750	8.690	0.650	0.000
MARBLE FINISHERS		BLD		27.310	0.000	1.5	1.5	2.0	6.550	8.080	0.000	0.460
MARBLE MASON		BLD		29.070	30.320	1.5	1.5	2.0	6.550	8.080	0.000	0.460
MILLWRIGHT		BLD		27.250	28.950	1.5	1.5	2.0	6.400	9.640	0.000	0.500
MILLWRIGHT		HWY		26.290	27.990	1.5	1.5	2.0	6.400	9.640	0.000	0.500
OPERATING ENGINEER		BLD	1	30.690	33.690	1.5	1.5	2.0	6.750	10.25	0.000	1.400
OPERATING ENGINEER		BLD	2	28.540	33.690	1.5	1.5	2.0	6.750	10.25	0.000	1.400
OPERATING ENGINEER		BLD	3	26.960	33.690	1.5	1.5	2.0	6.750	10.25	0.000	1.400
OPERATING ENGINEER		HWY	1	31.950	34.950	1.5	1.5	2.0	6.750	10.25	0.000	1.400
OPERATING ENGINEER		HWY	2	29.440	34.950	1.5	1.5	2.0	6.750	10.25	0.000	1.400
OPERATING ENGINEER		HWY	3	25.290	34.950	1.5	1.5	2.0	6.750	10.25	0.000	1.400
PAINTER		ALL		25.270	26.270	1.5	1.5	1.5	4.850	6.100	0.000	0.600
PAINTER OVER 30FT		ALL		26.520	27.520	1.5	1.5	1.5	4.850	6.100	0.000	0.600
PAINTER PWR EQMT		ALL		25.770	26.770	1.5	1.5	1.5	4.850	6.100	0.000	0.600
PILEDRIVER		BLD		26.380	27.700	1.5	1.5	2.0	6.710	6.300	0.000	0.600
PILEDRIVER		HWY		26.940	28.690	1.5	1.5	2.0	6.880	8.520	0.000	0.450
PIPEFITTER		ALL		33.400	36.740	1.5	1.5	2.0	5.000	9.810	0.000	0.850
PLASTERER		BLD		27.800	29.800	1.5	1.5	2.0	4.500	5.450	0.000	0.500
PLUMBER		ALL		33.400	36.740	1.5	1.5	2.0	5.000	9.810	0.000	0.850
ROOFER		BLD		23.800	25.050	1.5	1.5	2.0	7.340	5.120	0.000	0.220
SHEETMETAL WORKER		BLD		24.750	26.430	1.5	1.5	2.0	7.040	8.190	0.000	0.410
SPRINKLER FITTER		BLD		36.140	38.890	1.5	1.5	2.0	8.200	6.550	0.000	0.250
STONE MASON		BLD		29.620	31.120	1.5	1.5	2.0	6.550	8.080	0.000	0.460
TERRAZZO FINISHER		BLD		27.310	0.000	1.5	1.5	2.0	6.550	8.080	0.000	0.460
TERRAZZO MASON		BLD		29.070	30.320	1.5	1.5	2.0	6.550	8.080	0.000	0.460
TILE LAYER		BLD		26.380	27.700	1.5	1.5	2.0	6.710	6.300	0.000	0.600
TILE MASON		BLD		29.070	30.320	1.5	1.5	2.0	6.550	8.080	0.000	0.460
TRUCK DRIVER		ALL	1	28.487	0.000	1.5	1.5	2.0	9.050	4.062	0.000	0.250
TRUCK DRIVER		ALL	2	28.887	0.000	1.5	1.5	2.0	9.050	4.062	0.000	0.250
TRUCK DRIVER		ALL	3	29.087	0.000	1.5	1.5	2.0	9.050	4.062	0.000	0.250
TRUCK DRIVER		ALL	4	29.337	0.000	1.5	1.5	2.0	9.050	4.062	0.000	0.250
TRUCK DRIVER		ALL	5	30.087	0.000	1.5	1.5	2.0	9.050	4.062	0.000	0.250
TRUCK DRIVER		O&C	1	22.790	0.000	1.5	1.5	2.0	9.050	4.062	0.000	0.250

TRUCK DRIVER	O&C 2	23.110	0.000	1.5	1.5	2.0	9.050	4.062	0.000	0.250
TRUCK DRIVER	O&C 3	23.270	0.000	1.5	1.5	2.0	9.050	4.062	0.000	0.250
TRUCK DRIVER	O&C 4	23.470	0.000	1.5	1.5	2.0	9.050	4.062	0.000	0.250
TRUCK DRIVER	O&C 5	24.070	0.000	1.5	1.5	2.0	9.050	4.062	0.000	0.250
TUCKPOINTER	BLD	29.620	31.120	1.5	1.5	2.0	6.550	8.080	0.000	0.460

Legend :

M-F>8 (Overtime is required for any hour greater than 8 worked each day, Monday through Friday.)

OSA (Overtime is required for every hour worked on Saturday)

OSH (Overtime is required for every hour worked on Sunday and Holidays)

H/W (Health & Welfare Insurance)

Pensn (Pension)

Vac (Vacation)

Trng (Training)

## Explanations

### HENDERSON COUNTY

The following list is considered as those days for which holiday rates of wages for work performed apply: New Years Day, Memorial/Decoration Day, Fourth of July, Labor Day, Veterans Day, Thanksgiving Day, Christmas Day. Generally, any of these holidays which fall on a Sunday is celebrated on the following Monday. This then makes work performed on that Monday payable at the appropriate overtime rate for holiday pay. Common practice in a given local may alter certain days of celebration such as the day after Thanksgiving for Veterans Day. If in doubt, please check with IDOL.

Oil and chip resealing (O&C) means the application of road oils and liquid asphalt to coat an existing road surface, followed by application of aggregate chips or gravel to coated surface, and subsequent rolling of material to seal the surface.

### EXPLANATION OF CLASSES

ASBESTOS - GENERAL - removal of asbestos material/mold and hazardous materials from any place in a building, including mechanical systems where those mechanical systems are to be removed. This includes the removal of asbestos materials/mold and hazardous materials from ductwork or pipes in a building when the building is to be demolished at the time or at some close future date.

ASBESTOS - MECHANICAL - removal of asbestos material from mechanical systems, such as pipes, ducts, and boilers, where the mechanical systems are to remain.

### CERAMIC TILE FINISHER, MARBLE FINISHER, TERRAZZO FINISHER

Assisting, helping or supporting the tile, marble and terrazzo mechanic by performing their historic and traditional work assignments required to complete the proper installation of the work covered by

said crafts. The term "Ceramic" is used for naming the classification only and is in no way a limitation of the product handled. Ceramic takes into consideration most hard tiles.

#### ELECTRONIC SYSTEMS TECHNICIAN

Installation, service and maintenance of low-voltage systems which utilizes the transmission and/or transference of voice, sound, vision, or digital for commercial, education, security and entertainment purposes for the following: TV monitoring and surveillance, background/foreground music, intercom and telephone interconnect, field programming, inventory control systems, microwave transmission, multi-media, multiplex, radio page, school, intercom and sound burglar alarms and low voltage master clock systems.

Excluded from this classification are energy management systems, life safety systems, supervisory controls and data acquisition systems not intrinsic with the above listed systems, fire alarm systems, nurse call systems and raceways exceeding fifteen feet in length.

#### LABORER, SKILLED - BUILDING

The skilled laborer building (BLD) classification shall encompass the following types of work, irrespective of the site of the work: tending of carpenters in unloading, handling, stockpiling and distribution operations, also other building crafts, mixing, handling, and conveying of all materials used by masons, plasterers and other building construction crafts, whether done by hand or by any process. The drying of plastering when done by salamander heat, and the cleaning and clearing of all debris. All work pertaining to and in preparation of asbestos abatement and removal. The building of scaffolding and staging for masons and plasterers. The excavations for buildings and all other construction, digging, of trenches, piers, foundations and holes, digging, lagging, sheeting, cribbing, bracing and propping of foundations, holes, caissons, cofferdams, and dikes, the setting of all guidelines for machine or hand excavation and subgrading. The mixing, handling, conveying, pouring, vibrating, gunniting and otherwise applying of concrete, whether by hand or other method of concrete for any walls, foundations, floors, or for other construction concrete sealant men. The wrecking, stripping, dismantling, and handling of concrete forms and false work, and the building of centers for fireproofing purposes. Boring machine, gas, electric or air in preparation for shoving pipe, telephone cable, and so forth, under highways, roads, streets and alleys. All hand and power operating cross cut saws when used for clearing. All work in compressed air construction. All work on acetylene burners in salvaging. The blocking and tamping of concrete. The laying of sewer tile and conduit, and pre-cast materials. The assembling and dismantling of all jacks and sectional scaffolding, including elevator construction and running of slip form jacks. The work of drill running and blasting, including wagon drills. The wrecking, stripping, dismantling, cleaning, moving and oiling of forms. The cutting off of concrete piles. The loading, unloading, handling and carrying to place of installation of all rods, (and materials for use in reinforcing) concrete and the hoisting of same and all signaling where hoist is used in this type of construction coming under the jurisdiction of the Laborers' Union. And, all other labor work not awarded to any other craft. Mortar mixers, kettlemen and carrier of hot stuff, tool crib men, watchmen (Laborer), firemen or salamander tenders, flagmen, deck hands, installation and maintenance of temporary gas-fired heating units, gravel box men, dumpmen and spotters, fencing Laborers, cleaning lumber, pit men, material checkers, dispatchers, unloading explosives, asphalt plant laborers,

writer of scale tickets, fireproofing laborers, janitors, asbestos abatement and removal laborers, handling of materials treated with oil, creosote, chloride, asphalt, and/or foreign material harmful to skin or clothing, Laborers with de-watering systems, gunnite nozzle men, laborers tending masons with hot material or where foreign materials are used, Laborers handling masterplate or similar materials, laser beam operator, concrete burning machine operator, material selector men working with firebrick or combustible material, dynamite men, track laborers, cement handlers, chloride handlers, the unloading and laborers with steel workers and re-bars, concrete workers (wet), luteman, asphalt raker, curb asphalt machine operator, ready mix scalemen, permanent, portable or temporary plant drilling machine operator, plaster tenders, underpinning and shoring of buildings, fire watch, signaling of all power equipment, to include trucks excavating equipment, etc., tree topper or trimmer when in connection to construction, tunnel helpers in free air, batch dumpers, kettle and tar men, tank cleaners, plastic installers, scaffold workers, motorized buggies or motorized unit used for wet concrete or handling of building materials, sewer workers, rod and chain men, vibrator operators, mortar mixer operator, cement silica, clay, fly ash, lime and plasters, handlers (bulk or bag), cofferdam workers, on concrete paving, placing, cutting and tying of reinforcing, deck hand, dredge hand and shore laborers, bankmen on floating plant, asphalt workers with machine & layers, grade checker, power tools, caisson workers, lead man on sewer work, welders, cutters, burners and torch men, chain saw operators, paving breaker, jackhammer and drill operator, layout man and/or drainage tile layer, steel form setters -- street and highway, air tamping hammerman, signal man on crane, concrete saw operator, screen man on asphalt pavers, front end man on chip spreader, multiple concrete duct -- lead man.

#### LABORER, SKILLED - HIGHWAY

The skilled laborer heavy and highway (HWY) classification shall encompass the following types of work, irrespective of the site of the work: handling of materials treated with oil, creosote, asphalt and/or any foreign materials harmful to skin or clothing, track laborers, chloride handlers, the unloading and loading with steel workers and re-bars, concrete workers (wet), tunnel helpers in free air, batch dumpers, mason tenders, kettle and tar men, plastic installers, scaffold workers, motorized buggies or motorized unit used for wet concrete or handling of building materials, laborers with de-watering systems, sewer workers plus depth, rod and chainmen, vibrator operators, mortar mixer operators, cement silica, clay, fly ash, lime and plasters, handlers (bulk or bag), cofferdam workers plus depth, on concrete paving, placing, cutting and tying or reinforcing, deck hand, dredge hand shore laborers, bankmen on floating plant, asphalt workers with machine, and layers, grade checker, power tools, stripping of all concrete forms excluding paving forms, dumpmen and spotters, when necessary, caisson workers plus depth, gunnite nozzle men, welders, cutters, burners and torchmen, chain saw operators, paving breaker, jackhammer and drill operators, layout man and/or drainage tile layer, steel form setters - street and highway, air tamping hammerman, signal man on crane, concrete saw operator, screedman on asphalt pavers, front end man on chip spreader, multiple concrete duct, luteman, asphalt raker, curb asphalt machine operator, ready mix scalemen (portable or temporary plant), laser beam operator, concrete burning machine operator, and coring machine operator.

#### TRUCK DRIVER - BUILDING, HEAVY AND HIGHWAY CONSTRUCTION

Class 1. Drivers on 2 axle trucks hauling less than 9 ton. Air compressor and welding machines and brooms, including those pulled by separate units, truck driver helpers, warehouse employees, mechanic

helpers, greasers and tiremen, pickup trucks when hauling materials, tools, or workers to and from and on-the-job site, and fork lifts up to 6,000 lb. capacity.

Class 2. Two or three axle trucks hauling more than 9 ton but hauling less than 16 ton. A-frame winch trucks, hydrolift trucks, vactor trucks or similar equipment when used for transportation purposes. Fork lifts over 6,000 lb. capacity, winch trucks, four axle combination units, and ticket writers.

Class 3. Two, three or four axle trucks hauling 16 ton or more. Drivers on water pulls, articulated dump trucks, mechanics and working forepersons, and dispatchers. Five axle or more combination units.

Class 4. Low Boy and Oil Distributors.

Class 5. Drivers who require special protective clothing while employed on hazardous waste work.

#### TRUCK DRIVER - OIL AND CHIP RESEALING ONLY.

This shall encompass laborers, workers and mechanics who drive contractor or subcontractor owned, leased, or hired pickup, dump, service, or oil distributor trucks. The work includes transporting materials and equipment (including but not limited to, oils, aggregate supplies, parts, machinery and tools) to or from the job site; distributing oil or liquid asphalt and aggregate; stock piling material when in connection with the actual oil and chip contract. The Truck Driver (Oil & Chip Resealing) wage classification does not include supplier delivered materials.

#### OPERATING ENGINEERS - BUILDING

Class 1. Cranes; Overhead Cranes; Gradall; All Cherry Pickers; Mechanics; Central Concrete Mixing Plant Operator; Road Pavers (27E - Dual Drum - Tri Batchers); Blacktop Plant Operators and Plant Engineers; 3 Drum Hoist; Derricks; Hydro Cranes; Shovels; Skimmer Scoops; Koehring Scooper; Drag Lines; Backhoe; Derrick Boats; Pile Drivers and Skid Rigs; Clamshells; Locomotive Cranes; Dredge (all types) Motor Patrol; Power Blades - Dumore - Elevating and similar types; Tower Cranes (Crawler-Mobile) and Stationary; Crane-type Backfiller; Drott Yumbo and similar types considered as Cranes; Caisson Rigs; Dozer; Tournadozer; Work Boats; Ross Carrier; Helicopter; Tournapulls - all and similar types; Scoops (all sizes); Pushcats; Endloaders (all types); Asphalt Surfacing Machine; Slip Form Paver; Rock Crusher; Heavy Equipment Greaser; CMI, CMI Belt Placer, Auto Grade & 3 Track and similar types; Side Booms; Multiple Unit Earth Movers; Creter Crane; Trench Machine; Pump-crete-Belt Crete-Squeeze Cretes-Screw-type Pumps and Gypsum; Bulker & Pump - Operator will clean; Formless Finishing Machine; Flaherty Spreader or similar types; Screed Man on Laydown Machine; Wheel Tractors (industrial or Farm-type w/Dozer-Hoe-Endloader or other attachments); F.W.D. & Similar Types; Vermeer Concrete Saw.

Class 2. Dinkeys; Power Launches; PH One-pass Soil Cement Machine (and similar types); Pugmill with Pump; Backfillers; Euclid Loader; Forklifts; Jeeps w/Ditching Machine or other attachments; Tuneluger; Automatic Cement and Gravel Batching Plants; Mobile Drills (Soil Testing) and similar types; Gurries and Similar Types; (1) and (2) Drum Hoists (Buck Hoist and Similar Types); Chicago Boom; Boring Machine & Pipe Jacking Machine; Hydro Boom; Dewatering System; Straw Blower; Hydro Seeder; Assistant Heavy Equipment Greaser on Spread;

Tractors (Track type) without Power Unit pulling Rollers; Rollers on Asphalt -- Brick Macadam; Concrete Breakers; Concrete Spreaders; Mule Pulling Rollers; Center Stripper; Cement Finishing Machines & CMI Texture & Reel Curing Machines; Cement Finishing Machine; Barber Green or similar loaders; Vibro Tamper (All similar types) Self-propelled; Winch or Boom Truck; Mechanical Bull Floats; Mixers over 3 Bag to 27E; Tractor pulling Power Blade or Elevating Grader; Porter Rex Rail; Clary Screed; Truck Type Hoptoe Oilers; Fireman; Spray Machine on Paving; Curb Machines; Truck Crane Oilers; Oil Distributor; Truck-Mounted Saws.

Class 3. Air Compressor; Power Subgrader; Straight Tractor; Trac Air without attachments; Herman Nelson Heater, Dravo, Warner, Silent Glo, and similar types; Roller: Five (5) Ton and under on Earth or Gravel; Form Grader; Crawler Crane & Skid Rig Oilers; Freight Elevators - permanently installed; Pump; Light Plant; Generator; Conveyor (1) or (2) - Operator will clean; Welding Machine; Mixer (3) Bag and Under (Standard Capacity with skip); Bulk Cement Plant; Oiler on Central Concrete Mixing Plant.

#### OPERATING ENGINEERS - HEAVY AND HIGHWAY CONSTRUCTION

Class 1. Cranes; Hydro Crane; Shovels; Crane Type Backfiller; Tower Cranes - Mobile & Crawler & Stationary; Derricks & Hoists (3 Drum); Draglines; Drott Yumbo & similar types considered as Cranes; Back Hoe; Derrick Boats; Pile Driver and Skid Rigs; Clam Shell; Locomotive - Cranes; Road Pavers - Single Drum - Dual Drum - Tri Batcher; Motor Patrols & Power Blades - Dumore - Elevating & Similar Types; Mechanics; Central Concrete Mixing Plant Operator; Asphalt Batch Plant Operators and Plant Engineers; Gradall; Caisson Rigs; Skimmer Scoop - Koering Scooper; Dredges (all types); Hoptoe; All Cherry Pickers; Work Boat; Ross Carrier; Helicopter; Dozer; Tournadozer; Tournapulls - all and similar types; Multiple Unit Earth Movers; Scoops (all sizes); Pushcats; Endloaders (all types); Asphalt Surfacing Machine; Slip Form Paver; Rock Crusher; Heavy Equipment Greaser (top greaser on spread); CMI, Auto Grade, CMI Belt Placer & 3 Track and similar types; Side Booms; Starting Engineer on Pipeline; Asphalt Heater & Planer Combination (used to plane streets); Wheel Tractors (with dozer, hoe or endloader attachments); F.W.D. and Similar types; Blaw Knox Spreader and Similar types; Trench Machines; Pump Crete - Belt Crete - Squeeze Crete - screw type pumps and gypsum (operator will clean); Formless Finishing Machines; Flaherty Spreader or similar types; Screed Man on Laydown Machine; Vermeer Concrete Saw.

Class 2. Bulker & Pump; Power Launches; Boring Machine & Pipe Jacking Machine; Dinkeys; P-H One Pass Soil Cement Machines and similar types; Wheel Tractors (Industry or farm type - other); Back Fillers; Euclid Loader; Fork Lifts; Jeep w/Ditching Machine or other attachments; Tunneluger; Automatic Cement & Gravel Batching Plants; Mobile Drills - Soil Testing and similar types; Pugmill with pump; All (1) and (2) Drum Hoists; Dewatering System; Straw Blower; Hydro-Seeder; Boring Machine; Hydro-Boom; Bump Grinders (self-propelled); Assistant Heavy Equipment Greaser; Apsco Spreader; Tractors (track-type) without Power Units Pulling Rollers on Asphalt - Brick or Macadam; Concrete Breakers; Concrete Spreaders; Cement Strippers; Cement Finishing Machines & CMI Texture & Reel Curing Machines; Vibro-Tampers (all similar types self-propelled); Mechanical Bull Floats; Self-propelled Concrete Saws; Mixers-over three (3) bags to 27E; Winch and Boom Trucks; Tractor Pulling Power Blade or Elevating Grader; Porter Rex Rail; Clary Screed; Mule Pulling Rollers; Pugmill without Pump; Barber Greene or similar Loaders; Track Type Tractor w/Power Unit attached (minimum); Fireman; Spray Machine on Paving; Curb Machines; Paved Ditch Machine; Power Broom;

Self-Propelled Conveyors; Power Subgrader; Oil Distributor; Straight Tractor; Truck Crane Oiler; Truck Type Oilers; Directional boring machine; Horizontal directional drill.

Class 3. Straight framed articulating end dump vehicle and Truck mounted vac unit (separately powered); Trac Air Machine (without attachments); Herman Nelson Heater, Dravo Warner, Silent Glo & similar types; Rollers - five ton and under on earth and gravel; Form Graders; Pumps; Light Plant; Generator; Air Compressor (1) or (2); Conveyor; Welding Machine; Mixer - 3 bags and under; Bulk Cement Plant; Oilers.

#### Other Classifications of Work:

For definitions of classifications not otherwise set out, the Department generally has on file such definitions which are available. If a task to be performed is not subject to one of the classifications of pay set out, the Department will upon being contacted state which neighboring county has such a classification and provide such rate, such rate being deemed to exist by reference in this document. If no neighboring county rate applies to the task, the Department shall undertake a special determination, such special determination being then deemed to have existed under this determination. If a project requires these, or any classification not listed, please contact IDOL at 217-782-1710 for wage rates or clarifications.

#### LANDSCAPING

Landscaping work falls under the existing classifications for laborer, operating engineer and truck driver. The work performed by landscape plantsman and landscape laborer is covered by the existing classification of laborer. The work performed by landscape operators (regardless of equipment used or its size) is covered by the classifications of operating engineer. The work performed by landscape truck drivers (regardless of size of truck driven) is covered by the classifications of truck driver.



# Warren County Prevailing Wage for February 2010

Trade Name	RG	TYP	C	Base	FRMAN	*M-F>8	OSA	OSH	H/W	Pensn	Vac	Trng
=====	==	===	=	=====	=====	=====	===	===	=====	=====	=====	=====
ASBESTOS ABT-GEN		BLD		25.740	26.740	1.5	1.5	2.0	7.290	8.000	0.000	0.800
ASBESTOS ABT-GEN		HWY		24.390	24.890	1.5	1.5	2.0	7.290	7.600	0.000	0.900
ASBESTOS ABT-MEC		BLD		19.750	20.750	1.5	1.5	2.0	5.750	2.500	0.000	0.000
BOILERMAKER		BLD		34.170	37.170	2.0	2.0	2.0	6.820	8.550	0.000	0.350
BRICK MASON		BLD		29.620	31.120	1.5	1.5	2.0	6.550	8.080	0.000	0.460
CARPENTER		BLD		28.330	30.580	1.5	1.5	2.0	7.000	10.00	0.000	0.320
CARPENTER		HWY		29.770	32.020	1.5	1.5	2.0	7.000	10.00	0.000	0.320
CEMENT MASON		ALL		24.590	25.090	1.5	1.5	2.0	5.050	8.400	0.000	0.500
CERAMIC TILE FNSHER		BLD		27.310	0.000	1.5	1.5	2.0	6.550	8.080	0.000	0.460
ELECTRIC PWR EQMT OP		ALL		32.770	0.000	1.5	1.5	2.0	4.750	9.170	0.000	0.000
ELECTRIC PWR GRNDMAN		ALL		22.480	0.000	1.5	1.5	2.0	4.750	6.290	0.000	0.000
ELECTRIC PWR LINEMAN		ALL		36.410	38.750	1.5	1.5	2.0	4.750	10.19	0.000	0.000
ELECTRIC PWR TRK DRV		ALL		23.590	0.000	1.5	1.5	2.0	4.750	6.610	0.000	0.000
ELECTRICIAN		BLD		28.950	31.450	1.5	1.5	2.0	5.150	8.180	0.000	0.250
ELECTRONIC SYS TECH		BLD		26.330	28.080	1.5	1.5	2.0	5.250	7.790	0.000	0.250
ELEVATOR CONSTRUCTOR		BLD		37.850	42.580	2.0	2.0	2.0	10.03	9.460	2.270	0.000
GLAZIER		BLD		21.580	22.870	1.5	1.5	2.0	6.050	5.400	0.000	0.350
HT/FROST INSULATOR		BLD		27.860	29.060	1.5	1.5	2.0	5.000	11.00	0.000	0.800
IRON WORKER		ALL		23.700	24.950	1.5	1.5	2.0	5.760	8.290	0.000	0.260
LABORER		BLD		24.740	25.740	1.5	1.5	2.0	7.290	8.000	0.000	0.800
LABORER		HWY		23.390	23.890	1.5	1.5	2.0	7.290	7.600	0.000	0.800
LABORER, SKILLED		BLD		24.740	25.740	1.5	1.5	2.0	7.290	8.000	0.000	0.800
LABORER, SKILLED		HWY		23.690	24.190	1.5	1.5	2.0	7.290	7.600	0.000	0.800
LATHER		BLD		28.330	30.580	1.5	1.5	2.0	7.000	10.00	0.000	0.320
MACHINIST		BLD		42.770	44.770	1.5	1.5	2.0	7.750	8.690	0.650	0.000
MARBLE FINISHERS		BLD		27.310	0.000	1.5	1.5	2.0	6.550	8.080	0.000	0.460
MARBLE MASON		BLD		29.070	30.320	1.5	1.5	2.0	6.550	8.080	0.000	0.460
MILLWRIGHT		BLD		28.890	31.140	1.5	1.5	2.0	7.000	9.740	0.000	0.320
MILLWRIGHT		HWY		30.180	32.430	1.5	1.5	2.0	7.000	10.09	0.000	0.320
OPERATING ENGINEER		BLD	1	30.690	33.690	1.5	1.5	2.0	6.750	10.25	0.000	1.400
OPERATING ENGINEER		BLD	2	28.540	33.690	1.5	1.5	2.0	6.750	10.25	0.000	1.400
OPERATING ENGINEER		BLD	3	26.960	33.690	1.5	1.5	2.0	6.750	10.25	0.000	1.400
OPERATING ENGINEER		HWY	1	31.950	34.950	1.5	1.5	2.0	6.750	10.25	0.000	1.400
OPERATING ENGINEER		HWY	2	29.440	34.950	1.5	1.5	2.0	6.750	10.25	0.000	1.400
OPERATING ENGINEER		HWY	3	25.290	34.950	1.5	1.5	2.0	6.750	10.25	0.000	1.400
PAINTER		ALL		25.270	26.270	1.5	1.5	1.5	4.850	6.100	0.000	0.600
PAINTER OVER 30FT		ALL		26.520	27.520	1.5	1.5	1.5	4.850	6.100	0.000	0.600
PAINTER PWR EQMT		ALL		25.770	26.770	1.5	1.5	1.5	4.850	6.100	0.000	0.600
PILEDRIVER		BLD		28.830	31.080	1.5	1.5	2.0	7.000	10.00	0.000	0.320
PILEDRIVER		HWY		30.770	33.020	1.5	1.5	2.0	7.000	10.00	0.000	0.320
PIPEFITTER		ALL		33.400	36.740	1.5	1.5	2.0	5.000	9.810	0.000	0.850
PLASTERER		BLD		27.000	28.250	1.5	1.5	2.0	6.390	10.63	0.000	0.500
PLUMBER		ALL		33.400	36.740	1.5	1.5	2.0	5.000	9.810	0.000	0.850
ROOFER		BLD		23.800	25.050	1.5	1.5	2.0	7.340	5.120	0.000	0.220
SHEETMETAL WORKER		BLD		28.270	30.120	1.5	1.5	2.0	7.040	8.790	0.000	0.410
SPRINKLER FITTER		BLD		36.140	38.890	1.5	1.5	2.0	8.200	6.550	0.000	0.250
STONE MASON		BLD		29.620	31.120	1.5	1.5	2.0	6.550	8.080	0.000	0.460
TERRAZZO FINISHER		BLD		27.310	0.000	1.5	1.5	2.0	6.550	8.080	0.000	0.460
TERRAZZO MASON		BLD		29.070	30.320	1.5	1.5	2.0	6.550	8.080	0.000	0.460
TILE MASON		BLD		29.070	30.320	1.5	1.5	2.0	6.550	8.080	0.000	0.460
TRUCK DRIVER		ALL	1	28.487	0.000	1.5	1.5	2.0	9.050	4.062	0.000	0.250
TRUCK DRIVER		ALL	2	28.887	0.000	1.5	1.5	2.0	9.050	4.062	0.000	0.250
TRUCK DRIVER		ALL	3	29.087	0.000	1.5	1.5	2.0	9.050	4.062	0.000	0.250
TRUCK DRIVER		ALL	4	29.337	0.000	1.5	1.5	2.0	9.050	4.062	0.000	0.250
TRUCK DRIVER		ALL	5	30.087	0.000	1.5	1.5	2.0	9.050	4.062	0.000	0.250
TRUCK DRIVER		O&C	1	22.790	0.000	1.5	1.5	2.0	9.050	4.062	0.000	0.250
TRUCK DRIVER		O&C	2	23.110	0.000	1.5	1.5	2.0	9.050	4.062	0.000	0.250
TRUCK DRIVER		O&C	3	23.270	0.000	1.5	1.5	2.0	9.050	4.062	0.000	0.250

TRUCK DRIVER	O&C 4	23.470	0.000	1.5	1.5	2.0	9.050	4.062	0.000	0.250
TRUCK DRIVER	O&C 5	24.070	0.000	1.5	1.5	2.0	9.050	4.062	0.000	0.250
TUCKPINTER	BLD	29.620	31.120	1.5	1.5	2.0	6.550	8.080	0.000	0.460

Legend:

M-F>8 (Overtime is required for any hour greater than 8 worked each day, Monday through Friday.)

OSA (Overtime is required for every hour worked on Saturday)

OSH (Overtime is required for every hour worked on Sunday and Holidays)

H/W (Health & Welfare Insurance)

Pensn (Pension)

Vac (Vacation)

Trng (Training)

## Explanations

### WARREN COUNTY

The following list is considered as those days for which holiday rates of wages for work performed apply: New Years Day, Memorial/Decoration Day, Fourth of July, Labor Day, Veterans Day, Thanksgiving Day, Christmas Day. Generally, any of these holidays which fall on a Sunday is celebrated on the following Monday. This then makes work performed on that Monday payable at the appropriate overtime rate for holiday pay. Common practice in a given local may alter certain days of celebration such as the day after Thanksgiving for Veterans Day. If in doubt, please check with IDOL.

Oil and chip resealing (O&C) means the application of road oils and liquid asphalt to coat an existing road surface, followed by application of aggregate chips or gravel to coated surface, and subsequent rolling of material to seal the surface.

### EXPLANATION OF CLASSES

ASBESTOS - GENERAL - removal of asbestos material/mold and hazardous materials from any place in a building, including mechanical systems where those mechanical systems are to be removed. This includes the removal of asbestos materials/mold and hazardous materials from ductwork or pipes in a building when the building is to be demolished at the time or at some close future date.

ASBESTOS - MECHANICAL - removal of asbestos material from mechanical systems, such as pipes, ducts, and boilers, where the mechanical systems are to remain.

### CERAMIC TILE FINISHER, MARBLE FINISHER, TERRAZZO FINISHER

Assisting, helping or supporting the tile, marble and terrazzo mechanic by performing their historic and traditional work assignments required to complete the proper installation of the work covered by said crafts. The term "Ceramic" is used for naming the classification only and is in no way a limitation of the product handled. Ceramic

takes into consideration most hard tiles.

#### ELECTRONIC SYSTEMS TECHNICIAN

Installation, service and maintenance of low-voltage systems which utilizes the transmission and/or transference of voice, sound, vision, or digital for commercial, education, security and entertainment purposes for the following: TV monitoring and surveillance, background/foreground music, intercom and telephone interconnect, field programming, inventory control systems, microwave transmission, multi-media, multiplex, radio page, school, intercom and sound burglar alarms and low voltage master clock systems.

Excluded from this classification are energy management systems, life safety systems, supervisory controls and data acquisition systems not intrinsic with the above listed systems, fire alarm systems, nurse call systems and raceways exceeding fifteen feet in length.

#### LABORER, SKILLED - BUILDING

The skilled laborer building (BLD) classification shall encompass the following types of work, irrespective of the site of the work: tending of carpenters in unloading, handling, stockpiling and distribution operations, also other building crafts, mixing, handling, and conveying of all materials used by masons, plasterers and other building construction crafts, whether done by hand or by any process. The drying of plastering when done by salamander heat, and the cleaning and clearing of all debris. All work pertaining to and in preparation of asbestos abatement and removal. The building of scaffolding and staging for masons and plasterers. The excavations for buildings and all other construction, digging, of trenches, piers, foundations and holes, digging, lagging, sheeting, cribbing, bracing and propping of foundations, holes, caissons, cofferdams, and dikes, the setting of all guidelines for machine or hand excavation and subgrading. The mixing, handling, conveying, pouring, vibrating, gunniting and otherwise applying of concrete, whether by hand or other method of concrete for any walls, foundations, floors, or for other construction concrete sealant men. The wrecking, stripping, dismantling, and handling of concrete forms and false work, and the building of centers for fireproofing purposes. Boring machine, gas, electric or air in preparation for shoving pipe, telephone cable, and so forth, under highways, roads, streets and alleys. All hand and power operating cross cut saws when used for clearing. All work in compressed air construction. All work on acetylene burners in salvaging. The blocking and tamping of concrete. The laying of sewer tile and conduit, and pre-cast materials. The assembling and dismantling of all jacks and sectional scaffolding, including elevator construction and running of slip form jacks. The work of drill running and blasting, including wagon drills. The wrecking, stripping, dismantling, cleaning, moving and oiling of forms. The cutting off of concrete piles. The loading, unloading, handling and carrying to place of installation of all rods, (and materials for use in reinforcing) concrete and the hoisting of same and all signaling where hoist is used in this type of construction coming under the jurisdiction of the Laborers' Union. And, all other labor work not awarded to any other craft. Mortar mixers, kettlemen and carrier of hot stuff, tool crib men, watchmen (Laborer), firemen or salamander tenders, flagmen, deck hands, installation and maintenance of temporary gas-fired heating units, gravel box men, dumpmen and spotters, fencing Laborers, cleaning lumber, pit men, material checkers, dispatchers, unloading explosives, asphalt plant laborers, writer of scale tickets, fireproofing laborers, janitors, asbestos abatement and removal laborers, handling of materials treated with

oil, creosote, chloride, asphalt, and/or foreign material harmful to skin or clothing, Laborers with de-watering systems, gunnite nozzle men, laborers tending masons with hot material or where foreign materials are used, Laborers handling masterplate or similar materials, laser beam operator, concrete burning machine operator, material selector men working with firebrick or combustible material, dynamite men, track laborers, cement handlers, chloride handlers, the unloading and laborers with steel workers and re-bars, concrete workers (wet), luteman, asphalt raker, curb asphalt machine operator, ready mix scalemen, permanent, portable or temporary plant drilling machine operator, plaster tenders, underpinning and shoring of buildings, fire watch, signaling of all power equipment, to include trucks excavating equipment, etc., tree topper or trimmer when in connection to construction, tunnel helpers in free air, batch dumpers, kettle and tar men, tank cleaners, plastic installers, scaffold workers, motorized buggies or motorized unit used for wet concrete or handling of building materials, sewer workers, rod and chain men, vibrator operators, mortar mixer operator, cement silica, clay, fly ash, lime and plasters, handlers (bulk or bag), cofferdam workers, on concrete paving, placing, cutting and tying of reinforcing, deck hand, dredge hand and shore laborers, bankmen on floating plant, asphalt workers with machine & layers, grade checker, power tools, caisson workers, lead man on sewer work, welders, cutters, burners and torch men, chain saw operators, paving breaker, jackhammer and drill operator, layout man and/or drainage tile layer, steel form setters -- street and highway, air tamping hammerman, signal man on crane, concrete saw operator, screen man on asphalt pavers, front end man on chip spreader, multiple concrete duct -- lead man.

#### LABORER, SKILLED - HIGHWAY

The skilled laborer heavy and highway (HWY) classification shall encompass the following types of work, irrespective of the site of the work: handling of materials treated with oil, creosote, asphalt and/or any foreign materials harmful to skin or clothing, track laborers, chloride handlers, the unloading and loading with steel workers and re-bars, concrete workers (wet), tunnel helpers in free air, batch dumpers, mason tenders, kettle and tar men, plastic installers, scaffold workers, motorized buggies or motorized unit used for wet concrete or handling of building materials, laborers with de-watering systems, sewer workers plus depth, rod and chainmen, vibrator operators, mortar mixer operators, cement silica, clay, fly ash, lime and plasters, handlers (bulk or bag), cofferdam workers plus depth, on concrete paving, placing, cutting and tying or reinforcing, deck hand, dredge hand shore laborers, bankmen on floating plant, asphalt workers with machine, and layers, grade checker, power tools, stripping of all concrete forms excluding paving forms, dumpmen and spotters, when necessary, caisson workers plus depth, gunnite nozzle men, welders, cutters, burners and torchmen, chain saw operators, paving breaker, jackhammer and drill operators, layout man and/or drainage tile layer, steel form setters - street and highway, air tamping hammerman, signal man on crane, concrete saw operator, screedman on asphalt pavers, front end man on chip spreader, multiple concrete duct, luteman, asphalt raker, curb asphalt machine operator, ready mix scalemen (portable or temporary plant), laser beam operator, concrete burning machine operator, and coring machine operator.

#### TRUCK DRIVER - BUILDING, HEAVY AND HIGHWAY CONSTRUCTION

Class 1. Drivers on 2 axle trucks hauling less than 9 ton. Air compressor and welding machines and brooms, including those pulled by separate units, truck driver helpers, warehouse employees, mechanic helpers, greasers and tiremen, pickup trucks when hauling materials, tools, or workers to and from and on-the-job site, and fork lifts up

to 6,000 lb. capacity.

Class 2. Two or three axle trucks hauling more than 9 ton but hauling less than 16 ton. A-frame winch trucks, hydrolift trucks, vactor trucks or similar equipment when used for transportation purposes. Fork lifts over 6,000 lb. capacity, winch trucks, four axle combination units, and ticket writers.

Class 3. Two, three or four axle trucks hauling 16 ton or more. Drivers on water pulls, articulated dump trucks, mechanics and working forepersons, and dispatchers. Five axle or more combination units.

Class 4. Low Boy and Oil Distributors.

Class 5. Drivers who require special protective clothing while employed on hazardous waste work.

#### TRUCK DRIVER - OIL AND CHIP RESEALING ONLY.

This shall encompass laborers, workers and mechanics who drive contractor or subcontractor owned, leased, or hired pickup, dump, service, or oil distributor trucks. The work includes transporting materials and equipment (including but not limited to, oils, aggregate supplies, parts, machinery and tools) to or from the job site; distributing oil or liquid asphalt and aggregate; stock piling material when in connection with the actual oil and chip contract. The Truck Driver (Oil & Chip Resealing) wage classification does not include supplier delivered materials.

#### OPERATING ENGINEERS - BUILDING

Class 1. Cranes; Overhead Cranes; Gradall; All Cherry Pickers; Mechanics; Central Concrete Mixing Plant Operator; Road Pavers (27E - Dual Drum - Tri Batchers); Blacktop Plant Operators and Plant Engineers; 3 Drum Hoist; Derricks; Hydro Cranes; Shovels; Skimmer Scoops; Koehring Scooper; Drag Lines; Backhoe; Derrick Boats; Pile Drivers and Skid Rigs; Clamshells; Locomotive Cranes; Dredge (all types) Motor Patrol; Power Blades - Dumore - Elevating and similar types; Tower Cranes (Crawler-Mobile) and Stationary; Crane-type Backfiller; Drott Yumbo and similar types considered as Cranes; Caisson Rigs; Dozer; Tournadozer; Work Boats; Ross Carrier; Helicopter; Tournapulls - all and similar types; Scoops (all sizes); Pushcats; Endloaders (all types); Asphalt Surfacing Machine; Slip Form Paver; Rock Crusher; Heavy Equipment Greaser; CMI, CMI Belt Placer, Auto Grade & 3 Track and similar types; Side Booms; Multiple Unit Earth Movers; Creter Crane; Trench Machine; Pump-crete-Belt Crete-Squeeze Cretes-Screw-type Pumps and Gypsum; Bulker & Pump - Operator will clean; Formless Finishing Machine; Flaherty Spreader or similar types; Screed Man on Laydown Machine; Wheel Tractors (industrial or Farm-type w/Dozer-Hoe-Endloader or other attachments); F.W.D. & Similar Types; Vermeer Concrete Saw.

Class 2. Dinkeys; Power Launches; PH One-pass Soil Cement Machine (and similar types); Pugmill with Pump; Backfillers; Euclid Loader; Forklifts; Jeeps w/Ditching Machine or other attachments; Tuneluger; Automatic Cement and Gravel Batching Plants; Mobile Drills (Soil Testing) and similar types; Gurries and Similar Types; (1) and (2) Drum Hoists (Buck Hoist and Similar Types); Chicago Boom; Boring Machine & Pipe Jacking Machine; Hydro Boom; Dewatering System; Straw Blower; Hydro Seeder; Assistant Heavy Equipment Greaser on Spread; Tractors (Track type) without Power Unit pulling Rollers; Rollers on Asphalt -- Brick Macadem; Concrete Breakers; Concrete Spreaders; Mule

Pulling Rollers; Center Stripper; Cement Finishing Machines & CMI Texture & Reel Curing Machines; Cement Finishing Machine; Barber Green or similar loaders; Vibro Tamper (All similar types) Self-propelled; Winch or Boom Truck; Mechanical Bull Floats; Mixers over 3 Bag to 27E; Tractor pulling Power Blade or Elevating Grader; Porter Rex Rail; Clary Screed; Truck Type Hoptoe Oilers; Fireman; Spray Machine on Paving; Curb Machines; Truck Crane Oilers; Oil Distributor; Truck-Mounted Saws.

Class 3. Air Compressor; Power Subgrader; Straight Tractor; Trac Air without attachments; Herman Nelson Heater, Dravo, Warner, Silent Glo, and similar types; Roller: Five (5) Ton and under on Earth or Gravel; Form Grader; Crawler Crane & Skid Rig Oilers; Freight Elevators - permanently installed; Pump; Light Plant; Generator; Conveyor (1) or (2) - Operator will clean; Welding Machine; Mixer (3) Bag and Under (Standard Capacity with skip); Bulk Cement Plant; Oiler on Central Concrete Mixing Plant.

#### OPERATING ENGINEERS - HEAVY AND HIGHWAY CONSTRUCTION

Class 1. Cranes; Hydro Crane; Shovels; Crane Type Backfiller; Tower Cranes - Mobile & Crawler & Stationary; Derricks & Hoists (3 Drum); Draglines; Drott Yumbo & similar types considered as Cranes; Back Hoe; Derrick Boats; Pile Driver and Skid Rigs; Clam Shell; Locomotive - Cranes; Road Pavers - Single Drum - Dual Drum - Tri Batcher; Motor Patrols & Power Blades - Dumore - Elevating & Similar Types; Mechanics; Central Concrete Mixing Plant Operator; Asphalt Batch Plant Operators and Plant Engineers; Gradall; Caisson Rigs; Skimmer Scoop - Koering Scooper; Dredges (all types); Hoptoe; All Cherry Pickers; Work Boat; Ross Carrier; Helicopter; Dozer; Tornadoizer; Tournapulls - all and similar types; Multiple Unit Earth Movers; Scoops (all sizes); Pushcats; Endloaders (all types); Asphalt Surfacing Machine; Slip Form Paver; Rock Crusher; Heavy Equipment Greaser (top greaser on spread); CMI, Auto Grade, CMI Belt Placer & 3 Track and similar types; Side Booms; Starting Engineer on Pipeline; Asphalt Heater & Planer Combination (used to plane streets); Wheel Tractors (with dozer, hoe or endloader attachments); F.W.D. and Similar types; Blaw Knox Spreader and Similar types; Trench Machines; Pump Crete - Belt Crete - Squeeze Crete - screw type pumps and gypsum (operator will clean); Formless Finishing Machines; Flaherty Spreader or similar types; Screed Man on Laydown Machine; Vermeer Concrete Saw.

Class 2. Bulker & Pump; Power Launches; Boring Machine & Pipe Jacking Machine; Dinkeys; P-H One Pass Soil Cement Machines and similar types; Wheel Tractors (Industry or farm type - other); Back Fillers; Euclid Loader; Fork Lifts; Jeep w/Ditching Machine or other attachments; Tunneluger; Automatic Cement & Gravel Batching Plants; Mobile Drills - Soil Testing and similar types; Pugmill with pump; All (1) and (2) Drum Hoists; Dewatering System; Straw Blower; Hydro-Seeder; Boring Machine; Hydro-Boom; Bump Grinders (self-propelled); Assistant Heavy Equipment Greaser; Apsco Spreader; Tractors (track-type) without Power Units Pulling Rollers on Asphalt - Brick or Macadam; Concrete Breakers; Concrete Spreaders; Cement Strippers; Cement Finishing Machines & CMI Texture & Reel Curing Machines; Vibro-Tampers (all similar types self-propelled); Mechanical Bull Floats; Self-propelled Concrete Saws; Mixers-over three (3) bags to 27E; Winch and Boom Trucks; Tractor Pulling Power Blade or Elevating Grader; Porter Rex Rail; Clary Screed; Mule Pulling Rollers; Pugmill without Pump; Barber Greene or similar Loaders; Track Type Tractor w/Power Unit attached (minimum); Fireman; Spray Machine on Paving; Curb Machines; Paved Ditch Machine; Power Broom; Self-Propelled Conveyors; Power Subgrader; Oil Distributor; Straight Tractor; Truck Crane Oiler; Truck Type Oilers; Directional boring

machine; Horizontal directional drill.

Class 3. Straight framed articulating end pump vehicles and Truck mounted vac unit (separately powered); Trac Air Machine (without attachments); Herman Nelson Heater, Dravo Warner, Silent Glo & similar types; Rollers - five ton and under on earth and gravel; Form Graders; Pumps; Light Plant; Generator; Air Compressor (1) or (2); Conveyor; Welding Machine; Mixer - 3 bags and under; Bulk Cement Plant; Oilers.

#### Other Classifications of Work:

For definitions of classifications not otherwise set out, the Department generally has on file such definitions which are available. If a task to be performed is not subject to one of the classifications of pay set out, the Department will upon being contacted state which neighboring county has such a classification and provide such rate, such rate being deemed to exist by reference in this document. If no neighboring county rate applies to the task, the Department shall undertake a special determination, such special determination being then deemed to have existed under this determination. If a project requires these, or any classification not listed, please contact IDOL at 217-782-1710 for wage rates or clarifications.

#### LANDSCAPING

Landscaping work falls under the existing classifications for laborer, operating engineer and truck driver. The work performed by landscape plantsman and landscape laborer is covered by the existing classification of laborer. The work performed by landscape operators (regardless of equipment used or its size) is covered by the classifications of operating engineer. The work performed by landscape truck drivers (regardless of size of truck driven) is covered by the classifications of truck driver.