

CONTRACT 72781				
F.A.S. RTE.	SECTION	COUNTY	TOTAL SHEETS	SHEET NO.
1597	14 (W, RS-7)	ADAMS/PIKE	152	30
STA. 984+40		TO STA. 1436+65		
FED. ROAD DIST. NO.		ILLINOIS FED. AID PROJECT		

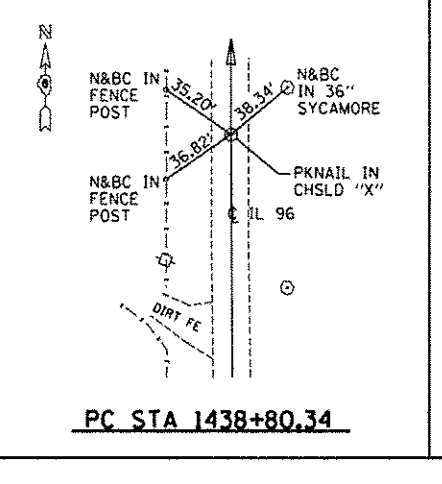
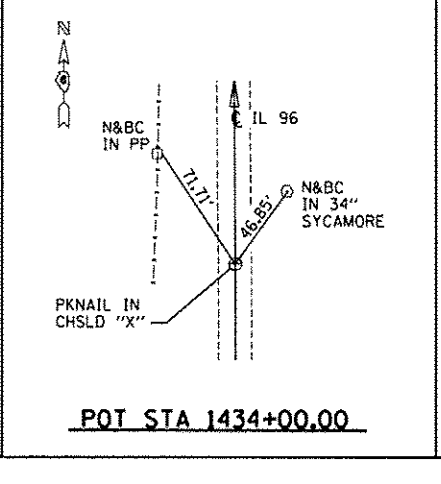
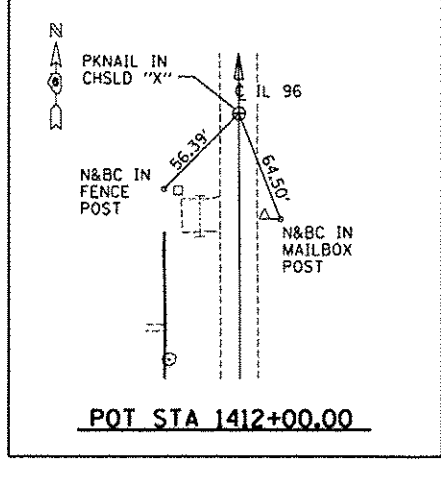
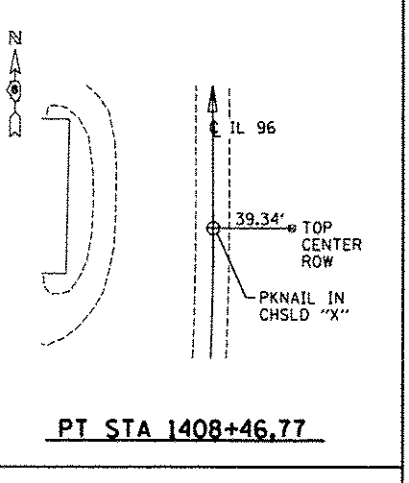
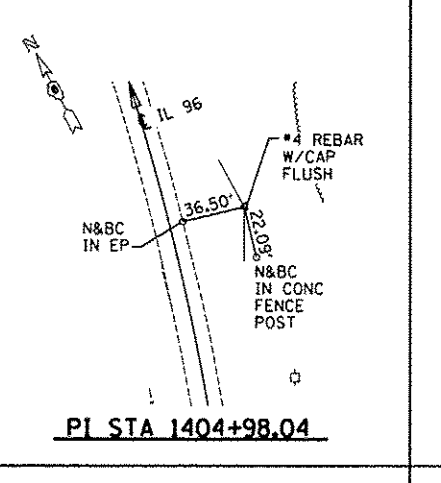
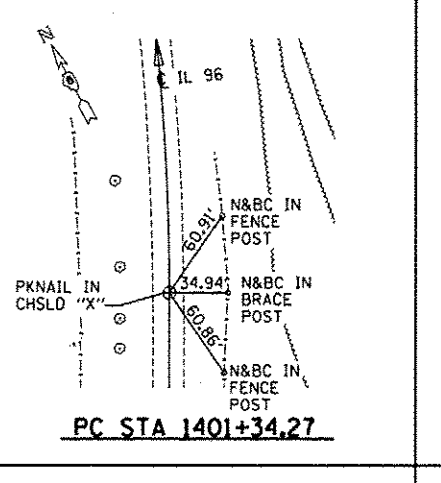
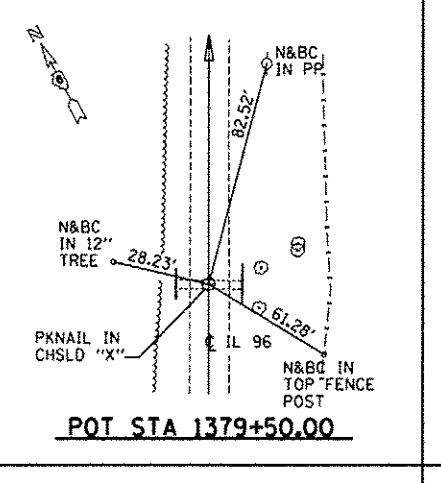
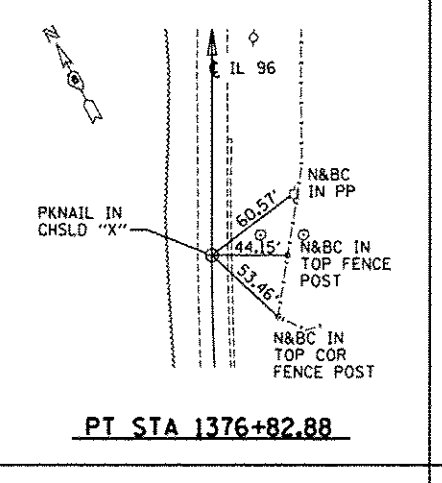
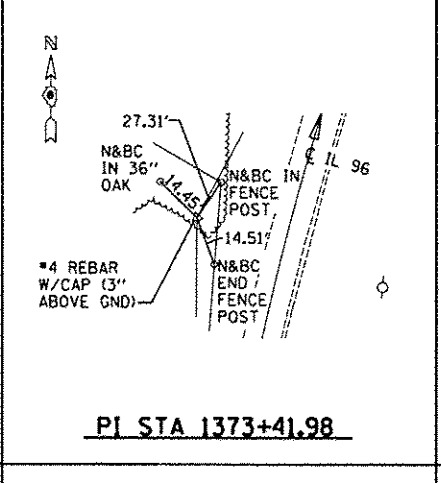
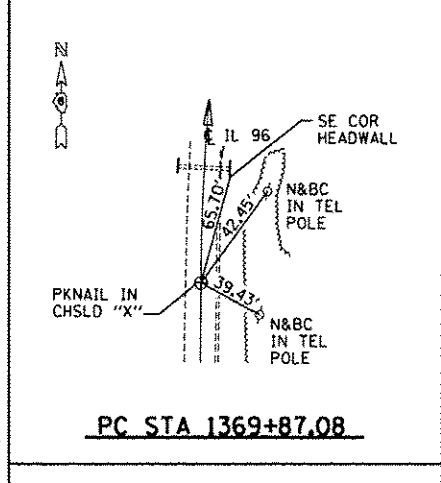
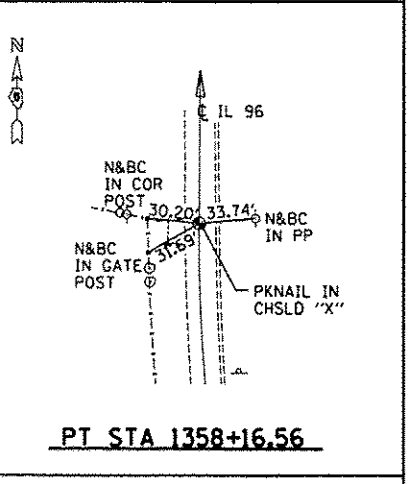
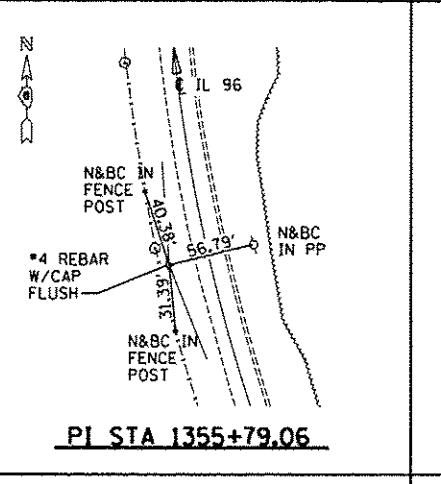
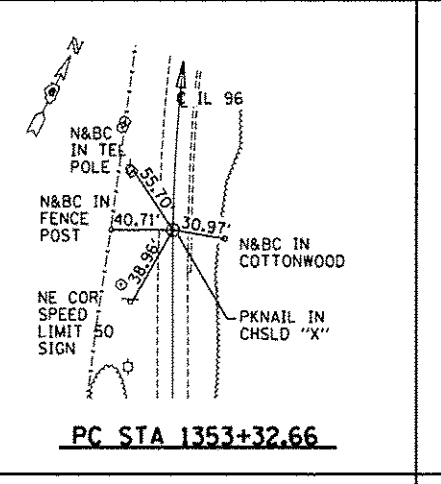
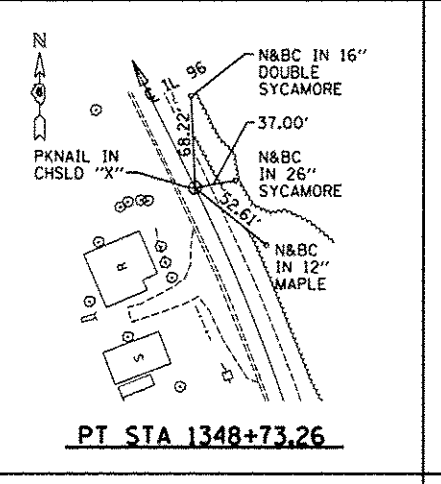
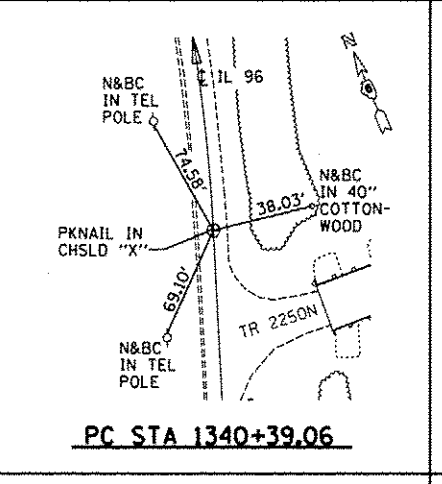
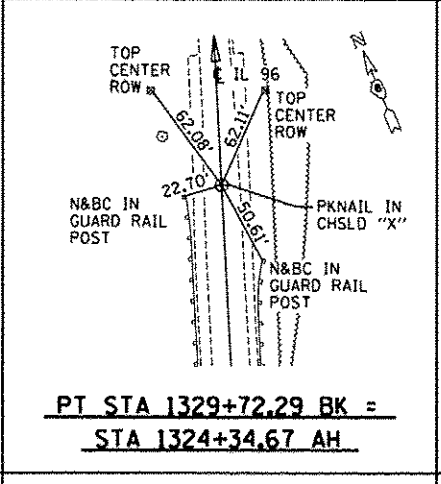
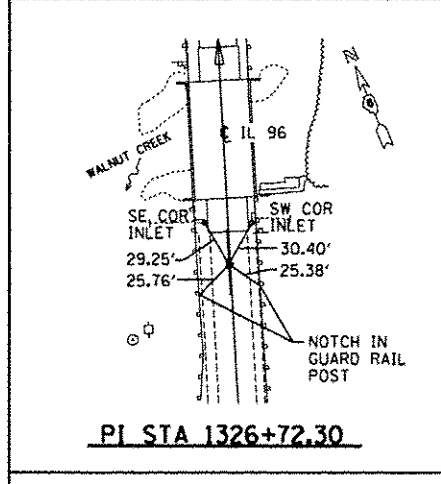
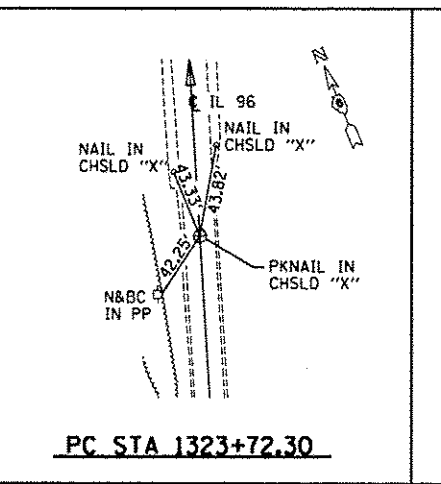
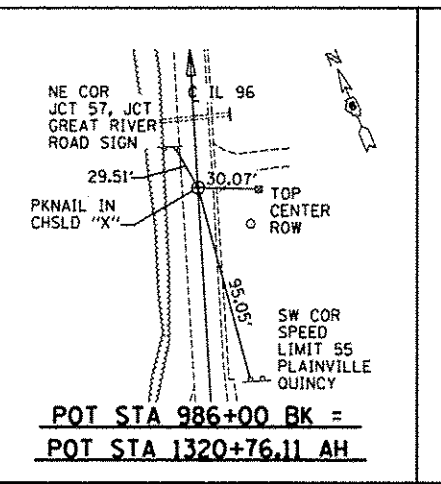
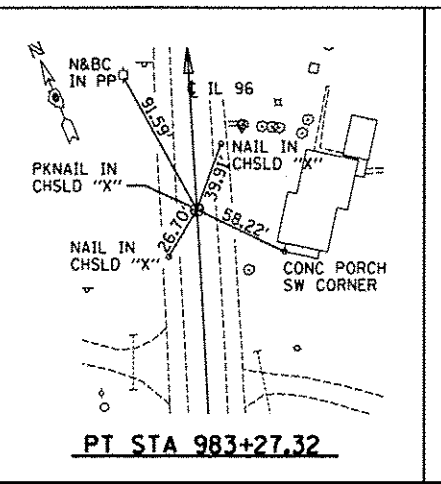
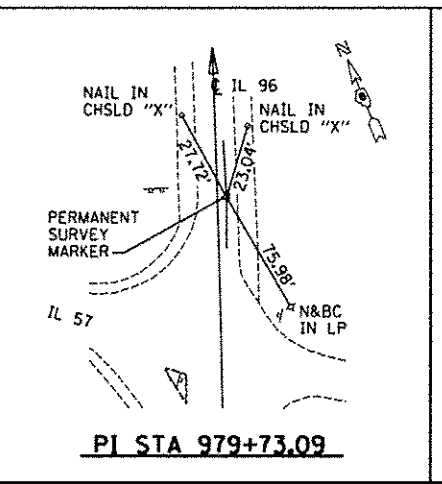
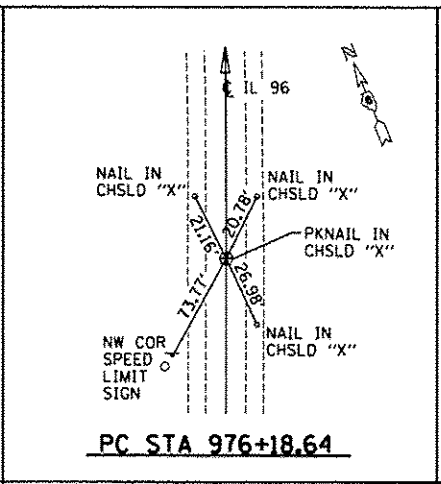
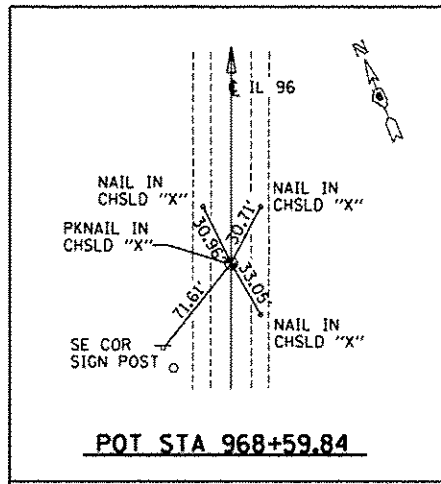

REVISIONS	
NAME	DATE

ILLINOIS DEPARTMENT OF TRANSPORTATION
HORIZONTAL CONTROL TIE POINTS

SHEET 1 OF 1
F.A.S. ROUTE 1597 (IL 96)
SECTION 14 (W, RS-7)
ADAMS/PIKE COUNTY

SCALE: VERT. _____
HORIZ. _____

DATE _____ DRAWN BY: BNK
CHECKED BY: DBS