

BID PROPOSAL INSTRUCTIONS

ABOUT IDOT PROPOSALS: All proposals are potential bidding proposals. Each proposal contains all certifications and affidavits, a proposal signature sheet and a proposal bid bond.

PREQUALIFICATION

Any contractor who desires to become pre-qualified to bid on work advertised by IDOT must submit the properly completed pre-qualification forms to the Bureau of Construction no later than 4:30 p.m. prevailing time twenty-one days prior to the letting of interest. This pre-qualification requirement applies to first time contractors, contractors renewing expired ratings, contractors maintaining continuous pre-qualification or contractors requesting revised ratings. To be eligible to bid, existing pre-qualification ratings must be effective through the date of letting.

WHO CAN BID ?

Bids will be accepted from only those companies that request and receive written Authorization to Bid from IDOT's Central Bureau of Construction.

REQUESTS FOR AUTHORIZATION TO BID

Contractors wanting to bid on items included in a particular letting must submit the properly completed "Request for Authorization to Bid/or Not For Bid Status" (BDE 124) and the ORIGINAL "Affidavit of Availability" (BC 57) to the proper office no later than 4:30 p.m. prevailing time, three (3) days prior to the letting date.

WHAT CONSTITUTES WRITTEN AUTHORIZATION TO BID?

When a prospective prime bidder submits a "Request for Authorization to Bid/or Not For Bid Status"(BDE 124) he/she must indicate at that time which items are being requested For Bidding purposes. Only those items requested For Bidding will be analyzed. After the request has been analyzed, the bidder will be issued an **Authorization to Bid or Not for Bid Report**, approved by the Central Bureau of Construction and the Chief Procurement Officer that indicates which items have been approved For Bidding. If **Authorization to Bid** cannot be approved, the **Authorization to Bid or Not for Bid Report** will indicate the reason for denial.

ABOUT AUTHORIZATION TO BID

Firms that have not received an Authorization to Bid or Not For Bid Report within a reasonable time of complete and correct original document submittal should contact the Department as to the status. Firms unsure as to authorization status should call the Prequalification Section of the Bureau of Construction at the number listed at the end of these instructions.

ADDENDA AND REVISIONS

It is the bidder's responsibility to determine which, if any, addenda or revisions pertain to any project they may be bidding. Failure to incorporate all relevant addenda or revisions may cause the bid to be declared unacceptable.

Each addendum or revision will be included with the Electronic Plans and Proposals. Addenda and revisions will also be placed on the Addendum/Revision Checklist and each subscription service subscriber will be notified by e-mail of each addendum and revision issued.

The Internet is the Department's primary way of doing business. The subscription service emails are an added courtesy the Department provides. It is suggested that bidders check IDOT's website at <http://www.dot.il.gov/desenv/delett.html> before submitting final bid information.

IDOT IS NOT RESPONSIBLE FOR ANY E-MAIL FAILURES.

Addenda questions may be directed to the Contracts Office at (217)782-7806 or DOT.D&Econtracts@illinois.gov

Technical questions about downloading these files may be directed to Tim Garman at (217)524-1642 or Timothy.Garman@illinois.gov.

STANDARD GUIDELINES FOR SUBMITTING BIDS

- All pages should be single sided.
- Use the Cover Page that is provided in the Bid Proposal (posted on the IDOT Web Site) as the first page of your submitted bid. It has the item number in large bold type in the upper left-hand corner and lines provided for your company name and address in the upper right-hand corner.
- Do not use report covers, presentation folders or special bindings and do not staple multiple times on left side like a book. Use only 1 staple in the upper left hand corner. Make sure all elements of your bid are stapled together including the bid bond or guaranty check (if required).
- Do not include any certificates of eligibility, your authorization to bid, Addendum Letters or affidavit of availability.
- Do not include the Subcontractor Documentation with your bid (pages i – iii and pages a – g). This documentation is required only if you are awarded the project.
- Use the envelope cover sheet (provided with the proposal) as the cover for the proposal envelope.
- Do not rely on overnight services to deliver your proposal prior to 10 AM on letting day. It will not be read if it is delivered after 10 AM.
- Do not submit your Substance Abuse Prevention Program (SAPP) with your bid. If you are awarded the contract this form is to be submitted to the district engineer at the pre-construction conference.

BID SUBMITTAL CHECKLIST

- Cover page** (the sheet that has the item number on it) – This should be the first page of your bid proposal, **followed by your bid (the Schedule of Prices/Pay Items)**. If you are using special software or CBID to generate your schedule of prices, do not include the blank pages of the schedule of prices that came with the proposal package.
- Page 4 (Item 9)** – Check “YES” if you will use a subcontractor(s) with an annual value over \$50,000. Include the subcontractor(s) name, address, general type of work to be performed and the dollar amount. If you will use subcontractor(s) but are uncertain who or the dollar amount; check “YES” but leave the lines blank.
- After page 4** – Insert the following documents: The **Illinois Office Affidavit** (Not applicable to federally funded projects) followed by Cost Adjustments for Steel, Bituminous and Fuel (if applicable) and the Contractor Letter of Assent (if applicable). The general rule should be, if you don’t know where it goes, put it after page 4.
- Page 10 (Paragraph J)** – Check “YES” or “NO” whether your company has any business in Iran.
- Page 10 (Paragraph K)** – (Not applicable to federally funded projects) List the name of the apprenticeship and training program sponsor holding the certificate of registration from the US Department of Labor. If no applicable program exists, please indicate the work/job category **Your bid will not be read if this is not completed.** Do not include certificates with your bid. Keep the certificates in your office in case they are requested by IDOT.
- Page 11 (Paragraph L)** – A copy of your State Board of Elections certificate of registration is no longer required with your bid.
- Page 11 (Paragraph M)** – Indicate if your company has hired a lobbyist in connection with the job for which you are submitting the bid proposal.
- Page 12 (Paragraph C)** – This is a work sheet to determine if a completed Form A is required. It is not part of the form and you do not need to make copies for each completed Form A.
- Pages 14-17 (Form A)** – One Form A (4 pages) is required for each applicable person in your company. Copies of the forms can be used and only need to be changed when the information changes. The certification signature and date must be original for each letting. **Do not staple the forms together.** If you answered “NO” to all of the questions in Paragraph C (page 12), complete the first section (page 14) with your company information and then sign and date the Not Applicable statement on page 17.
- Page 18 (Form B)** - If you check “YES” to having other current or pending contracts it is acceptable to use the phrase, “See Affidavit of Availability on file”. **Ownership Certification** (at the bottom of the page) - Check N/A if the Form A(s) you submitted accounts for 100 percent of the company ownership. Check YES if any percentage of ownership falls outside of the parameters that require reporting on the Form A. Checking NO indicates that the Form A(s) you submitted is not correct and you will be required to submit a revised Form A.
- Page 20 (Workforce Projection)** – Be sure to include the Duration of the Project. It is acceptable to use the phrase “Per Contract Specifications”.

Proposal Bid Bond – (Insert after the proposal signature page) Submit your proposal Proposal Bid Bond (if applicable) using the current Proposal Bid Bond form provided in the proposal package. The Power of Attorney page should be stapled to the Proposal Bid Bond. If you are using an electronic bond, include your bid bond number on the Proposal Bid Bond and attach the Proof of Insurance printed from the Surety’s Web Site.

Disadvantaged Business Utilization Plan and/or Good Faith Effort – The last items in your bid should be the DBE Utilization Plan (SBE 2026), followed by the DBE Participation Statement (SBE 2025) and supporting paperwork. If you have documentation of a Good Faith Effort, it is to follow the SBE Forms.

The Bid Letting is now available in streaming Audio/Video from the IDOT Web Site. A link to the stream will be placed on the main page of the current letting on the day of the Letting. The stream will not begin until 10 AM. The actual reading of the bids does not begin until approximately 10:30 AM.

Following the Letting, the As-Read Tabulation of Bids will be posted by the end of the day. You will find the link on the main Web page for the current letting.

QUESTIONS: pre-letting up to execution of the contract

Contractor pre-qualification	217-782-3413
Small Business, Disadvantaged Business Enterprise (DBE)	217-785-4611
Contracts, Bids, Letting process or Internet downloads	217-782-7806
Estimates Unit.....	217-785-3483
Aeronautics.....	217-785-8515
IDNR (Land Reclamation, Water Resources, Natural Resources).....	217-782-6302

QUESTIONS: following contract execution

Subcontractor documentation, payments	217-782-3413
Railroad Insurance	217-785-0275

20

RETURN WITH BID

Proposal Submitted By
Name
Address
City

Letting February 28, 2014

NOTICE TO PROSPECTIVE BIDDERS

This proposal can be used for bidding purposes by only those companies that request and receive written AUTHORIZATION TO BID from IDOT's Central Bureau of Construction.

BIDDERS NEED NOT RETURN THE ENTIRE PROPOSAL

Notice to Bidders, Specifications, Proposal, Contract and Contract Bond



**Illinois Department
of Transportation**

Springfield, Illinois 62764

**Contract No. 64J29
LEE-OGLE Counties
Section (109,110)RS-5
Routes FAS 1177 & FAU 5452
Project ACRS-ACM-000S(957)
District 2 Construction Funds**

PLEASE MARK THE APPROPRIATE BOX BELOW:

- A Bid Bond is included.
- A Cashier's Check or a Certified Check is included
- An Annual Bid Bond is included or is on file with IDOT.

Plans Included
Herein

Prepared by

Checked by

F

(Printed by authority of the State of Illinois)

Page intentionally left blank

RETURN WITH BID



PROPOSAL

TO THE DEPARTMENT OF TRANSPORTATION

1. Proposal of _____

Taxpayer Identification Number (Mandatory) _____

For the improvement identified and advertised for bids in the Invitation for Bids as:

**Contract No. 64J29
LEE-OGLE Counties
Section (109,110)RS-5
Project ACRS-ACM-000S(957)
Routes FAS 1177 & FAU 5452
District 2 Construction Funds**

13.6 miles of resurfacing on IL 251 from I-88 to Chicago Rd. in Lee and Ogle Counties.

2. The undersigned bidder will furnish all labor, material and equipment to complete the above described project in a good and workmanlike manner as provided in the contract documents provided by the Department of Transportation. This proposal will become part of the contract and the terms and conditions contained in the contract documents will govern performance and payments.

RETURN WITH BID

3. **ASSURANCE OF EXAMINATION AND INSPECTION/WAIVER.** The undersigned bidder further declares that he/she has carefully examined the proposal, plans, specifications, addenda form of contract and contract bond, and special provisions, and that he/she has inspected in detail the site of the proposed work, and that he/she has familiarized themselves with all of the local conditions affecting the contract and the detailed requirements of construction, and understands that in making this bid proposal he/she waives all right to plead any misunderstanding regarding the same.

4. **EXECUTION OF CONTRACT AND CONTRACT BOND.** The undersigned bidder further agrees to execute a contract for this work and present the same to the department within fifteen (15) days after the contract has been mailed to him/her. The undersigned further agrees that he/she and his/her surety will execute and present within fifteen (15) days after the contract has been mailed to him/her contract bond satisfactory to and in the form prescribed by the Department of Transportation, in the penal sum of the full amount of the contract, or as specified in the special provisions, guaranteeing the faithful performance of the work in accordance with the terms of the contract.

5. **PROPOSAL GUARANTY.** Accompanying this proposal is either a bid bond on the department form, executed by a corporate surety company satisfactory to the department, or a proposal guaranty check consisting of a bank cashier's check or a properly certified check for not less than 5 per cent of the amount bid or for the amount specified in the following schedule:

<u>Amount of Bid</u>		<u>Proposal Guaranty</u>		<u>Amount of Bid</u>		<u>Proposal Guaranty</u>	
Up to	\$5,000	\$150		\$2,000,000	to	\$3,000,000	\$100,000
\$5,000	to \$10,000	\$300		\$3,000,000	to	\$5,000,000	\$150,000
\$10,000	to \$50,000	\$1,000		\$5,000,000	to	\$7,500,000	\$250,000
\$50,000	to \$100,000	\$3,000		\$7,500,000	to	\$10,000,000	\$400,000
\$100,000	to \$150,000	\$5,000		\$10,000,000	to	\$15,000,000	\$500,000
\$150,000	to \$250,000	\$7,500		\$15,000,000	to	\$20,000,000	\$600,000
\$250,000	to \$500,000	\$12,500		\$20,000,000	to	\$25,000,000	\$700,000
\$500,000	to \$1,000,000	\$25,000		\$25,000,000	to	\$30,000,000	\$800,000
\$1,000,000	to \$1,500,000	\$50,000		\$30,000,000	to	\$35,000,000	\$900,000
\$1,500,000	to \$2,000,000	\$75,000		over		\$35,000,000	\$1,000,000

Bank cashier's checks or properly certified checks accompanying bid proposals will be made payable to the Treasurer, State of Illinois.

If a combination bid is submitted, the proposal guaranties which accompany the individual bid proposals making up the combination will be considered as also covering the combination bid.

The amount of the proposal guaranty check is _____ \$(_____). If this proposal is accepted and the undersigned will fail to execute a contract bond as required herein, it is hereby agreed that the amount of the proposal guaranty will become the property of the State of Illinois, and shall be considered as payment of damages due to delay and other causes suffered by the State because of the failure to execute said contract and contract bond; otherwise, the bid bond will become void or the proposal guaranty check will be returned to the undersigned.

Attach Cashier's Check or Certified Check Here

In the event that one proposal guaranty check is intended to cover two or more bid proposals, the amount must be equal to the sum of the proposal guaranties which would be required for each individual bid proposal. If the guaranty check is placed in another bid proposal, state below where it may be found.

The proposal guaranty check will be found in the bid proposal for:

Item _____

Section No. _____

County _____

Mark the proposal cover sheet as to the type of proposal guaranty submitted.

RETURN WITH BID

6. **COMBINATION BIDS.** The undersigned bidder further agrees that if awarded the contract for the sections contained in the following combination, he/she will perform the work in accordance with the requirements of each individual contract comprising the combination bid specified in the schedule below, and that the combination bid shall be prorated against each section in proportion to the bid submitted for the same. If an error is found to exist in the gross sum bid for one or more of the individual sections included in a combination, the combination bid shall be corrected as provided in the specifications.

When a combination bid is submitted, the schedule below must be completed in each proposal comprising the combination.

If alternate bids are submitted for one or more of the sections comprising the combination, a combination bid must be submitted for each alternate.

Schedule of Combination Bids

Combination No.	Sections Included in Combination	Combination Bid	
		Dollars	Cents

7. **SCHEDULE OF PRICES.** The undersigned bidder submits herewith, in accordance with the rules and instructions, a schedule of prices for the items of work for which bids are sought. The unit prices bid are in U.S. dollars and cents, and all extensions and summations have been made. The bidder understands that the quantities appearing in the bid schedule are approximate and are provided for the purpose of obtaining a gross sum for the comparison of bids. If there is an error in the extension of the unit prices, the unit prices will govern. Payment to the contractor awarded the contract will be made only for actual quantities of work performed and accepted or materials furnished according to the contract. The scheduled quantities of work to be done and materials to be furnished may be increased, decreased or omitted as provided elsewhere in the contract.

8. **AUTHORITY TO DO BUSINESS IN ILLINOIS.** Section 20-43 of the Illinois Procurement Code (the Code) (30 ILCS 500/20-43) provides that a person (other than an individual acting as a sole proprietor) must be a legal entity authorized to do business in the State of Illinois prior to submitting the bid.

9. **EXECUTION OF CONTRACT:** The Department of Transportation will, in accordance with the rules governing Department procurements, execute the contract and shall be the sole entity having the authority to accept performance and make payments under the contract. Execution of the contract by the Chief Procurement Officer (CPO) or the State Purchasing Officer (SPO) is for approval of the procurement process and execution of the contract by the Department. Neither the CPO nor the SPO shall be responsible for administration of the contract or determinations respecting performance or payment there under except as otherwise permitted in the Code.

10. **The services of a subcontractor will be used.**

Check box Yes
 Check box No

For known subcontractors with subcontracts with an annual value of more than \$50,000, the contract shall include their name, address, general type of work to be performed, and the dollar allocation for each subcontractor. (30 ILCS 500/20-120)

ILLINOIS DEPARTMENT OF TRANSPORTATION
 SCHEDULE OF PRICES
 CONTRACT
 NUMBER -

64J29

State Job # - C-92-024-13

Project Number
 ACRS-ACM-000S/957/

Route
 FAS 1177
 FAU 5452

County Name - LEE- OGLE-

Code - 103 - 141 -

District - 2 - 2 -

Section Number - (109,110)RS-5

Item Number	Pay Item Description	Unit of Measure	Quantity	x	Unit Price	=	Total Price
Z0008758	AERIAL SPEED CHK MK	FOOT	36.000				
Z0012500	CONC CURB REPAIR	FOOT	162.000				
Z0034105	MATL TRANSFER DEVICE	TON	32,071.000				
Z0040315	PILOT CAR	DAY	20.000				
Z0051500	REM & RESET ST SIGNS	EACH	1.000				
Z0055100	RUMBLE RESURF	SQ YD	183.000				
Z0076600	TRAINEES	HOUR	500.000		0.800		400.000
Z0076604	TRAINEES TPG	HOUR	500.000		15.000		7,500.000
20200600	EXC & GR EX SHOULDER	UNIT	18.000				
35101400	AGG BASE CSE B	TON	287.000				
40600200	BIT MATLS PR CT	TON	134.900				
40600300	AGG PR CT	TON	691.000				
40600525	LEV BIND HM N50	TON	204.600				
40600627	LB MM IL-9.5FG N50	TON	12,712.000				
40600895	CONSTRUC TEST STRIP	EACH	2.000				

ILLINOIS DEPARTMENT OF TRANSPORTATION
 SCHEDULE OF PRICES
 CONTRACT
 NUMBER -

64J29

State Job # - C-92-024-13

County Name - LEE- OGLE-

Code - 103 - 141 -

District - 2 - 2 -

Section Number - (109,110)RS-5

Project Number
 ACRS-ACM-000S/957/

Route
 FAS 1177
 FAU 5452

Item Number	Pay Item Description	Unit of Measure	Quantity	x	Unit Price	=	Total Price
40600982	HMA SURF REM BUTT JT	SQ YD	2,560.000				
40600990	TEMPORARY RAMP	SQ YD	913.000				
40601005	HMA REPL OVER PATCH	TON	960.000				
40603310	HMA SC "C" N50	TON	356.000				
40603335	HMA SC "D" N50	TON	19,469.000				
40800050	INCIDENTAL HMA SURF	TON	1,835.000				
44000158	HMA SURF REM 2 1/4	SQ YD	104,648.000				
44002232	HMA RM OV PATCH 8	SQ YD	2,142.000				
44300100	AREA REF CR CON TREAT	SQ YD	126,049.500				
48102100	AGG WEDGE SHLD TYPE B	TON	5,866.000				
48203020	HMA SHOULDERS 5 3/4	SQ YD	1,582.000				
63000003	SPBGR TY A 9FT POSTS	FOOT	612.500				
63100087	TRAF BAR TERM T6A	EACH	4.000				
63100167	TR BAR TRM T1 SPL TAN	EACH	16.000				
63200310	GUARDRAIL REMOV	FOOT	1,465.000				

ILLINOIS DEPARTMENT OF TRANSPORTATION
 SCHEDULE OF PRICES
 CONTRACT
 NUMBER -

64J29

State Job # - C-92-024-13

County Name - LEE- OGLE-

Code - 103 - 141 -

District - 2 - 2 -

Section Number - (109,110)RS-5

Project Number
 ACRS-ACM-000S/957/

Route
 FAS 1177
 FAU 5452

Item Number	Pay Item Description	Unit of Measure	Quantity	x	Unit Price	=	Total Price
63301210	REM RE-E SPBGR TY A	FOOT	175.000				
63500105	DELINEATORS	EACH	16.000				
66700305	PERM SURV MKRS T2	EACH	3.000				
67000400	ENGR FIELD OFFICE A	CAL MO	5.000				
67100100	MOBILIZATION	L SUM	1.000				
70100310	TRAF CONT-PROT 701421	L SUM	1.000				
70100460	TRAF CONT-PROT 701306	L SUM	1.000				
70100600	TRAF CONT-PROT 701336	L SUM	1.000				
70100825	TRAF CONT-PROT 701456	L SUM	1.000				
70102625	TR CONT & PROT 701606	L SUM	1.000				
70102635	TR CONT & PROT 701701	L SUM	1.000				
70103815	TR CONT SURVEILLANCE	CAL DA	20.000				
70300100	SHORT TERM PAVT MKING	FOOT	22,182.000				
70301000	WORK ZONE PAVT MK REM	SQ FT	2,465.000				
78000200	THPL PVT MK LINE 4	FOOT	12,573.000				

ILLINOIS DEPARTMENT OF TRANSPORTATION
 SCHEDULE OF PRICES
 CONTRACT
 NUMBER -

64J29

State Job # - C-92-024-13

County Name - LEE- OGLE-

Code - 103 - 141 -

District - 2 - 2 -

Section Number - (109,110)RS-5

Project Number
 ACRS-ACM-000S/957/

Route
 FAS 1177
 FAU 5452

Item Number	Pay Item Description	Unit of Measure	Quantity	x	Unit Price	=	Total Price
78000500	THPL PVT MK LINE 8	FOOT	1,020.000				
78000600	THPL PVT MK LINE 12	FOOT	390.000				
78000650	THPL PVT MK LINE 24	FOOT	409.000				
78001110	PAINT PVT MK LINE 4	FOOT	370,411.000				
78100100	RAISED REFL PAVT MKR	EACH	975.000				
78200410	GUARDRAIL MKR TYPE A	EACH	34.000				
78201000	TERMINAL MARKER - DA	EACH	16.000				
78300200	RAISED REF PVT MK REM	EACH	845.000				

CONTRACT NUMBER

64J29

THIS IS THE TOTAL BID

\$ _____

NOTES:

1. Each PAY ITEM should have a UNIT PRICE and a TOTAL PRICE.
2. The UNIT PRICE shall govern if no TOTAL PRICE is shown or if there is a discrepancy between the product of the UNIT PRICE multiplied by the QUANTITY.
3. If a UNIT PRICE is omitted, the TOTAL PRICE will be divided by the QUANTITY in order to establish a UNIT PRICE.
4. A bid may be declared UNACCEPTABLE if neither a unit price nor a total price is shown.

RETURN WITH BID

STATE REQUIRED ETHICAL STANDARDS GOVERNING CONTRACT PROCUREMENT: ASSURANCES, CERTIFICATIONS AND DISCLOSURES

I. GENERAL

A. Article 50 of the Code establishes the duty of all State CPOs, SPOs, and their designees to maximize the value of the expenditure of public moneys in procuring goods, services, and contracts for the State of Illinois and to act in a manner that maintains the integrity and public trust of State government. In discharging this duty, they are charged by law to use all available information, reasonable efforts, and reasonable actions to protect, safeguard, and maintain the procurement process of the State of Illinois.

B. In order to comply with the provisions of Article 50 and to carry out the duty established therein, all bidders are to adhere to ethical standards established for the procurement process, and to make such assurances, disclosures and certifications required by law. Except as otherwise required in subsection III, paragraphs J-M, by execution of the Proposal Signature Sheet, the bidder indicates that each of the mandated assurances have been read and understood, that each certification is made and understood, and that each disclosure requirement has been understood and completed.

C. In addition to all other remedies provided by law, failure to comply with any assurance, failure to make any disclosure or the making of a false certification shall be grounds for the CPO to void the contract, and may result in the suspension or debarment of the bidder or subcontractor. If a false certification is made by a subcontractor the contractor's submitted bid and the executed contract may not be declared void unless the contractor refuses to terminate the subcontract upon the State's request after a finding that the subcontractor's certification was false.

I acknowledge, understand and accept these terms and conditions.

II. ASSURANCES

The assurances hereinafter made by the bidder are each a material representation of fact upon which reliance is placed should the Department enter into the contract with the bidder.

A. Conflicts of Interest

Section 50-13. Conflicts of Interest.

(a) Prohibition. It is unlawful for any person holding an elective office in this State, holding a seat in the General Assembly, or appointed to or employed in any of the offices or agencies of state government and who receives compensation for such employment in excess of 60% of the salary of the Governor of the State of Illinois, or who is an officer or employee of the Capital Development Board or the Illinois State Toll Highway Authority, or who is the spouse or minor child of any such person to have or acquire any contract, or any direct pecuniary interest in any contract therein, whether for stationery, printing, paper, or any services, materials, or supplies, that will be wholly or partially satisfied by the payment of funds appropriated by the General Assembly of the State of Illinois or in any contract of the Capital Development Board or the Illinois State Toll Highway Authority.

(b) Interests. It is unlawful for any firm, partnership, association or corporation, in which any person listed in subsection (a) is entitled to receive (i) more than 7 1/2% of the total distributable income or (ii) an amount in excess of the salary of the Governor, to have or acquire any such contract or direct pecuniary interest therein.

(c) Combined interests. It is unlawful for any firm, partnership, association, or corporation, in which any person listed in subsection (a) together with his or her spouse or minor children is entitled to receive (i) more than 15%, in the aggregate, of the total distributable income or (ii) an amount in excess of 2 times the salary of the Governor, to have or acquire any such contract or direct pecuniary interest therein.

(d) Securities. Nothing in this Section invalidates the provisions of any bond or other security previously offered or to be offered for sale or sold by or for the State of Illinois.

(e) Prior interests. This Section does not affect the validity of any contract made between the State and an officer or employee of the State or member of the General Assembly, his or her spouse, minor child or any combination of those persons if that contract was in existence before his or her election or employment as an officer, member, or employee. The contract is voidable, however, if it cannot be completed within 365 days after the officer, member, or employee takes office or is employed.

The current salary of the Governor is \$177,412.00. Sixty percent of the salary is \$106,447.20.

RETURN WITH BID

The bidder assures the Department that the award and execution of the contract would not cause a violation of Section 50-13, or that an effective exemption has been issued by the Board of Ethics to any individual subject to the Section 50-13 prohibitions pursuant to the provisions of Section 50-20 of the Code. Information concerning the exemption process is available from the Department upon request.

B. Negotiations

Section 50-15. Negotiations.

It is unlawful for any person employed in or on a continual contractual relationship with any of the offices or agencies of State government to participate in contract negotiations on behalf of that office or agency with any firm, partnership, association, or corporation with whom that person has a contract for future employment or is negotiating concerning possible future employment.

The bidder assures the Department that the award and execution of the contract would not cause a violation of Section 50-15, and that the bidder has no knowledge of any facts relevant to the kinds of acts prohibited therein.

C. Inducements

Section 50-25. Inducement.

Any person who offers or pays any money or other valuable thing to any person to induce him or her not to bid for a State contract or as recompense for not having bid on a State contract is guilty of a Class 4 felony. Any person who accepts any money or other valuable thing for not bidding for a State contract or who withholds a bid in consideration of the promise for the payment of money or other valuable thing is guilty of a Class 4 felony.

The bidder assures the Department that the award and execution of the contract would not cause a violation of Section 50-25, and that the bidder has no knowledge of any facts relevant to the kinds of acts prohibited therein.

D. Revolving Door Prohibition

Section 50-30. Revolving door prohibition.

CPOs, SPOs, procurement compliance monitors, their designees whose principal duties are directly related to State procurement, and executive officers confirmed by the Senate are expressly prohibited for a period of 2 years after terminating an affected position from engaging in any procurement activity relating to the State agency most recently employing them in an affected position for a period of at least 6 months. The prohibition includes, but is not limited to: lobbying the procurement process; specifying; bidding; proposing bid, proposal, or contract documents; on their own behalf or on behalf of any firm, partnership, association, or corporation. This Section applies only to persons who terminate an affected position on or after January 15, 1999.

The bidder assures the Department that the award and execution of the contract would not cause a violation of Section 50-30, and that the bidder has no knowledge of any facts relevant to the kinds of acts prohibited therein.

E. Reporting Anticompetitive Practices

Section 50-40. Reporting anticompetitive practices.

When, for any reason, any vendor, bidder, contractor, CPO, SPO, designee, elected official, or State employee suspects collusion or other anticompetitive practice among any bidders, offerors, contractors, proposers, or employees of the State, a notice of the relevant facts shall be transmitted to the Attorney General and the CPO.

The bidder assures the Department that it has not failed to report any relevant facts concerning the practices addressed in Section 50-40 which may involve the contract for which the bid is submitted.

F. Confidentiality

Section 50-45. Confidentiality.

Any CPO, SPO, designee, or executive officer who willfully uses or allows the use of specifications, competitive bid documents, proprietary competitive information, proposals, contracts, or selection information to compromise the fairness or integrity of the procurement, bidding, or contract process shall be subject to immediate dismissal, regardless of the Personnel code, any contract, or any collective bargaining agreement, and may in addition be subject to criminal prosecution.

The bidder assures the Department that it has no knowledge of any fact relevant to the practices addressed in Section 50-45 which may involve the contract for which the bid is submitted.

RETURN WITH BID

G. Insider Information

Section 50-50. Insider information.

It is unlawful for any current or former elected or appointed State official or State employee to knowingly use confidential information available only by virtue of that office or employment for actual or anticipated gain for themselves or another person.

The bidder assures the Department that it has no knowledge of any facts relevant to the practices addressed in Section 50-50 which may involve the contract for which the bid is submitted.

I acknowledge, understand and accept these terms and conditions for the above assurances.

III. CERTIFICATIONS

The certifications hereinafter made by the bidder are each a material representation of fact upon which reliance is placed should the Department enter into the contract with the bidder. Section 50-2 of the Code provides that every person that has entered into a multi-year contract and every subcontractor with a multi-year subcontract shall certify, by July 1 of each fiscal year covered by the contract after the initial fiscal year, to the responsible CPO whether it continues to satisfy the requirements of Article 50 pertaining to the eligibility for a contract award. If a contractor or subcontractor is not able to truthfully certify that it continues to meet all requirements, it shall provide with its certification a detailed explanation of the circumstances leading to the change in certification status. A contractor or subcontractor that makes a false statement material to any given certification required under Article 50 is, in addition to any other penalties or consequences prescribed by law, subject to liability under the Whistleblower Reward and Protection Act for submission of a false claim.

A. Bribery

Section 50-5. Bribery.

(a) Prohibition. No person or business shall be awarded a contract or subcontract under this Code who:

(1) has been convicted under the laws of Illinois or any other state of bribery or attempting to bribe an officer or employee of the State of Illinois or any other state in that officer's or employee's official capacity; or

(2) has made an admission of guilt of that conduct that is a matter of record but has not been prosecuted for that conduct.

(b) Businesses. No business shall be barred from contracting with any unit of State or local government, or subcontracting under such a contract, as a result of a conviction under this Section of any employee or agent of the business if the employee or agent is no longer employed by the business and:

(1) the business has been finally adjudicated not guilty; or

(2) the business demonstrates to the governmental entity with which it seeks to contract, or which is signatory to the contract which the subcontract relates, and that entity finds that the commission of the offense was not authorized, requested, commanded, or performed by a director, officer, or high managerial agent on behalf of the business as provided in paragraph (2) of subsection (a) of Section 5-4 of the Criminal Code of 2012.

(c) Conduct on behalf of business. For purposes of this Section, when an official, agent, or employee of a business committed the bribery or attempted bribery on behalf of the business and in accordance with the direction or authorization of a responsible official of the business, the business shall be chargeable with the conduct.

(d) Certification. Every bid submitted to and contract executed by the State, and every subcontract subject to Section 20-120 of the Code shall contain a certification by the contractor or the subcontractor, respectively, that the contractor or subcontractor is not barred from being awarded a contract or subcontract under this Section and acknowledges that the CPO may declare the related contract void if any certifications required by this Section are false. A contractor who makes a false statement, material to the certification, commits a Class 3 felony.

The contractor or subcontractor certifies that it is not barred from being awarded a contract under Section 50.5.

B. Felons

Section 50-10. Felons.

(a) Unless otherwise provided, no person or business convicted of a felony shall do business with the State of Illinois or any State agency, or enter into a subcontract, from the date of conviction until 5 years after the date of completion of the sentence for that felony, unless no person held responsible by a prosecutorial office for the facts upon which the conviction was based continues to have any involvement with the business.

(b) Certification. Every bid submitted to and contract executed by the State and every subcontract subject to Section 20-120 of the Code shall contain a certification by the bidder or contractor or subcontractor, respectively, that the bidder, contractor, or subcontractor is not barred from being awarded a contract or subcontract under this Section and acknowledges that the CPO may declare the related contract void if any of the certifications required by this Section are false.

RETURN WITH BID

C. Debt Delinquency

Section 50-11 and 50-12. Debt Delinquency.

The contractor or bidder or subcontractor, respectively, certifies that it, or any affiliate, is not barred from being awarded a contract or subcontract under the Code. Section 50-11 prohibits a person from entering into a contract with a State agency, or entering into a subcontract, if it knows or should know that it, or any affiliate, is delinquent in the payment of any debt to the State as defined by the Debt Collection Board. Section 50-12 prohibits a person from entering into a contract with a State agency, or entering into a subcontract, if it, or any affiliate, has failed to collect and remit Illinois Use Tax on all sales of tangible personal property into the State of Illinois in accordance with the provisions of the Illinois Use Tax Act. The bidder or contractor or subcontractor, respectively, further acknowledges that the CPO may declare the related contract void if this certification is false or if the bidder, contractor, or subcontractor, or any affiliate, is determined to be delinquent in the payment of any debt to the State during the term of the contract.

D. Prohibited Bidders, Contractors and Subcontractors

Section 50-10.5 and 50-60(c). Prohibited bidders, contractors and subcontractors.

The bidder or contractor or subcontractor, respectively, certifies in accordance with 30 ILCS 500/50-10.5 that no officer, director, partner or other managerial agent of the contracting business has been convicted of a felony under the Sarbanes-Oxley Act of 2002 or a Class 3 or Class 2 felony under the Illinois Securities Law of 1953 or if in violation of Subsection (c) for a period of five years from the date of conviction. Every bid submitted to and contract executed by the State and every subcontract subject to Section 20-120 of the Code shall contain a certification by the bidder, contractor, or subcontractor, respectively, that the bidder, contractor, or subcontractor is not barred from being awarded a contract or subcontract under this Section and acknowledges that the CPO shall declare the related contract void if any of the certifications completed pursuant to this Section are false.

E. Section 42 of the Environmental Protection Act

The bidder or contractor or subcontractor, respectively, certifies in accordance with 30 ILCS 500/50-14 that the bidder, contractor, or subcontractor, is not barred from being awarded a contract or entering into a subcontract under this Section which prohibits the bidding on or entering into contracts with the State of Illinois or a State agency, or entering into any subcontract, that is subject to the Code by a person or business found by a court or the Pollution Control Board to have committed a willful or knowing violation of Section 42 of the Environmental Protection Act for a period of five years from the date of the order. The bidder or contractor or subcontractor, respectively, acknowledges that the CPO may declare the contract void if this certification is false.

F. Educational Loan

Section 3 of the Educational Loan Default Act provides no State agency shall contract with an individual for goods or services if that individual is in default, as defined in Section 2 of this Act, on an educational loan. Any contract used by any State agency shall include a statement certifying that the individual is not in default on an educational loan as provided in this Section.

The bidder, if an individual as opposed to a corporation, partnership or other form of business organization, certifies that the bidder is not in default on an educational loan as provided in Section 3 of the Act.

G. Bid-Rigging/Bid Rotating

Section 33E-11 of the Criminal Code of 2012 provides:

(a) Every bid submitted to and public contract executed pursuant to such bid by the State or a unit of local government shall contain a certification by the prime contractor that the prime contractor is not barred from contracting with any unit of State or local government as a result of a violation of either Section 33E-3 or 33E-4 of this Article.

(b) A contractor who makes a false statement, material to the certification, commits a Class 3 felony.

A violation of Section 33E-3 would be represented by a conviction of the crime of bid-rigging which, in addition to Class 3 felony sentencing, provides that any person convicted of this offense or any similar offense of any state or the United States which contains the same elements as this offense shall be barred for 5 years from the date of conviction from contracting with any unit of State or local government. No corporation shall be barred from contracting with any unit of State or local government as a result of a conviction under this Section of any employee or agent of such corporation if the employee so convicted is no longer employed by the corporation and: (1) it has been finally adjudicated not guilty or (2) if it demonstrates to the governmental entity with which it seeks to contract and that entity finds that the commission of the offense was neither authorized, requested, commanded, nor performed by a director, officer or a high managerial agent in behalf of the corporation.

RETURN WITH BID

A violation of Section 33E-4 would be represented by a conviction of the crime of bid-rotating which, in addition to Class 2 felony sentencing, provides that any person convicted of this offense or any similar offense of any state or the United States which contains the same elements as this offense shall be permanently barred from contracting with any unit of State or local government. No corporation shall be barred from contracting with any unit of State or local government as a result of a conviction under this Section of any employee or agent of such corporation if the employee so convicted is no longer employed by the corporation and: (1) it has been finally adjudicated not guilty or (2) if it demonstrates to the governmental entity with which it seeks to contract and that entity finds that the commission of the offense was neither authorized, requested, commanded, nor performed by a director, officer or a high managerial agent in behalf of the corporation.

The bidder certifies that it is not barred from contracting with the Department by reason of a violation of either Section 33E-3 or Section 33E-4.

H. International Anti-Boycott

Section 5 of the International Anti-Boycott Certification Act provides every contract entered into by the State of Illinois for the manufacture, furnishing, or purchasing of supplies, material, or equipment or for the furnishing of work, labor, or services, in an amount exceeding the threshold for small purchases according to the purchasing laws of this State or \$10,000.00, whichever is less, shall contain certification, as a material condition of the contract, by which the contractor agrees that neither the contractor nor any substantially-owned affiliated company is participating or shall participate in an international boycott in violation of the provisions of the U.S. Export Administration Act of 1979 or the regulations of the U.S. Department of Commerce promulgated under that Act.

The bidder makes the certification set forth in Section 5 of the Act.

I. Drug Free Workplace

The Illinois "Drug Free Workplace Act" applies to this contract and it is necessary to comply with the provisions of the "Act" if the contractor is a corporation, partnership, or other entity (including a sole proprietorship) which has 25 or more employees.

The bidder certifies that if awarded a contract in excess of \$5,000 it will provide a drug free workplace in compliance with the provisions of the Act.

J. Disclosure of Business Operations in Iran

Section 50-36 of the Code, 30ILCS 500/50-36 provides that each bid, offer, or proposal submitted for a State contract shall include a disclosure of whether or not the Company acting as the bidder, offeror, or proposing entity, or any of its corporate parents or subsidiaries, within the 24 months before submission of the bid, offer, or proposal had business operations that involved contracts with or provision of supplies or services to the Government of Iran, companies in which the Government of Iran has any direct or indirect equity share, consortiums or projects commissioned by the Government of Iran, or companies involved in consortiums or projects commissioned by the Government of Iran and either of the following conditions apply:

- (1) More than 10% of the Company's revenues produced in or assets located in Iran involve oil-related activities or mineral-extraction activities; less than 75% of the Company's revenues produced in or assets located in Iran involve contracts with or provision of oil-related or mineral-extraction products or services to the Government of Iran or a project or consortium created exclusively by that government; and the Company has failed to take substantial action.
- (2) The Company has, on or after August 5, 1996, made an investment of \$20 million or more, or any combination of investments of at least \$10 million each that in the aggregate equals or exceeds \$20 million in any 12-month period, which directly or significantly contributes to the enhancement of Iran's ability to develop petroleum resources of Iran.

The terms "Business operations", "Company", "Mineral-extraction activities", "Oil-related activities", "Petroleum resources", and "Substantial action" are all defined in the Code.

Failure to make the disclosure required by the Code shall cause the bid, offer or proposal to be considered not responsive. The disclosure will be considered when evaluating the bid or awarding the contract. The name of each Company disclosed as doing business or having done business in Iran will be provided to the State Comptroller.

Check the appropriate statement:

Company has no business operations in Iran to disclose.

Company has business operations in Iran as disclosed the attached document.

RETURN WITH BID

K. Apprenticeship and Training Certification (Does not apply to federal aid projects)

In accordance with the provisions of Section 30-22 (6) of the Code, the bidder certifies that it is a participant, either as an individual or as part of a group program, in the approved apprenticeship and training programs applicable to each type of work or craft that the bidder will perform with its own forces. The bidder further certifies for work that will be performed by subcontract that each of its subcontractors submitted for approval either (a) is, at the time of such bid, participating in an approved, applicable apprenticeship and training program; or (b) will, prior to commencement of performance of work pursuant to this contract, begin participation in an approved apprenticeship and training program applicable to the work of the subcontract. The Department, at any time before or after award, may require the production of a copy of each applicable Certificate of Registration issued by the United States Department of Labor evidencing such participation by the contractor and any or all of its subcontractors. Applicable apprenticeship and training programs are those that have been approved and registered with the United States Department of Labor. The bidder shall list in the space below, the official name of the program sponsor holding the Certificate of Registration for all of the types of work or crafts in which the bidder is a participant and that will be performed with the bidder's forces. Types of work or craft work that will be subcontracted shall be included and listed as subcontract work. The list shall also indicate any type of work or craft job category that does not have an applicable apprenticeship or training program. **The bidder is responsible for making a complete report and shall make certain that each type of work or craft job category that will be utilized on the project as reported on the Construction Employee Workforce Projection (Form BC-1256) and returned with the bid is accounted for and listed.**

NA-FEDERAL

The requirements of this certification and disclosure are a material part of the contract, and the contractor shall require this certification provision to be included in all approved subcontracts. In order to fulfill this requirement, it shall not be necessary that an applicable program sponsor be currently taking or that it will take applications for apprenticeship, training or employment during the performance of the work of this contract.

RETURN WITH BID

L. Political Contributions and Registration with the State Board of Elections

Sections 20-160 and 50-37 of the Code regulate political contributions from business entities and any affiliated entities or affiliated persons bidding on or contracting with the state. Generally under Section 50-37, any business entity, and any affiliated entity or affiliated person of the business entity, whose current year contracts with all state agencies exceed an awarded value of \$50,000, are prohibited from making any contributions to any political committees established to promote the candidacy of the officeholder responsible for the awarding of the contracts or any other declared candidate for that office for the duration of the term of office of the incumbent officeholder or a period 2 years after the termination of the contract, whichever is longer. Any business entity and affiliated entities or affiliated persons whose state contracts in the current year do not exceed an awarded value of \$50,000, but whose aggregate pending bids and proposals on state contracts exceed \$50,000, either alone or in combination with contracts not exceeding \$50,000, are prohibited from making any political contributions to any political committee established to promote the candidacy of the officeholder responsible for awarding the pending contract during the period beginning on the date the invitation for bids or request for proposals is issued and ending on the day after the date of award or selection if the entity was not awarded or selected. Section 20-160 requires certification of registration of affected business entities in accordance with procedures found in Section 9-35 of The Election Code.

By submission of a bid, the contractor business entity acknowledges and agrees that it has read and understands Sections 20-160 and 50-37 of the Code, and that it makes the following certification:

The undersigned bidder certifies that it has registered as a business with the State Board of Elections and acknowledges a continuing duty to update the registration in accordance with the above referenced statutes. If the business entity is required to register, the CPO shall verify that it is in compliance on the date the bid or proposal is due. The CPO shall not accept a bid or proposal if the business entity is not in compliance with the registration requirements.

These requirements and compliance with the above referenced statutory sections are a material part of the contract, and any breach thereof shall be cause to void the contract under Section 50-60 of the Code. This provision does not apply to Federal-aid contracts.

M. Lobbyist Disclosure

Section 50-38 of the Code requires that any bidder or offeror on a State contract that hires a person required to register under the Lobbyist Registration Act to assist in obtaining a contract shall:

- (i) Disclose all costs, fees, compensation, reimbursements, and other remunerations paid or to be paid to the lobbyist related to the contract,
- (ii) Not bill or otherwise cause the State of Illinois to pay for any of the lobbyist's costs, fees, compensation, reimbursements, or other remuneration, and
- (iii) Sign a verification certifying that none of the lobbyist's costs, fees, compensation, reimbursements, or other remuneration were billed to the State.

This information, along with all supporting documents, shall be filed with the agency awarding the contract and with the Secretary of State. The CPO shall post this information, together with the contract award notice, in the online Procurement Bulletin.

Pursuant to Subsection (c) of this Section, no person or entity shall retain a person or entity to attempt to influence the outcome of a procurement decision made under the Code for compensation contingent in whole or in part upon the decision or procurement. Any person who violates this subsection is guilty of a business offense and shall be fined not more than \$10,000.

Bidder acknowledges that it is required to disclose the hiring of any person required to register pursuant to the Illinois Lobbyist Registration Act (25 ILCS 170) in connection with this contract.

Bidder has not hired any person required to register pursuant to the Illinois Lobbyist Registration Act in connection with this contract.

Or

Bidder has hired the following persons required to register pursuant to the Illinois Lobbyist Registration Act in connection with the contract:

Name and address of person: _____
All costs, fees, compensation, reimbursements and other remuneration paid to said person: _____

I acknowledge, understand and accept these terms and conditions for the above certifications.

RETURN WITH BID

IV. DISCLOSURES

- A. The disclosures hereinafter made by the bidder are each a material representation of fact upon which reliance is placed should the Department enter into the contract with the bidder. The bidder further certifies that the Department has received the disclosure forms for each bid.

The CPO may void the bid, or contract, respectively, if it is later determined that the bidder or subcontractor rendered a false or erroneous disclosure. A contractor or subcontractor may be suspended or debarred for violations of the Code. Furthermore, the CPO may void the contract and the surety providing the performance bond shall be responsible for completion of the contract.

B. Financial Interests and Conflicts of Interest

1. Section 50-35 of the Code provides that all bids of more than \$25,000 shall be accompanied by disclosure of the financial interests of the bidder. This disclosed information for the successful bidder, will be maintained as public information subject to release by request pursuant to the Freedom of Information Act, filed with the Procurement Policy Board, and shall be incorporated as a material term of the contract. Furthermore, pursuant to Section 5-5, the Procurement Policy Board may review a proposal, bid, or contract and issue a recommendation to void a contract or reject a proposal or bid based on any violation of the Code or the existence of a conflict of interest as provided in subsections (b) and (d) of Section 50-35.

The financial interests to be disclosed shall include ownership or distributive income share that is in excess of 5%, or an amount greater than 60% of the annual salary of the Governor, of the bidding entity or its parent entity, whichever is less, unless the contractor or bidder is a publicly traded entity subject to Federal 10K reporting, in which case it may submit its 10K disclosure in place of the prescribed disclosure. If a bidder is a privately held entity that is exempt from Federal 10K reporting, but has more than 200 shareholders, it may submit the information that Federal 10K companies are required to report, and list the names of any person or entity holding any ownership share that is in excess of 5%. The disclosure shall include the names, addresses, and dollar or proportionate share of ownership of each person making the disclosure, their instrument of ownership or beneficial relationship, and notice of any potential conflict of interest resulting from the current ownership or beneficial interest of each person making the disclosure having any of the relationships identified in Section 50-35 and on the disclosure form.

The current annual salary of the Governor is \$177,412.00.

In addition, all disclosures shall indicate any other current or pending contracts, proposals, leases, or other ongoing procurement relationships the bidding entity has with any other unit of state government and shall clearly identify the unit and the contract, proposal, lease, or other relationship.

2. Disclosure Forms. Disclosure Form A is attached for use concerning the individuals meeting the above ownership or distributive share requirements. A separate Disclosure Form A must be submitted with the bid for each individual meeting the above requirements. In addition, a second form (Disclosure Form B) provides for the disclosure of current or pending procurement relationships with other (non-IDOT) state agencies and a total ownership certification. **The forms must be included with each bid.**

C. Disclosure Form Instructions

Form A Instructions for Financial Information & Potential Conflicts of Interest

If the bidder is a publicly traded entity subject to Federal 10K reporting, the 10K Report may be submitted to meet the requirements of Form A. If a bidder is a privately held entity that is exempt from Federal 10K reporting, but has more than 200 shareholders, it may submit the information that Federal 10K companies are required to report, and list the names of any person or entity holding any ownership share that is in excess of 5%. If a bidder is not subject to Federal 10K reporting, the bidder must determine if any individuals are required by law to complete a financial disclosure form. To do this, the bidder should answer each of the following questions. A "YES" answer indicates Form A must be completed. If the answer to each of the following questions is "NO", then the NOT APPLICABLE STATEMENT on Form A must be signed and dated by a person that is authorized to execute contracts for the bidding company. Note: These questions are for assistance only and are not required to be completed.

1. Does anyone in your organization have a direct or beneficial ownership share of greater than 5% of the bidding entity or parent entity? YES ___ NO ___
2. Does anyone in your organization have a direct or beneficial ownership share of less than 5%, but which has a value greater than 60% of the annual salary of the Governor? YES ___ NO ___
3. Does anyone in your organization receive more than 60% of the annual salary of the Governor of the bidding entity's or parent entity's distributive income? YES ___ NO ___
4. Does anyone in your organization receive greater than 5% of the bidding entity's or parent entity's total distributive income, but which is less than 60% of the annual salary of the Governor? YES ___ NO ___

(Note: Only one set of forms needs to be completed per person per bid even if a specific individual would require a yes answer to more than one question.)

A "YES" answer to any of these questions requires the completion of Form A. The bidder must determine each individual in the bidding entity or the bidding entity's parent company that would cause the questions to be answered "Yes". Each form must be signed and dated by a person that is authorized to execute contracts for your organization. **Photocopied or stamped signatures are not acceptable.** The person signing can be, but does not have to be, the person for which the form is being completed. The bidder is responsible for the accuracy of any information provided.

If the answer to each of the above questions is "NO", then the NOT APPLICABLE STATEMENT of Form A must be signed and dated by a person that is authorized to execute contracts for your company.

RETURN WITH BID

Form B: Instructions for Identifying Other Contracts & Procurement Related Information

Disclosure Form B must be completed for each bid submitted by the bidding entity. *Note: Checking the NOT APPLICABLE STATEMENT on Form A does not allow the bidder to ignore Form B. Form B must be completed, checked, and dated or the bidder may be considered nonresponsive and the bid will not be accepted.*

The Bidder shall identify, by checking Yes or No on Form B, whether it has any pending contracts (including leases), bids, proposals, or other ongoing procurement relationship with any other (non-IDOT) State of Illinois agency. If "No" is checked, the bidder only needs to complete the check box on the bottom of Form B. If "Yes" is checked, the bidder must do one of the following:

Option I: If the bidder did not submit an Affidavit of Availability to obtain authorization to bid, the bidder must list all non-IDOT State of Illinois agency pending contracts, leases, bids, proposals, and other ongoing procurement relationships. These items may be listed on Form B or on an attached sheet(s). Do not include IDOT contracts. Contracts with cities, counties, villages, etc. are not considered State of Illinois agency contracts and are not to be included. Contracts with other State of Illinois agencies such as the Department of Natural Resources or the Capital Development Board must be included. Bidders who submit Affidavits of Availability are suggested to use Option II.

Option II: If the bidder is required and has submitted an Affidavit of Availability in order to obtain authorization to bid, the bidder may write or type "See Affidavit of Availability" which indicates that the Affidavit of Availability is incorporated by reference and includes all non-IDOT State of Illinois agency pending contracts, leases, bids, proposals, and other ongoing procurement relationships. For any contracts that are not covered by the Affidavit of Availability, the bidder must identify them on Form B or on an attached sheet(s). These might be such things as leases.

RETURN WITH BID

**ILLINOIS DEPARTMENT
OF TRANSPORTATION**

**Form A
Financial Information &
Potential Conflicts of Interest
Disclosure**

Contractor Name		
Legal Address		
City, State, Zip		
Telephone Number	Email Address	Fax Number (if available)

Disclosure of the information contained in this Form is required by the Section 50-35 of the Code (30 ILCS 500). Vendors desiring to enter into a contract with the State of Illinois must disclose the financial information and potential conflict of interest information as specified in this Disclosure Form. This information shall become part of the publicly available contract file. This Form A must be completed for bids in excess of \$25,000, and for all open-ended contracts. **A publicly traded company may submit a 10K disclosure (or equivalent if applicable) in satisfaction of the requirements set forth in Form A. See Disclosure Form Instructions.**

The current annual salary of the Governor is \$177,412.00.

DISCLOSURE OF FINANCIAL INFORMATION

- 1. Disclosure of Financial Information.** The individual named below has an interest in the BIDDER (or its parent) in terms of ownership or distributive income share in excess of 5%, or an interest which has a value of more than 60% of the annual salary of the Governor. **(Make copies of this form as necessary and attach a separate Disclosure Form A for each individual meeting these requirements)**

FOR INDIVIDUAL (type or print information)	
NAME:	_____
ADDRESS	_____
Type of ownership/distributable income share:	
stock _____	sole proprietorship _____ Partnership _____ other: (explain on separate sheet):
% or \$ value of ownership/distributable income share: _____	

- 2. Disclosure of Potential Conflicts of Interest.** Check "Yes" or "No" to indicate which, if any, of the following potential conflict of interest relationships apply. If the answer to any question is "Yes", please attach additional pages and describe.

- (a) State employment, currently or in the previous 3 years, including contractual employment of services. Yes ___ No ___

If your answer is yes, please answer each of the following questions.

- Are you currently an officer or employee of either the Capitol Development Board or the Illinois State Toll Highway Authority? Yes ___ No ___
- Are you currently appointed to or employed by any agency of the State of Illinois? If you are currently appointed to or employed by any agency of the State of Illinois, and your annual salary exceeds 60% of the annual salary of the Governor provide the name the State agency for which you are employed and your annual salary. _____

RETURN WITH BID

- 3. If you are currently appointed to or employed by any agency of the State of Illinois, and your annual salary exceeds 60% of the annual salary of the Governor, are you entitled to receive (i) more than 7 1/2% of the total distributable income of your firm, partnership, association or corporation, or (ii) an amount in excess of 100% of the annual salary of the Governor? Yes ___ No ___

- 4. If you are currently appointed to or employed by any agency of the State of Illinois, and your annual salary exceeds 60% of the annual salary of the Governor, are you and your spouse or minor children entitled to receive (i) more than 15% in aggregate of the total distributable income of your firm, partnership, association or corporation, or (ii) an amount in excess of two times the salary of the Governor? Yes ___ No ___

(b) State employment of spouse, father, mother, son, or daughter, including contractual employment for services in the previous 2 years.

Yes ___ No ___

If your answer is yes, please answer each of the following questions.

- 1. Is your spouse or any minor children currently an officer or employee of the Capitol Development Board or the Illinois State Toll Highway Authority? Yes ___ No ___

- 2. Is your spouse or any minor children currently appointed to or employed by any agency of the State of Illinois? If your spouse or minor children is/are currently appointed to or employed by any agency of the State of Illinois, and his/her annual salary exceeds 60% of the annual salary of the Governor, provide the name of the spouse and/or minor children, the name of the State agency for which he/she is employed and his/her annual salary. _____

-
- 3. If your spouse or any minor children is/are currently appointed to or employed by any agency of the State of Illinois, and his/her annual salary exceeds 60% of the annual salary of the Governor, are you entitled to receive (i) more than 7 1/2% of the total distributable income of your firm, partnership, association or corporation, or (ii) an amount in excess 100% of the annual salary of the Governor? Yes ___ No ___

 - 4. If your spouse or any minor children are currently appointed to or employed by any agency of the State of Illinois, and his/her annual salary exceeds 60% of the annual salary of the Governor, are you and your spouse or any minor children entitled to receive (i) more than 15% in the aggregate of the total distributable income from your firm, partnership, association or corporation, or (ii) an amount in excess of two times the salary of the Governor? Yes ___ No ___

(c) Elective status; the holding of elective office of the State of Illinois, the government of the United States, any unit of local government authorized by the Constitution of the State of Illinois or the statutes of the State of Illinois currently or in the previous 3 years.

Yes ___ No ___

(d) Relationship to anyone holding elective office currently or in the previous 2 years; spouse, father, mother, son, or daughter.

Yes ___ No ___

(e) Appointive office; the holding of any appointive government office of the State of Illinois, the United State of America, or any unit of local government authorized by the Constitution of the State of Illinois or the statutes of the State of Illinois, which office entitles the holder to compensation in excess of the expenses incurred in the discharge of that office currently or in the previous 3 years.

Yes ___ No ___

(f) Relationship to anyone holding appointive office currently or in the previous 2 years; spouse, father, mother, son, or daughter.

Yes ___ No ___

(g) Employment, currently or in the previous 3 years, as or by any registered lobbyist of the State government.

Yes ___ No ___

RETURN WITH BID

(h) Relationship to anyone who is or was a registered lobbyist in the previous 2 years; spouse, father, mother, son, or daughter. Yes ___ No ___

(i) Compensated employment, currently or in the previous 3 years, by any registered election or reelection committee registered with the Secretary of State or any county clerk of the State of Illinois, or any political action committee registered with either the Secretary of State or the Federal Board of Elections. Yes ___ No ___

(j) Relationship to anyone; spouse, father, mother, son, or daughter; who was a compensated employee in the last 2 years by any registered election or re-election committee registered with the Secretary of State or any county clerk of the State of Illinois, or any political action committee registered with either the Secretary of State or the Federal Board of Elections. Yes ___ No ___

3. Communication Disclosure.

Disclose the name and address of each lobbyist and other agent of the bidder or offeror who is not identified in Section 2 of this form, who is has communicated, is communicating, or may communicate with any State officer or employee concerning the bid or offer. This disclosure is a continuing obligation and must be promptly supplemented for accuracy throughout the process and throughout the term of the contract. If no person is identified, enter "None" on the line below:

Name and address of person(s): _____

RETURN WITH BID

4. Debarment Disclosure. For each of the persons identified under Sections 2 and 3 of this form, disclose whether any of the following has occurred within the previous 10 years: debarment from contracting with any governmental entity; professional licensure discipline; bankruptcies; adverse civil judgments and administrative findings; and criminal felony convictions. This disclosure is a continuing obligation and must be promptly supplemented for accuracy throughout the procurement process and term of the contract. If no person is identified, enter "None" on the line below:

Name of person(s): _____

Nature of disclosure: _____

APPLICABLE STATEMENT

This Disclosure Form A is submitted on behalf of the INDIVIDUAL named on previous page. Under penalty of perjury, I certify the contents of this disclosure to be true and accurate to the best of my knowledge.

Completed by: _____
Signature of Individual or Authorized Representative Date

NOT APPLICABLE STATEMENT

Under penalty of perjury, I have determined that no individuals associated with this organization meet the criteria that would require the completion of this Form A.

This Disclosure Form A is submitted on behalf of the CONTRACTOR listed on the previous page.

Signature of Authorized Representative Date

The bidder has a continuing obligation to supplement these disclosures under Sec. 50-35 of the Code.

RETURN WITH BID

ILLINOIS DEPARTMENT OF TRANSPORTATION

Form B Other Contracts & Financial Related Information Disclosure

Contractor Name, Legal Address, City, State, Zip, Telephone Number, Email Address, Fax Number (if available)

Disclosure of the information contained in this Form is required by the Section 50-35 of the Code (30 ILCS 500). This information shall become part of the publicly available contract file. This Form B must be completed for bids in excess of \$25,000, and for all open-ended contracts.

DISCLOSURE OF OTHER CONTRACTS AND PROCUREMENT RELATED INFORMATION

1. Identifying Other Contracts & Procurement Related Information. The BIDDER shall identify whether it has any pending contracts (including leases), bids, proposals, or other ongoing procurement relationship with any other State of Illinois agency: Yes ___ No ___

If "No" is checked, the bidder only needs to complete the signature box on the bottom of this page.

2. If "Yes" is checked. Identify each such relationship by showing State of Illinois agency name and other descriptive information such as bid or project number (attach additional pages as necessary). SEE DISCLOSURE FORM INSTRUCTIONS:

THE FOLLOWING STATEMENT MUST BE CHECKED

Signature of Authorized Representative, Date

OWNERSHIP CERTIFICATION

Please certify that the following statement is true if the individuals for all submitted Form A disclosures do not total 100% of ownership.

Any remaining ownership interest is held by individuals receiving less than \$106,447.20 of the bidding entity's or parent entity's distributive income or holding less than a 5% ownership interest.

Yes No N/A (Form A disclosure(s) established 100% ownership)

RETURN WITH BID

SPECIAL NOTICE TO CONTRACTORS

The following requirements of the Illinois Department of Human Rights' Rules and Regulations are applicable to bidders on all construction contracts advertised by the Illinois Department of Transportation:

CONSTRUCTION EMPLOYEE UTILIZATION PROJECTION

- (a) All bidders on construction contracts shall complete and submit, along with and as part of their bids, a Bidder's Employee Utilization Form (Form BC-1256) setting forth a projection and breakdown of the total workforce intended to be hired and/or allocated to such contract work by the bidder including a projection of minority and female employee utilization in all job classifications on the contract project.
- (b) The Department of Transportation shall review the Employee Utilization Form, and workforce projections contained therein, of the contract awardee to determine if such projections reflect an underutilization of minority persons and/or women in any job classification in accordance with the Equal Employment Opportunity Clause and Section 7.2 of the Illinois Department of Human Rights' Rules and Regulations for Public Contracts adopted as amended on September 17, 1980. If it is determined that the contract awardee's projections reflect an underutilization of minority persons and/or women in any job classification, it shall be advised in writing of the manner in which it is underutilizing and such awardee shall be considered to be in breach of the contract unless, prior to commencement of work on the contract project, it submits revised satisfactory projections or an acceptable written affirmative action plan to correct such underutilization including a specific timetable geared to the completion stages of the contract.
- (c) The Department of Transportation shall provide to the Department of Human Rights a copy of the contract awardee's Employee Utilization Form, a copy of any required written affirmative action plan, and any written correspondence related thereto. The Department of Human Rights may review and revise any action taken by the Department of Transportation with respect to these requirements.

RETURN WITH BID

**Contract No. 64J29
LEE-OGLE Counties
Section (109,110)RS-5
Project ACRS-ACM-000S(957)
Routes FAS 1177 & FAU 5452
District 2 Construction Funds**

PART II. WORKFORCE PROJECTION - continued

- B. Included in "Total Employees" under Table A is the total number of **new hires** that would be employed in the event the undersigned bidder is awarded this contract.

The undersigned bidder projects that: (number) _____ new hires would be recruited from the area in which the contract project is located; and/or (number) _____ new hires would be recruited from the area in which the bidder's principal office or base of operation is located.

- C. Included in "Total Employees" under Table A is a projection of numbers of persons to be employed directly by the undersigned bidder as well as a projection of numbers of persons to be employed by subcontractors.

The undersigned bidder estimates that (number) _____ persons will be directly employed by the prime contractor and that (number) _____ persons will be employed by subcontractors.

PART III. AFFIRMATIVE ACTION PLAN

- A. The undersigned bidder understands and agrees that in the event the foregoing minority and female employee utilization projection included under **PART II** is determined to be an underutilization of minority persons or women in any job category, and in the event that the undersigned bidder is awarded this contract, he/she will, prior to commencement of work, develop and submit a written Affirmative Action Plan including a specific timetable (geared to the completion stages of the contract) whereby deficiencies in minority and/or female employee utilization are corrected. Such Affirmative Action Plan will be subject to approval by the contracting agency and the **Department of Human Rights**.
- B. The undersigned bidder understands and agrees that the minority and female employee utilization projection submitted herein, and the goals and timetable included under an Affirmative Action Plan if required, are deemed to be part of the contract specifications.

Company _____ Telephone Number _____

Address _____

NOTICE REGARDING SIGNATURE

The Bidder's signature on the Proposal Signature Sheet will constitute the signing of this form. The following signature block needs to be completed only if revisions are required.

Signature: _____ Title: _____ Date: _____

- Instructions: All tables must include subcontractor personnel in addition to prime contractor personnel.
- Table A - Include both the number of employees that would be hired to perform the contract work and the total number currently employed (Table B) that will be allocated to contract work, and include all apprentices and on-the-job trainees. The "Total Employees" column should include all employees including all minorities, apprentices and on-the-job trainees to be employed on the contract work.
 - Table B - Include all employees currently employed that will be allocated to the contract work including any apprentices and on-the-job trainees currently employed.
 - Table C - Indicate the racial breakdown of the total apprentices and on-the-job trainees shown in Table A.

RETURN WITH BID

ADDITIONAL FEDERAL REQUIREMENTS

In addition to the Required Contract Provisions for Federal-Aid Construction Contracts (FHWA 1273), all bidders make the following certifications.

- A. By the execution of this proposal, the signing bidder certifies that the bidding entity has not, either directly or indirectly, entered into any agreement, participated in any collusion, or otherwise taken any action, in restraint of free competitive bidding in connection with the submitted bid. This statement made by the undersigned bidder is true and correct under penalty of perjury under the laws of the United States.
- B. **CERTIFICATION, EQUAL EMPLOYMENT OPPORTUNITY:**
1. Have you participated in any previous contracts or subcontracts subject to the equal opportunity clause. YES _____ NO _____
 2. If answer to #1 is yes, have you filed with the Joint Reporting Committee, the Director of OFCC, any Federal agency, or the former President's Committee on Equal Employment Opportunity, all reports due under the applicable filing requirements of those organizations?
YES _____ NO _____

RETURN WITH BID

**Contract No. 64J29
LEE-OGLE Counties
Section (109,110)RS-5
Project ACRS-ACM-000S(957)
Routes FAS 1177 & FAU 5452
District 2 Construction Funds**

PROPOSAL SIGNATURE SHEET

The undersigned bidder hereby makes and submits this bid on the subject Proposal, thereby assuring the Department that all requirements of the Invitation for Bids and rules of the Department have been met, that there is no misunderstanding of the requirements of paragraph 3 of this Proposal, and that the contract will be executed in accordance with the rules of the Department if an award is made on this bid.

(IF AN INDIVIDUAL)

Firm Name _____
Signature of Owner _____
Business Address _____

(IF A CO-PARTNERSHIP)

Firm Name _____
By _____
Business Address _____
Name and Address of All Members of the Firm:

(IF A CORPORATION)

Corporate Name _____
By _____
Signature of Authorized Representative

Typed or printed name and title of Authorized Representative
Attest _____
Signature
(IF A JOINT VENTURE, USE THIS SECTION FOR THE MANAGING PARTY AND THE SECOND PARTY SHOULD SIGN BELOW)
Business Address _____

(IF A JOINT VENTURE)

Corporate Name _____
By _____
Signature of Authorized Representative

Typed or printed name and title of Authorized Representative
Attest _____
Signature
Business Address _____

If more than two parties are in the joint venture, please attach an additional signature sheet.



This Annual Proposal Bid Bond shall become effective at 12:01 AM (CDST) on _____ and shall be valid until _____ 11:59 PM (CDST).

KNOW ALL PERSONS BY THESE PRESENTS, That We _____

as PRINCIPAL, and _____

as SURETY, and held jointly, severally and firmly bound unto the STATE OF ILLINOIS in the penal sum of 5 percent of the total bid price, or for the amount specified in the bid proposal under "Proposal Guaranty" in effect on the date of the Invitation for Bids, whichever is the lesser sum, well and truly to be paid unto said STATE OF ILLINOIS, for the payment of which we bind ourselves, our heirs, executors, administrators, successors and assigns.

THE CONDITION OF THE FOREGOING OBLIGATION IS SUCH that whereas, the PRINCIPAL may submit bid proposal(s) to the STATE OF ILLINOIS, acting through the Department of Transportation, for various improvements published in the Transportation Bulletin during the effective term indicated above.

NOW, THEREFORE, if the Department shall accept the bid proposal(s) of the PRINCIPAL; and if the PRINCIPAL shall, within the time and as specified in the bidding and contract documents; and if, after award by the Department, the PRINCIPAL shall enter into a contract in accordance with the terms of the bidding and contract documents including evidence of the required insurance coverages and providing such bond as specified with good and sufficient surety for the faithful performance of such contract and for the prompt payment of labor and material furnished in the prosecution thereof; or if, in the event of the failure of the PRINCIPAL to enter into such contract and to give the specified bond, the PRINCIPAL pays to the Department the difference not to exceed the penalty hereof between the amount specified in the bid proposal and such larger amount for which the Department may contract with another party to perform the work covered by said bid proposal, then this obligation shall be null and void, otherwise, it shall remain in full force and effect.

IN THE EVENT the Department determines the PRINCIPAL has failed to comply with any requirement as set forth in the preceding paragraph, then Surety shall pay the penal sum to the Department within fifteen (15) days of written demand therefor. If Surety does not make full payment within such period of time, the Department may bring an action to collect the amount owed. Surety is liable to the Department for all its expenses, including attorney's fees, incurred in any litigation in which it prevails either in whole or in part.

In TESTIMONY WHEREOF, the said PRINCIPAL has caused this instrument to be signed by its officer _____ day of _____ A.D., _____.

In TESTIMONY WHEREOF, the said SURETY has caused this instrument to be signed by its officer _____ day of _____ A.D., _____.

(Company Name)

(Company Name)

By _____
(Signature and Title)

By _____
(Signature of Attorney-in-Fact)

Notary for PRINCIPAL

Notary for SURETY

STATE OF _____
COUNTY OF _____

STATE OF _____
COUNTY OF _____

Signed and attested before me on _____ (date)

Signed and attested before me on _____ (date)

by _____
(Name of Notary Public)

by _____
(Name of Notary Public)

(Seal) _____
(Signature of Notary Public)

(Seal) _____
(Signature of Notary Public)

(Date Commission Expires)

(Date Commission Expires)

In lieu of completing the above section of the Annual Proposal Bid Bond form, the Principal may file an Electronic Bid Bond. By signing the proposal(s) the Principal is ensuring the identified electronic bid bond has been executed and the Principal and Surety are firmly bound unto the State of Illinois under the conditions of the bid bond as shown above.

Electronic Bid Bond ID #	Company/Bidder Name	Signature and Title
--------------------------	---------------------	---------------------

This bond may be terminated, at Surety's request, upon giving not less than thirty (30) days prior written notice of the cancellation/termination of the bond. Said written notice shall be issued to the Illinois Department of Transportation, Chief Contracts Official, 2300 South Dirksen Parkway, Springfield, Illinois, 62764, and shall be served in person, by receipted courier delivery or certified or registered mail, return receipt requested. Said notice period shall commence on the first calendar day following the Department's receipt of written cancellation/termination notice. Surety shall remain firmly bound to all obligations herein for proposals submitted prior to the cancellation/termination. Surety shall be released and discharged from any obligation(s) for proposals submitted for any letting or date after the effective date of cancellation/termination.



Item No. _____

Letting Date _____

KNOW ALL PERSONS BY THESE PRESENTS, That We _____

as PRINCIPAL, and _____

as SURETY, and held jointly, severally and firmly bound unto the STATE OF ILLINOIS in the penal sum of 5 percent of the total bid price, or for the amount specified in the bid proposal under "Proposal Guaranty" in effect on the date of the Invitation for Bids, whichever is the lesser sum, well and truly to be paid unto said STATE OF ILLINOIS, for the payment of which we bind ourselves, our heirs, executors, administrators, successors and assigns.

THE CONDITION OF THE FOREGOING OBLIGATION IS SUCH that whereas, the PRINCIPAL has submitted a bid proposal to the STATE OF ILLINOIS, acting through the Department of Transportation, for the improvement designated by the Transportation Bulletin Item Number and Letting Date indicated above.

NOW, THEREFORE, if the Department shall accept the bid proposal of the PRINCIPAL; and if the PRINCIPAL shall, within the time and as specified in the bidding and contract documents; and if, after award by the Department, the PRINCIPAL shall enter into a contract in accordance with the terms of the bidding and contract documents including evidence of the required insurance coverages and providing such bond as specified with good and sufficient surety for the faithful performance of such contract and for the prompt payment of labor and material furnished in the prosecution thereof; or if, in the event of the failure of the PRINCIPAL to enter into such contract and to give the specified bond, the PRINCIPAL pays to the Department the difference not to exceed the penalty hereof between the amount specified in the bid proposal and such larger amount for which the Department may contract with another party to perform the work covered by said bid proposal, then this obligation shall be null and void, otherwise, it shall remain in full force and effect.

IN THE EVENT the Department determines the PRINCIPAL has failed to comply with any requirement as set forth in the preceding paragraph, then Surety shall pay the penal sum to the Department within fifteen (15) days of written demand therefor. If Surety does not make full payment within such period of time, the Department may bring an action to collect the amount owed. Surety is liable to the Department for all its expenses, including attorney's fees, incurred in any litigation in which it prevails either in whole or in part.

In TESTIMONY WHEREOF, the said PRINCIPAL has caused this instrument to be signed by its officer _____ day of _____ A.D., _____

(Company Name)

By _____
(Signature and Title)

Notary for PRINCIPAL

STATE OF _____
COUNTY OF _____

Signed and attested before me on _____ (date)
by _____
(Name of Notary Public)

(Seal) _____
(Signature of Notary Public)

(Date Commission Expires)

In TESTIMONY WHEREOF, the said SURETY has caused this instrument to be signed by its officer _____ day of _____ A.D., _____

(Company Name)

By _____
(Signature of Attorney-in-Fact)

Notary for SURETY

STATE OF _____
COUNTY OF _____

Signed and attested before me on _____ (date)
by _____
(Name of Notary Public)

(Seal) _____
(Signature of Notary Public)

(Date Commission Expires)

In lieu of completing the above section of the Proposal Bid Bond form, the Principal may file an Electronic Bid Bond. By signing the proposal the Principal is ensuring the identified electronic bid bond has been executed and the Principal and Surety are firmly bound unto the State of Illinois under the conditions of the bid bond as shown above.

Electronic Bid Bond ID # _____ Company/Bidder Name _____ Signature and Title _____

(1) Policy

It is public policy that disadvantageded businesses as defined in 49 CFR Part 26 and the Special Provision shall have the maximum opportunity to participate in the performance of contracts financed in whole or in part with Federal or State funds. Consequently the requirements of 49 CFR Part 26 apply to this contract.

(2) Obligation

The contractor agrees to ensure that disadvantageded businesses as defined in 49 CFR Part 26 and the Special Provision have the maximum opportunity to participate in the performance of contracts or subcontracts financed in whole or in part with Federal or State funds. The contractor shall take all necessary and reasonable steps in accordance with 49 CFR Part 26 and the Special Provision to ensure that said businesses have the maximum opportunity to compete for and perform under this contract. The contractor shall not discriminate on the basis of race, color, national origin or sex in the award and performance of contracts.

(3) Project and Bid Identification

Complete the following information concerning the project and bid:

Route _____	Total Bid _____
Section _____	Contract DBE Goal _____
Project _____	(Percent) (Dollar Amount)
County _____	
Letting Date _____	
Contract No. _____	
Letting Item No. _____	

(4) Assurance

I, acting in my capacity as an officer of the undersigned bidder (or bidders if a joint venture), hereby assure the Department that on this project my company : (check one)

Meets or exceeds contract award goals and has provided documented participation as follows:
Disadvantaged Business Participation _____ percent

Attached are the signed participation statements, forms SBE 2025, required by the Special Provision evidencing availability and use of each business participating in this plan and assuring that each business will perform a commercially useful function in the work of the contract.

Failed to meet contract award goals and has included good faith effort documentation to meet the goals and that my company has provided participation as follows:
Disadvantaged Business Participation _____ percent

The contract goals should be accordingly modified or waived. Attached is all information required by the Special Provision in support of this request including good faith effort. Also attached are the signed participation statements, forms SBE 2025, required by the Special Provision evidencing availability and use of each business participating in this plan and assuring that each business will perform a commercially useful function in the work of the contract.

Company

By _____

Title _____

Date _____

The "as read" Low Bidder is required to comply with the Special Provision.

Submit only one utilization plan for each project. The utilization plan shall be submitted in accordance with the special provision.

Bureau of Small Business Enterprises **Local Let Projects**
2300 South Dirksen Parkway Submit forms to the
Springfield, Illinois 62764 Local Agency

The Department of Transportation is requesting disclosure of information that is necessary to accomplish the purpose as outlined under State and Federal law. Disclosure of this information is **REQUIRED**. Failure to provide any information will result in the contract not being awarded. This form has been approved by the State Forms Manager Center.



Subcontractor Registration _____

Letting _____

Participation Statement

Item No. _____

(1) Instructions

Contract _____

This form must be completed for each disadvantaged business participating in the Utilization Plan. This form shall be submitted in accordance with the special provision and will be attached to the Utilization Plan form.. If additional space is needed complete an additional form for the firm.

(2) Work

Table with 5 columns: Pay Item No., Description, Quantity, Unit Price, Total. Includes a Total row at the bottom right.

(3) Partial Payment Items

For any of the above items which are partial pay items, specifically describe the work and subcontract dollar amount:

(4) Commitment

The undersigned certify that the information included herein is true and correct, and that the DBE firm listed below has agreed to perform a commercially useful function in the work of the contract item(s) listed above and to execute a contract with the prime contractor. The undersigned further understand that no changes to this statement may be made without prior approval from the Department’s Bureau of Small Business Enterprises and that complete and accurate information regarding actual work performed on this project and the payment therefore must be provided to the Department.

Signature for Prime Contractor

Signature for DBE Firm

Title _____

Title _____

Date _____

Date _____

Contact _____

Contact Person _____

Phone _____

Phone _____

Firm Name _____

Firm Name _____

Address _____

Address _____

City/State/Zip _____

City/State/Zip _____

E _____

WC _____

The Department of Transportation is requesting disclosure of information that is necessary to accomplish the statutory purpose as outlined under the state and federal law. Disclosure of this information is REQUIRED. Failure to provide any information will result in the contract not being awarded. This form has been approved by the State Forms Management Center.

PROPOSAL ENVELOPE



PROPOSALS

for construction work advertised for bids by the
Illinois Department of Transportation

Item No.	Item No.	Item No.

Submitted By:

Name:
Address:
Phone No.

Bidders should use an IDOT proposal envelope or affix this form to the front of a 10" x 13" envelope for the submittal of bids. If proposals are mailed, they should be enclosed in a second or outer envelope addressed to:

Engineer of Design and Environment - Room 326
Illinois Department of Transportation
2300 South Dirksen Parkway
Springfield, Illinois 62764

NOTICE

Individual bids, including Bid Bond and/or supplemental information if required, should be securely stapled.

CONTRACTOR OFFICE COPY OF CONTRACT SPECIFICATIONS

NOTICE

None of the following material needs to be returned with the bid package unless the special provisions require documentation and/or other information to be submitted.

**Contract No. 64J29
LEE-OGLE Counties
Section (109,110)RS-5
Project ACRS-ACM-000S(957)
Routes FAS 1177 & FAU 5452
District 2 Construction Funds**



Illinois Department of Transportation

SUBCONTRACTOR DOCUMENTATION

Public Acts 96-0795, 96-0920, and 97-0895 enacted substantial changes to the provisions of the Code (30 ILCS 500). Among the changes are provisions affecting subcontractors. The Contractor awarded this contract will be required as a material condition of the contract to implement and enforce the contract requirements applicable to subcontractors that entered into a contractual agreement with a total value of \$50,000 or more with a person or entity who has a contract subject to the Code and approved in accordance with article 108.01 of the Standard Specifications for Road and Bridge Construction.

If the Contractor seeks approval of subcontractors to perform a portion of the work, and approval is granted by the Department, the Contractor shall provide a copy of the subcontract to the Illinois Department of Transportation's CPO upon request within 15 calendar days after execution of the subcontract.

Financial disclosures required pursuant to Sec. 50-35 of the Code must be submitted for all applicable subcontractors. The subcontract shall contain the certifications required to be made by subcontractors pursuant to Article 50 of the Code. This Notice to Bidders includes a document incorporating all required subcontractor certifications and disclosures for use by the Contractor in compliance with this mandate. The document is entitled State Required Ethical Standards Governing Subcontractors.

RETURN WITH SUBCONTRACT

STATE ETHICAL STANDARDS GOVERNING SUBCONTRACTORS

Article 50 of the Code establishes the duty of all State CPOs, SPOs, and their designees to maximize the value of the expenditure of public moneys in procuring goods, services, and contracts for the State of Illinois and to act in a manner that maintains the integrity and public trust of State government. In discharging this duty, they are charged by law to use all available information, reasonable efforts, and reasonable actions to protect, safeguard, and maintain the procurement process of the State of Illinois.

The certifications hereinafter made by the subcontractor are each a material representation of fact upon which reliance is placed should the Department approve the subcontractor. The CPO may terminate or void the contract approval if it is later determined that the bidder or subcontractor rendered a false or erroneous certification. If a false certification is made by a subcontractor the contractor's submitted bid and the executed contract may not be declared void unless the contractor refuses to terminate the subcontract upon the State's request after a finding that the subcontractor's certification was false.

Section 50-2 of the Code provides that every person that has entered into a multi-year contract and every subcontractor with a multi-year subcontract shall certify, by July 1 of each fiscal year covered by the contract after the initial fiscal year, to the responsible CPO whether it continues to satisfy the requirements of Article 50 pertaining to the eligibility for a contract award. If a contractor or subcontractor is not able to truthfully certify that it continues to meet all requirements, it shall provide with its certification a detailed explanation of the circumstances leading to the change in certification status. A contractor or subcontractor that makes a false statement material to any given certification required under Article 50 is, in addition to any other penalties or consequences prescribed by law, subject to liability under the Whistleblower Reward and Protection Act for submission of a false claim.

A. Bribery

Section 50-5. Bribery.

(a) Prohibition. No person or business shall be awarded a contract or subcontract under this Code who:

(1) has been convicted under the laws of Illinois or any other state of bribery or attempting to bribe an officer or employee of the State of Illinois or any other state in that officer's or employee's official capacity; or

(2) has made an admission of guilt of that conduct that is a matter of record but has not been prosecuted for that conduct.

(b) Businesses. No business shall be barred from contracting with any unit of State or local government, or subcontracting under such a contract, as a result of a conviction under this Section of any employee or agent of the business if the employee or agent is no longer employed by the business and:

(1) the business has been finally adjudicated not guilty; or

(2) the business demonstrates to the governmental entity with which it seeks to contract, or which is signatory to the contract to which the subcontract relates, and that entity finds that the commission of the offense was not authorized, requested, commanded, or performed by a director, officer, or high managerial agent on behalf of the business as provided in paragraph (2) of subsection (a) of Section 5-4 of the Criminal Code of 2012.

(c) Conduct on behalf of business. For purposes of this Section, when an official, agent, or employee of a business committed the bribery or attempted bribery on behalf of the business and in accordance with the direction or authorization of a responsible official of the business, the business shall be chargeable with the conduct.

(d) Certification. Every bid submitted to and contract executed by the State, and every subcontract subject to Section 20-120 of the Code shall contain a certification by the contractor or the subcontractor, respectively, that the contractor or subcontractor is not barred from being awarded a contract or subcontract under this Section and acknowledges that the CPO may declare the related contract void if any certifications required by this Section are false. A contractor who makes a false statement, material to the certification, commits a Class 3 felony.

The contractor or subcontractor certifies that it is not barred from being awarded a contract under Section 50.5.

B. Felons

Section 50-10. Felons.

(a) Unless otherwise provided, no person or business convicted of a felony shall do business with the State of Illinois or any State agency, or enter into a subcontract, from the date of conviction until 5 years after the date of completion of the sentence for that felony, unless no person held responsible by a prosecutorial office for the facts upon which the conviction was based continues to have any involvement with the business.

(b) Certification. Every bid submitted to and contract executed by the State and every subcontract subject to Section 20-120 of the Code shall contain a certification by the bidder or contractor or subcontractor, respectively, that the bidder, contractor, or subcontractor is not barred from being awarded a contract or subcontract under this Section and acknowledges that the CPO may declare the related contract void if any of the certifications required by this Section are false.

RETURN WITH SUBCONTRACT

C. Debt Delinquency

Section 50-11 and 50-12. Debt Delinquency.

The contractor or bidder or subcontractor, respectively, certifies that it, or any affiliate, is not barred from being awarded a contract or subcontract under the Code. Section 50-11 prohibits a person from entering into a contract with a State agency, or entering into a subcontract, if it knows or should know that it, or any affiliate, is delinquent in the payment of any debt to the State as defined by the Debt Collection Board. Section 50-12 prohibits a person from entering into a contract with a State agency, or entering into a subcontract, if it, or any affiliate, has failed to collect and remit Illinois Use Tax on all sales of tangible personal property into the State of Illinois in accordance with the provisions of the Illinois Use Tax Act. The bidder or contractor or subcontractor, respectively, further acknowledges that the CPO may declare the related contract void if this certification is false or if the bidder, contractor, or subcontractor, or any affiliate, is determined to be delinquent in the payment of any debt to the State during the term of the contract.

D. Prohibited Bidders, Contractors and Subcontractors

Section 50-10.5 and 50-60(c). Prohibited bidders, contractors and subcontractors.

The bidder or contractor or subcontractor, respectively, certifies in accordance with 30 ILCS 500/50-10.5 that no officer, director, partner or other managerial agent of the contracting business has been convicted of a felony under the Sarbanes-Oxley Act of 2002 or a Class 3 or Class 2 felony under the Illinois Securities Law of 1953 or if in violation of Subsection (c) for a period of five years from the date of conviction. Every bid submitted to and contract executed by the State and every subcontract subject to Section 20-120 of the Code shall contain a certification by the bidder, contractor, or subcontractor, respectively, that the bidder, contractor, or subcontractor is not barred from being awarded a contract or subcontract under this Section and acknowledges that the CPO shall declare the related contract void if any of the certifications completed pursuant to this Section are false.

E. Section 42 of the Environmental Protection Act

The bidder or contractor or subcontractor, respectively, certifies in accordance with 30 ILCS 500/50-14 that the bidder, contractor, or subcontractor, is not barred from being awarded a contract or entering into a subcontract under this Section which prohibits the bidding on or entering into contracts with the State of Illinois or a State agency, or entering into any subcontract, that is subject to the Code by a person or business found by a court or the Pollution Control Board to have committed a willful or knowing violation of Section 42 of the Environmental Protection Act for a period of five years from the date of the order. The bidder or contractor or subcontractor, respectively, acknowledges that the CPO may declare the contract void if this certification is false.

The undersigned, on behalf of the subcontracting company, has read and understands the above certifications and makes the certifications as required by law.

<hr style="border: 0; border-top: 1px solid black; margin-bottom: 5px;"/> Name of Subcontracting Company		
<hr style="border: 0; border-top: 1px solid black; margin-bottom: 5px;"/> Authorized Officer	<hr style="border: 0; border-top: 1px solid black; margin-bottom: 5px;"/> Date	

RETURN WITH SUBCONTRACT
SUBCONTRACTOR DISCLOSURES

I. DISCLOSURES

- A. The disclosures hereinafter made by the subcontractor are each a material representation of fact upon which reliance is placed. The subcontractor further certifies that the Department has received the disclosure forms for each subcontract.

The CPO may void the bid, contract, or subcontract, respectively, if it is later determined that the bidder or subcontractor rendered a false or erroneous disclosure. A contractor or subcontractor may be suspended or debarred for violations of the Code. Furthermore, the CPO may void the contract.

B. Financial Interests and Conflicts of Interest

1. Section 50-35 of the Code provides that all subcontracts with a total value of \$50,000 or more, from subcontractors identified in Section 20-120 of the Code, shall be accompanied by disclosure of the financial interests of the subcontractor. This disclosed information for the subcontractor, will be maintained as public information subject to release by request pursuant to the Freedom of Information Act, filed with the Procurement Policy Board, and shall be incorporated as a material term of the Prime Contractor's contract. Furthermore, pursuant to this Section, the Procurement Policy Board may recommend to allow or void a contract or subcontract based on a potential conflict of interest.

The financial interests to be disclosed shall include ownership or distributive income share that is in excess of 5%, or an amount greater than 60% of the annual salary of the Governor, of the subcontracting entity or its parent entity, whichever is less, unless the subcontractor is a publicly traded entity subject to Federal 10K reporting, in which case it may submit its 10K disclosure in place of the prescribed disclosure. If a subcontractor is a privately held entity that is exempt from Federal 10K reporting, but has more than 200 shareholders, it may submit the information that Federal 10K companies are required to report, and list the names of any person or entity holding any ownership share that is in excess of 5%. The disclosure shall include the names, addresses, and dollar or proportionate share of ownership of each person making the disclosure, their instrument of ownership or beneficial relationship, and notice of any potential conflict of interest resulting from the current ownership or beneficial interest of each person making the disclosure having any of the relationships identified in Section 50-35 and on the disclosure form.

The current annual salary of the Governor is \$177,412.00.

In addition, all disclosures shall indicate any other current or pending contracts, subcontracts, proposals, leases, or other ongoing procurement relationships the subcontracting entity has with any other unit of state government and shall clearly identify the unit and the contract, subcontract, proposal, lease, or other relationship.

2. Disclosure Forms. Disclosure Form A is attached for use concerning the individuals meeting the above ownership or distributive share requirements. A separate Disclosure Form A must be submitted with the bid for each individual meeting the above requirements. In addition, a second form (Disclosure Form B) provides for the disclosure of current or pending procurement relationships with other (non-IDOT) state agencies and a total ownership certification. **The forms must be included with each bid.**

C. Disclosure Form Instructions

Form A Instructions for Financial Information & Potential Conflicts of Interest

If the subcontractor is a publicly traded entity subject to Federal 10K reporting, the 10K Report may be submitted to meet the requirements of Form A. If a subcontractor is a privately held entity that is exempt from Federal 10K reporting, but has more than 200 shareholders, it may submit the information that Federal 10K companies are required to report, and list the names of any person or entity holding any ownership share that is in excess of 5%. If a subcontractor is not subject to Federal 10K reporting, the subcontractor must determine if any individuals are required by law to complete a financial disclosure form. To do this, the subcontractor should answer each of the following questions. A "YES" answer indicates Form A must be completed. If the answer to each of the following questions is "NO", then the **NOT APPLICABLE STATEMENT** on the second page of Form A must be signed and dated by a person that is authorized to execute contracts for the subcontracting company. Note: These questions are for assistance only and are not required to be completed.

1. Does anyone in your organization have a direct or beneficial ownership share of greater than 5% of the bidding entity or parent entity? YES ___ NO ___
2. Does anyone in your organization have a direct or beneficial ownership share of less than 5%, but which has a value greater than 60% of the annual salary of the Governor? YES ___ NO ___
3. Does anyone in your organization receive more than 60% of the annual salary of the Governor of the subcontracting entity's or parent entity's distributive income? YES ___ NO ___

(Note: Distributive income is, for these purposes, any type of distribution of profits. An annual salary is not distributive income.)

4. Does anyone in your organization receive greater than 5% of the subcontracting entity's or parent entity's total distributive income, but which is less than 60% of the annual salary of the Governor? YES ___ NO ___

(Note: Only one set of forms needs to be completed per person per subcontract even if a specific individual would require a yes answer to more than one question.)

A "YES" answer to any of these questions requires the completion of Form A. The subcontractor must determine each individual in the subcontracting entity or the subcontracting entity's parent company that would cause the questions to be answered "Yes". Each form must be signed and dated by a person that is authorized to execute contracts for your organization. **Photocopied or stamped signatures are not acceptable.** The person signing can be, but does not have to be, the person for which the form is being completed. The subcontractor is responsible for the accuracy of any information provided.

If the answer to each of the above questions is "NO", then the **NOT APPLICABLE STATEMENT** on page 2 of Form A must be signed and dated by a person that is authorized to execute contracts for your company.

RETURN WITH SUBCONTRACT

Form B: Instructions for Identifying Other Contracts & Procurement Related Information

Disclosure Form B must be completed for each subcontract submitted by the subcontracting entity. *Note: Checking the NOT APPLICABLE STATEMENT on Form A does not allow the subcontractor to ignore Form B. Form B must be completed, checked, and dated or the subcontract will not be approved.*

The Subcontractor shall identify, by checking Yes or No on Form B, whether it has any pending contracts, subcontracts, leases, bids, proposals, or other ongoing procurement relationship with any other (non-IDOT) State of Illinois agency. If "No" is checked, the subcontractor only needs to complete the check box on the bottom of Form B. If "Yes" is checked, the subcontractor must list all non-IDOT State of Illinois agency pending contracts, subcontracts, leases, bids, proposals, and other ongoing procurement relationships. These items may be listed on Form B or on an attached sheet(s). Contracts with cities, counties, villages, etc. are not considered State of Illinois agency contracts and are not to be included. Contracts or subcontracts with other State of Illinois agencies such as the Department of Natural Resources or the Capital Development Board must be included.

**ILLINOIS DEPARTMENT
OF TRANSPORTATION**

**Form A
Subcontractor: Financial
Information & Potential Conflicts
of Interest Disclosure**

Subcontractor Name		
Legal Address		
City, State, Zip		
Telephone Number	Email Address	Fax Number (if available)

Disclosure of the information contained in this Form is required by the Section 50-35 of the Code (30 ILCS 500). Subcontractors desiring to enter into a subcontract of a State of Illinois contract must disclose the financial information and potential conflict of interest information as specified in this Disclosure Form. This information shall become part of the publicly available contract file. This Form A must be completed for subcontracts with a total value of \$50,000 or more, from subcontractors identified in Section 20-120 of the Code, and for all open-ended contracts. **A publicly traded company may submit a 10K disclosure (or equivalent if applicable) in satisfaction of the requirements set forth in Form A. See Disclosure Form Instructions.**

The current annual salary of the Governor is \$177,412.00.

DISCLOSURE OF FINANCIAL INFORMATION

1. Disclosure of Financial Information. The individual named below has an interest in the SUBCONTRACTOR (or its parent) in terms of ownership or distributive income share in excess of 5%, or an interest which has a value of more than 60% of the annual salary of the Governor. **(Make copies of this form as necessary and attach a separate Disclosure Form A for each individual meeting these requirements)**

FOR INDIVIDUAL (type or print information)	
NAME:	_____
ADDRESS	_____
Type of ownership/distributable income share:	
stock _____ sole proprietorship _____ Partnership _____ other: (explain on separate sheet):	
% or \$ value of ownership/distributable income share:	_____

2. Disclosure of Potential Conflicts of Interest. Check "Yes" or "No" to indicate which, if any, of the following potential conflict of interest relationships apply. If the answer to any question is "Yes", please attach additional pages and describe.

(a) State employment, currently or in the previous 3 years, including contractual employment of services.

Yes ___ No ___

If your answer is yes, please answer each of the following questions.

1. Are you currently an officer or employee of either the Capitol Development Board or the Illinois State Toll Highway Authority? Yes ___ No ___

2. Are you currently appointed to or employed by any agency of the State of Illinois? If you are currently appointed to or employed by any agency of the State of Illinois, and your annual salary exceeds 60% of the annual salary of the Governor, provide the name the State agency for which you are employed and your annual salary. _____

RETURN WITH SUBCONTRACT

3. If you are currently appointed to or employed by any agency of the State of Illinois, and your annual salary exceeds 60% of the annual salary of the Governor, are you entitled to receive (i) more than 7 1/2% of the total distributable income of your firm, partnership, association or corporation, or (ii) an amount in excess of 100% of the annual salary of the Governor?
Yes ___ No ___

4. If you are currently appointed to or employed by any agency of the State of Illinois, and your annual salary exceeds 60% of the annual salary of the Governor, are you and your spouse or minor children entitled to receive (i) more than 15 % in the aggregate of the total distributable income of your firm, partnership, association or corporation, or (ii) an amount in excess of two times the salary of the Governor?
Yes ___ No ___

(b) State employment of spouse, father, mother, son, or daughter, including contractual employment services in the previous 2 years.

Yes ___ No ___

If your answer is yes, please answer each of the following questions.

1. Is your spouse or any minor children currently an officer or employee of the Capitol Development Board or the Illinois State Toll Highway Authority?
Yes ___ No ___

2. Is your spouse or any minor children currently appointed to or employed by any agency of the State of Illinois? If your spouse or minor children is/are currently appointed to or employed by any agency of the State of Illinois, and his/her annual salary exceeds 60% of the annual salary of the Governor, provide the name of your spouse and/or minor children, the name of the State agency for which he/she is employed and his/her annual salary. _____

3. If your spouse or any minor children is/are currently appointed to or employed by any agency of the State of Illinois, and his/her annual salary exceeds 60% of the annual salary of the Governor, are you entitled to receive (i) more than 7 1/2% of the total distributable income of your firm, partnership, association or corporation, or (ii) an amount in excess of 100% of the annual salary of the Governor?
Yes ___ No ___

4. If your spouse or any minor children are currently appointed to or employed by any agency of the State of Illinois, and his/her annual salary exceeds 60% of the annual salary of the Governor, are you and your spouse or minor children entitled to receive (i) more than 15 % in the aggregate of the total distributable income of your firm, partnership, association or corporation, or (ii) an amount in excess of two times the salary of the Governor?
Yes ___ No ___

(c) Elective status; the holding of elective office of the State of Illinois, the government of the United States, any unit of local government authorized by the Constitution of the State of Illinois or the statutes of the State of Illinois currently or in the previous 3 years.
Yes ___ No ___

(d) Relationship to anyone holding elective office currently or in the previous 2 years; spouse, father, mother, son, or daughter.
Yes ___ No ___

(e) Appointive office; the holding of any appointive government office of the State of Illinois, the United States of America, or any unit of local government authorized by the Constitution of the State of Illinois or the statutes of the State of Illinois, which office entitles the holder to compensation in excess of the expenses incurred in the discharge of that office currently or in the previous 3 years.
Yes ___ No ___

(f) Relationship to anyone holding appointive office currently or in the previous 2 years; spouse, father, mother, son, or daughter.
Yes ___ No ___

(g) Employment, currently or in the previous 3 years, as or by any registered lobbyist of the State government.
Yes ___ No ___

RETURN WITH SUBCONTRACT

(h) Relationship to anyone who is or was a registered lobbyist in the previous 2 years; spouse, father, mother, son, or daughter. Yes ___ No ___

(i) Compensated employment, currently or in the previous 3 years, by any registered election or reelection committee registered with the Secretary of State or any county clerk of the State of Illinois, or any political action committee registered with either the Secretary of State or the Federal Board of Elections. Yes ___ No ___

(j) Relationship to anyone; spouse, father, mother, son, or daughter; who was a compensated employee in the last 2 years by any registered election or re-election committee registered with the Secretary of State or any county clerk of the State of Illinois, or any political action committee registered with either the Secretary of State or the Federal Board of Elections. Yes ___ No ___

3 Communication Disclosure.

Disclose the name and address of each lobbyist and other agent of the bidder or offeror who is not identified in Section 2 of this form, who is has communicated, is communicating, or may communicate with any State officer or employee concerning the bid or offer. This disclosure is a continuing obligation and must be promptly supplemented for accuracy throughout the process and throughout the term of the contract. If no person is identified, enter "None" on the line below:

Name and address of person(s): _____

RETURN WITH SUBCONTRACT

4. Debarment Disclosure. For each of the persons identified under Sections 2 and 3 of this form, disclose whether any of the following has occurred within the previous 10 years: debarment from contracting with any governmental entity; professional licensure discipline; bankruptcies; adverse civil judgments and administrative findings; and criminal felony convictions. This disclosure is a continuing obligation and must be promptly supplemented for accuracy throughout the procurement process and term of the contract. If no person is identified, enter "None" on the line below:

Name of person(s): _____

Nature of disclosure: _____

APPLICABLE STATEMENT

This Disclosure Form A is submitted on behalf of the INDIVIDUAL named on previous page. Under penalty of perjury, I certify the contents of this disclosure to be true and accurate to the best of my knowledge.

Completed by: _____ Date _____
Signature of Individual or Authorized Officer

NOT APPLICABLE STATEMENT

Under penalty of perjury, I have determined that no individuals associated with this organization meet the criteria that would require the completion of this Form A.

This Disclosure Form A is submitted on behalf of the SUBCONTRACTOR listed on the previous page.

_____ Date _____
Signature of Authorized Officer

RETURN WITH SUBCONTRACT

ILLINOIS DEPARTMENT OF TRANSPORTATION

Form B
Subcontractor: Other Contracts & Financial Related Information Disclosure

Form with fields: Subcontractor Name, Legal Address, City, State, Zip, Telephone Number, Email Address, Fax Number (if available)

Disclosure of the information contained in this Form is required by the Section 50-35 of the Code (30 ILCS 500). This information shall become part of the publicly available contract file. This Form B must be completed for subcontracts with a total value of \$50,000 or more, from subcontractors identified in Section 20-120 of the Code, and for all open-ended contracts.

DISCLOSURE OF OTHER CONTRACTS, SUBCONTRACTS, AND PROCUREMENT RELATED INFORMATION

1. Identifying Other Contracts & Procurement Related Information. The SUBCONTRACTOR shall identify whether it has any pending contracts, subcontracts, including leases, bids, proposals, or other ongoing procurement relationship with any other State of Illinois agency: Yes ___ No ___

If "No" is checked, the subcontractor only needs to complete the signature box on the bottom of this page.

2. If "Yes" is checked. Identify each such relationship by showing State of Illinois agency name and other descriptive information such as bid or project number (attach additional pages as necessary). SEE DISCLOSURE FORM INSTRUCTIONS:

THE FOLLOWING STATEMENT MUST BE CHECKED

Signature box with fields for Signature of Authorized Officer and Date

OWNERSHIP CERTIFICATION

Please certify that the following statement is true if the individuals for all submitted Form A disclosures do not total 100% of ownership

Any remaining ownership interest is held by individuals receiving less than \$106,447.20 of the bidding entity's or parent entity's distributive income or holding less than a 5% ownership interest.

Yes No N/A (Form A disclosure(s) established 100% ownership)



NOTICE TO BIDDERS

- 1. TIME AND PLACE OF OPENING BIDS.** Sealed proposals for the improvement described herein will be received by the Department of Transportation. Electronic bids are to be submitted to the electronic bidding system (ics-Integrated Contractors Exchange). Paper-based bids are to be submitted to the Chief Procurement Officer for the Department of Transportation in care of the Chief Contracts Official at the Harry R. Hanley Building, 2300 South Dirksen Parkway, in Springfield, Illinois until 10:00 o'clock a.m. February 28, 2014. All bids will be gathered, sorted, publicly opened and read in the auditorium at the Department of Transportation's Harry R. Hanley Building shortly after the 10:00 a.m. cut off time.
- 2. DESCRIPTION OF WORK.** The proposed improvement is identified and advertised for bids in the Invitation for Bids as:

**Contract No. 64J29
LEE-OGLE Counties
Section (109,110)RS-5
Project ACRS-ACM-000S(957)
Routes FAS 1177 & FAU 5452
District 2 Construction Funds**

13.6 miles of resurfacing on IL 251 from I-88 to Chicago Rd. in Lee and Ogle Counties.

- 3. INSTRUCTIONS TO BIDDERS.** (a) This Notice, the invitation for bids, proposal and letter of award shall, together with all other documents in accordance with Article 101.09 of the Standard Specifications for Road and Bridge Construction, become part of the contract. Bidders are cautioned to read and examine carefully all documents, to make all required inspections, and to inquire or seek explanation of the same prior to submission of a bid.

(b) State law, and, if the work is to be paid wholly or in part with Federal-aid funds, Federal law requires the bidder to make various certifications as a part of the proposal and contract. By execution and submission of the proposal, the bidder makes the certification contained therein. A false or fraudulent certification shall, in addition to all other remedies provided by law, be a breach of contract and may result in termination of the contract.
- 4. AWARD CRITERIA AND REJECTION OF BIDS.** This contract will be awarded to the lowest responsive and responsible bidder considering conformity with the terms and conditions established by the Department in the rules, Invitation for Bids and contract documents. The issuance of plans and proposal forms for bidding based upon a prequalification rating shall not be the sole determinant of responsibility. The Department reserves the right to determine responsibility at the time of award, to reject any or all proposals, to readvertise the proposed improvement, and to waive technicalities.

By Order of the
Illinois Department of Transportation

Ann L. Schneider,
Secretary

INDEX
 FOR
 SUPPLEMENTAL SPECIFICATIONS
 AND RECURRING SPECIAL PROVISIONS

Adopted January 1, 2014

This index contains a listing of SUPPLEMENTAL SPECIFICATIONS, frequently used RECURRING SPECIAL PROVISIONS, and LOCAL ROADS AND STREETS RECURRING SPECIAL PROVISIONS.

ERRATA Standard Specifications for Road and Bridge Construction (Adopted 1-1-12) (Revised 1-1-14)

SUPPLEMENTAL SPECIFICATIONS

<u>Std. Spec. Sec.</u>	<u>Page No.</u>
101 Definition of Terms	1
102 Advertisement, Bidding, Award, and Contract Execution	2
105 Control of Work	3
106 Control of Materials	5
107 Legal Regulations and Responsibility to Public	6
108 Prosecution and Progress	14
109 Measurement and Payment	15
202 Earth and Rock Excavation	17
211 Topsoil and Compost	18
253 Planting Woody Plants	19
280 Temporary Erosion and Sediment Control	21
312 Stabilized Subbase	22
406 Hot-Mix Asphalt Binder and Surface Course	23
407 Hot-Mix Asphalt Pavement (Full-Depth)	26
420 Portland Cement Concrete Pavement	30
424 Portland Cement Concrete Sidewalk	32
440 Removal of Existing Pavement and Appurtenances	33
503 Concrete Structures	34
504 Precast Concrete Structures	37
506 Cleaning and Painting New Steel Structures	38
512 Piling	39
516 Drilled Shafts	40
521 Bearings	41
540 Box Culverts	42
588 Bridge Relief Joint System	43
589 Elastic Joint Sealer	45
602 Catch Basin, Manhole, Inlet, Drainage Structure, and Valve Vault Construction, Adjustment, and Reconstruction	46
603 Adjusting Frames and Grates of Drainage and Utility Structures	47
606 Concrete Gutter, Curb, Median, and Paved Ditch	49
610 Shoulder Inlets with Curb	50
639 Precast Prestressed Concrete Sight Screen	51
642 Shoulder Rumble Strips	52
643 Impact Attenuators	53
644 High Tension Cable Median Barrier	55
701 Work Zone Traffic Control and Protection	57
706 Impact Attenuators, Temporary	60
707 Movable Traffic Barrier	63
708 Temporary Water Filled Barrier	65
730 Wood Sign Support	67
780 Pavement Striping	68
860 Master Controller	73
1001 Cement	74
1003 Fine Aggregates	75
1004 Coarse Aggregates	77
1006 Metals	81
1011 Mineral Filler	83
1017 Packaged, Dry, Combined Materials for Mortar	84
1018 Packaged Rapid Hardening Mortar or Concrete	85
1019 Controlled Low-Strength Material	86

1020	Portland Cement Concrete	87
1024	Grout and Nonshrink Grout	126
1030	Hot-Mix Asphalt	127
1040	Drain Pipe, Tile, Drainage Mat, and Wall Drain	132
1042	Precast Concrete Products	133
1070	Foundation and Breakaway Devices	134
1073	Controller	135
1081	Materials for Planting	136
1082	Preformed Bearing Pads	137
1083	Elastomeric Bearings	138
1095	Pavement Markings	139
1101	General Equipment	142
1102	Hot-Mix Asphalt Equipment	144
1105	Pavement Marking Equipment	146
1106	Work Zone Traffic Control Devices	147

RECURRING SPECIAL PROVISIONS

The following RECURRING SPECIAL PROVISIONS indicated by an "X" are applicable to this contract and are included by reference:

<u>CHECK SHEET #</u>	<u>PAGE NO.</u>
1 X	Additional State Requirements for Federal-Aid Construction Contracts (Eff. 2-1-69) (Rev. 1-1-10) 149
2 X	Subletting of Contracts (Federal-Aid Contracts) (Eff. 1-1-88) (Rev. 5-1-93) 152
3 X	EEO (Eff. 7-21-78) (Rev. 11-18-80) 153
4	Specific Equal Employment Opportunity Responsibilities Non Federal-Aid Contracts (Eff. 3-20-69) (Rev. 1-1-94) 163
5	Required Provisions - State Contracts (Eff. 4-1-65) (Rev. 1-1-13) 168
6	Asbestos Bearing Pad Removal (Eff. 11-1-03) 173
7	Asbestos Waterproofing Membrane and Asbestos Hot-Mix Asphalt Surface Removal (Eff. 6-1-89) (Rev. 1-1-09) 174
8	Haul Road Stream Crossings, Other Temporary Stream Crossings, and In-Stream Work Pads (Eff. 1-2-92) (Rev. 1-1-98) 175
9	Construction Layout Stakes Except for Bridges (Eff. 1-1-99) (Rev. 1-1-07) 176
10	Construction Layout Stakes (Eff. 5-1-93) (Rev. 1-1-07) 179
11	Use of Geotextile Fabric for Railroad Crossing (Eff. 1-1-95) (Rev. 1-1-07) 182
12	Subsealing of Concrete Pavements (Eff. 11-1-84) (Rev. 1-1-07) 184
13	Hot-Mix Asphalt Surface Correction (Eff. 11-1-87) (Rev. 1-1-09) 188
14	Pavement and Shoulder Resurfacing (Eff. 2-1-00) (Rev. 1-1-09) 190
15	PCC Partial Depth Hot-Mix Asphalt Patching (Eff. 1-1-98) (Rev. 1-1-07) 191
16 X	Patching with Hot-Mix Asphalt Overlay Removal (Eff. 10-1-95) (Rev. 1-1-07) 193
17	Polymer Concrete (Eff. 8-1-95) (Rev. 1-1-08) 194
18	PVC Pipeliner (Eff. 4-1-04) (Rev. 1-1-07) 196
19	Pipe Underdrains (Eff. 9-9-87) (Rev. 1-1-07) 197
20 X	Guardrail and Barrier Wall Delineation (Eff. 12-15-93) (Rev. 1-1-12) 198
21	Bicycle Racks (Eff. 4-1-94) (Rev. 1-1-12) 202
22	Temporary Modular Glare Screen System (Eff. 1-1-00) (Rev. 1-1-07) 204
23	Temporary Portable Bridge Traffic Signals (Eff. 8-1-03) (Rev. 1-1-07) 206
24	Work Zone Public Information Signs (Eff. 9-1-02) (Rev. 1-1-07) 208
25	Night Time Inspection of Roadway Lighting (Eff. 5-1-96) 209
26	English Substitution of Metric Bolts (Eff. 7-1-96) 210
27	English Substitution of Metric Reinforcement Bars (Eff. 4-1-96) (Rev. 1-1-03) 211
28	Calcium Chloride Accelerator for Portland Cement Concrete (Eff. 1-1-01) (Rev. 1-1-13) 212
29	Portland Cement Concrete Inlay or Overlay for Pavements (Eff. 11-1-08) (Rev. 1-1-13) 213
30	Quality Control of Concrete Mixtures at the Plant (Eff. 8-1-00) (Rev. 1-1-14) 216
31	Quality Control/Quality Assurance of Concrete Mixtures (Eff. 4-1-92) (Rev. 1-1-14) 224
32	Digital Terrain Modeling for Earthwork Calculations (Eff. 4-1-07) 240
33	Pavement Marking Removal (Eff. 4-1-09) 242
34	Preventive Maintenance – Bituminous Surface Treatment (Eff. 1-1-09) (Rev. 1-1-12) 243
35	Preventive Maintenance – Cape Seal (Eff. 1-1-09) (Rev. 1-1-12) 249
36	Preventive Maintenance – Micro-Surfacing (Eff. 1-1-09) (Rev. 1-1-12) 264
37	Preventive Maintenance – Slurry Seal (Eff. 1-1-09) (Rev. 1-1-12) 275
38	Temporary Raised Pavement Markers (Eff. 1-1-09) (Rev. 1-1-14) 285
39	Restoring Bridge Approach Pavements Using High-Density Foam (Eff. 1-1-09) (Rev. 1-1-12) 286

TABLE OF CONTENTS

LOCATION OF PROJECT	1
DESCRIPTION OF PROJECT	1
TRAFFIC CONTROL PLAN	1
ADJUSTED PLAN QUANTITY FOR SURFACE COURSE MIXTURES	6
CONCRETE CURB REPAIR	6
ENGINEER’S FIELD OFFICE TYPE A	7
GUARDRAIL REMOVAL	7
HOT-MIX ASPHALT MIXTURE IL-9.5FG (BMPR)	7
HOT MIX ASPHALT QUALITY CONTROL FOR PERFORMANCE (BMPR)	11
HOT-MIX ASPHALT SURFACE REMOVAL	15
HOT-MIX ASPHALT SURFACE COURSE, CUT OFF DATE	15
MATERIAL TRANSFER DEVICE (BDE)	15
MILLING RESTRICTIONS	17
REMOVING AND RESETTING STREET SIGNS	17
TRAFFIC CONTROL SURVEILLANCE	17
WORK ZONE PAVEMENT MARKING AND REMOVAL	18
AUTOMATED FLAGGER ASSISTANCE DEVICES (BDE)	18
DISADVANTAGED BUSINESS ENTERPRISE PARTICIPATION (BDE)	20
FRICITION AGGREGATE (BDE)	30
HOT-MIX ASPHALT – MIXTURE DESIGN COMPOSITION AND VOLUMETRIC REQUIREMENTS (BDE)	33
HOT-MIX ASPHALT – MIXTURE DESIGN VERIFICATION AND PRODUCTION (BDE)	36
PAVEMENT MARKING FOR BIKE SYMBOL (BDE)	39
PAVEMENT PATCHING (BDE)	39
PAYROLLS AND PAYROLL RECORDS (BDE)	39
PROGRESS PAYMENTS (BDE)	41
RECLAIMED ASPHALT PAVEMENT AND RECLAIMED ASPHALT SHINGLES (BDE)	42
REMOVAL AND DISPOSAL OF REGULATED SUBSTANCES (BDE)	52
REMOVAL AND DISPOSAL OF SURPLUS MATERIALS (BDE)	56
TRACKING THE USE OF PESTICIDES (BDE)	57
TRAINING SPECIAL PROVISIONS (BDE)	58
IDOT TRAINING PROGRAM GRADUATE ON-THE-JOB TRAINING SPECIAL PROVISION (TPG)	ERROR! BOOKMARK NOT DEFINED.

WARM MIX ASPHALT (BDE) 62
WEEKLY DBE TRUCKING REPORTS (BDE)..... 67
WORKING DAYS (BDE)..... 67
BITUMINOUS MATERIALS COST ADJUSTMENTS (BDE) (RETURN FORM WITH BID)..... 67
FUEL COST ADJUSTMENT (BDE) (RETURN FORM WITH BID)..... 70
PROJECT LABOR AGREEMENT - QUARTERLY EMPLOYMENT REPORT 74
PROJECT LABOR AGREEMENT 75

STATE OF ILLINOIS

SPECIAL PROVISIONS

The following Special Provisions supplement the "Standard Specifications for Road and Bridge Construction, Adopted January 1, 2012", the latest edition of the "Manual on Uniform Traffic Control Devices for Streets and Highways", and the "Manual of Test Procedures for Materials" in effect on the date of invitation for bids, and the "Supplemental Specifications and Recurring Special Provisions" indicated on the Check Sheet included herein, which apply to and govern the construction of FAS Route 1177 & FAU Route 5452 (IL 251), Project ACRS-ACM-000S(957), Section (109, 110)RS-5, Lee & Ogle Counties, Contract 64J29, and in case of conflict with any part, or parts, of said Specifications, the said Special Provisions shall take precedence and shall govern.

LOCATION OF PROJECT

IL 251 from 0.1 mile north of I-88 to Chicago Road.

DESCRIPTION OF PROJECT

This project includes 13.6 miles of patching, milling and hot-mix asphalt resurfacing.

TRAFFIC CONTROL PLAN

Effective January 14, 1999

Traffic Control shall be according to the applicable sections of the Standard Specifications for Road and Bridge Construction, the applicable guidelines contained in the National Manual on Uniform Traffic Control Devices for Streets and Highways, Illinois Supplement to the National Manual on Uniform Traffic Control Devices, these special provisions, and any special details and Highway Standards contained herein and in the plans.

Special attention is called to Articles 107.09 and 107.14 of the Standard Specifications for Road and Bridge Construction and the following Highway Standards relating to traffic control.

Standards:

701001	701006	701011	701201	701301	701306
701311	701326	701421	701426	701456	701601
701701	701901				

Details:

Rough Grooved Surface Sign (DS 91.2)
Traffic Control for Transition Areas (DS 38.1)
Traffic Control & Protection at Turn Bays (to remain open to traffic) (DS 94.2)
Informational Warning Signs (for narrow travel lanes) (DS 39.2)

Signs:

No bracing shall be allowed on post-mounted signs.

Post-mounted signs shall be installed using standard 720011, 728001, 729001, on 4"x4" wood posts, or on any other "break away" connection if accepted by the FHWA and corresponding letter is provided to the resident.

All signs are required on both sides of the road when the median is greater than 10 feet and on one way roadways.

The "WORKERS" (W21-1a(O)-48) signs shall be replaced with symbol "Right or Left Lane Closed Ahead" (W4-2R or L(O)-48) signs on multilane roadways.

"BUMP" (W8-1(O)48) signs shall be installed as directed by the Engineer.

"UNEVEN LANES" W8-11(O)48 signs shall be installed at 1 mile intervals or as directed by the Engineer.

"LOW SHOULDER" W8-9(O)48 signs shall be installed at 1 mile intervals or as directed by the Engineer.

When covering existing Department signs, no tape shall be used on the reflective portion of the sign. Contact the District sign shop for covering techniques.

All regulatory signs shall be maintained at a 5 foot minimum bottom (rural), 7 foot minimum (urban).

Plate altering signs shall have the same sheeting as the base sign.

No more than one (1) plate shall be used to alter a sign.

Any post stubs without a sign in place and visible shall have a reflector placed on each post.

Devices:

Cones or reflectorized cones shall not be used during hours of darkness.

A minimum of 3 drums spaced at 4 feet shall be placed at each return when the sideroad is open.

On all standards and any devices required by Section 701 of the Standard Specifications for Road and Bridge Construction, the device spacing shall be revised to the following dimensions:

Where the spacing shown on the standard is 25 feet, the devices shall be placed at 20 feet.
Where the spacing shown on the standard is 50 feet, the devices shall be placed at 40 feet.
Where the spacing shown on the standard is 100 feet, the devices shall be placed at 80 feet.

Flaggers:

Flagger at Sideroads and Commercial Entrances:

Effective: August 1, 2011

Flaggers shall comply with all requirements contained in the Department's "Flagger Handbook" dated September 2011. The flagger equipment listed for flaggers employed by the Illinois Department of Transportation shall apply to all flaggers.

All workers and flaggers shall wear ANSI Class E pants and an ANSI Class 2 vest that in combination meet the requirements of ANSI/ISEA 107-2004 for Conspicuity Class 3 garments during hours of darkness.

In addition to the flaggers shown on applicable standards, on major sideroads flaggers shall be required on all legs of the intersection. Major sideroads for this project shall be I-88, US 30 and Steward Road.

In addition to the flaggers shown on applicable standards, a flagger shall be required on high volume commercial entrances listed below. High volume commercial entrances for this project shall be NONE.

When the mainline flagger is within 200 feet of an intersection, the sideroad flagger shall be required.

When the road is closed to through traffic and it is necessary to provide access for local traffic, all flaggers as shown on the applicable standards will be required. No reduction in the number of flaggers shall be allowed.

Revise the first and second paragraph of Article 701.20(i) of the Standard Specifications to read:

"Signs, barricades, or other traffic control devices required by the Engineer, over and above those shown on the standard or detailed in the plans and provisions, will be paid for according to Article 109.04. All flaggers required at sideroads and commercial entrances remaining open to traffic not shown on the Highway Standards, required by article 701.13(a) or listed above, shall be paid for according to Article 109.04."

Pavement Marking:

All temporary pavement markings that will be operational during the winter months (December through March) shall be paint.

Short term pavement markings on a milled surface shall be paint.

Temporary pavement markings shall not be included in the cost of the standard rather it shall be paid for separately at the contract unit prices of specified temporary pavement marking items.

Highway Standards Application.

Traffic Control and Protection Standard 701701: This work shall be done according to Section 701 of the Standard Specifications and the Typical Application of Traffic Control Devices for Highway Construction, Standard 701701, and as specified herein.

The “left” leg of the intersection shown on this standard also applies when the right turn lane is closed. When the right turn lane is closed, “RIGHT TURN LANE CLOSED AHEAD” shall be substituted for the LEFT TURN LANE CLOSED AHEAD” and the set up would be a mirror image to what is shown.

This work shall be included in the contract unit price per Lump Sum for TRAFFIC CONTROL AND PROTECTION STANDARD 701701.

Traffic Control and Protection, Standard 701326: This work shall be done according to Section 701 of the Standard Specifications and the Typical Applications of Traffic Control Devices for Highway Construction, Standard 701326, and as specified herein.

Additional barricades, flagger signs, Yield or Stop signs and flaggers shall be required at the intersections. Barricade spacing shall be at 15 foot centers within these intersections and Yield or Stop signs shall be used to control traffic.

When work is within 200 feet of an intersection, flagger signs and flaggers shall be required on the sideroad at the discretion of the Engineer.

These additional devices shall be paid for as part of Traffic Control and Protection 701326 and not as an addition to the contract.

Other Devices.

Traffic Control for Narrow Travel Lanes: The Contractor shall provide informational warning signs regarding narrow travel lanes in construction areas. MAX WIDTH XX'-XX" X MILES AHEAD (W12-I103-48) signs with a width restriction of 12'-0" shall be installed at the following locations and the distance from the crossroads as noted; US 34 & IL 251 (13 MILES AHEAD), US 52 & IL 251 (12 MILES AHEAD), IL 38 & IL 251 (north junction) (2 MILES AHEAD), and at IL 251 & IL 38 (south junction) (1 MILE AHEAD).

The material of these signs shall be 0.125 inch thick aluminum, Type AP White and fluorescent orange reflective sheeting, and 6 inch D Series font Black vinyl lettering meeting the requirements of Sections 1090 and 1091 of the Standard Specifications for Road and Bridge Construction.

Additional Narrow Width (W12-I102(O)-48) signs with a width restriction of 12'-0" and a “___ MILES” (W16-3A(O)-3612) plate mounted below the signs shall be installed near the intersections of IL 251 & Welland Road (7 MILES), IL 251 & Chicago Road, on US 30 at IL 251 with an arrow plate (W1-7 (36x18)) Jack Dame Drive & IL 251, on Steward Road with an arrow (W1-6L (36x18)), and on Perry Road with an arrow plate (W1-7 (36x18)).

The material of these signs shall be 0.125 inch thick aluminum, Type AA Fluorescent orange reflective sheeting, and 12 inch D Series font black vinyl lettering meeting the requirements of Sections 1090 and 1091 of the Standard Specifications for Road and Bridge Construction.

Two signs at each location shall be required where the median is greater than 10 feet.

The Contractor shall notify the Traffic Operations Section of the Bureau of Operations by fax (815/284-5489) and the Bureau of Project Implementation (815/284-5348) in writing by means of fax (to the numbers provided) and also by letter to the District Office. **This request shall be submitted between three and four weeks (21 to 28 days) prior to the anticipated lane restriction to allow the State adequate time to permit wide loads.**

The contractor shall be responsible for providing, erecting, maintaining, and removing these signs. All cost involved in conforming with this provision shall be considered a part of TRAFFIC CONTROL AND PROTECTION STANDARD 701201.

Pilot Car: During the bituminous priming operation, the Contractor shall be required to provide a pilot car to lead the traffic through the areas primed.

The pilot car shall be a pickup truck, carrying the Contractor's company insignia, equipped with "PILOT CAR - FOLLOW ME" (G-20-4(0)) signs. Two signs shall be mounted on the vehicle so as to be clearly visible from both directions. The bottom of the sign shall be mounted at least 1 foot above the top of the cab. The pilot car shall be equipped with a two-way radio so normal communication with the flagger at each end of the work area can be maintained.

The pilot car shall be paid for by the day. If the pilot car is used less than four hours, the operation will be counted as a half day.

This work will be paid for at the contract unit price per Day for PILOT CAR for each car required by the Engineer.

Maintenance of Traffic: The two lane two-way section of the mainline shall be kept open to one-way traffic at all times during working hours and two-way traffic during non-working hours.

The Contractor shall be required to notify the Lee & Ogle County Highway Departments, the corresponding Township Commissioner, emergency response agencies (i.e.: fire, ambulance, police), school bus companies and the Department of Transportation (Bureau of Project Implementation) regarding any changes in traffic control.

The Contractor shall be required to notify the Lee & Ogle County Highway Departments and/or corresponding Township Commissioner for any sideroad closure or opening.

Guardrail work shall be completed using Traffic Control and Protection Standard 701006 and Article 701.17(f).

The Contractor shall have all lanes open on weekends, unless prior approval is obtained from the Resident Engineer.

The pavement patch removal and replacement shall be completed using Traffic Control and Protection Standard 701201, 701601 and Traffic Control at Transitions.

The sawing of patches, resurfacing and placing of shoulder aggregate shall be completed using Traffic Control and Protection Standard 701306, 701601 and Traffic Control at Transitions.

The resurfacing and placing of shoulder aggregate shall be completed using Traffic Control and Protection Standard 701306, 701601 and Traffic Control at Transitions.

Placing and removing pavement marking shall be completed using Traffic Control and Protection Standard 701306, 701311, 701426 or 701701.

The partial ramp closure shall be completed using Traffic Control and Protection Standard 701456.

Guardrail removal and replacement shall be completed Monday – Friday using Traffic Control and Protection Standard 701326.

ADJUSTED PLAN QUANTITY FOR SURFACE COURSE MIXTURES

Effective: June 15, 2010

The adjusted plan quantity for surface course mixtures shall be calculated according to Article 406.13(b) and the following. The maximum allowed average bulk specific gravity for the approved mix design (Gmb) will be:

2.460 for Mixture C

2.470 for Mixture D

2.610 for Mixture E

2.710 for Mixture F

CONCRETE CURB REPAIR

This work shall be done in accordance with Section 440 and 606 of the Standard Specifications and shall include the removal and replacement of the existing curb.

This work will be paid for at the contract unit price per Foot for CONCRETE CURB REPAIR.

ENGINEER'S FIELD OFFICE TYPE A

Effective: January 1, 2012

Engineer's Field Office Type A shall be in accordance with Article 670.02 of the Standard Specifications:

Add (s) to the end of 670.02

(s) Cellular phone with a minimum of 500 anytime minutes per month for use by the site resident engineer/technician.

GUARDRAIL REMOVAL

Effective: August 20, 1990

Revised: August 26, 1997

This work shall be done in accordance with Section 632 of the Standard Specifications except that all removed guardrail will become the property of the Contractor.

This work will be paid for at the contract unit price per Foot for GUARDRAIL REMOVAL, measured from center-to-center of end post.

HOT-MIX ASPHALT MIXTURE IL-9.5FG (BMPR)

Effective: July 1, 2005

Revised: December 28, 2010

Description. This work shall consist of constructing fine graded hot-mix asphalt (HMA) surface course or leveling binder with an IL-9.5FG mixture. Work shall be according to Sections 406, 407 and 1030 of the Standard Specifications, except as modified herein.

Materials. Revise Article 1003.03(c) of the Standard Specifications to read:

“(c) Gradation. The fine aggregate gradation for all HMA shall be FA 1, FA 2, FA 20, or FA 21. For mixture IL-9.5FG, the fine aggregate fraction shall consist of at least 67 percent manufactured sand meeting FA 20 gradation. The manufactured sand shall be stone sand, slag sand, steel slag sand, or combinations thereof.”

Mixture Design. Add the following to the table in Article 1030.04(a)(1):

"High ESAL, MIXTURE COMPOSITION (% PASSING) ^{1/}		
Sieve Size	IL-9.5FG	
	min	max
1 1/2 in (37.5 mm)		
1 in. (25 mm)		
3/4 in. (19 mm)		
1/2 in. (12.5 mm)		100
3/8 in. (9.5 mm)	90	100
#4 (4.75 mm)	60 ^{4/}	75 ^{4/}
#8 (2.36 mm)	45 ^{4/}	60 ^{4/}
#16 (1.18 mm)	25	40
#30 (600 μm)	15	30
#50 (300 μm)	8	15
#100 (150 μm)	6	10
#200 (75 μm)	4	6.5
Ratio Dust/Asphalt Binder		1.0

4/ When used as level binder placed less than 1 in. (25 mm) thick, the min and max percent passing shall each be increased 5%.

Revise the table in Article 1030.04(b)(1) of the Standard Specifications to read:

"VOLUMETRIC REQUIREMENTS High ESAL					
N _{design}	Voids in the Mineral Aggregate (VMA), % minimum				Voids Filled with Asphalt Binder (VFA), %
	IL- 25.0	IL- 19.0	IL- 12.5	IL-9.5	
50	12.0	13.0	14.0	15 ^{1/}	65 - 78
70					
90					
105					65 - 75 ^{2/}

1/ The VMA for IL-9.5FG shall be a minimum of 15.0 percent.

2/ The VFA range for IL-9.5FG shall be 65 - 78 percent."

Quality Control/Quality Assurance (QC/QA). Revise the second table in Article 1030.05(d)(4) to read:

DENSITY CONTROL LIMITS			
Mixture Composition		Parameter	Individual Test ^{3/}
IL-9.5FG	Lifts < 1.25 in. (32 mm)	N _{design} 50 - 105	91.0 – 97.0% ^{2/}
	Lifts ≥ 1.25 in. (32 mm)	N _{design} 50 - 105	93.0 – 97.0%
IL-9.5, IL-12.5		N _{design} ≥ 90	92.0 – 96.0 %
IL-9.5, IL-9.5L, IL-12.5		N _{design} < 90	92.5 – 97.4 %
IL-19.0, IL-25.0		N _{design} ≥ 90	93.0 – 96.0 %
IL-19.0, IL-19.0L, IL-25.0		N _{design} < 90	93.0 – 97.4 %
All Other		N _{design} = 30	93.0 ^{1/} - 97.4 %

1/ 92.0 % when placed as first lift on an unimproved subgrade.

2/ Density shall be determined by cores or by correlated, approved thin lift nuclear gauge.

3/ Bulk Specific Gravity and Density that are determined using coated samples must be in accordance with ASTM 1188-96.

CONSTRUCTION REQUIREMENTS

Leveling Binder. Revise the table and second paragraph of Article 406.05(c) of the Standard Specifications to read:

"Leveling Binder	
Nominal, Compacted, Leveling Binder Thickness, in. (mm)	Mixture Composition
≤ 1 1/4 (32)	IL-9.5, IL-9.5 FG, or IL-9.5L
> 1 1/4 to 2 (32 to 50)	IL-9.5, IL-9.5FG, IL-9.5L, or IL-12.5

The density requirements of Article 1030.05(d)(4) shall apply for leveling binder, machine method, when the nominal, compacted thickness is: 3/4 in. (19 mm) or greater for IL-9.5FG mixtures, 1 1/4 in. (32 mm) or greater for IL-9.5 and IL-9.5L mixtures, and 1 1/2 in. (38 mm) or greater for IL-12.5 mixtures."

Compaction. Revise Table 1 in Article 406.07(a) of the Standard Specifications to read:

"TABLE 1 - MINIMUM ROLLER REQUIREMENTS FOR HMA				
	Breakdown Roller (one of the following)	Intermediate Roller	Final Roller (one or more of the following)	Density Requirement
Level Binder: (When the density requirements of Article 406.05(c) do not apply.)	P 3/	- -	VS, P 3/, TB, TF, 3W	To the satisfaction of the Engineer.
Level Binder: (When placed at $\leq 1 \frac{1}{4}$ (32 mm) and density requirements apply.)	TB, 3W	P 3/	VS, TB, TF	As specified in Articles: 1030.05(d)(3), (d)(4), and (d)(7).
Binder and Surface 1/ (When the density requirements of Article 406.05(c) apply.)	VD, P 3/, TB, 3W	P 3/	VS, TB, TF	As specified in Articles: 1030.05(d)(3), (d)(4), and (d)(7).
Bridge Decks 2/	TB	- -	TF	As specified in Articles: 582.05 and 582.06.

- 1/ If the average delivery at the job site is 85 ton/hr (75 metric ton/hr) or less, any roller combination may be used provided it includes a steel wheeled roller and the required density and smoothness is obtained.
- 2/ One TB may be used for both breakdown and final rolling on bridge decks 300 ft (90 m) or less in length, except when the air temperature is less than 60 °F (15 °C).
- 3/ A vibratory roller (VD) may be used in lieu of the pneumatic-tired roller on mixtures containing polymer modified asphalt binder.

Basis of Payment. Add the following two paragraphs after the third paragraph of Article 406.14 of the Standard Specifications:

"Mixture IL-9.5FG will be paid for at the contract unit price per ton (metric ton) for LEVELING BINDER (HAND METHOD), IL-9.5FG, of the Ndesign specified; LEVELING BINDER (MACHINE METHOD), IL-9.5FG, of the Ndesign specified; or HOT-MIX ASPHALT SURFACE COURSE, IL-9.5FG, of the Ndesign specified.

Mixture IL-9.5FG in which polymer modified asphalt binders are required will be paid for at the contract unit price per ton (metric ton) for POLYMERIZED LEVELING BINDER (HAND METHOD), IL-9.5FG, of the Ndesign specified; POLYMERIZED LEVELING BINDER (MACHINE METHOD), IL-9.5FG, of the Ndesign specified; or POLYMERIZED HOT-MIX ASPHALT SURFACE COURSE, IL-9.5FG, of the Ndesign specified.”

HOT MIX ASPHALT QUALITY CONTROL FOR PERFORMANCE (BMPR)

Effective: January 1, 2012

Revised: December 1, 2013

Description. This special provision describes the procedures for production, placement and payment of hot-mix asphalt (HMA). This work shall be according to the Standard Specifications except as modified herein. This special provision shall apply to HMA mixtures as listed in the following table.

Mixture/Use:	HMA Surface Course, Mix “D”, N50
Location:	Entire project
Mixture/Use:	Leveling Binder (Machine Method) IL-9.5 FG, N50
Location:	Entire project
Mixture/Use:	
Location:	

Exceptions may be approved for small tonnage less than 800 (725 metric) tons and miscellaneous mixture applications as defined by the Engineer.

- Delete Articles:
- 406.06(b)(1), 2nd Paragraph (Temperature requirements)
 - 406.06 (e), 3rd Paragraph (Pavers speed requirements)
 - 406.07 (Compaction)
 - 1030.05(a)(4, 5, 9,) (QC/QA Documents)
 - 1030.05(d)(2)a. (Plant Tests)
 - 1030.05(d)(2)b. (Dust-to-Asphalt and Moisture Content)
 - 1030.05(d)(2)d. (Small Tonnage)
 - 1030.05(d)(2)f. (HMA Sampling)
 - 1030.05(d)(3) (Required Field Tests)
 - 1030.05(d)(4) (Control Limits)
 - 1030.05(d)(5) (Control Charts)
 - 1030.05(d)(7) (Corrective Action for Field Tests (Density))
 - 1030.05(e) (Quality Assurance by the Engineer)
 - 1030.05(f) (Acceptance by the Engineer)
 - 1030.06(a), 3rd paragraph (Before start-up...)
 - 1030.06(a), 7th paragraph (After an acceptable...)
 - 1030.06(a), 8th paragraph (If a mixture...)
 - 1030.06(a), 9th paragraph (A nuclear/core...)

Definitions:

- (a) Quality Control (QC): All production and construction activities by the Contractor required to achieve the required level of quality.
- (b) Quality Assurance (QA): All monitoring and testing activities by the Engineer required to assess product quality, level of payment, and acceptability of the product.
- (c) Pay Parameters: Pay Parameters shall be field Voids in the Mineral Aggregate (VMA), voids, and density. Field VMA will be calculated using the combined aggregates bulk specific gravity (G_{sb}) from the mix design.
- (d) Mixture Lot. A lot shall begin once an acceptable test strip has been completed and the AJMF has been determined. If the test strip is waived, a subplot shall begin with the start of production. A mixture lot shall consist of four sublots unless it is the last or only lot, in which case it may consist of as few as one subplot.
- (e) Mixture Sublot. A mixture subplot for field VMA, voids, and Dust/AC will be a maximum of 1000 tons (910 metric tons).
- If the remaining quantity is greater than 200 but less than 1000 tons, a subplot will consist of that amount.
 - If the remaining quantity is less than or equal to 200 tons, the quantity shall be combined with the previous subplot.
- (f) Density Interval. Density Intervals shall be every 0.2 mile (320 m) for lift thickness equal to or less than 3 in. (75 mm) and 0.1 mile (160 m) for lift thickness greater than 3 in. (75 mm).
- (g) Density Sublot. A subplot for density shall be the average of five consecutive Density Intervals. If a Density Interval is less than 200 ft (60 m), it will be combined with the previous Density Intervals.
- If one or two Density Intervals remain outside a subplot, they shall be included in the previous subplot.
 - If three or more Density Intervals remain, they shall be considered a subplot.
- (h) Density Test: A density test consists of a core taken at a random longitudinal and random transverse offset within each Density Interval. The HMA maximum theoretical gravity (G_{mm}) will be based on the running average of four Department test results. Initial G_{mm} will be based on the average of the first four test results. If less than four G_{mm} results are available, use an average of all available Department G_{mm} test results.

The random transverse offset excludes a distance from each outer edge equal to the lift thickness or a minimum of 4 in. (100 mm). If a core is located within one foot of an unconfined edge, 2.0 percent density will be added to the density of that core.

Quality Control (QC) by the Contractor:

The Contractor’s QC plan shall include the schedule of testing for both pay parameters and non-pay parameters required to control the product such as asphalt binder content and mixture gradation. The minimum test frequency shall be according to the following table.

Minimum Quality Control Sampling and Testing Requirements

Quality Characteristic		Minimum Test Frequency
Mixture Gradation		1 per subplot
Asphalt Binder Content		
Dust/AC Ratio		
Field VMA		
Voids	G_{mb}	
	G_{mm}	

The Contractor’s splits in conjunction with other quality control tests shall be used to control production.

The Contractor shall submit split jobsite mix sample test results to the Engineer within 48 hours of the time of sampling. All QC testing shall be performed in a qualified laboratory by personnel who have successfully completed the Department’s HMA Level I training.

Quality Assurance (QA) by the Engineer:

Voids, field VMA and Dust/AC ratio: The Engineer will determine the random tonnage and the Contractor shall be responsible for obtaining the sample according to the “PFP Hot-Mix Asphalt Random Jobsite Sampling” procedure.

Density: The Engineer will identify the random locations for each density testing interval. The Contractor shall be responsible for obtaining the four inch cores within the same day and prior to opening to traffic unless otherwise approved by the Engineer according to the “PFP and QCP Random Density Procedure”. The locations will be identified after final rolling and cores shall be obtained under the supervision of the Engineer. All core holes shall be filled immediately upon completion of coring. All water shall be removed from the core holes prior to filling. All core holes shall be filled with a rapid hardening mortar or concrete which shall be mixed in a separate container prior to placement in the hole. Any depressions in the surface of the filled core holes greater than 1/4 inch at the time of final inspection will require removal of the fill material to the depth of the lift thickness and replacement.

The Engineer will witness and secure all mixture and density samples. The Contractor shall transport the secured sample to a location designated by the Engineer.

The Engineer will test one or all of the randomly selected split samples from each lot for voids, field VMA and dust/AC ratio. The Engineer will test a minimum of one sample per project. The Engineer will test all of the pavement cores for density. All QA testing will be performed in a qualified laboratory by personnel who have successfully completed the Department's HMA Level I training. QA test results will be available to the Contractor within 10 working days from receipt of secured cores and split mixture samples.

The Engineer will maintain a complete record of all Department test results and copies will be provided to the Contractor with each set of subplot results. The records will contain, as a minimum, the originals of all Department test results and raw data, random numbers used and resulting calculations for sampling locations, and quality level analysis calculations.

If the QA results do not meet the 100% subplot pay factor limits or do not compare to QC results within the precision limits listed below, the Engineer will test all split mix samples for the lot.

Test Parameter	Limits of Precision
G _{mb}	0.030
G _{mm}	0.026
Field VMA	1.0 %

Acceptance by the Engineer: All of the Department's tests shall be within the acceptable limits listed below:

Parameter		Acceptable Limits
Field VMA		-1.0 – +3.0% ^{1/}
Voids		2.0 – 6.0%
Density:	IL-9.5, IL-12.5, IL-19.0, IL-25.0, IL-4.75, IL-9.5FG ^{3/}	90.0 – 98.0%
	SMA	92.0 – 98.0%
Dust / AC Ratio		0.4 – 1.6 ^{2/}

1/ Based on minimum required VMA from mix design

2/ Does not apply to SMA.

3/ Acceptable density limits for IL-9.5FG placed less than 1.25 in. shall be 89.0% - 98.0%

In addition, no visible pavement distresses shall be present such as, but not limited to, segregation, excessive coarse aggregate fracturing or flushing.

Basis of Payment: Payment will be based on the calculation of the Composite Pay Factor using QA results for each mix according to the "QCP Payment Calculation" document.

Dust / AC Ratio. A monetary deduction will be made using the pay adjustment table below for dust/AC ratios that deviate from the 0.6 to 1.2 range. If the tested subplot is outside of this range, the Department will test the remaining sublots for Dust / AC pay adjustment.

Dust / AC Pay Adjustment Table^{1/}

Range	Deduct / subplot
$0.6 \leq X \leq 1.2$	\$0
$0.5 \leq X < 0.6$ or $1.2 < X \leq 1.4$	\$1000
$0.4 \leq X < 0.5$ or $1.4 < X \leq 1.6$	\$3000
$X < 0.4$ or $X > 1.6$	Shall be removed and replaced

1/ Does not apply to SMA

HOT-MIX ASPHALT SURFACE REMOVAL

Effective: February 10, 1995

The taper area with variable depth milling shall be paid for as HOT-MIX ASPHALT SURFACE REMOVAL, 2¼".

This work will be paid for at the contract unit price per Square Yard for HOT-MIX ASPHALT SURFACE REMOVAL, 2¼".

HOT-MIX ASPHALT SURFACE COURSE, CUT OFF DATE

Effective: December 8, 1998

Revised: October 17, 2007

Placement of Hot-Mix Asphalt Surface Course will not be permitted after October 15 unless approved, in writing, by the Resident Engineer.

MATERIAL TRANSFER DEVICE (BDE)

Effective Date: June 15, 1999

Revised Date: January 1, 2009

Description. This work shall consist of placing HMA leveling Binder (Machine Method) and Surface Course Mixtures according to Section 406 of the Standard Specifications, except that these materials shall be placed using a material transfer device.

Materials and Equipment. The material transfer device shall have a minimum surge capacity of 15 tons (13.5 metric tons), shall be self-propelled and capable of moving independent of the paver, and shall be equipped with the following:

- (a) Front-Dump Hopper and Conveyor. The conveyor shall provide a positive restraint along the sides of the conveyor to prevent material spillage. Material Transfer devices having paver style hoppers shall have a horizontal bar restraint placed across the foldable wings which prevents the wings from being folded.
- (b) Paver Hopper Insert. The paver hopper insert shall have a minimum capacity of 14 tons (12.7 metric tons).
- (c) Mixer/Agitator Mechanism. This re-mixing mechanism shall consist of a segmented, anti-segregation, re-mixing auger or two full-length longitudinal paddle mixers designed for the purpose of re-mixing the hot-mix asphalt (HMA). The longitudinal paddle mixers shall be located in the paver hopper insert.

CONSTRUCTION REQUIREMENTS

General. The material transfer device shall be used for the placement of all HMA Leveling Binder (Machine Method) and Surface Course Mixtures placed with a paver, but excluding shoulders. The material transfer device speed shall be adjusted to the speed of the paver to maintain a continuous, non-stop paving operation.

Use of a material transfer device with a roadway contact pressure exceeding 20 psi (138 kPa) will be limited to partially completed segments of full-depth HMA pavement where the thickness of binder in place is 10 in. (250 mm) or greater.

Structures. The material transfer device may be allowed to travel over structures under the following conditions:

- (a) Approval will be given by the Engineer.
- (b) The vehicle shall be emptied of HMA material prior to crossing the structure and shall travel at crawl speed across the structure.
- (c) The tires of the vehicle shall travel on or in close proximity and parallel to the beam and/or girder lines of the structure.

Method of Measurement. This work will be measured for payment in tons (metric tons) for all HMA Leveling Binder (Machine Method) and Surface Course materials placed with a material transfer device.

Basis of Payment. This work will be paid for at the contract unit price per ton (metric ton) for MATERIAL TRANSFER DEVICE.

The various HMA mixtures placed with the material transfer device will be paid for as specified in their respective specifications. The Contractor may choose to use the material transfer device for other applications on this project; however, no additional compensation will be allowed.

MILLING RESTRICTIONS

Milling operations shall be performed such that a vertical milled face no greater than 1½ inches exists between adjacent open lanes of traffic at any time. This may be accomplished by the following treatment methods: Make multiple passes with the mill, each one less the 1½ inches; place a temporary wedge or have milled sloped edge with a minimum 1:3 slope; or mill all lanes in a given area so that no difference in elevation exists when all adjacent lanes are opened to traffic. Other methods may be used if approved by the Engineer prior to implementing the procedure.

This work shall be included in the cost of HMA Surface Removal, at the thickness specified.

REMOVING AND RESETTING STREET SIGNS

This work shall consist of removing and resetting the stop sign at Sta. 471+30 at Butler Hills Road at the proper sight line according to the MUTCD.

If the metal post is damaged by the Contractor, a new one shall be provided by the Contractor, and shall be included in the cost of the removal and resetting according to Article 729 of the Standard Specifications.

This work will be paid for at the contract unit price per Each for REMOVING AND RESETTING STREET SIGNS.

TRAFFIC CONTROL SURVEILLANCE

Effective: January 1, 2011

Revise the first sentence of the first paragraph of Article 701.10 of the Standard Specifications to read:

“When open holes, broken pavement, trenches over 3 in. deep and 4 in. wide or other hazards are present within 8 ft of the edge of an open lane, the Contractor shall furnish traffic control surveillance at all times, whether or not the Contractor is engaged in construction operations.”

WORK ZONE PAVEMENT MARKING AND REMOVAL

Effective: December 29, 2008

This work shall consist of installing and removing temporary pavement marking according to Section 703 of the Standard Specifications and the following:

Paint pavement marking shall be used on the final wearing surface when the temporary pavement marking will conflict with the permanent pavement marking such as on tapers, crossovers and lane shifts.

All temporary paint on the final wearing surface shall be removed according to Article 1101.12 Water Blaster with Vacuum Recovery and the applicable portions of Section 703 of the Standard Specifications and as described herein.

Add the following paragraph to Article 1101.12 of the Standard Specifications.

For the high pressure water spray, the pressure at the nozzle shall be approximately 25,000 psi with maximum flow rate of 15 gal/min. The nozzle shall be in close proximity to the pavement surface.

AUTOMATED FLAGGER ASSISTANCE DEVICES (BDE)

Effective: January 1, 2008

Description. This work shall consist of furnishing and operating automated flagger assistance devices (AFADs) as part of the work zone traffic control and protection for two-lane highways where two-way traffic is maintained over one lane of pavement. Use of these devices shall be at the option of the Contractor.

Equipment. AFADs shall be according to the FHWA memorandum, "MUTCD - Revised Interim Approval for the use of Automated Flagger Assistance Devices in Temporary Traffic Control Zones (IA-4R)", dated January 28, 2005. The devices shall be mounted on a trailer or a moveable cart and shall meet the requirements of NCHRP 350, Category 4.

The AFAD shall be the Stop/Slow type. This device uses remotely controlled "STOP" and "SLOW" signs to alternately control right-of-way.

Signs for the AFAD shall be according to Article 701.03 of the Standard Specifications and the MUTCD. The signs shall be 24 x 24 in. (600 x 600 mm) having an octagon shaped "STOP" sign on one side and a diamond shaped "SLOW" sign on the opposite side. The letters on the signs shall be 8 in. (200 mm) high. If the "STOP" sign has louvers, the full sign face shall be visible at a distance of 50 ft (15 m) and greater.

The signs shall be supplemented with one of the following types of lights.

- (a) Flashing Lights. When flashing lights are used, white or red flashing lights shall be mounted within the "STOP" sign face and white or yellow flashing lights within the "SLOW" sign face.
- (b) Stop and Warning Beacons. When beacons are used, a stop beacon shall be mounted 24 in. (600 mm) or less above the "STOP" sign face and a warning beacon mounted 24 in. (600 mm) or less above, below, or to the side of the "SLOW" sign face. As an option, a Type B warning light may be used in lieu of the warning beacon.

A "WAIT ON STOP" sign shall be placed on the right hand side of the roadway at a point where drivers are expected to stop. The sign shall be 24 x 30 in. (600 x 750 mm) with a black legend and border on a white background. The letters shall be at least 6 in. (150 mm) high.

This device may include a gate arm or mast arm that descends to a horizontal position when the "STOP" sign is displayed and rises to a vertical position when the "SLOW" sign is displayed. When included, the end of the arm shall reach at least to the center of the lane being controlled. The arm shall have alternating red and white retroreflective stripes, on both sides, sloping downward at 45 degrees toward the side on which traffic will pass. The stripes shall be 6 in. (150 mm) in width and at least 2 in. (50 mm) in height.

Flagging Requirements. Flaggers and flagging requirements shall be according to Article 701.13 of the Standard Specifications and the following.

AFADs shall be placed at each end of the traffic control, where a flagger is shown on the plans. The flaggers shall be able to view the face of the AFAD and approaching traffic during operation.

To stop traffic, the "STOP" sign shall be displayed, the corresponding lights/beacon shall flash, and when included, the gate arm shall descend to a horizontal position. To permit traffic to move, the "SLOW" sign shall be displayed, the corresponding lights/beacon shall flash, and when included, the gate arm shall rise to a vertical position.

If used at night, the AFAD location shall be illuminated according to Section 701 of the Standard Specifications.

When not in use, AFADs will be considered nonoperating equipment and shall be stored according to Article 701.11 of the Standard Specifications.

Basis of Payment. This work will not be paid for separately but shall be considered as included in the cost of the various traffic control items included in the contract.

DISADVANTAGED BUSINESS ENTERPRISE PARTICIPATION (BDE)

Effective: September 1, 2000

Revised: August 2, 2011

FEDERAL OBLIGATION. The Department of Transportation, as a recipient of federal financial assistance, is required to take all necessary and reasonable steps to ensure nondiscrimination in the award and administration of contracts. Consequently, the federal regulatory provisions of 49 CFR Part 26 apply to this contract concerning the utilization of disadvantaged business enterprises. For the purposes of this Special Provision, a disadvantaged business enterprise (DBE) means a business certified by the Department in accordance with the requirements of 49 CFR Part 26 and listed in the Illinois Unified Certification Program (IL UCP) DBE Directory.

STATE OBLIGATION. This Special Provision will also be used by the Department to satisfy the requirements of the Business Enterprise for Minorities, Females, and Persons with Disabilities Act, 30 ILCS 575. When this Special Provision is used to satisfy state law requirements on 100 percent state-funded contracts, the federal government has no involvement in such contracts (not a federal-aid contract) and no responsibility to oversee the implementation of this Special Provision by the Department on those contracts. DBE participation on 100 percent state-funded contracts will not be credited toward fulfilling the Department's annual overall DBE goal required by the US Department of Transportation to comply with the federal DBE program requirements.

CONTRACTOR ASSURANCE. The Contractor makes the following assurance and agrees to include the assurance in each subcontract that the Contractor signs with a subcontractor.

The Contractor, subrecipient, or subcontractor shall not discriminate on the basis of race, color, national origin, or sex in the performance of this contract. The Contractor shall carry out applicable requirements of 49 CFR Part 26 in the award and administration of contracts funded in whole or in part with federal or state funds. Failure by the Contractor to carry out these requirements is a material breach of this contract, which may result in the termination of this contract or such other remedy as the recipient deems appropriate.

OVERALL GOAL SET FOR THE DEPARTMENT. As a requirement of compliance with 49 CFR Part 26, the Department has set an overall goal for DBE participation in its federally assisted contracts. That goal applies to all federal-aid funds the Department will expend in its federally assisted contracts for the subject reporting fiscal year. The Department is required to make a good faith effort to achieve the overall goal. The dollar amount paid to all approved DBE companies performing work called for in this contract is eligible to be credited toward fulfillment of the Department's overall goal.

CONTRACT GOAL TO BE ACHIEVED BY THE CONTRACTOR. This contract includes a specific DBE utilization goal established by the Department. The goal has been included because the Department has determined that the work of this contract has subcontracting opportunities that may be suitable for performance by DBE companies. The determination is based on an assessment of the type of work, the location of the work, and the availability of DBE companies to do a part of the work. The assessment indicates that, in the absence of unlawful discrimination, and in an arena of fair and open competition, DBE companies can be expected to perform 7.00% of the work. This percentage is set as the DBE participation goal for this contract. Consequently, in addition to the other award criteria established for this contract, the Department will only award this contract to a bidder who makes a good faith effort to meet this goal of DBE participation in the performance of the work. A bidder makes a good faith effort for award consideration if either of the following is done in accordance with the procedures set for in this Special Provision:

- (a) The bidder documents that enough DBE participation has been obtained to meet the goal: or
- (b) The bidder documents that a good faith effort has been made to meet the goal, even though the effort did not succeed in obtaining enough DBE participation to meet the goal.

DBE LOCATOR REFERENCES. Bidders shall consult the IL UCP DBE Directory as a reference source for DBE-certified companies. In addition, the Department maintains a letting and item specific DBE locator information system whereby DBE companies can register their interest in providing quotes on particular bid items advertised for letting. Information concerning DBE companies willing to quote work for particular contracts may be obtained by contacting the Department's Bureau of Small Business Enterprises at telephone number (217)785-4611, or by visiting the Department's website at www.dot.il.gov.

BIDDING PROCEDURES. Compliance with this Special Provision is a material bidding requirement. The failure of the bidder to comply will render the bid not responsive.

- (a) The bidder shall submit a Disadvantaged Business Utilization Plan on Department forms SBE 2025 and 2026 with the bid.
- (b) The Utilization Plan shall indicate that the bidder either has obtained sufficient DBE participation commitments to meet the contract goal or has not obtained enough DBE participation commitments in spite of a good faith effort to meet the goal. The Utilization Plan shall further provide the name, telephone number, and telefax number of a responsible official of the bidder designated for purposes of notification of plan approval or disapproval under the procedures of this Special Provision.

- (c) The Utilization Plan shall include a DBE Participation Commitment Statement, Department form SBE 2025, for each DBE proposed for the performance of work to achieve the contract goal. For bidding purposes, submission of the completed SBE 2025 forms, signed by the DBEs and faxed to the bidder will be acceptable as long as the original is available and provided upon request. All elements of information indicated on the said form shall be provided, including but not limited to the following:
- (1) The names and addresses of DBE firms that will participate in the contract;
 - (2) A description, including pay item numbers, of the work each DBE will perform;
 - (3) The dollar amount of the participation of each DBE firm participating. The dollar amount of participation for identified work shall specifically state the quantity, unit price, and total subcontract price for the work to be completed by the DBE. If partial pay items are to be performed by the DBE, indicate the portion of each item, a unit price where appropriate and the subcontract price amount;
 - (4) DBE Participation Commitment Statements, form SBE 2025, signed by the bidder and each participating DBE firm documenting the commitment to use the DBE subcontractors whose participation is submitted to meet the contract goal;
 - (5) if the bidder is a joint venture comprised of DBE companies and non-DBE companies, the plan must also include a clear identification of the portion of the work to be performed by the DBE partner(s); and,
 - (6) If the contract goal is not met, evidence of good faith efforts.

GOOD FAITH EFFORT PROCEDURES. The contract will not be awarded until the Utilization Plan submitted by the apparent successful bidder is approved. All information submitted by the bidder must be complete, accurate and adequately document that enough DBE participation has been obtained or document that good faith efforts of the bidder, in the event enough DBE participation has not been obtained, before the Department will commit to the performance of the contract by the bidder. The Utilization Plan will be approved by the Department if the Utilization Plan documents sufficient commercially useful DBE work performance to meet the contract goal or the bidder submits sufficient documentation of a good faith effort to meet the contract goal pursuant to 49 CFR Part 26, Appendix A. The Utilization Plan will not be approved by the Department if the Utilization Plan does not document sufficient DBE participation to meet the contract goal unless the apparent successful bidder documented in the Utilization Plan that it made a good faith effort to meet the goal. This means that the bidder must show that all necessary and reasonable steps were taken to achieve the contract goal. Necessary and reasonable steps are those which, by their scope, intensity and appropriateness to the objective, could reasonably be expected to obtain sufficient DBE participation, even if they were not successful. The Department will consider the quality, quantity, and intensity of the kinds of efforts that the bidder has made. Mere *pro forma* efforts, in other words, efforts done as a matter of form, are not good faith efforts; rather, the bidder is expected to have taken genuine efforts that would be reasonably expected of a bidder actively and aggressively trying to obtain DBE participation sufficient to meet the contract goal.

- (a) The following is a list of types of action that the Department will consider as part of the evaluation of the bidder's good faith efforts to obtain participation. These listed factors are not intended to be a mandatory checklist and are not intended to be exhaustive. Other factors or efforts brought to the attention of the Department may be relevant in appropriate cases, and will be considered by the Department.
- (1) Soliciting through all reasonable and available means (e.g. attendance at pre-bid meetings, advertising and/or written notices) the interest of all certified DBE companies that have the capability to perform the work of the contract. The bidder must solicit this interest within sufficient time to allow the DBE companies to respond to the solicitation. The bidder must determine with certainty if the DBE companies are interested by taking appropriate steps to follow up initial solicitations.
 - (2) Selecting portions of the work to be performed by DBE companies in order to increase the likelihood that the DBE goals will be achieved. This includes, where appropriate, breaking out contract work items into economically feasible units to facilitate DBE participation, even when the prime Contractor might otherwise prefer to perform these work items with its own forces.
 - (3) Providing interested DBE companies with adequate information about the plans, specifications, and requirements of the contract in a timely manner to assist them in responding to a solicitation.
 - (4) a. Negotiating in good faith with interested DBE companies. It is the bidder's responsibility to make a portion of the work available to DBE subcontractors and suppliers and to select those portions of the work or material needs consistent with the available DBE subcontractors and suppliers, so as to facilitate DBE participation. Evidence of such negotiation includes the names, addresses, and telephone numbers of DBE companies that were considered; a description of the information provided regarding the plans and specifications for the work selected for subcontracting; and evidence as to why additional agreements could not be reached for DBE companies to perform the work.
 - b. A bidder using good business judgment would consider a number of factors in negotiating with subcontractors, including DBE subcontractors, and would take a firm's price and capabilities as well as contract goals into consideration. However, the fact that there may be some additional costs involved in finding and using DBE companies is not in itself sufficient reason for a bidder's failure to meet the contract DBE goal, as long as such costs are reasonable. Also the ability or desire of a bidder to perform the work of a contract with its own organization does not relieve the bidder of the responsibility to make good faith efforts. Bidders are not, however, required to accept higher quotes from DBE companies if the price difference is excessive or unreasonable.

- (5) Not rejecting DBE companies as being unqualified without sound reasons based on a thorough investigation of their capabilities. The bidder's standing within its industry, membership in specific groups, organizations, or associations and political or social affiliations (for example union vs. non-union employee status) are not legitimate causes for the rejection or non-solicitation of bids in the bidder's efforts to meet the project goal.
 - (6) Making efforts to assist interested DBE companies in obtaining bonding, lines of credit, or insurance as required by the recipient or Contractor.
 - (7) Making efforts to assist interested DBE companies in obtaining necessary equipment, supplies, materials, or related assistance or services.
 - (8) Effectively using the services of available minority/women community organizations; minority/women contractors' groups; local, state, and federal minority/women business assistance offices; and other organizations as allowed on a case-by-case basis to provide assistance in the recruitment and placement of DBE companies.
- (b) If the Department determines that the apparent successful bidder has made a good faith effort to secure the work commitment of DBE companies to meet the contract goal, the Department will award the contract provided that it is otherwise eligible for award. If the Department determines that the bidder has failed to meet the requirements of this Special Provision or that a good faith effort has not been made, the Department will notify the responsible company official designated in the Utilization Plan that the bid is not responsive. The notification shall include a statement of reasons for the determination.
- (c) The bidder may request administrative reconsideration of a determination adverse to the bidder within the five working days after the receipt of the notification date of the determination by delivering the request to the Department of Transportation, Bureau of Small Business Enterprises, Contract Compliance Section, 2300 South Dirksen Parkway, Room 319, Springfield, Illinois 62764 (Telefax: (217)785-1524). Deposit of the request in the United States mail on or before the fifth business day shall not be deemed delivery. The determination shall become final if a request is not made and delivered. A request may provide additional written documentation and/or argument concerning the issues raised in the determination statement of reasons, provided the documentation and arguments address efforts made prior to submitting the bid. The request will be forwarded to the Department's Reconsideration Officer. The Reconsideration Officer will extend an opportunity to the bidder to meet in person in order to consider all issues of documentation and whether the bidder made a good faith effort to meet the goal. After the review by the Reconsideration Officer, the bidder will be sent a written decision within ten working days after receipt of the request for consideration, explaining the basis for finding that the bidder did or did not meet the goal or make adequate good faith efforts to do so. A final decision by the Reconsideration Officer that a good faith effort was made shall approve the Utilization Plan submitted by the bidder and shall clear the contract for award. A final decision that a good faith effort was not made shall render the bid not responsive.

CALCULATING DBE PARTICIPATION. The Utilization Plan values represent work anticipated to be performed and paid for upon satisfactory completion. The Department is only able to count toward the achievement of the overall goal and the contract goal the value of payments made for the work actually performed by DBE companies. In addition, a DBE must perform a commercially useful function on the contract to be counted. A commercially useful function is generally performed when the DBE is responsible for the work and is carrying out its responsibilities by actually performing, managing, and supervising the work involved. The Department and Contractor are governed by the provisions of 49 CFR Part 26.55(c) on questions of commercially useful functions as it affects the work. Specific counting guidelines are provided in 49 CFR Part 26.55, the provisions of which govern over the summary contained herein.

- (a) DBE as the Contractor: 100 percent goal credit for that portion of the work performed by the DBE's own forces, including the cost of materials and supplies. Work that a DBE subcontracts to a non-DBE does not count toward the DBE goals.
- (b) DBE as a joint venture Contractor: 100 percent goal credit for that portion of the total dollar value of the contract equal to the distinct, clearly defined portion of the work performed by the DBE's own forces.
- (c) DBE as a subcontractor: 100 percent goal credit for the work of the subcontract performed by the DBE's own forces, including the cost of materials and supplies, excluding the purchase of materials and supplies or the lease of equipment by the DBE subcontractor from the prime Contractor or its affiliates. Work that a DBE subcontractor in turn subcontracts to a non-DBE does not count toward the DBE goal.
- (d) DBE as a trucker: 100 percent goal credit for trucking participation provided the DBE is responsible for the management and supervision of the entire trucking operation for which it is responsible. At least one truck owned, operated, licensed, and insured by the DBE must be used on the contract. Credit will be given for the following:
 - (1) The DBE may lease trucks from another DBE firm, including an owner-operator who is certified as a DBE. The DBE who leases trucks from another DBE receives credit for the total value of the transportation services the lessee DBE provides on the contract.
 - (2) The DBE may also lease trucks from a non-DBE firm, including from an owner-operator. The DBE who leases trucks from a non-DBE is entitled to credit only for the fee or commission is receives as a result of the lease arrangement.
- (e) DBE as a material supplier:
 - (1) 60 percent goal credit for the cost of the materials or supplies purchased from a DBE regular dealer.
 - (2) 100 percent goal credit for the cost of materials of supplies obtained from a DBE manufacturer.

- (3) 100 percent credit for the value of reasonable fees and commissions for the procurement of materials and supplies if not a regular dealer or manufacturer.

CONTRACT COMPLIANCE. Compliance with this Special Provision is an essential part of the contract. The Department is prohibited by federal regulations from crediting the participation of a DBE included in the Utilization Plan toward either the contract goal or the Department's overall goal until the amount to be applied toward the goals has been paid to the DBE. The following administrative procedures and remedies govern the compliance by the Contractor with the contractual obligations established by the Utilization Plan. After approval of the Utilization Plan and award of the contract, the Utilization Plan and individual DBE Participation Statements become part of the contract. If the Contractor did not succeed in obtaining enough DBE participation to achieve the advertised contract goal, and the Utilization Plan was approved and contract awarded based upon a determination of good faith, the total dollar value of DBE work calculated in the approved Utilization Plan as a percentage of the awarded contract value shall become the amended contract goal. All work indicated for performance by an approved DBE shall be performed, managed, and supervised by the DBE executing the Participation Statement.

- (a) NO AMENDMENT. No amendment to the Utilization Plan may be made without prior written approval from the Department's Bureau of Small Business Enterprises. All requests for amendment to the Utilization Plan shall be submitted to the Department of Transportation, Bureau of Small Business Enterprises, Contract Compliance Section, 2300 South Dirksen Parkway, Room 319, Springfield, Illinois 62764. Telephone number (217)785-4611. Telefax number (217)785-1524.
- (b) TERMINATION OR REPLACEMENT. The Contractor shall not terminate or replace a DBE listed on the approved Utilization Plan, or perform with other forces work designated for a listed DBE except as provided in the Special Provision.
- (c) CHANGES TO WORK. Any deviation from the DBE condition-of-award or contract plans, specifications, or special provisions must be approved, in writing, by the Department as provided elsewhere in the Contract. The Contractor shall notify affected DBEs in writing of any changes in the scope of work which result in a reduction in the dollar amount condition-of-award to the contract. Where the revision includes work committed to a new DBE subcontractor, not previously involved in the project, then a Request for Approval of Subcontractor, Department form BC 260A, must be signed and submitted. If the commitment of work is in the form of additional tasks assigned to an existing subcontract, than a new Request for Approval of Subcontractor shall not be required. However, the Contractor must document efforts to assure that the existing DBE subcontractor is capable of performing the additional work and has agreed in writing to the change.

(d) ALTERNATIVE WORK METHODS. In addition to the above requirements for reductions in the condition of award, additional requirements apply to the two cases of Contractor-initiated work substitution proposals. Where the contract allows alternate work methods which serve to delete or create underruns in condition of award DBE work, and the Contractor selects that alternate method or, where the Contractor proposes a substitute work method or material that serves to diminish or delete work committed to a DBE and replace it with other work, then the Contractor must demonstrate one of the following:

- (1) That the replacement work will be performed by the same DBE (as long as the DBE is certified in the respective item of work) in a modification of the condition of award; or
- (2) That the DBE is aware that its work will be deleted or will experience underruns and has agreed in writing to the change. If this occurs, the Contractor shall substitute other work of equivalent value to a certified DBE or provide documentation of good faith efforts to do so; or
- (3) That the DBE is not capable of performing the replacement work or has declined to perform the work at a reasonable competitive price. If this occurs, the Contractor shall substitute other work of equivalent value to a certified DBE or provide documentation of good faith efforts to do so.

(e) TERMINATION AND REPLACEMENT PROCEDURES. The Contractor shall not terminate or replace a DBE subcontractor listed in the approved Utilization Plan without prior written consent. This includes, but is not limited to, instances in which the Contractor seeks to perform work originally designated for a DBE subcontractor with its own forces or those of an affiliate, a non-DBE firm, or with another DBE firm. Written consent will be granted only if the Bureau of Small Business Enterprises agrees, for reasons stated in its concurrence document, that the Contractor has good cause to terminate or replace the DBE firm. Before transmitting to the Bureau of Small Business Enterprises any request to terminate and/or substitute a DBE subcontractor, the Contractor shall give notice in writing to the DBE subcontractor, with a copy to the Bureau, of its intent to request to terminate and/or substitute, and the reason for the request. The Contractor shall give the DBE five days to respond to the Contractor's notice. The DBE so notified shall advise the Bureau and the Contractor of the reasons, if any, why it objects to the proposed termination of its subcontract and why the Bureau should not approve the Contractor's action. If required in a particular case as a matter of public necessity, the Bureau may provide a response period shorter than five days.

For purposes of this paragraph, good cause includes the following circumstances:

- (1) The listed DBE subcontractor fails or refuses to execute a written contract;
- (2) The listed DBE subcontractor fails or refuses to perform the work of its subcontract in a way consistent with normal industry standards. Provided, however, that good cause does not exist if the failure or refusal of the DBE subcontractor to perform its work on the subcontract results from the bad faith or discriminatory action of the prime contractor;

- (3) The listed DBE subcontractor fails or refuses to meet the prime Contractor's reasonable, nondiscriminatory bond requirements;
- (4) The listed DBE subcontractor becomes bankrupt, insolvent, or exhibits credit unworthiness;
- (5) The listed DBE subcontractor is ineligible to work on public works projects because of suspension and debarment proceedings pursuant 2 CFR Parts 180, 215 and 1,200 or applicable state law.
- (6) You have determined that the listed DBE subcontractor is not a responsible contractor;
- (7) The listed DBE subcontractor voluntarily withdraws from the projects and provides to you written notice of its withdrawal;
- (8) The listed DBE is ineligible to receive DBE credit for the type of work required;
- (9) A DBE owner dies or becomes disabled with the result that the listed DBE contractor is unable to complete its work on the contract;
- (10) Other documented good cause that compels the termination of the DBE subcontractor. Provided, that good cause does not exist if the prime Contractor seeks to terminate a DBE it relied upon to obtain the contract so that the prime Contractor can self-perform the work for which the DBE contractor was engaged or so that the prime Contractor can substitute another DBE or non-DBE contractor after contract award.

When a DBE is terminated, or fails to complete its work on the Contract for any reason the Contractor shall make a good faith effort to find another DBE to substitute for the original DBE to perform at least the same amount of work under the contract as the terminated DBE to the extent needed to meet the established Contract goal.

- (f) PAYMENT RECORDS. The Contractor shall maintain a record of payments for work performed to the DBE participants. The records shall be made available to the Department for inspection upon request. After the performance of the final item of work or delivery of material by a DBE and final payment therefore to the DBE by the Contractor, but not later than thirty calendar days after payment has been made by the Department to the Contractor for such work or material, the Contractor shall submit a DBE Payment Agreement on Department form SBE 2115 to the Regional Engineer. If full and final payment has not been made to the DBE, the DBE Payment Agreement shall indicate whether a disagreement as to the payment required exists between the Contractor and the DBE or if the Contractor believes that the work has not been satisfactorily completed. If the Contractor does not have the full amount of work indicated in the Utilization Plan performed by the BDE companies indicated in the Utilization Plan and after good faith efforts are reviewed, the Department may deduct from contract payments to the Contractor the amount of the goal not achieved as liquidated and ascertained damages. The Contractor may request an administrative reconsideration of any amount deducted as damages pursuant to subsection (h) of this part.
- (g) ENFORCEMENT. The Department reserves the right to withhold payment to the Contractor to enforce the provisions of this Special Provision. Final payment shall not be made on the contract until such time as the Contractor submits sufficient documentation demonstrating achievement of the goal in accordance with this Special Provision or after liquidated damages have been determined and collected.
- (h) RECONSIDERATION. Notwithstanding any other provision of the contract, including but not limited to Article 109.09 of the Standard Specifications, the Contractor may request administrative reconsideration of a decision to deduct the amount of the goal not achieved as liquidated damages. A request to reconsider shall be delivered to the Contract Compliance Section and shall be handled and considered in the same manner as set forth in paragraph (c) of "Good Faith Effort Procedures" of this Special Provision, except a final decision that a good faith effort was not made during contract performance to achieve the goal agreed to in the Utilization Plan shall be the final administrative decision of the Department.

FRICITION AGGREGATE (BDE)

Effective: January 1, 2011

Revise Article 1004.01(a)(4) of the Standard Specifications to read:

- “ (4) Crushed Stone. Crushed stone shall be the angular fragments resulting from crushing undisturbed, consolidated deposits of rock by mechanical means. Crushed stone shall be divided into the following, when specified.
- a. Carbonate Crushed Stone. Carbonate crushed stone shall be either dolomite or limestone. Dolomite shall contain 11.0 percent or more magnesium oxide (MgO). Limestone shall contain less than 11.0 percent magnesium oxide (MgO).
 - b. Crystalline Crushed Stone. Crystalline crushed stone shall be either metamorphic or igneous stone, including but is not limited to, quartzite, granite, rhyolite and diabase.”

Revise Article 1004.03(a) of the Standard Specifications to read:

“1004.03 Coarse Aggregate for Hot-Mix Asphalt (HMA). The aggregate shall be according to Article 1004.01 and the following.

- (a) Description. The coarse aggregate for HMA shall be according to the following table.

Use	Mixture	Aggregates Allowed
Class A	Seal or Cover	<u>Allowed Alone or in Combination:</u> Gravel Crushed Gravel Carbonate Crushed Stone Crystalline Crushed Stone Crushed Sandstone Crushed Slag (ACBF) Crushed Steel Slag Crushed Concrete
HMA All Other	Stabilized Subbase Shoulders or	<u>Allowed Alone or in Combination:</u> Gravel Crushed Gravel Carbonate Crushed Stone Crystalline Crushed Stone Crushed Sandstone Crushed Slag (ACBF) Crushed Steel Slag ^{1/} Crushed Concrete
HMA High ESAL Low ESAL	Binder IL-25.0, IL-19.0, or IL-19.0L SMA Binder	<u>Allowed Alone or in Combination:</u> Crushed Gravel Carbonate Crushed Stone ^{2/} Crystalline Crushed Stone Crushed Sandstone Crushed Slag (ACBF) Crushed Concrete ^{3/}
HMA High ESAL Low ESAL	C Surface and Leveling Binder IL-12.5, IL-9.5, or IL-9.5L SMA Ndesign 50 Surface	<u>Allowed Alone or in Combination:</u> Crushed Gravel Carbonate Crushed Stone ^{2/} Crystalline Crushed Stone Crushed Sandstone Crushed Slag (ACBF) Crushed Steel Slag ^{4/} Crushed Concrete ^{3/}
HMA High ESAL	D Surface and Leveling Binder IL-12.5 or IL-9.5 SMA Ndesign 50 Surface	<u>Allowed Alone or in Combination:</u> Crushed Gravel Carbonate Crushed Stone (other than Limestone) ^{2/} Crystalline Crushed Stone Crushed Sandstone Crushed Slag (ACBF) ^{5/} Crushed Steel Slag ^{4/ 5/} Crushed Concrete ^{3/}
		<u>Other Combinations Allowed:</u>

Use	Mixture	Aggregates Allowed	
		<i>Up to...</i>	<i>With...</i>
		25% Limestone	Dolomite
		50% Limestone	Any Mixture D aggregate other than Dolomite
		75% Limestone	Crushed Slag (ACBF) ^{5/} or Crushed Sandstone
HMA High ESAL	E Surface IL-12.5 or IL-9.5 SMA Ndesign 80 Surface	<u>Allowed Alone or in Combination:</u> Crushed Gravel Crystalline Crushed Stone Crushed Sandstone Crushed Slag (ACBF) ^{5/} Crushed Steel Slag ^{5/} Crushed Concrete ^{3/} No Limestone.	
		<u>Other Combinations Allowed:</u>	
		<i>Up to...</i>	<i>With...</i>
		50% Dolomite ^{2/}	Any Mixture E aggregate
		75% Dolomite ^{2/}	Crushed Sandstone, Crushed Slag (ACBF) ^{5/} , Crushed Steel Slag ^{5/} , or Crystalline Crushed Stone
75% Crushed Gravel or Crushed Concrete ^{3/}	Crushed Sandstone, Crystalline Crushed Stone, Crushed Slag (ACBF) ^{5/} , or Crushed Steel Slag ^{5/}		
HMA High ESAL	F Surface IL-12.5 or IL-9.5 SMA Ndesign 80 Surface	<u>Allowed Alone or in Combination:</u> Crystalline Crushed Stone Crushed Sandstone Crushed Slag (ACBF) ^{5/} Crushed Steel Slag ^{5/} No Limestone.	
		<u>Other Combinations Allowed:</u>	
		<i>Up to...</i>	<i>With...</i>

Use	Mixture	Aggregates Allowed	
		50% Gravel, Concrete ^{3/} , Dolomite ^{2/}	Crushed Crushed or Crushed Sandstone, Crushed Slag (ACBF) ^{5/} , Crushed Steel Slag ^{5/} , or Crystalline Crushed Stone

- 1/ Crushed steel slag allowed in shoulder surface only.
- 2/ Carbonate crushed stone shall not be used in SMA Ndesign 80. In SMA Ndesign 50, carbonate crushed stone shall not be blended with any of the other aggregates allowed alone in Ndesign 50 SMA binder or Ndesign 50 SMA surface.
- 3/ Crushed concrete will not be permitted in SMA mixes.
- 4/ Crushed steel slag shall not be used as leveling binder.
- 5/ When either slag is used, the blend percentages listed shall be by volume.”

HOT-MIX ASPHALT – MIXTURE DESIGN COMPOSITION AND VOLUMETRIC REQUIREMENTS (BDE)

Effective: November 1, 2013

Revise Article 406.14(b) of the Standard Specifications to read.

“(b) If the HMA placed during the initial test strip (1) is determined to be unacceptable to remain in place by the Engineer, and (2) was not produced within 2.0 to 6.0 percent air voids or within the individual control limits of the JMF, the mixture and test strip will not be paid for and the mixture shall be removed at the Contractor’s expense. An additional test strip and mixture will be paid for in full, if produced within 2.0 to 6.0 percent air voids and within the individual control limits of the JMF.”

Revise Article 406.14(c) of the Standard Specifications to read.

“(c) If the HMA placed during the initial test strip (1) is determined to be unacceptable to remain in place by the Engineer, and (2) was produced within 2.0 to 6.0 percent air voids and within the individual control limits of the JMF, the mixture shall be removed. Removal will be paid in accordance to Article 109.04. This initial mixture and test strip will be paid for at the contract unit prices. The additional mixture will be paid for at the contract unit price, and any additional test strips will be paid for at one half the unit price of each test strip.”

Revise Article 1030.04(a)(1) of the Standard Specifications to read.

“(1) High ESAL Mixtures. The Job Mix Formula (JMF) shall fall within the following limits.

High ESAL, MIXTURE COMPOSITION (% PASSING) ^{1/}										
Sieve Size	IL-25.0 mm		IL-19.0 mm		IL-12.5 mm		IL-9.5 mm		IL-4.75 mm	
	min	max	min	max	min	max	min	max	min	max
1 1/2 in. (37.5 mm)		100								
1 in. (25 mm)	90	100		100						
3/4 in. (19 mm)		90	82	100		100				
1/2 in. (12.5 mm)	45	75	50	85	90	100		100		100
3/8 in. (9.5 mm)						89	90	100		100
#4 (4.75 mm)	24	42 ^{2/}	24	50 ^{2/}	28	65	32	69	90	100
#8 (2.36 mm)	16	31	20	36	28	48 ^{3/}	32	52 ^{3/}	70	90
#16 (1.18 mm)	10	22	10	25	10	32	10	32	50	65
#50 (300 μm)	4	12	4	12	4	15	4	15	15	30
#100 (150 μm)	3	9	3	9	3	10	3	10	10	18
#200 (75 μm)	3	6	3	6	4	6	4	6	7	9
Ratio Dust/Asphalt Binder		1.0		1.0		1.0		1.0		1.0 ^{4/}

1/ Based on percent of total aggregate weight.

2/ The mixture composition shall not exceed 40 percent passing the #4 (4.75 mm) sieve for binder courses with Ndesign ≥ 90.

3/ The mixture composition shall not exceed 44 percent passing the #8 (2.36 mm) sieve for surface courses with Ndesign ≥ 90.

4/ Additional minus No. 200 (0.075 mm) material required by the mix design shall be mineral filler, unless otherwise approved by the Engineer.”

Delete Article 1030.04(a)(4) of the Standard Specifications.

Revise Article 1030.04(b)(1) of the Standard Specifications to read.

“(1) High ESAL Mixtures. The target value for the air voids of the HMA shall be 4.0 percent at the design number of gyrations. The VMA and VFA of the HMA design shall be based on the nominal maximum size of the aggregate in the mix, and shall conform to the following requirements.

VOLUMETRIC REQUIREMENTS High ESAL						
Ndesign	Voids in the Mineral Aggregate (VMA), % minimum					Voids Filled with Asphalt Binder (VFA), %
	IL-25.0	IL-19.0	IL-12.5	IL-9.5	IL-4.75 ^{1/}	
50	12.0	13.0	14.0	15.0	18.5	65 – 78 ^{2/}
70					65 - 75	
90						
105						

1/ Maximum Draindown for IL-4.75 shall be 0.3 percent

2/ VFA for IL-4.75 shall be 76-83 percent”

Delete Article 1030.04(b)(4) of the Standard Specifications.

Revise the Control Limits Table in Article 1030.05(d)(4) of the Standard Specifications to read.

“CONTROL LIMITS					
Parameter	High ESAL Low ESAL	High ESAL Low ESAL	All Other	IL-4.75	IL-4.75
	Individual Test	Moving Avg. of 4	Individual Test	Individual Test	Moving Avg. of 4
% Passing: ^{1/}					
1/2 in. (12.5 mm)	± 6 %	± 4 %	± 15 %		
No. 4 (4.75 mm)	± 5 %	± 4 %	± 10 %		
No. 8 (2.36 mm)	± 5 %	± 3 %			
No. 16 (1.18 mm)				± 4 %	± 3 %
No. 30 (600 µm)	± 4 %	± 2.5 %			
Total Dust Content No. 200 (75 µm)	± 1.5 %	± 1.0 %	± 2.5 %	± 1.5 %	± 1.0 %
Asphalt Binder Content	± 0.3 %	± 0.2 %	± 0.5 %	± 0.3 %	± 0.2 %
Voids	± 1.2 %	± 1.0 %	± 1.2 %	± 1.2 %	± 1.0 %
VMA	-0.7 % ^{2/}	-0.5 % ^{2/}		-0.7 % ^{2/}	-0.5 % ^{2/}

1/ Based on washed ignition oven

2/ Allowable limit below minimum design VMA requirement”

HOT-MIX ASPHALT – MIXTURE DESIGN VERIFICATION AND PRODUCTION (BDE)

Effective: November 1, 2013

Description. This special provision provides the requirements for Hamburg Wheel and tensile strength testing for High ESAL, IL-4.75, and Stone Matrix Asphalt (SMA) hot-mix asphalt (HMA) mixes during mix design verification and production. This special provision also provides the plant requirements for hydrated lime addition systems used in the production of High ESAL, IL-4.75, and SMA mixes.

Mix Design Testing. Add the following to Article 1030.04 of the Standard Specifications:

“(d) Verification Testing. High ESAL, IL-4.75, and SMA mix designs submitted for verification will be tested to ensure that the resulting mix designs will pass the required criteria for the Hamburg Wheel Test (Illinois Modified AASHTO T 324) and the Tensile Strength Test (Illinois Modified AASHTO T 283). The Department will perform a verification test on gyratory specimens compacted by the Contractor. If the mix fails the Department’s verification test, the Contractor shall make necessary changes to the mix and provide passing Hamburg Wheel and tensile strength test results from a private lab. The Department will verify the passing results.

All new and renewal mix designs shall meet the following requirements for verification testing.

(1) Hamburg Wheel Test Criteria. The maximum allowable rut depth shall be 0.5 in. (12.5 mm). The minimum number of wheel passes at the 0.5 in. (12.5 mm) rut depth criteria shall be based on the high temperature binder grade of the mix as specified in the mix requirements table of the plans.

Illinois Modified AASHTO T 324 Requirements ^{1/}

PG Grade	Number of Passes
PG 58-xx (or lower)	5,000
PG 64-xx	7,500
PG 70-xx	15,000
PG 76-xx (or higher)	20,000

1/ When produced at temperatures of 275 ± 5 °F (135 ± 3 °C) or less, loose Warm Mix Asphalt shall be oven aged at 270 ± 5 °F (132 ± 3 °C) for two hours prior to gyratory compaction of Hamburg Wheel specimens.

- (2) Tensile Strength Criteria. The minimum allowable conditioned tensile strength shall be 415 kPa (60 psi) for non-polymer modified performance graded (PG) asphalt binder and 550 kPa (80 psi) for polymer modified PG asphalt binder. The maximum allowable unconditioned tensile strength shall be 1380 kPa (200 psi).”

Production Testing. Revise Article 1030.06(a) of the Standard Specifications to read:

- “(a) High ESAL, IL-4.75 and SMA Mixtures. For each contract, a 300 ton (275 metric tons) test strip will be required at the beginning of HMA production for each mixture with a quantity of 3000 tons (2750 metric tons) or more according to the Manual of Test Procedures for Materials “Hot Mix Asphalt Test Strip Procedures”.

Before start-up, target values shall be determined by applying gradation correction factors to the JMF when applicable. These correction factors shall be determined from previous experience. The target values, when approved by the Engineer, shall be used to control HMA production. Plant settings and control charts shall be set according to target values.

Before constructing the test strip, target values shall be determined by applying gradation correction factors to the JMF when applicable. After any JMF adjustment, the JMF shall become the Adjusted Job Mix Formula (AJMF). Upon completion of the first acceptable test strip, the JMF shall become the AJMF regardless of whether or not the JMF has been adjusted. If an adjustment/plant change is made, the Engineer may require a new test strip to be constructed. If the HMA placed during the initial test strip is determined to be unacceptable to remain in place by the Engineer, it shall be removed and replaced.

The limitations between the JMF and AJMF are as follows.

Parameter	Adjustment
1/2 in. (12.5 mm)	± 5.0 %
No. 4 (4.75 mm)	± 4.0 %
No. 8 (2.36 mm)	± 3.0 %
No. 30 (600 µm)	*
No. 200 (75 µm)	*
Asphalt Binder Content	± 0.3 %

* In no case shall the target for the amount passing be greater than the JMF.

Any adjustments outside the above limitations will require a new mix design.

Mixture sampled to represent the test strip shall include additional material sufficient for the Department to conduct Hamburg Wheel testing according to Illinois Modified AASHTO T324 (approximately 60 lb (27 kg) total).

The Contractor shall immediately cease production upon notification by the Engineer of failing Hamburg Wheel test. All prior produced material may be paved out provided all other mixture criteria is being met. No additional mixture shall be produced until the Engineer receives passing Hamburg Wheel tests.

The Department may conduct additional Hamburg Wheel tests on production material as determined by the Engineer.”

Revise the title of Article 1030.06(b) of the Standard Specifications to read:

“(b) Low ESAL and All Other Mixtures.”

System for Hydrated Lime Addition. Revise the fourth sentence of the third paragraph of Article 1030.04(c) of the Standard Specifications to read:

“The method of application shall be according to Article 1102.01(a)(10).”

Replace the first three sentences of the second paragraph of Article 1102.01(a)(10) of the Standard Specifications to read:

“When hydrated lime is used as the anti-strip additive, a separate bin or tank and feeder system shall be provided to store and accurately proportion the lime onto the aggregate either as a slurry, as dry lime applied to damp aggregates, or as dry lime injected onto the hot aggregates prior to adding the liquid asphalt cement. If the hydrated lime is added either as a slurry or as dry lime on damp aggregates, the lime and aggregates shall be mixed by a power driven pugmill to provide a uniform coating of the lime prior to entering the dryer. If dry hydrated lime is added to the hot dry aggregates in a dryer-drum plant, the lime shall be added in such a manner that the lime will not become entrained into the air stream of the dryer-drum and that thorough dry mixing shall occur prior to the injection point of the liquid asphalt. When a batch plant is used, the hydrated lime shall be added to the mixture in the weigh hopper or as approved by the Engineer.”

Basis of Payment. Replace the seventh paragraph of Article 406.14 of the Standard Specifications with the following:

“For mixes designed and verified under the Hamburg Wheel criteria, the cost of furnishing and introducing anti-stripping additives in the HMA will not be paid for separately, but shall be considered as included in the contract unit price of the HMA item involved.

If an anti-stripping additive is required for any other HMA mix, the cost of the additive will be paid for according to Article 109.04. The cost incurred in introducing the additive into the HMA will not be paid for separately, but shall be considered as included in the contract unit price of the HMA item involved.

No additional compensation will be awarded to the Contractor because of reduced production rates associated with the addition of the anti-stripping additive.”

PAVEMENT MARKING FOR BIKE SYMBOL (BDE)

Effective: January 1, 2014

Add the following to the SYMBOLS table in Article 780.14 of the Standard Specifications:

“Symbol	Large Size sq ft (sq m)	Small Size Sq ft (sq m)
Bike Symbol	6.0 (0.56)	--“

PAVEMENT PATCHING (BDE)

Effective: January 1, 2010

Revise the first sentence of the second paragraph of Article 701.17(e)(1) of the Standard Specifications to read:

“In addition to the traffic control and protection shown elsewhere in the contract for pavement, two devices shall be placed immediately in front of each open patch, open hole, and broken pavement where temporary concrete barriers are not used to separate traffic from the work area.”

PAYROLLS AND PAYROLL RECORDS (BDE)

Effective: January 1, 2014

FEDERAL AID CONTRACTS. Revise the following section of Check Sheet #1 of the Recurring Special Provisions to read:

“STATEMENTS AND PAYROLLS

The payroll records shall include the worker’s name, the worker’s address, the worker’s telephone number when available, the worker’s social security number, the worker’s classification or classifications, the worker’s gross and net wages paid in each pay period, the worker’s number of hours worked each day, the worker’s starting and ending times of work each day. However, any Contractor or subcontractor who remits contributions to a fringe benefit fund that is not jointly maintained and jointly governed by one or more employers and one or more labor organization must additionally submit the worker’s hourly wage rate, the worker’s hourly overtime wage rate, the worker’s hourly fringe benefit rates, the name and address of each fringe benefit fund, the plan sponsor of each fringe benefit, if applicable, and the plan administrator of each fringe benefit, if applicable.

The Contractor and each subcontractor shall submit payroll records to the Engineer each week from the start to the completion of their respective work, except that full social security numbers and home addresses shall not be included on weekly transmittals. Instead, the payrolls shall include an identification number for each employee (e.g., the last four digits of the employee's social security number). In addition, starting and ending times of work each day may be omitted from the payroll records submitted to the Engineer. The submittals shall be on the Department's form SBE 48, or an approved facsimile. When there has been no activity during a work week, a payroll record shall still be submitted with the appropriate box ("No Work", "Suspended", or "Complete") checked on the form."

STATE CONTRACTS. Revise Section IV of Check Sheet #5 of the Recurring Special Provisions to read:

"IV. COMPLIANCE WITH THE PREVAILING WAGE ACT

1. **Prevailing Wages.** All wages paid by the Contractor and each subcontractor shall be in compliance with The Prevailing Wage Act (820 ILCS 130), as amended, except where a prevailing wage violates a federal law, order, or ruling, the rate conforming to the federal law, order, or ruling shall govern. The Contractor shall be responsible to notify each subcontractor of the wage rates set forth in this contract and any revisions thereto. If the Department of Labor revises the wage rates, the Contractor will not be allowed additional compensation on account of said revisions.
2. **Payroll Records.** The Contractor and each subcontractor shall make and keep, for a period of five years from the later of the date of final payment under the contract or completion of the contract, records of the wages paid to his/her workers. The payroll records shall include the worker's name, the worker's address, the worker's telephone number when available, the worker's social security number, the worker's classification or classifications, the worker's gross and net wages paid in each pay period, the worker's number of hours worked each day, the worker's starting and ending times of work each day. However, any contractor or subcontractor who remits contributions to a fringe benefit fund that is not jointly maintained and jointly governed by one or more employers and one or more labor organization must additionally submit the worker's hourly wage rate, the worker's hourly overtime wage rate, the worker's hourly fringe benefit rates, the name and address of each fringe benefit fund, the plan sponsor of each fringe benefit, if applicable, and the plan administrator of each fringe benefit, if applicable. Upon seven business days' notice, these records shall be available at a location within the State, during reasonable hours, for inspection by the Department or the Department of Labor; and Federal, State, or local law enforcement agencies and prosecutors.

3. Submission of Payroll Records. The Contractor and each subcontractor shall submit payroll records to the Engineer each week from the start to the completion of their respective work, except that full social security numbers and home addresses shall not be included on weekly transmittals. Instead the payrolls shall include an identification number for each employee (e.g., the last four digits of the employee's social security number). In addition, starting and ending times of work each day may be omitted from the payroll records submitted to the Engineer. The submittals shall be on the Department's form SBE 48, or an approved facsimile. When there has been no activity during a work week, a payroll record shall still be submitted with the appropriate box ("No Work", "Suspended", or "Complete") checked on the form.

Each submittal shall be accompanied by a statement signed by the Contractor or subcontractor, or an officer, employee, or officer thereof, which avers that: (i) he or she has examined the records and such records are true and accurate; (ii) the hourly rate paid to each worker is not less than the general prevailing rate of hourly wages required by the Act; and (iii) the Contractor or subcontractor is aware that filing a payroll record that he/she knows to be false is a Class A misdemeanor.

4. Employee Interviews. The Contractor and each subcontractor shall permit his/her employees to be interviewed on the job, during working hours, by compliance investigators of the Department or the Department of Labor."

PROGRESS PAYMENTS (BDE)

Effective: November 2, 2013

Revise Article 109.07(a) of the Standard Specifications to read:

- "(a) Progress Payments. At least once each month, the Engineer will make a written estimate of the quantity of work performed in accordance with the contract, and the value thereof at the contract unit prices. The amount of the estimate approved as due for payment will be vouchered by the Department and presented to the State Comptroller for payment. No amount less than \$1000.00 will be approved for payment other than the final payment.

Progress payments may be reduced by liens filed pursuant to Section 23(c) of the Mechanics' Lien Act, 770 ILCS 60/23(c).

If a Contractor or subcontractor has defaulted on a loan issued under the Department's Disadvantaged Business Revolving Loan Program (20 ILCS 2705/2705-610), progress payments may be reduced pursuant to the terms of that loan agreement. In such cases, the amount of the estimate related to the work performed by the Contractor or subcontractor, in default of the loan agreement, will be offset, in whole or in part, and vouchered by the Department to the Working Capital Revolving Fund or designated escrow account. Payment for the work shall be considered as issued and received by the Contractor or subcontractor on the date of the offset voucher. Further, the amount of the offset voucher shall be a credit against the Department's obligation to pay the Contractor, the Contractor's obligation to pay the subcontractor, and the Contractor's or subcontractor's total loan indebtedness to the Department. The offset shall continue until such time as the entire loan indebtedness is satisfied. The Department will notify the Contractor and Fund Control Agent in a timely manner of such offset. The Contractor or subcontractor shall not be entitled to additional payment in consideration of the offset.

The failure to perform any requirement, obligation, or term of the contract by the Contractor shall be reason for withholding any progress payments until the Department determines that compliance has been achieved."

RECLAIMED ASPHALT PAVEMENT AND RECLAIMED ASPHALT SHINGLES (BDE)

Effective: November 1, 2012

Revise: November 1, 2013

Revise Section 1031 of the Standard Specifications to read:

"SECTION 1031. RECLAIMED ASPHALT PAVEMENT AND RECLAIMED ASPHALT SHINGLES

1031.01 Description. Reclaimed asphalt pavement and reclaimed asphalt shingles shall be according to the following.

- (a) Reclaimed Asphalt Pavement (RAP). RAP is the material produced by cold milling or crushing an existing hot-mix asphalt (HMA) pavement. The Contractor shall supply written documentation that the RAP originated from routes or airfields under federal, state, or local agency jurisdiction.

(b) Reclaimed Asphalt Shingles (RAS). Reclaimed asphalt shingles (RAS). RAS is from the processing and grinding of preconsumer or post-consumer shingles. RAS shall be a clean and uniform material with a maximum of 0.5 percent unacceptable material, as defined in Bureau of Materials and Physical Research Policy Memorandum “Reclaimed Asphalt Shingle (RAS) Sources”, by weight of RAS. All RAS used shall come from a Bureau of Materials and Physical Research approved processing facility where it shall be ground and processed to 100 percent passing the 3/8 in. (9.5 mm) sieve and 93 percent passing the #4 (4.75 mm) sieve based on a dry shake gradation. RAS shall be uniform in gradation and asphalt binder content and shall meet the testing requirements specified herein. In addition, RAS shall meet the following Type 1 or Type 2 requirements.

(1) Type 1. Type 1 RAS shall be processed, preconsumer asphalt shingles salvaged from the manufacture of residential asphalt roofing shingles.

(2) Type 2. Type 2 RAS shall be processed post-consumer shingles only, salvaged from residential, or four unit or less dwellings not subject to the National Emission Standards for Hazardous Air Pollutants (NESHAP).

1031.02 Stockpiles. RAP and RAS stockpiles shall be according to the following.

(a) RAP Stockpiles. The Contractor shall construct individual, sealed RAP stockpiles meeting one of the following definitions. No additional RAP shall be added to the pile after the pile has been sealed. Stockpiles shall be sufficiently separated to prevent intermingling at the base. Stockpiles shall be identified by signs indicating the type as listed below (i.e. “Homogeneous Surface”).

Prior to milling, the Contractor shall request the District provide documentation on the quality of the RAP to clarify the appropriate stockpile.

(1) Fractionated RAP (FRAP). FRAP shall consist of RAP from Class I, HMA (High and Low ESAL) mixtures. The coarse aggregate in FRAP shall be crushed aggregate and may represent more than one aggregate type and/or quality but shall be at least C quality. All FRAP shall be fractionated prior to testing by screening into a minimum of two size fractions with the separation occurring on or between the #4 (4.75 mm) and 1/2 in. (12.5 mm) sieves. Agglomerations shall be minimized such that 100 percent of the RAP shall pass the sieve size specified below for the mix into which the FRAP will be incorporated.

Mixture FRAP will be used in:	Sieve Size that 100% of FRAP Shall Pass
IL-25.0	2 in. (50 mm)
IL-19.0	1 1/2 in. (40 mm)
IL-12.5	1 in. (25 mm)
IL-9.5	3/4 in. (20 mm)
IL-4.75	1/2 in. (13 mm)

- (2) Homogeneous. Homogeneous RAP stockpiles shall consist of RAP from Class I, HMA (High and Low ESAL) mixtures and represent: 1) the same aggregate quality, but shall be at least C quality; 2) the same type of crushed aggregate (either crushed natural aggregate, ACBF slag, or steel slag); 3) similar gradation; and 4) similar asphalt binder content. If approved by the Engineer, combined single pass surface/binder millings may be considered "homogenous" with a quality rating dictated by the lowest coarse aggregate quality present in the mixture.
- (3) Conglomerate. Conglomerate RAP stockpiles shall consist of RAP from Class I, HMA (High and Low ESAL) mixtures. The coarse aggregate in this RAP shall be crushed aggregate and may represent more than one aggregate type and/or quality but shall be at least C quality. This RAP may have an inconsistent gradation and/or asphalt binder content prior to processing. All conglomerate RAP shall be processed prior to testing by crushing to where all RAP shall pass the 5/8 in. (16 mm) or smaller screen. Conglomerate RAP stockpiles shall not contain steel slag.
- (4) Conglomerate "D" Quality (DQ). Conglomerate DQ RAP stockpiles shall consist of RAP from Class I, HMA (High or Low ESAL), or "All Other" (as defined by Article 1030.04(a)(3)) mixtures. The coarse aggregate in this RAP may be crushed or round but shall be at least D quality. This RAP may have an inconsistent gradation and/or asphalt binder content. Conglomerate DQ RAP stockpiles shall not contain steel slag.
- (5) Non-Quality. RAP stockpiles that do not meet the requirements of the stockpile categories listed above shall be classified as "Non-Quality".

RAP/FRAP containing contaminants, such as earth, brick, sand, concrete, sheet asphalt, bituminous surface treatment (i.e. chip seal), pavement fabric, joint sealants, etc., will be unacceptable unless the contaminants are removed to the satisfaction of the Engineer. Sheet asphalt shall be stockpiled separately.

- (b) RAS Stockpiles. Type 1 and Type 2 RAS shall be stockpiled separately and shall not be intermingled. Each stockpile shall be signed indicating what type of RAS is present.

Unless otherwise specified by the Engineer, mechanically blending manufactured sand (FM 20 or FM 22) up to an equal weight of RAS with the processed RAS will be permitted to improve workability. The sand shall be "B Quality" or better from an approved Aggregate Gradation Control System source. The sand shall be accounted for in the mix design and during HMA production.

Records identifying the shingle processing facility supplying the RAS, RAS type and lot number shall be maintained by project contract number and kept for a minimum of three years.

1031.03 Testing. RAP/FRAP and RAS testing shall be according to the following.

(a) RAP/FRAP Testing. When used in HMA, the RAP/FRAP shall be sampled and tested either during or after stockpiling.

(1) During Stockpiling. For testing during stockpiling, washed extraction samples shall be run at the minimum frequency of one sample per 500 tons (450 metric tons) for the first 2000 tons (1800 metric tons) and one sample per 2000 tons (1800 metric tons) thereafter. A minimum of five tests shall be required for stockpiles less than 4000 tons (3600 metric tons).

(2) After Stockpiling. For testing after stockpiling, the Contractor shall submit a plan for approval to the District proposing a satisfactory method of sampling and testing the RAP/FRAP pile either in-situ or by restockpiling. The sampling plan shall meet the minimum frequency required above and detail the procedure used to obtain representative samples throughout the pile for testing.

Each sample shall be split to obtain two equal samples of test sample size. One of the two test samples from the final split shall be labeled and stored for Department use. The Contractor shall extract the other test sample according to Department procedure. The Engineer reserves the right to test any sample (split or Department-taken) to verify Contractor test results.

(b) RAS Testing. RAS or RAS blended with manufactured sand shall be sampled and tested during stockpiling according to Illinois Department of Transportation Policy Memorandum, "Reclaimed Asphalt Shingle (RAS) Source".

Samples shall be collected during stockpiling at the minimum frequency of one sample per 200 tons (180 metric tons) for the first 1000 tons (900 metric tons) and one sample per 250 tons (225 metric tons) thereafter. A minimum of five samples are required for stockpiles less than 1000 tons (900 metric tons). Once a ≤ 1000 ton (900 metric ton), five-sample/test stockpile has been established it shall be sealed. Additional incoming RAS or RAS blended with manufactured sand shall be stockpiled in a separate working pile as designated in the Quality Control plan and only added to the sealed stockpile when the test results of the working pile are complete and are found to meet the tolerances specified herein for the original sealed RAS stockpile.

Before testing, each sample shall be split to obtain two test samples. One of the two test samples from the final split shall be labeled and stored for Department use. The Contractor shall perform a washed extraction and test for unacceptable materials on the other test sample according to Department procedures. The Engineer reserves the right to test any sample (split or Department-taken) to verify Contractor test results.

If the sampling and testing was performed at the shingle processing facility in accordance with the QC Plan, the Contractor shall obtain and make available all of the test results from start of the initial stockpile.

1031.04 Evaluation of Tests. Evaluation of tests results shall be according to the following.

- (a) Evaluation of RAP/FRAP Test Results. All of the extraction results shall be compiled and averaged for asphalt binder content and gradation and, when applicable G_{mm} . Individual extraction test results, when compared to the averages, will be accepted if within the tolerances listed below.

Parameter	FRAP/Homogeneous /Conglomerate	Conglomerate "D" Quality
1 in. (25 mm)		± 5 %
1/2 in. (12.5 mm)	± 8 %	± 15 %
No. 4 (4.75 mm)	± 6 %	± 13 %
No. 8 (2.36 mm)	± 5 %	
No. 16 (1.18 mm)		± 15 %
No. 30 (600 μm)	± 5 %	
No. 200 (75 μm)	± 2.0 %	± 4.0 %
Asphalt Binder	± 0.4 % ^{1/}	± 0.5 %
G_{mm}	± 0.03	

1/ The tolerance for FRAP shall be ± 0.3 %.

If more than 20 percent of the individual sieves and/or asphalt binder content tests are out of the above tolerances, the RAP/FRAP shall not be used in HMA unless the RAP/FRAP representing the failing tests is removed from the stockpile. All test data and acceptance ranges shall be sent to the District for evaluation.

With the approval of the Engineer, the ignition oven may be substituted for extractions according to the Illinois Test Procedure, "Calibration of the Ignition Oven for the Purpose of Characterizing Reclaimed Asphalt Pavement (RAP)".

- (b) Evaluation of RAS and RAS Blended with Manufactured Sand Test Results. All of the test results, with the exception of percent unacceptable materials, shall be compiled and averaged for asphalt binder content and gradation. Individual test results, when compared to the averages, will be accepted if within the tolerances listed below.

Parameter	RAS
No. 8 (2.36 mm)	± 5 %
No. 16 (1.18 mm)	± 5 %
No. 30 (600 μm)	± 4 %
No. 200 (75 μm)	± 2.0 %
Asphalt Binder Content	± 1.5 %

If more than 20 percent of the individual sieves and/or asphalt binder content tests are out of the above tolerances, or if the percent unacceptable material exceeds 0.5 percent by weight of material retained on the # 4 (4.75 mm) sieve, the RAS or RAS blend shall not be used in Department projects. All test data and acceptance ranges shall be sent to the District for evaluation.

1031.05 Quality Designation of Aggregate in RAP/FRAP.

(a) RAP. The aggregate quality of the RAP for homogenous, conglomerate, and conglomerate "D" quality stockpiles shall be set by the lowest quality of coarse aggregate in the RAP stockpile and are designated as follows.

(1) RAP from Class I, Superpave/HMA (High ESAL), or (Low ESAL) IL-9.5L surface mixtures are designated as containing Class B quality coarse aggregate.

(2) RAP from Superpave/HMA (Low ESAL) IL-19.0L binder mixture is designated as Class D quality coarse aggregate.

(3) RAP from Class I, Superpave/HMA (High ESAL) binder mixtures, bituminous base course mixtures, and bituminous base course widening mixtures are designated as containing Class C quality coarse aggregate.

(4) RAP from bituminous stabilized subbase and BAM shoulders are designated as containing Class D quality coarse aggregate.

(b) FRAP. If the Engineer has documentation of the quality of the FRAP aggregate, the Contractor shall use the assigned quality provided by the Engineer.

If the quality is not known, the quality shall be determined as follows. Coarse and fine FRAP stockpiles containing plus #4 (4.75 mm) sieve coarse aggregate shall have a maximum tonnage of 5,000 tons (4,500 metric tons). The Contractor shall obtain a representative sample witnessed by the Engineer. The sample shall be a minimum of 50 lb (25 kg). The sample shall be extracted according to Illinois Modified AASHTO T 164 by a consultant prequalified by the Department for the specified testing. The consultant shall submit the test results along with the recovered aggregate to the District Office. The cost for this testing shall be paid by the Contractor. The District will forward the sample to the BMPR Aggregate Lab for MicroDeval Testing, according to Illinois Modified AASHTO T 327. A maximum loss of 15.0 percent will be applied for all HMA applications.

1031.06 Use of RAP/FRAP and/or RAS in HMA. The use of RAP/FRAP and/or RAS shall be a Contractor's option when constructing HMA in all contracts.

(a) RAP/FRAP. The use of RAP/FRAP in HMA shall be as follows.

(1) Coarse Aggregate Size. The coarse aggregate in all RAP shall be equal to or less than the nominal maximum size requirement for the HMA mixture to be produced.

- (2) Steel Slag Stockpiles. Homogeneous RAP stockpiles containing steel slag will be approved for use in all HMA (High ESAL and Low ESAL) Surface and Binder Mixture applications.
 - (3) Use in HMA Surface Mixtures (High and Low ESAL). RAP/FRAP stockpiles for use in HMA surface mixtures (High and Low ESAL) shall be FRAP or homogeneous in which the coarse aggregate is Class B quality or better. RAP/FRAP from Conglomerate stockpiles shall be considered equivalent to limestone for frictional considerations. Known frictional contributions from plus #4 (4.75 mm) homogeneous RAP and FRAP stockpiles will be accounted for in meeting frictional requirements in the specified mixture.
 - (4) Use in HMA Binder Mixtures (High and Low ESAL), HMA Base Course, and HMA Base Course Widening. RAP/FRAP stockpiles for use in HMA binder mixtures (High and Low ESAL), HMA base course, and HMA base course widening shall be FRAP, homogeneous, or conglomerate, in which the coarse aggregate is Class C quality or better.
 - (5) Use in Shoulders and Subbase. RAP/FRAP stockpiles for use in HMA shoulders and stabilized subbase (HMA) shall be FRAP, homogeneous, conglomerate, or conglomerate DQ.
 - (6) When the Contractor chooses the RAP option, the percentage of RAP shall not exceed the amounts indicated in Article 1031.06(c)(1) below for a given N Design.
- (b) RAS. RAS meeting Type 1 or Type 2 requirements will be permitted in all HMA applications as specified herein.
- (c) RAP/FRAP and/or RAS Usage Limits. Type 1 or Type 2 RAS may be used alone or in conjunction with RAP or FRAP in HMA mixtures up to a maximum of 5.0% by weight of the total mix.
- (1) RAP/RAS. When RAP is used alone or RAP is used in conjunction with RAS, the percentage of virgin asphalt binder replacement shall not exceed the amounts listed in the Max RAP/RAS ABR table listed below for the given N design.

RAP/RAS Maximum Asphalt Binder Replacement (ABR) Percentage

HMA Mixtures ^{1/, 2/}	RAP/RAS Maximum ABR %		
Ndesign	Binder/Leveling Binder	Surface	Polymer Modified
30	30	30	10
50	25	15	10
70	15	10	10
90	10	10	10
105	10	10	10

1/ For HMA “All Other” (shoulder and stabilized subbase) N-30, the RAP/RAS ABR shall not exceed 50 percent of the mixture.

2/ When RAP/RAS ABR exceeds 20 percent, the high and low virgin asphalt binder grades shall each be reduced by one grade (i.e. 25 percent ABR would require a virgin asphalt binder grade of PG64-22 to be reduced to a PG58-28). If warm mix asphalt (WMA) technology is utilized, and production temperatures do not exceed 275 °F (135 °C) the high and low virgin asphalt binder grades shall each be reduced by one grade when RAP/RAS ABR exceeds 25 percent (i.e. 26 percent RAP/RAS ABR would require a virgin asphalt binder grade of PG64-22 to be reduced to a PG58-28).

(2) FRAP/RAS. When FRAP is used alone or FRAP is used in conjunction with RAS, the percentage of virgin asphalt binder replacement shall not exceed the amounts listed in the FRAP/RAS table listed below for the given N design.

FRAP/RAS Maximum Asphalt Binder Replacement (ABR) Percentage

HMA Mixtures ^{1/, 2/}	FRAP/RAS Maximum ABR %		
Ndesign	Binder/Leveling Binder	Surface	Polymer Modified ^{3/, 4/}
30	40	40	10
50	40	30	10
70	30	20	10
90	30	20	10
105	30	15	10

1/ For HMA “All Other” (shoulder and stabilized subbase) N30, the FRAP/RAS ABR shall not exceed 50 percent of the mixture.

- 2/ When FRAP/RAS ABR exceeds 20 percent for all mixes the high and low virgin asphalt binder grades shall each be reduced by one grade (i.e. 25 percent ABR would require a virgin asphalt binder grade of PG64-22 to be reduced to a PG58-28). If warm mix asphalt (WMA) technology is utilized, and production temperatures do not exceed 275 °F (135 °C) the high and low virgin asphalt binder grades shall each be reduced by one grade when FRAP/RAS ABR exceeds 25 percent (i.e. 26 percent ABR would require a virgin asphalt binder grade of PG64-22 to be reduced to a PG58-28).
- 3/ For SMA the FRAP/RAS ABR shall not exceed 20 percent.
- 4/ For IL-4.75 mix the FRAP/RAS ABR shall not exceed 30 percent.

1031.07 HMA Mix Designs. At the Contractor's option, HMA mixtures may be constructed utilizing RAP/FRAP and/or RAS material meeting the detailed requirements specified herein.

- (a) RAP/FRAP and/or RAS. RAP/FRAP and/or RAS mix designs shall be submitted for verification. If additional RAP/FRAP stockpiles are tested and found that no more than 20 percent of the results, as defined under "Testing" herein, are outside of the control tolerances set for the original RAP/FRAP stockpile and HMA mix design, and meets all of the requirements herein, the additional RAP/FRAP stockpiles may be used in the original mix design at the percent previously verified.
- (b) RAS. Type 1 and Type 2 RAS are not interchangeable in a mix design. A RAS stone bulk specific gravity (Gsb) of 2.500 shall be used for mix design purposes.

1031.08 HMA Production. HMA production utilizing RAP/FRAP and/or RAS shall be as follows.

- (a) RAP/FRAP. The coarse aggregate in all RAP/FRAP used shall be equal to or less than the nominal maximum size requirement for the HMA mixture being produced.

To remove or reduce agglomerated material, a scalping screen, gator, crushing unit, or comparable sizing device approved by the Engineer shall be used in the RAP feed system to remove or reduce oversized material. If material passing the sizing device adversely affects the mix production or quality of the mix, the sizing device shall be set at a size specified by the Engineer.

If the RAP/FRAP control tolerances or QC/QA test results require corrective action, the Contractor shall cease production of the mixture containing RAP/FRAP and either switch to the virgin aggregate design or submit a new RAP/FRAP design.

- (b) RAS. RAS shall be incorporated into the HMA mixture either by a separate weight depletion system or by using the RAP weigh belt. Either feed system shall be interlocked with the aggregate feed or weigh system to maintain correct proportions for all rates of production and batch sizes. The portion of RAS shall be controlled accurately to within ± 0.5 percent of the amount of RAS utilized. When using the weight depletion system, flow indicators or sensing devices shall be provided and interlocked with the plant controls such that the mixture production is halted when RAS flow is interrupted.

When producing HMA containing RAS, a positive dust control system shall be utilized.

- (c) RAP/FRAP and/or RAS. HMA plants utilizing RAP/FRAP and/or RAS shall be capable of automatically recording and printing the following information.

(1) Dryer Drum Plants.

- a. Date, month, year, and time to the nearest minute for each print.
- b. HMA mix number assigned by the Department.
- c. Accumulated weight of dry aggregate (combined or individual) in tons (metric tons) to the nearest 0.1 ton (0.1 metric ton).
- d. Accumulated dry weight of RAP/FRAP/RAS in tons (metric tons) to the nearest 0.1 ton (0.1 metric ton).
- e. Accumulated mineral filler in revolutions, tons (metric tons), etc. to the nearest 0.1 unit.
- f. Accumulated asphalt binder in gallons (liters), tons (metric tons), etc. to the nearest 0.1 unit.
- g. Residual asphalt binder in the RAP/FRAP material as a percent of the total mix to the nearest 0.1 percent.
- h. Aggregate and RAP/FRAP moisture compensators in percent as set on the control panel. (Required when accumulated or individual aggregate and RAP/FRAP are printed in wet condition.)

(2) Batch Plants.

- a. Date, month, year, and time to the nearest minute for each print.
- b. HMA mix number assigned by the Department.
- c. Individual virgin aggregate hot bin batch weights to the nearest pound (kilogram).

- d. Mineral filler weight to the nearest pound (kilogram).
- f. RAP/FRAP/RAS weight to the nearest pound (kilogram).
- g. Virgin asphalt binder weight to the nearest pound (kilogram).
- h. Residual asphalt binder in the RAP/FRAP/RAS material as a percent of the total mix to the nearest 0.1 percent.

The printouts shall be maintained in a file at the plant for a minimum of one year or as directed by the Engineer and shall be made available upon request. The printing system will be inspected by the Engineer prior to production and verified at the beginning of each construction season thereafter.

1031.09 RAP in Aggregate Surface Course and Aggregate Shoulders. The use of RAP in aggregate surface course (temporary access entrances only) and aggregate wedge shoulders Type B shall be as follows.

- (a) Stockpiles and Testing. RAP stockpiles may be any of those listed in Article 1031.02, except “Non-Quality” and “FRAP”. The testing requirements of Article 1031.03 shall not apply. RAP used to construct aggregate surface course and aggregate shoulders shall be according to the current Bureau of Materials and Physical Research’s Policy Memorandum, “Reclaimed Asphalt Pavement (RAP) for Aggregate Applications”.
- (b) Gradation. One hundred percent of the RAP material shall pass the 1 1/2 in. (37.5 mm) sieve. The RAP material shall be reasonably well graded from coarse to fine. RAP material that is gap-graded or single sized will not be accepted.”

REMOVAL AND DISPOSAL OF REGULATED SUBSTANCES (BDE)

Effective: January 1, 2012

Revised: November 2, 2012

Revise Article 669.01 of the Standard Specifications to read:

“669.01 Description. This work shall consist of the transportation and proper disposal of contaminated soil and water. This work shall also consist of the removal, transportation, and proper disposal of underground storage tanks (UST), their content and associated underground piping to the point where the piping is above the ground, including determining the content types and estimated quantities.”

Revise Article 669.08 of the Standard Specifications to read:

“669.08 Contaminated Soil and/or Groundwater Monitoring. The Contractor shall hire a qualified environmental firm to monitor the area containing the regulated substances. The affected area shall be monitored with a photoionization detector (PID) utilizing a lamp of 10.6eV or greater or a flame ionization detector (FID). Any field screen reading on the PID or FID in excess of background levels indicates the potential presence of contaminated material requiring handling as a non-special waste, special waste, or hazardous waste. No excavated soils can be taken to a clean construction and demolition debris (CCDD) facility or an uncontaminated soil fill operation with detectable PID or FID meter readings that are above background. The PID or FID meter shall be calibrated on-site and background level readings taken and recorded daily. All testing shall be done by a qualified engineer/technician. Such testing and monitoring shall be included in the work. The Contractor shall identify the exact limits of removal of non-special waste, special waste, or hazardous waste. All limits shall be approved by the Engineer prior to excavation. The Contractor shall take all necessary precautions.

Based upon the land use history of the subject property and/or PID or FID readings indicating contamination, a soil or groundwater sample shall be taken from the same location and submitted to an approved laboratory. Soil or groundwater samples shall be analyzed for the contaminants of concern, including pH, based on the property's land use history or the parameters listed in the maximum allowable concentration (MAC) for chemical constituents in uncontaminated soil established pursuant to Subpart F of 35 Illinois Administrative Code 1100.605. The analytical results shall serve to document the level of soil contamination. Soil and groundwater samples may be required at the discretion of the Engineer to verify the level of soil and groundwater contamination.

Samples shall be grab samples (not combined with other locations). The samples shall be taken with decontaminated or disposable instruments. The samples shall be placed in sealed containers and transported in an insulated container to the laboratory. The container shall maintain a temperature of 39 °F (4 °C). All samples shall be clearly labeled. The labels shall indicate the sample number, date sampled, location and elevation, and any other observations.

The laboratory shall use analytical methods which are able to meet the lowest appropriate practical quantitation limits (PQL) or estimated quantitation limit (EQL) specified in "Test Methods for Evaluating Solid Wastes, Physical/Chemical Methods", EPA Publication No. SW-846 and "Methods for the Determination of Organic Compounds in Drinking Water", EPA, EMSL, EPA-600/4-88/039. For parameters where the specified cleanup objective is below the acceptable detection limit (ADL), the ADL shall serve as the cleanup objective. For other parameters the ADL shall be equal to or below the specified cleanup objective.”

Replace the first two paragraphs of Article 669.09 of the Standard Specifications with the following:

“669.09 Contaminated Soil and/or Groundwater Management and Disposal. The management and disposal of contaminated soil and/or groundwater shall be according to the following:

- (a) Soil Analytical Results Exceed Most Stringent MAC. When the soil analytical results indicate that detected levels exceed the most stringent maximum allowable concentration (MAC) for chemical constituents in uncontaminated soil established pursuant to Subpart F of 35 Illinois Administrative Code 1100.605, the soil shall be managed as follows:
- (1) When analytical results indicate inorganic chemical constituents exceed the most stringent MAC but they are still considered within area background levels by the Engineer, the excavated soil can be utilized within the construction limits as fill, when suitable. Such soil excavated for storm sewers can be placed back into the excavated trench as backfill, when suitable, unless trench backfill is specified. If the soils cannot be utilized within the construction limits, they shall be managed and disposed of off-site as a non-special waste, special waste, or hazardous waste as applicable.
 - (2) When analytical results indicate chemical constituents exceed the most stringent MAC but do not exceed the MAC for a Metropolitan Statistical Area (MSA) County, the excavated soil can be utilized within the construction limits as fill, when suitable, or managed and disposed of off-site as “uncontaminated soil” at a CCDD facility or an uncontaminated soil fill operation within an MSA County provided the pH of the soil is within the range of 6.25 - 9.0, inclusive.
 - (3) When analytical results indicate chemical constituents exceed the most stringent MAC but do not exceed the MAC for an MSA County excluding Chicago, or the MAC within the Chicago corporate limits, the excavated soil can be utilized within the construction limits as fill, when suitable, or managed and disposed of off-site as “uncontaminated soil” at a CCDD facility or an uncontaminated soil fill operation within an MSA County excluding Chicago or within the Chicago corporate limits provided the pH of the soil is within the range of 6.25 - 9.0, inclusive.
 - (4) When analytical results indicate chemical constituents exceed the most stringent MAC but do not exceed the MAC for an MSA County excluding Chicago, the excavated soil can be utilized within the construction limits as fill, when suitable, or managed and disposed of off-site as “uncontaminated soil” at a CCDD facility or an uncontaminated soil fill operation within an MSA County excluding Chicago provided the pH of the soil is within the range of 6.25 - 9.0, inclusive.
 - (5) When the Engineer determines soil cannot be managed according to Articles 669.09(a)(1) through (a)(4) above, the soil shall be managed and disposed of off-site as a non-special waste, special waste, or hazardous waste as applicable.

- (b) Soil Analytical Results Do Not Exceed Most Stringent MAC. When the soil analytical results indicate that detected levels do not exceed the most stringent MAC but the pH of the soil is less than 6.25 or greater than 9.0, the excavated soil can be utilized within the construction limits or managed and disposed of off-site as “uncontaminated soil” according to Article 202.03. However the excavated soil cannot be taken to a CCDD facility or an uncontaminated soil fill operation.
- (c) Groundwater. When groundwater analytical results indicate the detected levels are above Appendix B, Table E of 35 Illinois Administrative Code 742, the most stringent Tier 1 Groundwater Remediation Objectives for Groundwater Component of the Groundwater Ingestion Route for Class 1 groundwater, the groundwater shall be managed off-site as a special waste.

All groundwater encountered within lateral trenches may be managed within the trench and allowed to infiltrate back into the ground. If the groundwater cannot be managed within the trench it must be removed as a special or hazardous waste. The Contractor is prohibited from managing groundwater within the trench by discharging it through any existing or new storm sewer. The Contractor shall install backfill plugs within the area of groundwater contamination.

One backfill plug shall be placed down gradient to the area of groundwater contamination. Backfill plugs shall be installed at intervals not to exceed 50 ft (15 m). Backfill plugs are to be 4 ft (1.2 m) long, measured parallel to the trench, full trench width and depth. Backfill plugs shall not have any fine aggregate bedding or backfill, but shall be entirely cohesive soil or any class of concrete. The Contractor shall provide test data that the material has a permeability of less than 10^{-7} cm/sec according to ASTM D 5084, Method A or per another test method approved by the Engineer.”

Revise Article 669.14 of the Standard Specifications to read:

“669.14 Final Environmental Construction Report. At the end of the project, the Contractor will prepare and submit three copies of the Environmental Construction Report on the activities conducted during the life of the project, one copy shall be submitted to the Resident Engineer, one copy shall be submitted to the District's Environmental Studies Unit, and one copy shall be submitted with an electronic copy in Adode.pdf format to the Geologic and Waste Assessment Unit, Bureau of Design and Environment, IDOT, 2300 South Dirksen Parkway, Springfield, Illinois 62764. The technical report shall include all pertinent information regarding the project including, but not limited to:

- (a) Measures taken to identify, monitor, handle, and dispose of soil or groundwater containing regulated substances, to prevent further migration of regulated substances, and to protect workers,

- (b) Cost of identifying, monitoring, handling, and disposing of soil or groundwater containing regulated substances, the cost of preventing further migration of regulated substances, and the cost for worker protection from the regulated substances. All cost should be in the format of the contract pay items listed in the contract plans (identified by the preliminary environmental site investigation (PESA) site number),
- (c) Plan sheets showing the areas containing the regulated substances,
- (d) Field sampling and testing results used to identify the nature and extent of the regulated substances,
- (e) Waste manifests (identified by the preliminary environmental site investigation (PESA) site number) for special or hazardous waste disposal, and
- (f) Landfill tickets (identified by the preliminary environmental site investigation (PESA) site number) for non-special waste disposal.”

Revise the second paragraph of Article 669.16 of the Standard Specifications to read:

“The transportation and disposal of soil and other materials from an excavation determined to be contaminated will be paid for at the contract unit price per cubic yard (cubic meter) for NON-SPECIAL WASTE DISPOSAL, SPECIAL WASTE DISPOSAL, or HAZARDOUS WASTE DISPOSAL.”

REMOVAL AND DISPOSAL OF SURPLUS MATERIALS (BDE)

Effective: November 2, 2012

Revise the first four paragraphs of Article 202.03 of the Standard Specifications to read:

“202.03 Removal and Disposal of Surplus, Unstable, Unsuitable, and Organic Materials. Suitable excavated materials shall not be wasted without permission of the Engineer. The Contractor shall dispose of all surplus, unstable, unsuitable, and organic materials, in such a manner that public or private property will not be damaged or endangered.

Suitable earth, stones and boulders naturally occurring within the right-of-way may be placed in fills or embankments in lifts and compacted according to Section 205. Broken concrete without protruding metal bars, bricks, rock, stone, reclaimed asphalt pavement with no expansive aggregate, or uncontaminated dirt and sand generated from construction or demolition activities may be used in embankment or in fill. If used in fills or embankments, these materials shall be placed and compacted to the satisfaction of the Engineer; shall be buried under a minimum of 2 ft (600 mm) of earth cover (except when the materials include only uncontaminated dirt); and shall not create an unsightly appearance or detract from the natural topographic features of an area. Broken concrete without protruding metal bars, bricks, rock, or stone may be used as riprap as approved by the Engineer. If the materials are used for fill in locations within the right-of-way but outside project construction limits, the Contractor must specify to the Engineer, in writing, how the landscape restoration of the fill areas will be accomplished. Placement of fill in such areas shall not commence until the Contractor's landscape restoration plan is approved by the Engineer.

Aside from the materials listed above, all other construction and demolition debris or waste shall be disposed of in a licensed landfill, recycled, reused, or otherwise disposed of as allowed by State or Federal laws and regulations. When the Contractor chooses to dispose of uncontaminated soil at a clean construction and demolition debris (CCDD) facility or at an uncontaminated soil fill operation, it shall be the Contractor's responsibility to have the pH of the material tested to ensure the value is between 6.25 and 9.0, inclusive. A copy of the pH test results shall be provided to the Engineer.

A permit shall be obtained from IEPA and made available to the Engineer prior to open burning of organic materials (i.e., plant refuse resulting from pruning or removal of trees or shrubs) or other construction or demolition debris. Organic materials originating within the right-of-way limits may be chipped or shredded and placed as mulch around landscape plantings within the right-of-way when approved by the Engineer. Chipped or shredded material to be placed as mulch shall not exceed a depth of 6 in. (150 mm)."

TRACKING THE USE OF PESTICIDES (BDE)

Effective: August 1, 2012

Add the following paragraph after the first paragraph of Article 107.23 of the Standard Specifications:

"Within 48 hours of the application of pesticides, including but not limited to herbicides, insecticides, algacides, and fungicides, the Contractor shall complete and return to the Engineer, Operations form "OPER 2720"."

TRAINING SPECIAL PROVISIONS (BDE)

Effective: October 15, 1975

This Training Special Provision supersedes Section 7b of the Special Provision entitled "Specific Equal Employment Opportunity Responsibilities," and is in implementation of 23 U.S.C. 140(a).

As part of the Contractor's equal employment opportunity affirmative action program, training shall be provided as follows:

The Contractor shall provide on-the-job training aimed at developing full journeyman in the type of trade or job classification involved. The number of trainees to be trained under this contract will be 1. In the event the Contractor subcontracts a portion of the contract work, he shall determine how many, if any, of the trainees are to be trained by the subcontractor, provided however, that the Contractor shall retain the primary responsibility for meeting the training requirements imposed by this special provision. The Contractor shall also insure that this Training Special Provision is made applicable to such subcontract. Where feasible, 25 percent of apprentices or trainees in each occupation shall be in their first year of apprenticeship or training.

The number of trainees shall be distributed among the work classifications on the basis of the Contractor's needs and the availability of journeymen in the various classifications within the reasonable area of recruitment. Prior to commencing construction, the Contractor shall submit to the Illinois Department of Transportation for approval the number of trainees to be trained in each selected classification and training program to be used. Furthermore, the Contractor shall specify the starting time for training in each of the classifications. The Contractor will be credited for each trainee employed by him on the contract work who is currently enrolled or becomes enrolled in an approved program and will be reimbursed for such trainees as provided hereinafter.

Training and upgrading of minorities and women toward journeyman status is a primary objective of this Training Special Provision. Accordingly, the Contractor shall make every effort to enroll minority trainees and women (e.g. by conducting systematic and direct recruitment through public and private sources likely to yield minority and women trainees) to the extent such persons are available within a reasonable area of recruitment. The Contractor will be responsible for demonstrating the steps that he has taken in pursuance thereof, prior to a determination as to whether the Contractor is in compliance with this Training Special Provision. This training commitment is not intended, and shall not be used, to discriminate against any applicant for training, whether a member of a minority group or not.

No employee shall be employed as a trainee in any classification in which he has successfully completed a training course leading to journeyman status or in which he has been employed as a journeyman. The Contractor should satisfy this requirement by including appropriate questions in the employee application or by other suitable means. Regardless of the method used, the Contractor's records should document the findings in each case.

The minimum length and type of training for each classification will be as established in the training program selected by the Contractor and approved by the Illinois Department of Transportation and the Federal Highway Administration. The Illinois Department of Transportation and the Federal Highway Administration shall approve a program, if it is reasonably calculated to meet the equal employment opportunity obligations of the Contractor and to qualify the average trainee for journeyman status in the classification concerned by the end of the training period. Furthermore, apprenticeship programs registered with the U.S. Department of Labor, Bureau of Apprenticeship and Training, or with a State apprenticeship agency recognized by the Bureau and training programs approved by not necessarily sponsored by the U.S. Department of Labor, Manpower Administration, Bureau of Apprenticeship and Training shall also be considered acceptable provided it is being administered in a manner consistent with the equal employment obligations of Federal-aid highway construction contracts. Approval or acceptance of a training program shall be obtained from the State prior to commencing work on the classification covered by the program. It is the intention of these provisions that training is to be provided in the construction crafts rather than clerk-typists or secretarial-type positions. Training is permissible in lower level management positions such as office engineers, estimators, timekeepers, etc., where the training is oriented toward construction applications. Training in the laborer classification may be permitted provided that significant and meaningful training is provided and approved by the Illinois Department of Transportation and the Federal Highway Administration. Some offsite training is permissible as long as the training is an integral part of an approved training program and does not comprise a significant part of the overall training.

Except as otherwise noted below, the Contractor will be reimbursed 80 cents per hour of training given an employee on this contract in accordance with an approved training program. As approved by the Engineer, reimbursement will be made for training of persons in excess of the number specified herein. This reimbursement will be made even though the Contractor receives additional training program funds from other sources, provided such other source does not specifically prohibit the Contractor from receiving other reimbursement. Reimbursement for offsite training indicated above may only be made to the Contractor where he does one or more of the following and the trainees are concurrently employed on a Federal-aid project; contributes to the cost of the training, provides the instruction to the trainee or pays the trainee's wages during the offsite training period.

No payment shall be made to the Contractor if either the failure to provide the required training, or the failure to hire the trainee as a journeyman, is caused by the Contractor and evidences a lack of good faith on the part of the Contractor in meeting the requirement of this Training Special Provision. It is normally expected that a trainee will begin his training on the project as soon as feasible after start of work utilizing the skill involved and remain on the project as long as training opportunities exist in his work classification or until he has completed his training program.

It is not required that all trainees be on board for the entire length of the contract. A Contractor will have fulfilled his responsibilities under this Training Special Provision if he has provided acceptable training to the number of trainees specified. The number trained shall be determined on the basis of the total number enrolled on the contract for a significant period.

Trainees will be paid at least 60 percent of the appropriate minimum journeyman's rate specified in the contract for the first half of the training period, 75 percent for the third quarter of the training period, and 90 percent for the last quarter of the training period, unless apprentices or trainees in an approved existing program are enrolled as trainees on this project. In that case, the appropriate rates approved by the Departments of Labor or Transportation in connection with the existing program shall apply to all trainees being trained for the same classification who are covered by this Training Special Provision.

The Contractor shall furnish the trainee a copy of the program he will follow in providing the training. The Contractor shall provide each trainee with a certification showing the type and length of training satisfactorily complete.

The Contractor shall provide for the maintenance of records and furnish periodic reports documenting his performance under this Training Special Provision.

Method of Measurement. The unit of measurement is in hours.

Basis of Payment. This work will be paid for at the contract unit price of 80 cents per hour for TRAINEES. The estimated total number of hours, unit price, and total price have been included in the schedule of prices.

IDOT TRAINING PROGRAM GRADUATE ON-THE-JOB TRAINING SPECIAL PROVISION (TPG)

Effective: August 1, 2012

Revised: February 1, 2014

In addition to the Contractor's equal employment opportunity affirmative action efforts undertaken as elsewhere required by this Contract, the Contractor is encouraged to participate in the incentive program to provide additional on-the-job training to certified graduates of IDOT funded pre-apprenticeship training programs outlined by this Special Provision.

It is the policy of IDOT to fund IDOT pre-apprenticeship training programs throughout Illinois to provide training and skill-improvement opportunities to assure the increased participation of minority groups, disadvantaged persons and women in all phases of the highway construction industry. The intent of this IDOT Training Program Graduate (TPG) Special Provision is to place certified graduates of these IDOT funded pre-apprentice training programs on IDOT project sites when feasible, and provide the graduates with meaningful on-the-job training intended to lead to journey-level employment. IDOT and its sub-recipients, in carrying out the responsibilities of a state contract, shall determine which construction contracts shall include "Training Program Graduate Special Provisions." To benefit from the incentives to encourage the participation in the additional on-the-job training under this Training Program Graduate Special Provision, the Contractor shall make every reasonable effort to employ certified graduates of IDOT funded Pre-apprenticeship Training Programs to the extent such persons are available within a reasonable recruitment area.

Participation pursuant to IDOT's requirements by the Contractor or subcontractor in this Training Program Graduate (TPG) Special Provision entitles the Contractor or subcontractor to be reimbursed at \$15.00 per hour for training given a certified TPG on this contract. As approved by the Department, reimbursement will be made for training persons as specified herein. This reimbursement will be made even though the Contractor or subcontractor may receive additional training program funds from other sources for other trainees, provided such other source does not specifically prohibit the Contractor or subcontractor from receiving other reimbursement. For purposes of this Special Provision the Contractor is not relieved of requirements under applicable federal law, the Illinois Prevailing Wage Act, and is not eligible for other training fund reimbursements in addition to the Training Program Graduate (TPG) Special Provision reimbursement.

No payment shall be made to the Contractor if the Contractor or subcontractor fails to provide the required training. It is normally expected that a TPG will begin training on the project as soon as feasible after start of work utilizing the skill involved and remain on the project through completion of the contract, so long as training opportunities exist in his work classification or until he has completed his training program. Should the TPG's employment end in advance of the completion of the contract, the Contractor shall promptly notify the designated IDOT staff member under this Special Provision that the TPG's involvement in the contract has ended and supply a written report of the reason for the end of the involvement, the hours completed by the TPG under the Contract and the number of hours for which the incentive payment provided under this Special Provision will be or has been claimed for the TPG.

The Contractor will provide for the maintenance of records and furnish periodic reports documenting its performance under this Special Provision.

METHOD OF MEASUREMENT: The unit of measurement is in hours.

BASIS OF PAYMENT: This work will be paid for at the contract unit price of \$15.00 per hour for certified TRAINEES TRAINING PROGRAM GRADUATE. The estimated total number of hours, unit price and total price have been included in the schedule of prices.

The Contractor shall provide training opportunities aimed at developing full journeyworker in the type of trade or job classification involved. The initial number of TPGs for which the incentive is available under this contract is 1. During the course of performance of the Contract the Contractor may seek approval from the Department for additional incentive eligible TPGs. In the event the Contractor subcontracts a portion of the contract work, it shall determine how many, if any, of the TPGs are to be trained by the subcontractor, provided however, that the Contractor shall retain the primary responsibility for meeting the training requirements imposed by this Special Provision. The Contractor shall also insure that this Training Program Graduate Special Provision is made applicable to such subcontract if the TPGs are to be trained by a subcontractor and that the incentive payment is passed on to each subcontractor.

For the Contractor to meet the obligations for participation in this TPG incentive program under this Special Provision, the Department has contracted with several entities to provide screening, tutoring and pre-training to individuals interested in working in the applicable construction classification and has certified those students who have successfully completed the program and are eligible to be TPGs. A designated IDOT staff member, the Director of the Office of Business and Workforce Diversity (OBWD), will be responsible for providing assistance and referrals to the Contractor for the applicable TPGs. For this contract, the Director of OBWD is designated as the responsible IDOT staff member to provide the assistance and referral services related to the placement for this Special Provision. For purposes of this Contract, contacting the Director of OBWD and interviewing each candidate he/she recommends constitutes reasonable recruitment.

Prior to commencing construction, the Contractor shall submit to the Department for approval the TPGs to be trained in each selected classification. Furthermore, the Contractor shall specify the starting time for training in each of the classifications. No employee shall be employed as a TPG in any classification in which he/she has successfully completed a training course leading to journeyman status or in which he/she has been employed as a journeyman. Notwithstanding the on-the-job training purpose of this TPG Special Provision, some offsite training is permissible as long as the offsite training is an integral part of the work of the contract and does not comprise a significant part of the overall training.

Training and upgrading of TPGs of IDOT pre-apprentice training programs is intended to move said TPGs toward journeyman status and is the primary objective of this Training Program Graduate Special Provision. Accordingly, the Contractor shall make every effort to enroll TPGs by recruitment through the IDOT funded TPG programs to the extent such persons are available within a reasonable area of recruitment. The Contractor will be responsible for demonstrating the steps that it has taken in pursuance thereof, prior to a determination as to whether the Contractor is in compliance and entitled to the Training Program Graduate Special Provision \$15.00 an hour incentive.

The Contractor or subcontractor shall provide each TPG with a certificate showing the type and length of training satisfactorily completed.

WARM MIX ASPHALT (BDE)

Effective: January 1, 2012

Revised: November 1, 2013

Description. This work shall consist of designing, producing and constructing Warm Mix Asphalt (WMA) in lieu of Hot Mix Asphalt (HMA) at the Contractor's option. Work shall be according to Sections 406, 407, 408, 1030, and 1102 of the Standard Specifications, except as modified herein. In addition, any references to HMA in the Standard Specifications, or the special provisions shall be construed to include WMA.

WMA is an asphalt mixture which can be produced at temperatures lower than allowed for HMA utilizing approved WMA technologies. WMA technologies are defined as the use of additives or processes which allow a reduction in the temperatures at which HMA mixes are produced and placed. WMA is produced by the use of additives, a water foaming process, or combination of both. Additives include minerals, chemicals or organics incorporated into the asphalt binder stream in a dedicated delivery system. The process of foaming injects water into the asphalt binder stream, just prior to incorporation of the asphalt binder with the aggregate.

Approved WMA technologies may also be used in HMA provided all the requirements specified herein, with the exception of temperature, are met. However, asphalt mixtures produced at temperatures in excess of 275 °F (135 °C) will not be considered WMA when determining the grade reduction of the virgin asphalt binder grade.

Materials.

Add the following to Article 1030.02 of the Standard Specifications.

“(h) Warm Mix Asphalt (WMA) Technologies (Note 3)”

Add the following note to Article 1030.02 of the Standard Specifications.

“Note 3. Warm mix additives or foaming processes shall be selected from the current Bureau of Materials and Physical Research Approved List, “Warm-Mix Asphalt Technologies”.”

Equipment.

Revise the first paragraph of Article 1102.01 of the Standard Specifications to read:

“**1102.01 Hot-Mix Asphalt Plant.** The hot-mix asphalt (HMA) plant shall be the batch-type, continuous-type, or dryer drum plant. The plants shall be evaluated for prequalification rating and approval to produce HMA according to the current Bureau of Materials and Physical Research Policy Memorandum, “Approval of Hot-Mix Asphalt Plants and Equipment”. Once approved, the Contractor shall notify the Bureau of Materials and Physical Research to obtain approval of all plant modifications. The plants shall not be used to produce mixtures concurrently for more than one project or for private work unless permission is granted in writing by the Engineer. The plant units shall be so designed, coordinated and operated that they will function properly and produce HMA having uniform temperatures and compositions within the tolerances specified. The plant units shall meet the following requirements.”

Add the following to Article 1102.01(a) of the Standard Specifications.

“(13) Equipment for Warm Mix Technologies.

- a. Foaming. Metering equipment for foamed asphalt shall have an accuracy of ± 2 percent of the actual water metered. The foaming control system shall be electronically interfaced with the asphalt binder meter.

- b. Additives. Additives shall be introduced into the plant according to the supplier's recommendations and shall be approved by the Engineer. The system for introducing the WMA additive shall be interlocked with the aggregate feed or weigh system to maintain correct proportions for all rates of production and batch sizes."

Mix Design Verification.

Add the following to Article 1030.04 of the Standard Specifications.

"(e) Warm Mix Technologies.

- (1) Foaming. WMA mix design verification will not be required when foaming technology is used alone (without WMA additives). However, the foaming technology shall only be used on HMA designs previously approved by the Department.
- (2) Additives. WMA mix designs utilizing additives shall be submitted to the Engineer for mix design verification.

Production.

Revise the second paragraph of Article 1030.06(a) of the Standard Specifications to read:

"At the start of mix production for HMA, WMA, and HMA using WMA technologies, QC/QA mixture start-up will be required for the following situations; at the beginning of production of a new mixture design, at the beginning of each production season, and at every plant utilized to produce mixtures, regardless of the mix."

Quality Control/Quality Assurance Testing.

Revise the table in Article 1030.05(d)(2)a. of the Standard Specifications to read:

Parameter	Frequency of Tests	Frequency of Tests	Test Method See Manual of Test Procedures for Materials
	High ESAL Mixture Low ESAL Mixture	All Other Mixtures	
Aggregate Gradation % passing sieves: 1/2 in. (12.5 mm), No. 4 (4.75 mm), No. 8 (2.36 mm), No. 30 (600 μm) No. 200 (75 μm) Note 1.	1 washed ignition oven test on the mix per half day of production Note 4.	1 washed ignition oven test on the mix per day of production Note 4.	Illinois Procedure
Asphalt Binder Content by Ignition Oven Note 2.	1 per half day of production	1 per day	Illinois-Modified AASHTO T 308
VMA Note 3.	Day's production ≥ 1200 tons: 1 per half day of production Day's production < 1200 tons: 1 per half day of production for first 2 days and 1 per day thereafter (first sample of the day)	N/A	Illinois-Modified AASHTO R 35
Air Voids Bulk Specific Gravity of Gyratory Sample Note 5.	Day's production ≥ 1200 tons: 1 per half day of production Day's production < 1200 tons: 1 per half day of production for first 2 days and 1 per day thereafter (first sample of the day)	1 per day	Illinois-Modified AASHTO T 312
Maximum Specific Gravity of Mixture	Day's production ≥ 1200 tons: 1 per half day of production Day's production < 1200 tons: 1 per half day of production for first 2 days and 1 per day thereafter (first	1 per day	Illinois-Modified AASHTO T 209

Parameter	Frequency of Tests		Test Method See Manual of Test Procedures for Materials
	High ESAL Mixture Low ESAL Mixture sample of the day)	All Other Mixtures	

Note 1. The No. 8 (2.36 mm) and No. 30 (600 µm) sieves are not required for All Other Mixtures.

Note 2. The Engineer may waive the ignition oven requirement for asphalt binder content if the aggregates to be used are known to have ignition asphalt binder content calibration factors which exceed 1.5 percent. If the ignition oven requirement is waived, other Department approved methods shall be used to determine the asphalt binder content.

Note 3. The G_{sb} used in the voids in the mineral aggregate (VMA) calculation shall be the same average G_{sb} value listed in the mix design.

Note 4. The Engineer reserves the right to require additional hot bin gradations for batch

Note 5. The WMA compaction temperature for mixture volumetric testing shall be 270 ± 5 °F (132 ± 3 °C) for quality control testing. The WMA compaction temperature for quality assurance testing will be 270 ± 5 °F (132 ± 3 °C) if the mixture is not allowed to cool to room temperature. If the mixture is allowed to cool to room temperature it shall be reheated to standard HMA compaction temperatures.”

Construction Requirements.

Revise the second paragraph of Article 406.06(b)(1) of the Standard Specifications to read:

“The HMA shall be delivered at a temperature of 250 to 350 °F (120 to 175 °C).
 WMA shall be delivered at a minimum temperature of 215 °F (102 °C).”

Basis of Payment.

This work will be paid at the contract unit price bid for the HMA pay items involved. Anti-strip will not be paid for separately, but shall be considered as included in the cost of the work.

WEEKLY DBE TRUCKING REPORTS (BDE)

Effective: June 2, 2012

The Contractor shall provide a weekly report of Disadvantaged Business Enterprise (DBE) trucks hired by the Contractor or subcontractors (i.e. not owned by the Contractor or subcontractors) that are used on the jobsite; or used for the delivery and/or removal of equipment/material to and from the jobsite. The jobsite shall also include offsite locations, such as plant sites or storage sites, when those locations are used solely for this contract.

The report shall be submitted on the form provided by the Department within ten business days following the reporting period. The reporting period shall be Monday through Sunday for each week reportable trucking activities occur. The report shall be submitted to the Engineer and a copy shall be provided to the district EEO Officer.

Any costs associated with providing weekly DBE trucking reports shall be considered as included in the contract unit prices bid for the various items of work involved and no additional compensation will be allowed.

WORKING DAYS (BDE)

Effective: January 1, 2002

The Contractor shall complete the work within 75 working days.

BITUMINOUS MATERIALS COST ADJUSTMENTS (BDE) (RETURN FORM WITH BID)

Effective: November 2, 2006

Revised: August 1, 2013

Description. Bituminous material cost adjustments will be made to provide additional compensation to the Contractor, or credit to the Department, for fluctuations in the cost of bituminous materials when optioned by the Contractor. The adjustments shall apply to permanent and temporary hot-mix asphalt (HMA) mixtures, bituminous surface treatments (cover and seal coats), and preventative maintenance type surface treatments. The adjustments shall not apply to bituminous prime coats, tack coats, crack filling/sealing, or joint filling/sealing.

The bidder shall indicate on the attached form whether or not this special provision will be part of the contract and submit the completed form with his/her bid. Failure to submit the form, or failure to fill out the form completely, shall make this contract exempt of bituminous materials cost adjustments.

Method of Adjustment. Bituminous materials cost adjustments will be computed as follows.

$$CA = (BPI_P - BPI_L) \times (\%AC_V / 100) \times Q$$

- Where: CA = Cost Adjustment, \$.
BPI_P = Bituminous Price Index, as published by the Department for the month the work is performed, \$/ton (\$/metric ton).
BPI_L = Bituminous Price Index, as published by the Department for the month prior to the letting, \$/ton (\$/metric ton).
%AC_V = Percent of virgin Asphalt Cement in the Quantity being adjusted. For HMA mixtures, the % AC_V will be determined from the adjusted job mix formula. For bituminous materials applied, a performance graded or cutback asphalt will be considered to be 100% AC_V and undiluted emulsified asphalt will be considered to be 65% AC_V.
Q = Authorized construction Quantity, tons (metric tons) (see below).

For HMA mixtures measured in square yards: $Q, \text{ tons} = A \times D \times (G_{mb} \times 46.8) / 2000$. For HMA mixtures measured in square meters: $Q, \text{ metric tons} = A \times D \times (G_{mb} \times 1) / 1000$. When computing adjustments for full-depth HMA pavement, separate calculations will be made for the binder and surface courses to account for their different G_{mb} and % AC_V.

For bituminous materials measured in gallons: $Q, \text{ tons} = V \times 8.33 \text{ lb/gal} \times SG / 2000$

For bituminous materials measured in liters: $Q, \text{ metric tons} = V \times 1.0 \text{ kg/L} \times SG / 1000$

- Where: A = Area of the HMA mixture, sq yd (sq m).
D = Depth of the HMA mixture, in. (mm).
G_{mb} = Average bulk specific gravity of the mixture, from the approved mix design.
V = Volume of the bituminous material, gal (L).
SG = Specific Gravity of bituminous material as shown on the bill of lading.

Basis of Payment. Bituminous materials cost adjustments may be positive or negative but will only be made when there is a difference between the BPI_L and BPI_P in excess of five percent, as calculated by:

$$\text{Percent Difference} = \{(BPI_L - BPI_P) \div BPI_L\} \times 100$$

Bituminous materials cost adjustments will be calculated for each calendar month in which applicable bituminous material is placed; and will be paid or deducted when all other contract requirements for the work placed during the month are satisfied. The adjustments shall not apply during contract time subject to liquidated damages for completion of the entire contract.

Return With Bid

**ILLINOIS DEPARTMENT
OF TRANSPORTATION**

**OPTION FOR
BITUMINOUS MATERIALS COST ADJUSTMENTS**

The bidder shall submit this completed form with his/her bid. Failure to submit the form, or failure to fill out the form completely, shall make this contract exempt of bituminous materials cost adjustments. After award, this form, when submitted, shall become part of the contract.

Contract No.: _____

Company Name: _____

Contractor's Option:

Is your company opting to include this special provision as part of the contract?

Yes No

Signature: _____ **Date:** _____

FUEL COST ADJUSTMENT (BDE) (RETURN FORM WITH BID)

Effective: April 1, 2009

Revised: July 1, 2009

Description. Fuel cost adjustments will be made to provide additional compensation to the Contractor, or a credit to the Department, for fluctuations in fuel prices when optioned by the Contractor. The bidder shall indicate on the attached form whether or not this special provision will be part of the contract and submit the completed form with his/her bid. Failure to submit the form or failure to indicate contract number, company name and sign and date the form shall make this contract exempt of fuel cost adjustments for all categories of work. Failure to indicate "Yes" for any category of work will make that category of work exempt from fuel cost adjustment.

General. The fuel cost adjustment shall apply to contract pay items as grouped by category. The adjustment shall only apply to those categories of work checked "Yes", and only when the cumulative plan quantities for a category exceed the required threshold. Adjustments to work items in a category, either up or down, and work added by adjusted unit price will be subject to fuel cost adjustment only when the category representing the added work was subject to the fuel cost adjustment. Added work paid for by time and materials will not be subject to fuel cost adjustment. Category descriptions and thresholds for application and the fuel usage factors which are applicable to each are as follows:

(a) Categories of Work.

- (1) Category A: Earthwork. Contract pay items performed under Sections 202, 204, and 206 including any modified standard or nonstandard items where the character of the work to be performed is considered earthwork. The cumulative total of all applicable item plan quantities shall exceed 25,000 cu yd (20,000 cu m). Included in the fuel usage factor is a weighted average 0.10 gal/cu yd (0.50 liters/cu m) factor for trucking.
- (2) Category B: Subbases and Aggregate Base Courses. Contract pay items constructed under Sections 311, 312 and 351 including any modified standard or nonstandard items where the character of the work to be performed is considered construction of a subbase or aggregate, stabilized or modified base course. The cumulative total of all applicable item plan quantities shall exceed 5000 tons (4500 metric tons). Included in the fuel usage factor is a 0.60 gal/ton (2.50 liters/metric ton) factor for trucking.
- (3) Category C: Hot-Mix Asphalt (HMA) Bases, Pavements and Shoulders. Contract pay items constructed under Sections 355, 406, 407 and 482 including any modified standard or nonstandard items where the character of the work to be performed is considered HMA bases, pavements and shoulders. The cumulative total of all applicable item plan quantities shall exceed 5000 tons (4500 metric tons). Included in the fuel usage factor is 0.60 gal/ton (2.50 liters/metric ton) factor for trucking.

- (4) Category D: Portland Cement Concrete (PCC) Bases, Pavements and Shoulders. Contract pay items constructed under Sections 353, 420, 421 and 483 including any modified standard or nonstandard items where the character of the work to be performed is considered PCC base, pavement or shoulder. The cumulative total of all applicable item plan quantities shall exceed 7500 sq yd (6000 sq m). Included in the fuel usage factor is 1.20 gal/cu yd (5.94 liters/cu m) factor for trucking.
- (5) Category E: Structures. Structure items having a cumulative bid price that exceeds \$250,000 for pay items constructed under Sections 502, 503, 504, 505, 512, 516 and 540 including any modified standard or nonstandard items where the character of the work to be performed is considered structure work when similar to that performed under these sections and not included in categories A through D.

(b) Fuel Usage Factors.

English Units Category	Factor	Units
A - Earthwork	0.34	gal / cu yd
B – Subbase and Aggregate Base courses	0.62	gal / ton
C – HMA Bases, Pavements and Shoulders	1.05	gal / ton
D – PCC Bases, Pavements and Shoulders	2.53	gal / cu yd
E – Structures	8.00	gal / \$1000

Metric Units Category	Factor	Units
A - Earthwork	1.68	liters / cu m
B – Subbase and Aggregate Base courses	2.58	liters / metric ton
C – HMA Bases, Pavements and Shoulders	4.37	liters / metric ton
D – PCC Bases, Pavements and Shoulders	12.52	liters / cu m
E – Structures	30.28	liters / \$1000

(c) Quantity Conversion Factors.

Category	Conversion	Factor
B	sq yd to ton	0.057 ton / sq yd / in depth
	sq m to metric ton	0.00243 metric ton / sq m / mm depth
C	sq yd to ton	0.056 ton / sq yd / in depth
	sq m to metric ton	0.00239 m ton / sq m / mm depth
D	sq yd to cu yd	0.028 cu yd / sq yd / in depth
	sq m to cu m	0.001 cu m / sq m / mm depth

Method of Adjustment. Fuel cost adjustments will be computed as follows.

$$CA = (FPI_P - FPI_L) \times FUF \times Q$$

Where: CA = Cost Adjustment, \$
FPI_P = Fuel Price Index, as published by the Department for the month the work is performed, \$/gal (\$/liter)
FPI_L = Fuel Price Index, as published by the Department for the month prior to the letting, \$/gal (\$/liter)
FUF = Fuel Usage Factor in the pay item(s) being adjusted
Q = Authorized construction Quantity, tons (metric tons) or cu yd (cu m)

The entire FUF indicated in paragraph (b) will be used regardless of use of trucking to perform the work.

Progress Payments. Fuel cost adjustments will be calculated for each calendar month in which applicable work is performed; and will be paid or deducted when all other contract requirements for the items of work are satisfied. The adjustments shall not apply during contract time subject to liquidated damages for completion of the entire contract.

Final Quantities. Upon completion of the work and determination of final pay quantities, an adjustment will be prepared to reconcile any differences between estimated quantities previously paid and the final quantities. The value for the balancing adjustment will be based on a weighted average of FPI_P and Q only for those months requiring the cost adjustment. The cost adjustment will be applicable to the final measured quantities of all applicable pay items.

Basis of Payment. Fuel cost adjustments may be positive or negative but will only be made when there is a difference between the FPI_L and FPI_P in excess of five percent, as calculated by:

$$\text{Percent Difference} = \{(FPI_L - FPI_P) \div FPI_L\} \times 100$$

Return With Bid

**ILLINOIS DEPARTMENT
OF TRANSPORTATION**

**OPTION FOR
FUEL COST ADJUSTMENT**

The bidder shall submit this completed form with his/her bid. Failure to submit the form or properly complete contract number, company name, and sign and date the form shall make this contract exempt of fuel cost adjustments in all categories. Failure to indicate "Yes" for any category of work at the time of bid will make that category of work exempt from fuel cost adjustment. After award, this form, when submitted shall become part of the contract.

Contract No.: _____

Company Name: _____

Contractor's Option:

Is your company opting to include this special provision as part of the contract plans for the following categories of work?

- | | | |
|--|-----|--------------------------|
| Category A Earthwork. | Yes | <input type="checkbox"/> |
| Category B Subbases and Aggregate Base Courses | Yes | <input type="checkbox"/> |
| Category C HMA Bases, Pavements and Shoulders | Yes | <input type="checkbox"/> |
| Category D PCC Bases, Pavements and Shoulders | Yes | <input type="checkbox"/> |
| Category E Structures | Yes | <input type="checkbox"/> |

Signature: _____ **Date:** _____

PROJECT LABOR AGREEMENT - QUARTERLY EMPLOYMENT REPORT

Public Act 97-0199 requires the Department to submit quarterly reports regarding the number of minorities and females employed under Project Labor Agreements. To assist in this reporting effort, the Contractor shall provide a quarterly workforce participation report for all minority and female employees working under the project labor agreement of this contract. The data shall be reported on Construction Form BC 820, Project Labor Agreement (PLA) Workforce Participation Quarterly Reporting Form available on the Department's website <http://www.dot.il.gov/const/conforms.html>.

The report shall be submitted no later than the 15th of the month following the end of each quarter (i.e. April 15 for the January – March reporting period). The form shall be emailed to DOT.PLA.Reporting@illinois.gov or faxed to (217) 524-4922.

Any costs associated with complying with this provision shall be considered as included in the contract unit prices bid for the various items of work involved and no additional compensation will be allowed.

Illinois Department of Transportation
PROJECT LABOR AGREEMENT

This Project Labor Agreement (“PLA” or “Agreement”) is entered into this _____ day of _____, 2013, by and between the Illinois Department of Transportation (“IDOT” or “Department”) in its proprietary capacity, and each relevant Illinois AFL-CIO Building Trades signatory hereto as determined by the Illinois AFL-CIO Statewide Project Labor Agreement Committee on behalf of each of its affiliated members (individually and collectively, the “Unions”). This PLA shall apply to Construction Work (as defined herein) to be performed by IDOT’s Prime Contractor and each of its subcontractors of whatever tier (“Subcontractor” or “Subcontractors”) on Contract No. **64J29** (hereinafter, the “Project”).

ARTICLE 1 - INTENT AND PURPOSES

- 1.1 This PLA is entered into in accordance with the Project Labor Agreement Act (“Act”, 30 ILCS 571). It is mutually understood and agreed that the terms and conditions of this PLA are intended to promote the public interest in obtaining timely and economical completion of the Project by encouraging productive and efficient construction operations; by establishing a spirit of harmony and cooperation among the parties; and by providing for peaceful and prompt settlement of any and all labor grievances or jurisdictional disputes of any kind without strikes, lockouts, slowdowns, delays, or other disruptions to the prosecution of the work. The parties acknowledge the obligations of the Contractors and Subcontractors to comply with the provisions of the Act. The parties will work with the Contractors and Subcontractors within the parameters of other statutory and regulatory requirements to implement the Act’s goals and objectives.
- 1.2 As a condition of the award of the contract for performance of work on the Project, IDOT’s Prime Contractor and each of its Subcontractors shall execute a “Contractor Letter of Assent”, in the form attached hereto as Exhibit A, prior to commencing Construction Work on the Project. The Contractor shall submit a Subcontractor’s Contractor Letter of Assent to the Department prior to the Subcontractor’s performance of Construction Work on the Project. Upon request copies of the applicable collective bargaining agreements will be provided by the appropriate signatory labor organization consistent with this Agreement and at the pre-job conference referenced in Article III, Section 3.1.
- 1.3 Each Union affiliate and separate local representing workers engaged in Construction Work on the Project in accordance with this PLA are bound to this agreement by the Illinois AFL-CIO Statewide Project Labor Agreement Committee which is the central committee established with full authority to negotiate and sign PLAs with the State on behalf of all respective crafts. Upon their signing the Contractor Letter of Assent, the Prime Contractor, each Subcontractor, and the individual Unions shall thereafter be deemed a party to this PLA. No party signatory to this PLA shall, contract or subcontract, nor permit any other person, firm, company, or entity to contract or subcontract for the performance of Construction Work for the Project to any person, firm, company, or entity that does not agree in writing to become bound for the term of this Project by the terms of this PLA prior to commencing such work and to the applicable area-wide collective bargaining agreement(s) with the Union(s) signatory hereto.

- 1.4 It is understood that the Prime Contractor(s) and each Subcontractor will be considered and accepted by the Unions as separate employers for the purposes of collective bargaining, and it is further agreed that the employees working under this PLA shall constitute a bargaining unit separate and distinct from all others. The parties hereto also agree that this PLA shall be applicable solely with respect to this Project, and shall have no bearing on the interpretation of any other collective bargaining agreement or as to the recognition of any bargaining unit other than for the specific purposes of this Project.
- 1.5 In the event of a variance or conflict, whether explicit or implicit, between the terms and conditions of this PLA and the provisions of any other applicable national, area, or local collective bargaining agreement, the terms and conditions of this PLA shall supersede and control. For any work performed under the NTL Articles of Agreement, the National Stack/Chimney Agreement, the National Cooling Tower Agreement, the National Agreement of the International Union of Elevator Constructors, and for any instrument calibration work and loop checking performed under the UA/IBEW Joint National Agreement for Instrument and Control Systems Technicians, the preceding sentence shall apply only with respect to Articles I, II, V, VI, and VII.
- 1.6 Subject to the provisions of paragraph 1.5 of this Article, it is the parties' intent to respect the provisions of any other collective bargaining agreements that may now or hereafter pertain, whether between the Prime Contractor and one or more of the Unions or between a Subcontractor and one or more of the Unions. Accordingly, except and to the extent of any contrary provision set forth in this PLA, the Prime Contractor and each of its Subcontractors agrees to be bound and abide by the terms of the following in order of precedence: (a) the applicable collective bargaining agreement between the Prime Contractor and one or more of the Unions made signatory hereto; (b) the applicable collective bargaining agreement between a Subcontractor and one or more of the Unions made signatory hereto; or (c) the current applicable area collective bargaining agreement for the relevant Union that is the agreement certified by the Illinois Department of Labor for purposes of establishing the Prevailing Wage applicable to the Project. The Union will provide copies of the applicable collective bargaining agreements pursuant to part (c) of the preceding sentence to the Prime Contractor. Assignments by the Contractors or Subcontractors amongst the trades shall be consistent with area practices; in the event of unresolved disagreements as to the propriety of such assignments, the provisions of Article VI shall apply.
- 1.7 Subject to the limitations of paragraphs 1.4 to 1.6 of this Article, the terms of each applicable collective bargaining agreement as determined in accordance with paragraph 1.6 are incorporated herein by reference, and the terms of this PLA shall be deemed incorporated into such other applicable collective bargaining agreements only for purposes of their application to the Project.

- 1.8 To the extent necessary to comply with the requirements of any fringe benefit fund to which the Prime Contractor or Subcontractor is required to contribute under the terms of an applicable collective bargaining agreement pursuant to the preceding paragraph, the Prime Contractor or Subcontractor shall execute all "Participation Agreements" as may be reasonably required by the Union to accomplish such purpose; provided, however, that such Participation Agreements shall, when applicable to the Prime Contractor or Subcontractor solely as a result of this PLA, be amended as reasonably necessary to reflect such fact. Upon written notice in the form of a lien of a Contractor's or Subcontractor's delinquency from any applicable fringe benefit fund, IDOT will withhold from the Contractor's periodic pay request an amount sufficient to extinguish any delinquency obligation of the Contractor or Subcontractor arising out of the Project.
- 1.9 In the event that the applicable collective bargaining agreement between a Prime Contractor and the Union or between the Subcontractor and the Union expires prior to the completion of this Project, the expired applicable contract's terms will be maintained until a new applicable collective bargaining agreement is ratified. The wages and fringe benefits included in any new applicable collective bargaining agreement will apply on and after the effective date of the newly negotiated collective bargaining agreement, except to the extent wage and fringe benefit retroactivity is specifically agreed upon by the relevant bargaining parties.

ARTICLE II – APPLICABILITY, RECOGNITION, AND COMMITMENTS

- 2.1 The term Construction Work as used herein shall include all "construction, demolition, rehabilitation, renovation, or repair" work performed by a "laborer or mechanic" at the "site of the work" for the purpose of "building" the specific structures and improvements that constitute the Project. Terms appearing within quotation marks in the preceding sentence shall have the meaning ascribed to them pursuant to 29 CFR Part 5 and Illinois labor laws.
- 2.2 By executing the Letters of Assent, Prime Contractor and each of its Subcontractors recognizes the Unions signatory to this PLA as the sole and exclusive bargaining representatives for their craft employees employed on the jobsite for this Project. Unions who are signatory to this PLA will have recognition on the Project for their craft.
- 2.3 The Prime Contractor and each of its Subcontractors retains and shall be permitted to exercise full and exclusive authority and responsibility for the management of its operations, except as expressly limited by the terms of this PLA or by the terms and conditions of the applicable collective bargaining agreement.
- 2.4 Except to the extent contrary to an express provision of the relevant collective bargaining agreement, equipment or materials used in the Project may be pre-assembled or pre-fabricated, and there shall be no refusal by the Union to handle, transport, install, or connect such equipment or materials. Equipment or materials delivered to the job-site will be unloaded and handled promptly without regard to potential jurisdictional disputes; any such disputes shall be handled in accordance with the provisions of this PLA.

- 2.5 The parties are mutually committed to promoting a safe working environment for all personnel at the job-site. It shall be the responsibility of each employer to which this PLA applies to provide and maintain safe working conditions for its employees, and to comply with all applicable federal, state, and local health and safety laws and regulations.
- 2.6 The use or furnishing of alcohol or drugs and the conduct of any other illegal activity at the job-site is strictly prohibited. The parties shall take every practical measure consistent with the terms of applicable collective bargaining agreements to ensure that the job-site is free of alcohol and drugs.
- 2.7 All parties to this PLA agree that they will not discriminate against any employee based on race, creed, religion, color, national origin, union activity, age, gender or sexual orientation and shall comply with all applicable federal, state, and local laws.
- 2.8 In accordance with the Act and to promote diversity in employment, IDOT will establish, in cooperation with the other parties, the apprenticeship hours which are to be performed by minorities and females on the Project. IDOT shall consider the total hours to be performed by these underrepresented groups, as a percentage of the workforce, and create aspirational goals for each Project, based on the level of underutilization for the service area of the Project (together "Project Employment Objectives"). IDOT shall provide a quarterly report regarding the racial and gender composition of the workforce on the Project.

Persons currently lacking qualifications to enter apprenticeship programs will have the opportunity to obtain skills through basic training programs as have been established by the Department. The parties will endeavor to support such training programs to allow participants to obtain the requisite qualifications for the Project Employment Objectives.

The parties agree that all Contractors and Subcontractors working on the Project shall be encouraged to utilize the maximum number of apprentices as permitted under the terms of the applicable collective bargaining agreements to realize the Project Employment Objectives.

The Unions shall assist the Contractor and each Subcontractor in efforts to satisfy Project Employment Objectives. A Contractor or Subcontractor may request from a Union specific categories of workers necessary to satisfy Project Employment Objectives. The application of this section shall be consistent with all local Union collective bargaining agreements, and the hiring hall rules and regulations established for the hiring of personnel, as well as the apprenticeship standards set forth by each individual Union.

- 2.9 The parties hereto agree that engineering/architectural/surveying consultants' materials testing employees are subject to the terms of this PLA for Construction Work performed for a Contractor or Subcontractor on this Project. These workers shall be fully expected to objectively and responsibly perform their duties and obligations owed to the Department without regard to the potential union affiliation of such employees or of other employees on the Project.
- 2.10 This Agreement shall not apply to IDOT employees or employees of any other governmental entity.

ARTICLE III - ADMINISTRATION OF AGREEMENT

- 3.1 In order to assure that all parties have a clear understanding of the PLA, and to promote harmony, at the request of the Unions a post-award pre-job conference will be held among the Prime Contractor, all Subcontractors and Union representatives prior to the start of any Construction Work on the Project. No later than the conclusion of such pre-job conference, the parties shall, among other matters, provide to one another contact information for their respective representatives (including name, address, phone number, facsimile number, e-mail). Nothing herein shall be construed to limit the right of the Department to discuss or explain the purpose and intent of this PLA with prospective bidders or other interested parties prior to or following its award of the job.
- 3.2 Representatives of the Prime Contractor and the Unions shall meet as often as reasonably necessary following award until completion of the Project to assure the effective implementation of this PLA.
- 3.3 Any notice contemplated under Article VI and VII of this Agreement to a signatory labor organization shall be made in writing to the Local Union with copies to the local union's International Representative.

ARTICLE IV - HOURS OF WORK AND GENERAL CONDITIONS

- 4.1 The standard work day and work week for Construction Work on the Project shall be consistent with the respective collective bargaining agreements. In the event Project site or other job conditions dictate a change in the established starting time and/or a staggered lunch period for portions of the Project or for specific crafts, the Prime Contractor, relevant Subcontractors and business managers of the specific crafts involved shall confer and mutually agree to such changes as appropriate. If proposed work schedule changes cannot be mutually agreed upon between the parties, the hours fixed at the time of the pre-job meeting shall prevail.
- 4.2 Shift work may be established and directed by the Prime Contractor or relevant Subcontractor as reasonably necessary or appropriate to fulfill the terms of its contract with the Department. If used, shift hours, rates and conditions shall be as provided in the applicable collective bargaining agreement.
- 4.3 The parties agree that chronic and/or unexcused absenteeism is undesirable and must be controlled in accordance with procedures established by the applicable collective bargaining agreement. Any employee disciplined for absenteeism in accordance with such procedures shall be suspended from all work on the Project for not less than the maximum period permitted under the applicable collective bargaining agreement.
- 4.4 Except as may be otherwise expressly provided by the applicable collective bargaining agreement, employment begins and ends at the Project site; employees shall be at their place of work at the starting time; and employees shall remain at their place of work until quitting time.
- 4.5 Except as may be otherwise expressly provided by the applicable collective bargaining agreement, there shall be no limit on production by workmen, no restrictions on the full use of tools or equipment, and no restrictions on efficient use of manpower or techniques of construction other than as may be required by safety regulations.

- 4.6 The parties recognize that specialized or unusual equipment may be installed on the Project. In such cases, the Union recognizes the right of the Prime Contractor or Subcontractor to involve the equipment supplier or vendor's personnel in supervising the setting up of the equipment, making modifications and final alignment, and performing similar activities that may be reasonably necessary prior to and during the start-up procedure in order to protect factory warranties. The Prime Contractor or Subcontractor shall notify the Union representatives in advance of any work at the job-site by such vendor personnel in order to promote a harmonious relationship between the equipment vendor's personnel and other Project employees.
- 4.7 For the purpose of promoting full and effective implementation of this PLA, authorized Union representatives shall have access to the Project job-site during scheduled work hours. Such access shall be conditioned upon adherence to all reasonable visitor and security rules of general applicability that may be established for the Project site at the pre-job conference or from time to time thereafter.

ARTICLE V – GRIEVANCE PROCEDURES FOR DISPUTES ARISING UNDER A PARTICULAR COLLECTIVE BARGAINING AGREEMENT

- 5.1 In the event a dispute arises under a particular collective bargaining agreement specifically not including jurisdictional disputes referenced in Article VI below, said dispute shall be resolved by the Grievance/Arbitration procedure of the applicable collective bargaining agreement. The resulting determination from this process shall be final and binding on all parties bound to its process.
- 5.2 Employers covered under this Agreement shall have the right to discharge or discipline any employee who violates the provisions of this Agreement. Such discharge or discipline by a contractor or subcontractor shall be subject to Grievance/Arbitration procedure of the applicable collective bargaining agreement only as to the fact of such violation of this agreement. If such fact is established, the penalty imposed shall not be disturbed. Work at the Project site shall continue without disruption or hindrance of any kind as a result of a Grievance/Arbitration procedure under this Article.
- 5.3 In the event there is a deadlock in the foregoing procedure, the parties agree that the matter shall be submitted to arbitration for the selection and decision of an Arbitrator governed under paragraph 6.8.

ARTICLE VI –DISPUTES: GENERAL PRINCIPLES

- 6.1 This Agreement is entered into to prevent strikes, lost time, lockouts and to facilitate the peaceful adjustment of jurisdictional disputes in the building and construction industry and to prevent waste and unnecessary avoidable delays and expense, and for the further purpose of at all times securing for the employer sufficient skilled workers.
- 6.2 A panel of Permanent Arbitrators are attached as addendum (A) to this agreement. By mutual agreement between IDOT and the Unions, the parties can open this section of the agreement as needed to make changes to the list of permanent arbitrators.

- 6.3 The PLA Jurisdictional Dispute Resolution Process (“Process”) sets forth the procedures below to resolve jurisdictional disputes between and among Contractors, Subcontractors, and Unions engaged in the building and construction industry. Further, the Process will be followed for any grievance or dispute arising out of the interpretation or application of this PLA by the parties except for the prohibition on attorneys contained in 6.11. All decisions made through the Process are final and binding upon all parties.

DISPUTE PROCESS

- 6.4 Administrative functions under the Process shall be performed through the offices of the President and/or Secretary-Treasurer of the Illinois State Federation of Labor, or their designated representative, called the Administrator. In no event shall any officer, employee, agent, attorney, or other representative of the Illinois Federation of Labor, AFL-CIO be subject to any subpoena to appear or testify at any jurisdictional dispute hearing.
- 6.5 There shall be no abandonment of work during any case participating in this Process or in violation of the arbitration decision. All parties to this Process release the Illinois State Federation of Labor (“Federation”) from any liability arising from its action or inaction and covenant not to sue the Federation, nor its officers, employees, agents or attorneys.
- 6.6 In the event of a dispute relating to trade or work jurisdiction, all parties, including the employers, Contractors or Subcontractors, agree that a final and binding resolution of the dispute shall be resolved as follows:
- (a) Representatives of the affected trades and the Contractor or Subcontractor shall meet on the job site within two (2) business days after receiving written notice in an effort to resolve the dispute. (In the event there is a dispute between local unions affiliated with the same International Union, the decision of the General President, or his/her designee, as the internal jurisdictional authority of that International Union, shall constitute a final and binding decision and determination as to the jurisdiction of work.)
 - (b) If no settlement is achieved subsequent to the preceding Paragraph, the matter shall be referred to the local area Building & Construction Trades Council, which shall meet with the affected trades within two (2) business days subsequent to receiving written notice. In the event the parties do not wish to avail themselves of the local Building & Construction Trades Council, the parties may elect to invoke the services of their respective International Representatives with no extension of the time limitations. An agreement reached at this Step shall be final and binding upon all parties.

(c) If no settlement agreement is reached during the proceedings contemplated by Paragraphs "a" or "b" above, the matter shall be immediately referred to the Illinois Jurisdictional Dispute Process for final and binding resolution of said dispute. Said referral submission shall be in writing and served upon the Illinois State Federation of Labor, or the Administrator, pursuant to paragraph 6.4 of this agreement. The Administrator shall, within three (3) days, provide for the selection of an available Arbitrator to hear said dispute within this time period. Upon good cause shown and determined by the Administrator, an additional three (3) day extension for said hearing shall be granted at the sole discretion of the Administrator. Only upon mutual agreement of all parties may the Administrator extend the hearing for a period in excess of the time frames contemplated under this Paragraph. Business days are defined as Monday through Friday, excluding contract holidays.

6.7 The primary concern of the Process shall be the adjustment of jurisdictional disputes arising out of the Project. A sufficient number of Arbitrators shall be selected from list of approved Arbitrators as referenced Sec. 6.2 and shall be assigned per Sec. 6.8. Decisions shall be only for the Project and shall become effective immediately upon issuance and complied with by all parties. The authority of the Arbitrator shall be restricted and limited specifically to the terms and provisions of Article VI and generally to this Agreement as a whole.

6.8 The Arbitrator chosen shall be randomly selected based on the list of Arbitrators in Sec. 6.2 and geographical location of the jurisdictional dispute and upon his/her availability, and ability to conduct a Hearing within two (2) business days of said notice. The Arbitrator may issue a "bench" decision immediately following the Hearing or he/she may elect to only issue a written decision, said decision must be issued within two (2) business days subsequent to the completion of the Hearing. Copies of all notices, pleadings, supporting memoranda, decisions, etc. shall be provided to all disputing parties and the Illinois State Federation of Labor.

Any written decision shall be in accordance with this Process and shall be final and binding upon all parties to the dispute and may be a "short form" decision. Fees and costs of the arbitrator shall be divided evenly between the contesting parties except that any party wishing a full opinion and decision beyond the short form decision shall bear the reasonable fees and costs of such full opinion. The decision of the Arbitrator shall be final and binding upon the parties hereto, their members, and affiliates.

In cases of jurisdictional disputes or other disputes between a signatory labor organization and another labor organization, both of which is an affiliate or member of the same International Union, the matter or dispute shall be settled in the manner set forth by their International Constitution and/or as determined by the International Union's General President whose decision shall be final and binding upon all parties. In no event shall there be an abandonment of work.

6.9 In rendering a decision, the Arbitrator shall determine:

(a) First, whether a previous agreement of record or applicable agreement, including a disclaimer agreement, between National or International Unions to the dispute or agreements between local unions involved in the dispute, governs;

- (b) Only if the Arbitrator finds that the dispute is not covered by an appropriate or applicable agreement of record or agreement between the crafts to the dispute, he shall then consider the established trade practice in the industry and prevailing practice in the locality. Where there is a previous decision of record governing the case, the Arbitrator shall give equal weight to such decision of record, unless the prevailing practice in the locality in the past ten years favors one craft. In that case, the Arbitrator shall base his decision on the prevailing practice in the locality. Except, that if the Arbitrator finds that a craft has improperly obtained the prevailing practice in the locality through raiding, the undercutting of wages or by the use of vertical agreements, the Arbitrator shall rely on the decision of record and established trade practice in the industry rather than the prevailing practice in the locality; and,
 - (c) Only if none of the above criteria is found to exist, the Arbitrator shall then consider that because efficiency, cost or continuity and good management are essential to the well being of the industry, the interests of the consumer or the past practices of the employer shall not be ignored.
- 6.10 The Arbitrator shall set forth the basis for his/her decision and shall explain his/her findings regarding the applicability of the above criteria. If lower ranked criteria are relied upon, the Arbitrator shall explain why the higher-ranked criteria were not deemed applicable. The Arbitrator's decision shall only apply to the Project. Agreements of Record, for other PLA projects, are applicable only to those parties signatory to such agreements. Decisions of Record are those that were either attested to by the former Impartial Jurisdictional Disputes Board or adopted by the National Arbitration Panel.
- 6.11 All interested parties, as determined by the Arbitrator, shall be entitled to make presentations to the Arbitrator. Any interested labor organization affiliated to the PLA Committee and party present at the Hearing, whether making a presentation or not, by such presence shall be deemed to accept the jurisdiction of the Arbitrator and to agree to be bound by its decision. In addition to the representative of the local labor organization, a representative of the labor organization's International Union may appear on behalf of the parties. Each party is responsible for arranging for its witnesses. In the event an Arbitrator's subpoena is required, the party requiring said subpoena shall prepare the subpoena for the Arbitrator to execute. Service of the subpoena upon any witness shall be the responsibility of the issuing party.

Attorneys shall not be permitted to attend or participate in any portion of a Hearing.

The parties are encouraged to determine, prior to Hearing, documentary evidence which may be presented to the Arbitrator on a joint basis.

- 6.12 The Order of Presentation in all Hearings before an Arbitrator shall be
- I. Identification and Stipulation of the Parties
 - II. Unions(s) claiming the disputed work presents its case
 - III. Union(s) assigned the disputed work presents its case
 - IV. Employer assigning the disputed work presents its case
 - V. Evidence from other interested parties (i.e., general contractor, project manager, owner)
 - VI. Rebuttal by union(s) claiming the disputed work
 - VII. Additional submissions permitted and requested by Arbitrator
 - VIII. Closing arguments by the parties
- 6.13 All parties bound to the provisions of this Process hereby release the Illinois State Federation of Labor and IDOT, their respective officers, agents, employees or designated representatives, specifically including any Arbitrator participating in said Process, from any and all liability or claim, of whatsoever nature, and specifically incorporating the protections provided in the Illinois Arbitration Act, as amended from time to time.
- 6.14 The Process, as an arbitration panel, nor its Administrator, shall have any authority to undertake any action to enforce its decision(s). Rather, it shall be the responsibility of the prevailing party to seek appropriate enforcement of a decision, including findings, orders or awards of the Arbitrator or Administrator determining non-compliance with a prior award or decision.
- 6.15 If at any time there is a question as to the jurisdiction of the Illinois Jurisdictional Dispute Resolution Process, the primary responsibility for any determination of the arbitrability of a dispute and the jurisdiction of the Arbitrator shall be borne by the party requesting the Arbitrator to hear the underlying jurisdictional dispute. The affected party or parties may proceed before the Arbitrator even in the absence or one or more stipulated parties with the issue of jurisdiction as an additional item to be decided by the Arbitrator. The Administrator may participate in proceedings seeking a declaration or determination that the underlying dispute is subject to the jurisdiction and process of the Illinois Jurisdictional Dispute Resolution Process. In any such proceedings, the non-prevailing party and/or the party challenging the jurisdiction of the Illinois Jurisdictional Dispute Resolution Process shall bear all the costs, expenses and attorneys' fees incurred by the Illinois Jurisdictional Dispute Resolution Process and/or its Administrator in establishing its jurisdiction.

ARTICLE VII - WORK STOPPAGES AND LOCKOUTS

- 7.1 During the term of this PLA, no Union or any of its members, officers, stewards, employees, agents or representatives shall instigate, support, sanction, maintain, or participate in any strike, picketing, walkout, work stoppage, slow down or other activity that interferes with the routine and timely prosecution of work at the Project site or at any other contractor's or supplier's facility that is necessary to performance of work at the Project site. Hand billing at the Project site during the designated lunch period and before commencement or following conclusion of the established standard workday shall not, in itself, be deemed an activity that interferes with the routine and timely prosecution of work on the Project.

7.2 Should any activity prohibited by paragraph 7.1 of this Article occur, the Union shall undertake all steps reasonably necessary to promptly end such prohibited activities.

7.2.A No Union complying with its obligations under this Article shall be liable for acts of employees for which it has no responsibility or for the unauthorized acts of employees it represents. Any employee who participates or encourages any activity prohibited by paragraph 7.1 shall be immediately suspended from all work on the Project for a period equal to the greater of (a) 60 days; or (b) the maximum disciplinary period allowed under the applicable collective bargaining agreement for engaging in comparable unauthorized or prohibited activity.

7.2.B Neither the PLA Committee nor its affiliates shall be liable for acts of employees for which it has no responsibility. The principal officer or officers of the PLA Committee will immediately instruct, order and use the best efforts of his office to cause the affiliated union or unions to cease any violations of this Article. The PLA Committee in its compliance with this obligation shall not be liable for acts of its affiliates. The principal officer or officers of any involved affiliate will immediately instruct, order or use the best effort of his office to cause the employees the union represents to cease any violations of this Article. A union complying with this obligation shall not be liable for unauthorized acts of employees it represents. The failure of the Contractor to exercise its rights in any instance shall not be deemed a waiver of its rights in any other instance.

During the term of this PLA, the Prime Contractor and its Subcontractors shall not engage in any lockout at the Project site of employees covered by this Agreement.

7.3 Upon notification of violations of this Article, the principal officer or officers of the local area Building and Construction Trades Council, and the Illinois AFL-CIO Statewide Project Labor Agreement Committee as appropriate, will immediately instruct, order and use their best efforts to cause the affiliated union or unions to cease any violations of this Article. A Trades Council and the Committee otherwise in compliance with the obligations under this paragraph shall not be liable for unauthorized acts of its affiliates.

7.4 In the event that activities in violation of this Article are not immediately halted through the efforts of the parties, any aggrieved party may invoke the special arbitration provisions set forth in paragraph 7.5 of this Article.

7.5 Upon written notice to the other involved parties by the most expeditious means available, any aggrieved party may institute the following special arbitration procedure when a breach of this Article is alleged:

7.5.A The party invoking this procedure shall notify the individual designated as the Permanent Arbitrator pursuant to paragraph 6.8 of the nature of the alleged violation; such notice shall be by the most expeditious means possible. The initiating party may also furnish such additional factual information as may be reasonably necessary for the Permanent Arbitrator to understand the relevant circumstances. Copies of any written materials provided to the arbitrator shall also be contemporaneously provided by the most expeditious means possible to the party alleged to be in violation and to all other involved parties.

- 7.5.B Upon receipt of said notice the Permanent Arbitrator shall set and hold a hearing within twenty-four (24) hours if it is contended the violation is ongoing, but not before twenty-four (24) hours after the written notice to all parties involved as required above.
- 7.5.C The Permanent Arbitrator shall notify the parties by facsimile or any other effective written means, of the place and time chosen by the Permanent Arbitrator for this hearing. Said hearing shall be completed in one session. A failure of any party or parties to attend said hearing shall not delay the hearing of evidence or issuance of an Award by the Permanent Arbitrator.
- 7.5.D The sole issue at the hearing shall be whether a violation of this Article has, in fact, occurred. An Award shall be issued in writing within three (3) hours after the close of the hearing, and may be issued without a written opinion. If any party desires a written opinion, one shall be issued within fifteen (15) days, but its issuance shall not delay compliance with, or enforcement of, the Award. The Permanent Arbitrator may order cessation of the violation of this Article, and such Award shall be served on all parties by hand or registered mail upon issuance.
- 7.5.E Such Award may be enforced by any court of competent jurisdiction upon the filing of the Award and such other relevant documents as may be required. Facsimile or other hardcopy written notice of the filing of such enforcement proceedings shall be given to the other relevant parties. In a proceeding to obtain a temporary order enforcing the Permanent Arbitrator's Award as issued under this Article, all parties waive the right to a hearing and agree that such proceedings may be ex parte. Such agreement does not waive any party's right to participate in a hearing for a final order of enforcement. The Court's order or orders enforcing the Permanent Arbitrator's Award shall be served on all parties by hand or by delivery to their last known address or by registered mail.
- 7.6 Individuals found to have violated the provisions of this Article are subject to immediate termination. In addition, IDOT reserves the right to terminate this PLA as to any party found to have violated the provisions of this Article.
- 7.7 Any rights created by statute or law governing arbitration proceedings inconsistent with the above procedure or which interfere with compliance therewith are hereby waived by parties to whom they accrue.
- 7.8 The fees and expenses of the Permanent Arbitrator shall be borne by the party or parties found in violation, or in the event no violation is found, such fees and expenses shall be borne by the moving party.

ARTICLE VIII – TERMS OF AGREEMENT

- 8.1 If any Article or provision of this Agreement shall be declared invalid, inoperative or unenforceable by operation of law or by any of the above mentioned tribunals of competent jurisdiction, the remainder of this Agreement or the application of such Article or provision to persons or circumstances other than those as to which it has been held invalid, inoperative or unenforceable shall not be affected thereby.

- 8.2 This Agreement shall be in full force as of and from the date of the Notice of Award until the Project contract is closed.
- 8.3 This PLA may not be changed or modified except by the subsequent written agreement of the parties. All parties represent that they have the full legal authority to enter into this PLA. This PLA may be executed by the parties in one or more counterparts.
- 8.4 Any liability arising out of this PLA shall be several and not joint. IDOT shall not be liable to any person or other party for any violation of this PLA by any other party, and no Contractor or Union shall be liable for any violation of this PLA by any other Contractor or Union.
- 8.5 The failure or refusal of a party to exercise its rights hereunder in one or more instances shall not be deemed a waiver of any such rights in respect of a separate instance of the same or similar nature.

[The Balance of This Page Intentionally Left Blank]

Addendum A

IDOT Slate of Permanent Arbitrators

1. Bruce Feldacker
2. Thomas F. Gibbons
3. Edward J. Harrick
4. Brent L. Motchan
5. Robert Perkovich
6. Byron Yaffee
7. Glenn A. Zipp

Execution Page

Illinois Department of Transportation

Omer Osman, Director of Highways

Matthew Hughes, Director Finance & Administration

Michael A. Forti, Chief Counsel

Ann L. Schneider, Secretary

(Date)

Illinois AFL-CIO Statewide Project Labor Agreement Committee, representing the Unions listed below:

(Date)

List Unions:

****RETURN WITH BID****

Exhibit A - Contractor Letter of Assent

(Date)

To All Parties:

In accordance with the terms and conditions of the contract for Construction Work on [Contract No. 64J29], this Letter of Assent hereby confirms that the undersigned Prime Contractor or Subcontractor agrees to be bound by the terms and conditions of the Project Labor Agreement established and entered into by the Illinois Department of Transportation in connection with said Project.

It is the understanding and intent of the undersigned party that this Project Labor Agreement shall pertain only to the identified Project. In the event it is necessary for the undersigned party to become signatory to a collective bargaining agreement to which it is not otherwise a party in order that it may lawfully make certain required contributions to applicable fringe benefit funds, the undersigned party hereby expressly conditions its acceptance of and limits its participation in such collective bargaining agreement to its work on the Project.

(Authorized Company Officer)

(Company)

****RETURN WITH BID****

STATE OF ILLINOIS

DEPARTMENT OF TRANSPORTATION

DIVISION OF HIGHWAYS

PROPOSED
HIGHWAY PLANS

FAS ROUTE 1177 (IL 251) & FAU ROUTE 5452 (IL 251)
SECTION (109, 110) RS-5

PROJECT: *ACRS-ACM-0005(957)*

3P RESURFACING
LEE/OGLE COUNTY

C-92-024-13 R 1E

FOR INDEX OF SHEETS, SEE SHEET NO. 2

FOR STATE STANDARDS, SEE SHEET NO. 3

FLAGG TOWNSHIP SECTION 36
REYNOLDS TOWNSHIP SECTIONS 1, 2, 11, 12, 13, 14, 23, 24, 26, 35
VIOLA TOWNSHIP SECTIONS 2, 11, 14, 23, 26, 35
BROOKLYN TOWNSHIP SECTIONS 2, 3

IMPROVEMENT ENDS
STA. 47+63

PROJECT ENDS
STA. 46+22

STATION EQUATION:
OGLE COUNTY STA. 0+00
LEE COUNTY STA. 1066+43

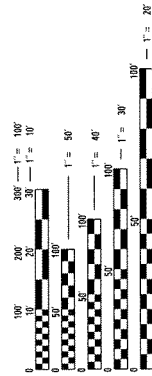

FULL SIZE PLANS HAVE BEEN PREPARED USING STANDARD ENGINEERING SCALES. REDUCED SIZED PLANS WILL NOT CONFORM TO STANDARD SCALES. IN MAKING MEASUREMENTS ON REDUCED PLANS, THE ABOVE SCALES MAY BE USED.

JULIE
JOINT UTILITY LOCATION INFORMATION FOR EXCAVATION
1-800-892-0123
OR 811

STUDIES AND PLANS ENGINEER: MASOOD AHMAD

STUDIES AND PLANS SQUAD LEADER: TRACI DUDEN (815) 284-5932
EMAIL: traci.duden@illinois.gov

CONTRACT NO. 64J29

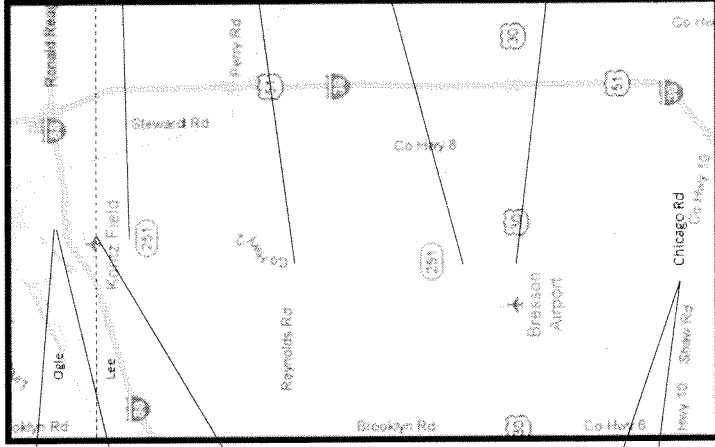

GROSS LENGTH = 72995 FT. = 13.71 MILE
NET LENGTH = 71831 FT. = 13.60 MILE

SECTION	COUNTY	TOTAL SHEET SHEETS NO.
(109, 110) RS-5	LEE/OGLE	109
ILLINOIS CONTRACT NO. 64J29		1

*FAS RTE 1177 & FAU RTE 5452

D-92-005-13

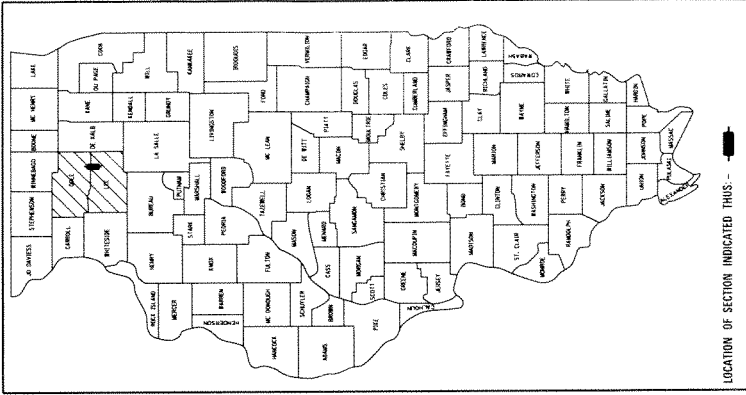

LOCATION OF SECTION INDICATED THIS -

STATE OF ILLINOIS
DEPARTMENT OF TRANSPORTATION
DIVISION OF HIGHWAYS

SUBMITTED *Nov. 8 2013*
Dana C. Day
DEPUTY DIRECTOR OF HIGHWAYS REGION ENGINEER

ENGINEER OF DESIGN AND ENVIRONMENT

DIRECTOR OF HIGHWAYS CHIEF ENGINEER

PRINTED BY THE AUTHORITY
OF THE STATE OF ILLINOIS

INDEX OF SHEETS

1	COVER SHEET
2	INDEX OF SHEETS & DISTRICT STANDARDS
3	HIGHWAY STANDARDS
4 - 6	GENERAL NOTES
7 - 10	SUMMARY OF QUANTITIES
11 - 24	TYPICAL SECTIONS
25 - 32	HMA SCHEDULE
33 - 36	ENTRANCE SCHEDULE
37 - 38	PATCHING SCHEDULE
39 - 44	SCHEDULE OF QUANTITIES
45 - 48	PAVEMENT MARKING SCHEDULE
49 - 86	PLAN SHEETS
87	DETAIL OF HOT-MIX ASPHALT SHOULDER AT GUARDRAIL DIST STD 23.4)
88	PAVEMENT PATCHING DETAIL (DIST STD 33.4)
89	DELINEATOR AND POST ORIENTATION (DIST STD 37.4)
90	AERIAL SPEED CHECK ZONES (DIST STD 46.4)
91	RUMBLE RESURFACING (DIST STD 91.4)
92	TYPICAL MARKING FOR PAINTED ISLANDS (DIST STD 93.4)
93	INFORMATIONAL WARNING SIGN (FOR NARROW TRAVEL LANES) (DIST STD 39.2)
94	HOT-MIX ASPHALT APPROACHES & MAILBOX RETURNS FOR TWO LIFT (3P) RESURFACING PROJECTS (DIST STD 47.2)
95	SAFETY EDGE (3P PROJECTS) (DIST STD 49.2)
96	PERMANENT SURVEY MARKERS (DIST STD 66.2)
97	ROUGH GROOVED SURFACE SIGN (DIST STD 91.2)
98	TRAFFIC CONTROL AND PROTECTION AT TURN BAYS (TO REMAIN OPEN TO TRAFFIC) (DIST STD 94.2)
99 - 102	TRAFFIC CONTROL FOR TRANSITION AREAS (DIST STD 38.1)
103 - 105	TYPICAL PAVEMENT MARKING (DIST STD 41.1)
106 - 109	REMOVE AND REERECT STEEL PLATE BEAM GUARDRAIL (DIST STD 53.1)

STATE STANDARDS

- 000001-06 STANDARD SYMBOLS, ABBREVIATIONS, AND PATTERNS
 - 001006 DECIMAL OF AN INCH AND OF A FOOT
- 630001-10 STEEL PLATE BEAM GUARDRAIL
- 630201-06 PCC/HMA STABILIZATION AT STEEL PLATE BEAM GUARDRAIL
- 630301-06 SHOULDER WIDENING FOR TYPE 1 (SPECIAL) GUARDRAIL TERMINALS
- 631032-08 TRAFFIC BARRIER TERMINAL, TYPE 6A
- 635001-01 DELINEATORS
- 635006-03 REFLECTOR AND TERMINAL MARKER PLACEMENT
- 635011-02 REFLECTOR MARKER AND MOUNTING DETAILS
- 701001-02 OFF-ROAD OPERATIONS, 2L, 2W, MORE THAN 15'(4.5 M) AWAY
- 701006-05 OFF-ROAD OPERATIONS, 2L, 2W, 4.5 M (15') TO 600 MM (24") FROM PAVEMENT EDGE
- 701011-04 OFF-ROAD MOVING OPERATIONS, 2L, 2W, DAY ONLY
- 701201-04 LANE CLOSURE, 2L, 2W, DAY ONLY, FOR SPEEDS \geq 45 MPH
- 701301-04 LANE CLOSURE, 2L, 2W, SHORT TIME OPERATIONS
- 701306-03 LANE CLOSURE, 2L, 2W, SLOW MOVING OPERATIONS - DAY ONLY FOR SPEEDS \geq 45 MPH
- 701311-03 LANE CLOSURE, 2L, 2W, MOVING OPERATIONS - DAY ONLY
- 701326-04 LANE CLOSURE, 2L, 2W, PAVEMENT WIDENING, FOR SPEEDS \geq 45 MPH
- 701336-06 LANE CLOSURE, 2L, 2W, WORK AREA IN SERIES, FOR SPEEDS \geq 45 MPH
- 701421-06 LANE CLOSURE, MULTILINE, DAY OPERATIONS ONLY, FOR SPEEDS \geq 45MPH TO 55 MPH
- 701426-06 LANE CLOSURE, MULTILANE, INTERMITTENT OR MOVING OPERATIONS FOR SPEEDS > 45 MPH
- 701456-03 PARTIAL EXIT RAMP CLOSURE FREEWAY/EXPRESSWAY
- 701601-09 URBAN LANE CLOSURE, MULTILANE, 1W OR 2W, WITH NONTRAVERSABLE MEDIAN
- 701701-09 URBAN LANE CLOSURE, MULTILANE, INTERSECTION
- 701901-03 TRAFFIC CONTROL DEVICES
- 720006-04 SIGN PANEL ERECTION DETAILS
- 720011-01 METAL POSTS FOR SIGNS, MARKERS & DELINEATORS
- 728001-01 TELESCOPING STEEL SIGN SUPPOSRT
- 729001-01 APPLICATIONS OF TYPES A & B METAL POSTS (FOR SIGNS & MARKERS)
- 780001-04 TYPICAL PAVEMENT MARKINGS
- 781001-03 TYPICAL APPLICATIONS RAISED REFLECTIVE PAVEMENT MARKERS

GENERAL NOTES

The final top 4 inches of soil in any right-of-way area disturbed by the Contractor must be capable of supporting vegetation. The soil must be from the A horizon (zero to 2' deep) of soil profiles of local soils.

The Contractor shall seed all disturbed areas within the project limits. Seeding Class 4 or 2A shall be used, except in front of properties where the grass will be mowed, then use Seeding, Class 1. Class 2A shall be used on front slopes and ditch bottoms. Class 4 shall be used behind Type A gutter, on all backslopes and areas behind the backslope, and beyond the toe of front slope on fill sections without ditches. **(Include the following sentence ONLY if seeding is less than 0.5 Acre)** This work will be included in the contract unit price per Unit for EXCAVATING AND GRADING EXISTING SHOULDER.

Fertilizer shall be applied to all disturbed areas and incorporated into the seedbed prior to seeding or placement of sod at the rate specified in Sections 250 and 252 of the Standard Specifications. This work shall be included in the cost of EXCAVATING AND GRADING EXISTING SHOULDER.

Mulch Method II shall be applied over all seeded areas. This shall be included in the cost of the EXCAVATING AND GRADING EXISTING SHOULDER.

The existing hot-mix asphalt on private and commercial entrances shall be bladed off or milled and disposed of outside the project limits. This could be the entire entrance or tapered at the end depending on if the mainline is resurfaced or milled and resurfaced. The cost of the blading, milling, rolling, and disposal is included in the contract unit price for INCIDENTAL HOT-MIX ASPHALT SURFACING.

The drop off that occurs at entrance edges as a result of resurfacing of the entrance shall be corrected using aggregate shoulder material. This work shall be paid for by the TON for Aggregate Shoulders of the type specified in the plans.

Milling machines on this project shall be capable of removing a layer of bituminous a minimum 6' wide and 1½ inches in depth in a single pass.

The following Mixture Requirements are applicable for this project:

Quality Management Program to be used	QCP	QCP	QC/QA	QC/QA
Mixture Uses(s):	Surface	Level Binder	Top Lift Shoulders	Lower Lift Shoulders
PG:	PG 64-22	PG 64-22	PG 64-22	PG 64-22
Design Air Voids	4.0 @ N50	4.0 @ N50	3 @ N50	2 @ N50
Mixture Composition (Gradation Mixture)	IL 9.5	IL-9.5 FG	IL 9.5 or 9.5 FG	BAM or IL 19.0
Friction Aggregate	D	N/A	C	N/A
20 Year ESAL	2.8	2.8	N/A	N/A

The Contractor will be required to furnish 5 1/2" high brass stencils as approved by the Engineer and install stationing at 250' intervals. Stationing shall be placed on both lanes of 2-lane highways and on the outside lanes in both directions on 4-lane highways. The stations shall be placed 6" inside the pavement marking edge so they can be read from the shoulder. This work will be included in the cost of the final pavement surface.

The area to be primed shall be limited to that which can be covered with HMA on the next days productivity, but no more than five days in advance of the placement of the HMA, unless approved by the Engineer.

Reflective Crack Control shall be placed on the existing surface prior to any resurfacing, unless pavement is milled then it will be placed on the binder course.

To help avoid excess drop offs at the edge of pavement, the existing aggregate wedge or shoulder is to be pulled up and rolled to match the edge of pavement before placing any bituminous material. All costs associated with pulling up the shoulders shall be considered included in the contract unit price per Ton for HOT-MIX ASPHALT SURFACE COURSE of the type specified.

If, during the grinding or resurfacing operations, the existing mailboxes become a hindrance, the Contractor shall be required to carefully remove and reinstall the mailboxes as directed by the Engineer. This work shall be included in the contract unit price for the INCIDENTAL HOT-MIX ASPHALT SURFACING.

Delineators shall be installed as shown in Standard 635001, except that the post shall be rotated 180° and only metal-backed delineators shall be permitted. Delineators shall be placed at the ends of approach guardrail terminal sections, and at each headwall or end section of AR Culverts. This work will be paid for at the contract unit price each for DELINEATORS.

All Borrow/Waste/Use sites must be approved by the Department prior to removing any material from the project or initiating any earthmoving activities, including temporary stockpiling outside the limits of construction.

The excavated materials from earth excavation widening, grading and shaping ditches, and excavating and grading shoulders shall be used to build up the shoulder throughout the job to conform with the typical sections and shoulder widening for terminals as shown on the plans.

Embankment quantities for the construction of the Traffic Barrier Terminals as shown in the plans are included in quantities for Excavating and Grading Existing Shoulder.

The Contractor shall supply the Resident Engineer with the manufacturer's installation requirements for the type of Steel Plate Beam Guardrail Terminal Type 1 Special (Tangent) or Steel Plate Beam Guardrail Terminal Type I Special (Flared).

One 16d galvanized nail shall be used to toe nail the wood block out to the wood post on all Traffic Barrier Terminal Type I Specials.

Pavement Marking shall be done according to Standard 780001, except as follows:

1. All words, such as ONLY, shall be 8 feet high.
2. All non-freeway arrows shall be the large size.
3. The distance between yellow no-passing lines shall be 8 inches, not 7 inches, as shown in the detail of Typical Lane and Edge Lines.
4. Centerline Skip Dash Pavement Marking on multi-lane divided, multi-lane undivided, and one-way roadway shall be according to District Standard 41.1.

PERMANENT SURVEY MARKERS, TYPE II, shall be set at intervals of 1 mile or as directed by the Engineer. Bridge or culvert projects shall have one survey marker placed near the structure. Estimated: 3 Each.

Permanent Survey Markers, Type II shall be cast-in-place as shown on District Standard 66.2. Option 2 would be to install a vaulted style, monumented as described by NGS as a 3D monument (Top Security Sleeve Rod Monument), with installation instructions provided by the District Chief of Surveys. If poured in place, the bottom of the marker shall be 5'-0" below the ground surface.

The Permanent Survey Markers, if possible, shall be installed at the beginning of the job and protected throughout.

The Contractor shall submit to the Engineer a description of location, elevation, and coordinates for each permanent survey marker. The horizontal coordinates must be derived by GPS and the elevation derived using an electronic level. The meta data, such as the Geoid used, (NGS adjustment ie: 97 HARN, 03, 07), and the base point(s) name or number shall be submitted along with a complete collection log. If collected using RTK method, it will require either 3 collections (averaged) from 2 different bases, or a minimum of 3 collections (averaged), at least 2 hours apart, from the same base. If using a CORS type network, the collection procedure shall include localizing with check shots on at least 2 different HARN monuments both before and after collection. The level circuit shall be run from furnished mark to furnished mark and then adjusted. The error of closure shall be submitted with the electronic level notes in a recognized format approved by the Engineer and/or the Chief of Surveys. The Engineer shall submit this information to the District Chief of Surveys.

The Contractor shall be responsible for protecting utility property during construction operations as outlined in Article 107.31 of the Standard Specifications. A minimum of 48 hours advance notice is required for non-emergency work. The JULIE number is 800-892-0123. The following listed utilities located within the project limits or immediately adjacent to the project construction limits are members of JULIE:

AT&T Communications (630/552-4677)	Commonwealth Edison Co. (815/490-2869)
Frontier (815/895-1515)	NICOR Gas Co. (630/983-8676)
Magellan Midstream Partners (918/573-1005)	Comcast Cable (815/395-8977)
MCI World Com (972/729-6016)	G4S Technology, LLC (630/739-0546)
City of Rochelle/Sam Tesreau (815/561-2023)	

IDOT is not a member of JULIE. If you are near any overhead lighting, intersection lighting or traffic signals, contact the IDOT Traffic Office at 815/284-5469 at least 48 hours prior to work.

CADD data will be available to Contractors and Consultants working on this project. This information will be provided upon request as MicroStation CADD files and Geopak coordinate geometry files ONLY. If data is required in other formats it will be your responsibility to make these conversions. If any discrepancy or inconsistency arises between the electronic data and the information on the hard copy, the information on the hard copy should be used. Contact the District's Project Engineer to request these files.

SUMMARY OF QUANTITIES

M232 (R) M23 (U)

CODE NUMBER	ITEM	UNITS	TOTAL	80% FED 20% STATE LEE CO 0005	80% FED 20% STATE OGLE CO 0005
20200600	EXCAVATING AND GRADING EXISTING SHOULDER	UNIT	18	FAS 1177 18	FAU 5452
35101400	AGGREGATE BASE COURSE, TYPE B	TON	287	287	
40600200	BITUMINOUS MATERIALS (PRIME COAT)	TON	134.9	120.5	14.4
40600300	AGGREGATE (PRIME COAT)	TON	691	616	75
40600525	LEVELING BINDER (HAND METHOD), N50	TON	204.6	190.9	13.7
40600627	LEVELING BINDER (MACHINE METHOD), IL-9.5 FG, N50	TON	12712	11358	1354
40600895	CONSTRUCTING TEST STRIP	EACH	2	2	
40600982	HOT MIX ASPHALT SURFACE REMOVAL - BUTT JOINT	SQ YD	2560	2560	
40600990	TEMPORARY RAMP	SQ YD	913	697	216
40601005	HOT MIX ASPHALT REPLACEMENT OVER PATCHES	TON	960	960	
40603310	HOT MIX ASPHALT SURFACE COURSE, MIX "C", N50	TON	356	307	49
40603335	HOT-MIX ASPHALT SURFACE COURSE, MIX "D", N50	TON	19469	17397	2072
40800050	INCIDENTAL HOT-MIX ASPHALT SURFACING	TON	1835	1519	316
44000158	HOT-MIX ASPHALT SURFACE REMOVAL, 2 1/4"	SQ YD	104648	79106	25542

*SPECIALTY ITEMS

Rev.

SUMMARY OF QUANTITIES

FAS 1177 FAU 5452

CODE NUMBER	ITEM	UNITS	TOTAL	80% FED LEE CO 0005	20% STATE OGLE CO 0005
44002232	HOT MIX ASPHALT REMOVAL OVER PATCHES, 8"	SQ YD	2142	2142	
44300100	AREA REFLECTIVE CRACK CONTROL TREATMENT	SQ YD	126049.5	126049.5	
48102100	AGGREGATE WEDGE SHOULDER, TYPE B	TON	5866	5638	228
48203020	HOT MIX ASPHALT SHOULDERS, 5 3/4"	SQ YD	1582	1582	
63000003	STEEL PLATE BEAM GUARDRAIL, TYPE A, 9 FOOT POSTS	FOOT	612.5	612.5	
63100087	TRAFFIC BARRIER TERMINAL, TYPE 6A	EACH	4	4	
63100167	TRAFFIC BARRIER TERMINAL, TYPE 1 (SPECIAL) TANGENT	EACH	16	16	
63200310	GUARDRAIL REMOVAL	FOOT	1465.0	1465.0	
63301210	REMOVE AND REERECT STEEL PLATE BEAM GUARDRAIL, TYPE A	FOOT	175	175	
63500105	DELINEATORS	EACH	16	16	
66700305	PERMANENT SURVEY MARKERS, TYPE II	EACH	3	2	1
67000400	ENGINEER'S FIELD OFFICE, TYPE A	CAL MO	5	5	
67100100	MOBILIZATION	L. SUM	1	0.5	0.5
70100310	TRAFFIC CONTROL AND PROTECTION, STANDARD 70142.1	L. SUM	1	0.5	0.5
70100460	TRAFFIC CONTROL AND PROTECTION, STANDARD 701306	L. SUM	1	0.5	0.5

*SPECIALTY ITEMS

SUMMARY OF QUANTITIES

CODE NUMBER	ITEM	UNITS	TOTAL	80% FED 20% STATE LEE CO 0005	80% FED 20% STATE OGLE CO 0005
70100600	TRAFFIC CONTROL AND PROTECTION, STANDARD 701336	L. SUM	1	0.5	0.5
70100825	TRAFFIC CONTROL AND PROTECTION, STANDARD 701456	L. SUM	1	0.5	0.5
70102625	TRAFFIC CONTROL AND PROTECTION, STANDARD 701606	L. SUM	1	0.5	0.5
70102635	TRAFFIC CONTROL AND PROTECTION, STANDARD 701701	L. SUM	1	0.5	0.5
70103815	TRAFFIC CONTROL SURVEILLANCE	CAL DAY	20	18	2
70300100	SHORT-TERM PAVEMENT MARKING	FOOT	22182	20350	1832
70301000	WORK ZONE PAVEMENT MARKING REMOVAL	SQ. FT.	2465	2261	204
* 78000200	THERMOPLASTIC PAVEMENT MARKING - LINE 4"	FOOT	12573		12573
* 78000500	THERMOPLASTIC PAVEMENT MARKING - LINE 8"	FOOT	1020		1020
* 78000600	THERMOPLASTIC PAVEMENT MARKING - LINE 12"	FOOT	390		390
* 78000650	THERMOPLASTIC PAVEMENT MARKING - LINE 24"	FOOT	409	300	109
* 78001110	PAINT PAVEMENT MARKING - LINE 4"	FOOT	370411	352667	17744
* 78100100	RAISED REFLECTIVE PAVEMENT MARKER	EACH	975	849	126
* 78200410	GUARDRAIL MARKERS, TYPE A	EACH	34	34	

*SPECIALTY ITEMS

SUMMARY OF QUANTITIES

FAS 1177 FAU 5452

CODE NUMBER	ITEM	UNITS	TOTAL	80% FED LEE CO 0005	20% STATE OGLE CO 0005
78201000	TERMINAL MARKER - DIRECT APPLIED	EACH	16	16	
78300200	RAISED REFLECTIVE PAVEMENT MARKER REMOVAL	EACH	845	764	81
Z0008758	AERIAL SPEED CHECK MARKING	FOOT	36	36	
Z0012500	CONCRETE CURB REPAIR	FOOT	162		162
Z0034105	MATERIAL TRANSFER DEVICE	TON	32071	28754	3317
Z0040315	PILOT CAR	DAY	20	18	2
Z0051500	REMOVING AND RESETTING STREET SIGNS	EACH	1	1	
Z0076600	TRAINEE'S	HOURL	500	500	
Z0055100	RUMBLE RESURFACING	SQ YD	183	183	
Z0076604	TRAINEE'S - TRAINING PROGRAM GRADUATE	HOURL	500	500	

* SPECIALTY ITEM

Ø 0042

IL 251

LEE CO

STA 389+00 to STA 463+21.5
 STA 473+78.5 to STA 558+82.5**
 STA 561+17.5 to STA 575+06
 STA 579+67 to STA 621+46**

STA 623+29 to STA 734+32.5**
 STA 738+67.5 to STA 786+76.5
 STA 794+41.5 to STA 841+52.5

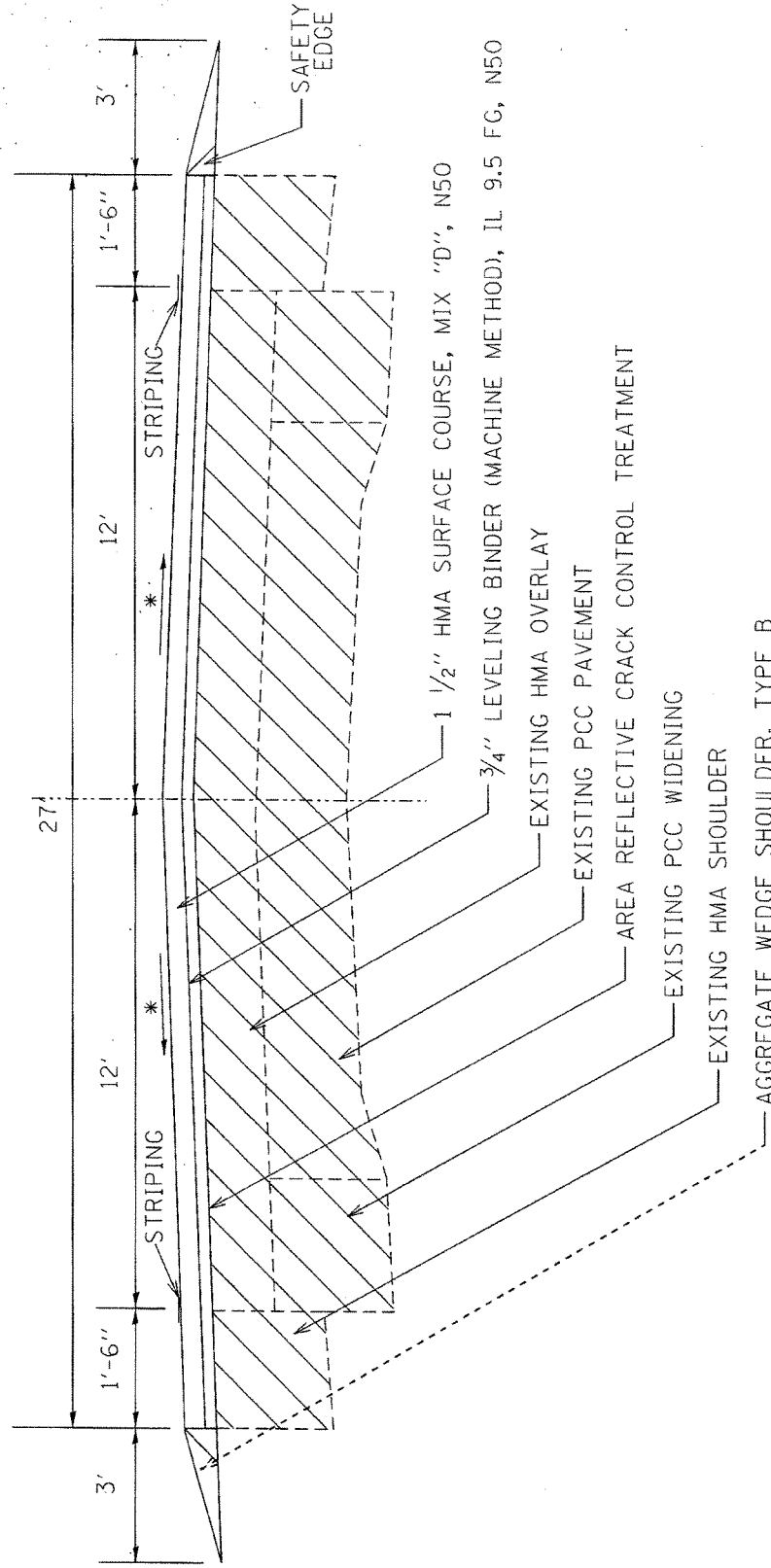

**GUARDRAIL LOCATION

*MAINTAIN EXISTING CROSS SLOPE (MIN. 1/8" PER FOOT)

HMA MIXTURE APPLICATION RATE = 112lb/sy/in

FILE NAME = c:\pw-work\pw\dot\goff\j\148316607\0200513-sh1-typical.dgn	STATE OF ILLINOIS DEPARTMENT OF TRANSPORTATION		TYPICAL SECTION		F.A. RTE.	SECTION	COUNTY	TOTAL SHEETS	SHEET NO.
USER NAME = goff,jl				(109, 110) RS-5	LEE/DGLE	109	11		
PLOT DATE = Thu Jan 24 13:25:01 2013			FED. ROAD DIST. NO.	ILLINOIS	FED. AID PROJECT	CONTRACT NO. 64J29			

IL 251

LEE CO

STA 463+89 to STA 473+11

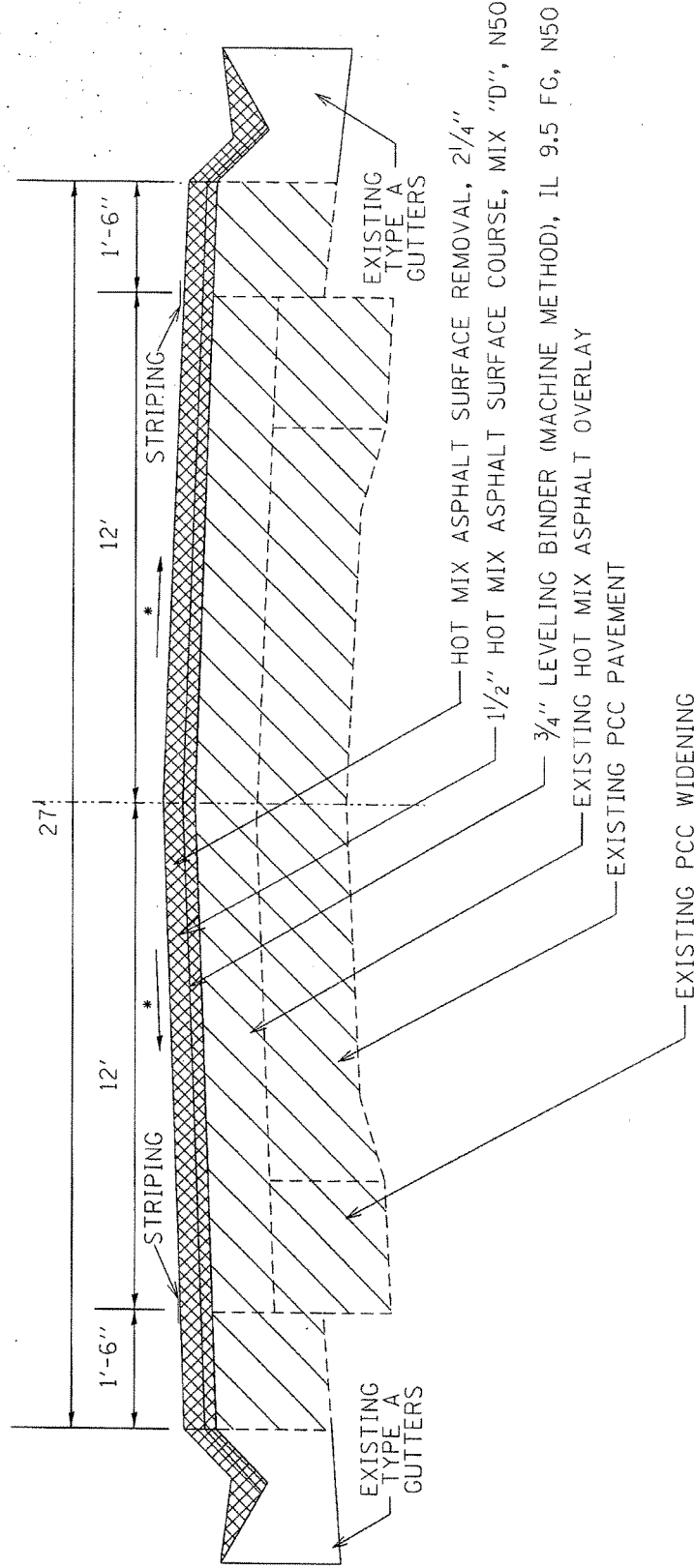

* MAINTAIN EXISTING CROSS SLOPE (MIN. 1/8" PER FOOT)

HMA MIXTURE APPLICATION RATE = 112lb/sy/in

FILE NAME = c:\pw-work\pwwork\goff\j\48315607\0200513-sht-typical.dgn	STATE OF ILLINOIS DEPARTMENT OF TRANSPORTATION		TYPICAL SECTION		F.A. RTE. *	SECTION (109, 110) RS-5	COUNTY LEE/OGLE	TOTAL SHEET NO. 109	SHEET NO. 12
USER NAME = goffj					*			CONTRACT NO. 64J29	
PILOT DATE = Thu Jan 24 13:25:07 2013						ILLINOIS	FED. AID PROJECT		

LEE CO
 IL 251
 STA EQUATION
 COUNTY LINE

STA 559+50 to STA 560+50
 STA 735+00 to STA 738+00**
 STA 787+44 to STA 789+79
 STA 790+69 to STA 793+74**
 STA 842+20 to STA 998+50
 STA 999+40 to STA 1066+43

OGLE CO
 STA 0+00 to 22+52

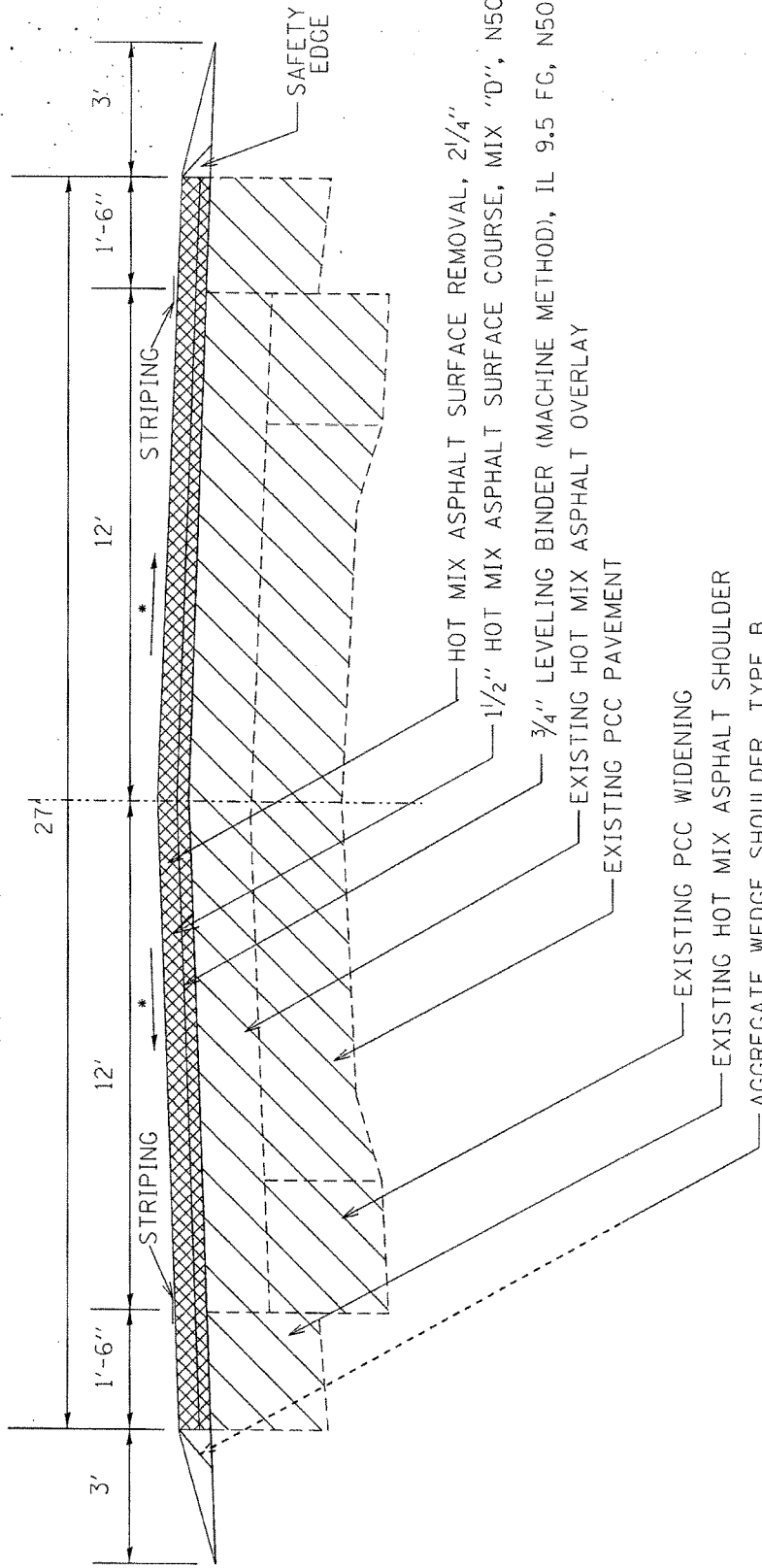

** GUARDRAIL LOCATION
 * MAINTAIN EXISTING CROSS SLOPE (MIN. 1/8" PER FOOT)

HMA MIXTURE APPLICATION RATE = 112lb/sy/in

FILE NAME = c:\p...work\pindot\gof\j\08316607\0200513-shr-typical.dgn	STATE OF ILLINOIS		DEPARTMENT OF TRANSPORTATION		TYPICAL SECTION		F.A. RTE. SECTION		COUNTY SHEETS		TOTAL SHEET NO.	
USER NAME = gof\j	STATE OF ILLINOIS		DEPARTMENT OF TRANSPORTATION		TYPICAL SECTION		* (109, 110) RS-5		LEE/OGLE 109 13		CONTRACT NO. 64J29	
PLOT DATE = Thu Jan 24 13:25:05 2013	STATE OF ILLINOIS		DEPARTMENT OF TRANSPORTATION		TYPICAL SECTION		* FED. ROAD DIST. NO. ILLINOIS FED. AID PROJECT		COUNTY SHEETS		TOTAL SHEET NO.	

IL 251

OGLE CO

STA. 22+52 to 46+22

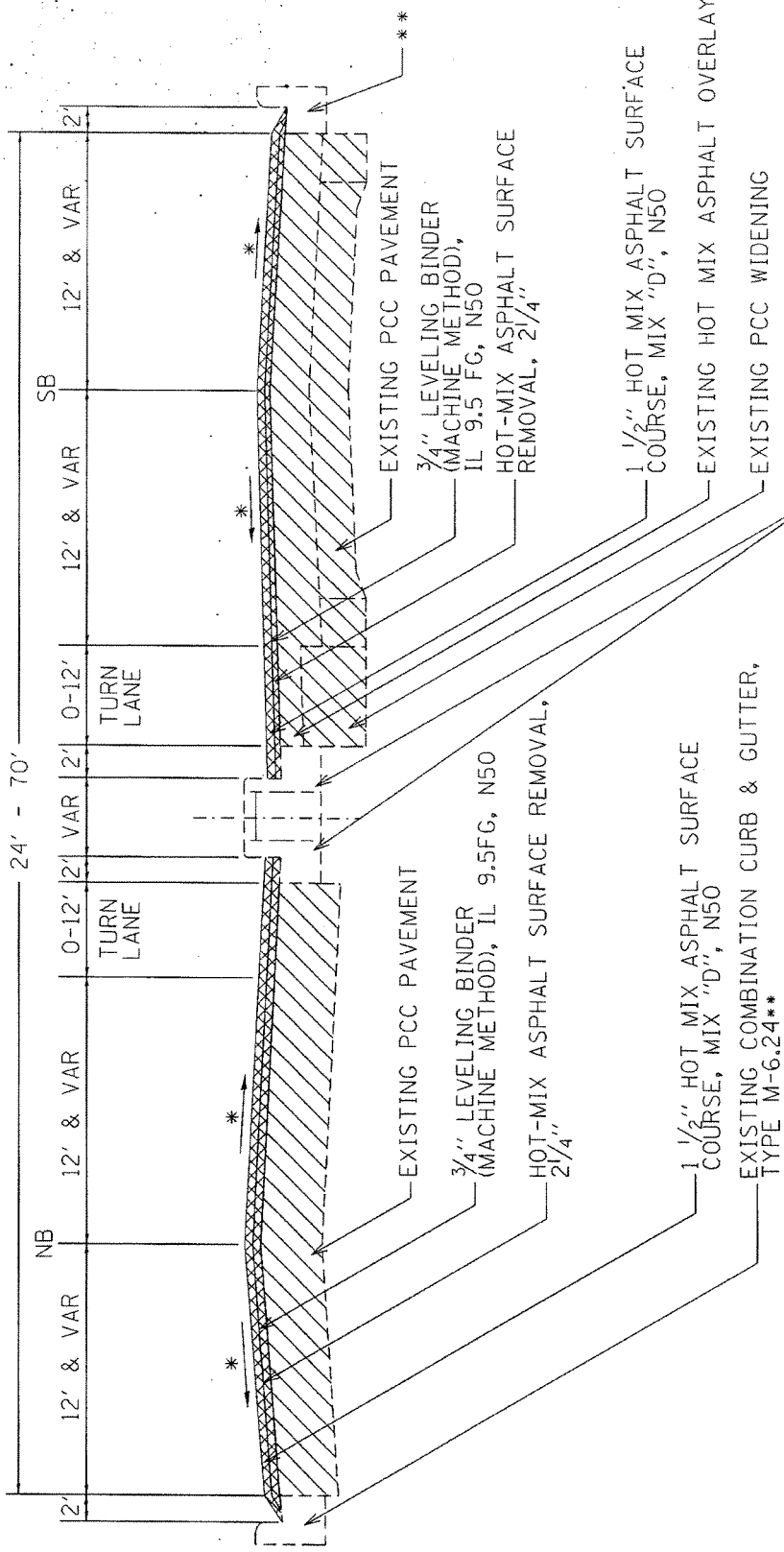

**3' AGGREGATE WEDGE SHOULDER
 STA 22+52 TO 34+40 LT
 STA 22+52 TO 31+00 RT
 *MAINTAIN EXISTING CROSS SLOPE (MIN. 1/8" PER FOOT)

HMA MIXTURE APPLICATION RATE = 112lb/sy/in

FILE NAME =		STATE OF ILLINOIS		TOTAL SHEETS		SHEET NO.	
c:\p...work\p...dot\goff\j\08316607\0200513-sht-typical.dgn		DEPARTMENT OF TRANSPORTATION		109		14	
USER NAME = goffj		TYPICAL SECTION		COUNTY		CONTRACT NO.	
PLOT DATE = Thu Jan 24 13:25:02 2013		SECTION		LEE/OGLE		64129	
		F.A. RTE.		SECTION		FED. ROAD DIST. NO.	
		*		109, 110 R5-5		ILLINOIS FED. AID PROJECT	
		*					

MAINLINE BUTT-JOINT

LEE CO

STA 388+10 to STA 389+00 STA 621+46 to STA 622+36
 STA 575+06 to STA 575+96 STA 623+39 to STA 623+29
 STA 578+77 to STA 579+67

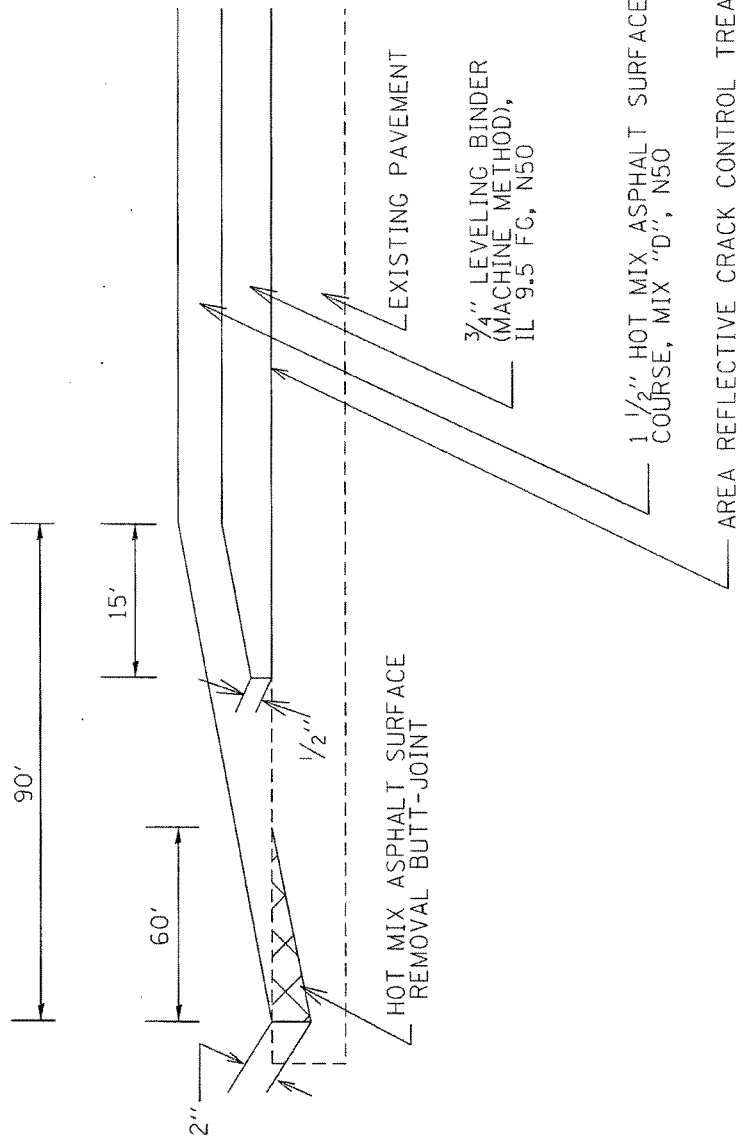

HMA MIXTURE APPLICATION RATE = 112lb/sy/in

FILE NAME = c:\pwwork\pwwork\goffj\0200513-sht-typlacel.dgn		STATE OF ILLINOIS DEPARTMENT OF TRANSPORTATION		TYPICAL SECTION		F.A. RTE. SECTION		COUNTY		TOTAL SHEETS		SHEET NO.	
USER NAME = goffj						* (109, 110) RS-5		LEE/OGLE		109		15	
PLOT DATE = Thu Jan 24 13:25:02 2013						* FED. ROAD DIST. NO. ILLINOIS FED. AID PROJECT		CONTRACT NO.		64429			

2 1/4" TAPERS
LEE CO

STA 463+21.5 to STA 463+89
 STA 473+11 to STA 473+78.5
 STA 558+82.5 to STA 559+50
 STA 560+50 to STA 561+17.5
 STA 734+32.5 to STA 735+00

STA 738+00 to STA 738+67.5
 STA 786+76.5 to STA 787+44
 STA 793+74 to STA 794+41.5
 STA 841+52.5 to STA 842+20

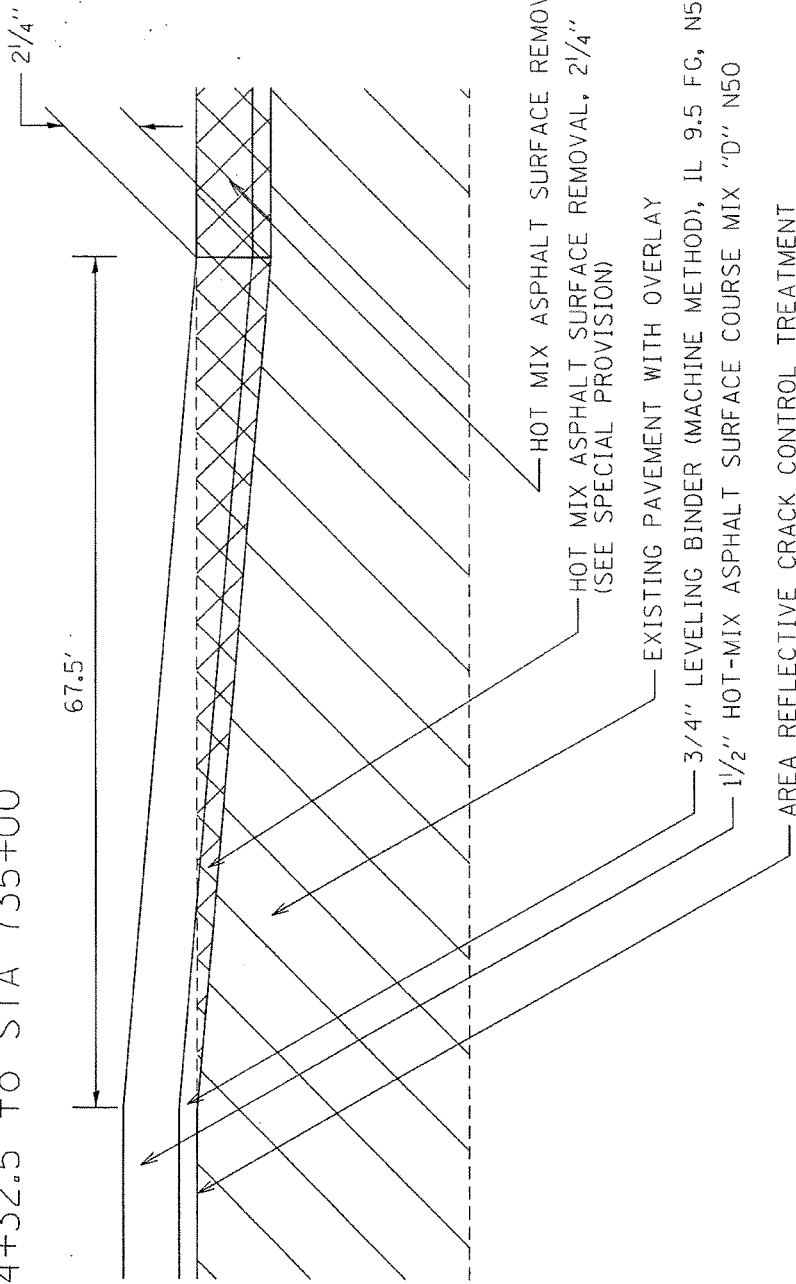

HMA MIXTURE APPLICATION RATE = 112lb/sy/in

FILE NAME = c:\pwr-work\pwr\dot\goff\j\0316607\0200513-sht-tyaice1.dgn	STATE OF ILLINOIS		TYPICAL SECTION		F.A. RTE.	SECTION	COUNTY	TOTAL SHEETS	SHEET NO.	
USER NAME = goff,j	DEPARTMENT OF TRANSPORTATION				.	(109, 110) RS-5	LEE/OGLE	109	16	
PLOT DATE = Thu Jan 24 13:25:06 2013					.			CONTRACT NO. 64429		
					ILLINOIS		FED. ROAD DIST. NO. FED. AID PROJECT			

SIDERoadS

LEE CO

BEEMERVILLE RD
STAINBROOK RD
LEE RD

EXISTING R.O.W.
END OF RETURN

VARIABLE

1 1/4"

EDGE OF PAVEMENT

2 1/4" INCIDENTAL HOT-MIX
ASPHALT SURFACING

HMA SURFACE REMOVAL - BUTT JOINT

1 1/2" HMA SURFACE
COURSE, MIX "D", N50

3/4" LEVELING BINDER
(MACHINE METHOD),
IL 9.5 FG, N50

HMA MIXTURE APPLICATION RATE = 112lb/sy/in

FILE NAME = c:\px-work\pwwork\goff\j\40315607\1200513-sht-typical.edn		STATE OF ILLINOIS DEPARTMENT OF TRANSPORTATION		TYPICAL SECTION		F.A. RTE. *		SECTION (109, 110) RS-5		COUNTY LEE/OGLE		TOTAL SHEET SHEETS 109 17	
USER NAME = goffj		CONTRACT NO. 64J29		FED. ROAD DIST. NO.		ILLINOIS		FED. AID PROJECT		CONTRACT NO. 64J29		TOTAL SHEET SHEETS 109 17	
PLOT DATE = Thu Jan 24 13:25:04 2013													

LEE CO SIDEROADS OGLE CO
 LEE CO/OGLE CO GURLER RD PRIVATE RD
 BUTLER HILL RD STEWARD RD
 HERMAN RD
 MCGIRR RD
 REYNOLDS RD
 SVELA RD
 ROCHELLE RD
 PERRY RD
 ELVA RD
 CONRAD RD

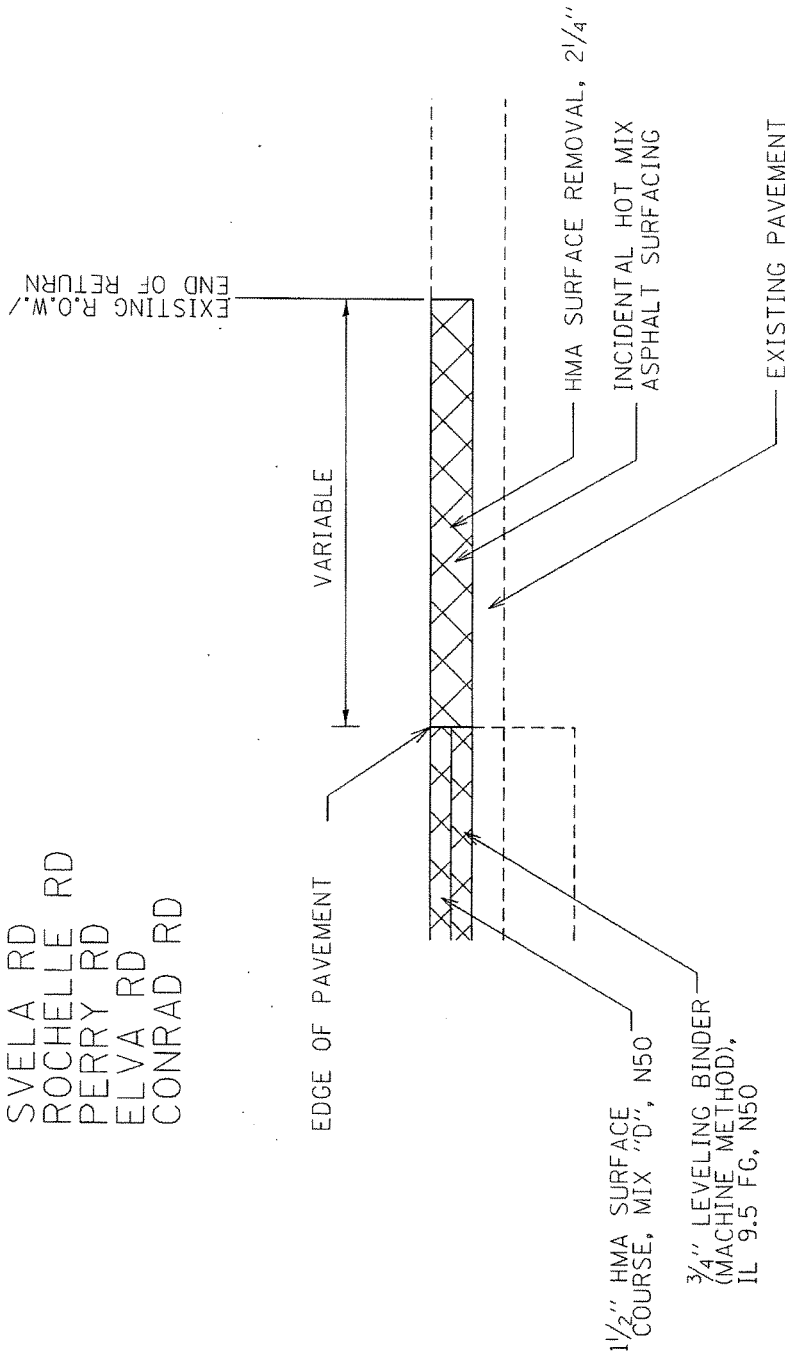

HMA MIXTURE APPLICATION RATE = 112lb/sy/in

FILE NAME = c:\pwr\work\pwr.dot\goff\j\0316687\0200513-sht-typcal.dgn		STATE OF ILLINOIS DEPARTMENT OF TRANSPORTATION		TYPICAL SECTION		TOTAL SHEETS 109 18	
USER NAME = goff,j		F.A. RTE. *		SECTION (109, 110) RS-5		COUNTY LEE/OGLE	
PLOT DATE = Thu Jan 24 13:25:03 2013		*		FED. ROAD DIST. NO.		CONTRACT NO. 64J29	
				ILLINOIS		FED. AID PROJECT	

I-88 SW & NW RAMP
OGLE CO

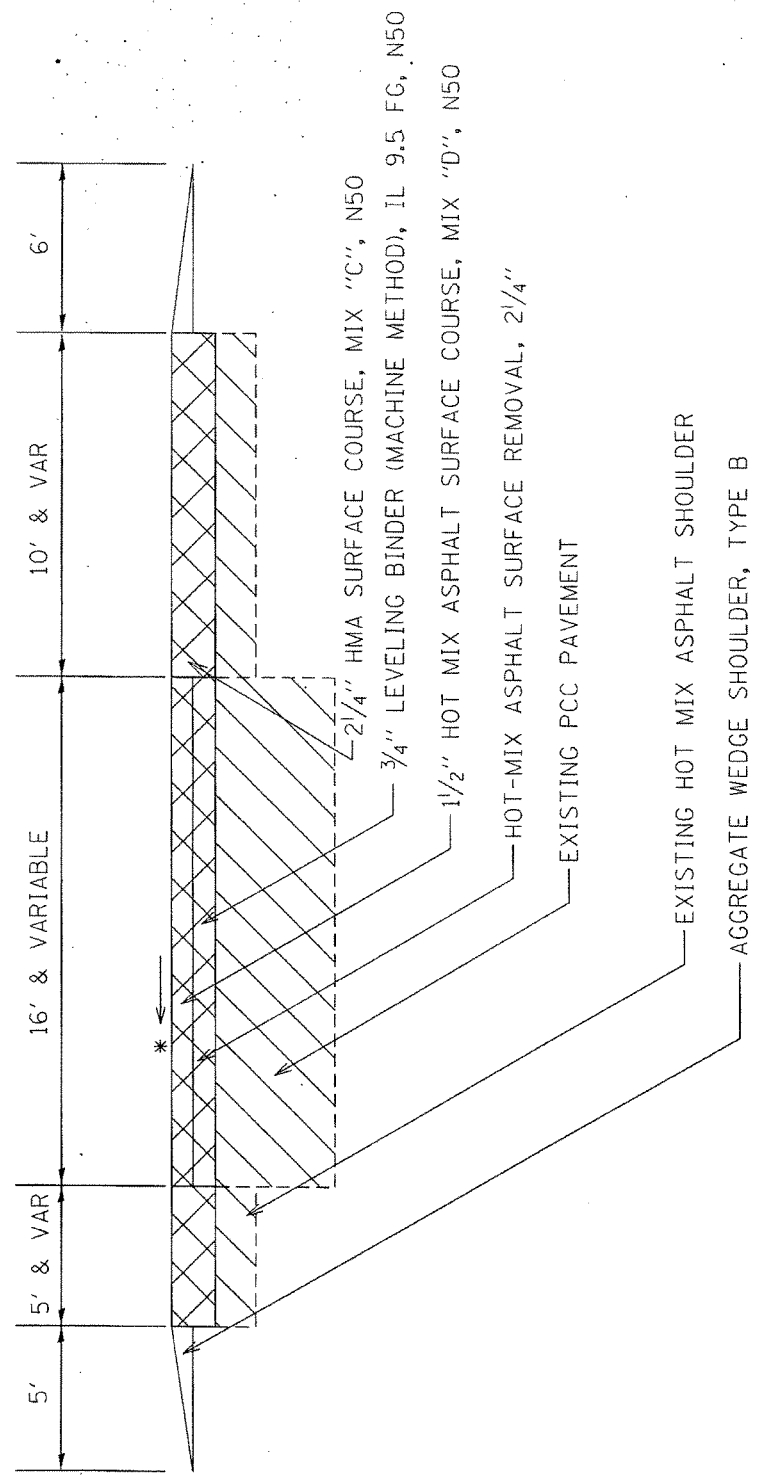

*MAINTAIN EXISTING CROSS SLOPE (MIN. 1/8" PER FOOT) HMA MIXTURE APPLICATION RATE = 112lb/sy/in

FILE NAME = c:\pwwork\pwwork\goff\j\0200513-sht-typical.dgn
 USER NAME = goff,j
 PLOT DATE = Thu Jan 24 13:25:08 2013

STATE OF ILLINOIS DEPARTMENT OF TRANSPORTATION		TYPICAL SECTION		SECTION		COUNTY		TOTAL SHEET	
				(109, 110) RS-5		LEE/OGLE		SHEETS NO.	
								109 19	
								CONTRACT NO. 64,129	
				ILLINOIS FED. AID PROJECT					

IL 251
LEE CO

STA 475+23 to STA 478+54 RT STA 476+09 to STA 479+04 LT

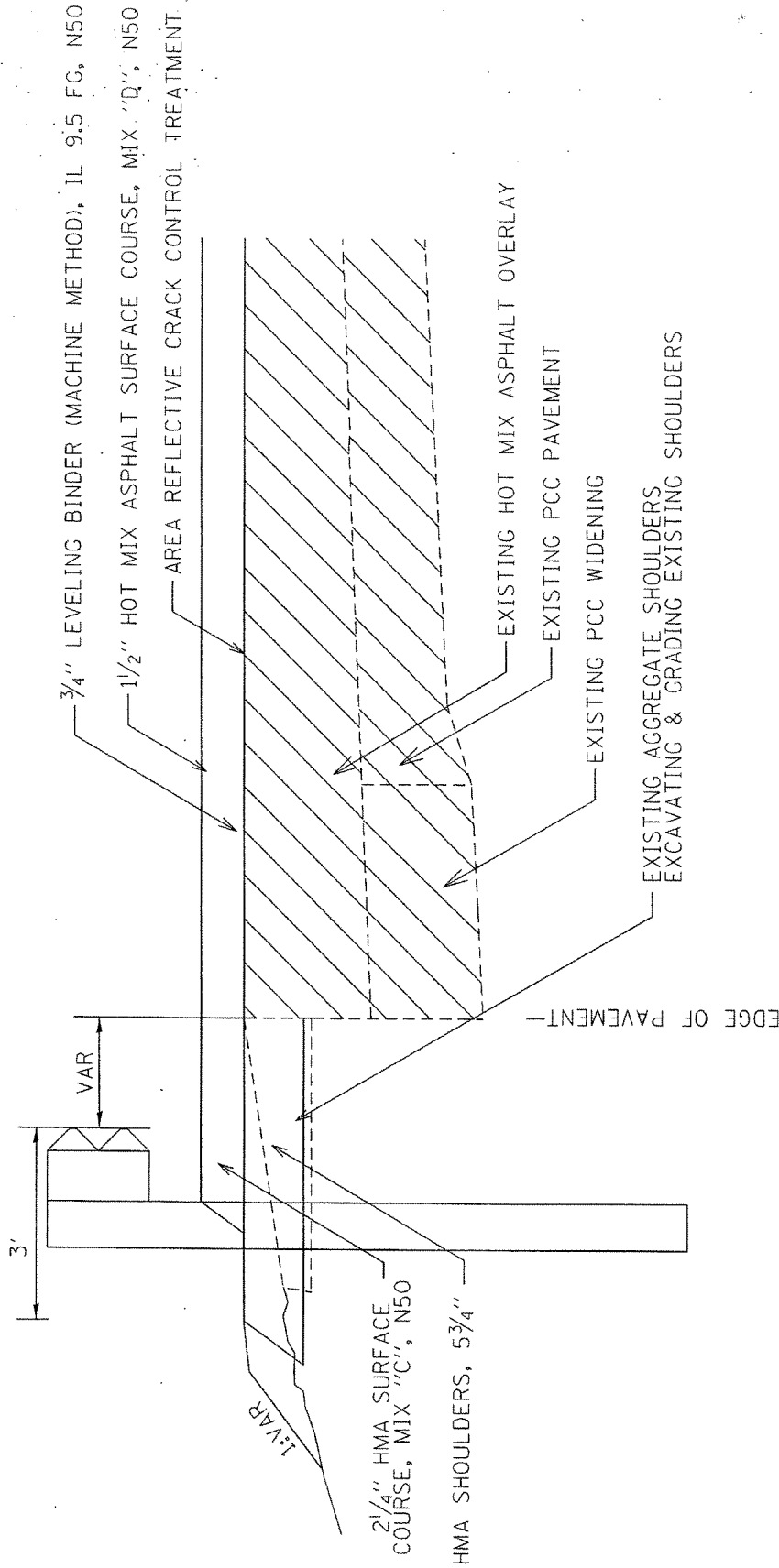

*MAINTAIN EXISTING CROSS SLOPE (MIN. 1/8" PER FOOT) HMA MIXTURE APPLICATION RATE = 112lb/sy/in

FILE NAME = c:\p...work\p...data\goff\j\48316607\0200513-sh-typical.dgn		STATE OF ILLINOIS DEPARTMENT OF TRANSPORTATION		TYPICAL SECTION		F.A. RTE. *		SECTION 1109, 110 RS-5		COUNTY LEE/OGLE		TOTAL SHEETS NO. 109 20	
USER NAME = goff,j		DEPARTMENT OF TRANSPORTATION		TYPICAL SECTION		*		1109, 110 RS-5		LEE/OGLE		CONTRACT NO. 64429	
PLOT DATE = Thu Jan 24 13:25:06 2013		DEPARTMENT OF TRANSPORTATION		TYPICAL SECTION		ILLINOIS		FED. ROAD DIST. NO.		FED. AID PROJECT			

IL 251
LEE CO

STA 619+90 to STA 622+36 LT STA 623+39 to STA 625+93 LT
 STA 620+42 to STA 622+36 RT STA 623+39 to STA 625+44 RT

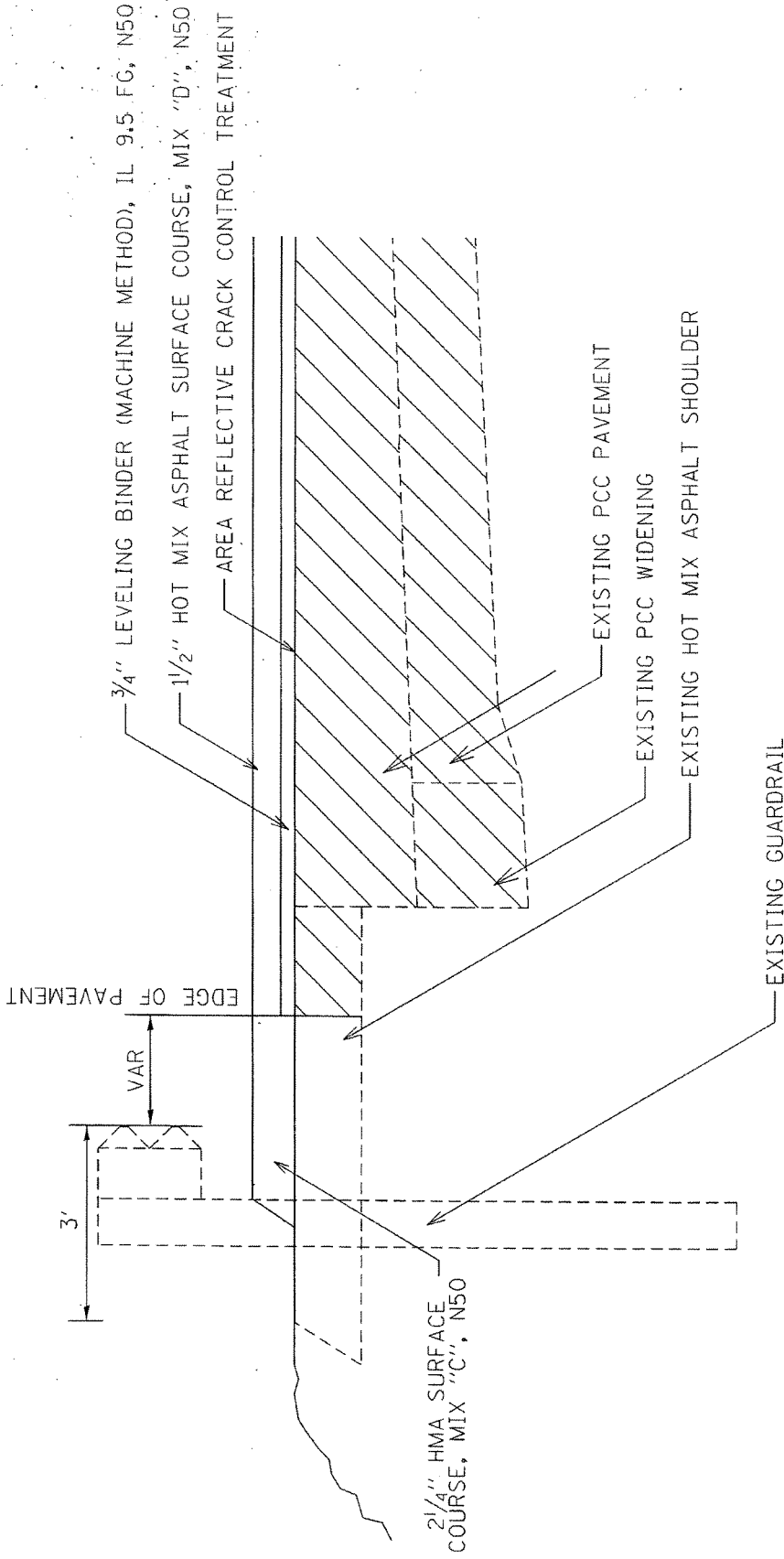

*MAINTAIN EXISTING CROSS SLOPE (MIN. 1/8" PER FOOT)

HMA MIXTURE APPLICATION RATE = 112lb/sy/in

FILE NAME = c:\p...work\p...dot\goff\j\d0316607\0200513-shr-typ.cad.dgn		STATE OF ILLINOIS DEPARTMENT OF TRANSPORTATION		TYPICAL SECTION		F.A. RTE. *		SECTION (109, 110) RS-5		COUNTY LEE/OGLE		TOTAL SHEETS SHEETS NO. 109 21	
USER NAME = goffj						*				CONTRACT NO. 64429			
PLOT DATE = Thu Jan 24 13:25:10 2013						ILLINOIS		FED. AID PROJECT					

IL 251
LEE CO

STA 683+27 to STA 686+03 RT STA 683+20 to STA 685+87.5 LT

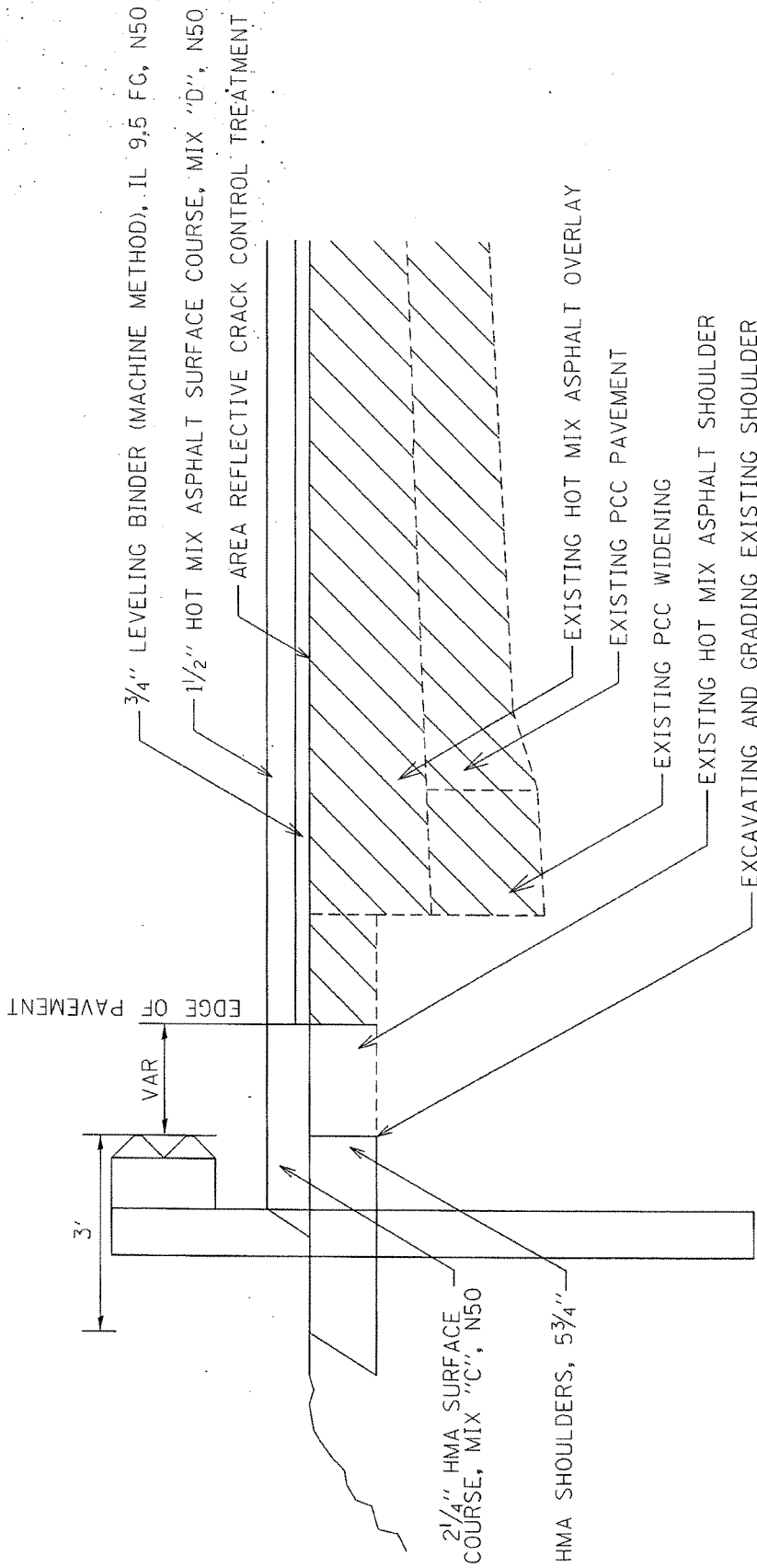

* MAINTAIN EXISTING CROSS SLOPE (MIN. 1/8" PER FOOT) HMA MIXTURE APPLICATION RATE = 112lb/sy/in

FILE NAME = c:\pwork\pwork\goff\j\031660\0200513-sh-typical.dgn

USER NAME = goff,j

PLOT DATE = Thu Jan 24 13:25:12 2013

STATE OF ILLINOIS
DEPARTMENT OF TRANSPORTATION

TYPICAL SECTION

F.A. RTE.	SECTION	COUNTY	TOTAL SHEETS	SHEET NO.
*	(109, 110) RS-5	LEE/OGLE	109	22
*			CONTRACT NO. 64J29	
FED. ROAD DIST. NO.		ILLINOIS FED. AID PROJECT		

IL 251
LEE CO

STA 734+40 to STA 736+60 RT STA 789+88 to STA 790+10 RT
 STA 734+77 to STA 736+60 LT STA 790+35 to STA 792+97 LT
 STA 789+88 to STA 790+10 LT STA 790+35 to STA 792+42 RT

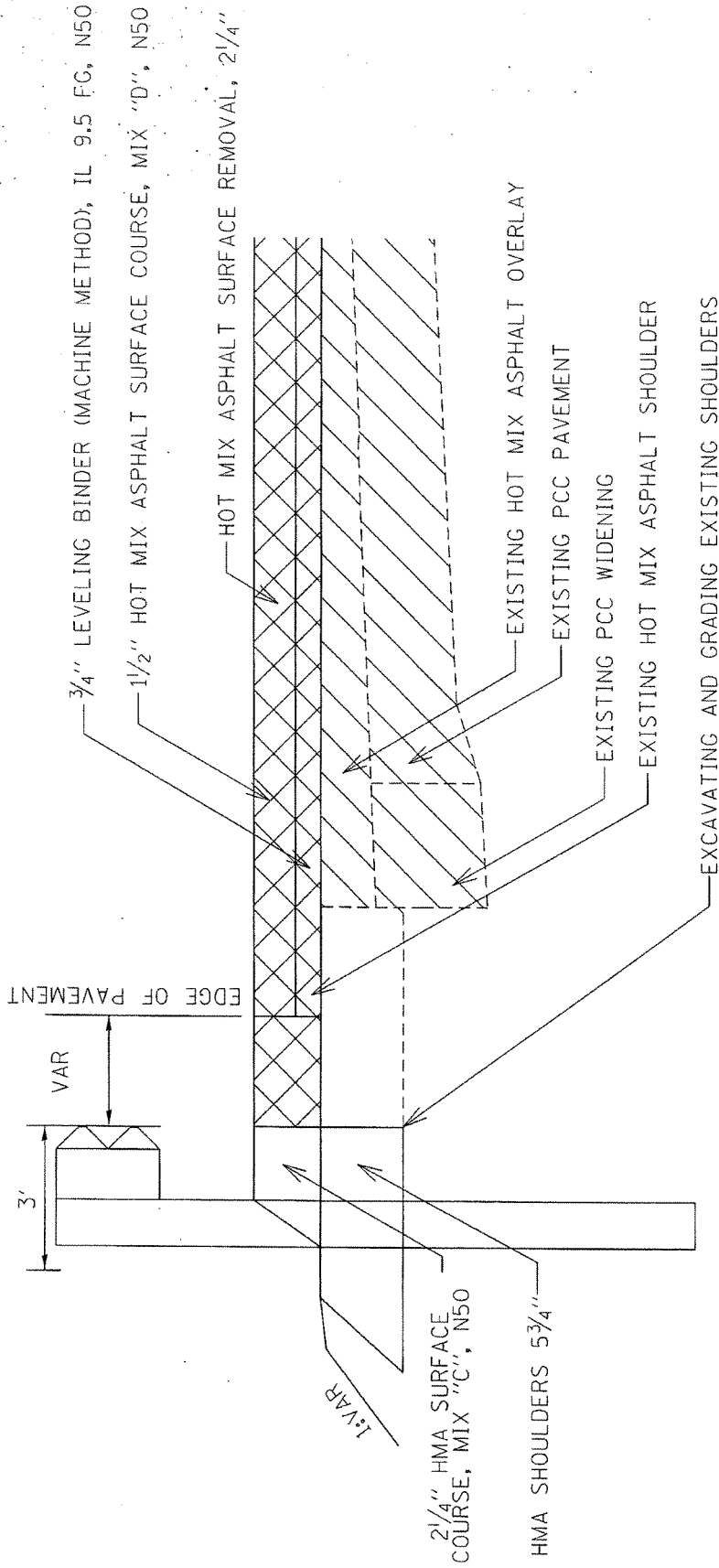

* MAINTAIN EXISTING CROSS SLOPE (MIN. 1/8" PER FOOT) HMA MIXTURE APPLICATION RATE = 112lb/sy/in

FILE NAME = c:\pwwork\pandot\goff\j\0316607\0200513-sht-typical.dgn		STATE OF ILLINOIS DEPARTMENT OF TRANSPORTATION		TYPICAL SECTION		F.A. RTE. *		SECTION 1109, 110; RS-5		COUNTY LEE/OGLE		TOTAL SHEETS 109		SHEET NO. 23	
USER NAME = goffj		PLOT DATE = Thu Jan 24 13:25:11 2013		*		FED. ROAD DIST. NO.		ILLINOIS		FED. AID PROJECT		CONTRACT NO. 64429			

IL 251
LEE CO

STA 996+05 to STA 998+50 RT STA 999+40 to STA 1000+79 LT
 STA 997+16 to STA 998+50 LT STA 999+40 to STA 1000+74 RT

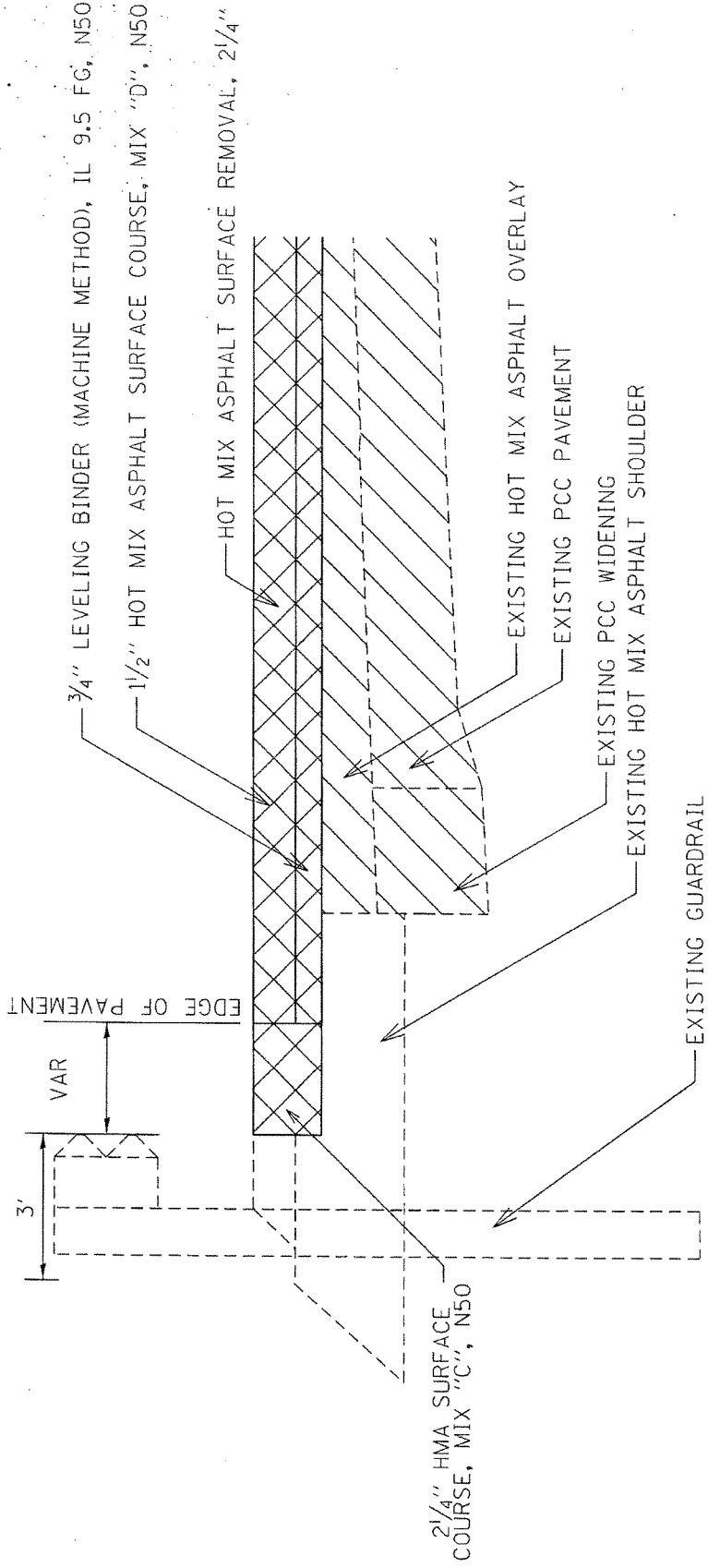

* MAINTAIN EXISTING CROSS SLOPE (MIN. 1/8" PER FOOT)		HMA MIXTURE APPLICATION RATE = 112lb/sy/in	
FILE NAME =	STATE OF ILLINOIS	F.A. RTE.	TOTAL SHEETS
c:\p-wor-k\p-r-d-a-t-a\g-o-f-f-j\40316607\0200513-sh-t-typical.dgn	DEPARTMENT OF TRANSPORTATION	*	NO.
USER NAME = goff,jj		* 1109, 1101 RS-5	109 24
PLOT DATE = Thu Jan 24 13:25:11 2013			CONTRACT NO. 64J29
		FED. ROAD DIST. NO.	ILLINOIS FED. AID PROJECT

HOT-MIX ASPHALT SCHEDULE

LOCATION	REMARKS	BITUMINOUS			EXC & GRADING	BIT MATL'S (PRIME COAT)	AGG (PRIME COAT)	LEVELING BINDER (HM) N50	LEVELING BINDER (MM) IL 9.5 N50	HMA SURF REM - BUTT JOINT	TEMP RAMP
		PAVEMENT									
		LENGTH	WIDTH	AREA							
STA TO STA		FT	FT	SQ YD	EX SHDR	TON	TON	TON	TON	SQ YD	SQ YD
MAINLINE						2 APPS	2 APPS				
LEE COUNTY											
388 + 10.0 - 389 + 00.0	BUTT JOINT	90	27	270		0.2	0.8		15	270	35
389 + 00.0 - 463 + 21.5		7421.5	27	22265		12.7	66.8	21.1	1247		
463 + 21.5 - 463 + 89.0	TAPER	67.5	27	203		0.1	0.6	0.2	11		
463 + 89.0 - 473 + 11.0	TYPE A GUTTER	922	31	3730		2.1	11.2	2.6	209		
473 + 11.0 - 473 + 78.5	TAPER	67.5	27	203		0.1	0.6	0.2	11		
473 + 78.5 - 558 + 82.5		8504	27	25512		14.6	76.5	24.2	1429		
558 + 82.5 - 559 + 50.0	TAPER	67.5	27	203		0.1	0.6	0.2	11		
559 + 50.0 - 560 + 50.0	SURF REM	100	31	344		0.2	1.0	0.3	19		
560 + 50.0 - 561 + 17.5	TAPER	67.5	27	203		0.1	0.6	0.2	11		
561 + 17.5 - 575 + 06.0		1388.5	27	4166		2.4	12.5	3.9	233		
575 + 06.0 - 575 + 96.0	BUTT JOINT	90	27	270		0.2	0.8	0.3	15	270	35
575 + 96.0 - 578 + 77.0	US 30 OMISSION	281	27	843							
578 + 77.0 - 579 + 67.0	BUTT JOINT	90	27	270		0.2	0.8	0.3	15	270	35
579 + 67.0 - 621 + 46.0		4179	27	12537		7.2	37.6	11.9	702		
621 + 46.0 - 622 + 36.0	BUTT JOINT	90	27	270		0.2	0.8	0.3	15	270	35
622 + 36.0 - 623 + 39.0	BR OMISSION	103	27	309							
623 + 39.0 - 624 + 29.0	BUTT JOINT	90	27	270		0.2	0.8	0.3	15	270	35
624 + 29.0 - 734 + 32.5		11003.5	27	33011		18.9	99.0	31.3	1849		
734 + 32.5 - 735 + 00.0	TAPER	67.5	27	203		0.1	0.6	0.2	11		
735 + 00.0 - 738 + 00.0	SURF REM	300	27	900		0.5	2.7	0.9	50		
738 + 00.0 - 738 + 67.5	TAPER	67.5	27	203		0.1	0.6	0.2	11		
738 + 67.5 - 786 + 76.5		4809	27	14427		8.3	43.3	13.7	808		
786 + 76.5 - 787 + 44.0	TAPER	67.5	27	203		0.1	0.6	0.2	11		
787 + 44.0 - 789 + 79.0	SURF REM	235	27	705		0.4	2.1	0.7	39		38
789 + 79.0 - 790 + 69.0	BR OMISSION	90	27	270							
790 + 69.0 - 793 + 74.0	SURF REM	305	27	915		0.5	2.7	0.9	51		38
793 + 74.0 - 794 + 41.5	TAPER	67.5	27	203		0.1	0.6	0.2	11		
794 + 41.5 - 841 + 52.5		4711	27	14133		8.1	42.4	13.4	791		
841 + 52.5 - 842 + 20.0	TAPER	67.5	27	203		0.1	0.6	0.2	11		
842 + 20.0 - 998 + 50.0	SURF REM	15630	27	46890		26.8	140.7	44.4	2626		38
998 + 50.0 - 999 + 40.0	BR OMISSION	90	27	270							
999 + 40.0 - 1066 + 43.0	SURF REM	6703	27	20109		11.5	60.3	19.0	1126		38
LEE COUNTY MAINLINE SUBTOTAL					0.0	116.0	608.4	190.8	11358	1350	326

HOT-MIX ASPHALT SCHEDULE

LOCATION	REMARKS	BITUMINOUS			EXC & GRADING EX SHDR	BIT MATL'S (PRIME COAT)	AGG (PRIME COAT)	LEVELING BINDER (HM) N50	LEVELING BINDER (MM) IL 9.5 N50	HMA SURF REM - BUTT JOINT	TEMP RAMP
		PAVEMENT									
		LENGTH	WIDTH	AREA							
STA TO STA		FT	FT	SQ YD	UNIT	TON	TON	TON	TON	SQ YD	SQ YD
OGLE COUNTY						2 APPS	2 APPS				
0 + 00.0 - 22 + 52.0	SURF REM	2252	27	6756		3.9	20.3	6.4	378		
22 + 52.0 - 46 + 22.0	SURF REM	2370	VAR	16653		9.5	50.0	6.7	933		83
OGLE COUNTY MAINLINE SUBTOTAL					0.0	13.4	70.2	13.1	1311	0	83
GUARDRAIL SHOULDERS						2 APPS					
475 + 23.0 - 478 + 54.0	RT	331		218	2.2	0.1					
476 + 09.0 - 479 + 04.0	LT	295		181	1.8	0.1					
619 + 90.0 - 622 + 36.0	RT	246		82							
620 + 42.0 - 622 + 36.0	LT	194		65							
623 + 39.0 - 625 + 93.0	RT	254		85							
623 + 39.0 - 625 + 44.0	LT	205		68							
683 20.0 - 685 87.5	LT	267.5		245	2.4	0.1					
683 27.0 - 686 03.0	RT	276		304	3.0	0.2					
734 40.0 - 736 60.0	RT	220		149	1.5	0.1					
734 77.0 - 736 60.0	LT	183		237	2.4	0.1					
789 83.0 - 790 10.0	RT	27		20	0.2	0.0					
789 86.0 - 790 10.0	LT	24		19	0.2	0.0					
790 35.0 - 792 97.0	LT	262		193	1.9	0.1					
790 35.0 - 792 42.0	RT	207		201	2.0	0.1					
996 05.0 - 998 50.0	RT	245		82							
997 16.0 - 998 50.0	LT	134		45							
999 + 40.0 - 1000 + 74.0	RT	134	27	45							
999 + 40.0 - 1000 + 79.0	LT	139	27	46							
LEE COUNTY GUARDRAIL SUBTOTAL					17.7	1.0	0.0	0.0	0	0	0

HOT-MIX ASPHALT SCHEDULE

LOCATION	REMARKS	BITUMINOUS			20200600	40600200	40600300	40600525	40600627	40600982	40600990
		PAVEMENT			EXC & GRADING	BIT MATL'S (PRIME COAT)	AGG (PRIME COAT)	LEVELING BINDER (HM) N50	LEVELING BINDER (MM) IL 9.5 N50	HMA SURF REM - BUTT JOINT	TEMP RAMP
		LENGTH	WIDTH	AREA	EX SHDR	TON	TON	TON	TON	SQ YD	SQ YD
STA TO STA		FT	FT	SQ YD	UNIT	TON	TON	TON	TON	SQ YD	SQ YD
SIDERoads						1 APP					
LEE COUNTY											
Beemerville Rd.	West	44	26	183.49		0.1	0.3			183	14
Beemerville Rd.	East	43	18	190.67		0.1	0.3			191	10
Butler Hill Rd.	West	75	22	346.22		0.1	0.5				18
Stainbrook Rd.	West	35	16	102.87		0.0	0.2			103	9
Stainbrook Rd.	East	25	16	81.03		0.0	0.1			81	9
Lee Rd.	West	42	22	298.80		0.1	0.4			299	12
Lee Rd.	East	47	26	353.40		0.1	0.5			353	14
Herman Rd.	West	45	20	238.20		0.1	0.4				11
Herman Rd.	East	36	22	238.40		0.1	0.4				12
McGirr Rd.	West	50	24	412.10		0.1	0.6				20
McGirr Rd.	East	43	22	496.85		0.1	0.7				18
Reynolds Rd.	West	27	24	157.92		0.0	0.2				20
Reynolds Rd.	East	42	27	189.08		0.1	0.3				23
Svela Rd.	West	76	20	233.04		0.1	0.3				17
Rochelle Rd.	East	61	20	256.34		0.1	0.4				17
Perry Rd.	West	48	25	258.48		0.1	0.4				21
Perry Rd.	East	43	26	291.62		0.1	0.4				22
Elva Rd.	West	29	25	126.66		0.0	0.2				21
Elva Rd.	East	32	22	135.42		0.0	0.2				18
Conrad Rd.	West	27	28	142.35		0.0	0.2				23
Gurler Rd.	West	46	25	103.67		0.0	0.1				21
Gurler Rd.	East	40	25	62.94		0.0	0.0				21
LEE COUNTY SIDEROAD SUBTOTAL					0.0	1.4	7.2	0.0	0	1210	371

HOT-MIX ASPHALT SCHEDULE

LOCATION	REMARKS	BITUMINOUS			20200600	40600200	40600300	40600525	40600627	40600982	40600990	
		PAVEMENT			EXC & GRADING	BIT MATL'S (PRIME COAT)	AGG (PRIME COAT)	LEVELING BINDER (HM) N50	LEVELING BINDER (MM) IL 9.5 N50	HMA SURF REM - BUTT JOINT	TEMP RAMP	
		LENGTH	WIDTH	AREA	EX SHDR	TON	TON	TON	TON	SQ YD	SQ YD	
STA TO STA		FT	FT	SQ YD	UNIT	TON	TON	TON	TON	SQ YD	SQ YD	
OGLE COUNTY												
Gurler Rd.	West	46	25	91.93		0.0	0.1				21	
Gurler Rd.	East	40	25	146.99		0.0	0.2				21	
Private Rd.	East	37	22	157.96		0.0	0.2				18	
Steward Rd.	East	181	26	962.52		0.3	1.4				22	
						2 APPS	2 APPS					
I-88 Ramp	Southwest	111	31	413.52		0.2	1.2	0.3	23		26	
I-88 Ramp	Northwest	100	30	360.38		0.2	1.1	0.3	20		25	
OGLE COUNTY SIDEROAD SUBTOTAL					0.0	0.8	4.4	0.6	43.3	0.0	133	
					TOTAL LEE CO	17.7	118.4	616	190.8	11358	2560	697
					TOTAL OGLE CO	0.0	14.2	75	13.7	1354	0	216
TOTALS					17.7	132.6	690	204.6	12712	2560	913	

HOT-MIX ASPHALT SCHEDULE

LOCATION	REMARKS	BITUMINOUS			HMA SURF	HMA SURF	INC	HMA	AREA CRACK	AGG	HMA	MAT'L
		PAVEMENT			CSE MIX	CSE MIX "D"	HMA	SURFACE	CONTROL	WEDGE	SHLDRS	TRANS
		LENGTH	WIDTH	AREA	"C" N50	N50	SURF	REMOVAL - 2	TREATMENT	SHLD TYPE	5 3/4"	DEVICE
STA TO STA		FT	FT	SQ YD	TON	TON	TON	SQ YD	SQ YD	TON	SQ YD	TON
MAINLINE												
LEE COUNTY												
388 + 10.0 - 389 + 00.0	BUTT JOINT	90	27	270		27				10		42
389 + 00.0 - 463 + 21.5		7421.5	27	22265		1908			22265	790		3154
463 + 21.5 - 463 + 89.0	TAPER	67.5	27	203		17		203		7		29
463 + 89.0 - 473 + 11.0	TYPE A GUTTER	922	31	3730		320		3730				529
473 + 11.0 - 473 + 78.5	TAPER	67.5	27	203		17		203		7		29
473 + 78.5 - 558 + 82.5		8504	27	25512		2186			25512	906		3615
558 + 82.5 - 559 + 50.0	TAPER	67.5	27	203		17		203		7		29
559 + 50.0 - 560 + 50.0	SURF REM	100	31	344		30		344		4		49
560 + 50.0 - 561 + 17.5	TAPER	67.5	27	203		17		203		7		29
561 + 17.5 - 575 + 06.0		1388.5	27	4166		357			4166	148		590
575 + 06.0 - 575 + 96.0	BUTT JOINT	90	27	270		27				10		42
575 + 96.0 - 578 + 77.0	US 30 OMISSION	281	27	843								
578 + 77.0 - 579 + 67.0	BUTT JOINT	90	27	270		27				10		42
579 + 67.0 - 621 + 46.0		4179	27	12537		1074			12537	445		1776
621 + 46.0 - 622 + 36.0	BUTT JOINT	90	27	270		27				10		42
622 + 36.0 - 623 + 39.0	BR OMISSION	103	27	309								
623 + 39.0 - 624 + 29.0	BUTT JOINT	90	27	270		27				10		42
624 + 29.0 - 734 + 32.5		11003.5	27	33011		2828			33011	1172		4677
734 + 32.5 - 735 + 00.0	TAPER	67.5	27	203		17		203		7		29
735 + 00.0 - 738 + 00.0	SURF REM	300	27	900		77		900		13		128
738 + 00.0 - 738 + 67.5	TAPER	67.5	27	203		17		203		7		29
738 + 67.5 - 786 + 76.5		4809	27	14427		1236			14427	512		2044
786 + 76.5 - 787 + 44.0	TAPER	67.5	27	203		17		203		7		29
787 + 44.0 - 789 + 79.0	SURF REM	235	27	705		60		705		10		100
789 + 79.0 - 790 + 69.0	BR OMISSION	90	27	270								
790 + 69.0 - 793 + 74.0	SURF REM	305	27	915		78		915		13		130
793 + 74.0 - 794 + 41.5	TAPER	67.5	27	203		17		203		7		29
794 + 41.5 - 841 + 52.5		4711	27	14133		1211			14133	502		2002
841 + 52.5 - 842 + 20.0	TAPER	67.5	27	203		17		203		7		29
842 + 20.0 - 998 + 50.0	SURF REM	15630	27	46890		4018		46890		672		6643
998 + 50.0 - 999 + 40.0	BR OMISSION	90	27	270								
999 + 40.0 - 1066 + 43.0	SURF REM	6703	27	20109		1723		20109		288		2849
LEE COUNTY MAINLINE SUBTOTAL					0	17397	0	75416	126049.5	5588	0	28754

HOT-MIX ASPHALT SCHEDULE

40603310 40603335 40800050 44000158 44300100 48102100 48203020 Z0034105

LOCATION	REMARKS	BITUMINOUS PAVEMENT			HMA SURF CSE MIX "C" N50	HMA SURF CSE MIX "D" N50	INC HMA SURF	HMA SURFACE REMOVAL - 2 1/4"	AREA CRACK CONTROL TREATMENT	AGG WEDGE SHLD TYPE B	HMA SHLDRS 5 3/4"	MAT'L TRANS DEVICE
		LENGTH	WIDTH	AREA	TON	TON	TON	SQ YD	SQ YD	TON	SQ YD	TON
		FT	FT	SQ YD								
OGLE COUNTY												
0 + 00.0 - 22 + 52.0	SURF REM	2252	27	6756		579		6756		97		957
22 + 52.0 - 46 + 22.0	SURF REM	2370	VAR	16653		1427		16653		102		2359
OGLE COUNTY MAINLINE SUBTOTAL					0	2006	0	23409	0	199	0	3317
GUARDRAIL SHOULDERS												
475 + 23.0 - 478 + 54.0	RT	331		218	31						218	
476 + 09.0 - 479 + 04.0	LT	295		181	25						181	
619 + 90.0 - 622 + 36.0	RT	246		82	11							
620 + 42.0 - 622 + 36.0	LT	194		65	9							
623 + 39.0 - 625 + 93.0	RT	254		85	12							
623 + 39.0 - 625 + 44.0	LT	205		68	10							
683 20.0 - 685 87.5	LT	267.5		245	18						245	
683 27.0 - 686 03.0	RT	276		304	24						304	
734 40.0 - 736 60.0	RT	220		149	11						149	
734 77.0 - 736 60.0	LT	183		237	26						237	
789 83.0 - 790 10.0	RT	27		20	3						20	
789 86.0 - 790 10.0	LT	24		19	3						19	
790 35.0 - 792 97.0	LT	262		193	17						97	
790 35.0 - 792 42.0	RT	207		201	18						113	
996 05.0 - 998 50.0	RT	245		82	11							
997 16.0 - 998 50.0	LT	134		45	6							
999 + 40.0 - 1000 + 74.0	RT	134	27	45	6							
999 + 40.0 - 1000 + 79.0	LT	139	27	46	6							
LEE COUNTY GUARDRAIL SUBTOTAL					247	0	0	0	0	0	1582	0

HOT-MIX ASPHALT SCHEDULE

LOCATION	REMARKS	BITUMINOUS			40603310	40603335	40800050	44000158	44300100	48102100	48203020	Z0034105	
		PAVEMENT			HMA SURF	HMA SURF	INC	HMA	HMA	AREA CRACK	AGG	HMA	MAT'L
		STA TO STA	LENGTH	WIDTH	AREA	CSE MIX	CSE MIX "D"	HMA	SURFACE	CONTROL	WEDGE	SHLDRS	TRANS
			FT	FT	SQ YD	"C" N50	N50	SURF	REMOVAL - 2	TREATMENT	SHLD TYPE	5 3/4"	DEVICE
				TON	TON	TON	SQ YD	SQ YD	TON	SQ YD	TON		
SIDEROADS													
LEE COUNTY													
Beemerville Rd.	West	44	26	183.49			23			5			
Beemerville Rd.	East	43	18	190.67			24			5			
Butler Hill Rd.	West	75	22	346.22			53	346		3			
Stainbrook Rd.	West	35	16	102.87			13			4			
Stainbrook Rd.	East	25	16	81.03			10			3			
Lee Rd.	West	42	22	298.80	20		38			4			
Lee Rd.	East	47	26	353.40	23		45			5			
Herman Rd.	West	45	20	238.20	7		37	238		2			
Herman Rd.	East	36	22	238.40	10		37	238		2			
McGirr Rd.	West	50	24	412.10			63	412					
McGirr Rd.	East	43	22	496.85			77	497					
Reynolds Rd.	West	27	24	157.92			24	158		1			
Reynolds Rd.	East	42	27	189.08			29	189		2			
Sveia Rd.	West	76	20	233.04			36	233		3			
Rochelle Rd.	East	61	20	256.34			39	256		3			
Perry Rd.	West	48	25	258.48			40	258		2			
Perry Rd.	East	43	26	291.62			45	292		2			
Elva Rd.	West	29	25	126.66			20	127		1			
Elva Rd.	East	32	22	135.42			21	135		1			
Conrad Rd.	West	27	28	142.35			22	142		1			
Gurler Rd.	West	46	25	103.67			16	104		1			
Gurler Rd.	East	40	25	62.94			10	63		1			
LEE COUNTY SIDEROAD SUBTOTAL					60	0	721	3689	0	50	0	0	

HOT-MIX ASPHALT SCHEDULE

LOCATION	REMARKS	BITUMINOUS			40603310	40603335	40800050	44000158	44300100	48102100	48203020	20034105	
		PAVEMENT			HMA SURF	HMA SURF	INC	HMA	HMA SURFACE	AREA CRACK	AGG WEDGE	HMA	MAT'L
		LENGTH	WIDTH	AREA	CSE MIX	CSE MIX "D"	HMA	SURFACE	CONTROL	SHLD TYPE	SHLDRS	TRANS	
STA TO STA		FT	FT	SQ YD	"C" N50	N50	SURF	REMOVAL - 2 1/4"	TREATMENT	B	5 3/4"	DEVICE	
					TON	TON	TON	SQ YD	SQ YD	TON	SQ YD	TON	
OGLE COUNTY													
Gurler Rd.	West	46	25	91.93			14	92		1.0			
Gurler Rd.	East	40	25	146.99			23	147		0.9			
Private Rd.	East	37	22	157.96			24	158		1.6			
Steward Rd.	East	181	26	962.52			148	963		7.8			
I-88 Ramp	Southwest	111	31	413.52	24	35		414		9.5			
I-88 Ramp	Northwest	100	30	360.38	24	31		360		8.6			
OGLE COUNTY SIDEROAD SUBTOTAL					48.9	66.3	209.3	2133.3	0.0	29.4	0.0	0.0	
TOTAL LEE CO					307	17397	721	79106	126049.5	5638	1582	28754	
TOTAL OGLE CO					49	2072	209	25542	0	228	0	3317	
TOTALS					356	19468	930	104648	126049.5	5866	1582	32071	

ENTRANCE SCHEDULE

35101400 40600200 40800050

LOCATION	OFFSET	TYPE	REMARKS				AGG BASE COURSE TYPE B	BIT MATL'S (PRIME COAT)	INC HOT MIX SURF
				LENGTH	WIDTH	AREA			
				FT	FT	SQ YD	TON	TON	TON
LEE COUNTY									
388+53	RT	FE	AGG	26.5	24	115.11			
388+53	LT	FE	AGG	26.5	24	115.11			
406+79	RT	FE	AGG	26.5	24	115.11			
406+79	LT	FE	AGG	26.5	24	115.11			
422+55	LT	CE	HMA	26.5	25.5	119.53		0.03	18
427+04	RT	MBTO	AGG	8	20	57.78	31	0.08	10
427+22	LT	CE	HMA	26.5	25.2	118.64		0.03	18
429+65	LT	FE	AGG	26.5	24	115.11			
430+79	RT	FE W/ MBTO	AGG	26.5	24	127.06	31	0.08	10
430+94	LT	PE W/ MBTO	HMA	26.5	12	91.72		0.03	14
448+68	RT	PE W/ MBTO	HMA	26.5	23	124.11		0.04	19
450+64	RT	PE W/ MBTO	HMA	26.5	17	106.44		0.03	16
452+02	RT	PE W/ MBTO	HMA	26.5	14.6	99.38		0.03	15
457+11	RT	PE W/ MBTO	HMA	26.5	15.4	101.73		0.03	16
459+23	LT	FE	AGG	26.5	24	115.11			
471+12	RT	PE W/ MBTO	HMA	26.5	13.1	94.96		0.03	15
478+87	LT	FE	AGG	26.5	24	115.11			
478+73	RT	PE W/ MBTO	HMA	26.5	15.5	102.03		0.03	16
489+91	LT	FE	AGG	26.5	24	115.11			
489+91	RT	FE	AGG	26.5	24	115.11			
511+05	RT	MBTO	HMA	8	20	57.78		0.02	9
511+00	LT	PE	HMA	26.5	12.1	80.07		0.02	12
514+37	RT	FE	AGG	26.5	24	115.11			
529+89	RT	FE	AGG	26.5	24	115.11			
542+05	LT	FE	AGG	26.5	24	115.11			
550+70	RT	FE	AGG	26.5	24	115.11			
557+18	LT	FE	HMA	26.5	24	115.11		0.03	18
557+18	RT	FE	AGG	26.5	24	115.11			
572+16	RT	FE	AGG	26.5	24	115.11			
575+04	RT	MBTO	AGG	8	20	57.78	31	0.08	10
578+71	RT	CE	HMA	26.5	34.8	146.91		0.04	23
578+71	LT	CE	HMA	26.5	35	147.50		0.04	23
579+61	LT	CE	HMA	26.5	34.8	146.91		0.04	23
579+99	RT	CE W/ MBTO	HMA	26.5	35	159.44		0.05	25
580+25	LT	PE	HMA	26.5	19	100.39		0.03	15

ENTRANCE SCHEDULE

35101400 40600200 40800050

LOCATION	OFFSET	TYPE	REMARKS				AGG BASE COURSE TYPE B	BIT MATL'S (PRIME COAT)	INC HOT MIX SURF
				LENGTH	WIDTH	AREA			
				FT	FT	SQ YD	TON	TON	TON
588+16	RT	FE	AGG	26.5	24	115.11			
590+72	LT	FE	AGG	26.5	24	115.11			
590+82	RT	PE W/ MBTO	HMA	26.5	12	91.72		0.03	14
598+95	LT	FE	AGG	26.5	24	115.11			
598+95	RT	FE	AGG	26.5	24	115.11			
606+33	RT	PE W/ MBTO	AGG	26.5	24	127.06	58	0.18	20
608+59	LT	FE	AGG	26.5	24	115.11			
620+10	RT	FE	AGG	26.5	24	115.11			
627+02	RT	MBTO	HMA	8	20	57.78		0.02	9
627+02	LT	PE	HMA	26.5	24	115.11		0.03	18
630+17	RT	FE	AGG	26.5	24	115.11			
634+82	LT	FE	AGG	26.5	24	115.11			
638+81	RT	PE W/ MBTO	AGG	26.5	24	127.06	58	0.18	20
646+34	RT	FE	AGG	26.5	24	115.11			
650+26	LT	FE	AGG	26.5	24	115.11			
656+57	LT	FE	AGG	26.5	24	115.11			
659+63	RT	FE	HMA	26.5	24	115.11		0.03	18
665+65	LT	FE	AGG	26.5	24	115.11			
672+68	RT	FE	AGG	26.5	24	115.11			
676+70	LT	FE	AGG	26.5	24	115.11			
695+52	LT	FE	AGG	26.5	24	115.11			
700+69	LT	MBTO	HMA	8	20	57.78		0.02	9
700+69	RT	PE	HMA	26.5	17	94.50		0.03	15
709+65	LT	FE	AGG	26.5	24	115.11			
709+65	RT	FE	AGG	26.5	24	115.11			
714+86	LT	FE	HMA	26.5	24	115.11		0.03	18
722+86	LT	FE	AGG	26.5	24	115.11			
732+32	RT	FE	AGG	26.5	24	115.11			
735+09	LT	FE	AGG	26.5	24	115.11			
735+09	RT	FE	AGG	26.5	24	115.11			
743+54	LT	FE	AGG	26.5	24	115.11			
745+95	LT	PE W/ MBTO	HMA	26.5	13.5	96.14		0.03	15
750+21	LT	PE	HMA	26.5	12	79.78		0.02	12
751+01	LT	PE W/ MBTO	HMA	26.5	18	109.39		0.03	17
755+39	RT	FE	HMA	26.5	24	115.11		0.03	18

ENTRANCE SCHEDULE

35101400 40600200 40800050

LOCATION	OFFSET	TYPE	REMARKS				AGG BASE COURSE TYPE B	BIT MATL'S (PRIME COAT)	INC HOT MIX SURF
				LENGTH	WIDTH	AREA			
				FT	FT	SQ YD	TON	TON	TON
770+32	RT	FE	AGG	26.5	24	115.11			
770+32	LT	FE	AGG	26.5	24	115.11			
781+42	LT	FE	AGG	26.5	24	115.11			
784+60	LT	PE W/ MBTO	HMA	26.5	24.3	127.94		0.04	20
784+60	RT	FE	AGG	26.5	24	115.11			
787+10	LT	PE W/ MBTO	HMA	26.5	18.6	111.16		0.03	17
791+70	RT	FE	AGG	26.5	24	115.11			
800+70	RT	FE	AGG	26.5	24	115.11			
809+01	LT	PE	HMA	26.5	21	106.28		0.03	16
809+01	RT	MBTO	AGG	8	20	57.78	31	0.08	10
815+78	RT	FE	HMA	26.5	24	115.11		0.03	18
815+94	LT	FE	AGG	26.5	24	115.11			
822+62	LT	FE	AGG	26.5	24	115.11			
829+44	RT	FE	AGG	26.5	24	115.11			
830+28	RT	MBTO	HMA	8	20	57.78		0.02	9
830+28	LT	PE	HMA	26.5	19	100.39		0.03	15
833+35	LT	FE	AGG	26.5	24	115.11			
836+71	LT	PE	HMA	26.5	12	79.78		0.02	12
836+71	RT	MBTO	HMA	8	20	57.78		0.02	9
839+36	RT	PE W/ MBTO	HMA	26.5	22.1	121.46		0.03	19
860+62	RT	FE	AGG	26.5	24	115.11			
883+83	LT	FE	AGG	26.5	24	115.11			
883+70	RT	FE	AGG	26.5	24	115.11			
927+52	RT	FE	AGG	26.5	24	115.11			
971+85	LT	CE	HMA	26.5	35	147.50		0.04	23
973+87	LT	PE W/ MBTO	AGG	26.5	16	103.50	47	0.15	16
992+12	LT	FE	AGG	26.5	24	115.11			
995+38	RT	FE	AGG	26.5	24	115.11			
1002+42	RT	FE	AGG	26.5	24	115.11			
1004+80	LT	FE	AGG	26.5	24	115.11			
1013+27	LT	FE	AGG	26.5	24	115.11			
1013+27	RT	FE	AGG	26.5	24	115.11			
1026+40	RT	FE	AGG	26.5	24	115.11			
1026+29	LT	FE	AGG	26.5	24	115.11			
1032+79	RT	FE	AGG	26.5	24	115.11			

FAS 1177 & FAU 5452 (IL 251)
 SEC (109, 110)RS-5
 LEE/OGLE CO
 CONTRACT NO 64J29
 SHEET 36 OF 109

ENTRANCE SCHEDULE

35101400 40600200 40800050

LOCATION	OFFSET	TYPE	REMARKS				AGG BASE COURSE TYPE B	BIT MATL'S (PRIME COAT)	INC HOT MIX SURF
				LENGTH	WIDTH	AREA			
				FT	FT	SQ YD	TON	TON	TON
1037+94	LT	PE	HMA	26.5	12	79.78		0.02	12
1037+84	RT	FE	AGG	26.5	24	115.11			
1038+77	RT	PE	HMA	26.5	14.5	87.14		0.02	13
1038+77	LT	MBTO	HMA	8	20	57.78		0.02	9
1039+92	RT	FE	AGG	26.5	24	115.11			
1049+72	LT	FE	AGG	26.5	24	115.11			
1052+04	LT	PE W/ MBTO	HMA	26.5	14.7	99.67		0.03	15
1052+30	RT	FE	AGG	26.5	24	115.11			
1053+90	RT	PE	HMA	26.5	12	79.78		0.02	12
1053+90	LT	MBTO	HMA	8	20	57.78		0.02	9
1055+45	RT	CE	HMA	26.5	25.5	119.53		0.03	18
SUBTOTAL LEE CO							287	2.14	798
OGLE COUNTY									
6+61	LT	PE W/ MBTO	HMA	26.5	12	91.72		0.03	14
9+37	RT	FE	AGG	26.5	24	115.11			
9+37	LT	PE W/ MBTO	HMA	26.5	12	91.72		0.03	14
11+09	LT	PE	HMA	26.5	12	79.78		0.02	12
13+87	LT	CE	HMA	26.5	35	147.50		0.04	23
17+17	LT	PE W/ MBTO	HMA	26.5	12	91.72		0.03	14
17+90	RT	PE	HMA	26.5	12	79.78		0.02	12
20+12	LT	FE	HMA	26.5	24	115.11		0.03	18
29+64	LT	FE	AGG	26.5	24	115.11			
SUBTOTAL OGLE CO							0	0.20	107
TOTAL							287	2.3	905

PATCHING SCHEDULE						
	LENGTH FOOT	WIDTH FOOT	AREA SQ YD	40601005 HMA REPL OVER PATCHES	44002232 HMA REM OVER PATCHES, 8"	
LEE COUNTY				TON	SQ YD	
395+50 TO 395+54	4	27	12	5	12	
396+42 TO 396+46	4	27	12	5	12	
400+07 TO 400+11	4	27	12	5	12	
401+46 TO 401+50	4	27	12	5	12	
408+60 TO 408+64	4	27	12	5	12	
414+80 TO 414+84	4	27	12	5	12	
420+77 TO 420+81	4	27	12	5	12	
428+17 TO 428+21	4	27	12	5	12	
438+08 TO 438+18	10	27	30	13	30	
453+18 TO 453+33	15	27	45	20	45	
458+83 TO 458+95	12	27	36	16	36	
459+84 TO 459+88	4	27	12	5	12	
461+08 TO 461+12	4	27	12	5	12	
474+83 TO 474+87	4	27	12	5	12	
482+62 TO 482+82	20	27	60	27	60	
490+74 TO 490+78	4	27	12	5	12	
491+44 TO 491+59	15	27	45	20	45	
493+94 TO 494+03	9	27	27	12	27	
495+98 TO 496+16	18	27	54	24	54	
500+51 TO 500+55	4	27	12	5	12	
504+82 TO 504+86	4	27	12	5	12	
512+65 TO 512+69	4	27	12	5	12	
514+40 TO 514+44	4	27	12	5	12	
516+27 TO 516+31	4	27	12	5	12	
523+21 TO 523+25	4	27	12	5	12	
523+93 TO 523+97	4	27	12	5	12	
530+56 TO 530+60	4	27	12	5	12	
532+70 TO 532+74	4	27	12	5	12	
543+89 TO 543+93	4	27	12	5	12	
544+83 TO 545+01	18	27	54	24	54	
550+72 TO 550+76	4	27	12	5	12	
554+39 TO 554+43	4	27	12	5	12	
586+47 TO 586+51	4	27	12	5	12	
596+39 TO 596+43	4	27	12	5	12	
601+08 TO 601+12	4	27	12	5	12	
603+02 TO 603+06	4	27	12	5	12	
604+50 TO 604+54	4	27	12	5	12	
616+04 TO 616+08	4	27	12	5	12	
617+03 TO 617+07	4	27	12	5	12	
626+39 TO 626+53	14	27	42	19	42	
628+31 TO 628+35	4	27	12	5	12	
632+35 TO 632+39	4	27	12	5	12	
636+17 TO 636+21	4	27	12	5	12	
637+12 TO 637+16	4	27	12	5	12	

PATCHING SCHEDULE						
	LENGTH FOOT	WIDTH FOOT	AREA SQ YD	40601005 HMA REPL OVER PATCHES	44002232 HMA REM OVER PATCHES, 8"	
LEE COUNTY				TON		SQ YD
641+81 TO 641+85	4	27	12	5		12
643+49 TO 643+53	4	27	12	5		12
648+37 TO 648+57	20	27	60	27		60
655+76 TO 655+80	4	27	12	5		12
658+14 TO 658+18	4	27	12	5		12
661+70 TO 661+74	4	27	12	5		12
680+32 TO 680+36	4	27	12	5		12
681+00 TO 681+23	23	27	69	31		69
686+36 TO 686+40	4	27	12	5		12
689+87 TO 689+91	4	27	12	5		12
693+77 TO 693+81	4	27	12	5		12
695+82 TO 695+86	4	27	12	5		12
706+80 TO 706+84	4	27	12	5		12
711+69 TO 711+73	4	27	12	5		12
726+71 TO 726+75	4	27	12	5		12
732+34 TO 732+38	4	27	12	5		12
741+59 TO 741+63	4	27	12	5		12
743+01 TO 743+05	4	27	12	5		12
758+15 TO 758+19	4	27	12	5		12
760+61 TO 760+65	4	27	12	5		12
767+21 TO 767+25	4	27	12	5		12
796+78 TO 797+00	22	27	66	30		66
811+07 TO 811+11	4	27	12	5		12
817+45 TO 817+49	4	27	12	5		12
825+87 TO 825+91	4	27	12	5		12
827+06 TO 827+10	4	27	12	5		12
829+67 TO 829+71	4	27	12	5		12
831+33 TO 831+37	4	27	12	5		12
TO BE USED AS DIRECTED BY RE			834	374		834
			TOTAL	2142	960	2142

SEE DISTRICT STANDARD 33.4 FOR PATCHING DETAILS

SCHEDULE OF QUANTITIES

63000003 STEEL PLATE BEAM GUARDRAIL, TYPE A, 9 FOOT POSTS

<u>FOOT</u>	<u>LOCATION</u>	<u>OFFSET</u>	<u>REMARKS</u>
	<u>LEE CO</u>		
87.5	477+09.0 TO 477+96.5	LT	
137.5	683+42.5 TO 684+80.0	LT	
125	683+57.0 TO 684+82.0	RT	
75	735+84.0 TO 736+60.0	RT	
75	735+84.0 TO 736+60.0	LT	
12.5	790+80.0 TO 790+92.5	RT	
100	790+80.0 TO 791+80.0	LT	
612.5	TOTAL		

63100087 TRAFFIC BARRIER TERMINAL, TYPE 6A

<u>EACH</u>	<u>LOCATION</u>	<u>OFFSET</u>	<u>REMARKS</u>
	<u>LEE CO</u>		
1	789+88.0 TO 790+10.0	RT	McGirr Rd
1	789+88.0 TO 790+10.0	LT	McGirr Rd
1	790+35.0 TO 790+80.0	RT	McGirr Rd
1	790+35.0 TO 790+80.0	LT	McGirr Rd
4	TOTAL		

SCHEDULE OF QUANTITIES

63100167 TRAFFIC BARRIER TERMINAL, TYPE 1 (SPECIAL) TANGENT

<u>EACH</u>	<u>LOCATION</u>		<u>OFFSET</u>	<u>REMARKS</u>
	<u>LEE CO</u>			
1	475+74.0	TO 476+24.0	RT	
1	476+59.0	TO 477+09.0	LT	
1	477+96.5	TO 478+46.5	RT	
1	477+96.5	TO 478+46.5	LT	
1	683+20.0	TO 683+42.5	LT	Lee Rd
1	683+27.0	TO 683+57.0	RT	Lee Rd
1	684+80.0	TO 685+30.0	LT	
1	684+82.0	TO 685+32.0	RT	
1	735+34.5	TO 735+84.5	RT	
1	735+37.5	TO 735+87.5	LT	
1	736+22.0	TO 736+60.0	RT	Herman Rd
1	736+37.5	TO 736+60.0	LT	Herman Rd
1	789+88.0	TO	RT	McGirr Rd
1	789+88.0	TO	LT	McGirr Rd
1	790+92.5	TO 791+42.5	RT	
1	791+80.0	TO 792+30.0	LT	

16	TOTAL
-----------	--------------

SCHEDULE OF QUANTITIES

63200310 GUARDRAIL REMOVAL

<u>FOOT</u>	<u>LOCATION</u>	<u>OFFSET</u>	<u>REMARKS</u>
	<u>LEE CO</u>		
50	475+74.0 TO 476+24.0	RT	
50	477+96.0 TO 478+46.5	RT	
187.5	476+59.0 TO 478+46.5	LT	
212.5	683+27.0 TO 685+27.0	RT	
237.5	683+20.0 TO 685+30.0	LT	
150.0	735+34.0 TO 736+60.0	RT	
137.5	735+34.0 TO 736+60.0	LT	
75	789+88.0 TO 790+10.0	RT	
75	789+88.0 TO 790+10.0	LT	
102.5	790+35.0 TO 791+37.5	RT	
187.5	790+35.0 TO 792+25.0	LT	
1465.0	TOTAL		

63301210 REMOVE AND REERECT STEEL PLATE BEAM GUARDRAIL, TYPE A

<u>FOOT</u>	<u>LOCATION</u>	<u>OFFSET</u>	<u>REMARKS</u>
	<u>LEE CO</u>		
175	476+24.0 TO 477+96.5	RT	
175	TOTAL		

SCHEDULE OF QUANTITIES

63500105 DELINEATORS

<u>EACH</u>	<u>LOCATION</u> <u>LEE CO</u>	<u>OFFSET</u>	<u>REMARKS</u>
1	475+74.0	RT	
1	476+59.0	LT	
1	478+46.5	RT	
1	478+46.5	LT	
1	683+20.0	RT	LEE RD
1	683+30.0	LT	LEE RD
1	685+30.0	LT	
1	685+32.0	RT	
1	735+34.5	RT	
1	735+37.5	LT	
1	736+60.0	RT	HERMAN RD
1	736+60.0	LT	HERMAN RD
1	789+88.0	RT	MCGIRR RD
1	789+88.0	LT	MCGIRR RD
1	791+42.5	RT	
1	792+30.0	LT	
16	TOTAL		

66700305 PERMANENT SURVEY MARKERS, TYPE II

<u>EACH</u>	<u>LOCATION</u> <u>LEE CO</u>	<u>OFFSET</u>	<u>REMARKS</u>
2	CONTACT IDOT SURVEY DEPARTMENT FOR LOCATIONS <u>OGLE CO</u>		
1	CONTACT IDOT SURVEY DEPARTMENT FOR LOCATIONS		
3	TOTAL		

SCHEDULE OF QUANTITIES

782004100 GUARDRAIL MARKERS, TYPE A

<u>EACH</u>	<u>LOCATION</u>	<u>OFFSET</u>	<u>REMARKS</u>
	<u>LEE CO</u>		
5	475+74.0 TO 478+46.5	RT	
4	476+59.0 TO 478+46.5	LT	
5	683+27.0 TO 685+32.0	RT	
5	683+30.0 TO 685+30.0	LT	
3	735+34.5 TO 736+60.0	RT	
3	735+37.5 TO 736+60.0	LT	
1	789+88.0 TO 790+10.0	RT	
1	789+88.0 TO 790+10.0	LT	
3	790+35.0 TO 791+42.5	RT	
4	790+35.0 TO 792+30.0	LT	
34	TOTAL		

78201000 TERMINAL MARKER DIRECT APPLIED

<u>EACH</u>	<u>LOCATION</u>	<u>OFFSET</u>	<u>REMARKS</u>
	<u>LEE CO</u>		
1	475+74.0	RT	
1	476+59.0	LT	
1	478+46.5	RT	
1	478+46.5	LT	
1	683+20.0	RT	LEE RD
1	683+30.0	LT	LEE RD
1	685+30.0	LT	
1	685+32.0	RT	
1	735+34.5	RT	
1	735+37.5	LT	
1	736+60.0	RT	HERMAN RD
1	736+60.0	LT	HERMAN RD
1	789+88.0	RT	MCGIRR RD
1	789+88.0	LT	MCGIRR RD
1	791+42.5	RT	
1	792+30.0	LT	
16	TOTAL		

SCHEDULE OF QUANTITIES

Z0012500 CONCRETE CURB REPAIR

<u>FOOT</u>	<u>LOCATION</u>		<u>OFFSET</u>	<u>REMARKS</u>
	<u>OGLE CO</u>			
32	28+20.0	TO 28+52.0	LT	
29	30+35.0	TO 30+64.0	LT	
66	31+20.0	TO 31+86.0	LT	
25	35+23.0	TO 35+48.0	RT	
10	46+17.0	TO 46+27.0	LT	
162	TOTAL			

Z0051500 REMOVING AND RESETTING STREET SIGNS

<u>EACH</u>	<u>LOCATION</u>		<u>OFFSET</u>	<u>REMARKS</u>
	<u>LEE CO</u>			
1	471+30.0		LT	<u>BUTLER HILLS ROAD</u> STOP SIGN
1	TOTAL			

Z0055100 RUMBLE RESURFACING

<u>SQ YD</u>	<u>LOCATION</u>		<u>REMARKS</u>
	<u>LEE CO</u>		
91.7	S LEG IL 251 @ US 30		
91.7	N LEG IL 251 @ US 30		
183.4	TOTAL		

PAVEMENT MARKING SCHEDULE

70300100 SHORT-TERM PAVEMENT MARKING

<u>FOOT</u>	<u>LOCATION</u>	<u>OFFSET</u>	<u>REMARKS</u>
	<u>LEE CO</u>		
20350	388+10.0 TO 1066+43.0		3 Applications
	<u>OGLE CO</u>		
1832	0+00 TO 46+22.0		3 Applications
22182	TOTAL		

70301000 WORK ZONE PAVEMENT MARKING REMOVAL

<u>SQ FT</u>	<u>LOCATION</u>	<u>OFFSET</u>	<u>REMARKS</u>
	<u>LEE CO</u>		
2261	388+10.0 TO 1066+43.0		SHORT TERM
	<u>OGLE CO</u>		
204	0+00 TO 46+22.0		SHORT TERM
2465	TOTAL		

78000200 THERMOPLASTIC PAVEMENT MARKING - LINE 4"

<u>FOOT</u>	<u>LOCATION</u>	<u>OFFSET</u>	<u>REMARKS</u>
	<u>OGLE CO</u>		
2826	22+18.0 TO 36+31.0		Edge White
9394	22+18.0 TO 26+45.0		2- Double Yellow
353	22+18.0 TO 36+31.0		Skip Dash
12573	TOTAL		

78000500 THERMOPLASTIC PAVEMENT MARKING - LINE 8"

<u>FOOT</u>	<u>LOCATION</u>	<u>OFFSET</u>	<u>REMARKS</u>
	<u>OGLE CO</u>		
220	30+00.0 TO 32+20.0		LT TURN LANE
220	36+30.0 TO 38+50.0		LT TURN LANE
220	44+00.0 TO 46+20.0		LT TURN LANE
180	STEWARD ROAD		PAINTED ISLAND
180	I-88 RAMP		PAINTED ISLAND
1020	TOTAL		

PAVEMENT MARKING SCHEDULE

78000600 THERMOPLASTIC PAVEMENT MARKING - LINE 12"

<u>FOOT</u>	<u>LOCATION</u>	<u>OFFSET</u>	<u>REMARKS</u>
	<u>OGLE CO</u>		
150	22+18.0 TO 28+00.0		PAINTED ISLAND (MEDIAN)
120	STEWARD ROAD		PAINTED ISLAND
120	I-88 RAMP		PAINTED ISLAND
390	TOTAL		

78000650 THERMOPLASTIC PAVEMENT MARKING - LINE 24"

<u>FOOT</u>	<u>LOCATION</u>	<u>OFFSET</u>	<u>REMARKS</u>
	<u>LEE CO</u>		<u>STOP BARS</u>
32	BEEMERVILLE RD		
16	BUTLER HILL RD		
24	STAINBROOK RD		
32	LEE RD		
24	HERMAN RD		
32	MC GIRR RD		
24	REYNOLDS RD		
12	SVELVA RD		
12	ROCHELLE RD		
32	PERRY RD		
32	ELVA RD		
12	CONRAD RD		
16	GURLER RD		
300	LEE CO SUBTOTAL		

	<u>OGLE CO</u>		<u>STOP BARS</u>
16	GURLER RD		
16	PRIVATE RD		
35	STEWARD ROAD		
42	I-88 RAMP		
109	OGLE CO SUBTOTAL		
409	TOTAL		

PAVEMENT MARKING SCHEDULE

78001110 PAINT PAVEMENT MARKING - LINE 4"

<u>FOOT</u>	<u>LOCATION</u>		<u>OFFSET</u>	<u>REMARKS</u>
	<u>LEE CO</u>			<u>2 APPLICATIONS</u>
271332	388+10.0	TO	1066+43.0	Edge White
17944	388+10.0	TO	432+96.0	Double Yellow
2245	432+96.0	TO	441+94.0	No Passing LT
581	441+94.0	TO	453+55.0	Skip Dash
2508	453+55.0	TO	463+58.0	No Passing RT
1056	463+58.0	TO	466+22.0	Double Yellow
2113	466+22.0	TO	474+67.0	no passing LT
291	474+67.0	TO	480+48.0	skip dash
2113	480+48.0	TO	488+93.0	no passing RT
3433	488+93.0	TO	502+66.0	no passing LT
2375	502+66.0	TO	512+16.0	no passing RT
3433	512+16.0	TO	525+89.0	no passing LT
1267	525+89.0	TO	551+23.0	skip dash
1453	551+23.0	TO	557+04.0	no passing RT
106	557+04.0	TO	559+15.0	skip dash
1585	559+15.0	TO	565+49.0	no passing LT
14335	565+49.0	TO	852+19.0	skip dash
2113	852+19.0	TO	860+64.0	no passing RT
4856	860+64.0	TO	872+78.0	Double Yellow
2245	872+78.0	TO	881+76.0	no passing LT
5544	881+76.0	TO	992+64.0	skip dash
2113	992+64.0	TO	1001+09.0	no passing RT
2113	1001+09.0	TO	1009+54.0	no passing LT
2270	1009+54.0	TO	1054+94.0	skip dash
2245	1054+94.0	TO	1063+92.0	no passing RT
1004	1063+92.0	TO	1066+43.0	Double Yellow
352667	LEE CO SUBTOTAL			
	<u>OGLE CO</u>			
8872	0+00	TO	22+18.0	Edge White
8872	0+00	TO	22+18.0	Double Yellow
17744	OGLE CO SUBTOTAL			
370411	TOTAL			

PAVEMENT MARKING SCHEDULE

78100100 RAISED REFLECTIVE PAVEMENT MAKER

<u>EACH</u>	<u>LOCATION</u>	<u>OFFSET</u>	<u>REMARKS</u>
	<u>LEE CO</u>		
849	388+10.0 TO 1066+43.0		TWO-WAY AMBER
	<u>OGLE CO</u>		
29	0+00 TO 22+52.0		TWO-WAY AMBER
61	22+52.0 TO 46+22.0		TWO-WAY AMBER
12	30+00.0 TO 32+20.0		ONE-WAY AMBER
12	36+30.0 TO 38+50.0		ONE-WAY AMBER
12	44+00.0 TO 46+20.0		ONE-WAY AMBER
126	OGLE CO SUBTOTAL		
975	TOTAL		

78300200 RAISED REFLECTIVE PAVEMENT MAKER REMOVAL

<u>EACH</u>	<u>LOCATION</u>	<u>OFFSET</u>	<u>REMARKS</u>
	<u>LEE CO</u>		
764	388+37.0 TO 1066+43.0		ASSUMING 10% MISSING
	<u>OGLE CO</u>		
26	0+00 TO 22+52.0		ASSUMING 10% MISSING
55	22+52.0 TO 46+22.0		
81	OGLE CO SUBTOTAL		
845	TOTAL		

Z0008758 AERIAL SPEED CHECK MARKING

<u>FOOT</u>	<u>LOCATION</u>	<u>OFFSET</u>	<u>REMARKS</u>
	<u>LEE CO</u>		
36	3 MILES N OF US 30		CONTACT ILLINOIS STATE POLICE FOR EXACT LOCATION

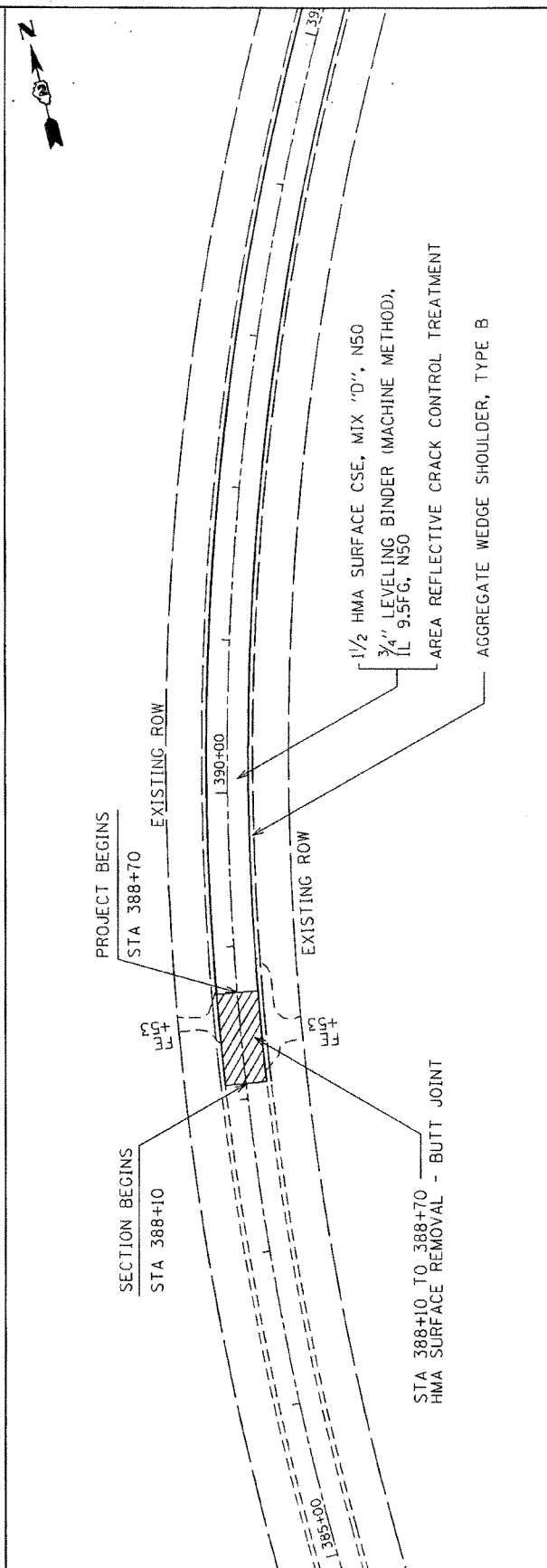
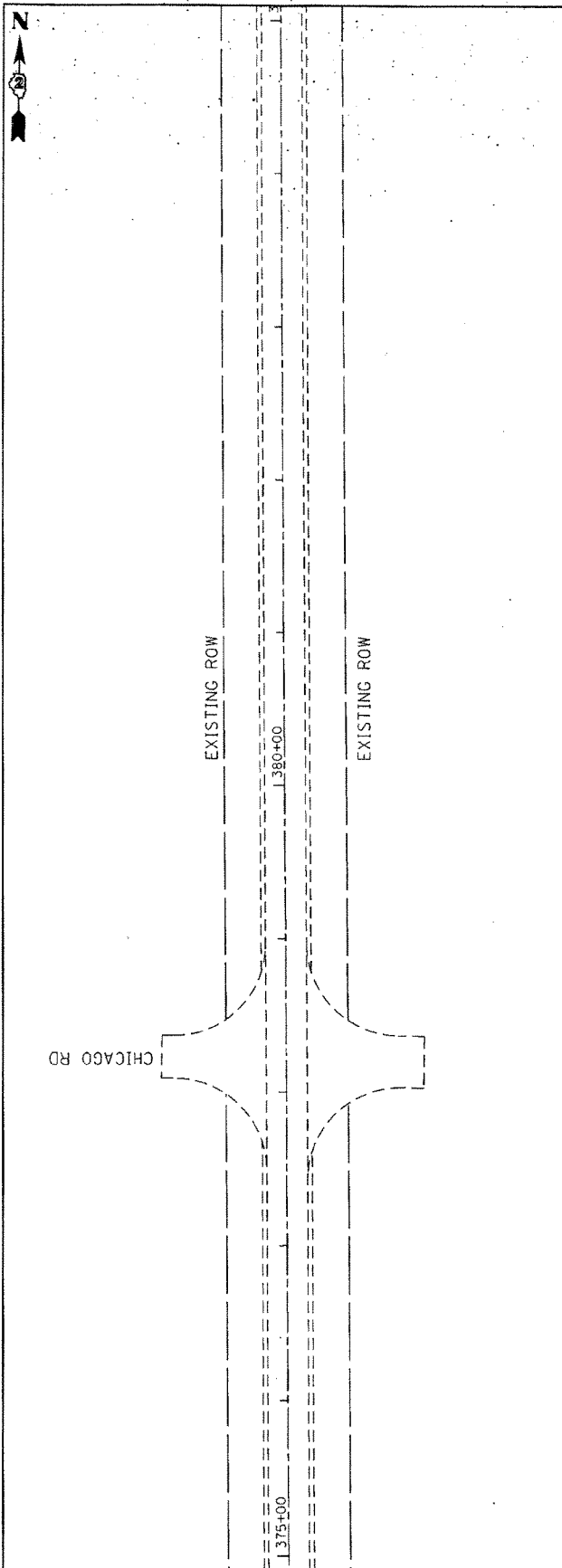

FILE NAME = c:\pr-work\pmdot\goff\j\48316607\0200513-shr-pln_ogle.dgn	STATE OF ILLINOIS		TOTAL SHEETS	
USER NAME = goff,ji	DEPARTMENT OF TRANSPORTATION		COUNTY	SHEETS
PLOT DATE = Thu Jan 24 13:24:17 2013	IL 251 PLAN SHEET		LEE/OGLE	109
	SECTION		CONTRACT NO. 64J29	
	F.A. RTE.		ILLINOIS FED. AID PROJECT	
	* (109, 110) RS-5			
	* FAS 1177 & FAU 5452			

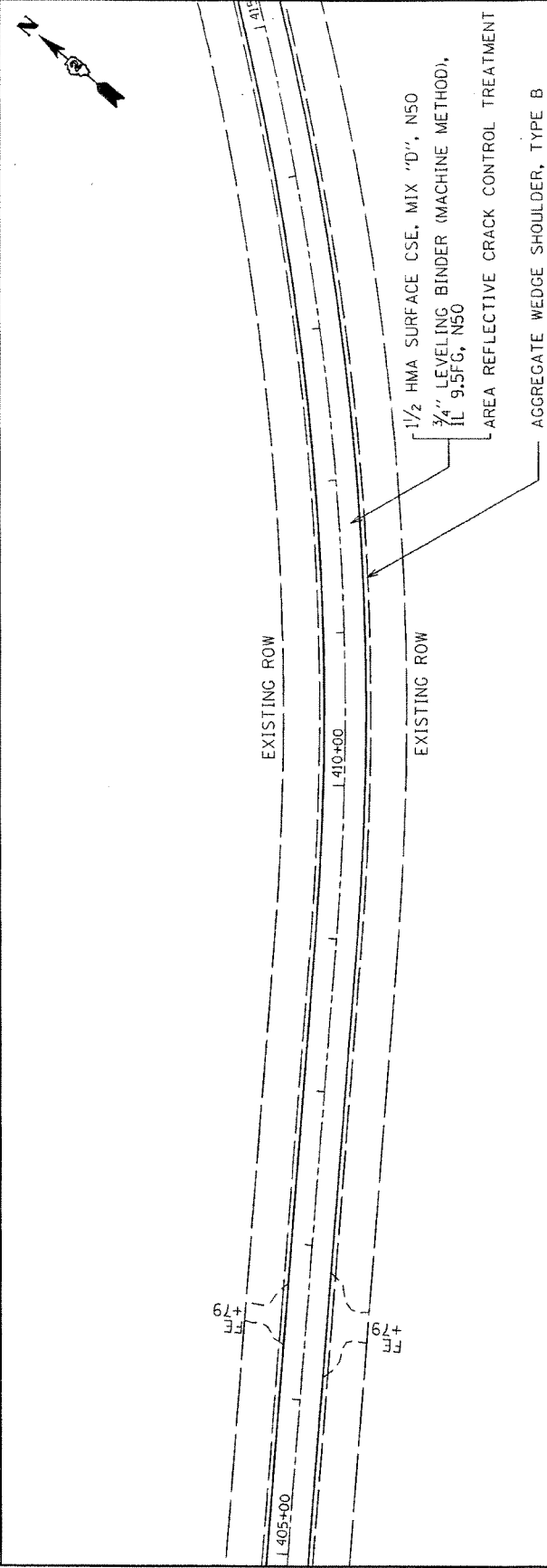
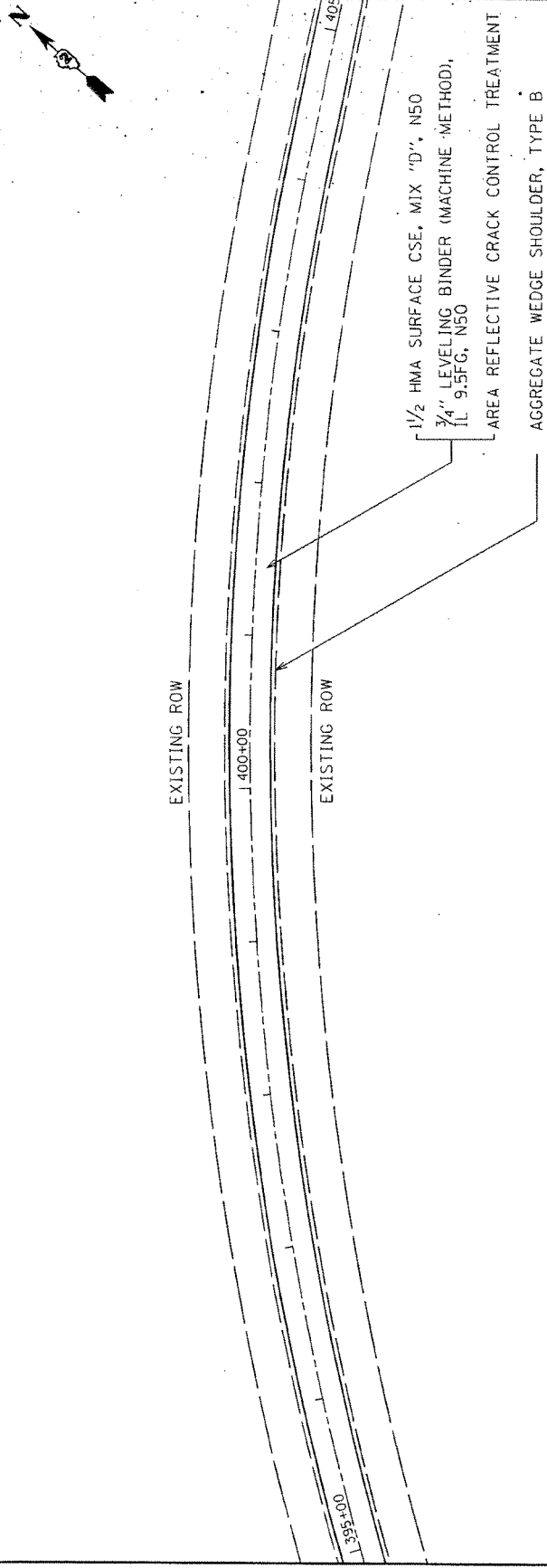

FILE NAME = c:\pwwork\pwwork\goffj\140316607\0200513-sht-pln.ogle.dgn		STATE OF ILLINOIS DEPARTMENT OF TRANSPORTATION		IL 251 PLAN SHEET		F.A. RTE.	SECTION	COUNTY	TOTAL SHEETS NO.	SHEET NO.
USER NAME = goffj		DEPARTMENT OF TRANSPORTATION		IL 251 PLAN SHEET		*	(109, 110) RS-5	LEE/ZOGLE	109	50
PLOT DATE = Thu Jan 24 13:24:18 2013		DEPARTMENT OF TRANSPORTATION		IL 251 PLAN SHEET		* FAS 1177 & FAU 5452		CONTRACT NO.		64J29
		DEPARTMENT OF TRANSPORTATION		IL 251 PLAN SHEET		ILLINOIS		FED. ROAD DIST. NO.		AID PROJECT

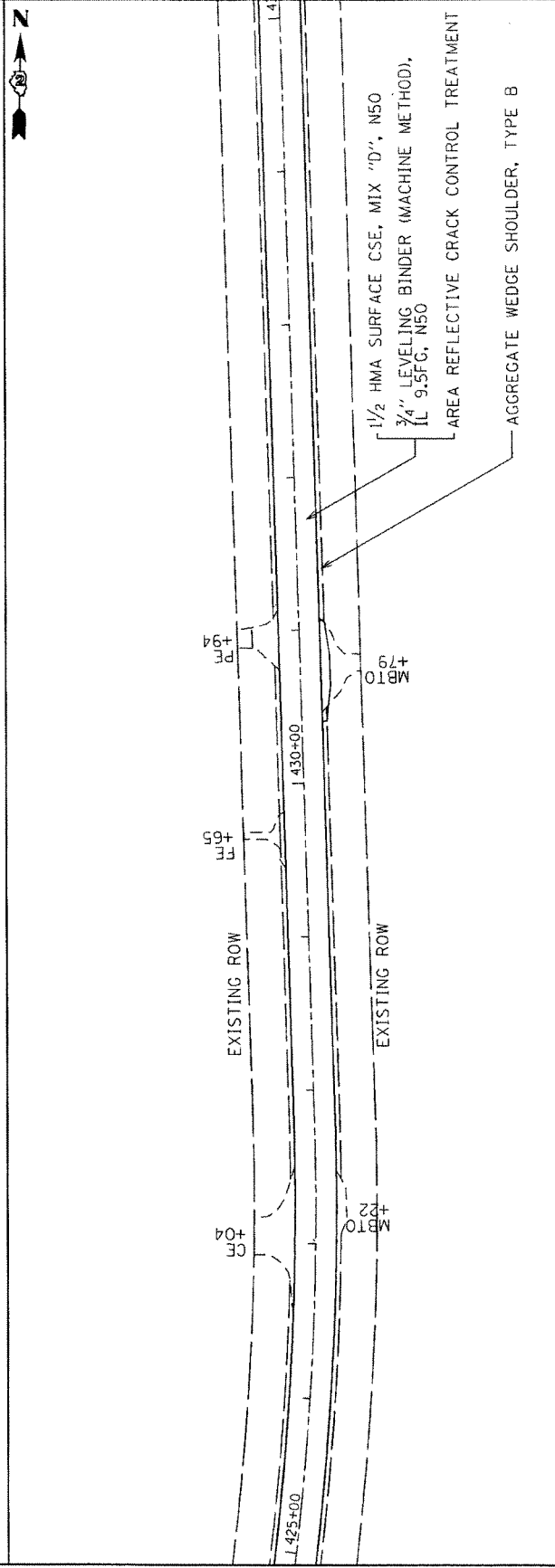
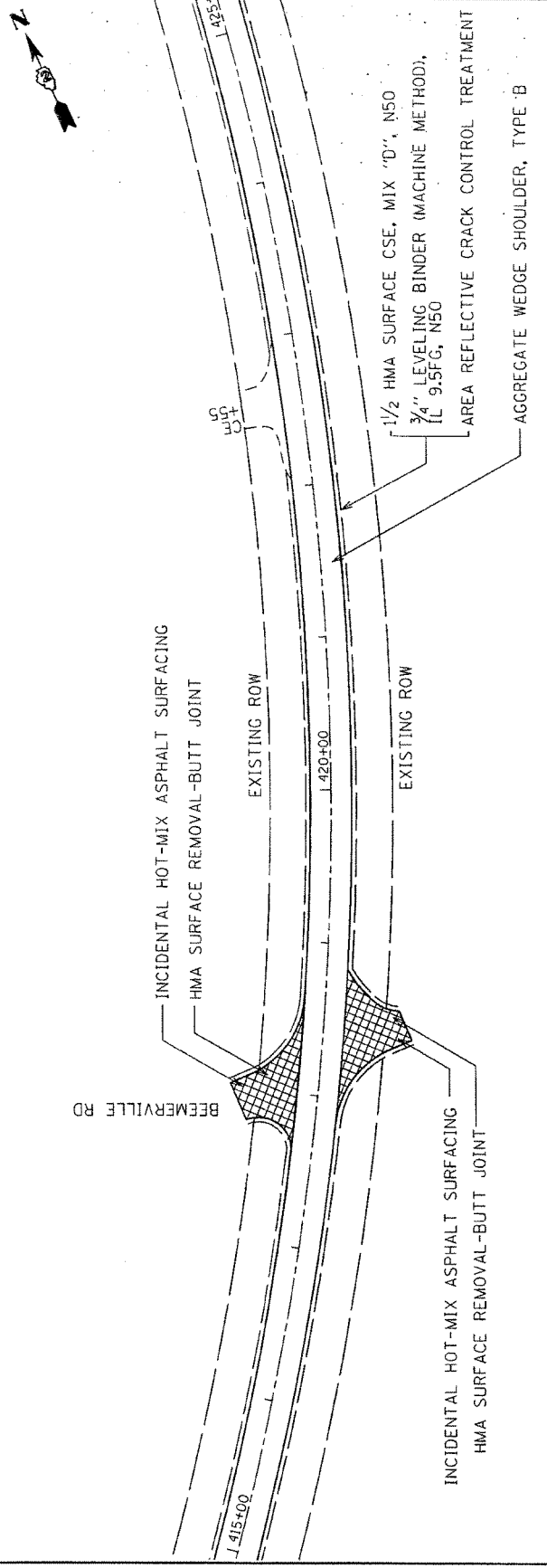

FILE NAME = c:\pwwork\pmdot\goff\j\40316607\2005\3-shc-pln ogle.dgn	STATE OF ILLINOIS DEPARTMENT OF TRANSPORTATION		IL 251 PLAN SHEET	F.A. RTE. • • FAS 1177 & FAU 5452	SECTION (109, 110) RS-5	COUNTY LEE/OGLE	TOTAL SHEETS	SHEET NO.
USER NAME = goff\j							109	51
PLOT DATE = Thu Jan 24 13:24:18 2013				FED. ROAD DIST. NO. ILLINOIS		CONTRACT NO. 64J29		FED. AID PROJECT



EXISTING ROW

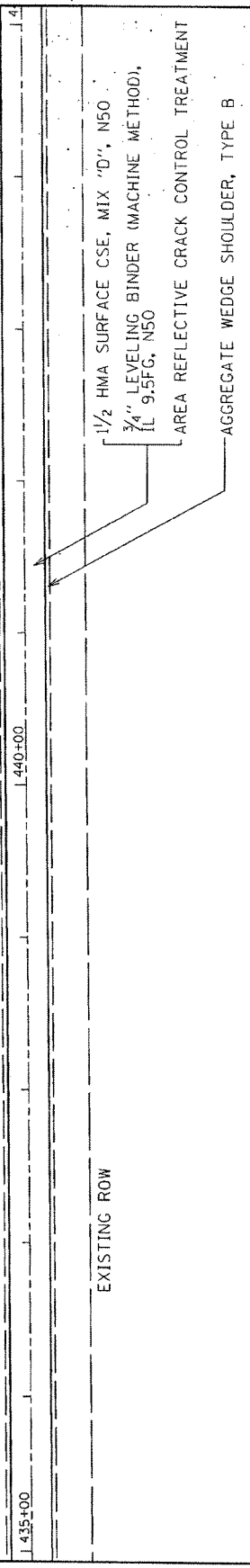

EXISTING ROW

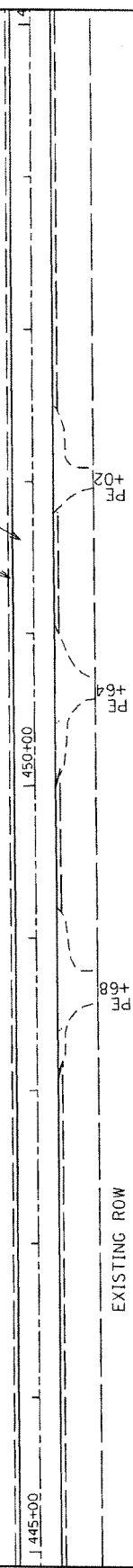

FILE NAME =
 c:\pwwork\pwwork\goff\j\ad036607\AD200513-sht-pin_ogle.dgn
 USER NAME = goff\j
 PLOT DATE = Thu Jan 24 13:24:19 2013

STATE OF ILLINOIS
DEPARTMENT OF TRANSPORTATION

IL 251 PLAN SHEET

F.A. RITE.	SECTION	TOTAL SHEETS	SHEET NO.
	(109, 110) RS-5	109	52
• FAS 1177 & FAU 5452	CONTRACT NO.	64J29	
FED. ROAD DIST. NO.	ILLINOIS FED. AID PROJECT		

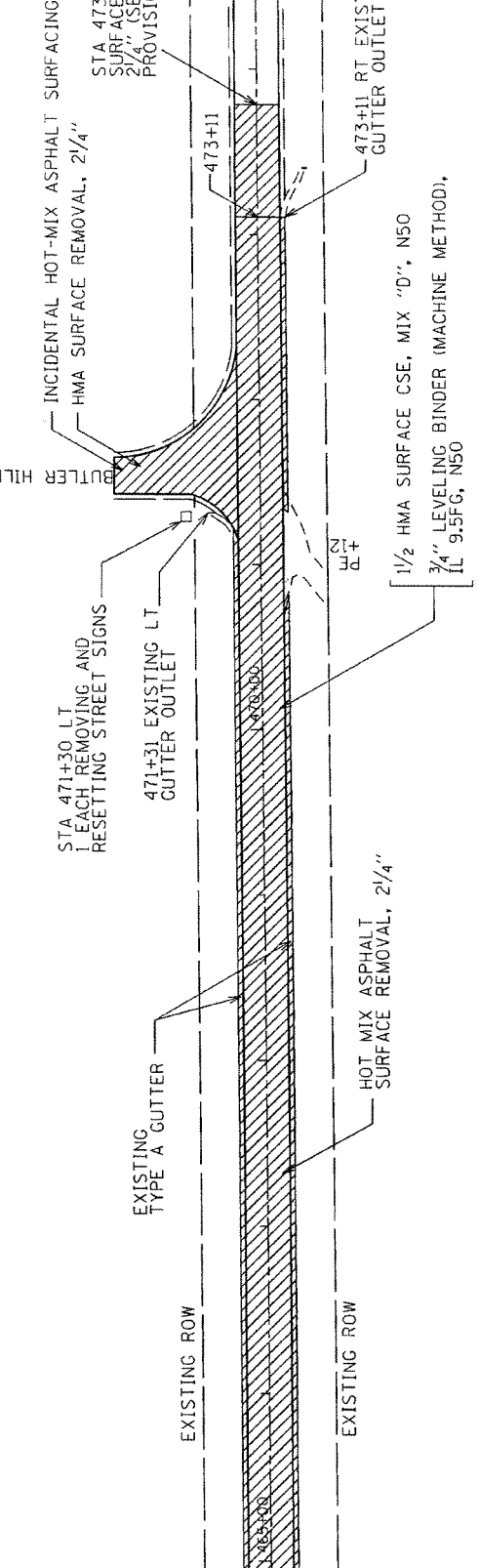
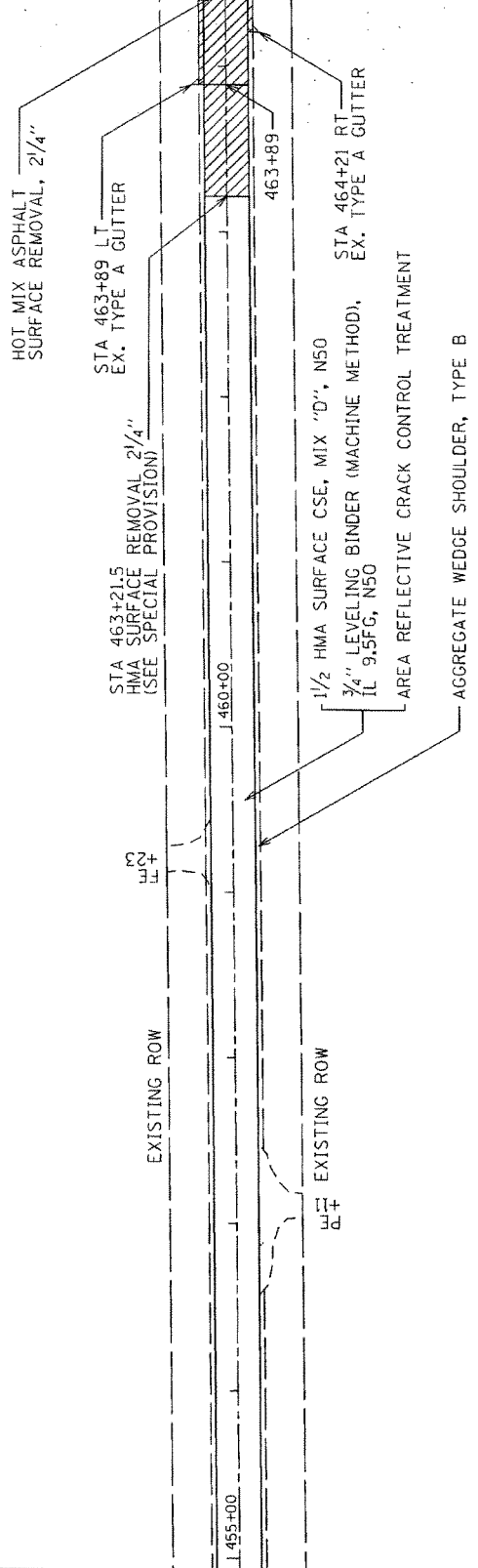

FILE NAME =
 c:\pw-work\pwork\goff\j\0316607\0200513-sht-pln_ogle.dgn
 USER NAME = goffj
 PLOT DATE = Thu Jan 24 13:24:20 2013

STATE OF ILLINOIS
DEPARTMENT OF TRANSPORTATION

IL 251 PLAN SHEET

F.A. RTE.	SECTION	COUNTY	TOTAL SHEETS	SHEET NO.
•	(109, 110) RS-5	LEE/ZOGL	109	53
• FAS 1177 & FAU 5452			CONTRACT NO.	64J29
FED. ROAD DIST. NO. ILLINOIS FED. AID PROJECT				

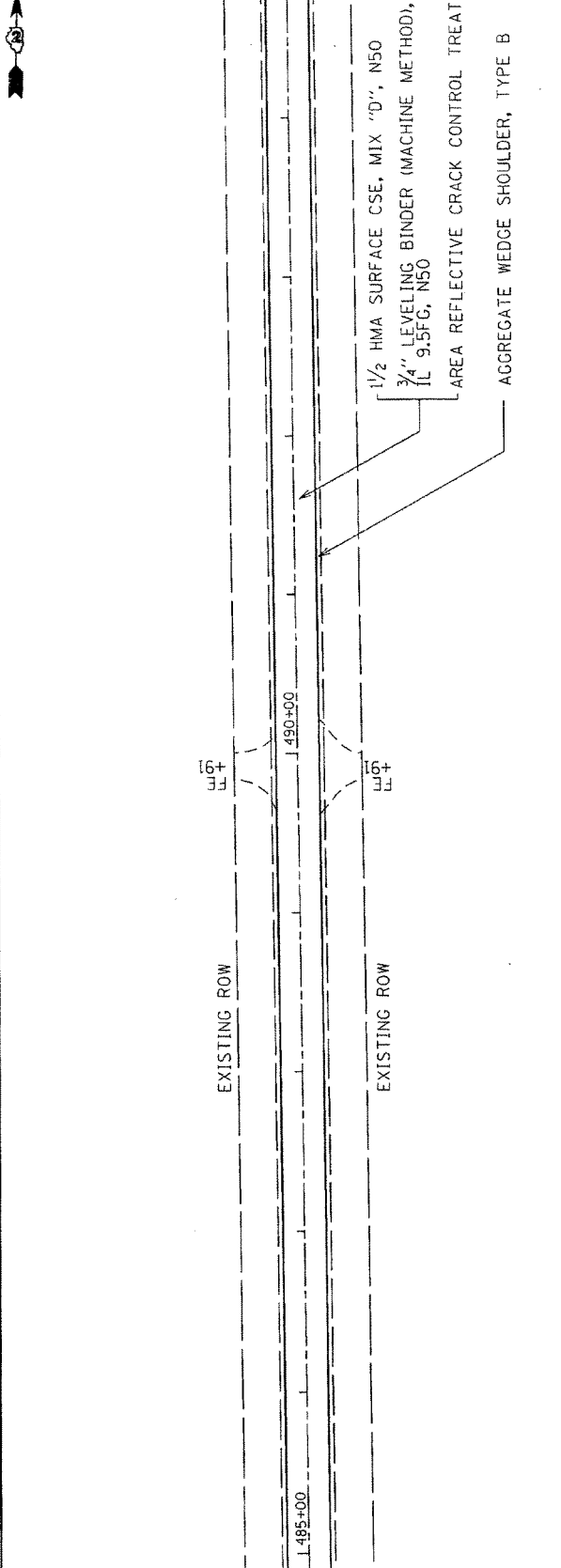
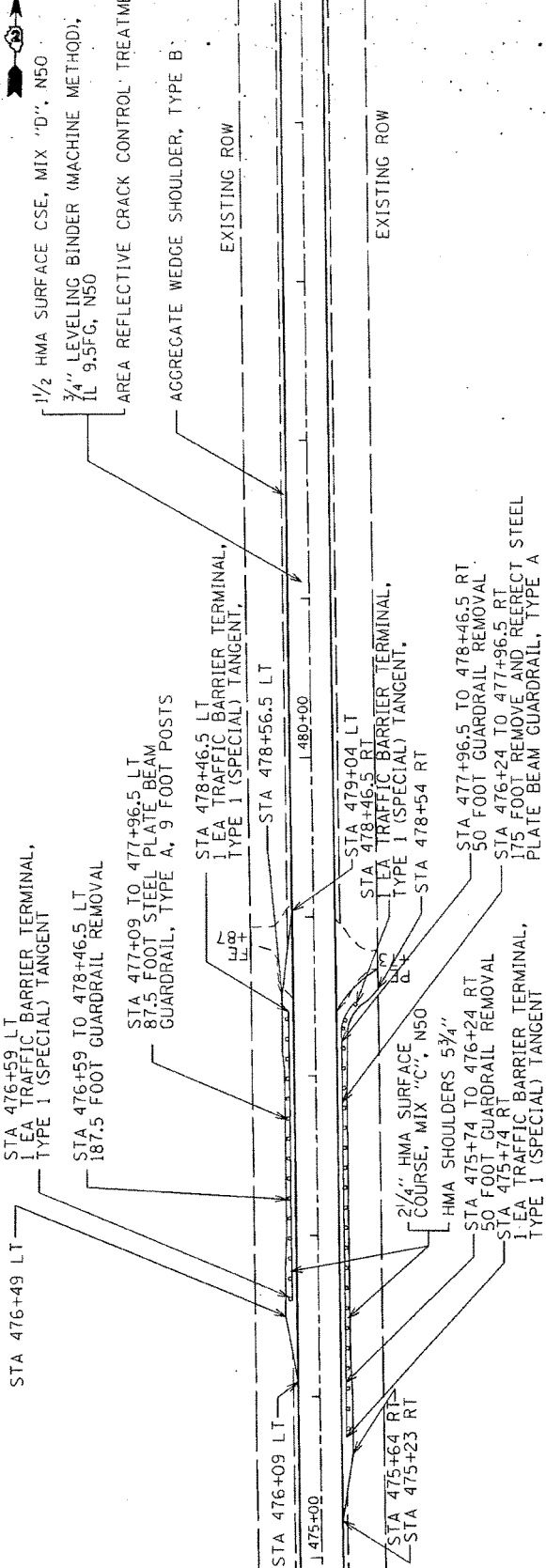

FILE NAME = c:\p-w\work\p-w\dot\goff\j\46031660\0200513-sht-pln_ogle.dgn		STATE OF ILLINOIS		IL 251 PLAN SHEET		F.A. RTE.		SECTION		COUNTY		TOTAL SHEETS		SHEET NO.	
USER NAME = goffj		DEPARTMENT OF TRANSPORTATION				* (109, 110) RS-5		(109, 110) RS-5		LEE/OGLE		109		54	
PLOT DATE = Thu Jan 24 13:24:21 2013						* FAS 1177 & FAU 5452		FAS 1177 & FAU 5452		CONTRACT NO.		64		29	
						ILLINOIS		ILLINOIS		FED. AID PROJECT					



EXISTING ROW

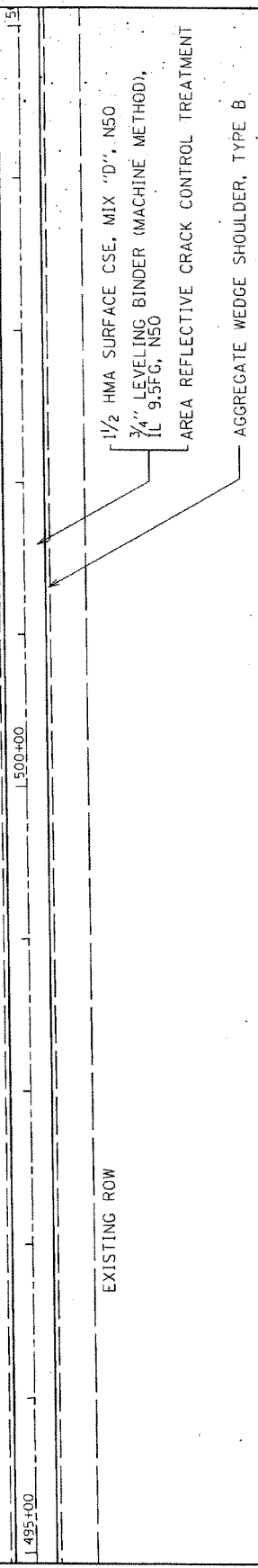

AGGREGATE WEDGE SHOULDER, TYPE B

1/2" HMA SURFACE CSE, MIX "D", N50
 3/4" LEVELING BINDER (MACHINE METHOD),
 IL 9.5FG, N50
 AREA REFLECTIVE CRACK CONTROL TREATMENT

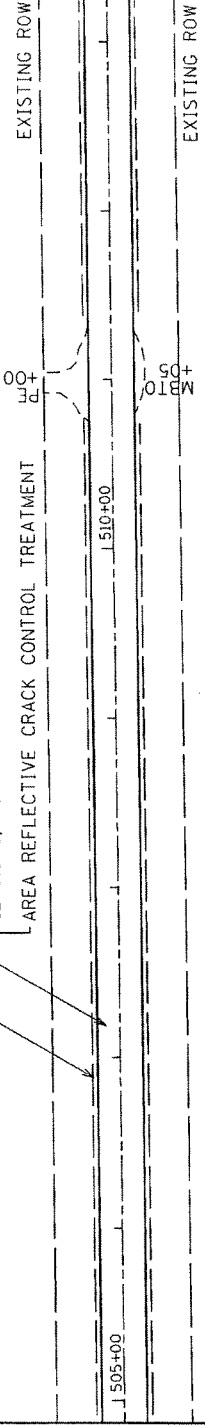

FILE NAME =
 c:\pwork\pindot\gof\j\08316607\0200513-shr-pln_ogle.dgn
 USER NAME = gof\j
 PLOT DATE = Thu Jan 24 13:24:22 2013

STATE OF ILLINOIS
DEPARTMENT OF TRANSPORTATION

IL 251 PLAN SHEET

F.A. RTE.	SECTION	COUNTY	TOTAL SHEETS	SHEET NO.
• FAS 1177 & FAU 5452	(109, 110) RS-5	LEE/OGLE	109	55
FED. ROAD DIST. NO. ILLINOIS	FED. AID PROJECT	CONTRACT NO. 64J29		

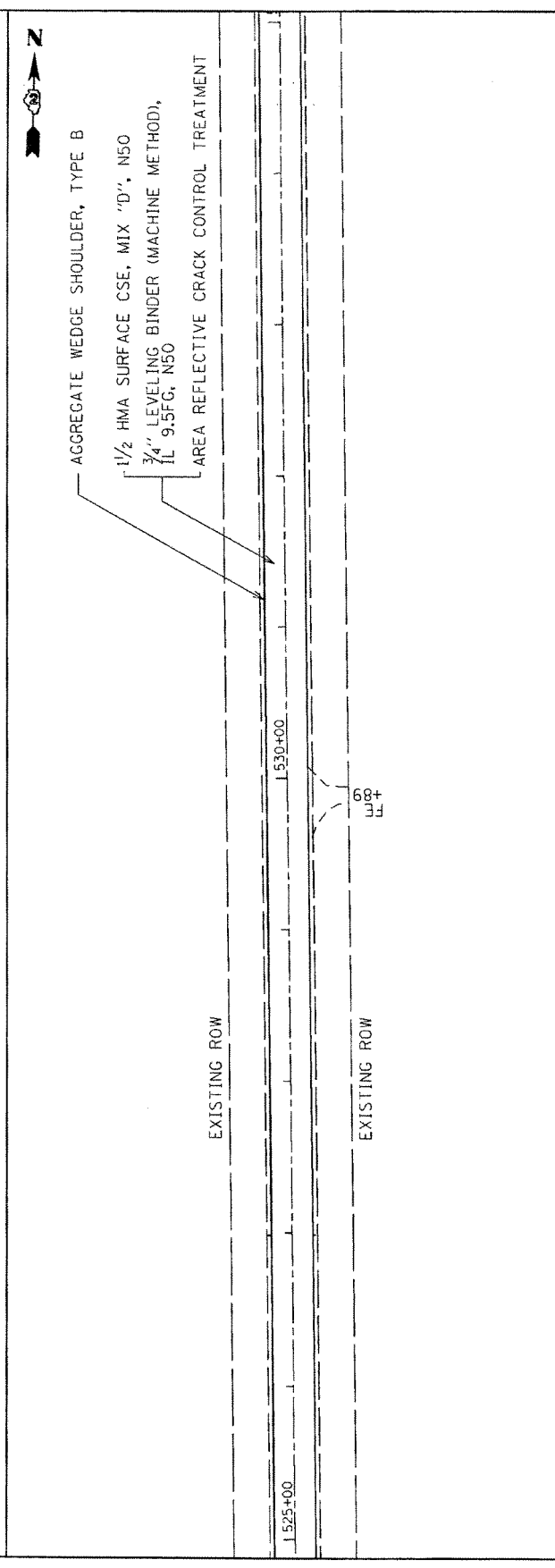
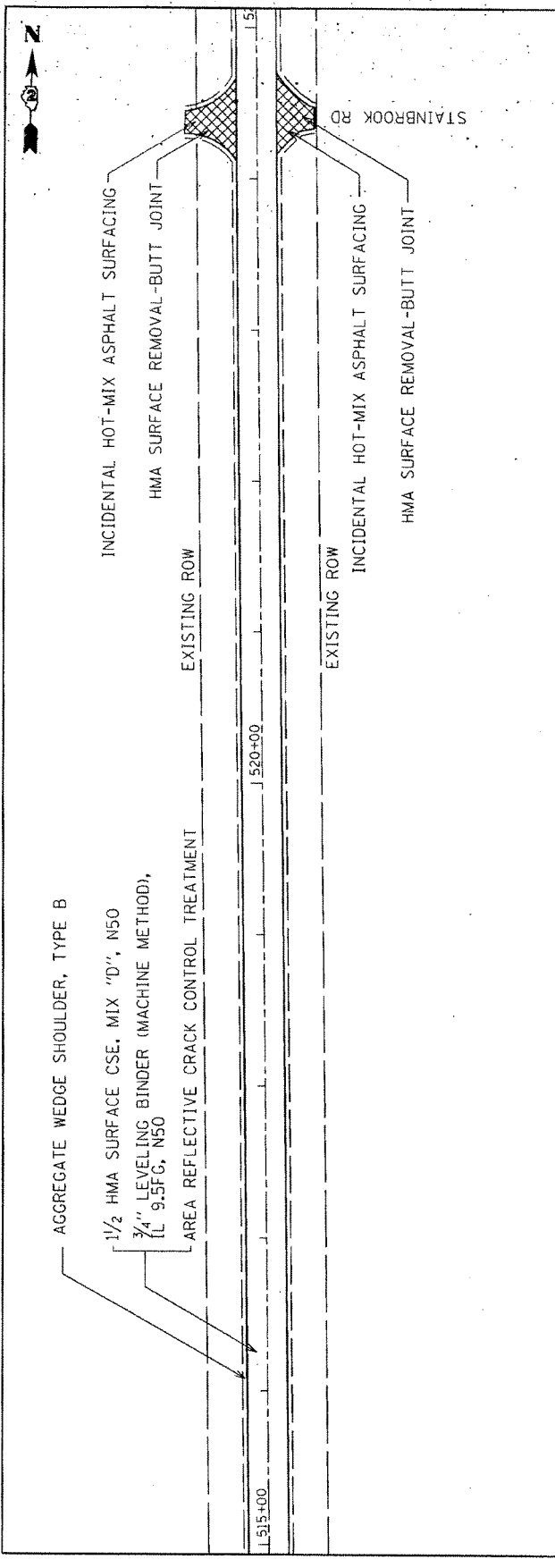

FILE NAME = c:\pm-work\pwr\dwt\geoff\j\0316607\AD200513-sht-pln_ogls.dgn		STATE OF ILLINOIS DEPARTMENT OF TRANSPORTATION		IL 251 PLAN SHEET		F.A. RTE.	SECTION	COUNTY	TOTAL SHEETS	SHEET NO.
USER NAME = geoff.j						*	(109, 110) RS-5	LEE/OGLE	109	56
PLOT DATE = Thu Jan 24 13:24:23 2013						* FAS 1177 & FAU 5452		CONTRACT NO. 64J29		
						ILLINOIS		FED. AID PROJECT		

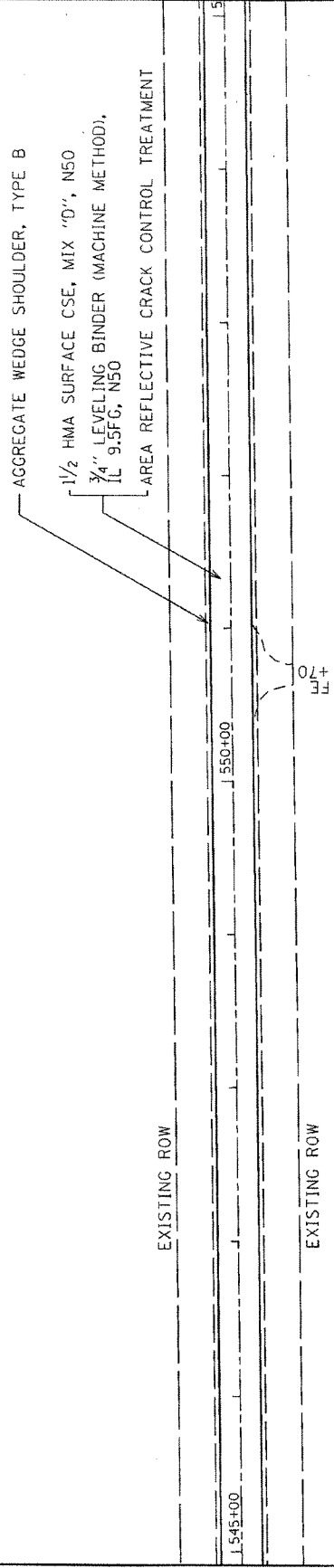
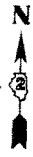
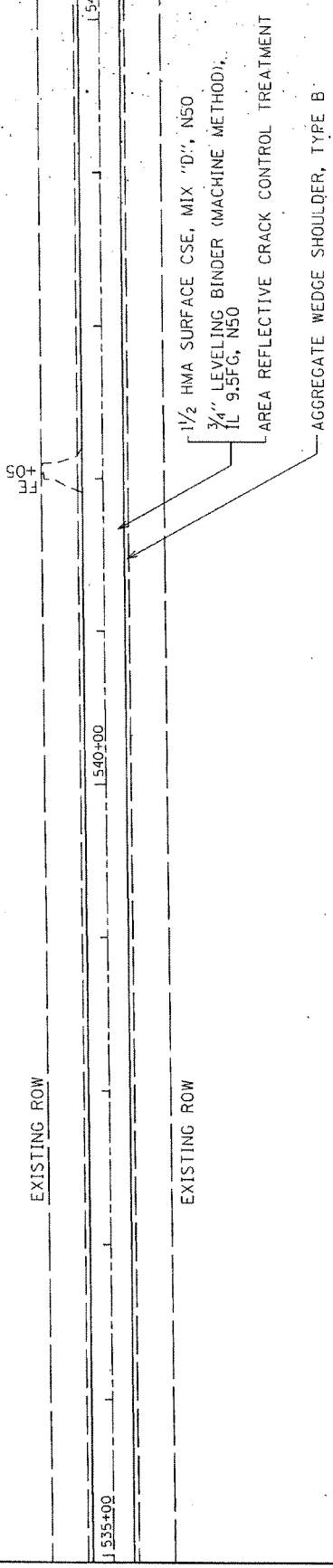

FILE NAME = c:\pwwork\pwwork\goff\j\122005\122005\3-sht-pln_ogle.dgn		STATE OF ILLINOIS DEPARTMENT OF TRANSPORTATION		IL 251 PLAN SHEET		TOTAL SHEET SHEETS NO.	
USER NAME = goff\j				F.A. RTE.		COUNTY	
PLOT DATE = Thu Jan 24 13:24:24 2013		SECTION		FED. ROAD DIST. NO.		CONTRACT NO.	
		• FAS 1177 & FAU 5452		ILLINOIS		64J29	
		• (109, 110) RS-5		LEE/OGLE		109 57	



HMA SURFACE REMOVAL, 2 1/4"

STA 558+82.5
HMA SURFACE REMOVAL, 2 1/4"
(SEE SPECIAL PROVISION)

STA 561+17.5
HMA SURFACE REMOVAL, 2 1/4"
(SEE SPECIAL PROVISION)

EXISTING ROW

559+50

560+50

EXISTING ROW

1/2" HMA SURFACE CSE, MIX "D", N50
3/4" LEVELING BINDER (MACHINE METHOD),
LL 9.5FG, N50

AREA REFLECTIVE CRACK CONTROL TREATMENT
AGGREGATE WEDGE SHOULDER, TYPE B



1/2" HMA SURFACE CSE, MIX "D", N50
3/4" LEVELING BINDER (MACHINE METHOD),
LL 9.5FG, N50

AREA REFLECTIVE CRACK CONTROL TREATMENT

AGGREGATE WEDGE SHOULDER, TYPE B

EXISTING ROW

570+00

EXISTING ROW

FILE NAME =
c:\pwwork\pwwork\goff\j\40316687\0200513-sht-pln ogle.dgn

USER NAME = goffj

PLOT DATE = Thu Jan 24 13:24:25 2013

**STATE OF ILLINOIS
DEPARTMENT OF TRANSPORTATION**

IL 251 PLAN SHEET

F.A. RTE.	SECTION	COUNTY	TOTAL SHEETS	SHEET NO.
• FAS 1177 & FAU 5452	(109, 110) RS-5	LEE/OGLE	109	58
FED. ROAD DIST. NO.	ILLINOIS FED. AID PROJECT	CONTRACT NO. 64J29		

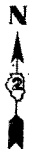

U.S. 30

STA 575+36 TO 575+96
HMA SURFACE REMOVAL,
BUTT JOINT

STA 578+77 TO 579+37
HMA SURFACE REMOVAL,
BUTT JOINT

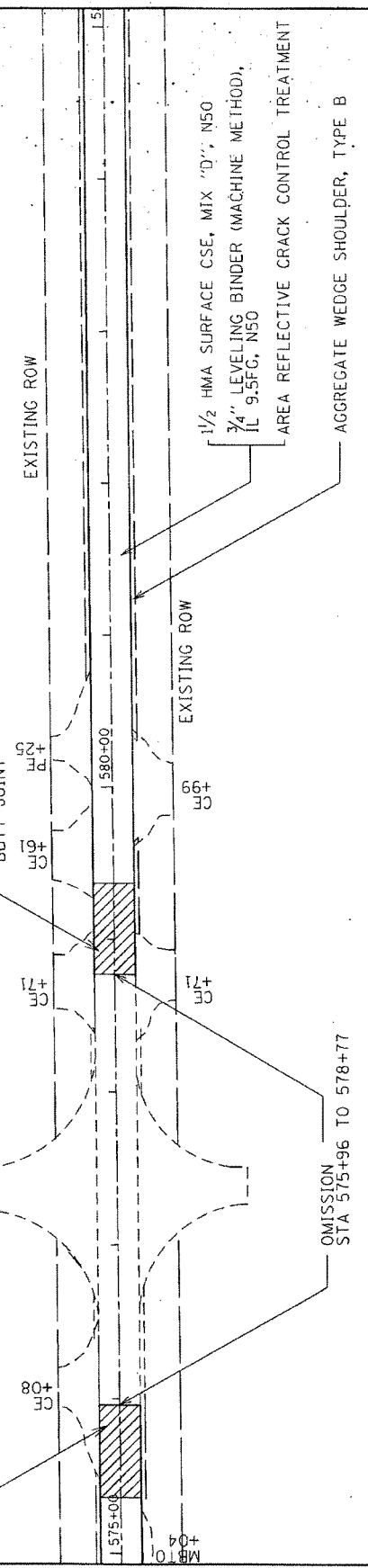

EXISTING ROW

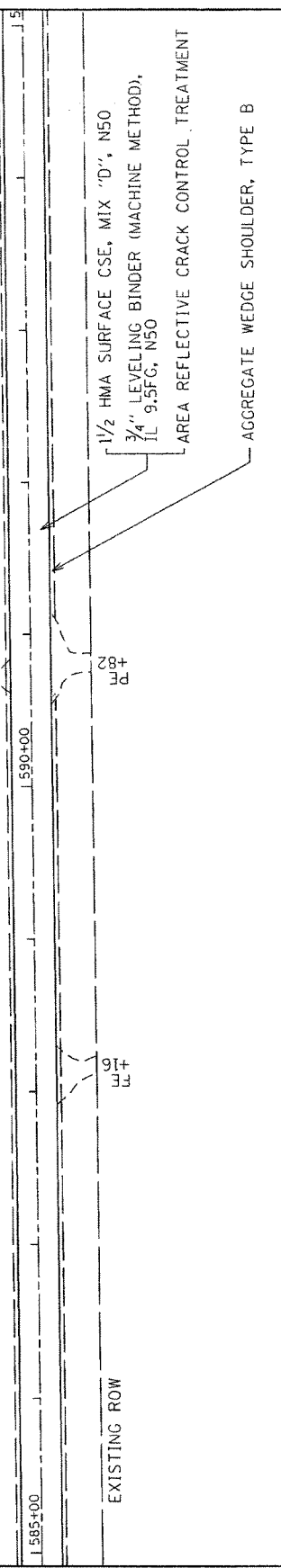

FILE NAME =
 c:\p_m_work\pwidot\goff_j\1\0316507\200513-sht-pln_og1e.dgn
 USER NAME = goff_j
 PLOT DATE = Thu Jan 24 13:24:26 2013

STATE OF ILLINOIS
DEPARTMENT OF TRANSPORTATION

IL 251 PLAN SHEET

F.A. RTE.	SECTION	COUNTY	TOTAL SHEET NO.
* FAS 1177 & FAU 5452	(109, 110) RS-5	LEE/OGLE	109
FED. ROAD DIST. NO.	ILLINOIS	FED. AID PROJECT	CONTRACT NO. 64J29
			59

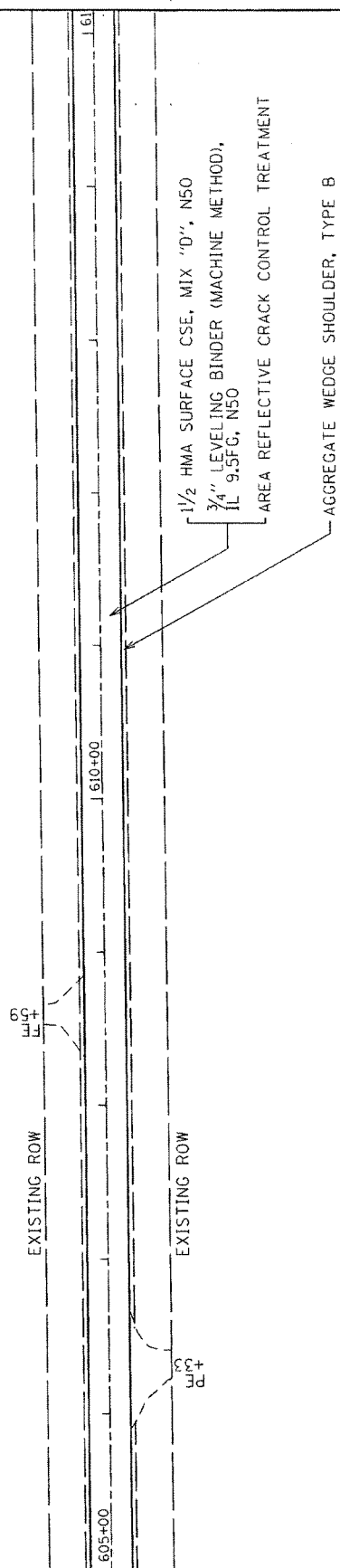
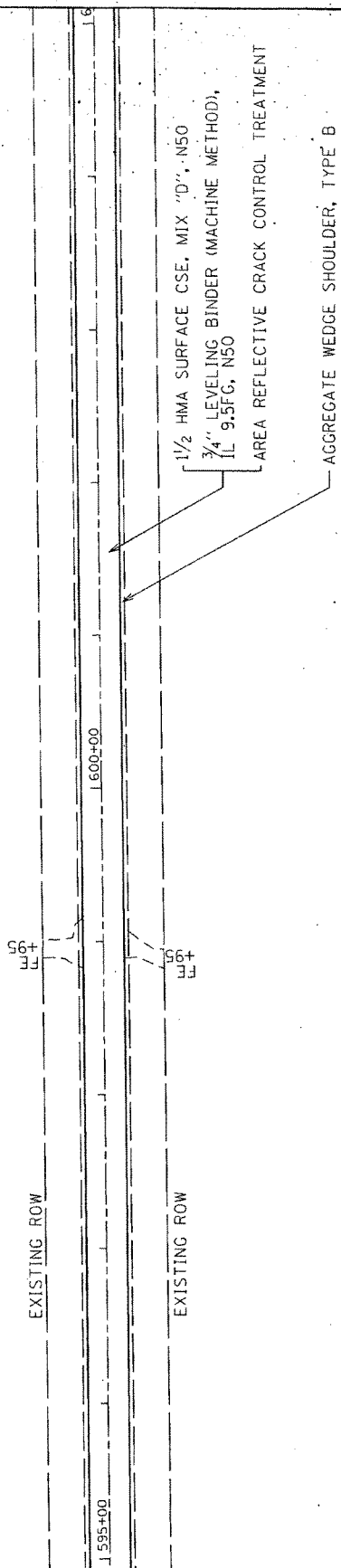

FILE NAME = c:\pw_work\pripdot\goffj\0316687\0200513-sht-pln_ogle.dgn		STATE OF ILLINOIS		IL 251 PLAN SHEET		F.A. RTE.		SECTION		TOTAL SHEET NO.	
USER NAME = goffj		DEPARTMENT OF TRANSPORTATION				• FAS 1177 & FAU 5452		(109, 110) RS-5		109 60	
PLOT DATE = Thu Jan 24 13:24:27 2013						• ILLINOIS FED. AID PROJECT		CONTRACT NO. 64J29			

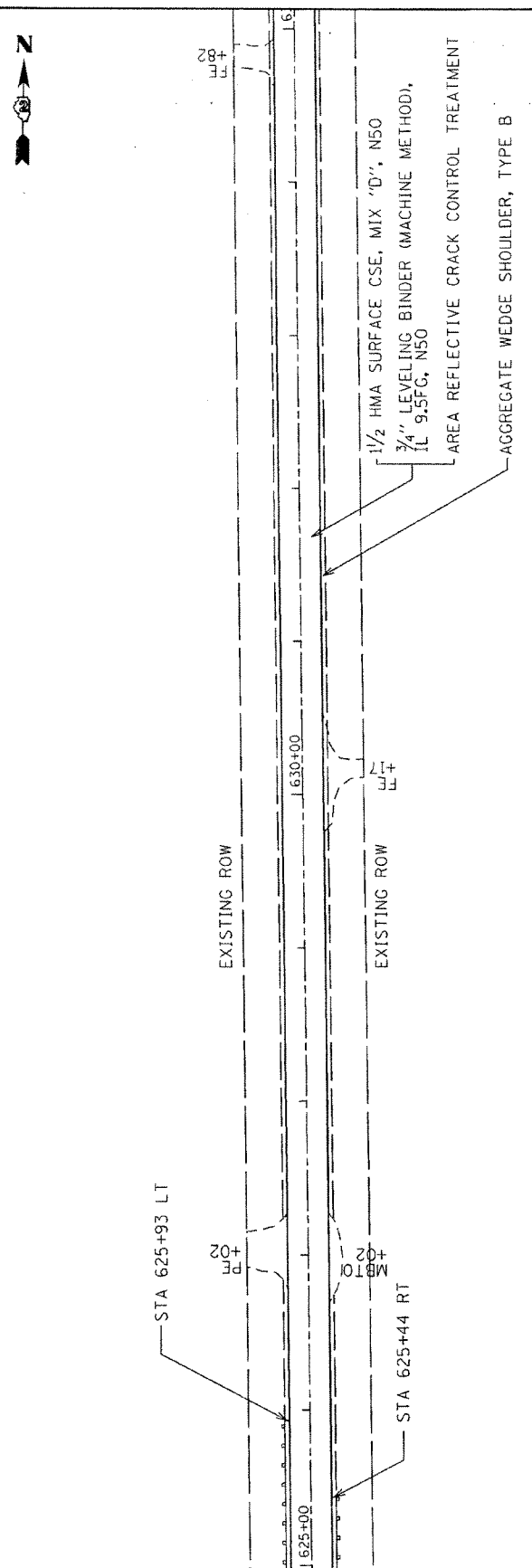
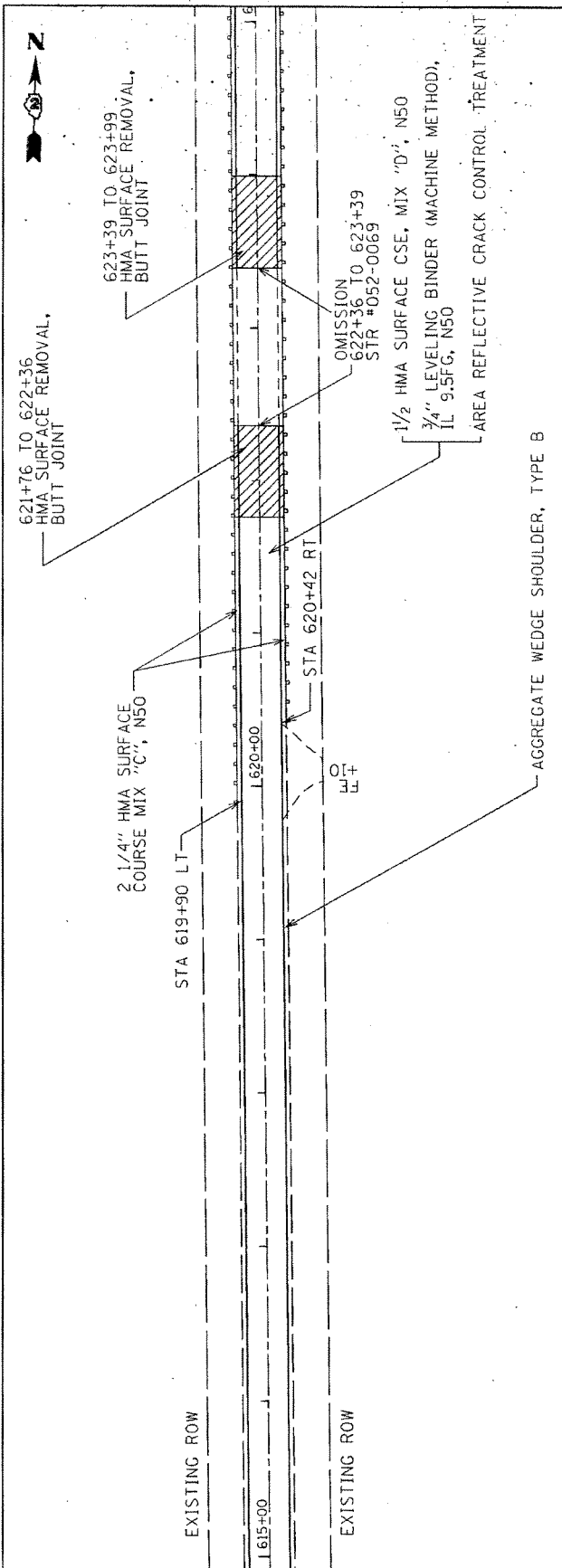

FILE NAME =		STATE OF ILLINOIS		TOTAL SHEETS	
c:\pwwork\p\midot\goffj\0316607\0200513-sht-pin_ogle.dgn		DEPARTMENT OF TRANSPORTATION		109	
USER NAME = goffj		IL 251 PLAN SHEET		SHEET NO. 61	
PLOT DATE = Thu Jan 24 13:24:28 2013		SECTION		CONTRACT NO. 64J29	
		(109, 110) RS-5		LEE/OGLE	
		F.A. RTE.		FED. ROAD DIST. NO.	
		• FAS 1177 & FAU 5452		ILLINOIS FED. AID PROJECT	



EXISTING ROW

1635+00 1640+00

EXISTING ROW

1/2" HMA SURFACE CSE, MIX "D", N50
3/4" LEVELING BINDER (MACHINE METHOD),
IL 9.5FG, N50
AREA REFLECTIVE CRACK CONTROL TREATMENT
AGGREGATE WEDGE SHOULDER, TYPE B



EXISTING ROW

1645+00 1650+00

EXISTING ROW

1/2" HMA SURFACE CSE, MIX "D", N50
3/4" LEVELING BINDER (MACHINE METHOD),
IL 9.5FG, N50
AREA REFLECTIVE CRACK CONTROL TREATMENT
AGGREGATE WEDGE SHOULDER, TYPE B

FILE NAME =
c:\pwwork\pwwork\goff\j\0316607\0200513-shr-plan_ogle.dgn
USER NAME = goff\j
PLOT DATE = Thu Jan 24 13:24:29 2013

STATE OF ILLINOIS
DEPARTMENT OF TRANSPORTATION

IL 251 PLAN SHEET

F.A. RTE.	SECTION	COUNTY	TOTAL SHEETS	SHEET NO.
• FAS 1177 & FAU 5452	(109, 110) RS-5	LEE/OGLE	109	62
FED. ROAD DIST. NO.	ILLINOIS FED. AID PROJECT		CONTRACT NO. 64J29	



EXISTING ROW

1 660+00

EXISTING ROW

1/2" HMA SURFACE CSE, MIX "D", N50
 3/4" LEVELING BINDER (MACHINE METHOD),
 IL 9.5FG, N50
 AREA REFLECTIVE CRACK CONTROL TREATMENT
 AGGREGATE WEDGE SHOULDER, TYPE B



EXISTING ROW

1 670+00

EXISTING ROW

1/2" HMA SURFACE CSE, MIX "D", N50
 3/4" LEVELING BINDER (MACHINE METHOD),
 IL 9.5FG, N50
 AREA REFLECTIVE CRACK CONTROL TREATMENT
 AGGREGATE WEDGE SHOULDER, TYPE B

FILE NAME =
 c:\pw-work\p\ridot\geoff\j\160316607\0200513-sht-pln_ogle.dgn

USER NAME = geoffj

PLOT DATE = Thu Jan 24 13:24:30 2013

STATE OF ILLINOIS
DEPARTMENT OF TRANSPORTATION

IL 251 PLAN SHEET

F.A. RTE.	SECTION	COUNTY	TOTAL SHEETS	SHEET NO.
*	(109, 110) RS-5	LEE/OGLE	109	63
* FAS 1177 & FAU 5452		CONTRACT NO. 64J29		
FED. ROAD DIST. NO.		ILLINOIS FED. AID PROJECT		

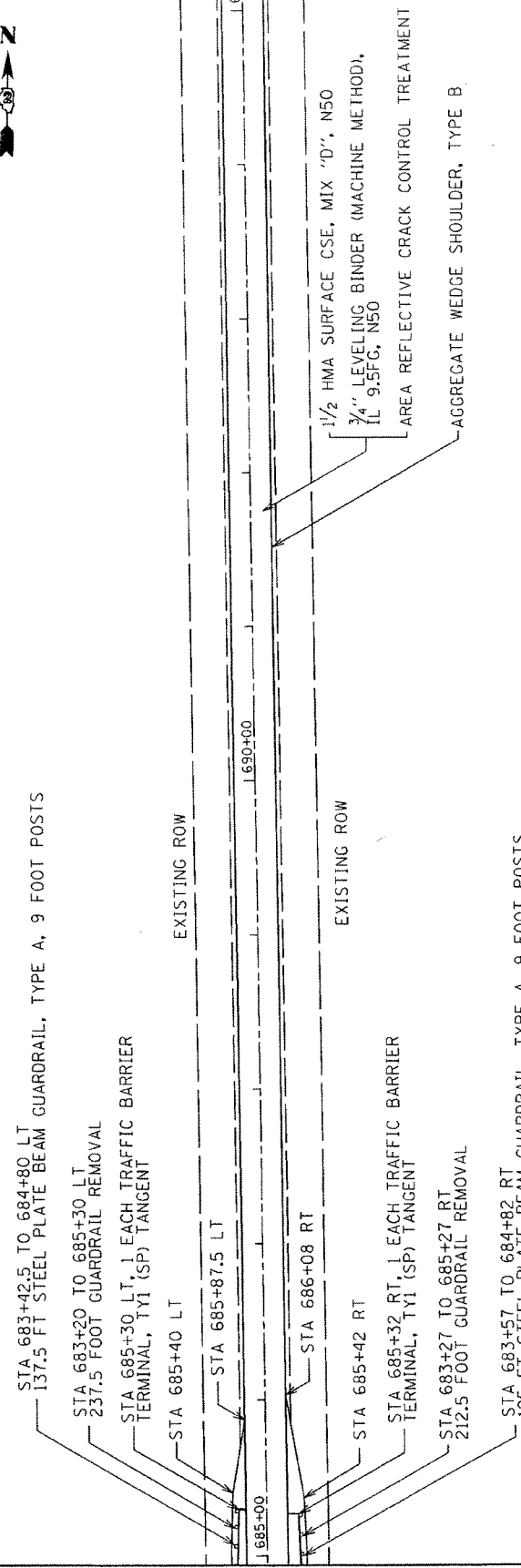
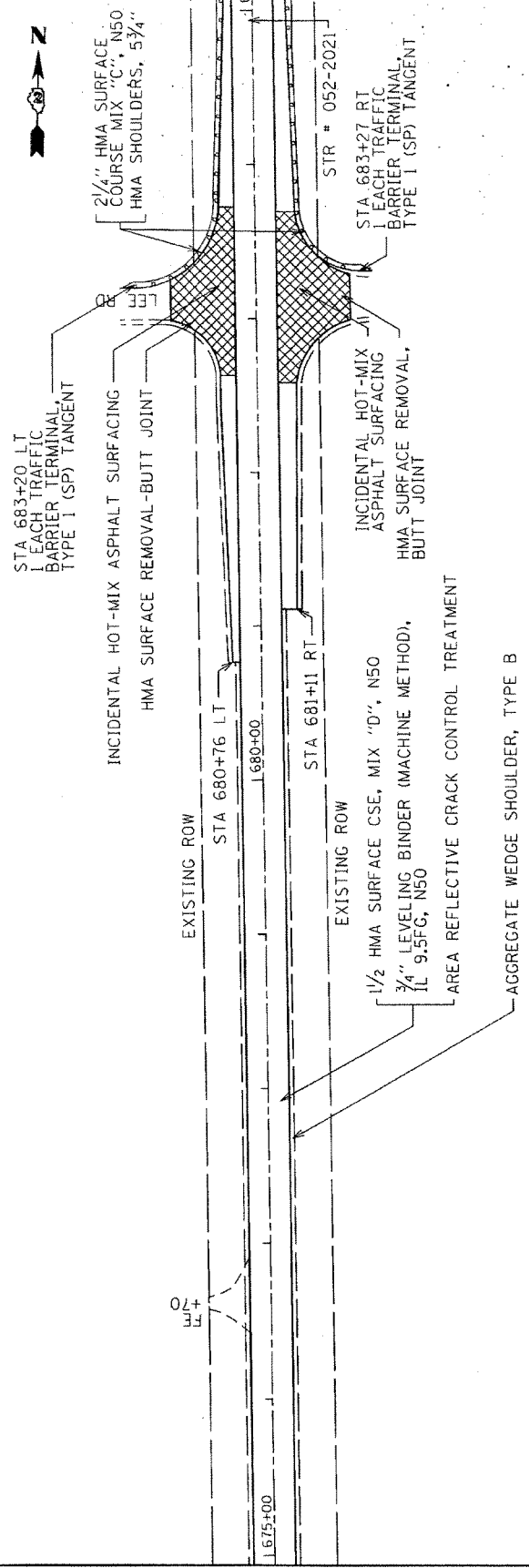

FILE NAME = c:\pwwork\pwwork\goff\j\68316607\0200513-shr.pln ogle.dgn	STATE OF ILLINOIS DEPARTMENT OF TRANSPORTATION		IL 251 PLAN SHEET	F.A. R.T.E.	SECTION	COUNTY	TOTAL SHEETS
USER NAME = goff\j				•	(109, 110) RS-5	LEE/OGLE	109
PLOT DATE = Thu Jan 24 13:24:31 2013				• FAS 1177 & FAU 5452		CONTRACT NO. 64J29	
				FED. ROAD DIST. NO. ILLINOIS	FED. AID PROJECT		

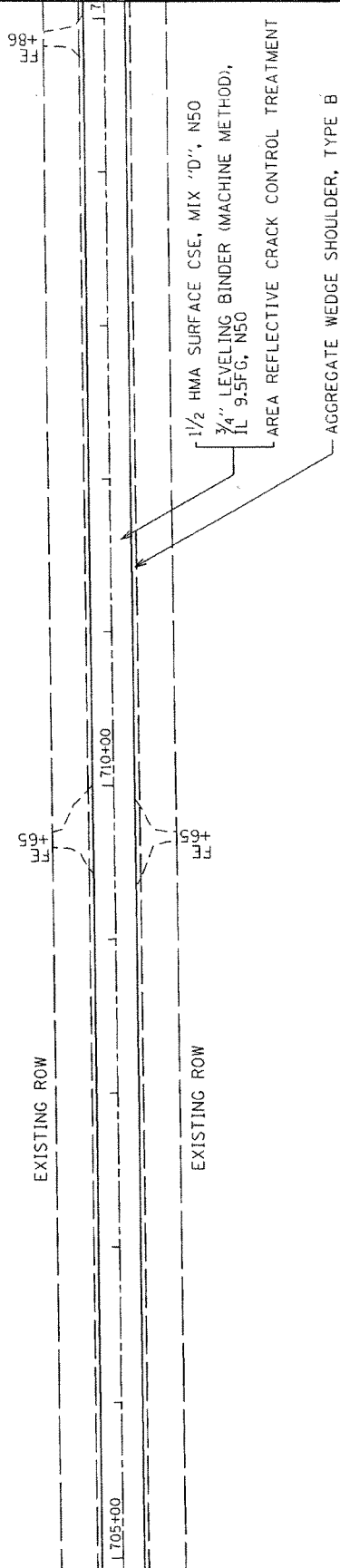
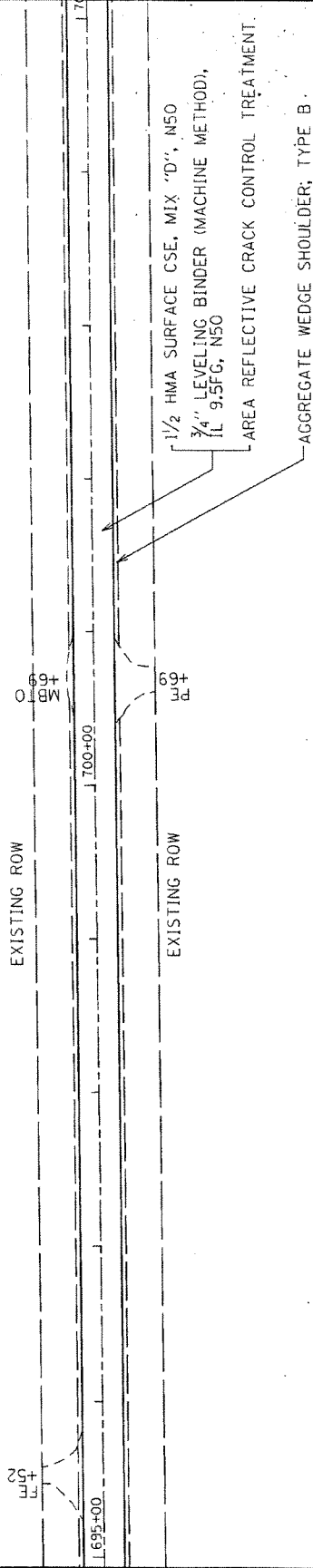

FILE NAME =
 c:\pwork\pwork\dot\goff\j\02316607\0200513-sht-pln ogle.dgn
 USER NAME = goffj
 PLOT DATE = Thu Jan 24 13:24:32 2013

STATE OF ILLINOIS
DEPARTMENT OF TRANSPORTATION

IL 251 PLAN SHEET

F.A. RTE.	SECTION	COUNTY	TOTAL SHEETS	SHEET NO.
* FAS 1177 & FAU 5452	(109, 110) RS-5	LEE/OGLE	109	65
FED. ROAD DIST. NO.	ILLINOIS FED. AID PROJECT	CONTRACT NO. 64J29		

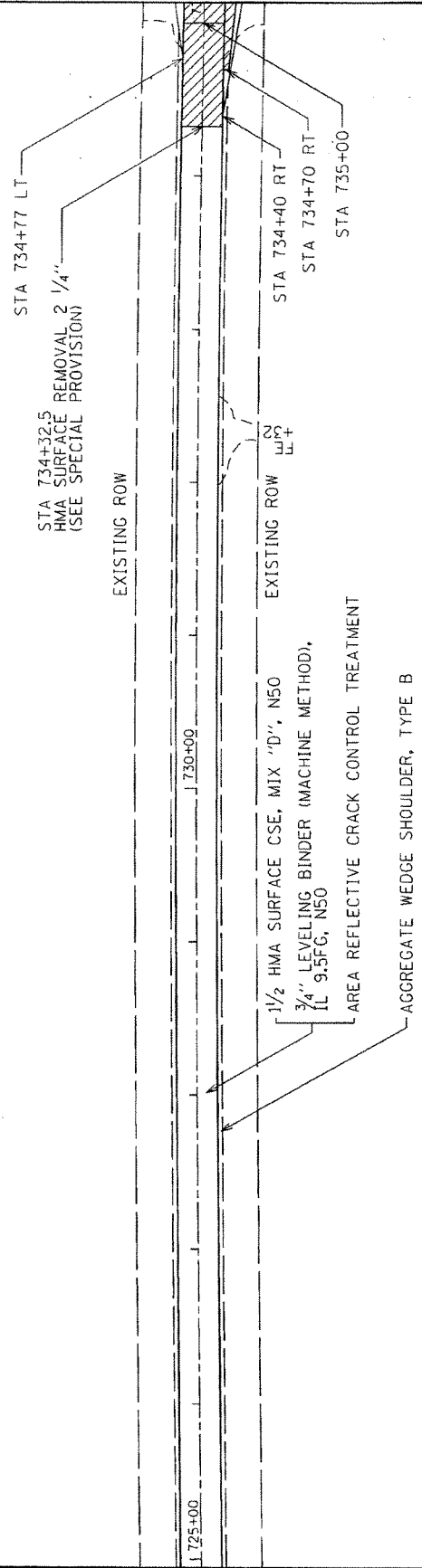
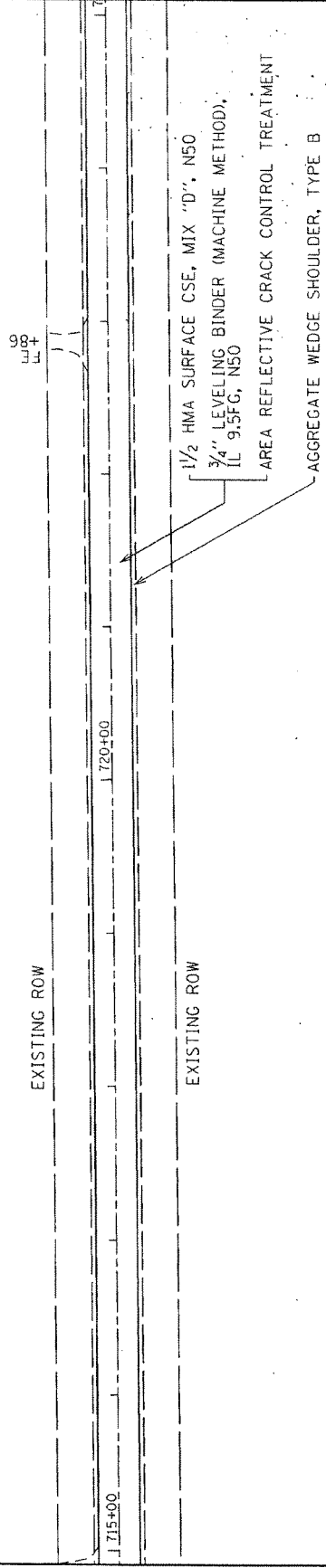

FILE NAME = c:\pw-work\pwr\dwt\geff\j\08316607\200513-sht-pln_ogje.dgn		STATE OF ILLINOIS		IL 251 PLAN SHEET		TOTAL SHEET NO.	
USER NAME = geff,j		DEPARTMENT OF TRANSPORTATION		SECTION		TOTAL SHEETS	
PLOT DATE = Thu Jan 24 13:24:33 2013				109, 110, RS-5		109	
				FAS 1177 & FAU 5452		CONTRACT NO. 64J29	
				ILLINOIS		FED. AID PROJECT	



EXISTING ROW

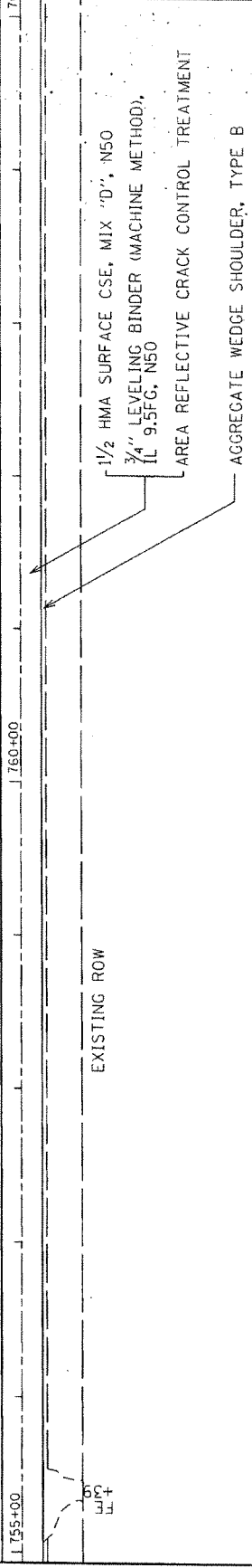

EXISTING ROW

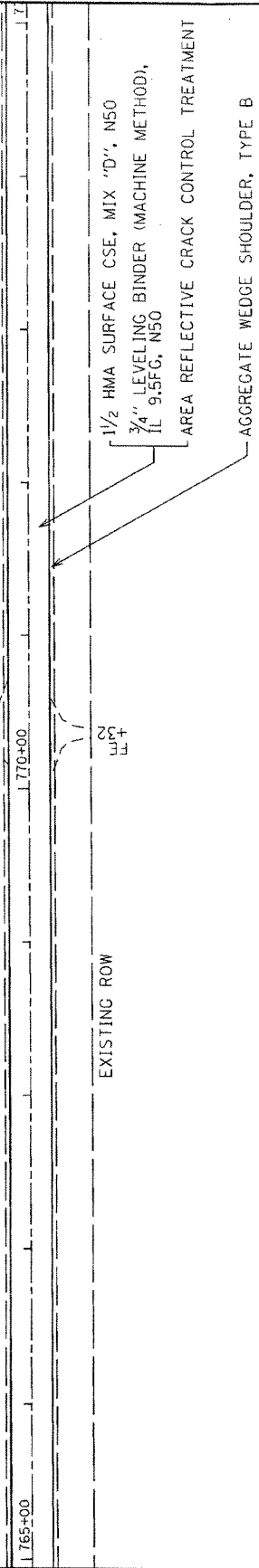

FILE NAME =
 c:\pwwork\pwwork\goff\j\02316607\0200513-sht-pln_ogle.dgn
 USER NAME = goff\j
 PLOT DATE = Thu Jan 24 13:24:34 2013

STATE OF ILLINOIS
DEPARTMENT OF TRANSPORTATION

IL 251 PLAN SHEET

F.A. RTE.	SECTION	COUNTY	TOTAL SHEETS
			SHEETS NO.
• FAS 1177 & FAU 5452	(109, 110) RS-5	LEE/OGLE	109
			68
FED. ROAD DIST. NO. ILLINOIS		CONTRACT NO. 64J29	

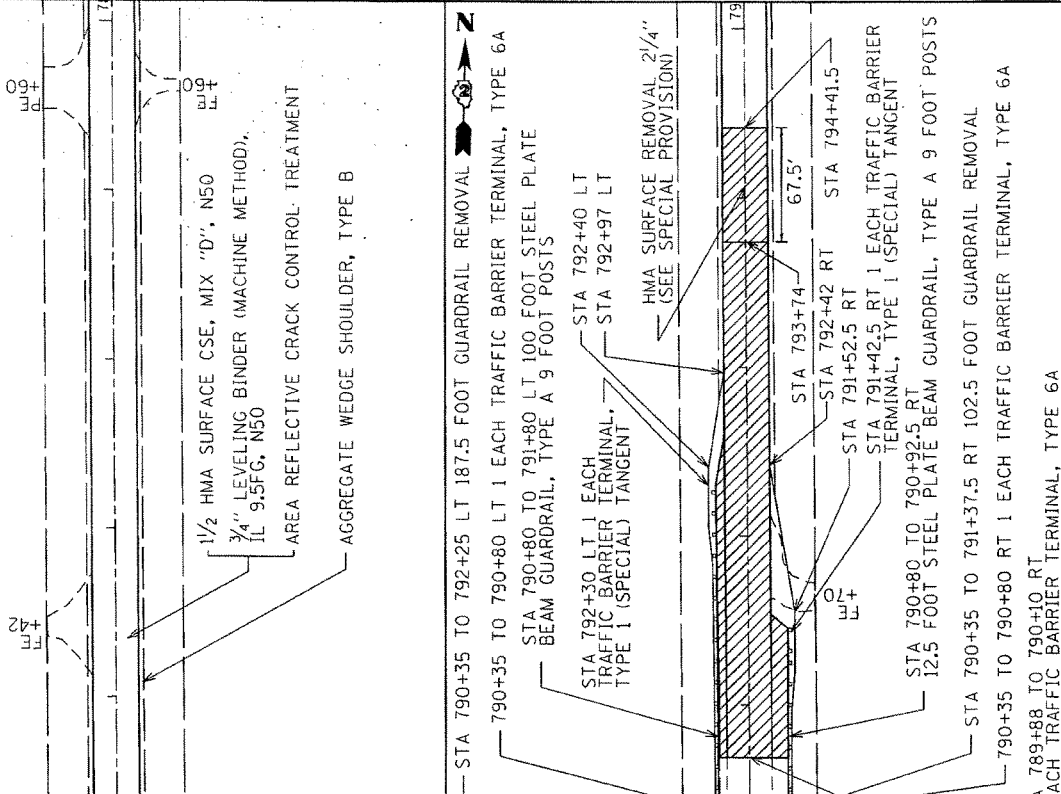

STA 789+88 TO 790+10 LT 1 EACH TRAFFIC BARRIER TERMINAL, TYPE 6A
 STA 789+88 TO 790+10 LT 75 FOOT GUARDRAIL REMOVAL
 STA 789+88 LT 1 EACH TRAFFIC BARRIER TERMINAL, TYPE 1 (SP) TANGENT
 STA 790+80 TO 791+80 LT 100 FOOT STEEL PLATE BEAM GUARDRAIL, TYPE A 9 FOOT POSTS
 STA 792+30 LT 1 EACH TRAFFIC BARRIER TERMINAL, TYPE 1 (SPECIAL) TANGENT
 STA 792+40 LT 1 EACH TRAFFIC BARRIER TERMINAL, TYPE 1 (SPECIAL) TANGENT
 STA 792+97 LT 1 EACH TRAFFIC BARRIER TERMINAL, TYPE 1 (SPECIAL) TANGENT
 HMA SURFACE REMOVAL 2 1/4" (SEE SPECIAL PROVISION)
 1/2" HMA SURFACE CSE, MIX "D", N50
 3/4" LEVELING BINDER (MACHINE METHOD), IL 9.5FG, N50
 AREA REFLECTIVE CRACK CONTROL TREATMENT
 AGGREGATE WEDGE SHOULDER, TYPE B
 STA 790+35 TO 792+25 LT 187.5 FOOT GUARDRAIL REMOVAL
 STA 793+74
 STA 792+42 RT
 STA 794+41.5
 STA 791+52.5 RT
 STA 791+42.5 RT 1 EACH TRAFFIC BARRIER TERMINAL, TYPE 1 (SPECIAL) TANGENT
 STA 790+80 TO 790+92.5 RT 12.5 FOOT STEEL PLATE BEAM GUARDRAIL, TYPE A 9 FOOT POSTS
 STA 790+35 TO 791+37.5 RT 102.5 FOOT GUARDRAIL REMOVAL
 STA 790+35 TO 790+80 RT 1 EACH TRAFFIC BARRIER TERMINAL, TYPE 6A
 STA 789+88 TO 790+10 RT 1 EACH TRAFFIC BARRIER TERMINAL, TYPE 6A
 STA 789+88 TO 790+08 RT 75 FOOT GUARDRAIL REMOVAL
 STA 789+88 RT 1 EACH TRAFFIC BARRIER TERMINAL, TYPE 1 (SP) TANGENT
 STA 789+79 TO 790+69 OMISSION TO STR# 052-2024
 STA 788+37
 STA 788+07
 STA 787+44
 STA 786+76.5
 STA 786+00
 STA 785+00
 INCIDENTAL HOT-MIX ASPHALT SURFACING
 HMA SURFACE REMOVAL, 2 1/4" EXISTING ROW
 1/2" HMA SURFACE CSE, MIX "D", N50
 3/4" LEVELING BINDER (MACHINE METHOD), IL 9.5FG, N50
 AREA REFLECTIVE CRACK CONTROL TREATMENT
 AGGREGATE WEDGE SHOULDER, TYPE B
 HMA SURFACE REMOVAL, 2 1/4"
 INCIDENTAL HOT-MIX ASPHALT SURFACE
 STA 789+88 TO 790+08 RT 75 FOOT GUARDRAIL REMOVAL

FILE NAME =	STATE OF ILLINOIS			TOTAL SHEETS	69
cr:\pw-work\p\rdot\geoff\j\0316687\0200513-sht-pln ogle.dgn	DEPARTMENT OF TRANSPORTATION			SHEETS	109
USER NAME = geoff.j	IL 251 PLAN SHEET			COUNTY	LEE/ZOGLE
PLOT DATE = Thu Jan 24 13:24:36 2013	F.A. RTE.			SECTION	CONTRACT NO.
	• FAS 1177 & FAU 5452			(109, 110) RS-5	64J29
	FED. ROAD DIST. NO.			ILLINOIS FED. AID PROJECT	



EXISTING ROW

1 795+00

1 800+00

EXISTING ROW

TR
+70

1/2" HMA SURFACE CSE, MIX "D", N50
 3/4" LEVELING BINDER (MACHINE METHOD),
 IL 9.5FG, N50
 AREA REFLECTIVE CRACK CONTROL TREATMENT
 AGGREGATE WEDGE SHOULDER, TYPE B



EXISTING ROW

1 805+00

1 810+00

TR
+01

MBTO
+01

1/2" HMA SURFACE CSE, MIX "D", N50
 3/4" LEVELING BINDER (MACHINE METHOD),
 IL 9.5FG, N50
 AREA REFLECTIVE CRACK CONTROL TREATMENT
 AGGREGATE WEDGE SHOULDER, TYPE B

FILE NAME =
c:\pw-work\pwidet\geoff\j\ad0316607\ad200513-sht-pln ogle.dgn

USER NAME = geoffj

PLOT DATE = Thu Jan 24 13:24:37 2013

**STATE OF ILLINOIS
 DEPARTMENT OF TRANSPORTATION**

IL 251 PLAN SHEET

F.A. RTE.	SECTION	COUNTY	TOTAL SHEET SHEETS	SHEET NO.
*	(109, 110) RS-5	LEE/OGLE	109	70
* FAS 1177 & FAU 5452		CONTRACT NO.	64J29	
FED. ROAD DIST. NO.		ILLINOIS	FED. AID PROJECT	

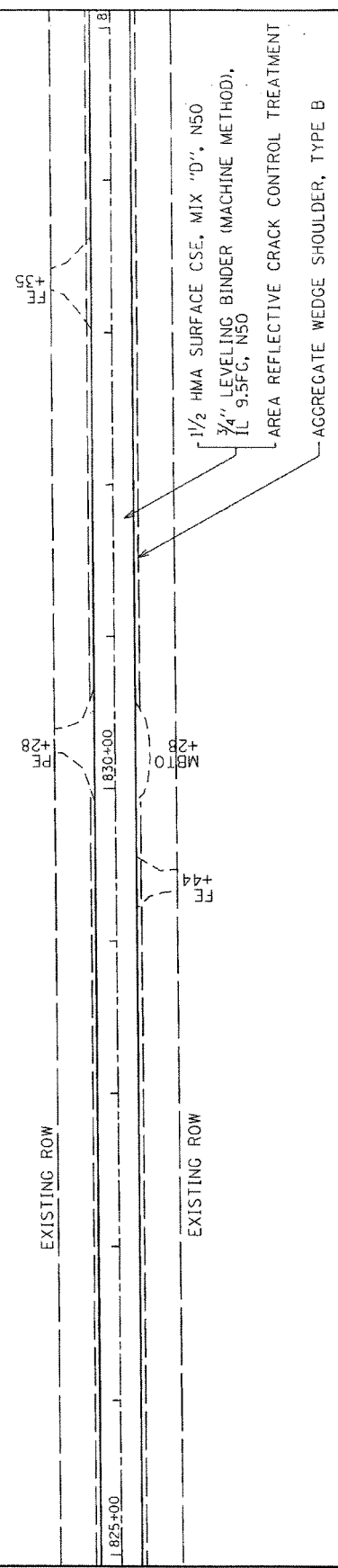
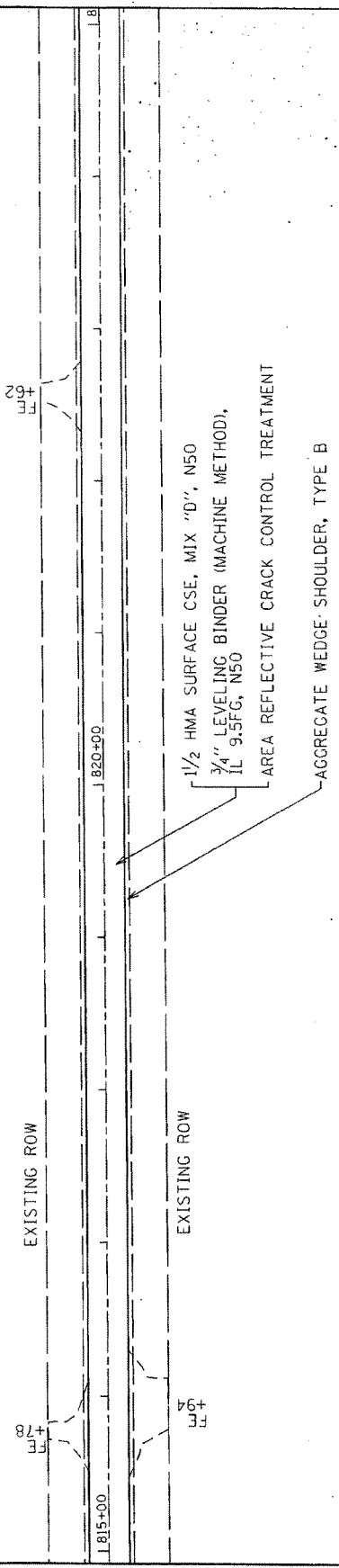

FILE NAME = c:\p-w\work\pvidot\goffj\180316687\18200513-sit-pln_ogle.dgn		STATE OF ILLINOIS DEPARTMENT OF TRANSPORTATION		IL 251 PLAN SHEET		F.A. RTE. • FAS 1177 & FAU 5452		SECTION (109, 110) RS-5		COUNTY LEE/OGLE		TOTAL SHEET SHEETS NO. 109 71	
USER NAME = goffj						• FED. ROAD DIST. NO. ILLINOIS		FED. AID PROJECT		CONTRACT NO. 64J29			
PLOT DATE = Thu Jan 24 13:24:37 2013													



INCIDENTAL HOT-MIX ASPHALT SURFACING

HMA SURFACE REMOVAL 2 1/4"

HOT MIX ASPHALT SURFACE REMOVAL, 2 1/4"

STA 841+52.5
HMA SURFACE
REMOVAL 2 1/4"
(SEE SPECIAL
PROVISION)

EXISTING ROW

PE +71

J 835+00

J 840+00

MB10 +71

EXISTING ROW

STA 842+20

1/2" HMA SURFACE CSE, MIX "D", N50

3/4" LEVELING BINDER (MACHINE METHOD),
IL 9.5FG, N50

AREA REFLECTIVE CRACK CONTROL TREATMENT

AGGREGATE WEDGE SHOULDER, TYPE B

INCIDENTAL HOT-MIX ASPHALT SURFACING
HMA SURFACE REMOVAL 2 1/4"



EXISTING ROW

J 845+00

J 850+00

EXISTING ROW

1/2" HMA SURFACE CSE, MIX "D", N50

3/4" LEVELING BINDER (MACHINE METHOD),
IL 9.5FG, N50

AGGREGATE WEDGE SHOULDER, TYPE B

HOT MIX ASPHALT SURFACE REMOVAL, 2 1/4"

FILE NAME =
c:\pw-work\pwidot\geff\j\0316607\0200513-sht-pln ogledgn
USER NAME = geffj
PLOT DATE = Thu Jan 24 13:24:38 2013

**STATE OF ILLINOIS
DEPARTMENT OF TRANSPORTATION**

IL 251 PLAN SHEET

F.A. RTE.	SECTION	COUNTY	TOTAL SHEETS	SHEET NO.
• FAS 1177 & FAU 5452	(109, 110) RS-5	LEE/ZOGLE	109	72
FED. ROAD DIST. NO.	ILLINOIS FED. AID PROJECT		CONTRACT NO.	64J29

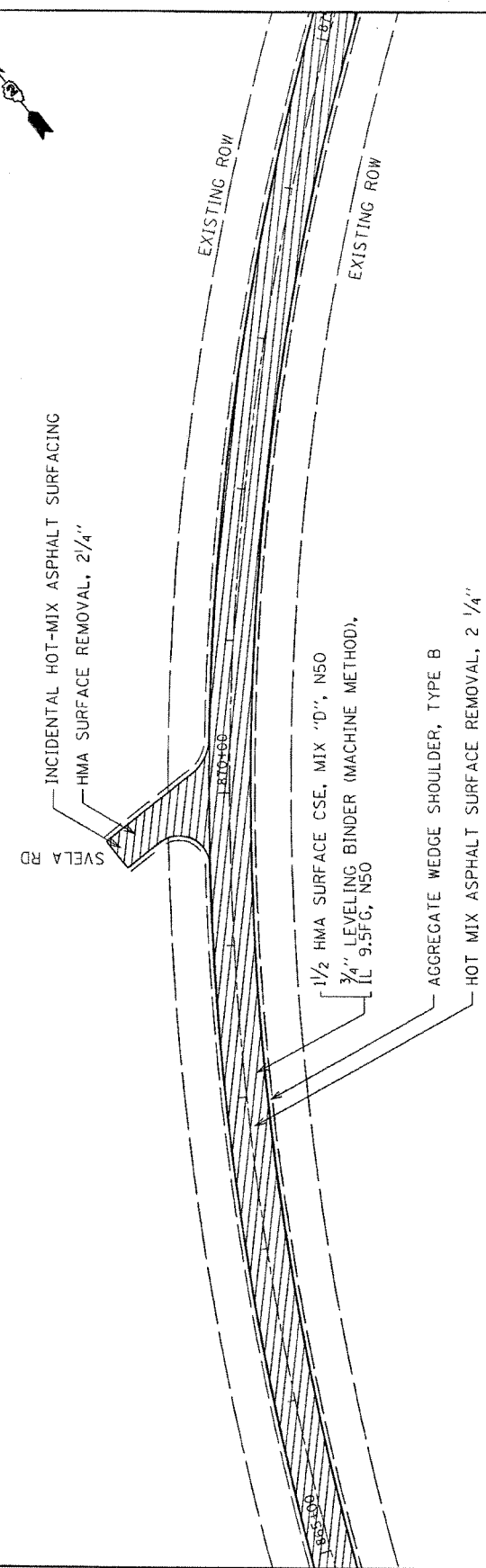
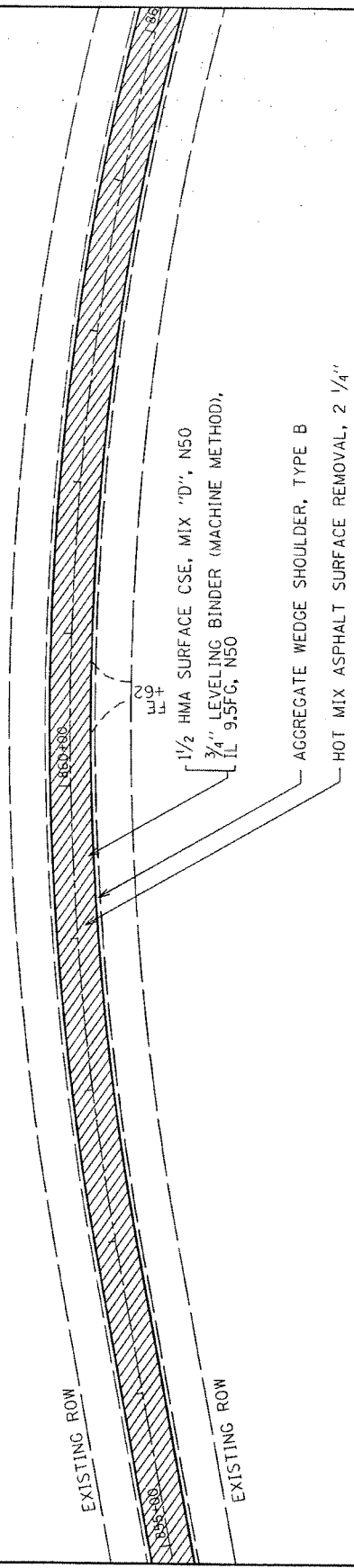

FILE NAME =
 c:\pwwork\pwwork\goff\j\0316607\0200513-sht-pln_ogle.dgn
 USER NAME = goff,j
 PLOT DATE = Thu Jan 24 13:24:39 2013

STATE OF ILLINOIS
DEPARTMENT OF TRANSPORTATION

IL 251 PLAN SHEET

F.A. RTE.	SECTION	COUNTY	TOTAL SHEETS	SHEET NO.
*	(109, 110) RS-5	LEE/OGLE	109	73
* FAS 1177 & FAU 5452		CONTRACT NO. 64J29		
FED. ROAD DIST. NO.		ILLINOIS FED. AID PROJECT		

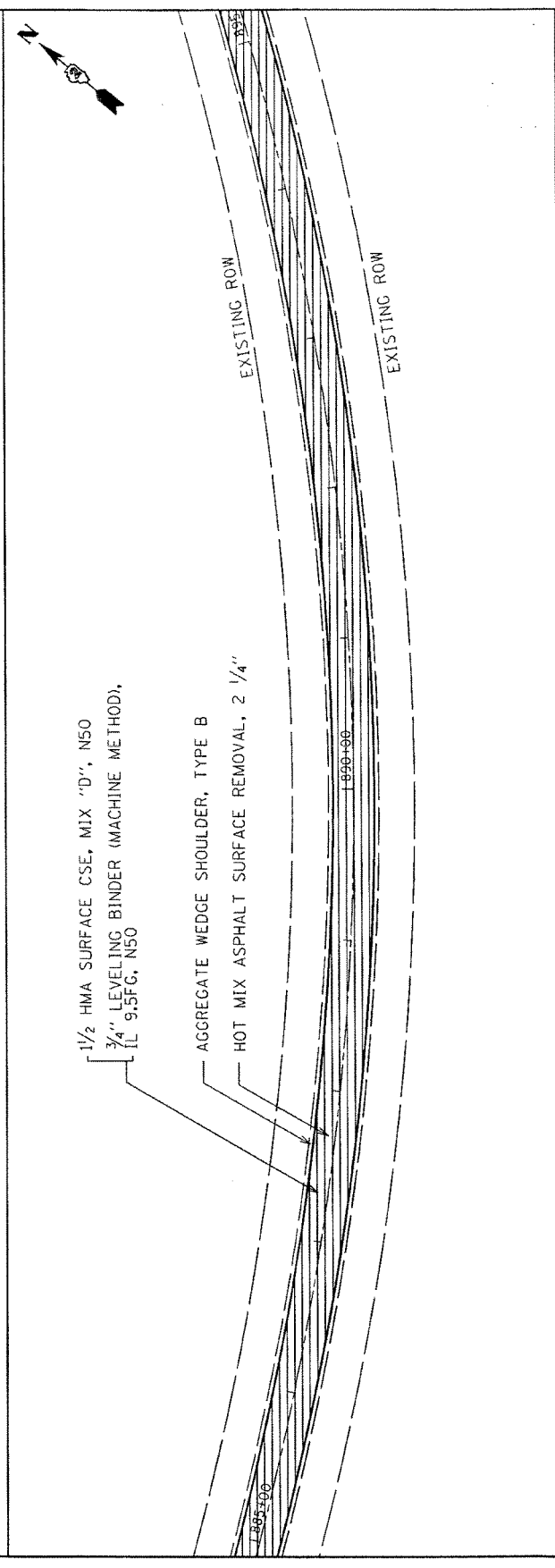
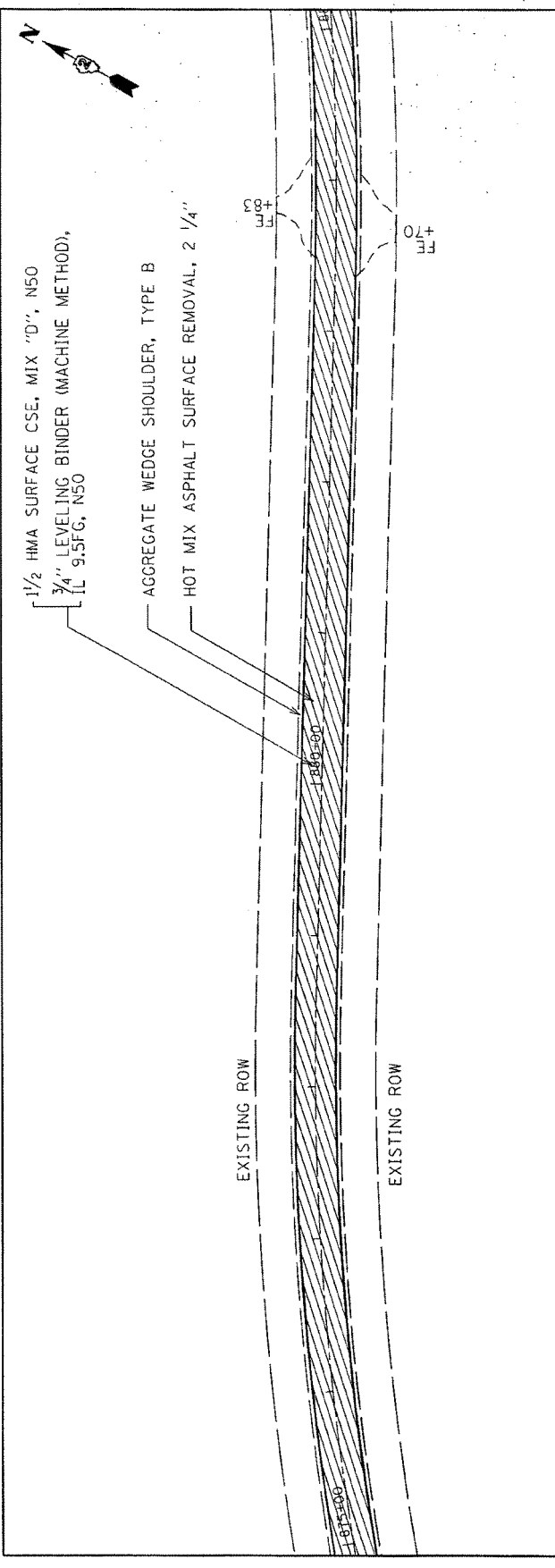

FILE NAME = c:\pwwork\pindot\goff\j\140316607\12200513-sht-pin ogle.dgn		STATE OF ILLINOIS		TOTAL SHEET NO.	
USER NAME = goffj		DEPARTMENT OF TRANSPORTATION		SHEETS 109 74	
PLOT DATE = Thu Jan 24 13:24:40 2013		SECTION		CONTRACT NO. 64J29	
		F.A. RTE.		COUNTY	
		• FAS 1177 & FAU 5452		LEE/OGLE	
		ILLINOIS FED. AID PROJECT			

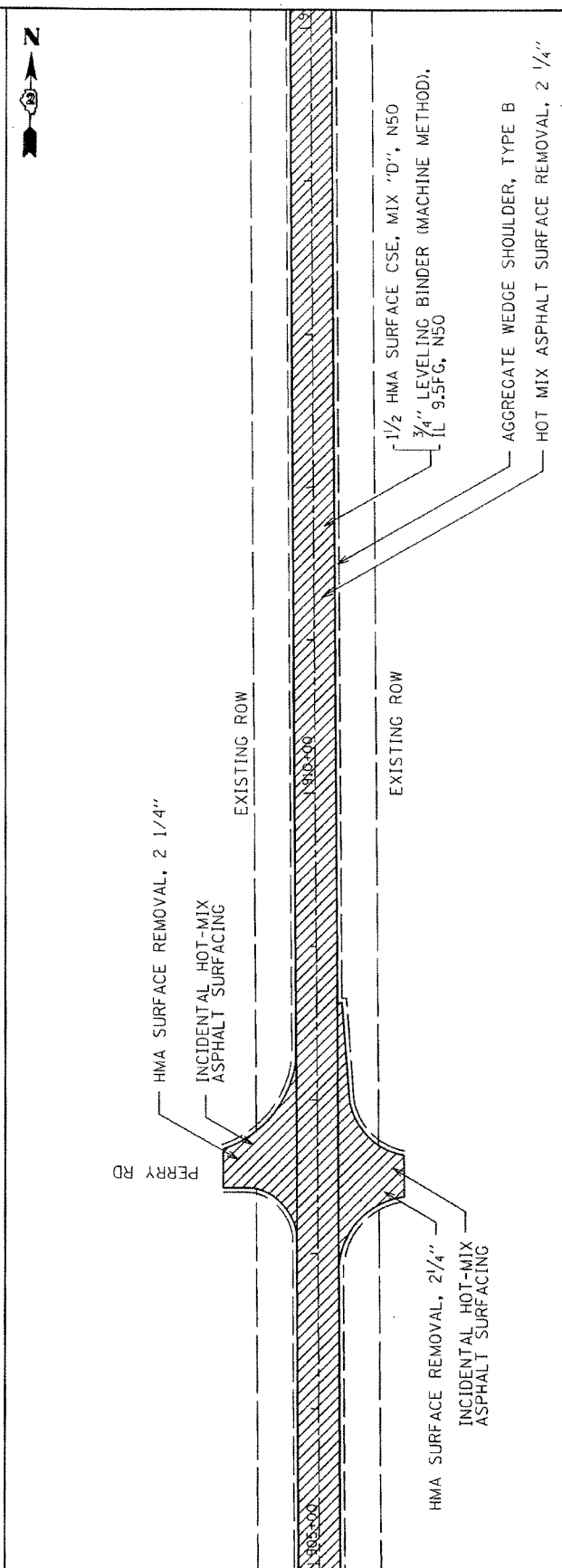
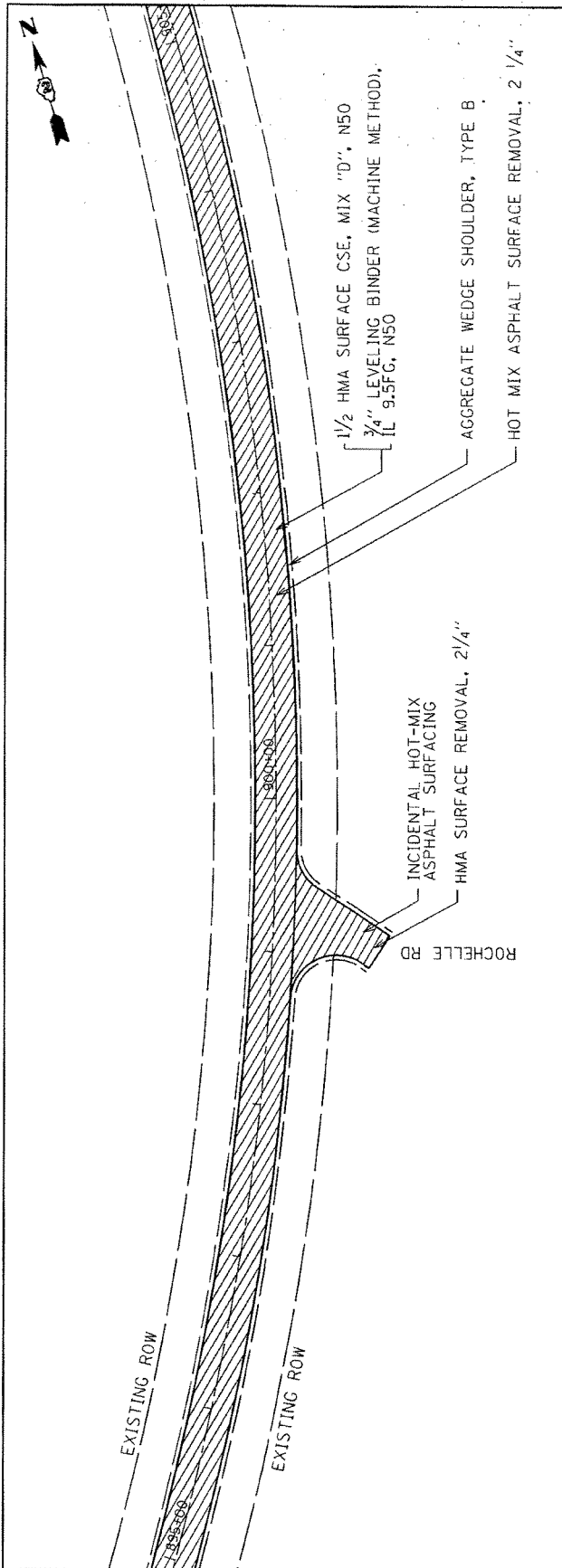

FILE NAME =		STATE OF ILLINOIS		TOTAL SHEET	
c:\p...work\pvidot\goff\j\0316687\0200513-sht-pln ogle.dgn		DEPARTMENT OF TRANSPORTATION		SHEETS NO.	
USER NAME = goffj		IL 251 PLAN SHEET		109	
PLOT DATE = Thu Jan 24 13:24:41 2013		SECTION		CONTRACT NO. 64J29	
		(109, 110) RS-5		LEE/OGLE	
		F.A. RTE.		FED. ROAD DIST. NO.	
		• FAS 1177 & FAU 5452		ILLINOIS FED. AID PROJECT	
		•			



EXISTING ROW



EXISTING ROW

1/2" HMA SURFACE CSE, MIX "D", N50
 3/4" LEVELING BINDER (MACHINE METHOD),
 IL 9.5FG, N50

AGGREGATE WEDGE SHOULDER, TYPE B

HOT MIX ASPHALT SURFACE REMOVAL, 2 1/4"



EXISTING ROW

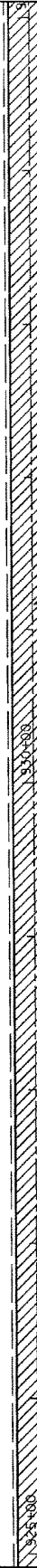

EXISTING ROW

1/2" HMA SURFACE CSE, MIX "D", N50
 3/4" LEVELING BINDER (MACHINE METHOD),
 IL 9.5FG, N50

AGGREGATE WEDGE SHOULDER, TYPE B

HOT MIX ASPHALT SURFACE REMOVAL, 2 1/4"

FILE NAME =
 c:\pw-work\pvidet\goff\j\0316607\0200513-sht-pin_ogle.dgn

USER NAME = goff\j

PLOT DATE = Thu Jan 24 13:24:42 2013

STATE OF ILLINOIS
DEPARTMENT OF TRANSPORTATION

IL 251 PLAN SHEET

F.A. RTE.	SECTION	COUNTY	TOTAL SHEETS	SHEET NO.
•	(109, 110) RS-5	LEE/OGLE	109	76
• FAS 1177 & FAU 5452		CONTRACT NO. 64J29		
FED. ROAD DIST. NO.		ILLINOIS FED. AID PROJECT		



EXISTING ROW

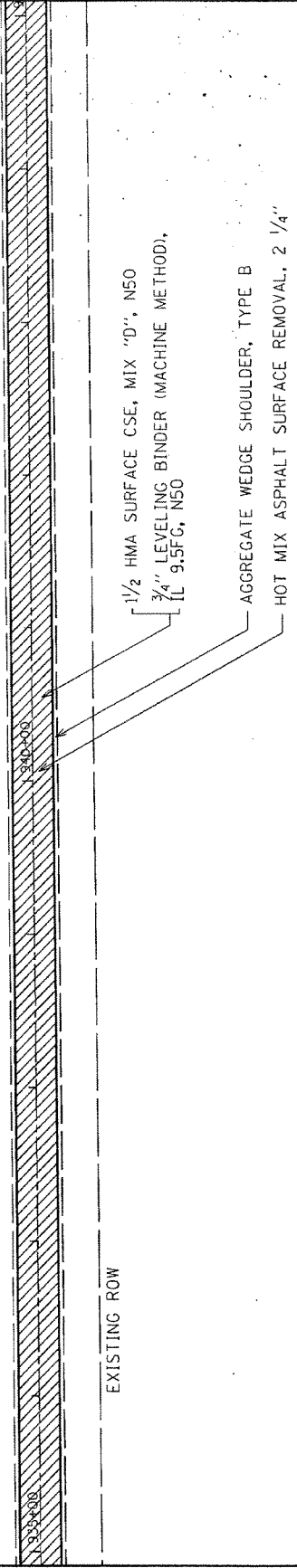

EXISTING ROW

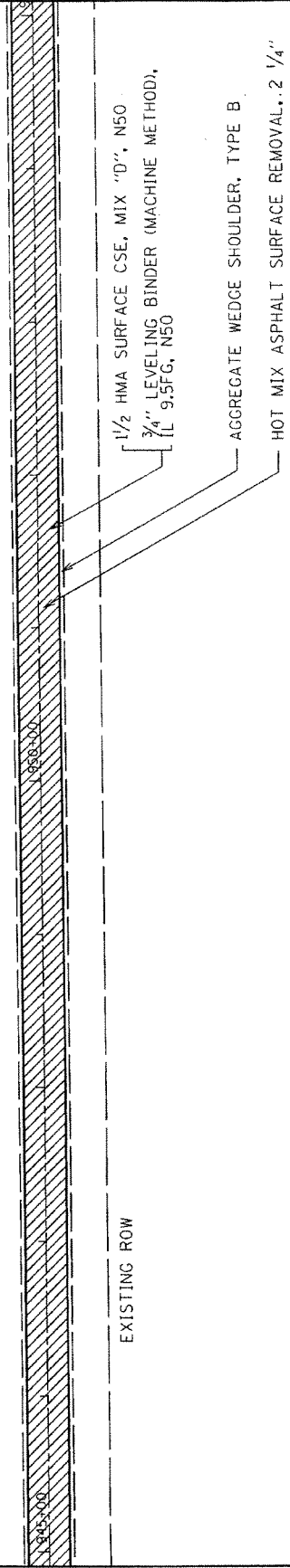

FILE NAME = c:\pwworkspace\pmdot\goff\j\0316607\1200513-shc-pln_ogle.dgn		STATE OF ILLINOIS		TOTAL SHEET SHEETS NO.	
USER NAME = goff\j		DEPARTMENT OF TRANSPORTATION		COUNTY	
PLOT DATE = Thu Jan 24 13:24:43 2013		SECTION		LEE/OGLE	
		IL 251 PLAN SHEET		CONTRACT NO. 64J29	
		F.A. RTE.		FED. ROAD DIST. NO.	
		* FAS 1177 & FAU 5452		ILLINOIS FED. AID PROJECT	
		(109, 110) RS-5		109 77	



EXISTING ROW

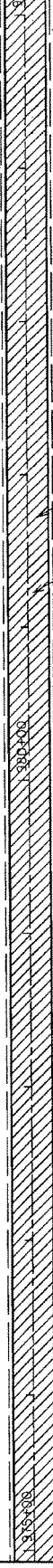

EXISTING ROW

1/2" HMA SURFACE CSE, MIX "D", N50
3/4" LEVELING BINDER (MACHINE METHOD),
IL 9.5FG, N50

AGGREGATE WEDGE SHOULDER, TYPE B
HOT MIX ASPHALT SURFACE REMOVAL, 2 1/4"



EXISTING ROW

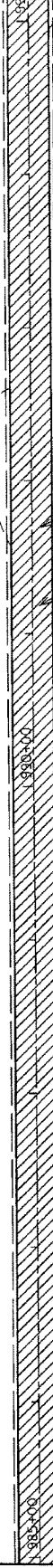

EXISTING ROW

1/2" HMA SURFACE CSE, MIX "D", N50
3/4" LEVELING BINDER (MACHINE METHOD),
IL 9.5FG, N50

AGGREGATE WEDGE SHOULDER, TYPE B
HOT MIX ASPHALT SURFACE REMOVAL, 2 1/4"

FILE NAME = c:\p-h-work\p-h\dot\goff\j\0316607\0200517-shr-pln.ogla.dgn	STATE OF ILLINOIS		IL 251 PLAN SHEET	F.A. RTE. *	SECTION	COUNTY	TOTAL SHEET
USER NAME = goff, j	DEPARTMENT OF TRANSPORTATION			* FAS 1177 & FAU 5452	(109, 110) RS-5	LEE/OGLE	SHEETS NO.
PLOT DATE = Thu Jan 24 13:24:45 2013				ILLINOIS FED. AID PROJECT			109 79
							CONTRACT NO. 64J29

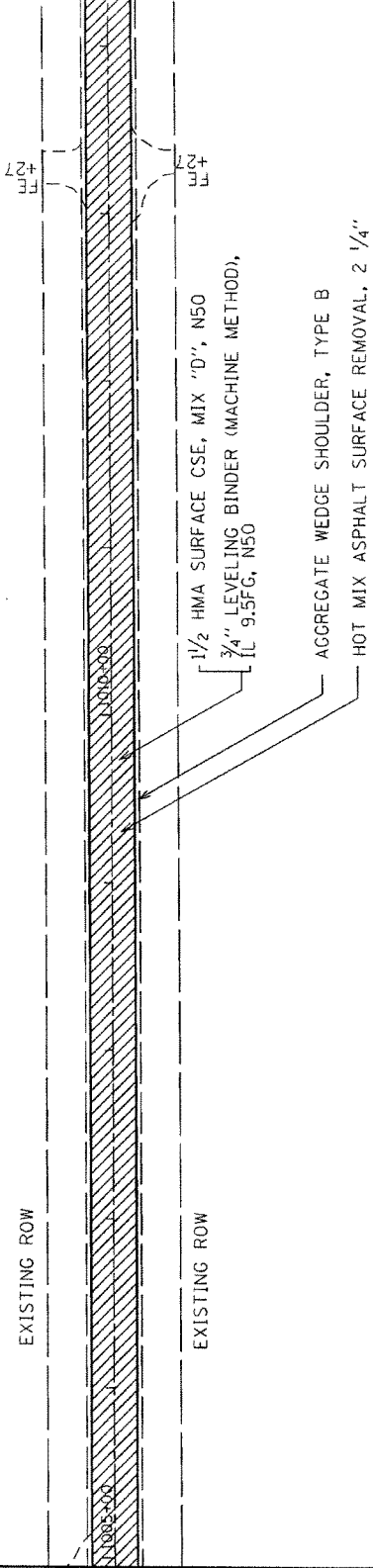
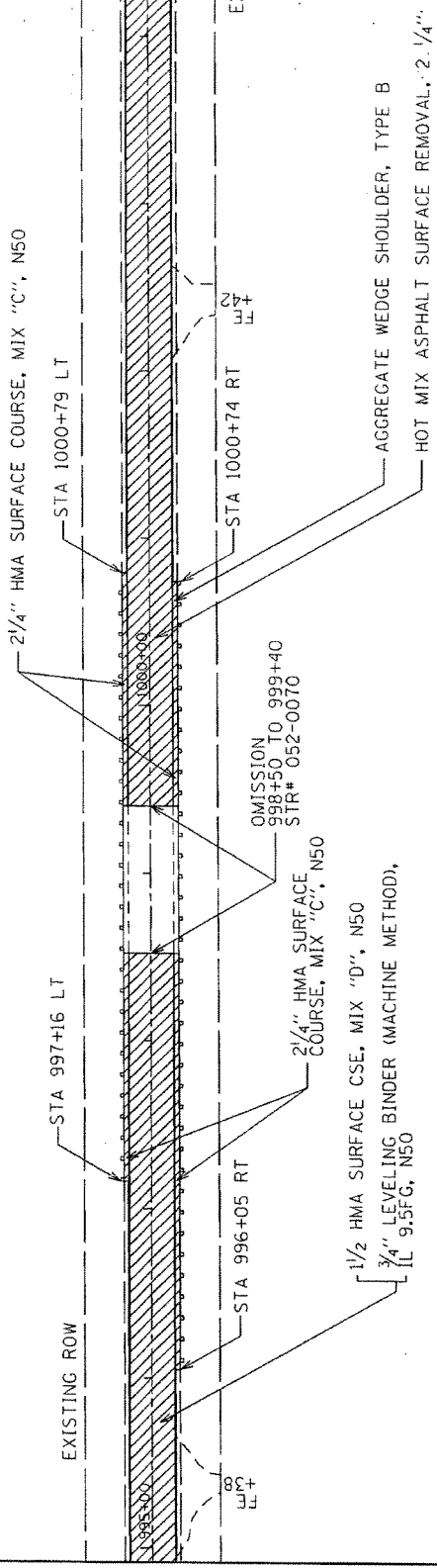

FILE NAME =
 ct:\pw-wor-k\p\dot\geoff\j\02316687\0200513-sht-pln_ogle.dgn
 USER NAME = geoffj
 PLOT DATE = Thu Jan 24 13:24:46 2013

STATE OF ILLINOIS
DEPARTMENT OF TRANSPORTATION

IL 251 PLAN SHEET

F.A. RTE.	SECTION	COUNTY	TOTAL SHEET NO.
• FAS 1177 & FAU 5452	(109, 110) RS-5	LEE/OGLE	109 80
FED. ROAD DIST. NO.	ILLINOIS	FED. AID PROJECT	CONTRACT NO.
			64,029



EXISTING ROW

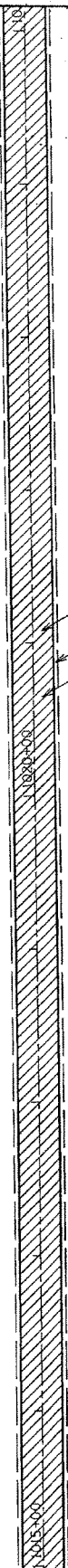

EXISTING ROW

1/2" HMA SURFACE CSE, MIX "D", N50
 3/4" LEVELING BINDER (MACHINE METHOD),
 IL 9.5FG, N50

AGGREGATE WEDGE SHOULDER, TYPE B

HOT MIX ASPHALT SURFACE REMOVAL, 2 1/4"



EXISTING ROW



EXISTING ROW

1/2" HMA SURFACE CSE, MIX "D", N50
 3/4" LEVELING BINDER (MACHINE METHOD),
 IL 9.5FG, N50

AGGREGATE WEDGE SHOULDER, TYPE B

HOT MIX ASPHALT SURFACE REMOVAL, 2 1/4"

FILE NAME = c:\p-work\pmdot\goff\j\ed8316607\0200513-shr-pln_ogle.dgn

USER NAME = goffj

PLOT DATE = Thu Jan 24 13:24:48 2013

STATE OF ILLINOIS
DEPARTMENT OF TRANSPORTATION

IL 251 PLAN SHEET

F.A. RTE.	SECTION	COUNTY	TOTAL SHEETS	SHEET NO.
•	(109, 110) RS-5	LEE/OGLE	109	81
• FAS 1177 & FAU 5452		CONTRACT NO.		64J29
FED. ROAD DIST. NO. ILLINOIS FED. AID PROJECT				

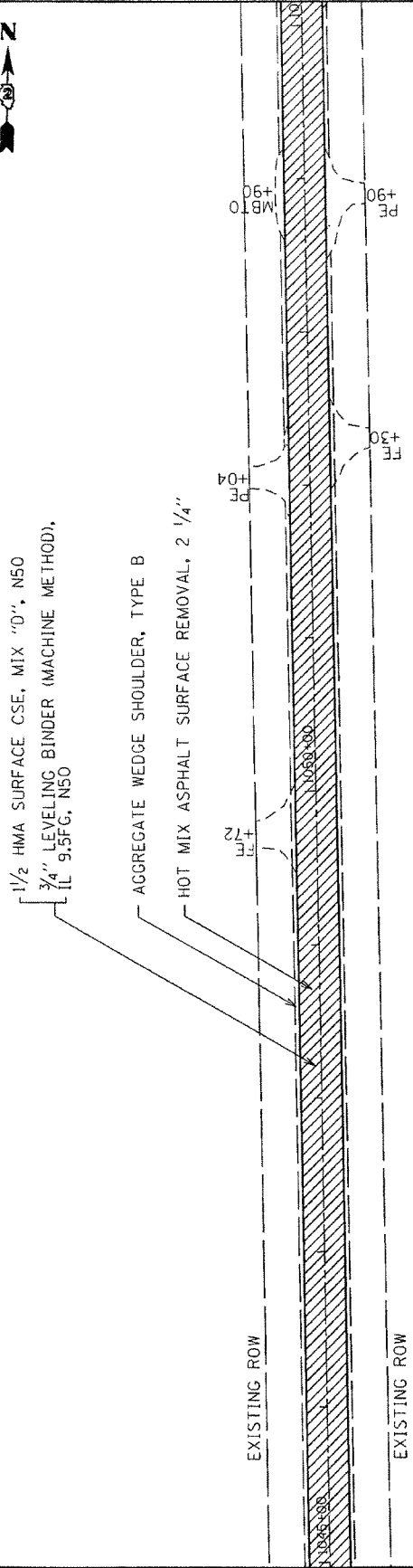
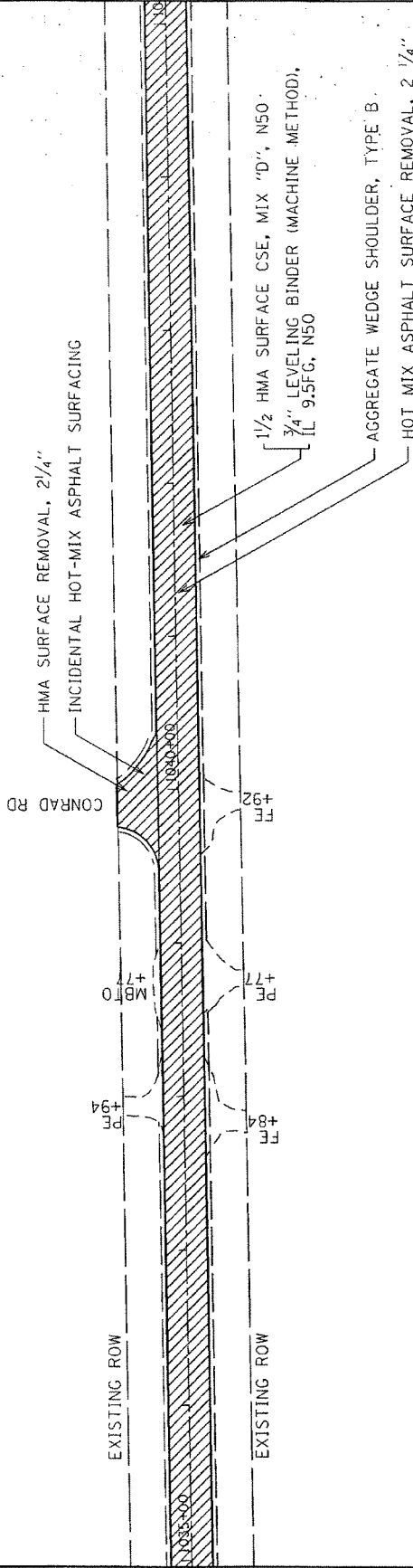

FILE NAME = c:\pwwork\pwwork\pwwork\goffr.j\0316607\0200513-shr-pln_ogle.dgn
 USER NAME = goffr.j
 PLOT DATE = Thu Jan 24 13:24:49 2013

STATE OF ILLINOIS
DEPARTMENT OF TRANSPORTATION

IL 251 PLAN SHEET

F.A. RTE.	SECTION	COUNTY	TOTAL SHEETS NO.	SHEET NO.
*	(109, 110) RS-5	LEE/OGLE	109	82
* FAS 1177 & FAU 5452		CONTRACT NO. 64J29		
FED. ROAD DIST. NO.		ILLINOISIFIED AID PROJECT		

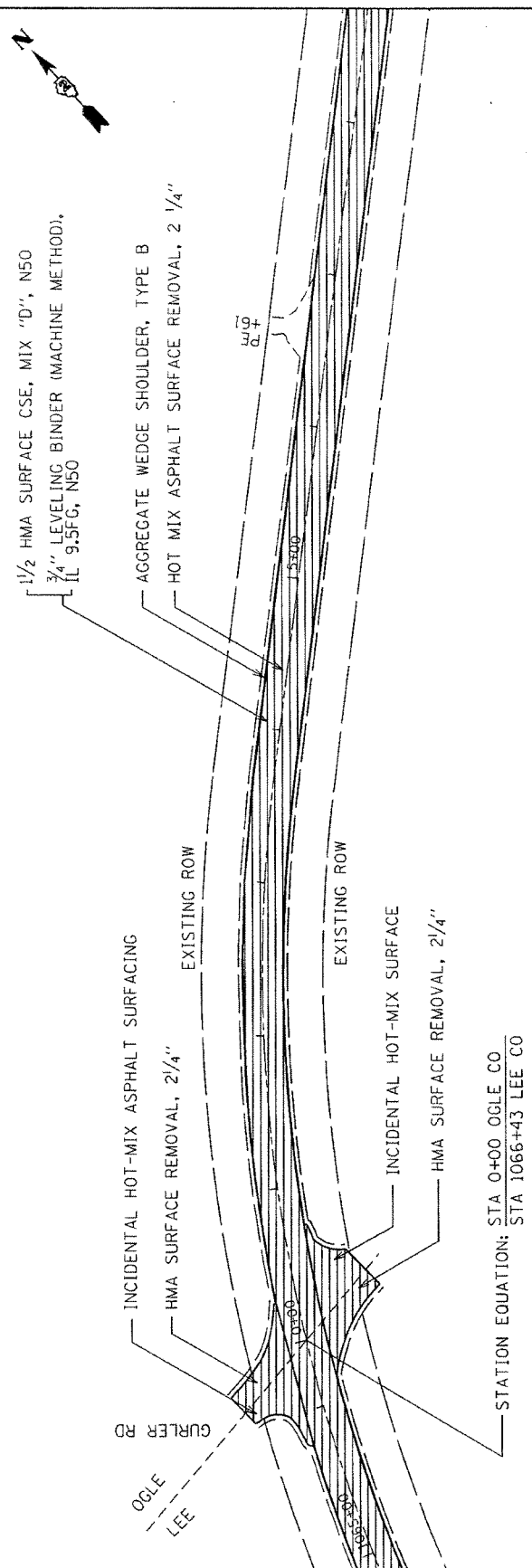
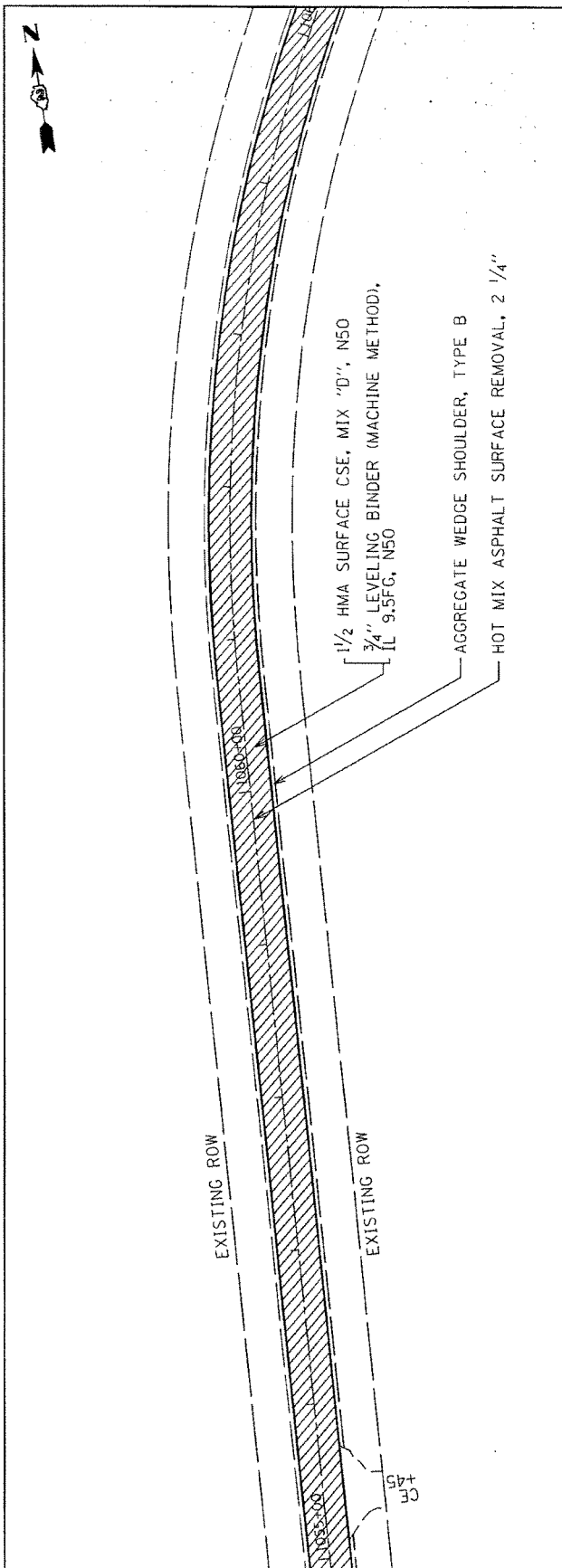

FILE NAME = c:\pwwork\pmdot\goff\j\10316607\2005\3-sht-pln ogle.dgn		STATE OF ILLINOIS DEPARTMENT OF TRANSPORTATION		IL 251 PLAN SHEET		F.A. RTE.		SECTION		COUNTY		TOTAL SHEETS		SHEET NO.	
USER NAME = goff,jl		STATION EQUATION: STA 0+00 OGLE CO STA 1066+43 LEE CO				• FAS 1177 & FAU 5452		(109, 110) RS-5		LEE/OGLE		109		83	
PLOT DATE = Thu Jan 24 13:24:51 2013						• ILLINOIS FED. AID PROJECT						CONTRACT NO.		64J29	

1/2" HMA SURFACE CSE, MIX "D", N50
 3/4" LEVELING BINDER (MACHINE METHOD),
 L 9.5FG, N50

AGGREGATE WEDGE SHOULDER, TYPE B

HOT MIX ASPHALT SURFACE REMOVAL, 2 1/4"

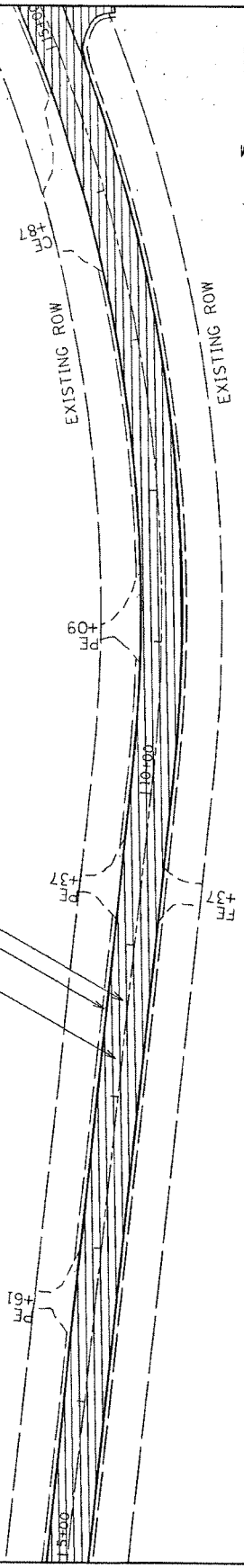

AGGREGATE W



STA 22+52 LANE TRANS.

EXISTING ROW

EXISTING ROW

PRIVATE RD

INCIDENTAL HOT-MIX SURFACING
 HMA SURFACE REMOVAL, 2 1/4"

1/2" HMA SURFACE CSE, MIX "D", N50
 3/4" LEVELING BINDER (MACHINE METHOD),
 L 9.5FG, N50

AGGREGATE WEDGE SHOULDER, TYPE B

HOT MIX ASPHALT SURFACE REMOVAL, 2 1/4"

FILE NAME =
 c:\pwwork\pindot\goff\j\0315607\0200513-sht-pln_ogle.dgn
 USER NAME = goffj
 PLOT DATE = Thu Jan 24 13:24:52 2013

STATE OF ILLINOIS
DEPARTMENT OF TRANSPORTATION

IL 251 PLAN SHEET

F.A. RTE.	SECTION	COUNTY	TOTAL SHEETS	SHEET NO.
• FAS 1177 & FAU 5452	(109, 110) RS-5	LEE/OGLE	109	84
FED. ROAD DIST. NO.	ILLINOIS FED. AID PROJECT	CONTRACT NO. 64J29		

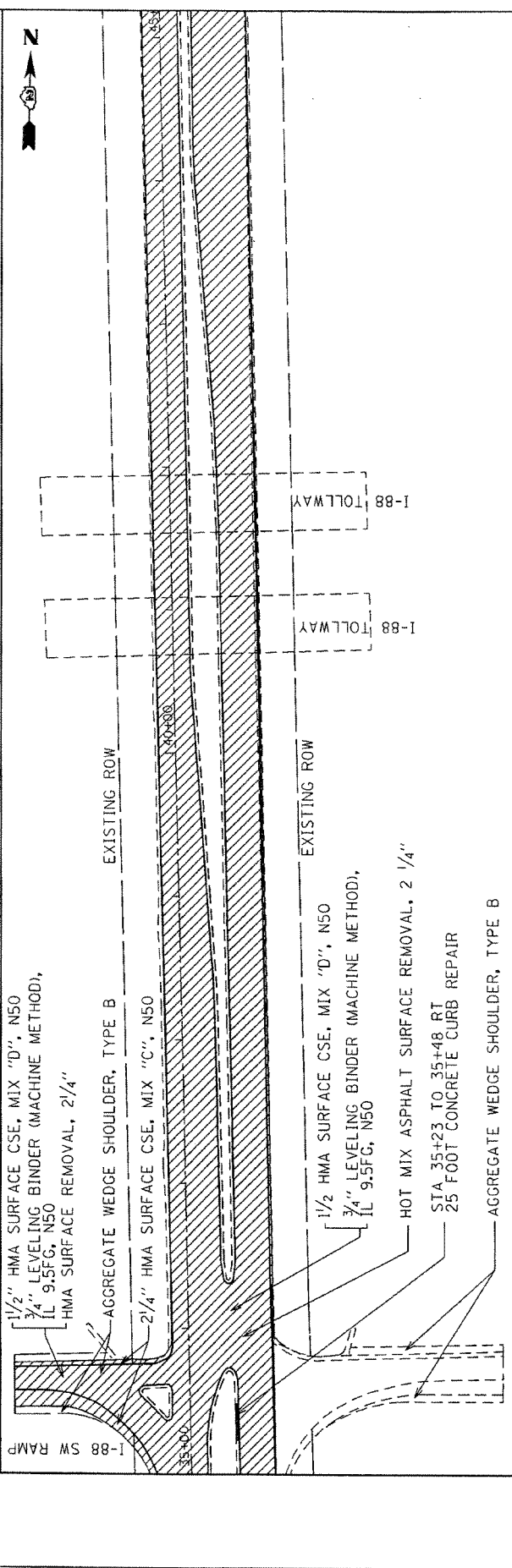
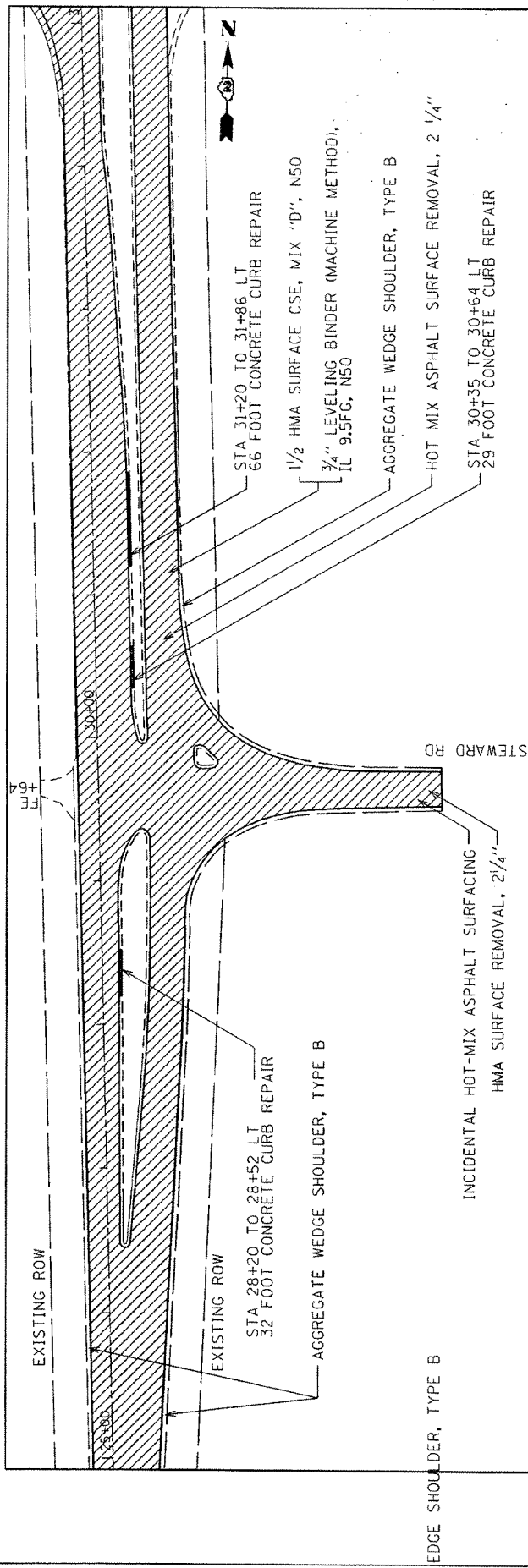

FILE NAME = c:\pwwork\pndot\gof\j\0316607\0200513-shr-pln.ogle.dgn		STATE OF ILLINOIS		TOTAL SHEET NO.	
USER NAME = gof\j		DEPARTMENT OF TRANSPORTATION		SHEETS	
PLOT DATE = Thu Jan 24 13:24:54 2013		IL 251 PLAN SHEET		109	
		SECTION		CONTRACT NO. 64.029	
		(109, 110) RS-5		FED. ROAD DIST. NO. ILLINOIS FED. AID PROJECT	
		F.A. RTE.		LEE/OGLE	
		• FAS 1177 & FAU 5452			

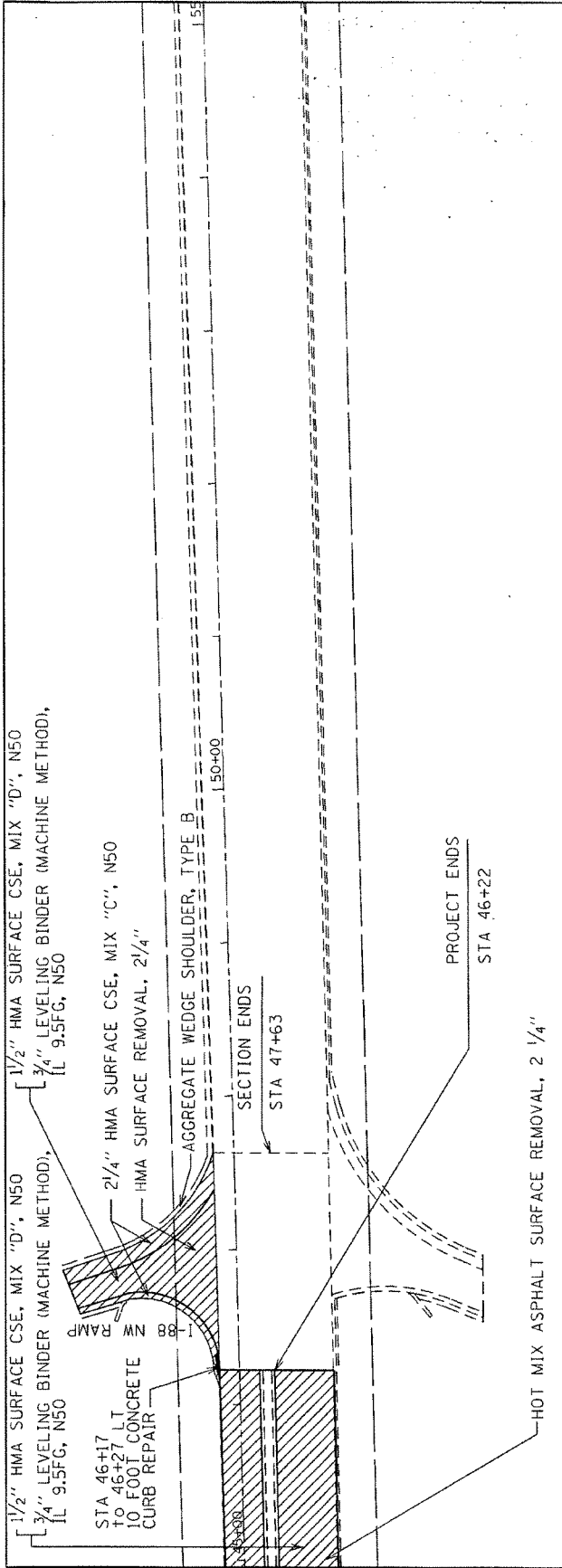

FILE NAME = c:\pwwork\pwwork\goff\j\00316607\0200513-shr-pln ogle.dgn		STATE OF ILLINOIS DEPARTMENT OF TRANSPORTATION		IL 251 PLAN SHEET		F.A. RTE. •		SECTION (109, 110) RS-5		TOTAL SHEETS 109		SHEET NO. 86	
USER NAME = goff,j		DEPARTMENT OF TRANSPORTATION		IL 251 PLAN SHEET		* FAS 1177 & FAU 5452		CONTRACT NO. 64J29		TOTAL SHEETS 109		SHEET NO. 86	
PLOT DATE = Thu Jan 24 13:24:55 2013		DEPARTMENT OF TRANSPORTATION		IL 251 PLAN SHEET		* FAS 1177 & FAU 5452		CONTRACT NO. 64J29		TOTAL SHEETS 109		SHEET NO. 86	
		DEPARTMENT OF TRANSPORTATION		IL 251 PLAN SHEET		* FAS 1177 & FAU 5452		CONTRACT NO. 64J29		TOTAL SHEETS 109		SHEET NO. 86	
		DEPARTMENT OF TRANSPORTATION		IL 251 PLAN SHEET		* FAS 1177 & FAU 5452		CONTRACT NO. 64J29		TOTAL SHEETS 109		SHEET NO. 86	

PAVEMENT PATCHING DETAIL

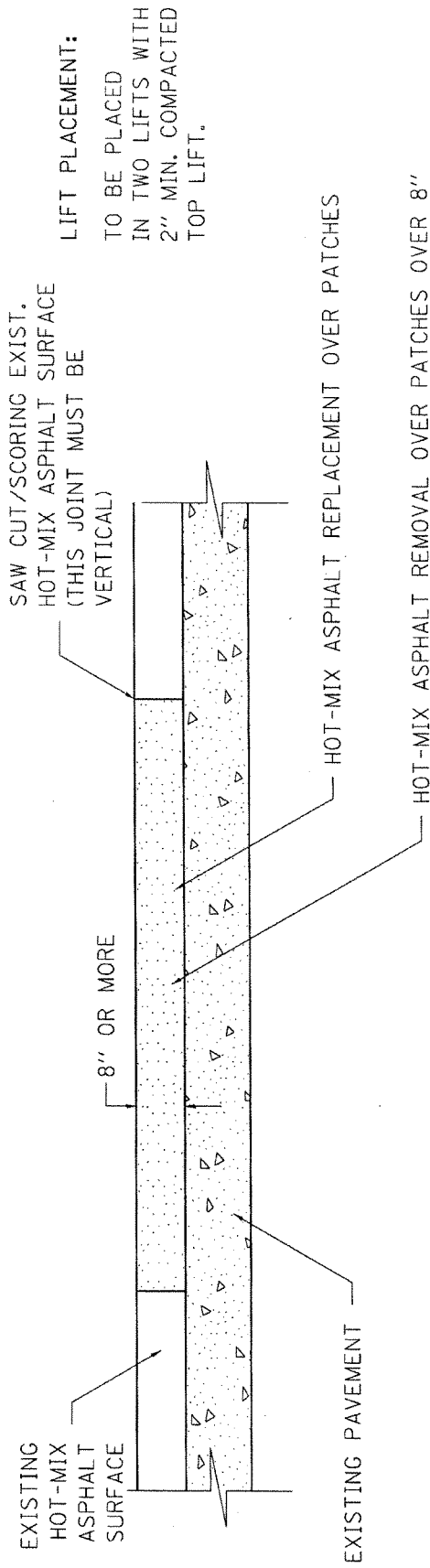

LIFT PLACEMENT:
TO BE PLACED
IN TWO LIFTS WITH
2" MIN. COMPACTED
TOP LIFT.

SEQUENCE OF CONSTRUCTION:

1. REMOVE THE EXISTING HOT-MIX ASPHALT SURFACE.
2. REPLACE HOT-MIX ASPHALT SURFACE.

GENERAL NOTES:

1. FOR BASIS OF PAYMENT: SEE THE RECURRING SPECIAL PROVISION "PATCHING WITH HOT-MIX ASPHALT OVERLAY REMOVAL".
- ALL DIMENSIONS ARE IN INCHES UNLESS OTHERWISE NOTED.

REVISED - 10-03-11

PAVEMENT PATCHING DETAIL 33.4

FILE NAME = c:\pw-work\pwwork\goff\j\0316607\0200513-shr-typicoe.dgn	STATE OF ILLINOIS		F.A. RTE.	SECTION	COUNTY	TOTAL SHEETS	SHEET NO.
	DEPARTMENT OF TRANSPORTATION		REGION 2 / DISTRICT 2 STANDARD	(109, 110) RS-5	LEE/OGLE	109	88
USER NAME = goffj			FED. ROAD DIST. NO.	ILLINOIS	FED. AID PROJECT	CONTRACT NO. 64J29	
PLOT DATE = Tue Nov 05 11:45:55 2013							

DELINEATOR AND POST ORIENTATION

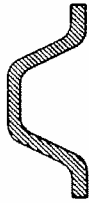

SECTION D-D

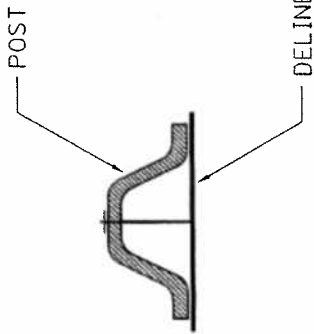

DIRECTION OF TRAFFIC

DELINEATORS SHALL BE INSTALLED ACCORDING TO STANDARD 635001 EXCEPT THAT THE POST SHALL BE ROTATED 180°. THE POST WILL HAVE THE WIDE SIDE FACING TRAFFIC AND THE DELINEATOR ATTACHED AS SHOWN ABOVE.

ALL DIMENSIONS ARE IN INCHES UNLESS OTHERWISE NOTED.

REVISED - 10-03-11

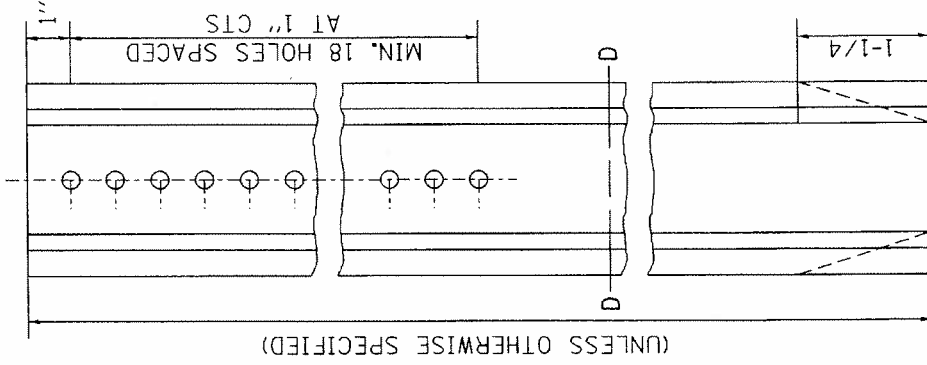

(UNLESS OTHERWISE SPECIFIED)

DELINEATOR AND POST ORIENTATION 37.4

FILE NAME = c:\p\work\p\midot\go\ffj\d0316687\0200513-sht-typicol.dgn	STATE OF ILLINOIS DEPARTMENT OF TRANSPORTATION		REGION 2 / DISTRICT 2 STANDARD	F.A. RTE. •	SECTION (109, 110) RS-5	COUNTY LEE/OGLE	TOTAL SHEETS 109	SHEET NO. 89
	USER NAME = go\ffj			•		CONTRACT NO. 64J29	FED. ROAD DIST. NO. ILLINOIS FED. AID PROJECT	
PLOT DATE = Tue Nov 05 11:46:22 2013								

AERIAL SPEED CHECK ZONES

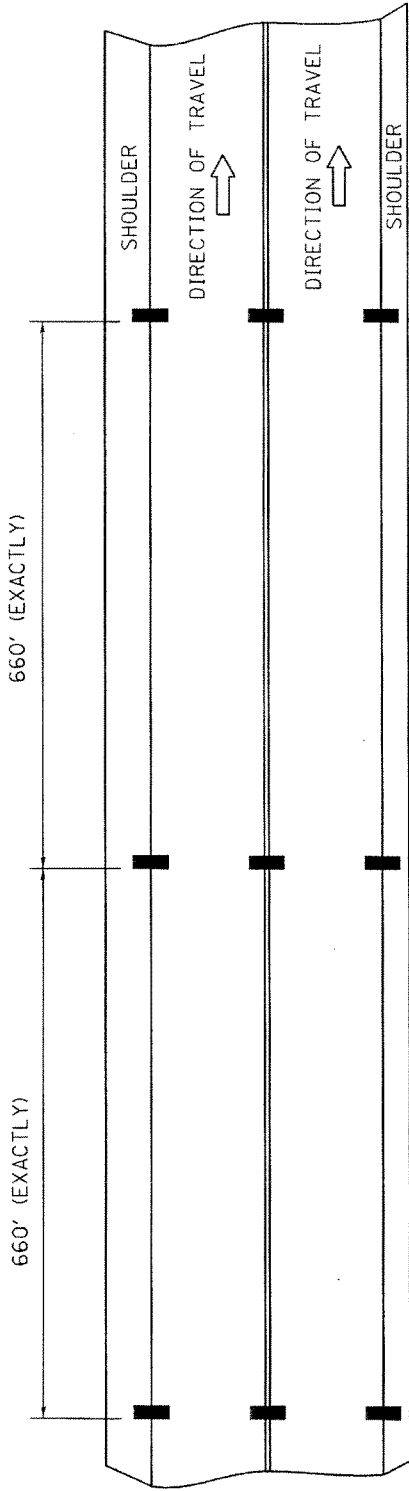

USE THERMOPLASTIC PAVEMENT MARKINGS

PAVEMENT MARKING DETAIL

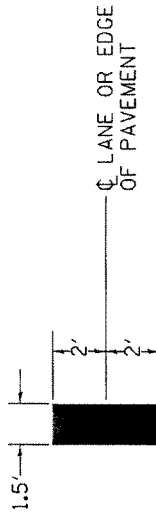

REVISED - 8-27-13
REVISED - 10-03-11

POLICE AERIAL SPEED CHECK ZONES

ESTABLISHED ZONES AND NEW ZONES REQUESTED BY THE ILLINOIS STATE POLICE SHALL BE MARKED CONSISTENT WITH THE REQUIREMENTS OF SECTION 3B-21 OF THE MUTCD. WHEN NEW ZONES ARE PLACED IT WILL BE NECESSARY TO HAVE A REPRESENTATIVE OF THE STATE POLICE PRESENT SO THAT THE ACCURACY OF THE MEASUREMENT CAN BE ATTESTED TO IN COURT.

ILLINOIS STATE POLICE

DISTRICT 1 STERLING 815/632-4010 CARROLL, LEE, OGLE, WHITESIDE
DISTRICT 7 EAST MOLINE 309/752-4915 HENRY, ROCK ISLAND
DISTRICT 16 PECAATONICA 815/239-1152 BOONE, JO DAVIESS, STEPHENSON, WINNEBAGO

BASIS OF PAYMENT:

THIS WORK SHALL BE PAID FOR AT THE CONTRACT UNIT PRICE PER FOOT FOR AERIAL SPEED CHECK MARKING.

AERIAL SPEED CHECK ZONES 46.4

FILE NAME = c:\pwr\work\pml\dot\goff\j\ed\315687\0200513-sh-typical.dgn	STATE OF ILLINOIS DEPARTMENT OF TRANSPORTATION	REGION 2 / DISTRICT 2 STANDARD	F.A. RTE. •	SECTION (109, 110) RS-5	COUNTY LEE/OGLE	TOTAL SHEET SHEETS 109	SHEET NO. 90
USER NAME = goff,j			FED. ROAD DIST. NO. ILLINOIS		CONTRACT NO. 64J29	FED. AID PROJECT	
PLOT DATE = Tue Nov 05 11:46:08 2013							

RUMBLE RESURFACING

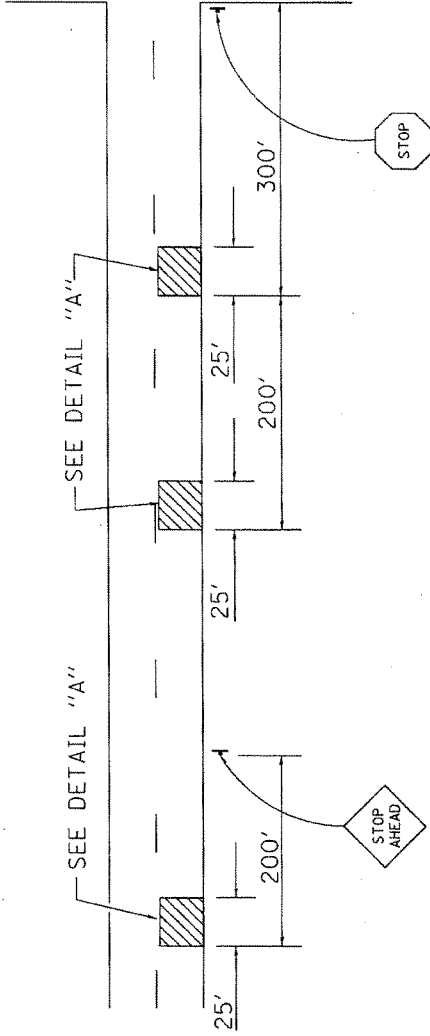

GROOVED

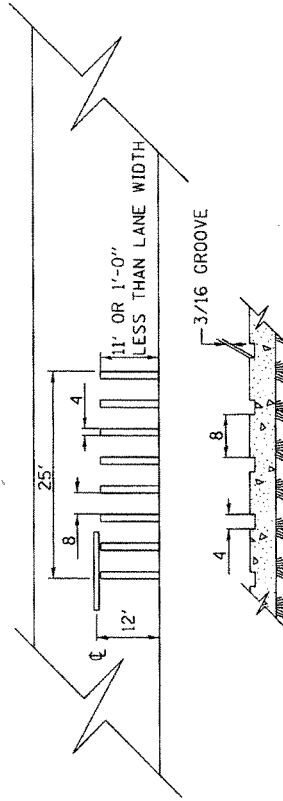

DETAIL "A"

NOTES

THE GROOVES SHALL BE CONSTRUCTED WITH A MILLING MACHINE CAPABLE OF COLD MILLING THE EXISTING SURFACE IN THE PATTERN SHOWN.

RUMBLE RESURFACING SHALL BE MEASURED FOR PAYMENT IN PLACE AND THE AREA COMPUTED IN SQUARE YARDS. THE LENGTH SHALL BE THE DISTANCE FROM OUTSIDE EDGE TO OUTSIDE EDGE OF THE GROOVE WHICH WILL BE APPROXIMATELY 25'. THE WIDTH SHALL BE 1' LESS THAN LANE WIDTH.

RUMBLE STRIPS SHALL BE CONSTRUCTED AS SHOWN AND PAID FOR PER SQUARE YARD AS RUMBLE RESURFACING.

ALL DIMENSIONS ARE IN INCHES UNLESS OTHERWISE NOTED.

REVISED - 10-05-11

RUMBLE RESURFACING 91.4

FILE NAME = c:\pwwork\pwwork\goff\j\08316607\0200513-sht-typical.dgn	STATE OF ILLINOIS DEPARTMENT OF TRANSPORTATION	REGION 2 / DISTRICT 2 STANDARD	F.A. RTE. •	SECTION (109, 110) RS-5	COUNTY LEE/OGLE	TOTAL SHEETS 109	SHEET NO. 91
USER NAME = goff,j			FED. ROAD DIST. NO.	ILLINOIS FED. AID PROJECT	CONTRACT NO. 64J29		
PLOT DATE = Tue Nov 05 11:46:09 2013							

TYPICAL MARKING FOR PAINTED ISLANDS

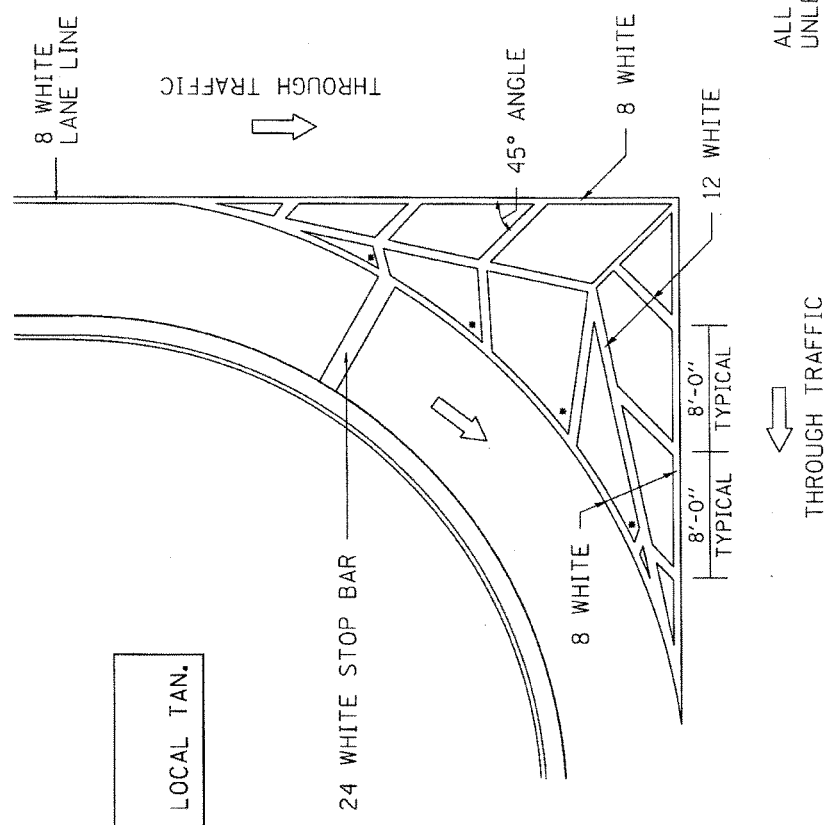

NOTE:
* 45° TO LOCAL TAN.

ALL DIMENSIONS ARE IN INCHES
UNLESS OTHERWISE NOTED.

REVISED - 10-05-11

TYPICAL MARKING FOR PAINTED ISLANDS 93.4

FILE NAME = c:\pwork\pwork\pwork\geff\j\ad3f6687\0200513-sht-typical.odg	STATE OF ILLINOIS		SECTION		COUNTY		TOTAL SHEETS	
	DEPARTMENT OF TRANSPORTATION		REGION 2 / DISTRICT 2 STANDARD		F.A. RTE. • (109, 110) RS-5		LEE/OGLE 109	
USER NAME = geffj			FED. ROAD DIST. NO.		ILLINOIS FED. AID PROJECT		CONTRACT NO. 64J29	
PLOT DATE = Tue Nov 05 11:46:10 2013								

INFORMATIONAL WARNING SIGN (FOR NARROW TRAVEL LANES)

NOTES
 W12-2 - Horizontal Clearance Sign
 48.0" across sides, 1.9" Radius,
 0.8" Border, 0.5" Indent, Black on
 Orange; Standard Arrow Custom
 10.4" X 8.1" 180° Black 11 Inch
 D Series Lettering; Standard Arrow
 Custom 10.4" X 8.1" 0°

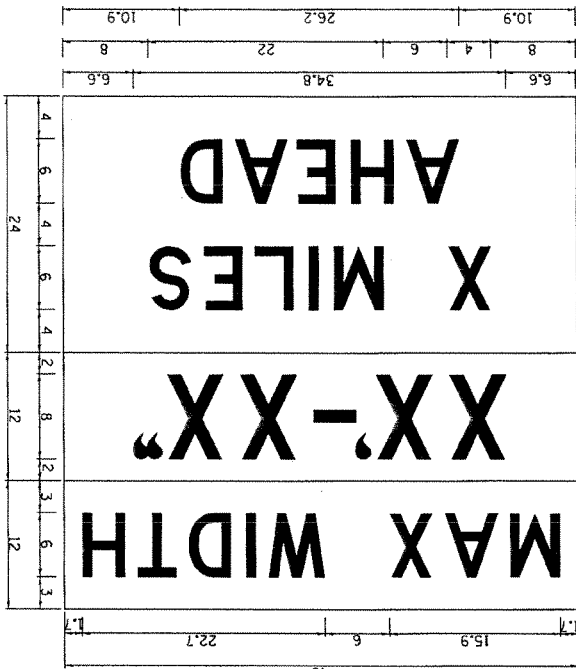
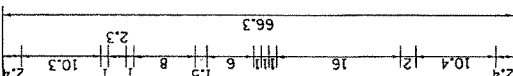
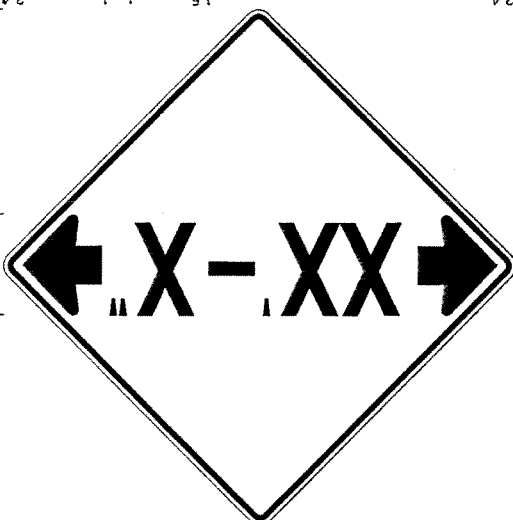
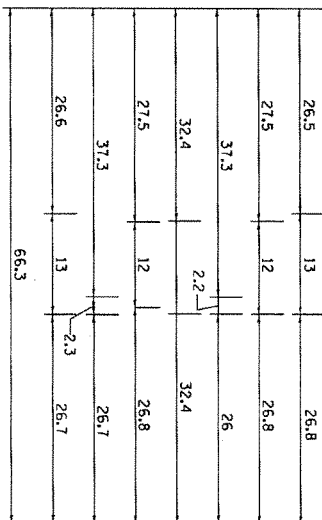

W12-1103 (width is BD);
 No border, Black on White;
 (MAX WIDTH) D;

No border, Black on Orange;
 (XX-XX) D;

No border, Black on White;
 (X MILES) D; (AHEAD) D;

All work to furnish and install these signs shall be included in the cost of the Traffic Control Standards and shall not be paid for separately. OTHERWISE NOTED.

REVISED - 5-15-09

INFORMATIONAL WARNING SIGNS (FOR NARROW TRAVEL LANES) 39.2

FILE NAME = c:\pwwork\pwwork\goff\j\ad0316607\0200513-sh4-tuprca1.dgn	STATE OF ILLINOIS DEPARTMENT OF TRANSPORTATION	REGION 2 / DISTRICT 2 STANDARD	F.A. RTE. •	SECTION (109, 110) RS-5	COUNTY LEE/OGLE	TOTAL SHEETS 109	SHEET NO. 93
USER NAME = goff j						CONTRACT NO. 64J29	
PLOT DATE = Tue Nov 05 11:46:23 2013							

HOT-MIX ASPHALT APPROACHES & MAILBOX RETURNS FOR TWO LIFT (3P) RESURFACING PROJECTS

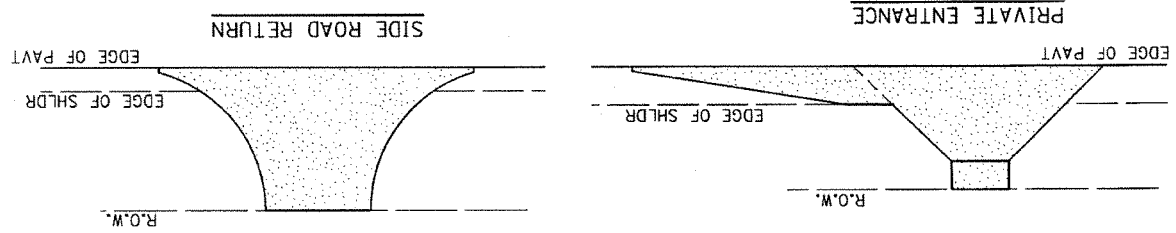
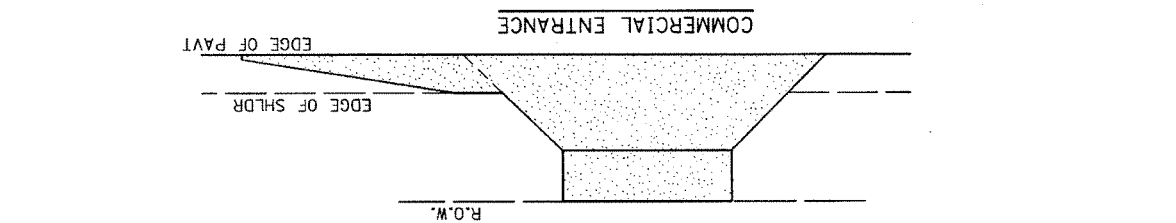
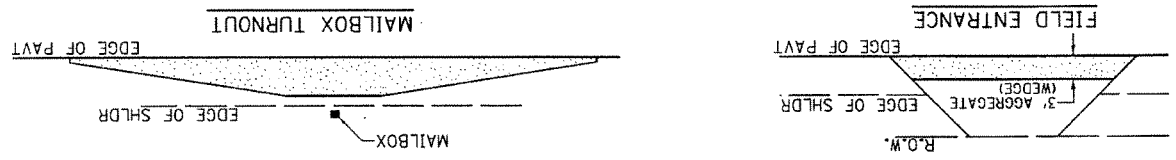

NOTE: EXISTING HMA PE'S, CE'S, SR'S, & MB TURNOUTS
 Place 2 1/4 " Incidental Hot-Mix Asphalt Surfacing #4080050 on entrance to conform to the existing configuration.

EXISTING AGG. PE'S & CE'S
 Place 2" Incidental Hot-Mix Asphalt Surfacing #4080050 on existing entrance to conform to the present configuration.

EXISTING AGG. SIDEROADS
 Place 3" Incidental Hot-Mix Asphalt Surfacing #4080050 on sidewalk to conform to the present configuration.

EXISTING AGG. MAILBOX TURNOUTS
 Existing Agg. Mailbox Turnouts shall be constructed as shown below.

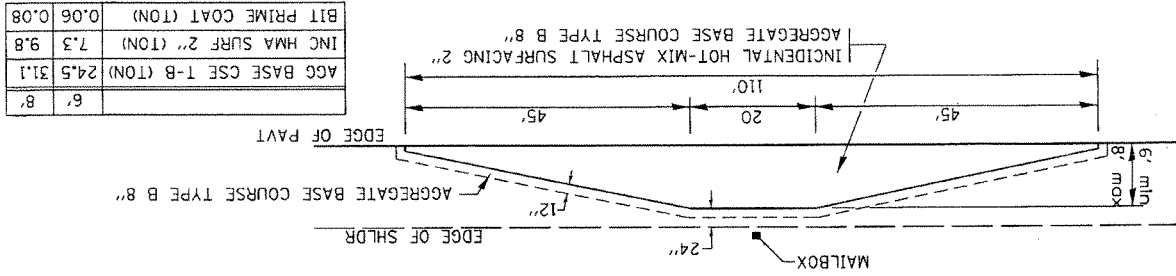

6'	8'	AGG BASE CSE T-B (TON)	24.5	31.1
7.3	9.8	INC HMA SURF 2" (TON)	7.3	9.8
0.06	0.08	BIT PRIME COAT (TON)	0.06	0.08

REVISED - 10-21-08

HOT-MIX ASPHALT APPROACHES & MAILBOX RETURNS FOR TWO LIFT (3P) RESURFACING PROJECTS 47.2

FILE NAME = c:\pwwork\pwwork\goff\j\60316607\0200513-shit-typical.dgn	STATE OF ILLINOIS DEPARTMENT OF TRANSPORTATION	REGION 2 / DISTRICT 2 STANDARD	F.A. RTE. •	SECTION (109, 110) RS-5	COUNTY LEE/OGLE	TOTAL SHEETS 109	SHEET NO. 94
USER NAME = goff\j						CONTRACT NO. 64J29	
PLOT DATE = Tue Nov 05 11:46:18 2013						FED. ROAD DIST. NO. ILLINOIS	FED. AID PROJECT

SAFETY EDGE (3P PROJECTS)

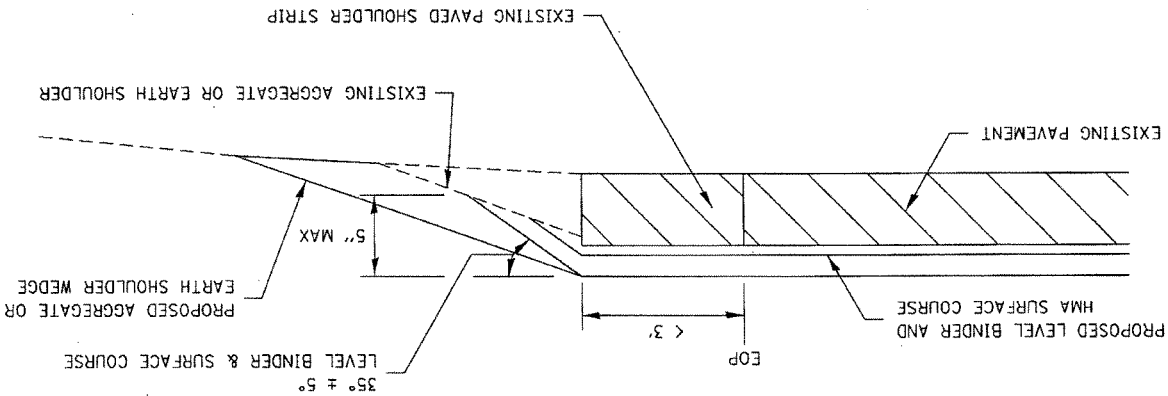

NO MILLING: ADJACENT SHOULDER FLUSH WITH OR LOWER THAN EXISTING PAVEMENT

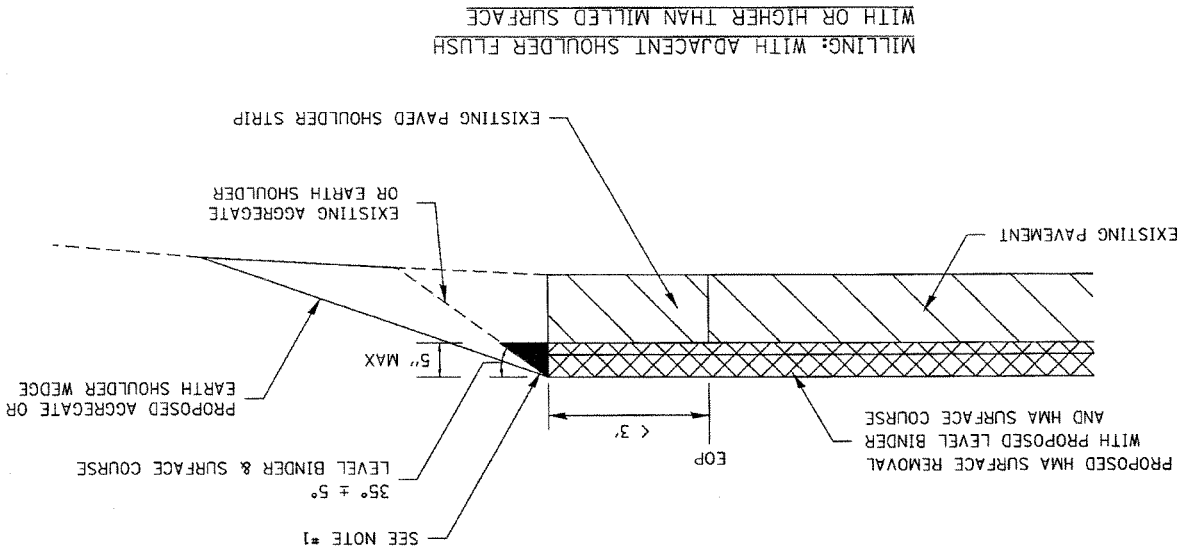

MILLING: WITH ADJACENT SHOULDER FLUSH WITH OR HIGHER THAN MILLED SURFACE

NOTES : THE DEVICE WHICH FORMS THE SAFETY EDGE SHALL BE MOUNTED ON THE PAVEMENT AGAINST THE END GATE AND SHALL BE REMOVABLE OR BE ABLE TO BE LIFTED WHEN NOT IN USE. THE DEVICE SHALL BE DESIGNED TO MAINTAIN CONTACT WITH SURFACE OF THE SHOULDER AND ALLOW AUTOMATIC TRANSITION TO CROSS ROADS, DRIVEWAYS AND OBSTRUCTIONS. THE DEVICE SHALL ALSO CONSTRAIN THE HMA MATERIAL AND INCREASE THE CONSOLIDATION OF THE EXTRUDED PROFILE. THE USE OF A CONVENTIONAL SINGLE PLATE STRIKE-OFF WILL NOT BE ALLOWED.

ROLLERS WILL NOT BE ALLOWED ON THE SLOPED FACE OF THE SAFETY EDGE.

REVISOR - 10-11-13

SAFETY EDGE (3P PROJECTS) 49.2

FILE NAME =	ct:\pwwork\pwwork\goff\j\60316607\0200513-shr-typical.dgn		
USER NAME =	goff\j		
PLOT DATE =	Tue Nov 05 11:46:17 2013		
STATE OF ILLINOIS		DEPARTMENT OF TRANSPORTATION	
REGION 2 / DISTRICT 2 STANDARD			
F.A. RTE.	SECTION	COUNTY	TOTAL SHEET NO.
•	(109, 110) RS-5	LEE/OGLE	109 95
•			CONTRACT NO. 64J29
FED. ROAD DIST. NO.		ILLINOIS FED. AID PROJECT	

WITNESS MARKER FOR PERMANENT SURVEY MARKERS, TYPE II

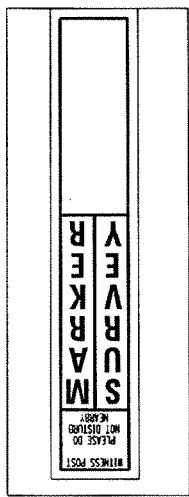

GENERAL NOTES

A WITNESS MARKER SHALL BE INSTALLED WITHIN 1' OF ALL PERMANENT SURVEY MARKERS TYPE II EXCEPT IN AREAS WHERE THE MARKER IS IN THE SIDEWALK. THIS WORK WILL BE INCLUDED TO THE CONTRACT UNIT PRICE PER EACH FOR PERMANENT SURVEY MARKERS, TYPE II.

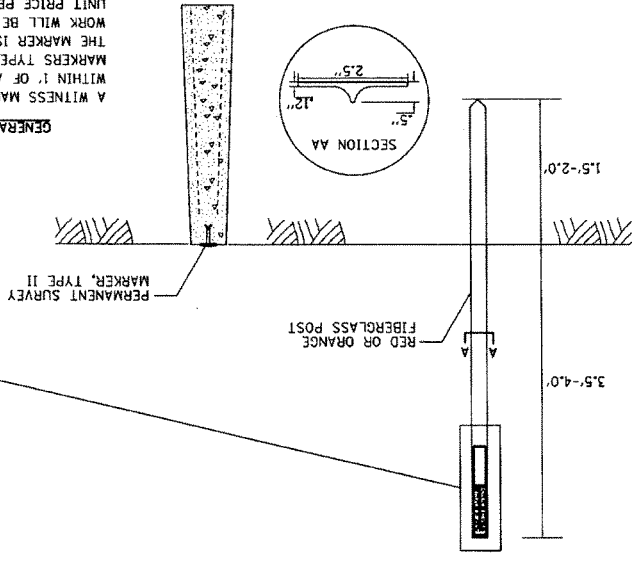

PERMANENT SURVEY MARKERS, TYPE II

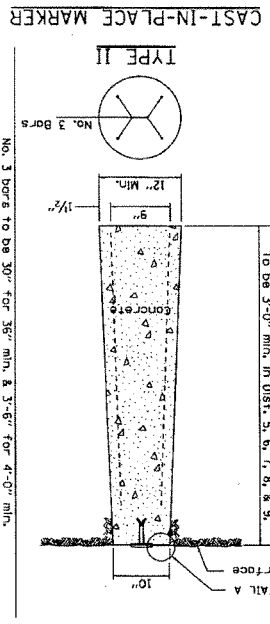

Use pure cement and water or approved epoxy to seal marker tablet in rock ledge, concrete pavement or structure. Hole shall be 1/2" diameter. Tablet constructed in rock ledge or concrete.

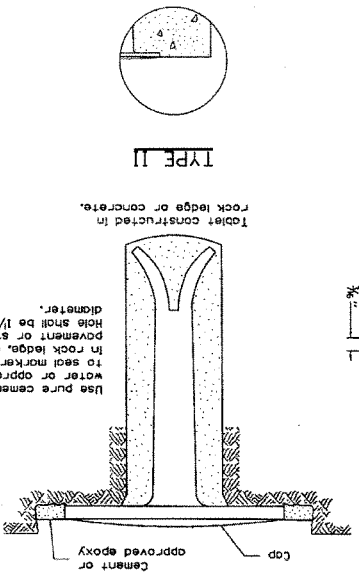

WITNESS MARKER & PERMANENT SURVEY MARKERS, TYPE II 66.2

REVISED - 10-14-11

FILE NAME =	ct:\pm-work\p\m\dot\goff\j\0316607\0200513-shr-typm.cad.dgn
USER NAME =	goffj
PLOT DATE =	Tue Nov 05 11:46:20 2013
STATE OF ILLINOIS	REGION 2/DISTRICT 2
DEPARTMENT OF TRANSPORTATION	STANDARD
F.A. RTE.	* (109, 110) RS-5
SECTION	* FAS 1177 & FAU 5452
COUNTY	LEE/OGLE
TOTAL SHEETS	109
SHEET NO.	96
CONTRACT NO.	64J29
FED. ROAD DIST. NO.	ILLINOIS FED. AID PROJECT

ROUGH GROOVED SURFACE SIGN

ILLINOIS STANDARD W8-1107

SIGN PANEL TYPE 1

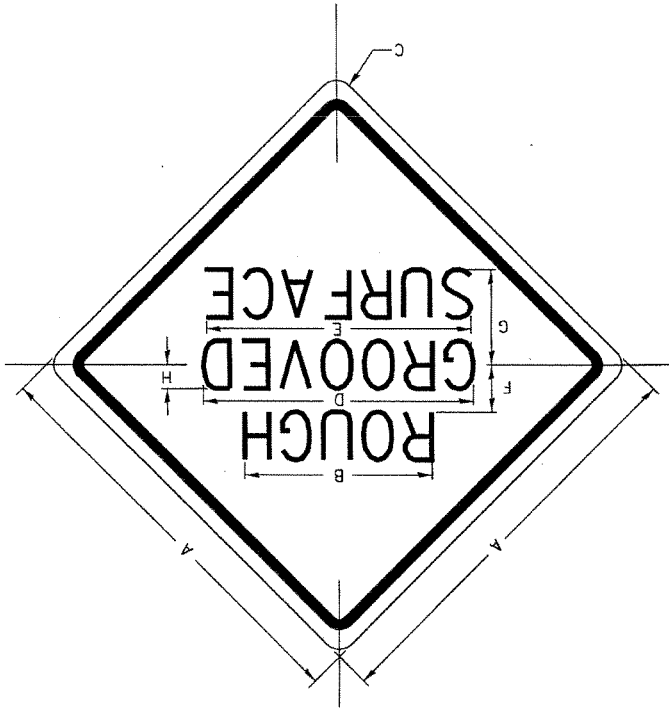

COLOR: LEGEND AND BORDER - BLACK NON-REFLECTIVE
 BACKGROUND - ORANGE REFLECTORIZED

SIGN SIZE		DIMENSIONS							
A	48.0	B	24.1	C	3.0	D	34.0	E	33.0
F	6.0	G	13.0	H	3.5				

SIGN SIZE	SERIES			MARGIN	BORDER	BLANK STD.
	1	2	3			
48x48	7C	7C	7C	0.8	1.2	B4-48D

ALL DIMENSIONS IN INCHES.

REVISED - 10-14-11

SIGN PANELS AND FACE MATERIALS SHALL BE ACCORDING TO SECTION 720 OF THE STANDARD SPECIFICATIONS METAL POSTS SHALL BE IN ACCORDANCE WITH STD. T20011. ALL MOUNTING HARDWARE SHALL BE ALUMINUM, STAINLESS STEEL, ZINC OR CADMIUM PLATED STEEL AND SHALL BE INCLUDED TO THE COST OF THE INSTALLATION. UNLESS OTHERWISE NOTED, ALL DIMENSIONS ARE IN INCHES

GENERAL NOTES

ROUGH GROOVED SURFACE SIGN 91.2

FILE NAME =	STATE OF ILLINOIS	SECTION	COUNTY	TOTAL SHEETS	SHEET NO.
ca:\p-wrk\p\ridot\goff\j\80316607\0200513-shr-typcal.dgn	REGION 2/ DISTRICT 2 STANDARD	(109, 110) RS-5	LEE/OGLE	109	97
USER NAME = goffj	DEPARTMENT OF TRANSPORTATION	CONTRACT NO. 64J29			
PLOT DATE = Tue Nov 05 11:46:11 2013	ILLINOIS FED. AID PROJECT				

TRAFFIC CONTROL AND PROTECTION AT TURN BAYS (TO REMAIN OPEN TO TRAFFIC)

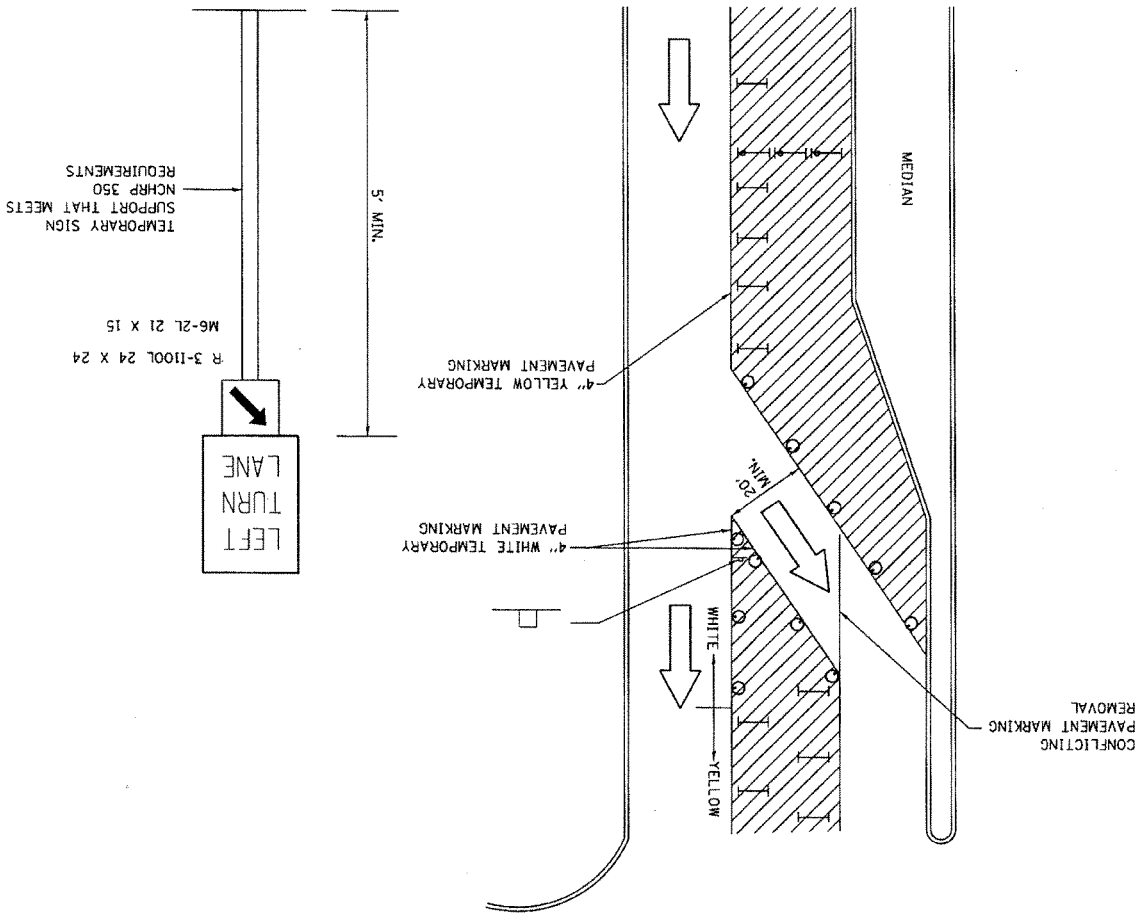

GENERAL NOTES

CONES MAY BE SUBSTITUTED FOR BARRICADES OR DRUMS AT HALF THE SPACING DURING DAY OPERATIONS. CONES SHALL BE A MINIMUM OF 28 IN HEIGHT. STEADY BURNING LIGHTS WILL NOT BE REQUIRED ON BARRICADES OR DRUMS FOR DAY OPERATIONS. ALL LIGHTS WILL BE MONODIRECTIONAL. TEMPORARY PAVEMENT MARKING SHALL BE PLACED THROUGHOUT THE BARRICADED AREA OF EACH BAY WHERE THE CLOSURE TIME IS GREATER THAN FOURTEEN DAYS.

THIS APPLICATION ALSO APPLIES WHEN WORK IS BEING PERFORMED IN THE RIGHT LANE(S) AND THE RIGHT TURN BAY IS TO REMAIN OPEN. UNDER THIS CONDITION, "RIGHT TURN LANE" R3-100 24 X 24 AND M6-2R 21 X 15 SHALL BE USED.

LONGITUDINAL DIMENSIONS MAY BE ADJUSTED TO FIT FIELD CONDITIONS. THESE CONTROLS SHALL SUPPLEMENT MAINLINE TRAFFIC CONTROL FOR LANE CLOSURES.

TRAFFIC CONTROL AND PROTECTION AT TURN BAYS (TO REMAIN OPEN TO TRAFFIC) SHALL BE INCLUDED IN THE COST SPECIFIED TRAFFIC CONTROL STANDARDS OR ITEMS. ALL DIMENSIONS ARE IN INCHES UNLESS OTHERWISE NOTED.

TRAFFIC CONTROL AND PROTECTION AT TURN BAYS (TO REMAIN OPEN TO TRAFFIC) 94.2

LEGEND

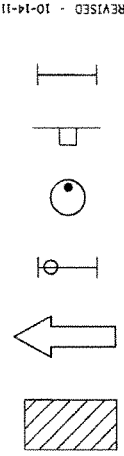

REVISED - 10-14-11

FILE NAME = c:\pwr_nork\pwr\dot\goff\j\0316607\0200513-sht-typical.dgn	STATE OF ILLINOIS DEPARTMENT OF TRANSPORTATION		REGION 2 / DISTRICT 2 STANDARD	F.A. RTE. •	SECTION (109, 110) RS-5	COUNTY LEE/OGLE	TOTAL SHEETS 109	SHEET NO. 98
USER NAME = goffj	CONTRACT NO. 64J29		ILLINOIS FED. AID PROJECT	FED. ROAD DIST. NO.				
PLOT DATE = Tue Nov 05 11:46:24 2013								

TRAFFIC CONTROL FOR TRANSITION AREAS

CASE 1

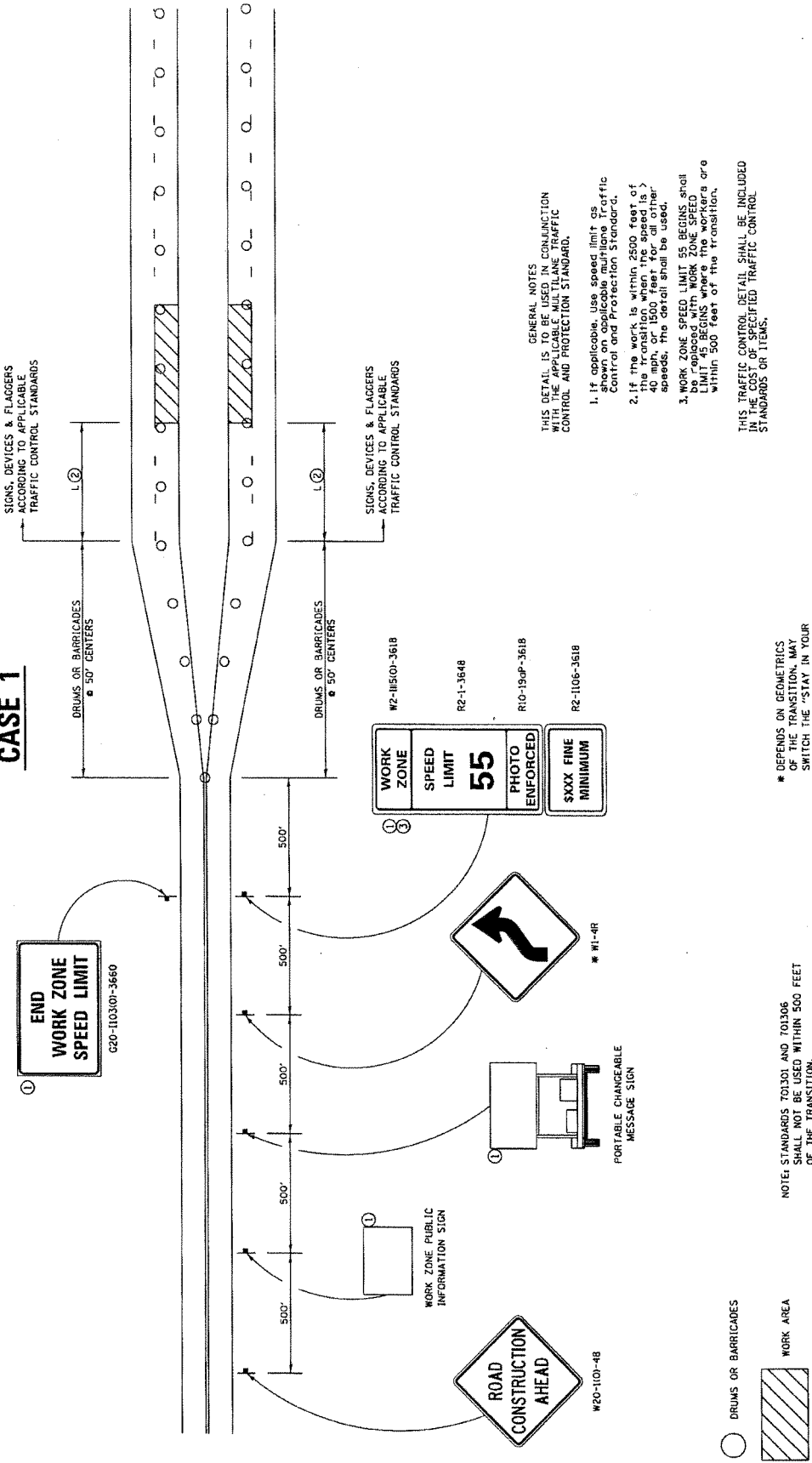

GENERAL NOTES
THIS DETAIL IS TO BE USED IN CONJUNCTION WITH THE APPLICABLE MULTILANE TRAFFIC CONTROL AND PROTECTION STANDARD.

1. If applicable, use speed limit signs shown on applicable traffic control and protection standard.
2. If the work is within 2500 feet of the work zone, the speed limit sign shall be placed at 400 feet for all other speeds, the detail shall be used.
3. WORK ZONE SPEED LIMIT 55 BEGINS shall be replaced with WORK ZONE SPEED LIMIT 45 BEGINS where the workers are within 500 feet of the transition.

THIS TRAFFIC CONTROL DETAIL SHALL BE INCLUDED IN THE LIST OF SPECIFIED TRAFFIC CONTROL STANDARDS OR ITEMS.

* DEPENDS ON GEOMETRICS OF THE TRANSITION. SWITCH TO "STAY IN YOUR LANE" AND "WEAVE SIGNS"

NOTE: STANDARDS 701301 AND 701306 SHALL NOT BE USED WITHIN 500 FEET OF THE TRANSITION.

TRAFFIC CONTROL FOR TRANSITION AREAS		SHEET 1 OF 4		38.1	
FILE NAME =	c:\pwwork\pwwork\goff\j\020607\02060513-sht1-typrcal.dgn	F.A. RTE.	SECTION	COUNTY	TOTAL SHEETS NO.
USER NAME =	goff,j		(109, 110) RS-5	LEE/OGLE	109
PLOT DATE =	Tue Nov 05 13:12:37 2013		* FAS 1177 & FAU 5452	CONTRACT NO.	64J29
STATE OF ILLINOIS DEPARTMENT OF TRANSPORTATION			REGION 2/DISTRICT 2 STANDARD		
FED. ROAD DIST. NO. ILLINOIS FED. AID PROJECT					

TRAFFIC CONTROL FOR TRANSITION AREAS CASE 2

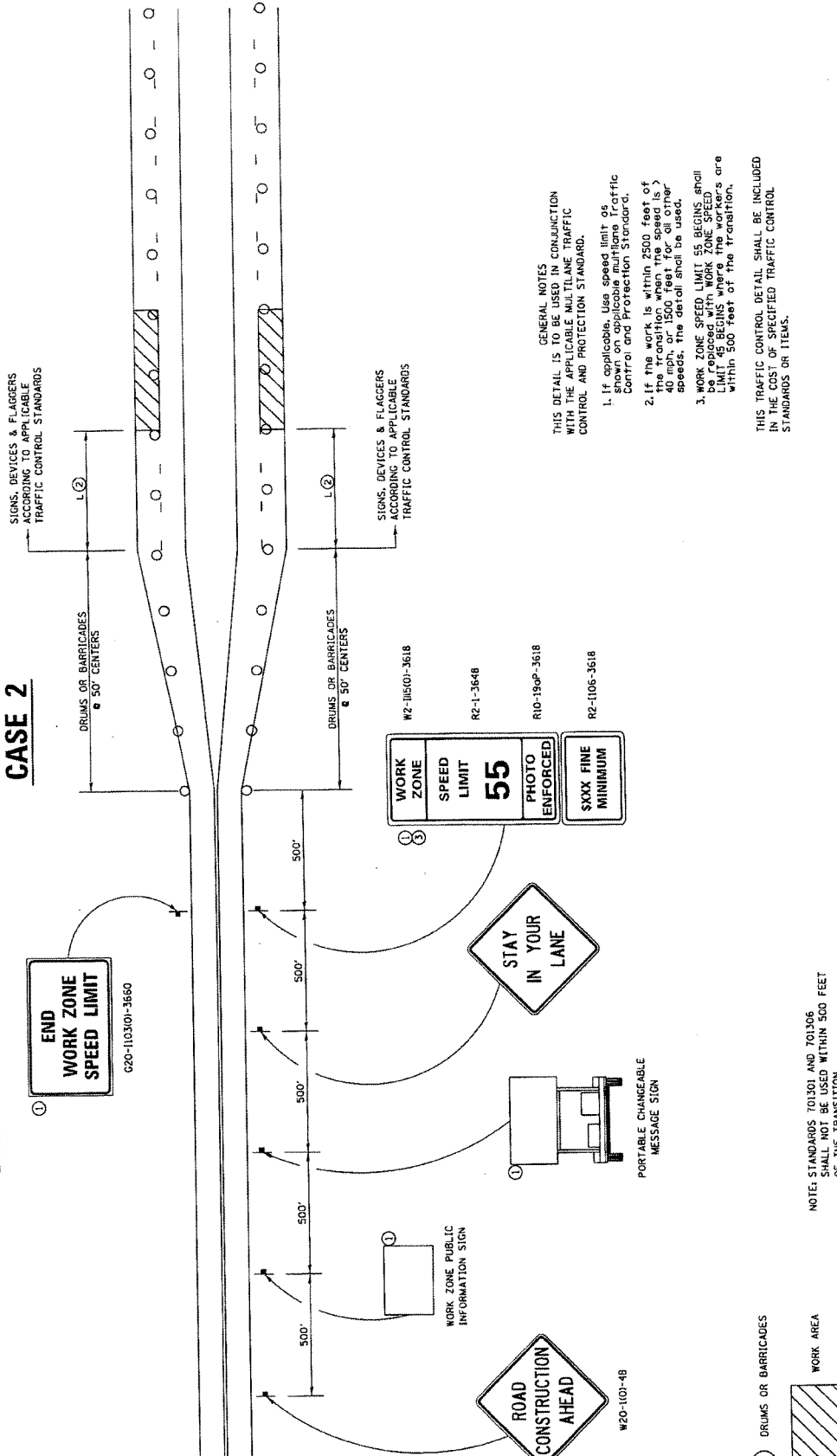

GENERAL NOTES
THIS DETAIL IS TO BE USED IN CONJUNCTION WITH THE APPLICABLE MULTILANE TRAFFIC CONTROL AND PROTECTION STANDARD.

1. If applicable, use speed limit as shown on applicable multiline Traffic Control and Protection Standard.
2. If the work is within 2500 feet of the transition when the speed is > 40 mph, or 1500 feet for all other speeds, the detail shall be used.
3. WORK ZONE SPEED LIMIT 55 BEGINS shall be replaced with WORK ZONE SPEED LIMIT 50 if the work zone is within 500 feet of the transition.

THIS TRAFFIC CONTROL DETAIL SHALL BE INCLUDED IN THE COST OF SPECIFIED TRAFFIC CONTROL STANDARDS OR ITEMS.

NOTE: STANDARDS 701301 AND 701306 SHALL NOT BE USED WITHIN 500 FEET OF THE TRANSITION.

R-27-13
1-16-13

TRAFFIC CONTROL FOR TRANSITION AREAS		SHEET 2 OF 4	38.1
F.A. RTE.	SECTION	COUNTY	TOTAL SHEETS
*	(109, 110) RS-5	LEE/OGLE	109 100
REGION 2/DISTRICT 2 STANDARD		CONTRACT NO.	64J29
STATE OF ILLINOIS DEPARTMENT OF TRANSPORTATION		FED. ROAD DIST. NO.	ILLINOIS FED. AID PROJECT

FILE NAME =
c:\pwworking\pwworking\goff\j\140316607\0200513-shr-tpc.dgn
USER NAME = goffj
PLOT DATE = Tue Nov 05 13:12:38 2013

TRAFFIC CONTROL FOR TRANSITION AREAS

CASE 3

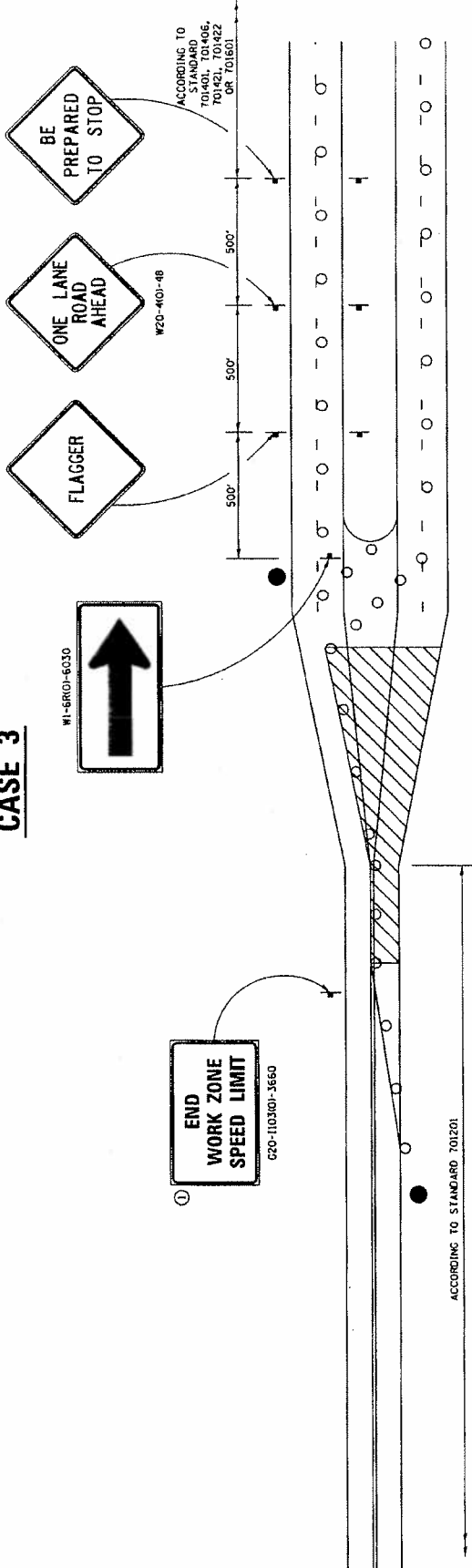

GENERAL NOTES
 THIS DETAIL IS TO BE CONSTRUCTION WITH THE APPLICABLE MULTILANE TRAFFIC CONTROL AND PROTECTION STANDARD.

1. If applicable, use speed limit as shown on applicable multiline Traffic Control and Protection Standard.
2. If the work is within 2500 feet of the transition when the speed is > 40 mph, or 1500 feet for all other speeds, the detail shall be used.
3. The approach WORK ZONE SPEED LIMIT SIGNS shall be placed within 500 feet of the transition.

THIS TRAFFIC CONTROL DETAIL SHALL BE INCLUDED IN THE COST OF SPECIFIED TRAFFIC CONTROL STANDARDS OR ITEMS.

NOTE: STANDARDS 701301 AND 701306 SHALL NOT BE USED WITHIN 500 FEET OF THE TRANSITION.

● FLAGGER WITH TRAFFIC CONTROL SIGN

○ DRUMS OR BARRICADES



8-21-13
 5-00-12

TRAFFIC CONTROL FOR TRANSITION AREAS SHEET 3 OF 4 38.1

FILE NAME = c:\pwwork\pwwork\go\ff\j\0316687\0280513-sht-typical.dgn	STATE OF ILLINOIS DEPARTMENT OF TRANSPORTATION	REGION 2/DISTRICT 2 STANDARD	F.A. RTE.	SECTION	COUNTY	TOTAL SHEETS	SHEET NO.
			*	(109, 110) RS-5	LEE/OGLE	109	101
USER NAME = goff.jl	DEPARTMENT OF TRANSPORTATION		FAS 1177 & FAU 5452		CONTRACT NO. 64J29		
PLOT DATE = Tue Nov 05 13:12:39 2013	DEPARTMENT OF TRANSPORTATION		ILLINOIS FED. AID PROJECT				

TRAFFIC CONTROL FOR TRANSITION AREAS CASE 4

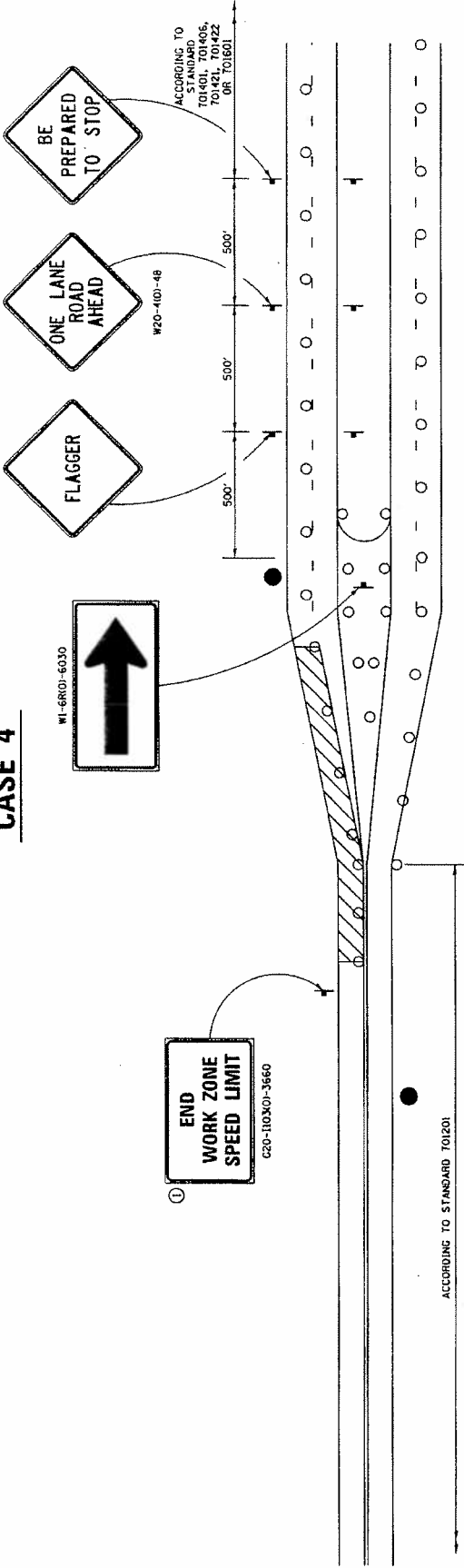

GENERAL NOTES
THIS DETAIL IS TO BE USED IN CONJUNCTION WITH THE APPLICABLE SINGLE LANE TRAFFIC CONTROL AND PROTECTION STANDARDS.

1. If applicable, use speed limit as shown on applicable auxiliary Traffic Control and Protection Standard.
2. If the work is within 2500 feet of the transition when the speed is > 40 mph, or 1500 feet for all other speeds, the detail shall be used.
3. WORK ZONE SPEED LIMIT 55 BEGINS shall be replaced with WORK ZONE SPEED LIMIT 45 BEGINS where the workers are within 500 feet of the transition.

THIS TRAFFIC CONTROL DETAIL SHALL BE INCLUDED IN THE COST OF SPECIFIED TRAFFIC CONTROL STANDARDS OR ITEMS.

NOTE: STANDARDS T01101 AND T01306 SHALL NOT BE USED WITHIN 500 FEET OF THE TRANSITION.

8-27-13
5-08-12

TRAFFIC CONTROL FOR TRANSITION AREAS		SHEET 4 OF 4		38.1	
FILE NAME =	c:\pw-work\pwidot\goff\j\0316607\0200513-hht-typical.dgn	F.A. RITE.	SECTION	COUNTY	TOTAL SHEETS
USER NAME =	goffj	*	(109, 110) RS-5	LEE/OGLE	109 102
PLOT DATE =	Tue Nov 05 13:12:40 2013	FED. ROAD DIST. NO.		CONTRACT NO.	
		ILLINOIS		64J29	
STATE OF ILLINOIS DEPARTMENT OF TRANSPORTATION		REGION 2/DISTRICT 2 STANDARD			

TYPICAL PAVEMENT MARKINGS

MEDIAN PAVEMENT MARKING

TYPICAL PAVEMENT MARKING FOR FLUSH MEDIAN AT LEFT TURN LANE

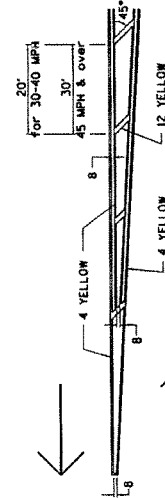
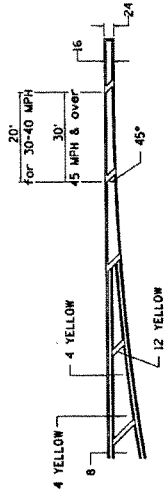
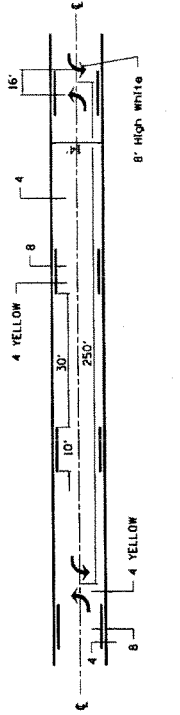

** ALL DIMENSIONS ARE IN INCHES UNLESS OTHERWISE NOTED.

TYPICAL PARKING SPACING

TYPICAL ISLAND OFFSET SHOULDER WIDTH

STANDARD CROSSWALK MARKING

See Schedules for Locations

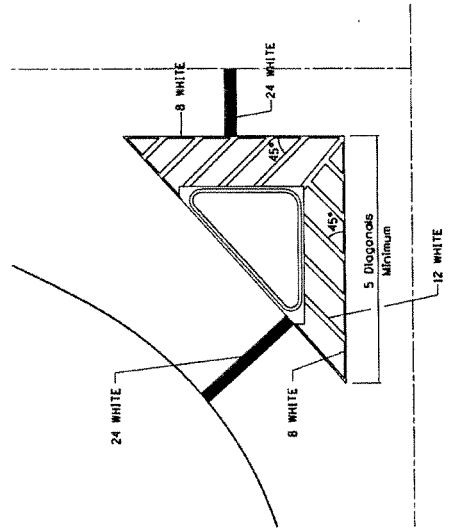
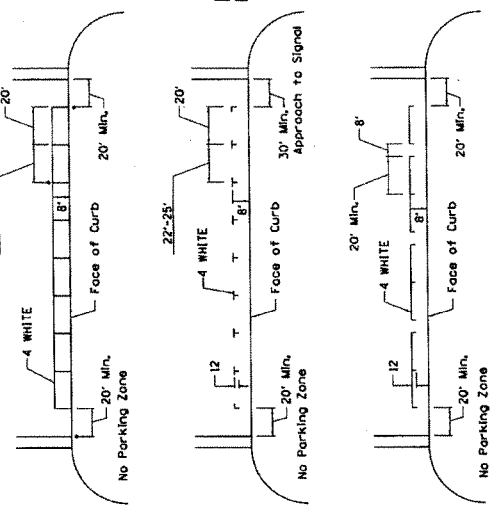

* Distance to the nearest edge of the roadway shall be the absence of a marked crosswalk.

FILE NAME = c:\pw_work\pmdot\goff.j\0316607\0200513-sht-typical.dgn	STATE OF ILLINOIS		F.A. RTE. *	SECTION (109, 110) RS-5	COUNTY LEE/OGLE	TOTAL SHEETS 109	SHEET NO. 103
USER NAME = goff.j	DEPARTMENT OF TRANSPORTATION		REGION 2/DISTRICT 2 STANDARD		* FAS 1177 & FAU 5452	CONTRACT NO. 64J29	
PLOT DATE = Tue Nov 05 11:46:01 2013			ILLINOIS FED. AID PROJECT				

TYPICAL PAVEMENT MARKINGS

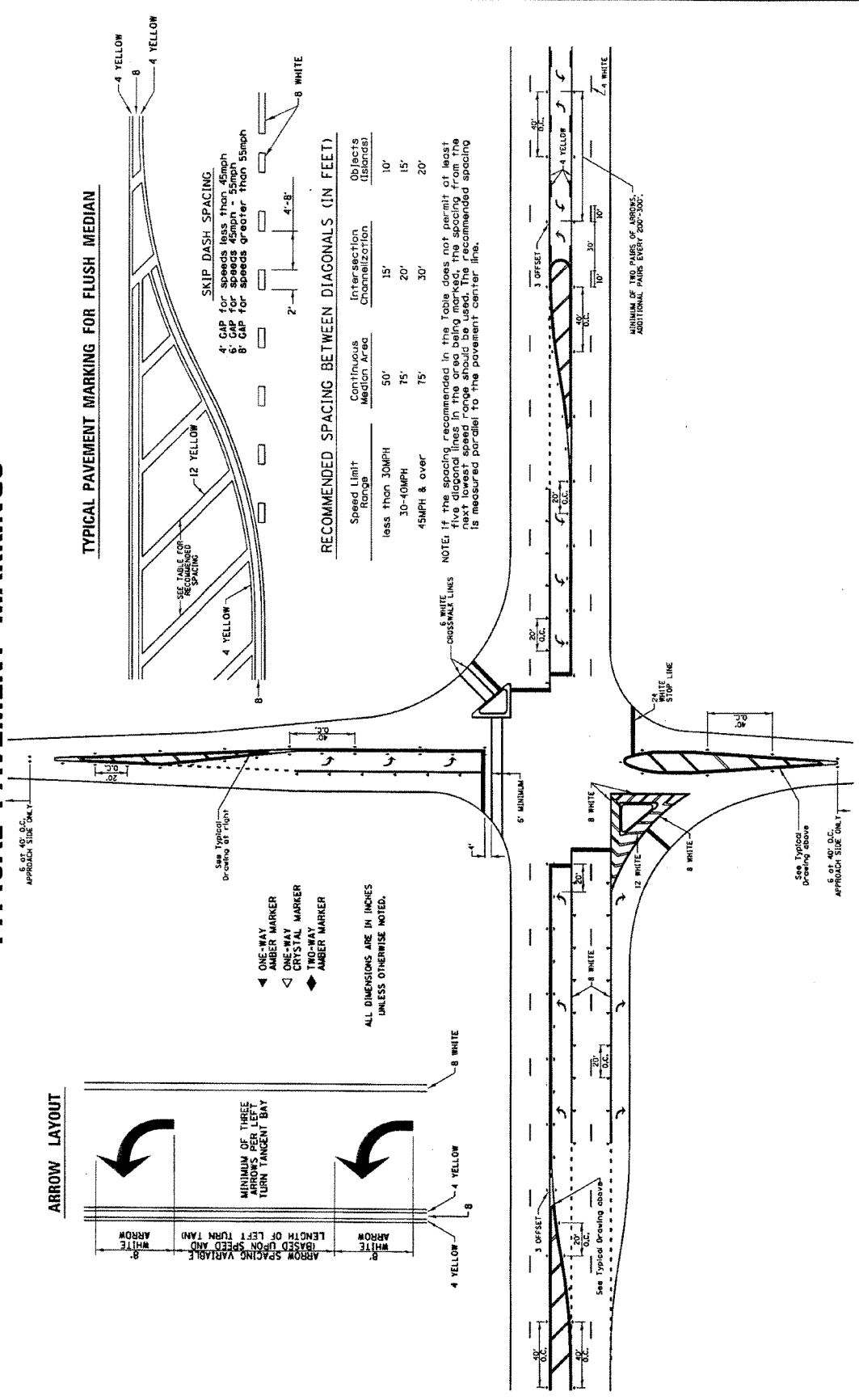

RECOMMENDED SPACING BETWEEN DIAGONALS (IN FEET)

Speed Limit Range	Continuous Median Area	Intersection Channelization	Objects (Islands)
less than 30MPH	50'	15'	10'
30-40MPH	75'	20'	15'
45MPH & over	75'	30'	20'

NOTE: If the spacing recommended in the Table does not permit of least five diagonal lines in the area being marked, the spacing from the next lowest speed range should be used. The recommended spacing is measured parallel to the pavement center line.

STATE OF ILLINOIS
DEPARTMENT OF TRANSPORTATION

REGION 2/DISTRICT 2
STANDARD

F.A. RTE. * SECTION (109, 110) RS-5 COUNTY LEE/OGLE TOTAL SHEETS 109 SHEET NO. 104

* FAS 1177 & FAU 5452 CONTRACT NO. 64J29

FED. ROAD DIST. NO. ILLINOIS FED. AID PROJECT

FILE NAME = c:\ph-work\pvidot\goff\j\0316607\0200513-shr-typical.dgn
USER NAME = goffj
PLOT DATE = Tue Nov 05 11:46:05 2013

TYPICAL PAVEMENT MARKINGS

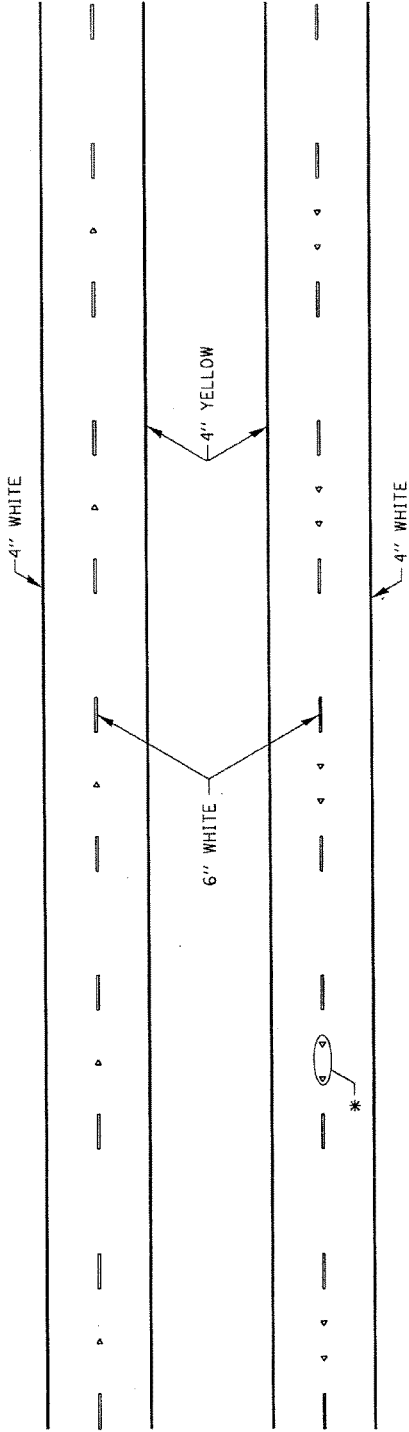

MULTI-LANE / DIVIDED

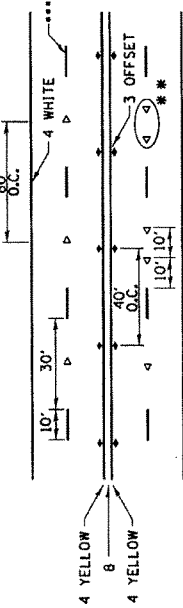

SYMBOLS

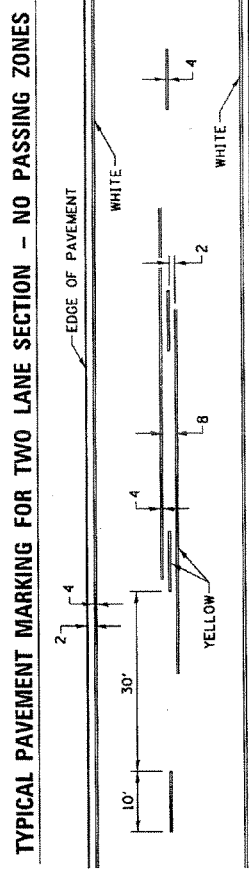

TYPICAL PAVEMENT MARKING FOR TWO LANE SECTION - NO PASSING ZONES

MULTI-LANE / UNDIVIDED & ONE WAY

(FOR MULTI-LANE UNDIVIDED HIGHWAYS USE THIS DETAIL NOT HIGHWAY STANDARD 781001)

TYPICAL PAVEMENT MARKINGS SHEET 3 OF 3 41.1

FILE NAME = c:\pwwork\pwwork\goff\j\0316607\0200513-sh-t-typcal.dgn	STATE OF ILLINOIS DEPARTMENT OF TRANSPORTATION	REGION 2/DISTRICT 2 STANDARD	F.A. RTE. *	SECTION (109, 110) RS-5	COUNTY LEE/OGLE	TOTAL SHEETS 109	SHEET NO. 105
USER NAME = goff,j			* FAS 1177 & FAU 5452		CONTRACT NO. 64J29		
PLOT DATE = Tue Nov 05 11:46:07 2013			FED. ROAD DIST. NO. ILLINOIS	AID PROJECT			

REMOVE AND REERECT STEEL PLATE BEAM GUARDRAIL

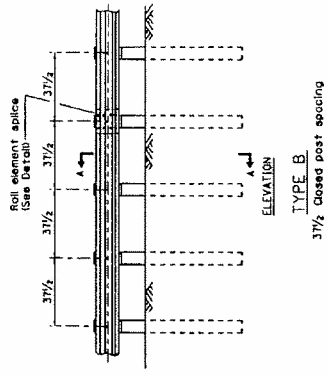

TYPE B
37 1/2" Closed post spacing

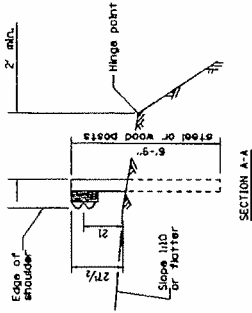

SECTION A-A

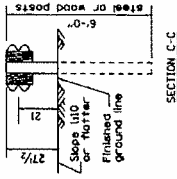

SECTION C-C

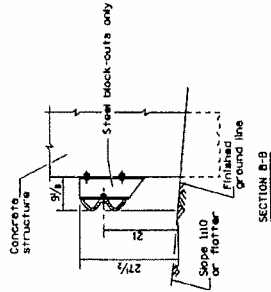

SECTION B-B

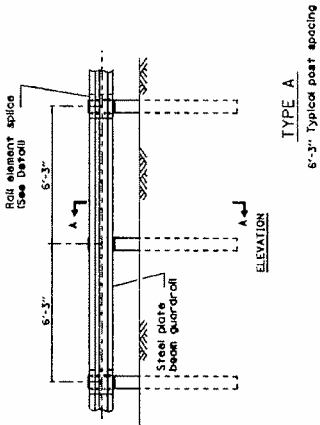

TYPE A
6'-3" Typical post spacing

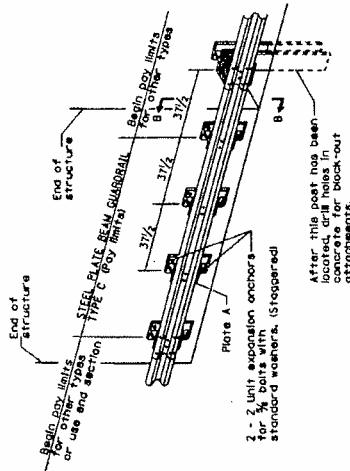

TYPE C
37 1/2" Block-out spacing

GENERAL NOTES
All slope ratios are expressed as units vertical to 10 units horizontal displacement (V:H) unless otherwise shown.
All dimensions are in inches unless otherwise shown.
The existing steel posts may be drilled to match the bar pattern of the new steel post and be replaced, or a new steel post may be provided.
This detail is applicable to the guardrail system used prior to January 1, 2007. For details of the new guardrail system, see Standard S3200.

TYPE D
Double steel plate beam guardrail
6'-3" typical post spacing

REMOVE AND REERECT STEEL PLATE BEAM GUARDRAIL SHEET 1 of 4 53.1

FILE NAME = c:\pw\work\pwidot\goff\j\0316607\2200513-sh-t-typical.dgn	STATE OF ILLINOIS DEPARTMENT OF TRANSPORTATION	REGION 2 / DISTRICT 2 STANDARD	F.A. RTE. •	SECTION (109, 110) RS-5	COUNTY LEE/OGLE	TOTAL SHEETS 109	SHEET NO. 106
USER NAME = goff.j			FED. ROAD DIST. NO. •	ILLINOIS FED. AID PROJECT	CONTRACT NO. 64J29		
PLOT DATE = Tue Nov 05 11:46:12 2013							

REMOVE AND REERECT STEEL PLATE BEAM GUARDRAIL

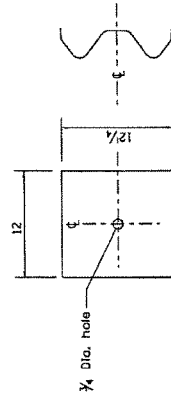
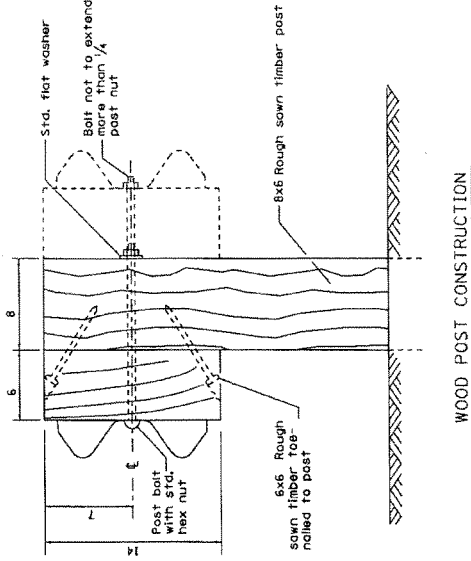
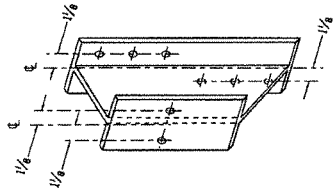
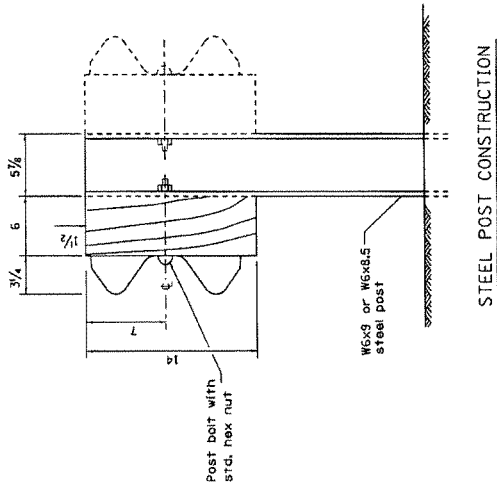

NOTE

Plate A shall be placed between rail element and block-out if non-ferrous materials are used. When steel block-outs are used, Plate A shall not be used.

PLATE A

REMOVE AND REERECT STEEL PLATE BEAM GUARDRAIL SHEET 2 of 4 53.1

<p>FILE NAME = c:\pwr-work\pwr\doct\goff\j\0316607\0200513-sht-typicoal.dgn</p> <p>USER NAME = goff\j</p> <p>PLOT DATE = Tue Nov 05 11:46:13 2013</p>	<p>STATE OF ILLINOIS DEPARTMENT OF TRANSPORTATION</p>	<p>REGION 2 / DISTRICT 2 STANDARD</p>	<p>F.A. RTE. •</p>	<p>SECTION (109, 110) RS-5</p>	<p>COUNTY LEE/OGLE</p>	<p>TOTAL SHEETS 109</p>	<p>SHEET NO. 107</p>
			<p>FED. ROAD DIST. NO. ILLINOIS</p>	<p>FED. AID PROJECT</p>		<p>CONTRACT NO. 64J29</p>	

REQUIRED CONTRACT PROVISIONS FEDERAL-AID CONSTRUCTION CONTRACTS

- I. General
- II. Nondiscrimination
- III. Nonsegregated Facilities
- IV. Davis-Bacon and Related Act Provisions
- V. Contract Work Hours and Safety Standards Act Provisions
- VI. Subletting or Assigning the Contract
- VII. Safety: Accident Prevention
- VIII. False Statements Concerning Highway Projects
- IX. Implementation of Clean Air Act and Federal Water Pollution Control Act
- X. Compliance with Governmentwide Suspension and Debarment Requirements
- XI. Certification Regarding Use of Contract Funds for Lobbying

ATTACHMENTS

A. Employment and Materials Preference for Appalachian Development Highway System or Appalachian Local Access Road Contracts (included in Appalachian contracts only)

I. GENERAL

1. Form FHWA-1273 must be physically incorporated in each construction contract funded under Title 23 (excluding emergency contracts solely intended for debris removal). The contractor (or subcontractor) must insert this form in each subcontract and further require its inclusion in all lower tier subcontracts (excluding purchase orders, rental agreements and other agreements for supplies or services).

The applicable requirements of Form FHWA-1273 are incorporated by reference for work done under any purchase order, rental agreement or agreement for other services. The prime contractor shall be responsible for compliance by any subcontractor, lower-tier subcontractor or service provider.

Form FHWA-1273 must be included in all Federal-aid design-build contracts, in all subcontracts and in lower tier subcontracts (excluding subcontracts for design services, purchase orders, rental agreements and other agreements for supplies or services). The design-builder shall be responsible for compliance by any subcontractor, lower-tier subcontractor or service provider.

Contracting agencies may reference Form FHWA-1273 in bid proposal or request for proposal documents, however, the Form FHWA-1273 must be physically incorporated (not referenced) in all contracts, subcontracts and lower-tier subcontracts (excluding purchase orders, rental agreements and other agreements for supplies or services related to a construction contract).

2. Subject to the applicability criteria noted in the following sections, these contract provisions shall apply to all work performed on the contract by the contractor's own organization and with the assistance of workers under the contractor's immediate superintendence and to all work performed on the contract by piecework, station work, or by subcontract.

3. A breach of any of the stipulations contained in these Required Contract Provisions may be sufficient grounds for withholding of progress payments, withholding of final payment, termination of the contract, suspension / debarment or any other action determined to be appropriate by the contracting agency and FHWA.

4. Selection of Labor: During the performance of this contract, the contractor shall not use convict labor for any purpose within the limits of a construction project on a Federal-aid highway unless it is labor performed by convicts who are on parole, supervised release, or probation. The term Federal-aid highway does not include roadways functionally classified as local roads or rural minor collectors.

II. NONDISCRIMINATION

The provisions of this section related to 23 CFR Part 230 are applicable to all Federal-aid construction contracts and to all related construction subcontracts of \$10,000 or more. The provisions of 23 CFR Part 230 are not applicable to material supply, engineering, or architectural service contracts.

In addition, the contractor and all subcontractors must comply with the following policies: Executive Order 11246, 41 CFR 60, 29 CFR 1625-1627, Title 23 USC Section 140, the Rehabilitation Act of 1973, as amended (29 USC 794), Title VI of the Civil Rights Act of 1964, as amended, and related regulations including 49 CFR Parts 21, 26 and 27; and 23 CFR Parts 200, 230, and 633.

The contractor and all subcontractors must comply with: the requirements of the Equal Opportunity Clause in 41 CFR 60-1.4(b) and, for all construction contracts exceeding \$10,000, the Standard Federal Equal Employment Opportunity Construction Contract Specifications in 41 CFR 60-4.3.

Note: The U.S. Department of Labor has exclusive authority to determine compliance with Executive Order 11246 and the policies of the Secretary of Labor including 41 CFR 60, and 29 CFR 1625-1627. The contracting agency and the FHWA have the authority and the responsibility to ensure compliance with Title 23 USC Section 140, the Rehabilitation Act of 1973, as amended (29 USC 794), and Title VI of the Civil Rights Act of 1964, as amended, and related regulations including 49 CFR Parts 21, 26 and 27; and 23 CFR Parts 200, 230, and 633.

The following provision is adopted from 23 CFR 230, Appendix A, with appropriate revisions to conform to the U.S. Department of Labor (US DOL) and FHWA requirements.

1. Equal Employment Opportunity: Equal employment opportunity (EEO) requirements not to discriminate and to take affirmative action to assure equal opportunity as set forth under laws, executive orders, rules, regulations (28 CFR 35, 29 CFR 1630, 29 CFR 1625-1627, 41 CFR 60 and 49 CFR 27) and orders of the Secretary of Labor as modified by the provisions prescribed herein, and imposed pursuant to 23 U.S.C. 140 shall constitute the EEO and specific affirmative action standards for the contractor's project activities under this contract. The provisions of the Americans with Disabilities Act of 1990 (42 U.S.C. 12101 et seq.) set forth under 28 CFR 35 and 29 CFR 1630 are incorporated by reference in this contract. In the execution of this contract, the contractor agrees to comply with the following minimum specific requirement activities of EEO:

a. The contractor will work with the contracting agency and the Federal Government to ensure that it has made every good faith effort to provide equal opportunity with respect to all of its terms and conditions of employment and in their review of activities under the contract.

b. The contractor will accept as its operating policy the following statement:

"It is the policy of this Company to assure that applicants are employed, and that employees are treated during employment, without regard to their race, religion, sex, color, national origin, age or disability. Such action shall include: employment, upgrading, demotion, or transfer; recruitment or recruitment advertising; layoff or termination; rates of pay or other forms of compensation; and selection for training, including apprenticeship, pre-apprenticeship, and/or on-the-job training."

2. EEO Officer: The contractor will designate and make known to the contracting officers an EEO Officer who will have the responsibility for and must be capable of effectively administering and promoting an active EEO program and who must be assigned adequate authority and responsibility to do so.

3. Dissemination of Policy: All members of the contractor's staff who are authorized to hire, supervise, promote, and discharge employees, or who recommend such action, or who are substantially involved in such action, will be made fully cognizant of, and will implement, the contractor's EEO policy and contractual responsibilities to provide EEO in each grade and classification of employment. To ensure that the above agreement will be met, the following actions will be taken as a minimum:

a. Periodic meetings of supervisory and personnel office employees will be conducted before the start of work and then not less often than once every six months, at which time the contractor's EEO policy and its implementation will be reviewed and explained. The meetings will be conducted by the EEO Officer.

b. All new supervisory or personnel office employees will be given a thorough indoctrination by the EEO Officer, covering all major aspects of the contractor's EEO obligations within thirty days following their reporting for duty with the contractor.

c. All personnel who are engaged in direct recruitment for the project will be instructed by the EEO Officer in the contractor's procedures for locating and hiring minorities and women.

d. Notices and posters setting forth the contractor's EEO policy will be placed in areas readily accessible to employees, applicants for employment and potential employees.

e. The contractor's EEO policy and the procedures to implement such policy will be brought to the attention of employees by means of meetings, employee handbooks, or other appropriate means.

4. Recruitment: When advertising for employees, the contractor will include in all advertisements for employees the notation: "An Equal Opportunity Employer." All such advertisements will be placed in publications having a large circulation among minorities and women in the area from which the project work force would normally be derived.

a. The contractor will, unless precluded by a valid bargaining agreement, conduct systematic and direct recruitment through public and private employee referral sources likely to yield qualified minorities and women. To meet this requirement, the contractor will identify sources of potential minority group employees, and establish with such identified sources procedures whereby minority and women applicants may be referred to the contractor for employment consideration.

b. In the event the contractor has a valid bargaining agreement providing for exclusive hiring hall referrals, the contractor is expected to observe the provisions of that agreement to the extent that the system meets the contractor's compliance with EEO contract provisions. Where implementation of such an agreement has the effect of discriminating against minorities or women, or obligates the contractor to do the same, such implementation violates Federal nondiscrimination provisions.

c. The contractor will encourage its present employees to refer minorities and women as applicants for employment. Information and procedures with regard to referring such applicants will be discussed with employees.

5. Personnel Actions: Wages, working conditions, and employee benefits shall be established and administered, and personnel actions of every type, including hiring, upgrading, promotion, transfer, demotion, layoff, and termination, shall be taken without regard to race, color, religion, sex, national origin, age or disability. The following procedures shall be followed:

a. The contractor will conduct periodic inspections of project sites to insure that working conditions and employee facilities do not indicate discriminatory treatment of project site personnel.

b. The contractor will periodically evaluate the spread of wages paid within each classification to determine any evidence of discriminatory wage practices.

c. The contractor will periodically review selected personnel actions in depth to determine whether there is evidence of discrimination. Where evidence is found, the contractor will promptly take corrective action. If

the review indicates that the discrimination may extend beyond the actions reviewed, such corrective action shall include all affected persons.

d. The contractor will promptly investigate all complaints of alleged discrimination made to the contractor in connection with its obligations under this contract, will attempt to resolve such complaints, and will take appropriate corrective action within a reasonable time. If the investigation indicates that the discrimination may affect persons other than the complainant, such corrective action shall include such other persons. Upon completion of each investigation, the contractor will inform every complainant of all of their avenues of appeal.

6. Training and Promotion:

a. The contractor will assist in locating, qualifying, and increasing the skills of minorities and women who are applicants for employment or current employees. Such efforts should be aimed at developing full journey level status employees in the type of trade or job classification involved.

b. Consistent with the contractor's work force requirements and as permissible under Federal and State regulations, the contractor shall make full use of training programs, i.e., apprenticeship, and on-the-job training programs for the geographical area of contract performance. In the event a special provision for training is provided under this contract, this subparagraph will be superseded as indicated in the special provision. The contracting agency may reserve training positions for persons who receive welfare assistance in accordance with 23 U.S.C. 140(a).

c. The contractor will advise employees and applicants for employment of available training programs and entrance requirements for each.

d. The contractor will periodically review the training and promotion potential of employees who are minorities and women and will encourage eligible employees to apply for such training and promotion.

7. Unions: If the contractor relies in whole or in part upon unions as a source of employees, the contractor will use good faith efforts to obtain the cooperation of such unions to increase opportunities for minorities and women. Actions by the contractor, either directly or through a contractor's association acting as agent, will include the procedures set forth below:

a. The contractor will use good faith efforts to develop, in cooperation with the unions, joint training programs aimed toward qualifying more minorities and women for membership in the unions and increasing the skills of minorities and women so that they may qualify for higher paying employment.

b. The contractor will use good faith efforts to incorporate an EEO clause into each union agreement to the end that such union will be contractually bound to refer applicants without regard to their race, color, religion, sex, national origin, age or disability.

c. The contractor is to obtain information as to the referral practices and policies of the labor union except that to the extent such information is within the exclusive possession of the labor union and such labor union refuses to furnish such information to the contractor, the contractor shall so certify to the contracting agency and shall set forth what efforts have been made to obtain such information.

d. In the event the union is unable to provide the contractor with a reasonable flow of referrals within the time limit set forth in the collective bargaining agreement, the contractor will, through independent recruitment efforts, fill the employment vacancies without regard to race, color, religion, sex, national origin, age or disability; making full efforts to obtain qualified and/or qualifiable minorities and women. The failure of a union to provide sufficient referrals (even though it is obligated to provide exclusive referrals under the terms of a collective bargaining agreement) does not relieve the contractor from the requirements of this paragraph. In the event the union referral practice prevents the contractor from meeting the obligations pursuant to Executive Order 11246, as amended, and these special provisions, such contractor shall immediately notify the contracting agency.

8. Reasonable Accommodation for Applicants / Employees with Disabilities: The contractor must be familiar with the requirements for and comply with the Americans with Disabilities Act and all rules and regulations established there under. Employers must provide reasonable accommodation in all employment activities unless to do so would cause an undue hardship.

9. Selection of Subcontractors, Procurement of Materials and Leasing of Equipment: The contractor shall not discriminate on the grounds of race, color, religion, sex, national origin, age or disability in the selection and retention of subcontractors, including procurement of materials and leases of equipment. The contractor shall take all necessary and reasonable steps to ensure nondiscrimination in the administration of this contract.

a. The contractor shall notify all potential subcontractors and suppliers and lessors of their EEO obligations under this contract.

b. The contractor will use good faith efforts to ensure subcontractor compliance with their EEO obligations.

10. Assurance Required by 49 CFR 26.13(b):

a. The requirements of 49 CFR Part 26 and the State DOT's U.S. DOT-approved DBE program are incorporated by reference.

b. The contractor or subcontractor shall not discriminate on the basis of race, color, national origin, or sex in the performance of this contract. The contractor shall carry out applicable requirements of 49 CFR Part 26 in the award and administration of DOT-assisted contracts. Failure by the contractor to carry out these requirements is a material breach of this contract, which may result in the termination of this contract or such other remedy as the contracting agency deems appropriate.

11. Records and Reports: The contractor shall keep such records as necessary to document compliance with the EEO requirements. Such records shall be retained for a period of three years following the date of the final payment to the contractor for all contract work and shall be available at reasonable times and places for inspection by authorized representatives of the contracting agency and the FHWA.

a. The records kept by the contractor shall document the following:

(1) The number and work hours of minority and non-minority group members and women employed in each work classification on the project;

(2) The progress and efforts being made in cooperation with unions, when applicable, to increase employment opportunities for minorities and women; and

(3) The progress and efforts being made in locating, hiring, training, qualifying, and upgrading minorities and women;

b. The contractors and subcontractors will submit an annual report to the contracting agency each July for the duration of the project, indicating the number of minority, women, and non-minority group employees currently engaged in each work classification required by the contract work. This information is to be reported on [Form FHWA-1391](#). The staffing data should represent the project work force on board in all or any part of the last payroll period preceding the end of July. If on-the-job training is being required by special provision, the contractor will be required to collect and report training data. The employment data should reflect the work force on board during all or any part of the last payroll period preceding the end of July.

III. NONSEGREGATED FACILITIES

This provision is applicable to all Federal-aid construction contracts and to all related construction subcontracts of \$10,000 or more.

The contractor must ensure that facilities provided for employees are provided in such a manner that segregation on the basis of race, color,

religion, sex, or national origin cannot result. The contractor may neither require such segregated use by written or oral policies nor tolerate such use by employee custom. The contractor's obligation extends further to ensure that its employees are not assigned to perform their services at any location, under the contractor's control, where the facilities are segregated. The term "facilities" includes waiting rooms, work areas, restaurants and other eating areas, time clocks, restrooms, washrooms, locker rooms, and other storage or dressing areas, parking lots, drinking fountains, recreation or entertainment areas, transportation, and housing provided for employees. The contractor shall provide separate or single-user restrooms and necessary dressing or sleeping areas to assure privacy between sexes.

IV. Davis-Bacon and Related Act Provisions

This section is applicable to all Federal-aid construction projects exceeding \$2,000 and to all related subcontracts and lower-tier subcontracts (regardless of subcontract size). The requirements apply to all projects located within the right-of-way of a roadway that is functionally classified as Federal-aid highway. This excludes roadways functionally classified as local roads or rural minor collectors, which are exempt. Contracting agencies may elect to apply these requirements to other projects.

The following provisions are from the U.S. Department of Labor regulations in 29 CFR 5.5 "Contract provisions and related matters" with minor revisions to conform to the FHWA-1273 format and FHWA program requirements.

1. Minimum wages

a. All laborers and mechanics employed or working upon the site of the work, will be paid unconditionally and not less often than once a week, and without subsequent deduction or rebate on any account (except such payroll deductions as are permitted by regulations issued by the Secretary of Labor under the Copeland Act (29 CFR part 3)), the full amount of wages and bona fide fringe benefits (or cash equivalents thereof) due at time of payment computed at rates not less than those contained in the wage determination of the Secretary of Labor which is attached hereto and made a part hereof, regardless of any contractual relationship which may be alleged to exist between the contractor and such laborers and mechanics.

Contributions made or costs reasonably anticipated for bona fide fringe benefits under section 1(b)(2) of the Davis-Bacon Act on behalf of laborers or mechanics are considered wages paid to such laborers or mechanics, subject to the provisions of paragraph 1.d. of this section; also, regular contributions made or costs incurred for more than a weekly period (but not less often than quarterly) under plans, funds, or programs which cover the particular weekly period, are deemed to be constructively made or incurred during such weekly period. Such laborers and mechanics shall be paid the appropriate wage rate and fringe benefits on the wage determination for the classification of work actually performed, without regard to skill, except as provided in 29 CFR 5.5(a)(4). Laborers or mechanics performing work in more than one classification may be compensated at the rate specified for each classification for the time actually worked therein: Provided, That the employer's payroll records accurately set forth the time spent in each classification in which work is performed. The wage determination (including any additional classification and wage rates conformed under paragraph 1.b. of this section) and the Davis-Bacon poster (WH-1321) shall be posted at all times by the contractor and its subcontractors at the site of the work in a prominent and accessible place where it can be easily seen by the workers.

b.(1) The contracting officer shall require that any class of laborers or mechanics, including helpers, which is not listed in the wage determination and which is to be employed under the contract shall be classified in conformance with the wage determination. The contracting officer shall approve an additional classification and wage rate and fringe benefits therefore only when the following criteria have been met:

(i) The work to be performed by the classification requested is not performed by a classification in the wage determination; and

(ii) The classification is utilized in the area by the construction industry; and

(iii) The proposed wage rate, including any bona fide fringe benefits, bears a reasonable relationship to the wage rates contained in the wage determination.

(2) If the contractor and the laborers and mechanics to be employed in the classification (if known), or their representatives, and the contracting officer agree on the classification and wage rate (including the amount designated for fringe benefits where appropriate), a report of the action taken shall be sent by the contracting officer to the Administrator of the Wage and Hour Division, Employment Standards Administration, U.S. Department of Labor, Washington, DC 20210. The Administrator, or an authorized representative, will approve, modify, or disapprove every additional classification action within 30 days of receipt and so advise the contracting officer or will notify the contracting officer within the 30-day period that additional time is necessary.

(3) In the event the contractor, the laborers or mechanics to be employed in the classification or their representatives, and the contracting officer do not agree on the proposed classification and wage rate (including the amount designated for fringe benefits, where appropriate), the contracting officer shall refer the questions, including the views of all interested parties and the recommendation of the contracting officer, to the Wage and Hour Administrator for determination. The Wage and Hour Administrator, or an authorized representative, will issue a determination within 30 days of receipt and so advise the contracting officer or will notify the contracting officer within the 30-day period that additional time is necessary.

(4) The wage rate (including fringe benefits where appropriate) determined pursuant to paragraphs 1.b.(2) or 1.b.(3) of this section, shall be paid to all workers performing work in the classification under this contract from the first day on which work is performed in the classification.

c. Whenever the minimum wage rate prescribed in the contract for a class of laborers or mechanics includes a fringe benefit which is not expressed as an hourly rate, the contractor shall either pay the benefit as stated in the wage determination or shall pay another bona fide fringe benefit or an hourly cash equivalent thereof.

d. If the contractor does not make payments to a trustee or other third person, the contractor may consider as part of the wages of any laborer or mechanic the amount of any costs reasonably anticipated in providing bona fide fringe benefits under a plan or program, Provided, That the Secretary of Labor has found, upon the written request of the contractor, that the applicable standards of the Davis-Bacon Act have been met. The Secretary of Labor may require the contractor to set aside in a separate account assets for the meeting of obligations under the plan or program.

2. Withholding

The contracting agency shall upon its own action or upon written request of an authorized representative of the Department of Labor, withhold or cause to be withheld from the contractor under this contract, or any other Federal contract with the same prime contractor, or any other federally-assisted contract subject to Davis-Bacon prevailing wage requirements, which is held by the same prime contractor, so much of the accrued payments or advances as may be considered necessary to pay laborers and mechanics, including apprentices, trainees, and helpers, employed by the contractor or any subcontractor the full amount of wages required by the contract. In the event of failure to pay any laborer or mechanic, including any apprentice, trainee, or helper, employed or working on the site of the work, all or part of the wages required by the contract, the contracting agency may, after written notice to the contractor, take such

action as may be necessary to cause the suspension of any further payment, advance, or guarantee of funds until such violations have ceased.

3. Payrolls and basic records

a. Payrolls and basic records relating thereto shall be maintained by the contractor during the course of the work and preserved for a period of three years thereafter for all laborers and mechanics working at the site of the work. Such records shall contain the name, address, and social security number of each such worker, his or her correct classification, hourly rates of wages paid (including rates of contributions or costs anticipated for bona fide fringe benefits or cash equivalents thereof of the types described in section 1(b)(2)(B) of the Davis-Bacon Act), daily and weekly number of hours worked, deductions made and actual wages paid. Whenever the Secretary of Labor has found under 29 CFR 5.5(a)(1)(iv) that the wages of any laborer or mechanic include the amount of any costs reasonably anticipated in providing benefits under a plan or program described in section 1(b)(2)(B) of the Davis-Bacon Act, the contractor shall maintain records which show that the commitment to provide such benefits is enforceable, that the plan or program is financially responsible, and that the plan or program has been communicated in writing to the laborers or mechanics affected, and records which show the costs anticipated or the actual cost incurred in providing such benefits. Contractors employing apprentices or trainees under approved programs shall maintain written evidence of the registration of apprenticeship programs and certification of trainee programs, the registration of the apprentices and trainees, and the ratios and wage rates prescribed in the applicable programs.

b. (1) The contractor shall submit weekly for each week in which any contract work is performed a copy of all payrolls to the contracting agency. The payrolls submitted shall set out accurately and completely all of the information required to be maintained under 29 CFR 5.5(a)(3)(i), except that full social security numbers and home addresses shall not be included on weekly transmittals. Instead the payrolls shall only need to include an individually identifying number for each employee (e.g., the last four digits of the employee's social security number). The required weekly payroll information may be submitted in any form desired. Optional Form WH-347 is available for this purpose from the Wage and Hour Division Web site at <http://www.dol.gov/esa/whd/forms/wh347instr.htm> or its successor site. The prime contractor is responsible for the submission of copies of payrolls by all subcontractors. Contractors and subcontractors shall maintain the full social security number and current address of each covered worker, and shall provide them upon request to the contracting agency for transmission to the State DOT, the FHWA or the Wage and Hour Division of the Department of Labor for purposes of an investigation or audit of compliance with prevailing wage requirements. It is not a violation of this section for a prime contractor to require a subcontractor to provide addresses and social security numbers to the prime contractor for its own records, without weekly submission to the contracting agency..

(2) Each payroll submitted shall be accompanied by a "Statement of Compliance," signed by the contractor or subcontractor or his or her agent who pays or supervises the payment of the persons employed under the contract and shall certify the following:

(i) That the payroll for the payroll period contains the information required to be provided under §5.5 (a)(3)(ii) of Regulations, 29 CFR part 5, the appropriate information is being maintained under §5.5 (a)(3)(i) of Regulations, 29 CFR part 5, and that such information is correct and complete;

(ii) That each laborer or mechanic (including each helper, apprentice, and trainee) employed on the contract during the payroll period has been paid the full weekly wages earned, without rebate, either directly or indirectly, and that no deductions have been made either directly or indirectly from the full wages earned, other than permissible deductions as set forth in Regulations, 29 CFR part 3;

(iii) That each laborer or mechanic has been paid not less than the applicable wage rates and fringe benefits or cash equivalents for the classification of work performed, as specified in the applicable wage determination incorporated into the contract.

(3) The weekly submission of a properly executed certification set forth on the reverse side of Optional Form WH-347 shall satisfy the requirement for submission of the "Statement of Compliance" required by paragraph 3.b.(2) of this section.

(4) The falsification of any of the above certifications may subject the contractor or subcontractor to civil or criminal prosecution under section 1001 of title 18 and section 231 of title 31 of the United States Code.

c. The contractor or subcontractor shall make the records required under paragraph 3.a. of this section available for inspection, copying, or transcription by authorized representatives of the contracting agency, the State DOT, the FHWA, or the Department of Labor, and shall permit such representatives to interview employees during working hours on the job. If the contractor or subcontractor fails to submit the required records or to make them available, the FHWA may, after written notice to the contractor, the contracting agency or the State DOT, take such action as may be necessary to cause the suspension of any further payment, advance, or guarantee of funds. Furthermore, failure to submit the required records upon request or to make such records available may be grounds for debarment action pursuant to 29 CFR 5.12.

4. Apprentices and trainees

a. Apprentices (programs of the USDOL).

Apprentices will be permitted to work at less than the predetermined rate for the work they performed when they are employed pursuant to and individually registered in a bona fide apprenticeship program registered with the U.S. Department of Labor, Employment and Training Administration, Office of Apprenticeship Training, Employer and Labor Services, or with a State Apprenticeship Agency recognized by the Office, or if a person is employed in his or her first 90 days of probationary employment as an apprentice in such an apprenticeship program, who is not individually registered in the program, but who has been certified by the Office of Apprenticeship Training, Employer and Labor Services or a State Apprenticeship Agency (where appropriate) to be eligible for probationary employment as an apprentice.

The allowable ratio of apprentices to journeymen on the job site in any craft classification shall not be greater than the ratio permitted to the contractor as to the entire work force under the registered program. Any worker listed on a payroll at an apprentice wage rate, who is not registered or otherwise employed as stated above, shall be paid not less than the applicable wage rate on the wage determination for the classification of work actually performed. In addition, any apprentice performing work on the job site in excess of the ratio permitted under the registered program shall be paid not less than the applicable wage rate on the wage determination for the work actually performed. Where a contractor is performing construction on a project in a locality other than that in which its program is registered, the ratios and wage rates (expressed in percentages of the journeyman's hourly rate) specified in the contractor's or subcontractor's registered program shall be observed.

Every apprentice must be paid at not less than the rate specified in the registered program for the apprentice's level of progress, expressed as a percentage of the journeymen hourly rate specified in the applicable wage determination. Apprentices shall be paid fringe benefits in accordance with the provisions of the apprenticeship program. If the apprenticeship program does not specify fringe benefits, apprentices must be paid the full amount of fringe benefits listed on the wage determination for the applicable classification. If the Administrator determines that a different practice prevails for the applicable apprentice classification, fringes shall be paid in accordance with that determination.

In the event the Office of Apprenticeship Training, Employer and Labor Services, or a State Apprenticeship Agency recognized by the Office, withdraws approval of an apprenticeship program, the contractor will no longer be permitted to utilize apprentices at less than the applicable predetermined rate for the work performed until an acceptable program is approved.

b. Trainees (programs of the USDOL).

Except as provided in 29 CFR 5.16, trainees will not be permitted to work at less than the predetermined rate for the work performed unless they are employed pursuant to and individually registered in a program which has received prior approval, evidenced by formal certification by the U.S. Department of Labor, Employment and Training Administration.

The ratio of trainees to journeymen on the job site shall not be greater than permitted under the plan approved by the Employment and Training Administration.

Every trainee must be paid at not less than the rate specified in the approved program for the trainee's level of progress, expressed as a percentage of the journeyman hourly rate specified in the applicable wage determination. Trainees shall be paid fringe benefits in accordance with the provisions of the trainee program. If the trainee program does not mention fringe benefits, trainees shall be paid the full amount of fringe benefits listed on the wage determination unless the Administrator of the Wage and Hour Division determines that there is an apprenticeship program associated with the corresponding journeyman wage rate on the wage determination which provides for less than full fringe benefits for apprentices. Any employee listed on the payroll at a trainee rate who is not registered and participating in a training plan approved by the Employment and Training Administration shall be paid not less than the applicable wage rate on the wage determination for the classification of work actually performed. In addition, any trainee performing work on the job site in excess of the ratio permitted under the registered program shall be paid not less than the applicable wage rate on the wage determination for the work actually performed.

In the event the Employment and Training Administration withdraws approval of a training program, the contractor will no longer be permitted to utilize trainees at less than the applicable predetermined rate for the work performed until an acceptable program is approved.

c. Equal employment opportunity. The utilization of apprentices, trainees and journeymen under this part shall be in conformity with the equal employment opportunity requirements of Executive Order 11246, as amended, and 29 CFR part 30.

d. Apprentices and Trainees (programs of the U.S. DOT).

Apprentices and trainees working under apprenticeship and skill training programs which have been certified by the Secretary of Transportation as promoting EEO in connection with Federal-aid highway construction programs are not subject to the requirements of paragraph 4 of this Section IV. The straight time hourly wage rates for apprentices and trainees under such programs will be established by the particular programs. The ratio of apprentices and trainees to journeymen shall not be greater than permitted by the terms of the particular program.

5. Compliance with Copeland Act requirements. The contractor shall comply with the requirements of 29 CFR part 3, which are incorporated by reference in this contract.

6. Subcontracts. The contractor or subcontractor shall insert Form FHWA-1273 in any subcontracts and also require the subcontractors to include Form FHWA-1273 in any lower tier subcontracts. The prime contractor shall be responsible for the compliance by any subcontractor or lower tier subcontractor with all the contract clauses in 29 CFR 5.5.

7. Contract termination: debarment. A breach of the contract clauses in 29 CFR 5.5 may be grounds for termination of the contract, and for

debarment as a contractor and a subcontractor as provided in 29 CFR 5.12.

8. Compliance with Davis-Bacon and Related Act requirements. All rulings and interpretations of the Davis-Bacon and Related Acts contained in 29 CFR parts 1, 3, and 5 are herein incorporated by reference in this contract.

9. Disputes concerning labor standards. Disputes arising out of the labor standards provisions of this contract shall not be subject to the general disputes clause of this contract. Such disputes shall be resolved in accordance with the procedures of the Department of Labor set forth in 29 CFR parts 5, 6, and 7. Disputes within the meaning of this clause include disputes between the contractor (or any of its subcontractors) and the contracting agency, the U.S. Department of Labor, or the employees or their representatives.

10. Certification of eligibility.

a. By entering into this contract, the contractor certifies that neither it (nor he or she) nor any person or firm who has an interest in the contractor's firm is a person or firm ineligible to be awarded Government contracts by virtue of section 3(a) of the Davis-Bacon Act or 29 CFR 5.12(a)(1).

b. No part of this contract shall be subcontracted to any person or firm ineligible for award of a Government contract by virtue of section 3(a) of the Davis-Bacon Act or 29 CFR 5.12(a)(1).

c. The penalty for making false statements is prescribed in the U.S. Criminal Code, 18 U.S.C. 1001.

V. CONTRACT WORK HOURS AND SAFETY STANDARDS ACT

The following clauses apply to any Federal-aid construction contract in an amount in excess of \$100,000 and subject to the overtime provisions of the Contract Work Hours and Safety Standards Act. These clauses shall be inserted in addition to the clauses required by 29 CFR 5.5(a) or 29 CFR 4.6. As used in this paragraph, the terms laborers and mechanics include watchmen and guards.

1. Overtime requirements. No contractor or subcontractor contracting for any part of the contract work which may require or involve the employment of laborers or mechanics shall require or permit any such laborer or mechanic in any workweek in which he or she is employed on such work to work in excess of forty hours in such workweek unless such laborer or mechanic receives compensation at a rate not less than one and one-half times the basic rate of pay for all hours worked in excess of forty hours in such workweek.

2. Violation; liability for unpaid wages; liquidated damages. In the event of any violation of the clause set forth in paragraph (1.) of this section, the contractor and any subcontractor responsible therefor shall be liable for the unpaid wages. In addition, such contractor and subcontractor shall be liable to the United States (in the case of work done under contract for the District of Columbia or a territory, to such District or to such territory), for liquidated damages. Such liquidated damages shall be computed with respect to each individual laborer or mechanic, including watchmen and guards, employed in violation of the clause set forth in paragraph (1.) of this section, in the sum of \$10 for each calendar day on which such individual was required or permitted to work in excess of the standard workweek of forty hours without payment of the overtime wages required by the clause set forth in paragraph (1.) of this section.

3. Withholding for unpaid wages and liquidated damages. The FHWA or the contacting agency shall upon its own action or upon written request of an authorized representative of the Department of Labor withhold or cause to be withheld, from any moneys payable on account of work performed by the contractor or subcontractor under any such

contract or any other Federal contract with the same prime contractor, or any other federally-assisted contract subject to the Contract Work Hours and Safety Standards Act, which is held by the same prime contractor, such sums as may be determined to be necessary to satisfy any liabilities of such contractor or subcontractor for unpaid wages and liquidated damages as provided in the clause set forth in paragraph (2.) of this section.

4. Subcontracts. The contractor or subcontractor shall insert in any subcontracts the clauses set forth in paragraph (1.) through (4.) of this section and also a clause requiring the subcontractors to include these clauses in any lower tier subcontracts. The prime contractor shall be responsible for compliance by any subcontractor or lower tier subcontractor with the clauses set forth in paragraphs (1.) through (4.) of this section.

VI. SUBLETTING OR ASSIGNING THE CONTRACT

This provision is applicable to all Federal-aid construction contracts on the National Highway System.

1. The contractor shall perform with its own organization contract work amounting to not less than 30 percent (or a greater percentage if specified elsewhere in the contract) of the total original contract price, excluding any specialty items designated by the contracting agency. Specialty items may be performed by subcontract and the amount of any such specialty items performed may be deducted from the total original contract price before computing the amount of work required to be performed by the contractor's own organization (23 CFR 635.116).

a. The term "perform work with its own organization" refers to workers employed or leased by the prime contractor, and equipment owned or rented by the prime contractor, with or without operators. Such term does not include employees or equipment of a subcontractor or lower tier subcontractor, agents of the prime contractor, or any other assignees. The term may include payments for the costs of hiring leased employees from an employee leasing firm meeting all relevant Federal and State regulatory requirements. Leased employees may only be included in this term if the prime contractor meets all of the following conditions:

(1) the prime contractor maintains control over the supervision of the day-to-day activities of the leased employees;

(2) the prime contractor remains responsible for the quality of the work of the leased employees;

(3) the prime contractor retains all power to accept or exclude individual employees from work on the project; and

(4) the prime contractor remains ultimately responsible for the payment of predetermined minimum wages, the submission of payrolls, statements of compliance and all other Federal regulatory requirements.

b. "Specialty Items" shall be construed to be limited to work that requires highly specialized knowledge, abilities, or equipment not ordinarily available in the type of contracting organizations qualified and expected to bid or propose on the contract as a whole and in general are to be limited to minor components of the overall contract.

2. The contract amount upon which the requirements set forth in paragraph (1) of Section VI is computed includes the cost of material and manufactured products which are to be purchased or produced by the contractor under the contract provisions.

3. The contractor shall furnish (a) a competent superintendent or supervisor who is employed by the firm, has full authority to direct performance of the work in accordance with the contract requirements, and is in charge of all construction operations (regardless of who performs the work) and (b) such other of its own organizational resources (supervision, management, and engineering services) as the contracting officer determines is necessary to assure the performance of the contract.

4. No portion of the contract shall be sublet, assigned or otherwise disposed of except with the written consent of the contracting officer, or authorized representative, and such consent when given shall not be construed to relieve the contractor of any responsibility for the fulfillment of the contract. Written consent will be given only after the contracting agency has assured that each subcontract is evidenced in writing and that it contains all pertinent provisions and requirements of the prime contract.

5. The 30% self-performance requirement of paragraph (1) is not applicable to design-build contracts; however, contracting agencies may establish their own self-performance requirements.

VII. SAFETY: ACCIDENT PREVENTION

This provision is applicable to all Federal-aid construction contracts and to all related subcontracts.

1. In the performance of this contract the contractor shall comply with all applicable Federal, State, and local laws governing safety, health, and sanitation (23 CFR 635). The contractor shall provide all safeguards, safety devices and protective equipment and take any other needed actions as it determines, or as the contracting officer may determine, to be reasonably necessary to protect the life and health of employees on the job and the safety of the public and to protect property in connection with the performance of the work covered by the contract.

2. It is a condition of this contract, and shall be made a condition of each subcontract, which the contractor enters into pursuant to this contract, that the contractor and any subcontractor shall not permit any employee, in performance of the contract, to work in surroundings or under conditions which are unsanitary, hazardous or dangerous to his/her health or safety, as determined under construction safety and health standards (29 CFR 1926) promulgated by the Secretary of Labor, in accordance with Section 107 of the Contract Work Hours and Safety Standards Act (40 U.S.C. 3704).

3. Pursuant to 29 CFR 1926.3, it is a condition of this contract that the Secretary of Labor or authorized representative thereof, shall have right of entry to any site of contract performance to inspect or investigate the matter of compliance with the construction safety and health standards and to carry out the duties of the Secretary under Section 107 of the Contract Work Hours and Safety Standards Act (40 U.S.C.3704).

VIII. FALSE STATEMENTS CONCERNING HIGHWAY PROJECTS

This provision is applicable to all Federal-aid construction contracts and to all related subcontracts.

In order to assure high quality and durable construction in conformity with approved plans and specifications and a high degree of reliability on statements and representations made by engineers, contractors, suppliers, and workers on Federal-aid highway projects, it is essential that all persons concerned with the project perform their functions as carefully, thoroughly, and honestly as possible. Willful falsification, distortion, or misrepresentation with respect to any facts related to the project is a violation of Federal law. To prevent any misunderstanding regarding the seriousness of these and similar acts, Form FHWA-1022 shall be posted on each Federal-aid highway project (23 CFR 635) in one or more places where it is readily available to all persons concerned with the project:

18 U.S.C. 1020 reads as follows:

"Whoever, being an officer, agent, or employee of the United States, or of any State or Territory, or whoever, whether a person, association, firm, or corporation, knowingly makes any false statement, false representation, or false report as to the character, quality, quantity, or cost of the material used or to be used, or the quantity or quality of the work performed or to be performed, or the cost thereof in connection with the submission of plans, maps, specifications, contracts, or costs of construction on any highway or related project submitted for approval to the Secretary of Transportation; or

Whoever knowingly makes any false statement, false representation, false report or false claim with respect to the character, quality, quantity, or cost of any work performed or to be performed, or materials furnished or to be furnished, in connection with the construction of any highway or related project approved by the Secretary of Transportation; or

Whoever knowingly makes any false statement or false representation as to material fact in any statement, certificate, or report submitted pursuant to provisions of the Federal-aid Roads Act approved July 1, 1916, (39 Stat. 355), as amended and supplemented;

Shall be fined under this title or imprisoned not more than 5 years or both."

IX. IMPLEMENTATION OF CLEAN AIR ACT AND FEDERAL WATER POLLUTION CONTROL ACT

This provision is applicable to all Federal-aid construction contracts and to all related subcontracts.

By submission of this bid/proposal or the execution of this contract, or subcontract, as appropriate, the bidder, proposer, Federal-aid construction contractor, or subcontractor, as appropriate, will be deemed to have stipulated as follows:

1. That any person who is or will be utilized in the performance of this contract is not prohibited from receiving an award due to a violation of Section 508 of the Clean Water Act or Section 306 of the Clean Air Act.

2. That the contractor agrees to include or cause to be included the requirements of paragraph (1) of this Section X in every subcontract, and further agrees to take such action as the contracting agency may direct as a means of enforcing such requirements.

X. CERTIFICATION REGARDING DEBARMENT, SUSPENSION, INELIGIBILITY AND VOLUNTARY EXCLUSION

This provision is applicable to all Federal-aid construction contracts, design-build contracts, subcontracts, lower-tier subcontracts, purchase orders, lease agreements, consultant contracts or any other covered transaction requiring FHWA approval or that is estimated to cost \$25,000 or more – as defined in 2 CFR Parts 180 and 1200.

1. Instructions for Certification – First Tier Participants:

a. By signing and submitting this proposal, the prospective first tier participant is providing the certification set out below.

b. The inability of a person to provide the certification set out below will not necessarily result in denial of participation in this covered transaction. The prospective first tier participant shall submit an explanation of why it cannot provide the certification set out below. The certification or explanation will be considered in connection with the department or agency's determination whether to enter into this transaction. However, failure of the prospective first tier participant to furnish a certification or an explanation shall disqualify such a person from participation in this transaction.

c. The certification in this clause is a material representation of fact upon which reliance was placed when the contracting agency determined to enter into this transaction. If it is later determined that the prospective participant knowingly rendered an erroneous certification, in addition to other remedies available to the Federal Government, the contracting agency may terminate this transaction for cause of default.

d. The prospective first tier participant shall provide immediate written notice to the contracting agency to whom this proposal is submitted if any time the prospective first tier participant learns that its certification was erroneous when submitted or has become erroneous by reason of changed circumstances.

e. The terms "covered transaction," "debarred," "suspended," "ineligible," "participant," "person," "principal," and "voluntarily excluded,"

as used in this clause, are defined in 2 CFR Parts 180 and 1200. "First Tier Covered Transactions" refers to any covered transaction between a grantee or subgrantee of Federal funds and a participant (such as the prime or general contract). "Lower Tier Covered Transactions" refers to any covered transaction under a First Tier Covered Transaction (such as subcontracts). "First Tier Participant" refers to the participant who has entered into a covered transaction with a grantee or subgrantee of Federal funds (such as the prime or general contractor). "Lower Tier Participant" refers any participant who has entered into a covered transaction with a First Tier Participant or other Lower Tier Participants (such as subcontractors and suppliers).

f. The prospective first tier participant agrees by submitting this proposal that, should the proposed covered transaction be entered into, it shall not knowingly enter into any lower tier covered transaction with a person who is debarred, suspended, declared ineligible, or voluntarily excluded from participation in this covered transaction, unless authorized by the department or agency entering into this transaction.

g. The prospective first tier participant further agrees by submitting this proposal that it will include the clause titled "Certification Regarding Debarment, Suspension, Ineligibility and Voluntary Exclusion-Lower Tier Covered Transactions," provided by the department or contracting agency, entering into this covered transaction, without modification, in all lower tier covered transactions and in all solicitations for lower tier covered transactions exceeding the \$25,000 threshold.

h. A participant in a covered transaction may rely upon a certification of a prospective participant in a lower tier covered transaction that is not debarred, suspended, ineligible, or voluntarily excluded from the covered transaction, unless it knows that the certification is erroneous. A participant is responsible for ensuring that its principals are not suspended, debarred, or otherwise ineligible to participate in covered transactions. To verify the eligibility of its principals, as well as the eligibility of any lower tier prospective participants, each participant may, but is not required to, check the Excluded Parties List System website (<https://www.epls.gov/>), which is compiled by the General Services Administration.

i. Nothing contained in the foregoing shall be construed to require the establishment of a system of records in order to render in good faith the certification required by this clause. The knowledge and information of the prospective participant is not required to exceed that which is normally possessed by a prudent person in the ordinary course of business dealings.

j. Except for transactions authorized under paragraph (f) of these instructions, if a participant in a covered transaction knowingly enters into a lower tier covered transaction with a person who is suspended, debarred, ineligible, or voluntarily excluded from participation in this transaction, in addition to other remedies available to the Federal Government, the department or agency may terminate this transaction for cause or default.

* * * * *

2. Certification Regarding Debarment, Suspension, Ineligibility and Voluntary Exclusion – First Tier Participants:

a. The prospective first tier participant certifies to the best of its knowledge and belief, that it and its principals:

(1) Are not presently debarred, suspended, proposed for debarment, declared ineligible, or voluntarily excluded from participating in covered transactions by any Federal department or agency;

(2) Have not within a three-year period preceding this proposal been convicted of or had a civil judgment rendered against them for commission of fraud or a criminal offense in connection with obtaining, attempting to obtain, or performing a public (Federal, State or local) transaction or contract under a public transaction; violation of Federal or State antitrust statutes or commission of embezzlement, theft, forgery, bribery, falsification or destruction of records, making false statements, or receiving stolen property;

(3) Are not presently indicted for or otherwise criminally or civilly charged by a governmental entity (Federal, State or local) with

commission of any of the offenses enumerated in paragraph (a)(2) of this certification; and

(4) Have not within a three-year period preceding this application/proposal had one or more public transactions (Federal, State or local) terminated for cause or default.

b. Where the prospective participant is unable to certify to any of the statements in this certification, such prospective participant shall attach an explanation to this proposal.

2. Instructions for Certification - Lower Tier Participants:

(Applicable to all subcontracts, purchase orders and other lower tier transactions requiring prior FHWA approval or estimated to cost \$25,000 or more - 2 CFR Parts 180 and 1200)

a. By signing and submitting this proposal, the prospective lower tier is providing the certification set out below.

b. The certification in this clause is a material representation of fact upon which reliance was placed when this transaction was entered into. If it is later determined that the prospective lower tier participant knowingly rendered an erroneous certification, in addition to other remedies available to the Federal Government, the department, or agency with which this transaction originated may pursue available remedies, including suspension and/or debarment.

c. The prospective lower tier participant shall provide immediate written notice to the person to which this proposal is submitted if at any time the prospective lower tier participant learns that its certification was erroneous by reason of changed circumstances.

d. The terms "covered transaction," "debarred," "suspended," "ineligible," "participant," "person," "principal," and "voluntarily excluded," as used in this clause, are defined in 2 CFR Parts 180 and 1200. You may contact the person to which this proposal is submitted for assistance in obtaining a copy of those regulations. "First Tier Covered Transactions" refers to any covered transaction between a grantee or subgrantee of Federal funds and a participant (such as the prime or general contract). "Lower Tier Covered Transactions" refers to any covered transaction under a First Tier Covered Transaction (such as subcontracts). "First Tier Participant" refers to the participant who has entered into a covered transaction with a grantee or subgrantee of Federal funds (such as the prime or general contractor). "Lower Tier Participant" refers any participant who has entered into a covered transaction with a First Tier Participant or other Lower Tier Participants (such as subcontractors and suppliers).

e. The prospective lower tier participant agrees by submitting this proposal that, should the proposed covered transaction be entered into, it shall not knowingly enter into any lower tier covered transaction with a person who is debarred, suspended, declared ineligible, or voluntarily excluded from participation in this covered transaction, unless authorized by the department or agency with which this transaction originated.

f. The prospective lower tier participant further agrees by submitting this proposal that it will include this clause titled "Certification Regarding Debarment, Suspension, Ineligibility and Voluntary Exclusion-Lower Tier Covered Transaction," without modification, in all lower tier covered transactions and in all solicitations for lower tier covered transactions exceeding the \$25,000 threshold.

g. A participant in a covered transaction may rely upon a certification of a prospective participant in a lower tier covered transaction that is not debarred, suspended, ineligible, or voluntarily excluded from the covered transaction, unless it knows that the certification is erroneous. A participant is responsible for ensuring that its principals are not suspended, debarred, or otherwise ineligible to participate in covered transactions. To verify the eligibility of its principals, as well as the eligibility of any lower tier prospective participants, each participant may, but is not required to, check the Excluded Parties List System website (<https://www.epls.gov/>), which is compiled by the General Services Administration.

h. Nothing contained in the foregoing shall be construed to require establishment of a system of records in order to render in good faith the

certification required by this clause. The knowledge and information of participant is not required to exceed that which is normally possessed by a prudent person in the ordinary course of business dealings.

i. Except for transactions authorized under paragraph e of these instructions, if a participant in a covered transaction knowingly enters into a lower tier covered transaction with a person who is suspended, debarred, ineligible, or voluntarily excluded from participation in this transaction, in addition to other remedies available to the Federal Government, the department or agency with which this transaction originated may pursue available remedies, including suspension and/or debarment.

* * * * *

Certification Regarding Debarment, Suspension, Ineligibility and Voluntary Exclusion--Lower Tier Participants:

1. The prospective lower tier participant certifies, by submission of this proposal, that neither it nor its principals is presently debarred, suspended, proposed for debarment, declared ineligible, or voluntarily excluded from participating in covered transactions by any Federal department or agency.

2. Where the prospective lower tier participant is unable to certify to any of the statements in this certification, such prospective participant shall attach an explanation to this proposal.

* * * * *

XI. CERTIFICATION REGARDING USE OF CONTRACT FUNDS FOR LOBBYING

This provision is applicable to all Federal-aid construction contracts and to all related subcontracts which exceed \$100,000 (49 CFR 20).

1. The prospective participant certifies, by signing and submitting this bid or proposal, to the best of his or her knowledge and belief, that:

a. No Federal appropriated funds have been paid or will be paid, by or on behalf of the undersigned, to any person for influencing or attempting to influence an officer or employee of any Federal agency, a Member of Congress, an officer or employee of Congress, or an employee of a Member of Congress in connection with the awarding of any Federal contract, the making of any Federal grant, the making of any Federal loan, the entering into of any cooperative agreement, and the extension, continuation, renewal, amendment, or modification of any Federal contract, grant, loan, or cooperative agreement.

b. If any funds other than Federal appropriated funds have been paid or will be paid to any person for influencing or attempting to influence an officer or employee of any Federal agency, a Member of Congress, an officer or employee of Congress, or an employee of a Member of Congress in connection with this Federal contract, grant, loan, or cooperative agreement, the undersigned shall complete and submit Standard Form-LLL, "Disclosure Form to Report Lobbying," in accordance with its instructions.

2. This certification is a material representation of fact upon which reliance was placed when this transaction was made or entered into. Submission of this certification is a prerequisite for making or entering into this transaction imposed by 31 U.S.C. 1352. Any person who fails to file the required certification shall be subject to a civil penalty of not less than \$10,000 and not more than \$100,000 for each such failure.

3. The prospective participant also agrees by submitting its bid or proposal that the participant shall require that the language of this certification be included in all lower tier subcontracts, which exceed \$100,000 and that all such recipients shall certify and disclose accordingly.

**MINIMUM WAGES FOR FEDERAL AND FEDERALLY
ASSISTED CONSTRUCTION CONTRACTS**

This project is funded, in part, with Federal-aid funds and, as such, is subject to the provisions of the Davis-Bacon Act of March 3, 1931, as amended (46 Sta. 1494, as amended, 40 U.S.C. 276a) and of other Federal statutes referred to in a 29 CFR Part 1, Appendix A, as well as such additional statutes as may from time to time be enacted containing provisions for the payment of wages determined to be prevailing by the Secretary of Labor in accordance with the Davis-Bacon Act and pursuant to the provisions of 29 CFR Part 1. The prevailing rates and fringe benefits shown in the General Wage Determination Decisions issued by the U.S. Department of Labor shall, in accordance with the provisions of the foregoing statutes, constitute the minimum wages payable on Federal and federally assisted construction projects to laborers and mechanics of the specified classes engaged on contract work of the character and in the localities described therein.

General Wage Determination Decisions, modifications and supersedes decisions thereto are to be used in accordance with the provisions of 29 CFR Parts 1 and 5. Accordingly, the applicable decision, together with any modifications issued, must be made a part of every contract for performance of the described work within the geographic area indicated as required by an applicable DBRA Federal prevailing wage law and 29 CFR Part 5. The wage rates and fringe benefits contained in the General Wage Determination Decision shall be the minimum paid by contractors and subcontractors to laborers and mechanics.

NOTICE

The most current **General Wage Determination Decisions** (wage rates) are available on the IDOT web site. They are located on the Letting and Bidding page at <http://www.dot.state.il.us/desenv/delett.html>.

In addition, ten (10) days prior to the letting, the applicable Federal wage rates will be e-mailed to subscribers. It is recommended that all contractors subscribe to the Federal Wage Rates List or the Contractor's Packet through IDOT's subscription service.

PLEASE NOTE: if you have already subscribed to the Contractor's Packet you will automatically receive the Federal Wage Rates.

The instructions for subscribing are at <http://www.dot.state.il.us/desenv/subsc.html>.

If you have any questions concerning the wage rates, please contact IDOT's Chief Contract Official at 217-782-7806.