

E2 PLAN DETAIL - TILE
SCALE : 1:1

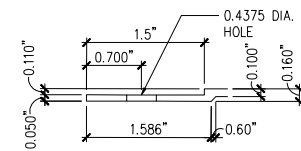

G2 SECTION - TILE
SCALE : 1:1

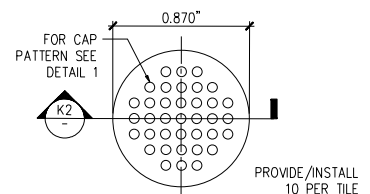

J2 PLAN - T/O CONCEALED CAP
SCALE : 2:1

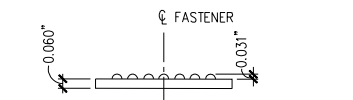

K2 SECTION - CONCEALED CAP
SCALE : 2:1

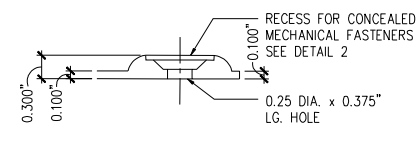

G5 SECTION - TILE
SCALE : 1:1

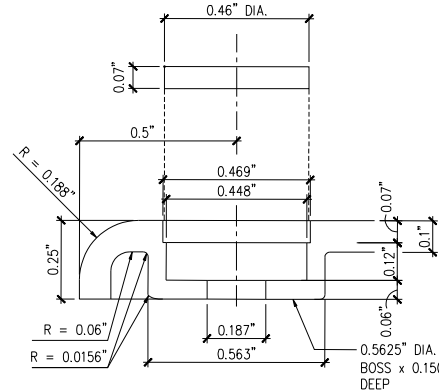

K5 CAP DETAIL
SCALE : 4:1

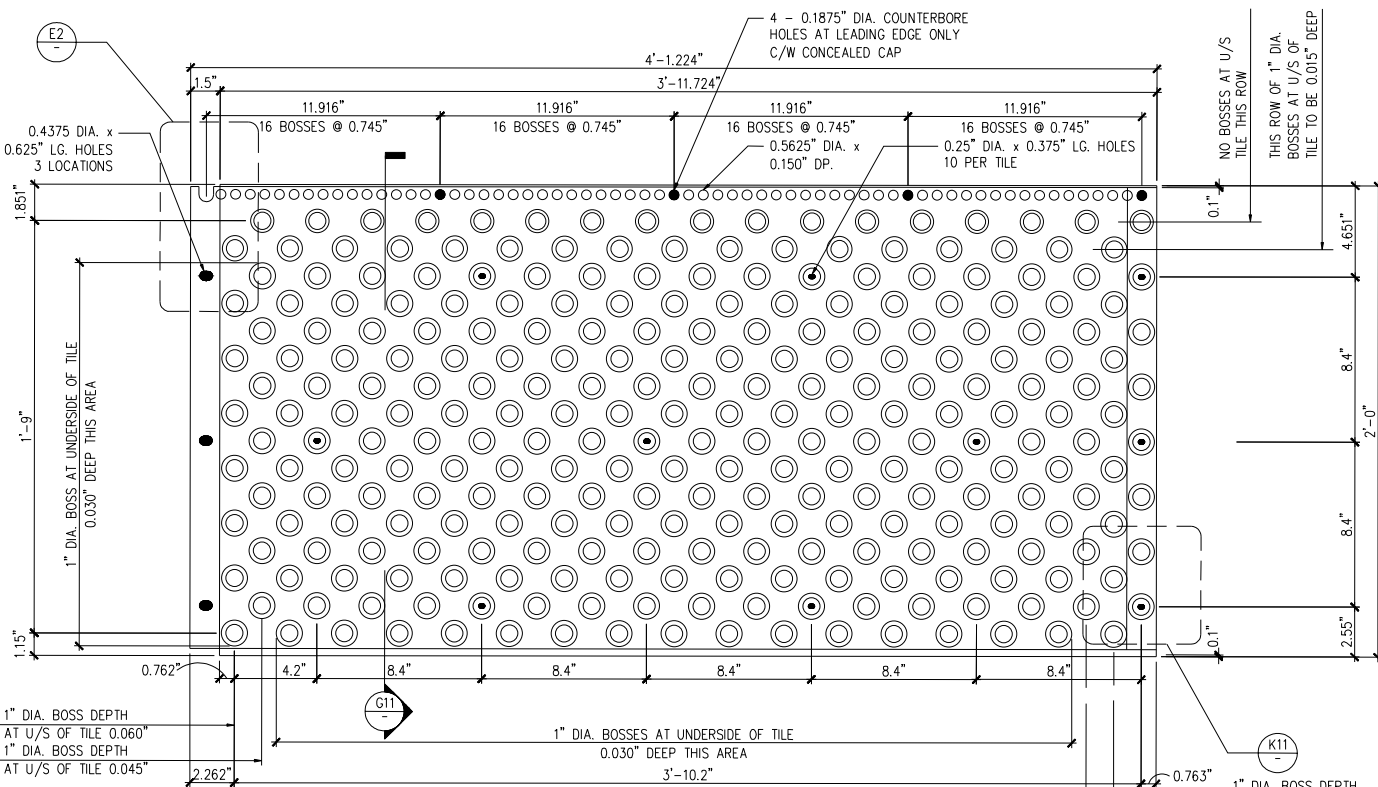

E11 PLAN - TILE
SCALE : 3" = 1'-0"

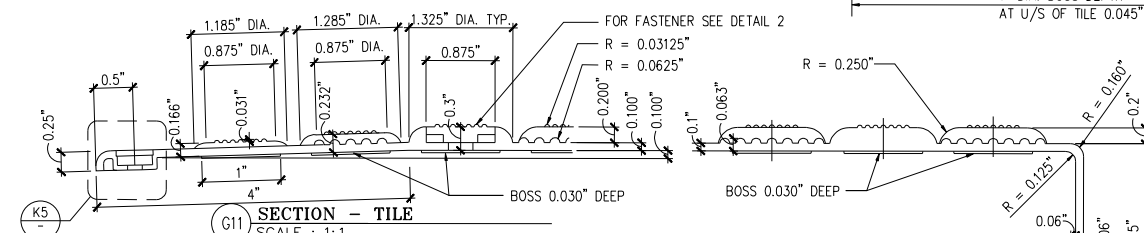

G11 SECTION - TILE
SCALE : 1:1

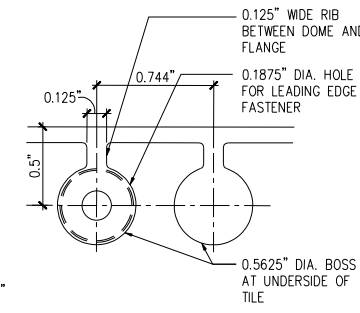

K8 PLAN AT U/S OF FASTENER
SCALE : 2:1

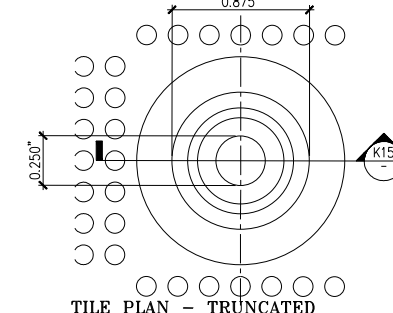

K11 TILE PLAN - TRUNCATED DOME FASTENER LOCATION
SCALE : 1:1

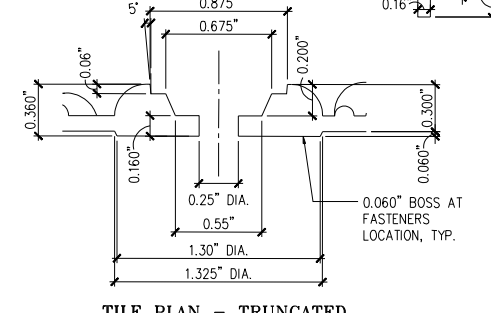

K15 TILE PLAN - TRUNCATED DOME FASTENER LOCATION
SCALE : 1:1

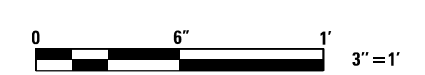

FROM STANDARD DETAILS DEPICTED
ON CITY OF CHICAGO STANDARD DRAWING A-53:
DATED MARCH 25, 2009.

2:10:54 PM 01/17/08-cow29-A-620.dgn



USER NAME = whbruce	DESIGNED - WHB	REVISED - 12/18/2013
PLOT SCALE = 8:0.0009 ' / in.	CHECKED - CRR	REVISED -
PLOT DATE = 12/17/2013	DRAWN - WHB	REVISED -
	CHECKED - CRR	REVISED -

STATE OF ILLINOIS
DEPARTMENT OF TRANSPORTATION

PEORIA STREET STATION
TACTILE PANEL PLAN, SECTION AND DETAILS

MUN	SECTION	COUNTY	TOTAL SHEETS	SHEET NO.
2090	2013-011R	COOK	356	254
CONTRACT NO.			60W29	
ILLINOIS FED. AID PROJECT FED. AID PROJECT				

SHEET NO. A-620 OF 117 SHEETS