

DETAILS OF SURFACING AT INTERSECTIONS AND SIDEROADS

F.A.S.	SECTION	COUNTY	TOTAL SHEETS	SHEET NO.
800	07-00075-00-RS	WABASH	4	3
FED. ROAD DIST. NO. 7	ILLINOIS	LANCASTER-FRIENDSVILLE RD		
LEC JOB # H081006WB		CONTRACT # 9594		

DETAIL OF TAPER STA. 0+75 TO STA. 1+25

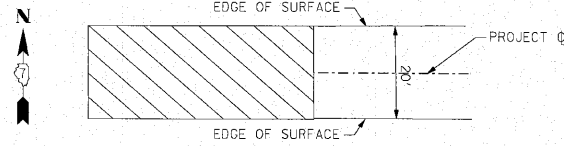

NOTE: THE QUANTITY SHOWN FOR HOT-MIX ASPHALT SURFACE COURSE, MIX "C", N70 INCLUDES 8.7 TONS OF MATERIAL FOR THE TAPER FROM STATION 0+75 TO STATION 1+25.

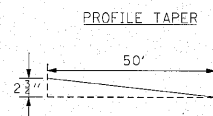

DETAIL OF TAPER STA. 23+40 TO STA. 23+90 & STA. 24+65 TO STA. 25+15

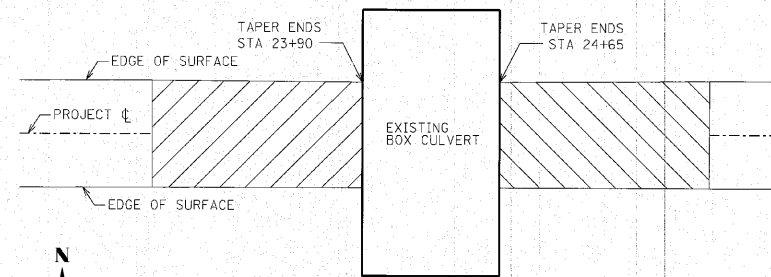

BOX CULVERT TAPER DETAIL
STA 23+40 TO STA 23+90 & STA 24+65 TO STA 25+15

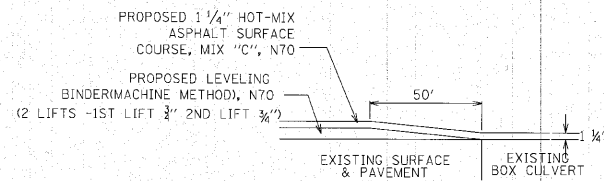

DETAIL OF INTERSECTION 48+50 LT

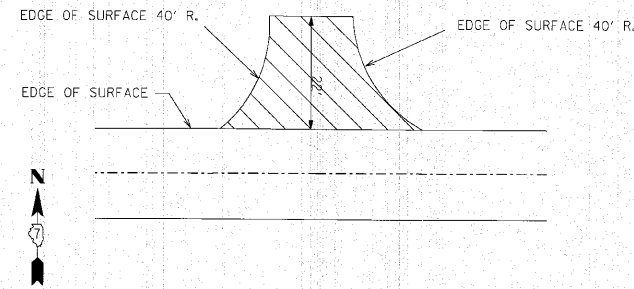

NOTE: THE QUANTITY SHOWN FOR HOT-MIX ASPHALT SURFACE COURSE, MIX "C", N70 INCLUDES 14.4 TONS OF MATERIAL FOR THE SIDEROAD LT

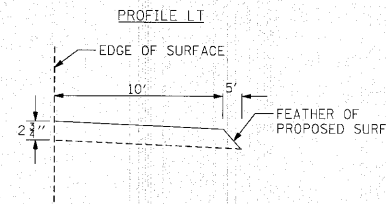

DETAIL OF TAPER STA. 80+15 TO STA. 80+65 & STA. 81+15 TO STA. 81+65

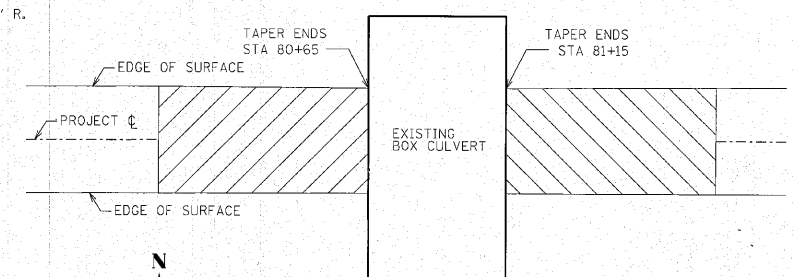

BOX CULVERT TAPER DETAIL
STA 80+15 TO STA 80+65 & STA 81+15 TO STA 81+65

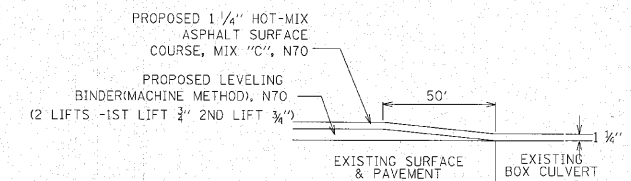

DETAIL OF INTERSECTION 89+80 LT

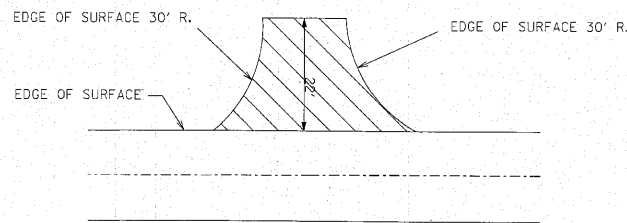

NOTE: THE QUANTITY SHOWN FOR HOT-MIX ASPHALT SURFACE COURSE, MIX "C", N70 INCLUDES 9.5 TONS OF MATERIAL FOR THE SIDEROAD LT.

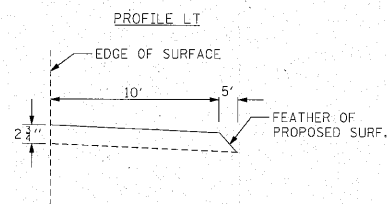

DETAIL OF INTERSECTION 130+50 LT AND RT

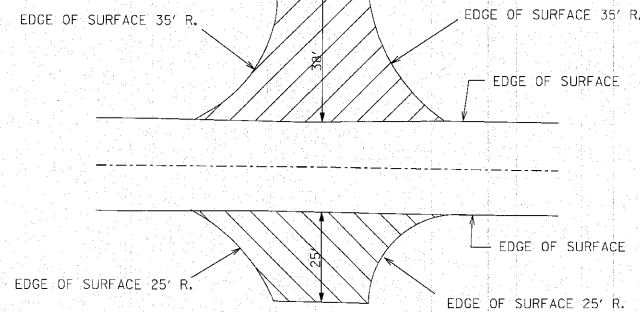

NOTE: THE QUANTITY SHOWN FOR HOT-MIX ASPHALT SURFACE COURSE, MIX "C", N70 INCLUDES 25.5 TONS OF MATERIAL FOR THE SIDEROAD LT APPROACH AND RADII AND 14.1 TONS OF MATERIAL FOR THE SIDEROAD RT. APPROACH AND RADII.

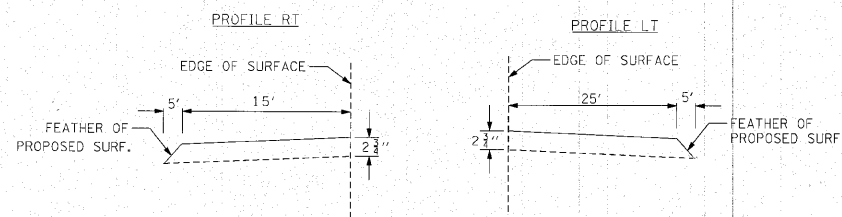

DETAIL OF TAPER STA. 146+10 TO STA. 146+60 & STA. 146+95 TO STA. 147+45

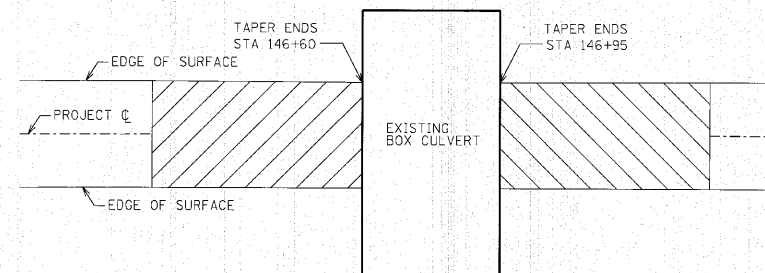

BOX CULVERT TAPER DETAIL
STA 146+10 TO STA 146+60 & STA 146+95 TO STA 147+45

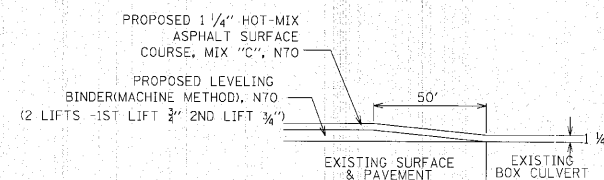

DETAIL OF INTERSECTION 158+02 LT AND RT AND TAPER STA. 158+25 TO STA. 158+75

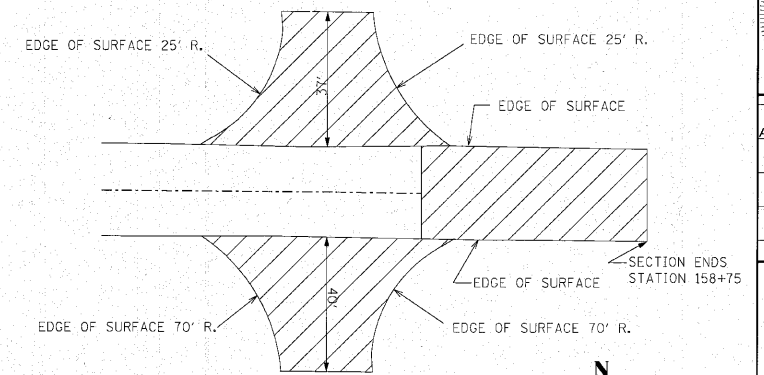

NOTE: THE QUANTITY SHOWN FOR HOT-MIX ASPHALT SURFACE COURSE, MIX "C", N70 INCLUDES 25.0 TONS OF MATERIAL FOR THE SIDEROAD LT APPROACH AND RADII; 36.6 TONS OF MATERIAL FOR THE SIDEROAD RT. APPROACH AND RADII; AND 8.8 TONS OF MATERIAL FOR THE TAPER FROM STATION 158+25 TO STATION 158+75.

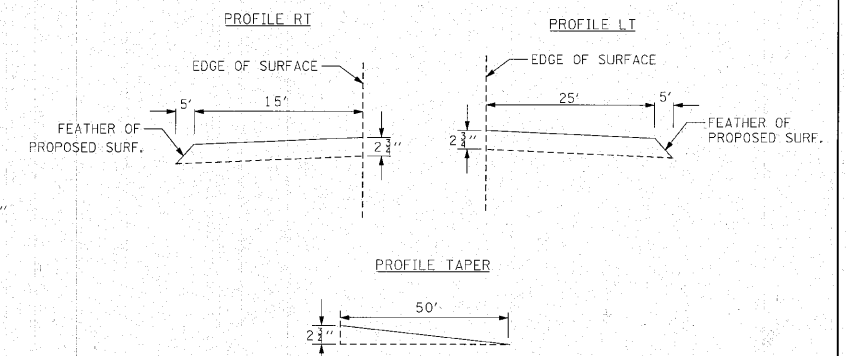

323 W. 3RD ST.
P.O. BOX 160
MT. CARMEL, IL
62863
PHONE:
(618)-262-8651
FAX:
(618)-263-3327

405 W. STATE ST.
SUITE 1
PRINCETON, IN
47670
PHONE:
(812)-386-7611
FAX:
(812)-385-2812



PROFESSIONAL DESIGN FIRM
LAND SURVEY & PROFESSIONAL ENGINEERING CORPORATION
184-00887
(62-032435)(35-002769)

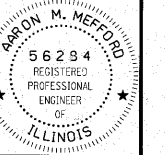

AARON M. MEFFORD
NAME
Aaron M. Mefford
SIGNATURE
10-20-10
DATE
11-30-11
EXPIRES