

# **BID PROPOSAL INSTRUCTIONS**

**ABOUT IDOT PROPOSALS:** All proposals are potential bidding proposals. Each proposal contains all certifications and affidavits, a proposal signature sheet and a proposal bid bond.

## **PREQUALIFICATION**

Any contractor who desires to become pre-qualified to bid on work advertised by IDOT must submit the properly completed pre-qualification forms to the Bureau of Construction no later than 4:30 p.m. prevailing time twenty-one days prior to the letting of interest. This pre-qualification requirement applies to first time contractors, contractors renewing expired ratings, contractors maintaining continuous pre-qualification or contractors requesting revised ratings. To be eligible to bid, existing pre-qualification ratings must be effective through the date of letting.

## **WHO CAN BID ?**

Bids will be accepted from only those companies that request and receive written Authorization to Bid from IDOT's Central Bureau of Construction.

## **REQUESTS FOR AUTHORIZATION TO BID**

Contractors wanting to bid on items included in a particular letting must submit the properly completed "Request for Authorization to Bid/or Not For Bid Status" (BDE 124) and the ORIGINAL "Affidavit of Availability" (BC 57) to the proper office no later than 4:30 p.m. prevailing time, three (3) days prior to the letting date.

## **WHAT CONSTITUTES WRITTEN AUTHORIZATION TO BID?**

When a prospective prime bidder submits a "Request for Authorization to Bid/or Not For Bid Status"(BDE 124) he/she must indicate at that time which items are being requested For Bidding purposes. Only those items requested For Bidding will be analyzed. After the request has been analyzed, the bidder will be issued an **Authorization to Bid or Not for Bid Report**, approved by the Central Bureau of Construction and the Chief Procurement Officer that indicates which items have been approved For Bidding. If **Authorization to Bid** cannot be approved, the **Authorization to Bid or Not for Bid Report** will indicate the reason for denial.

## **ABOUT AUTHORIZATION TO BID**

Firms that have not received an Authorization to Bid or Not For Bid Report within a reasonable time of complete and correct original document submittal should contact the Department as to the status. Firms unsure as to authorization status should call the Prequalification Section of the Bureau of Construction at the number listed at the end of these instructions.

## **ADDENDA AND REVISIONS**

It is the bidder's responsibility to determine which, if any, addenda or revisions pertain to any project they may be bidding. Failure to incorporate all relevant addenda or revisions may cause the bid to be declared unacceptable.

Each addendum or revision will be included with the Electronic Plans and Proposals. Addenda and revisions will also be placed on the Addendum/Revision Checklist and each subscription service subscriber will be notified by e-mail of each addendum and revision issued.

The Internet is the Department's primary way of doing business. The subscription service emails are an added courtesy the Department provides. It is suggested that bidders check IDOT's website at <http://www.idot.illinois.gov/doing-business/procurements/construction-services/construction-bulletins/transportation-bulletin/index#TransportationBulletin> before submitting final bid information.

***IDOT IS NOT RESPONSIBLE FOR ANY E-MAIL FAILURES.***

Addenda questions may be directed to the Contracts Office at (217)782-7806 or [DOT.DE-Contracts@Illinois.gov](mailto:DOT.DE-Contracts@Illinois.gov)

Technical questions about downloading these files may be directed to Tim Garman at (217)524-1642 or [Timothy.Garman@illinois.gov](mailto:Timothy.Garman@illinois.gov).

## **STANDARD GUIDELINES FOR SUBMITTING PAPER BIDS**

- All pages should be single sided.
- Use the Cover Page that is provided in the Bid Proposal (posted on the IDOT Web Site) as the first page of your submitted bid. It has the item number in large bold type in the upper left-hand corner and lines provided for your company name and address in the upper right-hand corner.
- Do not use report covers, presentation folders or special bindings and do not staple multiple times on left side like a book. Use only 1 staple in the upper left hand corner. Make sure all elements of your bid are stapled together including the bid bond or guaranty check (if required).
- **Do not include any certificates of eligibility, your authorization to bid, Addendum Letters or affidavit of availability.**
- Do not include the Subcontractor Documentation with your bid (pages i – iii and pages a – g). This documentation is required only if you are awarded the project.
- Use the envelope cover sheet (provided with the proposal) as the cover for the proposal envelope.
- Do not rely on overnight services to deliver your proposal prior to 10 AM on letting day. It will not be read if it is delivered after 10 AM.
- Do not submit your Substance Abuse Prevention Program (SAPP) with your bid. If you are awarded the contract this form is to be submitted to the district engineer at the pre-construction conference.

## **BID SUBMITTAL CHECKLIST**

- Cover page** (the sheet that has the item number on it) – This should be the first page of your bid proposal, **followed by your bid (the Schedule of Prices/Pay Items)**. If you are using special software or CBID to generate your schedule of prices, do not include the blank pages of the schedule of prices that came with the proposal package.
- Page 4 (Item 9)** – Check “YES” if you will use a subcontractor(s) with an annual value over \$50,000. Include the subcontractor(s) name, address, general type of work to be performed and the dollar amount. If you will use subcontractor(s) but are uncertain who or the dollar amount; check “YES” but leave the lines blank.
- After page 4** – Insert the following documents: Cost Adjustments for Steel, Bituminous and Fuel (if applicable) and the Contractor Letter of Assent (if applicable). The general rule should be, if you don’t know where it goes, put it after page 4.
- Page 10 (Paragraph J)** – Check “YES” or “NO” whether your company has any business in Iran.
- Page 10 (Paragraph K)** – (Not applicable to federally funded projects) List the name of the apprenticeship and training program sponsor holding the certificate of registration from the US Department of Labor. If no applicable program exists, please indicate the work/job category. **Do not include certificates with your bid.** Keep the certificates in your office in case they are requested by IDOT.
- Page 11 (Paragraph L)** – Your State Board of Elections certificate of registration is no longer required with your bid.
- Page 11 (Paragraph M)** – Indicate if your company has hired a lobbyist in connection with the job for which you are submitting the bid proposal.
- Page 12 (Paragraph C)** – This is a work sheet to determine if a completed Form A is required. It is not part of the form and you do not need to make copies for each completed Form A.
- Pages 14-17 (Form A)** – One Form A (4 pages) is required for each applicable person in your company. Copies of the forms can be used and only need to be changed when the information changes. The certification signature and date must be original for each letting. **Do not staple the forms together.** If you answered “NO” to all of the questions in Paragraph C (page 12), complete the first section (page 14) with your company information and then sign and date the Not Applicable statement on page 17.
- Page 18 (Form B)** - If you check “YES” to having other current or pending contracts it is acceptable to use the phrase, “See Affidavit of Availability on file”. **Ownership Certification** (at the bottom of the page) - Check N/A if the Form A(s) you submitted accounts for 100 percent of the company ownership. Check YES if any percentage of ownership falls outside of the parameters that require reporting on the Form A. Checking NO indicates that the Form A(s) you submitted is not correct and you will be required to submit a revised Form A.
- Page 20 (Workforce Projection)** – Be sure to include the Duration of the Project. It is acceptable to use the phrase “Per Contract Specifications”.

- Proposal Bid Bond** – (Insert after the proposal signature page) Submit your Proposal Bid Bond (if applicable) using the current Proposal Bid Bond form provided in the proposal package. The Power of Attorney page should be stapled to the Proposal Bid Bond. If you are using an electronic bond, include your bid bond number on the Proposal Bid Bond and attach the Proof of Insurance printed from the Surety’s Web Site.
- Disadvantaged Business Utilization Plan and/or Good Faith Effort – Do Not Submit with Bid** The bidder shall submit a Disadvantaged Business Utilization Plan on completed Department forms SBE 2025 and 2026. (1) The final Utilization Plan must be submitted within five calendar days after the date of the letting. (2) To meet the five day requirement, the bidder may send the Utilization Plan electronically by scanning and sending to [DOT.DBE.UP@illinois.gov](mailto:DOT.DBE.UP@illinois.gov) or faxing to (217) 785-1524. The subject line must include the bid Item Number and the Letting date. The Utilization Plan should be sent as one .pdf file, rather than multiple files and emails for the same Item Number. It is the responsibility of the bidder to obtain confirmation of email or fax delivery.

Alternatively, the Utilization Plan may be sent by certified mail or delivery service within the five calendar day period. If a question arises concerning the mailing date of a Utilization Plan, the mailing date will be established by the U.S. Postal Service postmark on the certified mail receipt from the U.S. Postal Service or the receipt issued by a delivery service. It is the responsibility of the bidder to ensure the postmark or receipt date is affixed within the five days if the bidder intends to rely upon mailing or delivery to satisfy the submission day requirement. The Utilization Plan is to be submitted to:

Illinois Department of Transportation  
 Bureau of Small Business Enterprises  
 Contract Compliance Section  
 2300 South Dirksen Parkway, Room 319  
 Springfield, Illinois 62764

**The Bid Letting is now available in streaming Audio/Video from the IDOT Web Site.** A link to the stream will be placed on the main page of the current letting on the day of the Letting. The stream will not begin until 10 AM.

Following the Letting, the As-Read Tabulation of Bids will be posted by the end of the day. You will find the link on the main Web page for the current letting.

**QUESTIONS: pre-letting up to execution of the contract**

Contractor pre-qualification .....	217-782-3413
Small Business, Disadvantaged Business Enterprise (DBE) .....	217-785-4611
Contracts, Bids, Letting process or Internet downloads .....	217-782-7806
Estimates Unit.....	217-785-3483
Aeronautics.....	217-785-8515
IDNR (Land Reclamation, Water Resources, Natural Resources).....	217-782-6302

**QUESTIONS: following contract execution**

Subcontractor documentation, payments .....	217-782-3413
Railroad Insurance .....	217-785-0275

RETURN WITH BID

135

Proposal Submitted By
Name
Address
City

Letting January 20, 2017

**NOTICE TO PROSPECTIVE BIDDERS**

This proposal can be used for bidding purposes by only those companies that request and receive written AUTHORIZATION TO BID from IDOT's Central Bureau of Construction.

**BIDDERS NEED NOT RETURN THE ENTIRE PROPOSAL**

**Notice to Bidders,  
Specifications,  
Proposal, Contract  
and Contract Bond**



**Illinois Department  
of Transportation**

Springfield, Illinois 62764

**Contract No. 85646  
LEE County  
Section 13-00325-00-RS  
Routes FAS 188 & FAS 1181 (Ch 15 & Ch 14, Ch 24)  
Project RS-0103(141)  
District 2 Construction Funds**

PLEASE MARK THE APPROPRIATE BOX BELOW:

- A Bid Bond is included.
- A Cashier's Check or a Certified Check is included
- An Annual Bid Bond is included or is on file with IDOT.

Prepared by	
Checked by	F

**Page intentionally left blank**

RETURN WITH BID



PROPOSAL

TO THE DEPARTMENT OF TRANSPORTATION

1. Proposal of \_\_\_\_\_

\_\_\_\_\_

Taxpayer Identification Number (Mandatory) \_\_\_\_\_

For the improvement identified and advertised for bids in the Invitation for Bids as:

**Contract No. 85646  
LEE County  
Section 13-00325-00-RS  
Project RS-0103(141)  
Routes FAS 188 & FAS 1181 (Ch 15 & Ch 14, Ch 24)  
District 2 Construction Funds**

**Resurfacing on Harmon Road from Sterling Road to Balch Road; Sterling Road from Harmon Road to Walton Road and Walton Road to the Village of Walton.**

2. The undersigned bidder will furnish all labor, material and equipment to complete the above described project in a good and workmanlike manner as provided in the contract documents provided by the Department of Transportation. This proposal will become part of the contract and the terms and conditions contained in the contract documents will govern performance and payments.

**RETURN WITH BID**

3. **ASSURANCE OF EXAMINATION AND INSPECTION/WAIVER.** The undersigned bidder further declares that he/she has carefully examined the proposal, plans, specifications, addenda form of contract and contract bond, and special provisions, and that he/she has inspected in detail the site of the proposed work, and that he/she has familiarized themselves with all of the local conditions affecting the contract and the detailed requirements of construction, and understands that in making this bid proposal he/she waives all right to plead any misunderstanding regarding the same.
  
4. **EXECUTION OF CONTRACT AND CONTRACT BOND.** The undersigned bidder further agrees to execute a contract for this work and present the same to the department within fifteen (15) days after the contract has been mailed to him/her. The undersigned further agrees that he/she and his/her surety will execute and present within fifteen (15) days after the contract has been mailed to him/her contract bond satisfactory to and in the form prescribed by the Department of Transportation, in the penal sum of the full amount of the contract, or as specified in the special provisions, guaranteeing the faithful performance of the work in accordance with the terms of the contract.
  
5. **PROPOSAL GUARANTY.** Accompanying this proposal is either a bid bond on the department form, executed by a corporate surety company satisfactory to the department, or a proposal guaranty check consisting of a bank cashier's check or a properly certified check for not less than 5 per cent of the amount bid or for the amount specified in the following schedule:

<u>Amount of Bid</u>		<u>Proposal Guaranty</u>	<u>Amount of Bid</u>		<u>Proposal Guaranty</u>	
Up to	\$5,000 .....	\$150	\$2,000,000	to	\$3,000,000 .....	\$100,000
\$5,000	to \$10,000 .....	\$300	\$3,000,000	to	\$5,000,000 .....	\$150,000
\$10,000	to \$50,000 .....	\$1,000	\$5,000,000	to	\$7,500,000 .....	\$250,000
\$50,000	to \$100,000 .....	\$3,000	\$7,500,000	to	\$10,000,000 .....	\$400,000
\$100,000	to \$150,000 .....	\$5,000	\$10,000,000	to	\$15,000,000 .....	\$500,000
\$150,000	to \$250,000 .....	\$7,500	\$15,000,000	to	\$20,000,000 .....	\$600,000
\$250,000	to \$500,000 .....	\$12,500	\$20,000,000	to	\$25,000,000 .....	\$700,000
\$500,000	to \$1,000,000 .....	\$25,000	\$25,000,000	to	\$30,000,000 .....	\$800,000
\$1,000,000	to \$1,500,000 .....	\$50,000	\$30,000,000	to	\$35,000,000 .....	\$900,000
\$1,500,000	to \$2,000,000 .....	\$75,000	over		\$35,000,000 .....	\$1,000,000

Bank cashier's checks or properly certified checks accompanying bid proposals will be made payable to the Treasurer, State of Illinois.

If a combination bid is submitted, the proposal guaranties which accompany the individual bid proposals making up the combination will be considered as also covering the combination bid.

The amount of the proposal guaranty check is \_\_\_\_\_ \$( \_\_\_\_\_ ). If this proposal is accepted and the undersigned will fail to execute a contract bond as required herein, it is hereby agreed that the amount of the proposal guaranty will become the property of the State of Illinois, and shall be considered as payment of damages due to delay and other causes suffered by the State because of the failure to execute said contract and contract bond; otherwise, the bid bond will become void or the proposal guaranty check will be returned to the undersigned.

**Attach Cashier's Check or Certified Check Here**

In the event that one proposal guaranty check is intended to cover two or more bid proposals, the amount must be equal to the sum of the proposal guaranties which would be required for each individual bid proposal. If the guaranty check is placed in another bid proposal, state below where it may be found.

The proposal guaranty check will be found in the bid proposal for:

Item \_\_\_\_\_

Section No. \_\_\_\_\_

County \_\_\_\_\_

**Mark the proposal cover sheet as to the type of proposal guaranty submitted.**

**RETURN WITH BID**

6. **COMBINATION BIDS.** The undersigned bidder further agrees that if awarded the contract for the sections contained in the following combination, he/she will perform the work in accordance with the requirements of each individual contract comprising the combination bid specified in the schedule below, and that the combination bid shall be prorated against each section in proportion to the bid submitted for the same. If an error is found to exist in the gross sum bid for one or more of the individual sections included in a combination, the combination bid shall be corrected as provided in the specifications.

**When a combination bid is submitted, the schedule below must be completed in each proposal comprising the combination.**

**If alternate bids are submitted for one or more of the sections comprising the combination, a combination bid must be submitted for each alternate.**

**Schedule of Combination Bids**

Combination No.	Sections Included in Combination	Combination Bid	
		Dollars	Cents

7. **SCHEDULE OF PRICES.** The undersigned bidder submits herewith, in accordance with the rules and instructions, a schedule of prices for the items of work for which bids are sought. The unit prices bid are in U.S. dollars and cents, and all extensions and summations have been made. The bidder understands that the quantities appearing in the bid schedule are approximate and are provided for the purpose of obtaining a gross sum for the comparison of bids. If there is an error in the extension of the unit prices, the unit prices will govern. Payment to the contractor awarded the contract will be made only for actual quantities of work performed and accepted or materials furnished according to the contract. The scheduled quantities of work to be done and materials to be furnished may be increased, decreased or omitted as provided elsewhere in the contract.
8. **AUTHORITY TO DO BUSINESS IN ILLINOIS.** Section 20-43 of the Illinois Procurement Code (the Code) (30 ILCS 500/20-43) provides that a person (other than an individual acting as a sole proprietor) must be a legal entity authorized to transact business or conduct affairs in the State of Illinois prior to submitting the bid.
9. **EXECUTION OF CONTRACT:** The Department of Transportation will, in accordance with the rules governing Department procurements, execute the contract and shall be the sole entity having the authority to accept performance and make payments under the contract. Execution of the contract by the Chief Procurement Officer (CPO) or the State Purchasing Officer (SPO) is for approval of the procurement process and execution of the contract by the Department. Neither the CPO nor the SPO shall be responsible for administration of the contract or determinations respecting performance or payment there under except as otherwise permitted in the Code.
10. **The services of a subcontractor will be used.**

Check box Yes   
 Check box No

For known subcontractors with subcontracts with an annual value of more than \$50,000, the contract shall include their name, address, general type of work to be performed, and the dollar allocation for each subcontractor.  
 (30 ILCS 500/20-120)

---



---



RUN DATE - 11/22/16

CONTRACT NUMBER - 85646

PPS NBR -

RUN TIME - 183019

COUNTY NAME	CODE	DIST	SECTION NUMBER	PROJECT NUMBER	ROUTE
LEE	103	02	13-00325-00-RS	RS-0103/141/000	VARIOUS

ITEM NUMBER	PAY ITEM DESCRIPTION	UNIT OF MEASURE	QUANTITY	UNIT PRICE		TOTAL PRICE	
				DOLLARS	CENTS	DOLLARS	CTS
LR403300	SURFACE PROFILE MILL	SQ YD	85,195.000	X			
X7010216	TRAF CONT & PROT SPL	L SUM	1.000	X			
40600290	BIT MATLS TACK CT	POUND	57,507.000	X			
40600625	LEV BIND MM N50	TON	3,834.000	X			
40603310	HMA SC "C" N50	TON	7,187.000	X			
42400100	PC CONC SIDEWALK 4	SQ FT	585.000	X			
42400800	DETECTABLE WARNINGS	SQ FT	67.000	X			
44000157	HMA SURF REM 2	SQ YD	2,533.000	X			
44000500	COMB CURB GUTTER REM	FOOT	90.000	X			
44000600	SIDEWALK REM	SQ FT	585.000	X			
48101200	AGGREGATE SHLDS B	TON	1,960.000	X			
56109210	WATER VALVES ADJUST	EACH	1.000	X			
60255500	MAN ADJUST	EACH	1.000	X			
60604400	COMB CC&G TB6.18	FOOT	90.000	X			
67100100	MOBILIZATION	L SUM	1.000	X			

ITEM NUMBER	PAY ITEM DESCRIPTION	UNIT OF MEASURE	QUANTITY	UNIT PRICE		TOTAL PRICE	
				DOLLARS	CENTS	DOLLARS	CTS
70300100	SHORT TERM PAVT MKING	FOOT	7,042.000 X		=		
				TOTAL	\$		

- NOTE:
1. EACH PAY ITEM SHOULD HAVE A UNIT PRICE AND A TOTAL PRICE.
  2. THE UNIT PRICE SHALL GOVERN IF NO TOTAL PRICE IS SHOWN OR IF THERE IS A DISCREPANCY BETWEEN THE PRODUCT OF THE UNIT PRICE MULTIPLIED BY THE QUANTITY.
  3. IF A UNIT PRICE IS OMITTED, THE TOTAL PRICE WILL BE DIVIDED BY THE QUANTITY IN ORDER TO ESTABLISH A UNIT PRICE.
  4. A BID MAY BE DECLARED UNACCEPTABLE IF NEITHER A UNIT PRICE NOR A TOTAL PRICE IS SHOWN.

## RETURN WITH BID

### **STATE REQUIRED ETHICAL STANDARDS GOVERNING CONTRACT PROCUREMENT: ASSURANCES, CERTIFICATIONS AND DISCLOSURES**

#### **I. GENERAL**

**A.** Article 50 of the Code establishes the duty of all State CPOs, SPOs, and their designees to maximize the value of the expenditure of public moneys in procuring goods, services, and contracts for the State of Illinois and to act in a manner that maintains the integrity and public trust of State government. In discharging this duty, they are charged by law to use all available information, reasonable efforts, and reasonable actions to protect, safeguard, and maintain the procurement process of the State of Illinois.

**B.** In order to comply with the provisions of Article 50 and to carry out the duty established therein, all bidders are to adhere to ethical standards established for the procurement process, and to make such assurances, disclosures and certifications required by law. Except as otherwise required in subsection III, paragraphs J-M, by execution of the Proposal Signature Sheet, the bidder indicates that each of the mandated assurances have been read and understood, that each certification is made and understood, and that each disclosure requirement has been understood and completed.

**C.** In addition to all other remedies provided by law, failure to comply with any assurance, failure to make any disclosure or the making of a false certification shall be grounds for the CPO to void the contract, and may result in the suspension or debarment of the bidder or subcontractor. If a false certification is made by a subcontractor the contractor's submitted bid and the executed contract may not be declared void unless the contractor refuses to terminate the subcontract upon the State's request after a finding that the subcontractor's certification was false.

I acknowledge, understand and accept these terms and conditions.

#### **II. ASSURANCES**

The assurances hereinafter made by the bidder are each a material representation of fact upon which reliance is placed should the Department enter into the contract with the bidder.

##### **A. Conflicts of Interest**

Section 50-13. Conflicts of Interest.

(a) Prohibition. It is unlawful for any person holding an elective office in this State, holding a seat in the General Assembly, or appointed to or employed in any of the offices or agencies of state government and who receives compensation for such employment in excess of 60% of the salary of the Governor of the State of Illinois, or who is an officer or employee of the Capital Development Board or the Illinois State Toll Highway Authority, or who is the spouse or minor child of any such person to have or acquire any contract, or any direct pecuniary interest in any contract therein, whether for stationery, printing, paper, or any services, materials, or supplies, that will be wholly or partially satisfied by the payment of funds appropriated by the General Assembly of the State of Illinois or in any contract of the Capital Development Board or the Illinois State Toll Highway Authority.

(b) Interests. It is unlawful for any firm, partnership, association or corporation, in which any person listed in subsection (a) is entitled to receive (i) more than 7 1/2% of the total distributable income or (ii) an amount in excess of the salary of the Governor, to have or acquire any such contract or direct pecuniary interest therein.

(c) Combined interests. It is unlawful for any firm, partnership, association, or corporation, in which any person listed in subsection (a) together with his or her spouse or minor children is entitled to receive (i) more than 15%, in the aggregate, of the total distributable income or (ii) an amount in excess of 2 times the salary of the Governor, to have or acquire any such contract or direct pecuniary interest therein.

(d) Securities. Nothing in this Section invalidates the provisions of any bond or other security previously offered or to be offered for sale or sold by or for the State of Illinois.

(e) Prior interests. This Section does not affect the validity of any contract made between the State and an officer or employee of the State or member of the General Assembly, his or her spouse, minor child or any combination of those persons if that contract was in existence before his or her election or employment as an officer, member, or employee. The contract is voidable, however, if it cannot be completed within 365 calendar days after the officer, member, or employee takes office or is employed. The current salary of the Governor is \$177,412.00. Sixty percent of the salary is \$106,447.20.

## RETURN WITH BID

The bidder assures the Department that the award and execution of the contract would not cause a violation of Section 50-13, or that an effective exemption has been issued by the Board of Ethics to any individual subject to the Section 50-13 prohibitions pursuant to the provisions of Section 50-20 of the Code. Information concerning the exemption process is available from the Department upon request.

### **B. Negotiations**

Section 50-15. Negotiations.

It is unlawful for any person employed in or on a continual contractual relationship with any of the offices or agencies of State government to participate in contract negotiations on behalf of that office or agency with any firm, partnership, association, or corporation with whom that person has a contract for future employment or is negotiating concerning possible future employment.

The bidder assures the Department that the award and execution of the contract would not cause a violation of Section 50-15, and that the bidder has no knowledge of any facts relevant to the kinds of acts prohibited therein.

### **C. Inducements**

Section 50-25. Inducement.

Any person who offers or pays any money or other valuable thing to any person to induce him or her not to provide a submission to a vendor portal or to bid for a State contract or as recompense for not having bid on a State contract is guilty of a Class 4 felony. Any person who accepts any money or other valuable thing for not bidding for a State contract, not making a submission to a vendor portal, or who withholds a bid or submission to a vendor portal in consideration of the promise for the payment of money or other valuable thing is guilty of a Class 4 felony.

The bidder assures the Department that the award and execution of the contract would not cause a violation of Section 50-25, and that the bidder has no knowledge of any facts relevant to the kinds of acts prohibited therein.

### **D. Revolving Door Prohibition**

Section 50-30. Revolving door prohibition.

CPOs, SPOs, procurement compliance monitors, their designees whose principal duties are directly related to State procurement, and executive officers confirmed by the Senate are expressly prohibited for a period of 2 years after terminating an affected position from engaging in any procurement activity relating to the State agency most recently employing them in an affected position for a period of at least 6 months. The prohibition includes, but is not limited to: lobbying the procurement process; specifying; bidding; proposing bid, proposal, or contract documents; on their own behalf or on behalf of any firm, partnership, association, or corporation. This Section applies only to persons who terminate an affected position on or after January 15, 1999.

The bidder assures the Department that the award and execution of the contract would not cause a violation of Section 50-30, and that the bidder has no knowledge of any facts relevant to the kinds of acts prohibited therein.

### **E. Reporting Anticompetitive Practices**

Section 50-40. Reporting anticompetitive practices.

When, for any reason, any vendor, bidder, contractor, CPO, SPO, designee, elected official, or State employee suspects collusion or other anticompetitive practice among any bidders, offerors, contractors, proposers, or employees of the State, a notice of the relevant facts shall be transmitted to the Attorney General and the CPO.

The bidder assures the Department that it has not failed to report any relevant facts concerning the practices addressed in Section 50-40 which may involve the contract for which the bid or submission to a vendor portal is submitted.

### **F. Confidentiality**

Section 50-45. Confidentiality.

Any CPO, SPO, designee, or executive officer who willfully uses or allows the use of specifications, competitive bid documents, proprietary competitive information, proposals, contracts, or selection information to compromise the fairness or integrity of the procurement, bidding, or contract process shall be subject to immediate dismissal, regardless of the Personnel code, any contract, or any collective bargaining agreement, and may in addition be subject to criminal prosecution.

The bidder assures the Department that it has no knowledge of any fact relevant to the practices addressed in Section 50-45 which may involve the contract for which the bid is submitted.

## RETURN WITH BID

### G. Insider Information

Section 50-50. Insider information.

It is unlawful for any current or former elected or appointed State official or State employee to knowingly use confidential information available only by virtue of that office or employment for actual or anticipated gain for themselves or another person.

The bidder assures the Department that it has no knowledge of any facts relevant to the practices addressed in Section 50-50 which may involve the contract for which the bid is submitted.

I acknowledge, understand and accept these terms and conditions for the above assurances.

### III. CERTIFICATIONS

The certifications hereinafter made by the bidder are each a material representation of fact upon which reliance is placed should the Department enter into the contract with the bidder. Section 50-2 of the Code provides that every person that has entered into a multi-year contract and every subcontractor with a multi-year subcontract shall certify, by July 1 of each fiscal year covered by the contract after the initial fiscal year, to the responsible CPO whether it continues to satisfy the requirements of Article 50 pertaining to the eligibility for a contract award. If a contractor or subcontractor is not able to truthfully certify that it continues to meet all requirements, it shall provide with its certification a detailed explanation of the circumstances leading to the change in certification status. A contractor or subcontractor that makes a false statement material to any given certification required under Article 50 is, in addition to any other penalties or consequences prescribed by law, subject to liability under the Whistleblower Reward and Protection Act for submission of a false claim.

#### A. Bribery

Section 50-5. Bribery.

(a) Prohibition. No person or business shall be awarded a contract or subcontract under this Code who:

(1) has been convicted under the laws of Illinois or any other state of bribery or attempting to bribe an officer or employee of the State of Illinois or any other state in that officer's or employee's official capacity; or

(2) has made an admission of guilt of that conduct that is a matter of record but has not been prosecuted for that conduct.

(b) Businesses. No business shall be barred from contracting with any unit of State or local government, or subcontracting under such a contract, as a result of a conviction under this Section of any employee or agent of the business if the employee or agent is no longer employed by the business and:

(1) the business has been finally adjudicated not guilty; or

(2) the business demonstrates to the governmental entity with which it seeks to contract, or which is signatory to the contract which the subcontract relates, and that entity finds that the commission of the offense was not authorized, requested, commanded, or performed by a director, officer, or high managerial agent on behalf of the business as provided in paragraph (2) of subsection (a) of Section 5-4 of the Criminal Code of 2012.

(c) Conduct on behalf of business. For purposes of this Section, when an official, agent, or employee of a business committed the bribery or attempted bribery on behalf of the business and in accordance with the direction or authorization of a responsible official of the business, the business shall be chargeable with the conduct.

(d) Certification. Every bid submitted to and contract executed by the State, and every subcontract subject to Section 20-120 of the Code shall contain a certification by the contractor or the subcontractor, respectively, that the contractor or subcontractor is not barred from being awarded a contract or subcontract under this Section and acknowledges that the CPO may declare the related contract void if any certifications required by this Section are false. A contractor who makes a false statement, material to the certification, commits a Class 3 felony.

The contractor or subcontractor certifies that it is not barred from being awarded a contract under Section 50-5.

#### B. Felons

Section 50-10. Felons.

(a) Unless otherwise provided, no person or business convicted of a felony shall do business with the State of Illinois or any State agency, or enter into a subcontract, from the date of conviction until 5 years after the date of completion of the sentence for that felony, unless no person held responsible by a prosecutorial office for the facts upon which the conviction was based continues to have any involvement with the business.

(b) Certification. Every bid submitted to and contract executed by the State and every subcontract subject to Section 20-120 of the Code and every vendor's submission to a vendor portal shall contain a certification by the bidder or contractor or subcontractor, respectively, that the bidder, contractor, or subcontractor is not barred from being awarded a contract or subcontract under this Section and acknowledges that the CPO may declare the related contract void if any of the certifications required by this Section are false.

## RETURN WITH BID

### **C. Debt Delinquency**

Section 50-11 and 50-12. Debt Delinquency.

The contractor or bidder or subcontractor, respectively, certifies that it, or any affiliate, is not barred from being awarded a contract or subcontract under the Code. Section 50-11 prohibits a person from entering into a contract with a State agency, or entering into a subcontract, if it knows or should know that it, or any affiliate, is delinquent in the payment of any debt to the State as defined by the Debt Collection Board. Section 50-12 prohibits a person from entering into a contract with a State agency, or entering into a subcontract, if it, or any affiliate, has failed to collect and remit Illinois Use Tax on all sales of tangible personal property into the State of Illinois in accordance with the provisions of the Illinois Use Tax Act. The bidder or contractor or subcontractor, respectively, further acknowledges that the CPO may declare the related contract void if this certification is false or if the bidder, contractor, or subcontractor, or any affiliate, is determined to be delinquent in the payment of any debt to the State during the term of the contract.

### **D. Prohibited Bidders, Contractors and Subcontractors**

Section 50-10.5 and 50-60(c). Prohibited bidders, contractors and subcontractors.

The bidder or contractor or subcontractor, respectively, certifies in accordance with Section 50-10.5 that no officer, director, partner or other managerial agent of the contracting business has been convicted of a felony under the Sarbanes-Oxley Act of 2002 or a Class 3 or Class 2 felony under the Illinois Securities Law of 1953 or if in violation of Subsection (c) for a period of five years from the date of conviction. Every bid submitted to and contract executed by the State and every subcontract subject to Section 20-120 of the Code shall contain a certification by the bidder, contractor, or subcontractor, respectively, that the bidder, contractor, or subcontractor is not barred from being awarded a contract or subcontract under this Section and acknowledges that the CPO shall declare the related contract void if any of the certifications completed pursuant to this Section are false.

### **E. Section 42 of the Environmental Protection Act**

Section 50-14 Environmental Protection Act violations.

The bidder or contractor or subcontractor, respectively, certifies in accordance with Section 50-14 that the bidder, contractor, or subcontractor, is not barred from being awarded a contract or entering into a subcontract under this Section which prohibits the bidding on or entering into contracts with the State of Illinois or a State agency, or entering into any subcontract, that is subject to the Code by a person or business found by a court or the Pollution Control Board to have committed a willful or knowing violation of Section 42 of the Environmental Protection Act for a period of five years from the date of the order. The bidder or contractor or subcontractor, respectively, acknowledges that the CPO may declare the contract void if this certification is false.

### **F. Educational Loan**

Section 3 of the Educational Loan Default Act, 5 ILCS 385/3.

Pursuant to the Educational Loan Default Act no State agency shall contract with an individual for goods or services if that individual is in default on an educational loan.

The bidder, if an individual as opposed to a corporation, partnership or other form of business organization, certifies that the bidder is not in default on an educational loan as provided in Section 3 of the Act.

### **G. Bid-Rigging/Bid Rotating**

Section 33E-11 of the Criminal Code of 2012, 720 ILCS 5/3BE-11.

(a) Every bid submitted to and public contract executed pursuant to such bid by the State or a unit of local government shall contain a certification by the prime contractor that the prime contractor is not barred from contracting with any unit of State or local government as a result of a violation of either Section 33E-3 or 33E-4 of this Article.

(b) A contractor who makes a false statement, material to the certification, commits a Class 3 felony.

A violation of Section 33E-3 would be represented by a conviction of the crime of bid-rigging which, in addition to Class 3 felony sentencing, provides that any person convicted of this offense or any similar offense of any state or the United States which contains the same elements as this offense shall be barred for 5 years from the date of conviction from contracting with any unit of State or local government. No corporation shall be barred from contracting with any unit of State or local government as a result of a conviction under this Section of any employee or agent of such corporation if the employee so convicted is no longer employed by the corporation and: (1) it has been finally adjudicated not guilty or (2) if it demonstrates to the governmental entity with which it seeks to contract and that entity finds that the commission of the offense was neither authorized, requested, commanded, nor performed by a director, officer or a high managerial agent in behalf of the corporation.

The bidder certifies that it is not barred from contracting with the Department by reason of a violation of either Section 33E-3 or Section 33E-4.

## RETURN WITH BID

### **H. International Anti-Boycott**

Section 5 of the International Anti-Boycott Certification Act provides every contract entered into by the State of Illinois for the manufacture, furnishing, or purchasing of supplies, material, or equipment or for the furnishing of work, labor, or services, in an amount exceeding the threshold for small purchases according to the purchasing laws of this State or \$10,000.00, whichever is less, shall contain certification, as a material condition of the contract, by which the contractor agrees that neither the contractor nor any substantially-owned affiliated company is participating or shall participate in an international boycott in violation of the provisions of the U.S. Export Administration Act of 1979 or the regulations of the U.S. Department of Commerce promulgated under that Act.

The bidder makes the certification set forth in Section 5 of the Act.

### **I. Drug Free Workplace**

The Illinois "Drug Free Workplace Act" applies to this contract and it is necessary to comply with the provisions of the "Act" if the contractor is a corporation, partnership, or other entity (including a sole proprietorship) which has 25 or more employees.

The bidder certifies that if awarded a contract in excess of \$5,000 it will provide a drug free workplace in compliance with the provisions of the Act.

### **J. Disclosure of Business Operations in Iran**

Section 50-36 of the Code provides that each bid, offer, or proposal submitted for a State contract shall include a disclosure of whether or not the Company acting as the bidder, offeror, or proposing entity, or any of its corporate parents or subsidiaries, within the 24 months before submission of the bid, offer, or proposal had business operations that involved contracts with or provision of supplies or services to the Government of Iran, companies in which the Government of Iran has any direct or indirect equity share, consortiums or projects commissioned by the Government of Iran, or companies involved in consortiums or projects commissioned by the Government of Iran and either of the following conditions apply:

- (1) More than 10% of the Company's revenues produced in or assets located in Iran involve oil-related activities or mineral-extraction activities; less than 75% of the Company's revenues produced in or assets located in Iran involve contracts with or provision of oil-related or mineral-extraction products or services to the Government of Iran or a project or consortium created exclusively by that government; and the Company has failed to take substantial action.
- (2) The Company has, on or after August 5, 1996, made an investment of \$20 million or more, or any combination of investments of at least \$10 million each that in the aggregate equals or exceeds \$20 million in any 12-month period, which directly or significantly contributes to the enhancement of Iran's ability to develop petroleum resources of Iran.

The terms "Business operations", "Company", "Mineral-extraction activities", "Oil-related activities", "Petroleum resources", and "Substantial action" are all defined in the Code.

Failure to make the disclosure required by the Code may cause the bid, offer or proposal to be considered not responsive. The disclosure will be considered when evaluating the bid or awarding the contract. The name of each Company disclosed as doing business or having done business in Iran will be provided to the State Comptroller.

Check the appropriate statement:

Company has no business operations in Iran to disclose.

Company has business operations in Iran as disclosed on the attached document.

## RETURN WITH BID

### **K. Apprenticeship and Training Certification (Does not apply to federal aid projects)**

In accordance with the provisions of Section 30-22 (6) of the Code, the bidder certifies that it is a participant, either as an individual or as part of a group program, in the approved apprenticeship and training programs applicable to each type of work or craft that the bidder will perform with its own forces. The bidder further certifies for work that will be performed by subcontract that each of its subcontractors submitted for approval either (a) is, at the time of such bid, participating in an approved, applicable apprenticeship and training program; or (b) will, prior to commencement of performance of work pursuant to this contract, begin participation in an approved apprenticeship and training program applicable to the work of the subcontract. The Department, at any time before or after award, may require the production of a copy of each applicable Certificate of Registration issued by the United States Department of Labor evidencing such participation by the contractor and any or all of its subcontractors. Applicable apprenticeship and training programs are those that have been approved and registered with the United States Department of Labor. The bidder shall list in the space below, the official name of the program sponsor holding the Certificate of Registration for all of the types of work or crafts in which the bidder is a participant and that will be performed with the bidder's forces. Types of work or craft work that will be subcontracted shall be included and listed as subcontract work. The list shall also indicate any type of work or craft job category that does not have an applicable apprenticeship or training program. **The bidder is responsible for making a complete report and shall make certain that each type of work or craft job category that will be utilized on the project as reported on the Construction Employee Workforce Projection (Form BC-1256) and returned with the bid is accounted for and listed.**

Additionally, Section 30-22 of the Code requires that the bidder certify that an Illinois office be maintained as the primary place of employment for persons employed for this contract.

**NA-FEDERAL**

---

---

---

The requirements of these certifications and disclosures are a material part of the contract, and the contractor shall require these certification provisions to be included in all approved subcontracts. In order to fulfill this requirement, it shall not be necessary that an applicable program sponsor be currently taking, or that it will take applications for apprenticeship, training or employment during the performance of the work of this contract.



**RETURN WITH BID**

**L. Political Contributions and Registration with the State Board of Elections**

Sections 20-160 and 50-37 of the Code regulate political contributions from business entities and any affiliated entities or affiliated persons bidding on or contracting with the state. Generally under Section 50-37, any business entity, and any affiliated entity or affiliated person of the business entity, whose current year contracts with all state agencies exceed an awarded value of \$50,000, are prohibited from making any contributions to any political committees established to promote the candidacy of the officeholder responsible for the awarding of the contracts or any other declared candidate for that office for the duration of the term of office of the incumbent officeholder or a period 2 years after the termination of the contract, whichever is longer. Any business entity and affiliated entities or affiliated persons whose state contracts in the current year do not exceed an awarded value of \$50,000, but whose aggregate pending bids and proposals on state contracts exceed \$50,000, either alone or in combination with contracts not exceeding \$50,000, are prohibited from making any political contributions to any political committee established to promote the candidacy of the officeholder responsible for awarding the pending contract during the period beginning on the date the invitation for bids or request for proposals or any other procurement opportunity is issued and ending on the day after the date of award or selection if the entity was not awarded or selected. Section 20-160 requires certification of registration of affected business entities in accordance with procedures found in Section 9-35 of The Election Code.

By submission of a bid, the contractor business entity acknowledges and agrees that it has read and understands Sections 20-160 and 50-37 of the Code, and that it makes the following certification:

**The undersigned bidder certifies that it has registered as a business with the State Board of Elections and acknowledges a continuing duty to update the registration in accordance with the above referenced statutes. If the business entity is required to register, the CPO shall verify that it is in compliance on the date the bid or proposal is due. The CPO shall not accept a bid or proposal if the business entity is not in compliance with the registration requirements.**

These requirements and compliance with the above referenced statutory sections are a material part of the contract, and any breach thereof shall be cause to void the contract under Section 50-60 of the Code. This provision does not apply to Federal-aid contracts.

**M. Lobbyist Disclosure**

Section 50-38 of the Code requires that any bidder or offeror on a State contract that hires a person required to register under the Lobbyist Registration Act to assist in obtaining a contract shall:

- (i) Disclose all costs, fees, compensation, reimbursements, and other remunerations paid or to be paid to the lobbyist related to the contract,
- (ii) Not bill or otherwise cause the State of Illinois to pay for any of the lobbyist's costs, fees, compensation, reimbursements, or other remuneration, and
- (iii) Sign a verification certifying that none of the lobbyist's costs, fees, compensation, reimbursements, or other remuneration were billed to the State.

This information, along with all supporting documents, shall be filed with the agency awarding the contract and with the Secretary of State. The CPO shall post this information, together with the contract award notice, in the online Procurement Bulletin.

Pursuant to Subsection (c) of this Section, no person or entity shall retain a person or entity to attempt to influence the outcome of a procurement decision made under the Code for compensation contingent in whole or in part upon the decision or procurement. Any person who violates this subsection is guilty of a business offense and shall be fined not more than \$10,000.

Bidder acknowledges that it is required to disclose the hiring of any person required to register pursuant to the Illinois Lobbyist Registration Act (25 ILCS 170) in connection with this contract.

Bidder has not hired any person required to register pursuant to the Illinois Lobbyist Registration Act in connection with this contract.

Or

Bidder has hired the following persons required to register pursuant to the Illinois Lobbyist Registration Act in connection with the contract:

Name and address of person: \_\_\_\_\_  
All costs, fees, compensation, reimbursements and other remuneration paid to said person: \_\_\_\_\_  
\_\_\_\_\_  
\_\_\_\_\_

I acknowledge, understand and accept these terms and conditions for the above certifications.

## RETURN WITH BID

### IV. DISCLOSURES

- A. The disclosures hereinafter made by the bidder are each a material representation of fact upon which reliance is placed should the Department enter into the contract with the bidder. The bidder further certifies that the Department has received the disclosure forms for each bid.

The CPO may void the bid, or contract, respectively, if it is later determined that the bidder or subcontractor rendered a false or erroneous disclosure. A contractor or subcontractor may be suspended or debarred for violations of the Code. Furthermore, the CPO may void the contract and the surety providing the performance bond shall be responsible for completion of the contract.

### B. Financial Interests and Conflicts of Interest

1. Section 50-35 of the Code provides that all bids of more than \$50,000 and all submissions to a vendor portal shall be accompanied by disclosure of the financial interests of the bidder. This disclosed information for the successful bidder, will be maintained as public information subject to release by request pursuant to the Freedom of Information Act, filed with the Procurement Policy Board, and shall be incorporated as a material term of the contract. Furthermore, pursuant to Section 5-5, the Procurement Policy Board may review a proposal, bid, or contract and issue a recommendation to void a contract or reject a proposal or bid based on any violation of the Code or the existence of a conflict of interest as provided in subsections (b) and (d) of Section 50-35.

The financial interests to be disclosed shall include ownership or distributive income share that is in excess of 5%, or an amount greater than 60% of the annual salary of the Governor, of the bidding entity or its parent entity, whichever is less, unless the contractor or bidder is a publicly traded entity subject to Federal 10K reporting, in which case it may submit its 10K disclosure in place of the prescribed disclosure. If a bidder is a privately held entity that is exempt from Federal 10K reporting, but has more than 100 shareholders, it may submit the information that Federal 10K companies are required to report, and list the names of any individual or entity holding any ownership share that is in excess of 5%. The disclosure shall include the names, addresses, and dollar or proportionate share of ownership of each individual making the disclosure, their instrument of ownership or beneficial relationship, and notice of any potential conflict of interest resulting from the current ownership or beneficial interest of each individual making the disclosure having any of the relationships identified in Section 50-35 and on the disclosure form.

**The current annual salary of the Governor is \$177,412.00.**

In addition, all disclosures shall indicate any other current or pending contracts, proposals, leases, or other ongoing procurement relationships the bidding entity has with any other unit of state government and shall clearly identify the unit and the contract, proposal, lease, or other relationship.

2. Disclosure Forms. Disclosure Form A is attached for use concerning the individuals meeting the above ownership or distributive share requirements. A separate Disclosure Form A must be submitted with the bid for each individual meeting the above requirements. In addition, a second form (Disclosure Form B) provides for the disclosure of current or pending procurement relationships with other (non-IDOT) state agencies and a total ownership certification. **The forms must be included with each bid.**

### C. Disclosure Form Instructions

#### Form A Instructions for Financial Information & Potential Conflicts of Interest

If the bidder is a publicly traded entity subject to Federal 10K reporting, the 10K Report may be submitted to meet the requirements of Form A. If a bidder is a privately held entity that is exempt from Federal 10K reporting, but has more than 100 shareholders, it may submit the information that Federal 10K companies are required to report, and list the names of any individual or entity holding any ownership share that is in excess of 5%. If a bidder is not subject to Federal 10K reporting, the bidder must determine if any individuals are required by law to complete a financial disclosure form. To do this, the bidder should answer each of the following questions. A "YES" answer indicates Form A must be completed. If the answer to each of the following questions is "NO", then the NOT APPLICABLE STATEMENT on Form A must be signed and dated by an individual that is authorized to execute contracts for the bidding company. Note: These questions are for assistance only and are not required to be completed.

1. Does anyone in your organization have a direct or beneficial ownership share of greater than 5% of the bidding entity or parent entity? YES \_\_\_ NO \_\_\_
2. Does anyone in your organization have a direct or beneficial ownership share of less than 5%, but which has a value greater than 60% of the annual salary of the Governor? YES \_\_\_ NO \_\_\_
3. Does anyone in your organization receive more than 60% of the annual salary of the Governor of the bidding entity's or parent entity's distributive income? YES \_\_\_ NO \_\_\_
4. Does anyone in your organization receive greater than 5% of the bidding entity's or parent entity's total distributive income, but which is less than 60% of the annual salary of the Governor? YES \_\_\_ NO \_\_\_

(Note: Only one set of forms needs to be completed per individual per bid even if a specific individual would require a yes answer to more than one question.)

A "YES" answer to any of these questions requires the completion of Form A. The bidder must determine each individual in the bidding entity or the bidding entity's parent company that would cause the questions to be answered "Yes". Each form must be signed and dated by an individual that is authorized to execute contracts for your organization. The individual signing can be, but does not have to be, the individual for which the form is being completed. The bidder is responsible for the accuracy of any information provided.

If the answer to each of the above questions is "NO", then the NOT APPLICABLE STATEMENT of Form A must be signed and dated by an individual that is authorized to execute contracts for your company.

## RETURN WITH BID

### **Form B: Instructions for Identifying Other Contracts & Procurement Related Information**

Disclosure Form B must be completed for each bid submitted by the bidding entity. *Note: Checking the NOT APPLICABLE STATEMENT on Form A does not allow the bidder to ignore Form B. Form B must be completed, checked, and dated or the bidder may be considered nonresponsive and the bid will not be accepted.*

The Bidder shall identify, by checking Yes or No on Form B, whether it has any pending contracts (including leases), bids, proposals, or other ongoing procurement relationship with any other (non-IDOT) State of Illinois agency. If "No" is checked, the bidder only needs to complete the check box on the bottom of Form B. If "Yes" is checked, the bidder must do one of the following:

Option I: If the bidder did not submit an Affidavit of Availability to obtain authorization to bid, the bidder must list all non-IDOT State of Illinois agency pending contracts, leases, bids, proposals, and other ongoing procurement relationships. These items may be listed on Form B or on an attached sheet(s). Do not include IDOT contracts. Contracts with cities, counties, villages, etc. are not considered State of Illinois agency contracts and are not to be included. Contracts with other State of Illinois agencies such as the Department of Natural Resources or the Capital Development Board must be included. Bidders who submit Affidavits of Availability are suggested to use Option II.

Option II: If the bidder is required and has submitted an Affidavit of Availability in order to obtain authorization to bid, the bidder may write or type "See Affidavit of Availability" which indicates that the Affidavit of Availability is incorporated by reference and includes all non-IDOT State of Illinois agency pending contracts, leases, bids, proposals, and other ongoing procurement relationships. For any contracts that are not covered by the Affidavit of Availability, the bidder must identify them on Form B or on an attached sheet(s). These might be such things as leases.

RETURN WITH BID

ILLINOIS DEPARTMENT OF TRANSPORTATION

Form A Financial Information & Potential Conflicts of Interest Disclosure

Contractor Name, Legal Address, City, State, Zip, Telephone Number, Email Address, Fax Number (if available)

Disclosure of the information contained in this Form is required by Section 50-35 of the Code (30 ILCS 500). Vendors desiring to enter into a contract with the State of Illinois must disclose the financial information and potential conflict of interest information as specified in this Disclosure Form. This information shall become part of the publicly available contract file. This Form A must be completed for bids in excess of \$50,000, and for all open-ended contracts. A publicly traded company may submit a 10K disclosure (or equivalent if applicable) in satisfaction of the requirements set forth in Form A. See Disclosure Form Instructions.

The current annual salary of the Governor is \$177,412.00.

DISCLOSURE OF FINANCIAL INFORMATION

- 1. Disclosure of Financial Information. The individual named below has an interest in the BIDDER (or its parent) in terms of ownership or distributive income share in excess of 5%, or an interest which has a value of more than 60% of the annual salary of the Governor. (Make copies of this form as necessary and attach a separate Disclosure Form A for each individual meeting these requirements)

FOR INDIVIDUAL (type or print information) NAME: ADDRESS Type of ownership/distributable income share: stock sole proprietorship Partnership other: (explain on separate sheet): % or \$ value of ownership/distributable income share:

- 2. Disclosure of Potential Conflicts of Interest. Check "Yes" or "No" to indicate which, if any, of the following potential conflict of interest relationships apply. If the answer to any question is "Yes", please attach additional pages and describe.

(a) State employment, currently or in the previous 3 years, including contractual employment of services. Yes \_\_\_ No \_\_\_

If your answer is yes, please answer each of the following questions.

- 1. Are you currently an officer or employee of either the Capitol Development Board or the Illinois State Toll Highway Authority? Yes \_\_\_ No \_\_\_
2. Are you currently appointed to or employed by any agency of the State of Illinois? If you are currently appointed to or employed by any agency of the State of Illinois, and your annual salary exceeds 60% of the annual salary of the Governor provide the name the State agency for which you are employed and your annual salary.

**RETURN WITH BID**

3. If you are currently appointed to or employed by any agency of the State of Illinois, and your annual salary exceeds 60% of the annual salary of the Governor, are you entitled to receive (i) more than 7 1/2% of the total distributable income of your firm, partnership, association or corporation, or (ii) an amount in excess of 100% of the annual salary of the Governor? Yes \_\_\_ No \_\_\_
4. If you are currently appointed to or employed by any agency of the State of Illinois, and your annual salary exceeds 60% of the annual salary of the Governor, are you and your spouse or minor children entitled to receive (i) more than 15% in aggregate of the total distributable income of your firm, partnership, association or corporation, or (ii) an amount in excess of two times the salary of the Governor? Yes \_\_\_ No \_\_\_

---

(b) State employment of spouse, father, mother, son, or daughter, including contractual employment for services in the previous 2 years.

Yes \_\_\_ No \_\_\_

If your answer is yes, please answer each of the following questions.

1. Is your spouse or any minor children currently an officer or employee of the Capitol Development Board or the Illinois State Toll Highway Authority? Yes \_\_\_ No \_\_\_
2. Is your spouse or any minor children currently appointed to or employed by any agency of the State of Illinois? If your spouse or minor children is/are currently appointed to or employed by any agency of the State of Illinois, and his/her annual salary exceeds 60% of the annual salary of the Governor, provide the name of the spouse and/or minor children, the name of the State agency for which he/she is employed and his/her annual salary. \_\_\_\_\_
- 
3. If your spouse or any minor children is/are currently appointed to or employed by any agency of the State of Illinois, and his/her annual salary exceeds 60% of the annual salary of the Governor, are you entitled to receive (i) more than 7 1/2% of the total distributable income of your firm, partnership, association or corporation, or (ii) an amount in excess 100% of the annual salary of the Governor? Yes \_\_\_ No \_\_\_
4. If your spouse or any minor children are currently appointed to or employed by any agency of the State of Illinois, and his/her annual salary exceeds 60% of the annual salary of the Governor, are you and your spouse or any minor children entitled to receive (i) more than 15% in the aggregate of the total distributable income from your firm, partnership, association or corporation, or (ii) an amount in excess of two times the salary of the Governor? Yes \_\_\_ No \_\_\_

---

(c) Elective status; the holding of elective office of the State of Illinois, the government of the United States, any unit of local government authorized by the Constitution of the State of Illinois or the statutes of the State of Illinois currently or in the previous 3 years. Yes \_\_\_ No \_\_\_

---

(d) Relationship to anyone holding elective office currently or in the previous 2 years; spouse, father, mother, son, or daughter. Yes \_\_\_ No \_\_\_

---

(e) Appointive office; the holding of any appointive government office of the State of Illinois, the United State of America, or any unit of local government authorized by the Constitution of the State of Illinois or the statutes of the State of Illinois, which office entitles the holder to compensation in excess of the expenses incurred in the discharge of that office currently or in the previous 3 years. Yes \_\_\_ No \_\_\_

---

(f) Relationship to anyone holding appointive office currently or in the previous 2 years; spouse, father, mother, son, or daughter. Yes \_\_\_ No \_\_\_

---

(g) Employment, currently or in the previous 3 years, as or by any registered lobbyist of the State government. Yes \_\_\_ No \_\_\_

---

**RETURN WITH BID**

(h) Relationship to anyone who is or was a registered lobbyist in the previous 2 years; spouse, father, mother, son, or daughter. Yes \_\_\_ No \_\_\_

---

(i) Compensated employment, currently or in the previous 3 years, by any registered election or reelection committee registered with the Secretary of State or any county clerk of the State of Illinois, or any political action committee registered with either the Secretary of State or the Federal Board of Elections. Yes \_\_\_ No \_\_\_

---

(j) Relationship to anyone; spouse, father, mother, son, or daughter; who was a compensated employee in the last 2 years by any registered election or re-election committee registered with the Secretary of State or any county clerk of the State of Illinois, or any political action committee registered with either the Secretary of State or the Federal Board of Elections. Yes \_\_\_ No \_\_\_

---

**3. Communication Disclosure.**

Disclose the name and address of each lobbyist and other agent of the bidder or offeror who is not identified in Section 2 of this form, who is has communicated, is communicating, or may communicate with any State officer or employee concerning the bid or offer. This disclosure is a continuing obligation and must be promptly supplemented for accuracy throughout the process and throughout the term of the contract. If no person is identified, enter "None" on the line below:

Name and address of person(s): \_\_\_\_\_  
\_\_\_\_\_  
\_\_\_\_\_  
\_\_\_\_\_

**RETURN WITH BID**

**4. Suspension or Debarment Disclosure.** For each of the persons identified under Sections 2 and 3 of this form, disclose whether any of the following has occurred within the previous 10 years: suspension or debarment from contracting with any governmental entity; professional licensure discipline; bankruptcies; adverse civil judgments and administrative findings; and criminal felony convictions. This disclosure is a continuing obligation and must be promptly supplemented for accuracy throughout the procurement process and term of the contract. If no person is identified, enter "None" on the line below:

Name of person(s): \_\_\_\_\_

Nature of disclosure: \_\_\_\_\_  
\_\_\_\_\_  
\_\_\_\_\_

**APPLICABLE STATEMENT**

**This Disclosure Form A is submitted on behalf of the INDIVIDUAL named on previous page. Under penalty of perjury, I certify the contents of this disclosure to be true and accurate to the best of my knowledge.**

Completed by:  \_\_\_\_\_  
Signature of Individual or Authorized Representative Date

**NOT APPLICABLE STATEMENT**

**Under penalty of perjury, I have determined that no individuals associated with this organization meet the criteria that would require the completion of this Form A.**

**This Disclosure Form A is submitted on behalf of the CONTRACTOR listed on the previous page.**

\_\_\_\_\_  
Signature of Authorized Representative Date

The bidder has a continuing obligation to supplement these disclosures under Sec. 50-35 of the Code.

RETURN WITH BID

ILLINOIS DEPARTMENT OF TRANSPORTATION

Form B Other Contracts & Financial Related Information Disclosure

Contractor Name, Legal Address, City, State, Zip, Telephone Number, Email Address, Fax Number (if available)

Disclosure of the information contained in this Form is required by Section 50-35 of the Code (30 ILCS 500). This information shall become part of the publicly available contract file. This Form B must be completed for all bids.

DISCLOSURE OF OTHER CONTRACTS AND PROCUREMENT RELATED INFORMATION

1. Identifying Other Contracts & Procurement Related Information. The BIDDER shall identify whether it has any pending contracts (including leases), bids, proposals, or other ongoing procurement relationship with any other State of Illinois agency: Yes \_\_\_ No \_\_\_

If "No" is checked, the bidder only needs to complete the signature box on this page.

2. If "Yes" is checked. Identify each such relationship by showing State of Illinois agency name and other descriptive information such as bid or project number (attach additional pages as necessary). SEE DISCLOSURE FORM INSTRUCTIONS:

THE FOLLOWING STATEMENT MUST BE CHECKED

Signature of Authorized Representative, Date

OWNERSHIP CERTIFICATION

Please certify that the following statement is true if the individuals for all submitted Form A disclosures do not total 100% of ownership.

Any remaining ownership interest is held by individuals receiving less than \$106,447.20 of the bidding entity's or parent entity's distributive income or holding less than a 5% ownership interest.

Yes No N/A (Form A disclosure(s) established 100% ownership)



## **RETURN WITH BID**

### **SPECIAL NOTICE TO CONTRACTORS**

The following requirements of the Illinois Department of Human Rights Act are applicable to bidders on all construction contracts advertised by the Illinois Department of Transportation:

#### **CONSTRUCTION EMPLOYEE UTILIZATION PROJECTION**

- (a) All bidders on construction contracts shall complete and submit, along with and as part of their bids, a Bidder's Employee Utilization Form (Form BC-1256) setting forth a projection and breakdown of the total workforce intended to be hired and/or allocated to such contract work by the bidder including a projection of minority and female employee utilization in all job classifications on the contract project.
- (b) The Department of Transportation shall review the Employee Utilization Form, and workforce projections contained therein, of the contract awardee to determine if such projections reflect an underutilization of minority persons and/or women in any job classification in accordance with the Equal Employment Opportunity Clause and Title 44, Illinois Administrative Code, Section 750.120. If it is determined that the contract awardee's projections reflect an underutilization of minority persons and/or women in any job classification, it shall be advised in writing of the manner in which it is underutilizing and such awardee shall be considered to be in breach of the contract unless, prior to commencement of work on the contract project, it submits revised satisfactory projections or an acceptable written affirmative action plan to correct such underutilization including a specific timetable geared to the completion stages of the contract.
- (c) The Department of Transportation shall provide to the Department of Human Rights a copy of the contract awardee's Employee Utilization Form, a copy of any required written affirmative action plan, and any written correspondence related thereto. The Department of Human Rights may review and revise any action taken by the Department of Transportation with respect to these requirements.



**RETURN WITH BID**

**Contract No. 85646  
LEE County  
Section 13-00325-00-RS  
Project RS-0103(141)  
Routes FAS 188 & FAS 1181 (Ch 15 & Ch 14, Ch 24)  
District 2 Construction Funds**

**PART II. WORKFORCE PROJECTION - continued**

- B. Included in "Total Employees" under Table A is the total number of **new hires** that would be employed in the event the undersigned bidder is awarded this contract.

The undersigned bidder projects that: (number) \_\_\_\_\_ new hires would be recruited from the area in which the contract project is located; and/or (number) \_\_\_\_\_ new hires would be recruited from the area in which the bidder's principal office or base of operation is located.

- C. Included in "Total Employees" under Table A is a projection of numbers of persons to be employed directly by the undersigned bidder as well as a projection of numbers of persons to be employed by subcontractors.

The undersigned bidder estimates that (number) \_\_\_\_\_ persons will be directly employed by the prime contractor and that (number) \_\_\_\_\_ persons will be employed by subcontractors.

**PART III. AFFIRMATIVE ACTION PLAN**

- A. The undersigned bidder understands and agrees that in the event the foregoing minority and female employee utilization projection included under **PART II** is determined to be an underutilization of minority persons or women in any job category, and in the event that the undersigned bidder is awarded this contract, he/she will, prior to commencement of work, develop and submit a written Affirmative Action Plan including a specific timetable (geared to the completion stages of the contract) whereby deficiencies in minority and/or female employee utilization are corrected. Such Affirmative Action Plan will be subject to approval by the contracting agency and the **Illinois Department of Human Rights**.
- B. The undersigned bidder understands and agrees that the minority and female employee utilization projection submitted herein, and the goals and timetable included under an Affirmative Action Plan if required, are deemed to be part of the contract specifications.

Company \_\_\_\_\_ Telephone Number \_\_\_\_\_

Address \_\_\_\_\_

**NOTICE REGARDING SIGNATURE**

The Bidder's signature on the Proposal Signature Sheet will constitute the signing of this form. The following signature block needs to be completed only if revisions are required.

Signature:  \_\_\_\_\_ Title: \_\_\_\_\_ Date: \_\_\_\_\_

- Instructions: All tables must include subcontractor personnel in addition to prime contractor personnel.
- Table A - Include both the number of employees that would be hired to perform the contract work and the total number currently employed (Table B) that will be allocated to contract work, and include all apprentices and on-the-job trainees. The "Total Employees" column should include all employees including all minorities, apprentices and on-the-job trainees to be employed on the contract work.
- Table B - Include all employees currently employed that will be allocated to the contract work including any apprentices and on-the-job trainees currently employed.
- Table C - Indicate the racial breakdown of the total apprentices and on-the-job trainees shown in Table A.

**RETURN WITH BID**

**ADDITIONAL FEDERAL REQUIREMENTS**

In addition to the Required Contract Provisions for Federal-Aid Construction Contracts (FHWA 1273), all bidders make the following certifications.

- A. By the execution of this proposal, the signing bidder certifies that the bidding entity has not, either directly or indirectly, entered into any agreement, participated in any collusion, or otherwise taken any action, in restraint of free competitive bidding in connection with the submitted bid. This statement made by the undersigned bidder is true and correct under penalty of perjury under the laws of the United States.
- B. CERTIFICATION, EQUAL EMPLOYMENT OPPORTUNITY:
1. Have you participated in any previous contracts or subcontracts subject to the equal opportunity clause. YES \_\_\_\_\_ NO \_\_\_\_\_
  2. If answer to #1 is yes, have you filed with the Joint Reporting Committee, the Director of OFCC, any Federal agency, or the former President's Committee on Equal Employment Opportunity, all reports due under the applicable filing requirements of those organizations?  
YES \_\_\_\_\_ NO \_\_\_\_\_

**RETURN WITH BID**

**Contract No. 85646  
LEE County  
Section 13-00325-00-RS  
Project RS-0103(141)  
Routes FAS 188 & FAS 1181 (Ch 15 & Ch 14, Ch 24)  
District 2 Construction Funds**

PROPOSAL SIGNATURE SHEET

The undersigned bidder hereby makes and submits this bid on the subject Proposal, thereby assuring the Department that all requirements of the Invitation for Bids and rules of the Department have been met, that there is no misunderstanding of the requirements of paragraph 3 of this Proposal, and that the contract will be executed in accordance with the rules of the Department if an award is made on this bid.

(IF AN INDIVIDUAL) Firm Name \_\_\_\_\_  
Signature of Owner \_\_\_\_\_  
Business Address \_\_\_\_\_  
\_\_\_\_\_

(IF A CO-PARTNERSHIP) Firm Name \_\_\_\_\_  
By \_\_\_\_\_  
Business Address \_\_\_\_\_  
Name and Address of All Members of the Firm: \_\_\_\_\_  
\_\_\_\_\_

(IF A CORPORATION) Corporate Name \_\_\_\_\_  
By \_\_\_\_\_  
Signature of Authorized Representative \_\_\_\_\_  
Typed or printed name and title of Authorized Representative \_\_\_\_\_  
Attest \_\_\_\_\_  
Signature \_\_\_\_\_  
(IF A JOINT VENTURE, USE THIS SECTION FOR THE MANAGING PARTY AND THE SECOND PARTY SHOULD SIGN BELOW) Business Address \_\_\_\_\_

(IF A JOINT VENTURE) Corporate Name \_\_\_\_\_  
By \_\_\_\_\_  
Signature of Authorized Representative \_\_\_\_\_  
Typed or printed name and title of Authorized Representative \_\_\_\_\_  
Attest \_\_\_\_\_  
Signature \_\_\_\_\_  
Business Address \_\_\_\_\_

If more than two parties are in the joint venture, please attach an additional signature sheet.



This Annual Proposal Bid Bond shall become effective at 12:01 AM (CDST) on \_\_\_\_\_ and shall be valid until \_\_\_\_\_ 11:59 PM (CDST).

KNOW ALL PERSONS BY THESE PRESENTS, That We \_\_\_\_\_

as PRINCIPAL, and \_\_\_\_\_

as SURETY, and held jointly, severally and firmly bound unto the STATE OF ILLINOIS in the penal sum of 5 percent of the total bid price, or for the amount specified in the bid proposal under "Proposal Guaranty" in effect on the date of the Invitation for Bids, whichever is the lesser sum, well and truly to be paid unto said STATE OF ILLINOIS, for the payment of which we bind ourselves, our heirs, executors, administrators, successors and assigns.

THE CONDITION OF THE FOREGOING OBLIGATION IS SUCH that whereas, the PRINCIPAL may submit bid proposal(s) to the STATE OF ILLINOIS, acting through the Department of Transportation, for various improvements published in the Transportation Bulletin during the effective term indicated above.

NOW, THEREFORE, if the Department shall accept the bid proposal(s) of the PRINCIPAL; and if the PRINCIPAL shall, within the time and as specified in the bidding and contract documents; and if, after award by the Department, the PRINCIPAL shall enter into a contract in accordance with the terms of the bidding and contract documents including evidence of the required insurance coverages and providing such bond as specified with good and sufficient surety for the faithful performance of such contract and for the prompt payment of labor and material furnished in the prosecution thereof; or if, in the event of the failure of the PRINCIPAL to enter into such contract and to give the specified bond, the PRINCIPAL pays to the Department the difference not to exceed the penalty hereof between the amount specified in the bid proposal and such larger amount for which the Department may contract with another party to perform the work covered by said bid proposal, then this obligation shall be null and void, otherwise, it shall remain in full force and effect.

IN THE EVENT the Department determines the PRINCIPAL has failed to comply with any requirement as set forth in the preceding paragraph, then Surety shall pay the penal sum to the Department within fifteen (15) days of written demand therefor. If Surety does not make full payment within such period of time, the Department may bring an action to collect the amount owed. Surety is liable to the Department for all its expenses, including attorney's fees, incurred in any litigation in which it prevails either in whole or in part.

In TESTIMONY WHEREOF, the said PRINCIPAL has caused this instrument to be signed by its officer \_\_\_\_\_ day of \_\_\_\_\_ A.D., \_\_\_\_\_

In TESTIMONY WHEREOF, the said SURETY has caused this instrument to be signed by its officer \_\_\_\_\_ day of \_\_\_\_\_ A.D., \_\_\_\_\_

\_\_\_\_\_  
(Company Name)

\_\_\_\_\_  
(Company Name)

By \_\_\_\_\_  
(Signature and Title)

By \_\_\_\_\_  
(Signature of Attorney-in-Fact)

**Notary for PRINCIPAL**

**Notary for SURETY**

STATE OF \_\_\_\_\_  
COUNTY OF \_\_\_\_\_

STATE OF \_\_\_\_\_  
COUNTY OF \_\_\_\_\_

Signed and attested before me on \_\_\_\_\_ (date)

Signed and attested before me on \_\_\_\_\_ (date)

by \_\_\_\_\_  
(Name of Notary Public)

by \_\_\_\_\_  
(Name of Notary Public)

(Seal) \_\_\_\_\_  
(Signature of Notary Public)

(Seal) \_\_\_\_\_  
(Signature of Notary Public)

\_\_\_\_\_  
(Date Commission Expires)

\_\_\_\_\_  
(Date Commission Expires)

In lieu of completing the above section of the Annual Proposal Bid Bond form, the Principal may file an Electronic Bid Bond. By signing the proposal(s) the Principal is ensuring the identified electronic bid bond has been executed and the Principal and Surety are firmly bound unto the State of Illinois under the conditions of the bid bond as shown above.

---

Electronic Bid Bond ID #	Company/Bidder Name	Signature and Title
--------------------------	---------------------	---------------------

This bond may be terminated, at Surety's request, upon giving not less than thirty (30) days prior written notice of the cancellation/termination of the bond. Said written notice shall be issued to the Illinois Department of Transportation, Chief Contracts Official, 2300 South Dirksen Parkway, Springfield, Illinois, 62764, and shall be served in person, by receipted courier delivery or certified or registered mail, return receipt requested. Said notice period shall commence on the first calendar day following the Department's receipt of written cancellation/termination notice. Surety shall remain firmly bound to all obligations herein for proposals submitted prior to the cancellation/termination. Surety shall be released and discharged from any obligation(s) for proposals submitted for any letting or date after the effective date of cancellation/termination.



Return with Bid

Division of Highways
Proposal Bid Bond

Item No. \_\_\_\_\_

Letting Date \_\_\_\_\_

KNOW ALL PERSONS BY THESE PRESENTS, That We \_\_\_\_\_

as PRINCIPAL, and \_\_\_\_\_

as SURETY, and held jointly, severally and firmly bound unto the STATE OF ILLINOIS in the penal sum of 5 percent of the total bid price, or for the amount specified in the bid proposal under "Proposal Guaranty" in effect on the date of the Invitation for Bids, whichever is the lesser sum, well and truly to be paid unto said STATE OF ILLINOIS, for the payment of which we bind ourselves, our heirs, executors, administrators, successors and assigns.

THE CONDITION OF THE FOREGOING OBLIGATION IS SUCH that whereas, the PRINCIPAL has submitted a bid proposal to the STATE OF ILLINOIS, acting through the Department of Transportation, for the improvement designated by the Transportation Bulletin Item Number and Letting Date indicated above.

NOW, THEREFORE, if the Department shall accept the bid proposal of the PRINCIPAL; and if the PRINCIPAL shall, within the time and as specified in the bidding and contract documents; and if, after award by the Department, the PRINCIPAL shall enter into a contract in accordance with the terms of the bidding and contract documents including evidence of the required insurance coverages and providing such bond as specified with good and sufficient surety for the faithful performance of such contract and for the prompt payment of labor and material furnished in the prosecution thereof; or if, in the event of the failure of the PRINCIPAL to enter into such contract and to give the specified bond, the PRINCIPAL pays to the Department the difference not to exceed the penalty hereof between the amount specified in the bid proposal and such larger amount for which the Department may contract with another party to perform the work covered by said bid proposal, then this obligation shall be null and void, otherwise, it shall remain in full force and effect.

IN THE EVENT the Department determines the PRINCIPAL has failed to comply with any requirement as set forth in the preceding paragraph, then Surety shall pay the penal sum to the Department within fifteen (15) days of written demand therefor. If Surety does not make full payment within such period of time, the Department may bring an action to collect the amount owed. Surety is liable to the Department for all its expenses, including attorney's fees, incurred in any litigation in which it prevails either in whole or in part.

In TESTIMONY WHEREOF, the said PRINCIPAL has caused this instrument to be signed by its officer \_\_\_\_\_ day of \_\_\_\_\_ A.D., \_\_\_\_\_

In TESTIMONY WHEREOF, the said SURETY has caused this instrument to be signed by its officer \_\_\_\_\_ day of \_\_\_\_\_ A.D., \_\_\_\_\_

(Company Name)

(Company Name)

By \_\_\_\_\_ (Signature and Title)

By \_\_\_\_\_ (Signature of Attorney-in-Fact)

Notary for PRINCIPAL

Notary for SURETY

STATE OF \_\_\_\_\_
COUNTY OF \_\_\_\_\_

STATE OF \_\_\_\_\_
COUNTY OF \_\_\_\_\_

Signed and attested before me on \_\_\_\_\_ (date)
by \_\_\_\_\_

Signed and attested before me on \_\_\_\_\_ (date)
by \_\_\_\_\_

(Name of Notary Public)

(Name of Notary Public)

(Seal) \_\_\_\_\_ (Signature of Notary Public)

(Seal) \_\_\_\_\_ (Signature of Notary Public)

(Date Commission Expires)

(Date Commission Expires)

In lieu of completing the above section of the Proposal Bid Bond form, the Principal may file an Electronic Bid Bond. By signing the proposal the Principal is ensuring the identified electronic bid bond has been executed and the Principal and Surety are firmly bound unto the State of Illinois under the conditions of the bid bond as shown above.

Electronic Bid Bond ID # \_\_\_\_\_ Company/Bidder Name \_\_\_\_\_ Signature and Title \_\_\_\_\_



**(1) Policy**

It is public policy that disadvantageded businesses as defined in 49 CFR Part 26 and the Special Provision shall have the maximum opportunity to participate in the performance of contracts financed in whole or in part with Federal or State funds. Consequently the requirements of 49 CFR Part 26 apply to this contract.

**(2) Obligation**

The contractor agrees to ensure that disadvantageded businesses as defined in 49 CFR Part 26 and the Special Provision have the maximum opportunity to participate in the performance of contracts or subcontracts financed in whole or in part with Federal or State funds. The contractor shall take all necessary and reasonable steps in accordance with 49 CFR Part 26 and the Special Provision to ensure that said businesses have the maximum opportunity to compete for and perform under this contract. The contractor shall not discriminate on the basis of race, color, national origin or sex in the award and performance of contracts.

**(3) Project and Bid Identification**

Complete the following information concerning the project and bid:

Route _____	Total Bid _____
Section _____	Contract DBE Goal _____ (Percent) _____ (Dollar Amount)
Project _____	
County _____	
Letting Date _____	
Contract No. _____	
Letting Item No. _____	

**(4) Assurance**

I, acting in my capacity as an officer of the undersigned bidder (or bidders if a joint venture), hereby assure the Department that on this project my company : (check one)

- Meets or exceeds contract award goals and has provided documented participation as follows:  
Disadvantaged Business Participation \_\_\_\_\_ percent

Attached are the signed participation statements, forms SBE 2025, required by the Special Provision evidencing availability and use of each business participating in this plan and assuring that each business will perform a commercially useful function in the work of the contract.

- Failed to meet contract award goals and has included good faith effort documentation to meet the goals and that my company has provided participation as follows:

Disadvantaged Business Participation \_\_\_\_\_ percent

The contract goals should be accordingly modified or waived. Attached is all information required by the Special Provision in support of this request including good faith effort. Also attached are the signed participation statements, forms SBE 2025, required by the Special Provision evidencing availability and use of each business participating in this plan and assuring that each business will perform a commercially useful function in the work of the contract.

\_\_\_\_\_  
Company

By \_\_\_\_\_

Title \_\_\_\_\_

Date \_\_\_\_\_

The "as read" Low Bidder is required to comply with the Special Provision.

Submit only one utilization plan for each project. The utilization plan shall be submitted in accordance with the special provision.

Bureau of Small Business Enterprises      **Local Let Projects**  
2300 South Dirksen Parkway                  Submit forms to the  
Springfield, Illinois 62764                      Local Agency

The Department of Transportation is requesting disclosure of information that is necessary to accomplish the purpose as outlined under State and Federal law. Disclosure of this information is **REQUIRED**. Failure to provide any information will result in the contract not being awarded. This form has been approved by the State Forms Manager Center.



**Illinois Department  
of Transportation**

**DBE Participation Statement**

Subcontractor Registration Number \_\_\_\_\_

Letting \_\_\_\_\_

**Participation Statement**

Item No. \_\_\_\_\_

(1) Instructions

Contract No. \_\_\_\_\_

This form must be completed for each disadvantaged business participating in the Utilization Plan. This form shall be submitted in accordance with the special provision and will be attached to the Utilization Plan form. If additional space is needed complete an additional form for the firm. Trucking participation items; description must list what is anticipated towards goal credit.

(2) Work:

**Please indicate:** J/V \_\_\_\_\_ Manufacturer \_\_\_\_\_ Supplier (60%) \_\_\_\_\_ Subcontractor \_\_\_\_\_ Trucking \_\_\_\_\_

Pay Item No.	Description (Anticipated items for trucking)*	Quantity	Unit Price	Total
<b>Total</b>				

(3) Partial Payment Items (For any of the above items which are partial pay items)

Description must be sufficient to determine a Commercially Useful Function, specifically describe the work and subcontract dollar amount:

\*Applies to trucking only

(4) Commitment

When a DBE is to be a second-tier subcontractor, or if the first-tier DBE subcontractor is going to be subcontracting a portion of its subcontract, it must be clearly indicated on the DBE Participation Statement, and the details of the transaction fully explained.

In the event a DBE subcontractor second-tiers a portion of its subcontract to one or more subcontractors during the work of a contract, the prime must submit a DBE Participation Statement, with the details of the transaction(s) fully explained.

The undersigned certify that the information included herein is true and correct, and that the DBE firm listed below has agreed to perform a commercially useful function in the work of the contract item(s) listed above and to execute a contract with the prime contractor or 1<sup>st</sup> Tier subcontractor. The undersigned further understand that no changes to this statement may be made without prior approval from the Department's Bureau of Small Business Enterprises and that complete and accurate information regarding actual work performed on this project and the payment therefore must be provided to the Department.

Signature for Contractor \_\_ 1<sup>st</sup> Tier \_\_ 2<sup>nd</sup> Tier

Signature for DBE Firm \_\_ 1<sup>st</sup> Tier \_\_ 2<sup>nd</sup> Tier

Date \_\_\_\_\_

Date \_\_\_\_\_

Contact Person \_\_\_\_\_

Contact Person \_\_\_\_\_

Title \_\_\_\_\_

Title \_\_\_\_\_

Firm Name \_\_\_\_\_

Firm Name \_\_\_\_\_

Address \_\_\_\_\_

Address \_\_\_\_\_

City/State/Zip \_\_\_\_\_

City/State/Zip \_\_\_\_\_

Phone \_\_\_\_\_

Phone \_\_\_\_\_

Email Address \_\_\_\_\_

Email Address \_\_\_\_\_

E \_\_\_\_\_

WC \_\_\_\_\_

The Department of Transportation is requesting disclosure of information that is necessary to accomplish the statutory purpose as outlined under the state and federal law. Disclosure of this information is **REQUIRED**. Failure to provide any information will result in the contract not being awarded. This form has been approved by the State Forms Management Center.

# PROPOSAL ENVELOPE



## PROPOSALS

for construction work advertised for bids by the  
Illinois Department of Transportation

Item No.	Item No.	Item No.

Submitted By:

Name:
Address:
Phone No.

Bidders should use an IDOT proposal envelope or affix this form to the front of a 10" x 13" envelope for the submittal of bids. If proposals are mailed, they should be enclosed in a second or outer envelope addressed to:

Engineer of Design and Environment - Room 326  
Illinois Department of Transportation  
2300 South Dirksen Parkway  
Springfield, Illinois 62764

### **NOTICE**

**Individual bids, including Bid Bond and/or supplemental information if required, should be securely stapled.**

# CONTRACTOR OFFICE COPY OF CONTRACT SPECIFICATIONS

## NOTICE

None of the following material needs to be returned with the bid package unless the special provisions require documentation and/or other information to be submitted.

**Contract No. 85646  
LEE County  
Section 13-00325-00-RS  
Project RS-0103(141)  
Routes FAS 188 & FAS 1181 (Ch 15 & Ch 14, Ch 24)  
District 2 Construction Funds**



**Illinois Department of Transportation**

## **SUBCONTRACTOR DOCUMENTATION**

Public Acts 96-0795, 96-0920, and 97-0895 enacted substantial changes to the provisions of the Code (30 ILCS 500). Among the changes are provisions affecting subcontractors. The Contractor awarded this contract will be required as a material condition of the contract to implement and enforce the contract requirements applicable to subcontractors that entered into a contractual agreement with a total value of \$50,000 or more with a person or entity who has a contract subject to the Code and approved in accordance with article 108.01 of the Standard Specifications for Road and Bridge Construction.

If the Contractor seeks approval of subcontractors to perform a portion of the work, and approval is granted by the Department, the Contractor shall provide a copy of the subcontract to the Illinois Department of Transportation's CPO upon request within 15 calendar days after execution of the subcontract.

Financial disclosures required pursuant to Sec. 50-35 of the Code must be submitted for all applicable subcontractors. The subcontract shall contain the certifications required to be made by subcontractors pursuant to Article 50 of the Code. This Notice to Bidders includes a document incorporating all required subcontractor certifications and disclosures for use by the Contractor in compliance with this mandate. The document is entitled State Required Ethical Standards Governing Subcontractors.

## RETURN WITH SUBCONTRACT

### STATE ETHICAL STANDARDS GOVERNING SUBCONTRACTORS

Article 50 of the Code establishes the duty of all State CPOs, SPOs, and their designees to maximize the value of the expenditure of public moneys in procuring goods, services, and contracts for the State of Illinois and to act in a manner that maintains the integrity and public trust of State government. In discharging this duty, they are charged by law to use all available information, reasonable efforts, and reasonable actions to protect, safeguard, and maintain the procurement process of the State of Illinois.

The certifications hereinafter made by the subcontractor are each a material representation of fact upon which reliance is placed should the Department approve the subcontractor. The CPO may terminate or void the contract approval if it is later determined that the bidder or subcontractor rendered a false or erroneous certification. If a false certification is made by a subcontractor the contractor's submitted bid and the executed contract may not be declared void unless the contractor refuses to terminate the subcontract upon the State's request after a finding that the subcontractor's certification was false.

Section 50-2 of the Code provides that every person that has entered into a multi-year contract and every subcontractor with a multi-year subcontract shall certify, by July 1 of each fiscal year covered by the contract after the initial fiscal year, to the responsible CPO whether it continues to satisfy the requirements of Article 50 pertaining to the eligibility for a contract award. If a contractor or subcontractor is not able to truthfully certify that it continues to meet all requirements, it shall provide with its certification a detailed explanation of the circumstances leading to the change in certification status. A contractor or subcontractor that makes a false statement material to any given certification required under Article 50 is, in addition to any other penalties or consequences prescribed by law, subject to liability under the Whistleblower Reward and Protection Act for submission of a false claim.

#### **A. Bribery**

Section 50-5. Bribery.

(a) Prohibition. No person or business shall be awarded a contract or subcontract under this Code who:

(1) has been convicted under the laws of Illinois or any other state of bribery or attempting to bribe an officer or employee of the State of Illinois or any other state in that officer's or employee's official capacity; or

(2) has made an admission of guilt of that conduct that is a matter of record but has not been prosecuted for that conduct.

(b) Businesses. No business shall be barred from contracting with any unit of State or local government, or subcontracting under such a contract, as a result of a conviction under this Section of any employee or agent of the business if the employee or agent is no longer employed by the business and:

(1) the business has been finally adjudicated not guilty; or

(2) the business demonstrates to the governmental entity with which it seeks to contract, or which is signatory to the contract to which the subcontract relates, and that entity finds that the commission of the offense was not authorized, requested, commanded, or performed by a director, officer, or high managerial agent on behalf of the business as provided in paragraph (2) of subsection (a) of Section 5-4 of the Criminal Code of 2012.

(c) Conduct on behalf of business. For purposes of this Section, when an official, agent, or employee of a business committed the bribery or attempted bribery on behalf of the business and in accordance with the direction or authorization of a responsible official of the business, the business shall be chargeable with the conduct.

(d) Certification. Every bid submitted to and contract executed by the State, and every subcontract subject to Section 20-120 of the Code shall contain a certification by the contractor or the subcontractor, respectively, that the contractor or subcontractor is not barred from being awarded a contract or subcontract under this Section and acknowledges that the CPO may declare the related contract void if any certifications required by this Section are false. A contractor who makes a false statement, material to the certification, commits a Class 3 felony.

The contractor or subcontractor certifies that it is not barred from being awarded a contract under Section 50-5.

#### **B. Felons**

Section 50-10. Felons.

(a) Unless otherwise provided, no person or business convicted of a felony shall do business with the State of Illinois or any State agency, or enter into a subcontract, from the date of conviction until 5 years after the date of completion of the sentence for that felony, unless no person held responsible by a prosecutorial office for the facts upon which the conviction was based continues to have any involvement with the business.

(b) Certification. Every bid submitted to and contract executed by the State and every subcontract subject to Section 20-120 of the Code shall contain a certification by the bidder or contractor or subcontractor, respectively, that the bidder, contractor, or subcontractor is not barred from being awarded a contract or subcontract under this Section and acknowledges that the CPO may declare the related contract void if any of the certifications required by this Section are false.

**RETURN WITH SUBCONTRACT**

**C. Debt Delinquency**

Section 50-11 and 50-12. Debt Delinquency.

The contractor or bidder or subcontractor, respectively, certifies that it, or any affiliate, is not barred from being awarded a contract or subcontract under the Code. Section 50-11 prohibits a person from entering into a contract with a State agency, or entering into a subcontract, if it knows or should know that it, or any affiliate, is delinquent in the payment of any debt to the State as defined by the Debt Collection Board. Section 50-12 prohibits a person from entering into a contract with a State agency, or entering into a subcontract, if it, or any affiliate, has failed to collect and remit Illinois Use Tax on all sales of tangible personal property into the State of Illinois in accordance with the provisions of the Illinois Use Tax Act. The bidder or contractor or subcontractor, respectively, further acknowledges that the CPO may declare the related contract void if this certification is false or if the bidder, contractor, or subcontractor, or any affiliate, is determined to be delinquent in the payment of any debt to the State during the term of the contract.

**D. Prohibited Bidders, Contractors and Subcontractors**

Section 50-10.5 and 50-60(c). Prohibited bidders, contractors and subcontractors.

The bidder or contractor or subcontractor, respectively, certifies in accordance with 30 ILCS 500/50-10.5 that no officer, director, partner or other managerial agent of the contracting business has been convicted of a felony under the Sarbanes-Oxley Act of 2002 or a Class 3 or Class 2 felony under the Illinois Securities Law of 1953 or if in violation of Subsection (c) for a period of five years from the date of conviction. Every bid submitted to and contract executed by the State and every subcontract subject to Section 20-120 of the Code shall contain a certification by the bidder, contractor, or subcontractor, respectively, that the bidder, contractor, or subcontractor is not barred from being awarded a contract or subcontract under this Section and acknowledges that the CPO shall declare the related contract void if any of the certifications completed pursuant to this Section are false.

**E. Section 42 of the Environmental Protection Act**

The bidder or contractor or subcontractor, respectively, certifies in accordance with 30 ILCS 500/50-14 that the bidder, contractor, or subcontractor, is not barred from being awarded a contract or entering into a subcontract under this Section which prohibits the bidding on or entering into contracts with the State of Illinois or a State agency, or entering into any subcontract, that is subject to the Code by a person or business found by a court or the Pollution Control Board to have committed a willful or knowing violation of Section 42 of the Environmental Protection Act for a period of five years from the date of the order. The bidder or contractor or subcontractor, respectively, acknowledges that the CPO may declare the contract void if this certification is false.

**The undersigned, on behalf of the subcontracting company, has read and understands the above certifications and makes the certifications as required by law.**

_____ Name of Subcontracting Company		
_____ Authorized Officer	_____ Date	

**RETURN WITH SUBCONTRACT**  
**SUBCONTRACTOR DISCLOSURES**

**I. DISCLOSURES**

- A.** The disclosures hereinafter made by the subcontractor are each a material representation of fact upon which reliance is placed. The subcontractor further certifies that the Department has received the disclosure forms for each subcontract.

The CPO may void the bid, contract, or subcontract, respectively, if it is later determined that the bidder or subcontractor rendered a false or erroneous disclosure. A contractor or subcontractor may be scuspended or debarred for violations of the Code. Furthermore, the CPO may void the contract.

**B. Financial Interests and Conflicts of Interest**

1. Section 50-35 of the Code provides that all subcontracts with a total value of \$50,000 or more, from subcontractors identified in Section 20-120 of the Code, shall be accompanied by disclosure of the financial interests of the subcontractor. This disclosed information for the subcontractor, will be maintained as public information subject to release by request pursuant to the Freedom of Information Act, filed with the Procurement Policy Board, and shall be incorporated as a material term of the Prime Contractor's contract. Furthermore, pursuant to this Section, the Procurement Policy Board may recommend to allow or void a contract or subcontract based on a potential conflict of interest.

The financial interests to be disclosed shall include ownership or distributive income share that is in excess of 5%, or an amount greater than 60% of the annual salary of the Governor, of the subcontracting entity or its parent entity, whichever is less, unless the subcontractor is a publicly traded entity subject to Federal 10K reporting, in which case it may submit its 10K disclosure in place of the prescribed disclosure. If a subcontractor is a privately held entity that is exempt from Federal 10K reporting, but has more than 100 shareholders, it may submit the information that Federal 10K companies are required to report, and list the names of any individual or entity holding any ownership share that is in excess of 5%. The disclosure shall include the names, addresses, and dollar or proportionate share of ownership of each individual making the disclosure, their instrument of ownership or beneficial relationship, and notice of any potential conflict of interest resulting from the current ownership or beneficial interest of each individual making the disclosure having any of the relationships identified in Section 50-35 and on the disclosure form.

**The current annual salary of the Governor is \$177,412.00.**

In addition, all disclosures shall indicate any other current or pending contracts, subcontracts, proposals, leases, or other ongoing procurement relationships the subcontracting entity has with any other unit of state government and shall clearly identify the unit and the contract, subcontract, proposal, lease, or other relationship.

2. Disclosure Forms. Disclosure Form A is attached for use concerning the individuals meeting the above ownership or distributive share requirements. A separate Disclosure Form A must be submitted with the bid for each individual meeting the above requirements. In addition, a second form (Disclosure Form B) provides for the disclosure of current or pending procurement relationships with other (non-IDOT) state agencies and a total ownership certification.

**C. Disclosure Form Instructions**

**Form A Instructions for Financial Information & Potential Conflicts of Interest**

If the subcontractor is a publicly traded entity subject to Federal 10K reporting, the 10K Report may be submitted to meet the requirements of Form A. If a subcontractor is a privately held entity that is exempt from Federal 10K reporting, but has more than 100 shareholders, it may submit the information that Federal 10K companies are required to report, and list the names of any individual or entity holding any ownership share that is in excess of 5%. If a subcontractor is not subject to Federal 10K reporting, the subcontractor must determine if any individuals are required by law to complete a financial disclosure form. To do this, the subcontractor should answer each of the following questions. A "YES" answer indicates Form A must be completed. If the answer to each of the following questions is "NO", then the **NOT APPLICABLE STATEMENT** on the second page of Form A must be signed and dated by an individual that is authorized to execute contracts for the subcontracting company. Note: These questions are for assistance only and are not required to be completed.

1. Does anyone in your organization have a direct or beneficial ownership share of greater than 5% of the bidding entity or parent entity? YES \_\_\_ NO \_\_\_
2. Does anyone in your organization have a direct or beneficial ownership share of less than 5%, but which has a value greater than 60% of the annual salary of the Governor? YES \_\_\_ NO \_\_\_
3. Does anyone in your organization receive more than 60% of the annual salary of the Governor of the subcontracting entity's or parent entity's distributive income? YES \_\_\_ NO \_\_\_

(Note: Distributive income is, for these purposes, any type of distribution of profits. An annual salary is not distributive income.)

4. Does anyone in your organization receive greater than 5% of the subcontracting entity's or parent entity's total distributive income, but which is less than 60% of the annual salary of the Governor? YES \_\_\_ NO \_\_\_

(Note: Only one set of forms needs to be completed per individual per subcontract even if a specific individual would require a yes answer to more than one question.)

A "YES" answer to any of these questions requires the completion of Form A. The subcontractor must determine each individual in the subcontracting entity or the subcontracting entity's parent company that would cause the questions to be answered "Yes". Each form must be signed and dated by an individual that is authorized to execute contracts for your organization. The individual signing can be, but does not have to be, the individual for which the form is being completed. The subcontractor is responsible for the accuracy of any information provided.

If the answer to each of the above questions is "NO", then the **NOT APPLICABLE STATEMENT** on page 2 of Form A must be signed and dated by an individual that is authorized to execute contracts for your company.



## RETURN WITH SUBCONTRACT

### **Form B: Instructions for Identifying Other Contracts & Procurement Related Information**

Disclosure Form B must be completed for each subcontract submitted by the subcontracting entity. *Note: Checking the NOT APPLICABLE STATEMENT on Form A does not allow the subcontractor to ignore Form B. Form B must be completed, checked, and dated or the subcontract will not be approved.*

The Subcontractor shall identify, by checking Yes or No on Form B, whether it has any pending contracts, subcontracts, leases, bids, proposals, or other ongoing procurement relationship with any other (non-IDOT) State of Illinois agency. If "No" is checked, the subcontractor only needs to complete the check box on the bottom of Form B. If "Yes" is checked, the subcontractor must list all non-IDOT State of Illinois agency pending contracts, subcontracts, leases, bids, proposals, and other ongoing procurement relationships. These items may be listed on Form B or on an attached sheet(s). Contracts with cities, counties, villages, etc. are not considered State of Illinois agency contracts and are not to be included. Contracts or subcontracts with other State of Illinois agencies such as the Department of Natural Resources or the Capital Development Board must be included.

ILLINOIS DEPARTMENT OF TRANSPORTATION

Form A Subcontractor: Financial Information & Potential Conflicts of Interest Disclosure

Subcontractor Name, Legal Address, City, State, Zip, Telephone Number, Email Address, Fax Number (if available)

Disclosure of the information contained in this Form is required by Section 50-35 of the Code (30 ILCS 500). Subcontractors desiring to enter into a subcontract of a State of Illinois contract must disclose the financial information and potential conflict of interest information as specified in this Disclosure Form.

The current annual salary of the Governor is \$177,412.00.

DISCLOSURE OF FINANCIAL INFORMATION

1. Disclosure of Financial Information. The individual named below has an interest in the SUBCONTRACTOR (or its parent) in terms of ownership or distributive income share in excess of 5%, or an interest which has a value of more than 60% of the annual salary of the Governor.

FOR INDIVIDUAL (type or print information) NAME: ADDRESS Type of ownership/distributable income share: stock sole proprietorship Partnership other: (explain on separate sheet): % or \$ value of ownership/distributable income share:

2. Disclosure of Potential Conflicts of Interest. Check "Yes" or "No" to indicate which, if any, of the following potential conflict of interest relationships apply. If the answer to any question is "Yes", please attach additional pages and describe.

(a) State employment, currently or in the previous 3 years, including contractual employment of services. Yes \_\_\_ No \_\_\_

If your answer is yes, please answer each of the following questions.

1. Are you currently an officer or employee of either the Capitol Development Board or the Illinois State Toll Highway Authority? Yes \_\_\_ No \_\_\_

2. Are you currently appointed to or employed by any agency of the State of Illinois? If you are currently appointed to or employed by any agency of the State of Illinois, and your annual salary exceeds 60% of the annual salary of the Governor, provide the name the State agency for which you are employed and your annual salary.

**RETURN WITH SUBCONTRACT**

3. If you are currently appointed to or employed by any agency of the State of Illinois, and your annual salary exceeds 60% of the annual salary of the Governor, are you entitled to receive (i) more than 7 1/2% of the total distributable income of your firm, partnership, association or corporation, or (ii) an amount in excess of 100% of the annual salary of the Governor?  
Yes \_\_\_ No \_\_\_

4. If you are currently appointed to or employed by any agency of the State of Illinois, and your annual salary exceeds 60% of the annual salary of the Governor, are you and your spouse or minor children entitled to receive (i) more than 15 % in the aggregate of the total distributable income of your firm, partnership, association or corporation, or (ii) an amount in excess of two times the salary of the Governor?  
Yes \_\_\_ No \_\_\_

---

(b) State employment of spouse, father, mother, son, or daughter, including contractual employment services in the previous 2 years.

Yes \_\_\_ No \_\_\_

If your answer is yes, please answer each of the following questions.

1. Is your spouse or any minor children currently an officer or employee of the Capitol Development Board or the Illinois State Toll Highway Authority?  
Yes \_\_\_ No \_\_\_

2. Is your spouse or any minor children currently appointed to or employed by any agency of the State of Illinois? If your spouse or minor children is/are currently appointed to or employed by any agency of the State of Illinois, and his/her annual salary exceeds 60% of the annual salary of the Governor, provide the name of your spouse and/or minor children, the name of the State agency for which he/she is employed and his/her annual salary. \_\_\_\_\_

3. If your spouse or any minor children is/are currently appointed to or employed by any agency of the State of Illinois, and his/her annual salary exceeds 60% of the annual salary of the Governor, are you entitled to receive (i) more than 7 1/2% of the total distributable income of your firm, partnership, association or corporation, or (ii) an amount in excess of 100% of the annual salary of the Governor?  
Yes \_\_\_ No \_\_\_

4. If your spouse or any minor children are currently appointed to or employed by any agency of the State of Illinois, and his/her annual salary exceeds 60% of the annual salary of the Governor, are you and your spouse or minor children entitled to receive (i) more than 15 % in the aggregate of the total distributable income of your firm, partnership, association or corporation, or (ii) an amount in excess of two times the salary of the Governor?  
Yes \_\_\_ No \_\_\_

---

(c) Elective status; the holding of elective office of the State of Illinois, the government of the United States, any unit of local government authorized by the Constitution of the State of Illinois or the statutes of the State of Illinois currently or in the previous 3 years.  
Yes \_\_\_ No \_\_\_

---

(d) Relationship to anyone holding elective office currently or in the previous 2 years; spouse, father, mother, son, or daughter.  
Yes \_\_\_ No \_\_\_

---

(e) Appointive office; the holding of any appointive government office of the State of Illinois, the United States of America, or any unit of local government authorized by the Constitution of the State of Illinois or the statutes of the State of Illinois, which office entitles the holder to compensation in excess of the expenses incurred in the discharge of that office currently or in the previous 3 years.  
Yes \_\_\_ No \_\_\_

---

(f) Relationship to anyone holding appointive office currently or in the previous 2 years; spouse, father, mother, son, or daughter.  
Yes \_\_\_ No \_\_\_

---

(g) Employment, currently or in the previous 3 years, as or by any registered lobbyist of the State government.  
Yes \_\_\_ No \_\_\_

---

**RETURN WITH SUBCONTRACT**

(h) Relationship to anyone who is or was a registered lobbyist in the previous 2 years; spouse, father, mother, son, or daughter. Yes \_\_\_ No \_\_\_

---

(i) Compensated employment, currently or in the previous 3 years, by any registered election or reelection committee registered with the Secretary of State or any county clerk of the State of Illinois, or any political action committee registered with either the Secretary of State or the Federal Board of Elections. Yes \_\_\_ No \_\_\_

---

(j) Relationship to anyone; spouse, father, mother, son, or daughter; who was a compensated employee in the last 2 years by any registered election or re-election committee registered with the Secretary of State or any county clerk of the State of Illinois, or any political action committee registered with either the Secretary of State or the Federal Board of Elections. Yes \_\_\_ No \_\_\_

---

**3 Communication Disclosure.**

Disclose the name and address of each lobbyist and other agent of the bidder or offeror who is not identified in Section 2 of this form, who is has communicated, is communicating, or may communicate with any State officer or employee concerning the bid or offer. This disclosure is a continuing obligation and must be promptly supplemented for accuracy throughout the process and throughout the term of the contract. If no person is identified, enter "None" on the line below:

Name and address of person(s): \_\_\_\_\_  
\_\_\_\_\_  
\_\_\_\_\_  
\_\_\_\_\_

**RETURN WITH SUBCONTRACT**

**4. Suspension or Debarment Disclosure.** For each of the persons identified under Sections 2 and 3 of this form, disclose whether any of the following has occurred within the previous 10 years: suspension or debarment from contracting with any governmental entity; professional licensure discipline; bankruptcies; adverse civil judgments and administrative findings; and criminal felony convictions. This disclosure is a continuing obligation and must be promptly supplemented for accuracy throughout the procurement process and term of the contract. If no person is identified, enter "None" on the line below:

Name of person(s): \_\_\_\_\_

Nature of disclosure: \_\_\_\_\_  
\_\_\_\_\_  
\_\_\_\_\_

**APPLICABLE STATEMENT**

**This Disclosure Form A is submitted on behalf of the INDIVIDUAL named on previous page. Under penalty of perjury, I certify the contents of this disclosure to be true and accurate to the best of my knowledge.**

Completed by:  \_\_\_\_\_ Date \_\_\_\_\_  
Signature of Individual or Authorized Officer

**NOT APPLICABLE STATEMENT**

**Under penalty of perjury, I have determined that no individuals associated with this organization meet the criteria that would require the completion of this Form A.**

**This Disclosure Form A is submitted on behalf of the SUBCONTRACTOR listed on the previous page.**

\_\_\_\_\_ Date \_\_\_\_\_  
Signature of Authorized Officer

RETURN WITH SUBCONTRACT

ILLINOIS DEPARTMENT OF TRANSPORTATION

Form B Subcontractor: Other Contracts & Financial Related Information Disclosure

Form with fields: Subcontractor Name, Legal Address, City, State, Zip, Telephone Number, Email Address, Fax Number (if available)

Disclosure of the information contained in this Form is required by Section 50-35 of the Code (30 ILCS 500). This information shall become part of the publicly available contract file.

DISCLOSURE OF OTHER CONTRACTS, SUBCONTRACTS, AND PROCUREMENT RELATED INFORMATION

1. Identifying Other Contracts & Procurement Related Information. The SUBCONTRACTOR shall identify whether it has any pending contracts, subcontracts, including leases, bids, proposals, or other ongoing procurement relationship with any other State of Illinois agency: Yes \_\_\_ No \_\_\_ If "No" is checked, the subcontractor only needs to complete the signature box on this page.

2. If "Yes" is checked. Identify each such relationship by showing State of Illinois agency name and other descriptive information such as bid or project number (attach additional pages as necessary). SEE DISCLOSURE FORM INSTRUCTIONS:

THE FOLLOWING STATEMENT MUST BE CHECKED

Signature box with fields for Signature of Authorized Officer and Date

OWNERSHIP CERTIFICATION

Please certify that the following statement is true if the individuals for all submitted Form A disclosures do not total 100% of ownership

Any remaining ownership interest is held by individuals receiving less than \$106,447.20 of the bidding entity's or parent entity's distributive income or holding less than a 5% ownership interest.

Yes No N/A (Form A disclosure(s) established 100% ownership)



## NOTICE TO BIDDERS

- 1. TIME AND PLACE OF OPENING BIDS.** Sealed proposals for the improvement described herein will be received by the Department of Transportation. Electronic bids are to be submitted to the electronic bidding system (iCX-Integrated Contractors Exchange). Paper-based bids are to be submitted to the Chief Procurement Officer for the Department of Transportation in care of the Chief Contracts Official at the Harry R. Hanley Building, 2300 South Dirksen Parkway, in Springfield, Illinois until 10:00 a.m. January 20, 2017. All bids will be gathered, sorted, publicly opened and read in the auditorium at the Department of Transportation's Harry R. Hanley Building shortly after 10:00 a.m.
- 2. DESCRIPTION OF WORK.** The proposed improvement is identified and advertised for bids in the Invitation for Bids as:

**Contract No. 85646  
LEE County  
Section 13-00325-00-RS  
Project RS-0103(141)  
Routes FAS 188 & FAS 1181 (Ch 15 & Ch 14, Ch 24)  
District 2 Construction Funds**

**Resurfacing on Harmon Road from Sterling Road to Balch Road; Sterling Road from Harmon Road to Walton Road and Walton Road to the Village of Walton.**

- 3. INSTRUCTIONS TO BIDDERS.** (a) This Notice, the invitation for bids, proposal and letter of award shall, together with all other documents in accordance with Article 101.09 of the Standard Specifications for Road and Bridge Construction, become part of the contract. Bidders are cautioned to read and examine carefully all documents, to make all required inspections, and to inquire or seek explanation of the same prior to submission of a bid.  
  
(b) State law, and, if the work is to be paid wholly or in part with Federal-aid funds, Federal law requires the bidder to make various certifications as a part of the proposal and contract. By execution and submission of the proposal, the bidder makes the certification contained therein. A false or fraudulent certification shall, in addition to all other remedies provided by law, be a breach of contract and may result in termination of the contract.
- 4. AWARD CRITERIA AND REJECTION OF BIDS.** This contract will be awarded to the lowest responsive and responsible bidder considering conformity with the terms and conditions established by the Department in the rules, Invitation for Bids and contract documents. The issuance of plans and proposal forms for bidding based upon a prequalification rating shall not be the sole determinant of responsibility. The Department reserves the right to determine responsibility at the time of award, to reject any or all proposals, to readvertise the proposed improvement, and to waive technicalities.

By Order of the  
Illinois Department of Transportation

Randall S. Blankenhorn,  
Secretary

INDEX  
FOR  
SUPPLEMENTAL SPECIFICATIONS  
AND RECURRING SPECIAL PROVISIONS

Adopted January 1, 2017

This index contains a listing of SUPPLEMENTAL SPECIFICATIONS, frequently used RECURRING SPECIAL PROVISIONS, and LOCAL ROADS AND STREETS RECURRING SPECIAL PROVISIONS.

ERRATA Standard Specifications for Road and Bridge Construction  
(Adopted 4-1-16) (Revised 1-1-17)

**SUPPLEMENTAL SPECIFICATIONS**

<b><u>Std. Spec. Sec.</u></b>		<b><u>Page No.</u></b>
106	Control of Materials.....	1
403	Bituminous Surface Treatment (Class A-1, A-2, A-3) .....	2
420	Portland Cement Concrete Pavement .....	3
502	Excavation for Structures.....	5
503	Concrete Structures.....	7
504	Precast Concrete Structures .....	10
542	Pipe Culverts.....	11
586	Sand Backfill for Vaulted Abutments .....	12
670	Engineer’s Field Office and Laboratory .....	14
704	Temporary Concrete Barrier .....	15
888	Pedestrian Push-Button .....	17
1003	Fine Aggregates .....	18
1004	Coarse Aggregates.....	19
1006	Metals .....	21
1020	Portland Cement Concrete.....	22
1103	Portland Cement Concrete Equipment.....	24



CHECK SHEET  
FOR  
RECURRING SPECIAL PROVISIONS

Adopted January 1, 2017

The following RECURRING SPECIAL PROVISIONS indicated by an "X" are applicable to this contract and are included by reference:

RECURRING SPECIAL PROVISIONS

<u>CHECK SHEET #</u>		<u>PAGE NO.</u>
1	X Additional State Requirements for Federal-Aid Construction Contracts	26
2	X Subletting of Contracts (Federal-Aid Contracts)	29
3	X EEO	30
4	Specific EEO Responsibilities Non Federal-Aid Contracts	40
5	Required Provisions - State Contracts	45
6	Asbestos Bearing Pad Removal	51
7	Asbestos Waterproofing Membrane and Asbestos HMA Surface Removal	52
8	Temporary Stream Crossings and In-Stream Work Pads	53
9	Construction Layout Stakes Except for Bridges	54
10	Construction Layout Stakes	57
11	Use of Geotextile Fabric for Railroad Crossing	60
12	Subsealing of Concrete Pavements	62
13	Hot-Mix Asphalt Surface Correction	66
14	Pavement and Shoulder Resurfacing	68
15	Patching with Hot-Mix Asphalt Overlay Removal	69
16	Polymer Concrete	70
17	PVC Pipeliner	72
18	Bicycle Racks	73
19	Temporary Portable Bridge Traffic Signals	75
20	Work Zone Public Information Signs	77
21	Nighttime Inspection of Roadway Lighting	78
22	English Substitution of Metric Bolts	79
23	Calcium Chloride Accelerator for Portland Cement Concrete	80
24	Quality Control of Concrete Mixtures at the Plant	81
25	Quality Control/Quality Assurance of Concrete Mixtures	89
26	Digital Terrain Modeling for Earthwork Calculations	105
27	Reserved	107
28	Preventive Maintenance – Bituminous Surface Treatment (A-1)	108
29	Preventive Maintenance – Cape Seal	114
30	Preventive Maintenance – Micro-Surfacing	129
31	Preventive Maintenance – Slurry Seal	140
32	Temporary Raised Pavement Markers	149
33	Restoring Bridge Approach Pavements Using High-Density Foam	150
34	Portland Cement Concrete Inlay or Overlay	153

CHECK SHEET  
FOR  
LOCAL ROADS AND STREETS RECURRING SPECIAL PROVISIONS

The following LOCAL ROADS AND STREETS RECURRING SPECIAL PROVISIONS indicated by an "X" are applicable to this contract and are included by reference:

LOCAL ROADS AND STREETS RECURRING SPECIAL PROVISIONS

<u>CHECK SHEET #</u>	<u>PAGE NO.</u>
LRS 1 <b>Reserved</b> .....	158
LRS 2 <input type="checkbox"/> Furnished Excavation .....	159
LRS 3 <input checked="" type="checkbox"/> Work Zone Traffic Control Surveillance .....	160
LRS 4 <input checked="" type="checkbox"/> Flaggers in Work Zones .....	161
LRS 5 <input type="checkbox"/> Contract Claims .....	162
LRS 6 <input type="checkbox"/> Bidding Requirements and Conditions for Contract Proposals .....	163
LRS 7 <input type="checkbox"/> Bidding Requirements and Conditions for Material Proposals .....	169
LRS 8 <b>Reserved</b> .....	175
LRS 9 <input type="checkbox"/> Bituminous Surface Treatments .....	176
LRS 10 <b>Reserved</b> .....	177
LRS 11 <input type="checkbox"/> Employment Practices .....	178
LRS 12 <input type="checkbox"/> Wages of Employees on Public Works .....	180
LRS 13 <input type="checkbox"/> Selection of Labor .....	182
LRS 14 <input type="checkbox"/> Paving Brick and Concrete Paver Pavements and Sidewalks .....	183
LRS 15 <input type="checkbox"/> Partial Payments .....	186
LRS 16 <input type="checkbox"/> Protests on Local Lettings .....	187
LRS 17 <input type="checkbox"/> Substance Abuse Prevention Program.....	188
LRS 18 <input type="checkbox"/> Multigrade Cold Mix Asphalt .....	189

LEE COUNTY  
SECTION 13-00325-00-RS  
Walton Rd, Sterling Rd,  
Harmon Road  
PROJECT RS-0103(141)

INDEX OF SPECIAL PROVISIONS

ITEM	PAGE
Description of Work	1
Traffic Control and Protection	1 - 3
Surface Profile Milling	3
Bituminous Materials (Tack Coat)	3
Butt Joints	4
Aggregate Shoulders	4
Short Term Pavement Marking	4
Final Pavement Marking	4
Project Status	5

**INDEX LOCAL ROADS AND STREETS SPECIAL PROVISIONS**

<u>LR #</u>	<u>Pg #</u>	<u>Special Provision Title</u>	<u>Effective</u>	<u>Revised</u>
LR SD12		<input type="checkbox"/> Slab Movement Detection Device	Nov. 11, 1984	Jan. 1, 2007
LR SD13		<input type="checkbox"/> Required Cold Milled Surface Texture	Nov. 1, 1987	Jan. 1, 2007
LR 107-2		<input type="checkbox"/> Railroad Protective Liability Insurance for Local Lettings	Mar. 1, 2005	Jan. 1, 2006
LR 107-4	6	<input checked="" type="checkbox"/> Insurance	Feb. 1, 2007	Aug. 1, 2007
LR 108		<input type="checkbox"/> Combination Bids	Jan. 1, 1994	Mar. 1, 2005
LR 109		<input type="checkbox"/> Equipment Rental Rates	Jan. 1, 2012	
LR 212		<input type="checkbox"/> Shaping Roadway	Aug. 1, 1969	Jan. 1, 2002
LR 355-1		<input type="checkbox"/> Bituminous Stabilized Base Course, Road Mix or Traveling Plant Mix	Oct. 1, 1973	Jan. 1, 2007
LR 355-2		<input type="checkbox"/> Bituminous Stabilized Base Course, Plant Mix	Feb. 20, 1963	Jan. 1, 2007
LR 400-1		<input type="checkbox"/> Bituminous Treated Earth Surface	Jan. 1, 2007	Apr. 1, 2012
LR 400-2		<input type="checkbox"/> Bituminous Surface Plant Mix (Class B)	Jan. 1, 2008	
LR 400-3		<input type="checkbox"/> Hot In-Place Recycling (HIR) – Surface Recycling	Jan. 1, 2012	
LR 400-4		<input type="checkbox"/> Full-Depth Reclamation (FDR) with Emulsified Asphalt	Apr. 1, 2012	Jun. 1, 2012
LR 400-5		<input type="checkbox"/> Cold In-Place Recycling (CIR) With Emulsified Asphalt	Apr. 1, 2012	Jun. 1, 2012
LR 400-6		<input type="checkbox"/> Cold In Place Recycling (CIR) with Foamed Asphalt	June 1, 2012	
LR 400-7		<input type="checkbox"/> Full-Depth Reclamation (FDR) with Foamed Asphalt	June 1, 2012	
LR 402		<input type="checkbox"/> Salt Stabilized Surface Course	Feb. 20, 1963	Jan. 1, 2007
LR 403-1		<input type="checkbox"/> Surface Profile Milling of Existing, Recycled or Reclaimed Flexible Pavement	Apr. 1, 2012	Jun. 1, 2012
LR 403-2		<input type="checkbox"/> Bituminous Hot Mix Sand Seal Coat	Aug. 1, 1969	Jan. 1, 2007
LR 403-3		<input type="checkbox"/> Preventive Maintenance - Bituminous Surface Treatment (A-1)	July 1, 2016	
LR 406		<input type="checkbox"/> Filling HMA Core Holes with Non-Shrink Grout	Jan. 1, 2008	
LR 420		<input type="checkbox"/> PCC Pavement (Special)	May 12, 1964	Jan. 2, 2007
LR 442		<input type="checkbox"/> Bituminous Patching Mixtures for Maintenance Use	Jan. 1, 2004	Jun. 1, 2007
LR 451		<input type="checkbox"/> Crack Filling Bituminous Pavement with Fiber-Asphalt	Oct. 1, 1991	Jan. 1, 2007
LR 503-1		<input type="checkbox"/> Furnishing Class SI Concrete	Oct. 1, 1973	Jan. 1, 2002
LR 503-2		<input type="checkbox"/> Furnishing Class SI Concrete (Short Load)	Jan. 1, 1989	Jan. 1, 2002
LR 542		<input type="checkbox"/> Pipe Culverts, Type _____ (Furnished)	Sep. 1, 1964	Jan. 1, 2007
LR 663		<input type="checkbox"/> Calcium Chloride Applied	Jun. 1, 1958	Jan. 1, 2007
LR 702	7	<input checked="" type="checkbox"/> Construction and Maintenance Signs	Jan. 1, 2004	Jun. 1, 2007
LR 1000-1		<input type="checkbox"/> Cold In-Place Recycling (CIR) and Full Depth Reclamation (FDR) with Emulsified Asphalt Mix Design Procedures	Apr. 1, 2012	Jun. 1, 2012
LR 1000-2		<input type="checkbox"/> Cold In-Place Recycling (CIR) and Full Depth Reclamation (FDR) with Foamed Asphalt Mix Design Procedures	June 1, 2012	
LR 1004		<input type="checkbox"/> Coarse Aggregate for Bituminous Surface Treatment	Jan. 1, 2002	Jan. 1, 2007
LR 1030	8	<input checked="" type="checkbox"/> Growth Curve	Mar. 1, 2008	Jan. 1, 2010
LR 1032-1		<input type="checkbox"/> Emulsified Asphalts	Jan. 1, 2007	Feb. 7, 2008
LR 1102		<input type="checkbox"/> Road Mix or Traveling Plan Mix Equipment	Jan. 1, 2007	
LR 80029-1		<input type="checkbox"/> Disadvantaged Business Enterprise Participation for Local Lettings	Aug. 26, 2016	

## BDE SPECIAL PROVISIONS

The following special provisions indicated by an "x" are applicable to this contract. An \* indicates a new or revised special provision for the letting.

<u>File Name</u>	<u>Pg.</u>	<u>Special Provision Title</u>	<u>Effective</u>	<u>Revised</u>
80099		Accessible Pedestrian Signals (APS)	April 1, 2003	Jan. 1, 2014
80274		Aggregate Subgrade Improvement	April 1, 2012	April 1, 2016
80192	10	X Automated Flagger Assistance Device	Jan. 1, 2008	
80173		Bituminous Materials Cost Adjustments	Nov. 2, 2006	July 1, 2015
80241		Bridge Demolition Debris	July 1, 2009	
50261		Building Removal-Case I (Non-Friable and Friable Asbestos)	Sept. 1, 1990	April 1, 2010
50481		Building Removal-Case II (Non-Friable Asbestos)	Sept. 1, 1990	April 1, 2010
50491		Building Removal-Case III (Friable Asbestos)	Sept. 1, 1990	April 1, 2010
50531		Building Removal-Case IV (No Asbestos)	Sept. 1, 1990	April 1, 2010
80366	12	X Butt Joints	July 1, 2016	
80198		Completion Date (via calendar days)	April 1, 2008	
80199		Completion Date (via calendar days) Plus Working Days	April 1, 2008	
80293		Concrete Box Culverts with Skews > 30 Degrees and Design Fills ≤ 5 Feet	April 1, 2012	July 1, 2016
80311		Concrete End Sections for Pipe Culverts	Jan. 1, 2013	April 1, 2016
80277		Concrete Mix Design – Department Provided	Jan. 1, 2012	April 1, 2016
80261		Construction Air Quality – Diesel Retrofit	June 1, 2010	Nov. 1, 2014
80029	13	X Disadvantaged Business Enterprise Participation	Sept. 1, 2000	July 2, 2016
* 80378		Dowel Bar Inserter	Jan. 1, 2017	
80229		Fuel Cost Adjustment	April 1, 2009	July 1, 2015
80304		Grooving for Recessed Pavement Markings	Nov. 1, 2012	Aug. 1, 2014
80246	24	X Hot-Mix Asphalt – Density Testing of Longitudinal Joints	Jan. 1, 2010	April 1, 2016
80347		Hot-Mix Asphalt – Pay for Performance Using Percent Within Limits – Jobsite Sampling	Nov. 1, 2014	April 1, 2016
80376	25	X Hot-Mix Asphalt – Tack Coat	Nov. 1, 2016	
80367		Light Poles	July 1, 2016	
80368		Light Tower	July 1, 2016	
80336		Longitudinal Joint and Crack Patching	April 1, 2014	April 1, 2016
80369		Mast Arm Assembly and Pole	July 1, 2016	
80045		Material Transfer Device	June 15, 1999	Aug. 1, 2014
80165		Moisture Cured Urethane Paint System	Nov. 1, 2006	Jan. 1, 2010
80349		Pavement Marking Blackout Tape	Nov. 1, 2014	April 1, 2016
80371		Pavement Marking Removal	July 1, 2016	
80298		Pavement Marking Tape Type IV	April 1, 2012	April 1, 2016
80377		Portable Changeable Message Signs	Nov. 1, 2016	
* 80359		Portland Cement Concrete Bridge Deck Curing	April 1, 2015	Jan. 1, 2017
80338		Portland Cement Concrete Partial Depth Hot-Mix Asphalt Patching	April 1, 2014	April 1, 2016
80300		Preformed Plastic Pavement Marking Type D - Inlaid	April 1, 2012	April 1, 2016
80328	26	X Progress Payments	Nov. 2, 2013	
34261		Railroad Protective Liability Insurance	Dec. 1, 1986	Jan. 1, 2006
80157		Railroad Protective Liability Insurance (5 and 10)	Jan. 1, 2006	
80306	27	X Reclaimed Asphalt Pavement (RAP) and Reclaimed Asphalt Shingles (RAS)	Nov. 1, 2012	April 1, 2016
* 80340		Speed Display Trailer	April 2, 2014	Jan. 1, 2017
80127		Steel Cost Adjustment	April 2, 2004	July 1, 2015
* 80379		Steel Plate Beam Guardrail	Jan. 1, 2017	
80317		Surface Testing of Hot-Mix Asphalt Overlays	Jan. 1, 2013	April 1, 2016
20338		Training Special Provisions	Oct. 15, 1975	
80318		Traversable Pipe Grate	Jan. 1, 2013	April 1, 2014
* 80381		Traffic Barrier Terminal, Type 1 Special	Jan. 1, 2017	

<u>File Name</u>	<u>Pg.</u>		<u>Special Provision Title</u>	<u>Effective</u>	<u>Revised</u>
* 80380			Tubular Markers	Jan. 1, 2017	
80288	37	X	Warm Mix Asphalt	Jan. 1, 2012	April 1, 2016
80302	39	X	Weekly DBE Trucking Reports	June 2, 2012	April 2, 2015
80289			Wet Reflective Thermoplastic Pavement Marking	Jan. 1, 2012	
80071	40	X	Working Days	Jan. 1, 2002	

The following special provisions are in the 2017 Supplemental Specifications and Recurring Special Provisions.

<u>File Name</u>	<u>Special Provision Title</u>	<u>New Location</u>	<u>Effective</u>	<u>Revised</u>
80360	Coarse Aggregate Quality	Article 1004.01	July 1, 2015	
80363	Engineer's Field Office	Article 670.07	April 1, 2016	
80358	Equal Employment Opportunity	Recurring CS #1 and #5	April 1, 2015	
80364	Errata for the 2016 Standard Specifications	Supplemental	April 1, 2016	
80342	Mechanical Side Tie Bar Inserter	Articles 420.03, 420.05, and 1103.19	Aug. 1, 2014	April 1, 2016
80370	Mechanical Splicers	Article 1006.10	July 1, 2016	
80361	Overhead Sign Structures Certification of Metal Fabricator	Article 106.08	Nov. 1, 2015	April 1, 2016
80365	Pedestrian Push-Button	Article 888.03	April 1, 2016	
80353	Portland Cement Concrete Inlay or Overlay	Recurring CS #34	Jan. 1, 2015	April 1, 2016
80372	Preventive Maintenance – Bituminous Surface Treatment (A-1)	Recurring CS #28	Jan. 1, 2009	July 1, 2016
80373	Preventive Maintenance – Cape Seal	Recurring CS #29	Jan. 1, 2009	July 1, 2016
80374	Preventive Maintenance – Micro Surfacing	Recurring CS #30	Jan. 1, 2009	July 1, 2016
80375	Preventive Maintenance – Slurry Seal	Recurring CS #31	Jan. 1, 2009	July 1, 2016
80362	Steel Slag in Trench Backfill	Articles 1003.01 and 1003.04	Jan. 1, 2016	
80355	Temporary Concrete Barrier	Articles 704.02, 704.04, 704.05, and 704.06	Jan. 1, 2015	July 1, 2015

The following special provisions require additional information from the designer. The additional information needs to be included in a separate document attached to this check sheet. The Project Development and Implementation section will then include the information in the applicable special provision. The Special Provisions are:

- Bridge Demolition Debris
- Building Removal-Case I
- Building Removal-Case II
- Building Removal-Case III
- Building Removal-Case IV
- Completion Date
- Completion Date Plus Working Days
- DBE Participation
- Material Transfer Device
- Railroad Protective Liability Insurance
- Training Special Provisions
- Working Days



The following Special Provisions supplement the "Standard Specifications for Road and Bridge Construction", Adopted April 1, 2016, the latest edition of the "Manual on Uniform Traffic Control Devices for Streets and Highways", and the "Manual of Test Procedures of Materials" in effect on the date of invitation of bids, and the Supplemental Specifications and Recurring Special Provisions indicated on the Check Sheet included here in which apply to and govern the construction of 13-00325-00-RS, Lee County, and in case of conflict with any part, or parts, of said Specifications, the said Special Provisions shall take precedence and shall govern.

**DESCRIPTION OF WORK:**

The work on this contract shall consist of furnishing all labor, material, and equipment necessary to construct a 2" overlay of Sterling Road and Walton Road & a 2" mill & overlay on Harmon Road. The project also includes grinding of existing bumps due to transverse joints, as well as to construct curb ramps in the Village of Harmon. Side Road transitions, Mailbox Turnouts, Private Entrances, and Field Entrances shall also be re-surfaced as directed by the Engineer. The shoulders will consist of a Type B aggregate wedge.

**TRAFFIC CONTROL AND PROTECTION SPECIAL:**

Traffic Control shall be according to the applicable sections of the Standard Specifications for Road and Bridge Construction, the applicable guidelines contained in the National Manual on Uniform Traffic Control Devices for Streets and Highways, Illinois Supplement to the National Manual on Uniform Traffic Control Devices, these special provisions, and any special details and Highway Standards contained herein and in the plans.

Special attention is called to Articles 107.09 and 107.14 of the Standard Specifications for Road and Bridge Construction and the following Highway Standards relating to traffic control.

**Insert Standard Numbers (Six-digit number only)**

Standards:

701006	701011	701301	701306	701311	701801	701901
720011	728001	729001				

General:

Where construction activities involve sidewalks on both sides of the street, the work shall be staged so that both sidewalks are not out of service at the same time.

Signs:

No bracing shall be allowed on post-mounted signs.

Post-mounted signs shall be installed using standard 720011, 728001, 729001, on 4"x4" wood posts, or on any other "break away" connection if accepted by the FHWA and corresponding letter is provided to the resident.

All signs are required on both sides of the road when the median is greater than 10 feet and on one way roadways.

The "WORKERS" (W21-1a(O)-48) signs shall be replaced with symbol "Right or Left Lane Closed Ahead" (W4-2R or L(O)-48) signs on multilane roadways.

"BUMP" (W8-1(O)48) signs shall be installed as directed by the Engineer.

"UNEVEN LANES" W8-11(O)48 signs shall be installed at 1 mile intervals or as directed by the Engineer.

"LOW SHOULDER" W8-9(O)48 signs shall be installed at 1 mile intervals or as directed by the Engineer.

"NO PASSING ZONES NOT STRIPED NEXT \_\_\_ MILES" (G20-I 100(O)) signs shall be 60" x 36".

When covering existing Department signs, no tape shall be used on the reflective portion of the sign. Contact the District sign shop for covering techniques.

Install a "TO ACTIVATE SIGNAL" sign below the "STOP HERE ON RED" sign. The detail of this sign is included in the plans.

All regulatory signs shall be maintained at a 5 foot minimum bottom (rural), 7 foot minimum (urban).

Plate altering signs shall have the same sheeting as the base sign.

No more than one plate shall be used to alter a sign.

Any post stubs without a sign in place and visible shall have a reflector placed on each post.

#### Devices:

Cones or reflectorized cones shall not be used during hours of darkness.

A minimum of 3 drums spaced at 4 feet shall be placed at each return when the side road is open.

On all standards, and the devices listed in Section 701 of the Standard Specifications, the device spacing shall be revised to the following dimensions:

Where the spacing shown on the standard is 25 feet, the devices shall be placed at 20 feet.

Where the spacing shown on the standard is 50 feet, the devices shall be placed at 40 feet.

Where the spacing shown on the standard is 100 feet, the devices shall be placed at 80 feet.

#### Flagger at Side roads and Commercial Entrances:

Flaggers shall comply with all requirements and signaling methods contained in the Department's "Traffic Control Field Manual" current at the time of letting. The flagger equipment listed for flaggers employed by the Illinois Department of Transportation shall apply to all flaggers

All workers and flaggers shall wear ANSI Class E pants and an ANSI Class 2 vest that in combination meet the requirements of ANSI/ISEA 107-2004 for Conspicuity Class 3 garments during hours of darkness.

In addition to the flaggers shown on applicable standards, on major side roads, flaggers shall be required on all legs of the intersection. Major side roads for this project shall be IL Rt. 26, Dutch Rd., Pump Factory Rd., Hoyle Rd., Atkinson Rd., Wheeler Rd, & Commerce Dr.

In addition to the flaggers shown on applicable standards, a flagger shall be required on high volume commercial entrances listed below. There are no high volume commercial entrances contained within project limits.

When the mainline flagger is within 200 feet of an intersection, the side road flagger shall be required.

When the road is closed to through traffic and it is necessary to provide access for local traffic, all flaggers as shown on the applicable standards will be required. No reduction in the number of flaggers shall be allowed.

Revise the first and second paragraph of Article 701.20(i) of the Standard Specifications to read:

"Signs, barricades, other traffic control devices, or flaggers required by the Engineer, over and above



those shown in the contract documents, will be paid for according to Article 109.04.

**Maintenance of Traffic:**

The mainline shall be kept open to one-way traffic at all times during working hours and two-way traffic during non-working hours.

The Contractor shall be required to notify the Lee County Highway Department, the corresponding Township Commissioner, emergency response agencies (i.e.: fire, ambulance, police), school bus companies and the Department of Transportation (Bureau of Project Implementation) regarding any changes in traffic control.

The Contractor shall be required to notify the Lee County Highway Department and/or corresponding Township Commissioner for any side road closure or opening.

The resurfacing and placing of shoulder aggregate shall be completed using Traffic Control and Protection Standard 701306.

Placing and removing pavement marking shall be completed using Traffic Control and Protection Standard 701306, 701311.

The milling and resurfacing shall be completed using Traffic Control and Protection Standard 701306.

The striping shall be completed using Traffic Control and Protection Standard 701311.

**Traffic Control & Protection Standard 701801:**

This work shall be done according to Section 701 of the Standard Specifications, Traffic Control and Protection Standard 701801, and as specified herein. The sidewalk shall not be closed to perform the work. No alternate sidewalk is to be provided. Because there is no sidewalk to redirect to, the sidewalk shall remain open at all times.

During working hours, the contractor shall designate a person each work day responsible for assisting pedestrians through and around the work area. This person shall be capable of stopping their work duties immediately in order to assist and escort pedestrians as required through or around the work zone. This person shall be known to the Engineer. This person shall be distinguishable from other personnel on the job site. This shall be accomplished by wearing an ANSI Class 2 garment that is a different color from the rest of the personnel on-site, but still meeting the color requirements in Article 701.12 of the Standard Specifications. Pedestrian access shall be maintained at all times.

During non-working hours, the work area shall be graded, level, accessible, and free from hazards. Temporary ramps shall be placed as necessary at each end of the removed sidewalk and at the crossing meeting, the slope requirements of a permanent ramp and sidewalk. It shall remain open to pedestrians. Aggregate will be allowed as a temporary sidewalk surface for a maximum of 5 days. The work shall be scheduled such that the sidewalk and curb and gutter work is completed by Friday, so that pedestrians are using a paved sidewalk.

This work shall be included in the contract unit price per Lump Sum for TRAFFIC CONTROL AND PROTECTION SPECIAL.

**SURFACE PROFILE MILLING:**

The purpose of this work is to provide a smooth surface prior to any paving operation. The contractor will not be required to mill the entire roadway surface but only mill the transverse joints and any other areas designated by the Engineer. The Hot Mix Asphalt paving shall not commence until the subbase is approved by the Engineer.

**Method of Payment:**

This work shall be paid for at the contract unit price per square yard for SURFACE PROFILE MILLING, which price shall include all equipment, labor and transportation of the removed material as described herein, and no additional compensation shall be allowed.

**BITUMINOUS MATERIALS (TACK COAT):**

All existing bituminous surfaces shall be primed at a rate of 0.05 pounds per square foot with SS-1 or RC-70, full width as directed by the Engineer. All Prime used shall be paid for at the contract unit price bid per POUND for BITUMINOUS MATERIALS (TACK COAT).

**BUTT JOINTS:**

Butt Joints shall be saw cut on the mainline at the Southern Walton village limit, 2 joints at IL – Rt. 26, and at any bituminous entrance meeting Walton, Sterling, & Harmon Roads. The joint shall be cut at these locations and cleaned back a minimum of 50 feet, tapering from (2.0) inches at the joint to (0) inches, for the full width of the road. All equipment, materials and labor required to complete this process shall be considered incidental to the HMA SC MIX C, N50 pay item. This shall include the disposal of any removed material. **Joints shall not be cut more than five working days prior to placement of the Hot Mix Asphalt.** Bump signs shall be placed once the joints are cut. No additional compensation will be allowed

**AGGREGATE SHOULDERS:**

This work shall conform to Section 481 of the Standard Specifications for Road and Bridge Construction. The contractor shall install a 3 ft. wedge shoulder adjacent to the resurfacing and as shown in the plans. Any loose aggregate left on the new Hot Mix Asphalt surface must be broomed off. This work will be paid for at the contract unit price per Ton for AGGREGATE SHOULDERS, Type B. In addition, before the overlay is placed, the contractor shall blade the existing shoulder stone up to the existing pavement edge. No additional compensation will be allowed for this work and shall be considered incidental to AGGREGATE SHOULDERS Type B.

**SHORT TERM PAVEMENT MARKING:**

This work shall conform to Section 703 of the Standard Specifications for Road and Bridge Construction. Tape marking box ends with product lot numbers shall be furnished to the Resident Engineer. The Short-Term Pavement Markings on a milled surface shall be paint. This work will be paid for at the contract unit price per Foot for SHORT TERM PAVEMENT MARKING.

**FINAL PAVEMENT MARKING:**

The final striping of the roadway will be furnished and applied by the Lee County Highway Department within 7 working days after the completion of the final surface course. This work will consist of removing the temporary striping and applying the final pavement marking. The contractor shall maintain the traffic control until the final striping is complete and will be given 2 days notice after the final striping is complete to remove all signs.

**PROJECT STATUS**

**LOCAL AGENCY:** LEE COUNTY HIGHWAY DEPARTMENT

**PROJECT:** Harmon Rd, Sterling Rd, Walton Rd

**SECTION:** 13-00325-00-RS

**JOB NO:** C-92-060-16

**LIST BELOW ANY COMMITMENTS WHICH SHOULD BE INCLUDED IN THE PLANS OR REQUIRE FOLLOW-UP DURING CONSTRUCTION.**

**ENVIRONMENTAL:** NONE

**PUBLIC:** NONE

**LAND ACQUISITION:** N/A

**DESIGN:** NONE

**OTHER:** NONE

**UTILITIES:** Have plans been sent to all utility companies? YES

State of Illinois  
Department of Transportation  
Bureau of Local Roads and Streets

SPECIAL PROVISION  
FOR  
INSURANCE

Effective: February 1, 2007  
Revised: August 1, 2007

All references to Sections or Articles in this specification shall be construed to mean specific Section or Article of the Standard Specifications for Road and Bridge Construction, adopted by the Department of Transportation.

The Contractor shall name the following entities as additional insured under the Contractor's general liability insurance policy in accordance with Article 107.27:

Lee County

---

---

---

---

---

---

---

---

The entities listed above and their officers, employees, and agents shall be indemnified and held harmless in accordance with Article 107.26.

State of Illinois  
Department of Transportation  
Bureau of Local Roads and Streets  
SPECIAL PROVISION  
FOR  
CONSTRUCTION AND MAINTENANCE SIGNS

Effective: January 1, 2004  
Revised: June 1, 2007

All references to Sections or Articles in this specification shall be construed to mean a specific Section or Article of the Standard Specifications for Road and Bridge Construction, adopted by the Department of Transportation.

701.14. Signs. Add the following paragraph to Article 701.14:

All warning signs shall have minimum dimensions of 1200 mm x 1200 mm (48" x 48") and have a black legend on a fluorescent orange reflectorized background, meeting, as a minimum, Type AP reflectivity requirements of Table 1091-2 in Article 1091.02.

State of Illinois  
DEPARTMENT OF TRANSPORTATION  
Bureau of Local Roads & Streets

SPECIAL PROVISION  
FOR  
GROWTH CURVE

Effective: March 1, 2008  
Revised: January 1, 2010

All references to Sections and Articles in this Special Provision shall be construed to mean specific Sections and Articles in the Standard Specifications for Road and Bridge Construction adopted by the Department of Transportation.

The Contractor shall perform a growth curve at the beginning of placement of each type of mix and each lift. The growth curve for each type of mix and each lift shall be performed within the first 200 tons (180 metric tons). If an adjustment is made to the specific mix design, the Engineer reserves the right to request an additional growth curve and supporting tests at the Contractor's expense.

Compaction of the growth curve shall commence immediately after the course is placed and at a temperature of not less than 280 °F (140 °C). The growth curve, consisting of a plot of lb/cu ft (kg/cu m) vs. number of passes with the project breakdown roller, shall be developed. Roller speed during the growth curve testing shall be the same as the normal paving operation. This curve shall be established by use of a nuclear gauge. Tests shall be taken after each pass until the highest lb/cu ft (kg/cu m) is obtained. This value shall be the target density provided the HMA Gyratory air voids are within acceptable limits. If the HMA Gyratory air voids are not within the specified limits, corrective action shall be taken, and a new target density shall be established.

A new growth curve is required if the breakdown roller used on the growth curve is replaced with a new roller during production. The target density shall apply only to the specific gauge used. If additional gauges are to be used to determine density specification compliance, the Contractor shall establish a unique minimum allowable target density from the growth curve location for each gauge.

At least one core sample per day shall be taken at a location specified by the Engineer. Core densities will be determined using the Illinois-Modified AASHTO T 166 or T 275 procedure by the Department. The core density shall be according to Articles 1030.05(d)(4) and (d)(7). The QA Manager is responsible for assuring and documenting that the determined number of roller passes has been accomplished. The Engineer reserves the right to take core samples at any time to verify density from the nuclear gauge,

All lifts and confined longitudinal joint edges shall be compacted to an average nuclear gauge density of not less than 95 percent nor greater than 102 percent of the target density obtained on the growth curve. Unconfined longitudinal joint edges shall be compacted to an average nuclear gauge density of not less than 93 percent nor greater than 102 percent of the target density obtained on the growth curve. The average nuclear gauge density shall be based on tests representing one day's production.

Quality Control density tests shall be performed at randomly selected locations within 1/2 mile (800 m) intervals per lift per lane. In no case shall more than one half day's production be completed without density testing being performed. Longitudinal joint density testing shall be performed at each random density test location. Longitudinal joint testing shall be located at a distance equal to the lift thickness or a minimum of 2 in. (50 mm) from each pavement edge.

If the Contractor is not controlling the compaction process and is making no effort to take corrective action, the operation shall stop as directed by the Engineer.

## **AUTOMATED FLAGGER ASSISTANCE DEVICES (BDE)**

Effective: January 1, 2008

Description. This work shall consist of furnishing and operating automated flagger assistance devices (AFADs) as part of the work zone traffic control and protection for two-lane highways where two-way traffic is maintained over one lane of pavement. Use of these devices shall be at the option of the Contractor.

Equipment. AFADs shall be according to the FHWA memorandum, "MUTCD - Revised Interim Approval for the use of Automated Flagger Assistance Devices in Temporary Traffic Control Zones (IA-4R)", dated January 28, 2005. The devices shall be mounted on a trailer or a moveable cart and shall meet the requirements of NCHRP 350, Category 4.

The AFAD shall be the Stop/Slow type. This device uses remotely controlled "STOP" and "SLOW" signs to alternately control right-of-way.

Signs for the AFAD shall be according to Article 701.03 of the Standard Specifications and the MUTCD. The signs shall be 24 x 24 in. (600 x 600 mm) having an octagon shaped "STOP" sign on one side and a diamond shaped "SLOW" sign on the opposite side. The letters on the signs shall be 8 in. (200 mm) high. If the "STOP" sign has louvers, the full sign face shall be visible at a distance of 50 ft (15 m) and greater.

The signs shall be supplemented with one of the following types of lights.

- (a) Flashing Lights. When flashing lights are used, white or red flashing lights shall be mounted within the "STOP" sign face and white or yellow flashing lights within the "SLOW" sign face.
- (b) Stop and Warning Beacons. When beacons are used, a stop beacon shall be mounted 24 in. (600 mm) or less above the "STOP" sign face and a warning beacon mounted 24 in. (600 mm) or less above, below, or to the side of the "SLOW" sign face. As an option, a Type B warning light may be used in lieu of the warning beacon.

A "WAIT ON STOP" sign shall be placed on the right hand side of the roadway at a point where drivers are expected to stop. The sign shall be 24 x 30 in. (600 x 750 mm) with a black legend and border on a white background. The letters shall be at least 6 in. (150 mm) high.

This device may include a gate arm or mast arm that descends to a horizontal position when the "STOP" sign is displayed and rises to a vertical position when the "SLOW" sign is displayed. When included, the end of the arm shall reach at least to the center of the lane being controlled. The arm shall have alternating red and white retroreflective stripes, on both sides, sloping downward at 45 degrees toward the side on which traffic will pass. The stripes shall be 6 in. (150 mm) in width and at least 2 in. (50 mm) in height.



Flagging Requirements. Flaggers and flagging requirements shall be according to Article 701.13 of the Standard Specifications and the following.

AFADs shall be placed at each end of the traffic control, where a flagger is shown on the plans. The flaggers shall be able to view the face of the AFAD and approaching traffic during operation.

To stop traffic, the "STOP" sign shall be displayed, the corresponding lights/beacon shall flash, and when included, the gate arm shall descend to a horizontal position. To permit traffic to move, the "SLOW" sign shall be displayed, the corresponding lights/beacon shall flash, and when included, the gate arm shall rise to a vertical position.

If used at night, the AFAD location shall be illuminated according to Section 701 of the Standard Specifications.

When not in use, AFADs will be considered nonoperating equipment and shall be stored according to Article 701.11 of the Standard Specifications.

Basis of Payment. This work will not be paid for separately but shall be considered as included in the cost of the various traffic control items included in the contract.

80192

## BUTT JOINTS (BDE)

Effective: July 1, 2016

Add the following to Article 406.08 of the Standard Specifications.

- "(c) Temporary Plastic Ramps. Temporary plastic ramps shall be made of high density polyethylene meeting the properties listed below. Temporary plastic ramps shall only be used on roadways with permanent posted speeds of 55 mph or less. The ramps shall have a minimum taper rate of 1:30 (V:H). The leading edge of the plastic ramp shall have a maximum thickness of 1/4 in. (6 mm) and the trailing edge shall match the height of the adjacent pavement  $\pm$  1/4 in. ( $\pm$  6 mm).

The ramp will be accepted by certification. The Contractor shall furnish a certification from the manufacturer stating the temporary plastic ramp meets the following requirements.

Physical Property	Test Method	Requirement
Melt Index	ASTM D 1238	8.2 g/10 minutes
Density	ASTM D 1505	0.965 g/cc
Tensile Strength @ Break	ASTM D 638	2223 psi (15 MPa)
Tensile Strength @ Yield	ASTM D 638	4110 psi (28 MPa)
Elongation @ Yield <sup>1/</sup> , percent	ASTM D 638	7.3 min.
Durometer Hardness, Shore D	ASTM D 2240	65
Heat Deflection Temperature, 66 psi	ASTM D 648	176 °F (80 °C)
Low Temperature Brittleness, F <sub>50</sub>	ASTM D 746	<-105 °F (<-76 °C)

1/ Crosshead speed -2 in./minute

The temporary plastic ramps shall be installed according to the manufacturer's specifications and fastened with anchors meeting the manufacturer's recommendations. Temporary plastic ramps that fail to stay in place or create a traffic hazard shall be replaced immediately with temporary HMA ramps at the Contractor's expense."

80366

## DISADVANTAGED BUSINESS ENTERPRISE PARTICIPATION (BDE)

Effective: September 1, 2000

Revised: January 2, 2016

FEDERAL OBLIGATION. The Department of Transportation, as a recipient of federal financial assistance, is required to take all necessary and reasonable steps to ensure nondiscrimination in the award and administration of contracts. Consequently, the federal regulatory provisions of 49 CFR Part 26 apply to this contract concerning the utilization of disadvantaged business enterprises. For the purposes of this Special Provision, a disadvantaged business enterprise (DBE) means a business certified by the Department in accordance with the requirements of 49 CFR Part 26 and listed in the Illinois Unified Certification Program (IL UCP) DBE Directory.

STATE OBLIGATION. This Special Provision will also be used by the Department to satisfy the requirements of the Business Enterprise for Minorities, Females, and Persons with Disabilities Act, 30 ILCS 575. When this Special Provision is used to satisfy state law requirements on 100 percent state-funded contracts, the federal government has no involvement in such contracts (not a federal-aid contract) and no responsibility to oversee the implementation of this Special Provision by the Department on those contracts. DBE participation on 100 percent state-funded contracts will not be credited toward fulfilling the Department's annual overall DBE goal required by the US Department of Transportation to comply with the federal DBE program requirements.

CONTRACTOR ASSURANCE. The Contractor makes the following assurance and agrees to include the assurance in each subcontract that the Contractor signs with a subcontractor.

The Contractor, subrecipient, or subcontractor shall not discriminate on the basis of race, color, national origin, or sex in the performance of this contract. The Contractor shall carry out applicable requirements of 49 CFR Part 26 in the award and administration of contracts funded in whole or in part with federal or state funds. Failure by the Contractor to carry out these requirements is a material breach of this contract, which may result in the termination of this contract or such other remedy as the recipient deems appropriate, which may include, but is not limited to:

- (a) Withholding progress payments;
- (b) Assessing sanctions;
- (c) Liquidated damages; and/or
- (d) Disqualifying the Contractor from future bidding as non-responsible.

OVERALL GOAL SET FOR THE DEPARTMENT. As a requirement of compliance with 49 CFR Part 26, the Department has set an overall goal for DBE participation in its federally assisted contracts. That goal applies to all federal-aid funds the Department will expend in its federally assisted contracts for the subject reporting fiscal year. The Department is required to make a

good faith effort to achieve the overall goal. The dollar amount paid to all approved DBE companies performing work called for in this contract is eligible to be credited toward fulfillment of the Department's overall goal.

CONTRACT GOAL TO BE ACHIEVED BY THE CONTRACTOR. This contract includes a specific DBE utilization goal established by the Department. The goal has been included because the Department has determined that the work of this contract has subcontracting opportunities that may be suitable for performance by DBE companies. The determination is based on an assessment of the type of work, the location of the work, and the availability of DBE companies to do a part of the work. The assessment indicates that, in the absence of unlawful discrimination, and in an arena of fair and open competition, DBE companies can be expected to perform 2.00 % of the work. This percentage is set as the DBE participation goal for this contract. Consequently, in addition to the other award criteria established for this contract, the Department will only award this contract to a bidder who makes a good faith effort to meet this goal of DBE participation in the performance of the work. A bidder makes a good faith effort for award consideration if either of the following is done in accordance with the procedures set for in this Special Provision:

- (a) The bidder documents that enough DBE participation has been obtained to meet the goal or,
- (b) The bidder documents that a good faith effort has been made to meet the goal, even though the effort did not succeed in obtaining enough DBE participation to meet the goal.

DBE LOCATOR REFERENCES. Bidders shall consult the IL UCP DBE Directory as a reference source for DBE-certified companies. In addition, the Department maintains a letting and item specific DBE locator information system whereby DBE companies can register their interest in providing quotes on particular bid items advertised for letting. Information concerning DBE companies willing to quote work for particular contracts may be obtained by contacting the Department's Bureau of Small Business Enterprises at telephone number (217) 785-4611, or by visiting the Department's website at:

<http://www.idot.illinois.gov/doing-business/certifications/disadvantaged-business-enterprise-certification/il-ucp-directory/index>.

BIDDING PROCEDURES. Compliance with this Special Provision is required prior to the award of the contract and the failure of the low bidder to comply will render the bid not responsive.

In order to assure the timely award of the contract, the low bidder shall submit:

- (a) The bidder shall submit a Disadvantaged Business Utilization Plan on completed Department forms SBE 2025 and 2026.
  - (1) The final Utilization Plan must be submitted within five calendar days after the date of the letting.

- (2) To meet the five day requirement, the bidder may send the Utilization Plan electronically by scanning and sending to [DOT.DBE.UP@illinois.gov](mailto:DOT.DBE.UP@illinois.gov) or faxing to (217) 785-1524. The subject line must include the bid Item Number and the Letting date. The Utilization Plan should be sent as one .pdf file, rather than multiple files and emails for the same Item Number. It is the responsibility of the bidder to obtain confirmation of email or fax delivery.

Alternatively, the Utilization Plan may be sent by certified mail or delivery service within the five calendar day period. If a question arises concerning the mailing date of a Utilization Plan, the mailing date will be established by the U.S. Postal Service postmark on the original certified mail receipt from the U.S. Postal Service or the receipt issued by a delivery service. It is the responsibility of the bidder to ensure the postmark or receipt date is affixed within the five days if the bidder intends to rely upon mailing or delivery to satisfy the submission day requirement. The Utilization Plan is to be submitted to:

Illinois Department of Transportation  
Bureau of Small Business Enterprises  
Contract Compliance Section  
2300 South Dirksen Parkway, Room 319  
Springfield, Illinois 62764

The Department will not accept a Utilization Plan if it does not meet the five day submittal requirement and the bid will be declared not responsive. In the event the bid is declared not responsive due to a failure to submit a Utilization Plan or failure to comply with the bidding procedures set forth herein, the Department may elect to cause the forfeiture of the penal sum of the bidder's proposal guaranty, and may deny authorization to bid the project if re-advertised for bids. The Department reserves the right to invite any other bidder to submit a Utilization Plan at any time for award consideration or to extend the time for award.

- (b) The Utilization Plan shall indicate that the bidder either has obtained sufficient DBE participation commitments to meet the contract goal or has not obtained enough DBE participation commitments in spite of a good faith effort to meet the goal. The Utilization Plan shall further provide the name, telephone number, and telefax number of a responsible official of the bidder designated for purposes of notification of Utilization Plan approval or disapproval under the procedures of this Special Provision.
- (c) The Utilization Plan shall include a DBE Participation Commitment Statement, Department form SBE 2025, for each DBE proposed for the performance of work to achieve the contract goal. For bidding purposes, submission of the completed SBE 2025 forms, signed by the DBEs and scanned or faxed to the bidder will be acceptable as long as the original is available and provided upon request. All elements of information indicated on the said form shall be provided, including but not limited to the following:

- (1) The names and addresses of DBE firms that will participate in the contract;
- (2) A description, including pay item numbers, of the work each DBE will perform;
- (3) The dollar amount of the participation of each DBE firm participating. The dollar amount of participation for identified work shall specifically state the quantity, unit price, and total subcontract price for the work to be completed by the DBE. If partial pay items are to be performed by the DBE, indicate the portion of each item, a unit price where appropriate and the subcontract price amount;
- (4) DBE Participation Commitment Statements, form SBE 2025, signed by the bidder and each participating DBE firm documenting the commitment to use the DBE subcontractors whose participation is submitted to meet the contract goal;
- (5) If the bidder is a joint venture comprised of DBE companies and non-DBE companies, the Utilization Plan must also include a clear identification of the portion of the work to be performed by the DBE partner(s); and,
- (6) If the contract goal is not met, evidence of good faith efforts; the documentation of good faith efforts must include copies of each DBE and non-DBE subcontractor quote submitted to the bidder when a non-DBE subcontractor is selected over a DBE for work on the contract.

GOOD FAITH EFFORT PROCEDURES. The contract will not be awarded until the Utilization Plan submitted by the apparent successful bidder is approved. All information submitted by the bidder must be complete, accurate and adequately document that enough DBE participation has been obtained or document that good faith efforts of the bidder, in the event enough DBE participation has not been obtained, before the Department will commit to the performance of the contract by the bidder. The Utilization Plan will be approved by the Department if the Utilization Plan documents sufficient commercially useful DBE work to meet the contract goal or the bidder submits sufficient documentation of a good faith effort to meet the contract goal pursuant to 49 CFR Part 26, Appendix A. The Utilization Plan will not be approved by the Department if the Utilization Plan does not document sufficient DBE participation to meet the contract goal unless the apparent successful bidder documented in the Utilization Plan that it made a good faith effort to meet the goal. This means that the bidder must show that all necessary and reasonable steps were taken to achieve the contract goal. Necessary and reasonable steps are those which, by their scope, intensity and appropriateness to the objective, could reasonably be expected to obtain sufficient DBE participation, even if they were not successful. The Department will consider the quality, quantity, and intensity of the kinds of efforts that the bidder has made. Mere *pro forma* efforts, in other words, efforts done as a matter of form, are not good faith efforts; rather, the bidder is expected to have taken genuine efforts that would be reasonably expected of a bidder actively and aggressively trying to obtain DBE participation sufficient to meet the contract goal.

- (a) The following is a list of types of action that the Department will consider as part of the evaluation of the bidder's good faith efforts to obtain participation. These listed factors

are not intended to be a mandatory checklist and are not intended to be exhaustive. Other factors or efforts brought to the attention of the Department may be relevant in appropriate cases, and will be considered by the Department.

- (1) Soliciting through all reasonable and available means (e.g. attendance at pre-bid meetings, advertising and/or written notices) the interest of all certified DBE companies that have the capability to perform the work of the contract. The bidder must solicit this interest within sufficient time to allow the DBE companies to respond to the solicitation. The bidder must determine with certainty if the DBE companies are interested by taking appropriate steps to follow up initial solicitations.
- (2) Selecting portions of the work to be performed by DBE companies in order to increase the likelihood that the DBE goals will be achieved. This includes, where appropriate, breaking out contract work items into economically feasible units to facilitate DBE participation, even when the prime Contractor might otherwise prefer to perform these work items with its own forces.
- (3) Providing interested DBE companies with adequate information about the plans, specifications, and requirements of the contract in a timely manner to assist them in responding to a solicitation.
- (4) a. Negotiating in good faith with interested DBE companies. It is the bidder's responsibility to make a portion of the work available to DBE subcontractors and suppliers and to select those portions of the work or material needs consistent with the available DBE subcontractors and suppliers, so as to facilitate DBE participation. Evidence of such negotiation includes the names, addresses, and telephone numbers of DBE companies that were considered; a description of the information provided regarding the plans and specifications for the work selected for subcontracting; and evidence as to why additional agreements could not be reached for DBE companies to perform the work.  
  
b. A bidder using good business judgment would consider a number of factors in negotiating with subcontractors, including DBE subcontractors, and would take a firm's price and capabilities as well as contract goals into consideration. However, the fact that there may be some additional costs involved in finding and using DBE companies is not in itself sufficient reason for a bidder's failure to meet the contract DBE goal, as long as such costs are reasonable. Also the ability or desire of a bidder to perform the work of a contract with its own organization does not relieve the bidder of the responsibility to make good faith efforts. Bidders are not, however, required to accept higher quotes from DBE companies if the price difference is excessive or unreasonable. In accordance with subsection (c)(6) of the above Bidding Procedures, the documentation of good faith efforts must include copies of each DBE and non-DBE subcontractor quote submitted to the bidder when a non-DBE subcontractor was selected over a DBE for work on the contract.

- (5) Not rejecting DBE companies as being unqualified without sound reasons based on a thorough investigation of their capabilities. The bidder's standing within its industry, membership in specific groups, organizations, or associations and political or social affiliations (for example union vs. non-union employee status) are not legitimate causes for the rejection or non-solicitation of bids in the bidder's efforts to meet the project goal.
  - (6) Making efforts to assist interested DBE companies in obtaining bonding, lines of credit, or insurance as required by the recipient or Contractor.
  - (7) Making efforts to assist interested DBE companies in obtaining necessary equipment, supplies, materials, or related assistance or services.
  - (8) Effectively using the services of available minority/women community organizations; minority/women contractors' groups; local, state, and federal minority/women business assistance offices; and other organizations as allowed on a case-by-case basis to provide assistance in the recruitment and placement of DBE companies.
- (b) If the Department determines that the apparent successful bidder has made a good faith effort to secure the work commitment of DBE companies to meet the contract goal, the Department will award the contract provided that it is otherwise eligible for award. If the Department determines that the bidder has failed to meet the requirements of this Special Provision or that a good faith effort has not been made, the Department will notify the responsible company official designated in the Utilization Plan that the bid is not responsive. The notification shall include a statement of reasons for the determination. If the Utilization Plan is not approved because it is deficient as a technical matter, unless waived by the Department, the bidder will be notified and will be allowed no more than a five calendar day period in order to cure the deficiency.
- (c) The bidder may request administrative reconsideration of a determination adverse to the bidder within the five working days after the receipt of the notification date of the determination by delivering the request to the Department of Transportation, Bureau of Small Business Enterprises, Contract Compliance Section, 2300 South Dirksen Parkway, Room 319, Springfield, Illinois 62764 (Telefax: (217) 785-1524). Deposit of the request in the United States mail on or before the fifth business day shall not be deemed delivery. The determination shall become final if a request is not made and delivered. A request may provide additional written documentation or argument concerning the issues raised in the determination statement of reasons, provided the documentation and arguments address efforts made prior to submitting the bid. The request will be forwarded to the Department's Reconsideration Officer. The Reconsideration Officer will extend an opportunity to the bidder to meet in person in order to consider all issues of documentation and whether the bidder made a good faith effort to meet the goal. After the review by the Reconsideration Officer, the bidder will be sent a written decision within ten working days after receipt of the request for consideration, explaining the basis for finding that the bidder did or did not meet the goal or make adequate good faith efforts to do so. A final decision by the Reconsideration



Officer that a good faith effort was made shall approve the Utilization Plan submitted by the bidder and shall clear the contract for award. A final decision that a good faith effort was not made shall render the bid not responsive.

CALCULATING DBE PARTICIPATION. The Utilization Plan values represent work anticipated to be performed and paid for upon satisfactory completion. The Department is only able to count toward the achievement of the overall goal and the contract goal the value of payments made for the work actually performed by DBE companies. In addition, a DBE must perform a commercially useful function on the contract to be counted. A commercially useful function is generally performed when the DBE is responsible for the work and is carrying out its responsibilities by actually performing, managing, and supervising the work involved. The Department and Contractor are governed by the provisions of 49 CFR Part 26.55(c) on questions of commercially useful functions as it affects the work. Specific counting guidelines are provided in 49 CFR Part 26.55, the provisions of which govern over the summary contained herein.

- (a) DBE as the Contractor: 100 percent goal credit for that portion of the work performed by the DBE's own forces, including the cost of materials and supplies. Work that a DBE subcontracts to a non-DBE does not count toward the DBE goals.
- (b) DBE as a joint venture Contractor: 100 percent goal credit for that portion of the total dollar value of the contract equal to the distinct, clearly defined portion of the work performed by the DBE's own forces.
- (c) DBE as a subcontractor: 100 percent goal credit for the work of the subcontract performed by the DBE's own forces, including the cost of materials and supplies, excluding the purchase of materials and supplies or the lease of equipment by the DBE subcontractor from the prime Contractor or its affiliates. Work that a DBE subcontractor in turn subcontracts to a non-DBE does not count toward the DBE goal.
- (d) DBE as a trucker: 100 percent goal credit for trucking participation provided the DBE is responsible for the management and supervision of the entire trucking operation for which it is responsible. At least one truck owned, operated, licensed, and insured by the DBE must be used on the contract. Credit will be given for the following:
  - (1) The DBE may lease trucks from another DBE firm, including an owner-operator who is certified as a DBE. The DBE who leases trucks from another DBE receives credit for the total value of the transportation services the lessee DBE provides on the contract.
  - (2) The DBE may also lease trucks from a non-DBE firm, including from an owner-operator. The DBE who leases trucks from a non-DBE is entitled to credit only for the fee or commission is receives as a result of the lease arrangement.
- (e) DBE as a material supplier:

- (1) 60 percent goal credit for the cost of the materials or supplies purchased from a DBE regular dealer.
- (2) 100 percent goal credit for the cost of materials of supplies obtained from a DBE manufacturer.
- (3) 100 percent credit for the value of reasonable fees and commissions for the procurement of materials and supplies if not a DBE regular dealer or DBE manufacturer.

CONTRACT COMPLIANCE. Compliance with this Special Provision is an essential part of the contract. The Department is prohibited by federal regulations from crediting the participation of a DBE included in the Utilization Plan toward either the contract goal or the Department's overall goal until the amount to be applied toward the goals has been paid to the DBE. The following administrative procedures and remedies govern the compliance by the Contractor with the contractual obligations established by the Utilization Plan. After approval of the Utilization Plan and award of the contract, the Utilization Plan and individual DBE Participation Statements become part of the contract. If the Contractor did not succeed in obtaining enough DBE participation to achieve the advertised contract goal, and the Utilization Plan was approved and contract awarded based upon a determination of good faith, the total dollar value of DBE work calculated in the approved Utilization Plan as a percentage of the awarded contract value shall become the amended contract goal. All work indicated for performance by an approved DBE shall be performed, managed, and supervised by the DBE executing the DBE Participation Commitment Statement.

- (a) NO AMENDMENT. No amendment to the Utilization Plan may be made without prior written approval from the Department's Bureau of Small Business Enterprises. All requests for amendment to the Utilization Plan shall be submitted to the Department of Transportation, Bureau of Small Business Enterprises, Contract Compliance Section, 2300 South Dirksen Parkway, Room 319, Springfield, Illinois 62764. Telephone number (217) 785-4611. Telefax number (217) 785-1524.
- (b) CHANGES TO WORK. Any deviation from the DBE condition-of-award or contract plans, specifications, or special provisions must be approved, in writing, by the Department as provided elsewhere in the Contract. The Contractor shall notify affected DBEs in writing of any changes in the scope of work which result in a reduction in the dollar amount condition-of-award to the contract. Where the revision includes work committed to a new DBE subcontractor, not previously involved in the project, then a Request for Approval of Subcontractor, Department form BC 260A or AER 260A, must be signed and submitted. If the commitment of work is in the form of additional tasks assigned to an existing subcontract, then a new Request for Approval of Subcontractor shall not be required. However, the Contractor must document efforts to assure that the existing DBE subcontractor is capable of performing the additional work and has agreed in writing to the change.

- (c) SUBCONTRACT. The Contractor must provide DBE subcontracts to IDOT upon request. Subcontractors shall ensure that all lower tier subcontracts or agreements with DBEs to supply labor or materials be performed in accordance with this Special Provision.
- (d) ALTERNATIVE WORK METHODS. In addition to the above requirements for reductions in the condition of award, additional requirements apply to the two cases of Contractor-initiated work substitution proposals. Where the contract allows alternate work methods which serve to delete or create underruns in condition of award DBE work, and the Contractor selects that alternate method or, where the Contractor proposes a substitute work method or material that serves to diminish or delete work committed to a DBE and replace it with other work, then the Contractor must demonstrate one of the following:
- (1) That the replacement work will be performed by the same DBE (as long as the DBE is certified in the respective item of work) in a modification of the condition of award; or
  - (2) That the DBE is aware that its work will be deleted or will experience underruns and has agreed in writing to the change. If this occurs, the Contractor shall substitute other work of equivalent value to a certified DBE or provide documentation of good faith efforts to do so; or
  - (3) That the DBE is not capable of performing the replacement work or has declined to perform the work at a reasonable competitive price. If this occurs, the Contractor shall substitute other work of equivalent value to a certified DBE or provide documentation of good faith efforts to do so.
- (e) TERMINATION AND REPLACEMENT PROCEDURES. The Contractor shall not terminate or replace a DBE listed on the approved Utilization Plan, or perform with other forces work designated for a listed DBE except as provided in this Special Provision. The Contractor shall utilize the specific DBEs listed to perform the work and supply the materials for which each is listed unless the Contractor obtains the Department's written consent as provided in subsection (a) of this part. Unless Department consent is provided for termination of a DBE subcontractor, the Contractor shall not be entitled to any payment for work or material unless it is performed or supplied by the DBE in the Utilization Plan.

As stated above, the Contractor shall not terminate or replace a DBE subcontractor listed in the approved Utilization Plan without prior written consent. This includes, but is not limited to, instances in which the Contractor seeks to perform work originally designated for a DBE subcontractor with its own forces or those of an affiliate, a non-DBE firm, or with another DBE firm. Written consent will be granted only if the Bureau of Small Business Enterprises agrees, for reasons stated in its concurrence document, that the Contractor has good cause to terminate or replace the DBE firm. Before transmitting to the Bureau of Small Business Enterprises any request to terminate and/or substitute a DBE subcontractor, the Contractor shall give notice in writing to the DBE subcontractor,

with a copy to the Bureau, of its intent to request to terminate and/or substitute, and the reason for the request. The Contractor shall give the DBE five days to respond to the Contractor's notice. The DBE so notified shall advise the Bureau and the Contractor of the reasons, if any, why it objects to the proposed termination of its subcontract and why the Bureau should not approve the Contractor's action. If required in a particular case as a matter of public necessity, the Bureau may provide a response period shorter than five days.

For purposes of this paragraph, good cause includes the following circumstances:

- (1) The listed DBE subcontractor fails or refuses to execute a written contract;
- (2) The listed DBE subcontractor fails or refuses to perform the work of its subcontract in a way consistent with normal industry standards. Provided, however, that good cause does not exist if the failure or refusal of the DBE subcontractor to perform its work on the subcontract results from the bad faith or discriminatory action of the prime contractor;
- (3) The listed DBE subcontractor fails or refuses to meet the prime Contractor's reasonable, nondiscriminatory bond requirements;
- (4) The listed DBE subcontractor becomes bankrupt, insolvent, or exhibits credit unworthiness;
- (5) The listed DBE subcontractor is ineligible to work on public works projects because of suspension and debarment proceedings pursuant 2 CFR Parts 180, 215 and 1200 or applicable state law.
- (6) You have determined that the listed DBE subcontractor is not a responsible contractor;
- (7) The listed DBE subcontractor voluntarily withdraws from the projects and provides to you written notice of its withdrawal;
- (8) The listed DBE is ineligible to receive DBE credit for the type of work required;
- (9) A DBE owner dies or becomes disabled with the result that the listed DBE contractor is unable to complete its work on the contract;
- (10) Other documented good cause that compels the termination of the DBE subcontractor. Provided, that good cause does not exist if the prime Contractor seeks to terminate a DBE it relied upon to obtain the contract so that the prime Contractor can self-perform the work for which the DBE contractor was engaged or so that the prime Contractor can substitute another DBE or non-DBE contractor after contract award.

When a DBE is terminated, or fails to complete its work on the Contract for any reason the Contractor shall make a good faith effort to find another DBE to substitute for the original DBE to perform at least the same amount of work under the contract as the terminated DBE to the extent needed to meet the established Contract goal. The good faith efforts shall be documented by the Contractor. If the Department requests documentation under this provision, the Contractor shall submit the documentation within seven days, which may be extended for an additional seven days if necessary at the request of the Contractor. The Department shall provide a written determination to the Contractor stating whether or not good faith efforts have been demonstrated.

- (f) PAYMENT RECORDS. The Contractor shall maintain a record of payments for work performed to the DBE participants. The records shall be made available to the Department for inspection upon request. After the performance of the final item of work or delivery of material by a DBE and final payment therefore to the DBE by the Contractor, but not later than thirty calendar days after payment has been made by the Department to the Contractor for such work or material, the Contractor shall submit a DBE Payment Agreement on Department form SBE 2115 to the Resident Engineer. If full and final payment has not been made to the DBE, the DBE Payment Agreement shall indicate whether a disagreement as to the payment required exists between the Contractor and the DBE or if the Contractor believes that the work has not been satisfactorily completed. If the Contractor does not have the full amount of work indicated in the Utilization Plan performed by the DBE companies indicated in the Utilization Plan and after good faith efforts are reviewed, the Department may deduct from contract payments to the Contractor the amount of the goal not achieved as liquidated and ascertained damages. The Contractor may request an administrative reconsideration of any amount deducted as damages pursuant to subsection (h) of this part.
- (g) ENFORCEMENT. The Department reserves the right to withhold payment to the Contractor to enforce the provisions of this Special Provision. Final payment shall not be made on the contract until such time as the Contractor submits sufficient documentation demonstrating achievement of the goal in accordance with this Special Provision or after liquidated damages have been determined and collected.
- (h) RECONSIDERATION. Notwithstanding any other provision of the contract, including but not limited to Article 109.09 of the Standard Specifications, the Contractor may request administrative reconsideration of a decision to deduct the amount of the goal not achieved as liquidated damages. A request to reconsider shall be delivered to the Contract Compliance Section and shall be handled and considered in the same manner as set forth in paragraph (c) of "Good Faith Effort Procedures" of this Special Provision, except a final decision that a good faith effort was not made during contract performance to achieve the goal agreed to in the Utilization Plan shall be the final administrative decision of the Department. The result of the reconsideration process is not administratively appealable to the U.S. Department of Transportation.

## HOT-MIX ASPHALT - DENSITY TESTING OF LONGITUDINAL JOINTS (BDE)

Effective: January 1, 2010

Revised: April 1, 2016

Description. This work shall consist of testing the density of longitudinal joints as part of the quality control/quality assurance (QC/QA) of hot-mix asphalt (HMA). Work shall be according to Section 1030 of the Standard Specifications except as follows.

Quality Control/Quality Assurance (QC/QA). Delete the second and third sentence of the third paragraph of Article 1030.05(d)(3) of the Standard Specifications.

Add the following paragraphs to the end of Article 1030.05(d)(3) of the Standard Specifications:

“Longitudinal joint density testing shall be performed at each random density test location. Longitudinal joint testing shall be located at a distance equal to the lift thickness or a minimum of 4 in. (100 mm), from each pavement edge. (i.e. for a 5 in. (125 mm) lift the near edge of the density gauge or core barrel shall be within 5 in. (125 mm) from the edge of pavement.) Longitudinal joint density testing shall be performed using either a correlated nuclear gauge or cores.

- a. Confined Edge. Each confined edge density shall be represented by a one-minute nuclear density reading or a core density and shall be included in the average of density readings or core densities taken across the mat which represents the Individual Test.
- b. Unconfined Edge. Each unconfined edge joint density shall be represented by an average of three one-minute density readings or a single core density at the given density test location and shall meet the density requirements specified herein. The three one-minute readings shall be spaced 10 ft (3 m) apart longitudinally along the unconfined pavement edge and centered at the random density test location.”

Revise the Density Control Limits table in Article 1030.05(d)(4) of the Standard Specifications to read:

"Mixture Composition	Parameter	Individual Test (includes confined edges)	Unconfined Edge Joint Density Minimum
IL-4.75	N <sub>design</sub> = 50	93.0 – 97.4% <sup>1/</sup>	91.0%
IL-9.5	N <sub>design</sub> = 90	92.0 – 96.0%	90.0%
IL-9.5, IL-9.5L	N <sub>design</sub> < 90	92.5 – 97.4%	90.0%
IL-19.0	N <sub>design</sub> = 90	93.0 – 96.0%	90.0%
IL-19.0, IL-19.0L	N <sub>design</sub> < 90	93.0 <sup>2/</sup> – 97.4%	90.0%
SMA	N <sub>design</sub> = 50 & 80	93.5 – 97.4%	91.0%”

80246

**HOT-MIX ASPHALT – TACK COAT (BDE)**

Effective: November 1, 2016

Revise Article 1032.06(a) of the Standard Specifications to read:

“(a) Anionic Emulsified Asphalt. Anionic emulsified asphalts shall be according to AASHTO M 140. SS-1h emulsions used as a tack coat shall have the cement mixing test waived.”

80376

## **PROGRESS PAYMENTS (BDE)**

Effective: November 2, 2013

Revise Article 109.07(a) of the Standard Specifications to read:

- “(a) Progress Payments. At least once each month, the Engineer will make a written estimate of the quantity of work performed in accordance with the contract, and the value thereof at the contract unit prices. The amount of the estimate approved as due for payment will be vouchered by the Department and presented to the State Comptroller for payment. No amount less than \$1000.00 will be approved for payment other than the final payment.

Progress payments may be reduced by liens filed pursuant to Section 23(c) of the Mechanics' Lien Act, 770 ILCS 60/23(c).

If a Contractor or subcontractor has defaulted on a loan issued under the Department's Disadvantaged Business Revolving Loan Program (20 ILCS 2705/2705-610), progress payments may be reduced pursuant to the terms of that loan agreement. In such cases, the amount of the estimate related to the work performed by the Contractor or subcontractor, in default of the loan agreement, will be offset, in whole or in part, and vouchered by the Department to the Working Capital Revolving Fund or designated escrow account. Payment for the work shall be considered as issued and received by the Contractor or subcontractor on the date of the offset voucher. Further, the amount of the offset voucher shall be a credit against the Department's obligation to pay the Contractor, the Contractor's obligation to pay the subcontractor, and the Contractor's or subcontractor's total loan indebtedness to the Department. The offset shall continue until such time as the entire loan indebtedness is satisfied. The Department will notify the Contractor and Fund Control Agent in a timely manner of such offset. The Contractor or subcontractor shall not be entitled to additional payment in consideration of the offset.

The failure to perform any requirement, obligation, or term of the contract by the Contractor shall be reason for withholding any progress payments until the Department determines that compliance has been achieved.”

80328



## RECLAIMED ASPHALT PAVEMENT AND RECLAIMED ASPHALT SHINGLES (BDE)

Effective: November 1, 2012

Revise: April 1, 2016

Revise Section 1031 of the Standard Specifications to read:

### "SECTION 1031. RECLAIMED ASPHALT PAVEMENT AND RECLAIMED ASPHALT SHINGLES

**1031.01 Description.** Reclaimed asphalt pavement and reclaimed asphalt shingles shall be according to the following.

- (a) Reclaimed Asphalt Pavement (RAP). RAP is the material produced by cold milling or crushing an existing hot-mix asphalt (HMA) pavement. The Contractor shall supply written documentation that the RAP originated from routes or airfields under federal, state, or local agency jurisdiction.
- (b) Reclaimed Asphalt Shingles (RAS). Reclaimed asphalt shingles (RAS). RAS is from the processing and grinding of preconsumer or post-consumer shingles. RAS shall be a clean and uniform material with a maximum of 0.5 percent unacceptable material, as defined in Bureau of Materials and Physical Research Policy Memorandum, "Reclaimed Asphalt Shingle (RAS) Sources", by weight of RAS. All RAS used shall come from a Bureau of Materials and Physical Research approved processing facility where it shall be ground and processed to 100 percent passing the 3/8 in. (9.5 mm) sieve and 93 percent passing the #4 (4.75 mm) sieve based on a dry shake gradation. RAS shall be uniform in gradation and asphalt binder content and shall meet the testing requirements specified herein. In addition, RAS shall meet the following Type 1 or Type 2 requirements.
  - (1) Type 1. Type 1 RAS shall be processed, preconsumer asphalt shingles salvaged from the manufacture of residential asphalt roofing shingles.
  - (2) Type 2. Type 2 RAS shall be processed post-consumer shingles only, salvaged from residential, or four unit or less dwellings not subject to the National Emission Standards for Hazardous Air Pollutants (NESHAP).

**1031.02 Stockpiles.** RAP and RAS stockpiles shall be according to the following.

- (a) RAP Stockpiles. The Contractor shall construct individual, sealed RAP stockpiles meeting one of the following definitions. No additional RAP shall be added to the pile after the pile has been sealed. Stockpiles shall be sufficiently separated to prevent intermingling at the base. Stockpiles shall be identified by signs indicating the type as listed below (i.e. "Homogeneous Surface").

Prior to milling, the Contractor shall request the District provide documentation on the quality of the RAP to clarify the appropriate stockpile.

- (1) Fractionated RAP (FRAP). FRAP shall consist of RAP from Class I, HMA (High and Low ESAL) mixtures. The coarse aggregate in FRAP shall be crushed aggregate and may represent more than one aggregate type and/or quality, but shall be at least C quality. All FRAP shall be fractionated prior to testing by screening into a minimum of two size fractions with the separation occurring on or between the #4 (4.75 mm) and 1/2 in. (12.5 mm) sieves. Agglomerations shall be minimized such that 100 percent of the RAP shall pass the sieve size specified below for the mix into which the FRAP will be incorporated.

Mixture FRAP will be used in:	Sieve Size that 100 % of FRAP Shall Pass
IL-19.0	1 1/2 in. (40 mm)
IL-9.5	3/4 in. (20 mm)
IL-4.75	1/2 in. (13 mm)

- (2) Homogeneous. Homogeneous RAP stockpiles shall consist of RAP from Class I, HMA (High and Low ESAL) mixtures and represent: 1) the same aggregate quality, but shall be at least C quality; 2) the same type of crushed aggregate (either crushed natural aggregate, ACBF slag, or steel slag); 3) similar gradation; and 4) similar asphalt binder content. If approved by the Engineer, combined single pass surface/binder millings may be considered "homogeneous" with a quality rating dictated by the lowest coarse aggregate quality present in the mixture.
- (3) Conglomerate. Conglomerate RAP stockpiles shall consist of RAP from Class I, HMA (High and Low ESAL) mixtures. The coarse aggregate in this RAP shall be crushed aggregate and may represent more than one aggregate type and/or quality, but shall be at least C quality. This RAP may have an inconsistent gradation and/or asphalt binder content prior to processing. All conglomerate RAP shall be processed prior to testing by crushing to where all RAP shall pass the 5/8 in. (16 mm) or smaller screen. Conglomerate RAP stockpiles shall not contain steel slag.
- (4) Non-Quality. RAP stockpiles that do not meet the requirements of the stockpile categories listed above shall be classified as "Non-Quality".

RAP/FRAP containing contaminants, such as earth, brick, sand, concrete, sheet asphalt, bituminous surface treatment (i.e. chip seal), pavement fabric, joint sealants, etc., will be unacceptable unless the contaminants are removed to the satisfaction of the Engineer. Sheet asphalt shall be stockpiled separately.

- (b) RAS Stockpiles. Type 1 and Type 2 RAS shall be stockpiled separately and shall not be intermingled. Each stockpile shall be signed indicating what type of RAS is present.

Unless otherwise specified by the Engineer, mechanically blending manufactured sand (FM 20 or FM 22) up to an equal weight of RAS with the processed RAS will be permitted to improve workability. The sand shall be "B Quality" or better from an approved Aggregate Gradation Control System source. The sand shall be accounted for in the mix design and during HMA production.

Records identifying the shingle processing facility supplying the RAS, RAS type, and lot number shall be maintained by project contract number and kept for a minimum of three years.

**1031.03 Testing.** RAP/FRAP and RAS testing shall be according to the following.

(a) RAP/FRAP Testing. When used in HMA, the RAP/FRAP shall be sampled and tested either during or after stockpiling.

(1) During Stockpiling. For testing during stockpiling, washed extraction samples shall be run at the minimum frequency of one sample per 500 tons (450 metric tons) for the first 2000 tons (1800 metric tons) and one sample per 2000 tons (1800 metric tons) thereafter. A minimum of five tests shall be required for stockpiles less than 4000 tons (3600 metric tons).

(2) After Stockpiling. For testing after stockpiling, the Contractor shall submit a plan for approval to the District proposing a satisfactory method of sampling and testing the RAP/FRAP pile either in-situ or by restockpiling. The sampling plan shall meet the minimum frequency required above and detail the procedure used to obtain representative samples throughout the pile for testing.

Each sample shall be split to obtain two equal samples of test sample size. One of the two test samples from the final split shall be labeled and stored for Department use. The Contractor shall extract the other test sample according to Department procedure. The Engineer reserves the right to test any sample (split or Department-taken) to verify Contractor test results.

(b) RAS Testing. RAS or RAS blended with manufactured sand shall be sampled and tested during stockpiling according to Bureau of Materials and Physical Research Policy Memorandum, "Reclaimed Asphalt Shingle (RAS) Source".

Samples shall be collected during stockpiling at the minimum frequency of one sample per 200 tons (180 metric tons) for the first 1000 tons (900 metric tons) and one sample per 250 tons (225 metric tons) thereafter. A minimum of five samples are required for stockpiles less than 1000 tons (900 metric tons). Once a  $\leq 1000$  ton (900 metric ton), five-sample/test stockpile has been established it shall be sealed. Additional incoming RAS or RAS blended with manufactured sand shall be stockpiled in a separate working pile as designated in the Quality Control plan and only added to the sealed stockpile when the test results of the working pile are complete and are found to meet the tolerances specified herein for the original sealed RAS stockpile.

Before testing, each sample shall be split to obtain two test samples. One of the two test samples from the final split shall be labeled and stored for Department use. The Contractor shall perform a washed extraction and test for unacceptable materials on the other test sample according to Department procedures. The Engineer reserves the right to test any sample (split or Department-taken) to verify Contractor test results.

If the sampling and testing was performed at the shingle processing facility in accordance with the QC Plan, the Contractor shall obtain and make available all of the test results from start of the initial stockpile.

**1031.04 Evaluation of Tests.** Evaluation of test results shall be according to the following.

- (a) Evaluation of RAP/FRAP Test Results. All of the extraction results shall be compiled and averaged for asphalt binder content and gradation, and when applicable  $G_{mm}$ . Individual extraction test results, when compared to the averages, will be accepted if within the tolerances listed below.

Parameter	FRAP/Homogeneous/ Conglomerate
1 in. (25 mm)	
1/2 in. (12.5 mm)	± 8 %
No. 4 (4.75 mm)	± 6 %
No. 8 (2.36 mm)	± 5 %
No. 16 (1.18 mm)	
No. 30 (600 μm)	± 5 %
No. 200 (75 μm)	± 2.0 %
Asphalt Binder	± 0.4 % <sup>1/</sup>
$G_{mm}$	± 0.03

1/ The tolerance for FRAP shall be ± 0.3 %.

If more than 20 percent of the individual sieves and/or asphalt binder content tests are out of the above tolerances, the RAP/FRAP shall not be used in HMA unless the RAP/FRAP representing the failing tests is removed from the stockpile. All test data and acceptance ranges shall be sent to the District for evaluation.

With the approval of the Engineer, the ignition oven may be substituted for extractions according to the ITP, "Calibration of the Ignition Oven for the Purpose of Characterizing Reclaimed Asphalt Pavement (RAP)".

- (b) Evaluation of RAS and RAS Blended with Manufactured Sand Test Results. All of the test results, with the exception of percent unacceptable materials, shall be compiled and averaged for asphalt binder content and gradation. Individual test results, when compared to the averages, will be accepted if within the tolerances listed below.

Parameter	RAS
No. 8 (2.36 mm)	± 5 %
No. 16 (1.18 mm)	± 5 %
No. 30 (600 µm)	± 4 %
No. 200 (75 µm)	± 2.0 %
Asphalt Binder Content	± 1.5 %

If more than 20 percent of the individual sieves and/or asphalt binder content tests are out of the above tolerances, or if the percent unacceptable material exceeds 0.5 percent by weight of material retained on the # 4 (4.75 mm) sieve, the RAS or RAS blend shall not be used in Department projects. All test data and acceptance ranges shall be sent to the District for evaluation.

**1031.05 Quality Designation of Aggregate in RAP/FRAP.**

(a) RAP. The aggregate quality of the RAP for homogeneous and conglomerate stockpiles shall be set by the lowest quality of coarse aggregate in the RAP stockpile and are designated as follows.

(1) RAP from Class I, Superpave/HMA (High ESAL), or (Low ESAL) IL-9.5L surface mixtures are designated as containing Class B quality coarse aggregate.

(2) RAP from Class I binder, Superpave/HMA (High ESAL) binder, or (Low ESAL) IL-19.0L binder mixtures are designated as containing Class C quality coarse aggregate.

(b) FRAP. If the Engineer has documentation of the quality of the FRAP aggregate, the Contractor shall use the assigned quality provided by the Engineer.

If the quality is not known, the quality shall be determined as follows. Coarse and fine FRAP stockpiles containing plus #4 (4.75 mm) sieve coarse aggregate shall have a maximum tonnage of 5000 tons (4500 metric tons). The Contractor shall obtain a representative sample witnessed by the Engineer. The sample shall be a minimum of 50 lb (25 kg). The sample shall be extracted according to Illinois Modified AASHTO T 164 by a consultant laboratory prequalified by the Department for the specified testing. The consultant laboratory shall submit the test results along with the recovered aggregate to the District Office. The cost for this testing shall be paid by the Contractor. The District will forward the sample to the Bureau of Materials and Physical Research Aggregate Lab for MicroDeval Testing, according to ITP 327. A maximum loss of 15.0 percent will be applied for all HMA applications.

**1031.06 Use of RAP/FRAP and/or RAS in HMA.** The use of RAP/FRAP and/or RAS shall be the Contractor's option when constructing HMA in all contracts.

(a) RAP/FRAP. The use of RAP/FRAP in HMA shall be as follows.

- (1) Coarse Aggregate Size. The coarse aggregate in all RAP shall be equal to or less than the nominal maximum size requirement for the HMA mixture to be produced.
  - (2) Steel Slag Stockpiles. Homogeneous RAP stockpiles containing steel slag will be approved for use in all HMA (High ESAL and Low ESAL) Surface and Binder Mixture applications.
  - (3) Use in HMA Surface Mixtures (High and Low ESAL). RAP/FRAP stockpiles for use in HMA surface mixtures (High and Low ESAL) shall be FRAP or homogeneous in which the coarse aggregate is Class B quality or better. RAP/FRAP from Conglomerate stockpiles shall be considered equivalent to limestone for frictional considerations. Known frictional contributions from plus #4 (4.75 mm) homogeneous RAP and FRAP stockpiles will be accounted for in meeting frictional requirements in the specified mixture.
  - (4) Use in HMA Binder Mixtures (High and Low ESAL), HMA Base Course, and HMA Base Course Widening. RAP/FRAP stockpiles for use in HMA binder mixtures (High and Low ESAL), HMA base course, and HMA base course widening shall be FRAP, homogeneous, or conglomerate, in which the coarse aggregate is Class C quality or better.
  - (5) Use in Shoulders and Subbase. RAP/FRAP stockpiles for use in HMA shoulders and stabilized subbase (HMA) shall be FRAP, homogeneous, or conglomerate.
  - (6) When the Contractor chooses the RAP option, the percentage of RAP shall not exceed the amounts indicated in Article 1031.06(c)(1) below for a given Ndesign.
- (b) RAS. RAS meeting Type 1 or Type 2 requirements will be permitted in all HMA applications as specified herein.
- (c) RAP/FRAP and/or RAS Usage Limits. Type 1 or Type 2 RAS may be used alone or in conjunction with RAP or FRAP in HMA mixtures up to a maximum of 5.0 percent by weight of the total mix.
- (1) RAP/RAS. When RAP is used alone or RAP is used in conjunction with RAS, the percentage of virgin asphalt binder replacement shall not exceed the amounts listed in the Max RAP/RAS ABR table listed below for the given Ndesign.

**RAP/RAS Maximum Asphalt Binder Replacement (ABR) Percentage**

HMA Mixtures <i>1, 2</i>	RAP/RAS Maximum ABR %		
	Binder/Leveling Binder	Surface	Polymer Modified
Ndesign			
30	30	30	10

50	25	15	10
70	15	10	10
90	10	10	10

- 1/ For Low ESAL HMA shoulder and stabilized subbase, the RAP/RAS ABR shall not exceed 50 percent of the mixture.
  - 2/ When RAP/RAS ABR exceeds 20 percent, the high and low virgin asphalt binder grades shall each be reduced by one grade (i.e. 25 percent ABR would require a virgin asphalt binder grade of PG 64-22 to be reduced to a PG 58-28). If warm mix asphalt (WMA) technology is utilized and production temperatures do not exceed 275 °F (135 °C), the high and low virgin asphalt binder grades shall each be reduced by one grade when RAP/RAS ABR exceeds 25 percent (i.e. 26 percent RAP/RAS ABR would require a virgin asphalt binder grade of PG 64-22 to be reduced to a PG 58-28).
- (2) FRAP/RAS. When FRAP is used alone or FRAP is used in conjunction with RAS, the percentage of virgin asphalt binder replacement shall not exceed the amounts listed in the FRAP/RAS table listed below for the given Ndesign.

**FRAP/RAS Maximum Asphalt Binder Replacement (ABR) Percentage**

HMA Mixtures <i>1, 2/</i>	FRAP/RAS Maximum ABR %		
	Ndesign	Binder/Leveling Binder	Surface
30	50	40	10
50	40	35	10
70	40	30	10
90	40	30	10

- 1/ For Low ESAL HMA shoulder and stabilized subbase, the FRAP/RAS ABR shall not exceed 50 percent of the mixture.
- 2/ When FRAP/RAS ABR exceeds 20 percent for all mixes, the high and low virgin asphalt binder grades shall each be reduced by one grade (i.e. 25 percent ABR would require a virgin asphalt binder grade of PG 64-22 to be reduced to a PG 58-28). If warm mix asphalt (WMA) technology is utilized and production temperatures do not exceed 275 °F (135 °C), the high and low virgin asphalt binder grades shall each be reduced by one grade when FRAP/RAS ABR exceeds 25 percent (i.e. 26 percent ABR would require a virgin asphalt binder grade of PG 64-22 to be reduced to a PG 58-28).
- 3/ For SMA the FRAP/RAS ABR shall not exceed 20 percent.

4/ For IL-4.75 mix the FRAP/RAS ABR shall not exceed 30 percent.

**1031.07 HMA Mix Designs.** At the Contractor's option, HMA mixtures may be constructed utilizing RAP/FRAP and/or RAS material meeting the detailed requirements specified herein.

- (a) RAP/FRAP and/or RAS. RAP/FRAP and/or RAS mix designs shall be submitted for verification. If additional RAP/FRAP and/or RAS stockpiles are tested and found that no more than 20 percent of the results, as defined under "Testing" herein, are outside of the control tolerances set for the original RAP/FRAP and/or RAS stockpile and HMA mix design, and meets all of the requirements herein, the additional RAP/FRAP and/or RAS stockpiles may be used in the original mix design at the percent previously verified.
- (b) RAS. Type 1 and Type 2 RAS are not interchangeable in a mix design. A RAS stone bulk specific gravity ( $G_{sb}$ ) of 2.300 shall be used for mix design purposes.

**1031.08 HMA Production.** HMA production utilizing RAP/FRAP and/or RAS shall be as follows.

- (a) RAP/FRAP. The coarse aggregate in all RAP/FRAP used shall be equal to or less than the nominal maximum size requirement for the HMA mixture being produced.

To remove or reduce agglomerated material, a scalping screen, gator, crushing unit, or comparable sizing device approved by the Engineer shall be used in the RAP feed system to remove or reduce oversized material. If material passing the sizing device adversely affects the mix production or quality of the mix, the sizing device shall be set at a size specified by the Engineer.

If the RAP/FRAP control tolerances or QC/QA test results require corrective action, the Contractor shall cease production of the mixture containing RAP/FRAP and either switch to the virgin aggregate design or submit a new RAP/FRAP design.

- (b) RAS. RAS shall be incorporated into the HMA mixture either by a separate weight depletion system or by using the RAP weigh belt. Either feed system shall be interlocked with the aggregate feed or weigh system to maintain correct proportions for all rates of production and batch sizes. The portion of RAS shall be controlled accurately to within  $\pm 0.5$  percent of the amount of RAS utilized. When using the weight depletion system, flow indicators or sensing devices shall be provided and interlocked with the plant controls such that the mixture production is halted when RAS flow is interrupted.
- (c) RAP/FRAP and/or RAS. HMA plants utilizing RAP/FRAP and/or RAS shall be capable of automatically recording and printing the following information.

(1) Dryer Drum Plants.

- a. Date, month, year, and time to the nearest minute for each print.



- b. HMA mix number assigned by the Department.
- c. Accumulated weight of dry aggregate (combined or individual) in tons (metric tons) to the nearest 0.1 ton (0.1 metric ton).
- d. Accumulated dry weight of RAP/FRAP/RAS in tons (metric tons) to the nearest 0.1 ton (0.1 metric ton).
- e. Accumulated mineral filler in revolutions, tons (metric tons), etc. to the nearest 0.1 unit.
- f. Accumulated asphalt binder in gallons (liters), tons (metric tons), etc. to the nearest 0.1 unit.
- g. Residual asphalt binder in the RAP/FRAP material as a percent of the total mix to the nearest 0.1 percent.
- h. Aggregate and RAP/FRAP moisture compensators in percent as set on the control panel. (Required when accumulated or individual aggregate and RAP/FRAP are printed in wet condition.)

(2) Batch Plants.

- a. Date, month, year, and time to the nearest minute for each print.
- b. HMA mix number assigned by the Department.
- c. Individual virgin aggregate hot bin batch weights to the nearest pound (kilogram).
- d. Mineral filler weight to the nearest pound (kilogram).
- e. RAP/FRAP/RAS weight to the nearest pound (kilogram).
- f. Virgin asphalt binder weight to the nearest pound (kilogram).
- g. Residual asphalt binder in the RAP/FRAP/RAS material as a percent of the total mix to the nearest 0.1 percent.

The printouts shall be maintained in a file at the plant for a minimum of one year or as directed by the Engineer and shall be made available upon request. The printing system will be inspected by the Engineer prior to production and verified at the beginning of each construction season thereafter.

| **1031.09 RAP in Aggregate Surface Course and Aggregate Wedge Shoulders, Type B.**  
The use of RAP in aggregate surface course (temporary access entrances only) and aggregate wedge shoulders, Type B shall be as follows.

| (a) Stockpiles and Testing. RAP stockpiles may be any of those listed in Article 1031.02, except "Non-Quality" and "FRAP". The testing requirements of Article 1031.03 shall not apply. RAP used shall be according to the current Bureau of Materials and Physical Research Policy Memorandum, "Reclaimed Asphalt Pavement (RAP) for Aggregate Applications".

(b) Gradation. One hundred percent of the RAP material shall pass the 1 1/2 in. (37.5 mm) sieve. The RAP material shall be reasonably well graded from coarse to fine. RAP material that is gap-graded or single sized will not be accepted."

80306

## WARM MIX ASPHALT (BDE)

Effective: January 1, 2012

Revised: April 1, 2016

Description. This work shall consist of designing, producing and constructing Warm Mix Asphalt (WMA) in lieu of Hot Mix Asphalt (HMA) at the Contractor's option. Work shall be according to Sections 406, 407, 408, 1030, and 1102 of the Standard Specifications, except as modified herein. In addition, any references to HMA in the Standard Specifications, or the special provisions shall be construed to include WMA.

WMA is an asphalt mixture which can be produced at temperatures lower than allowed for HMA utilizing approved WMA technologies. WMA technologies are defined as the use of additives or processes which allow a reduction in the temperatures at which HMA mixes are produced and placed. WMA is produced by the use of additives, a water foaming process, or combination of both. Additives include minerals, chemicals or organics incorporated into the asphalt binder stream in a dedicated delivery system. The process of foaming injects water into the asphalt binder stream, just prior to incorporation of the asphalt binder with the aggregate.

Approved WMA technologies may also be used in HMA provided all the requirements specified herein, with the exception of temperature, are met. However, asphalt mixtures produced at temperatures in excess of 275 °F (135 °C) will not be considered WMA when determining the grade reduction of the virgin asphalt binder grade.

### Equipment.

Revise the first paragraph of Article 1102.01 of the Standard Specifications to read:

**"1102.01 Hot-Mix Asphalt Plant.** The hot-mix asphalt (HMA) plant shall be the batch-type, continuous-type, or dryer drum plant. The plants shall be evaluated for prequalification rating and approval to produce HMA according to the current Bureau of Materials and Physical Research Policy Memorandum, "Approval of Hot-Mix Asphalt Plants and Equipment". Once approved, the Contractor shall notify the Bureau of Materials and Physical Research to obtain approval of all plant modifications. The plants shall not be used to produce mixtures concurrently for more than one project or for private work unless permission is granted in writing by the Engineer. The plant units shall be so designed, coordinated and operated that they will function properly and produce HMA having uniform temperatures and compositions within the tolerances specified. The plant units shall meet the following requirements."

Add the following to Article 1102.01(a) of the Standard Specifications.

"(11) Equipment for Warm Mix Technologies.

- a. Foaming. Metering equipment for foamed asphalt shall have an accuracy of  $\pm 2$  percent of the actual water metered. The foaming control system shall be electronically interfaced with the asphalt binder meter.

- b. Additives. Additives shall be introduced into the plant according to the supplier's recommendations and shall be approved by the Engineer. The system for introducing the WMA additive shall be interlocked with the aggregate feed or weigh system to maintain correct proportions for all rates of production and batch sizes."

Mix Design Verification.

Add the following to Article 1030.04 of the Standard Specifications.

"(e) Warm Mix Technologies.

- (1) Foaming. WMA mix design verification will not be required when foaming technology is used alone (without WMA additives). However, the foaming technology shall only be used on HMA designs previously approved by the Department.
- (2) Additives. WMA mix designs utilizing additives shall be submitted to the Engineer for mix design verification."

Construction Requirements.

Revise the second paragraph of Article 406.06(b)(1) of the Standard Specifications to read:

"The HMA shall be delivered at a temperature of 250 to 350 °F (120 to 175 °C).  
WMA shall be delivered at a minimum temperature of 215 °F (102 °C)."

Basis of Payment.

This work will be paid at the contract unit price bid for the HMA pay items involved. Anti-strip will not be paid for separately, but shall be considered as included in the cost of the work.

80288

## WEEKLY DBE TRUCKING REPORTS (BDE)

Effective: June 2, 2012

| Revised: April 2, 2015

| The Contractor shall submit a weekly report of Disadvantaged Business Enterprise (DBE) trucks hired by the Contractor or subcontractors (i.e. not owned by the Contractor or subcontractors) that are used for DBE goal credit.

| The report shall be submitted to the Engineer on Department form "SBE 723" within ten business days following the reporting period. The reporting period shall be Monday through Sunday for each week reportable trucking activities occur.

Any costs associated with providing weekly DBE trucking reports shall be considered as included in the contract unit prices bid for the various items of work involved and no additional compensation will be allowed.

80302

**WORKING DAYS (BDE)**

Effective: January 1, 2002

The Contractor shall complete the work within *45* working days.

80071

STATE OF ILLINOIS  
DEPARTMENT OF TRANSPORTATION  
**PLANS FOR**  
**PROPOSED LOCAL AGENCY IMPROVEMENT**  
**FEDERAL - AID SECONDARY PROJECT**

FAS 188 & 1181- (Harmon Rd, Sterling Rd, Walton Rd)

SECTION 13-00325-00-RS

LEE COUNTY

PROJECT RS-0103 (141)

JOB NO. C-92-060-16

NET LENGTH 6.67 MILES

CONSTRUCTION TYPE CODE ---0005

**SUMMARY OF QUANTITIES**

<u>INDEX OF SHEETS</u>	<u>CODE NO.</u>	<u>QUANTITY</u>	<u>UNIT</u>	<u>DESCRIPTION</u>
Cover Sheet	1	40600290	57,507	LB BIT MATLS TACK COAT
Summary of Quantities	1	40600625	3,834	TON LEVELING BINDER (MM) N50
Location Map	2	40603310	7,187	TON HMA SC MIX "C" N50
Pavement Quantity Calcs	3	42400100	585	SQ. FT. PCC. SIDEWALK, 4"
Typical Sections (Rdwy.)	4-8	42400800	67	SQ. FT. DETECTABLE WARNINGS
Typical Entrances	9	44000157	2533	SQ. YD. HMA SURFACE REMOVAL, 2"
Typical Side Road	10	44000500	90	FT. COMB. CONC. C & G REM.
Typical MB Turnout	11	44000600	585	SQ. FT. SIDEWALK REMOVAL
ADA Ramp Det. Harmon Rd.	12-21	48101200	1960	TON AGGREGATE SHOULDERS TYPE B
Standard No. 424001-09	22, 23	56109210	1	EACH WATER VALVE TO BE ADJ.
Standard No. 424026-01	24	60255500	1	EACH MANHOLES TO BE ADJ.
Standard No. 701006-05	25	60604400	90	FT. COMB. CONC. C & G TY B.16
Standard No. 701011-04	26	67100100	1	L.S. MOBILIZATION
Standard No. 701301-04	27	70300100	7,042	FT. SHORT-TERM PAV'T MARKING
Standard No. 701306-03	28	LR403300	85,195	SQ. YD. SURFACE PROFILE MILLING
Standard No. 701311-03	29	X7010216	1	L.S. TRAFFIC CONTROL & PROT. SPL
Standard No. 701801-06	30, 31			
Standard No. 701901-06	32-34			
Standard No. 720011-01	35			
Standard No. 728001-01	36			
Standard No. 729001-01	37			

Rural Major Collector

LAFO Policy Contract No. 85646

ADT: (10% Trucks) 750

Approved 11-17-16

Don M. Ambrose  
County Engineer

Passed 11-18-16 2016

Andy M. Burtis  
District Engineer of Local Roads and Streets

Releasing for Bid 11-18 2016  
Based on Limited Review

Kevin F. Marchek  
DEPUTY DIRECTOR OF HIGHWAYS / REGION 2 ENGINEER  
Illinois Department of Transportation

These Plans were prepared by me or a full-time member of my staff working under my personal supervision

P.E. nick jama

Date: 11-17-16

License Expires

11-17

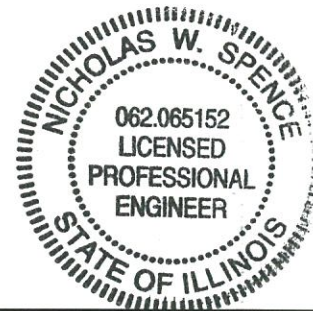

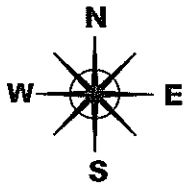

# LEE COUNTY

SECTION: 13-00325-00-RS  
 PROJECT: RS-0103 (141)  
 Walton Rd, Sterling Rd, Harmon Rd  
 HMA OVERLAY PROJECT

Palmyra	Dixon	Nelson	Reynolds	Alto
Nelson	South Dixon	Nelson	Bradford	Willow Creek
Harmon	Marion	Amboy	Ice Center	Wyoming
Hamilton	East Grove	May	Sublette	Brooklyn

NET LENGTH: 6.67 Miles

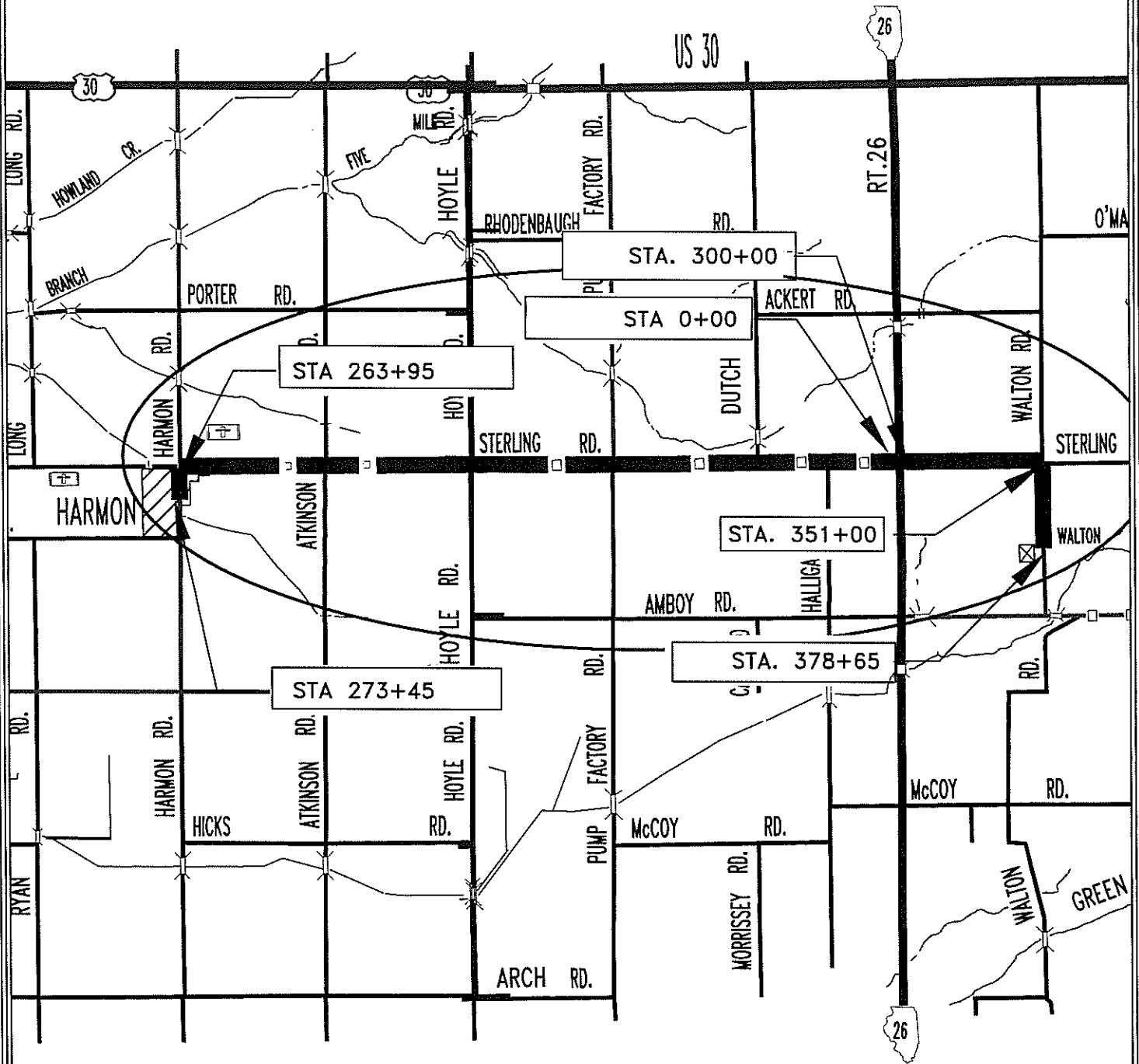



**CALCULATIONS FOR PAVEMENT QUANTITIES**

FAS 188 & 1181

13-00325-00-RS

Lee County

**MAINLINE**

Type	From Station	To Station	Road Width (Feet)	Gutter Width (Feet)	SY	Avg. Level Binder Depth (in)	Surface Course Depth (in)	Unit Weight Binder, lb/sy	Unit Weight Surface, lb/sy	Level Binder Tons	Surface Course Tons	3' Wedge Agg Shld Tons
Sterling Road	0+00	263+95	22	-	64,521	0.75	1.25	90	150	2,903	4,839	1,510
Harmon Road	263+95	273+45	22	-	2,322	0.75	1.25	90	150	105	174	
Sterling Road	300+00	351+00	21	-	11,900	0.75	1.25	90	150	536	893	292
Walton Road	351+00	378+65	21	-	6,452	0.75	1.25	90	150	290	484	158
<b>Project Totals</b>		<b>35,210</b>			<b>85,195</b>					<b>3,834</b>	<b>6,390</b>	<b>1,960</b>

SHORT-TERM PAVEMENT MARKING= 7,042 FT  
 BIT MTLs PRIME COAT QUANTITY= 57,507 LBS

LF/40\*4\*2  
 SF\*.075

**MISCELLANEOUS HMA QUANTITIES**

Type	Qty	Tons per Entrance	Tons
Private Ent.	28	=	252
Field Ent.	30	=	90
Mail Box Turnout	15	=	75
Side Road	16	=	224
Commercial Ent.	13	=	156
			<b>797</b>

**PAVEMENT QUANTITY TOTALS**

Bit. Matls Tack Coat (LB)	Level Binder (Ton)	HMA Surface Course (Ton)	Short-Term Striping (Ft.)	3' Wedge Agg. Shldrs (Ton)
57,507	3,834	7,187	7,042	1,960

Contract # 85646

# PROPOSED

SECTION - HARMON ROAD  
 STATION 263+95 TO 273+45

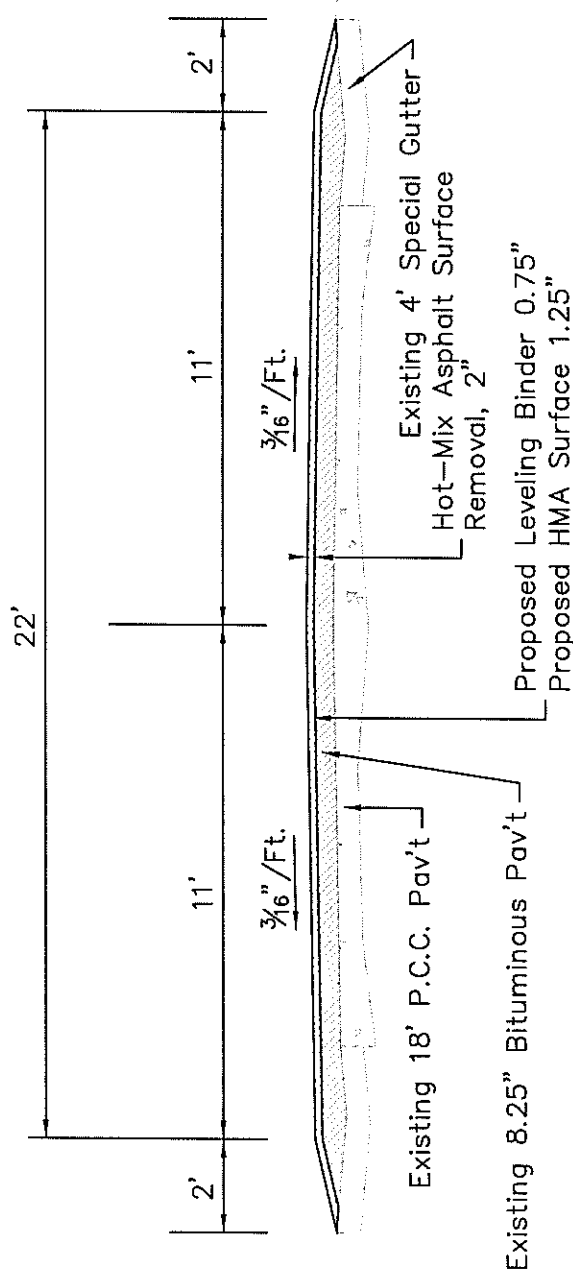

Sec. 13-00325-00-RS  
 LEE COUNTY  
 Harmon Road  
 Project RS-0103(141)  
 Contract # 85646

Mixture Use:	Leveling Binder	Surface
PG:	PG 64-22	PG 64-22
Design Air Voids	3.0 @ N50	3.0 @ N50
Mixture Composition (Gradation Mixture)	IL 9.5 FG	IL 9.5
Friction Aggregate	C	N/A
20 Year ESAL	0.2	0.2
Mix Unit Weight	112 LBS / SY / IN.	

# PROPOSED

SECTION - STERLING ROAD  
STATION 247+00 TO 263+95

Sec. 13-00325-00-RS  
LEE COUNTY  
Sterling Road  
Project RS-0103(141)  
Contract # 85646

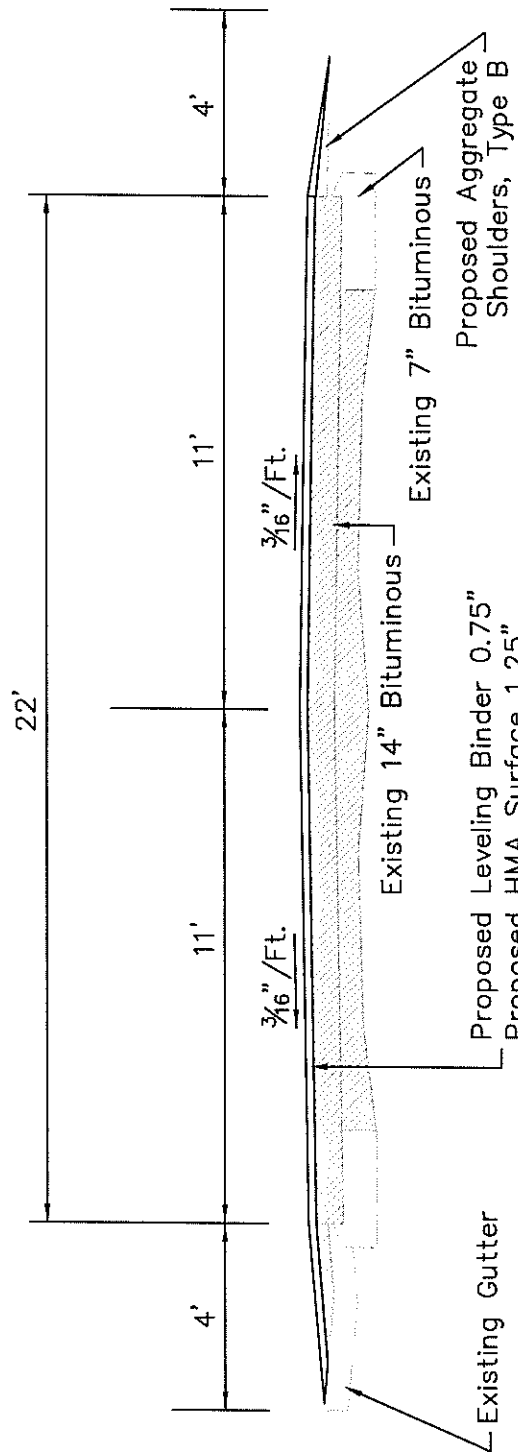

Mixture Use:	LB	Surface
PG:	PG 64-22	PG 64-22
Design Air Voids	3.0 @ N50	3.0 @ N50
Mixture Composition (Gradation Mixture)	IL 9.5 FG	IL 9.5
Friction Aggregate	C	N/A
20 Year ESAL	0.2	0.2
Mix Unit Weight	112 LBS / SY / IN.	

# PROPOSED

SECTION - STERLING ROAD  
 STATION 0+00 TO 247+00  
 (IL-26 To The West)

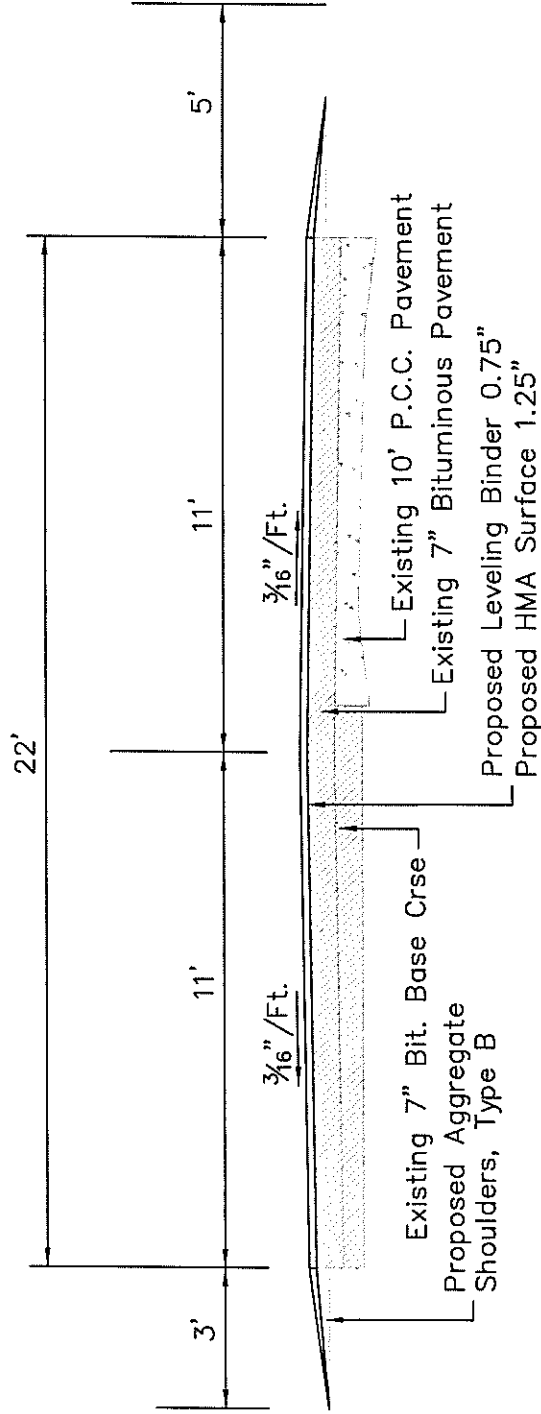

Mixture Use:	LB	Surface
PG:	PG 64-22	PG 64-22
Design Air Voids	3.0 @ N50	3.0 @ N50
Mixture Composition (Gradation Mixture)	IL 9.5 FG	IL 9.5
Friction Aggregate	C	N/A
20 Year ESAL	0.2	0.2
Mix Unit Weight	112 LBS / SY / IN.	

Sec. 13-00325-00-RS  
 LEE COUNTY  
 Sterling Road  
 Project RS-0103(141)  
 Contract # 85646

# PROPOSED

SECTION - STERLING/WALTON ROAD  
STATION 300+00 TO 351+00

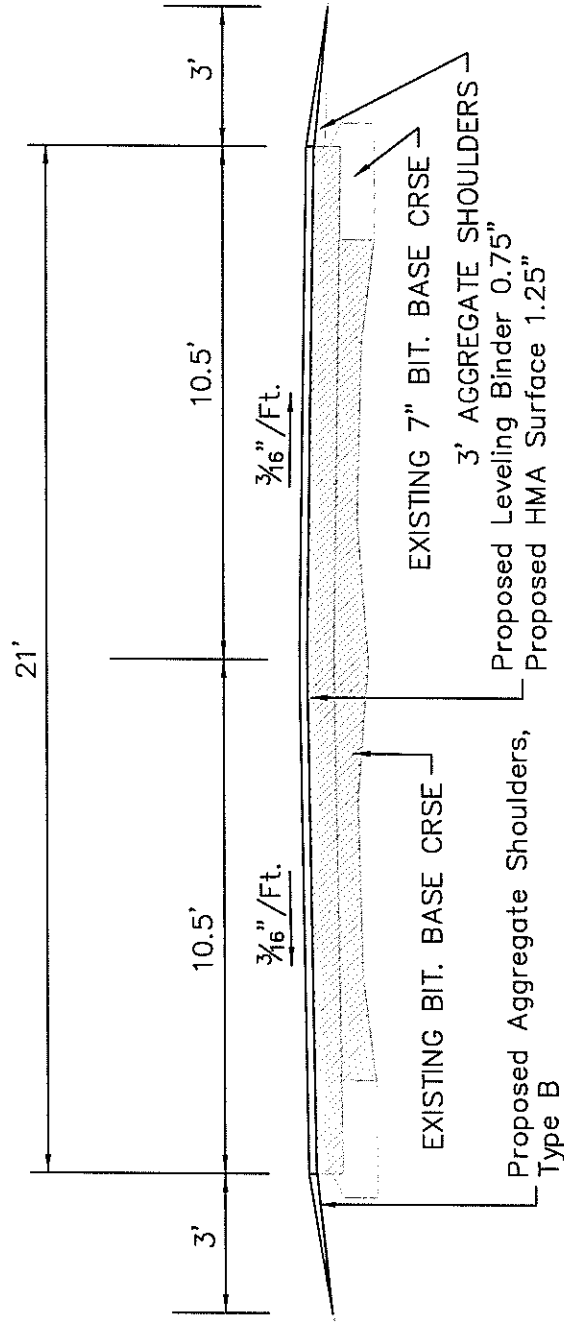

Mixture Use:	LB	Surface
PG:	PG 64-22	PG 64-22
Design Air Voids	3.0 @ N50	3.0 @ N50
Mixture Composition (Gradation Mixture)	IL 9.5 FG	IL 9.5
Friction Aggregate	C	N/A
20 Year ESAL	0.2	0.2
Mix Unit Weight	112 LBS / SY / IN.	

Sec. 13-00325-00-RS  
LEE COUNTY  
Sterling/Walton Road  
Project RS-0103(141)  
Contract # 85646

# PROPOSED

SECTION - WALTON ROAD  
 STATION 351+00 TO 378+65

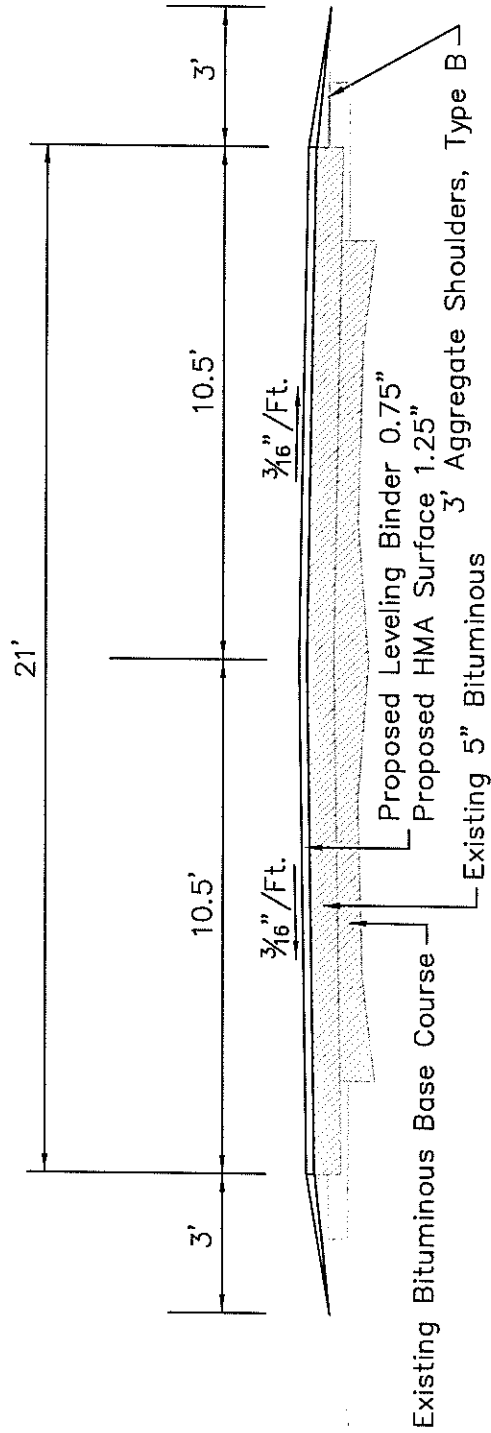

Mixture Use:	LB	Surface
PG:	PG 64-22	PG 64-22
Design Air Voids	3.0 @ N50	3.0 @ N50
Mixture Composition (Gradation Mixture)	IL 9.5 FG	IL 9.5
Friction Aggregate	C	N/A
20 Year ESAL	0.2	0.2
Mix Unit Weight	112 LBS / SY / IN.	

Sec. 13-00325-00-RS  
 LEE COUNTY  
 Walton Road  
 Project RS-0103(141)  
 Contract # 85646

# TYPICAL ENTRANCES

SEC. 13-00325-00-RS  
 LEE COUNTY  
 WALTON RD, STERLING  
 RD, HARMON RD

*Contract # 85646*

PRIVATE AND COMMERCIAL ENTRANCE

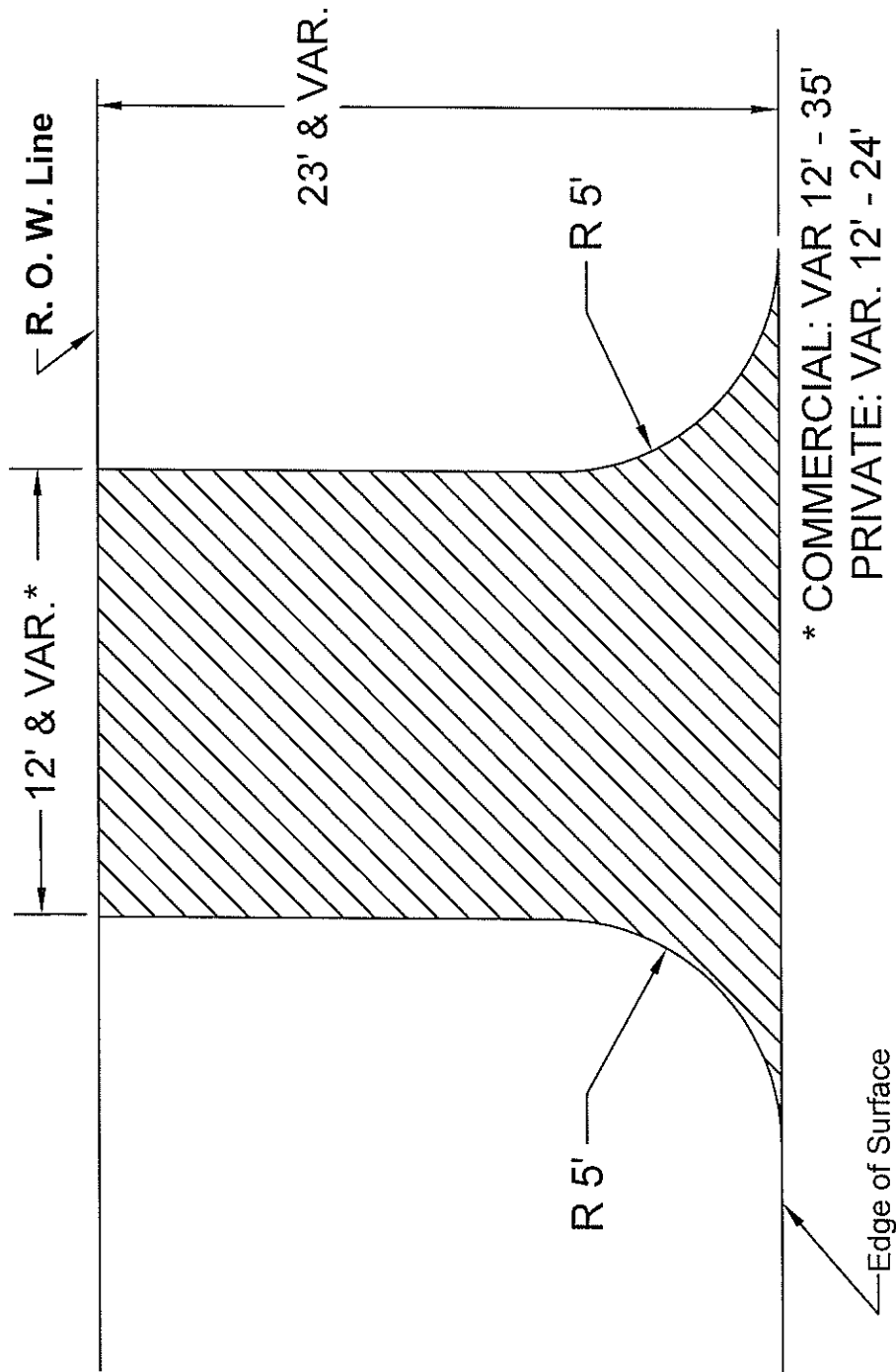

\* COMMERCIAL: VAR 12' - 35'  
 PRIVATE: VAR. 12' - 24'

FIELD ENTRANCE

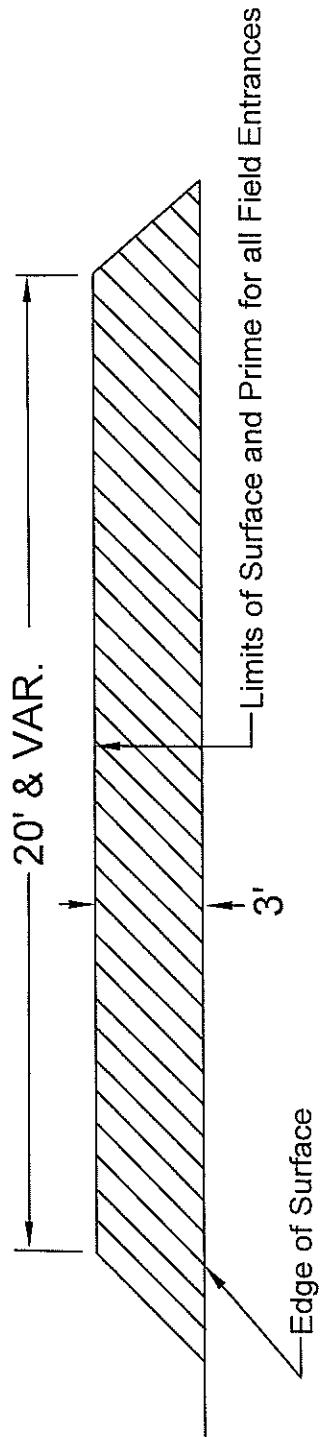

Hatched Area to be Surfaced With Variable Depth HMA SC "C" N50

# TYPICAL SIDE ROAD

SEC. 13-00325-00-RS  
LEE COUNTY  
Walton Rd, Sterling Rd,  
Harmon Rd.  
PROJECT RS0103 (141)  
*Contract # 85646*

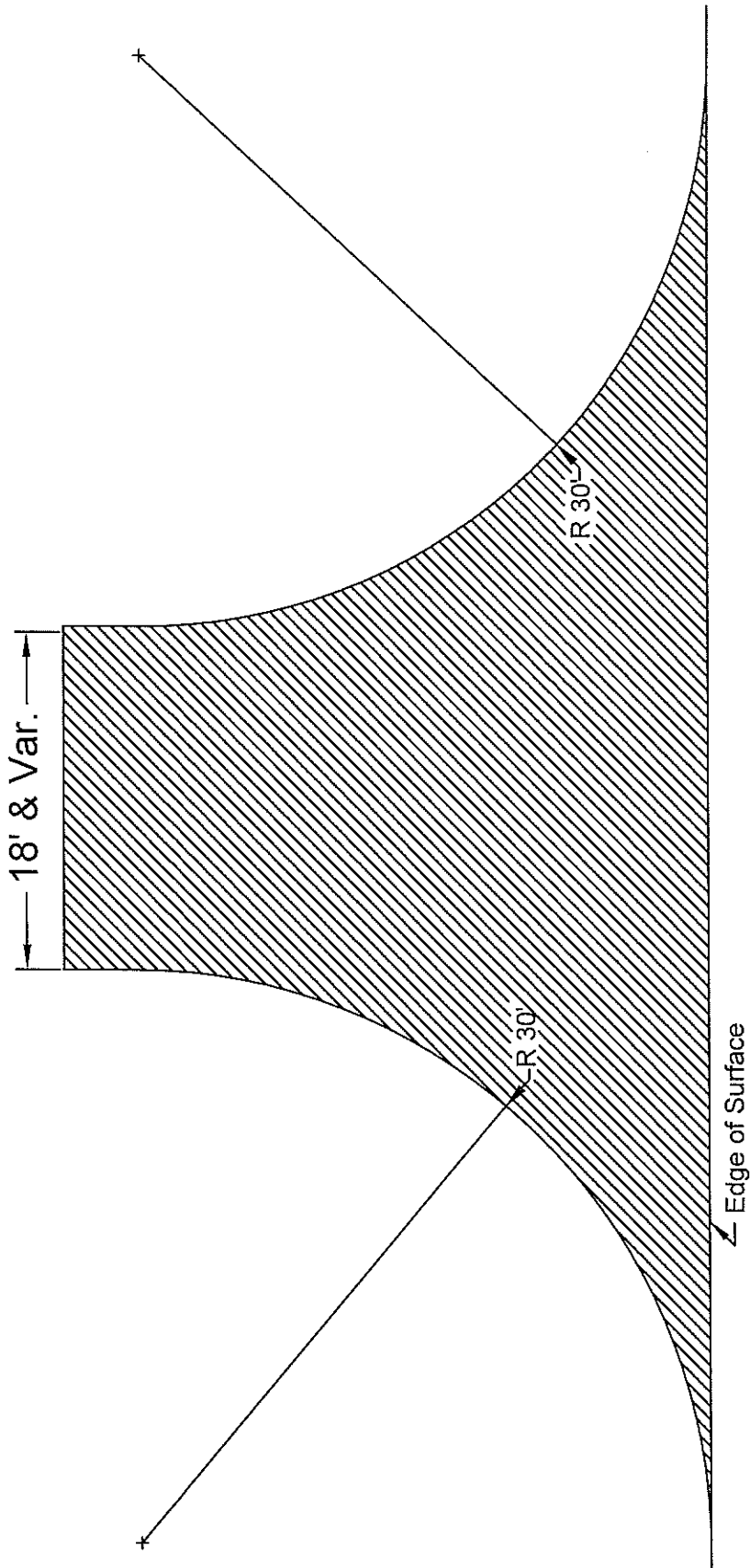

Hatched Area to be Surfaced With  
Variable Depth of HMA SC "C" N50



# TYPICAL MAIL BOX TURNOUT

SEC. 13-00325-00-RS  
LEE COUNTY  
WALTON RD, STERLING  
RD, HARMON RD  
PROJECT RS-0103 (141)  
Contract # 85646

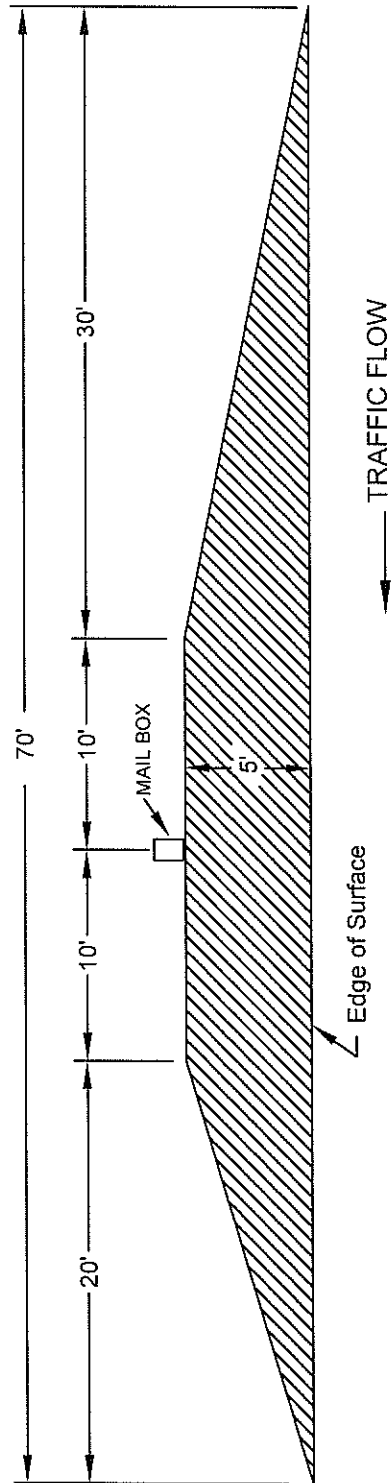

Hatched Area to be Surfaced with  
Variable Depth of HMA SC "C" N50

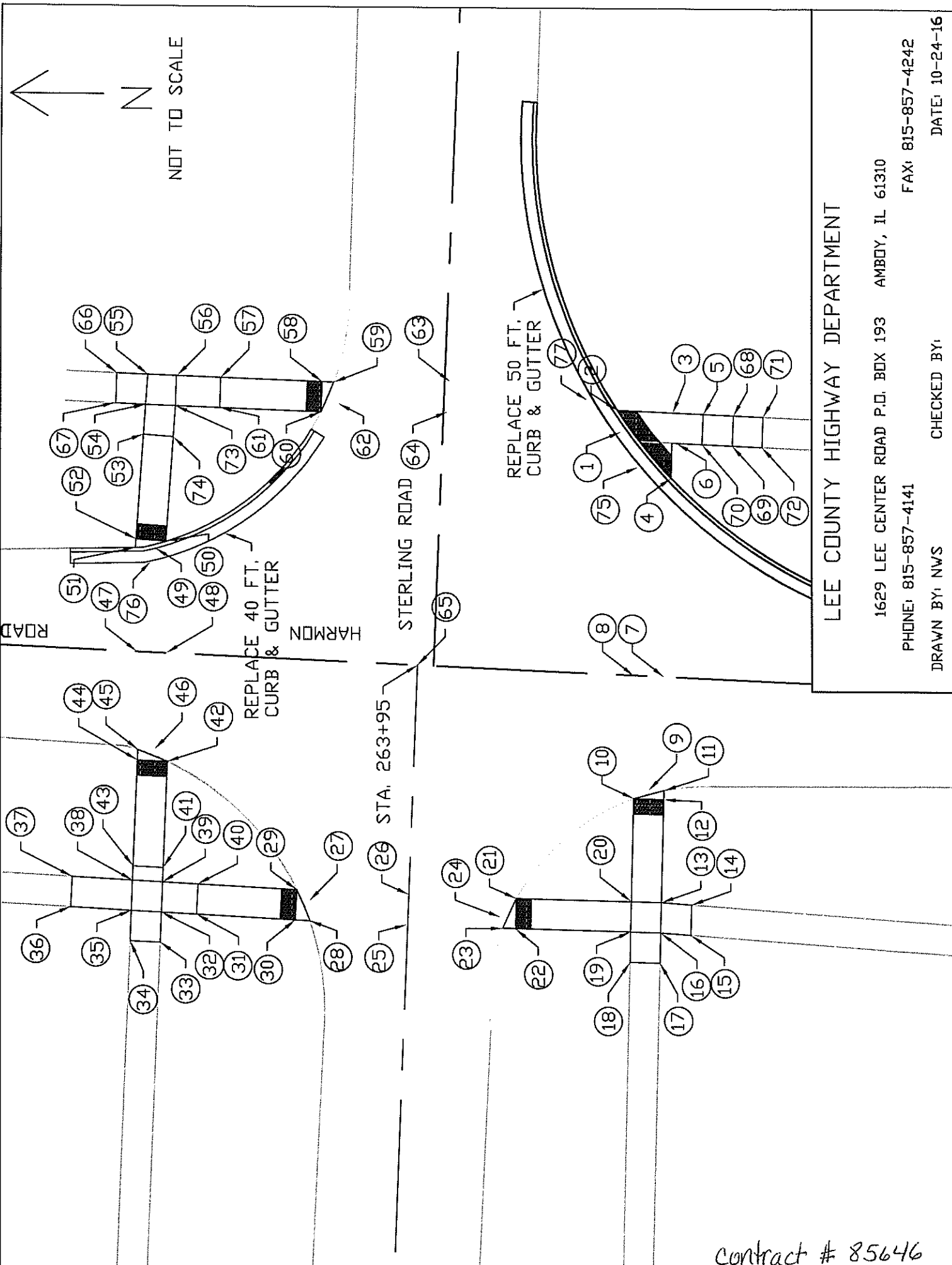

LEE COUNTY HIGHWAY DEPARTMENT

1629 LEE CENTER ROAD P.O. BOX 193 AMBOY, IL 61310

PHONE: 815-857-4141

FAX: 815-857-4242

DRAWN BY: NWS

CHECKED BY:

DATE: 10-24-16

Contract # 85646

Sterling Rd/ Harmon Rd Intersection

Sidewalk Compliance								
Point #	Proposed Elevation	Point to Point		Sidewalk Designation	Distance	Δ Elevation	Slope	Legally/Acceptable Range
					Ft.	Ft.	%	Pos. or Neg.
1	96.92			Edge of Pavement				
2	96.93	2	4	Crosswalk Cross Slope Condition	11	0.05	0.45%	0.0% to 2.0%
3	97.02	2	3	Landing/Turning Slope	7	0.09	1.29%	0.1% to 2.0%
4	96.88	4	6	Landing/Turning Slope	5	0.08	1.60%	0.1% to 2.0%
5	97.1	5	3	Ramp Running Slope	4	0.08	2.00%	0.5% to 8.3%
6	96.96	6	3	Ramp Cross Slope	4	0.06	1.50%	0.1% to 2.0%
68	97.08	5	68	Sidewalk Running Slope	4	0.08	2.00%	0.5% to 5.0%
69	97.02	68	69	Sidewalk Cross Slope	4	0.06	1.50%	0.0% to 2.0%
70	97.04	69	70	Sidewalk Running Slope	4	0.02	0.50%	0.5% to 5.0%
71	97	71	68	Sidewalk Running Slope	4	0.08	2.00%	0.5% to 5.0%
72	97	71	72	Sidewalk Cross Slope	4	0	0.00%	0.0% to 2.0%
		72	69	Sidewalk Running Slope	4	0.02	0.50%	0.5% to 5.0%
		70	5	Ramp Cross Slope	4	0.06	1.50%	0.1% to 2.0%
		70	6	Ramp Running Slope	4	0.08	2.00%	0.5% to 8.3%
		4	7	Crosswalk Running Slope	20	0.11	0.55%	0.0% to 5.0%
		75	8	Crosswalk Running Slope	20	0.14	0.70%	0.0% to 5.0%
7	96.99	7	8	Crosswalk Cross slope	4	0.05	1.25%	0.0% to 2.0%
8	97.04	8	10	Crosswalk Running Slope	20	0.24	1.20%	0.0% to 5.0%
9	96.79							
10	96.8	10	11	Crosswalk Cross slope	4	0.02	0.50%	0.0% to 2.0%
11	96.78	11	12	Landing/Turning Slope	1	0.02	2.00%	0.1% to 2.0%
12	96.8	12	13	Ramp Running Slope	14	0.75	5.36%	0.5% to 8.3%
13	97.55	13	14	Sidewalk Running Slope	4	0.02	0.50%	0.5% to 5.0%
14	97.53	14	15	Sidewalk Cross Slope	4	0	0.00%	0.0% to 2.0%
15	97.53	15	16	Sidewalk Running Slope	4	0.08	2.00%	0.5% to 5.0%
16	97.61	16	17	Sidewalk Running Slope	4	0.14	3.50%	0.5% to 5.0%
17	97.75	17	18	Sidewalk Cross Slope	4	0	0.00%	0.0% to 2.0%
18	97.75	18	19	Sidewalk Running Slope	4	0.08	2.00%	0.5% to 5.0%
19	97.67	19	20	Landing/Turning Slope	4	0.06	1.50%	0.1% to 2.0%
20	97.61	20	10	Ramp Running Slope	14	0.81	5.79%	0.5% to 8.3%
21	97.08	21	23	Landing/Turning Slope	4	0.02	0.50%	0.1% to 2.0%
22	97.13	22	23	Landing/Turning Slope	2	0.03	1.50%	0.1% to 2.0%
23	97.1	22	19	Ramp Running Slope	15	0.54	3.60%	0.5% to 8.3%
24	97.09							
		21	20	Ramp Running Slope	15	0.53	3.53%	0.5% to 8.3%
		21	22	Ramp Cross Slope	4	0.05	1.25%	0.1% to 2.0%
		10	12	Ramp Cross Slope	4	0	0.00%	0.1% to 2.0%
		20	13	Landing/Turning Slope	4	0.06	1.50%	0.1% to 2.0%
		16	13	Landing/Turning Slope	4	0.06	1.50%	0.1% to 2.0%
		16	19	Landing/Turning Slope	4	0.06	1.50%	0.1% to 2.0%
		7	9	Crosswalk Running Slope	20	0.2	1.00%	0.0% to 5.0%
		23	25	Crosswalk Running Slope	15	0.14	0.93%	0.0% to 5.0%
		21	26	Crosswalk Running Slope	15	0.18	1.20%	0.0% to 5.0%
25	97.24	25	26	Crosswalk Cross Slope	4	0.02	0.50%	0.0% to 2.0%
26	97.26	26	27	Crosswalk Running Slope	15	0.13	0.87%	0.0% to 5.0%
27	97.39							
28	97.4	28	29	Crosswalk Cross Slope	4	0.02	0.50%	0.0% to 2.0%

Sterling Rd/ Harmon Rd Intersection

29	97.38	29	30	Ramp Cross Slope	4	0.05	1.25%	0.1% to 2.0%
30	97.43	30	31	Ramp Running Slope	13	0.9	6.92%	0.5% to 8.3%
31	98.33	31	32	Landing/Turning Slope	4	0.06	1.50%	0.1% to 2.0%
32	98.39	32	33	Sidewalk Running Slope	4	0.08	2.00%	0.5% to 5.0%
33	98.47	33	34	Sidewalk Cross Slope	4	0.01	0.25%	0.0% to 2.0%
34	98.48	34	35	Sidewalk Running Slope	4	0.05	1.25%	0.5% to 5.0%
35	98.43	35	36	Sidewalk Running Slope	8	0.12	1.50%	0.5% to 5.0%
36	98.55	36	37	Sidewalk Cross Slope	4	0	0.00%	0.0% to 2.0%
37	98.55	37	38	Sidewalk Running Slope	8	0.16	2.00%	0.5% to 5.0%
38	98.39	38	39	Landing/Turning Slope	4	0.06	1.50%	0.1% to 2.0%
39	98.33	39	40	Landing/Turning Slope	4	0.08	2.00%	0.1% to 2.0%
40	98.25	40	29	Ramp Running Slope	13	0.87	6.69%	0.5% to 8.3%
41	98.29	41	42	Ramp Running Slope	14	1.11	7.93%	0.5% to 8.3%
42	97.18	42	45	Crosswalk Cross Slope	4	0.02	0.50%	0.0% to 2.0%
43	98.35	43	44	Ramp running Slope	14	1.16	8.29%	0.5% to 8.3%
44	97.18	44	45	Landing/Turning Slope	1	0.02	2.00%	0.1% to 2.0%
45	97.16	44	42	Ramp Cross Slope	4	0	0.00%	0.1% to 2.0%
46	97.17	46	48	Crosswalk Running Slope	15	0.12	0.80%	0.0% to 5.0%
		41	43	Ramp Cross Slope	4	0.06	1.50%	0.1% to 2.0%
		38	43	Landing/Turning Slope	2	0.04	2.00%	0.1% to 2.0%
		39	41	Landing/Turning Slope	2	0.04	2.00%	0.1% to 2.0%
		32	39	Landing/Turning Slope	4	0.06	1.50%	0.1% to 2.0%
		32	35	Landing/Turning Slope	4	0.04	1.00%	0.1% to 2.0%
		35	38	Landing/Turning Slope	4	0.08	2.00%	0.1% to 2.0%
		31	40	Ramp Cross Slope	4	0.08	2.00%	0.1% to 2.0%
		28	30	Landing/Turning Slope	2	0.03	1.50%	0.1% to 2.0%
		45	47	Crosswalk Running Slope	15	0.11	0.73%	0.0% to 5.0%
		47	51	Crosswalk Running Slope	15	0.16	1.07%	0.0% to 5.0%
		25	28	Crosswalk Running Slope	15	0.16	1.07%	0.0% to 5.0%
47	97.27	47	48	Crosswalk Cross Slope	4	0.02	0.50%	0.0% to 2.0%
48	97.29							
49	97.12	49	76	Crosswalk Running Slope	15	0.15	1.00%	0.0% to 5.0%
50	97.13	50	51	Crosswalk Cross Slope	4	0.02	0.50%	
51	97.11	51	52	Landing/Turning Slope	1	0.02	2.00%	0.1% to 2.0%
52	97.13	52	53	Ramp Running Slope	14	0.86	6.14%	0.5% to 8.3%
53	97.99	53	54	Landing/Turning Slope	4	0.06	1.50%	0.1% to 2.0%
54	98.05	54	55	Sidewalk Cross Slope	4	0.04	1.00%	0.0% to 2.0%
55	98.09	55	56	Sidewalk Cross Slope	4	0.03	0.75%	0.0% to 2.0%
56	98.06	56	57	Landing/Turning Slope	6	0.09	1.50%	0.1% to 2.0%
57	97.97	57	58	Ramp Running Slope	13	0.73	5.62%	0.5% to 8.3%
58	97.24	58	59	Landing/Turning Slope	2	0.04	2.00%	0.1% to 2.0%
59	97.2	59	60	Crosswalk Cross Slope	4	0.02	0.50%	0.0% to 2.0%
60	97.18	60	61	Ramp Running Slope	13	0.77	5.92%	0.5% to 8.3%
61	97.95	61	73	Landing/Turning Slope	6	0.09	1.50%	0.1% to 2.0%
73	98.04							
74	98.02							
		73	74	Landing/Turning Slope	4	0.02	0.50%	0.1% to 2.0%
		74	50	Ramp Running Slope	14	0.89	6.36%	0.5% to 8.3%
		50	52	Ramp Cross Slope	4	0	0.00%	0.1% to 2.0%
		53	74	Ramp Cross Slope	4	0.03	0.75%	0.1% to 2.0%
		73	54	Landing/Turning Slope	4	0.01	0.25%	0.1% to 2.0%
		54	67	Sidewalk Running Slope	4	0.06	1.50%	0.5% to 5.0%

Sterling Rd/ Harmon Rd Intersection

		66	67	Sidewalk Cross Slope	4	0	0.00%	0.0% to 2.0%
		55	66	Sidewalk Running Slope	4	0.02	0.50%	0.5% to 5.0%
		73	56	Landing/Turning Slope	4	0.02	0.50%	0.1% to 2.0%
		61	57	Ramp Cross Slope	4	0.02	0.50%	0.1% to 2.0%
		60	58	Ramp Cross Slope	4	0.06	1.50%	0.1% to 2.0%
62	97.19	62	64	Crosswalk Running Slope	20	0.19	0.95%	0.0% to 5.0%
66	98.11							
67	98.11							
		59	63	Crosswalk Running Slope	20	0.2	1.00%	0.0% to 5.0%
		63	77	Crosswalk Running Slope	20	0.5	2.50%	0.0% to 5.0%
63	97.4	63	64	Crosswalk Cross Slope	4	0.02	0.50%	0.0% to 2.0%
64	97.38	64	1	Crosswalk Running Slope	20	0.44	2.20%	0.0% to 5.0%
65	97.34							

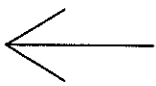

N

NOT TO SCALE

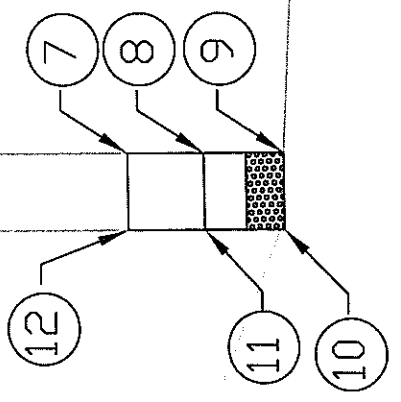

WHEELER ROAD (STA. 266+39)

ROAD

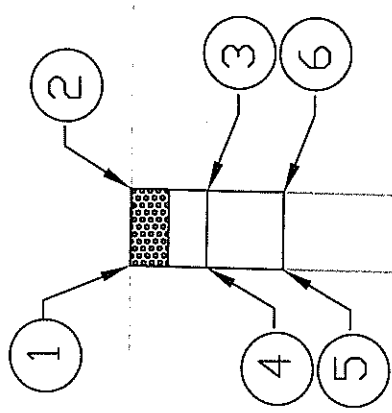

HARMON ROAD

LEE COUNTY HIGHWAY DEPARTMENT

1629 LEE CENTER ROAD P.O. BOX 193 AMBOY, IL 61310

PHONE: 815-857-4141 FAX: 815-857-4242

DRAWN BY: NWS CHECKED BY: DATE: 10-24-16

Contract # 85646

Sidewalk Compliance								
Point #	Proposed Elevation	Point to Point		Sidewalk Designation	Distance	Δ Elevation	Slope	Legally/Acceptable Range
					Ft.	Ft.	%	Pos. or Neg.
1	94.1	1	2	Crosswalk Cross Slope	4	0.04	1.00%	0.0% to 2.0%
2	94.14	2	3	Ramp Running Slope	4	0.06	1.50%	0.5% to 8.3%
3	94.08	3	6	Sidewalk Running Slope	4	0.06	1.50%	0.5% to 5.0%
4	94.04	4	1	Ramp Running Slope	4	0.06	1.50%	0.5% to 8.3%
5	94.02	4	5	Sidewalk Running Slope	4	0.02	0.50%	0.5% to 5.0%
6	94.02	5	6	Sidewalk Cross Slope	4	0	0.00%	0.1% to 2.0%
		3	4	Ramp Cross Slope	4	0.04	1.00%	0.1% to 2.0%
7	94.31	7	8	Sidewalk Running Slope	4	0.03	0.75%	0.5% to 5.0%
8	94.28	8	9	Ramp Running Slope	4	0.06	1.50%	0.5% to 8.3%
9	94.22	9	10	Crosswalk Cross Slope	4	0.02	0.50%	0.0% to 2.0%
10	94.2	10	11	Ramp Running Slope	4	0.06	1.50%	0.5% to 8.3%
11	94.26	11	12	Sidewalk Running Slope	4	0.05	1.25%	0.5% to 5.0%
12	94.31	12	7	Sidewalk Cross Slope	4	0	0.00%	0.1% to 2.0%
		8	11	Ramp Cross Slope	4	0.02	0.50%	0.1% to 2.0%
13	94.15	13	14	Crosswalk Cross Slope	4	0	0.00%	0.0% to 2.0%
14	94.15	10	14	Crosswalk Running Slope	10	0.05	0.50%	0.0% to 5.0%
		14	1	Crosswalk Running Slope	10	0.05	0.50%	0.0% to 5.0%
		9	13	Crosswalk Running Slope	10	0.07	0.70%	0.0% to 5.0%
		13	2	Crosswalk Running Slope	10	0.01	0.10%	0.0% to 5.0%

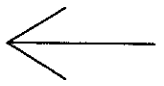

N

NOT TO SCALE

ROAD

HARMON

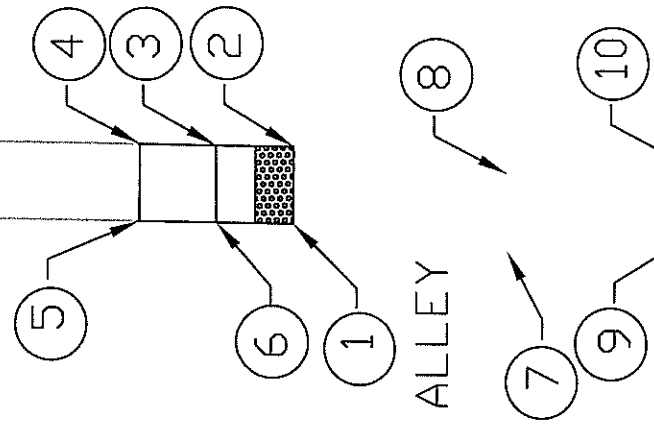

(STA. 265+61) ALLEY

LEE COUNTY HIGHWAY DEPARTMENT

1629 LEE CENTER ROAD P.O. BOX 193 AMBOY, IL 61310

PHONE: 815-857-4141

FAX: 815-857-4242

DRAWN BY: NWS

CHECKED BY:

DATE: 10-24-16



Sidewalk Compliance								
Point #	Proposed Elevation	Point to Point		Sidewalk Designation	Distance	Δ Elevation	Slope	Legally/Acceptable Range
					Ft.	Ft.	%	Pos. or Neg.
1	95.12	1	2	Crosswalk Cross Slope	4	0.02	0.50%	0.0% to 2.0%
2	95.10	2	3	Ramp Running Slope	4	0.06	1.50%	0.5% to 8.3%
3	95.16	3	4	Sidewalk Running Slope	4	0.02	0.50%	0.5% to 5.0%
4	95.18	4	5	Sidewalk Cross Slope	4	0.06	1.50%	0.1% to 2.0%
5	95.2	5	6	Sidewalk Running Slope	4	0.02	0.50%	0.5% to 5.0%
6	95.18	6	1	Ramp Running Slope	4	0.06	1.50%	0.5% to 8.3%
		3	6	Ramp Cross Slope	4	0.04	1.00%	0.1% to 2.0%
7	95.12	7	8	Crosswalk Cross Slope	4	0.02	0.50%	0.0% to 2.0%
8	95.11	8	2	Crosswalk Running Slope	7	0.01	0.14%	0.0% to 5.0%
9	95.2	9	7	Crosswalk Running Slope	7	0.08	1.14%	0.0% to 5.0%
10	95.18	10	8	Crosswalk Running Slope	7	0.07	1.00%	0.0% to 5.0%
		7	1	Crosswalk Running Slope	7	0	0.00%	0.0% to 5.0%

Contract # 85646

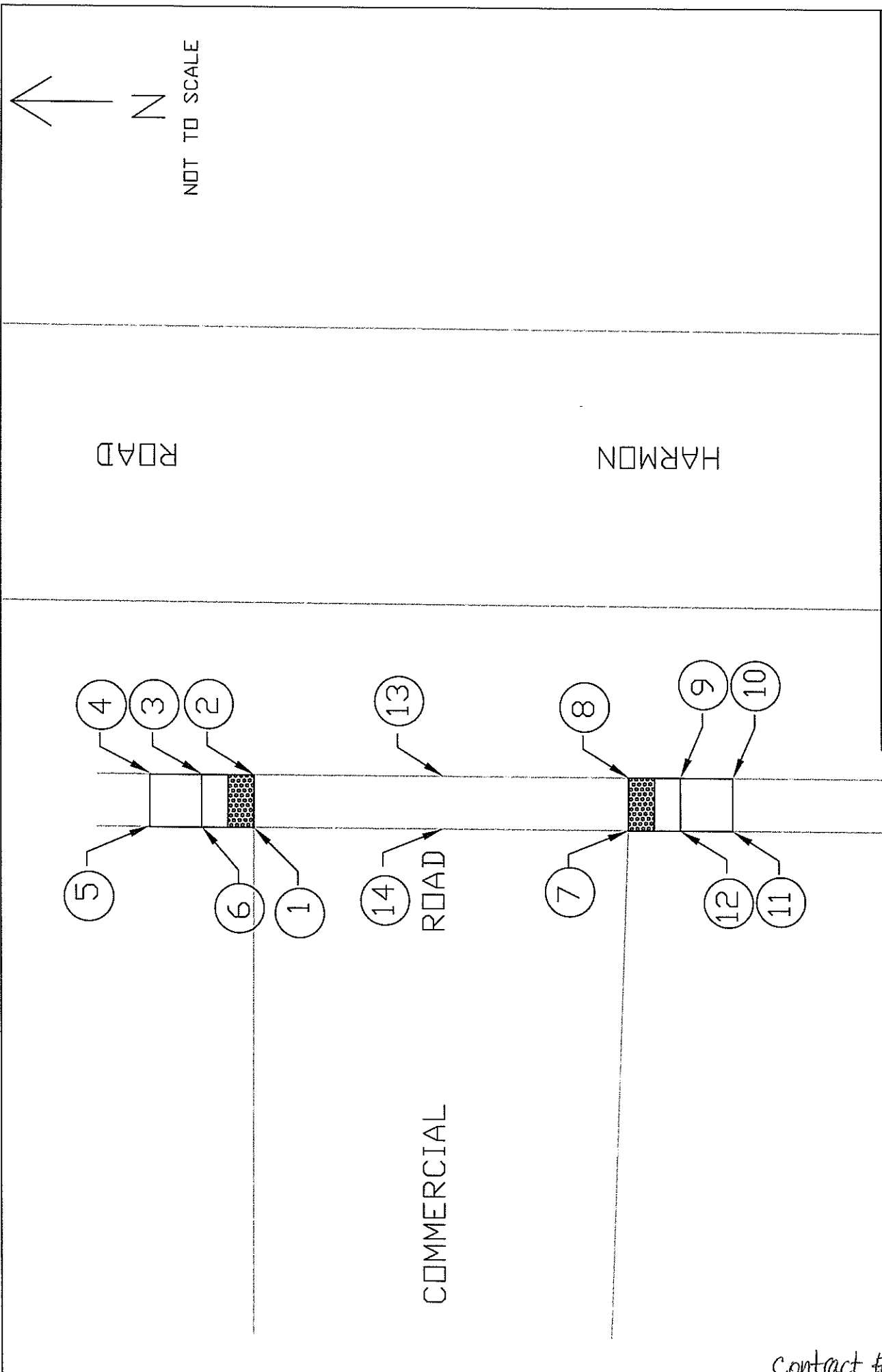

LEE COUNTY HIGHWAY DEPARTMENT  
 1629 LEE CENTER ROAD P.O. BOX 193 AMBOY, IL 61310  
 PHONE: 815-857-4141 FAX: 815-857-4242  
 DRAWN BY: NWS CHECKED BY: DATE: 10-24-16

Commercial Rd. Intersection

Sidewalk Compliance								
Point #	Proposed Elevation	Point to Point		Sidewalk Designation	Distance	Δ Elevation	Slope	Legally/Acceptable Range
					Ft.	Ft.	%	Pos. or Neg.
1	94.17	1	2	Crosswalk Cross Slope	4	0.02	0.50%	0.0% to 2.0%
2	94.15	2	3	Ramp Running Slope	4	0.06	1.50%	0.5% to 8.3%
3	94.21	3	4	Sidewalk Running Slope	4	0.02	0.50%	0.5% to 5.0%
4	94.23	4	5	Sidewalk Cross Slope	4	0.01	0.25%	0.1% to 2.0%
5	94.24	5	6	Sidewalk Running Slope	4	0.01	0.25%	0.5% to 5.0%
6	94.23	6	1	Ramp Running Slope	4	0.06	1.50%	0.5% to 8.3%
		3	6	Ramp Cross Slope	4	0.02	0.50%	0.1% to 2.0%
7	94.12	7	8	Crosswalk Cross Slope	4	0.02	0.50%	0.0% to 2.0%
8	94.1	8	9	Ramp Running Slope	4	0.06	1.50%	0.5% to 8.3%
9	94.04	9	10	Sidewalk Running Slope	4	0.02	0.50%	0.5% to 5.0%
10	94.02	10	11	Sidewalk Cross Slope	4	0	0.00%	0.1% to 2.0%
11	94.02	11	12	Sidewalk Running Slope	4	0.04	1.00%	0.5% to 5.0%
12	94.06	12	7	Ramp Running Slope	4	0.06	1.50%	0.5% to 8.3%
		9	12	Ramp Cross Slope	4	0.02	0.50%	0.1% to 2.0%
13	94.13	13	14	Crosswalk Cross Slope	4	0.02	0.50%	0.0% to 2.0%
14	94.15							
		1	14	Crosswalk Running Slope	15	0.02	0.13%	0.0% to 5.0%
		14	7	Crosswalk Running Slope	15	0.03	0.20%	0.0% to 5.0%
		2	13	Crosswalk Running Slope	15	0	0.00%	0.0% to 5.0%
		13	8	Crosswalk Running Slope	15	0.03	0.20%	0.0% to 5.0%

contract # 85646

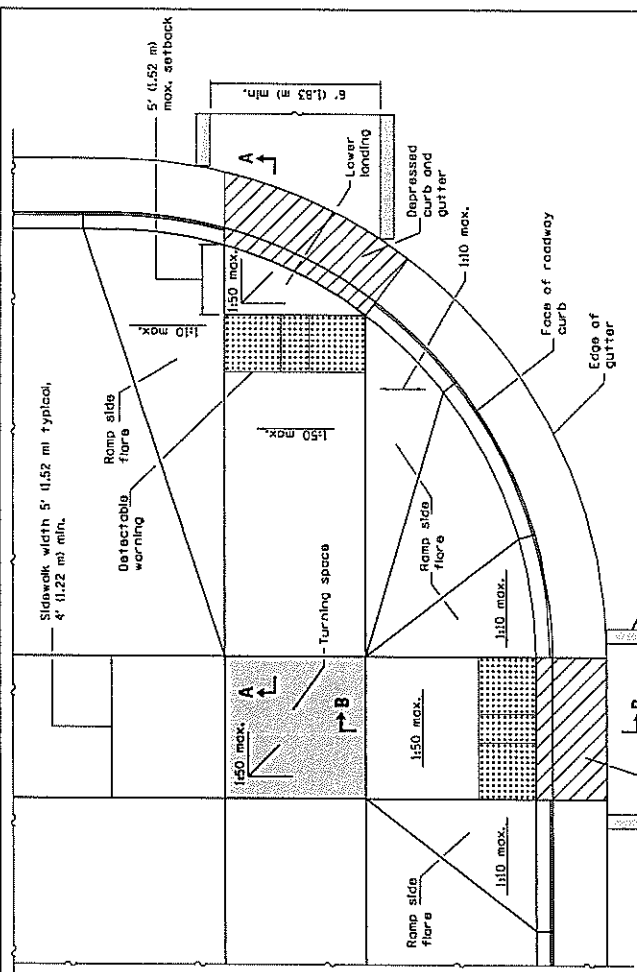

**RAMPS IN LANSCAPED AREA**  
**SETBACK ≤ 5'**

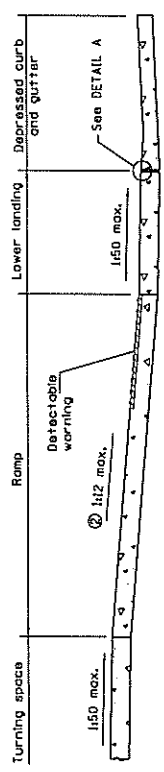

**SECTION A-A**

② The running slope of the curb ramp shall not require the ramp length to exceed 15' (4.5 m).

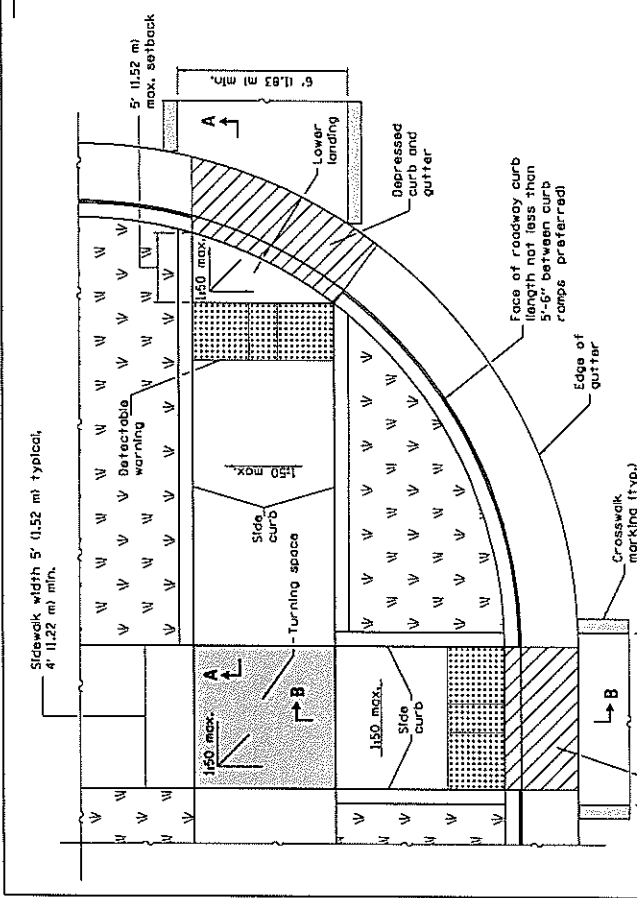

**RAMPS IN PAVED AREA**  
**SETBACK ≤ 5'**

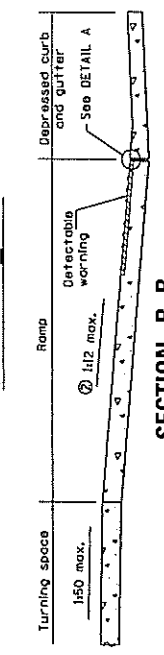

**SECTION B-B**

② The running slope of the curb ramp shall not require the ramp length to exceed 15' (4.5 m).

Flush with top of roadway curb and top of sidewalk

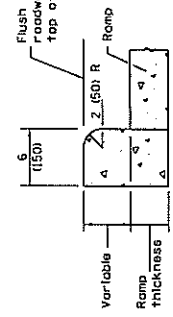

**SIDE CURB DETAIL**

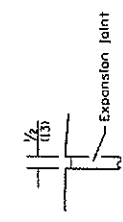

**DETAIL A**

See Sheet 2 for GENERAL NOTES.

PERPENDICULAR CURB RAMPS FOR SIDEWALKS	
(Sheet 1 of 2)	
DATE	REVISIONS
1-1-17	Add 2' dimension to det. warnings for setbacks greater than 5'.
1-1-15	① not appl. to int. sidewalks. Rev. gen. notes: Chd Upper landing to turning space.

STANDARD 424001-09

Illinois Department of Transportation  
 PASSED JANUARY 1, 2017  
 ENGINEER OF POLICY AND PROCEDURES  
 APPROVED JANUARY 1, 2017  
 ENGINEER OF DESIGN AND ENVIRONMENT

ISSUED 1-1-17

Contact # 85646

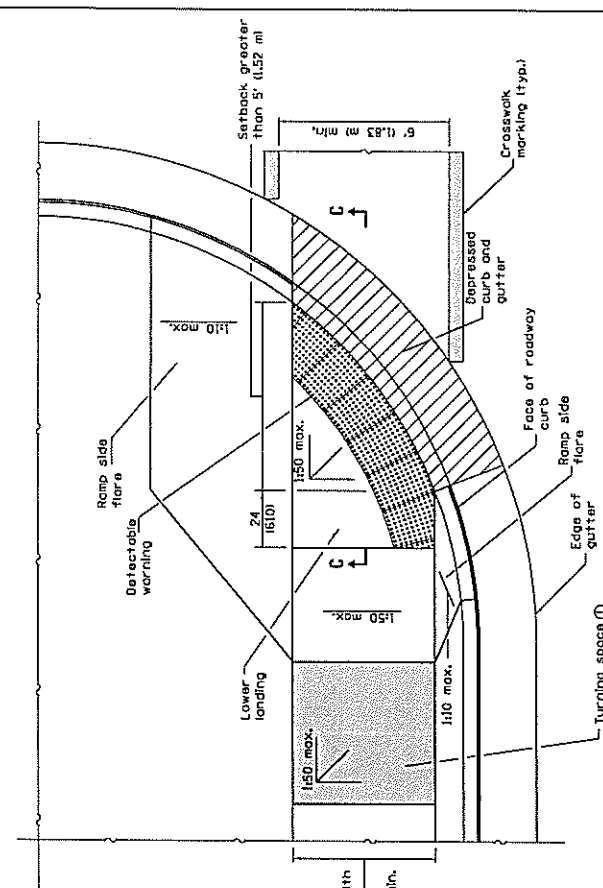

**RAMP IN LANDSCAPED AREA**

**SETBACK > 5'**

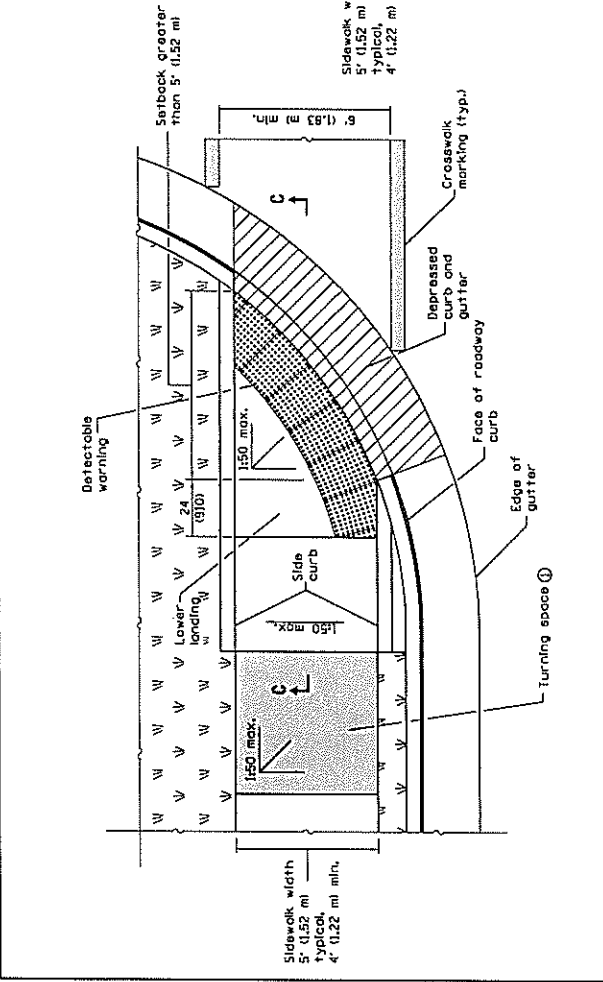

**RAMP IN PAVED AREA**

**SETBACK > 5'**

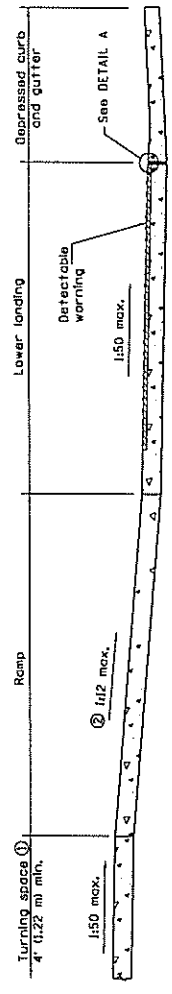

**SECTION C-C**

- ① Turning space not required for ramp slopes flatter than 1:20.
- ② The running slope of the curb ramp shall not require the ramp length to exceed 15' (4.5 m).

**GENERAL NOTES**  
 All slope ratios are expressed as units of vertical displacement to units of horizontal displacement (V:H).  
 Where the turning space is constrained on a side opposite a ramp, the minimum length of the turning space in the direction of the ramp-run shall be 5' (1.52 m).  
 Where 1:50 maximum slope is shown, 1:64 is preferred.  
 See Standard 606001 for details of depressed curb adjacent to curb ramp.  
 All dimensions are in inches (millimeters) unless otherwise shown.

<b>PERPENDICULAR CURB RAMPS FOR SIDEWALKS</b> <small>(Sheet 2 of 2)</small>
STANDARD 424001-09

Illinois Department of Transportation  
 PASSED BY BOARD OF TRANSPORTATION, 2017  
 APPROVED BY CHIEF ENGINEER OF TRANSPORTATION, 2017  
 APPROVED BY CHIEF ENGINEER OF DESIGN AND ENVIRONMENT, 2017

ISSUED 1-1-97

CONTACT # 85646

23

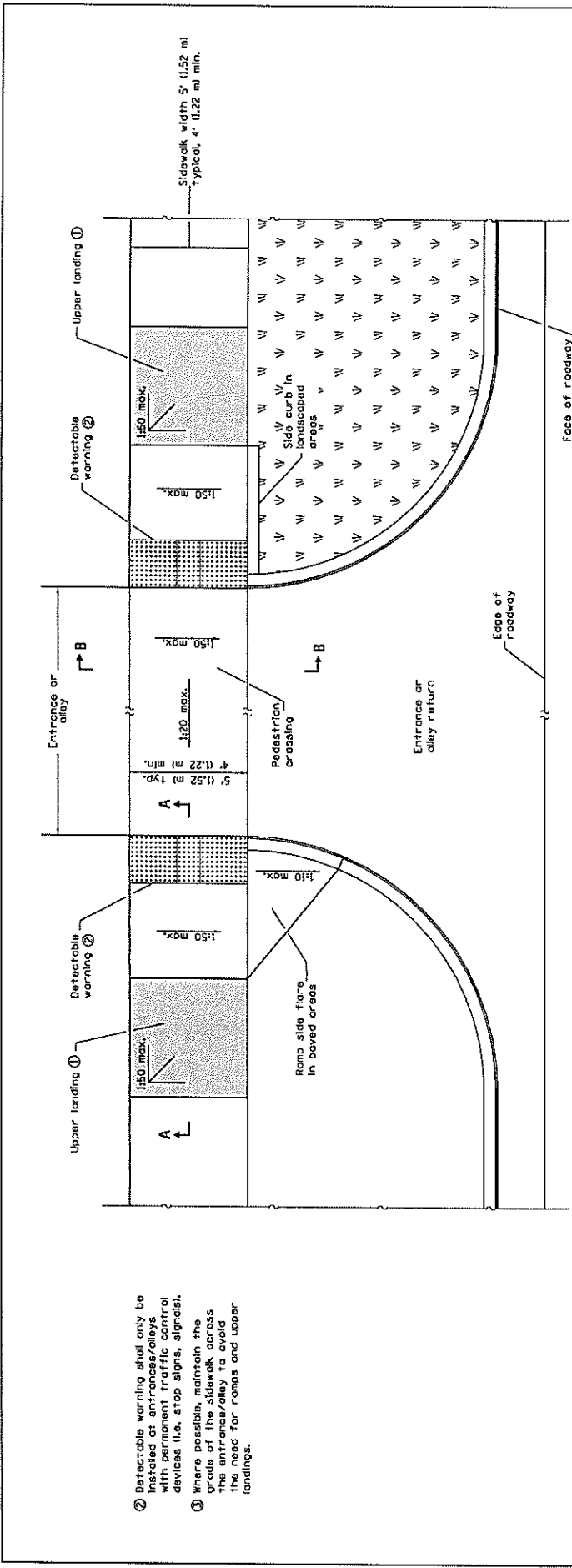

- ② Detectable warning shall only be installed at entrances/alleys with permanent traffic control devices (i.e. stop signs, signals).
- ③ Where possible, maintain the grade of the sidewalk across the entrance/alley to avoid the need for ramps and upper landings.

**ENTRANCE / ALLEY PEDESTRIAN CROSSING**

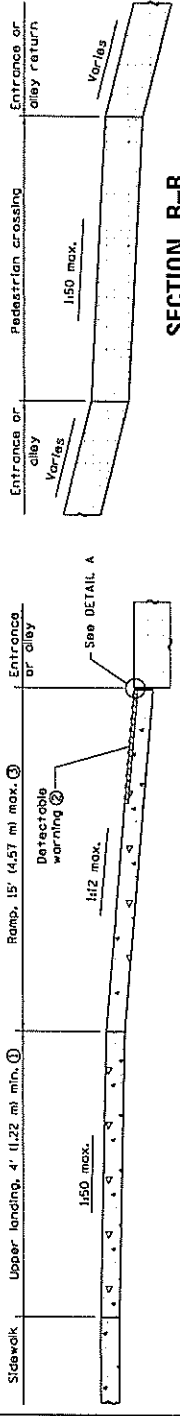

**SECTION A-A**

① Upper landing not required for ramp slopes flatter than 1:20.

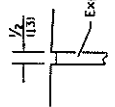

**DETAIL A**

**GENERAL NOTES**

All slope ratios are expressed as units of vertical displacement to units of horizontal displacement (V:H).  
Where 1:50 maximum slope is shown, 1:64 is preferred.  
All dimensions are in inches (millimeters) unless otherwise shown.

DATE	REVISIONS
1-1-13	Revised General Notes.
1-1-12	New standard.

PASSED ISSUED 1-1-12 ENGINEER OF PUBLIC AND PROGRESS APPROVED ENGINEER OF DESIGN AND ENVIRONMENT	Illinois Department of Transportation January 1, 2013 ENGINEER OF PUBLIC AND PROGRESS APPROVED ENGINEER OF DESIGN AND ENVIRONMENT
--	---

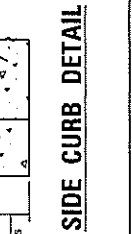

**SIDE CURB DETAIL**

**ENTRANCE / ALLEY PEDESTRIAN CROSSINGS**  
STANDARD 424026-01

Contract # 85646

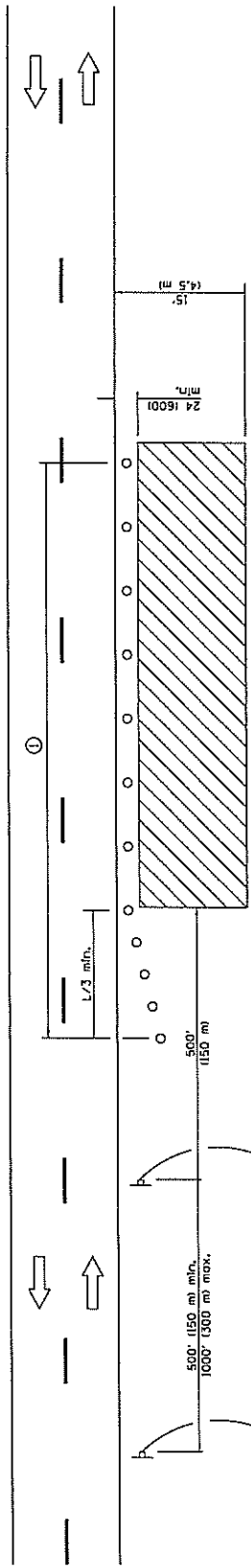

For contract construction projects  
W20-1103101-48

For maintenance and utility projects  
W20-1101-48

W21-1101-48

**TYPICAL APPLICATIONS**

- Utility operations
- Divert extensions
- Side slope changes
- Over-drill installation and maintenance
- Shoulder operations
- Shoulder repair
- Sign installation and maintenance

**SYMBOLS**

- Work area
- Sign
- Cone, drum or barricade

**GENERAL NOTES**

This Standard is used where any vehicles, equipment, workers or their activities will encroach in the area 15' (4.5 m) to 24' (6.00) from the edge of pavement.

Calculate L as follows:

SPEED LIMIT	FORMULAS
40 mph (70 km/h) or less	English: $L = \frac{WS^2}{60}$ Metric: $L = \frac{WS^2}{150}$
45 mph (80 km/h) or greater	English: $L = (WHS)$ Metric: $L = 0.65(WHS)$

W = width of offset in feet (meters)  
S = Normal posted speed mph (km/h)

All dimensions are in inches (millimeters) unless otherwise shown.

DATE	REVISIONS
1-1-14	Revised worker's sign number to agree with current MUTCD.
1-1-13	Omitted text 'WORKERS' sign.

**OFF-RD OPERATIONS, 2L, 2W, 15' (4.5 m) TO 24" (600 mm) FROM PAVEMENT EDGE**

STANDARD 701806-05

Illinois Department of Transportation  
ISSUED 1-1-87

APPROVED: [Signature] 2014  
ENGINEER OF SAFETY OPERATIONS  
APPROVED: [Signature] 2014  
ENGINEER OF DESIGN AND ENVIRONMENT

Contract # 85646

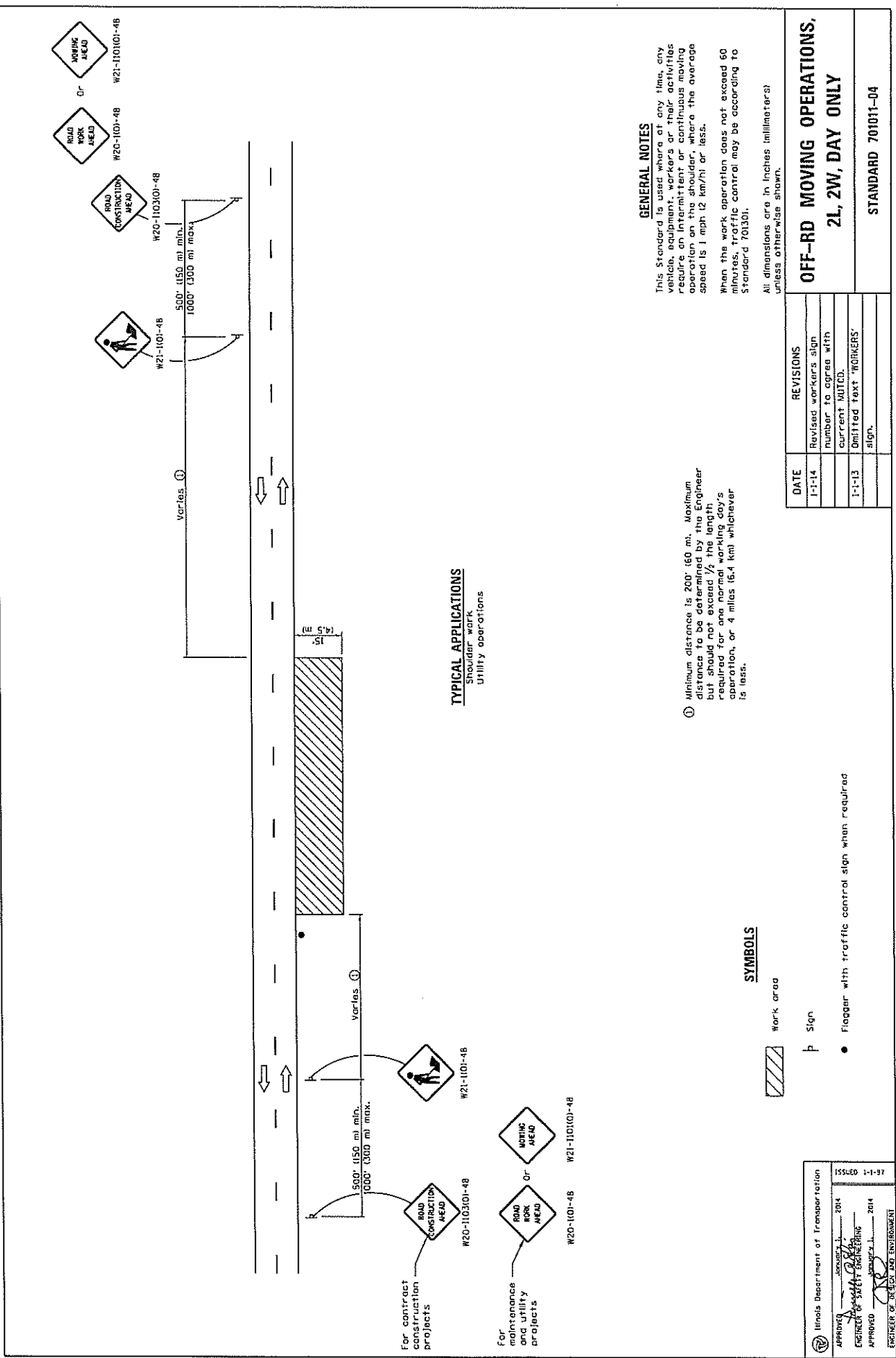

**TYPICAL APPLICATIONS**  
Shoulder work  
utility operations

For contract construction projects

For maintenance and utility projects

**GENERAL NOTES**

This Standard is used where at any time, any vehicle, equipment, workers or their activities require an intermittent or continuous moving operation on the shoulder, where the average speed is 1 mph (2 km/h) or less.  
When the work operation does not exceed 60 minutes, traffic control may be according to Standard 701301.

① Minimum distance is 200' (60 m). Maximum distance to be determined by the Engineer but should not exceed 1/2 the length required for one normal working day's operation, or 4 miles (6.4 km) whichever is less.

All dimensions are in inches (millimeters) unless otherwise shown.

**SYMBOLS**

- Work area
- Flagger with traffic control sign when required

OFF-ROAD MOVING OPERATIONS, 2L, 2W, DAY ONLY	
STANDARD 701011-04	
DATE	REVISIONS
1-1-14	Revised workers sign number to agree with current MUTCD.
1-1-13	Omitted text 'WORKERS' sign.

Illinois Department of Transportation  
ISSUED 1-1-97

APPROVED: [Signature] 2014  
ENGINEER OF SAFETY ENGINEERING

APPROVED: [Signature] 2014  
ENGINEER OF RECORD FOR ENVIRONMENT

Contract # 856416



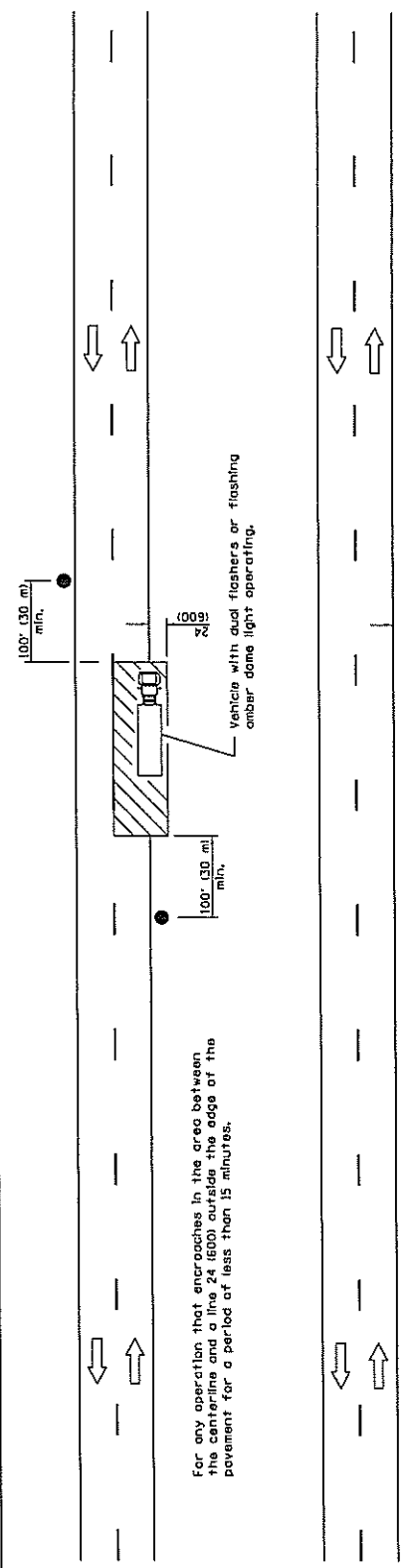

For any operation that encroaches in the area between the centerline and a line 24 (600) outside the edge of this pavement for a period of less than 15 minutes.

For any operation that is more than 24 (600) outside the edge of the pavement for a period of less than 60 minutes.

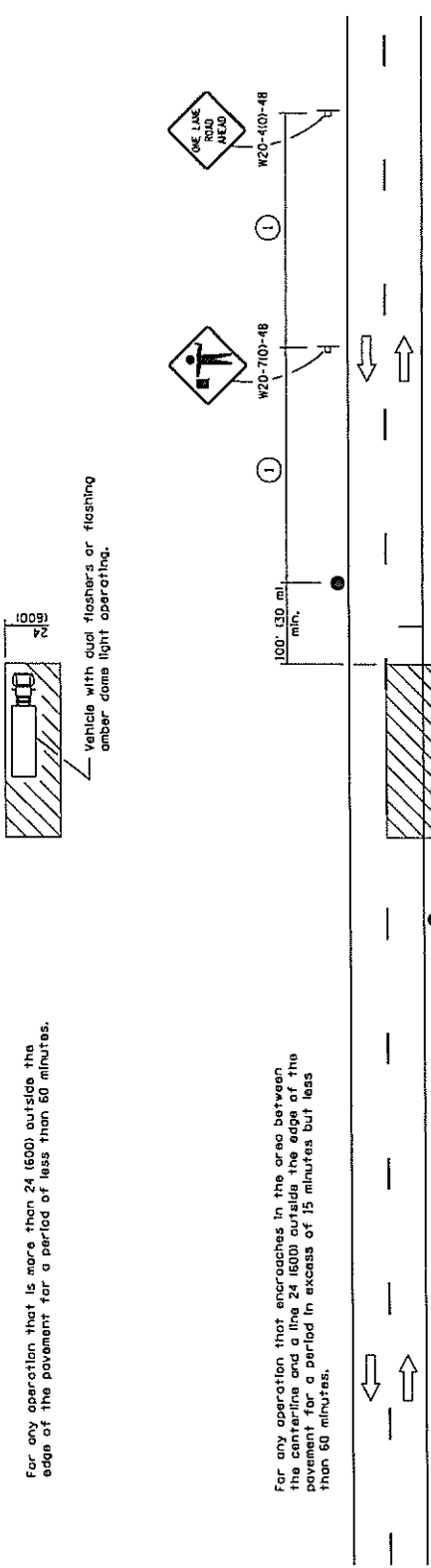

For any operation that encroaches in the area between the centerline and a line 24 (600) outside the edge of the pavement for a period in excess of 15 minutes but less than 60 minutes.

SIGN SPACING	
Posted Speed	Sign Spacing
55	500' (150 m)
60-65	350' (100 m)
<45	200' (60 m)

① = Refer to SIGN SPACING Table for distances.

All dimensions are in inches (millimeters) unless otherwise shown.

**SYMBOLS**

- ▨ Work area
- ⊥ Sign on portable or permanent support
- Flagger with traffic control sign

**TYPICAL APPLICATIONS**

- Marking patches
- Field layout
- String line
- Utility operations
- Cleaning up debris on pavement

DATE	REVISIONS
1-1-11	Revised flagger sign.
1-1-09	Switched units to English (metric).

**LANE CLOSURE, 2L, 2W, SHORT TIME OPERATIONS**

STANDARD 701301-04

Illinois Department of Transportation  
 APPROVED: [Signature] 2011  
 ENGINEER OF SURVEYING  
 APPROVED: [Signature] 2011  
 ENGINEER OF DESIGN AND ENVIRONMENT  
 ISSUED 1-1-97

Contract # 85646

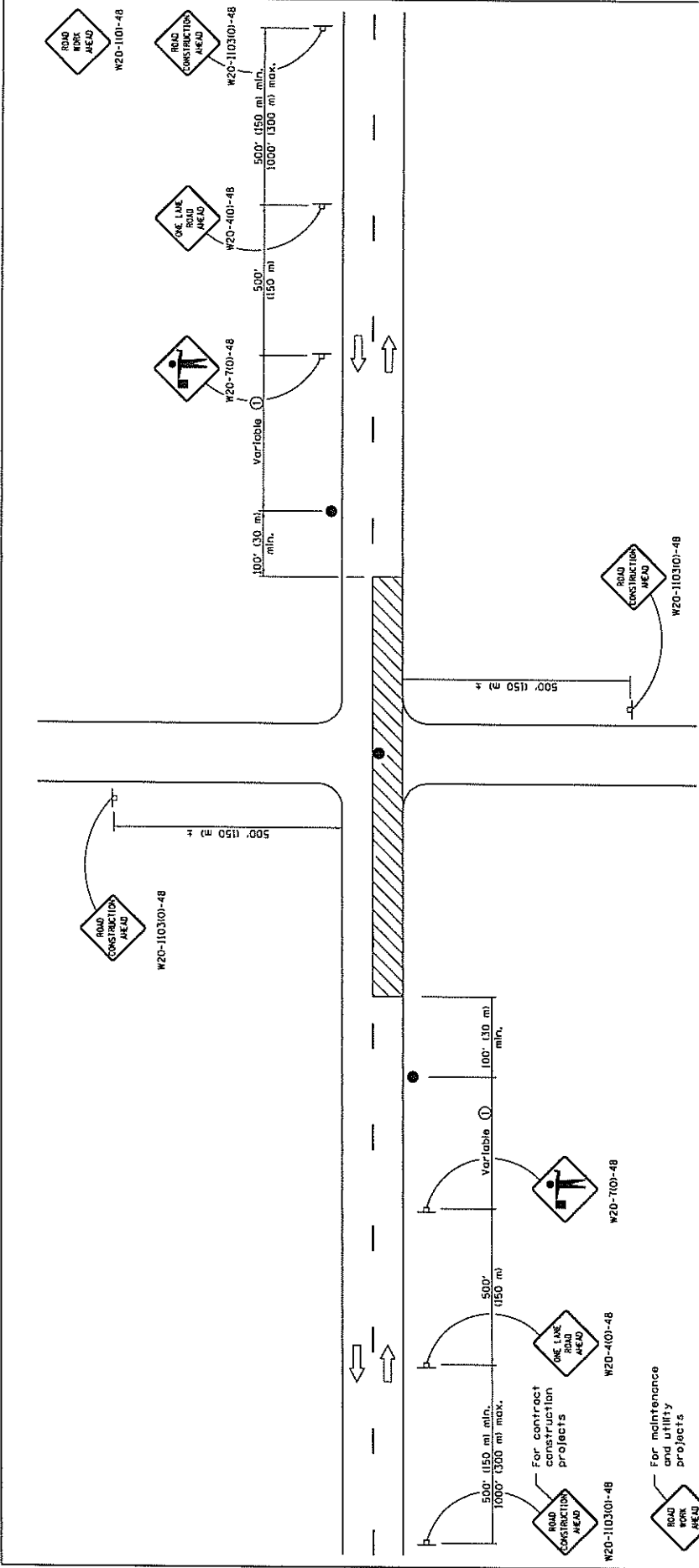

**GENERAL NOTES**

This Standard is used where at any time, any vehicle, equipment, workers or their activities are present on a highway or continuous moving roadway in the event of a traffic control operation. The minimum advance warning distance shall be greater than the average speed of movement in greater than mph (2 km/h) and less than 4 mph (6 km/h).  
When the operation does not exceed 60 minutes, traffic control may be according to Standard 701301.

All dimensions are in inches (millimeters) unless otherwise shown.

**LANE CLOSURE, 2L, 2W, SLOW MOVING OPERATIONS DAY ONLY, FOR SPEEDS > 45 MPH**  
STANDARD 701306-03

① Minimum distance is 200' (60 m). Maximum distance is determined by the Engineer but should not exceed 1/2 the length required for one normal working day's operation or 2 miles (3200 m), whichever is less.

**SYMBOLS**

- Work area
- Sign on portable or permanent support
- Flagger with traffic control sign

**TYPICAL APPLICATIONS**

- Bituminous resurfacing
- Utility operations
- Shoulder operations

APPROVED	ISSUED 1-1-97
ILLINOIS Department of Transportation	
APPROVED	
ENGINEER	
APPROVED	
ENGINEER	

Contract # 85646

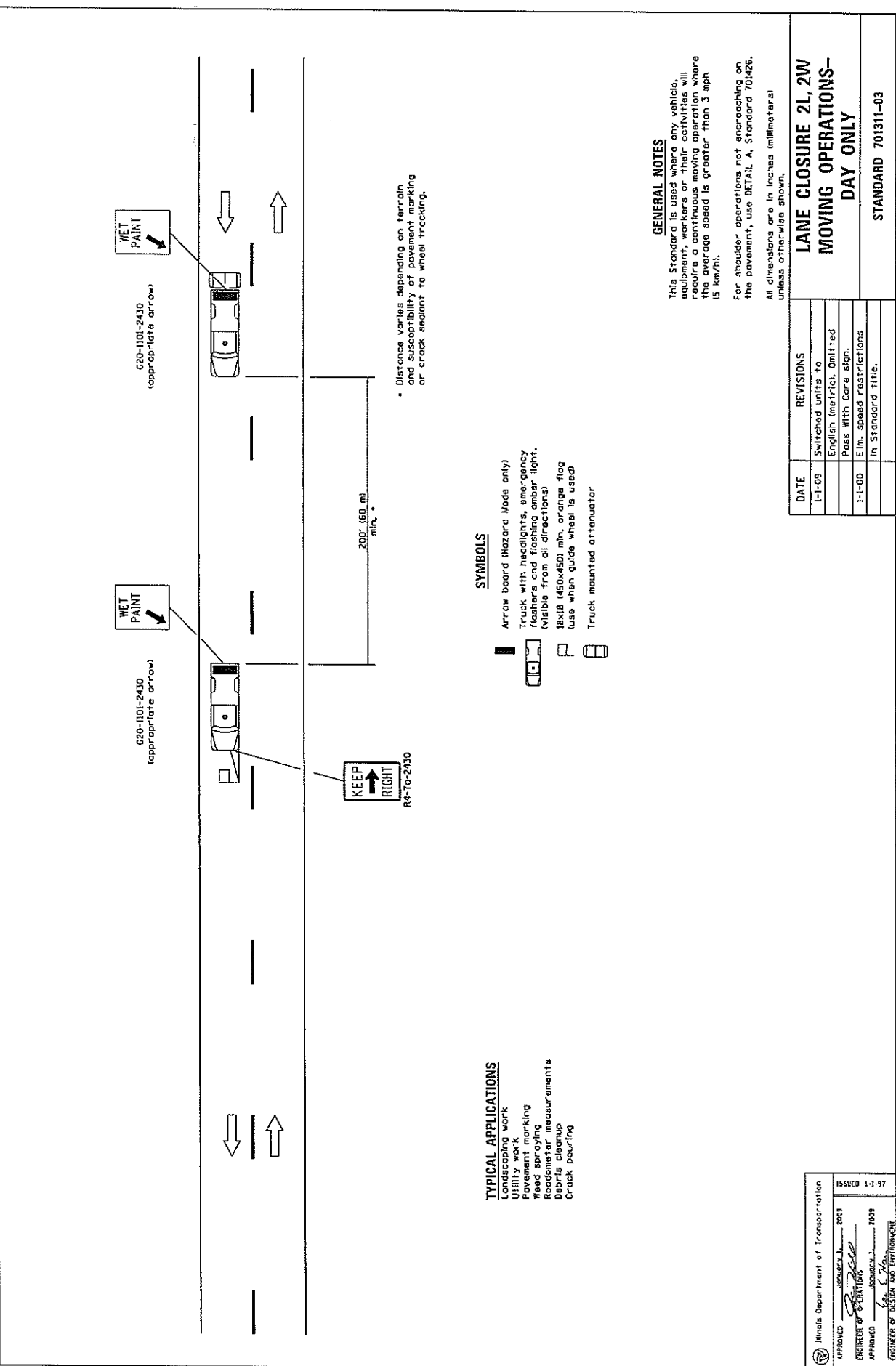

\* Distance varies depending on terrain and susceptibility of pavement marking or crack sealant to wheel tracking.

**TYPICAL APPLICATIONS**

- Landscaping work
- Utility work
- Pole work
- Road spraying
- Reconstruc. measurements
- Debris cleanup
- Crack pouring

**SYMBOLS**

- Arrow board (Hazard Mode only)
- Truck with headlights, emergency flashers and flashing amber light (visible from all directions)
- 18x18 (450x450) min. orange flag (use when guide wheel is used)
- Truck mounted attenuator

**GENERAL NOTES**

This Standard is used where any vehicle, equipment, workers or their activities will require a continuous moving operation where the average speed is greater than 3 mph (5 km/h).

For shoulder operations not encroaching on the pavement, use DETAIL A, Standard 701426. All dimensions are in inches (millimeter) unless otherwise shown.

Illinois Department of Transportation APPROVED: [Signature] 2009 ENGINEER OF OPERATIONS APPROVED: [Signature] 2009 ENGINEER OF DESIGN AND ENVIRONMENT		ISSUED 1-1-97
---	--	---------------

DATE	REVISIONS
1-1-09	Switched units to English (metric). Omitted Pass With Care sign.
1-1-00	Elim. speed restrictions in Standard title.

**LANE CLOSURE 2L, 2W  
MOVING OPERATIONS-  
DAY ONLY**  
STANDARD 701311-03

Contract # 85646

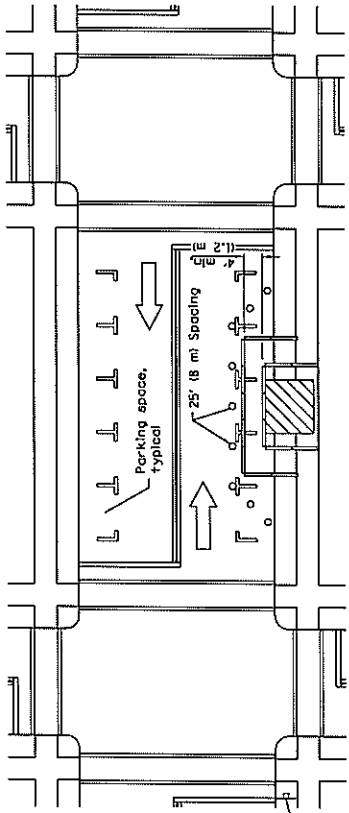

W20-1103101-48 for contract construction projects

or  
W20-1101-48 for maintenance and utility projects

**SIDEWALK DIVERSION**

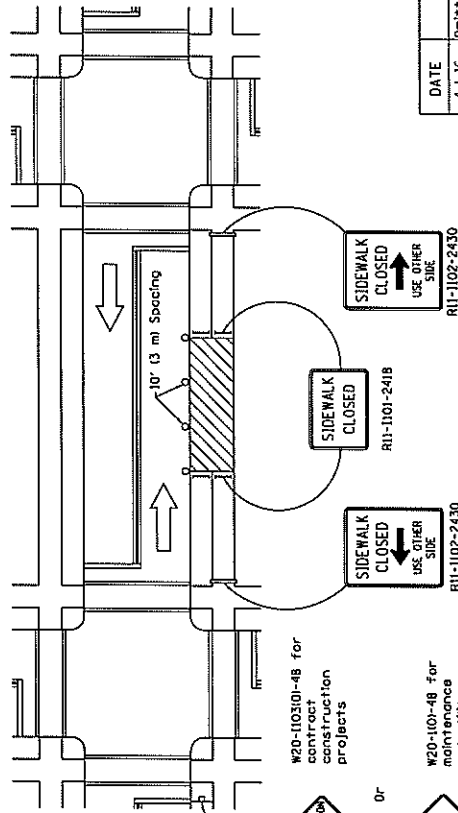

W20-1103101-48 for contract construction projects

or  
W20-1101-48 for maintenance and utility projects

**SIDEWALK CLOSURE**

**SYMBOLS**

- Work area
- Sign on portable or permanent support
- Barricade or drum
- Cone, drum or barricade
- Type III barricade
- Detectable pedestrian channelizing barricade

① Omit whenever duplicated by road work traffic control.

**GENERAL NOTES**

This Standard is used where, at any time, pedestrian traffic must be rerouted due to work being performed.

This Standard must be used in conjunction with other Traffic Control & Protection Standards when roadway traffic is affected.

Temporary facilities shall be detectable and accessible.

The temporary pedestrian facilities shall be provided on the same side of the closed facilities whenever possible.

The SIDEWALK CLOSED / USE OTHER SIDE sign shall be placed at the nearest crosswalk or intersection to each end of the closure. Where the closure occurs at a corner, the signs shall be erected on the corners across the street from the closure. The SIDEWALK CLOSED signs shall be used at the ends of the actual closures.

Type III barricades and R11-2-4830 signs shall be positioned as shown in "ROAD CLOSED TO ALL TRAFFIC" detail on Standard 701901.

All dimensions are in inches (millimeters) unless otherwise shown.

DATE	REVISIONS
4-1-16	Omitted orange safety fence from standard as this is covered in the std. spec.
1-1-12	Added SIDEWALK DIVERSION; Modified appearance of plan views. Retained Std.

**SIDEWALK, CORNER OR CROSSWALK CLOSURE**

STANDARD 701801-06

(Sheet 1 of 2)

Illinois Department of Transportation  
 APPROVED: [Signature] 2016  
 ENGINEER OF SAFETY ENGINEERING  
 APPROVED: [Signature] 2016  
 ENGINEER OF RECORD AND ENVIRONMENT

ISSUED 1-1-97

Contract # 85646

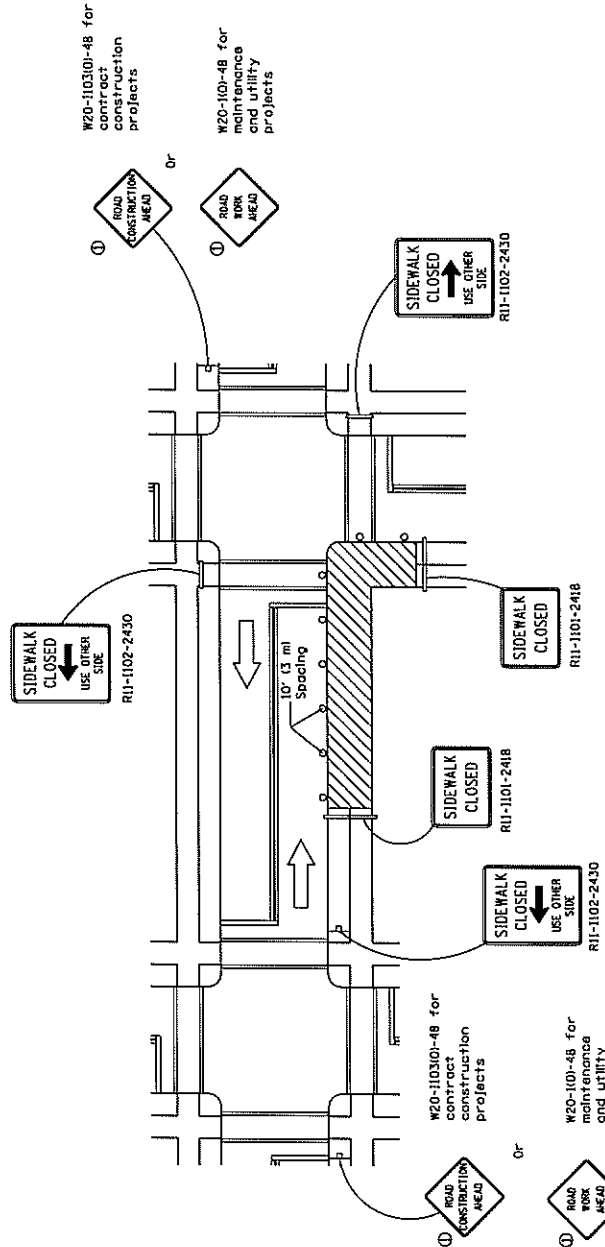

**CORNER CLOSURE**

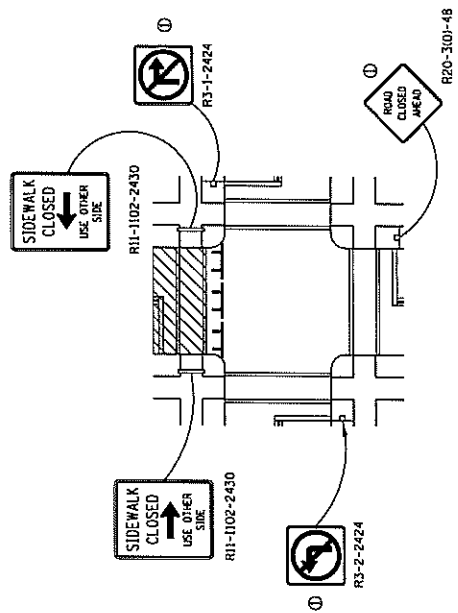

**CROSSWALK CLOSURE**

**SIDEWALK, CORNER OR CROSSWALK CLOSURE**  
 STANDARD 701801-06  
 (Sheet 2 of 2)

Illinois Department of Transportation  
 ISSUED 1-1-97  
 APPROVED: [Signature] 2016  
 ENGINEER OF SAFETY ENGINEERING  
 APPROVED: [Signature] 2016  
 ENGINEER OF DESIGN AND EQUIPMENT

Contract # 85646

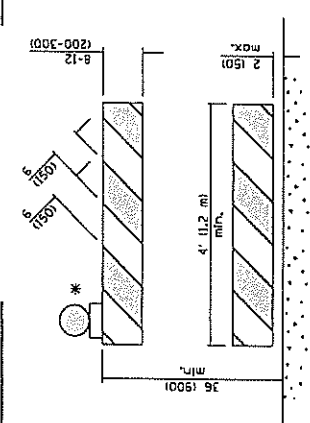
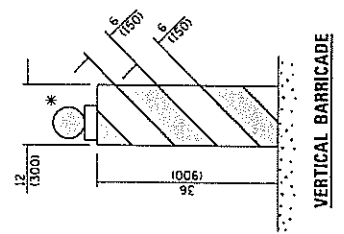
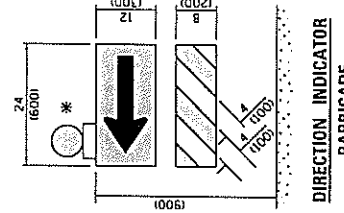
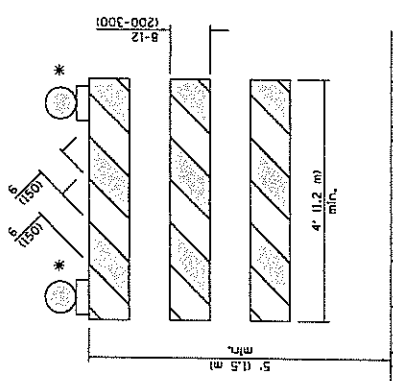
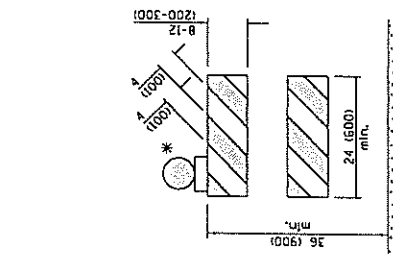
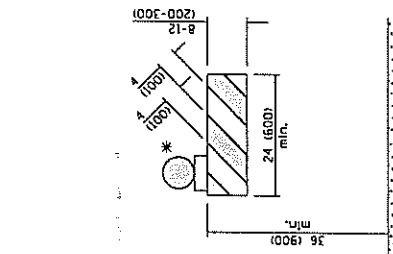
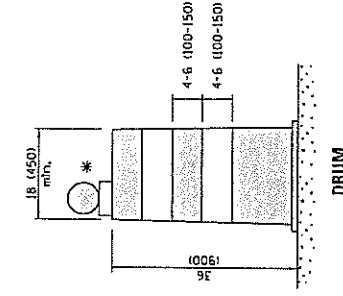
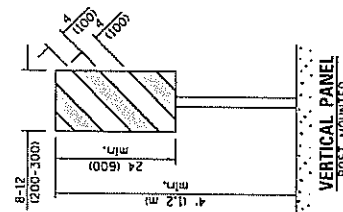
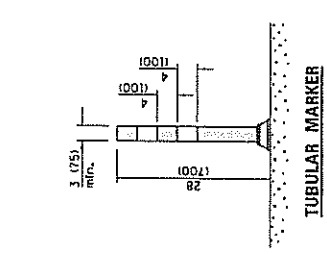
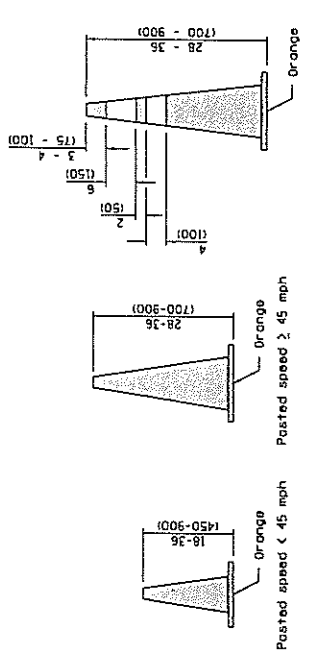

\* Warning lights (if required)

**GENERAL NOTES**  
 All heights shown shall be measured above the pavement surface.  
 All dimensions are in inches (millimeters) unless otherwise shown.

TRAFFIC CONTROL DEVICES	
DATE	REVISIONS
1-1-17	Changed FLEXIBLE DECLINEATOR TO TUBULAR MARKER.
4-1-16	Add dims to barricades. Rev. note for post mnt. signs. Rev. cone dtis. Add W12-100.

Michigan Department of Transportation  
 APPROVED: [Signature] 2017  
 PROJECT: [Signature] 2017  
 APPROVED: [Signature] 2017  
 ENGINEER/DESIGN: [Signature] 2017

Contract # 85646

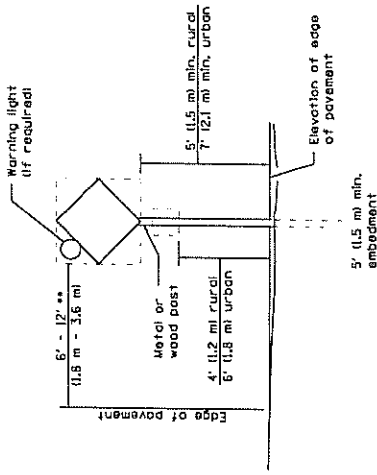

**POST MOUNTED SIGNS**

\*\* When curb or paved shoulder are present this dimension shall be 24 (600) to the face of curb or 5' (1.5 m) to the outside edge of the paved shoulder.

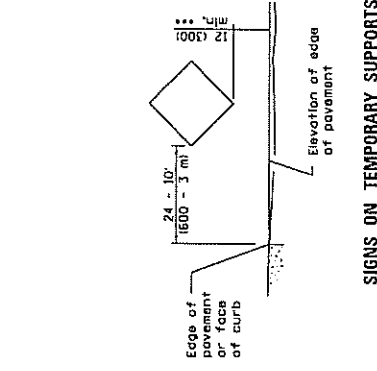

**SIGNS ON TEMPORARY SUPPORTS**

\*\*\* When work operations exceed four days, this dimension shall be 5' (1.5 m) min. If located behind other devices, the height shall be sufficient to be seen completely above the devices.

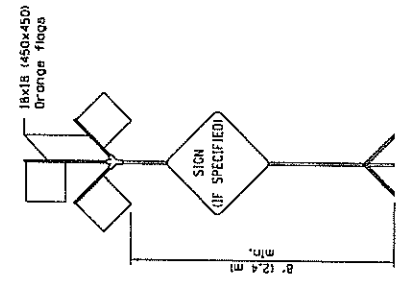

**HIGH LEVEL WARNING DEVICE**

ROAD CONSTRUCTION NEXT X MILES  
G20-110401-6036

END CONSTRUCTION  
G20-1105101-6024

This signing is required for all projects 2 miles (3200 m) or more in length.  
ROAD CONSTRUCTION NEXT X MILES sign shall be placed 500 (150 m) in advance of project limits.  
END CONSTRUCTION sign shall be erected at the end of the job unless another job is within 2 miles (3200 m).  
Dual sign displays shall be utilized on multi-lane highways.

**WORK LIMIT SIGNING**

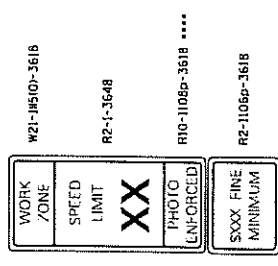

Sign assembly as shown on Standards or as allowed by District Operations.

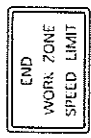

This sign shall be used when the above sign assembly is used.

**HIGHWAY CONSTRUCTION SPEED ZONE SIGNS**

.... R10-1108p shall only be used along roadways under the jurisdiction of the State.

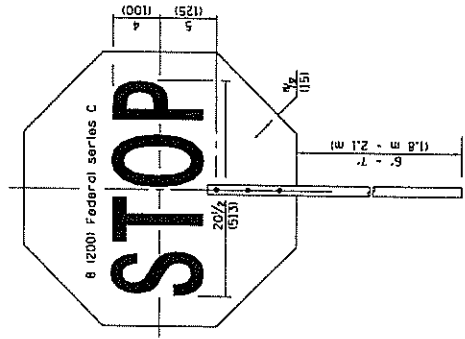

FRONT SIDE

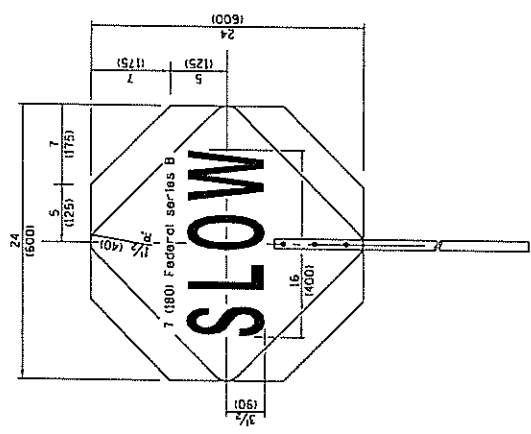

REVERSE SIDE

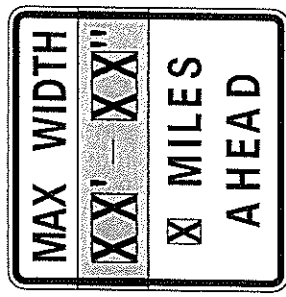

W12-1103-4848

**WIDTH RESTRICTION SIGN**

XX-XX" width and X miles are variable.

Minnesota Department of Transportation

APPROVED: \_\_\_\_\_ 2017

ENGINEER OF OPERATIONS

APPROVED: \_\_\_\_\_ 2017

INSURANCE DESIGN AND ENVIRONMENT

ISSUED 1-1-97

**FLAGGER TRAFFIC CONTROL SIGN**

**TRAFFIC CONTROL DEVICES**  
(Sheet 2 of 3)

STANDARD 701901-06

Contract # 85646

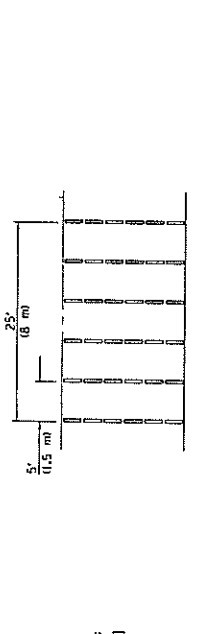
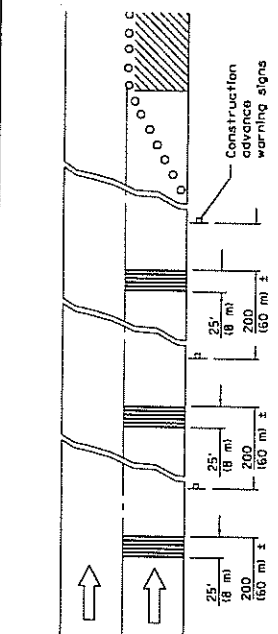

TYPICAL INSTALLATION

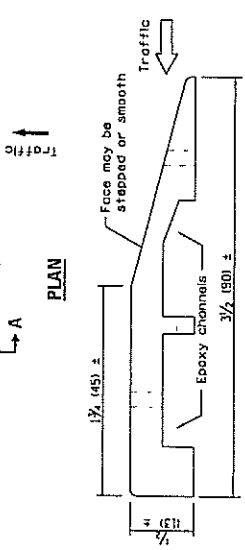
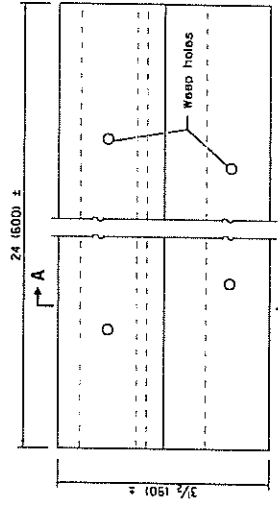

SECTION A-A

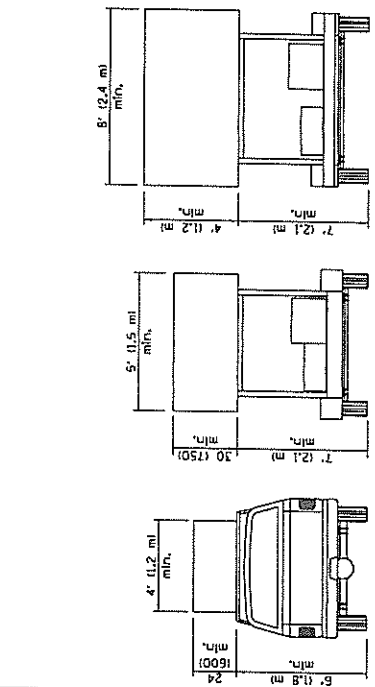

TYPE C TRAILER MOUNTED

TYPE B ROOF OR TRAILER MOUNTED

TYPE A ROOF MOUNTED

ARROW BOARDS

TEMPORARY RUMBLE STRIPS

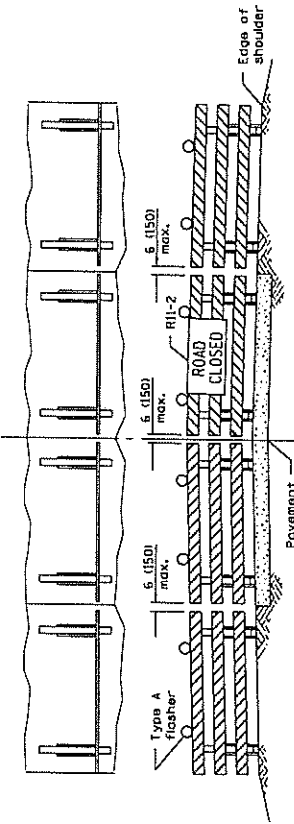
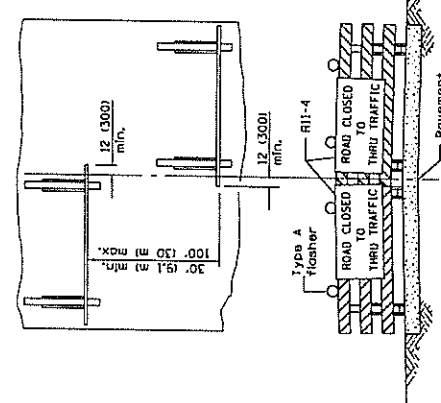

ROAD CLOSED TO ALL TRAFFIC

ReflectORIZED striping may be omitted on the back side of the barricades. If a Type III barricade with an attached sign panel which meets NCHRP 350 is not available, the sign may be mounted on an NCHRP 350 temporary sign support directly in front of the barricade.

TYPICAL APPLICATIONS OF TYPE III BARRICADES CLOSING A ROAD

ROAD CLOSED TO THRU TRAFFIC  
ReflectORIZED striping shall appear on both sides of the barricades. If a Type III barricade with an attached sign panel which meets NCHRP 350 is not available, the signs may be mounted on NCHRP 350 temporary sign supports directly in front of the barricade.

Illinois Department of Transportation	
APPROVED	ISSUED 1-1-97
DESIGNED BY	2017
ENGINEER OF OPERATIONS	
APPROVED	2017
DESIGNED BY	
ENGINEERING DESIGN AND DEVELOPMENT	

TRAFFIC CONTROL DEVICES  
STANDARD 701901-06  
Sheet 3 of 3

Contract # 85646



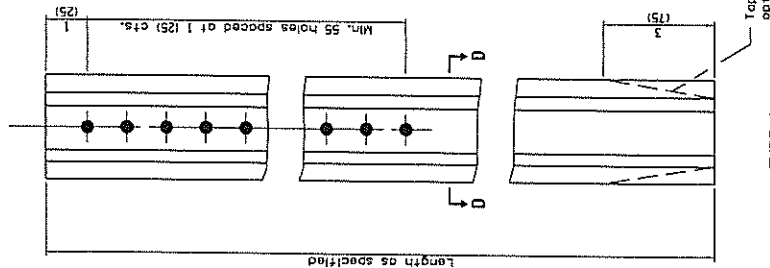

TYPE A

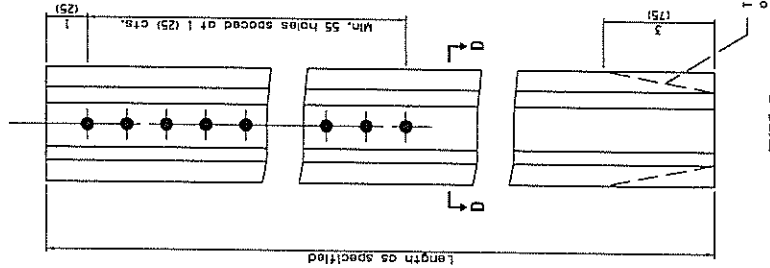

TYPE B

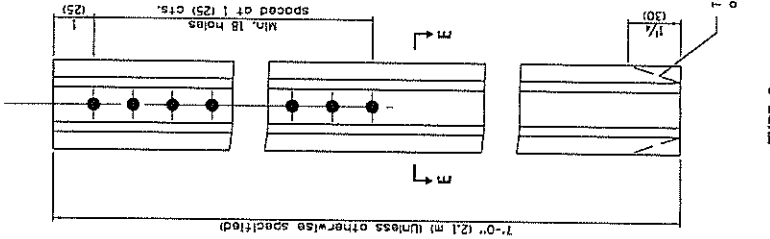

TYPE C

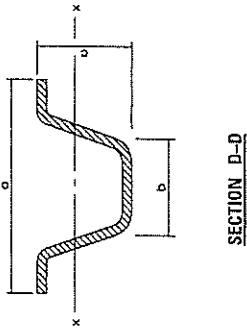

SECTION D-D

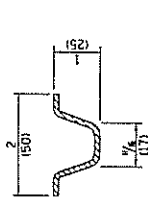

SECTION E-E

Steel - 1.12 lbs./ft. (1.67 kg/m)

**GENERAL NOTES**

Dimensions shown for cross sections are minimum.  
All holes are  $\frac{3}{8}$  (10).

Sx-x is the minimum section modulus about the x-x axis of the post as shown. For posts in which holes are punched or drilled for more than half their length, Sx-x shall be computed for the net section.

All dimensions are in inches (millimeters) unless otherwise shown.

	Sx-x	c	d	D	Sx-x	lbs./ft.
	in. <sup>3</sup>				(mm <sup>3</sup> )	(kg/m)
TYPE A	Steel	3/4	1/4	1 1/4	0.223	2.00
	Aluminum	3/4	1/4	1 1/4	0.435	0.90
TYPE B	Steel	3/4	1/4	1 1/4	0.34	3.00
	Aluminum	3/4	1/4	1 1/4	0.688	1.50

Illinois Department of Transportation  
 PASSED \_\_\_\_\_ 2001  
 ENGINEER OF PUBLIC WORKS  
 APPROVED \_\_\_\_\_ 2009  
 ENGINEER OF DESIGN AND ENVIRONMENT

ISSUED 1-1-97

DATE	REVISIONS
1-1-09	Switched units to English Imperial.
1-1-97	Revised Standard 2350-4.

**METAL POSTS FOR SIGNS, MARKERS & DELINEATORS**

STANDARD 720011-01

Contract # 85646

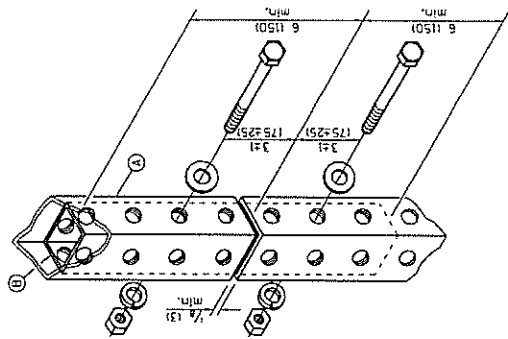

SPLICE DETAIL

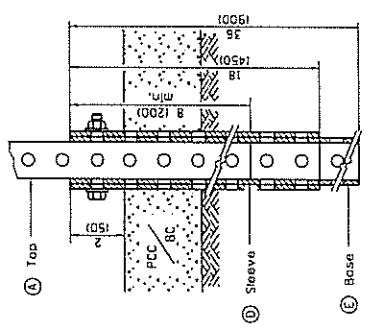

PAVEMENT MOUNT DETAIL

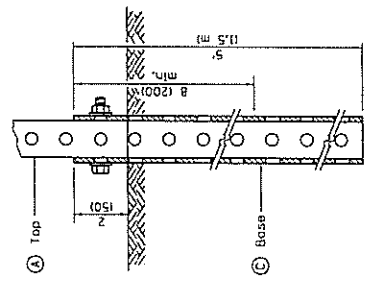

GROUND MOUNT DETAIL

Ⓐ	2 x 2 x var. (51 x 51) var-1
Ⓑ	1 1/4 x 1 1/4 x 12 (44 x 44 x 300)
Ⓒ	2/4 x 2/4 x 60 (57 x 57 x 1500)
Ⓓ	2/4 x 2/4 x 18 (64 x 64 x 450)
Ⓔ	2/4 x 2/4 x 36 (57 x 57 x 900)

**GENERAL NOTES**  
 All bolts 1/2 (M10) hex head zinc or cadmium plated.  
 All dimensions are in inches (millimeters) unless otherwise shown.

DATE	REVISIONS
1-1-09	Switched units to English (metric).
1-1-07	New Standard. Used to be part of Standard 720006.

Illinois Department of Transportation APPROVED: <i>[Signature]</i> 2009 ENGINEER OF OPERATIONS APPROVED: <i>[Signature]</i> 2009 ENGINEER OF DESIGN AND ESTIMATION	ISSUED 1-1-07
--	---------------

Contract # 85646

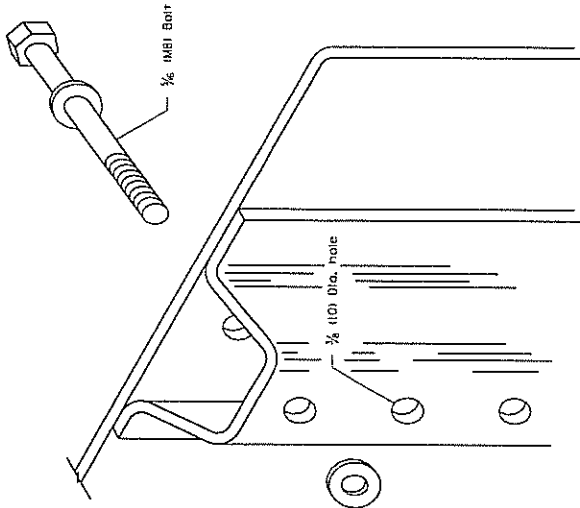

**DETAIL OF MOUNTING SIGN TO POST**  
 NOTE: Minimum of 2 bolts per post required.

**GENERAL NOTES**

DESIGN: Current AASHTO Standard Specifications for Structural Supports for Highway Signs, Luminaires and Traffic Signals.  
 LOADING: for 60 mph (95 km/h) wind velocity with 30% gust factor, normal to sign.  
 SOIL PRESSURE: Minimum allowable soil pressure 1.25 tsf (120 kPa).  
 See Standard 72001 for details of Types A and B posts.  
 All dimensions are in inches (millimeters) unless otherwise shown.

APPLICATIONS OF TYPES A & B METAL POSTS (FOR SIGNS & MARKERS)	
DATE	REVISIONS
1-1-09	Switched units to English (metric).
1-1-97	Renum. Standard 2363-2.
	STANDARD 729001-01

SIGN DEPTH (D)	H	NO. AND TYPE OF POST FOR SIGN WIDTH (W)			
		12 (300)	18 (450)	24 (600)	30 (750)
18 (450)	5'-0" (1.5 m)	A	A	A	A
	6'-0" (1.8 m)	A	A	A	A
	7'-0" (2.1 m)	A	A	A	A
24 (600)	5'-0" (1.5 m)	A	A	A	A
	6'-0" (1.8 m)	A	A	A	A
	7'-0" (2.1 m)	A	A	A	A
30 (750)	5'-0" (1.5 m)	A	A	A	A
	6'-0" (1.8 m)	A	A	A	A
	7'-0" (2.1 m)	A	A	A	A
36 (900)	5'-0" (1.5 m)	A	A	A	A
	6'-0" (1.8 m)	A	A	A	A
	7'-0" (2.1 m)	A	A	A	A
4'-0" (11.2 m)	5'-0" (1.5 m)	A	A	A	A
	6'-0" (1.8 m)	A	A	A	A
	7'-0" (2.1 m)	A	A	A	A

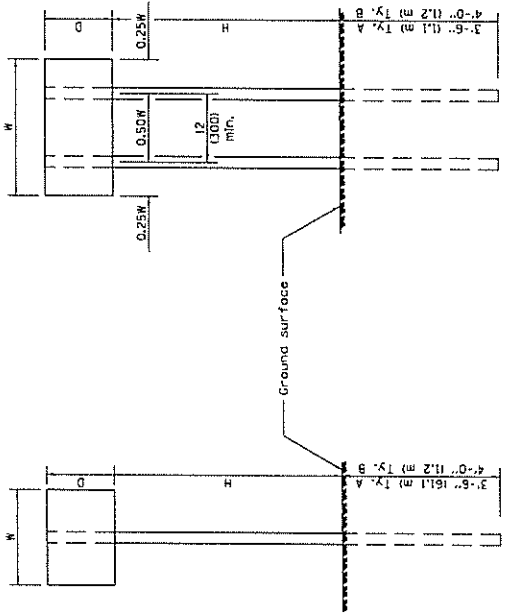

**TWO POST INSTALLATION**

**ONE POST INSTALLATION**

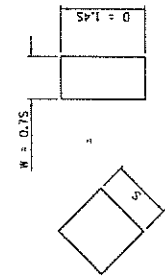

For diamond shaped sign with side S as shown, use required post size for a sign with W = 0.75 and D = 1.45.

Illinois Department of Transportation  
 PASSED: [Signature] JUNE 27, 2008  
 ENGINEER OF PROJECT AND PROCEDURES  
 APPROVED: [Signature] JUNE 27, 2008  
 ENGINEER OF DESIGN AND ENVIRONMENT

Contract # 85646

## REQUIRED CONTRACT PROVISIONS FEDERAL-AID CONSTRUCTION CONTRACTS

- I. General
- II. Nondiscrimination
- III. Nonsegregated Facilities
- IV. Davis-Bacon and Related Act Provisions
- V. Contract Work Hours and Safety Standards Act Provisions
- VI. Subletting or Assigning the Contract
- VII. Safety: Accident Prevention
- VIII. False Statements Concerning Highway Projects
- IX. Implementation of Clean Air Act and Federal Water Pollution Control Act
- X. Compliance with Governmentwide Suspension and Debarment Requirements
- XI. Certification Regarding Use of Contract Funds for Lobbying

### ATTACHMENTS

A. Employment and Materials Preference for Appalachian Development Highway System or Appalachian Local Access Road Contracts (included in Appalachian contracts only)

#### I. GENERAL

1. Form FHWA-1273 must be physically incorporated in each construction contract funded under Title 23 (excluding emergency contracts solely intended for debris removal). The contractor (or subcontractor) must insert this form in each subcontract and further require its inclusion in all lower tier subcontracts (excluding purchase orders, rental agreements and other agreements for supplies or services).

The applicable requirements of Form FHWA-1273 are incorporated by reference for work done under any purchase order, rental agreement or agreement for other services. The prime contractor shall be responsible for compliance by any subcontractor, lower-tier subcontractor or service provider.

Form FHWA-1273 must be included in all Federal-aid design-build contracts, in all subcontracts and in lower tier subcontracts (excluding subcontracts for design services, purchase orders, rental agreements and other agreements for supplies or services). The design-builder shall be responsible for compliance by any subcontractor, lower-tier subcontractor or service provider.

Contracting agencies may reference Form FHWA-1273 in bid proposal or request for proposal documents, however, the Form FHWA-1273 must be physically incorporated (not referenced) in all contracts, subcontracts and lower-tier subcontracts (excluding purchase orders, rental agreements and other agreements for supplies or services related to a construction contract).

2. Subject to the applicability criteria noted in the following sections, these contract provisions shall apply to all work performed on the contract by the contractor's own organization and with the assistance of workers under the contractor's immediate superintendence and to all work performed on the contract by piecework, station work, or by subcontract.

3. A breach of any of the stipulations contained in these Required Contract Provisions may be sufficient grounds for withholding of progress payments, withholding of final payment, termination of the contract, suspension / debarment or any other action determined to be appropriate by the contracting agency and FHWA.

4. Selection of Labor: During the performance of this contract, the contractor shall not use convict labor for any purpose within the limits of a construction project on a Federal-aid highway unless it is labor performed by convicts who are on parole, supervised release, or probation. The term Federal-aid highway does not include roadways functionally classified as local roads or rural minor collectors.

#### II. NONDISCRIMINATION

The provisions of this section related to 23 CFR Part 230 are applicable to all Federal-aid construction contracts and to all related construction subcontracts of \$10,000 or more. The provisions of 23 CFR Part 230 are not applicable to material supply, engineering, or architectural service contracts.

In addition, the contractor and all subcontractors must comply with the following policies: Executive Order 11246, 41 CFR 60, 29 CFR 1625-1627, Title 23 USC Section 140, the Rehabilitation Act of 1973, as amended (29 USC 794), Title VI of the Civil Rights Act of 1964, as amended, and related regulations including 49 CFR Parts 21, 26 and 27; and 23 CFR Parts 200, 230, and 633.

The contractor and all subcontractors must comply with: the requirements of the Equal Opportunity Clause in 41 CFR 60-1.4(b) and, for all construction contracts exceeding \$10,000, the Standard Federal Equal Employment Opportunity Construction Contract Specifications in 41 CFR 60-4.3.

Note: The U.S. Department of Labor has exclusive authority to determine compliance with Executive Order 11246 and the policies of the Secretary of Labor including 41 CFR 60, and 29 CFR 1625-1627. The contracting agency and the FHWA have the authority and the responsibility to ensure compliance with Title 23 USC Section 140, the Rehabilitation Act of 1973, as amended (29 USC 794), and Title VI of the Civil Rights Act of 1964, as amended, and related regulations including 49 CFR Parts 21, 26 and 27; and 23 CFR Parts 200, 230, and 633.

The following provision is adopted from 23 CFR 230, Appendix A, with appropriate revisions to conform to the U.S. Department of Labor (US DOL) and FHWA requirements.

**1. Equal Employment Opportunity:** Equal employment opportunity (EEO) requirements not to discriminate and to take affirmative action to assure equal opportunity as set forth under laws, executive orders, rules, regulations (28 CFR 35, 29 CFR 1630, 29 CFR 1625-1627, 41 CFR 60 and 49 CFR 27) and orders of the Secretary of Labor as modified by the provisions prescribed herein, and imposed pursuant to 23 U.S.C. 140 shall constitute the EEO and specific affirmative action standards for the contractor's project activities under this contract. The provisions of the Americans with Disabilities Act of 1990 (42 U.S.C. 12101 et seq.) set forth under 28 CFR 35 and 29 CFR 1630 are incorporated by reference in this contract. In the execution of this contract, the contractor agrees to comply with the following minimum specific requirement activities of EEO:

a. The contractor will work with the contracting agency and the Federal Government to ensure that it has made every good faith effort to provide equal opportunity with respect to all of its terms and conditions of employment and in their review of activities under the contract.

b. The contractor will accept as its operating policy the following statement:

"It is the policy of this Company to assure that applicants are employed, and that employees are treated during employment, without regard to their race, religion, sex, color, national origin, age or disability. Such action shall include: employment, upgrading, demotion, or transfer; recruitment or recruitment advertising; layoff or termination; rates of pay or other forms of compensation; and selection for training, including apprenticeship, pre-apprenticeship, and/or on-the-job training."

**2. EEO Officer:** The contractor will designate and make known to the contracting officers an EEO Officer who will have the responsibility for and must be capable of effectively administering and promoting an active EEO program and who must be assigned adequate authority and responsibility to do so.

**3. Dissemination of Policy:** All members of the contractor's staff who are authorized to hire, supervise, promote, and discharge employees, or who recommend such action, or who are substantially involved in such action, will be made fully cognizant of, and will implement, the contractor's EEO policy and contractual responsibilities to provide EEO in each grade and classification of employment. To ensure that the above agreement will be met, the following actions will be taken as a minimum:

a. Periodic meetings of supervisory and personnel office employees will be conducted before the start of work and then not less often than once every six months, at which time the contractor's EEO policy and its implementation will be reviewed and explained. The meetings will be conducted by the EEO Officer.

b. All new supervisory or personnel office employees will be given a thorough indoctrination by the EEO Officer, covering all major aspects of the contractor's EEO obligations within thirty days following their reporting for duty with the contractor.

c. All personnel who are engaged in direct recruitment for the project will be instructed by the EEO Officer in the contractor's procedures for locating and hiring minorities and women.

d. Notices and posters setting forth the contractor's EEO policy will be placed in areas readily accessible to employees, applicants for employment and potential employees.

e. The contractor's EEO policy and the procedures to implement such policy will be brought to the attention of employees by means of meetings, employee handbooks, or other appropriate means.

**4. Recruitment:** When advertising for employees, the contractor will include in all advertisements for employees the notation: "An Equal Opportunity Employer." All such advertisements will be placed in publications having a large circulation among minorities and women in the area from which the project work force would normally be derived.

a. The contractor will, unless precluded by a valid bargaining agreement, conduct systematic and direct recruitment through public and private employee referral sources likely to yield qualified minorities and women. To meet this requirement, the contractor will identify sources of potential minority group employees, and establish with such identified sources procedures whereby minority and women applicants may be referred to the contractor for employment consideration.

b. In the event the contractor has a valid bargaining agreement providing for exclusive hiring hall referrals, the contractor is expected to observe the provisions of that agreement to the extent that the system meets the contractor's compliance with EEO contract provisions. Where implementation of such an agreement has the effect of discriminating against minorities or women, or obligates the contractor to do the same, such implementation violates Federal nondiscrimination provisions.

c. The contractor will encourage its present employees to refer minorities and women as applicants for employment. Information and procedures with regard to referring such applicants will be discussed with employees.

**5. Personnel Actions:** Wages, working conditions, and employee benefits shall be established and administered, and personnel actions of every type, including hiring, upgrading, promotion, transfer, demotion, layoff, and termination, shall be taken without regard to race, color, religion, sex, national origin, age or disability. The following procedures shall be followed:

a. The contractor will conduct periodic inspections of project sites to insure that working conditions and employee facilities do not indicate discriminatory treatment of project site personnel.

b. The contractor will periodically evaluate the spread of wages paid within each classification to determine any evidence of discriminatory wage practices.

c. The contractor will periodically review selected personnel actions in depth to determine whether there is evidence of discrimination. Where evidence is found, the contractor will promptly take corrective action. If

the review indicates that the discrimination may extend beyond the actions reviewed, such corrective action shall include all affected persons.

d. The contractor will promptly investigate all complaints of alleged discrimination made to the contractor in connection with its obligations under this contract, will attempt to resolve such complaints, and will take appropriate corrective action within a reasonable time. If the investigation indicates that the discrimination may affect persons other than the complainant, such corrective action shall include such other persons. Upon completion of each investigation, the contractor will inform every complainant of all of their avenues of appeal.

## **6. Training and Promotion:**

a. The contractor will assist in locating, qualifying, and increasing the skills of minorities and women who are applicants for employment or current employees. Such efforts should be aimed at developing full journey level status employees in the type of trade or job classification involved.

b. Consistent with the contractor's work force requirements and as permissible under Federal and State regulations, the contractor shall make full use of training programs, i.e., apprenticeship, and on-the-job training programs for the geographical area of contract performance. In the event a special provision for training is provided under this contract, this subparagraph will be superseded as indicated in the special provision. The contracting agency may reserve training positions for persons who receive welfare assistance in accordance with 23 U.S.C. 140(a).

c. The contractor will advise employees and applicants for employment of available training programs and entrance requirements for each.

d. The contractor will periodically review the training and promotion potential of employees who are minorities and women and will encourage eligible employees to apply for such training and promotion.

**7. Unions:** If the contractor relies in whole or in part upon unions as a source of employees, the contractor will use good faith efforts to obtain the cooperation of such unions to increase opportunities for minorities and women. Actions by the contractor, either directly or through a contractor's association acting as agent, will include the procedures set forth below:

a. The contractor will use good faith efforts to develop, in cooperation with the unions, joint training programs aimed toward qualifying more minorities and women for membership in the unions and increasing the skills of minorities and women so that they may qualify for higher paying employment.

b. The contractor will use good faith efforts to incorporate an EEO clause into each union agreement to the end that such union will be contractually bound to refer applicants without regard to their race, color, religion, sex, national origin, age or disability.

c. The contractor is to obtain information as to the referral practices and policies of the labor union except that to the extent such information is within the exclusive possession of the labor union and such labor union refuses to furnish such information to the contractor, the contractor shall so certify to the contracting agency and shall set forth what efforts have been made to obtain such information.

d. In the event the union is unable to provide the contractor with a reasonable flow of referrals within the time limit set forth in the collective bargaining agreement, the contractor will, through independent recruitment efforts, fill the employment vacancies without regard to race, color, religion, sex, national origin, age or disability; making full efforts to obtain qualified and/or qualifiable minorities and women. The failure of a union to provide sufficient referrals (even though it is obligated to provide exclusive referrals under the terms of a collective bargaining agreement) does not relieve the contractor from the requirements of this paragraph. In the event the union referral practice prevents the contractor from meeting the obligations pursuant to Executive Order 11246, as amended, and these special provisions, such contractor shall immediately notify the contracting agency.

**8. Reasonable Accommodation for Applicants / Employees with Disabilities:** The contractor must be familiar with the requirements for and comply with the Americans with Disabilities Act and all rules and regulations established there under. Employers must provide reasonable accommodation in all employment activities unless to do so would cause an undue hardship.

**9. Selection of Subcontractors, Procurement of Materials and Leasing of Equipment:** The contractor shall not discriminate on the grounds of race, color, religion, sex, national origin, age or disability in the selection and retention of subcontractors, including procurement of materials and leases of equipment. The contractor shall take all necessary and reasonable steps to ensure nondiscrimination in the administration of this contract.

a. The contractor shall notify all potential subcontractors and suppliers and lessors of their EEO obligations under this contract.

b. The contractor will use good faith efforts to ensure subcontractor compliance with their EEO obligations.

**10. Assurance Required by 49 CFR 26.13(b):**

a. The requirements of 49 CFR Part 26 and the State DOT's U.S. DOT-approved DBE program are incorporated by reference.

b. The contractor or subcontractor shall not discriminate on the basis of race, color, national origin, or sex in the performance of this contract. The contractor shall carry out applicable requirements of 49 CFR Part 26 in the award and administration of DOT-assisted contracts. Failure by the contractor to carry out these requirements is a material breach of this contract, which may result in the termination of this contract or such other remedy as the contracting agency deems appropriate.

**11. Records and Reports:** The contractor shall keep such records as necessary to document compliance with the EEO requirements. Such records shall be retained for a period of three years following the date of the final payment to the contractor for all contract work and shall be available at reasonable times and places for inspection by authorized representatives of the contracting agency and the FHWA.

a. The records kept by the contractor shall document the following:

(1) The number and work hours of minority and non-minority group members and women employed in each work classification on the project;

(2) The progress and efforts being made in cooperation with unions, when applicable, to increase employment opportunities for minorities and women; and

(3) The progress and efforts being made in locating, hiring, training, qualifying, and upgrading minorities and women;

b. The contractors and subcontractors will submit an annual report to the contracting agency each July for the duration of the project, indicating the number of minority, women, and non-minority group employees currently engaged in each work classification required by the contract work. This information is to be reported on [Form FHWA-1391](#). The staffing data should represent the project work force on board in all or any part of the last payroll period preceding the end of July. If on-the-job training is being required by special provision, the contractor will be required to collect and report training data. The employment data should reflect the work force on board during all or any part of the last payroll period preceding the end of July.

**III. NONSEGREGATED FACILITIES**

This provision is applicable to all Federal-aid construction contracts and to all related construction subcontracts of \$10,000 or more.

The contractor must ensure that facilities provided for employees are provided in such a manner that segregation on the basis of race, color,

religion, sex, or national origin cannot result. The contractor may neither require such segregated use by written or oral policies nor tolerate such use by employee custom. The contractor's obligation extends further to ensure that its employees are not assigned to perform their services at any location, under the contractor's control, where the facilities are segregated. The term "facilities" includes waiting rooms, work areas, restaurants and other eating areas, time clocks, restrooms, washrooms, locker rooms, and other storage or dressing areas, parking lots, drinking fountains, recreation or entertainment areas, transportation, and housing provided for employees. The contractor shall provide separate or single-user restrooms and necessary dressing or sleeping areas to assure privacy between sexes.

**IV. Davis-Bacon and Related Act Provisions**

This section is applicable to all Federal-aid construction projects exceeding \$2,000 and to all related subcontracts and lower-tier subcontracts (regardless of subcontract size). The requirements apply to all projects located within the right-of-way of a roadway that is functionally classified as Federal-aid highway. This excludes roadways functionally classified as local roads or rural minor collectors, which are exempt. Contracting agencies may elect to apply these requirements to other projects.

The following provisions are from the U.S. Department of Labor regulations in 29 CFR 5.5 "Contract provisions and related matters" with minor revisions to conform to the FHWA-1273 format and FHWA program requirements.

**1. Minimum wages**

a. All laborers and mechanics employed or working upon the site of the work, will be paid unconditionally and not less often than once a week, and without subsequent deduction or rebate on any account (except such payroll deductions as are permitted by regulations issued by the Secretary of Labor under the Copeland Act (29 CFR part 3)), the full amount of wages and bona fide fringe benefits (or cash equivalents thereof) due at time of payment computed at rates not less than those contained in the wage determination of the Secretary of Labor which is attached hereto and made a part hereof, regardless of any contractual relationship which may be alleged to exist between the contractor and such laborers and mechanics.

Contributions made or costs reasonably anticipated for bona fide fringe benefits under section 1(b)(2) of the Davis-Bacon Act on behalf of laborers or mechanics are considered wages paid to such laborers or mechanics, subject to the provisions of paragraph 1.d. of this section; also, regular contributions made or costs incurred for more than a weekly period (but not less often than quarterly) under plans, funds, or programs which cover the particular weekly period, are deemed to be constructively made or incurred during such weekly period. Such laborers and mechanics shall be paid the appropriate wage rate and fringe benefits on the wage determination for the classification of work actually performed, without regard to skill, except as provided in 29 CFR 5.5(a)(4). Laborers or mechanics performing work in more than one classification may be compensated at the rate specified for each classification for the time actually worked therein: Provided, That the employer's payroll records accurately set forth the time spent in each classification in which work is performed. The wage determination (including any additional classification and wage rates conformed under paragraph 1.b. of this section) and the Davis-Bacon poster (WH-1321) shall be posted at all times by the contractor and its subcontractors at the site of the work in a prominent and accessible place where it can be easily seen by the workers.

b.(1) The contracting officer shall require that any class of laborers or mechanics, including helpers, which is not listed in the wage determination and which is to be employed under the contract shall be classified in conformance with the wage determination. The contracting officer shall approve an additional classification and wage rate and fringe benefits therefore only when the following criteria have been met:

(i) The work to be performed by the classification requested is not performed by a classification in the wage determination; and

(ii) The classification is utilized in the area by the construction industry; and

(iii) The proposed wage rate, including any bona fide fringe benefits, bears a reasonable relationship to the wage rates contained in the wage determination.

(2) If the contractor and the laborers and mechanics to be employed in the classification (if known), or their representatives, and the contracting officer agree on the classification and wage rate (including the amount designated for fringe benefits where appropriate), a report of the action taken shall be sent by the contracting officer to the Administrator of the Wage and Hour Division, Employment Standards Administration, U.S. Department of Labor, Washington, DC 20210. The Administrator, or an authorized representative, will approve, modify, or disapprove every additional classification action within 30 days of receipt and so advise the contracting officer or will notify the contracting officer within the 30-day period that additional time is necessary.

(3) In the event the contractor, the laborers or mechanics to be employed in the classification or their representatives, and the contracting officer do not agree on the proposed classification and wage rate (including the amount designated for fringe benefits, where appropriate), the contracting officer shall refer the questions, including the views of all interested parties and the recommendation of the contracting officer, to the Wage and Hour Administrator for determination. The Wage and Hour Administrator, or an authorized representative, will issue a determination within 30 days of receipt and so advise the contracting officer or will notify the contracting officer within the 30-day period that additional time is necessary.

(4) The wage rate (including fringe benefits where appropriate) determined pursuant to paragraphs 1.b.(2) or 1.b.(3) of this section, shall be paid to all workers performing work in the classification under this contract from the first day on which work is performed in the classification.

c. Whenever the minimum wage rate prescribed in the contract for a class of laborers or mechanics includes a fringe benefit which is not expressed as an hourly rate, the contractor shall either pay the benefit as stated in the wage determination or shall pay another bona fide fringe benefit or an hourly cash equivalent thereof.

d. If the contractor does not make payments to a trustee or other third person, the contractor may consider as part of the wages of any laborer or mechanic the amount of any costs reasonably anticipated in providing bona fide fringe benefits under a plan or program, Provided, That the Secretary of Labor has found, upon the written request of the contractor, that the applicable standards of the Davis-Bacon Act have been met. The Secretary of Labor may require the contractor to set aside in a separate account assets for the meeting of obligations under the plan or program.

## 2. Withholding

The contracting agency shall upon its own action or upon written request of an authorized representative of the Department of Labor, withhold or cause to be withheld from the contractor under this contract, or any other Federal contract with the same prime contractor, or any other federally-assisted contract subject to Davis-Bacon prevailing wage requirements, which is held by the same prime contractor, so much of the accrued payments or advances as may be considered necessary to pay laborers and mechanics, including apprentices, trainees, and helpers, employed by the contractor or any subcontractor the full amount of wages required by the contract. In the event of failure to pay any laborer or mechanic, including any apprentice, trainee, or helper, employed or working on the site of the work, all or part of the wages required by the contract, the contracting agency may, after written notice to the contractor, take such

action as may be necessary to cause the suspension of any further payment, advance, or guarantee of funds until such violations have ceased.

## 3. Payrolls and basic records

a. Payrolls and basic records relating thereto shall be maintained by the contractor during the course of the work and preserved for a period of three years thereafter for all laborers and mechanics working at the site of the work. Such records shall contain the name, address, and social security number of each such worker, his or her correct classification, hourly rates of wages paid (including rates of contributions or costs anticipated for bona fide fringe benefits or cash equivalents thereof of the types described in section 1(b)(2)(B) of the Davis-Bacon Act), daily and weekly number of hours worked, deductions made and actual wages paid. Whenever the Secretary of Labor has found under 29 CFR 5.5(a)(1)(iv) that the wages of any laborer or mechanic include the amount of any costs reasonably anticipated in providing benefits under a plan or program described in section 1(b)(2)(B) of the Davis-Bacon Act, the contractor shall maintain records which show that the commitment to provide such benefits is enforceable, that the plan or program is financially responsible, and that the plan or program has been communicated in writing to the laborers or mechanics affected, and records which show the costs anticipated or the actual cost incurred in providing such benefits. Contractors employing apprentices or trainees under approved programs shall maintain written evidence of the registration of apprenticeship programs and certification of trainee programs, the registration of the apprentices and trainees, and the ratios and wage rates prescribed in the applicable programs.

b. (1) The contractor shall submit weekly for each week in which any contract work is performed a copy of all payrolls to the contracting agency. The payrolls submitted shall set out accurately and completely all of the information required to be maintained under 29 CFR 5.5(a)(3)(i), except that full social security numbers and home addresses shall not be included on weekly transmittals. Instead the payrolls shall only need to include an individually identifying number for each employee ( e.g. , the last four digits of the employee's social security number). The required weekly payroll information may be submitted in any form desired. Optional Form WH-347 is available for this purpose from the Wage and Hour Division Web site at <http://www.dol.gov/esa/whd/forms/wh347instr.htm> or its successor site. The prime contractor is responsible for the submission of copies of payrolls by all subcontractors. Contractors and subcontractors shall maintain the full social security number and current address of each covered worker, and shall provide them upon request to the contracting agency for transmission to the State DOT, the FHWA or the Wage and Hour Division of the Department of Labor for purposes of an investigation or audit of compliance with prevailing wage requirements. It is not a violation of this section for a prime contractor to require a subcontractor to provide addresses and social security numbers to the prime contractor for its own records, without weekly submission to the contracting agency..

(2) Each payroll submitted shall be accompanied by a "Statement of Compliance," signed by the contractor or subcontractor or his or her agent who pays or supervises the payment of the persons employed under the contract and shall certify the following:

(i) That the payroll for the payroll period contains the information required to be provided under §5.5 (a)(3)(ii) of Regulations, 29 CFR part 5, the appropriate information is being maintained under §5.5 (a)(3)(i) of Regulations, 29 CFR part 5, and that such information is correct and complete;

(ii) That each laborer or mechanic (including each helper, apprentice, and trainee) employed on the contract during the payroll period has been paid the full weekly wages earned, without rebate, either directly or indirectly, and that no deductions have been made either directly or indirectly from the full wages earned, other than permissible deductions as set forth in Regulations, 29 CFR part 3;

(iii) That each laborer or mechanic has been paid not less than the applicable wage rates and fringe benefits or cash equivalents for the classification of work performed, as specified in the applicable wage determination incorporated into the contract.

(3) The weekly submission of a properly executed certification set forth on the reverse side of Optional Form WH-347 shall satisfy the requirement for submission of the "Statement of Compliance" required by paragraph 3.b.(2) of this section.

(4) The falsification of any of the above certifications may subject the contractor or subcontractor to civil or criminal prosecution under section 1001 of title 18 and section 231 of title 31 of the United States Code.

c. The contractor or subcontractor shall make the records required under paragraph 3.a. of this section available for inspection, copying, or transcription by authorized representatives of the contracting agency, the State DOT, the FHWA, or the Department of Labor, and shall permit such representatives to interview employees during working hours on the job. If the contractor or subcontractor fails to submit the required records or to make them available, the FHWA may, after written notice to the contractor, the contracting agency or the State DOT, take such action as may be necessary to cause the suspension of any further payment, advance, or guarantee of funds. Furthermore, failure to submit the required records upon request or to make such records available may be grounds for debarment action pursuant to 29 CFR 5.12.

#### 4. Apprentices and trainees

##### a. Apprentices (programs of the USDOL).

Apprentices will be permitted to work at less than the predetermined rate for the work they performed when they are employed pursuant to and individually registered in a bona fide apprenticeship program registered with the U.S. Department of Labor, Employment and Training Administration, Office of Apprenticeship Training, Employer and Labor Services, or with a State Apprenticeship Agency recognized by the Office, or if a person is employed in his or her first 90 days of probationary employment as an apprentice in such an apprenticeship program, who is not individually registered in the program, but who has been certified by the Office of Apprenticeship Training, Employer and Labor Services or a State Apprenticeship Agency (where appropriate) to be eligible for probationary employment as an apprentice.

The allowable ratio of apprentices to journeymen on the job site in any craft classification shall not be greater than the ratio permitted to the contractor as to the entire work force under the registered program. Any worker listed on a payroll at an apprentice wage rate, who is not registered or otherwise employed as stated above, shall be paid not less than the applicable wage rate on the wage determination for the classification of work actually performed. In addition, any apprentice performing work on the job site in excess of the ratio permitted under the registered program shall be paid not less than the applicable wage rate on the wage determination for the work actually performed. Where a contractor is performing construction on a project in a locality other than that in which its program is registered, the ratios and wage rates (expressed in percentages of the journeyman's hourly rate) specified in the contractor's or subcontractor's registered program shall be observed.

Every apprentice must be paid at not less than the rate specified in the registered program for the apprentice's level of progress, expressed as a percentage of the journeymen hourly rate specified in the applicable wage determination. Apprentices shall be paid fringe benefits in accordance with the provisions of the apprenticeship program. If the apprenticeship program does not specify fringe benefits, apprentices must be paid the full amount of fringe benefits listed on the wage determination for the applicable classification. If the Administrator determines that a different practice prevails for the applicable apprentice classification, fringes shall be paid in accordance with that determination.

In the event the Office of Apprenticeship Training, Employer and Labor Services, or a State Apprenticeship Agency recognized by the Office, withdraws approval of an apprenticeship program, the contractor will no longer be permitted to utilize apprentices at less than the applicable predetermined rate for the work performed until an acceptable program is approved.

##### b. Trainees (programs of the USDOL).

Except as provided in 29 CFR 5.16, trainees will not be permitted to work at less than the predetermined rate for the work performed unless they are employed pursuant to and individually registered in a program which has received prior approval, evidenced by formal certification by the U.S. Department of Labor, Employment and Training Administration.

The ratio of trainees to journeymen on the job site shall not be greater than permitted under the plan approved by the Employment and Training Administration.

Every trainee must be paid at not less than the rate specified in the approved program for the trainee's level of progress, expressed as a percentage of the journeyman hourly rate specified in the applicable wage determination. Trainees shall be paid fringe benefits in accordance with the provisions of the trainee program. If the trainee program does not mention fringe benefits, trainees shall be paid the full amount of fringe benefits listed on the wage determination unless the Administrator of the Wage and Hour Division determines that there is an apprenticeship program associated with the corresponding journeyman wage rate on the wage determination which provides for less than full fringe benefits for apprentices. Any employee listed on the payroll at a trainee rate who is not registered and participating in a training plan approved by the Employment and Training Administration shall be paid not less than the applicable wage rate on the wage determination for the classification of work actually performed. In addition, any trainee performing work on the job site in excess of the ratio permitted under the registered program shall be paid not less than the applicable wage rate on the wage determination for the work actually performed.

In the event the Employment and Training Administration withdraws approval of a training program, the contractor will no longer be permitted to utilize trainees at less than the applicable predetermined rate for the work performed until an acceptable program is approved.

c. Equal employment opportunity. The utilization of apprentices, trainees and journeymen under this part shall be in conformity with the equal employment opportunity requirements of Executive Order 11246, as amended, and 29 CFR part 30.

##### d. Apprentices and Trainees (programs of the U.S. DOT).

Apprentices and trainees working under apprenticeship and skill training programs which have been certified by the Secretary of Transportation as promoting EEO in connection with Federal-aid highway construction programs are not subject to the requirements of paragraph 4 of this Section IV. The straight time hourly wage rates for apprentices and trainees under such programs will be established by the particular programs. The ratio of apprentices and trainees to journeymen shall not be greater than permitted by the terms of the particular program.

**5. Compliance with Copeland Act requirements.** The contractor shall comply with the requirements of 29 CFR part 3, which are incorporated by reference in this contract.

**6. Subcontracts.** The contractor or subcontractor shall insert Form FHWA-1273 in any subcontracts and also require the subcontractors to include Form FHWA-1273 in any lower tier subcontracts. The prime contractor shall be responsible for the compliance by any subcontractor or lower tier subcontractor with all the contract clauses in 29 CFR 5.5.

**7. Contract termination: debarment.** A breach of the contract clauses in 29 CFR 5.5 may be grounds for termination of the contract, and for



debarment as a contractor and a subcontractor as provided in 29 CFR 5.12.

**8. Compliance with Davis-Bacon and Related Act requirements.** All rulings and interpretations of the Davis-Bacon and Related Acts contained in 29 CFR parts 1, 3, and 5 are herein incorporated by reference in this contract.

**9. Disputes concerning labor standards.** Disputes arising out of the labor standards provisions of this contract shall not be subject to the general disputes clause of this contract. Such disputes shall be resolved in accordance with the procedures of the Department of Labor set forth in 29 CFR parts 5, 6, and 7. Disputes within the meaning of this clause include disputes between the contractor (or any of its subcontractors) and the contracting agency, the U.S. Department of Labor, or the employees or their representatives.

#### **10. Certification of eligibility.**

a. By entering into this contract, the contractor certifies that neither it (nor he or she) nor any person or firm who has an interest in the contractor's firm is a person or firm ineligible to be awarded Government contracts by virtue of section 3(a) of the Davis-Bacon Act or 29 CFR 5.12(a)(1).

b. No part of this contract shall be subcontracted to any person or firm ineligible for award of a Government contract by virtue of section 3(a) of the Davis-Bacon Act or 29 CFR 5.12(a)(1).

c. The penalty for making false statements is prescribed in the U.S. Criminal Code, 18 U.S.C. 1001.

#### **V. CONTRACT WORK HOURS AND SAFETY STANDARDS ACT**

The following clauses apply to any Federal-aid construction contract in an amount in excess of \$100,000 and subject to the overtime provisions of the Contract Work Hours and Safety Standards Act. These clauses shall be inserted in addition to the clauses required by 29 CFR 5.5(a) or 29 CFR 4.6. As used in this paragraph, the terms laborers and mechanics include watchmen and guards.

**1. Overtime requirements.** No contractor or subcontractor contracting for any part of the contract work which may require or involve the employment of laborers or mechanics shall require or permit any such laborer or mechanic in any workweek in which he or she is employed on such work to work in excess of forty hours in such workweek unless such laborer or mechanic receives compensation at a rate not less than one and one-half times the basic rate of pay for all hours worked in excess of forty hours in such workweek.

**2. Violation; liability for unpaid wages; liquidated damages.** In the event of any violation of the clause set forth in paragraph (1.) of this section, the contractor and any subcontractor responsible therefor shall be liable for the unpaid wages. In addition, such contractor and subcontractor shall be liable to the United States (in the case of work done under contract for the District of Columbia or a territory, to such District or to such territory), for liquidated damages. Such liquidated damages shall be computed with respect to each individual laborer or mechanic, including watchmen and guards, employed in violation of the clause set forth in paragraph (1.) of this section, in the sum of \$10 for each calendar day on which such individual was required or permitted to work in excess of the standard workweek of forty hours without payment of the overtime wages required by the clause set forth in paragraph (1.) of this section.

**3. Withholding for unpaid wages and liquidated damages.** The FHWA or the contacting agency shall upon its own action or upon written request of an authorized representative of the Department of Labor withhold or cause to be withheld, from any moneys payable on account of work performed by the contractor or subcontractor under any such

contract or any other Federal contract with the same prime contractor, or any other federally-assisted contract subject to the Contract Work Hours and Safety Standards Act, which is held by the same prime contractor, such sums as may be determined to be necessary to satisfy any liabilities of such contractor or subcontractor for unpaid wages and liquidated damages as provided in the clause set forth in paragraph (2.) of this section.

**4. Subcontracts.** The contractor or subcontractor shall insert in any subcontracts the clauses set forth in paragraph (1.) through (4.) of this section and also a clause requiring the subcontractors to include these clauses in any lower tier subcontracts. The prime contractor shall be responsible for compliance by any subcontractor or lower tier subcontractor with the clauses set forth in paragraphs (1.) through (4.) of this section.

#### **VI. SUBLETTING OR ASSIGNING THE CONTRACT**

This provision is applicable to all Federal-aid construction contracts on the National Highway System.

1. The contractor shall perform with its own organization contract work amounting to not less than 30 percent (or a greater percentage if specified elsewhere in the contract) of the total original contract price, excluding any specialty items designated by the contracting agency. Specialty items may be performed by subcontract and the amount of any such specialty items performed may be deducted from the total original contract price before computing the amount of work required to be performed by the contractor's own organization (23 CFR 635.116).

a. The term "perform work with its own organization" refers to workers employed or leased by the prime contractor, and equipment owned or rented by the prime contractor, with or without operators. Such term does not include employees or equipment of a subcontractor or lower tier subcontractor, agents of the prime contractor, or any other assignees. The term may include payments for the costs of hiring leased employees from an employee leasing firm meeting all relevant Federal and State regulatory requirements. Leased employees may only be included in this term if the prime contractor meets all of the following conditions:

(1) the prime contractor maintains control over the supervision of the day-to-day activities of the leased employees;

(2) the prime contractor remains responsible for the quality of the work of the leased employees;

(3) the prime contractor retains all power to accept or exclude individual employees from work on the project; and

(4) the prime contractor remains ultimately responsible for the payment of predetermined minimum wages, the submission of payrolls, statements of compliance and all other Federal regulatory requirements.

b. "Specialty Items" shall be construed to be limited to work that requires highly specialized knowledge, abilities, or equipment not ordinarily available in the type of contracting organizations qualified and expected to bid or propose on the contract as a whole and in general are to be limited to minor components of the overall contract.

2. The contract amount upon which the requirements set forth in paragraph (1) of Section VI is computed includes the cost of material and manufactured products which are to be purchased or produced by the contractor under the contract provisions.

3. The contractor shall furnish (a) a competent superintendent or supervisor who is employed by the firm, has full authority to direct performance of the work in accordance with the contract requirements, and is in charge of all construction operations (regardless of who performs the work) and (b) such other of its own organizational resources (supervision, management, and engineering services) as the contracting officer determines is necessary to assure the performance of the contract.

4. No portion of the contract shall be sublet, assigned or otherwise disposed of except with the written consent of the contracting officer, or authorized representative, and such consent when given shall not be construed to relieve the contractor of any responsibility for the fulfillment of the contract. Written consent will be given only after the contracting agency has assured that each subcontract is evidenced in writing and that it contains all pertinent provisions and requirements of the prime contract.

5. The 30% self-performance requirement of paragraph (1) is not applicable to design-build contracts; however, contracting agencies may establish their own self-performance requirements.

## **VII. SAFETY: ACCIDENT PREVENTION**

This provision is applicable to all Federal-aid construction contracts and to all related subcontracts.

1. In the performance of this contract the contractor shall comply with all applicable Federal, State, and local laws governing safety, health, and sanitation (23 CFR 635). The contractor shall provide all safeguards, safety devices and protective equipment and take any other needed actions as it determines, or as the contracting officer may determine, to be reasonably necessary to protect the life and health of employees on the job and the safety of the public and to protect property in connection with the performance of the work covered by the contract.

2. It is a condition of this contract, and shall be made a condition of each subcontract, which the contractor enters into pursuant to this contract, that the contractor and any subcontractor shall not permit any employee, in performance of the contract, to work in surroundings or under conditions which are unsanitary, hazardous or dangerous to his/her health or safety, as determined under construction safety and health standards (29 CFR 1926) promulgated by the Secretary of Labor, in accordance with Section 107 of the Contract Work Hours and Safety Standards Act (40 U.S.C. 3704).

3. Pursuant to 29 CFR 1926.3, it is a condition of this contract that the Secretary of Labor or authorized representative thereof, shall have right of entry to any site of contract performance to inspect or investigate the matter of compliance with the construction safety and health standards and to carry out the duties of the Secretary under Section 107 of the Contract Work Hours and Safety Standards Act (40 U.S.C.3704).

## **VIII. FALSE STATEMENTS CONCERNING HIGHWAY PROJECTS**

This provision is applicable to all Federal-aid construction contracts and to all related subcontracts.

In order to assure high quality and durable construction in conformity with approved plans and specifications and a high degree of reliability on statements and representations made by engineers, contractors, suppliers, and workers on Federal-aid highway projects, it is essential that all persons concerned with the project perform their functions as carefully, thoroughly, and honestly as possible. Willful falsification, distortion, or misrepresentation with respect to any facts related to the project is a violation of Federal law. To prevent any misunderstanding regarding the seriousness of these and similar acts, Form FHWA-1022 shall be posted on each Federal-aid highway project (23 CFR 635) in one or more places where it is readily available to all persons concerned with the project:

18 U.S.C. 1020 reads as follows:

"Whoever, being an officer, agent, or employee of the United States, or of any State or Territory, or whoever, whether a person, association, firm, or corporation, knowingly makes any false statement, false representation, or false report as to the character, quality, quantity, or cost of the material used or to be used, or the quantity or quality of the work performed or to be performed, or the cost thereof in connection with the submission of plans, maps, specifications, contracts, or costs of construction on any highway or related project submitted for approval to the Secretary of Transportation; or

Whoever knowingly makes any false statement, false representation, false report or false claim with respect to the character, quality, quantity, or cost of any work performed or to be performed, or materials furnished or to be furnished, in connection with the construction of any highway or related project approved by the Secretary of Transportation; or

Whoever knowingly makes any false statement or false representation as to material fact in any statement, certificate, or report submitted pursuant to provisions of the Federal-aid Roads Act approved July 1, 1916, (39 Stat. 355), as amended and supplemented;

Shall be fined under this title or imprisoned not more than 5 years or both."

## **IX. IMPLEMENTATION OF CLEAN AIR ACT AND FEDERAL WATER POLLUTION CONTROL ACT**

This provision is applicable to all Federal-aid construction contracts and to all related subcontracts.

By submission of this bid/proposal or the execution of this contract, or subcontract, as appropriate, the bidder, proposer, Federal-aid construction contractor, or subcontractor, as appropriate, will be deemed to have stipulated as follows:

1. That any person who is or will be utilized in the performance of this contract is not prohibited from receiving an award due to a violation of Section 508 of the Clean Water Act or Section 306 of the Clean Air Act.

2. That the contractor agrees to include or cause to be included the requirements of paragraph (1) of this Section X in every subcontract, and further agrees to take such action as the contracting agency may direct as a means of enforcing such requirements.

## **X. CERTIFICATION REGARDING DEBARMENT, SUSPENSION, INELIGIBILITY AND VOLUNTARY EXCLUSION**

This provision is applicable to all Federal-aid construction contracts, design-build contracts, subcontracts, lower-tier subcontracts, purchase orders, lease agreements, consultant contracts or any other covered transaction requiring FHWA approval or that is estimated to cost \$25,000 or more – as defined in 2 CFR Parts 180 and 1200.

### **1. Instructions for Certification – First Tier Participants:**

a. By signing and submitting this proposal, the prospective first tier participant is providing the certification set out below.

b. The inability of a person to provide the certification set out below will not necessarily result in denial of participation in this covered transaction. The prospective first tier participant shall submit an explanation of why it cannot provide the certification set out below. The certification or explanation will be considered in connection with the department or agency's determination whether to enter into this transaction. However, failure of the prospective first tier participant to furnish a certification or an explanation shall disqualify such a person from participation in this transaction.

c. The certification in this clause is a material representation of fact upon which reliance was placed when the contracting agency determined to enter into this transaction. If it is later determined that the prospective participant knowingly rendered an erroneous certification, in addition to other remedies available to the Federal Government, the contracting agency may terminate this transaction for cause of default.

d. The prospective first tier participant shall provide immediate written notice to the contracting agency to whom this proposal is submitted if any time the prospective first tier participant learns that its certification was erroneous when submitted or has become erroneous by reason of changed circumstances.

e. The terms "covered transaction," "debarred," "suspended," "ineligible," "participant," "person," "principal," and "voluntarily excluded,"

as used in this clause, are defined in 2 CFR Parts 180 and 1200. "First Tier Covered Transactions" refers to any covered transaction between a grantee or subgrantee of Federal funds and a participant (such as the prime or general contract). "Lower Tier Covered Transactions" refers to any covered transaction under a First Tier Covered Transaction (such as subcontracts). "First Tier Participant" refers to the participant who has entered into a covered transaction with a grantee or subgrantee of Federal funds (such as the prime or general contractor). "Lower Tier Participant" refers any participant who has entered into a covered transaction with a First Tier Participant or other Lower Tier Participants (such as subcontractors and suppliers).

f. The prospective first tier participant agrees by submitting this proposal that, should the proposed covered transaction be entered into, it shall not knowingly enter into any lower tier covered transaction with a person who is debarred, suspended, declared ineligible, or voluntarily excluded from participation in this covered transaction, unless authorized by the department or agency entering into this transaction.

g. The prospective first tier participant further agrees by submitting this proposal that it will include the clause titled "Certification Regarding Debarment, Suspension, Ineligibility and Voluntary Exclusion-Lower Tier Covered Transactions," provided by the department or contracting agency, entering into this covered transaction, without modification, in all lower tier covered transactions and in all solicitations for lower tier covered transactions exceeding the \$25,000 threshold.

h. A participant in a covered transaction may rely upon a certification of a prospective participant in a lower tier covered transaction that is not debarred, suspended, ineligible, or voluntarily excluded from the covered transaction, unless it knows that the certification is erroneous. A participant is responsible for ensuring that its principals are not suspended, debarred, or otherwise ineligible to participate in covered transactions. To verify the eligibility of its principals, as well as the eligibility of any lower tier prospective participants, each participant may, but is not required to, check the Excluded Parties List System website (<https://www.epls.gov/>), which is compiled by the General Services Administration.

i. Nothing contained in the foregoing shall be construed to require the establishment of a system of records in order to render in good faith the certification required by this clause. The knowledge and information of the prospective participant is not required to exceed that which is normally possessed by a prudent person in the ordinary course of business dealings.

j. Except for transactions authorized under paragraph (f) of these instructions, if a participant in a covered transaction knowingly enters into a lower tier covered transaction with a person who is suspended, debarred, ineligible, or voluntarily excluded from participation in this transaction, in addition to other remedies available to the Federal Government, the department or agency may terminate this transaction for cause or default.

\* \* \* \* \*

## **2. Certification Regarding Debarment, Suspension, Ineligibility and Voluntary Exclusion – First Tier Participants:**

a. The prospective first tier participant certifies to the best of its knowledge and belief, that it and its principals:

(1) Are not presently debarred, suspended, proposed for debarment, declared ineligible, or voluntarily excluded from participating in covered transactions by any Federal department or agency;

(2) Have not within a three-year period preceding this proposal been convicted of or had a civil judgment rendered against them for commission of fraud or a criminal offense in connection with obtaining, attempting to obtain, or performing a public (Federal, State or local) transaction or contract under a public transaction; violation of Federal or State antitrust statutes or commission of embezzlement, theft, forgery, bribery, falsification or destruction of records, making false statements, or receiving stolen property;

(3) Are not presently indicted for or otherwise criminally or civilly charged by a governmental entity (Federal, State or local) with

commission of any of the offenses enumerated in paragraph (a)(2) of this certification; and

(4) Have not within a three-year period preceding this application/proposal had one or more public transactions (Federal, State or local) terminated for cause or default.

b. Where the prospective participant is unable to certify to any of the statements in this certification, such prospective participant shall attach an explanation to this proposal.

### **2. Instructions for Certification - Lower Tier Participants:**

(Applicable to all subcontracts, purchase orders and other lower tier transactions requiring prior FHWA approval or estimated to cost \$25,000 or more - 2 CFR Parts 180 and 1200)

a. By signing and submitting this proposal, the prospective lower tier is providing the certification set out below.

b. The certification in this clause is a material representation of fact upon which reliance was placed when this transaction was entered into. If it is later determined that the prospective lower tier participant knowingly rendered an erroneous certification, in addition to other remedies available to the Federal Government, the department, or agency with which this transaction originated may pursue available remedies, including suspension and/or debarment.

c. The prospective lower tier participant shall provide immediate written notice to the person to which this proposal is submitted if at any time the prospective lower tier participant learns that its certification was erroneous by reason of changed circumstances.

d. The terms "covered transaction," "debarred," "suspended," "ineligible," "participant," "person," "principal," and "voluntarily excluded," as used in this clause, are defined in 2 CFR Parts 180 and 1200. You may contact the person to which this proposal is submitted for assistance in obtaining a copy of those regulations. "First Tier Covered Transactions" refers to any covered transaction between a grantee or subgrantee of Federal funds and a participant (such as the prime or general contract). "Lower Tier Covered Transactions" refers to any covered transaction under a First Tier Covered Transaction (such as subcontracts). "First Tier Participant" refers to the participant who has entered into a covered transaction with a grantee or subgrantee of Federal funds (such as the prime or general contractor). "Lower Tier Participant" refers any participant who has entered into a covered transaction with a First Tier Participant or other Lower Tier Participants (such as subcontractors and suppliers).

e. The prospective lower tier participant agrees by submitting this proposal that, should the proposed covered transaction be entered into, it shall not knowingly enter into any lower tier covered transaction with a person who is debarred, suspended, declared ineligible, or voluntarily excluded from participation in this covered transaction, unless authorized by the department or agency with which this transaction originated.

f. The prospective lower tier participant further agrees by submitting this proposal that it will include this clause titled "Certification Regarding Debarment, Suspension, Ineligibility and Voluntary Exclusion-Lower Tier Covered Transaction," without modification, in all lower tier covered transactions and in all solicitations for lower tier covered transactions exceeding the \$25,000 threshold.

g. A participant in a covered transaction may rely upon a certification of a prospective participant in a lower tier covered transaction that is not debarred, suspended, ineligible, or voluntarily excluded from the covered transaction, unless it knows that the certification is erroneous. A participant is responsible for ensuring that its principals are not suspended, debarred, or otherwise ineligible to participate in covered transactions. To verify the eligibility of its principals, as well as the eligibility of any lower tier prospective participants, each participant may, but is not required to, check the Excluded Parties List System website (<https://www.epls.gov/>), which is compiled by the General Services Administration.

h. Nothing contained in the foregoing shall be construed to require establishment of a system of records in order to render in good faith the

certification required by this clause. The knowledge and information of participant is not required to exceed that which is normally possessed by a prudent person in the ordinary course of business dealings.

i. Except for transactions authorized under paragraph e of these instructions, if a participant in a covered transaction knowingly enters into a lower tier covered transaction with a person who is suspended, debarred, ineligible, or voluntarily excluded from participation in this transaction, in addition to other remedies available to the Federal Government, the department or agency with which this transaction originated may pursue available remedies, including suspension and/or debarment.

\* \* \* \* \*

**Certification Regarding Debarment, Suspension, Ineligibility and Voluntary Exclusion--Lower Tier Participants:**

1. The prospective lower tier participant certifies, by submission of this proposal, that neither it nor its principals is presently debarred, suspended, proposed for debarment, declared ineligible, or voluntarily excluded from participating in covered transactions by any Federal department or agency.

2. Where the prospective lower tier participant is unable to certify to any of the statements in this certification, such prospective participant shall attach an explanation to this proposal.

\* \* \* \* \*

**XI. CERTIFICATION REGARDING USE OF CONTRACT FUNDS FOR LOBBYING**

This provision is applicable to all Federal-aid construction contracts and to all related subcontracts which exceed \$100,000 (49 CFR 20).

1. The prospective participant certifies, by signing and submitting this bid or proposal, to the best of his or her knowledge and belief, that:

a. No Federal appropriated funds have been paid or will be paid, by or on behalf of the undersigned, to any person for influencing or attempting to influence an officer or employee of any Federal agency, a Member of Congress, an officer or employee of Congress, or an employee of a Member of Congress in connection with the awarding of any Federal contract, the making of any Federal grant, the making of any Federal loan, the entering into of any cooperative agreement, and the extension, continuation, renewal, amendment, or modification of any Federal contract, grant, loan, or cooperative agreement.

b. If any funds other than Federal appropriated funds have been paid or will be paid to any person for influencing or attempting to influence an officer or employee of any Federal agency, a Member of Congress, an officer or employee of Congress, or an employee of a Member of Congress in connection with this Federal contract, grant, loan, or cooperative agreement, the undersigned shall complete and submit Standard Form-LLL, "Disclosure Form to Report Lobbying," in accordance with its instructions.

2. This certification is a material representation of fact upon which reliance was placed when this transaction was made or entered into. Submission of this certification is a prerequisite for making or entering into this transaction imposed by 31 U.S.C. 1352. Any person who fails to file the required certification shall be subject to a civil penalty of not less than \$10,000 and not more than \$100,000 for each such failure.

3. The prospective participant also agrees by submitting its bid or proposal that the participant shall require that the language of this certification be included in all lower tier subcontracts, which exceed \$100,000 and that all such recipients shall certify and disclose accordingly.

## Contract Provision - Cargo Preference Requirements

In accordance with Title 46 CFR § 381.7 (b), the contractor agrees—

“(1) To utilize privately owned United States-flag commercial vessels to ship at least 50 percent of the gross tonnage (computed separately for dry bulk carriers, dry cargo liners, and tankers) involved, whenever shipping any equipment, material, or commodities pursuant to this contract, to the extent such vessels are available at fair and reasonable rates for United States-flag commercial vessels.

(2) To furnish within 20 days following the date of loading for shipments originating within the United States or within 30 working days following the date of loading for shipments originating outside the United States, a legible copy of a rated, ‘on-board’ commercial ocean bill-of-lading in English for each shipment of cargo described in paragraph (b) (1) of this section to both the Contracting Officer (through the prime contractor in the case of subcontractor bills-of-lading) and to the Division of National Cargo, Office of Market Development, Maritime Administration, Washington, DC 20590.

(3) To insert the substance of the provisions of this clause in all subcontracts issued pursuant to this contract.”

Provisions (1) and (2) apply to materials or equipment that are acquired solely for the project. The two provisions do not apply to goods or materials that come into inventories independent of the project, such as shipments of Portland cement, asphalt cement, or aggregates, when industry suppliers and contractors use these materials to replenish existing inventories.

**MINIMUM WAGES FOR FEDERAL AND FEDERALLY  
ASSISTED CONSTRUCTION CONTRACTS**

This project is funded, in part, with Federal-aid funds and, as such, is subject to the provisions of the Davis-Bacon Act of March 3, 1931, as amended (46 Sta. 1494, as amended, 40 U.S.C. 276a) and of other Federal statutes referred to in a 29 CFR Part 1, Appendix A, as well as such additional statutes as may from time to time be enacted containing provisions for the payment of wages determined to be prevailing by the Secretary of Labor in accordance with the Davis-Bacon Act and pursuant to the provisions of 29 CFR Part 1. The prevailing rates and fringe benefits shown in the General Wage Determination Decisions issued by the U.S. Department of Labor shall, in accordance with the provisions of the foregoing statutes, constitute the minimum wages payable on Federal and federally assisted construction projects to laborers and mechanics of the specified classes engaged on contract work of the character and in the localities described therein.

General Wage Determination Decisions, modifications and supersedes decisions thereto are to be used in accordance with the provisions of 29 CFR Parts 1 and 5. Accordingly, the applicable decision, together with any modifications issued, must be made a part of every contract for performance of the described work within the geographic area indicated as required by an applicable DBRA Federal prevailing wage law and 29 CFR Part 5. The wage rates and fringe benefits contained in the General Wage Determination Decision shall be the minimum paid by contractors and subcontractors to laborers and mechanics.