

BID PROPOSAL INSTRUCTIONS

ABOUT IDOT PROPOSALS: All proposals are potential bidding proposals. Each proposal contains all certifications and affidavits, a proposal signature sheet and a proposal bid bond.

PREQUALIFICATION

Any contractor who desires to become pre-qualified to bid on work advertised by IDOT must submit the properly completed pre-qualification forms to the Bureau of Construction no later than 4:30 p.m. prevailing time twenty-one days prior to the letting of interest. This pre-qualification requirement applies to first time contractors, contractors renewing expired ratings, contractors maintaining continuous pre-qualification or contractors requesting revised ratings. To be eligible to bid, existing pre-qualification ratings must be effective through the date of letting.

WHO CAN BID ?

Bids will be accepted from only those companies that request and receive written Authorization to Bid from IDOT's Central Bureau of Construction.

REQUESTS FOR AUTHORIZATION TO BID

Contractors wanting to bid on items included in a particular letting must submit the properly completed "Request for Authorization to Bid/or Not For Bid Status" (BDE 124) and the ORIGINAL "Affidavit of Availability" (BC 57) to the proper office no later than 4:30 p.m. prevailing time, three (3) days prior to the letting date.

WHAT CONSTITUTES WRITTEN AUTHORIZATION TO BID?

When a prospective prime bidder submits a "Request for Authorization to Bid/or Not For Bid Status"(BDE 124) he/she must indicate at that time which items are being requested For Bidding purposes. Only those items requested For Bidding will be analyzed. After the request has been analyzed, the bidder will be issued an **Authorization to Bid or Not for Bid Report**, approved by the Central Bureau of Construction and the Chief Procurement Officer that indicates which items have been approved For Bidding. If **Authorization to Bid** cannot be approved, the **Authorization to Bid or Not for Bid Report** will indicate the reason for denial.

ABOUT AUTHORIZATION TO BID

Firms that have not received an Authorization to Bid or Not For Bid Report within a reasonable time of complete and correct original document submittal should contact the Department as to the status. Firms unsure as to authorization status should call the Prequalification Section of the Bureau of Construction at the number listed at the end of these instructions.

ADDENDA AND REVISIONS

It is the bidder's responsibility to determine which, if any, addenda or revisions pertain to any project they may be bidding. Failure to incorporate all relevant addenda or revisions may cause the bid to be declared unacceptable.

Each addendum or revision will be included with the Electronic Plans and Proposals. Addenda and revisions will also be placed on the Addendum/Revision Checklist and each subscription service subscriber will be notified by e-mail of each addendum and revision issued.

The Internet is the Department's primary way of doing business. The subscription service emails are an added courtesy the Department provides. It is suggested that bidders check IDOT's website at <http://www.idot.illinois.gov/doing-business/procurements/construction-services/construction-bulletins/transportation-bulletin/index#TransportationBulletin> before submitting final bid information.

IDOT IS NOT RESPONSIBLE FOR ANY E-MAIL FAILURES.

Addenda questions may be directed to the Contracts Office at (217)782-7806 or DOT.DE-Contracts@illinois.gov

Technical questions about downloading these files may be directed to Tim Garman at (217)524-1642 or Timothy.Garman@illinois.gov.

STANDARD GUIDELINES FOR SUBMITTING PAPER BIDS

- All pages should be single sided.
- Use the Cover Page that is provided in the Bid Proposal (posted on the IDOT Web Site) as the first page of your submitted bid. It has the item number in large bold type in the upper left-hand corner and lines provided for your company name and address in the upper right-hand corner.
- Do not use report covers, presentation folders or special bindings and do not staple multiple times on left side like a book. Use only 1 staple in the upper left hand corner. Make sure all elements of your bid are stapled together including the bid bond or guaranty check (if required).
- **Do not include any certificates of eligibility, your authorization to bid, Addendum Letters or affidavit of availability.**
- Do not include the Subcontractor Documentation with your bid (pages i – iii and pages a – g). This documentation is required only if you are awarded the project.
- Use the envelope cover sheet (provided with the proposal) as the cover for the proposal envelope.
- Do not rely on overnight services to deliver your proposal prior to 10 AM on letting day. It will not be read if it is delivered after 10 AM.
- Do not submit your Substance Abuse Prevention Program (SAPP) with your bid. If you are awarded the contract this form is to be submitted to the district engineer at the pre-construction conference.

BID SUBMITTAL CHECKLIST

- Cover page** (the sheet that has the item number on it) – This should be the first page of your bid proposal, **followed by your bid (the Schedule of Prices/Pay Items)**. If you are using special software or CBID to generate your schedule of prices, do not include the blank pages of the schedule of prices that came with the proposal package.
- Page 4 (Item 9)** – Check “YES” if you will use a subcontractor(s) with an annual value over \$50,000. Include the subcontractor(s) name, address, general type of work to be performed and the dollar amount. If you will use subcontractor(s) but are uncertain who or the dollar amount; check “YES” but leave the lines blank.
- After page 4** – Insert the following documents: Cost Adjustments for Steel, Bituminous and Fuel (if applicable) and the Contractor Letter of Assent (if applicable). The general rule should be, if you don’t know where it goes, put it after page 4.
- Page 10 (Paragraph J)** – Check “YES” or “NO” whether your company has any business in Iran.
- Page 10 (Paragraph K)** – (Not applicable to federally funded projects) List the name of the apprenticeship and training program sponsor holding the certificate of registration from the US Department of Labor. If no applicable program exists, please indicate the work/job category. **Do not include certificates with your bid.** Keep the certificates in your office in case they are requested by IDOT.
- Page 11 (Paragraph L)** – Your State Board of Elections certificate of registration is no longer required with your bid.
- Page 11 (Paragraph M)** – Indicate if your company has hired a lobbyist in connection with the job for which you are submitting the bid proposal.
- Page 12 (Paragraph C)** – This is a work sheet to determine if a completed Form A is required. It is not part of the form and you do not need to make copies for each completed Form A.
- Pages 14-17 (Form A)** – One Form A (4 pages) is required for each applicable person in your company. Copies of the forms can be used and only need to be changed when the information changes. The certification signature and date must be original for each letting. **Do not staple the forms together.** If you answered “NO” to all of the questions in Paragraph C (page 12), complete the first section (page 14) with your company information and then sign and date the Not Applicable statement on page 17.
- Page 18 (Form B)** - If you check “YES” to having other current or pending contracts it is acceptable to use the phrase, “See Affidavit of Availability on file”. **Ownership Certification** (at the bottom of the page) - Check N/A if the Form A(s) you submitted accounts for 100 percent of the company ownership. Check YES if any percentage of ownership falls outside of the parameters that require reporting on the Form A. Checking NO indicates that the Form A(s) you submitted is not correct and you will be required to submit a revised Form A.
- Page 20 (Workforce Projection)** – Be sure to include the Duration of the Project. It is acceptable to use the phrase “Per Contract Specifications”.

- Proposal Bid Bond** – (Insert after the proposal signature page) Submit your Proposal Bid Bond (if applicable) using the current Proposal Bid Bond form provided in the proposal package. The Power of Attorney page should be stapled to the Proposal Bid Bond. If you are using an electronic bond, include your bid bond number on the Proposal Bid Bond and attach the Proof of Insurance printed from the Surety’s Web Site.
- Disadvantaged Business Utilization Plan and/or Good Faith Effort – Do Not Submit with Bid** The bidder shall submit a Disadvantaged Business Utilization Plan on completed Department forms SBE 2025 and 2026. (1) The final Utilization Plan must be submitted within five calendar days after the date of the letting. (2) To meet the five day requirement, the bidder may send the Utilization Plan electronically by scanning and sending to DOT.DBE.UP@illinois.gov or faxing to (217) 785-1524. The subject line must include the bid Item Number and the Letting date. The Utilization Plan should be sent as one .pdf file, rather than multiple files and emails for the same Item Number. It is the responsibility of the bidder to obtain confirmation of email or fax delivery.

Alternatively, the Utilization Plan may be sent by certified mail or delivery service within the five calendar day period. If a question arises concerning the mailing date of a Utilization Plan, the mailing date will be established by the U.S. Postal Service postmark on the certified mail receipt from the U.S. Postal Service or the receipt issued by a delivery service. It is the responsibility of the bidder to ensure the postmark or receipt date is affixed within the five days if the bidder intends to rely upon mailing or delivery to satisfy the submission day requirement. The Utilization Plan is to be submitted to:

Illinois Department of Transportation
 Bureau of Small Business Enterprises
 Contract Compliance Section
 2300 South Dirksen Parkway, Room 319
 Springfield, Illinois 62764

The Bid Letting is now available in streaming Audio/Video from the IDOT Web Site. A link to the stream will be placed on the main page of the current letting on the day of the Letting. The stream will not begin until 10 AM.

Following the Letting, the As-Read Tabulation of Bids will be posted by the end of the day. You will find the link on the main Web page for the current letting.

QUESTIONS: pre-letting up to execution of the contract

Contractor pre-qualification	217-782-3413
Small Business, Disadvantaged Business Enterprise (DBE)	217-785-4611
Contracts, Bids, Letting process or Internet downloads	217-782-7806
Estimates Unit.....	217-785-3483
Aeronautics.....	217-785-8515
IDNR (Land Reclamation, Water Resources, Natural Resources).....	217-782-6302

QUESTIONS: following contract execution

Subcontractor documentation, payments	217-782-3413
Railroad Insurance	217-785-0275

24

RETURN WITH BID

Proposal Submitted By
Name
Address
City

Letting January 20, 2017

NOTICE TO PROSPECTIVE BIDDERS

This proposal can be used for bidding purposes by only those companies that request and receive written AUTHORIZATION TO BID from IDOT's Central Bureau of Construction.
BIDDERS NEED NOT RETURN THE ENTIRE PROPOSAL

Notice to Bidders, Specifications, Proposal, Contract and Contract Bond



**Illinois Department
of Transportation**

Springfield, Illinois 62764

**Contract No. 64L64
Various Counties
Section D2 GR (NORTH) 2017
Various Routes
District 2 Construction Funds**

PLEASE MARK THE APPROPRIATE BOX BELOW:

- A Bid Bond is included.
- A Cashier's Check or a Certified Check is included.
- An Annual Bid Bond is included or is on file with IDOT.

Plans Included
Herein

Prepared by

S

Checked by

(Printed by authority of the State of Illinois)

Page intentionally left blank

RETURN WITH BID



PROPOSAL

TO THE DEPARTMENT OF TRANSPORTATION

1. Proposal of _____

Taxpayer Identification Number (Mandatory) _____

For the improvement identified and advertised for bids in the Invitation for Bids as:

**Contract No. 64L64
Various Counties
Section D2 GR (NORTH) 2017
Various Routes
District 2 Construction Funds**

This project consists of on-call guardrail and fence repairs along state maintained routes in Boone, Carroll, JoDaviess, Ogle, Stephenson and Winnebago Counties.

2. The undersigned bidder will furnish all labor, material and equipment to complete the above described project in a good and workmanlike manner as provided in the contract documents provided by the Department of Transportation. This proposal will become part of the contract and the terms and conditions contained in the contract documents will govern performance and payments.

RETURN WITH BID

6. **COMBINATION BIDS.** The undersigned bidder further agrees that if awarded the contract for the sections contained in the following combination, he/she will perform the work in accordance with the requirements of each individual contract comprising the combination bid specified in the schedule below, and that the combination bid shall be prorated against each section in proportion to the bid submitted for the same. If an error is found to exist in the gross sum bid for one or more of the individual sections included in a combination, the combination bid shall be corrected as provided in the specifications.

When a combination bid is submitted, the schedule below must be completed in each proposal comprising the combination.

If alternate bids are submitted for one or more of the sections comprising the combination, a combination bid must be submitted for each alternate.

Schedule of Combination Bids

Combination No.	Sections Included in Combination	Combination Bid	
		Dollars	Cents

7. **SCHEDULE OF PRICES.** The undersigned bidder submits herewith, in accordance with the rules and instructions, a schedule of prices for the items of work for which bids are sought. The unit prices bid are in U.S. dollars and cents, and all extensions and summations have been made. The bidder understands that the quantities appearing in the bid schedule are approximate and are provided for the purpose of obtaining a gross sum for the comparison of bids. If there is an error in the extension of the unit prices, the unit prices will govern. Payment to the contractor awarded the contract will be made only for actual quantities of work performed and accepted or materials furnished according to the contract. The scheduled quantities of work to be done and materials to be furnished may be increased, decreased or omitted as provided elsewhere in the contract.
8. **AUTHORITY TO DO BUSINESS IN ILLINOIS.** Section 20-43 of the Illinois Procurement Code (the Code) (30 ILCS 500/20-43) provides that a person (other than an individual acting as a sole proprietor) must be a legal entity authorized to transact business or conduct affairs in the State of Illinois prior to submitting the bid.
9. **EXECUTION OF CONTRACT:** The Department of Transportation will, in accordance with the rules governing Department procurements, execute the contract and shall be the sole entity having the authority to accept performance and make payments under the contract. Execution of the contract by the Chief Procurement Officer (CPO) or the State Purchasing Officer (SPO) is for approval of the procurement process and execution of the contract by the Department. Neither the CPO nor the SPO shall be responsible for administration of the contract or determinations respecting performance or payment there under except as otherwise permitted in the Code.

10. **The services of a subcontractor will be used.**

Check box Yes
 Check box No

For known subcontractors with subcontracts with an annual value of more than \$50,000, the contract shall include their name, address, general type of work to be performed, and the dollar allocation for each subcontractor. (30 ILCS 500/20-120)

ILLINOIS DEPARTMENT OF TRANSPORTATION
 SCHEDULE OF PRICES
 CONTRACT
 NUMBER -

State Job # - C-92-101-16

64L64

Project Number

Route

County Name - VARIOUS- -

VARIOUS

Code - 0 - -

District - 2 - -

Section Number - D2 GR (NORTH) 2017

Item Number	Pay Item Description	Unit of Measure	Quantity	x	Unit Price	=	Total Price
X6320310	LONG POST FOR SPBGR	EACH	30.000				
X6330725	SPBGR (SHORT RADIUS)	FOOT	75.000				
X6331101	TUBULAR THRIE BEAM	FOOT	75.000				
X6331110	STEEL POSTS SPECIAL	EACH	30.000				
X6432110	REPL IMP ATTN NRD TL3	EACH	20.000				
X6640594	CH LK FENCE POST 4	EACH	12.000				
X6640601	CH LK FENCE POST 6	EACH	12.000				
X7010216	TRAF CONT & PROT SPL	L SUM	1.000				
Z0008760	EMER WORK CALL OUT	EACH	10.000				
Z0012752	CONC STRUCTURE REPAIR	CU FT	24.000				
Z0020210	PULL POST ARRANGEMENT	EACH	3.000				
Z0029658	REP TB TERM T1 SP PST	EACH	80.000				
Z0052000	REPAIR SPBGR TY A	FOOT	1,700.000				
Z0052100	REPAIR SPBGR TY B	FOOT	50.000				
Z0052200	REPAIR SPBGR TY C	FOOT	50.000				

ILLINOIS DEPARTMENT OF TRANSPORTATION
 SCHEDULE OF PRICES
 CONTRACT
 NUMBER -

64L64

State Job # - C-92-101-16

Project Number

Route

County Name - VARIOUS- -

VARIOUS

Code - 0 - -

District - 2 - -

Section Number - D2 GR (NORTH) 2017

Item Number	Pay Item Description	Unit of Measure	Quantity	x	Unit Price	=	Total Price
Z0052410	REPAIR TRBT T1 SP TAN	EACH	37.000				
Z0052415	REPAIR TRBT T1 SP FLR	EACH	6.000				
Z0052600	REPAIR TR BAR TERM T2	EACH	6.000				
Z0053000	REPAIR TR BAR TERM T5	EACH	3.000				
Z0053200	REPAIR TR BAR TERM T6	EACH	6.000				
Z0053210	REPAIR TR BAR TRM T6A	EACH	3.000				
Z0053220	REPAIR TR BAR TRM T6B	EACH	3.000				
Z0053400	REPAIR TR BAR TERM T8	EACH	3.000				
Z0053500	REPAIR TR BAR TERM T9	EACH	3.000				
20400800	FURNISHED EXCAVATION	CU YD	150.000				
63100045	TRAF BAR TERM T2	EACH	3.000				
63100085	TRAF BAR TERM T6	EACH	3.000				
63100105	TRAF BAR TERM T10	EACH	3.000				
63100167	TR BAR TRM T1 SPL TAN	EACH	30.000				
63100169	TR BAR TRM T1 SPL FLR	EACH	9.000				

ILLINOIS DEPARTMENT OF TRANSPORTATION
 SCHEDULE OF PRICES
 CONTRACT
 NUMBER -

State Job # - C-92-101-16

64L64

Project Number

Route

County Name - VARIOUS- -

VARIOUS

Code - 0 - -

District - 2 - -

Section Number - D2 GR (NORTH) 2017

Item Number	Pay Item Description	Unit of Measure	Quantity	x	Unit Price	=	Total Price
63301210	REM RE-E SPBGR TY A	FOOT	75.000				
63500105	DELINEATORS	EACH	9.000				
66400105	CH LK FENCE 4	FOOT	75.000				
66400305	CH LK FENCE 6	FOOT	75.000				
66500105	WOV W FENCE 4	FOOT	750.000				
70200100	NIGHT WORK ZONE LIGHT	L SUM	1.000				
78200005	GRDRAIL REF TYPE A	EACH	12.000				

CONTRACT NUMBER

64L64

THIS IS THE TOTAL BID

\$ _____

NOTES:

1. Each PAY ITEM should have a UNIT PRICE and a TOTAL PRICE.
2. The UNIT PRICE shall govern if no TOTAL PRICE is shown or if there is a discrepancy between the product of the UNIT PRICE multiplied by the QUANTITY.
3. If a UNIT PRICE is omitted, the TOTAL PRICE will be divided by the QUANTITY in order to establish a UNIT PRICE.
4. A bid may be declared UNACCEPTABLE if neither a unit price nor a total price is shown.

RETURN WITH BID

STATE REQUIRED ETHICAL STANDARDS GOVERNING CONTRACT PROCUREMENT: ASSURANCES, CERTIFICATIONS AND DISCLOSURES

I. GENERAL

A. Article 50 of the Code establishes the duty of all State CPOs, SPOs, and their designees to maximize the value of the expenditure of public moneys in procuring goods, services, and contracts for the State of Illinois and to act in a manner that maintains the integrity and public trust of State government. In discharging this duty, they are charged by law to use all available information, reasonable efforts, and reasonable actions to protect, safeguard, and maintain the procurement process of the State of Illinois.

B. In order to comply with the provisions of Article 50 and to carry out the duty established therein, all bidders are to adhere to ethical standards established for the procurement process, and to make such assurances, disclosures and certifications required by law. Except as otherwise required in subsection III, paragraphs J-M, by execution of the Proposal Signature Sheet, the bidder indicates that each of the mandated assurances have been read and understood, that each certification is made and understood, and that each disclosure requirement has been understood and completed.

C. In addition to all other remedies provided by law, failure to comply with any assurance, failure to make any disclosure or the making of a false certification shall be grounds for the CPO to void the contract, and may result in the suspension or debarment of the bidder or subcontractor. If a false certification is made by a subcontractor the contractor's submitted bid and the executed contract may not be declared void unless the contractor refuses to terminate the subcontract upon the State's request after a finding that the subcontractor's certification was false.

I acknowledge, understand and accept these terms and conditions.

II. ASSURANCES

The assurances hereinafter made by the bidder are each a material representation of fact upon which reliance is placed should the Department enter into the contract with the bidder.

A. **Conflicts of Interest**

Section 50-13. Conflicts of Interest.

(a) Prohibition. It is unlawful for any person holding an elective office in this State, holding a seat in the General Assembly, or appointed to or employed in any of the offices or agencies of state government and who receives compensation for such employment in excess of 60% of the salary of the Governor of the State of Illinois, or who is an officer or employee of the Capital Development Board or the Illinois State Toll Highway Authority, or who is the spouse or minor child of any such person to have or acquire any contract, or any direct pecuniary interest in any contract therein, whether for stationery, printing, paper, or any services, materials, or supplies, that will be wholly or partially satisfied by the payment of funds appropriated by the General Assembly of the State of Illinois or in any contract of the Capital Development Board or the Illinois State Toll Highway Authority.

(b) Interests. It is unlawful for any firm, partnership, association or corporation, in which any person listed in subsection (a) is entitled to receive (i) more than 7 1/2% of the total distributable income or (ii) an amount in excess of the salary of the Governor, to have or acquire any such contract or direct pecuniary interest therein.

(c) Combined interests. It is unlawful for any firm, partnership, association, or corporation, in which any person listed in subsection (a) together with his or her spouse or minor children is entitled to receive (i) more than 15%, in the aggregate, of the total distributable income or (ii) an amount in excess of 2 times the salary of the Governor, to have or acquire any such contract or direct pecuniary interest therein.

(d) Securities. Nothing in this Section invalidates the provisions of any bond or other security previously offered or to be offered for sale or sold by or for the State of Illinois.

(e) Prior interests. This Section does not affect the validity of any contract made between the State and an officer or employee of the State or member of the General Assembly, his or her spouse, minor child or any combination of those persons if that contract was in existence before his or her election or employment as an officer, member, or employee. The contract is voidable, however, if it cannot be completed within 365 calendar days after the officer, member, or employee takes office or is employed. The current salary of the Governor is \$177,412.00. Sixty percent of the salary is \$106,447.20.

RETURN WITH BID

The bidder assures the Department that the award and execution of the contract would not cause a violation of Section 50-13, or that an effective exemption has been issued by the Board of Ethics to any individual subject to the Section 50-13 prohibitions pursuant to the provisions of Section 50-20 of the Code. Information concerning the exemption process is available from the Department upon request.

B. Negotiations

Section 50-15. Negotiations.

It is unlawful for any person employed in or on a continual contractual relationship with any of the offices or agencies of State government to participate in contract negotiations on behalf of that office or agency with any firm, partnership, association, or corporation with whom that person has a contract for future employment or is negotiating concerning possible future employment.

The bidder assures the Department that the award and execution of the contract would not cause a violation of Section 50-15, and that the bidder has no knowledge of any facts relevant to the kinds of acts prohibited therein.

C. Inducements

Section 50-25. Inducement.

Any person who offers or pays any money or other valuable thing to any person to induce him or her not to provide a submission to a vendor portal or to bid for a State contract or as recompense for not having bid on a State contract is guilty of a Class 4 felony. Any person who accepts any money or other valuable thing for not bidding for a State contract, not making a submission to a vendor portal, or who withholds a bid or submission to a vendor portal in consideration of the promise for the payment of money or other valuable thing is guilty of a Class 4 felony.

The bidder assures the Department that the award and execution of the contract would not cause a violation of Section 50-25, and that the bidder has no knowledge of any facts relevant to the kinds of acts prohibited therein.

D. Revolving Door Prohibition

Section 50-30. Revolving door prohibition.

CPOs, SPOs, procurement compliance monitors, their designees whose principal duties are directly related to State procurement, and executive officers confirmed by the Senate are expressly prohibited for a period of 2 years after terminating an affected position from engaging in any procurement activity relating to the State agency most recently employing them in an affected position for a period of at least 6 months. The prohibition includes, but is not limited to: lobbying the procurement process; specifying; bidding; proposing bid, proposal, or contract documents; on their own behalf or on behalf of any firm, partnership, association, or corporation. This Section applies only to persons who terminate an affected position on or after January 15, 1999.

The bidder assures the Department that the award and execution of the contract would not cause a violation of Section 50-30, and that the bidder has no knowledge of any facts relevant to the kinds of acts prohibited therein.

E. Reporting Anticompetitive Practices

Section 50-40. Reporting anticompetitive practices.

When, for any reason, any vendor, bidder, contractor, CPO, SPO, designee, elected official, or State employee suspects collusion or other anticompetitive practice among any bidders, offerors, contractors, proposers, or employees of the State, a notice of the relevant facts shall be transmitted to the Attorney General and the CPO.

The bidder assures the Department that it has not failed to report any relevant facts concerning the practices addressed in Section 50-40 which may involve the contract for which the bid or submission to a vendor portal is submitted.

F. Confidentiality

Section 50-45. Confidentiality.

Any CPO, SPO, designee, or executive officer who willfully uses or allows the use of specifications, competitive bid documents, proprietary competitive information, proposals, contracts, or selection information to compromise the fairness or integrity of the procurement, bidding, or contract process shall be subject to immediate dismissal, regardless of the Personnel code, any contract, or any collective bargaining agreement, and may in addition be subject to criminal prosecution.

The bidder assures the Department that it has no knowledge of any fact relevant to the practices addressed in Section 50-45 which may involve the contract for which the bid is submitted.

RETURN WITH BID

G. Insider Information

Section 50-50. Insider information.

It is unlawful for any current or former elected or appointed State official or State employee to knowingly use confidential information available only by virtue of that office or employment for actual or anticipated gain for themselves or another person.

The bidder assures the Department that it has no knowledge of any facts relevant to the practices addressed in Section 50-50 which may involve the contract for which the bid is submitted.

I acknowledge, understand and accept these terms and conditions for the above assurances.

III. CERTIFICATIONS

The certifications hereinafter made by the bidder are each a material representation of fact upon which reliance is placed should the Department enter into the contract with the bidder. Section 50-2 of the Code provides that every person that has entered into a multi-year contract and every subcontractor with a multi-year subcontract shall certify, by July 1 of each fiscal year covered by the contract after the initial fiscal year, to the responsible CPO whether it continues to satisfy the requirements of Article 50 pertaining to the eligibility for a contract award. If a contractor or subcontractor is not able to truthfully certify that it continues to meet all requirements, it shall provide with its certification a detailed explanation of the circumstances leading to the change in certification status. A contractor or subcontractor that makes a false statement material to any given certification required under Article 50 is, in addition to any other penalties or consequences prescribed by law, subject to liability under the Whistleblower Reward and Protection Act for submission of a false claim.

A. Bribery

Section 50-5. Bribery.

(a) Prohibition. No person or business shall be awarded a contract or subcontract under this Code who:

(1) has been convicted under the laws of Illinois or any other state of bribery or attempting to bribe an officer or employee of the State of Illinois or any other state in that officer's or employee's official capacity; or

(2) has made an admission of guilt of that conduct that is a matter of record but has not been prosecuted for that conduct.

(b) Businesses. No business shall be barred from contracting with any unit of State or local government, or subcontracting under such a contract, as a result of a conviction under this Section of any employee or agent of the business if the employee or agent is no longer employed by the business and:

(1) the business has been finally adjudicated not guilty; or

(2) the business demonstrates to the governmental entity with which it seeks to contract, or which is signatory to the contract which the subcontract relates, and that entity finds that the commission of the offense was not authorized, requested, commanded, or performed by a director, officer, or high managerial agent on behalf of the business as provided in paragraph (2) of subsection (a) of Section 5-4 of the Criminal Code of 2012.

(c) Conduct on behalf of business. For purposes of this Section, when an official, agent, or employee of a business committed the bribery or attempted bribery on behalf of the business and in accordance with the direction or authorization of a responsible official of the business, the business shall be chargeable with the conduct.

(d) Certification. Every bid submitted to and contract executed by the State, and every subcontract subject to Section 20-120 of the Code shall contain a certification by the contractor or the subcontractor, respectively, that the contractor or subcontractor is not barred from being awarded a contract or subcontract under this Section and acknowledges that the CPO may declare the related contract void if any certifications required by this Section are false. A contractor who makes a false statement, material to the certification, commits a Class 3 felony.

The contractor or subcontractor certifies that it is not barred from being awarded a contract under Section 50-5.

B. Felons

Section 50-10. Felons.

(a) Unless otherwise provided, no person or business convicted of a felony shall do business with the State of Illinois or any State agency, or enter into a subcontract, from the date of conviction until 5 years after the date of completion of the sentence for that felony, unless no person held responsible by a prosecutorial office for the facts upon which the conviction was based continues to have any involvement with the business.

(b) Certification. Every bid submitted to and contract executed by the State and every subcontract subject to Section 20-120 of the Code and every vendor's submission to a vendor portal shall contain a certification by the bidder or contractor or subcontractor, respectively, that the bidder, contractor, or subcontractor is not barred from being awarded a contract or subcontract under this Section and acknowledges that the CPO may declare the related contract void if any of the certifications required by this Section are false.

RETURN WITH BID

C. Debt Delinquency

Section 50-11 and 50-12. Debt Delinquency.

The contractor or bidder or subcontractor, respectively, certifies that it, or any affiliate, is not barred from being awarded a contract or subcontract under the Code. Section 50-11 prohibits a person from entering into a contract with a State agency, or entering into a subcontract, if it knows or should know that it, or any affiliate, is delinquent in the payment of any debt to the State as defined by the Debt Collection Board. Section 50-12 prohibits a person from entering into a contract with a State agency, or entering into a subcontract, if it, or any affiliate, has failed to collect and remit Illinois Use Tax on all sales of tangible personal property into the State of Illinois in accordance with the provisions of the Illinois Use Tax Act. The bidder or contractor or subcontractor, respectively, further acknowledges that the CPO may declare the related contract void if this certification is false or if the bidder, contractor, or subcontractor, or any affiliate, is determined to be delinquent in the payment of any debt to the State during the term of the contract.

D. Prohibited Bidders, Contractors and Subcontractors

Section 50-10.5 and 50-60(c). Prohibited bidders, contractors and subcontractors.

The bidder or contractor or subcontractor, respectively, certifies in accordance with Section 50-10.5 that no officer, director, partner or other managerial agent of the contracting business has been convicted of a felony under the Sarbanes-Oxley Act of 2002 or a Class 3 or Class 2 felony under the Illinois Securities Law of 1953 or if in violation of Subsection (c) for a period of five years from the date of conviction. Every bid submitted to and contract executed by the State and every subcontract subject to Section 20-120 of the Code shall contain a certification by the bidder, contractor, or subcontractor, respectively, that the bidder, contractor, or subcontractor is not barred from being awarded a contract or subcontract under this Section and acknowledges that the CPO shall declare the related contract void if any of the certifications completed pursuant to this Section are false.

E. Section 42 of the Environmental Protection Act

Section 50-14 Environmental Protection Act violations.

The bidder or contractor or subcontractor, respectively, certifies in accordance with Section 50-14 that the bidder, contractor, or subcontractor, is not barred from being awarded a contract or entering into a subcontract under this Section which prohibits the bidding on or entering into contracts with the State of Illinois or a State agency, or entering into any subcontract, that is subject to the Code by a person or business found by a court or the Pollution Control Board to have committed a willful or knowing violation of Section 42 of the Environmental Protection Act for a period of five years from the date of the order. The bidder or contractor or subcontractor, respectively, acknowledges that the CPO may declare the contract void if this certification is false.

F. Educational Loan

Section 3 of the Educational Loan Default Act, 5 ILCS 385/3.

Pursuant to the Educational Loan Default Act no State agency shall contract with an individual for goods or services if that individual is in default on an educational loan.

The bidder, if an individual as opposed to a corporation, partnership or other form of business organization, certifies that the bidder is not in default on an educational loan as provided in Section 3 of the Act.

G. Bid-Rigging/Bid Rotating

Section 33E-11 of the Criminal Code of 2012, 720 ILCS 5/33E-11.:

(a) Every bid submitted to and public contract executed pursuant to such bid by the State or a unit of local government shall contain a certification by the prime contractor that the prime contractor is not barred from contracting with any unit of State or local government as a result of a violation of either Section 33E-3 or 33E-4 of this Article

(b) A contractor who makes a false statement, material to the certification, commits a Class 3 felony.

A violation of Section 33E-3 would be represented by a conviction of the crime of bid-rigging which, in addition to Class 3 felony sentencing, provides that any person convicted of this offense or any similar offense of any state or the United States which contains the same elements as this offense shall be barred for 5 years from the date of conviction from contracting with any unit of State or local government. No corporation shall be barred from contracting with any unit of State or local government as a result of a conviction under this Section of any employee or agent of such corporation if the employee so convicted is no longer employed by the corporation and: (1) it has been finally adjudicated not guilty or (2) if it demonstrates to the governmental entity with which it seeks to contract and that entity finds that the commission of the offense was neither authorized, requested, commanded, nor performed by a director, officer or a high managerial agent in behalf of the corporation.

The bidder certifies that it is not barred from contracting with the Department by reason of a violation of either Section 33E-3 or Section 33E-4.

RETURN WITH BID

H. International Anti-Boycott

Section 5 of the International Anti-Boycott Certification Act provides every contract entered into by the State of Illinois for the manufacture, furnishing, or purchasing of supplies, material, or equipment or for the furnishing of work, labor, or services, in an amount exceeding the threshold for small purchases according to the purchasing laws of this State or \$10,000.00, whichever is less, shall contain certification, as a material condition of the contract, by which the contractor agrees that neither the contractor nor any substantially-owned affiliated company is participating or shall participate in an international boycott in violation of the provisions of the U.S. Export Administration Act of 1979 or the regulations of the U.S. Department of Commerce promulgated under that Act.

The bidder makes the certification set forth in Section 5 of the Act.

I. Drug Free Workplace

The Illinois "Drug Free Workplace Act" applies to this contract and it is necessary to comply with the provisions of the "Act" if the contractor is a corporation, partnership, or other entity (including a sole proprietorship) which has 25 or more employees.

The bidder certifies that if awarded a contract in excess of \$5,000 it will provide a drug free workplace in compliance with the provisions of the Act.

J. Disclosure of Business Operations in Iran

Section 50-36 of the Code provides that each bid, offer, or proposal submitted for a State contract shall include a disclosure of whether or not the Company acting as the bidder, offeror, or proposing entity, or any of its corporate parents or subsidiaries, within the 24 months before submission of the bid, offer, or proposal had business operations that involved contracts with or provision of supplies or services to the Government of Iran, companies in which the Government of Iran has any direct or indirect equity share, consortiums or projects commissioned by the Government of Iran, or companies involved in consortiums or projects commissioned by the Government of Iran and either of the following conditions apply:

- (1) More than 10% of the Company's revenues produced in or assets located in Iran involve oil-related activities or mineral-extraction activities; less than 75% of the Company's revenues produced in or assets located in Iran involve contracts with or provision of oil-related or mineral-extraction products or services to the Government of Iran or a project or consortium created exclusively by that government; and the Company has failed to take substantial action.
- (2) The Company has, on or after August 5, 1996, made an investment of \$20 million or more, or any combination of investments of at least \$10 million each that in the aggregate equals or exceeds \$20 million in any 12-month period, which directly or significantly contributes to the enhancement of Iran's ability to develop petroleum resources of Iran.

The terms "Business operations", "Company", "Mineral-extraction activities", "Oil-related activities", "Petroleum resources", and "Substantial action" are all defined in the Code.

Failure to make the disclosure required by the Code may cause the bid, offer or proposal to be considered not responsive. The disclosure will be considered when evaluating the bid or awarding the contract. The name of each Company disclosed as doing business or having done business in Iran will be provided to the State Comptroller.

Check the appropriate statement:

Company has no business operations in Iran to disclose.

Company has business operations in Iran as disclosed on the attached document.

RETURN WITH BID

K. Apprenticeship and Training Certification (Does not apply to federal aid projects)

In accordance with the provisions of Section 30-22 (6) of the Code, the bidder certifies that it is a participant, either as an individual or as part of a group program, in the approved apprenticeship and training programs applicable to each type of work or craft that the bidder will perform with its own forces. The bidder further certifies for work that will be performed by subcontract that each of its subcontractors submitted for approval either (a) is, at the time of such bid, participating in an approved, applicable apprenticeship and training program; or (b) will, prior to commencement of performance of work pursuant to this contract, begin participation in an approved apprenticeship and training program applicable to the work of the subcontract. The Department, at any time before or after award, may require the production of a copy of each applicable Certificate of Registration issued by the United States Department of Labor evidencing such participation by the contractor and any or all of its subcontractors. Applicable apprenticeship and training programs are those that have been approved and registered with the United States Department of Labor. The bidder shall list in the space below, the official name of the program sponsor holding the Certificate of Registration for all of the types of work or crafts in which the bidder is a participant and that will be performed with the bidder's forces. Types of work or craft work that will be subcontracted shall be included and listed as subcontract work. The list shall also indicate any type of work or craft job category that does not have an applicable apprenticeship or training program. **The bidder is responsible for making a complete report and shall make certain that each type of work or craft job category that will be utilized on the project as reported on the Construction Employee Workforce Projection (Form BC-1256) and returned with the bid is accounted for and listed.**

Additionally, Section 30-22 of the Code requires that the bidder certify that an Illinois office be maintained as the primary place of employment for persons employed for this contract.

The requirements of these certifications and disclosures are a material part of the contract, and the contractor shall require these certification provisions to be included in all approved subcontracts. In order to fulfill this requirement, it shall not be necessary that an applicable program sponsor be currently taking, or that it will take applications for apprenticeship, training or employment during the performance of the work of this contract.

TO BE RETURNED WITH BID

L. Political Contributions and Registration with the State Board of Elections

Sections 20-160 and 50-37 of the Code regulate political contributions from business entities and any affiliated entities or affiliated persons bidding on or contracting with the state. Generally under Section 50-37, any business entity, and any affiliated entity or affiliated person of the business entity, whose current year contracts with all state agencies exceed an awarded value of \$50,000, are prohibited from making any contributions to any political committees established to promote the candidacy of the officeholder responsible for the awarding of the contracts or any other declared candidate for that office for the duration of the term of office of the incumbent officeholder or a period 2 years after the termination of the contract, whichever is longer. Any business entity and affiliated entities or affiliated persons whose state contracts in the current year do not exceed an awarded value of \$50,000, but whose aggregate pending bids and proposals on state contracts exceed \$50,000, either alone or in combination with contracts not exceeding \$50,000, are prohibited from making any political contributions to any political committee established to promote the candidacy of the officeholder responsible for awarding the pending contract during the period beginning on the date the invitation for bids or request for proposals or any other procurement opportunity is issued and ending on the day after the date of award or selection if the entity was not awarded or selected. Section 20-160 requires certification of registration of affected business entities in accordance with procedures found in Section 9-35 of The Election Code.

By submission of a bid, the contractor business entity acknowledges and agrees that it has read and understands Sections 20-160 and 50-37 of the Code, and that it makes the following certification:

The undersigned bidder certifies that it has registered as a business with the State Board of Elections and acknowledges a continuing duty to update the registration in accordance with the above referenced statutes. If the business entity is required to register, the CPO shall verify that it is in compliance on the date the bid or proposal is due. The CPO shall not accept a bid or proposal if the business entity is not in compliance with the registration requirements.

These requirements and compliance with the above referenced statutory sections are a material part of the contract, and any breach thereof shall be cause to void the contract under Section 50-60 of the Code. This provision does not apply to Federal-aid contracts.

M. Lobbyist Disclosure

Section 50-38 of the Code requires that any bidder or offeror on a State contract that hires a person required to register under the Lobbyist Registration Act to assist in obtaining a contract shall:

- (i) Disclose all costs, fees, compensation, reimbursements, and other remunerations paid or to be paid to the lobbyist related to the contract,
- (ii) Not bill or otherwise cause the State of Illinois to pay for any of the lobbyist's costs, fees, compensation, reimbursements, or other remuneration, and
- (iii) Sign a verification certifying that none of the lobbyist's costs, fees, compensation, reimbursements, or other remuneration were billed to the State.

This information, along with all supporting documents, shall be filed with the agency awarding the contract and with the Secretary of State. The CPO shall post this information, together with the contract award notice, in the online Procurement Bulletin.

Pursuant to Subsection (c) of this Section, no person or entity shall retain a person or entity to attempt to influence the outcome of a procurement decision made under the Code for compensation contingent in whole or in part upon the decision or procurement. Any person who violates this subsection is guilty of a business offense and shall be fined not more than \$10,000.

Bidder acknowledges that it is required to disclose the hiring of any person required to register pursuant to the Illinois Lobbyist Registration Act (25 ILCS 170) in connection with this contract.

Bidder has not hired any person required to register pursuant to the Illinois Lobbyist Registration Act in connection with this contract.

Or

Bidder has hired the following persons required to register pursuant to the Illinois Lobbyist Registration Act in connection with the contract:

Name and address of person: _____
All costs, fees, compensation, reimbursements and other remuneration paid to said person: _____

I acknowledge, understand and accept these terms and conditions for the above certifications.

RETURN WITH BID

IV. DISCLOSURES

- A. The disclosures hereinafter made by the bidder are each a material representation of fact upon which reliance is placed should the Department enter into the contract with the bidder. The bidder further certifies that the Department has received the disclosure forms for each bid.

The CPO may void the bid, or contract, respectively, if it is later determined that the bidder or subcontractor rendered a false or erroneous disclosure. A contractor or subcontractor may be suspended or debarred for violations of the Code. Furthermore, the CPO may void the contract and the surety providing the performance bond shall be responsible for completion of the contract.

B. Financial Interests and Conflicts of Interest

1. Section 50-35 of the Code provides that all bids of more than \$50,000 and all submissions to a vendor portal shall be accompanied by disclosure of the financial interests of the bidder. This disclosed information for the successful bidder, will be maintained as public information subject to release by request pursuant to the Freedom of Information Act, filed with the Procurement Policy Board, and shall be incorporated as a material term of the contract. Furthermore, pursuant to Section 5-5, the Procurement Policy Board may review a proposal, bid, or contract and issue a recommendation to void a contract or reject a proposal or bid based on any violation of the Code or the existence of a conflict of interest as provided in subsections (b) and (d) of Section 50-35.

The financial interests to be disclosed shall include ownership or distributive income share that is in excess of 5%, or an amount greater than 60% of the annual salary of the Governor, of the bidding entity or its parent entity, whichever is less, unless the contractor or bidder is a publicly traded entity subject to Federal 10K reporting, in which case it may submit its 10K disclosure in place of the prescribed disclosure. If a bidder is a privately held entity that is exempt from Federal 10K reporting, but has more than 100 shareholders, it may submit the information that Federal 10K companies are required to report, and list the names of any person or entity holding any ownership share that is in excess of 5%. The disclosure shall include the names, addresses, and dollar or proportionate share of ownership of each individual making the disclosure, their instrument of ownership or beneficial relationship, and notice of any potential conflict of interest resulting from the current ownership or beneficial interest of each individual making the disclosure having any of the relationships identified in Section 50-35 and on the disclosure form.

The current annual salary of the Governor is \$177,412.00

In addition, all disclosures shall indicate any other current or pending contracts, proposals, leases, or other ongoing procurement relationships the bidding entity has with any other unit of state government and shall clearly identify the unit and the contract, proposal, lease, or other relationship.

2. Disclosure Forms. Disclosure Form A is attached for use concerning the individuals meeting the above ownership or distributive share requirements. A separate Disclosure Form A must be submitted with the bid for each individual meeting the above requirements. In addition, a second form (Disclosure Form B) provides for the disclosure of current or pending procurement relationships with other (non-IDOT) state agencies and a total ownership certification. **The forms must be included with each bid.**

C. Disclosure Form Instructions

Form A Instructions for Financial Information & Potential Conflicts of Interest

If the bidder is a publicly traded entity subject to Federal 10K reporting, the 10K Report may be submitted to meet the requirements of Form A. If a bidder is a privately held entity that is exempt from Federal 10K reporting, but has more than 100 shareholders, it may submit the information that Federal 10K companies are required to report, and list the names of any person or entity holding any ownership share that is in excess of 5%. If a bidder is not subject to Federal 10K reporting, the bidder must determine if any individuals are required by law to complete a financial disclosure form. To do this, the bidder should answer each of the following questions. A "YES" answer indicates Form A must be completed. If the answer to each of the following questions is "NO", then the NOT APPLICABLE STATEMENT on Form A must be signed and dated by an individual that is authorized to execute contracts for the bidding company. Note: These questions are for assistance only and are not required to be completed.

1. Does anyone in your organization have a direct or beneficial ownership share of greater than 5% of the bidding entity or parent entity? YES ___ NO ___
2. Does anyone in your organization have a direct or beneficial ownership share of less than 5%, but which has a value greater than 60% of the annual salary of the Governor? YES ___ NO ___
3. Does anyone in your organization receive more than 60% of the annual salary of the Governor of the bidding entity's or parent entity's distributive income? YES ___ NO ___

(Note: Distributive income is, for these purposes, any type of distribution of profits. An annual salary is not distributive income.)

4. Does anyone in your organization receive greater than 5% of the bidding entity's or parent entity's total distributive income, but which is less than 60% of the annual salary of the Governor? YES ___ NO ___

(Note: Only one set of forms needs to be completed per individual per bid even if a specific individual would require a yes answer to more than one question.)

A "YES" answer to any of these questions requires the completion of Form A. The bidder must determine each individual in the bidding entity or the bidding entity's parent company that would cause the questions to be answered "Yes". Each form must be signed and dated by an individual that is authorized to execute contracts for your organization. The individual signing can be, but does not have to be, the individual for which the form is being completed. The bidder is responsible for the accuracy of any information provided.

If the answer to each of the above questions is "NO", then the NOT APPLICABLE STATEMENT of Form A must be signed and dated by an individual that is authorized to execute contracts for your company.

RETURN WITH BID

Form B: Instructions for Identifying Other Contracts & Procurement Related Information

Disclosure Form B must be completed for each bid submitted by the bidding entity. *Note: Checking the NOT APPLICABLE STATEMENT on Form A does not allow the bidder to ignore Form B. Form B must be completed, checked, and dated or the bidder may be considered nonresponsive and the bid will not be accepted.*

The Bidder shall identify, by checking Yes or No on Form B, whether it has any pending contracts (including leases), bids, proposals, or other ongoing procurement relationship with any other (non-IDOT) State of Illinois agency. If "No" is checked, the bidder only needs to complete the check box on the bottom of Form B. If "Yes" is checked, the bidder must do one of the following:

Option I: If the bidder did not submit an Affidavit of Availability to obtain authorization to bid, the bidder must list all non-IDOT State of Illinois agency pending contracts, leases, bids, proposals, and other ongoing procurement relationships. These items may be listed on Form B or on an attached sheet(s). Do not include IDOT contracts. Contracts with cities, counties, villages, etc. are not considered State of Illinois agency contracts and are not to be included. Contracts with other State of Illinois agencies such as the Department of Natural Resources or the Capital Development Board must be included. Bidders who submit Affidavits of Availability are suggested to use Option II.

Option II: If the bidder is required and has submitted an Affidavit of Availability in order to obtain authorization to bid, the bidder may write or type "See Affidavit of Availability" which indicates that the Affidavit of Availability is incorporated by reference and includes all non-IDOT State of Illinois agency pending contracts, leases, bids, proposals, and other ongoing procurement relationships. For any contracts that are not covered by the Affidavit of Availability, the bidder must identify them on Form B or on an attached sheet(s). These might be such things as leases.

ILLINOIS DEPARTMENT OF TRANSPORTATION

Form A Financial Information & Potential Conflicts of Interest Disclosure

Contractor Name, Legal Address, City, State, Zip, Telephone Number, Email Address, Fax Number (if available)

Disclosure of the information contained in this Form is required by Section 50-35 of the Code (30 ILCS 500). Vendors desiring to enter into a contract with the State of Illinois must disclose the financial information and potential conflict of interest information as specified in this Disclosure Form. This information shall become part of the publicly available contract file. This Form A must be completed for bids in excess of \$50,000, and for all open-ended contracts. A publicly traded company may submit a 10K disclosure (or equivalent if applicable) in satisfaction of the requirements set forth in Form A. See Disclosure Form Instructions.

The current annual salary of the Governor is \$177,412.00.

DISCLOSURE OF FINANCIAL INFORMATION

1. Disclosure of Financial Information. The individual named below has an interest in the BIDDER (or its parent) in terms of ownership or distributive income share in excess of 5%, or an interest which has a value of more than 60% of the annual salary of the Governor. (Make copies of this form as necessary and attach a separate Disclosure Form A for each individual meeting these requirements)

FOR INDIVIDUAL (type or print information)
NAME:
ADDRESS
Type of ownership/distributable income share:
stock sole proprietorship Partnership other: (explain on separate sheet):
% or \$ value of ownership/distributable income share:

2. Disclosure of Potential Conflicts of Interest. Check "Yes" or "No" to indicate which, if any, of the following potential conflict of interest relationships apply. If the answer to any question is "Yes", please attach additional pages and describe.

(a) State employment, currently or in the previous 3 years, including contractual employment of services. Yes ___ No ___

If your answer is yes, please answer each of the following questions.

1. Are you currently an officer or employee of either the Capitol Development Board or the Illinois State Toll Highway Authority? Yes ___ No ___

2. Are you currently appointed to or employed by any agency of the State of Illinois? If you are currently appointed to or employed by any agency of the State of Illinois, and your annual salary exceeds 60% of the annual salary of the Governor, provide the name the State agency for which you are employed and your annual salary.

RETURN WITH BID

3. If you are currently appointed to or employed by any agency of the State of Illinois, and your annual salary exceeds 60% of the annual salary of the Governor, are you entitled to receive (i) more than 7 1/2% of the total distributable income of your firm, partnership, association or corporation, or (ii) an amount in excess of 100% of the annual salary of the Governor?
Yes ___ No ___

4. If you are currently appointed to or employed by any agency of the State of Illinois, and your annual salary exceeds 60% of the annual salary of the Governor, are you and your spouse or minor children entitled to receive (i) more than 15 % in the aggregate of the total distributable income of your firm, partnership, association or corporation, or (ii) an amount in excess of two times the salary of the Governor?
Yes ___ No ___

(b) State employment of spouse, father, mother, son, or daughter, including contractual employment for services in the previous 2 years.

Yes ___ No ___

If your answer is yes, please answer each of the following questions.

1. Is your spouse or any minor children currently an officer or employee of the Capitol Development Board or the Illinois State Toll Highway Authority?
Yes ___ No ___

2. Is your spouse or any minor children currently appointed to or employed by any agency of the State of Illinois? If your spouse or minor children is/are currently appointed to or employed by any agency of the State of Illinois, and his/her annual salary exceeds 60% of the annual salary of the Governor, provide the name of your spouse and/or minor children, the name of the State agency for which he/she is employed and his/her annual salary. _____

3. If your spouse or any minor children is/are currently appointed to or employed by any agency of the State of Illinois, and his/her annual salary exceeds 60% of the annual salary of the Governor, are you entitled to receive (i) more than 7 1/2% of the total distributable income of your firm, partnership, association or corporation, or (ii) an amount in excess of 100% of the annual salary of the Governor?
Yes ___ No ___

4. If your spouse or any minor children are currently appointed to or employed by any agency of the State of Illinois, and his/her annual salary exceeds 60% of the annual salary of the Governor, are you and your spouse or minor children entitled to receive (i) more than 15 % in the aggregate of the total distributable income of your firm, partnership, association or corporation, or (ii) an amount in excess of two times the salary of the Governor?
Yes ___ No ___

(c) Elective status; the holding of elective office of the State of Illinois, the government of the United States, any unit of local government authorized by the Constitution of the State of Illinois or the statutes of the State of Illinois currently or in the previous 3 years.
Yes ___ No ___

(d) Relationship to anyone holding elective office currently or in the previous 2 years; spouse, father, mother, son, or daughter.
Yes ___ No ___

(e) Appointive office; the holding of any appointive government office of the State of Illinois, the United States of America, or any unit of local government authorized by the Constitution of the State of Illinois or the statutes of the State of Illinois, which office entitles the holder to compensation in excess of the expenses incurred in the discharge of that office currently or in the previous 3 years.
Yes ___ No ___

(f) Relationship to anyone holding appointive office currently or in the previous 2 years; spouse, father, mother, son, or daughter.
Yes ___ No ___

(g) Employment, currently or in the previous 3 years, as or by any registered lobbyist of the State government.
Yes ___ No ___

RETURN WITH BID

(h) Relationship to anyone who is or was a registered lobbyist in the previous 2 years; spouse, father, mother, son, or daughter. Yes ___ No ___

(i) Compensated employment, currently or in the previous 3 years, by any registered election or reelection committee registered with the Secretary of State or any county clerk of the State of Illinois, or any political action committee registered with either the Secretary of State or the Federal Board of Elections. Yes ___ No ___

(j) Relationship to anyone; spouse, father, mother, son, or daughter; who was a compensated employee in the last 2 years by any registered election or re-election committee registered with the Secretary of State or any county clerk of the State of Illinois, or any political action committee registered with either the Secretary of State or the Federal Board of Elections. Yes ___ No ___

3. Communication Disclosure.

Disclose the name and address of each lobbyist and other agent of the bidder or offeror who is not identified in Section 2 of this form, who is has communicated, is communicating, or may communicate with any State officer or employee concerning the bid or offer. This disclosure is a continuing obligation and must be promptly supplemented for accuracy throughout the process and throughout the term of the contract. If no person is identified, enter "None" on the line below:

Name and address of person(s): _____

RETURN WITH BID

4. Suspension or Debarment Disclosure. For each of the persons identified under Sections 2 and 3 of this form, disclose whether any of the following has occurred within the previous 10 years: suspension or debarment from contracting with any governmental entity; professional licensure discipline; bankruptcies; adverse civil judgments and administrative findings; and criminal felony convictions. This disclosure is a continuing obligation and must be promptly supplemented for accuracy throughout the procurement process and term of the contract. If no person is identified, enter "None" on the line below:

Name of person(s): _____

Nature of disclosure: _____

APPLICABLE STATEMENT

This Disclosure Form A is submitted on behalf of the INDIVIDUAL named on previous page. Under penalty of perjury, I certify the contents of this disclosure to be true and accurate to the best of my knowledge.

Completed by: _____ Date _____
Signature of Individual or Authorized Representative

NOT APPLICABLE STATEMENT

Under penalty of perjury, I have determined that no individuals associated with this organization meet the criteria that would require the completion of this Form A.

This Disclosure Form A is submitted on behalf of the CONTRACTOR listed on the previous page.

_____ Date _____
Signature of Authorized Representative

The bidder has a continuing obligation to supplement these disclosures under Sec. 50-35 of the Code.

RETURN WITH BID

ILLINOIS DEPARTMENT OF TRANSPORTATION

Form B Other Contracts & Financial Related Information Disclosure

Contractor Name, Legal Address, City, State, Zip, Telephone Number, Email Address, Fax Number (if available)

Disclosure of the information contained in this Form is required by Section 50-35 of the Code (30 ILCS 500). This information shall become part of the publicly available contract file. This Form B must be completed for all bids.

DISCLOSURE OF OTHER CONTRACTS AND PROCUREMENT RELATED INFORMATION

- 1. Identifying Other Contracts & Procurement Related Information. The BIDDER shall identify whether it has any pending contracts... 2. If "Yes" is checked. Identify each such relationship by showing State of Illinois agency name and other descriptive information...

THE FOLLOWING STATEMENT MUST BE CHECKED

Signature of Authorized Representative, Date

OWNERSHIP CERTIFICATION

Please certify that the following statement is true if the individuals for all submitted Form A disclosures do not total 100% of ownership.

Any remaining ownership interest is held by individuals receiving less than \$106,447.20 of the bidding entity's or parent entity's distributive income or holding less than a 5% ownership interest.

- Yes No N/A (Form A disclosure(s) established 100% ownership)

RETURN WITH BID

SPECIAL NOTICE TO CONTRACTORS

The following requirements of the Illinois Department of Human Rights Act are applicable to bidders on all construction contracts advertised by the Illinois Department of Transportation:

CONSTRUCTION EMPLOYEE UTILIZATION PROJECTION

- (a) All bidders on construction contracts shall complete and submit, along with and as part of their bids, a Bidder's Employee Utilization Form (Form BC-1256) setting forth a projection and breakdown of the total workforce intended to be hired and/or allocated to such contract work by the bidder including a projection of minority and female employee utilization in all job classifications on the contract project.
- (b) The Department of Transportation shall review the Employee Utilization Form, and workforce projections contained therein, of the contract awardee to determine if such projections reflect an underutilization of minority persons and/or women in any job classification in accordance with the Equal Employment Opportunity Clause and Title 44, Illinois Administrative Code, Section 750.120. If it is determined that the contract awardee's projections reflect an underutilization of minority persons and/or women in any job classification, it shall be advised in writing of the manner in which it is underutilizing and such awardee shall be considered to be in breach of the contract unless, prior to commencement of work on the contract project, it submits revised satisfactory projections or an acceptable written affirmative action plan to correct such underutilization including a specific timetable geared to the completion stages of the contract.
- (c) The Department of Transportation shall provide to the Department of Human Rights a copy of the contract awardee's Employee Utilization Form, a copy of any required written affirmative action plan, and any written correspondence related thereto. The Department of Human Rights may review and revise any action taken by the Department of Transportation with respect to these requirements.

RETURN WITH BID

**Contract No. 64L64
Various Counties
Section D2 GR (NORTH) 2017
Various Routes
District 2 Construction Funds**

PART II. WORKFORCE PROJECTION - continued

- B. Included in "Total Employees" under Table A is the total number of **new hires** that would be employed in the event the undersigned bidder is awarded this contract.

The undersigned bidder projects that: (number) _____ new hires would be recruited from the area in which the contract project is located; and/or (number) _____ new hires would be recruited from the area in which the bidder's principal office or base of operation is located.

- C. Included in "Total Employees" under Table A is a projection of numbers of persons to be employed directly by the undersigned bidder as well as a projection of numbers of persons to be employed by subcontractors.

The undersigned bidder estimates that (number) _____ persons will be directly employed by the prime contractor and that (number) _____ persons will be employed by subcontractors.

PART III. AFFIRMATIVE ACTION PLAN

- A. The undersigned bidder understands and agrees that in the event the foregoing minority and female employee utilization projection included under **PART II** is determined to be an underutilization of minority persons or women in any job category, and in the event that the undersigned bidder is awarded this contract, he/she will, prior to commencement of work, develop and submit a written Affirmative Action Plan including a specific timetable (geared to the completion stages of the contract) whereby deficiencies in minority and/or female employee utilization are corrected. Such Affirmative Action Plan will be subject to approval by the contracting agency and the **Illinois Department of Human Rights**.
- B. The undersigned bidder understands and agrees that the minority and female employee utilization projection submitted herein, and the goals and timetable included under an Affirmative Action Plan if required, are deemed to be part of the contract specifications.

Company _____ Telephone Number _____

Address _____

NOTICE REGARDING SIGNATURE

The Bidder's signature on the Proposal Signature Sheet will constitute the signing of this form. The following signature block needs to be completed if revisions are required.

Signature: _____ Title: _____ Date: _____

- Instructions: All tables must include subcontractor personnel in addition to prime contractor personnel.
- Table A - Include both the number of employees that would be hired to perform the contract work and the total number currently employed (Table B) that will be allocated to contract work, and include all apprentices and on-the-job trainees. The "Total Employees" column should include all employees including all minorities, apprentices and on-the-job trainees to be employed on the contract work.
- Table B - Include all employees currently employed that will be allocated to the contract work including any apprentices and on-the-job trainees currently employed.
- Table C - Indicate the racial breakdown of the total apprentices and on-the-job trainees shown in Table A.

RETURN WITH BID
Contract No. 64L64
Various Counties
Section D2 GR (NORTH) 2017
Various Routes
District 2 Construction Funds

PROPOSAL SIGNATURE SHEET

The undersigned bidder hereby makes and submits this bid on the subject Proposal, thereby assuring the Department that all requirements of the Invitation for Bids and rules of the Department have been met, that there is no misunderstanding of the requirements of paragraph 3 of this Proposal, and that the contract will be executed in accordance with the rules of the Department if an award is made on this bid.

(IF AN INDIVIDUAL)

Firm Name _____

Signature of Owner _____

Business Address _____

(IF A CO-PARTNERSHIP)

Firm Name _____

By _____

Business Address _____

Name and Address of All Members of the Firm:

(IF A CORPORATION)

Corporate Name _____

By _____

Signature of Authorized Representative

Typed or printed name and title of Authorized Representative

Attest _____

Signature

(IF A JOINT VENTURE, USE THIS SECTION FOR THE MANAGING PARTY AND THE SECOND PARTY SHOULD SIGN BELOW)

Business Address _____

(IF A JOINT VENTURE)

Corporate Name _____

By _____

Signature of Authorized Representative

Typed or printed name and title of Authorized Representative

Attest _____

Signature

Business Address _____

If more than two parties are in the joint venture, please attach an additional signature sheet.



This Annual Proposal Bid Bond shall become effective at 12:01 AM (CDST) on _____ and shall be valid until _____ 11:59 PM (CDST).

KNOW ALL PERSONS BY THESE PRESENTS, That We _____

as PRINCIPAL, and _____

as SURETY, and held jointly, severally and firmly bound unto the STATE OF ILLINOIS in the penal sum of 5 percent of the total bid price, or for the amount specified in the bid proposal under "Proposal Guaranty" in effect on the date of the Invitation for Bids, whichever is the lesser sum, well and truly to be paid unto said STATE OF ILLINOIS, for the payment of which we bind ourselves, our heirs, executors, administrators, successors and assigns.

THE CONDITION OF THE FOREGOING OBLIGATION IS SUCH that whereas, the PRINCIPAL may submit bid proposal(s) to the STATE OF ILLINOIS, acting through the Department of Transportation, for various improvements published in the Transportation Bulletin during the effective term indicated above.

NOW, THEREFORE, if the Department shall accept the bid proposal(s) of the PRINCIPAL; and if the PRINCIPAL shall, within the time and as specified in the bidding and contract documents; and if, after award by the Department, the PRINCIPAL shall enter into a contract in accordance with the terms of the bidding and contract documents including evidence of the required insurance coverages and providing such bond as specified with good and sufficient surety for the faithful performance of such contract and for the prompt payment of labor and material furnished in the prosecution thereof; or if, in the event of the failure of the PRINCIPAL to enter into such contract and to give the specified bond, the PRINCIPAL pays to the Department the difference not to exceed the penalty hereof between the amount specified in the bid proposal and such larger amount for which the Department may contract with another party to perform the work covered by said bid proposal, then this obligation shall be null and void, otherwise, it shall remain in full force and effect.

IN THE EVENT the Department determines the PRINCIPAL has failed to comply with any requirement as set forth in the preceding paragraph, then Surety shall pay the penal sum to the Department within fifteen (15) days of written demand therefor. If Surety does not make full payment within such period of time, the Department may bring an action to collect the amount owed. Surety is liable to the Department for all its expenses, including attorney's fees, incurred in any litigation in which it prevails either in whole or in part.

In TESTIMONY WHEREOF, the said PRINCIPAL has caused this instrument to be signed by its officer _____ day of _____ A.D., _____

In TESTIMONY WHEREOF, the said SURETY has caused this instrument to be signed by its officer _____ day of _____ A.D., _____

(Company Name)

(Company Name)

By _____
(Signature and Title)

By _____
(Signature of Attorney-in-Fact)

Notary for PRINCIPAL

Notary for SURETY

STATE OF _____
COUNTY OF _____

STATE OF _____
COUNTY OF _____

Signed and attested before me on _____ (date)

Signed and attested before me on _____ (date)

by _____
(Name of Notary Public)

by _____
(Name of Notary Public)

(Seal) _____
(Signature of Notary Public)

(Seal) _____
(Signature of Notary Public)

(Date Commission Expires)

(Date Commission Expires)

In lieu of completing the above section of the Annual Proposal Bid Bond form, the Principal may file an Electronic Bid Bond. By signing the proposal(s) the Principal is ensuring the identified electronic bid bond has been executed and the Principal and Surety are firmly bound unto the State of Illinois under the conditions of the bid bond as shown above.

Electronic Bid Bond ID #	Company/Bidder Name	Signature and Title
--------------------------	---------------------	---------------------

This bond may be terminated, at Surety's request, upon giving not less than thirty (30) days prior written notice of the cancellation/termination of the bond. Said written notice shall be issued to the Illinois Department of Transportation, Chief Contracts Official, 2300 South Dirksen Parkway, Springfield, Illinois, 62764, and shall be served in person, by receipted courier delivery or certified or registered mail, return receipt requested. Said notice period shall commence on the first calendar day following the Department's receipt of written cancellation/termination notice. Surety shall remain firmly bound to all obligations herein for proposals submitted prior to the cancellation/termination. Surety shall be released and discharged from any obligation(s) for proposals submitted for any letting or date after the effective date of cancellation/termination.



Item No. _____

Letting Date _____

KNOW ALL PERSONS BY THESE PRESENTS, That We _____

as PRINCIPAL, and _____

as SURETY, and held jointly, severally and firmly bound unto the STATE OF ILLINOIS in the penal sum of 5 percent of the total bid price, or for the amount specified in the bid proposal under "Proposal Guaranty" in effect on the date of the Invitation for Bids, whichever is the lesser sum, well and truly to be paid unto said STATE OF ILLINOIS, for the payment of which we bind ourselves, our heirs, executors, administrators, successors and assigns.

THE CONDITION OF THE FOREGOING OBLIGATION IS SUCH that whereas, the PRINCIPAL has submitted a bid proposal to the STATE OF ILLINOIS, acting through the Department of Transportation, for the improvement designated by the Transportation Bulletin Item Number and Letting Date indicated above.

NOW, THEREFORE, if the Department shall accept the bid proposal of the PRINCIPAL; and if the PRINCIPAL shall, within the time and as specified in the bidding and contract documents; and if, after award by the Department, the PRINCIPAL shall enter into a contract in accordance with the terms of the bidding and contract documents including evidence of the required insurance coverages and providing such bond as specified with good and sufficient surety for the faithful performance of such contract and for the prompt payment of labor and material furnished in the prosecution thereof; or if, in the event of the failure of the PRINCIPAL to enter into such contract and to give the specified bond, the PRINCIPAL pays to the Department the difference not to exceed the penalty hereof between the amount specified in the bid proposal and such larger amount for which the Department may contract with another party to perform the work covered by said bid proposal, then this obligation shall be null and void, otherwise, it shall remain in full force and effect.

IN THE EVENT the Department determines the PRINCIPAL has failed to comply with any requirement as set forth in the preceding paragraph, then Surety shall pay the penal sum to the Department within fifteen (15) days of written demand therefor. If Surety does not make full payment within such period of time, the Department may bring an action to collect the amount owed. Surety is liable to the Department for all its expenses, including attorney's fees, incurred in any litigation in which it prevails either in whole or in part.

In TESTIMONY WHEREOF, the said PRINCIPAL has caused this instrument to be signed by its officer
_____ day of _____ A.D., _____ .

In TESTIMONY WHEREOF, the said SURETY has caused this instrument to be signed by its officer
_____ day of _____ A.D., _____ .

(Company Name)

(Company Name)

By _____
(Signature and Title)

By _____
(Signature of Attorney-in-Fact)

Notary for PRINCIPAL

Notary for SURETY

STATE OF _____
COUNTY OF _____

STATE OF _____
COUNTY OF _____

Signed and attested before me on _____ (date)
by _____
(Name of Notary Public)

Signed and attested before me on _____ (date)
by _____
(Name of Notary Public)

(Seal) _____
(Signature of Notary Public)

(Seal) _____
(Signature of Notary Public)

(Date Commission Expires)

(Date Commission Expires)

In lieu of completing the above section of the Proposal Bid Bond form, the Principal may file an Electronic Bid Bond. By signing the proposal the Principal is ensuring the identified electronic bid bond has been executed and the Principal and Surety are firmly bound unto the State of Illinois under the conditions of the bid bond as shown above.

Electronic Bid Bond ID # _____ Company/Bidder Name _____ Signature and Title _____



(1) Policy

It is public policy that disadvantageded businesses as defined in 49 CFR Part 26 and the Special Provision shall have the maximum opportunity to participate in the performance of contracts financed in whole or in part with Federal or State funds. Consequently the requirements of 49 CFR Part 26 apply to this contract.

(2) Obligation

The contractor agrees to ensure that disadvantageded businesses as defined in 49 CFR Part 26 and the Special Provision have the maximum opportunity to participate in the performance of contracts or subcontracts financed in whole or in part with Federal or State funds. The contractor shall take all necessary and reasonable steps in accordance with 49 CFR Part 26 and the Special Provision to ensure that said businesses have the maximum opportunity to compete for and perform under this contract. The contractor shall not discriminate on the basis of race, color, national origin or sex in the award and performance of contracts.

(3) Project and Bid Identification

Complete the following information concerning the project and bid:

Route _____

Section _____

Project _____

County _____

Letting Date _____

Contract No. _____

Letting Item No. _____

Total Bid _____

Contract DBE Goal _____

(Percent) (Dollar Amount)

(4) Assurance

I, acting in my capacity as an officer of the undersigned bidder (or bidders if a joint venture), hereby assure the Department that on this project my company : (check one)

- Meets or exceeds contract award goals and has provided documented participation as follows:
Disadvantaged Business Participation _____ percent

Attached are the signed participation statements, forms SBE 2025, required by the Special Provision evidencing availability and use of each business participating in this plan and assuring that each business will perform a commercially useful function in the work of the contract.

- Failed to meet contract award goals and has included good faith effort documentation to meet the goals and that my company has provided participation as follows:
Disadvantaged Business Participation _____ percent

The contract goals should be accordingly modified or waived. Attached is all information required by the Special Provision in support of this request including good faith effort. Also attached are the signed participation statements, forms SBE 2025, required by the Special Provision evidencing availability and use of each business participating in this plan and assuring that each business will perform a commercially useful function in the work of the contract.

_____ Company

By _____

Title _____

Date _____

The "as read" Low Bidder is required to comply with the Special Provision.

Submit only one utilization plan for each project. The utilization plan shall be submitted in accordance with the special provision.

Bureau of Small Business Enterprises **Local Let Projects**
2300 South Dirksen Parkway Submit forms to the
Springfield, Illinois 62764 Local Agency

The Department of Transportation is requesting disclosure of information that is necessary to accomplish the purpose as outlined under State and Federal law. Disclosure of this information is **REQUIRED**. Failure to provide any information will result in the contract not being awarded. This form has been approved by the State Forms Manager Center.

PROPOSAL ENVELOPE



PROPOSALS

for construction work advertised for bids by the
Illinois Department of Transportation

Item No.	Item No.	Item No.

Submitted By:

Name:
Address:
Phone No.

Bidders should use an IDOT proposal envelope or affix this form to the front of a 10" x 13" envelope for the submittal of bids. If proposals are mailed, they should be enclosed in a second or outer envelope addressed to:

Engineer of Design and Environment - Room 326
Illinois Department of Transportation
2300 South Dirksen Parkway
Springfield, Illinois 62764

NOTICE

Individual bids, including Bid Bond and/or supplemental information if required, should be securely stapled.

CONTRACTOR OFFICE COPY OF CONTRACT SPECIFICATIONS

NOTICE

None of the following material needs to be returned with the bid package unless the special provisions require documentation and/or other information to be submitted.

**Contract No. 64L64
Various Counties
Section D2 GR (NORTH) 2017
Various Routes
District 2 Construction Funds**



Illinois Department of Transportation

SUBCONTRACTOR DOCUMENTATION

Public Acts 96-0795, 96-0920, and 97-0895 enacted substantial changes to the provisions of the Code (30 ILCS 500). Among the changes are provisions affecting subcontractors. The Contractor awarded this contract will be required as a material condition of the contract to implement and enforce the contract requirements applicable to subcontractors that entered into a contractual agreement with a total value of \$50,000 or more with a person or entity who has a contract subject to the Code and approved in accordance with article 108.01 of the Standard Specifications for Road and Bridge Construction.

If the Contractor seeks approval of subcontractors to perform a portion of the work, and approval is granted by the Department, the Contractor shall provide a copy of the subcontract to the Illinois Department of Transportation's CPO upon request within 15 calendar days after execution of the subcontract.

Financial disclosures required pursuant to Sec. 50-35 of the Code must be submitted for all applicable subcontractors. The subcontract shall contain the certifications required to be made by subcontractors pursuant to Article 50 of the Code. This Notice to Bidders includes a document incorporating all required subcontractor certifications and disclosures for use by the Contractor in compliance with this mandate. The document is entitled State Required Ethical Standards Governing Subcontractors.

RETURN WITH SUBCONTRACT

STATE ETHICAL STANDARDS GOVERNING SUBCONTRACTORS

Article 50 of the Code establishes the duty of all State CPOs, SPOs, and their designees to maximize the value of the expenditure of public moneys in procuring goods, services, and contracts for the State of Illinois and to act in a manner that maintains the integrity and public trust of State government. In discharging this duty, they are charged by law to use all available information, reasonable efforts, and reasonable actions to protect, safeguard, and maintain the procurement process of the State of Illinois.

The certifications hereinafter made by the subcontractor are each a material representation of fact upon which reliance is placed should the Department approve the subcontractor. The CPO may terminate or void the contract approval if it is later determined that the bidder or subcontractor rendered a false or erroneous certification. If a false certification is made by a subcontractor the contractor's submitted bid and the executed contract may not be declared void unless the contractor refuses to terminate the subcontract upon the State's request after a finding that the subcontractor's certification was false.

Section 50-2 of the Code provides that every person that has entered into a multi-year contract and every subcontractor with a multi-year subcontract shall certify, by July 1 of each fiscal year covered by the contract after the initial fiscal year, to the responsible CPO whether it continues to satisfy the requirements of Article 50 pertaining to the eligibility for a contract award. If a contractor or subcontractor is not able to truthfully certify that it continues to meet all requirements, it shall provide with its certification a detailed explanation of the circumstances leading to the change in certification status. A contractor or subcontractor that makes a false statement material to any given certification required under Article 50 is, in addition to any other penalties or consequences prescribed by law, subject to liability under the Whistleblower Reward and Protection Act for submission of a false claim.

A. Bribery

Section 50-5. Bribery.

(a) Prohibition. No person or business shall be awarded a contract or subcontract under this Code who:

(1) has been convicted under the laws of Illinois or any other state of bribery or attempting to bribe an officer or employee of the State of Illinois or any other state in that officer's or employee's official capacity; or

(2) has made an admission of guilt of that conduct that is a matter of record but has not been prosecuted for that conduct.

(b) Businesses. No business shall be barred from contracting with any unit of State or local government, or subcontracting under such a contract, as a result of a conviction under this Section of any employee or agent of the business if the employee or agent is no longer employed by the business and:

(1) the business has been finally adjudicated not guilty; or

(2) the business demonstrates to the governmental entity with which it seeks to contract, or which is signatory to the contract to which the subcontract relates, and that entity finds that the commission of the offense was not authorized, requested, commanded, or performed by a director, officer, or high managerial agent on behalf of the business as provided in paragraph (2) of subsection (a) of Section 5-4 of the Criminal Code of 2012.

(c) Conduct on behalf of business. For purposes of this Section, when an official, agent, or employee of a business committed the bribery or attempted bribery on behalf of the business and in accordance with the direction or authorization of a responsible official of the business, the business shall be chargeable with the conduct.

(d) Certification. Every bid submitted to and contract executed by the State, and every subcontract subject to Section 20-120 of the Code shall contain a certification by the contractor or the subcontractor, respectively, that the contractor or subcontractor is not barred from being awarded a contract or subcontract under this Section and acknowledges that the CPO may declare the related contract void if any certifications required by this Section are false. A contractor who makes a false statement, material to the certification, commits a Class 3 felony.

The contractor or subcontractor certifies that it is not barred from being awarded a contract under Section 50-5.

B. Felons

Section 50-10. Felons.

Unless otherwise provided, no person or business convicted of a felony shall do business with the State of Illinois or any State agency, or enter into a subcontract, from the date of conviction until 5 years after the date of completion of the sentence for that felony, unless no person held responsible by a prosecutorial office for the facts upon which the conviction was based continues to have any involvement with the business.

Certification. Every bid submitted to and contract executed by the State and every subcontract subject to Section 20-120 of the Code shall contain a certification by the bidder or contractor or subcontractor, respectively, that the bidder, contractor, or subcontractor is not barred from being awarded a contract or subcontract under this Section and acknowledges that the CPO may declare the related contract void if any of the certifications required by this Section are false.

RETURN WITH SUBCONTRACT

C. Debt Delinquency

Section 50-11 and 50-12. Debt Delinquency.

The contractor or bidder or subcontractor, respectively, certifies that it, or any affiliate, is not barred from being awarded a contract or subcontract under the Code. Section 50-11 prohibits a person from entering into a contract with a State agency, or entering into a subcontract, if it knows or should know that it, or any affiliate, is delinquent in the payment of any debt to the State as defined by the Debt Collection Board. Section 50-12 prohibits a person from entering into a contract with a State agency, or entering into a subcontract, if it, or any affiliate, has failed to collect and remit Illinois Use Tax on all sales of tangible personal property into the State of Illinois in accordance with the provisions of the Illinois Use Tax Act. The bidder or contractor or subcontractor, respectively, further acknowledges that the CPO may declare the related contract void if this certification is false or if the bidder, contractor, or subcontractor, or any affiliate, is determined to be delinquent in the payment of any debt to the State during the term of the contract.

D. Prohibited Bidders, Contractors and Subcontractors

Section 50-10.5 and 50-60(c). Prohibited bidders, contractors and subcontractors.

The bidder or contractor or subcontractor, respectively, certifies in accordance with 30 ILCS 500/50-10.5 that no officer, director, partner or other managerial agent of the contracting business has been convicted of a felony under the Sarbanes-Oxley Act of 2002 or a Class 3 or Class 2 felony under the Illinois Securities Law of 1953 or if in violation of Subsection (c) for a period of five years from the date of conviction. Every bid submitted to and contract executed by the State and every subcontract subject to Section 20-120 of the Code shall contain a certification by the bidder, contractor, or subcontractor, respectively, that the bidder, contractor, or subcontractor is not barred from being awarded a contract or subcontract under this Section and acknowledges that the CPO shall declare the related contract void if any of the certifications completed pursuant to this Section are false.

E. Section 42 of the Environmental Protection Act

The bidder or contractor or subcontractor, respectively, certifies in accordance with 30 ILCS 500/50-14 that the bidder, contractor, or subcontractor, is not barred from being awarded a contract or entering into a subcontract under this Section which prohibits the bidding on or entering into contracts with the State of Illinois or a State agency, or entering into any subcontract, that is subject to the Code by a person or business found by a court or the Pollution Control Board to have committed a willful or knowing violation of Section 42 of the Environmental Protection Act for a period of five years from the date of the order. The bidder or contractor or subcontractor, respectively, acknowledges that the CPO may declare the contract void if this certification is false.

The undersigned, on behalf of the subcontracting company, has read and understands the above certifications and makes the certifications as required by law.

Name of Subcontracting Company

Authorized Officer

Date

RETURN WITH SUBCONTRACT
SUBCONTRACTOR DISCLOSURES

I. DISCLOSURES

- A.** The disclosures hereinafter made by the subcontractor are each a material representation of fact upon which reliance is placed. The subcontractor further certifies that the Department has received the disclosure forms for each subcontract.

The CPO may void the bid, contract, or subcontract, respectively, if it is later determined that the bidder or subcontractor rendered a false or erroneous disclosure. A contractor or subcontractor may be suspended or debarred for violations of the Code. Furthermore, the CPO may void the contract.

B. Financial Interests and Conflicts of Interest

1. Section 50-35 of the Code provides that all subcontracts with a total value of \$50,000 or more from subcontractors identified in Section 20-120 of the Code, shall be accompanied by disclosure of the financial interests of the subcontractor. This disclosed information for the subcontractor, will be maintained as public information subject to release by request pursuant to the Freedom of Information Act, filed with the Procurement Policy Board, and shall be incorporated as a material term of the Prime Contractor's contract. Furthermore, pursuant to this Section, the Procurement Policy Board may recommend to allow or void a contract or subcontract based on a potential conflict of interest.

The financial interests to be disclosed shall include ownership or distributive income share that is in excess of 5%, or an amount greater than 60% of the annual salary of the Governor, of the subcontracting entity or its parent entity, whichever is less, unless the subcontractor is a publicly traded entity subject to Federal 10K reporting, in which case it may submit its 10K disclosure in place of the prescribed disclosure. If a subcontractor is a privately held entity that is exempt from Federal 10K reporting, but has more than 100 shareholders, it may submit the information that Federal 10K companies are required to report, and list the names of any individual or entity holding any ownership share that is in excess of 5%. The disclosure shall include the names, addresses, and dollar or proportionate share of ownership of each individual making the disclosure, their instrument of ownership or beneficial relationship, and notice of any potential conflict of interest resulting from the current ownership or beneficial interest of each individual making the disclosure having any of the relationships identified in Section 50-35 and on the disclosure form.

The current annual salary of the Governor is \$177,412.00.

In addition, all disclosures shall indicate any other current or pending contracts, subcontracts, proposals, leases, or other ongoing procurement relationships the subcontracting entity has with any other unit of state government and shall clearly identify the unit and the contract, subcontract, proposal, lease, or other relationship.

2. Disclosure Forms. Disclosure Form A is attached for use concerning the individuals meeting the above ownership or distributive share requirements. A separate Disclosure Form A must be submitted with the bid for each individual meeting the above requirements. In addition, a second form (Disclosure Form B) provides for the disclosure of current or pending procurement relationships with other (non-IDOT) state agencies and a total ownership certification.

C. Disclosure Form Instructions

Form A Instructions for Financial Information & Potential Conflicts of Interest

If the subcontractor is a publicly traded entity subject to Federal 10K reporting, the 10K Report may be submitted to meet the requirements of Form A. If a subcontractor is a privately held entity that is exempt from Federal 10K reporting, but has more than 100 shareholders, it may submit the information that Federal 10K companies are required to report, and list the names of any individual or entity holding any ownership share that is in excess of 5%. If a subcontractor is not subject to Federal 10K reporting, the subcontractor must determine if any individuals are required by law to complete a financial disclosure form. To do this, the subcontractor should answer each of the following questions. A "YES" answer indicates Form A must be completed. If the answer to each of the following questions is "NO", then the NOT APPLICABLE STATEMENT on the second page of Form A must be signed and dated by an individual that is authorized to execute contracts for the subcontracting company. Note: These questions are for assistance only and are not required to be completed.

1. Does anyone in your organization have a direct or beneficial ownership share of greater than 5% of the bidding entity or parent entity? YES ___ NO ___
2. Does anyone in your organization have a direct or beneficial ownership share of less than 5%, but which has a value greater than 60% of the annual salary of the Governor? YES ___ NO ___
3. Does anyone in your organization receive more than 60% of the annual salary of the Governor of the subcontracting entity's or parent entity's distributive income? YES ___ NO ___

(Note: Distributive income is, for these purposes, any type of distribution of profits. An annual salary is not distributive income.)

4. Does anyone in your organization receive greater than 5% of the subcontracting entity's or parent entity's total distributive income, but which is less than 60% of the annual salary of the Governor? YES ___ NO ___

(Note: Only one set of forms needs to be completed per individual per subcontract even if a specific individual would require a yes answer to more than one question.)

A "YES" answer to any of these questions requires the completion of Form A. The subcontractor must determine each individual in the subcontracting entity or the subcontracting entity's parent company that would cause the questions to be answered "Yes". Each form must be signed and dated by an individual that is authorized to execute contracts for your organization. The individual signing can be, but does not have to be, the individual for which the form is being completed. The subcontractor is responsible for the accuracy of any information provided.

If the answer to each of the above questions is "NO", then the NOT APPLICABLE STATEMENT on page 2 of Form A must be signed and dated by an individual that is authorized to execute contracts for your company.

RETURN WITH SUBCONTRACT

Form B: Instructions for Identifying Other Contracts & Procurement Related Information

Disclosure Form B must be completed for each subcontract submitted by the subcontracting entity. *Note: Checking the NOT APPLICABLE STATEMENT on Form A does not allow the subcontractor to ignore Form B. Form B must be completed, checked, and dated or the subcontract will not be approved.*

The Subcontractor shall identify, by checking Yes or No on Form B, whether it has any pending contracts, subcontracts, leases, bids, proposals, or other ongoing procurement relationship with any other (non-IDOT) State of Illinois agency. If "No" is checked, the subcontractor only needs to complete the check box on the bottom of Form B. If "Yes" is checked, the subcontractor must list all non-IDOT State of Illinois agency pending contracts, subcontracts, leases, bids, proposals, and other ongoing procurement relationships. These items may be listed on Form B or on an attached sheet(s). Contracts with cities, counties, villages, etc. are not considered State of Illinois agency contracts and are not to be included. Contracts or subcontracts with other State of Illinois agencies such as the Department of Natural Resources or the Capital Development Board must be included.

ILLINOIS DEPARTMENT OF TRANSPORTATION

Form A Subcontractor: Financial Information & Potential Conflicts of Interest Disclosure

Subcontractor Name, Legal Address, City, State, Zip, Telephone Number, Email Address, Fax Number (if available)

Disclosure of the information contained in this Form is required by Section 50-35 of the Code (30 ILCS 500). Subcontractors desiring to enter into a subcontract of a State of Illinois contract must disclose the financial information and potential conflict of interest information as specified in this Disclosure Form.

The current annual salary of the Governor is \$177,412.00.

DISCLOSURE OF FINANCIAL INFORMATION

1. Disclosure of Financial Information. The individual named below has an interest in the SUBCONTRACTOR (or its parent) in terms of ownership or distributive income share in excess of 5%, or an interest which has a value of more than 60% of the annual salary of the Governor.

FOR INDIVIDUAL (type or print information) NAME: ADDRESS Type of ownership/distributable income share: stock sole proprietorship Partnership other: (explain on separate sheet): % or \$ value of ownership/distributable income share:

2. Disclosure of Potential Conflicts of Interest. Check "Yes" or "No" to indicate which, if any, of the following potential conflict of interest relationships apply. If the answer to any question is "Yes", please attach additional pages and describe.

(a) State employment, currently or in the previous 3 years, including contractual employment of services. Yes ___ No ___

If your answer is yes, please answer each of the following questions.

1. Are you currently an officer or employee of either the Capitol Development Board or the Illinois State Toll Highway Authority? Yes ___ No ___

2. Are you currently appointed to or employed by any agency of the State of Illinois? If you are currently appointed to or employed by any agency of the State of Illinois, and your annual salary exceeds 60% of the annual salary of the Governor, provide the name the State agency for which you are employed and your annual salary.

RETURN WITH SUBCONTRACT

3. If you are currently appointed to or employed by any agency of the State of Illinois, and your annual salary exceeds 60% of the annual salary of the Governor, are you entitled to receive (i) more than 7 1/2% of the total distributable income of your firm, partnership, association or corporation, or (ii) an amount in excess of 100% of the annual salary of the Governor?
Yes ___ No ___

4. If you are currently appointed to or employed by any agency of the State of Illinois, and your annual salary exceeds 60% of the annual salary of the Governor, are you and your spouse or minor children entitled to receive (i) more than 15 % in the aggregate of the total distributable income of your firm, partnership, association or corporation, or (ii) an amount in excess of two times the salary of the Governor?
Yes ___ No ___

(b) State employment of spouse, father, mother, son, or daughter, including contractual employment services in the previous 2 years.

Yes ___ No ___

If your answer is yes, please answer each of the following questions.

1. Is your spouse or any minor children currently an officer or employee of the Capitol Development Board or the Illinois Toll Highway Authority?
Yes ___ No ___

2. Is your spouse or any minor children currently appointed to or employed by any agency of the State of Illinois? If your spouse or minor children is/are currently appointed to or employed by any agency of the State of Illinois, and his/her annual salary exceeds 60% of the annual salary of the Governor, provide the name of your spouse and/or minor children, the name of the State agency for which he/she is employed and his/her annual salary. _____

3. If your spouse or any minor children is/are currently appointed to or employed by any agency of the State of Illinois, and his/her annual salary exceeds 60% of the annual salary of the Governor, as of 7/1/07 are you entitled to receive (i) more than 7 1/2% of the total distributable income of your firm, partnership, association or corporation, or (ii) an amount in excess of 100% of the annual salary of the Governor?
Yes ___ No ___

4. If your spouse or any minor children are currently appointed to or employed by any agency of the State of Illinois, and his/her annual salary exceeds 60% of the annual salary of the Governor, are you and your spouse or minor children entitled to receive (i) more than 15 % in the aggregate of the total distributable income of your firm, partnership, association or corporation, or (ii) an amount in excess of two times the annual salary of the Governor?
Yes ___ No ___

(c) Elective status; the holding of elective office of the State of Illinois, the government of the United States, any unit of local government authorized by the Constitution of the State of Illinois or the statutes of the State of Illinois currently or in the previous 3 years.
Yes ___ No ___

(d) Relationship to anyone holding elective office currently or in the previous 2 years; spouse, father, mother, son, or daughter.
Yes ___ No ___

(e) Appointive office; the holding of any appointive government office of the State of Illinois, the United States of America, or any unit of local government authorized by the Constitution of the State of Illinois or the statutes of the State of Illinois, which office entitles the holder to compensation in excess of the expenses incurred in the discharge of that office currently or in the previous 3 years.
Yes ___ No ___

(f) Relationship to anyone holding appointive office currently or in the previous 2 years; spouse, father, mother, son, or daughter.
Yes ___ No ___

(g) Employment, currently or in the previous 3 years, as or by any registered lobbyist of the State government.
Yes ___ No ___

RETURN WITH SUBCONTRACT

(h) Relationship to anyone who is or was a registered lobbyist in the previous 2 years; spouse, father, mother, son, or daughter. Yes ___ No ___

(i) Compensated employment, currently or in the previous 3 years, by any registered election or reelection committee registered with the Secretary of State or any county clerk of the State of Illinois, or any political action committee registered with either the Secretary of State or the Federal Board of Elections. Yes ___ No ___

(j) Relationship to anyone; spouse, father, mother, son, or daughter; who was a compensated employee in the last 2 years by any registered election or re-election committee registered with the Secretary of State or any county clerk of the State of Illinois, or any political action committee registered with either the Secretary of State or the Federal Board of Elections. Yes ___ No ___

3 Communication Disclosure.

Disclose the name and address of each lobbyist and other agent of the bidder or offeror who is not identified in Section 2 of this form, who is has communicated, is communicating, or may communicate with any State officer or employee concerning the bid or offer. This disclosure is a continuing obligation and must be promptly supplemented for accuracy throughout the process and throughout the term of the contract. If no person is identified, enter "None" on the line below:

Name and address of person(s): _____

RETURN WITH SUBCONTRACT

4. Suspension or Debarment Disclosure. For each of the persons identified under Sections 2 and 3 of this form, disclose whether any of the following has occurred within the previous 10 years: suspension or debarment from contracting with any governmental entity; professional licensure discipline; bankruptcies; adverse civil judgments and administrative findings; and criminal felony convictions. This disclosure is a continuing obligation and must be promptly supplemented for accuracy throughout the procurement process and term of the contract. If no person is identified, enter "None" on the line below:

Name of person(s): _____

Nature of disclosure: _____

APPLICABLE STATEMENT

This Disclosure Form A is submitted on behalf of the INDIVIDUAL named on previous page. Under penalty of perjury, I certify the contents of this disclosure to be true and accurate to the best of my knowledge.

Completed by: _____ Date _____
Signature of Individual or Authorized Officer

NOT APPLICABLE STATEMENT

Under penalty of perjury, I have determined that no individuals associated with this organization meet the criteria that would require the completion of this Form A.

This Disclosure Form A is submitted on behalf of the SUBCONTRACTOR listed on the previous page.

_____ Date _____
Signature of Authorized Officer

RETURN WITH SUBCONTRACT

ILLINOIS DEPARTMENT OF TRANSPORTATION

Form B
Subcontractor: Other Contracts & Financial Related Information Disclosure

Form with fields: Subcontractor Name, Legal Address, City, State, Zip, Telephone Number, Email Address, Fax Number (if available)

Disclosure of the information contained in this Form is required by Section 50-35 of the Code (30 ILCS 500). This information shall become part of the publicly available contract file. This Form B must be completed for subcontracts with a total value of \$50,000 or more, from subcontractors identified in Section 20-120 of the Code, and for all open-ended contracts.

DISCLOSURE OF OTHER CONTRACTS, SUBCONTRACTS, AND PROCUREMENT RELATED INFORMATION

1. Identifying Other Contracts & Procurement Related Information. The SUBCONTRACTOR shall identify whether it has any pending contracts, subcontracts, including leases, bids, proposals, or other ongoing procurement relationship with any other State of Illinois agency: Yes ___ No ___

If "No" is checked, the subcontractor only needs to complete the signature box on this page.

2. If "Yes" is checked. Identify each such relationship by showing State of Illinois agency name and other descriptive information such as bid or project number (attach additional pages as necessary). SEE DISCLOSURE FORM INSTRUCTIONS:

THE FOLLOWING STATEMENT MUST BE CHECKED

Signature box with fields: Signature of Authorized Representative, Date

OWNERSHIP CERTIFICATION

Please certify that the following statement is true if the individuals for all submitted Form A disclosures do not total 100% of ownership

Any remaining ownership interest is held by individuals receiving less than \$106,447.20 of the bidding entity's or parent entity's distributive income or holding less than a 5% ownership interest.

Yes No N/A (Form A disclosure(s) established 100% ownership)



NOTICE TO BIDDERS

1. TIME AND PLACE OF OPENING BIDS. Sealed proposals for the improvement described herein will be received by the Department of Transportation. Electronic bids are to be submitted to the electronic bidding system (iCX-Integrated Contractors Exchange). Paper-based bids are to be submitted to the Chief Procurement Officer for the Department of Transportation in care of the Chief Contracts Official at the Harry R. Hanley Building, 2300 South Dirksen Parkway, in Springfield, Illinois until 10:00 a.m. January 20, 2017. All bids will be gathered, sorted, publicly opened and read in the auditorium at the Department of Transportation's Harry R. Hanley Building shortly after 10:00 a.m.

2. DESCRIPTION OF WORK. The proposed improvement is identified and advertised for bids in the Invitation for Bids as:

**Contract No. 64L64
Various Counties
Section D2 GR (NORTH) 2017
Various Routes
District 2 Construction Funds**

This project consists of on-call guardrail and fence repairs along state maintained routes in Boone, Carroll, JoDaviess, Ogle, Stephenson and Winnebago Counties.

3. INSTRUCTIONS TO BIDDERS. (a) This Notice, the invitation for bids, proposal and letter of award shall, together with all other documents in accordance with Article 101.09 of the Standard Specifications for Road and Bridge Construction, become part of the contract. Bidders are cautioned to read and examine carefully all documents, to make all required inspections, and to inquire or seek explanation of the same prior to submission of a bid.

(b) State law, and, if the work is to be paid wholly or in part with Federal-aid funds, Federal law requires the bidder to make various certifications as a part of the proposal and contract. By execution and submission of the proposal, the bidder makes the certification contained therein. A false or fraudulent certification shall, in addition to all other remedies provided by law, be a breach of contract and may result in termination of the contract.

4. AWARD CRITERIA AND REJECTION OF BIDS. This contract will be awarded to the lowest responsive and responsible bidder considering conformity with the terms and conditions established by the Department in the rules, Invitation for Bids and contract documents. The issuance of plans and proposal forms for bidding based upon a prequalification rating shall not be the sole determinant of responsibility. The Department reserves the right to determine responsibility at the time of award, to reject any or all proposals, to readvertise the proposed improvement, and to waive technicalities.

By Order of the
Illinois Department of Transportation

Randall S. Blankenhorn,
Secretary

INDEX
FOR
SUPPLEMENTAL SPECIFICATIONS
AND RECURRING SPECIAL PROVISIONS

Adopted January 1, 2017

This index contains a listing of SUPPLEMENTAL SPECIFICATIONS and frequently used RECURRING SPECIAL PROVISIONS.

ERRATA Standard Specifications for Road and Bridge Construction (Adopted 4-1-16) (Revised 1-1-17)

SUPPLEMENTAL SPECIFICATIONS

<u>Std. Spec. Sec.</u>		<u>Page No.</u>
106	Control of Materials	1
403	Bituminous Surface Treatment (Class A-1, A-2, A-3)	2
420	Portland Cement Concrete Pavement	3
502	Excavation for Structures	5
503	Concrete Structures	7
504	Precast Concrete Structures	10
542	Pipe Culverts	11
586	Sand Backfill for Vaulted Abutments	12
670	Engineer's Field Office and Laboratory	14
704	Temporary Concrete Barrier	15
888	Pedestrian Push-Button	17
1003	Fine Aggregates	18
1004	Coarse Aggregates	19
1006	Metals	21
1020	Portland Cement Concrete	22
1103	Portland Cement Concrete Equipment	24

RECURRING SPECIAL PROVISIONS

The following RECURRING SPECIAL PROVISIONS indicated by an "X" are applicable to this contract and are included by reference:

<u>CHECK SHEET #</u>		<u>PAGE NO.</u>
1	Additional State Requirements for Federal-Aid Construction Contracts	26
2	Subletting of Contracts (Federal-Aid Contracts)	29
3	X EEO	30
4	X Specific EEO Responsibilities Non Federal-Aid Contracts	40
5	X Required Provisions - State Contracts	45
6	Asbestos Bearing Pad Removal	51
7	Asbestos Waterproofing Membrane and Asbestos HMA Surface Removal	52
8	Temporary Stream Crossings and In-Stream Work Pads	53
9	Construction Layout Stakes Except for Bridges	54
10	Construction Layout Stakes	57
11	Use of Geotextile Fabric for Railroad Crossing	60
12	Subsealing of Concrete Pavements	62
13	Hot-Mix Asphalt Surface Correction	66
14	Pavement and Shoulder Resurfacing	68
15	Patching with Hot-Mix Asphalt Overlay Removal	69
16	Polymer Concrete	70
17	PVC Pipeliner	72
18	Bicycle Racks	73
19	Temporary Portable Bridge Traffic Signals	75
20	X Work Zone Public Information Signs	77
21	Nighttime Inspection of Roadway Lighting	78
22	English Substitution of Metric Bolts	79
23	Calcium Chloride Accelerator for Portland Cement Concrete	80
24	Quality Control of Concrete Mixtures at the Plant	81
25	Quality Control/Quality Assurance of Concrete Mixtures	89
26	Digital Terrain Modeling for Earthwork Calculations	105
27	Reserved	107
28	Preventive Maintenance – Bituminous Surface Treatment (A-1)	108
29	Preventive Maintenance – Cape Seal	114
30	Preventive Maintenance – Micro-Surfacing	129
31	Preventive Maintenance – Slurry Seal	140
32	Temporary Raised Pavement Markers	149
33	Restoring Bridge Approach Pavements Using High-Density Foam	150
34	Portland Cement Concrete Inlay or Overlay	153

TABLE OF CONTENTS

LOCATION OF PROJECT 1
DESCRIPTION OF PROJECT 1
TRAFFIC CONTROL PLAN 2
TRAFFIC CONTROL AND PROTECTION (SPECIAL)..... 3
TRAFFIC CONTROL INSPECTION AND DEFICIENCY DEDUCTION..... 4
KEEPING ROADS OPEN TO TRAFFIC 4
SCOPE OF WORK 4
JOINT UTILITY LOCATION INFORMATION FOR EXCAVATORS..... 5
CONTRACTOR'S RESPONSIBILITY FOR DAMAGE TO EXISTING STRUCTURES 5
DAMAGE TO RIGHT-OF-WAY 5
DURATION OF CONTRACT 5
INTERPRETATION OF QUANTITIES 5
COMPLETION OF WORK 6
REGULAR WORK 6
NIGHTTIME WORK ZONE LIGHTING 7
EMERGENCY WORK CALL OUT 7
EXTRA WORK..... 8
WORK ORDERS 8
REMOVAL OR REPAIR OF GUARDRAIL OR FENCE 8
REALIGNING POSTS..... 9
TERMINAL MARKER 9
GUARDRAIL MARKERS, TYPE A 9
REMOVE AND RE-ERECT STEEL PLATE BEAM GUARDRAIL, TYPE A..... 10
LONG POST FOR STEEL PLATE BEAM GUARDRAIL 10
STEEL POSTS (SPECIAL)..... 11
TUBULAR THRIE BEAM 11
REPAIR TRAFFIC BARRIER TERMINAL TYPE 2 5, 6, 6A, 6B, 8 AND 9..... 12
DELINEATORS..... 12
CHAIN LINK FENCE..... 13
CHAIN LINK FENCE POST 13
WOVEN WIRE FENCE, 4 FOOT 13
PULL POST ARRANGEMENT 14

CONCRETE STRUCTURE REPAIR 14
REPAIR STEEL PLATE BEAM GUARDRAIL, TYPE A, B OR C..... 15
REPAIR TRAFFIC BARRIER TERMINAL, TYPE 1 SPECIAL (TANGENT) 15
REPAIR TRAFFIC BARRIER TERMINAL, TYPE 1 SPECIAL (FLARED) 16
TRAFFIC BARRIER TERMINAL, TYPE 1, SPECIAL 17
STEEL PLATE BEAM GUARDRAIL (SHORT RADIUS)..... 18
FURNISHED EXCAVATION 18
REPLACE IMPACT ATTENUATORS (NON-REDIRECTIVE), TEST LEVEL 3..... 19
REPAIR TRAFFIC BARRIER TERMINAL TYPE 1 SPECIAL – POST 19
AUTOMATED FLAGGER ASSISTANCE DEVICES (BDE)20
DISADVANTAGED BUSINESS ENTERPRISE PARTICIPATION (BDE).....21
PORTABLE CHANGEABLE MESSAGE SIGNS (BDE)32
PROGRESS PAYMENTS (BDE)33
SPEED DISPLAY TRAILER (BDE).....34
STEEL PLATE BEAM GUARDRAIL (BDE)35
TRAFFIC BARRIER TERMINAL, TYPE 1 SPECIAL (BDE)37
TUBULAR MARKERS (BDE).....38
WEEKLY DBE TRUCKING REPORTS (BDE).....39
VETERAN BUSINESS PROGRAM39

STATE OF ILLINOIS

SPECIAL PROVISIONS

The following Special Provisions supplement the "Standard Specifications for Road and Bridge Construction," adopted April 1, 2016, the latest edition of the "Manual on Uniform Traffic Control Devices for Streets and Highways," and the "Manual of Test Procedures for Materials" in effect on the date of invitation for bids, and the Supplemental Specifications and Recurring Special Provisions indicated on the Check Sheet included herein which apply to and govern the construction of Various Routes, Section D2 GR (North) 2017, Various Counties, Contract No. 64L64, and in case of conflict with any part or parts of said Specifications, the said Special Provisions shall take precedence and shall govern.

LOCATION OF PROJECT

Along all state maintained routes in Boone, Carroll, JoDaviess, Ogle, Stephenson, and Winnebago Counties.

DESCRIPTION OF PROJECT

The work in this contract consists of furnishing all labor, equipment, and materials necessary for the complete repair or replacement of damaged guardrail, fence, attenuators, and other highway appurtenances; also minor concrete repairs at locations throughout District 2. The damage to repair is generally a result of automobile accidents, therefore, the need and locations of any repairs are random in nature. Work includes providing proper traffic control. Some nighttime work may be required.

TRAFFIC CONTROL PLAN

Traffic Control shall be according to the applicable sections of the Standard Specifications for Road and Bridge Construction, the applicable guidelines contained in the National Manual on Uniform Traffic Control Devices for Streets and Highways, Illinois Supplement to the National Manual on Uniform Traffic Control Devices, these special provisions, and any special details and Highway Standards contained herein and in the plans.

Special attention is called to Articles 107.09 and 107.14 of the Standard Specifications for Road and Bridge Construction and the following Highway Standards relating to traffic control.

Standards:

701001	701006	701101	701106	701201	701301
701400	701401	701406	701411	701421	701426
701428	701501	701502	701601	701602	701606
701701	701901				

Additional traffic control and hour restrictions for closures may have to be imposed to facilitate the flow of traffic on certain sections of highways.

Signs:

No bracing shall be allowed on post-mounted signs.

Post-mounted signs shall be installed using standard 720011, 728001, 729001, on 4"x4" wood posts, or on any other "break away" connection if accepted by the FHWA and corresponding letter is provided to the resident.

The "WORKERS" (W21-1a(O)-48 signs shall be replaced with symbols "Right or Left Lane Closed Ahead" (W4-2R or L(O)-48 signs on multilane roadways.

Devices:

Direction Indicator Barricades shall exclusively be used in lane closure tapers. They shall be used only when traffic is being merged with an adjacent through lane or shifted onto a median crossover.

Vertical barricades shall not be used in weaves, in the gore areas on Highway Standard 701411 or on a 65 mph facility.

TRAFFIC CONTROL AND PROTECTION (SPECIAL)

This work shall be completed in accordance with all applicable portions of Section 701 of the Standard Specifications for Road and Bridge Construction, as stated herein, and as directed by the Engineer.

Each work order will require traffic control specific to its location and repair requirements. Even though there will be an unknown number of work orders with this contract, all traffic control costs for this contract shall be included in this lump sum pay item.

Due to the Department's Work Zone Safety and Mobility Policy, designated significant routes have been established. A color coded map of our District's designated significant routes can be found at IDOT's website.

Follow this path to the map:

http://www.dot.il.gov/illinoisshsp/WorkZoneSafetyMobility/03092009_Appendix_B.pdf

Scroll down to IDOT District 2 Map.

It will be the Contractor's responsibility to check the work order location with this map.

If the work location is in a yellow or red zone, the Contractor will be required to contact the District's Operation Traffic Section, at least 72 hours in advance of anticipated work, at 815/284-5474 for instructions and possible work time restrictions.

All Traffic Control and protection costs for this contract shall be considered to be included in the Lump Sum bid for TRAFFIC CONTROL AND PROTECTION (SPECIAL).

TRAFFIC CONTROL INSPECTION AND DEFICIENCY DEDUCTION

Any work on State right-of-way shall not begin unless proper work zone traffic control, in accordance with the plans, is utilized. When the engineer is notified or determines a traffic control deficiency exists, (s)he shall be the sole judge as to whether or not the deficiency is an immediate safety hazard. When judged an immediate safety hazard, repair/replacement work shall be immediately stopped and all equipment, personnel, and material that constitute the hazard shall be removed from the right-of-way until the traffic control deficiency is corrected.

For each incident judged to be an immediate hazard, \$400.00 shall be deducted from the compensation due to the contractor. For deficiencies not judged an immediate hazard, the contractor shall correct deficiencies within four (4) hours of notification. No extension of time for completion of regular or emergency work shall be allowed for time used to correct traffic control deficiencies.

When directed by the engineer, the contractor shall submit for approval to the District 2 Office of Traffic Operations, in writing, a schedule showing the location and day of any repair/replacement (s)he intends to perform. Twenty four hours notice is required in advance of any regular work performed. Verbal notice is acceptable for emergency work orders.

KEEPING ROADS OPEN TO TRAFFIC

All roads shall be kept open to two-way traffic at all times, except when construction operations require, as directed by the engineer, temporary closing of one lane. All lanes will be required to be open to traffic overnight, on weekends, and on holidays. The contractor shall give the appropriate IDOT Area Maintenance Field Engineer 24 hours notice before any lane closure. The field engineer will be the sole judge as to the necessity of lane closures and the length and duration of same.

Access to all residences, commercial entrances, and side roads shall be maintained during construction.

SCOPE OF WORK

The work in this contract consists of removing damaged guardrail, fencing, or attenuators and replacing it with new material as approved by the engineer and as specified elsewhere. This may also include the minor adjustment of connecting parts of the installation as specified elsewhere. Work also includes repair or replacement of damaged highway appurtenances and replacing minor concrete damaged to structures.

JOINT UTILITY LOCATION INFORMATION FOR EXCAVATORS

Whenever a question arises regarding the existence or location of buried utility, call the toll free J.U.L.I.E. telephone number, 1-800-892-0123, before starting excavation. Allow 48 hours for other than emergency assistance.

CONTRACTOR'S RESPONSIBILITY FOR DAMAGE TO EXISTING STRUCTURES

The Contractor is hereby advised that there may be drainage structures, storm sewers, sign foundations, culverts, electrical conduits, and other existing objects within the immediate work limits of this project and that he should use extreme care when driving posts.

The Contractor shall be held responsible for any damages to existing structures resulting from the operations of his equipment and employees. The Contractor shall, at his own expense, restore the damaged structures to a condition equal to that existing before damage was done, by repairing, rebuilding or replacing it as directed by the Engineer.

No extra compensation will be permitted the Contractor for compliance with the requirements specified herein.

DAMAGE TO RIGHT-OF-WAY

Any damage to the right-of-way caused by the Contractor's operations shall be repaired and/or restored to the satisfaction of the Engineer. All costs incurred to repair or restore the right-of-way shall be that of the Contractor and no additional compensation will be allowed.

DURATION OF CONTRACT

The work as specified in this contract shall begin upon the execution of the Contract, but no sooner than March 15, 2017, and continue until all work assigned prior to March 13, 2018 has been completed.

INTERPRETATION OF QUANTITIES

The quantities appearing in the Summary of Quantities of the plans are estimated for bidding purposes only.

The Contractor is hereby informed and shall understand that payment will be made only for actual quantities utilized and accepted as satisfactory.

The guardrail or fence installations must be satisfactorily completed, functional, and accepted by the Engineer before payment for any work is made in accordance with schedule of prices in the contract.

COMPLETION OF WORK

The work in accordance with this contract shall be considered either regular work or emergency work.

The contractor is allowed thirty (30) calendar days after the work authorization to complete regular work and have it accepted by the engineer. The contractor is allowed ten (10) calendar days after the work authorization to complete emergency work and have it accepted by the engineer. If work is not completed and accepted within these time limits, the contractor shall be liable to the Department the amount of \$50.00 per day per work order, not as a penalty but as liquidated damages for each day of overrun as specified herein.

The time (calendar days) required by the engineer to inspect the work will not be counted against the balance of days remaining for the contractor to perform the work.

A calendar day is every day on the calendar and starts at 12:00 midnight and ends at the following 12:00 midnight, 24 hours later. No liquidated damages will be assessed for any day less than twenty-four hours.

Work associated with replacing damaged sand module impact attenuators (IMPACT ATTENUATORS (NON-REDIRECTIVE), TEST LEVEL 3) shall be as specified herein. The contractor is allowed 36 hours after authorization to complete the work replacing damaged sand modules. **Liquidated damages are then charged at \$200.00 per calendar day per sand module** until the work is completed and accepted.

REGULAR WORK

When used in conjunction with this contract, Regular Work involves those situations where the amount or nature of damage does not pose an immediate hazard to the public, in the opinion of the Engineer.

Regular work will be initiated by a written work order from an authorized representative of the Department. Work of this type shall be completed within thirty (30) calendar days of the authorization of work. This work will not be paid for separately, but shall be considered incidental to the type of repairs on the work order.

NIGHTTIME WORK ZONE LIGHTING

Due to the State's Work Zone Safety and Mobility Policy, several high traffic volume routes have been designated as a Significant Route. They are typically Interstate routes, but not exclusively interstates. When guardrail repairs are required along a Significant Route, and a traffic lane closure will be required to perform the repairs, nighttime work will be required to help prevent long traffic backups. The work order will indicate the times when the repairs can be made. When nighttime work is required, 1 each for Nighttime Work Zone Lighting will be used for repairing guardrail damage at one location during the restricted nighttime hours of one night. All workers will be required to wear pants and vests meeting the ANSI Class 3 requirements. The nighttime work zone lighting requirements shall conform to the requirements is in the BDE Special Provisions.

A map showing all designated Significant Routes in Region 2 can be found at:

http://www.dot.il.gov/illinoisshsp/WorkZoneSafetyMobility/03092009_Appendix_B.pdf

Scroll down to IDOT District 2 Map.

This work and requirements will be paid for at the contract unit price EACH for NIGHTTIME WORK ZONE LIGHTING.

EMERGENCY WORK CALL OUT

Emergency Work means work that is required to correct a condition which is a hazard to the public, or is designated by the Engineer to be a hazard of such severity that life and/or property are endangered and immediate corrective action is required.

Emergency work can generally be described, but is not limited to damage in one of the following categories:

- a. Guardrail damage consisting of any openings or exposed ends
- b. Guardrail elements including either posts or panels which are laying in a down position
- c. Any damage which could cause a spearing effect
- d. Terminal end sections which have damaged posts or panel elements
- e. Attenuator damage which exposes a hazardous situation

Emergency work will be initiated by a verbal order from an authorized representative of the Department. Work of this type should be acted upon immediately and shall be completed within ten (10) calendar days of the verbal authorization of the work.

The location of guardrail or fence damage to be repaired as emergency work shall be determined by the Engineer.

Any extra costs associated with completing the emergency work within the time specified after receiving a work order shall be paid for at the contract unit price each for EMERGENCY WORK CALL OUT.

EXTRA WORK

Extra work to repair motorist caused damage not included in this contract as a pay item, may be assigned to the contractor. Extra work will be paid for in accordance with article 109.04 of the Standard Specifications for Road and Bridge Construction.

WORK ORDERS

No work is to be performed by the Contractor unless he/she possesses a work order authorizing the repairs. All repairs are to be made using new material and include the removal and disposal of the damaged material. All work orders will be sent to the Contractor's place of business, generally by Fax machine.

All work orders will be filled out and signed by the Engineer or Technician in charge. A work order will show the date, file number, location, and quantity of materials needed to make the repairs. If special instructions are required, they will be written on the work order. If there is a discrepancy of items or quantities on a work order, a revised work order must be obtained from the Engineer, if he agrees, before the repairs are started.

After the repairs have been completed, the Contractor is to place the completion date on the work order, sign it, and return it to the department's district office. The repairs will be inspected and, if completed in accordance with the contract, the Engineer will sign and date the Work Order. The work order will then be processed for payment.

REMOVAL OR REPAIR OF GUARDRAIL OR FENCE

Guardrail or fence shall not be removed from the state right-of-way under this contract unless each rail element, fence, or post to be removed is designated for removal. The engineer in charge will advise on each piece. All damaged material that has been replaced in accordance with the work orders shall become the property of the Contractor and disposed of by him/her outside the limits of the right of way and will not be paid for separately, but shall be included in the various contract unit prices in this contract.

All damaged material shall be replaced with new material unless otherwise specified.

Damaged guardrail removal will not be allowed unless total and complete removal and replacement can be made during one continuous operation.

REALIGNING POSTS

For all work order locations of steel plate beam guardrail installation or repair and traffic terminal repair or replacement, existing adjacent undamaged posts and rail that are out of plumb or misaligned are to be realigned and restored to the proper alignment. The posts shall be plumbed/realigned by a method which does not require the pulling of the posts out of the ground. The posts shall be re-plumbed and set (using a tamping method approved by the Engineer) with their front faces on the line shown on the plans, Standards, or as ordered by the Engineer. The post tops and bolt holes are to be at the correct height so that the rail element plates bolted to them will be parallel to the surface of the shoulder.

The Contractor is hereby informed and shall understand that the work described under REALIGNING POSTS shall be considered included to adjacent work being performed with no additional compensation provided.

TERMINAL MARKER

The terminal marker as shown on Standard 635006 will not be paid for separately, but shall be considered to be included in the contract unit price for new or repair Traffic Barrier Terminal, Type 1, Special, of the type specified.

GUARDRAIL MARKERS, TYPE A

This work shall consist of furnishing and installing replacement one-way or two-way guardrail reflectors with brackets fabricated in accordance with the details as shown in Standard 782006. The reflectors shall be circular meeting the requirements of Article 1097.03 of the Standard Specifications. The reflectors shall be amber or crystal in color to match the existing installation.

The brackets shall be installed by loosening the guardrail post bolt, slipping the "foot" of the bracket between the bolt head and the plate washer (or between the bolt head and the guardrail face if no plate washer is present) and retightening the bolt. The reflectors shall be fastened to the brackets with aluminum rivets.

This work will be paid for at the contract unit price each for GUARDRAIL MARKERS, TYPE A.

REMOVE AND RE-ERECT STEEL PLATE BEAM GUARDRAIL, TYPE A

This pay item is to be used for realigning lengths of **undamaged** guardrail which are out of alignment due to frost heave, erosion or other side slope failure. This type of work is maintenance in nature and shall only be performed at locations designed by the engineer.

This work consists of supplying all labor, materials and equipment to remove and re-erect existing steel plate beam guardrail. Work shall be in accordance with section 633 of the Standard Specifications for Road and Bridge Construction.

Existing steel block-outs shall be replaced with wooden block-outs during the removal and re-erect operations. The wood block-outs shall be according to the current standard applicable to the type of guardrail being re-erected.

The existing steel posts may be drilled to match the bolt pattern shown on Standard 630001 for the wood block-out or a new steel post shall be provided.

Any existing "C" posts shall be removed and new steel posts shall be provided for their replacement.

Work shall be measured and paid for at the contract unit price per foot for REMOVE AND RE-ERECT STEEL PLATE BEAM GUARDRAIL, TYPE A.

LONG POST FOR STEEL PLATE BEAM GUARDRAIL

This work consists of removing and disposing of damaged posts and replacing it with new W6 x 9, W6 x 8.5, 10 foot long steel posts.

The new 10 foot long steel posts shall be used at guardrail locations directed by the engineer.

New steel posts shall be in accordance with Section 630 and Article 1006.04 of the Standard Specifications. Removing and disposing of damaged posts will not be paid for separately, but shall be considered included in the contract unit price.

This work will be paid for at the contract unit price per each for LONG POST FOR STEEL PLATE BEAM GUARDRAIL.

STEEL POSTS (SPECIAL)

This work consists of replacing posts attached to concrete structures by unbolting the rail elements, removing the post which is to be replaced, by furnishing and setting a new post in accordance with Standards 630101 or 509001. The replacement post(s) shall conform to the length, size and type of the original installation. Sheared expansion bolts shall be replaced in kind. Replacement of sheared bolts will not be paid for separately, but shall be considered incidental to the contract unit price for STEEL POSTS, (SPECIAL). New steel posts and base plates shall be galvanized after fabrication, and shall match the configuration of the existing installation.

This work shall be paid for at the contract unit price each for STEEL POSTS, (SPECIAL).

TUBULAR THRIE BEAM

This work consists of removing all sections of damaged rail element plates and all bolts, nuts, washers, and other hardware connected with the damaged rail element, where directed by the Engineer, and furnishing and installing new thrie beam elements, bolts, nuts, washers and other hardware necessary to the plate installation. Plates, nuts, bolts, washers and other hardware are to match the original and adjacent installation in accordance with Standard 509001 and are to be galvanized to match the original and adjacent installation.

The Contractor shall adjust and realign existing rail element plates adjacent to rail elements removed and replaced as directed by the Engineer. Unbolting, bolting, adjusting, realigning or any other work necessary to accomplish the desired realignment shall be considered included in the contract unit price for Tubular Thrie Beam.

The furnishing and installing of all bolts, nuts, washers and other hardware necessary to comply with the above mentioned Special Provision will not be paid for separately, but shall be considered included in the contract unit price for Tubular Thrie Beam.

This work shall be paid for at the contract unit price per foot for TUBULAR THRIE BEAM, which price shall include realigning adjacent rail and/or posts as specified by the Engineer.

REPAIR TRAFFIC BARRIER TERMINAL TYPE 2 5, 6, 6A, 6B, 8 AND 9

This work consists of removing all damaged components of existing Traffic Barrier Terminals Type 2, 5, 6, 8 or 9 in accordance with the applicable portions of Sections 630 and 631 of the Standard Specifications; Standards 631011, 631026, 631031, 631036, and 631041; the plans; and the work order at the locations as specified by the Engineer. All replaced components are to be new.

These pay items shall be used when, in the opinion of the Engineer, 50% or less of the above ground barrier terminal components are damaged.

Undamaged traffic barrier terminal components and hardware may be reused in the new work, with the approval of the Engineer. The Engineer will make the determination and inform the Contractor prior to commencing repairs. The Contractor's bid shall reflect this in his bid for this item.

The Contractor shall adjust and realign existing rail element plates and posts adjacent to the traffic barrier terminal repaired, as directed by the Engineer. Unbolting, bolting, adjusting, realigning or any other work necessary to accomplish the desired realignment shall be considered included in the contract unit price for the repair of the traffic barrier terminal.

This work will be paid for at the contract unit price each for REPAIR TRAFFIC BARRIER TERMINAL, of the type specified.

DELINEATORS

This work shall consist of removing the damaged post and replacement and installation in accordance with Section 635 of the Standard Specifications and as shown in Standard 635001 with the exception that the post shall be rotated 180° and only metal backed delineators shall be permitted.

The metal post, delineators and all hardware shall be furnished by the Contractor.

This work will be paid for at the contract unit price per each for DELINEATORS.

CHAIN LINK FENCE

This work shall consist of removing and disposing of the damaged fence and posts and accessories, and installing new fence fabric and hardware to match the type of existing damaged fence in accordance with Standard 664001 and Section 664 of the Standard Specifications, and as directed by the Engineer.

This work includes all labor and materials, including splices to the existing fence, to make the required repairs as per the work order.

The work order will indicate the required fence size.

This work will be paid for at the contract unit price per foot for CHAIN LINK FENCE 4' or CHAIN LINK FENCE 6'.

CHAIN LINK FENCE POST

This work shall consist of removing damaged posts and concrete footings and installing new posts of the length required for 4' or 6' chain link fence in accordance with Standard 664001 and Section 664 of the Standard Specifications. The Class SI concrete required for the footings of the posts shall be included in the contract unit price. The work order will indicate the size of the post required.

Also included in this work is the realigning of posts in adjoining undamaged fence as directed by the Engineer. This work shall be considered incidental to the replacement item.

This work shall be paid for at the contract unit price per Each for CHAIN LINK FENCE POST, 4 FOOT or CHAIN LINK FENCE POST, 6 FOOT.

WOVEN WIRE FENCE, 4 FOOT

This work shall consist of the removal and disposal of the damaged fence and/or posts and installing a complete new fence, including line posts, in accordance with Standard 665001 and Section 665 of the Standard Specifications or as directed by the Engineer.

This work will be paid for at the contract unit price per foot for WOVEN WIRE FENCE, 4 FOOT.

PULL POST ARRANGEMENT

This work consists of the complete removal of the damaged pull post arrangement including existing concrete encasing the posts and bracing and its new replacement in accordance with Standard 665001 and Section 665 of the Standard Specifications.

Included in this work is the concrete for the anchoring the brace posts and pull post.

This work shall be paid for at the contract unit price each for PULL POST ARRANGEMENT.

CONCRETE STRUCTURE REPAIR

This work consists of repairing concrete structures at locations determined by the engineer.

Concrete removal equipment shall comply with the following:

The concrete saw shall be capable of sawing to a minimum depth of 1-1/2 inches.
Suitable power driven hand tools will be permitted with the approval of the engineer.
Concrete adhering to reinforcement bars shall be removed with a wire brush or other means approved by the engineer.

Class SI concrete in accordance with Section 503 of the Standard Specifications shall be used.

This work is intended to only make small areas of concrete repair where the post(s) were dislodged, not to reconstruct the structure. Only enough concrete is required to reattach the post or plate.

Included in this work the removal and satisfactory disposal of the damaged portions of the structure as directed.

Once the concrete has been poured, three days cure time will be required.

This work will be paid for at the contract unit price per Cubic Foot for CONCRETE STRUCTURE REPAIR.

REPAIR STEEL PLATE BEAM GUARDRAIL, TYPE A, B OR C

This work shall be completed in accordance with the applicable portions of Section 630 of the Standard Specifications, Standard 630001, as directed by the engineer, and as specified herein.

Work shall consist of removing and replacing all damaged steel plate beam guardrail (including posts) and components with new component parts.

Type C guardrail is an obsolete type of guardrail that is mounted on a concrete structure with block-outs spaced at approximately 3 foot centers and anchored to the concrete structure with two unit expansion anchors. Steel posts are not utilized in this installation. The repair is to be done to match the original installation.

This work will be measured and paid for at the contract unit price per Foot for REPAIR STEEL PLATE BEAM GUARDRAIL, of the type specified.

REPAIR TRAFFIC BARRIER TERMINAL, TYPE 1 SPECIAL (TANGENT)

This work occurs when the engineer determines that less than 50% of the above ground barrier terminal installation needs repair and consists of furnishing all labor and equipment to repair the damaged terminal. Work shall be done in accordance with applicable parts of Sections 630 and 631 of the Standard Specifications. Work includes providing all new components and hardware (nuts, bolts, and washers) in accordance with the manufacturer's specifications and re-assembling the terminal in accordance with the manufacturer's instructions.

Undamaged traffic barrier terminal components and hardware may be reused in the repair work, with the approval of the Engineer

Please note that the contract unit price for REPAIR TRAFFIC BARRIER TERMINAL, TYPE 1 SPECIAL (TANGENT) is to include the terminal marker shown on Standard 635006.

This work will be paid for at the contract unit price each for REPAIR TRAFFIC BARRIER TERMINAL, TYPE 1 SPECIAL (TANGENT).

REPAIR TRAFFIC BARRIER TERMINAL, TYPE 1 SPECIAL (FLARED)

This work occurs when the engineer determines that less than 50% of the above ground barrier terminal installation needs repair and consists of furnishing all labor and equipment to repair the damaged terminal. Work shall be done in accordance with applicable parts of Sections 630 and 631 of the Standard Specifications. Work includes providing all new components and hardware (nuts, bolts, and washers) in accordance with the manufacturer's specifications and re-assembling the terminal in accordance with the manufacturer's instructions.

Undamaged traffic barrier terminal components and hardware may be reused in the repair work, with the approval of the Engineer.

Please note that the contract unit price for REPAIR TRAFFIC BARRIER TERMINAL, TYPE 1 SPECIAL (FLARED) is to include the terminal marker shown on Standard 635006.

This work will be paid for at the contract unit price each for REPAIR TRAFFIC BARRIER TERMINAL, TYPE 1 SPECIAL (FLARED).

TRAFFIC BARRIER TERMINAL, TYPE 1, SPECIAL

This work shall consist of finishing and installing all new component parts for the Traffic Barrier Terminal Type 1 Special (Tangent) or (Special) according to Section 631 of the Standard Specifications, as directed by the engineer, and as stated herein.

See the attached recurring special provision for TRAFFIC BARRIER TERMINAL, TYPE 1, SPECIAL.

The contractor shall remove all damaged material and adjust and realign existing rail element plates and posts adjacent to the new traffic barrier terminal. Unbolting, bolting, adjusting, realigning, or any other work necessary to accomplish the desired realignment shall be considered included to the installation of the new traffic barrier terminal.

If a Traffic Barrier Terminal Type 1, Special is used to replace an obsolete traffic barrier commonly known as "bull nose", "turn down" or "Texas twist" end section, removal shall include the additional 25' of guardrail necessary to accommodate the full length of the new Type 1 Special. This work shall not be paid for separately, but shall be included in the contract unit price for a Traffic Barrier Terminal Type 1, Special (tangent or flared). The work order will show if this obsolete terminal is to be removed.

If a Traffic Barrier Terminal Type 4 assembly is damaged beyond repair, all remaining undamaged guardrail shall be removed up to the bridge terminal or as specified by the engineer. A NCHRP 350 approved terminal with a designed length of need will replace the Type 4 assembly. New guardrail, paid for separately, shall be erected to satisfy the length of need.

Included for payment at the contract unit price for TRAFFIC BARRIER TERMINAL TYPE 1, SPECIAL is the terminal marker shown on Standard 725001.

This work will be paid for at the contract unit price Each for TRAFFIC BARRIER TERMINAL TYPE 1, SPECIAL, of the type specified (tangent or flared).

STEEL PLATE BEAM GUARDRAIL (SHORT RADIUS)

This work consists of removing all sections of damaged rail including all posts and associated hardware, and furnishing and installing new radius guardrail including all necessary hardware where directed by the Engineer. Posts, plates, nuts, bolts, washers, and other hardware shall be galvanized and shall match the original and adjacent installation as to type and design.

The Contractor shall adjust and realign existing posts and rail adjacent to this work as directed by the Engineer. Unbolting, bolting, adjusting, realigning or any other work necessary to accomplish the desired realignment shall be considered included in the contract unit price.

The furnishing and installing of all bolts, nuts, washers and other hardware necessary to comply with the above mentioned Special Provision will not be paid for separately, but shall be considered included in the contract unit price.

The guardrail shall be factory fabricated to the radius of curvature necessary to match the existing guardrail configuration or as specified by the Engineer. The work order will show the radius needed for the rail element.

This work shall be paid for at the contract unit price per foot for STEEL PLATE BEAM GUARDRAIL (SHORT RADIUS).

FURNISHED EXCAVATION

This work shall be completed in accordance with the applicable portions of Section 204 of the Standard Specifications for Road and Bridge Construction, as directed by the Engineer, and as stated here in.

Description of work: Work will consist of providing furnished excavation to the work sight, shaping and compacting the material to the required needs of the guardrail installation. All disturbed areas in the right of way are to be seeded using Class 2A salt tolerant roadside mix.

Method of Measurement: Quantities for this pay item will be measured by the truck load. Prior to the start of the contract, the Contractor and the Engineer shall agree to a standard volume for the truck(s) to be utilized by the Contractor. When quantities are computed, a shrinkage factor of 25% shall be used.

This work will be paid for at the contract unit price per Cubic Yard for FURNISHED EXCAVATION, which will include all labor, equipment and material costs.

REPLACE IMPACT ATTENUATORS (NON-REDIRECTIVE), TEST LEVEL 3

This work shall be completed in accordance with Section 631 of the Standard Specifications for Road and Bridge Construction, as stated herein, and as directed by the Engineer.

This work includes replacing sand module impact attenuators damaged by traffic at various locations. Impact Attenuators shall meet the testing criteria contained in National Cooperative Highway Research Program (NCHRP) Report 350 for test level 3 and shall be on the Department's approved list. The attenuators are installed on existing base pads located on various multilane highways throughout the district/region.

Work shall include removing and disposing of each damaged sand module impact attenuator and its contents off the right of way, cleaning up any remaining debris from the damaged attenuator, and replacing the damaged attenuator with one of the matching the kind/type of the remaining attenuators. Mixing sand module impact attenuators of different manufacturers at any one location shall not be permitted. The replacement module(s) shall be filled with the designed weight of sand matching the number painted on the base pad or the weight shown in the manufacturer's detail.

Adjacent sand module impact attenuators that are not damaged, but have been shifted laterally from their original position shall be realigned or moved back to their original position, as directed by the Engineer.

Each individual replacement module, complete with the required hardware, filled with sand and properly installed, shall constitute one each. Realignment or moving adjacent undamaged modules back to their original positions shall not be paid for separately, but shall be considered included in the cost of replacement. This work to realign or shift undamaged modules shall be included with each replaced sand module impact attenuator.

This work will be paid for at the contract unit price Each for REPLACE IMPACT ATTENUATORS (NON-REDIRECTIVE), TEST LEVEL 3.

REPAIR TRAFFIC BARRIER TERMINAL TYPE 1 SPECIAL – POST

This work shall consist of repairing / replacing the end post on Traffic Barrier Terminal Type 1 Special of the type specified (tangent or flared). The contractor shall repair or replace the damaged post and then reconnect the terminal head to the new or repaired post. This work may also include the reconnection of the cable from the head to the post.

This work shall be paid for per EACH for REPAIR TRAFFIC BARRIER TERMINAL TYPE 1 SPECIAL – POST.

AUTOMATED FLAGGER ASSISTANCE DEVICES (BDE)

Effective: January 1, 2008

Description. This work shall consist of furnishing and operating automated flagger assistance devices (AFADs) as part of the work zone traffic control and protection for two-lane highways where two-way traffic is maintained over one lane of pavement. Use of these devices shall be at the option of the Contractor.

Equipment. AFADs shall be according to the FHWA memorandum, "MUTCD - Revised Interim Approval for the use of Automated Flagger Assistance Devices in Temporary Traffic Control Zones (IA-4R)", dated January 28, 2005. The devices shall be mounted on a trailer or a moveable cart and shall meet the requirements of NCHRP 350, Category 4.

The AFAD shall be the Stop/Slow type. This device uses remotely controlled "STOP" and "SLOW" signs to alternately control right-of-way.

Signs for the AFAD shall be according to Article 701.03 of the Standard Specifications and the MUTCD. The signs shall be 24 x 24 in. (600 x 600 mm) having an octagon shaped "STOP" sign on one side and a diamond shaped "SLOW" sign on the opposite side. The letters on the signs shall be 8 in. (200 mm) high. If the "STOP" sign has louvers, the full sign face shall be visible at a distance of 50 ft (15 m) and greater.

The signs shall be supplemented with one of the following types of lights.

- (a) Flashing Lights. When flashing lights are used, white or red flashing lights shall be mounted within the "STOP" sign face and white or yellow flashing lights within the "SLOW" sign face.
- (b) Stop and Warning Beacons. When beacons are used, a stop beacon shall be mounted 24 in. (600 mm) or less above the "STOP" sign face and a warning beacon mounted 24 in. (600 mm) or less above, below, or to the side of the "SLOW" sign face. As an option, a Type B warning light may be used in lieu of the warning beacon.

A "WAIT ON STOP" sign shall be placed on the right hand side of the roadway at a point where drivers are expected to stop. The sign shall be 24 x 30 in. (600 x 750 mm) with a black legend and border on a white background. The letters shall be at least 6 in. (150 mm) high.

This device may include a gate arm or mast arm that descends to a horizontal position when the "STOP" sign is displayed and rises to a vertical position when the "SLOW" sign is displayed. When included, the end of the arm shall reach at least to the center of the lane being controlled. The arm shall have alternating red and white retroreflective stripes, on both sides, sloping downward at 45 degrees toward the side on which traffic will pass. The stripes shall be 6 in. (150 mm) in width and at least 2 in. (50 mm) in height.

Flagging Requirements. Flaggers and flagging requirements shall be according to Article 701.13 of the Standard Specifications and the following.

AFADs shall be placed at each end of the traffic control, where a flagger is shown on the plans. The flaggers shall be able to view the face of the AFAD and approaching traffic during operation.

To stop traffic, the "STOP" sign shall be displayed, the corresponding lights/beacon shall flash, and when included, the gate arm shall descend to a horizontal position. To permit traffic to move, the "SLOW" sign shall be displayed, the corresponding lights/beacon shall flash, and when included, the gate arm shall rise to a vertical position.

If used at night, the AFAD location shall be illuminated according to Section 701 of the Standard Specifications.

When not in use, AFADs will be considered nonoperating equipment and shall be stored according to Article 701.11 of the Standard Specifications.

Basis of Payment. This work will not be paid for separately but shall be considered as included in the cost of the various traffic control items included in the contract.

DISADVANTAGED BUSINESS ENTERPRISE PARTICIPATION (BDE)

Effective: September 1, 2000

Revised: July 2, 2016

FEDERAL OBLIGATION. The Department of Transportation, as a recipient of federal financial assistance, is required to take all necessary and reasonable steps to ensure nondiscrimination in the award and administration of contracts. Consequently, the federal regulatory provisions of 49 CFR Part 26 apply to this contract concerning the utilization of disadvantaged business enterprises. For the purposes of this Special Provision, a disadvantaged business enterprise (DBE) means a business certified by the Department in accordance with the requirements of 49 CFR Part 26 and listed in the Illinois Unified Certification Program (IL UCP) DBE Directory.

STATE OBLIGATION. This Special Provision will also be used by the Department to satisfy the requirements of the Business Enterprise for Minorities, Females, and Persons with Disabilities Act, 30 ILCS 575. When this Special Provision is used to satisfy state law requirements on 100 percent state-funded contracts, the federal government has no involvement in such contracts (not a federal-aid contract) and no responsibility to oversee the implementation of this Special Provision by the Department on those contracts. DBE participation on 100 percent state-funded contracts will not be credited toward fulfilling the Department's annual overall DBE goal required by the US Department of Transportation to comply with the federal DBE program requirements.

CONTRACTOR ASSURANCE. The Contractor makes the following assurance and agrees to include the assurance in each subcontract that the Contractor signs with a subcontractor.

The Contractor, subrecipient, or subcontractor shall not discriminate on the basis of race, color, national origin, or sex in the performance of this contract. The Contractor shall carry out applicable requirements of 49 CFR Part 26 in the award and administration of contracts funded in whole or in part with federal or state funds. Failure by the Contractor to carry out these requirements is a material breach of this contract, which may result in the termination of this contract or such other remedy as the recipient deems appropriate, which may include, but is not limited to:

- (a) Withholding progress payments;
- (b) Assessing sanctions;
- (c) Liquidated damages; and/or
- (d) Disqualifying the Contractor from future bidding as non-responsible.

OVERALL GOAL SET FOR THE DEPARTMENT. As a requirement of compliance with 49 CFR Part 26, the Department has set an overall goal for DBE participation in its federally assisted contracts. That goal applies to all federal-aid funds the Department will expend in its federally assisted contracts for the subject reporting fiscal year. The Department is required to make a good faith effort to achieve the overall goal. The dollar amount paid to all approved DBE companies performing work called for in this contract is eligible to be credited toward fulfillment of the Department's overall goal.

CONTRACT GOAL TO BE ACHIEVED BY THE CONTRACTOR. This contract includes a specific DBE utilization goal established by the Department. The goal has been included because the Department has determined that the work of this contract has subcontracting opportunities that may be suitable for performance by DBE companies. The determination is based on an assessment of the type of work, the location of the work, and the availability of DBE companies to do a part of the work. The assessment indicates that, in the absence of unlawful discrimination, and in an arena of fair and open competition, DBE companies can be expected to perform **0.00%** of the work. This percentage is set as the DBE participation goal for this contract. Consequently, in addition to the other award criteria established for this contract, the Department will only award this contract to a bidder who makes a good faith effort to meet this goal of DBE participation in the performance of the work. A bidder makes a good faith effort for award consideration if either of the following is done in accordance with the procedures set for in this Special Provision:

- (a) The bidder documents that enough DBE participation has been obtained to meet the goal or,
- (b) The bidder documents that a good faith effort has been made to meet the goal, even though the effort did not succeed in obtaining enough DBE participation to meet the goal.

DBE LOCATOR REFERENCES. Bidders shall consult the IL UCP DBE Directory as a reference source for DBE-certified companies. In addition, the Department maintains a letting and item specific DBE locator information system whereby DBE companies can register their interest in providing quotes on particular bid items advertised for letting. Information concerning DBE companies willing to quote work for particular contracts may be obtained by contacting the Department's Bureau of Small Business Enterprises at telephone number (217) 785-4611, or by visiting the Department's website at: <http://www.idot.illinois.gov/doing-business/certifications/disadvantaged-business-enterprise-certification/il-ucp-directory/index>.

BIDDING PROCEDURES. Compliance with this Special Provision is required prior to the award of the contract and the failure of the low bidder to comply will render the bid not responsive.

In order to assure the timely award of the contract, the low bidder shall submit:

- (a) The bidder shall submit a DBE Utilization Plan on completed Department forms SBE 2025 and 2026.
 - (1) The final Utilization Plan must be submitted within five calendar days after the date of the letting in accordance with subsection (a)(2) of Bidding Procedures herein.
 - (2) To meet the five day requirement, the bidder may send the Utilization Plan electronically by scanning and sending to **DOT.DBE.UP@illinois.gov** or faxing to (217) 785-1524. The subject line must include the bid Item Number and the Letting date. The Utilization Plan should be sent as one .pdf file, rather than multiple files and emails for the same Item Number. It is the responsibility of the bidder to obtain confirmation of email or fax delivery.

Alternatively, the Utilization Plan may be sent by certified mail or delivery service within the five calendar day period. If a question arises concerning the mailing date of a Utilization Plan, the mailing date will be established by the U.S. Postal Service postmark on the certified mail receipt from the U.S. Postal Service or the receipt issued by a delivery service when the Utilization Plan is received by the Department. It is the responsibility of the bidder to ensure the postmark or receipt date is affixed within the five days if the bidder intends to rely upon mailing or delivery to satisfy the submission day requirement. The Utilization Plan is to be submitted to:

Illinois Department of Transportation
Bureau of Small Business Enterprises
Contract Compliance Section
2300 South Dirksen Parkway, Room 319
Springfield, Illinois 62764

The Department will not accept a Utilization Plan if it does not meet the five day submittal requirement and the bid will be declared not responsive. In the event the bid is declared not responsive due to a failure to submit a Utilization Plan or failure to comply with the bidding procedures set forth herein, the Department may elect to cause the forfeiture of the penal sum of the bidder's proposal guaranty, and may deny authorization to bid the project if re-advertised for bids. The Department reserves the right to invite any other bidder to submit a Utilization Plan at any time for award consideration.

- (b) The Utilization Plan shall indicate that the bidder either has obtained sufficient DBE participation commitments to meet the contract goal or has not obtained enough DBE participation commitments in spite of a good faith effort to meet the goal. The Utilization Plan shall further provide the name, telephone number, and telefax number of a responsible official of the bidder designated for purposes of notification of Utilization Plan approval or disapproval under the procedures of this Special Provision.
- (c) The Utilization Plan shall include a DBE Participation Commitment Statement, Department form SBE 2025, for each DBE proposed for the performance of work to achieve the contract goal. For bidding purposes, submission of the completed SBE 2025 forms, signed by the DBEs and scanned or faxed to the bidder will be acceptable as long as the original is available and provided upon request. All elements of information indicated on the said form shall be provided, including but not limited to the following:
 - (1) The names and addresses of DBE firms that will participate in the contract;
 - (2) A description, including pay item numbers, of the work each DBE will perform;
 - (3) The dollar amount of the participation of each DBE firm participating. The dollar amount of participation for identified work shall specifically state the quantity, unit price, and total subcontract price for the work to be completed by the DBE. If partial pay items are to be performed by the DBE, indicate the portion of each item, a unit price where appropriate and the subcontract price amount;
 - (4) DBE Participation Commitment Statements, form SBE 2025, signed by the bidder and each participating DBE firm documenting the commitment to use the DBE subcontractors whose participation is submitted to meet the contract goal;
 - (5) If the bidder is a joint venture comprised of DBE companies and non-DBE companies, the Utilization Plan must also include a clear identification of the portion of the work to be performed by the DBE partner(s); and,
 - (6) If the contract goal is not met, evidence of good faith efforts; the documentation of good faith efforts must include copies of each DBE and non-DBE subcontractor quote submitted to the bidder when a non-DBE subcontractor is selected over a DBE for work on the contract.

GOOD FAITH EFFORT PROCEDURES. The contract will not be awarded until the Utilization Plan submitted by the apparent successful bidder is approved. All information submitted by the bidder must be complete, accurate and adequately document that enough DBE participation has been obtained or document that good faith efforts of the bidder, in the event enough DBE participation has not been obtained, before the Department will commit to the performance of the contract by the bidder. The Utilization Plan will be approved by the Department if the Utilization Plan documents sufficient commercially useful DBE work to meet the contract goal or the bidder submits sufficient documentation of a good faith effort to meet the contract goal pursuant to 49 CFR Part 26, Appendix A. The Utilization Plan will not be approved by the Department if the Utilization Plan does not document sufficient DBE participation to meet the contract goal unless the apparent successful bidder documented in the Utilization Plan that it made a good faith effort to meet the goal. This means that the bidder must show that all necessary and reasonable steps were taken to achieve the contract goal. Necessary and reasonable steps are those which, by their scope, intensity and appropriateness to the objective, could reasonably be expected to obtain sufficient DBE participation, even if they were not successful. The Department will consider the quality, quantity, and intensity of the kinds of efforts that the bidder has made. Mere *pro forma* efforts, in other words, efforts done as a matter of form, are not good faith efforts; rather, the bidder is expected to have taken genuine efforts that would be reasonably expected of a bidder actively and aggressively trying to obtain DBE participation sufficient to meet the contract goal.

- (a) The following is a list of types of action that the Department will consider as part of the evaluation of the bidder's good faith efforts to obtain participation. These listed factors are not intended to be a mandatory checklist and are not intended to be exhaustive. Other factors or efforts brought to the attention of the Department may be relevant in appropriate cases, and will be considered by the Department.
- (1) Soliciting through all reasonable and available means (e.g. attendance at pre-bid meetings, advertising and/or written notices) the interest of all certified DBE companies that have the capability to perform the work of the contract. The bidder must solicit this interest within sufficient time to allow the DBE companies to respond to the solicitation. The bidder must determine with certainty if the DBE companies are interested by taking appropriate steps to follow up initial solicitations.
 - (2) Selecting portions of the work to be performed by DBE companies in order to increase the likelihood that the DBE goals will be achieved. This includes, where appropriate, breaking out contract work items into economically feasible units to facilitate DBE participation, even when the prime Contractor might otherwise prefer to perform these work items with its own forces.
 - (3) Providing interested DBE companies with adequate information about the plans, specifications, and requirements of the contract in a timely manner to assist them in responding to a solicitation.

- (4) a. Negotiating in good faith with interested DBE companies. It is the bidder's responsibility to make a portion of the work available to DBE subcontractors and suppliers and to select those portions of the work or material needs consistent with the available DBE subcontractors and suppliers, so as to facilitate DBE participation. Evidence of such negotiation includes the names, addresses, and telephone numbers of DBE companies that were considered; a description of the information provided regarding the plans and specifications for the work selected for subcontracting; and evidence as to why additional agreements could not be reached for DBE companies to perform the work.
 - b. A bidder using good business judgment would consider a number of factors in negotiating with subcontractors, including DBE subcontractors, and would take a firm's price and capabilities as well as contract goals into consideration. However, the fact that there may be some additional costs involved in finding and using DBE companies is not in itself sufficient reason for a bidder's failure to meet the contract DBE goal, as long as such costs are reasonable. Also the ability or desire of a bidder to perform the work of a contract with its own organization does not relieve the bidder of the responsibility to make good faith efforts. Bidders are not, however, required to accept higher quotes from DBE companies if the price difference is excessive or unreasonable. In accordance with subsection (c)(6) of the above Bidding Procedures, the documentation of good faith efforts must include copies of each DBE and non-DBE subcontractor quote submitted to the bidder when a non-DBE subcontractor was selected over a DBE for work on the contract.
- (5) Not rejecting DBE companies as being unqualified without sound reasons based on a thorough investigation of their capabilities. The bidder's standing within its industry, membership in specific groups, organizations, or associations and political or social affiliations (for example union vs. non-union employee status) are not legitimate causes for the rejection or non-solicitation of bids in the bidder's efforts to meet the project goal.
 - (6) Making efforts to assist interested DBE companies in obtaining bonding, lines of credit, or insurance as required by the recipient or Contractor.
 - (7) Making efforts to assist interested DBE companies in obtaining necessary equipment, supplies, materials, or related assistance or services.
 - (8) Effectively using the services of available minority/women community organizations; minority/women contractors' groups; local, state, and federal minority/women business assistance offices; and other organizations as allowed on a case-by-case basis to provide assistance in the recruitment and placement of DBE companies.

- (b) If the Department determines that the apparent successful bidder has made a good faith effort to secure the work commitment of DBE companies to meet the contract goal, the Department will award the contract provided that it is otherwise eligible for award. If the Department determines that the bidder has failed to meet the requirements of this Special Provision or that a good faith effort has not been made, the Department will notify the responsible company official designated in the Utilization Plan that the bid is not responsive. The notification shall include a statement of reasons for the determination. If the Utilization Plan is not approved because it is deficient as a technical matter, unless waived by the Department, the bidder will be notified and will be allowed no more than a five calendar day period in order to cure the deficiency.
- (c) The bidder may request administrative reconsideration of a determination adverse to the bidder within the five working days after the receipt of the notification date of the determination by delivering the request to the Department of Transportation, Bureau of Small Business Enterprises, Contract Compliance Section, 2300 South Dirksen Parkway, Room 319, Springfield, Illinois 62764 (Telefax: (217) 785-1524). Deposit of the request in the United States mail on or before the fifth business day shall not be deemed delivery. The determination shall become final if a request is not made and delivered. A request may provide additional written documentation or argument concerning the issues raised in the determination statement of reasons, provided the documentation and arguments address efforts made prior to submitting the bid. The request will be forwarded to the Department's Reconsideration Officer. The Reconsideration Officer will extend an opportunity to the bidder to meet in person in order to consider all issues of documentation and whether the bidder made a good faith effort to meet the goal. After the review by the Reconsideration Officer, the bidder will be sent a written decision within ten working days after receipt of the request for consideration, explaining the basis for finding that the bidder did or did not meet the goal or make adequate good faith efforts to do so. A final decision by the Reconsideration Officer that a good faith effort was made shall approve the Utilization Plan submitted by the bidder and shall clear the contract for award. A final decision that a good faith effort was not made shall render the bid not responsive.

CALCULATING DBE PARTICIPATION. The Utilization Plan values represent work anticipated to be performed and paid for upon satisfactory completion. The Department is only able to count toward the achievement of the overall goal and the contract goal the value of payments made for the work actually performed by DBE companies. In addition, a DBE must perform a commercially useful function on the contract to be counted. A commercially useful function is generally performed when the DBE is responsible for the work and is carrying out its responsibilities by actually performing, managing, and supervising the work involved. The Department and Contractor are governed by the provisions of 49 CFR Part 26.55(c) on questions of commercially useful functions as it affects the work. Specific counting guidelines are provided in 49 CFR Part 26.55, the provisions of which govern over the summary contained herein.

- (a) DBE as the Contractor: 100 percent goal credit for that portion of the work performed by the DBE's own forces, including the cost of materials and supplies. Work that a DBE subcontracts to a non-DBE does not count toward the DBE goals.

- (b) DBE as a joint venture Contractor: 100 percent goal credit for that portion of the total dollar value of the contract equal to the distinct, clearly defined portion of the work performed by the DBE's own forces.
- (c) DBE as a subcontractor: 100 percent goal credit for the work of the subcontract performed by the DBE's own forces, including the cost of materials and supplies, excluding the purchase of materials and supplies or the lease of equipment by the DBE subcontractor from the prime Contractor or its affiliates. Work that a DBE subcontractor in turn subcontracts to a non-DBE does not count toward the DBE goal.
- (d) DBE as a trucker: 100 percent goal credit for trucking participation provided the DBE is responsible for the management and supervision of the entire trucking operation for which it is responsible. At least one truck owned, operated, licensed, and insured by the DBE must be used on the contract. Credit will be given for the following:
 - (1) The DBE may lease trucks from another DBE firm, including an owner-operator who is certified as a DBE. The DBE who leases trucks from another DBE receives credit for the total value of the transportation services the lessee DBE provides on the contract.
 - (2) The DBE may also lease trucks from a non-DBE firm, including from an owner-operator. The DBE who leases trucks from a non-DBE is entitled to credit only for the fee or commission is receives as a result of the lease arrangement.
- (e) DBE as a material supplier:
 - (1) 60 percent goal credit for the cost of the materials or supplies purchased from a DBE regular dealer.
 - (2) 100 percent goal credit for the cost of materials of supplies obtained from a DBE manufacturer.
 - (3) 100 percent credit for the value of reasonable fees and commissions for the procurement of materials and supplies if not a DBE regular dealer or DBE manufacturer.

CONTRACT COMPLIANCE. Compliance with this Special Provision is an essential part of the contract. The Department is prohibited by federal regulations from crediting the participation of a DBE included in the Utilization Plan toward either the contract goal or the Department's overall goal until the amount to be applied toward the goals has been paid to the DBE. The following administrative procedures and remedies govern the compliance by the Contractor with the contractual obligations established by the Utilization Plan. After approval of the Utilization Plan and award of the contract, the Utilization Plan and individual DBE Participation Statements become part of the contract. If the Contractor did not succeed in obtaining enough DBE participation to achieve the advertised contract goal, and the Utilization Plan was approved and contract awarded based upon a determination of good faith, the total dollar value of DBE work calculated in the approved Utilization Plan as a percentage of the awarded contract value shall become the amended contract goal. All work indicated for performance by an approved DBE shall be performed, managed, and supervised by the DBE executing the DBE Participation Commitment Statement.

- (a) **NO AMENDMENT.** No amendment to the Utilization Plan may be made without prior written approval from the Department's Bureau of Small Business Enterprises. All requests for amendment to the Utilization Plan shall be submitted to the Department of Transportation, Bureau of Small Business Enterprises, Contract Compliance Section, 2300 South Dirksen Parkway, Room 319, Springfield, Illinois 62764. Telephone number (217) 785-4611. Telefax number (217) 785-1524.
- (b) **CHANGES TO WORK.** Any deviation from the DBE condition-of-award or contract plans, specifications, or special provisions must be approved, in writing, by the Department as provided elsewhere in the Contract. The Contractor shall notify affected DBEs in writing of any changes in the scope of work which result in a reduction in the dollar amount condition-of-award to the contract. Where the revision includes work committed to a new DBE subcontractor, not previously involved in the project, then a Request for Approval of Subcontractor, Department form BC 260A or AER 260A, must be signed and submitted. If the commitment of work is in the form of additional tasks assigned to an existing subcontract, then a new Request for Approval of Subcontractor shall not be required. However, the Contractor must document efforts to assure that the existing DBE subcontractor is capable of performing the additional work and has agreed in writing to the change.
- (c) **SUBCONTRACT.** The Contractor must provide DBE subcontracts to IDOT upon request. Subcontractors shall ensure that all lower tier subcontracts or agreements with DBEs to supply labor or materials be performed in accordance with this Special Provision.

- (d) ALTERNATIVE WORK METHODS. In addition to the above requirements for reductions in the condition of award, additional requirements apply to the two cases of Contractor-initiated work substitution proposals. Where the contract allows alternate work methods which serve to delete or create underruns in condition of award DBE work, and the Contractor selects that alternate method or, where the Contractor proposes a substitute work method or material that serves to diminish or delete work committed to a DBE and replace it with other work, then the Contractor must demonstrate one of the following:
- (1) That the replacement work will be performed by the same DBE (as long as the DBE is certified in the respective item of work) in a modification of the condition of award; or
 - (2) That the DBE is aware that its work will be deleted or will experience underruns and has agreed in writing to the change. If this occurs, the Contractor shall substitute other work of equivalent value to a certified DBE or provide documentation of good faith efforts to do so; or
 - (3) That the DBE is not capable of performing the replacement work or has declined to perform the work at a reasonable competitive price. If this occurs, the Contractor shall substitute other work of equivalent value to a certified DBE or provide documentation of good faith efforts to do so.
- (e) TERMINATION AND REPLACEMENT PROCEDURES. The Contractor shall not terminate or replace a DBE listed on the approved Utilization Plan, or perform with other forces work designated for a listed DBE except as provided in this Special Provision. The Contractor shall utilize the specific DBEs listed to perform the work and supply the materials for which each is listed unless the Contractor obtains the Department's written consent as provided in subsection (a) of this part. Unless Department consent is provided for termination of a DBE subcontractor, the Contractor shall not be entitled to any payment for work or material unless it is performed or supplied by the DBE in the Utilization Plan.

As stated above, the Contractor shall not terminate or replace a DBE subcontractor listed in the approved Utilization Plan without prior written consent. This includes, but is not limited to, instances in which the Contractor seeks to perform work originally designated for a DBE subcontractor with its own forces or those of an affiliate, a non-DBE firm, or with another DBE firm. Written consent will be granted only if the Bureau of Small Business Enterprises agrees, for reasons stated in its concurrence document, that the Contractor has good cause to terminate or replace the DBE firm. Before transmitting to the Bureau of Small Business Enterprises any request to terminate and/or substitute a DBE subcontractor, the Contractor shall give notice in writing to the DBE subcontractor, with a copy to the Bureau, of its intent to request to terminate and/or substitute, and the reason for the request. The Contractor shall give the DBE five days to respond to the Contractor's notice. The DBE so notified shall advise the Bureau and the Contractor of the reasons, if any, why it objects to the proposed termination of its subcontract and why the Bureau should not approve the Contractor's action. If required in a particular case as a matter of public necessity, the Bureau may provide a response period shorter than five days.

For purposes of this paragraph, good cause includes the following circumstances:

- (1) The listed DBE subcontractor fails or refuses to execute a written contract;
- (2) The listed DBE subcontractor fails or refuses to perform the work of its subcontract in a way consistent with normal industry standards. Provided, however, that good cause does not exist if the failure or refusal of the DBE subcontractor to perform its work on the subcontract results from the bad faith or discriminatory action of the prime contractor;
- (3) The listed DBE subcontractor fails or refuses to meet the prime Contractor's reasonable, nondiscriminatory bond requirements;
- (4) The listed DBE subcontractor becomes bankrupt, insolvent, or exhibits credit unworthiness;
- (5) The listed DBE subcontractor is ineligible to work on public works projects because of suspension and debarment proceedings pursuant 2 CFR Parts 180, 215 and 1200 or applicable state law.
- (6) You have determined that the listed DBE subcontractor is not a responsible contractor;
- (7) The listed DBE subcontractor voluntarily withdraws from the projects and provides to you written notice of its withdrawal;
- (8) The listed DBE is ineligible to receive DBE credit for the type of work required;
- (9) A DBE owner dies or becomes disabled with the result that the listed DBE subcontractor is unable to complete its work on the contract;
- (10) Other documented good cause that compels the termination of the DBE subcontractor. Provided, that good cause does not exist if the prime Contractor seeks to terminate a DBE it relied upon to obtain the contract so that the prime Contractor can self-perform the work for which the DBE contractor was engaged or so that the prime Contractor can substitute another DBE or non-DBE contractor after contract award.

When a DBE is terminated, or fails to complete its work on the Contract for any reason the Contractor shall make a good faith effort to find another DBE to substitute for the original DBE to perform at least the same amount of work under the contract as the terminated DBE to the extent needed to meet the established Contract goal. The good faith efforts shall be documented by the Contractor. If the Department requests documentation under this provision, the Contractor shall submit the documentation within seven days, which may be extended for an additional seven days if necessary at the request of the Contractor. The Department shall provide a written determination to the Contractor stating whether or not good faith efforts have been demonstrated.

- (f) PAYMENT RECORDS. The Contractor shall maintain a record of payments for work performed to the DBE participants. The records shall be made available to the Department for inspection upon request. After the performance of the final item of work or delivery of material by a DBE and final payment therefore to the DBE by the Contractor, but not later than thirty calendar days after payment has been made by the Department to the Contractor for such work or material, the Contractor shall submit a DBE Payment Agreement on Department form SBE 2115 to the Resident Engineer. If full and final payment has not been made to the DBE, the DBE Payment Agreement shall indicate whether a disagreement as to the payment required exists between the Contractor and the DBE or if the Contractor believes that the work has not been satisfactorily completed. If the Contractor does not have the full amount of work indicated in the Utilization Plan performed by the DBE companies indicated in the Utilization Plan and after good faith efforts are reviewed, the Department may deduct from contract payments to the Contractor the amount of the goal not achieved as liquidated and ascertained damages. The Contractor may request an administrative reconsideration of any amount deducted as damages pursuant to subsection (h) of this part.
- (g) ENFORCEMENT. The Department reserves the right to withhold payment to the Contractor to enforce the provisions of this Special Provision. Final payment shall not be made on the contract until such time as the Contractor submits sufficient documentation demonstrating achievement of the goal in accordance with this Special Provision or after liquidated damages have been determined and collected.
- (h) RECONSIDERATION. Notwithstanding any other provision of the contract, including but not limited to Article 109.09 of the Standard Specifications, the Contractor may request administrative reconsideration of a decision to deduct the amount of the goal not achieved as liquidated damages. A request to reconsider shall be delivered to the Contract Compliance Section and shall be handled and considered in the same manner as set forth in paragraph (c) of "Good Faith Effort Procedures" of this Special Provision, except a final decision that a good faith effort was not made during contract performance to achieve the goal agreed to in the Utilization Plan shall be the final administrative decision of the Department. The result of the reconsideration process is not administratively appealable to the U.S. Department of Transportation.

PORTABLE CHANGEABLE MESSAGE SIGNS (BDE)

Effective: November 1, 2016

Revise this second sentence of the first paragraph of Article 1106.02(i) of the Standard Specifications to read:

"The message panel shall be a minimum of 7 ft (2.1 m) above the edge of pavement in urban areas and a minimum of 5 ft (1.5 m) above the edge of pavement in rural areas, present a level appearance, and be capable of displaying up to eight characters in each of three lines at a time."

PROGRESS PAYMENTS (BDE)

Effective: November 2, 2013

Revise Article 109.07(a) of the Standard Specifications to read:

“(a) Progress Payments. At least once each month, the Engineer will make a written estimate of the quantity of work performed in accordance with the contract, and the value thereof at the contract unit prices. The amount of the estimate approved as due for payment will be vouchered by the Department and presented to the State Comptroller for payment. No amount less than \$1000.00 will be approved for payment other than the final payment.

Progress payments may be reduced by liens filed pursuant to Section 23(c) of the Mechanics’ Lien Act, 770 ILCS 60/23(c).

If a Contractor or subcontractor has defaulted on a loan issued under the Department’s Disadvantaged Business Revolving Loan Program (20 ILCS 2705/2705-610), progress payments may be reduced pursuant to the terms of that loan agreement. In such cases, the amount of the estimate related to the work performed by the Contractor or subcontractor, in default of the loan agreement, will be offset, in whole or in part, and vouchered by the Department to the Working Capital Revolving Fund or designated escrow account. Payment for the work shall be considered as issued and received by the Contractor or subcontractor on the date of the offset voucher. Further, the amount of the offset voucher shall be a credit against the Department’s obligation to pay the Contractor, the Contractor’s obligation to pay the subcontractor, and the Contractor’s or subcontractor’s total loan indebtedness to the Department. The offset shall continue until such time as the entire loan indebtedness is satisfied. The Department will notify the Contractor and Fund Control Agent in a timely manner of such offset. The Contractor or subcontractor shall not be entitled to additional payment in consideration of the offset.

The failure to perform any requirement, obligation, or term of the contract by the Contractor shall be reason for withholding any progress payments until the Department determines that compliance has been achieved.”

SPEED DISPLAY TRAILER (BDE)

Effective: April 2, 2014

Revised: January 1, 2017

Revise the third paragraph of Article 701.11 of the Standard Specifications to read:

“When not being utilized to inform and direct traffic, sign trailers, speed display trailers, arrow boards, and portable changeable message boards shall be treated as nonoperating equipment.”

Add the following to Article 701.15 of the Standard Specifications:

“(m) Speed Display Trailer. A speed display trailer is used to enhance safety of the traveling public and workers in work zones by alerting drivers of their speed, thus deterring them from driving above the posted work zone speed limit.”

Add the following to Article 701.20 of the Standard Specifications:

“(k) When speed display trailers are shown on the Standard, this work will not be paid for separately but shall be considered as included in the cost of the Standard.

For all other speed display trailers, this work will be paid for at the contract unit price per calendar month or fraction thereof for each trailer as SPEED DISPLAY TRAILER.”

Add the following to Article 1106.02 of the Standard Specifications:

“(o) Speed Display Trailer. The speed display trailer shall consist of a LED speed indicator display with self-contained, one-direction radar mounted on an orange see-through trailer. The height of the display and radar shall be such that it will function and be visible when located behind concrete barrier.

The speed measurement shall be by radar and provide a minimum detection distance of 1000 ft (300 m). The radar shall have an accuracy of ± 1 mile per hour.

The speed indicator display shall face approaching traffic and shall have a sign legend of “YOUR SPEED” immediately above or below the speed display. The sign letters shall be between 5 and 8 in. (125 and 200 mm) in height. The digital speed display shall show two digits (00 to 99) in mph. The color of the changeable message legend shall be a yellow legend on a black background. The minimum height of the numerals shall be 18 in. (450 mm), and the nominal legibility distance shall be at least 750 ft (250 m).

The speed indicator display shall be equipped with a violation alert that flashes the displayed detected speed when the work zone posted speed limit is exceeded. The speed indicator shall have a maximum speed cutoff. On roadway facilities with a normal posted speed limit greater than or equal to 45 mph, the detected speeds of vehicles traveling more than 25 mph over the work zone speed limit shall not be displayed. On facilities with normal posted speed limit of less than 45 mph, the detected speeds of vehicles traveling more than 15 mph over the work zone speeds limit shall not be displayed. On any roadway facility if detected speeds are less than 25 mph, they shall not be displayed. The display shall include automatic dimming for nighttime operation.

The speed indicator measurement and display functions shall be equipped with the power supply capable of providing 24 hours of uninterrupted service.”

STEEL PLATE BEAM GUARDRAIL (BDE)

Effective: January 1, 2017

Revise Article 630.02 of the Standard Specifications to read:

“**630.02 Materials.** Materials shall be according to the following.

Item	Article/Section
(a) Steel Plate Beam Guardrail	1006.25
(b) Wood Posts and Wood Block	1007.01, 1007.02, 1007.06
(c) Steel Posts, Blockouts, Restraints and Wire Rope for Guardrail	1006.23
(d) Preservative Treatment	1007.12
(e) Reinforcement Bars	1006.10
(f) Plastic Blockouts (Note 1)	
(g) Chemical Adhesive Resin System	1027.01
(h) Controlled Low-Strength Material (CLSM)	1019

Note 1. Plastic blockouts may be used in lieu of wood blockouts for steel plate beam guardrail. The plastic blockouts shall be the minimum dimensions shown on the plans and shall be on the Department’s qualified product list.”

Revise Article 630.05 of the Standard Specifications to read:

“**630.05 Posts.** Posts shall be as follows.

- (a) Wood Posts. Wood posts and blocks shall be treated. The posts and blocks shall be cut to the proper dimensions before treatment. No cutting of the posts or blocks will be permitted after treatment. Posts shall be erected according to Article 634.05.
- (b) Steel Posts. Steel posts may be driven by hand or mechanical methods provided they are protected by a suitable driving cap and the earth around the posts compacted, if necessary, after driving. When steel posts are driven to incorrect alignment or grade, they shall be removed and set according to Article 634.05.

When it is necessary to shorten the posts in the field, the lower portion shall be cut off in a manner to provide a smooth cut with minimum damage to the galvanizing. Cut areas shall be repaired according to the requirements of AASHTO M 36.”

Revise Article 630.06 of the Standard Specifications to read:

“630.06 Shoulder Stabilization at Guardrail. Shoulder stabilization shall be constructed at the locations of steel plate beam guardrail installation according to the details shown on the plans. On new construction projects, the material used in the shoulder stabilization shall be the same as that used in the adjacent paved shoulder. On shoulder resurfacing projects, the material used in the shoulder stabilization shall be the same as that used for the shoulder resurfacing.

When portland cement concrete is used, shoulder stabilization shall be constructed according to the applicable portions of Section 483. The shoulder stabilization shall be constructed simultaneously with the adjacent portland cement concrete shoulder. Guardrail posts shall be driven through leaveouts or holes cored in the completed shoulder stabilization. The void around each post shall be backfilled with earth or aggregate and capped with hot-mix asphalt (HMA) or CLSM.

When HMA is used, shoulder stabilization shall be constructed according to the applicable portions of Section 482. On new construction, the shoulder stabilization shall be constructed simultaneously with the HMA shoulder. On shoulder resurfacing projects, the portion of the shoulder stabilization below the surface of the existing paved shoulder shall be placed and compacted separately. The guardrail posts shall be driven through holes cored in the completed shoulder stabilization. The void around each post shall be backfilled with earth or aggregate and capped with HMA or CLSM.

When driving guardrail posts through existing shoulders, shoulder stabilization, or other paved areas, the posts shall be driven through cored holes. The void around each post shall be backfilled with earth or aggregate and capped with HMA or CLSM.”

Revise Article 630.08 of the Standard Specifications to read:

“630.08 Basis of Payment. This work will be paid for at the contract unit price per foot (meter) for NON-BLOCKED STEEL PLATE BEAM GUARDRAIL; STEEL PLATE BEAM GUARDRAIL, TYPE A, 6 FOOT (1.83 M) POSTS; STEEL PLATE BEAM GUARDRAIL, TYPE A, 9 FOOT (2.74 M) POSTS; STEEL PLATE BEAM GUARDRAIL, TYPE B, 6 FOOT (1.83 M) POSTS; STEEL PLATE BEAM GUARDRAIL, TYPE B, 9 FOOT (2.74 M) POSTS; or STEEL PLATE BEAM GUARDRAIL, TYPE D, 6 FOOT (1.83 M) POSTS.

When end sections are specified, they will not be paid for as a separate item, but shall be considered as included in the unit price for steel plate beam guardrail.

Steel plate beam guardrail mounted on existing culverts will be paid for at the contract unit price per foot (meter) for STRONG POST GUARDRAIL ATTACHED TO CULVERT or WEAK POST GUARDRAIL ATTACHED TO CULVERT, of the case specified.

Portland cement concrete shoulder stabilization at guardrail will be paid for according to Article 483.10.

HMA shoulder stabilization at guardrail will be paid for according to Article 482.08.

Excavation in rock will be paid for according to Article 502.13.

Steel plate beam guardrail incorporating long-span spacing will be paid for at the contract unit price per foot (meter) for LONG-SPAN GUARDRAIL OVER CULVERT, 12 FT 6 IN (3.8 M) SPAN; LONG-SPAN GUARDRAIL OVER CULVERT, 18 FT 9 IN (5.7 M) SPAN; or LONG-SPAN GUARDRAIL OVER CULVERT, 25 FT (7.6 M) SPAN.

Steel plate beam guardrail incorporating treated timber at the back side of the post will be paid for at the contract unit price per foot (meter) for BACK SIDE PROTECTION OF GUARDRAIL.”

TRAFFIC BARRIER TERMINAL, TYPE 1 SPECIAL (BDE)

Effective: January 1, 2017

Revise Article 631.04 of the Standard Specifications to read:

“631.04 Traffic Barrier Terminal, Type 1 Special (Tangent) and Traffic Barrier Terminal, Type 1 Special (Flared). These terminals shall meet the testing criteria contained in either NCHRP Report 350 or MASH. In addition to meeting the criteria in one or both of these references, the terminals shall be on the Department’s qualified product list.

The terminal shall be installed according to the manufacturer’s specifications. The beginning length of need point of the terminal shall be placed within 12 ft 6 in (3.8 m) of the length of need point shown on the plans.

The terminal shall be delineated with a terminal marker direct applied. No other guardrail delineation shall be attached to the terminal section.”

TUBULAR MARKERS (BDE)

Effective: January 1, 2017

Revise Article 701.03(j) of the Standard Specifications to read:

“(j) Tubular Markers 1106.02”

Revise Article 701.15(g) of the Standard Specifications to read:

“(g) Tubular Markers. Tubular markers are used to channelize traffic. They shall only be used when specified.”

Revise the second paragraph of Article 701.18(f) of the Standard Specifications to read:

“Devices no greater than 24 in. (600 mm) wide, may be used in place of tubular markers when the two-way operation is to be in place four days or less.”

Revise the second sentence of the second paragraph of Article 1106.02 of the Standard Specifications to read:

“These include cones, tubular markers, and plastic drums with no attachments.”

Revise the third sentence of the seventh paragraph of Article 1106.02 of the Standard Specifications to read:

“Sheeting used on cones, drums, and tubular markers shall be reboundable as tested according to ASTM D 4956.”

Revise Article 1106.02(f) of the Standard Specifications to read:

“(f) Tubular Markers. Tubular Markers shall be designed to bend under repeated impacts and return to an upright position without damage to the impacting vehicle or the markers. The markers shall be readily removable from the bases to permit field replacement.

The markers shall be orange in color having two white and two fluorescent orange bands.”

WEEKLY DBE TRUCKING REPORTS (BDE)

Effective: June 2, 2012

Revised: April 2, 2015

The Contractor shall submit a weekly report of Disadvantaged Business Enterprise (DBE) trucks hired by the Contractor or subcontractors (i.e. not owned by the Contractor or subcontractors) that are used for DBE goal credit.

The report shall be submitted to the Engineer on Department form "SBE 723" within ten business days following the reporting period. The reporting period shall be Monday through Sunday for each week reportable trucking activities occur.

Any costs associated with providing weekly DBE trucking reports shall be considered as included in the contract unit prices bid for the various items of work involved and no additional compensation will be allowed.

VETERAN BUSINESS PROGRAM

Effective: November 6, 2014

STATE OBLIGATION. This special provision will be used by the Department to satisfy the requirements of the Illinois Procurement Code, 30 ILCS 500/45-57. It is the goal of the State to promote and encourage the continued economic development of small businesses owned and controlled by qualified veterans and that qualified Service-Disabled Veteran-Owned Small Businesses (SDVOSB) and Veteran-Owned Small Businesses (VOSB) participate in the State's procurement process as both prime contractors and subcontractors.

CONTRACT GOAL TO BE ACHIEVED BY THE CONTRACTOR. This contract includes a specific Veteran Small Business participation goal of **0.00%** based on the availability of CMS certified veteran-owned and service-disabled veteran-owned small business (VOSB/SDVOSB) vendors to perform or provide the anticipated services and/or supplies required by this contract.

The Veteran Small Business participation goal is applicable to all bids. In addition to the other award criteria established for this contract, the Department will award this contract to a Vendor that meets the goal or makes good faith efforts to meet the goal. This goal is also applicable to change orders and allowances within the scope of work provided by the certified VOSB/SDVOSB vendor. If Vendor is a CMS certified VOSB/SDVOSB vendor, the entire goal is met and no subcontracting with a CMS certified VOSB/SDVOSB vendor is required; however, Vendor must submit a Utilization Plan indicating that the goal will be met by self-performance.

VETERAN SMALL BUSINESS CERTIFIED VENDOR LOCATOR REFERENCES. Vendors may consult CMS' Veteran Small Business Vendor Directory at www.sell2.illinois.gov/cms/business as well as the directories of other certifying agencies, but firms must be certified with CMS as VOSB/SDVOSB vendors at the time of bid/offer (see Title 44 Illinois Administrative Code Sec. 20.530).

BIDDING PROCEDURES. Compliance with this Special Provision is a material bidding requirement. The failure of the bidder to comply with this special provision will render the bid nonresponsive or not responsible.

At the time of the bid, Vendor, or Vendor's proposed subcontractor, must be certified with CMS as a VOSB or SDVOSB.

Following are guidelines for Vendor's completion of the Utilization Plan.

- (a) The bidder shall submit a Veteran Business Program (VBP) Utilization Plan. The format for the VBP Utilization Plan is included in this special provision.
- (b) Vendor should include any additional information that will add clarity to Vendor's proposed utilization of certified Veteran Small Business vendors to meet the targeted goal. The Utilization Plan must demonstrate that Vendor has either:
 - (1) met the entire contract goal;
 - (2) made good faith efforts towards meeting the entire goal; or
 - (3) made good faith efforts towards meeting a portion of the goal. Any submission of good faith efforts by Vendor shall be considered as a request for a full or partial waiver.
- (c) If the bidder is a joint venture comprised of Veteran Business Enterprises (VBE) companies and non-VBE companies, the plan must also include:
 - (1) A clear identification of the portion of work to be performed by the VOSB/SDVOSB partner(s); and
 - (2) An agreement between a vendor and a certified VOSB/SDVOSB vendor in which a certified VOSB/SDVOSB vendor promises not to provide subcontracting or pricing quotations to other vendors is prohibited. The Department may request additional information to demonstrate compliance. Vendor agrees to cooperate promptly with the Department in submitting to interviews, allowing entry to places of business, providing further documentation, and to soliciting the cooperation of a proposed certified VOSB/SDVOSB vendor. Failure to cooperate by Vendor and certified VOSB/SDVOSB vendor may render the bidder nonresponsive or not responsible. The contract will not be awarded to Vendor unless Vendor's Utilization Plan is approved.

GOOD FAITH EFFORT PROCEDURES. Vendor must submit a Utilization Plans and Letters of Intent that meet or exceed the published goal. If Vendor cannot meet the stated goal, Vendor must document and explain within the Utilization Plan the good faith efforts it undertook to meet the goal. Utilization Plans are due at the time of bid. Vendors may not be permitted to correct goal deficiencies after bid due dates. The Department will consider the quality, quantity, and intensity of Vendor's efforts but if the Department determines that a Vendor did not demonstrate good faith efforts towards meeting the goal on the bid, the bid may be deemed nonresponsive or not responsible.

The Utilization Plan contains a checklist of actions that the Department will consider as evidence of Vendor's good faith efforts to meet the goal. Other factors or efforts brought to the attention of the Department may be relevant in appropriate cases.

- (a) In evaluating Vendor's good faith efforts, the Department may consider whether the ability of other bidders to meet the contract goal suggests that good faith efforts could have resulted in Vendor meeting the goal.
- (b) If the Department determines that Vendor has made good faith efforts to meet the goal, the Department may award the contract provided that Vendor is otherwise eligible for award.
- (c) If the Department determines that good faith efforts have not been met, the bidder may be determined to be nonresponsive or not responsible.

CALCULATING CERTIFIED VOSB/SDVOSB VENDOR PARTICIPATION. The Utilization Plan documents work anticipated to be performed by all certified VOSB/SDVOSB vendors and paid for upon satisfactory completion. The Department is only able to count toward the achievement of the overall goal and the contract goal the value of payments made for the work actually performed by the VOSB/SDVOSB vendors. Applicable guidelines for counting payments attributable to contract goals are listed below:

- (a) A Vendor shall count towards the goal only expenditures to firms that perform a commercially useful function in the work of the contract.
 - (1) A firm is considered to perform a commercially useful function when it is responsible for execution of a distinct element of the work of a contract and carries out its responsibilities by actually performing, managing, and supervising the work involved. The certified VOSB/SDVOSB vendor must also be responsible, with respect to materials or supplies used on the contract, for negotiating price, determining quality and quantity, ordering the materials or supplies, and installing the materials (where applicable) and paying for the material or supplies. To determine whether a firm is performing a commercially useful function, the Department shall evaluate the amount of work subcontracted, whether the amount the firm is to be paid under the contract is commensurate with the work it is actually performing and the credit claimed for its performance of the work, industry practices, and other relevant factors.
 - (2) A certified VOSB/SDVOSB vendor does not perform a commercially useful function if its role is limited to that of an extra participant in a transaction or contract through which funds are passed through in order to obtain certified VOSB/SDVOSB vendor participation. In determining whether a certified VOSB/SDVOSB vendor is such an extra participant, the Department shall examine similar transactions, particularly those in which certified VOSB/SDVOSB vendors do not participate, and industry practices.

- (b) The value of the work actually performed or goods/equipment provided by the certified VOSB/SDVOSB vendor shall be counted towards the goal. The entire amount of that portion of the contract that is performed by the certified VOSB/SDVOSB vendor, including supplies purchased or equipment leased by the certified VOSB/SDVOSB vendor shall be counted, except supplies purchased and equipment rented from the Prime Vendor submitting this bid.
- (c) A vendor shall count the portion of the total dollar value of the Veteran Small Business contract equal to the distinct, clearly defined portion of the work of the contract that the certified VOSB/SDVOSB vendor performs toward the goal. A vendor shall also count the dollar value of work subcontracted to other certified VOSB/SDVOSB vendor. Work performed by the non-certified VOSB/SDVOSB party shall not be counted toward the goal. Work that a certified VOSB/SDVOSB vendor subcontracts to a non-certified VOSB/SDVOSB vendor will not count towards the goal.
- (d) A Vendor shall count toward the goal 100% of its expenditures for materials and supplies required under the contract and obtained from a certified VOSB/SDVOSB vendor manufacturer, regular dealer, or supplier. A Vendor shall count toward the goal the following expenditures to certified VOSB/SDVOSB vendors that are not manufacturers, regular dealers, or suppliers.
 - (1) The fees or commissions charged for providing a bona fide service, such as professional, technical, consultant or managerial services and assistance in the procurement of essential personnel, facilities, equipment, materials or supplies required for performance of the contract, provided that the fee or commission is determined by the Department to be reasonable and not excessive as compared with fees customarily allowed for similar services.
 - (2) The fees charged for delivery of materials and supplies required by the contract (but not the cost of the materials and supplies themselves) when the hauler, trucker, or delivery service is not also the manufacturer or a supplier of the materials and supplies being procured, provided that the fee is determined by the Department to be reasonable and not excessive as compared with fees customarily allowed for similar services. The certified VOSB/SDVOSB vendor's trucking firm must be responsible for the management and supervision of the entire trucking operation for which it is responsible on the contract, and must itself own and operate at least one fully licensed, insured and operational truck used on the contract.
 - (3) The fees or commissions charged for providing any bonds or insurance specifically required for the performance of the contract, provided that the fee or commission is determined by the Department to be reasonable and not excessive as compared with fees customarily allowed for similar services.
- (e) Certified VOSB/SDVOSB vendors who are performing on contract as second tier subcontractors may be counted in meeting the established Veteran Small Business goal for this contract as long as the Prime Vendor can provide documentation indicating the utilization of these vendors.

- (f) A Vendor shall not count towards the goal expenditures that are not direct, necessary and related to the work of the contract. Only the amount of services or goods that are directly attributable to the performance of the contract shall be counted. Ineligible expenditures include general office overhead or other Vendor support activities.

CONTRACT COMPLIANCE. Compliance with this section is an essential part of the contract. The following administrative procedures and remedies govern Vendor's compliance with the contractual obligations established by the Utilization Plan. After approval of the Plan and award of the contract, the Utilization Plan becomes part of the contract. If Vendor did not succeed in obtaining certified VOSB/SDVOSB vendor participation to achieve the goal and the Utilization Plan was approved and contract awarded based upon a determination of good faith, the total dollar value of certified VOSB/SDVOSB vendor work calculated in the approved Utilization Plan as a percentage of the awarded contract value shall become the contract goal. Vendors are encouraged to seek VOSB/SDVOSB firms during the course of performing the contract.

- (a) NO AMENDMENT. The Utilization Plan may not be amended after contract execution without the Department's prior written approval.
- (b) CHANGES TO WORK. Vendor may not make changes to its contractual certified VOSB/SDVOSB vendor commitments or substitute certified VOSB/SDVOSB vendors without the prior written approval of the Department. Unauthorized changes or substitutions, including performing the work designated for a certified VOSB/SDVOSB vendor with Vendor's own forces, shall be a violation of the utilization plan and a breach of the contract, and shall be cause to terminate the contract, and/or seek other contract remedies or sanctions. The facts supporting the request for changes must not have been known nor reasonably should have been known by the parties prior to entering into the subcontract. Vendor must negotiate with the certified VOSB/SDVOSB vendor to resolve the problem. Where there has been a mistake or disagreement about the scope of work or goods/equipment, provided the certified VOSB/SDVOSB vendor can be substituted only where agreement cannot be reached for a reasonable price or schedule for the correct scope of work, goods or equipment.

Substitutions of a certified VOSB/SDVOSB vendor may be permitted under the following circumstances and possibly others on a case-by-case basis:

- (1) Unavailability after receipt of reasonable notice to proceed;
- (2) Failure of performance;
- (3) Financial incapacity;
- (4) Refusal by the certified VOSB/SDVOSB vendor to honor the bid or proposal price or scope;
- (5) Material mistake of fact or law about the elements of the scope of work of a solicitation where a reasonable price cannot be agreed;
- (6) Failure of the certified VOSB/SDVOSB vendor to meet insurance, licensing or bonding requirements;

- (7) The certified VOSB/SDVOSB vendor's withdrawal of its bid or offer; or
- (8) Decertification of the certified VOSB/SDVOSB vendor.

If it becomes necessary to substitute a certified VOSB/SDVOSB vendor or otherwise change the Utilization Plan, Vendor must notify the Department in writing of the request to substitute a certified VOSB/SDVOSB vendor or otherwise change the Utilization Plan. The request must state specific reasons for the substitution or change. The Department will approve or deny a request for substitution or other change in the Utilization Plan within five business days of receipt of the request.

Where Vendor has established the basis for the substitution to the Department's satisfaction, it must make good faith efforts to meet the contract goal by substituting a certified VOSB/SDVOSB vendor. Documentation of a replacement certified VOSB/SDVOSB vendor, or of good faith efforts to replace the certified VOSB/SDVOSB vendor, must meet the requirements of the initial Utilization Plan. If the goal cannot be reached and good faith efforts have been made, Vendor may substitute with a non-certified VOSB/SDVOSB vendor or Vendor may perform the work.

When adding a VOSB/SDVOSB, a new certified VOSB/SDVOSB vendor agreement should be executed and submitted to the Department with the appropriate subcontractor approval forms prior to the subcontractor's performance of work on the project.

Vendor shall maintain a record of all relevant data with respect to the utilization of certified VOSB/SDVOSB vendors. Full access to these records shall be granted by Vendor upon 48 hours written demand by the Department to any duly authorized representative thereof, or to any municipal, state or federal authorities. The Department shall have the right to obtain from Vendor any additional data reasonably related or necessary to verify any representations by Vendor. After the performance of the final item of work or delivery of material by the certified VOSB/SDVOSB vendor and final payment to the certified VOSB/SDVOSB vendor by Vendor, but not later than 15 calendar days after such payment, Vendor shall submit a statement confirming the final payment and the total payments made to the certified VOSB/SDVOSB vendor under the contract.

The Department will periodically review Vendor's compliance with these provisions and the terms of its contract. Without limitation, Vendor's failure to comply with these provisions or its contractual commitments as contained in the Utilization Plan, failure to cooperate in providing information regarding its compliance with these provisions or its Utilization Plan, or provision of false or misleading information or statements concerning compliance, certification status or eligibility of the certified VOSB/SDVOSB vendor, good faith efforts or any other material fact or representation shall constitute a material breach of this contract and entitle the Department to declare a default, terminate the contract, or exercise those remedies provided for in the contract or at law or in equity.

The Department reserves the right to withhold payment to Vendor to enforce these provisions and Vendor's contractual commitments. Final payment shall not be made pursuant to the contract until Vendor submits sufficient documentation demonstrating compliance with its Utilization Plan.

****RETURN WITH BID****

VETERAN BUSINESS PROGRAM (VBP) UTILIZATION PLAN

The VBP Utilization Plan includes the Letters of Intent and Good Faith Efforts.

(Vendor)_____ submits the following Utilization Plan as part of our bid or offer in accordance with the requirements of the (VBP). We understand that all subcontractors must be certified with the CMS Veteran Small Business Program at the time of submission of all bids. We understand that compliance with this section is an essential part of this contract and that the Utilization Plan will become a part of the contract, if awarded.

Vendor submits the following statement:

- ___ Vendor is a certified VOSB/SDVOSB and plans to fully meet the goal through self-performance.
- ___ Vendor has identified certified VOSB/SDVOSB subcontractor(s) to fully meet the established goal and submits the attached completed Letter(s) of Intent; or
- ___ Vendor has made good faith efforts towards meeting the entire goal, or a portion of the goal, and hereby requests a waiver (complete checklist below).

****RETURN WITH BID****

Vendor's person responsible for compliance:

Name: Title:
Telephone: Email

DEMONSTRATION OF GOOD FAITH EFFORTS TO ACHIEVE GOAL AND REQUEST FOR WAIVER

If the Veteran Small Business participation goal was not achieved, the Good Faith Efforts Procedures and Guidelines outlined in Contract Compliance will be used to evaluate submitted utilization plans. Vendors providing Good Faith Effort documentation and request for waiver must complete and submit the Good Faith Effort Contact Log with the bid or offer. Failure to submit Good Faith Effort documentation in its entirety shall render Vendor's bid nonresponsive or not responsible and cause it to be rejected or render Vendor ineligible for contract award. Insufficient Good Faith Effort documentation may render the bidder nonresponsive or not responsible.

Below is a checklist of actions that will be used to evaluate a Vendor's Demonstration of Good Faith Efforts and Request for Waiver. Please check the actions which you completed. If any of the following actions are not completed, please attach a detailed written explanation indicating why such action was not completed. If any other efforts were made to obtain Veteran Small Business participation in addition to the items listed below, attach a detailed description of such efforts.

- _____ Utilize the Sell2Illinois website: www2.illinois.gov/cms/business to identify certified VOSB/SDVOSB vendors within the respective commodity/service codes denoted above and at a minimum email all listed vendors and solicit quotes from all vendors who express an interest via follow-up emails or telephone calls.
- _____ Solicit through all reasonable and available means (e.g., attendance at a vendor conference, advertising and/or written notices) the interest of certified VOSB/SDVOSB vendors that have the capability to perform the work of the contract. Vendor must solicit this interest within sufficient time to allow the certified VOSB/SDVOSB vendors to respond to the solicitation. Vendor must determine with certainty if the certified VOSB/SDVOSB vendors are interested by taking appropriate steps to follow up initial solicitations and encourage them to submit a bid or proposal. Vendor must provide interested certified VOSB/SDVOSB vendors with adequate information about the plans, specifications, and requirements of the contract in a timely manner to assist them in responding promptly to the solicitation.
- _____ Select portions of the work to be performed by certified VOSB/SDVOSB vendors in order to increase the likelihood that the goal will be achieved. This includes, where appropriate, breaking out contract work items into economically feasible units to facilitate certified VOSB/SDVOSB vendor participation, even when Vendor might otherwise prefer to perform these work items with its own forces.
- _____ Make a portion of the work available to certified VOSB/SDVOSB vendors and selecting those portions of the work or material needs consistent with their availability, so as to facilitate certified VOSB/SDVOSB vendor participation.

****RETURN WITH BID****

- _____ Negotiate in good faith with interested certified VOSB/SDVOSB vendors. Evidence of such negotiation must include the names, addresses, email addresses, and telephone numbers of certified VOSB/SDVOSB vendors that were considered; a description of the information provided regarding the plans and specifications for the work selected for subcontracting and evidence as to why additional agreements could not be reached for certified VOSB/SDVOSB vendors to perform the work. A Vendor using good business judgment may consider a number of factors in negotiating with certified VOSB/SDVOSB vendors and may take a firm's price and capabilities into consideration. The fact that there may be some additional costs involved in finding and using certified VOSB/SDVOSB vendors may not be in itself sufficient reason for a Vendor's failure to meet the goal, as long as such costs are reasonable. Vendors are not required to accept higher quotes from certified VOSB/SDVOSB vendors if the price difference is excessive or unreasonable.

- _____ Thoroughly investigate the capabilities of certified VOSB/SDVOSB vendors and not reject them as unqualified without documented reasons.

- _____ Make efforts to assist interested certified VOSB/SDVOSB vendors in obtaining lines of credit or insurance as required by the State.

- _____ Make efforts to assist interested certified VOSB/SDVOSB vendors in obtaining necessary equipment, supplies, materials, or related assistance or services.

****RETURN WITH BID****

GOOD FAITH EFFORTS CONTACT LOG

Use this Log to document all contacts and responses (telephone, e-mail, fax, etc.) regarding the solicitation of certified VOSB/SDVOSB vendors within the specific scope of work selected. It is not necessary to show contacts with certified VOSB/SDVOSB vendors who are identified on the Letter(s) of Intent. Keep and submit copies of all emails sent and received from prospective vendors. Include a copy of the commodity list or scope of work you solicited prospective vendors to perform. Duplicate this log as necessary; do not limit your contacts to the number of spaces shown.

Name of Certified Veteran Small Business Vendor	Date	Method of Contact	Scope of Work Solicited	Reason Agreement Was Not Reached

****RETURN WITH BID****

LETTER OF INTENT (LOI)

BETWEEN PRIME VENDOR AND CERTIFIED VETERAN SMALL BUSINESS VENDOR

Instructions: The Bidder is required to submit a separate, signed LOI from each identified certified VOSB/SDVOSB vendor (hereinafter "certified vendors"). **LOIs must be submitted with the Bid and must be signed by both parties.** The Prime Bidder shall not prohibit or otherwise limit certified vendor(s) from providing bids or quotes to other potential bidders. Each LOI shall include the dollar amount, percentage, and scope of work to be performed by each identified certified vendor. All LOI's shall be subject to Department approval.

Any changes involving or affecting the identified certified vendor(s) may not be permitted without written approval of the Department.

Contract Number:

Name of Vendor:

Name of Contact Person:

Address:

City, State and Zip:

Telephone: Fax: Email:

Name of Certified Veteran Small Business Vendor: Name of Contact Person:

Address:

City, State and Zip:

Telephone: Fax: Email:

Proposed % of Contract to be performed by the certified vendor firm: _____%

Proposed dollar amount of Contract to be performed by the certified vendor: \$_____

Description of work to be performed by the certified vendor firm:

Vendor and the Certified vendor above hereby agree that upon the execution of a contract for the above-named project between Bidder and the State of Illinois, the certified vendor will perform the scope of work for the percentage as indicated above.

Bidder (Company Name or D/B/A):

Certified Vendor (Company Name or D/B/A):

Signature:

Signature:

Printed Name:

Printed Name:

Title:

Title:

Date:

Date:

FOR INDEX OF SHEETS & STATE STANDARDS
SEE SHEET NO. 2

STATE OF ILLINOIS
DEPARTMENT OF TRANSPORTATION
DIVISION OF HIGHWAYS

PROPOSED HIGHWAY PLANS

VARIOUS ROUTES
SECTION D2 GR (NORTH) 2017

VARIOUS COUNTIES
C-92-101-16

SECTION
VARIOUS
COUNTY
VARIOUS

CONTRACT NO. 64L64
D-92-084-16

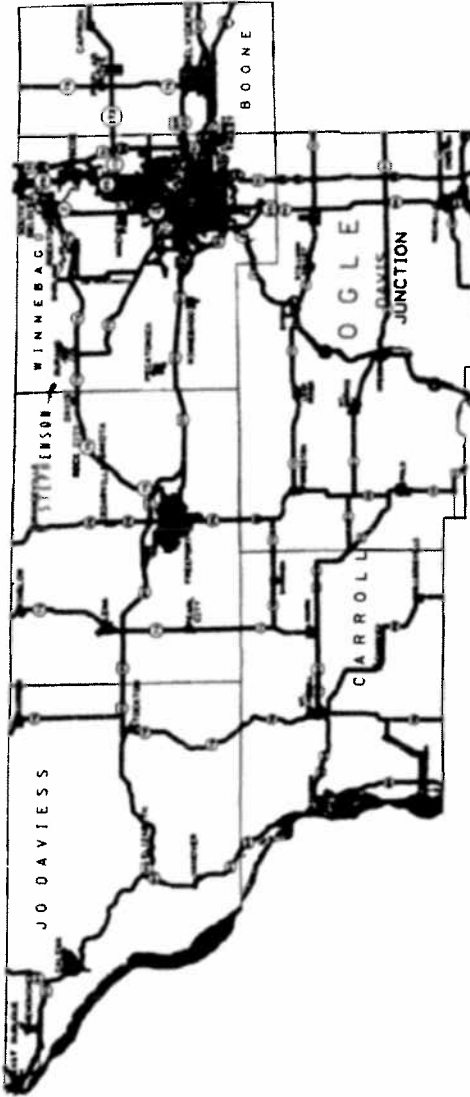
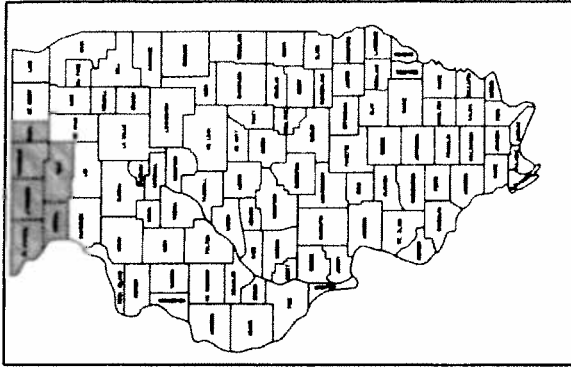

JULIE
JOINT UTILITY LOCATION INFORMATION FOR EXCAVATION
1-800-363-9123

CONTRACT NO. 64L64

VARIOUS ROUTES

SECTION D2 GR (NORTH) 2017

VARIOUS COUNTIES

STATE OF ILLINOIS
DEPARTMENT OF TRANSPORTATION
DIVISION OF HIGHWAYS

SUBMITTED

Oct 12 2016
Maell
DEPUTY DIRECTOR OF HIGHWAYS, REGION ENGINEER

20

ENGINEER OF DESIGN AND ENVIRONMENT

20

DIRECTOR OF HIGHWAYS, CHIEF ENGINEER

PRINTED BY THE AUTHORITY
OF THE STATE OF ILLINOIS

INDEX OF SHEETS

- 1 Cover Sheet
- 2 Index of Sheets
- 3-5 Summary of Quantities
- 6 General Notes
- 7. Repair Option for Damaged Traffic Barrier Terminal Type 4
- 8-11 Standard B.L.R. 26 (Standard shows old Type C guardrail)
- 12-13 Special Details for Buried Terminals) (Texas Twist)
- 14-15 Former State Standard (Traff. Barrier Term. Type 4) (For Information Only)
- 16. Former State Standard (Traff. Barrier Term. Type 7) (For Information Only)
- 17. Delineator and Post Orientation (District Standard 37.4)
- 18-21 Remove and Re-Erect Steel Plate Beam Guardrail
- 22-24 Former State Standard (Tubular Thrie Beam) (For Information Only)
- 25 Former State Standard (Traff. Barrier Term. Type 8) (For Information Only)
- 26 Former State Standard (Traff. Barrier Term. Type 9) (For Information Only)

STANDARDS

- 630001-11 Steel Plate Beam Guardrail
- 630101-10 Guardrail Mounted on Existing Culverts
- 630301-07 Shoulder Widening for Type 1 (Special) Guardrail Terminals
- 631011-10 Traffic Barrier Terminal, Type 2
- 631026-06 Traffic Barrier Terminal, Type 5
- 631031-15 Traffic Barrier Terminal, Type 6
- 631032-09 Traffic Barrier Terminal, Type 6A
- 631033-07 Traffic Barrier Terminal, Type 6B
- 631046-04 Traffic Barrier Terminal, Type 10
- 635001-02 Delineators
- 664001-02 Chain Link Fence
- 665001-02 Woven Wire Fence
- 701001-02 Typical Application of Traffic Control Devices
- 701006-05 Typical Application of Traffic Control Devices
- 701101-05 Typical Application of Traffic Control Devices
- 701106-02 Typical Application of Traffic Control Devices
- 701201-04 Typical Application of Traffic Control Devices
- 701301-04 Typical Application of Traffic Control Devices
- 701400-09 Typical Application of Traffic Control Devices
- 701401-10 Typical Application of Traffic Control Devices
- 701406-11 Typical Application of Traffic Control Devices
- 701411-09 Typical Application of Traffic Control Devices
- 701421-08 Typical Application of Traffic Control Devices
- 701426-09 Typical Application of Traffic Control Devices
- 701428-01 Traffic Control, Setup and Removal, Freeway/Expressway
- 701501-06 Typical Application of Traffic Control Devices
- 701502-07 Typical Application of Traffic Control Devices
- 701601-09 Typical Application of Traffic Control Devices
- 701602-08 Typical Application of Traffic Control Devices
- 701606-10 Typical Application of Traffic Control Devices
- 701701-10 Typical Application of Traffic Control Devices
- 701901-06 Traffic Control Devices
- 720011-01 Metal Posts For Signs, Markers, & Delineators
- 725001-01 Object and Terminal Markers
- 728001-01 Telescoping Steel Sign Support
- 729001-01 Application of Type A and B Metal Posts
- 782006 Guardrail and Barrier Wall Reflector Mounting Details

SUMMARY OF QUANTITIES

VARIOUS ROUTES
SECTION D2 GR (NORTH) 2017
VARIOUS COUNTIES
CONTRACT # 64L64
SHEET 3 OF 26

100% State
0021

CODE NO.	ITEM	UNIT	TOTAL QUANTITY	MCHD FUND	CONTRACT MAINT
20400800	FURNISHED EXCAVATION	CU YD	150	100	50
63100045	TRAFFIC BARRIER TERMINAL, TYPE 2	EACH	3	2	1
63100085	TRAFFIC BARRIER TERMINAL, TYPE 6	EACH	3	2	1
63100105	TRAFFIC BARRIER TERMINAL, TYPE 10	EACH	3	2	1
63100167	TRAFFIC BARRIER TERMINAL, TYPE 1 (SPECIAL) TANGENT	EACH	30	20	10
63100169	TRAFFIC BARRIER TERMINAL, TYPE 1 (SPECIAL) FLARED	EACH	9	6	3
63301210	REMOVE AND RE-ERECT STEEL PLATE BEAM GUARDRAIL, TYPE A	FOOT	75	50	25
63500105	DELINEATORS	EACH	9	6	3
66400105	CHAIN LINK FENCE, 4'	FOOT	75	50	25
66400305	CHAIN LINK FENCE, 6'	FOOT	75	50	25
66500105	WOVEN WIRE FENCE, 4'	FOOT	750	500	250
70200100	NIGHTTIME WORK ZONE LIGHTING	L SUM	1	0.67	0.33
78200005	GUARDRAIL REFLECTORS, TYPE A	EACH	12	8	4

SUMMARY OF QUANTITIES

VARIOUS ROUTES
SECTION D2 MCHD (NORTH) 2016
VARIOUS COUNTIES
CONTRACT # 64K94
SHEET 4 OF 26

100% State
0021

CODE NO.	ITEM	UNIT	TOTAL QUANTITY	MCHD FUND	CONTRACT MAINT
X6320310	LONG POST FOR STEEL PLATE BEAM GUARDRAIL	EACH	30	20	10
X6330725	STEEL PLATE BEAM GUARDRAIL (SHORT RADIUS)	FOOT	75	50	25
X6331101	TUBULAR THRIE BEAM	FOOT	75	50	25
X6331110	STEEL POSTS SPECIAL	EACH	30	20	10
X6432110	REPLACE IMPACT ATTENUATORS (NON-REDIRECTIVE), TEST LEVEL 3	EACH	20	15	5
X6640594	CHAIN LINK FENCE POST 4'	EACH	12	8	4
X6640601	CHAIN LINK FENCE POST 6'	EACH	12	8	4
X7010216	TRAFFIC CONTROL AND PROTECTION (SPECIAL)	L SUM	1	0.5	0.5
Z0008760	EMERGENCY WORK CALL OUT	EACH	10	5	5
Z0012752	CONCRETE STRUCTURE REPAIR	CU FT	24	16	8
Z0020210	PULL POST ARRANGEMENT	EACH	3	2	1
Z0029658	REPAIR TRAFFIC BARRIER TERMINAL TYPE 1 SPECIAL - Post	EACH	80	20	60
Z0052000	REPAIR STEEL PLATE BEAM GUARDRAIL, TYPE A	FOOT	1700	1000	700
Z0052100	REPAIR STEEL PLATE BEAM GUARDRAIL, TYPE B	FOOT	50	25	25

GENERAL NOTES

When posts are required to be placed through bituminous shoulders, all costs to do so shall be considered included in the contract unit cost of the work being done. The final top 3 inches of the area around the post shall be capped with either bituminous material or grout.

Standard 631021 (Traffic Barrier Terminal, Type 4) is obsolete and can no longer be installed. Typically, a Type 4 Terminal was used in the median of multi-lane divided highway. They are, however, still in use and when damage to one occurs, it is to be removed and replaced with a Traffic Barrier Terminal, Type 1, Special, that is to be at least 12 feet off the edge of the pavement. To obtain the 12 foot distance, the existing SPBGR Type A will have to be removed and re-erected with a flair rate of 1:30 until the face of the guardrail is 12 feet out from the edge of the pavement. At this point, (where the SPBGR Type A is 12 feet off the edge of pavement), a new Traffic Barrier Terminal Type 1, Special (Tangent or Flared) is to be installed

The Contractor shall supply the Resident Engineer with the manufacturer's installation requirements for the Traffic Barrier Terminal Type 1, Special to be used on this contract, both tangent and flared.

Wood blockouts on wood posts shall be connected with one nail to prevent the blockout from moving.

All disturbed areas in the right of way, caused by the Contractors operations, shall be seeded with class 2A salt tolerant roadside mixture as stated in Section 250, Article 250.07 of the Standard Specifications for Road and Bridge Construction. All costs for seeding shall be considered included in the unit cost of the work being performed.

If the Contractor would like the work location listed with GPS coordinates on the work orders, we can do that with units provided by the Contractor. We would require five (5) units for this contract, one for each of our field engineers and field technicians. The Contractor would be responsible for all costs to keep the units in operational condition. Please note that if the same contractor wins both guardrail repair contracts for our District, the total number of GPS units required would be ten (10).

Delineators shall be installed as shown in Standard 635001, except that the post shall be rotated 180° and only metal-backed delineators shall be permitted. Delineators shall be placed at the ends of approach guardrail terminal sections. This work will be paid for at the contract unit price each for DELINEATORS.

The Contractor shall be responsible for protecting utility property during construction operations as outlined in Article 107.31 of the Standard Specifications. A minimum of 48 hours advance notice is required for non-emergency work. The JULIE number is 800-892-0123.

IDOT is not a member of JULIE. If you are near any overhead lighting, intersection lighting or traffic signals, contact the IDOT Traffic Office at 815/284-5469 at least 48 hours prior to work.

Additional Options for Repair to Damaged Obsolete Traffic Barrier Terminal Type 4

Various Routes
D2 GR (North) 2017
Various Counties
Sheet 7 of 26
Contract Number: 64L64

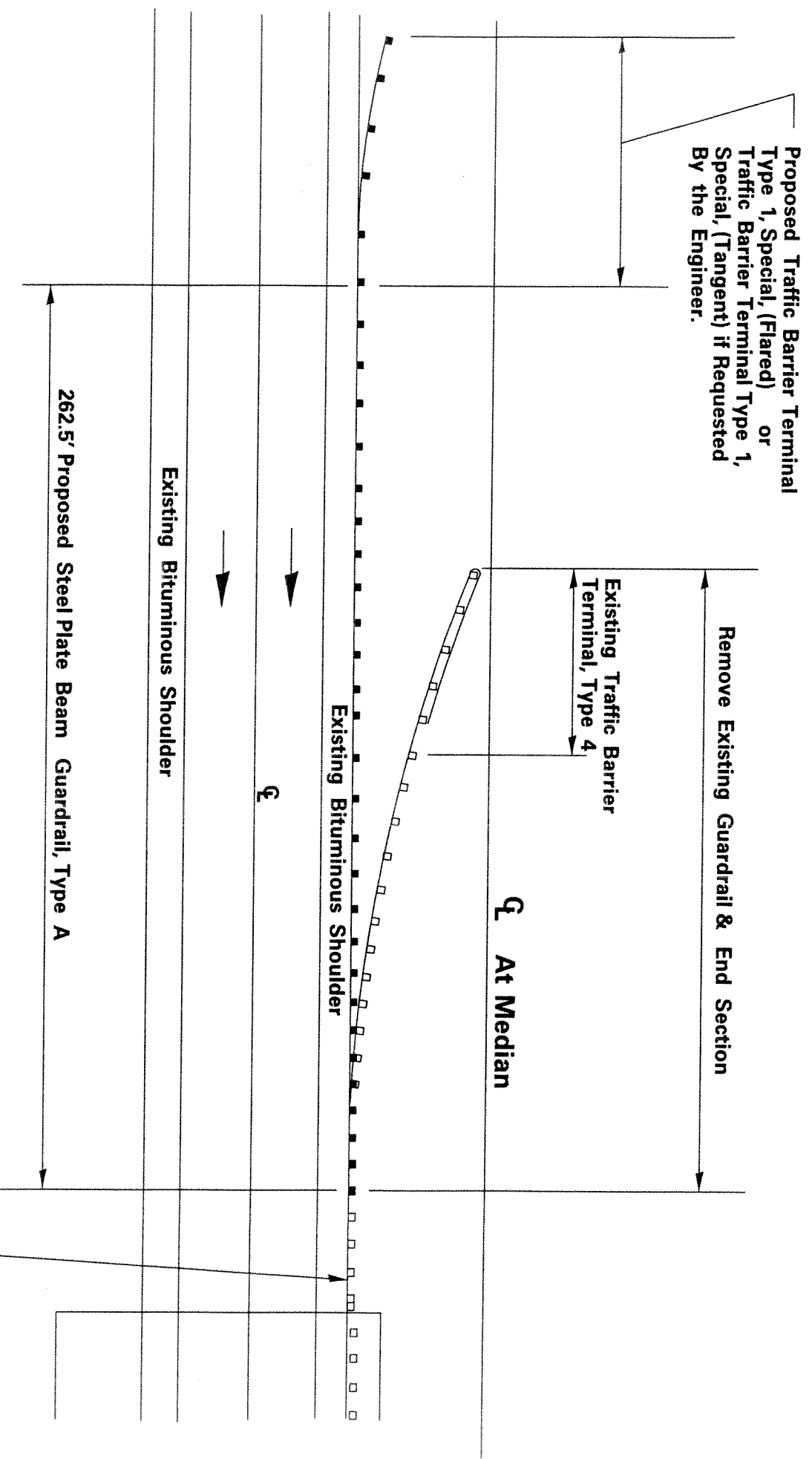

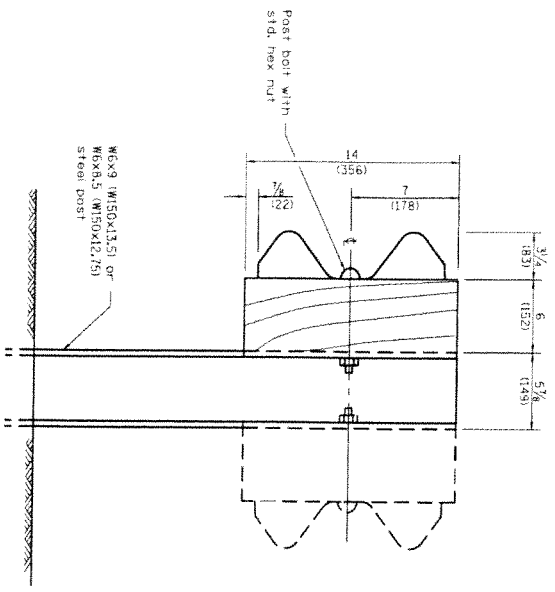

STEEL POST CONSTRUCTION

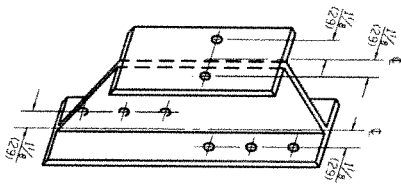

STEEL BLOCK-OUT DETAIL

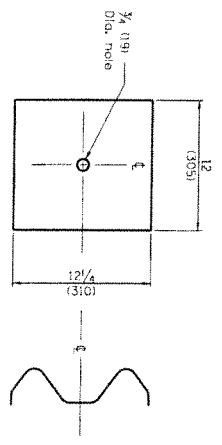

NOTE
Plate A shall be placed between rail element and block-out at non-splice mounting points only when steel block-outs are used.

PLATE A

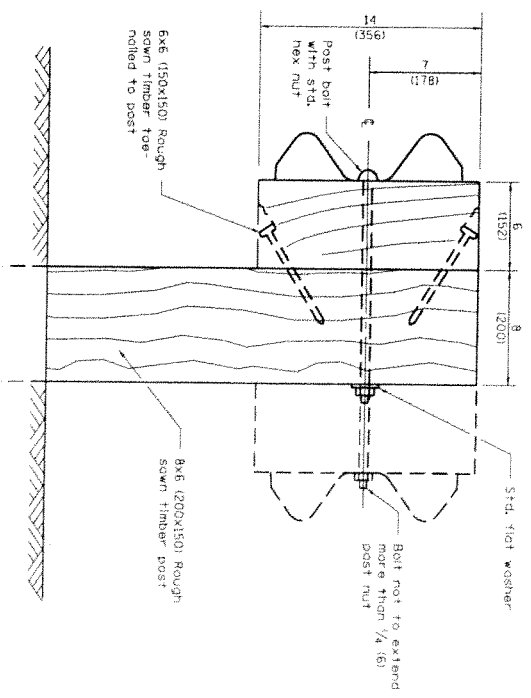

WOOD POST CONSTRUCTION

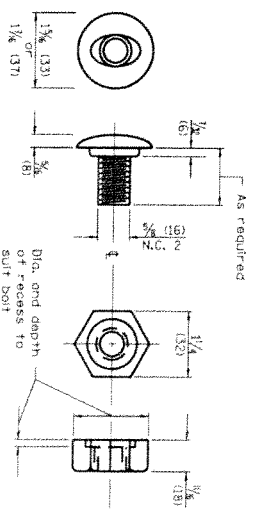

POST OR SPLICE BOLT & NUT

Illinois Department of Transportation
 APPROVED: [Signature] 2010
 ENGINEER OF LOCAL ROADS AND STREETS
 APPROVED: [Signature] 2010
 DIVISION OF DESIGN AND SURVEILLANCE
 ISSUED 1-1-08

Various Routes
 D2 GR (North) 2017
 Various Counties
 Sheet 9 of 26
 Contract #64L64

STEEL PLATE BEAM GUARDRAIL
27 1/2" (700mm) HEIGHT
 (Sheet 2 of 4)
STANDARD B.L.R. 26-2

STANDARD DESIGN STEEL PLATE BEAM GUARD RAIL

Various Routes
D2 GR (North) 2017
Various Counties
Sheet 13 of 26
Contract #64L64

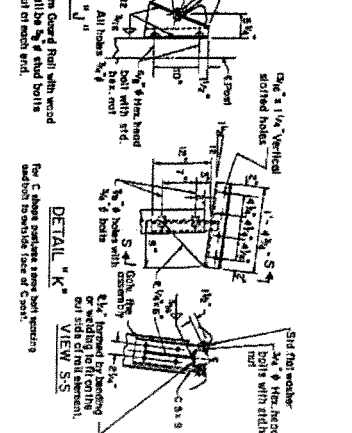
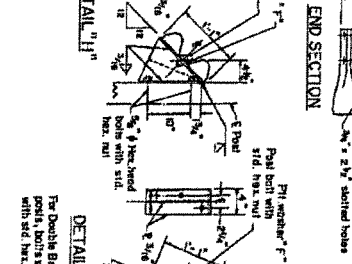
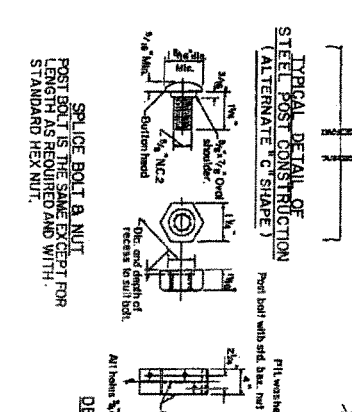
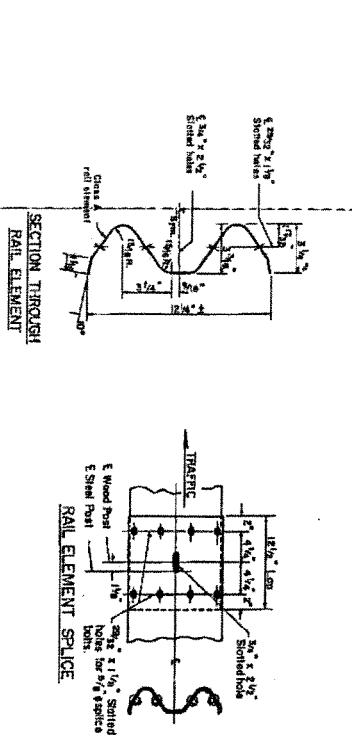
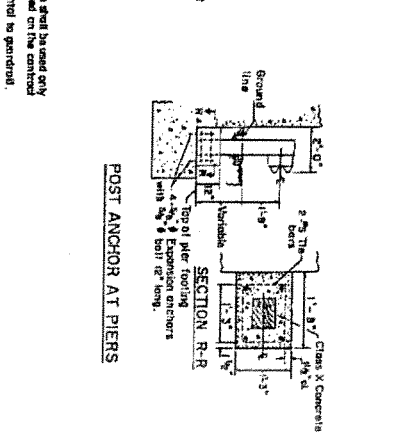
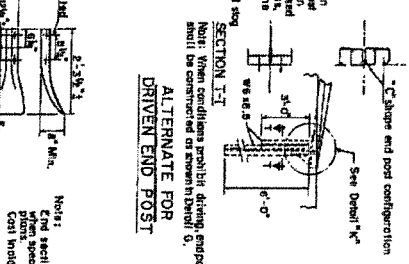
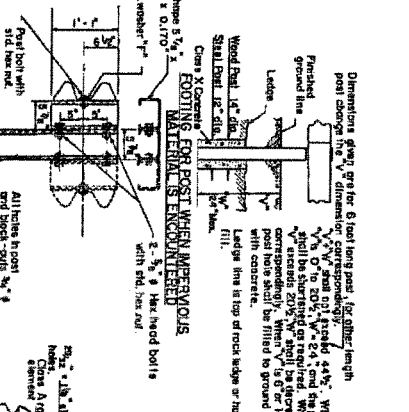
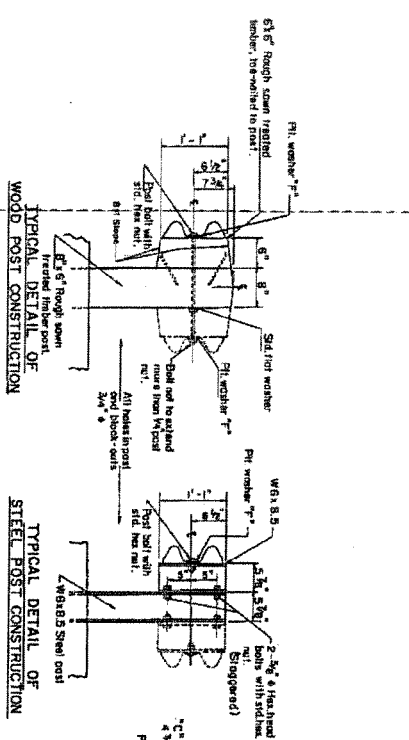

STATE OF ILLINOIS		ISSUED 2-11-66	
DEPARTMENT OF TRANSPORTATION			
DESIGNED BY	10/73	REVISED BY	2/11/76
CHECKED BY	6/1/76	APPROVED BY	6/1/76
APPROVED: <i>[Signature]</i>			
PROJECT NO. 979			
REGULATIONS 7-2-71			

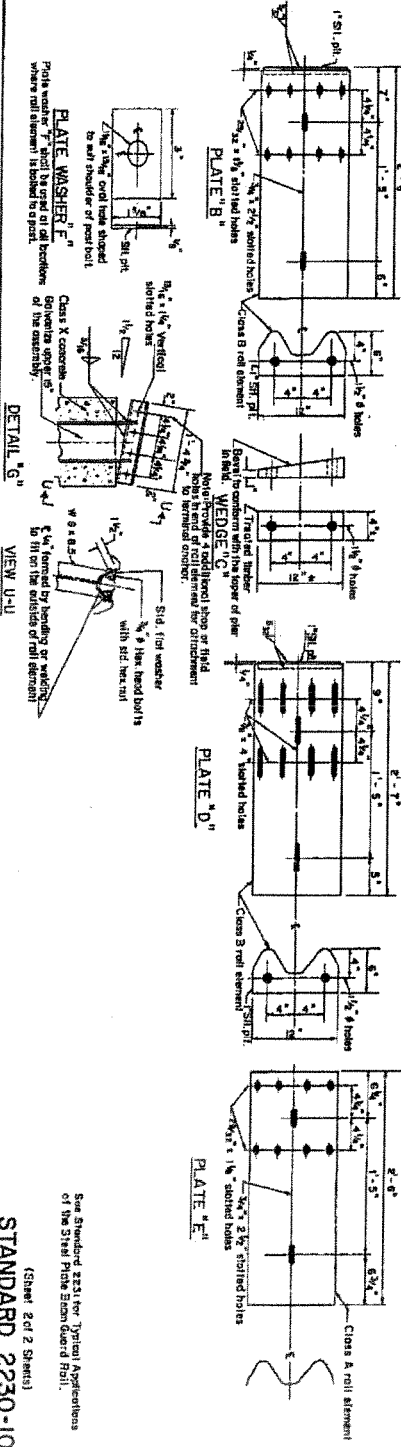

Various Routes
 D2 GR (North) 2017
 Various Counties
 Sheet 14 of 26
 Contract #64L64

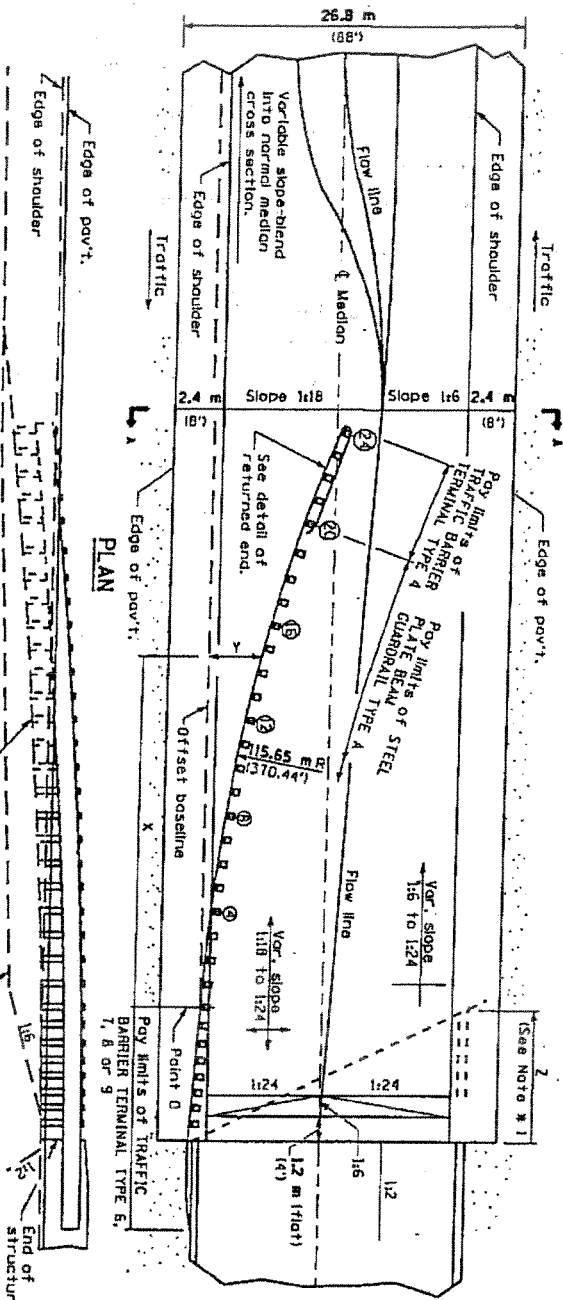

ASSEMBLY FOR 26.8 m (88 ft.) MEDIAN

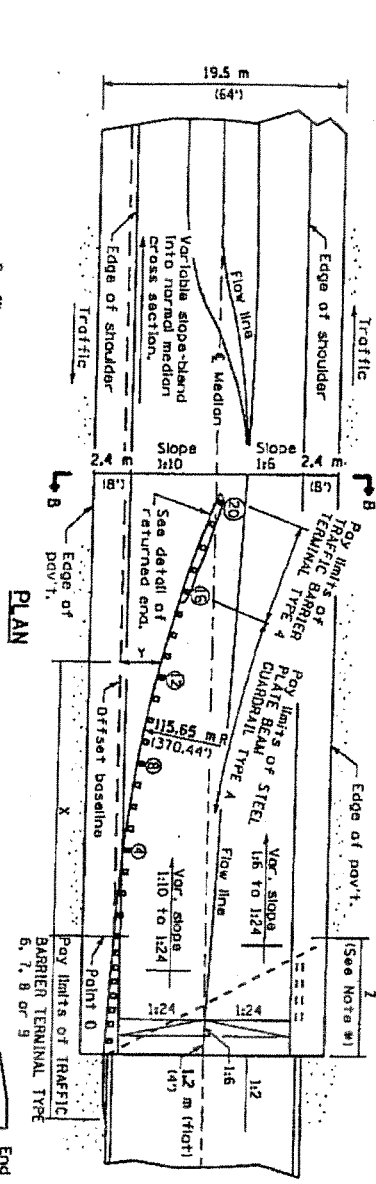

ASSEMBLY FOR 19.5 m (64 ft.) MEDIAN

OFFSETS TO FACE OF RAIL		
POST POINT	DISTANCE X (ft.)	OFFSET Y (ft.)
0	0	0
4	1.60 (24.93)	0.56 (11.83)
8	15.14 (45.68)	1.60 (5.28)
12	22.60 (74.16)	3.16 (10.37)
16	29.94 (98.23)	5.20 (17.05)
20	37.13 (121.83)	7.71 (25.31)
24	44.14 (144.83)	10.70 (35.09)

The location of point 0 will vary, being dependent on structure details and the type of traffic barrier terminal utilized, and passes through point D.

Offsets (Y) are measured between the face of rail and the offset baseline, which is parallel to the pavement edge and passes through point D.

GENERAL NOTES

See Standard 630001 for details of guard-rail not shown.

* For dual structures skewed right for ward, the nose of the Type 4 terminal shall be positioned longitudinally away from the structure for a distance equal to the dimension Z. Appropriate adjustments to the length of the Type 4 terminal and its offsets (Y) shall be calculated and noted. All additional lengths of guard-rail shall be in increments of 3.87 m (12'-6").

For dual structures that are 90° or skewed left for ward, the length of guard-rail is appropriate.

The bearing note X shall be held in position by (2) two eight penny nails driven into the post and bent over the top of the plate.

All slopes are expressed as units of vertical displacement to units of horizontal displacement (V:H).

All dimensions are in millimeters (inches unless otherwise shown).

DATE	REVISIONS
10-1-98	Revised distance in offset table.
1-1-97	Renum. Standard 2339-4.

TRAFFIC BARRIER TERMINAL TYPE 4
 STANDARD 631021-01
 (Sheet 1 of 2)

Minnesota Department of Transportation
 October 1, 1988
 Prepared by: *Charles E. Hildebrand*
 Checked by: *John J. Anderson*
 Approved by: *John J. Anderson*
 Project No. *64L64*
 Section *14*
 Sheet *14* of *26*

DELINEATOR AND POST ORIENTATION

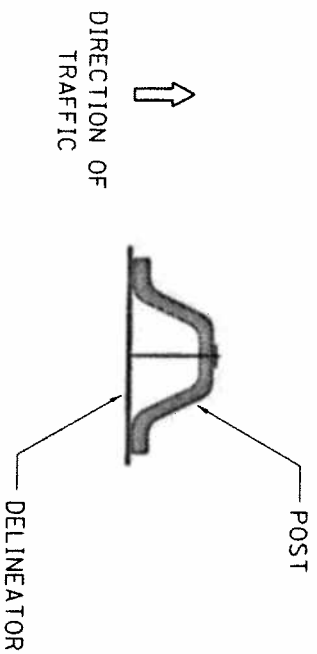

SECTION D-D

DELINEATORS SHALL BE INSTALLED ACCORDING TO STANDARD 635001 EXCEPT THAT THE POST SHALL BE ROTATED 180°. THE POST WILL HAVE THE WIDE SIDE FACING TRAFFIC AND THE DELINEATOR ATTACHED AS SHOWN ABOVE.

ALL DIMENSIONS ARE IN INCHES UNLESS OTHERWISE NOTED.

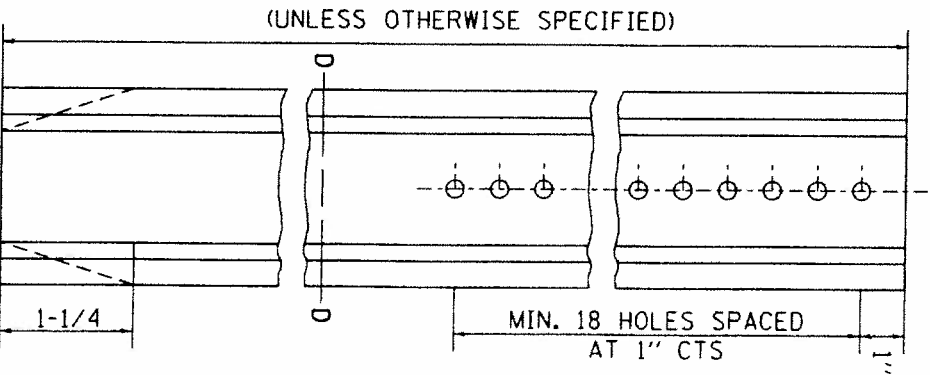

REVISED - 10-3-11	
REVISED -	
REVISED -	
REVISED -	

REGION 2 / DISTRICT 2 STANDARD			
SCALE: 79,5880' / 1" =	SHEET NO.	OF	SHEETS
			STA.
			TO STA.

F.A. RTE.	SECTION	COUNTY	TOTAL SHEET NO.
VAR	D2 GR (NORTH) 2017	VARIOUS	26
			17
FED. ROAD DIST. NO.		ILLINOIS FED. AID PROJECT	
		CONTRACT NO. 64L64	

PLOT DATE = Jul-05-2016 11:40:23 AM

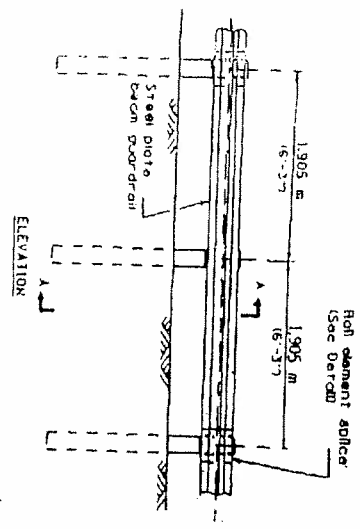

TYPE A
 1,905 m (6'-3") Typical post spacing

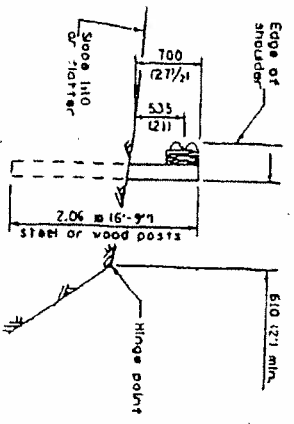

SECTION A-A

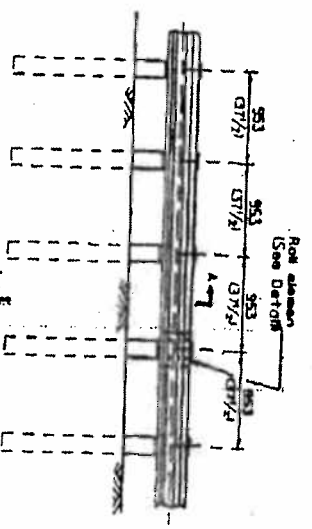

TYPE B
 953 (31 1/2") Closed post spacing

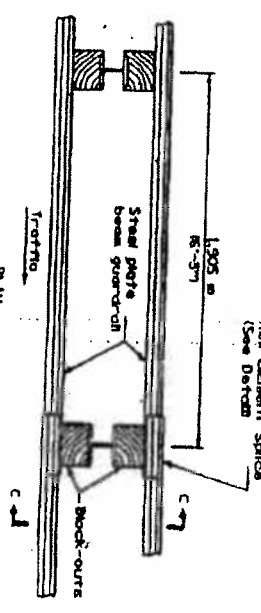

TYPE D
 Double steel plate beam guardrail
 1,905 m (6'-3") Typical post spacing

GENERAL NOTES

At slope grades or a embankment as units of vertical displacement to units of horizontal displacement (V/H).

All dimensions are in millimeters (inches) unless otherwise shown.

The existing steel posts may be drilled to accept the Bolt Pattern, or a new steel post shall be provided. This detail is applicable to the guardrail systems used prior to January 1, 2007. For systems on the Midwest Guardrail System, see Standard E3000.

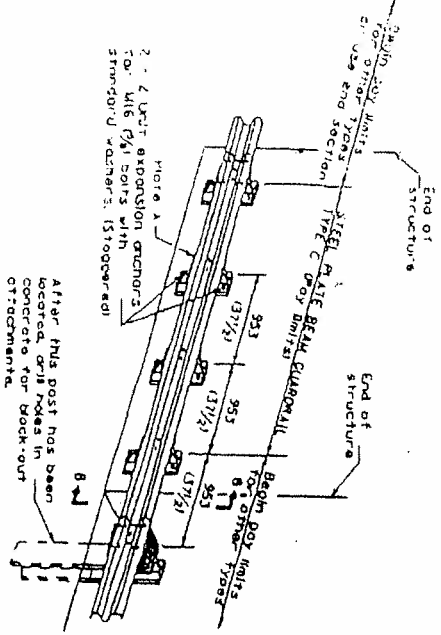

TYPE C
 953 (31 1/2") Back-out spacing

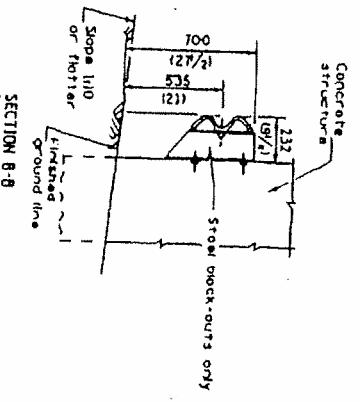

SECTION B-B

REMOVE AND REERECT STEEL PLATE BEAM GUARDRAIL

DETAIL

Sheet 1 of 26

Various Routes
 D2 GR (North) 2017
 Various Counties
 Sheet 19 of 26
 Contract #64164

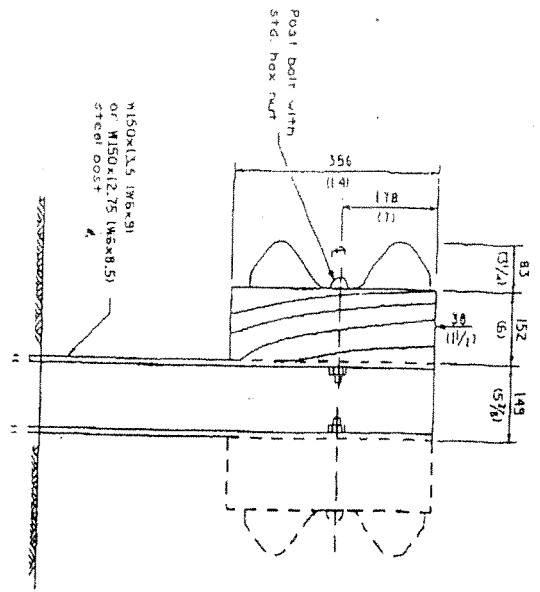

STEEL POST CONSTRUCTION

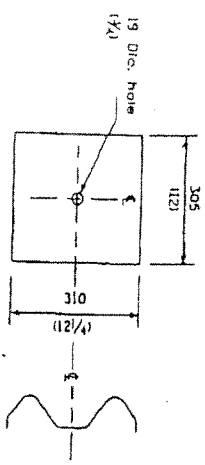

STEEL BLOCK-OUT DETAIL

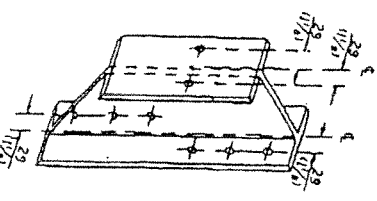

STEEL BLOCK-OUT DETAIL

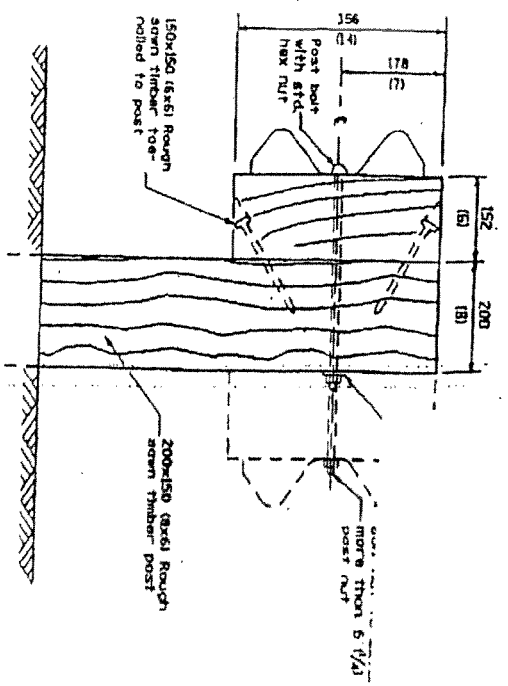

WOOD POST CONSTRUCTION

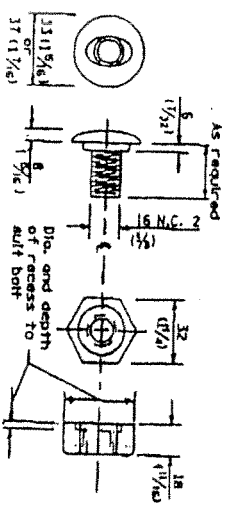

POST OR SPLICE BOLT & NUT

REMOVE AND REERECT
 STEEL PLATE BEAM GUARDRAIL
 (Sheet 2 of 26)
 DETAIL

Various Routes
 D2 GR (North) 2017
 Various Counties
 Sheet 20 of 26
 Contract #64L64

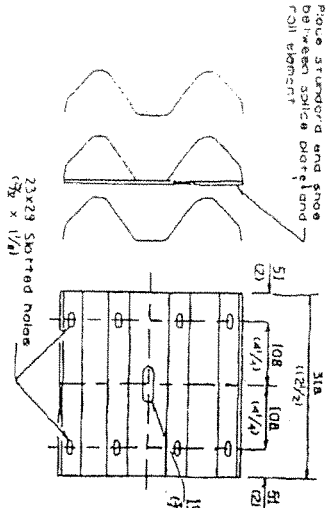

SPLICE PLATE

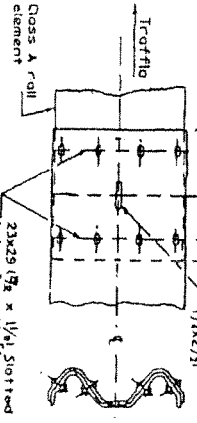

RAIL ELEMENT SPLICE

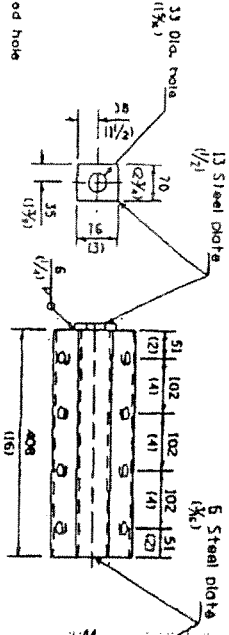

ANCHOR PLATE T DETAILS

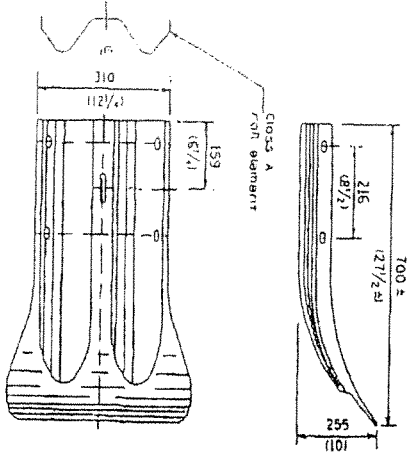
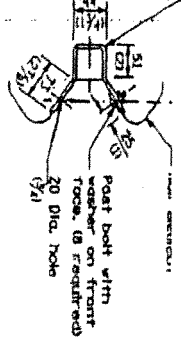

END SECTION

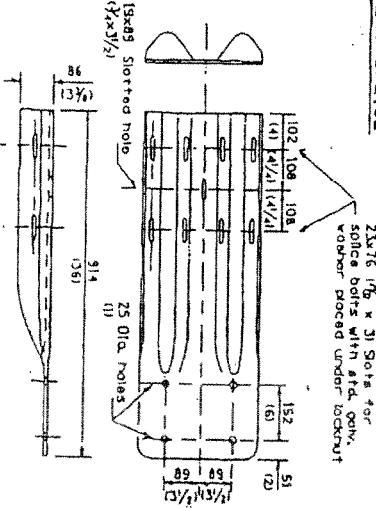

NOTE

When end shoe is attached to a bridge pier or post which has an expansion joint, the bolts shall be provided with a locknut or double nut and shall be tightened only to a point that will allow gradual movement. The standard end shoe shall be attached to the concrete with pre-drilled or self-drilling anchor bolts. The anchor rods shall be set flush with the surface of the concrete. Externally threaded studs protruding from the surface of the concrete will not be permitted.

END SHOE

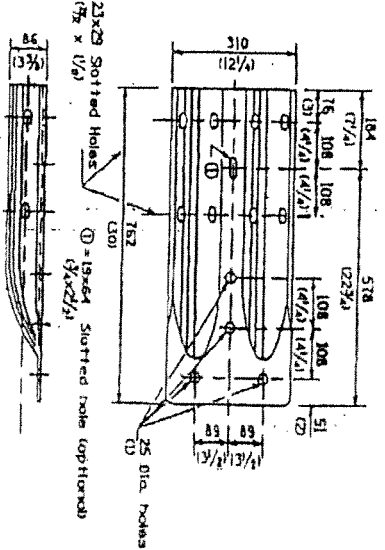

ALTERNATE END SHOE

REMOVE AND REERECT STEEL PLATE BEAM GUARDRAIL
 (Sheet 3 of 4)

Various Routes
 D2 GR (North) 2017
 Various Counties
 Sheet 22 of 26
 Contract #64L64

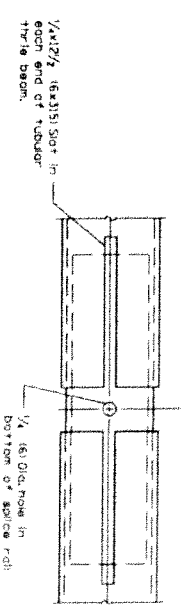
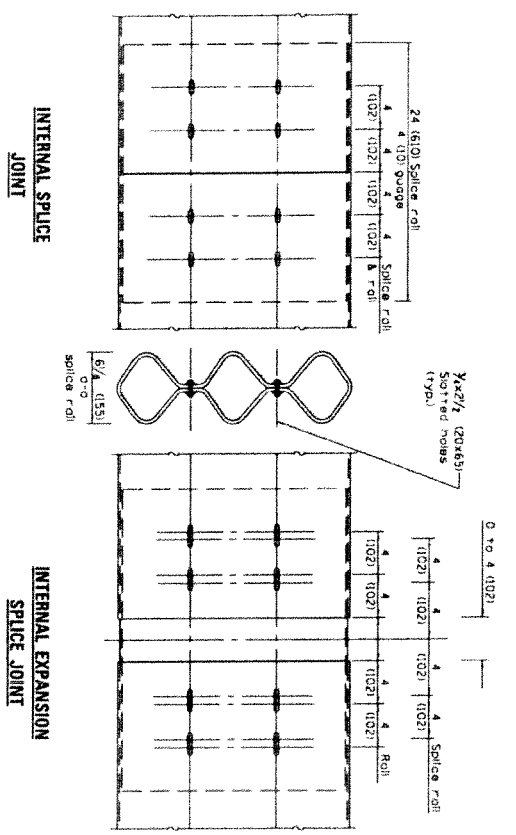
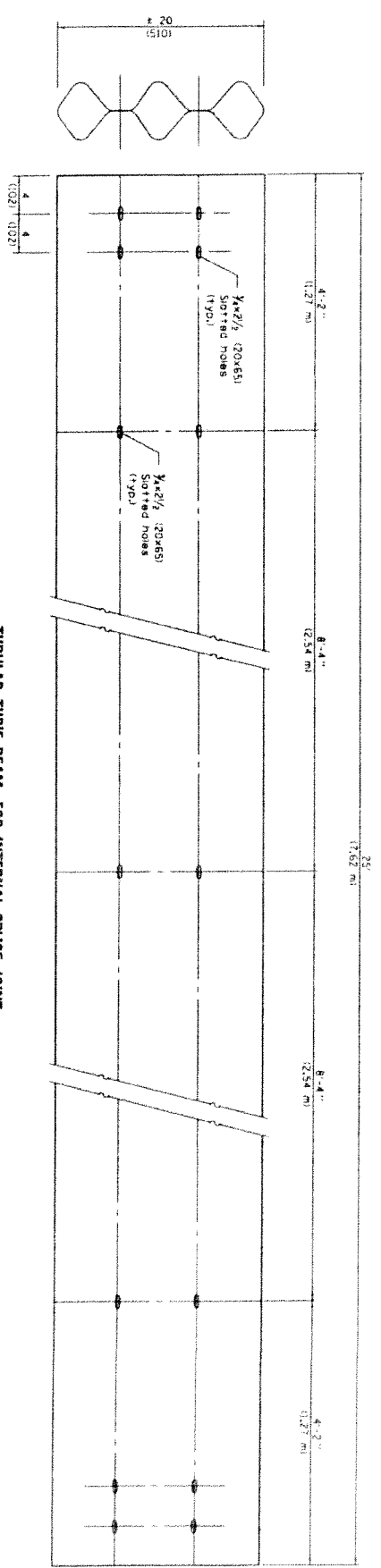

GENERAL NOTES

1. Refer to Standard 509001 for details of standard rail beam.

2. Refer to Standard 509001 for details of standard rail beam.

3. Refer to Standard 509001 for details of standard rail beam.

4. Refer to Standard 509001 for details of standard rail beam.

5. Refer to Standard 509001 for details of standard rail beam.

6. Refer to Standard 509001 for details of standard rail beam.

7. Refer to Standard 509001 for details of standard rail beam.

8. Refer to Standard 509001 for details of standard rail beam.

9. Refer to Standard 509001 for details of standard rail beam.

10. Refer to Standard 509001 for details of standard rail beam.

ISSUED 1-1-97
 APPROVED [Signature]
 ENGINEER OF DESIGN AND SUPERVISION

DATE	REVISIONS
1-1-11	Corrected note on splice
1-1-08	Switched units to English Imperial, added Plate Resistor Detail.

TUBULAR TRIRAIL BEAM RETROFIT RAIL FOR BRIDGES
 (Sheet 1 of 3)
 STANDARD 509001-02

Various Routes
 D2 GR (North) 2017
 Various Counties
 Sheet 23 of 26
 Contract #64L64

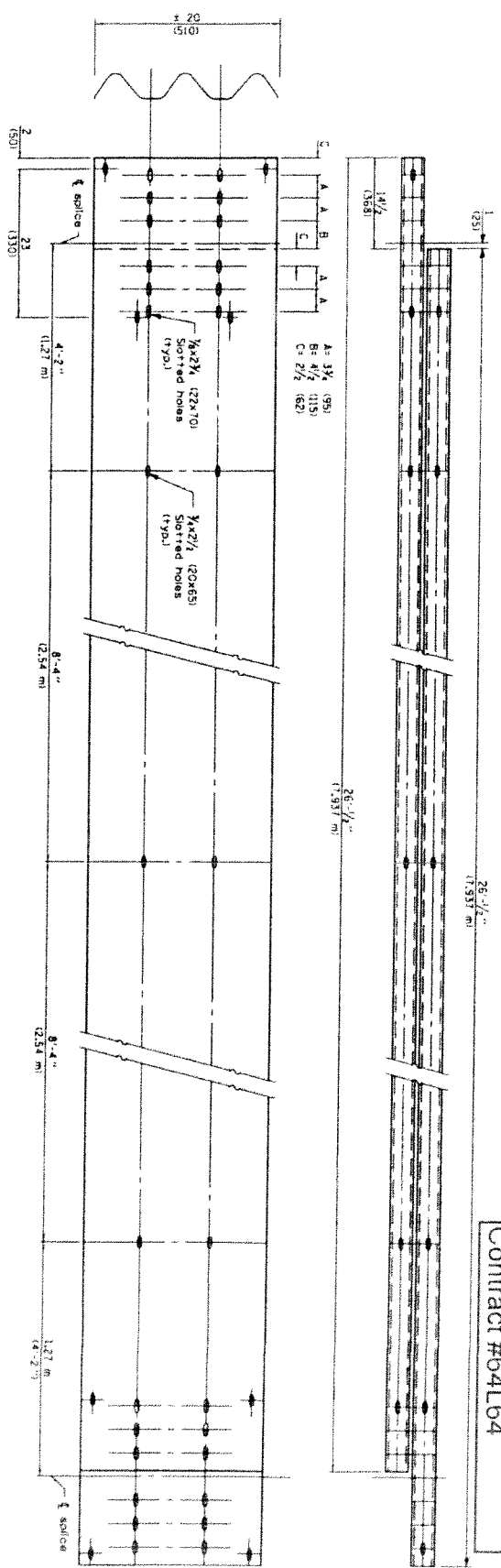

TUBULAR TRILE BEAM FOR LAP SPICE JOINT

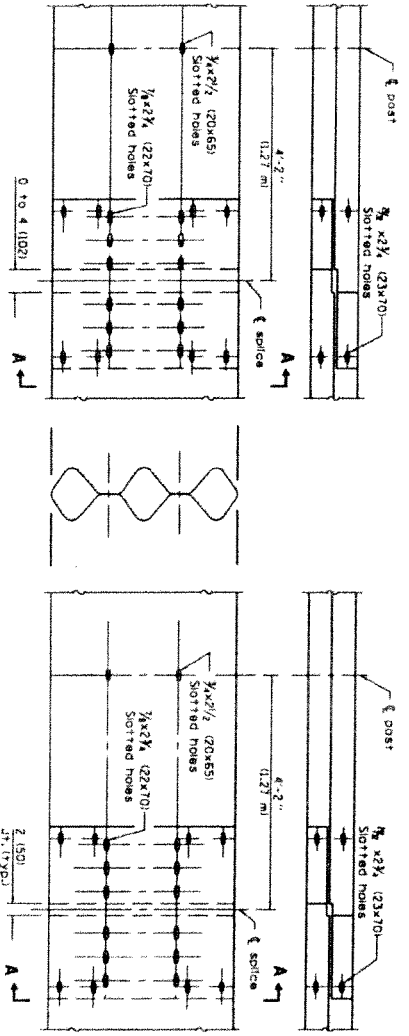

LAP EXPANSION SPACE JOINT

LAP SPICE JOINT

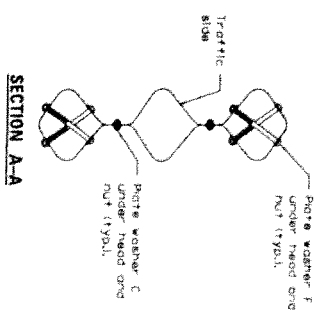

ISSUED 1-1-97
 APPROVED
 PROJECT: BRIDGE AND INFRASTRUCTURE

ISSUED 1-1-97
 APPROVED
 PROJECT: BRIDGE AND INFRASTRUCTURE

TUBULAR TRILE BEAM
 RETROFIT RAIL FOR BRIDGES
 STANDARD 509001-02
 (Sheet 2 of 3)

Post limits of TRAFFIC BARRIER TERMINAL TYPE 8 (1) shown.

For limits of other types

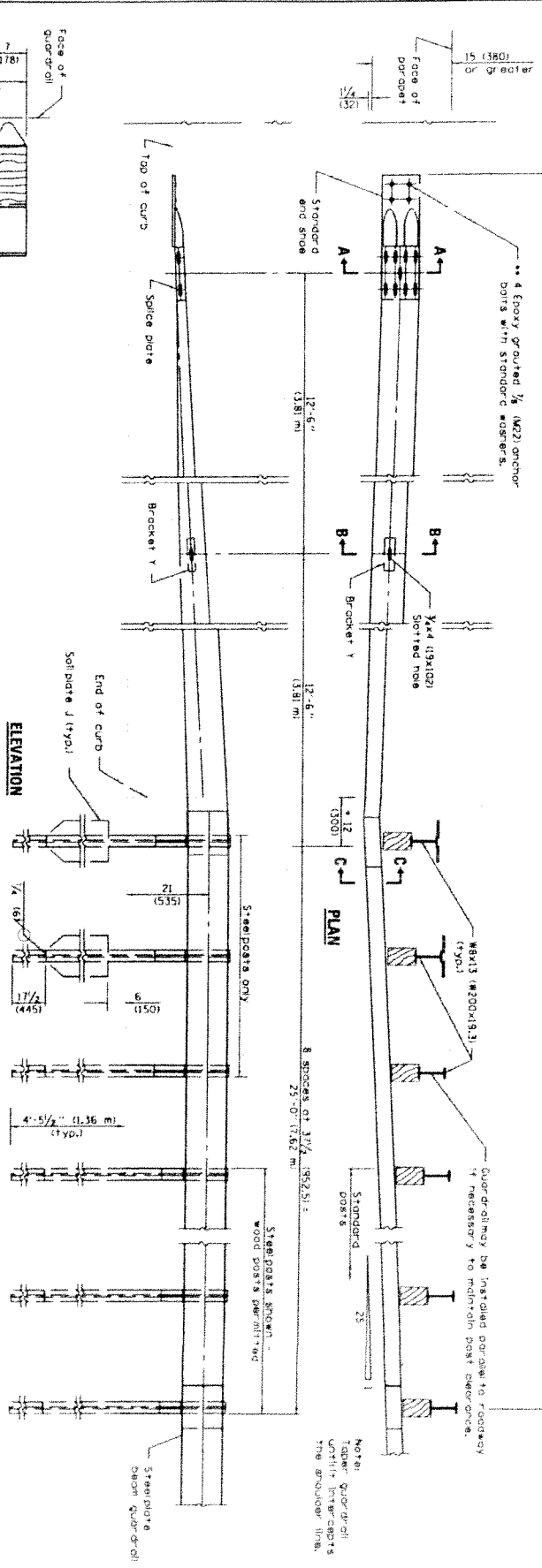

GENERAL NOTES

- See Standard 63002 for details of guard-raility shown.
- This dimension may be increased to fit field conditions. This post shall be located 1/8" from layout of the terminal shall be determined by its location.
- After tightening cut the anchor bolts flush with nuts, and remove the bolt head to prevent them from loosening.
- All dimensions are in inches (millimeters) unless otherwise shown.

Illinois Department of Transportation
ISSUED 1-1-97
REVISED 1-1-02
APPROVED 1-1-02
DESIGNED 1-1-02
CHECKED 1-1-02
DRAWN 1-1-02
PROJECT NO. 03-10-01-001
SHEET NO. 25 OF 26

DATE	REVISIONS
1-1-02	Switched units to English Imperial.
1-1-02	Revised 1/2" (M22) bolts.

**TRAFFIC BARRIER
TERMINAL TYPE 8**
STANDARD 631036-05

REVISIONS TO THE ILLINOIS PREVAILING WAGE RATES

The Prevailing rates of wages are included in the Contract proposals which are subject to Check Sheet #5 of the Supplemental Specifications and Recurring Special Provisions. The rates have been ascertained and certified by the Illinois Department of Labor for the locality in which the work is to be performed and for each craft or type of work or mechanic needed to execute the work of the Contract. As required by Prevailing Wage Act (820 ILCS 130/0.01, et seq.) and Check Sheet #5 of the Contract, not less than the rates of wages ascertained by the Illinois Department of Labor and as revised during the performance of a Contract shall be paid to all laborers, workers and mechanics performing work under the Contract. Post the scale of wages in a prominent and easily accessible place at the site of work.

If the Illinois Department of Labor revises the prevailing rates of wages to be paid as listed in the specification of rates, the contractor shall post the revised rates of wages and shall pay not less than the revised rates of wages. Current wage rate information shall be obtained by visiting the Illinois Department of Labor web site at <http://www.state.il.us/agency/idol/> or by calling 312-793-2814. It is the responsibility of the contractor to review the rates applicable to the work of the contract at regular intervals in order to insure the timely payment of current rates. Provision of this information to the contractor by means of the Illinois Department of Labor web site satisfies the notification of revisions by the Department to the contractor pursuant to the Act, and the contractor agrees that no additional notice is required. The contractor shall notify each of its subcontractors of the revised rates of wages.