

## **If you plan to submit a bid directly to the Department of Transportation**

### **PREQUALIFICATION**

Any contractor who desires to become pre-qualified to bid on work advertised by IDOT must submit the properly completed pre-qualification forms to the Bureau of Construction no later than 4:30 p.m. prevailing time twenty-one days prior to the letting of interest. This pre-qualification requirement applies to first time contractors, contractors renewing expired ratings, contractors maintaining continuous pre-qualification or contractors requesting revised ratings. To be eligible to bid, existing pre-qualification ratings must be effective through the date of letting.

### **REQUESTS FOR AUTHORIZATION TO BID**

Contractors downloading and/or ordering CD-ROM's and are wanting to bid on items included in a particular letting must submit the properly completed "Request for Authorization to Bid/or Not For Bid Status" (BDE 124INT) and the ORIGINAL, signed and notarized, "Affidavit of Availability" (BC 57) to the proper office no later than 4:30 p.m. prevailing time, three (3) days prior to the letting date.

### **WHO CAN BID ?**

Bids will be accepted from only those companies that request and receive written **Authorization to Bid** from IDOT's Central Bureau of Construction.

**WHAT CONSTITUTES WRITTEN AUTHORIZATION TO BID?** When a prospective prime bidder submits a "Request for Authorization to Bid/or Not For Bid Status" (BDE 124INT) he/she must indicate at that time which items are being requested For Bidding purposes. Only those items requested For Bidding will be analyzed. After the request has been analyzed, the bidder will be issued a **Proposal Denial and/or Authorization Form**, approved by the Central Bureau of Construction, that indicates which items have been approved For Bidding. If **Authorization to Bid** cannot be approved, the **Proposal Denial and/or Authorization Form** will indicate the reason for denial.

**ABOUT AUTHORIZATION TO BID:** Firms that have not received an authorization form within a reasonable time of complete and correct original document submittal should contact the department as to status. This is critical in the week before the letting. These documents must be received three days before the letting date. Firms unsure as to authorization status should call the Prequalification Section of the Bureau of Construction at the number listed at the end of these instructions.

**ADDENDA AND REVISIONS:** It is the contractor's responsibility to determine which, if any, addenda or revisions pertain to any project they may be bidding. Failure to incorporate all relevant addenda or revisions may cause the bid to be declared unacceptable.

Each addendum will be placed with the contract number. Addenda and revisions will also be placed on the Addendum/Revision Checklist and each subscription service subscriber will be notified by e-mail of each addendum and revision issued.

The Internet is the Department's primary way of doing business. The subscription server e-mails are an added courtesy the Department provides. It is suggested that bidder check IDOT's website <http://www.dot.il.gov/desenv/delett.html> before submitting final bid information.

**IDOT is not responsible for any e-mail related failures.**

Addenda Questions may be directed to the Contracts Office at (217)782-7806 or [D&Econtracts@dot.il.gov](mailto:D&Econtracts@dot.il.gov)

Technical Questions about downloading these files may be directed to Tim Garman (217)524-1642 or [garmantr@dot.il.gov](mailto:garmantr@dot.il.gov).

**WHAT MUST BE INCLUDED WHEN BIDS ARE SUBMITTED?:** Bidders need not return the entire proposal when bids are submitted. That portion of the proposal that must be returned includes the following:

1. All documents from the Proposal Cover Sheet through the Proposal Bid Bond
2. Other special documentation and/or information that may be required by the contract special provisions

All proposal documents, including Proposal Guaranty Checks or Proposal Bid Bonds, should be stapled together to prevent loss when bids are processed by IDOT personnel.

**ABOUT SUBMITTING BIDS:** It is recommended that bidders deliver bids in person to insure they arrive at the proper location prior to the time specified for the receipt of bids. Any bid received at the place of letting after the time specified will not be accepted.

**WHO SHOULD BE CALLED IF ASSISTANCE IS NEEDED?**

<b>Questions Regarding</b>	<b>Call</b>
Prequalification and/or Authorization to Bid	(217)782-3413
Preparation and submittal of bids	(217)782-7806
Mailing of plans and proposals	(217)782-7806
Electronic plans and proposals	(217)524-1642

**ADDENDUMS AND REVISIONS TO THE PROPOSAL FORMS**

Planholders should verify that they have received and incorporated the addendum and/or revision prior to submitting their bid. Failure by the bidder to include an addendum could result in a bid being rejected as irregular.

RETURN WITH BID

11

Proposal Submitted By
Name
Address
City

Letting January 19, 2007

BIDDERS NEED NOT RETURN THE ENTIRE PROPOSAL  
(See instructions inside front cover)

**NOTICE TO PROSPECTIVE BIDDERS**  
 This proposal can be used for bidding purposes  
 by only those companies that request and receive  
 written AUTHORIZATION TO BID from IDOT's  
 Central Bureau of Construction.  
 (SEE INSTRUCTIONS ON THE INSIDE OF COVER)

# Notice To Bidders, Specifications, Proposal, Contract and Contract Bond



**Illinois Department  
 of Transportation**

Springfield, Illinois 62764

Contract No. 64C55  
 JODAVIESS County  
 Section D2 MRS 2007-7  
 District 2 Construction Funds  
 Route FAP 301

PLEASE MARK THE APPROPRIATE BOX BELOW:

A Bid Bond is included.

A Cashier's Check or a Certified Check is included.

Plans Included  
 Herein

Prepared by	S
Checked by	

(Printed by authority of the State of Illinois)

---

---

## INSTRUCTIONS

**ABOUT IDOT PROPOSALS:** All proposals issued by IDOT are potential bidding proposals. Each proposal contains all Certifications and Affidavits, a Proposal Signature Sheet and a Proposal Bid Bond required for Prime Contractors to submit a bid after written **Authorization to Bid** has been issued by IDOT's Central Bureau of Construction.

**WHO CAN BID?:** Bids will be accepted from only those companies that request and receive written **Authorization to Bid** from IDOT's Central Bureau of Construction. To request authorization, a potential bidder must complete and submit Part B of the Request for Authorization to Bid/or Not For Bid Status form (BDE 124 INT) and submit an original Affidavit of Availability (BC 57).

**WHAT CONSTITUTES WRITTEN AUTHORIZATION TO BID?:** When a prospective prime bidder submits a "Request for Proposal Forms and Plans" he/she must indicate at that time which items are being requested For Bidding purposes. Only those items requested For Bidding will be analyzed. After the request has been analyzed, the bidder will be issued a **Proposal Denial and/or Authorization Form**, approved by the Central Bureau of Construction, that indicates which items have been approved For Bidding. If **Authorization to Bid** cannot be approved, the **Proposal Denial and/or Authorization Form** will indicate the reason for denial. If a contractor has requested to bid but has not received a **Proposal Denial and/or Authorization Form**, they should contact the Central Bureau of Construction in advance of the letting date.

**WHAT MUST BE INCLUDED WHEN BIDS ARE SUBMITTED?:** Bidders need not return the entire proposal when bids are submitted. That portion of the proposal that must be returned includes the following:

1. All documents from the Proposal Cover Sheet through the Proposal Bid Bond
2. Other special documentation and/or information that may be required by the contract special provisions

All proposal documents, including Proposal Guaranty Checks or Proposal Bid Bonds, should be stapled together to prevent loss when bids are processed by IDOT personnel.

**ABOUT SUBMITTING BIDS:** It is recommended that bidders deliver bids in person to insure they arrive at the proper location prior to the time specified for the receipt of bids. Any bid received at the place of letting after the time specified will not be accepted.

### WHO SHOULD BE CALLED IF ASSISTANCE IS NEEDED?

Questions Regarding	Call
Prequalification and/or Authorization to Bid	217/782-3413
Preparation and submittal of bids	217/782-7806
Mailing of CD-ROMS	217/782-7806

RETURN WITH BID



PROPOSAL

TO THE DEPARTMENT OF TRANSPORTATION

1. Proposal of \_\_\_\_\_

Taxpayer Identification Number (Mandatory) \_\_\_\_\_ a

for the improvement identified and advertised for bids in the Invitation for Bids as:

**Contract No. 64C55  
JODAVIESS County  
Section D2 MRS 2007-7  
Route FAP 301  
District 2 Construction Funds**

**1.2 miles of 27 feet width HMA resurfacing on U.S. Route 20/IL Route 84 from just north of Galena to IL Route 84.**

2. The undersigned bidder will furnish all labor, material and equipment to complete the above described project in a good and workmanlike manner as provided in the contract documents provided by the Department of Transportation. This proposal will become part of the contract and the terms and conditions contained in the contract documents shall govern performance and payments.



**RETURN WITH BID**

6. **COMBINATION BIDS.** The undersigned further agrees that if awarded the contract for the sections contained in the following combination, he/she will perform the work in accordance with the requirements of each individual proposal comprising the combination bid specified in the schedule below, and that the combination bid shall be prorated against each section in proportion to the bid submitted for the same. If an error is found to exist in the gross sum bid for one or more of the individual sections included in a combination, the combination bid shall be corrected as provided in the specifications.

**When a combination bid is submitted, the schedule below must be completed in each proposal comprising the combination.**

**If alternate bids are submitted for one or more of the sections comprising the combination, a combination bid must be submitted for each alternate.**

**Schedule of Combination Bids**

Combination No.	Sections Included in Combination	Combination Bid	
		Dollars	Cents

7. **SCHEDULE OF PRICES.** The undersigned bidder submits herewith, in accordance with the rules and instructions, a schedule of prices for the items of work for which bids are sought. The unit prices bid are in U.S. dollars and cents, and all extensions and summations have been made. The bidder understands that the quantities appearing in the bid schedule are approximate and are provided for the purpose of obtaining a gross sum for the comparison of bids. If there is an error in the extension of the unit prices, the unit prices shall govern. Payment to the contractor awarded the contract will be made only for actual quantities of work performed and accepted or materials furnished according to the contract. The scheduled quantities of work to be done and materials to be furnished may be increased, decreased or omitted as provided elsewhere in the contract.

8. **CERTIFICATE OF AUTHORITY.** The undersigned bidder, if a business organized under the laws of another State, assures the Department that it will furnish a copy of its certificate of authority to do business in the State of Illinois with the return of the executed contract and bond. Failure to furnish the certificate within the time provided for execution of an awarded contract may be cause for cancellation of the award and forfeiture of the proposal guaranty to the State.

ILLINOIS DEPARTMENT OF TRANSPORTATION  
 SCHEDULE OF PRICES  
 CONTRACT  
 NUMBER - 64C55

State Job # - C-92-143-06  
 PPS NBR - 0-00857-2005  
 County Name - JODAVIESS- -  
 Code - 85 - -  
 District - 2 - -  
 Section Number - D2 MRS 2007-7

Project Number

Route  
 FAP 301

Item Number	Pay Item Description	Unit of Measure	Quantity	x	Unit Price	=	Total Price
X7015005	CHANGEABLE MESSAGE SN	CAL DA	9.000				
40600200	BIT MATLS PR CT	TON	5.900				
40600300	AGG PR CT	TON	31.000				
40600735	P LEV BIND HM N70	TON	10.000				
40600837	P LEV BIND MM N70	TON	1,060.000				
40600982	HMA SURF REM BUTT JT	SQ YD	532.000				
40600990	TEMPORARY RAMP	SQ YD	89.000				
40603310	HMA SC "C" N50	TON	92.000				
40603540	P HMA SC "D" N70	TON	1,324.000				
40800050	INCIDENTAL HMA SURF	TON	73.000				
48101200	AGGREGATE SHLDS B	TON	506.000				
67100100	MOBILIZATION	L SUM	1.000				
70100460	TRAF CONT-PROT 701306	L SUM	1.000				
70300100	SHORT-TERM PAVT MKING	FOOT	2,192.000				
70301000	WORK ZONE PAVT MK REM	SQ FT	309.000				



ILLINOIS DEPARTMENT OF TRANSPORTATION  
 SCHEDULE OF PRICES  
 CONTRACT  
 NUMBER - 64C55

State Job # - C-92-143-06  
 PPS NBR - 0-00857-2005  
 County Name - JODAVIESS- -  
 Code - 85 - -  
 District - 2 - -  
 Section Number - D2 MRS 2007-7

Project Number

Route  
 FAP 301

Item Number	Pay Item Description	Unit of Measure	Quantity	x	Unit Price	=	Total Price
78000100	THPL PVT MK LTR & SYM	SQ FT	31.000				
78000200	THPL PVT MK LINE 4	FOOT	22,903.000				
78000500	THPL PVT MK LINE 8	FOOT	107.000				
78100100	RAISED REFL PAVT MKR	EACH	76.000				
78100200	TEMP RAIS REF PVT MKR	EACH	34.000				

**CONTRACT NUMBER**                    **64C55**

**THIS IS THE TOTAL BID**            **\$ \_\_\_\_\_**

**NOTES:**

1. Each PAY ITEM should have a UNIT PRICE and a TOTAL PRICE.
2. The UNIT PRICE shall govern if no TOTAL PRICE is shown or if there is a discrepancy between the product of the UNIT PRICE multiplied by the QUANTITY.
3. If a UNIT PRICE is omitted, the TOTAL PRICE will be divided by the QUANTITY in order to establish a UNIT PRICE.
4. A bid may be declared UNACCEPTABLE if neither a unit price nor a total price is shown.

## RETURN WITH BID

### **STATE REQUIRED ETHICAL STANDARDS GOVERNING CONTRACT PROCUREMENT: ASSURANCES, CERTIFICATIONS AND DISCLOSURES**

#### **I. GENERAL**

**A.** Article 50 of the Illinois Procurement Code establishes the duty of all State chief procurement officers, State purchasing officers, and their designees to maximize the value of the expenditure of public moneys in procuring goods, services, and contracts for the State of Illinois and to act in a manner that maintains the integrity and public trust of State government. In discharging this duty, they are charged by law to use all available information, reasonable efforts, and reasonable actions to protect, safeguard, and maintain the procurement process of the State of Illinois.

**B.** In order to comply with the provisions of Article 50 and to carry out the duty established therein, all bidders are to adhere to ethical standards established for the procurement process, and to make such assurances, disclosures and certifications required by law. By execution of the Proposal Signature Sheet, the bidder indicates that each of the mandated assurances has been read and understood, that each certification is made and understood, and that each disclosure requirement has been understood and completed.

**C.** In addition to all other remedies provided by law, failure to comply with any assurance, failure to make any disclosure or the making of a false certification shall be grounds for termination of the contract and the suspension or debarment of the bidder.

#### **II. ASSURANCES**

**A.** The assurances hereinafter made by the bidder are each a material representation of fact upon which reliance is placed should the Department enter into the contract with the bidder. The Department may terminate the contract if it is later determined that the bidder rendered a false or erroneous assurance, and the surety providing the performance bond shall be responsible for the completion of the contract.

##### **B. Felons**

1. The Illinois Procurement Code provides:

Section 50-10. Felons. Unless otherwise provided, no person or business convicted of a felony shall do business with the State of Illinois or any state agency from the date of conviction until 5 years after the date of completion of the sentence for that felony, unless no person held responsible by a prosecutorial office for the facts upon which the conviction was based continues to have any involvement with the business.

2. The bidder assures the Department that the award and execution of the contract would not cause a violation of Section 50-10.

##### **C. Conflicts of Interest**

1. The Illinois Procurement Code provides in pertinent part:

Section 50-13. Conflicts of Interest.

(a) Prohibition. It is unlawful for any person holding an elective office in this State, holding a seat in the General Assembly, or appointed to or employed in any of the offices or agencies of state government and who receives compensation for such employment in excess of 60% of the salary of the Governor of the State of Illinois, or who is an officer or employee of the Capital Development Board or the Illinois Toll Highway Authority, or who is the spouse or minor child of any such person to have or acquire any contract, or any direct pecuniary interest in any contract therein, whether for stationery, printing, paper, or any services, materials, or supplies, that will be wholly or partially satisfied by the payment of funds appropriated by the General Assembly of the State of Illinois or in any contract of the Capital Development Board or the Illinois Toll Highway authority.

(b) Interests. It is unlawful for any firm, partnership, association or corporation, in which any person listed in subsection (a) is entitled to receive (i) more than 7 1/2% of the total distributable income or (ii) an amount in excess of the salary of the Governor, to have or acquire any such contract or direct pecuniary interest therein.

(c) Combined interests. It is unlawful for any firm, partnership, association, or corporation, in which any person listed in subsection (a) together with his or her spouse or minor children is entitled to receive (i) more than 15%, in the aggregate, of the total distributable income or (ii) an amount in excess of 2 times the salary of the Governor, to have or acquire any such contract or direct pecuniary interest therein.

(d) Securities. Nothing in this Section invalidates the provisions of any bond or other security previously offered or to be offered for sale or sold by or for the State of Illinois.

(e) Prior interests. This Section does not affect the validity of any contract made between the State and an officer or employee of the State or member of the General Assembly, his or her spouse, minor child or any combination of those persons if that contract was in existence before his or her election or employment as an officer, member, or employee. The contract is voidable, however, if it cannot be completed within 365 days after the officer, member, or employee takes office or is employed.

The current salary of the Governor is \$150,700.00. Sixty percent of the salary is \$90,420.00.

## RETURN WITH BID

2. The bidder assures the Department that the award and execution of the contract would not cause a violation of Section 50-13, or that an effective exemption has been issued by the Board of Ethics to any individual subject to the Section 50-13 prohibitions pursuant to the provisions of Section 50-20 of the Code and Executive Order Number 3 (1998). Information concerning the exemption process is available from the Department upon request.

### **D. Negotiations**

1. The Illinois Procurement Code provides in pertinent part:

Section 50-15. Negotiations.

(a) It is unlawful for any person employed in or on a continual contractual relationship with any of the offices or agencies of State government to participate in contract negotiations on behalf of that office or agency with any firm, partnership, association, or corporation with whom that person has a contract for future employment or is negotiating concerning possible future employment.

2. The bidder assures the Department that the award and execution of the contract would not cause a violation of Section 50-15, and that the bidder has no knowledge of any facts relevant to the kinds of acts prohibited therein.

### **E. Inducements**

1. The Illinois Procurement Code provides:

Section 50-25. Inducement. Any person who offers or pays any money or other valuable thing to any person to induce him or her not to bid for a State contract or as recompense for not having bid on a State contract is guilty of a Class 4 felony. Any person who accepts any money or other valuable thing for not bidding for a State contract or who withholds a bid in consideration of the promise for the payment of money or other valuable thing is guilty of a Class 4 felony.

2. The bidder assures the Department that the award and execution of the contract would not cause a violation of Section 50-25, and that the bidder has no knowledge of any facts relevant to the kinds of acts prohibited therein.

### **F. Revolving Door Prohibition**

1. The Illinois Procurement Code provides:

Section 50-30. Revolving door prohibition. Chief procurement officers, associate procurement officers, State purchasing officers, their designees whose principal duties are directly related to State procurement, and executive officers confirmed by the Senate are expressly prohibited for a period of 2 years after terminating an affected position from engaging in any procurement activity relating to the State agency most recently employing them in an affected position for a period of at least 6 months. The prohibition includes, but is not limited to: lobbying the procurement process; specifying; bidding; proposing bid, proposal, or contract documents; on their own behalf or on behalf of any firm, partnership, association, or corporation. This Section applies only to persons who terminate an affected position on or after January 15, 1999.

2. The bidder assures the Department that the award and execution of the contract would not cause a violation of Section 50-30, and that the bidder has no knowledge of any facts relevant to the kinds of acts prohibited therein.

### **G. Reporting Anticompetitive Practices**

1. The Illinois Procurement Code provides:

Section 50-40. Reporting anticompetitive practices. When, for any reason, any vendor, bidder, contractor, chief procurement officer, State purchasing officer, designee, elected official, or State employee suspects collusion or other anticompetitive practice among any bidders, offerors, contractors, proposers, or employees of the State, a notice of the relevant facts shall be transmitted to the Attorney General and the chief procurement officer.

2. The bidder assures the Department that it has not failed to report any relevant facts concerning the practices addressed in Section 50-40 which may involve the contract for which the bid is submitted.

### **H. Confidentiality**

1. The Illinois Procurement Code provides:

Section 50-45. Confidentiality. Any chief procurement officer, State purchasing officer, designee, or executive officer who willfully uses or allows the use of specifications, competitive bid documents, proprietary competitive information, proposals, contracts, or selection information to compromise the fairness or integrity of the procurement, bidding, or contract process shall be subject to immediate dismissal, regardless of the Personnel code, any contract, or any collective bargaining agreement, and may in addition be subject to criminal prosecution.

2. The bidder assures the Department that it has no knowledge of any fact relevant to the practices addressed in Section 50-45 which may involve the contract for which the bid is submitted.

## RETURN WITH BID

### **I. Insider Information**

1. The Illinois Procurement Act provides:

Section 50-50. Insider information. It is unlawful for any current or former elected or appointed State official or State employee to knowingly use confidential information available only by virtue of that office or employment for actual or anticipated gain for themselves or another person.

2. The bidder assures the Department that it has no knowledge of any facts relevant to the practices addressed in Section 50-50 which may involve the contract for which the bid is submitted.

### **III. CERTIFICATIONS**

**A.** The certifications hereinafter made by the bidder are each a material representation of fact upon which reliance is placed should the Department enter into the contract with the bidder. The Department may terminate the contract if it is later determined that the bidder rendered a false or erroneous certification, and the surety providing the performance bond shall be responsible for completion of the contract.

#### **B. Bribery**

1. The Illinois Procurement Code provides:

Section 50-5. Bribery.

(a) Prohibition. No person or business shall be awarded a contract or subcontract under this Code who:

(1) has been convicted under the laws of Illinois or any other state of bribery or attempting to bribe an officer or employee of the State of Illinois or any other state in that officer's or employee's official capacity; or

(2) has made an admission of guilt of that conduct that is a matter of record but has not been prosecuted for that conduct.

(b) Businesses. No business shall be barred from contracting with any unit of State or local government as a result of a conviction under this Section of any employee or agent of the business if the employee or agent is no longer employed by the business and:

(1) the business has been finally adjudicated not guilty; or

(2) the business demonstrates to the governmental entity with which it seeks to contract, and that entity finds that the commission of the offense was not authorized, requested, commanded, or performed by a director, officer, or high managerial agent on behalf of the business as provided in paragraph (2) of subsection (a) of Section 5-4 of the Criminal Code of 1961.

(c) Conduct on behalf of business. For purposes of this Section, when an official, agent, or employee of a business committed the bribery or attempted bribery on behalf of the business and in accordance with the direction or authorization of a responsible official of the business, the business shall be chargeable with the conduct.

(d) Certification. Every bid submitted to and contract executed by the State shall contain a certification by the contractor that the contractor is not barred from being awarded a contract or subcontract under this Section. A contractor who makes a false statement, material to the certification, commits a Class 3 felony.

2. The bidder certifies that it is not barred from being awarded a contract under Section 50.5.

#### **C. Educational Loan**

1. Section 3 of the Educational Loan Default Act provides:

§ 3. No State agency shall contract with an individual for goods or services if that individual is in default, as defined in Section 2 of this Act, on an educational loan. Any contract used by any State agency shall include a statement certifying that the individual is not in default on an educational loan as provided in this Section.

2. The bidder, if an individual as opposed to a corporation, partnership or other form of business organization, certifies that the bidder is not in default on an educational loan as provided in Section 3 of the Act.

#### **D. Bid-Rigging/Bid Rotating**

1. Section 33E-11 of the Criminal Code of 1961 provides:

§ 33E-11. (a) Every bid submitted to and public contract executed pursuant to such bid by the State or a unit of local government shall contain a certification by the prime contractor that the prime contractor is not barred from contracting with any unit of State or local government as a result of a violation of either Section 33E-3 or 33E-4 of this Article. The State and units of local government shall provide the appropriate forms for such certification.

## RETURN WITH BID

(b) A contractor who makes a false statement, material to the certification, commits a Class 3 felony.

A violation of Section 33E-3 would be represented by a conviction of the crime of bid-rigging which, in addition to Class 3 felony sentencing, provides that any person convicted of this offense or any similar offense of any state or the United States which contains the same elements as this offense shall be barred for 5 years from the date of conviction from contracting with any unit of State or local government. No corporation shall be barred from contracting with any unit of State or local government as a result of a conviction under this Section of any employee or agent of such corporation if the employee so convicted is no longer employed by the corporation and: (1) it has been finally adjudicated not guilty or (2) if it demonstrates to the governmental entity with which it seeks to contract and that entity finds that the commission of the offense was neither authorized, requested, commanded, nor performed by a director, officer or a high managerial agent in behalf of the corporation.

A violation of Section 33E-4 would be represented by a conviction of the crime of bid-rotating which, in addition to Class 2 felony sentencing, provides that any person convicted of this offense or any similar offense of any state or the United States which contains the same elements as this offense shall be permanently barred from contracting with any unit of State or local government. No corporation shall be barred from contracting with any unit of State or local government as a result of a conviction under this Section of any employee or agent of such corporation if the employee so convicted is no longer employed by the corporation and: (1) it has been finally adjudicated not guilty or (2) if it demonstrates to the governmental entity with which it seeks to contract and that entity finds that the commission of the offense was neither authorized, requested, commanded, nor performed by a director, officer or a high managerial agent in behalf of the corporation.

2. The bidder certifies that it is not barred from contracting with the Department by reason of a violation of either Section 33E-3 or Section 33E-4.

### **E. International Anti-Boycott**

1. Section 5 of the International Anti-Boycott Certification Act provides:

§ 5. State contracts. Every contract entered into by the State of Illinois for the manufacture, furnishing, or purchasing of supplies, material, or equipment or for the furnishing of work, labor, or services, in an amount exceeding the threshold for small purchases according to the purchasing laws of this State or \$10,000.00, whichever is less, shall contain certification, as a material condition of the contract, by which the contractor agrees that neither the contractor nor any substantially-owned affiliated company is participating or shall participate in an international boycott in violation of the provisions of the U.S. Export Administration Act of 1979 or the regulations of the U.S. Department of Commerce promulgated under that Act.

2. The bidder makes the certification set forth in Section 5 of the Act.

### **F. Drug Free Workplace**

1. The Illinois "Drug Free Workplace Act" applies to this contract and it is necessary to comply with the provisions of the "Act" if the contractor is a corporation, partnership, or other entity (including a sole proprietorship) which has 25 or more employees.

2. The bidder certifies that if awarded a contract in excess of \$5,000 it will provide a drug free workplace by:

(a) Publishing a statement notifying employees that the unlawful manufacture, distribution, dispensation, possession or use of a controlled substance, including cannabis, is prohibited in the contractor's workplace; specifying the actions that will be taken against employees for violations of such prohibition; and notifying the employee that, as a condition of employment on such contract, the employee shall abide by the terms of the statement, and notify the employer of any criminal drug statute conviction for a violation occurring in the workplace no later than five (5) days after such conviction.

(b) Establishing a drug free awareness program to inform employees about the dangers of drug abuse in the workplace; the contractor's policy of maintaining a drug free workplace; any available drug counseling, rehabilitation, and employee assistance programs; and the penalties that may be imposed upon employees for drug violations.

(c) Providing a copy of the statement required by subparagraph (1) to each employee engaged in the performance of the contract and to post the statement in a prominent place in the workplace.

(d) Notifying the Department within ten (10) days after receiving notice from an employee or otherwise receiving actual notice of the conviction of an employee for a violation of any criminal drug statute occurring in the workplace.

(e) Imposing or requiring, within 30 days after receiving notice from an employee of a conviction or actual notice of such a conviction, an appropriate personnel action, up to and including termination, or the satisfactory participation in a drug abuse assistance or rehabilitation program approved by a federal, state or local health, law enforcement or other appropriate agency.

(f) Assisting employees in selecting a course of action in the event drug counseling, treatment, and rehabilitation is required and indicating that a trained referral team is in place.

(g) Making a good faith effort to continue to maintain a drug free workplace through implementation of the actions and efforts stated in this certification.

**G. Debt Delinquency**

1. The Illinois Procurement Code provides:

Section 50-11 and 50-12. Debt Delinquency.

The contractor or bidder certifies that it, or any affiliate, is not barred from being awarded a contract under 30 ILCS 500. Section 50-11 prohibits a person from entering into a contract with a State agency if it knows or should know that it, or any affiliate, is delinquent in the payment of any debt to the State as defined by the Debt Collection Board. Section 50-12 prohibits a person from entering into a contract with a State agency if it, or any affiliate, has failed to collect and remit Illinois Use Tax on all sales of tangible personal property into the State of Illinois in accordance with the provisions of the Illinois Use Tax Act. The contractor further acknowledges that the contracting State agency may declare the contract void if this certification is false or if the contractor, or any affiliate, is determined to be delinquent in the payment of any debt to the State during the term of the contract.

**H. Sarbanes-Oxley Act of 2002**

1. The Illinois Procurement Code provides:

Section 50-60(c).

The contractor certifies in accordance with 30 ILCS 500/50-10.5 that no officer, director, partner or other managerial agent of the contracting business has been convicted of a felony under the Sarbanes-Oxley Act of 2002 or a Class 3 or Class 2 felony under the Illinois Securities Law of 1953 for a period of five years prior to the date of the bid or contract. The contractor acknowledges that the contracting agency shall declare the contract void if this certification is false.

**I. ADDENDA**

The contractor or bidder certifies that all relevant addenda have been incorporated in to this contract. Failure to do so may cause the bid to be declared unacceptable.

**J. Section 42 of the Environmental Protection Act**

The contractor certifies in accordance with 30 ILCS 500/50-12 that the bidder or contractor is not barred from being awarded a contract under this Section which prohibits the bidding on or entering into contracts with the State of Illinois or a State agency by a person or business found by a court or the Pollution Control Board to have committed a willful or knowing violation of Section 42 of the Environmental Protection Act for a period of five years from the date of the order. The contractor acknowledges that the contracting agency may declare the contract void if this certification is false.

**K. Apprenticeship and Training Certification (Does not apply to federal aid projects)**

In accordance with the provisions of Section 30-22 (6) of the Illinois Procurement Code, the bidder certifies that it is a participant, either as an individual or as part of a group program, in the approved apprenticeship and training programs applicable to each type of work or craft that the bidder will perform with its own forces. The bidder further certifies for work that will be performed by subcontract that each of its subcontractors submitted for approval either (a) is, at the time of such bid, participating in an approved, applicable apprenticeship and training program; or (b) will, prior to commencement of performance of work pursuant to this contract, begin participation in an approved apprenticeship and training program applicable to the work of the subcontract. The Department, at any time before or after award, may require the production of a copy of each applicable Certificate of Registration issued by the United States Department of Labor evidencing such participation by the contractor and any or all of its subcontractors. Applicable apprenticeship and training programs are those that have been approved and registered with the United States Department of Labor. The bidder shall list in the space below, the official name of the program sponsor holding the Certificate of Registration for all of the types of work or crafts in which the bidder is a participant and that will be performed with the bidder's forces. Types of work or craft work that will be subcontracted shall be included and listed as subcontract work. The list shall also indicate any type of work or craft job category that does not have an applicable apprenticeship or training program. **The bidder is responsible for making a complete report and shall make certain that each type of work or craft job category that will be utilized on the project as reported on the Construction Employee Workforce Projection (Form BC-1256) and returned with the bid is accounted for and listed.**

---

---

---

The requirements of this certification and disclosure are a material part of the contract, and the contractor shall require this certification provision to be included in all approved subcontracts. In order to fulfill this requirement, it shall not be necessary that an applicable program sponsor be currently taking or that it will take applications for apprenticeship, training or employment during the performance of the work of this contract.

**TO BE RETURNED WITH BID**

**IV. DISCLOSURES**

**A.** The disclosures hereinafter made by the bidder are each a material representation of fact upon which reliance is placed should the Department enter into the contract with the bidder. The Department may terminate the contract if it is later determined that the bidder rendered a false or erroneous disclosure, and the surety providing the performance bond shall be responsible for completion of the contract.

**B. Financial Interests and Conflicts of Interest**

1. Section 50-35 of the Illinois Procurement Code provides that all bids of more than \$10,000 shall be accompanied by disclosure of the financial interests of the bidder. This disclosed information for the successful bidder, will be maintained as public information subject to release by request pursuant to the Freedom of Information Act.

The financial interests to be disclosed shall include ownership or distributive income share that is in excess of 5%, or an amount greater than 60% of the annual salary of the Governor, of the bidding entity or its parent entity, whichever is less, unless the contractor or bidder is a publicly traded entity subject to Federal 10K reporting, in which case it may submit its 10K disclosure in place of the prescribed disclosure. If a bidder is a privately held entity that is exempt from Federal 10K reporting, but has more than 400 shareholders, it may submit the information that Federal 10K companies are required to report, and list the names of any person or entity holding any ownership share that is in excess of 5%. The disclosure shall include the names, addresses, and dollar or proportionate share of ownership of each person making the disclosure, their instrument of ownership or beneficial relationship, and notice of any potential conflict of interest resulting from the current ownership or beneficial interest of each person making the disclosure having any of the relationships identified in Section 50-35 and on the disclosure form.

In addition, all disclosures shall indicate any other current or pending contracts, proposals, leases, or other ongoing procurement relationships the bidding entity has with any other unit of state government and shall clearly identify the unit and the contract, proposal, lease, or other relationship.

2. Disclosure Forms. Disclosure Form A is attached for use concerning the individuals meeting the above ownership or distributive share requirements. Subject individuals should be covered each by one form. In addition, a second form (Disclosure Form B) provides for the disclosure of current or pending procurement relationships with other (non-IDOT) state agencies. **The forms must be included with each bid or incorporated by reference.**

**C. Disclosure Form Instructions**

**Form A: For bidders that have previously submitted the information requested in Form A**

The Department has retained the Form A disclosures submitted by all bidders responding to these requirements for the April 24, 1998 or any subsequent letting conducted by the Department. The bidder has the option of submitting the information again or the bidder may sign the following certification statement indicating that the information previously submitted by the bidder is, as of the date of signature, current and accurate. The Certification must be signed and dated by a person who is authorized to execute contracts for the bidding company. Before signing this certification, the bidder should carefully review its prior submissions to ensure the Certification is correct. If the Bidder signs the Certification, the Bidder should proceed to Form B instructions.

**CERTIFICATION STATEMENT**

**I have determined that the Form A disclosure information previously submitted is current and accurate, and all forms are hereby incorporated by reference in this bid. Any necessary additional forms or amendments to previously submitted forms are attached to this bid.**

\_\_\_\_\_  
(Bidding Company)

\_\_\_\_\_  
Name of Authorized Representative (type or print)

\_\_\_\_\_  
Title of Authorized Representative (type or print)

\_\_\_\_\_  
Signature of Authorized Representative

\_\_\_\_\_  
Date



**Form A: For bidders who have NOT previously submitted the information requested in Form A**

If the bidder is a publicly traded entity subject to Federal 10K reporting, the 10K Report may be submitted to meet the requirements of Form A. If a bidder is a privately held entity that is exempt from Federal 10K reporting, but has more than 400 shareholders, it may submit the information that Federal 10K companies are required to report, and list the names of any person or entity holding any ownership share that is in excess of 5%. If a bidder is not subject to Federal 10K reporting, the bidder must determine if any individuals are required by law to complete a financial disclosure form. To do this, the bidder should answer each of the following questions. A "YES" answer indicates Form A must be completed. If the answer to each of the following questions is "NO", then the NOT APPLICABLE STATEMENT on the second page of Form A must be signed and dated by a person that is authorized to execute contracts for the bidding company. Note: These questions are for assistance only and are not required to be completed.

1. Does anyone in your organization have a direct or beneficial ownership share of greater than 5% of the bidding entity or parent entity? YES \_\_\_ NO \_\_\_
2. Does anyone in your organization have a direct or beneficial ownership share of less than 5%, but which has a value greater than \$90,420.00? YES \_\_\_ NO \_\_\_
3. Does anyone in your organization receive more than \$90,420.00 of the bidding entity's or parent entity's distributive income? (Note: Distributive income is, for these purposes, any type of distribution of profits. An annual salary is not distributive income.) YES \_\_\_ NO \_\_\_
4. Does anyone in your organization receive greater than 5% of the bidding entity's or parent entity's total distributive income, but which is less than \$90,420.00? YES \_\_\_ NO \_\_\_

(Note: Only one set of forms needs to be completed per person per bid even if a specific individual would require a yes answer to more than one question.)

A "YES" answer to any of these questions requires the completion of Form A. The bidder must determine each individual in the bidding entity or the bidding entity's parent company that would cause the questions to be answered "Yes". Each form must be signed and dated by a person that is authorized to execute contracts for your organization. **Photocopied or stamped signatures are not acceptable.** The person signing can be, but does not have to be, the person for which the form is being completed. The bidder is responsible for the accuracy of any information provided.

If the answer to each of the above questions is "NO", then the NOT APPLICABLE STATEMENT on page 2 of Form A must be signed and dated by a person that is authorized to execute contracts for your company.

**Form B: Identifying Other Contracts & Procurement Related Information** Disclosure Form B must be completed for each bid submitted by the bidding entity. It must be signed by an individual who is authorized to execute contracts for the bidding entity. *Note: Signing the NOT APPLICABLE STATEMENT on Form A does not allow the bidder to ignore Form B. Form B must be completed, signed and dated or the bidder may be considered nonresponsive and the bid will not be accepted.*

The Bidder shall identify, by checking Yes or No on Form B, whether it has any pending contracts (including leases), bids, proposals, or other ongoing procurement relationship with any other (non-IDOT) State of Illinois agency. If "No" is checked, the bidder only needs to complete the signature box on the bottom of Form B. If "Yes" is checked, the bidder must do one of the following:

Option I: If the bidder did not submit an Affidavit of Availability to obtain authorization to bid, the bidder must list all non-IDOT State of Illinois agency pending contracts, leases, bids, proposals, and other ongoing procurement relationships. These items may be listed on Form B or on an attached sheet(s). Do not include IDOT contracts. Contracts with cities, counties, villages, etc. are not considered State of Illinois agency contracts and are not to be included. Contracts with other State of Illinois agencies such as the Department of Natural Resources or the Capital Development Board must be included. Bidders who submit Affidavits of Availability are suggested to use Option II.

Option II: If the bidder is required and has submitted an Affidavit of Availability in order to obtain authorization to bid, the bidder may write or type "See Affidavit of Availability" which indicates that the Affidavit of Availability is incorporated by reference and includes all non-IDOT State of Illinois agency pending contracts, leases, bids, proposals, and other ongoing procurement relationships. For any contracts that are not covered by the Affidavit of Availability, the bidder must identify them on Form B or on an attached sheet(s). These might be such things as leases.

**D. Bidders Submitting More Than One Bid**

Bidders submitting multiple bids may submit one set of forms consisting of all required Form A disclosures and one Form B for use with all bids. Please indicate in the space provided below the bid item that contains the original disclosure forms and the bid items which incorporate the forms by reference.

- The bid submitted for letting item \_\_\_\_\_ contains the Form A disclosures or Certification Statement and the Form B disclosures. The following letting items incorporate the said forms by reference:

---



---

**ILLINOIS DEPARTMENT  
OF TRANSPORTATION**

**Form A  
Financial Information &  
Potential Conflicts of Interest  
Disclosure**

Contractor Name		
Legal Address		
City, State, Zip		
Telephone Number	Email Address	Fax Number (if available)

Disclosure of the information contained in this Form is required by the Section 50-35 of the Illinois Procurement Code (30 ILCS 500). Vendors desiring to enter into a contract with the State of Illinois must disclose the financial information and potential conflict of interest information as specified in this Disclosure Form. This information shall become part of the publicly available contract file. This Form A must be completed for bids in excess of \$10,000, and for all open-ended contracts. **A publicly traded company may submit a 10K disclosure (or equivalent if applicable) in satisfaction of the requirements set forth in Form A. See Disclosure Form Instructions.**

**DISCLOSURE OF FINANCIAL INFORMATION**

**1. Disclosure of Financial Information.** The individual named below has an interest in the BIDDER (or its parent) in terms of ownership or distributive income share in excess of 5%, or an interest which has a value of more than \$90,420.00 (60% of the Governor's salary as of 7/1/01). **(Make copies of this form as necessary and attach a separate Disclosure Form A for each individual meeting these requirements)**

**FOR INDIVIDUAL (type or print information)**

**NAME:** \_\_\_\_\_

**ADDRESS** \_\_\_\_\_

**Type of ownership/distributable income share:**

stock \_\_\_\_\_ sole proprietorship \_\_\_\_\_ Partnership \_\_\_\_\_ other: (explain on separate sheet):  
% or \$ value of ownership/distributable income share: \_\_\_\_\_

**2. Disclosure of Potential Conflicts of Interest.** Check "Yes" or "No" to indicate which, if any, of the following potential conflict of interest relationships apply. If the answer to any question is "Yes", please attach additional pages and describe.

(a) State employment, currently or in the previous 3 years, including contractual employment of services. Yes \_\_\_ No \_\_\_

If your answer is yes, please answer each of the following questions.

1. Are you currently an officer or employee of either the Capitol Development Board or the Illinois Toll Highway Authority? Yes \_\_\_ No \_\_\_
2. Are you currently appointed to or employed by any agency of the State of Illinois? If you are currently appointed to or employed by any agency of the State of Illinois, and your annual salary exceeds \$90,420.00, (60% of the Governor's salary as of 7/1/01) provide the name the State agency for which you are employed and your annual salary. \_\_\_\_\_

**RETURN WITH BID/OFFER**

- 3. If you are currently appointed to or employed by any agency of the State of Illinois, and your annual salary exceeds \$90,420.00, (60% of the Governor's salary as of 7/1/01) are you entitled to receive (i) more than 7 1/2% of the total distributable income of your firm, partnership, association or corporation, or (ii) an amount in excess of the salary of the Governor? Yes \_\_\_ No \_\_\_
- 4. If you are currently appointed to or employed by any agency of the State of Illinois, and your annual salary exceeds \$90,420.00, (60% of the Governor's salary as of 7/1/01) are you and your spouse or minor children entitled to receive (i) more than 15 % in the aggregate of the total distributable income of your firm, partnership, association or corporation, or (ii) an amount in excess of 2 times the salary of the Governor? Yes \_\_\_ No \_\_\_

---

(b) State employment of spouse, father, mother, son, or daughter, including contractual employment services in the previous 2 years.

Yes \_\_\_ No \_\_\_

If your answer is yes, please answer each of the following questions.

- 1. Is your spouse or any minor children currently an officer or employee of the Capitol Development Board or the Illinois Toll Highway Authority? Yes \_\_\_ No \_\_\_
- 2. Is your spouse or any minor children currently appointed to or employed by any agency of the State of Illinois? If your spouse or minor children is/are currently appointed to or employed by any agency of the State of Illinois, and his/her annual salary exceeds \$90,420.00, (60 % of the Governor's salary as of 7/1/01) provide the name of your spouse and/or minor children, the name of the State agency for which he/she is employed and his/her annual salary. \_\_\_\_\_  
\_\_\_\_\_
- 3. If your spouse or any minor children is/are currently appointed to or employed by any agency of the State of Illinois, and his/her annual salary exceeds \$90,420.00, (60% of the salary of the Governor as of 7/1/01) are you entitled to receive (i) more then 71/2% of the total distributable income of your firm, partnership, association or corporation, or (ii) an amount in excess of the salary of the Governor? Yes \_\_\_ No \_\_\_
- 4. If your spouse or any minor children are currently appointed to or employed by any agency of the State of Illinois, and his/her annual salary exceeds \$90,420.00, (60% of the Governor's salary as of 7/1/01) are you and your spouse or minor children entitled to receive (i) more than 15 % in the aggregate of the total distributable income of your firm, partnership, association or corporation, or (ii) an amount in excess of 2 times the salary of the Governor? Yes \_\_\_ No \_\_\_

---

(c) Elective status; the holding of elective office of the State of Illinois, the government of the United States, any unit of local government authorized by the Constitution of the State of Illinois or the statutes of the State of Illinois currently or in the previous 3 years.

Yes \_\_\_ No \_\_\_

---

(d) Relationship to anyone holding elective office currently or in the previous 2 years; spouse, father, mother, son, or daughter.

Yes \_\_\_ No \_\_\_

---

(e) Appointive office; the holding of any appointive government office of the State of Illinois, the United States of America, or any unit of local government authorized by the Constitution of the State of Illinois or the statutes of the State of Illinois, which office entitles the holder to compensation in excess of the expenses incurred in the discharge of that office currently or in the previous 3 years.

Yes \_\_\_ No \_\_\_

---

(f) Relationship to anyone holding appointive office currently or in the previous 2 years; spouse, father, mother, son, or daughter.

Yes \_\_\_ No \_\_\_

---

(g) Employment, currently or in the previous 3 years, as or by any registered lobbyist of the State government.

Yes \_\_\_ No \_\_\_

---

**RETURN WITH BID/OFFER**

(h) Relationship to anyone who is or was a registered lobbyist in the previous 2 years; spouse, father, mother, son, or daughter. Yes \_\_\_ No \_\_\_

(i) Compensated employment, currently or in the previous 3 years, by any registered election or reelection committee registered with the Secretary of State or any county clerk of the State of Illinois, or any political action committee registered with either the Secretary of State or the Federal Board of Elections. Yes \_\_\_ No \_\_\_

(j) Relationship to anyone; spouse, father, mother, son, or daughter; who was a compensated employee in the last 2 years by any registered election or re-election committee registered with the Secretary of State or any county clerk of the State of Illinois, or any political action committee registered with either the Secretary of State or the Federal Board of Elections. Yes \_\_\_ No \_\_\_

**APPLICABLE STATEMENT**

**This Disclosure Form A is submitted on behalf of the INDIVIDUAL named on previous page.**

Completed by: \_\_\_\_\_  
Name of Authorized Representative (type or print)

Completed by: \_\_\_\_\_  
Title of Authorized Representative (type or print)

Completed by: \_\_\_\_\_ Date \_\_\_\_\_  
Signature of Individual or Authorized Representative

**NOT APPLICABLE STATEMENT**

**I have determined that no individuals associated with this organization meet the criteria that would require the completion of this Form A.**

**This Disclosure Form A is submitted on behalf of the CONTRACTOR listed on the previous page.**

\_\_\_\_\_  
Name of Authorized Representative (type or print)

\_\_\_\_\_  
Title of Authorized Representative (type or print)

\_\_\_\_\_  
Signature of Authorized Representative Date \_\_\_\_\_

RETURN WITH BID/OFFER

**ILLINOIS DEPARTMENT  
OF TRANSPORTATION**

**Form B  
Other Contracts &  
Procurement Related Information  
Disclosure**

Contractor Name		
Legal Address		
City, State, Zip		
Telephone Number	Email Address	Fax Number (if available)

Disclosure of the information contained in this Form is required by the Section 50-35 of the Illinois Procurement Act (30 ILCS 500). This information shall become part of the publicly available contract file. This Form B must be completed for bids in excess of \$10,000, and for all open-ended contracts.

**DISCLOSURE OF OTHER CONTRACTS AND PROCUREMENT RELATED INFORMATION**

**1. Identifying Other Contracts & Procurement Related Information.** The BIDDER shall identify whether it has any pending contracts (including leases), bids, proposals, or other ongoing procurement relationship with any other State of Illinois agency: Yes \_\_\_ No \_\_\_

If **“No” is checked**, the bidder only needs to complete the signature box on the bottom of this page.

**2. If “Yes” is checked.** Identify each such relationship by showing State of Illinois agency name and other descriptive information such as bid or project number (attach additional pages as necessary). SEE DISCLOSURE FORM INSTRUCTIONS:

**THE FOLLOWING STATEMENT MUST BE SIGNED**

_____	
Name of Authorized Representative (type or print)	
_____	
Title of Authorized Representative (type or print)	
_____	_____
Signature of Authorized Representative	Date

## **RETURN WITH BID**

### **SPECIAL NOTICE TO CONTRACTORS**

The following requirements of the Illinois Department of Human Rights' Rules and Regulations are applicable to bidders on all construction contracts advertised by the Illinois Department of Transportation:

#### **CONSTRUCTION EMPLOYEE UTILIZATION PROJECTION**

- (a) All bidders on construction contracts shall complete and submit, along with and as part of their bids, a Bidder's Employee Utilization Form (Form BC-1256) setting forth a projection and breakdown of the total workforce intended to be hired and/or allocated to such contract work by the bidder including a projection of minority and female employee utilization in all job classifications on the contract project.
- (b) The Department of Transportation shall review the Employee Utilization Form, and workforce projections contained therein, of the contract awardee to determine if such projections reflect an underutilization of minority persons and/or women in any job classification in accordance with the Equal Employment Opportunity Clause and Section 7.2 of the Illinois Department of Human Rights' Rules and Regulations for Public Contracts adopted as amended on September 17, 1980. If it is determined that the contract awardee's projections reflect an underutilization of minority persons and/or women in any job classification, it shall be advised in writing of the manner in which it is underutilizing and such awardee shall be considered to be in breach of the contract unless, prior to commencement of work on the contract project, it submits revised satisfactory projections or an acceptable written affirmative action plan to correct such underutilization including a specific timetable geared to the completion stages of the contract.
- (c) The Department of Transportation shall provide to the Department of Human Rights a copy of the contract awardee's Employee Utilization Form, a copy of any required written affirmative action plan, and any written correspondence related thereto. The Department of Human Rights may review and revise any action taken by the Department of Transportation with respect to these requirements.



**RETURN WITH BID**

**Contract No. 64C55  
JODAVIESS County  
Section D2 MRS 2007-7  
Route FAP 301  
District 2 Construction Funds**

**PART II. WORKFORCE PROJECTION - continued**

B. Included in "Total Employees" under Table A is the total number of **new hires** that would be employed in the event the undersigned bidder is awarded this contract.

The undersigned bidder projects that: (number) \_\_\_\_\_ new hires would be recruited from the area in which the contract project is located; and/or (number) \_\_\_\_\_ new hires would be recruited from the area in which the bidder's principal office or base of operation is located.

C. Included in "Total Employees" under Table A is a projection of numbers of persons to be employed directly by the undersigned bidder as well as a projection of numbers of persons to be employed by subcontractors.

The undersigned bidder estimates that (number) \_\_\_\_\_ persons will be directly employed by the prime contractor and that (number) \_\_\_\_\_ persons will be employed by subcontractors.

**PART III. AFFIRMATIVE ACTION PLAN**

A. The undersigned bidder understands and agrees that in the event the foregoing minority and female employee utilization projection included under **PART II** is determined to be an underutilization of minority persons or women in any job category, and in the event that the undersigned bidder is awarded this contract, he/she will, prior to commencement of work, develop and submit a written Affirmative Action Plan including a specific timetable (geared to the completion stages of the contract) whereby deficiencies in minority and/or female employee utilization are corrected. Such Affirmative Action Plan will be subject to approval by the contracting agency and the **Department of Human Rights**.

B. The undersigned bidder understands and agrees that the minority and female employee utilization projection submitted herein, and the goals and timetable included under an Affirmative Action Plan if required, are deemed to be part of the contract specifications.

Company \_\_\_\_\_ Telephone Number \_\_\_\_\_  
\_\_\_\_\_  
Address \_\_\_\_\_

**NOTICE REGARDING SIGNATURE**

The Bidder's signature on the Proposal Signature Sheet will constitute the signing of this form. The following signature block needs to be completed only if revisions are required.

Signature: \_\_\_\_\_ Title: \_\_\_\_\_ Date: \_\_\_\_\_

- Instructions: All tables must include subcontractor personnel in addition to prime contractor personnel.
- Table A - Include both the number of employees that would be hired to perform the contract work and the total number currently employed (Table B) that will be allocated to contract work, and include all apprentices and on-the-job trainees. The "Total Employees" column should include all employees including all minorities, apprentices and on-the-job trainees to be employed on the contract work.
- Table B - Include all employees currently employed that will be allocated to the contract work including any apprentices and on-the-job trainees currently employed.
- Table C - Indicate the racial breakdown of the total apprentices and on-the-job trainees shown in Table A.



**RETURN WITH BID**

**Contract No. 64C55  
JODAVIESS County  
Section D2 MRS 2007-7  
Route FAP 301  
District 2 Construction Funds**

PROPOSAL SIGNATURE SHEET

The undersigned bidder hereby makes and submits this bid on the subject Proposal, thereby assuring the Department that all requirements of the Invitation for Bids and rules of the Department have been met, that there is no misunderstanding of the requirements of paragraph 3 of this Proposal, and that the contract will be executed in accordance with the rules of the Department if an award is made on this bid.

Firm Name \_\_\_\_\_  
(IF AN INDIVIDUAL) Signature of Owner \_\_\_\_\_  
Business Address \_\_\_\_\_  
\_\_\_\_\_

\_\_\_\_\_  
Firm Name \_\_\_\_\_  
By \_\_\_\_\_  
(IF A CO-PARTNERSHIP) Business Address \_\_\_\_\_  
\_\_\_\_\_  
Name and Address of All Members of the Firm:  
\_\_\_\_\_  
\_\_\_\_\_

\_\_\_\_\_  
Corporate Name \_\_\_\_\_  
By \_\_\_\_\_  
Signature of Authorized Representative  
\_\_\_\_\_  
Typed or printed name and title of Authorized Representative  
(IF A CORPORATION) Attest \_\_\_\_\_  
Signature  
(IF A JOINT VENTURE, USE THIS SECTION  
FOR THE MANAGING PARTY AND THE  
SECOND PARTY SHOULD SIGN BELOW) Business Address \_\_\_\_\_  
\_\_\_\_\_

\_\_\_\_\_  
Corporate Name \_\_\_\_\_  
By \_\_\_\_\_  
Signature of Authorized Representative  
\_\_\_\_\_  
Typed or printed name and title of Authorized Representative  
(IF A JOINT VENTURE) Attest \_\_\_\_\_  
Signature  
Business Address \_\_\_\_\_  
\_\_\_\_\_

If more than two parties are in the joint venture, please attach an additional signature sheet.



RETURN WITH BID

Division of Highways
Proposal Bid Bond
(Effective November 1, 1992)

Item No.
Letting Date

KNOW ALL MEN BY THESE PRESENTS, That We
as PRINCIPAL, and

held jointly, severally and firmly bound unto the STATE OF ILLINOIS in the penal sum of 5 percent of the total bid price, or for the amount specified in Article 102.09 of the "Standard Specifications for Road and Bridge Construction" in effect on the date of invitation for bids, whichever is the lesser sum, well and truly to be paid unto said STATE OF ILLINOIS, for the payment of which we bind ourselves, our heirs, executors, administrators, successors and assigns.

THE CONDITION OF THE FOREGOING OBLIGATION IS SUCH, That Whereas, the PRINCIPAL has submitted a bid proposal to the STATE OF ILLINOIS, acting through the Department of Transportation, for the improvement designated by the Transportation Bulletin Item Number and Letting Date indicated above.

NOW, THEREFORE, if the Department shall accept the bid proposal of the PRINCIPAL; and if the PRINCIPAL shall, within the time and as specified in the bidding and contract documents, submit a DBE Utilization Plan that is accepted and approved by the Department; and if, after award by the Department, the PRINCIPAL shall enter into a contract in accordance with the terms of the bidding and contract documents including evidence of the required insurance coverages and providing such bond as specified with good and sufficient surety for the faithful performance of such contract and for the prompt payment of labor and material furnished in the prosecution thereof; or if, in the event of the failure of the PRINCIPAL to make the required DBE submission or to enter into such contract and to give the specified bond, the PRINCIPAL pays to the Department the difference not to exceed the penalty hereof between the amount specified in the bid proposal and such larger amount for which the Department may contract with another party to perform the work covered by said bid proposal, then this obligation shall be null and void, otherwise, it shall remain in full force and effect.

IN THE EVENT the Department determines the PRINCIPAL has failed to comply with any requirement as set forth in the preceding paragraph, then Surety shall pay the penal sum to the Department within fifteen (15) days of written demand therefor. If Surety does not make full payment within such period of time, the Department may bring an action to collect the amount owed. Surety is liable to the Department for all its expenses, including attorney's fees, incurred in any litigation in which it prevails either in whole or in part.

In TESTIMONY WHEREOF, the said PRINCIPAL and the said SURETY have caused this instrument to be signed by their respective officers this day of A.D.,

PRINCIPAL SURETY
(Company Name) (Company Name)
By: (Signature & Title) By: (Signature of Attorney-in-Fact)

Notary Certification for Principal and Surety

STATE OF ILLINOIS,
COUNTY OF

I, a Notary Public in and for said County, do hereby certify that
and

(Insert names of individuals signing on behalf of PRINCIPAL & SURETY)

who are each personally known to me to be the same persons whose names are subscribed to the foregoing instrument on behalf of PRINCIPAL and SURETY, appeared before me this day in person and acknowledged respectively, that they signed and delivered said instrument as their free and voluntary act for the uses and purposes therein set forth.

Given under my hand and notarial seal this day of A.D.

My commission expires Notary Public

In lieu of completing the above section of the Proposal Bid Form, the Principal may file an Electronic Bid Bond. By signing below the Principal is ensuring the identified electronic bid bond has been executed and the Principal and Surety are firmly bound unto the State of Illinois under the conditions of the bid bond as shown above.

Electronic Bid Bond ID# Company/Bidder Name Signature and Title

# PROPOSAL ENVELOPE



# PROPOSALS

for construction work advertised for bids by the  
Illinois Department of Transportation

Item No.	Item No.	Item No.

Submitted By:

Name:
Address:
Phone No.

Bidders should use an IDOT proposal envelope or affix this form to the front of a 10" x 13" envelope for the submittal of bids. If proposals are mailed, they should be enclosed in a second or outer envelope addressed to:

Engineer of Design and Environment - Room 326  
Illinois Department of Transportation  
2300 South Dirksen Parkway  
Springfield, Illinois 62764

## **NOTICE**

**Individual bids, including Bid Bond and/or supplemental information if required, should be securely stapled.**

# CONTRACTOR OFFICE COPY OF CONTRACT SPECIFICATIONS

---

## NOTICE

None of the following material needs to be returned with the bid package unless the special provisions require documentation and/or other information to be submitted.

**Contract No. 64C55  
JODAVIESS County  
Section D2 MRS 2007-7  
Route FAP 301  
District 2 Construction Funds**



**Illinois Department of Transportation**



## NOTICE TO BIDDERS

**1. TIME AND PLACE OF OPENING BIDS.** Sealed proposals for the improvement described herein will be received by the Department of Transportation at the Harry R. Hanley Building, 2300 South Dirksen Parkway, in Springfield, Illinois until 10:00 o'clock a.m., January 19, 2007. All bids will be gathered, sorted, publicly opened and read in the auditorium at the Department of Transportation's Harry R. Hanley Building shortly after the 10:00 a.m. cut off time.

**2. DESCRIPTION OF WORK.** The proposed improvement is identified and advertised for bids in the Invitation for Bids as:

**Contract No. 64C55  
JODAVIESS County  
Section D2 MRS 2007-7  
Route FAP 301  
District 2 Construction Funds**

**1.2 miles of 27 feet width HMA resurfacing on U.S. Route 20/IL Route 84 from just north of Galena to IL Route 84.**

**3. INSTRUCTIONS TO BIDDERS.** (a) This Notice, the invitation for bids, proposal and letter of award shall, together with all other documents in accordance with Article 101.09 of the Standard Specifications for Road and Bridge Construction, become part of the contract. Bidders are cautioned to read and examine carefully all documents, to make all required inspections, and to inquire or seek explanation of the same prior to submission of a bid.

(b) State law, and, if the work is to be paid wholly or in part with Federal-aid funds, Federal law requires the bidder to make various certifications as a part of the proposal and contract. By execution and submission of the proposal, the bidder makes the certification contained therein. A false or fraudulent certification shall, in addition to all other remedies provided by law, be a breach of contract and may result in termination of the contract.

**4. AWARD CRITERIA AND REJECTION OF BIDS.** This contract will be awarded to the lowest responsive and responsible bidder considering conformity with the terms and conditions established by the Department in the rules, Invitation for Bids and contract documents. The issuance of plans and proposal forms for bidding based upon a prequalification rating shall not be the sole determinant of responsibility. The Department reserves the right to determine responsibility at the time of award, to reject any or all proposals, to readvertise the proposed improvement, and to waive technicalities.

By Order of the  
Illinois Department of Transportation

Timothy W. Martin, Secretary

BD 351 (Rev. 01/2003)

INDEX  
FOR  
SUPPLEMENTAL SPECIFICATIONS  
AND RECURRING SPECIAL PROVISIONS

Adopted January 1, 2007

This index contains a listing of SUPPLEMENTAL SPECIFICATIONS and frequently used RECURRING SPECIAL PROVISIONS.

SUPPLEMENTAL SPECIFICATIONS

Std. Spec. Sec.

Page No.

No Supplemental Specifications this year.

RECURRING SPECIAL PROVISIONS

The following RECURRING SPECIAL PROVISIONS indicated by an "X" are applicable to this contract and are included by reference:

<u>CHECK SHEET #</u>	<u>PAGE NO.</u>	
1	Additional State Requirements For Federal-Aid Construction Contracts (Eff. 2-1-69) (Rev. 1-1-07).....	1
2	Subletting of Contracts (Federal-Aid Contracts) (Eff. 1-1-88) (Rev. 5-1-93) .....	3
3	<b>X</b> EEO (Eff. 7-21-78) (Rev. 11-18-80) .....	4
4	<b>X</b> Specific Equal Employment Opportunity Responsibilities Non Federal-Aid Contracts (Eff. 3-20-69) (Rev. 1-1-94) .....	14
5	<b>X</b> Required Provisions - State Contracts (Eff. 4-1-65) (Rev. 1-1-07) .....	19
6	Reserved .....	24
7	National Pollutant Discharge Elimination System Permit (Eff. 7-1-94) (Rev. 1-1-03) .....	25
8	Haul Road Stream Crossings, Other Temporary Stream Crossings, and In-Stream Work Pads (Eff. 1-2-92) (Rev. 1-1-98).....	26
9	Construction Layout Stakes Except for Bridges (Eff. 1-1-99) (Rev. 1-1-07) .....	27
10	Construction Layout Stakes (Eff. 5-1-93) (Rev. 1-1-07) .....	30
11	Use of Geotextile Fabric for Railroad Crossing (Eff. 1-1-95) (Rev. 1-1-07) .....	33
12	Subsealing of Concrete Pavements (Eff. 11-1-84) (Rev. 1-1-07).....	35
13	Hot-Mix Asphalt Surface Removal (Cold Milling) (Eff. 11-1-87) (Rev. 1-1-07) .....	39
14	Pavement and Shoulder Resurfacing (Eff. 2-1-00) (Rev. 1-1-07) .....	41
15	PCC Partial Depth Hot-Mix Asphalt Patching (Eff. 1-1-98) (Rev. 1-1-07) .....	42
16	Patching with Hot-Mix Asphalt Overlay Removal (Eff. 10-1-95) (Rev. 1-1-07).....	44
17	Polymer Concrete (Eff. 8-1-95) (Rev. 3-1-05) .....	45
18	PVC Pipeliner (Eff. 4-1-04) (Rev. 1-1-07) .....	47
19	Pipe Underdrains (Eff. 9-9-87) (Rev. 1-1-07) .....	48
20	Guardrail and Barrier Wall Delineation (Eff. 12-15-93) (Rev. 1-1-97) .....	49
21	Bicycle Racks (Eff. 4-1-94) (Rev. 1-1-07) .....	53
22	Temporary Modular Glare Screen System (Eff. 1-1-00) (Rev. 1-1-07) .....	55
23	Temporary Portable Bridge Traffic Signals (Eff. 8-1-03) (Rev. 1-1-07) .....	57
24	Work Zone Public Information Signs (Eff. 9-1-02) (Rev. 1-1-07).....	59
25	Night Time Inspection of Roadway Lighting (Eff. 5-1-96).....	60
26	English Substitution of Metric Bolts (Eff. 7-1-96).....	61
27	English Substitution of Metric Reinforcement Bars (Eff. 4-1-96) (Rev. 1-1-03) .....	62
28	Calcium Chloride Accelerator for Portland Cement Concrete (Eff. 1-1-01) .....	63
29	Quality Control of Concrete Mixtures at the Plant-Single A (Eff. 8-1-00) (Rev. 1-1-04) .....	64
30	Quality Control of Concrete Mixtures at the Plant-Double A (Eff. 8-1-00) (Rev. 1-1-04) .....	70
31	Quality Control/Quality Assurance of Concrete Mixtures (Eff. 4-1-92) (Rev. 1-1-07) .....	78

## TABLE OF CONTENTS

LOCATION OF PROJECT .....	1
DESCRIPTION OF PROJECT .....	1
TRAFFIC CONTROL PLAN .....	1
ADDITIONAL FLAGGERS .....	2
MAINTENANCE OF TRAFFIC .....	2
CHANGEABLE MESSAGE SIGN .....	3
BITUMINOUS MATERIALS COST ADJUSTMENTS (BDE) (RETURN FORM WITH BID) .....	3
ERRATA FOR THE 2007 STANDARD SPECIFICATIONS (BDE) .....	6
HOT-MIX ASPHALT EQUIPMENT, SPREADING AND FINISHING MACHINE (BDE) .....	7
PAYMENTS TO SUBCONTRACTORS (BDE) .....	7
RECLAIMED ASPHALT PAVEMENT (RAP) (BDE) .....	8
SUBCONTRACTOR MOBILIZATION PAYMENTS (BDE) .....	13
THERMOPLASTIC PAVEMENT MARKINGS (BDE) .....	14
WORKING DAYS (BDE) .....	15
PROJECT LABOR AGREEMENT .....	16



## STATE OF ILLINOIS

---

### SPECIAL PROVISIONS

The following Special Provisions supplement the "Standard Specifications for Road and Bridge Construction," adopted January 1, 2007, the latest edition of the "Manual on Uniform Traffic Control Devices for Streets and Highways," and the "Manual of Test Procedures for Materials" in effect on the date of invitation for bids, and the Supplemental Specifications and Recurring Special Provisions indicated on the Check Sheet included herein which apply to and govern the construction of ROUTE: FAP Route 301, SECTION: D2 MRS 2007-7, COUNTY: Jo Daviess, CONTRACT: 64C55, and in case of conflict with any part or parts of said Specifications, the said Special Provisions shall take precedence and shall govern.

#### LOCATION OF PROJECT

Work will be on US 20/IL 84, northwest of Galena.

#### DESCRIPTION OF PROJECT

Work will include resurfacing with hot-mix asphalt and placing pavement markings using thermoplastic and raised reflective pavement markers, along with placing an aggregate shoulder wedge.

#### TRAFFIC CONTROL PLAN

Effective January 14, 1999

Traffic Control shall be according to the applicable sections of the Standard Specifications for Road and Bridge Construction, the applicable guidelines contained in the National Manual on Uniform Traffic Control Devices for Streets and Highways, Illinois Supplement to the National Manual on Uniform Traffic Control Devices, these special provisions, and any special details and Highway Standards contained herein and in the plans.

Special attention is called to Articles 107.09 and 107.14 of the Standard Specifications for Road and Bridge Construction and the following Highway Standards relating to traffic control.

Standards:

701006  
701311

701301  
702001

701306

Details:

District Standard 41.1 (Typical Pavement Markings)

Signs:

No additional bracing shall be allowed on post-mounted signs.

Post-mounted signs shall be installed using standards 720001, 728001, 729001, 4" x 4" Wood posts, or any other "break away" connection supported by FHWA letter provided to the Resident.

All signs are required on both sides of the road when the median is greater than 10 feet and on one way roadways.

"BUMP" (W8-1(O)48) signs shall be installed as directed by the Engineer.

"UNEVEN LANES" (W8-11(O)48) signs shall be installed as directed by the Engineer.

"LOW SHOULDER" W8-9(O)48 signs shall be installed at 2 mile intervals or as directed by the Engineer.

The cost of furnishing, erecting, maintaining, covering and removing the signs shall be included in the cost of TRAFFIC CONTROL AND PROTECTION STANDARD 701306.

### **ADDITIONAL FLAGGERS**

When work is being performed in the area near the intersection of US 20 & IL 84, a flagger will be required at each leg of the intersection.

All costs for the additional flaggers shall be considered to be included in the LUMP SUM cost of TRAFFIC CONTROL AND PROTECTION STANDARD 701306.

### **MAINTENANCE OF TRAFFIC**

The hot-mix asphalt resurfacing shall be completed using Traffic Control and Protection Standard 701306.

The aggregate shoulder wedge shall be placed using Traffic Control and Protection Standard 701306.

The thermoplastic pavement markings and raised reflective pavement markers installation shall be completed using Traffic Control and Protection Standard 701311.

Short term pavement marking, placement, and removal shall be completed using Traffic Control and Protection Standards 701301 and 701306.

The mainline shall be kept open to one-way traffic at all times during working hours and two-way traffic during non-working hours.

### **CHANGEABLE MESSAGE SIGN**

This work shall be done in accordance with the applicable portions of Section 701 of the Standard Specifications for Road and Bridge Construction, as directed by the Engineer, and as specified herein.

The sign is to be placed along the Eastbound lanes of US 20, 1 mile before the project limit, East of Illinois 84 (North). The sign is to be set up 2 days prior to the beginning of construction and is to remain in place throughout the construction timeframe.

The Engineer is to determine the wording used on the message sign, warning the traveling public of the construction project at the end of the 4 lane section.

This work will be paid for at the contract unit price per CALENDAR DAY for CHANGEABLE MESSAGE SIGN.

### **BITUMINOUS MATERIALS COST ADJUSTMENTS (BDE) (RETURN FORM WITH BID)**

Effective: November 2, 2006

Revised: January 2, 2007

Description. For projects with at least 1200 tons (1100 metric tons) of work involving applicable bituminous materials, cost adjustments will be made to provide additional compensation to the Contractor, or credit to the Department, for fluctuations in the cost of bituminous materials when optioned by the Contractor. The adjustments shall apply to permanent and temporary hot-mix asphalt (HMA) mixtures, bituminous surface treatments (cover and seal coats), and pavement preservation type surface treatments. The adjustments shall not apply to bituminous prime coats, tack coats, crack filling/sealing, or joint filling/sealing.

The bidder shall indicate on the attached form whether or not this special provision will be part of the contract and submit the completed form with his/her bid. Failure to submit the form, or failure to fill out the form completely, shall make this contract exempt of bituminous materials cost adjustments.

Method of Adjustment. Bituminous materials cost adjustments will be computed as follows.

$$CA = (BPI_P - BPI_L) \times (\%AC_V / 100) \times Q$$

Where: CA = Cost Adjustment, \$.

BPI<sub>P</sub> = Bituminous Price Index, as published by the Department for the month the work is performed, \$/ton (\$/metric ton).

BPI<sub>L</sub> = Bituminous Price Index, as published by the Department for the month prior to the letting, \$/ton (\$/metric ton).

%AC<sub>V</sub> = Percent of virgin Asphalt Cement in the Quantity being adjusted. For HMA mixtures, the % AC<sub>V</sub> will be determined from the adjusted job mix formula.

For bituminous materials applied, a performance graded or cutback asphalt will be considered to be 100% AC<sub>V</sub> and undiluted emulsified asphalt will be considered to be 65% AC<sub>V</sub>.

Q = Authorized construction Quantity, tons (metric tons) (see below).

For HMA mixtures measured in square yards:  $Q, \text{ tons} = A \times D \times (G_{mb} \times 46.8) / 2000$ . For HMA mixtures measured in square meters:  $Q, \text{ metric tons} = A \times D \times (G_{mb} \times 24.99) / 1000$ . When computing adjustments for full-depth HMA pavement, separate calculations will be made for the binder and surface courses to account for their different  $G_{mb}$  and % AC<sub>V</sub>.

For bituminous materials measured in gallons:  $Q, \text{ tons} = V \times 8.33 \text{ lb/gal} \times SG / 2000$

For bituminous materials measured in liters:  $Q, \text{ metric tons} = V \times 1.0 \text{ kg/L} \times SG / 1000$

Where: A = Area of the HMA mixture, sq yd (sq m).

D = Depth of the HMA mixture, in. (mm).

$G_{mb}$  = Average bulk specific gravity of the mixture, from the approved mix design.

V = Volume of the bituminous material, gal (L).

SG = Specific Gravity of bituminous material as shown on the bill of lading.

Basis of Payment. Bituminous materials cost adjustments may be positive or negative but will only be made when there is a difference between the BPI<sub>L</sub> and BPI<sub>P</sub> in excess of five percent, as calculated by:

$$\text{Percent Difference} = \{(BPI_L - BPI_P) \div BPI_L\} \times 100$$

Bituminous materials cost adjustments will be calculated for each calendar month in which applicable bituminous material is placed; and will be paid or deducted when all other contract requirements for the items of work are satisfied. The adjustments shall not apply during contract time subject to liquidated damages for completion of the entire contract.

Return With Bid

**ILLINOIS DEPARTMENT  
OF TRANSPORTATION**

**OPTION FOR  
BITUMINOUS MATERIALS COST ADJUSTMENTS**

The bidder shall submit this completed form with his/her bid. Failure to submit the form, or failure to fill out the form completely, shall make this contract exempt of bituminous materials cost adjustments. After award, this form, when submitted, shall become part of the contract.

**Contract No.:** \_\_\_\_\_

**Company Name:** \_\_\_\_\_

**Contractor's Option:**

Is your company opting to include this special provision as part of the contract?

Yes

No

**Signature:** \_\_\_\_\_ **Date:** \_\_\_\_\_

**ERRATA FOR THE 2007 STANDARD SPECIFICATIONS (BDE)**

Effective: January 1, 2007

- Page 60 Article 109.07(a). In the second line of the first paragraph change “amount” to “quantity”.
- Page 207 Article 406.14. In the second line of the second paragraph change “MIXTURE FOR CRACKS, JOINTS, AND FLANGWAYS, of the mixture composition specified;” to “MIXTURE FOR CRACKS, JOINTS, AND FLANGWAYS;”.
- Page 398 Article 540.07(b). Add the following two paragraphs after the third paragraph:  
  
“Excavation in rock will be measured for payment according to Article 502.12.  
  
Removal and disposal of unstable and/or unsuitable material below plan bedding grade will be measured for payment according to Article 202.07.”
- Page 398 Article 540.08. Add the following two paragraphs after the fifth paragraph:  
  
“Excavation in rock will be paid for according to Article 502.13.  
  
Removal and disposal of unstable and/or unsuitable material below plan bedding grade will be paid for according to Article 202.08.”
- Page 465 Article 551.06. In the second line of the first paragraph change “or” to “and/or”.
- Page 585 Article 701.19(a). Add “701400” to the second line of the first paragraph.
- Page 586 Article 701.19(c). Delete “701400” from the second line of the first paragraph.
- Page 586 Article 701.19. Add the following subparagraph to this Article:  
  
“(f) Removal of existing pavement markings and raised reflective pavement markers will be measured for payment according to Article 783.05.”
- Page 587 Article 701.20(b). Delete “TRAFFIC CONTROL AND PROTECTION 701400;” from the first paragraph.
- Page 588 Article 701.20. Add the following subparagraph to this Article.  
  
“(j) Removal of existing pavement markings and raised reflective pavement markers will be paid for according to Article 783.06.”
- Page 762 Article 1020.04. In Table 1 Classes of Portland Cement Concrete and Mix Design Criteria, add to the minimum cement factor for Class PC Concrete “5.65 (TY III)”, and add to the maximum cement factor for Class PC Concrete “7.05 (TY III)”.

- Page 765 Article 1020.04. In Table 1 Classes of Portland Cement Concrete and Mix Design Criteria (metric), add to the minimum cement factor for Class PC Concrete “335 (TY III)”, and add to the maximum cement factor for Class PC Concrete “418 (TY III)”.
- Page 809 Article 1030.05. Revise the subparagraph “(a) Quality Assurance by the Engineer.” to read “(e) Quality Assurance by the Engineer.”.
- Page 946 Article 1080.03(a)(1). In the third line of the first paragraph revise “(300 µm)” to “(600 µm)”.
- Page 963 Article 1083.02(b). In the second line of the first paragraph revise “ASTM D 4894” to “ASTM D 4895”.
- Page 1076 In the Index of Pay Items delete the pay item “BITUMINOUS SURFACE REMOVAL – BUTT JOINT”.
- Page 1081 In the Index of Pay Items add “Section 406, HOT-MIX ASPHALT SURFACE REMOVAL – BUTT JOINT, Page 207”.

**HOT-MIX ASPHALT EQUIPMENT, SPREADING AND FINISHING MACHINE (BDE)**

Effective: January 1, 2005

Revised: January 1, 2007

Revise the fourth paragraph of Article 1102.03 of the Standard Specifications to read:

“The paver shall be equipped with a receiving hopper having sufficient capacity for a uniform spreading operation. The hopper shall be equipped with a distribution system to uniformly place a non-segregated mixture in front of the screed. The distribution system shall have chain curtains, deflector plates, and /or other devices designed and built by the paver manufacturer to prevent segregation during distribution of the mixture from the hopper to the paver screed. The Contractor shall submit a written certification that the devices recommended by the paver manufacturer to prevent segregation have been installed and are operational. Prior to paving, the Contractor, in the presence of the Engineer, shall visually inspect paver parts specifically identified by the manufacturer for excessive wear and the need for replacement. The Contractor shall supply a completed check list to the Engineer noting the condition of the parts. Worn parts shall be replaced. The Engineer may require an additional inspection prior to placement of the surface course or at other times throughout the work.”

**PAYMENTS TO SUBCONTRACTORS (BDE)**

Effective: June 1, 2000

Revised: January 1, 2006

Federal regulations found at 49 CFR §26.29 mandate the Department to establish a contract clause to require Contractors to pay subcontractors for satisfactory performance of their subcontracts and to set the time for such payments.

State law also addresses the timing of payments to be made to subcontractors and material suppliers. Section 7 of the Prompt Payment Act, 30 ILCS 540/7, requires that when a Contractor receives any payment from the Department, the Contractor shall make corresponding, proportional payments to each subcontractor and material supplier performing work or supplying material within 15 calendar days after receipt of the Department payment. Section 7 of the Act further provides that interest in the amount of two percent per month, in addition to the payment due, shall be paid to any subcontractor or material supplier by the Contractor if the payment required by the Act is withheld or delayed without reasonable cause. The Act also provides that the time for payment required and the calculation of any interest due applies to transactions between subcontractors and lower-tier subcontractors and material suppliers throughout the contracting chain.

This Special Provision establishes the required federal contract clause, and adopts the 15 calendar day requirement of the State Prompt Payment Act for purposes of compliance with the federal regulation regarding payments to subcontractors. This contract is subject to the following payment obligations.

When progress payments are made to the Contractor according to Article 109.07 of the Standard Specifications, the Contractor shall make a corresponding payment to each subcontractor and material supplier in proportion to the work satisfactorily completed by each subcontractor and for the material supplied to perform any work of the contract. The proportionate amount of partial payment due to each subcontractor and material supplier throughout the contracting chain shall be determined by the quantities measured or otherwise determined as eligible for payment by the Department and included in the progress payment to the Contractor. Subcontractors and material suppliers shall be paid by the Contractor within 15 calendar days after the receipt of payment from the Department. The Contractor shall not hold retainage from the subcontractors. These obligations shall also apply to any payments made by subcontractors and material suppliers to their subcontractors and material suppliers; and to all payments made to lower tier subcontractors and material suppliers throughout the contracting chain. Any payment or portion of a payment subject to this provision may only be withheld from the subcontractor or material supplier to whom it is due for reasonable cause.

This Special Provision does not create any rights in favor of any subcontractor or material supplier against the State or authorize any cause of action against the State on account of any payment, nonpayment, delayed payment, or interest claimed by application of the State Prompt Payment Act. The Department will not approve any delay or postponement of the 15 day requirement except for reasonable cause shown after notice and hearing pursuant to Section 7(b) of the State Prompt Payment Act. State law creates other and additional remedies available to any subcontractor or material supplier, regardless of tier, who has not been paid for work properly performed or material furnished. These remedies are a lien against public funds set forth in Section 23(c) of the Mechanics Lien Act, 770 ILCS 60/23(c), and a recovery on the Contractor's payment bond according to the Public Construction Bond Act, 30 ILCS 550.

**RECLAIMED ASPHALT PAVEMENT (RAP) (BDE)**

Effective: January 1, 2007

Revised: January 2, 2007

In Article 1030.02(g), delete the last sentence of the first paragraph in (Note 2).



Revise Section 1031 of the Standard Specifications to read:

**“SECTION 1031. RECLAIMED ASPHALT PAVEMENT**

**1031.01 Description.** Reclaimed asphalt pavement (RAP) is reclaimed asphalt pavement resulting from cold milling or crushing of an existing dense graded hot-mix asphalt (HMA) pavement. The Contractor shall supply written documentation that the RAP originated from routes or airfields under federal, state, or local agency jurisdiction.

**1031.02 Stockpiles.** The Contractor shall construct individual, sealed RAP stockpiles meeting one of the following definitions. No additional RAP shall be added to the pile after the pile has been sealed. Stockpiles shall be sufficiently separated to prevent intermingling at the base. Stockpiles shall be identified by signs indicating the type as listed below (i.e. “Homogeneous Surface”).

Prior to milling, the Contractor shall request the District to provide verification of the quality of the RAP to clarify appropriate stockpile.

- (a) Homogeneous. Homogeneous RAP stockpiles shall consist of RAP from Class I, Superpave (High ESAL), HMA (High ESAL), or equivalent mixtures and represent: 1) the same aggregate quality, but shall be at least C quality; 2) the same type of crushed aggregate (either crushed natural aggregate, ACBF slag, or steel slag); 3) similar gradation; and 4) similar asphalt binder content. If approved by the Engineer, combined single pass surface/binder millings may be considered “homogenous” with a quality rating dictated by the lowest coarse aggregate quality present in the mixture.
- (b) Conglomerate 5/8. Conglomerate 5/8 RAP stockpiles shall consist of RAP from Class I, Superpave (High ESAL), HMA (High ESAL), or equivalent mixtures. The coarse aggregate in this RAP shall be crushed aggregate and may represent more than one aggregate type and/or quality but shall be at least C quality. This RAP may have an inconsistent gradation and/or asphalt binder content prior to processing. All conglomerate 5/8 RAP shall be processed prior to testing by crushing to where all RAP shall pass the 5/8 in. (16 mm) or smaller screen. Conglomerate 5/8 RAP stockpiles shall not contain steel slag or other expansive material as determined by the Department.
- (c) Conglomerate 3/8. Conglomerate 3/8 RAP stockpiles shall consist of RAP from Class I, Superpave (High ESAL), HMA (High ESAL), or equivalent mixtures. The coarse aggregate in this RAP shall be crushed aggregate and may represent more than one aggregate type and/or quality but shall be at least B quality. This RAP may have an inconsistent gradation and/or asphalt binder content prior to processing. All conglomerate 3/8 RAP shall be processed prior to testing by crushing to where all RAP shall pass the 3/8 in. (9.5 mm) or smaller screen. Conglomerate 3/8 RAP stockpiles shall not contain steel slag or other expansive material as determined by the Department.

- (d) Conglomerate “D” Quality (DQ). Conglomerate DQ RAP stockpiles shall consist of RAP from Class I, Superpave (High or Low ESAL), HMA (High or Low ESAL), or equivalent mixtures. The coarse aggregate in this RAP may be crushed or round but shall be at least D quality. This RAP may have an inconsistent gradation and/or asphalt binder content. Conglomerate DQ RAP stockpiles shall not contain steel slag or other expansive material as determined by the Department.
- (e) Non-Quality. RAP stockpiles that do not meet the requirements of the stockpile categories listed above shall be classified as “Non-Quality”.

RAP containing contaminants, such as earth, brick, sand, concrete, sheet asphalt, bituminous surface treatment (i.e. chip seal), pavement fabric, joint sealants, etc., will be unacceptable unless the contaminants are removed to the satisfaction of the Engineer. Sheet asphalt shall be stockpiled separately.

**1031.03 Testing.** When used in HMA, the RAP shall be sampled and tested either during or after stockpiling.

For testing during stockpiling, washed extraction samples shall be run at the minimum frequency of one sample per 500 tons (450 metric tons) for the first 2000 tons (1800 metric tons) and one sample per 2000 tons (1800 metric tons) thereafter. A minimum of five tests shall be required for stockpiles less than 4000 tons (3600 metric tons).

For testing after stockpiling, the Contractor shall submit a plan for approval to the District proposing a satisfactory method of sampling and testing the RAP pile either in-situ or by restocking. The sampling plan shall meet the minimum frequency required above and detail the procedure used to obtain representative samples throughout the pile for testing.

Before extraction, each field sample shall be split to obtain two samples of test sample size. One of the two test samples from the final split shall be labeled and stored for Department use. The Contractor shall extract the other test sample according to Department procedure. The Engineer reserves the right to test any sample (split or Department-taken) to verify Contractor test results.

- (a) Testing Conglomerate 3/8. In addition to the requirements above, conglomerate 3/8 RAP shall be tested for maximum theoretical specific gravity ( $G_{mm}$ ) at a frequency of one sample per 500 tons (450 metric tons) for the first 2000 tons (1800 metric tons) and one sample per 2000 tons (1800 metric tons) thereafter. A minimum of five tests shall be required for stockpiles less than 4000 tons (3600 metric tons).
- (b) Evaluation of Test Results. All of the extraction results shall be compiled and averaged for asphalt binder content and gradation and, when applicable  $G_{mm}$ . Individual extraction test results, when compared to the averages, will be accepted if within the tolerances listed below.

Parameter	Homogeneous / Conglomerate	Conglomerate "D" Quality
1 in. (25 mm)		± 5 %
1/2 in. (12.5 mm)	± 8 %	± 15 %
No. 4 (4.75 mm)	± 6 %	± 13 %
No. 8 (2.36 mm)	± 5 %	
No. 16 (1.18 mm)		± 15 %
No. 30 (600 μm)	± 5 %	
No. 200 (75 μm)	± 2.0 %	± 4.0 %
Asphalt Binder	± 0.4 % <sup>1/</sup>	± 0.5 %
G <sub>mm</sub>	± 0.02 % <sup>2/</sup>	

1/ The tolerance for conglomerate 3/8 shall be ± 0.3 %.

2/ Applies only to conglomerate 3/8. When variation of the G<sub>mm</sub> exceeds the ± 0.02 % tolerance, a new conglomerate 3/8 stockpile shall be created which will also require an additional mix design.

If more than 20 percent of the individual sieves are out of the gradation tolerances, or if more than 20 percent of the asphalt binder content test results fall outside the appropriate tolerances, the RAP shall not be used in HMA unless the RAP representing the failing tests is removed from the stockpile. All test data and acceptance ranges shall be sent to the District for evaluation.

With the approval of the Engineer, the ignition oven may be substituted for extractions according to the Illinois Test Procedure, "Calibration of the Ignition Oven for the Purpose of Characterizing Reclaimed Asphalt Pavement (RAP)".

**1031.04 Quality Designation of Aggregate in RAP.** The quality of the RAP shall be set by the lowest quality of coarse aggregate in the RAP stockpile and are designated as follows.

- (a) RAP from Class I, Superpave (High ESAL), or HMA (High ESAL) surface mixtures are designated as containing Class B quality coarse aggregate.
- (b) RAP from Superpave (Low ESAL)/HMA (Low ESAL) IL-19.0L binder and IL-9.5L surface mixtures are designated as Class D quality coarse aggregate.
- (c) RAP from Class I, Superpave (High ESAL), or HMA (High ESAL) binder mixtures, bituminous base course mixtures, and bituminous base course widening mixtures are designated as containing Class C quality coarse aggregate.
- (d) RAP from bituminous stabilized subbase and BAM shoulders are designated as containing Class D quality coarse aggregate.

**1031.05 Use of RAP in HMA.** The use of RAP in HMA shall be as follows.

- (a) Coarse Aggregate Size. The coarse aggregate in all RAP shall be equal to or less than the nominal maximum size requirement for the HMA mixture to be produced.
- (b) Steel Slag Stockpiles. RAP stockpiles containing steel slag or other expansive material, as determined by the Department, shall be homogeneous and will be approved for use in HMA (High ESAL and Low ESAL) surface mixtures only.
- (c) Use in HMA Surface Mixtures (High and Low ESAL). RAP stockpiles for use in HMA surface mixtures (High and Low ESAL) shall be either homogeneous or conglomerate 3/8, in which the coarse aggregate is Class B quality or better.
- (d) Use in HMA Binder Mixtures (High and Low ESAL), HMA Base Course, and HMA Base Course Widening. RAP stockpiles for use in HMA binder mixtures (High and Low ESAL), HMA base course, and HMA base course widening shall be homogeneous, conglomerate 5/8, or conglomerate 3/8, in which the coarse aggregate is Class C quality or better.
- (e) Use in Shoulders and Subbase. RAP stockpiles for use in HMA shoulders and stabilized subbase (HMA) shall be homogeneous, conglomerate 5/8, conglomerate 3/8, or conglomerate DQ.
- (f) The use of RAP shall be a contractor's option when constructing HMA in all contracts. When the contractor chooses the RAP option, the percentage of RAP shall not exceed the amounts indicated in the table for a given N Design.

Max RAP Percentage

SUPERPAVE MIXTURES <sup>1/, 3/</sup>	MAXIMUM % RAP			
	Ndesign	Binder/Leveling Binder	Surface	Polymer Modified
30	30	30	10	10
50	25	15	10	10
70	15 / 25 <sup>2/</sup>	10 / 15 <sup>2/</sup>	10	10
90	10	10	10	10
105	10	10	10	10

Note 1: For HMA Shoulder and Stabilized Sub-Base (HMA) N-30, the amount of RAP shall not exceed 50% of the mixture.

Note 2: Value of Max % RAP if 3/8 RAP is utilized.

Note 3: When RAP exceeds 20%, the high & low virgin asphalt binder grades shall each be reduced by one grade (i.e. 25% RAP would require a virgin asphalt binder grade of PG64-22 to be reduced to a PG58-28).

**1031.06 HMA Mix Designs.** At the Contractor's option, HMA mixtures may be constructed utilizing RAP material meeting the above detailed requirements.

RAP designs shall be submitted for volumetric verification. If additional RAP stockpiles are tested and found that no more than 20 percent of the results, as defined under "Testing" herein, are outside of the control tolerances set for the original RAP stockpile and HMA mix design, and meets all of the requirements herein, the additional RAP stockpiles may be used in the original mix design at the percent previously verified.

**1031.07 HMA Production.** The coarse aggregate in all RAP used shall be equal to or less than the nominal maximum size requirement for the HMA mixture being produced.

To remove or reduce agglomerated material, a scalping screen, crushing unit, or comparable sizing device approved by the Engineer shall be used in the RAP feed system to remove or reduce oversized material. If material passing the sizing device adversely affects the mix production or quality of the mix, the sizing device shall be set at a size specified by the Engineer.

If the RAP control tolerances or QC/QA test results require corrective action, the Contractor shall cease production of the mixture containing RAP and either switch to the virgin aggregate design or submit a new RAP design. When producing mixtures containing conglomerate 3/8 RAP, a positive dust control system shall be utilized.

HMA plants utilizing RAP shall be capable of automatically recording and printing the mixture proportions and asphalt binder content. The asphalt binder content as a percentage of the total mix shall be printed as well as the individual percentages of virgin asphalt binder and residual asphalt binder from the RAP.

**1031.08 RAP in Aggregate Surface Course and Aggregate Shoulders.** The use of RAP in aggregate surface course and aggregate shoulders shall be as follows.

- (a) Stockpiles and Testing. RAP stockpiles may be any of those listed in Article 1031.02, except "Other". The testing requirements of Article 1031.03 shall not apply.
- (b) Gradation. One hundred percent of the RAP material shall pass the 1 1/2 in. (37.5 mm) sieve. The RAP material shall be reasonably well graded from coarse to fine. RAP material that is gap-graded or single sized will not be accepted."

## **SUBCONTRACTOR MOBILIZATION PAYMENTS (BDE)**

Effective: April 2, 2005

To account for the preparatory work and operations necessary for the movement of subcontractor personnel, equipment, supplies, and incidentals to the project site and for all other work or operations that must be performed or costs incurred when beginning work approved for subcontracting in accordance with Article 108.01 of the Standard Specifications, the Contractor shall make a mobilization payment to each subcontractor.

This mobilization payment shall be made at least 14 days prior to the subcontractor starting work. The amount paid shall be equal to 3 percent of the amount of the subcontract reported on form BC 260A submitted for the approval of the subcontractor's work.

This provision shall be incorporated directly or by reference into each subcontract approved by the Department.

**THERMOPLASTIC PAVEMENT MARKINGS (BDE)**

Effective: January 1, 2007

Revise Article 1095.01(a)(2) of the Standard Specifications to read:

“(2) Pigment. The pigment used for the white thermoplastic compound shall be a high-grade pure (minimum 93 percent) titanium dioxide (TiO<sub>2</sub>). The white pigment content shall be a minimum of ten percent by weight and shall be uniformly distributed throughout the thermoplastic compound.

The pigments used for the yellow thermoplastic compound shall not contain any hazardous materials listed in the Environmental Protection Agency Code of Federal Regulations (CFR) 40, Section 261.24, Table 1. The combined total of RCRA listed heavy metals shall not exceed 100 ppm when tested by X-ray fluorescence spectroscopy. The pigments shall also be heat resistant, UV stable and color-fast yellows, golds, and oranges, which shall produce a compound which shall match Federal Standard 595 Color No. 33538. The pigment shall be uniformly distributed throughout the thermoplastic compound.”

Revise Article 1095.01(b)(1)e. of the Standard Specifications to read:

“e. Daylight Reflectance and Color. The thermoplastic compound after heating for four hours ± five minutes at 425 ± 3 °F (218.3 ± 2 °C) and cooled at 77 °F (25 °C) shall meet the following requirements for daylight reflectance and color, when tested, using a color spectrophotometer with 45 degree circumferential/zero degree geometry, illuminant C, and two degree observer angle. The color instrument shall measure the visible spectrum from 380 to 720 nm with a wavelength measurement interval and spectral bandpass of 10 nm.

White: Daylight Reflectance .....75 percent min.

\*Yellow: Daylight Reflectance .....45 percent min.

\*Shall meet the coordinates of the following color tolerance chart.

x	0.490	0.475	0.485	0.530
y	0.470	0.438	0.425	0.456”

Revise Article 1095.01(b)(1)k. of the Standard Specifications to read:

“k. Accelerated Weathering. After heating the thermoplastic for four hours ± five minutes at 425 ± 3 °F (218.3 ± 2 °C) the thermoplastic shall be applied to a steel wool abraded aluminum alloy panel (Federal Test Std. No. 141, Method 2013) at a film thickness of 30 mils (0.70 mm) and allowed to cool for 24 hours at room

temperature. The coated panel shall be subjected to accelerated weathering using the light and water exposure apparatus (fluorescent UV - condensation type) for 75 hours according to ASTM G 53 (equipped with UVB-313 lamps).

The cycle shall consist of four hours UV exposure at 122 °F (50 °C) followed by four hours of condensation at 104 °F (40 °C). UVB 313 bulbs shall be used. At the end of the exposure period, the panel shall not exceed 10 Hunter Lab Delta E units from the original material.”

**WORKING DAYS (BDE)**

Effective: January 1, 2002

The Contractor shall complete the work within 15 working days.

Illinois Department of Transportation

**PROJECT LABOR AGREEMENT**

This Project Labor Agreement ("PLA") is entered into this \_\_\_\_\_ day of \_\_\_\_\_, 2007, by and between the Illinois Department of Transportation ("IDOT" or "Department") in its proprietary capacity, and each relevant Illinois AFL-CIO Building Trades Council made signatory hereto by the Illinois AFL-CIO Statewide Project Labor Agreement Committee on behalf of itself and each of its affiliated members (individually and collectively, the "Union"). This PLA shall apply to Construction Work (as defined herein) to be performed by IDOT's Prime Contractor and each of its relevant subcontractors of whatever tier ("Subcontractor" or "Subcontractors") on Contract 64C55 (hereinafter, the "Project").

**ARTICLE 1 - INTENT AND PURPOSES**

- 1.1. This PLA is entered into in furtherance of Illinois Executive Order No. 2003-13. It is mutually understood and agreed that the terms and conditions of this PLA are intended to promote the public interest in obtaining timely and economical completion of the Project by encouraging productive and efficient construction operations; by establishing a spirit of harmony and cooperation among the parties; and by providing for peaceful and prompt settlement of any and all labor grievances or jurisdictional disputes of any kind without strikes, lockouts, slowdowns, delays or other disruptions to the prosecution of the work.
- 1.2. As a condition of the award of the contract for performance of work on the Project, IDOT's Prime Contractor and each of its Subcontractors shall be required to sign a "Contractor Letter of Assent", in the form attached hereto as Exhibit A, prior to commencing Construction Work on the Project. Each Union affiliate and separate local representing workers engaged in Construction Work on the Project in accordance with this PLA are bound to this agreement by the Illinois AFL-CIO Statewide Project Labor Agreement Committee which is the central committee established with full authority to negotiate and sign PLAs with the State on behalf of all respective crafts. Upon their signing the Letter of Assent, the Prime Contractor, each Subcontractor, and the individual Unions shall thereafter be deemed a party to this PLA. No party signatory to this PLA shall, contract or subcontract, nor permit any other person, firm, company or entity to contract or subcontract for the performance of Construction Work for the Project to any person, firm, company or entity that does not agree in writing to become bound by the terms of this PLA prior to commencing such work.
- 1.3. It is understood that the Prime Contractor(s) and each Subcontractor will be considered and accepted by the Unions as separate employers for the purposes of collective bargaining, and it is further agreed that the employees working under this PLA shall constitute a bargaining unit separate and distinct from all others. The Parties hereto also agree that this PLA shall be applicable solely with respect to this Project, and shall have no bearing on the interpretation of any other collective bargaining agreement or as to the recognition of any bargaining unit other than for the specific purposes of this Project.



- 1.4. In the event of a variance or conflict, whether explicit or implicit, between the terms and conditions of this PLA and the provisions of any other applicable national, area, or local collective bargaining agreement, the terms and conditions of this PLA shall supercede and control. For any work performed under the NTL Articles of Agreement, the National Stack/Chimney Agreement, the National Cooling Tower Agreement, the National Agreement of the International Union of Elevator Constructors, and for any instrument calibration work and loop checking performed under the UA/IBEW Joint National Agreement for Instrument and Control Systems Technicians, the preceding sentence shall apply only with respect to Articles I, II, V, VI, and VII.
- 1.5. Subject to the provisions of paragraph 1.4 of this Article, it is the parties' intent to respect the provisions of any other collective bargaining agreements that may now or hereafter pertain, whether between the Prime Contractor and one or more of the Unions or between a Subcontractor and one or more of the Unions. Accordingly, except and to the extent of any contrary provision set forth in this PLA, the Prime Contractor and each of its Subcontractors agrees to be bound and abide by the terms of the following in order of precedence: (a) the applicable collective bargaining agreement between the Prime Contractor and one or more of the Unions made signatory hereto; (b) the applicable collective bargaining agreement between a Subcontractor and one or more of the Unions made signatory hereto; or (c) the current applicable area collective bargaining agreement for the relevant Union that is the agreement certified by the Illinois Department of Labor for purposes of establishing the Prevailing Wage applicable to the Project. The Union will provide copies of the applicable collective bargaining agreements pursuant to part (c) of the preceding sentence to the Prime Contractor. Assignments by the Contractors amongst the trades shall be consistent with area practices; in the event of unresolved disagreements as to the propriety of such assignments, the provisions of Article VI shall apply.
- 1.6. Subject to the limitations of paragraphs 1.4 and 1.5 of this Article, the terms of each applicable collective bargaining agreement as determined in accordance with paragraph 1.5 are incorporated herein by reference, and the terms of this PLA shall be deemed incorporated into such other applicable collective bargaining agreements only for purposes of their application to the Project.
- 1.7. To the extent necessary to comply with the requirements of any fringe benefit fund to which the Prime Contractor or Subcontractor is required to contribute under the terms of an applicable collective bargaining agreement pursuant to the preceding paragraph, the Prime Contractor or Subcontractor shall execute all "Participation Agreements" as may be reasonably required by the Union to accomplish such purpose; provided, however, that such Participation Agreements shall, when applicable to the Prime Contractor or Subcontractor solely as a result of this PLA, be amended as reasonably necessary to reflect such fact. Upon written notice from any applicable fringe benefit fund, IDOT will withhold from the Prime Contractor payment of any delinquencies arising from this Project.

- 1.8. In the event that the applicable collective bargaining agreement between a Prime Contractor and the Union or between the Subcontractor and the Union expires prior to the completion of this Project, the expired applicable contract's terms will be maintained until a new applicable collective bargaining agreement is ratified. The wages and fringe benefits included in any new applicable collective bargaining agreement will apply on and after the effective date of the newly negotiated collective bargaining agreement, except to the extent wage and fringe benefit retroactivity is specifically agreed upon by the relevant bargaining parties.

## **ARTICLE II – APPLICABILITY, RECOGNITION, AND COMMITMENTS**

- 2.1 The term Construction Work as used herein shall include all “construction, prosecution, completion, or repair” work performed by a “laborer or mechanic” at the “site of the work” for the purpose of “building” the specific structures and improvements that constitute the Project. Terms appearing within quotation marks in the preceding sentence shall have the meaning ascribed to them pursuant to 29 CFR Part 5.
- 2.2 By executing the Letters of Assent, Prime Contractor and each of its Subcontractors recognizes the Unions signatory to this PLA as the sole and exclusive bargaining representatives for their craft employees employed on the jobsite for this Project. Unions who are signatory to this PLA will have recognition on the Project for their craft.
- 2.3 The Prime Contractor and each of its Subcontractors retains and shall be permitted to exercise full and exclusive authority and responsibility for the management of its operations, except as expressly limited by the terms of this PLA or by the terms and conditions of the applicable collective bargaining agreement.
- 2.4 Except to the extent contrary to an express provision of the relevant collective bargaining agreement, equipment or materials used in the Project may be pre-assembled or pre-fabricated, and there shall be no refusal by the Union to handle, transport, install, or connect such equipment or materials. Equipment or materials delivered to the job-site will be unloaded and handled promptly without regard to potential jurisdictional disputes; any such disputes shall be handled in accordance with the provisions of this PLA.
- 2.5 Unions commit to furnishing qualified and skilled craft persons as required by the Prime Contractor and its Subcontractors in fulfillment of their obligations to complete the Project. In order to promote the long-term development of a skilled and knowledgeable work force, the parties are encouraged to utilize apprentices to the maximum extent permitted by the applicable collective bargaining agreement.
- 2.6 The parties are mutually committed to promoting a safe working environment for all personnel at the job site. It shall be the responsibility of each employer to which this PLA applies to provide and maintain safe working conditions for its employees, and to comply with all applicable federal, state, and local health and safety laws and regulations.

- 2.7 The use or furnishing of alcohol or drugs and the conduct of any other illegal activity at the job-site is strictly prohibited. The parties shall take every practical measure consistent with the terms of applicable collective bargaining agreements to ensure that the job-site is free of alcohol and drugs.
- 2.8 All parties to this PLA agree that they shall not discriminate against any employee based on race, creed, color, national origin, union activity, age, or gender as required by all applicable federal, state, and local laws.
- 2.9 The Parties hereto agree that engineering consultants and materials testing employees, to the extent subject to the terms of this PLA, shall be fully expected to objectively and responsibly perform their duties and obligations owed to the Department without regard to the potential union affiliation of such employees or of other employees on the Project.

### **ARTICLE III - ADMINISTRATION OF AGREEMENT**

- 3.1 In order to assure that all parties have a clear understanding of the PLA and to promote harmony, a post-award pre-job conference will be held among the Prime Contractor, all Subcontractors and Union representatives prior to the start of any Construction Work on the Project. No later than the conclusion of such pre-job conference, the parties shall, among other matters, provide to one another contact information for their respective representatives (including name, address, phone number, facsimile number, e-mail). Nothing herein shall be construed to limit the right of the Department to discuss or explain the purpose and intent of this PLA with prospective bidders or other interested parties prior to or following its award of the job.
- 3.2 Representatives of the Prime Contractor and the Unions shall meet as often as reasonably necessary following award until completion of the Project to assure the effective implementation of this PLA.
- 3.3 Not less than once per month, Prime Contractor and all Subcontractors shall make available in writing to the Unions a Project status report that shall include, though not necessarily be limited to, planned activities for the next 30 day period and estimated numbers of employees by craft required for the next 30 day period. The purpose of this Project status report is to promote effective workforce planning and to facilitate resolution of any potential jurisdictional or other problems.
- 3.4 Not later than the earlier of (a) five business days following the pre-job conference, or (b) commencement of Construction Work, the Unions and Prime Contractor (on behalf of itself and all its subcontractors of whatever tier) shall confer and jointly designate a slate of three (3) permanent arbitrators (each a "Permanent Arbitrator") for the purpose of hearing disputes pursuant to Articles V and VII of this PLA. The slate of Permanent Arbitrators shall be selected from among the following individuals: Jack P. Cerone, Thomas F. Gibbons, Thomas G. Pagan, Robert Perkovich, Byron Yaffee, and Glenn A. Zipp. In the event that the Unions and Prime Contractor are not able to agree on a full

slate of three Permanent Arbitrators, the Department, after consultation with the Unions and Prime Contractor, shall designate such additional Permanent Arbitrators as may be necessary to establish the full slate. A single Permanent Arbitrator shall be selected from the slate of three on a rotating basis to adjudicate each arbitrable matter as it arises. In the event a Permanent Arbitrator is not available to adjudicate a particular matter in the order of rotation, the arbitration assignment shall pass to the next available Permanent Arbitrator.

#### **ARTICLE IV - HOURS OF WORK AND GENERAL CONDITIONS**

- 4.1 The standard work day for Construction Work on the Project shall be an established consecutive eight (8) hour period between the hours of 7:00 a.m. and 5:00 p.m. with one-half hour designated as unpaid period for lunch. The standard work week shall be five (5) consecutive days of work commencing on Monday. Starting time shall be established at the pre-job conference, and shall be applicable to all craft employees on the Project unless otherwise expressly agreed in writing. In the event Project site or other job conditions dictate a change in the established starting time and/or a staggered lunch period for portions of the Project or for specific crafts, the Prime Contractor, relevant Subcontractors and business managers of the specific crafts involved shall confer and mutually agree to such changes as appropriate. If proposed work schedule changes cannot be mutually agreed upon between the parties, the hours fixed at the time of the pre-job meeting shall prevail.
- 4.2 Shift work may be established and directed by the Prime Contractor or relevant Subcontractor as reasonably necessary or appropriate to fulfill the terms of its contract with the Department. If used, shift hours, rates and conditions shall be as provided in the applicable collective bargaining agreement.
- 4.3 The parties agree that chronic and/or unexcused absenteeism is undesirable and must be controlled in accordance with procedures established by the applicable collective bargaining agreement. Any employee disciplined for absenteeism in accordance with such procedures shall be suspended from all work on the Project for not less than the maximum period permitted under the applicable collective bargaining agreement.
- 4.4 Except as may be otherwise expressly provided by the applicable collective bargaining agreement, employment begins and ends at the Project site; employees shall be at their place of work at the starting time; and employees shall remain at their place of work until quitting time.
- 4.5 Except as may be otherwise expressly provided by the applicable collective bargaining agreement, there shall be no limit on production by workmen, no restrictions on the full use of tools or equipment, and no restrictions on efficient use of manpower or techniques of construction other than as may be required by safety regulations.

- 4.6 The parties recognize that specialized or unusual equipment may be installed on the Project. In such cases, the Union recognizes the right of the Prime Contractor or Subcontractor to involve the equipment supplier or vendor's personnel in supervising the setting up of the equipment, making modifications and final alignment, and performing similar activities that may be reasonably necessary prior to and during the start-up procedure in order to protect factory warranties. The Prime Contractor or Subcontractor shall notify the Union representatives in advance of any work at the job-site by such vendor personnel in order to promote a harmonious relationship between the equipment vendor's personnel and other Project employees.
- 4.7 For the purpose of promoting full and effective implementation of this PLA, authorized Union representatives shall have access to the Project job-site during scheduled work hours. Such access shall be conditioned upon adherence to all reasonable visitor and security rules of general applicability that may be established for the Project site at the pre-job conference or from time to time thereafter.

#### **ARTICLE V - GRIEVANCE AND ARBITRATION PROCEDURES**

- 5.1 Except as provided in Articles VI or VII, it is specifically agreed among the parties that any grievance or dispute arising out of the interpretation or application of this PLA shall be settled by means of the expedited arbitration process set forth in Paragraph 5.2 below. No such grievance or dispute shall be recognized unless called to the attention of the Prime Contractor and relevant Subcontractor by the Union or to the Union by the Prime Contractor or relevant Subcontractor within five (5) working days after the alleged violation was committed or discovered by the grieving party.
- 5.2 Grievances shall be settled according to the following procedure:
- 5.2.A. Step 1. The dispute shall be referred to the Steward of the craft union involved and a representative of the Prime Contractor and relevant Subcontractor at the job-site.
- 5.2.B. Step 2. In the event that the Steward and the contractors' representatives at the job-site cannot reach agreement within two (2) working days after a meeting is arranged and held, the matter shall be referred to the Union Business Manager and to executive representatives of the Prime Contractor and relevant Subcontractor.
- 5.2.C. Step 3. In the event the dispute is not resolved within five (5) working days after completion of Step 2, the relevant parties shall request a Permanent Arbitrator as determined in accordance with paragraph 3.4 of this PLA, who shall, within ten (10) working days, hear the grievance and make a written decision. Such decisions shall be final and binding on all parties. The parties shall each pay the expense of their own representative. The expense of the Permanent Arbitrator shall be divided equally between (1) the Prime Contractor and/or relevant Subcontractor, and (2) the involved Union.

- 5.3 Any failure of a party to comply fully with such final and binding decision of the Permanent Arbitrator may result in removal of the non-complying party from the site, in a holdback from the Prime Contractor or Subcontractor of any amounts awarded, or in such other relief as the Department may reasonably determine is necessary to promote final resolution of the dispute.
- 5.4 In the event any dispute or grievance should arise, the parties expressly agree that it shall be resolved without occurrence of any strike, work stoppage, slow-down or other prohibited activities as provided in Article VII of this PLA. Individuals or parties violating this section shall be subject to immediate discharge or other discipline.

#### ARTICLE VI - JURISDICTIONAL DISPUTES

- 6.1 As used in this Agreement, the term "jurisdictional dispute" shall be defined as any dispute, difference or disagreement involving the assignment of particular work to one class or craft of employees rather than to a different class or craft of employees, regardless of that Contractor's contractual relationship to any other employer, contractor, or organization on the site.
- 6.2 It is agreed by and between the parties to this Agreement that any and all jurisdictional disputes shall be resolved in the following manner; each of the steps hereinafter listed shall be initiated by the parties in sequence as set forth:
- (a) Negotiation by and between the Local Business Representative of the disputing Union and Employer shall take place within two (2) business days. Business days are defined as Monday through Friday excluding contract holidays. Such negotiations shall be pursued until it is apparent that the dispute cannot be resolved at the local level.
  - (b) The International Representatives of the disputing Union shall meet or confer and attempt to resolve said dispute. This meeting shall take place within two (2) business days. Business days are defined as Monday through Friday excluding contract holidays.
  - (c) The parties to the Jurisdictional Dispute shall submit the dispute directly to an Arbitrator after complying with paragraph (2b) above. The parties shall meet with the Arbitrator within three (3) business days. Business days are defined as Monday through Friday excluding contract holidays. An Arbitrator will be selected based on availability from the slate of permanent Arbitrators. The Arbitrator's bench decision will be given the day of the hearing and will be final and legally binding on this project only. The Arbitrator's bench decision will be implemented without delay. The cost of Arbitration will be shared equally by the disputing parties. Any party to the dispute can require that a "long form" written decision be provided from the Arbitrator, however the cost of the "long form" written decision will be the responsibility of the party making the request.

Notes:

- A jurisdictional dispute may be submitted based upon a pre-job assignment.
  - If any party to the jurisdictional disputes does not fully comply with the steps and time limits with each step, then the party in non-compliance will lose by “automatic default”.
  - Time limits at any step can be extended if all parties to the jurisdictional dispute mutually agree in writing.
  - All parties to a jurisdictional dispute can mutually agree to waive the time limits in steps (a) and (b) and proceed directly to an expedited arbitration hearing.
- (d) In rendering his decision, the Arbitrator shall determine:
- (1) First whether a previous agreement of record or applicable agreement, including a disclaimer agreement, between the National or International Unions to the dispute governs;
  - (2) Only if the Arbitrator finds that the dispute is not covered by an appropriate or applicable agreement of record or agreement between the crafts to the dispute, he shall then consider whether there is a previous decision of record governing the case;
  - (3) If the Arbitrator finds that a previous decision of record governs the case, the Arbitrator shall apply the decision of record in rendering his decision except under the following circumstances. After notice to the other parties to the dispute prior to the hearing that it intends to challenge the decision of record, if a trade challenging the decision of record is able to demonstrate that the recognized and established prevailing practice in the locality of the work has been contrary to the applicable decision of record, and that historically in that locality the work in dispute has not been performed by the other craft or crafts, the Arbitrator may rely on such prevailing practice rather than the decision of record. If the craft relying on the decision of record demonstrates that it has performed the work in dispute in the locality of the job, then the Arbitrator shall apply the decision of record in rendering his decision. If the Arbitrator finds that a craft has improperly obtained the prevailing practice in the locality through raiding, the undercutting of wagers or by the use of vertical agreements, the Arbitrator shall rely on the decision of record rather than the prevailing practice in the locality.
  - (4) If no decision of record is applicable, the Arbitrator shall then consider the established trade practice in the industry and prevailing practice in the locality; and

- (5) Only if none of the above criteria is found to exist, the Arbitrator shall then consider that because efficiency, cost or continuity and good management are essential to the well being of the industry, the interest of the consumer or the past practice of the employer shall not be ignored.

The Arbitrator shall set forth the basis for his decision and shall explain his findings regarding the applicability of the above criteria. If lower-ranked criteria are relied upon, the Arbitrator shall explain why the higher-ranked criteria were not deemed applicable. The Arbitrator's decision shall only apply to the job in dispute.

- (6) Agreements of record are applicable only to the party's signatory to such agreements. Decision of record are applicable to all trades.
- (7) The Arbitrator is not authorized to award back pay or any other damages for a mis-assignment of work. Nor may any party bring an independent action for back pay or any other damages, based upon a decision of an Arbitrator.

6.3 The signatory parties to this Agreement agree that jurisdictional disputes cannot and shall not interfere with the efficient and continuous operations required for the successful application of this Agreement. In the event a dispute arises, the Contractor's assignment shall be followed until the dispute is resolved.

6.4 Equipment or material delivered to the job site will be unloaded promptly without regard to jurisdictional disputes which will be handled as per the provisions of this Agreement. The Contractor will supply the Union with delivery schedules, allowing as much time as possible to insure the appropriate crafts will be available to unload the materials or equipment.

6.5 All signatory affiliates agree that upon request, a representative shall be assigned without delay to attempt a settlement in the event of a question on assignments.

## **ARTICLE VII - WORK STOPPAGES AND LOCKOUTS**

7.1 During the term of this PLA, no Union or any of its members, officers, stewards, employees, agents or representatives shall instigate, support, sanction, maintain, or participate in any strike, picketing, walkout, work stoppage, slow down or other activity that interferes with the routine and timely prosecution of work at the Project site or at any other contractor's or supplier's facility that is necessary to performance of work at the Project site. Hand billing at the Project site during the designated lunch period and before commencement or following conclusion of the established standard workday shall not, in itself, be deemed an activity that interferes with the routine and timely prosecution of work on the Project.



- 7.2 Should any activity prohibited by paragraph 7.1 of this Article occur, the Union shall undertake all steps reasonably necessary to promptly end such prohibited activities. No Union complying with its obligations under this Article shall be liable for acts of employees for which it has no responsibility or for the unauthorized acts of employees it represents. Any employee who participates in or encourages any activity prohibited by paragraph 7.1 shall be immediately suspended from all work on the Project for a period equal to the greater of (a) 60 days; or (b) the maximum disciplinary period allowed under the applicable collective bargaining agreement for engaging in comparable unauthorized or prohibited activity.
- 7.3 During the term of this PLA, the Prime Contractor and its Subcontractors shall not engage in any lockout at the Project site of employees covered by this Agreement.
- 7.4 Upon notification of violations of this Article, the principal officer or officers of the local area Building and Construction Trades Council, and the Illinois AFL-CIO Statewide Project Labor Agreement Committee as appropriate, will immediately instruct, order and use their best efforts to cause the affiliated union or unions to cease any violations of this Article. A Trades Council and the Committee otherwise in compliance with the obligations under this paragraph shall not be liable for unauthorized acts of its affiliates.
- 7.5 In the event that activities in violation of this Article are not immediately halted through the efforts of the parties, any aggrieved party may invoke the special arbitration provisions set forth in paragraph 7.6 of this Article.
- 7.6 Upon written notice to the other involved parties by the most expeditious means available, any aggrieved party may institute the following special arbitration procedure when a breach of this Article is alleged:
- 7.6.A The party invoking this procedure shall notify the individual designated as the Permanent Arbitrator pursuant to Article III of the nature of the alleged violation; such notice shall be by the most expeditious means possible. The initiating party may also furnish such additional factual information as may be reasonably necessary for the Permanent Arbitrator to understand the relevant circumstances. Copies of any written materials provided to the arbitrator shall also be contemporaneously provided by the most expeditious means possible to the party alleged to be in violation and to all other involved parties.
- 7.6.B Upon receipt of said notice the Permanent Arbitrator shall set and hold a hearing within twenty-four (24) hours if it is contended the violation is ongoing, but not before twenty-four (24) hours after the written notice to all parties involved as required above.
- 7.6.C The Permanent Arbitrator shall notify the parties by facsimile or any other effective written means, of the place and time chosen by the Permanent Arbitrator for this hearing. Said hearing shall be completed in one session. A failure of any party or parties to attend said hearing shall not delay the hearing of evidence or issuance of an Award by the Permanent Arbitrator.

7.6.D The sole issue at the hearing shall be whether a violation of this Article has, in fact, occurred. An Award shall be issued in writing within three (3) hours after the close of the hearing, and may be issued without a written opinion. If any party desires a written opinion, one shall be issued within fifteen (15) days, but its issuance shall not delay compliance with, or enforcement of, the Award. The Permanent Arbitrator may order cessation of the violation of this Article, and such Award shall be served on all parties by hand or registered mail upon issuance.

7.6.E Such Award may be enforced by any court of competent jurisdiction upon the filing of the Award and such other relevant documents as may be required. Facsimile or other hardcopy written notice of the filing of such enforcement proceedings shall be given to the other relevant parties. In a proceeding to obtain a temporary order enforcing the Permanent Arbitrator's Award as issued under this Article, all parties waive the right to a hearing and agree that such proceedings may be *ex parte*. Such agreement does not waive any party's right to participate in a hearing for a final order of enforcement. The Court's order or orders enforcing the Permanent Arbitrator's Award shall be served on all parties by hand or by delivery to their last known address or by registered mail.

7.7 Individuals found to have violated the provisions of this Article are subject to immediate termination. In addition, IDOT reserves the right to terminate this PLA as to any party found to have violated the provisions of this Article.

7.8 Any rights created by statute or law governing arbitration proceedings inconsistent with the above procedure or which interfere with compliance therewith are hereby waived by parties to whom they accrue.

7.9 The fees and expenses of the Permanent Arbitrator shall be borne by the party or parties found in violation, or in the event no violation is found, such fees and expenses shall be borne by the moving party.

#### **ARTICLE VIII – MISCELLANEOUS**

8.1 If any Article or provision of this PLA shall be declared invalid, inoperative or unenforceable by operation of law or by final non-appealable order of any tribunal of competent jurisdiction, such provision shall be deemed severed or limited, but only to the extent required to render the remaining provisions of this PLA enforceable consistent with the intent of the parties. The remainder of this PLA or the application of such Article or provision to persons or circumstances other than those as to which it has been held invalid, inoperative or unenforceable shall not be affected thereby.

8.2 The term of this PLA shall commence as of and from the date of the notice of award to the Prime Contractor and shall end upon final acceptance by IDOT of all work on the Project by the parties hereto.

- 8.3 This PLA may not be changed or modified except by the subsequent written agreement of the parties. All parties represent that they have the full legal authority to enter into this PLA. This PLA may be executed by the parties in one or more counterparts.
- 8.4 Any liability arising out of this PLA shall be several and not joint. IDOT shall not be liable to any person or other party for any violation of this PLA by any other party, and no Contractor or Union shall be liable for any violation of this PLA by any other Contractor or Union.
- 8.5 The failure or refusal of a party to exercise its rights hereunder in one or more instances shall not be deemed a waiver of any such rights in respect of a separate instance of the same or similar nature.

[The Balance of This Page Intentionally Left Blank]

**Execution Page**

**Illinois Department of Transportation**

\_\_\_\_\_  
Milton R. Sees, Director of Highways

\_\_\_\_\_  
Ann Schneider, Director Finance & Administration

\_\_\_\_\_  
Ellen Schanzle-Haskins, Chief Counsel

\_\_\_\_\_  
Timothy Martin, Secretary

\_\_\_\_\_  
(Date)

**Illinois AFL-CIO Statewide Project Labor Agreement Committee,  
representing the local unions listed below:**

\_\_\_\_\_  
\_\_\_\_\_

(Date)

**List Union Locals:**

Exhibit A – Contractor Letter of Assent

\_\_\_\_\_  
(Date)

To All Parties:

In accordance with the terms and conditions of the contract for Construction Work on [ ], this Letter of Assent hereby confirms that the undersigned Prime Contractor or Subcontractor agrees to be bound by the terms and conditions of the Project Labor Agreement established and entered into by the Illinois Department of Transportation in connection with said Project.

It is the understanding and intent of the undersigned party that this Project Labor Agreement shall pertain only to the identified Project. In the event it is necessary for the undersigned party to become signatory to a collective bargaining agreement to which it is not otherwise a party in order that it may lawfully make certain required contributions to applicable fringe benefit funds, the undersigned party hereby expressly conditions its acceptance of and limits its participation in such collective bargaining agreement to its work on the Project.

\_\_\_\_\_  
(Authorized Company Officer)

\_\_\_\_\_  
(Company)

C-92-143-06  
D-92-098-06

STATE OF ILLINOIS  
DEPARTMENT OF TRANSPORTATION  
PLANS FOR PROPOSED ROADWORK

FAP 301 (US 20/IL 84)  
D2 MRS 2007-7  
JoDavies County

R1W

**INDEX OF SHEETS**

- 1. Cover Sheet
- Index of Sheets
- 2-3 Summary of Quantities
- 4-5 General Notes
- 6-8 Typical Sections
- 9. Plan Sheet
- 10-14 Schedule of Work
- 15-16 District Standard (41.1)

**STANDARDS**

- 701006-02
- 701301-02
- 701306-01
- 701311--02
- 702001-06
- 720011
- 728001
- 729001
- 780001-01
- 781001-02

128N

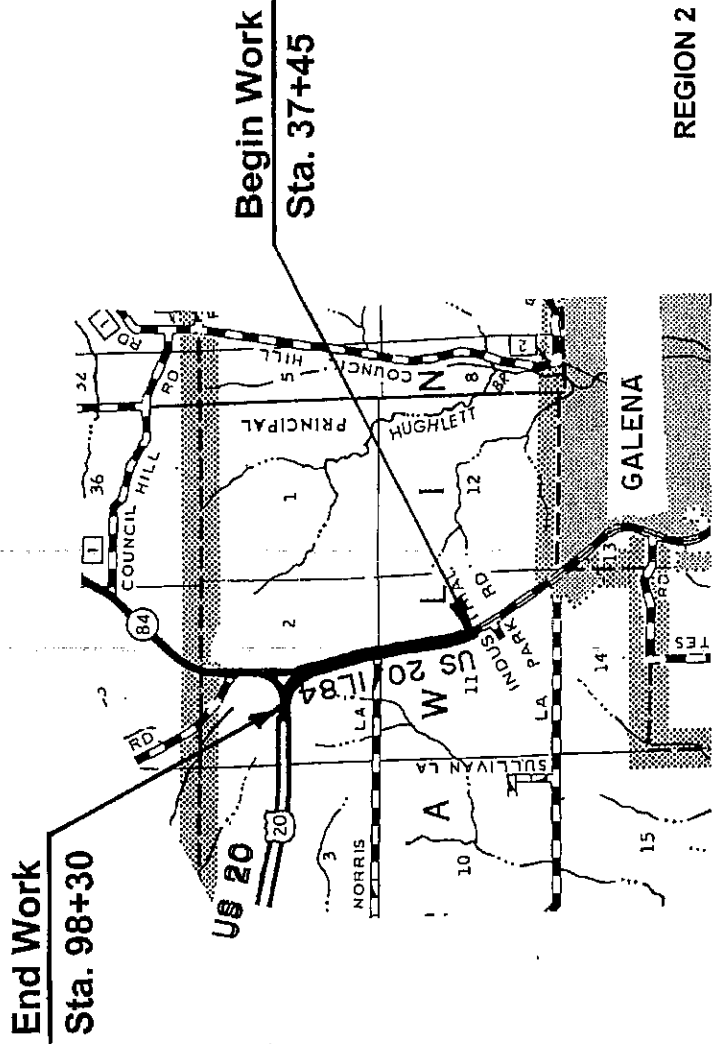
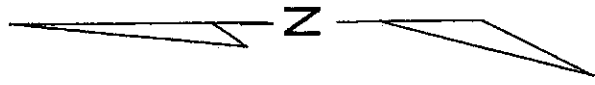

**NOTE:**  
Polymerized Hot-Mix Asphalt  
Is Required on this Project

REGION 2  
DIXON, ILLINOIS

CONTRACT NUMBER 64C55  
CALL J.U.I.E. BEFORE YOU DIG  
800-892-0123

RAWLINS TWP. -- Sec. 2, 11  
Gross & Net Length of Project = 6,085' = 1.152 Mile.

mrs2007-7

STATE OF ILLINOIS  
DEPARTMENT OF TRANSPORTATION  
DIVISION OF HIGHWAYS

SUBMITTED October 23, 2006

*Joseph E. Clowen*  
DEPUTY DIRECTOR OF HIGHWAYS, REGION 2 ENGINEER

SUMMARY OF QUANTITIES

I000  
100% STATE

CODE NUMBER	ITEM	UNIT	QUANTITY
40600200	BITUMINOUS MATERIALS (PRIME COAT)	TON	5.9
40600300	AGGREGATE (PRIME COAT)	TON	31
40603310	HOT-MIX ASPHALT SURFACE COURSE, MIX "C" N50	TON	92
40600735	POLYMERIZED LEVELING BINDER, (HAND METHOD), N70	TON	10
40600837	POLYMERIZED LEVELING BINDER, (MACHINE METHOD), N70	TON	1,060
40600982	HOT-MIX ASPHALT SURFACE REMOVAL - BUTT JOINT	SQ YD	532
40600990	TEMPORARY RAMP	SQ YD	89
40603540	POLYMERIZED HOT-MIX ASPHALT SURFACE COURSE, MIX "D" N70	TON	1,324
40800050	INCIDENTAL HOT-MIX ASPHALT SURFACING	TON	73
48101200	AGGREGATE SHOULDERS, TYPE B	TON	506
67100100	MOBILIZATION	L SUM	1
70100460	TRAFFIC CONTROL & PROTECTION, STANDARD 701306	L SUM	1
70300100	SHORT TERM PAVEMENT MARKING	FOOT	2,192
70301000	WORK ZONE PAVEMENT MARKING REMOVAL	SQ FT	309

\* Specialty Item  
Sumqtmrs2007-7





**GENERAL NOTES**

The millings from Hot-Mix Asphalt Surface Removal – Butt Joints shall be used to build up the existing shoulders, as shown on the typical sections and/or as directed by the Engineer. The shoulder shall be rolled and compacted as directed by the Engineer. Excess grindings or large chunks shall be properly disposed of by the Contractor. No grindings will be allowed on the foreslopes. This work shall be included in the contract unit price per SQ. YD. for HOT-MIX ASPHALT SURFACE REMOVAL – BUTT JOINT.

If, during the grinding or resurfacing operations, the existing mailboxes become a hindrance, the Contractor shall be required to carefully remove and reinstall the mailboxes as directed by the Engineer. This work shall be included in the contract unit price per ton for INCIDENTAL HOT-MIX ASPHALT SURFACING.

To help avoid excess drop offs at the edge of pavement, the existing aggregate wedge or shoulder, including all private entrances and gravel side road approaches shall be pulled up and rolled to match the edge of the pavement, as directed by the Engineer, prior to placing any Hot-Mix Asphalt. All costs associated with pulling up the shoulders and rolling shall be considered to be included in the contract unit price per TON for INCIDENTAL HOT-MIX ASPHALT SURFACING.

The following Mixture Requirements are applicable for all locations in this project.

Mixture Uses	Surface	Level Binder	Shoulder
AC/PG:	SBS PG 70-22	SBS PG 70-22	PG 58-22
RAP % (Max)	0	0	30%
Design Air Voids:	4.2 @ N70	4.2 @ N70	3 @ N50
Mixture Composition (Gradation Mixture)	IL 9.5	IL 9.5	IL 9.5 or 12.5
Friction Aggregate	D	N/A	C

Pavement Markings shall be done according to Standard 780001, except as follows:

- The distance between yellow no-passing lines shall be 8", not 7" as shown in the detail of
- Typical Lane and Edge Lines.

Estimated Thermoplastic Pavement Markings on this Project

Location	4" Yellow	4" White
US 20/IL 84	10,707	12,196
Project Grand Total	<b>10,707</b>	<b>12,196</b>

FAP 301  
D2 MRS 2007-7  
JoDaviess County  
Sheet 5 of 16  
Contract Number: 64C55

**GENERAL NOTES (Continued)**

The Contractor will be required to furnish 5-1/2" high brass stencils as approved by the Engineer and install stationing at 250' intervals. Stationing shall be placed on both lanes of 2-lane highways and on the outside lanes in both directions on 4-lane highways. The stations shall be placed 6" inside the pavement marking edge so they can be read from the shoulder. This work will be included in the cost of the final pavement surface.

# TYPICAL SECTIONS

## US 20/L 84

### Sta. 37 + 45 - 98 + 30

FAP 301

D2 MRS 2007-7

JoDaviess County

Sheet 6 of 16

Contract Number: 64C55

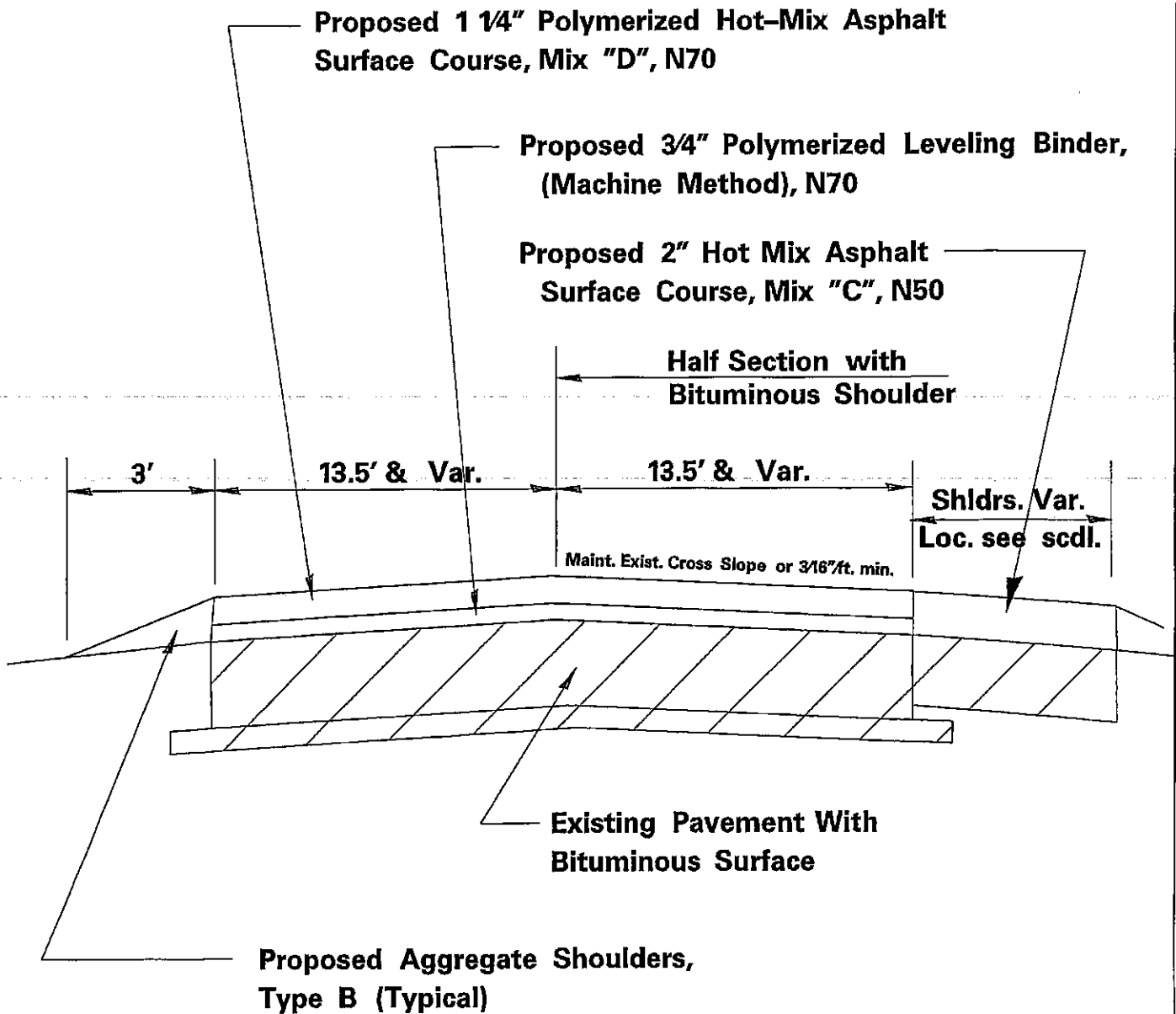

#### HOT-MIX ASPHALT APPLICATION RATES:

All Hot-Mix Asphalt Mixtures: 112lb/sq. yd/inch

Bituminous Materials (Prime Coat) = 0.000286 Ton/Sq. Yd.

Aggregate (Prime Coat) = 0.0015 Ton/Sq. Yd.

# HOT-MIX ASPHALT SURFACE REMOVAL - BUTT JOINT

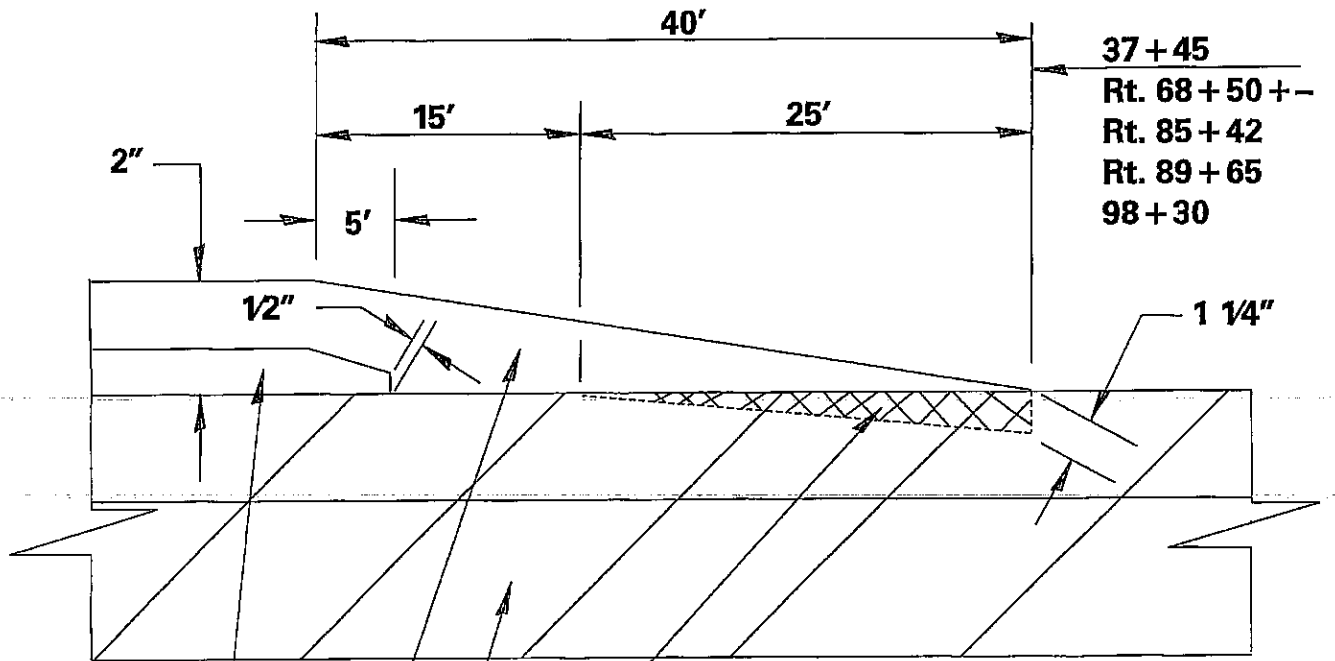

Hot-Mix Asphalt  
 Surface Removal - Butt Joint  
 0" - 1 1/4" in 25' - Full Pavement Width

Existing Pavement with Bituminous Surface

Polymerized HMA Surf. Cse., Mix "D", N70

3/4" Polymerized Leveling Binder,  
 (Machine Method), N70

**HOT-MIX ASPHALT APPLICATION RATES:**  
 All Hot-Mix Asphalt Mixtures: 112lb/sq. yd/inch  
 Bituminous Materials (Prime Coat) = 0.000286 Ton/Sq. Yd.  
 Aggregate (Prime Coat) = 0.0015 Ton/Sq. Yd.

# TYPICAL SECTIONS

FAP 301  
D2 MRS 2007-7  
JoDaviess County  
Sheet 8 of 16  
Contract Number: 64C55

\* For all P.E., C.E. & Mailbox Turnouts,  
EXCEPT Go to the end of Returns  
on Side Roads. However, some Side  
Roads on this Project will have Butt Joints  
-See Schedule.

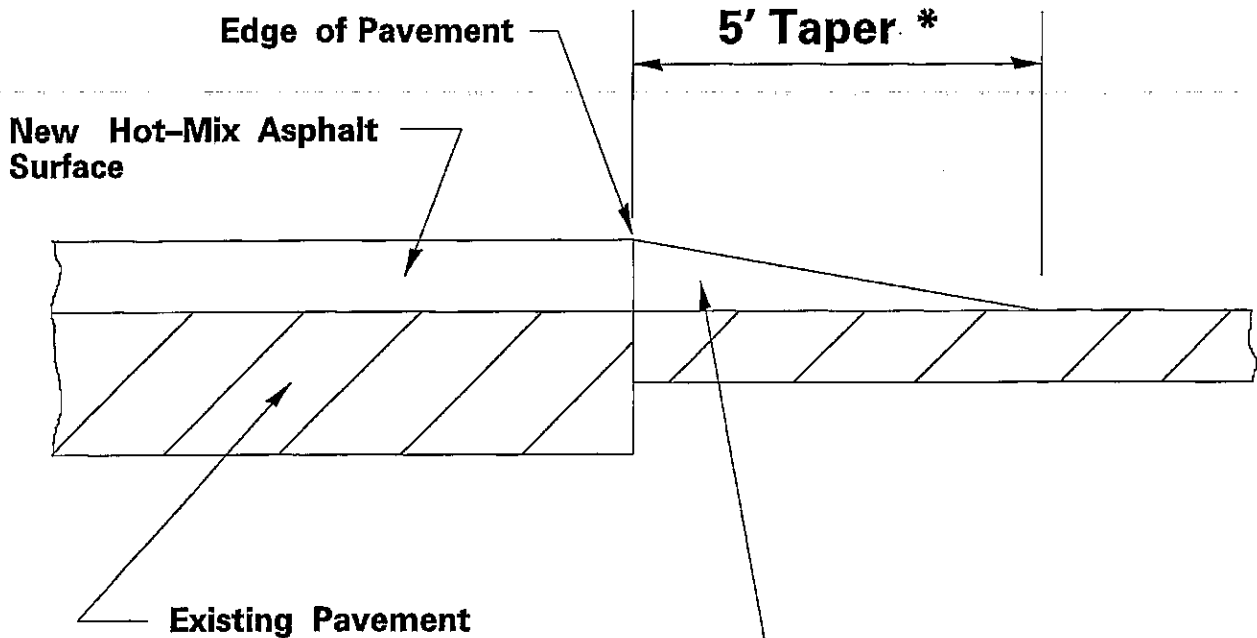

## Incidental Hot-Mix Asphalt Surfacing

**HOT-MIX ASPHALT APPLICATION RATES:**  
All Hot-Mix Asphalt Mixtures: 112lb/sq. yd/inch  
Bituminous Materials (Prime Coat) = 0.000286 Ton/Sq. Yd.  
Aggregate (Prime Coat) = 0.0015 Ton/Sq. Yd.

# Plan Sheet US 20/L 84

FAP 301  
D2 MRS 2007-7  
JoDaviss County  
Sheet 9 of 16  
Contract Number: 64C55

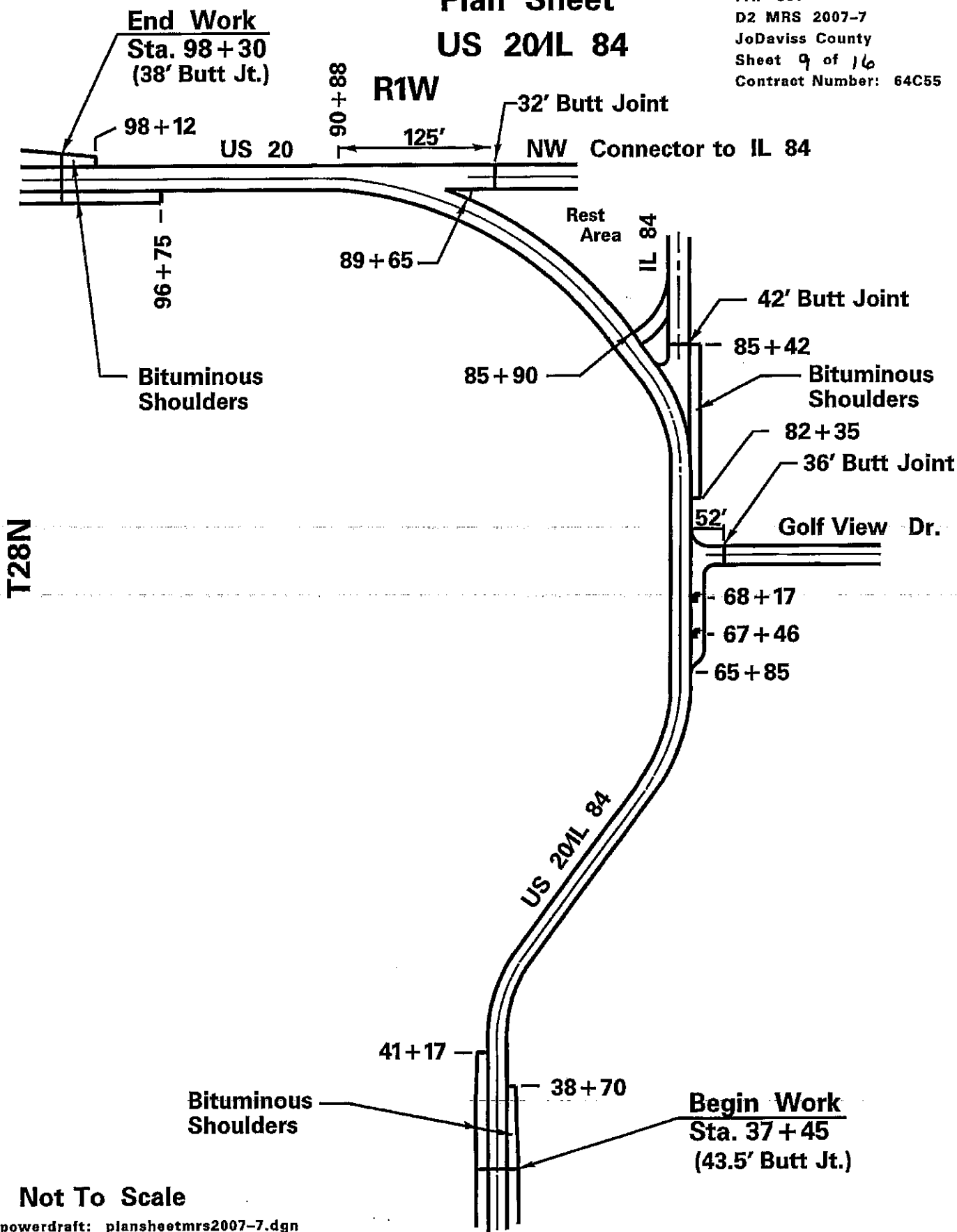

Not To Scale

powerdraft: plansheetmrs2007-7.dgn







### Schedule of Work

#### Hot-Mix Asphalt Surface Removal - Butt Joint

Location	Sq. Yd.
Sta. 37+45 – 37+70 (43.5' x 25')	120.8
Rt. Sta. 68+50+- (Golf View Dr.) (36' x 25')	100.0
Rt. Sta. 85+42 (IL 84 No.) (42' x 25')	116.6
Rt. Sta. 89+65 (W. connector to IL 84 No.) (32' x 25')	88.9
Sta. 98+05 -98+30 (38' x 25')	<u>105.6</u>
<b>Total</b>	<b>531.9</b>

#### Temporary Ramp

Location	Sq. Yd.
Sta. 37+45 (43.5' x 4.2')	20.3
Rt. Sta. 68+50+- (Golf View Dr.) (36' x 4.2')	16.8
Rt. Sta. 85+42 (IL 84 No.) (42' x 4.2')	19.6
Rt. Sta. 89+65 (Rd. to IL 84 No.) (32' x 4.2')	14.9
Sta. 98+30 (38' x 4.2')	<u>17.7</u>
<b>Total</b>	<b>89.3</b>

#### Raised Reflective Pavement Marker Removal

Location	Each
Sta. 37+45 to Sta. 98+30 (Double Amber)	<u>34</u>
<b>Total</b>	<b>34</b>

#### Raised Reflective Pavement Marker

Location	Each
Sta. 37+45 to Sta. 98+30 (Double Amber - 80' Ctrs.)	<u>76</u>
<b>Total</b>	<b>76</b>

### Schedule of Work (Continued)

#### Thermoplastic Pavement Marking – Letters and Symbols

Location	Sq. Ft.
Rt. Sta. 67+46 (Large Rt. Arrow)	15.6
Rt. Sta. 68+17 (Large Rt. Arrow)	<u>15.6</u>
<b>Total</b>	<b>31.2</b>

#### Thermoplastic Pavement Marking – Line 8 Inch

Location	Foot
Rt. Sta. 67+23 – 68+30	<u>107</u>
<b>Total</b>	<b>107</b>

FAP 301  
D2 MRS 2007-7  
JoDaviess County  
Sheet 14 of 16  
Contract Number: 64C55

**Thermoplastic Pavement Marking - Line 4 Inch**

US 20/IL 84 (FAP 301) Station Location	Lin. Ft.	Dashed Ctr. (Yellow 4") Foot	Edge Line (4" White) Foot	No Passing Zone Solid Yellow 4"	
				Lt.	Rt.
Start at 37+45 (1,280' N. of Industrial Dr.) (N. of Galena) Going West				--	--
37+45 - 49+01	1,156	--	2,312	1,156	1,156
49+01 - 60+25	1,124	281	2,248	1,124	--
60+25 - 62+60	235	--	420	235	235
62+60 - 73+59	1,099	275	2,076	--	1,099
73+59 - 98+30	2,471	--	4,602	2,471	2,471
Illinois 84 (No) ends at 85+42		--	134	87	87
		--	160	15	15
US 20 connector to IL 84 N.					
Along Golf View Drive		--	244	--	--
<b>TOTAL for US 20/IL 84</b>		<b>556</b>	<b>12,196</b>	<b>5,088</b>	<b>5,063</b>

FAP 301  
 D2 MRS 2007-7  
 JoDaviness County  
 Sheet 15 of 16  
 Contract Number: 64C55

# TYPICAL PAVEMENT MARKINGS

## TYPICAL PAVEMENT MARKING FOR FLUSH MEDIAN AT LEFT TURN LANE

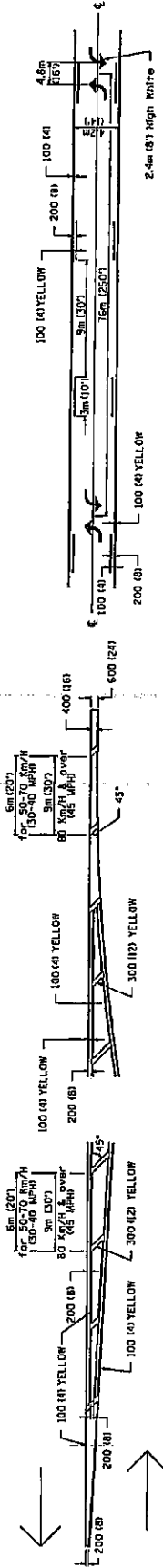

## MEDIAN PAVEMENT MARKING

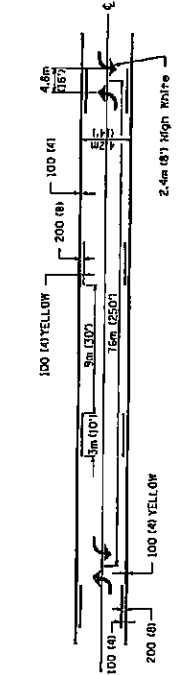

## TYPICAL ISLAND OFFSET SHOULDER WIDTH

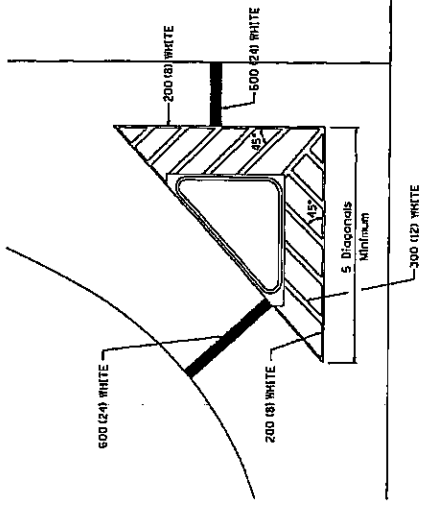

## TYPICAL PARKING SPACING

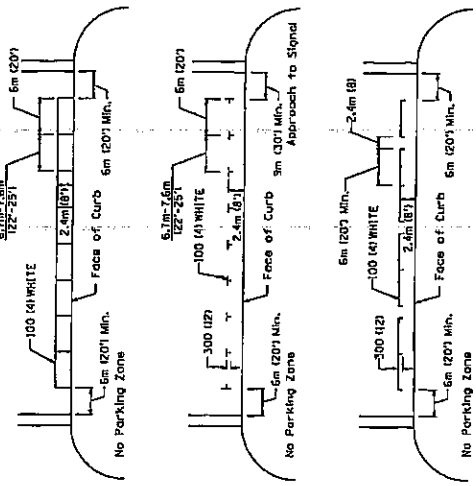

## STANDARD CROSSWALK MARKING

See Schedules for Locations

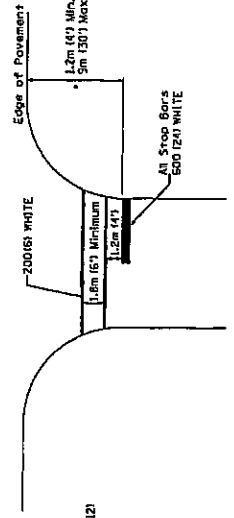

\* Distance to the nearest edge of the intersecting roadway in the absence of a marked crosswalk.

\*\* ALL DIMENSIONS ARE IN MILLIMETERS (INCHES) UNLESS OTHERWISE NOTED.

# TYPICAL PAVEMENT MARKINGS

## TYPICAL PAVEMENT MARKING FOR FLUSH MEDIAN

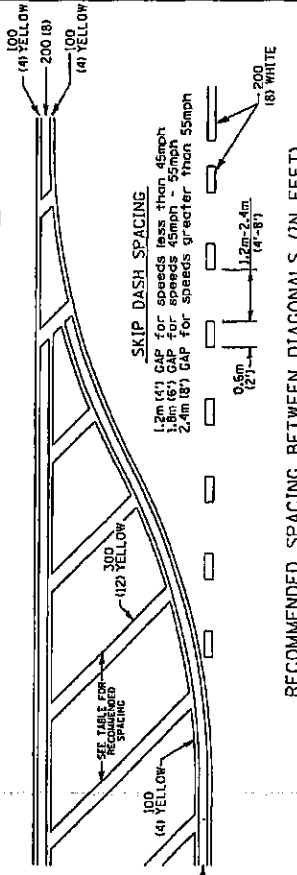

## ARROW LAYOUT

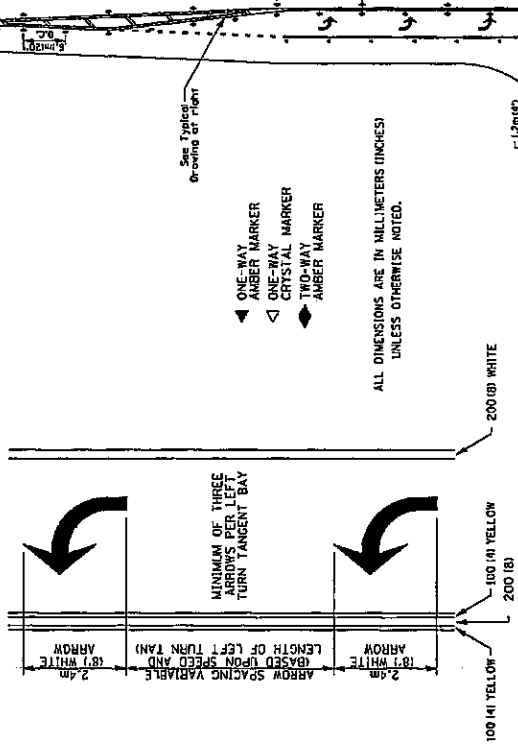

- ▶ ONE-WAY AMBER MARKER
- ◀ ONE-WAY AMBER MARKER
- ◁ ONE-WAY CRYSTAL MARKER
- ▷ TWO-WAY AMBER MARKER
- ◄ TWO-WAY AMBER MARKER

ALL DIMENSIONS ARE IN MILLIMETERS (INCHES) UNLESS OTHERWISE NOTED.

## TYPICAL PAVEMENT MARKING FOR TWO LANE SECTION - NO PASSING ZONES

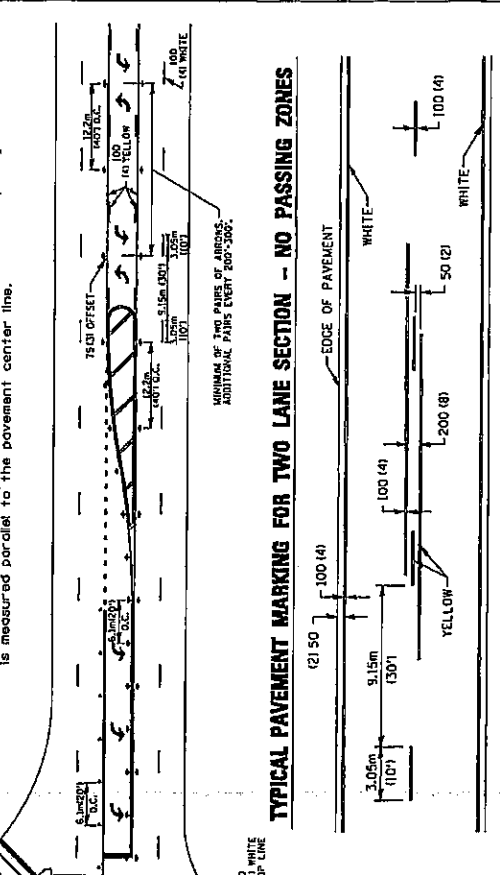

## SYMBOLS

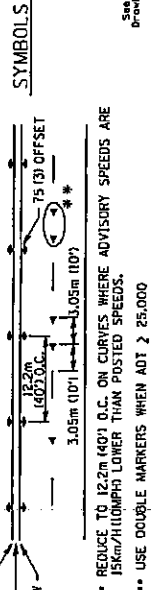

## MULTI-LANE / UNDIVIDED

## **ILLINOIS DEPARTMENT OF LABOR**

### **PREVAILING WAGES FOR JO DAVIESS COUNTY EFFECTIVE DECEMBER 2006**

The Prevailing rates of wages are included in the Contract proposals which are subject to Check Sheet #5 of the Supplemental Specifications and Recurring Special Provisions. The rates have been ascertained and certified by the Illinois Department of Labor for the locality in which the work is to be performed and for each craft or type of work or mechanic needed to execute the work of the Contract. As required by Prevailing Wage Act (820 ILCS 130/0.01, et seq.) and Check Sheet #5 of the Contract, not less than the rates of wages ascertained by the Illinois Department of Labor and as revised during the performance of a Contract shall be paid to all laborers, workers and mechanics performing work under the Contract. Post the scale of wages in a prominent and easily accessible place at the site of work.

If the Illinois Department of Labor revises the prevailing rates of wages to be paid as listed in the specification of rates, the contractor shall post the revised rates of wages and shall pay not less than the revised rates of wages. Current wage rate information shall be obtained by visiting the Illinois Department of Labor web site at <http://www.state.il.us/agency/idol/> or by calling 312-793-2814. It is the responsibility of the contractor to review the rates applicable to the work of the contract at regular intervals in order to insure the timely payment of current rates. Provision of this information to the contractor by means of the Illinois Department of Labor web site satisfies the notification of revisions by the Department to the contractor pursuant to the Act, and the contractor agrees that no additional notice is required. The contractor shall notify each of its subcontractors of the revised rates of wages.

# Jo Daviess County Prevailing Wage for December 2006

Trade Name	RG	TYP	C	Base	FRMAN	*M-F>8	OSA	OSH	H/W	Pensn	Vac	Trng
=====	==	==	=	=====	=====	=====	==	==	=====	=====	=====	=====
ASBESTOS ABT-GEN		BLD		23.760	24.760	1.5	1.5	2.0	5.850	8.730	0.000	0.600
ASBESTOS ABT-MEC		BLD		18.750	19.750	1.5	1.5	2.0	4.750	2.000	0.000	0.000
BOILERMAKER		BLD		28.970	31.970	2.0	2.0	2.0	8.020	6.600	0.000	0.210
BRICK MASON		BLD		30.000	32.500	1.5	1.5	2.0	5.500	8.680	0.000	0.420
CARPENTER		BLD		26.040	28.900	1.5	1.5	2.0	6.100	6.870	0.000	0.600
CARPENTER		HWY		26.440	28.190	1.5	1.5	2.0	6.300	6.500	0.000	0.400
CEMENT MASON		ALL		30.000	32.500	1.5	1.5	2.0	5.500	7.530	0.000	0.100
CERAMIC TILE FNSHER		BLD		24.860	0.000	1.5	1.5	2.0	5.500	4.000	0.000	0.360
COMMUNICATION TECH		BLD		28.700	30.700	1.5	1.5	2.0	8.200	8.340	0.000	0.570
ELECTRIC PWR EQMT OP		ALL		27.920	35.880	1.5	1.5	2.0	4.750	7.820	0.000	0.210
ELECTRIC PWR GRNDMAN		ALL		21.640	35.880	1.5	1.5	2.0	4.750	6.060	0.000	0.160
ELECTRIC PWR LINEMAN		ALL		33.220	35.880	1.5	1.5	2.0	4.750	9.310	0.000	0.250
ELECTRIC PWR TRK DRV		ALL		22.340	35.880	1.5	1.5	2.0	4.750	6.260	0.000	0.170
ELECTRICIAN	E	BLD		33.570	36.930	1.5	1.5	2.0	8.200	11.15	0.000	0.670
ELECTRICIAN	W	BLD		23.200	24.360	1.5	1.5	2.0	4.150	4.700	0.000	0.230
ELEVATOR CONSTRUCTOR		BLD		37.320	41.985	2.0	2.0	2.0	7.775	5.090	2.240	0.000
GLAZIER		BLD		20.580	21.810	1.5	1.5	2.0	4.750	3.900	0.000	0.200
HT/FROST INSULATOR		BLD		25.860	27.060	1.5	1.5	2.0	4.300	6.850	0.000	0.300
IRON WORKER	E	ALL		30.760	32.300	2.0	2.0	2.0	6.950	16.62	0.000	0.550
IRON WORKER	W	ALL		23.100	24.950	1.5	1.5	2.0	8.040	7.990	0.000	0.420
LABORER		BLD		23.760	24.760	1.5	1.5	2.0	5.850	8.730	0.000	0.600
LABORER		HWY		23.310	24.060	1.5	1.5	2.0	5.850	8.330	0.000	0.600
LABORER, SKILLED		HWY		24.710	25.460	1.5	1.5	2.0	5.850	8.330	0.000	0.600
LATHER		BLD		26.040	28.900	1.5	1.5	2.0	6.100	6.870	0.000	0.600
MACHINIST		BLD		36.890	38.890	2.0	2.0	2.0	4.380	5.650	2.550	0.000
MARBLE FINISHERS		BLD		24.860	0.000	1.5	1.5	2.0	5.500	4.000	0.000	0.360
MARBLE MASON		BLD		28.140	28.390	1.5	1.5	2.0	5.500	5.220	0.000	0.380
MILLWRIGHT		BLD		29.820	32.800	1.5	1.5	2.0	4.300	8.730	0.000	0.560
OPERATING ENGINEER		BLD	1	37.050	41.050	2.0	2.0	2.0	6.850	6.150	1.900	0.700
OPERATING ENGINEER		BLD	2	36.350	41.050	2.0	2.0	2.0	6.850	6.150	1.900	0.700
OPERATING ENGINEER		BLD	3	33.900	41.050	2.0	2.0	2.0	6.850	6.150	1.900	0.700
OPERATING ENGINEER		BLD	4	31.900	41.050	2.0	2.0	2.0	6.850	6.150	1.900	0.700
OPERATING ENGINEER		HWY	1	36.900	40.900	1.5	1.5	2.0	6.850	6.150	1.900	0.700
OPERATING ENGINEER		HWY	2	36.350	40.900	1.5	1.5	2.0	6.850	6.150	1.900	0.700
OPERATING ENGINEER		HWY	3	35.050	40.900	1.5	1.5	2.0	6.850	6.150	1.900	0.700
OPERATING ENGINEER		HWY	4	33.600	40.900	1.5	1.5	2.0	6.850	6.150	1.900	0.700
OPERATING ENGINEER		HWY	5	32.150	40.900	1.5	1.5	2.0	6.850	6.150	1.900	0.700
PAINTER		ALL		29.650	30.650	1.5	1.5	1.5	5.650	5.750	0.000	0.350
PILEDRIVER		BLD		27.040	30.010	1.5	1.5	2.0	6.100	6.870	0.000	0.600
PILEDRIVER		HWY		26.440	28.190	1.5	1.5	2.0	6.300	6.500	0.000	0.400
PIPEFITTER		BLD		33.700	36.060	1.5	1.5	2.0	6.430	7.130	0.000	0.630
PLASTERER		BLD		29.540	32.490	2.0	2.0	2.0	5.500	7.350	0.000	0.100
PLUMBER		BLD		33.700	36.060	1.5	1.5	2.0	6.430	7.130	0.000	0.630
ROOFER		BLD		33.650	35.650	1.5	1.5	2.0	6.110	3.160	0.000	0.330
SHEETMETAL WORKER		BLD		31.690	33.620	1.5	1.5	2.0	4.850	10.29	0.520	0.290
SPRINKLER FITTER		BLD		31.240	33.240	1.5	1.5	2.0	6.500	5.350	0.000	0.250
STONE MASON		BLD		30.000	32.500	1.5	1.5	2.0	5.500	8.680	0.000	0.420
TERRAZZO FINISHER		BLD		24.860	0.000	1.5	1.5	2.0	5.500	4.000	0.000	0.360
TERRAZZO MASON		BLD		28.140	28.390	1.5	1.5	2.0	5.500	5.220	0.000	0.380
TILE LAYER		BLD		26.040	28.900	1.5	1.5	2.0	6.100	6.870	0.000	0.600
TILE MASON		BLD		28.140	28.390	1.5	1.5	2.0	5.500	5.220	0.000	0.380
TRUCK DRIVER		O&C	1	20.630	0.000	1.5	1.5	2.0	7.250	3.317	0.000	0.000
TRUCK DRIVER		O&C	2	20.950	0.000	1.5	1.5	2.0	7.250	3.317	0.000	0.000
TRUCK DRIVER		O&C	3	21.110	0.000	1.5	1.5	2.0	7.250	3.317	0.000	0.000
TRUCK DRIVER		O&C	4	21.310	0.000	1.5	1.5	2.0	7.250	3.317	0.000	0.000
TRUCK DRIVER		O&C	5	21.910	0.000	1.5	1.5	2.0	7.250	3.317	0.000	0.000
TRUCK DRIVER	E	ALL	1	25.880	26.430	1.5	1.5	2.0	5.150	6.500	0.000	0.000
TRUCK DRIVER	E	ALL	2	26.030	26.430	1.5	1.5	2.0	5.150	6.500	0.000	0.000

TRUCK DRIVER	E	ALL	3	26.230	26.430	1.5	1.5	2.0	5.150	6.500	0.000	0.000
TRUCK DRIVER	E	ALL	4	26.430	26.430	1.5	1.5	2.0	5.150	6.500	0.000	0.000
TRUCK DRIVER	W	ALL	1	25.787	0.000	1.5	1.5	2.0	7.250	3.317	0.000	0.000
TRUCK DRIVER	W	ALL	2	26.187	0.000	1.5	1.5	2.0	7.250	3.317	0.000	0.000
TRUCK DRIVER	W	ALL	3	26.387	0.000	1.5	1.5	2.0	7.250	3.317	0.000	0.000
TRUCK DRIVER	W	ALL	4	26.637	0.000	1.5	1.5	2.0	7.250	3.317	0.000	0.000
TRUCK DRIVER	W	ALL	5	27.387	0.000	1.5	1.5	2.0	7.250	3.317	0.000	0.000
TUCKPOINTER		BLD		30.000	32.500	1.5	1.5	2.0	5.500	8.680	0.000	0.420

Legend:

M-F>8 (Overtime is required for any hour greater than 8 worked each day, Monday through Friday.)

OSA (Overtime is required for every hour worked on Saturday)

OSH (Overtime is required for every hour worked on Sunday and Holidays)

H/W (Health & Welfare Insurance)

Pensn (Pension)

Vac (Vacation)

Trng (Training)

## Explanations

### JO DAVIESS COUNTY

ELECTRICIANS (EAST) - Townships of Warren, Rush, Nora, Stockton, Wards Grove, Pleasant Valley and Berrenman.

IRONWORKERS (EAST) - That part of the county East of a North-South line from the North county line through Elizabeth, and East of a diagonal line from Elizabeth through Derinda Center to the South county line.

TRUCK DRIVERS (WEST) - That part of the county West of Rt. 78 including Stockton.

The following list is considered as those days for which holiday rates of wages for work performed apply: New Years Day, Memorial/Decoration Day, Fourth of July, Labor Day, Veterans Day, Thanksgiving Day, Christmas Day. Generally, any of these holidays which fall on a Sunday is celebrated on the following Monday. This then makes work performed on that Monday payable at the appropriate overtime rate for holiday pay. Common practice in a given local may alter certain days of celebration such as the day after Thanksgiving for Veterans Day. If in doubt, please check with IDOL.

Oil and chip resealing (O&C) means the application of road oils and liquid asphalt to coat an existing road surface, followed by application of aggregate chips or gravel to coated surface, and subsequent rolling of material to seal the surface.

### EXPLANATION OF CLASSES

ASBESTOS - GENERAL - removal of asbestos material/mold and hazardous materials from any place in a building, including mechanical systems



where those mechanical systems are to be removed. This includes the removal of asbestos materials/mold and hazardous materials from ductwork or pipes in a building when the building is to be demolished at the time or at some close future date.

ASBESTOS - MECHANICAL - removal of asbestos material from mechanical systems, such as pipes, ducts, and boilers, where the mechanical systems are to remain.

#### CERAMIC TILE FINISHER, MARBLE FINISHER, TERRAZZO FINISHER

Assisting, helping or supporting the tile, marble and terrazzo mechanic by performing their historic and traditional work assignments required to complete the proper installation of the work covered by said crafts. The term "Ceramic" is used for naming the classification only and is in no way a limitation of the product handled. Ceramic takes into consideration most hard tiles.

#### COMMUNICATIONS TECHNICIAN

Installing, manufacturing, assembling and maintaining sound and intercom, protection alarm (security), fire alarm, master antenna television, closed circuit television, low voltage control for computers and/or door monitoring, school communications systems, telephones and servicing of nurse and emergency calls, and the installation and maintenance of transmit and receive antennas, transmitters, receivers, and associated apparatus which operates in conjunction with above systems. All work associated with these system installations will be included EXCEPT the installation of protective metallic conduit in new construction projects (excluding less than ten-foot runs strictly for protection of cable) and 120 volt AC (or higher) power wiring and associated hardware.

#### LABORER, SKILLED - HIGHWAY

Individuals engaged in the following types of work, irrespective of the site of the work: asbestos abatement worker, handling of any materials with any foreign matter harmful to skin or clothing, track laborer, cement handlers, chloride handlers, the unloading and loading with steel workers and re-bars, concrete workers wet, tunnel helpers in free air, batch dumpers, mason tenders, kettle and tar men, tank cleaners, plastic installers, scaffold workers, motorized buggies or motorized unit used for wet concrete or handling of building materials, laborers with de-watering systems, sewer workers plus depth, rod and chainmen with technical engineers, rod and chainmen with land surveyors, rod and chainmen with surveyors, vibrator operators, cement silica, clay, fly ash, lime and plasters, handlers (bulk or bag), cofferdam workers plus depth, on concrete paving, placing, cutting and tying of reinforcing, deck hand, dredge hand, and shore laborers, bankmen on floating plant, grade checker, power tools, front end man on chip spreaders, cession workers plus depth, gunnite nozzle men, lead man on sewer work, welders, cutters, burners and torchmen, chainsaw operators, jackhammer and drill operators, layout man and/or drainage tile layer, steel form setter - street and highway, air tamping hammermen, signal man on crane, concrete saw operator, screedman on asphalt pavers, laborers tending masons with hot material or where foreign materials are used, mortar mixer operators, multiple concrete duct - leadsman, lumen, asphalt raker, curb asphalt machine operator, ready mix scalemen (permanent, portable or temporary plant), laborers handling masterplate or similar materials, laser beam operator, concrete burning machine operator, coring machine operator, plaster tender, underpinning and shoring of buildings, pump men, manhole and catch basin, dirt and stone tamper, hose men on concrete pumps, hazardous waste worker, lead base paint

abatement worker, lining of pipe, refusing machine, assisting on direct boring machine, the work of laying watermain, fire hydrants, all mechanical joints to watermain work, sewer worker, and tapping water service and forced lift station mechanical worker.

TRUCK DRIVER - BUILDING, HEAVY AND HIGHWAY CONSTRUCTION - WEST

Class 1. Drivers on 2 axle trucks hauling less than 9 ton. Air compressor and welding machines and brooms, including those pulled by separate units, truck driver helpers, warehouse employees, mechanic helpers, greasers and tiremen, pickup trucks when hauling materials, tools, or workers to and from an on-the-job site, and fork lifts up to 6,000 lb. capacity.

Class 2. Two or three axle trucks hauling more than 9 ton but hauling less than 16 ton. A-frame winch trucks, hydrolift trucks, vector trucks or similar equipment when used for transportation purposes. Fork lifts over 6,000 lb. capacity, winch trucks, four axle combination units, and ticket writers.

Class 3. Two, three or four axle trucks hauling 16 ton or more. Drivers on water pulls, articulated dump trucks, mechanics and working forepersons, and dispatchers. Five axle or more combination units.

Class 4. Low Boy and Oil Distributors.

Class 5. Drivers who require special protective clothing while employed on hazardous waste work.

TRUCK DRIVER - BUILDING, HEAVY AND HIGHWAY CONSTRUCTION - EAST

Class 1. Two or three Axle Trucks. A-frame Truck when used for transportation purposes; Air Compressors and Welding Machines, including those pulled by cars, pick-up trucks and tractors; Ambulances; Batch Gate Lockers; Batch Hopperman; Car and Truck Washers; Carry-alls; Fork Lifts and Hoisters; Helpers; Mechanics Helpers and Greasers; Oil Distributors 2-man operation; Pavement Breakers; Pole Trailer, up to 40 feet; Power Mower Tractors; Self-propelled Chip Spreader; Skipman; Slurry Trucks, 2-man operation; Slurry Truck Conveyor Operation, 2 or 3 man; Teamsters; Unskilled dumpman; and Truck Drivers hauling warning lights, barricades, and portable toilets on the job site.

Class 2. Four axle trucks; Dump Crets and Adgetors under 7 yards; Dumpsters, Track Trucks, Euclids, Hug Bottom Dump Turnapulls or Turnatrailers when pulling other than self-loading equipment or similar equipment under 16 cubic yards; Mixer Trucks under 7 yards; Ready-mix Plant Hopper Operator, and Winch Trucks, 2 Axles.

Class 3. Five axle trucks; Dump Crets and Adgetors 7 yards and over; Dumpsters, Track Trucks, Euclids, Hug Bottom Dump Turnatrailers or turnapulls when pulling other than self-loading equipment or similar equipment over 16 cubic yards; Explosives and/or Fission Material Trucks; Mixer Trucks 7 yards or over; Mobile Cranes while in transit; Oil Distributors, 1-man operation; Pole Trailer, over 40 feet; Pole and Expandable Trailers hauling material over 50 feet long; Slurry trucks, 1-man operation; Winch trucks, 3 axles or more; Mechanic--Truck Welder and Truck Painter.

Class 4. Six axle trucks; Dual-purpose vehicles, such as mounted crane trucks with hoist and accessories; Foreman; Master Mechanic;

Self-loading equipment like P.B. and trucks with scoops on the front.

TRUCK DRIVER - OIL AND CHIP RESEALING ONLY.

This shall encompass laborers, workers and mechanics who drive contractor or subcontractor owned, leased, or hired pickup, dump, service, or oil distributor trucks. The work includes transporting materials and equipment (including but not limited to, oils, aggregate supplies, parts, machinery and tools) to or from the job site; distributing oil or liquid asphalt and aggregate; stock piling material when in connection with the actual oil and chip contract. The Truck Driver (Oil & Chip Resealing) wage classification does not include supplier delivered materials.

OPERATING ENGINEERS - BUILDING

Class 1. Assistant Craft Foreman; Craft Foreman; Mechanic; Asphalt Plant; Asphalt Spreader; Autograde; Batch Plant; Benoto (requires Two Engineers); Boiler and Throttle Valve; Caisson Rigs; Central Redi-Mix Plant; Combination Back Hoe Front End-loader Machine; Compressor and Throttle Valve; Concrete Breaker (Truck Mounted); Concrete Conveyor; Concrete Paver; Concrete Placer; Concrete Pump (Truck Mounted); Concrete Tower, Cranes, All, Cranes, Hammerhead, Creter Crane; Crusher, Stone, etc.; Derricks, All; Derricks, Traveling; Formless Curb and Gutter Machine; Grader, Elevating; Grouting Machines; Highlift Shovels or Front Endloader 2-1/4 yd. and over; Hoists, Elevators, outside type rack and pinion and similar machines; Hoists, one, two and three Drum; Hoists, Two tigger One Floor; Hydraulic Backhoes; Hydraulic Boom Trucks; Locomotives, All; Motor Patrol; Pile Drivers and Skid Rig; Post Hole Digger; Pre-Stress Machine; Pump Cretes; Squeeze Cretes-screw Type Pumps; Gypsum Bulker and Pump; Raised and Blind Hole Drill; Rock Drill; Roto Mill Grinder; Scoops - Tractor Drawn; Slip-form Paver; Straddle Buggies; Tie Back Machine; Tractor with Book and Side Boom; Trenching Machines.

Class 2. Bobcat (over 3/4 cu. yd.); Boilers; Brick Forklift; Broom, All Power Propelled; Bulldozers; Concrete Mixer (Two Bag and Over); Conveyor, Portable; Forklift Trucks; Greaser Engineer; Highlift Shovels or Front Endloaders under 2-1/4 yd.; Hoists, Automatic; Hoists, Sewer Dragging Machine; Hoists, Tigger Single Drum; Rollers, All; Steam Generators; Tractors, All; Tractor Drawn Vibratory Roller; Winch Trucks with "A" Frame.

Class 3. Air Compressor; Asphalt Spreader; Combination - Small Equipment Operator; Generators; Heaters, Mechanical; Hoists, Inside Elevators - (Rheostat Manual Controlled); Hydraulic Power Units (Pile Driving and Extracting); Pumps, over 3" (1 to 3 not to exceed a total of 300 ft.); Pumps, Well Points; Welding Machines (2 through 5); Winches, 4 small Electric Drill Winches; Bobcat (up to and including 3/4 cu. yd.).

Class 4. Hoists, Inside Elevators, Push Button with Automatic Doors; Oilers; Brick Forklift.

OPERATING ENGINEERS - HEAVY AND HIGHWAY CONSTRUCTION

Class 1. Craft Foreman; Asphalt Plant, Asphalt Heater and Planer Combination; Asphalt Heater Scarfire; Asphalt Silo Tender; Asphalt Spreader; Autograder; ABG Paver; Backhoes with Caisson attachment; Ballast Regulator, Belt Loader; Caisson Rigs; Car Dumper; Central Redi-Mix Plant; Backhoe w/shear attachments; Combination Backhoe Front Endloader Machine, (1 cu. yd. Backhoe Bucket or over or with attachments); Concrete Breaker (Truck Mounted); Concrete Conveyor;

Concrete Paver over 27E cu. ft.; Concrete Placer; Concrete Tube Float; Cranes, all attachments; Cranes, Hammerhead, Linden, Peco & Machines of a like nature; Crete Crane; Crusher, Stone, etc.; Derricks, All; Derrick Boats; Derricks, Traveling; Directional Boring Machine over 12"; Dredges; Field Mechanic-Welder; Formless Curb and Gutter Machine; Gradall and Machines of a like nature; Grader, Elevating; Grader, Motor Grader, Motor Patrol, Auto Patrol, Form Grader, Pull Grader, Subgrader; Guard Rail Post Driver Mounted; Hoists, One, Two and Three Drum; Hydraulic Backhoes; Pile Drivers and Skid Rig; Pre-Stress Machine; Pump Cretes Dual Ram; Rock Drill - Crawler or Skid Rig; Rock Drill - Truck Mounted; Rock/Track Tamper; Roto Mill Grinder; Slip-Form Paver; Soil Test Drill Rig (Truck Mounted); Straddle Buggies; GCI Crane; Hydraulic Telescoping form (Tunnel); Tie Back Machine; Tractor Drawn Belt Loader; Tractor with Boom; Tractor-aire with Attachments; Traffic Barrier conveyor machine; Raised or Blind Hole; Trenching Machine; Truck Mounted Concrete Pump with Boom; Truck Mounted Concrete Conveyor; Underground Boring and/or Mining Machines; Wheel Excavator; Widener (APSCO).

Class 2. Batch Plant; Bituminous Mixer; Boiler and Throttle Valve; Bulldozers; Car Loader Trailing Conveyors; Combination Backhoe Front Endloader Machine (less than 1 cu. yd. Backhoe Bucket or over or with attachments); Compressor and Throttle Valve; Compressor, Common Receiver (3); Concrete Breaker or Hydro Hammer; Concrete Grinding Machine; Concrete Mixer or Paver 7S Series to and including 27 cu. ft.; Concrete Spreader; Concrete Curing Machine, Burlap Machine, Belting Machine and Sealing Machine; Conveyor Muck Cars (Haglund or Similar Type); Drills, all; Finishing Machine - Concrete; Greaser Engineer; Highlift Shovels or Front Endloader; Hoist - Sewer Dragging Machine; Hydraulic Boom Trucks (All Attachments); Hydro Blaster; Laser Screed; All Locomotives, Dinky; Pump Cretes; Squeeze Cretes-Screw Type Pumps, Gypsum Bulker and Pump; Roller, Asphalt; Rotary Snow Plows; Rototiller, Seaman, etc., self-propelled; Scoops - Tractor Drawn; Self-Propelled Compactor; Spreader - Chip - Stone, etc.; Scraper; Scraper - Prime Mover in Tandem (Regardless of Size); Tank Car Heater; Tractors, Push, Pulling Sheeps Foot, Disc, Compactor, etc. Tug Boats.

Class 3. Boilers; Brooms, All Power Propelled; Cement Supply Tender; Compressor, Common Receiver (2); Concrete Mixer (Two Bag and Over); Conveyor, Portable; Farm-Type Tractors Used for Mowing, Seeding, etc.; Fireman on Boilers; Forklift Trucks; Grouting Machine; Hoists, Automatic; Hoists, All Elevators; Hoists, Tugger Single Drum; Jeep Diggers, Low Boys; Pipe Jacking Machines; Post-Hole Digger; Power Saw, Concrete Power Driven; Pug Mills; Rollers, other than asphalt; Seed and Straw Blower; Steam Generators; Stump Machine; Winch Trucks with "A" Frame; Work Boats; Tamper - Form-Motor Driven.

Class 4. Air Compressor - Small and Large; Asphalt Spreader, Backend Man; Bobcat (Skid Steer) all; Combination - Small Equipment Operator; Directional Boring Machine up to 12"; Generators - Small 50kw and Under; Generators - Large over 50kw; Heaters, Mechanical; Hydraulic Power Unit (Pile Driving, Extracting, or Drilling); Hydro-Blaster; Light Plants, All (1 through 5); Pumps, over 3" (1 to 3 not to exceed a total of 300 ft.); Pumps, Well Points; Tract-aire; Welding Machines (2 through 5); Winches, 4 Small Electric Drill Winches.

Class 5. Oilers and Directional Boring Machine Locator.

Other Classifications of Work:

For definitions of classifications not otherwise set out, the Department generally has on file such definitions which are

available. If a task to be performed is not subject to one of the classifications of pay set out, the Department will upon being contacted state which neighboring county has such a classification and provide such rate, such rate being deemed to exist by reference in this document. If no neighboring county rate applies to the task, the Department shall undertake a special determination, such special determination being then deemed to have existed under this determination. If a project requires these, or any classification not listed, please contact IDOL at 618/993-7271 for wage rates or clarifications.

#### LANDSCAPING

Landscaping work falls under the existing classifications for laborer, operating engineer and truck driver. The work performed by landscape plantsman and landscape laborer is covered by the existing classification of laborer. The work performed by landscape operators (regardless of equipment used or its size) is covered by the classifications of operating engineer. The work performed by landscape truck drivers (regardless of size of truck driven) is covered by the classifications of truck driver.